stinger

Features & Functions
Guide



Welcome to the Kia Family!

Your new Kia vehicle has been designed, engineered and manufactured to provide you with years of comfortable and dependable driving. Kia is committed to quality, innovation, safety and — above all — your satisfaction.

Using this Features & Functions Guide

The information contained in this guide is a brief overview of the operation and features of your new Kia vehicle.

This Features & Functions Guide and the specific operational and safety information it provides are not a substitute for your Owner's Manual. In the interest of your safety and that of the vehicle's occupants, and to help you avoid risks that may result in death or serious injury, Kia reminds you to carefully read the Owner's Manual in order to fully familiarize yourself with the important information and safety warnings it contains.

While Kia endeavors to ensure that the information contained in this guide is accurate at the time of printing, Kia may change vehicle specifications without notice in advance of or after the fact and assumes no liability in connection with such changes.

Videos and QR Codes

Kia provides a number of video resources to assist you with becoming familiar with the features and functions found in your Kia vehicle. You can access these resources by snapping the QR Codes with your mobile device using the built-in QR Code Reader or a downloaded QR Code Reader App.

After opening the QR Code Reader App on your mobile device, the app will utilize your device's camera. Center the code in the camera viewing area — with some apps, as soon as the app recognizes the code, it will launch the corresponding video.

With other apps, you will have to snap or "take a picture" of the code. The app will then launch the corresponding video.

For operation specifics, refer to the instructions that come with the QR Code Reader App. You can also view the videos by visiting the following website: www.youtube.com/KiaFeatureVideos

QR CODE

One-Click Fuel Cap Video



*Refer to the inside front cover for more information on QR codes.
www.youtube.com/KiaFeatureVideos*

QUICK TIPS

If you're having trouble scanning codes, check the following:

- The code should be centered and focused in your mobile device's camera screen
- Consider moving your device closer to or farther away from the code
- The code should be well lit, without significant shadow
- Avoid scanning from a significant angle
- Confirm that the device's app supports 2D QR Code scanning
- Try another QR Code Reader App; not all apps are created equal
- After scanning, you may experience a "connection error" message or a "connecting" message with no subsequent response. These messages typically indicate that your device is having trouble connecting to the Internet

REMINDER: When accessing videos on your mobile device, standard cellular data rates may apply.

As you get to know your new Kia, you can explore this booklet to better understand how to operate its many features and systems. You can find the complete Table of Contents on the next two pages, but first, be sure to review the following to better understand some of your Kia's most used features:

- 1 Smart Key 51
- 2 Fuel Filler Release Button 58
- 3 Power Adjustable Driver's Seat* / Front Seat Headrest Adjustment. 46
- 4 Seat Warmers / Ventilated Seats* 44
- 5 Wiper Service Mode 31
- 6 Windshield Wipers & Washers 31
- 7 Idle, Stop & Go (ISG) System. 42
- 8 Smart Cruise Control (SCC) 18
- 9 Smart Power Liftgate* 52
- 10 Normal Maintenance Schedule 60
- 11 User Settings - Instrument Cluster 10
- 12 Bluetooth® Wireless Technology. 34-35
- 13 UVO link with Navigation. 39
- 14 Android Auto™ / Apple CarPlay® Setup 38
- 15 UVO link Activation / UVO Assistance* 36
- 16 Kia Access with UVO link App Download. 37
- 17 Kia Access with UVO link App Features Guide 37

Driving while distracted can result in a loss of vehicle control that may lead to an accident, severe personal injury and death. The driver's primary responsibility is in the safe and legal operation of a vehicle, and handheld devices, other equipment or vehicle systems which take the driver's eyes, attention and focus away from the safe operation of a vehicle or that are not permissible by law should never be used during operation of the vehicle.

www.kia.com
 Consumer Affairs - Roadside Assistance¹⁸:
 1-800-333-4KIA (800-333-4542)

Always check the Owner's Manual for complete operating information and safety warnings.

*IF EQUIPPED

VIDEOS & QR CODES Inside Cover

INSTRUMENT CLUSTER

Instrument Cluster Overview 04

Indicators & Warning Lights 05

Drive Mode Integrated Control System 06

Fuel Economy 07

Tire Pressure Monitoring System (TPMS) 08

VEHICLE SETTINGS

LCD Instrument Cluster Modes* 09

Trip Information / Trip Computer 09

User Settings 10

Vehicle Settings* - Audio Head Unit 11

Service Interval Mode 11

ADVANCED DRIVER ASSISTANCE SYSTEMS (ADAS)

Forward Collision-Avoidance Assist (FCA) 12

Lane Keeping Assist (LKA) 13

Blind-Spot Collision-Avoidance Assist (BCA) 14

Safe Exit Assist (SEA) 15

Driver Attention Warning (DAW) 16

Cruise Control (CC)* 17

Smart Cruise Control (SCC)* 18

Lane Following Assist (LFA) 20

Rear View Monitor (RVM)* 21

Surround View Monitor (SVM)* 21

Rear Cross-Traffic Collision Avoidance Assist (RCCA) 22

Forward*/Reverse Parking Distance Warning (PDW) 23

Head-Up Display (HUD)* 24

DRIVER'S PANEL

Electronic Stability Control (ESC) / Traction Control System (TCS) 25

Instrument Cluster Control (Instrument Panel Dimmer) 25

Hill-Start Assist Control (HAC) 25

Power Windows, Window Lock & Central Door Lock 26

Power Folding Outside Mirrors 26

Reverse Parking Aid Function 27

Heated Outside Mirrors 27

Auto Door Lock/Unlock 27

Engine Start/Stop Button 28

STEERING WHEEL CONTROLS

Headlights & High Beams 29

Turn Signals 30

Windshield Wipers & Washers 31

Lifting Wipers / Wiper Service Mode 31

Power Tilt / Telescoping Steering Wheel* 32

Manual Tilt / Telescoping Steering Wheel* 32

Heated Steering Wheel* 32

AUDIO SYSTEM

Audio Controls 33

Bluetooth® Wireless Technology 34

UVO link Activation* 36

UVO Assistance* 36

Kia Access with UVO link App Download 37

Kia Access with UVO link App Features Guide 37

Android Auto™ / Apple CarPlay® Setup 38

UVO link with Navigation* 39

CENTER PANEL

Multimedia USB Ports, Power Outlets & USB Charger Ports 40

Digital Clock 40

Wireless Smartphone Charging System 41

Idle, Stop and Go (ISG) System 42

Launch Control* 42

Automatic Climate Control System 43

Automatic Transmission (Shift by Cable* / Shift by Wire*) & Manual Shift Mode (Shift by Cable only) ... 44

Auto Hold 45

Electric Parking Brake (EPB)* 46

SEATING

Seat Warmers / Ventilated Seats* 47

Power Adjustable Driver's Seat* 48

Front Seat Headrest Adjustment 49

Driver Position Memory System* 49

OTHER KEY FEATURES

HomeLink® with Auto-Dimming Rearview Mirror* 50

Smart Key 51

Smart Power Liftgate* 52

Map/Room Lamps 54

Sunroof Operation* 55

Sunvisor 56

Hood Release Lever and Latch 56

Fuel Door Release Button 56

Fuel Cap/Malfunction Indicator (Check Engine Light) 57

SAFETY FEATURES

Seat Belts 58

Child-Protector Rear Door Lock 59

Occupant Detection System (ODS) 59

Passenger Airbag Off Indicator 59

NORMAL MAINTENANCE SCHEDULE - TURBO 60

LEGAL DISCLAIMERS Inside Back Cover

Instrument Cluster Overview

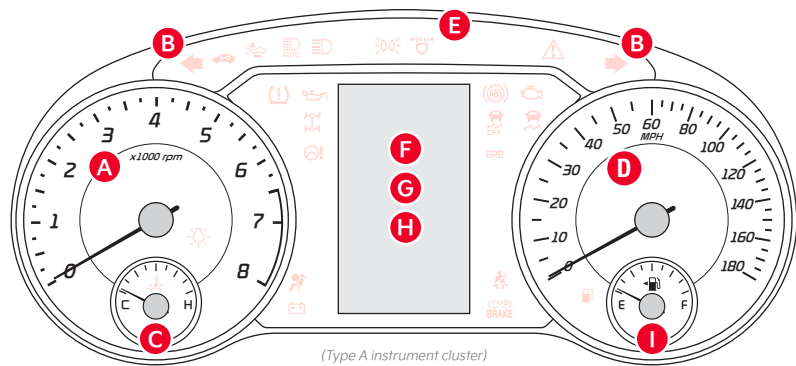

(Type A instrument cluster)

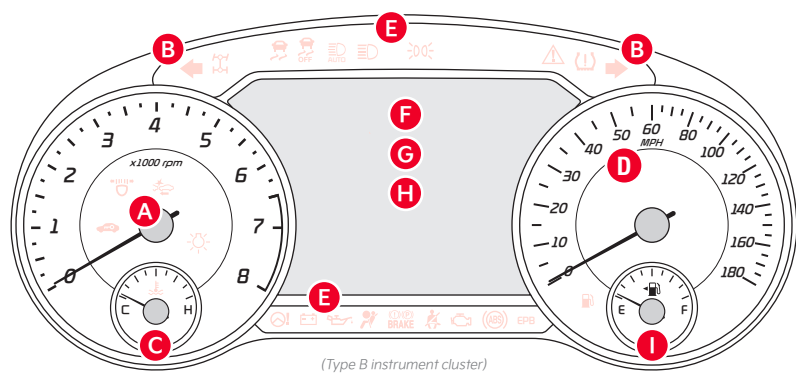

(Type B instrument cluster)

- A Tachometer
- F Gear Shift Position Indicator
- B Turn Signal Indicators
- G Odometer
- C Temperature Gauge
- H Trip Computer
- D Speedometer
- I Fuel Gauge
- E Indicator & Warning Lights
- Arrow direction indicates the side of the vehicle the fuel door is located

Your vehicle's instrument cluster & indicator light locations may differ from those in the illustrations. For more information on the instrument cluster and the function of all indicator and warning lights, please refer to section 2 in the Owner's Manual. Illustrations are for demonstration purposes only. Some indicators and warning lights may not appear in illustrations. On the vehicle, they may appear in the LCD.

Indicators & Warning Lights

-  Light ON Indicator
-  CRUISE Cruise Indicator
-  Lane Keeping Assist (LKA) Indicator*
-  EPB Electric Parking Brake
-  Immobilizer Indicator
-  High Beam Indicator
-  LED Headlamp Warning Light*
-  Electronic Stability Control (ESC) Warning Light
-  OFF Electronic Stability Control (ESC) OFF Light
-  Malfunction Indicator Light
-  Low Tire Pressure Indicator / Tire Pressure Monitoring System (TPMS) Malfunction Light
-  Liftgate Open Warning Light
-  Seat Belt Warning Light
-  (P) BRAKE Parking Brake & Brake Fluid Warning Light
-  Door Ajar Warning Light
-  Airbag Warning Light
-  Low Windshield Washer Fluid
-  Turn Signal Indicators
-  ABS Anti-Lock Braking System (ABS) Warning Light
-  AUTO HOLD Auto Hold Indicator
-  Charging System Warning Light
-  SET Cruise Set Indicator
-  Engine Oil Pressure Warning Light
-  Engine Coolant Temperature Warning Light
-  Low Fuel Level Warning Light
-  Electric Power Steering (EPS) Warning Indicator
-  (ABS) (EBD) Electronic Brake Force Distribution (EBD) System Warning Light - (Two separate indicators on Instrument Cluster lit at same time)
-  Forward Collision-Avoidance Assist Warning Indicator
-  ECO SPORT SNOW SMART ECO / SPORT / SMART Mode Indicator
-  Master Warning Light
-  Low Beam Assist (LBA) / Dynamic Bending Light (DBL)*
-  High Beam Assist (HBA) Indicator*
-  Auto-Stop Indicator (ISG)
-  AWD System Warning Light*

Your vehicle's instrument cluster & indicator light locations may differ from those in the illustrations. For more information on the instrument cluster and the function of all indicator and warning lights, please refer to section 2 in the Owner's Manual. Some indicators and warning lights may not appear in illustration. On the vehicle, they may appear in the LCD.

Drive Mode Integrated Control System

SMART, COMFORT, SPORT, CUSTOM* and ECO drive modes may be changed according to the driver's preference or road conditions. To change the drive mode, rotate the DRIVE MODE knob **A**.

SMART Mode - When SMART mode is selected, the system automatically selects the drive mode best suited to the current driving style. A SMART indicator will illuminate on the instrument cluster. The color of the SMART indicator (green, white, red) depends on the current driving style. To deactivate, rotate the DRIVE MODE knob **A** again to change the selection to another setting.

COMFORT Mode - The system's default mode is COMFORT mode (unless ECO Mode is selected) and is not displayed on the instrument cluster nor the audio system's screen.

SPORT Mode - An orange SPORT indicator will illuminate on the instrument cluster when selected. To deactivate, rotate the DRIVE MODE knob **A** again to change the selection to another setting.

CUSTOM Mode - When CUSTOM mode is selected, a graphic of the Stinger will display. The CUSTOM Mode allows the driver to mix aspects of other driving modes to make a customized mode.

ECO Mode - A green ECO indicator will illuminate on the instrument cluster. To deactivate, rotate the DRIVE MODE knob **A** again to change the selection to another setting.

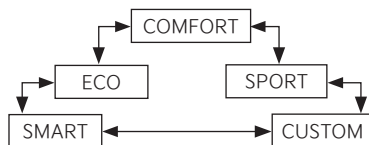
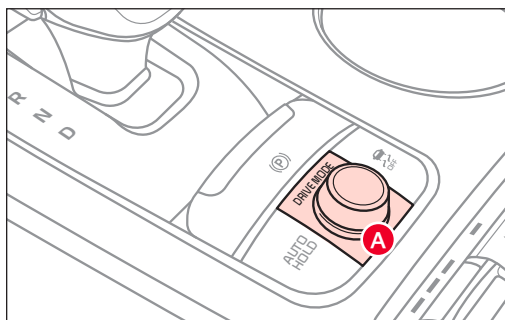

QR CODE

Drive Mode Video



Refer to the inside front cover for more information on QR codes.
www.youtube.com/KiaFeatureVideos

QUICK TIP

- When the Engine Start/Stop button is turned off, the system will default to COMFORT mode and each mode will need to be selected again when the vehicle restarts (except for ECO)

REMINDERS:

- When ECO mode is selected, the following may occur to help improve fuel economy:
 - Acceleration may be slightly reduced even when the accelerator is fully depressed
 - Air conditioner performance may be limited
 - Shift pattern of the automatic transmission may change
 - Engine noise may increase
 - System's power will be limited when driving uphill
- When SPORT mode is selected, fuel economy may decrease
- Steering effort may be slightly increased in Sport mode
- When the vehicle is placed in ECO mode, it will remain in ECO mode even when the ignition is cycled. SPORT mode will default to NORMAL mode after the ignition is cycled

For illustrative purposes only. Your actual display, buttons and/or features may vary.
 Refer to section 5 in the Owner's Manual for more information.

Fuel Economy

Several factors contribute to your vehicle's fuel economy, such as maintenance of your vehicle, driving style, environmental conditions, vehicle weight and vehicle aerodynamics. Below are some tips on how to help improve fuel economy:

- Keep your vehicle in good condition with regular maintenance
- Don't let the engine idle longer than necessary
- Drive at a moderate speed, accelerating smoothly
- Keep tires inflated to the recommended pressure
- Travel lightly, without carrying unnecessary weight in your vehicle
- Avoid placing large or heavy items on roof racks
- Avoid hilly, winding or poorly maintained roads

For more information on Fuel Economy, snap the QR Code above to view a video or refer to section 4 in the Owner's Manual.

QR CODE

Fuel Economy Video



*Refer to the inside front cover for more information on QR codes.
www.youtube.com/KiaFeatureVideos*

Tire Pressure Monitoring System (TPMS)^{† 27}

The TPMS indicator  functions as both Low Tire Pressure Light and TPMS Malfunction Indicator.

The TPMS indicator  is designed to illuminate if it detects one or more tires is significantly underinflated, if a spare tire has been installed that does not have a TPMS device, or when the outside temperature drops considerably.

The LCD screen in the instrument cluster will display the Low Tire Pressure indicator  showing which tire(s) are underinflated.

- Inflate tire(s) to specifications using an accurate digital tire pressure gauge. See front driver's door jamb for PSI specification
- When there is a problem with the TPMS, the TPMS Malfunction Indicator will blink for approximately one minute then illuminate. See dealer for service

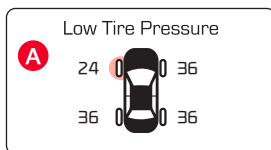

QR CODE

Tire Pressure Monitoring Video



Refer to the inside front cover for more information on QR codes.
www.youtube.com/KiaFeatureVideos

QUICK TIPS

- Even with TPMS, tire pressure should be checked manually at least once a month. Only adjust tire pressure on "cold tires" that have been sitting for 20 minutes, and tires that are not hot in temperature from direct sunlight or heat
- For proper maintenance, safety and optimal fuel economy, maintain recommended tire inflation pressure and stay within the load limits and weight distribution recommended for your vehicle
- In winter or cold weather, the TPMS light may illuminate if the tire pressure was adjusted to the recommended tire inflation pressure during warm weather

REMINDERS:







- Check the recommended tire pressure label located on the left side of driver's door jamb, visible when the door is open
- Consult your dealer for service if the Low Tire Pressure Light remains illuminated after inflating your tire(s)
- Personal electronic devices (such as laptops, wireless chargers, remote start systems, etc.) may interfere with the TPMS system, which may cause the Malfunction Warning Indicator (Check Engine Light) to illuminate

Image is for illustrative purposes only and may not reflect actual feature or operation. See section 6 in the Owner's Manual for more information.

LCD Instrument Cluster Modes*

The LCD Instrument Cluster modes can be changed by using the mode button **A** on the right side of the steering wheel.

Modes (Type B Instrument Cluster):

-  **Sport Mode***: This mode displays Gauge, Lap Timer, G-Force
-  **Trip Computer Mode***: Displays driving information for fuel economy, accumulated info, etc.
-  **Turn-by-Turn Mode***: Displays the route guidance and destination info
-  **Driving Assist Mode***: Displays the Lane Safety*, Driver Attention Warning*, Smart Cruise Control* and TPMS info
-  **User Settings Mode***: Change settings of the doors, lamps convenience, service interval and other features
-  **Information***: Displays digital speedometer, TPMS information
-  **Master Warning Mode***: Displays warning messages related to the vehicle when one or more systems is not operating normally

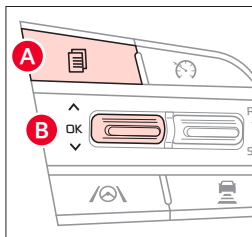

(Button layout on right of steering wheel)

QR CODE

Instrument Cluster's LCD Display Video



Refer to the inside front cover for more information on QR codes.
www.youtube.com/KiaFeatureVideos

Your vehicle's steering wheel buttons and LCD modes may differ from those in the illustrations.

Driving while distracted is dangerous and should be avoided. Drivers should remain attentive to driving and always exercise caution when using the steering wheel mounted controls while driving.

See section 4 in the Owner's Manual for more information.

Trip Information / Trip Computer

The Trip Computer is a driver information system that displays information related to driving when the Engine Start/Stop button is in the ON position.

To cycle through the LCD Instrument Cluster modes, press the Mode button **A** on the right side of the steering wheel.

When in the Trip Computer mode , press the Select/Reset (OK) button **B** to cycle through the screens. When displaying the TRIP screens, press and hold the OK button to reset the TRIP to zero.

REMINDERS:

- Appearance of Tripmeter display may differ as equipped
- All stored driving information (except Odometer and Range) is reset if the battery is disconnected

See section 4 in the Owner's Manual for more information.

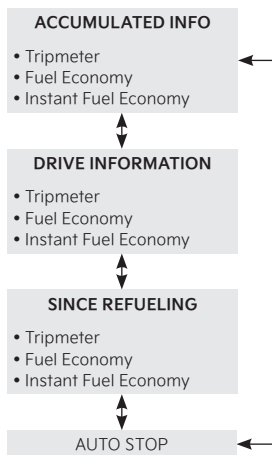

User Settings

To enter the User Settings mode in the LCD Instrument Cluster Modes, press the Mode button **A** when the vehicle is at a standstill and with the Engine Start/Stop button in the ON position and select User Settings .

You can navigate the selections on the display by pressing the Select/Reset (OK) button **B** up or down, and then pressing again to enter.

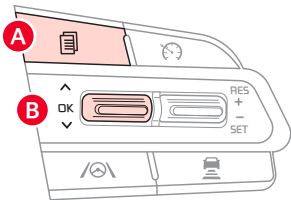

(Button layout on right of steering wheel)

QR CODE

Vehicle & User Settings Video



Refer to the inside front cover for more information on QR codes.
www.youtube.com/KiaFeatureVideos

User Settings Modes:

Driving Assistance

- SCC Reaction
- Driving Convenience*
- Warning Timing*
- Warning Volume*
- Driver Attention Warning
- Forward Safety
- Lane Safety
- Blind-Spot Safety*
- Parking Safety*

Head-Up Display (HUD)*

- Enable HUD
- Display Height
- Rotation
- Brightness
- Content Selection

Cluster

- Fuel Econ. Reset
- Wiper/Light Display
- Traffic Signs*
- Icy Road Warning
- Welcome Sound*
- Theme Selection*

Lights

- One-Touch Turn Signal
- Ambient Light Brightness*
- Ambient Light Color*
- Headlamp Delay*
- High Beam Assist

Door/Liftgate

- Automatically Lock
- Automatically Unlock
- Two-press Unlock*
- Power Liftgate*
- Power Liftgate Opening Speed*
- Power Liftgate Opening Height*
- Smart Liftgate*

Convenience

- Seat Easy Access*
- Steering Easy Access*
- Rear Occupant Alert
- Welcome Mirror/Light*
- Wireless Charging System*
- Service Interval
- Lateral Seat Support Enhancement*

Units

- Speed Unit
- Temperature Unit
- Fuel Economy Unit
- Torque Unit*
- Tire Pressure Unit
- Turbo Boost Pressure Unit*

See section 4 in the Owner's Manual for more information.

Vehicle Settings* - Audio Head Unit (Available on certain models)

To enter the Vehicle Settings mode in the audio head unit, press the SETUP key on the audio head unit or the SETUP icon onscreen. Then press Vehicle , which will take you to Vehicle Settings. Use the touchscreen to navigate through the menus.

Vehicle Settings:

Driver Assistance

- Driving Convenience
- Speed Limit Assist
- Warning Timing
- Warning Volume
- Driver Attention Warning
- Forward Safety
- Lane Safety
- Blind-Spot Safety
- Parking Safety

Drive Mode

- Drive Mode Alert*

Climate*

- Recirculate Air*
- Automatic Ventilation*
- Defog/Defrost Options*
- Climate Features*

Lights*

- Ambient Light*
- One Touch Turn Signal*
- Headlight Display*,
- High Beam Assist*

Door*

- Auto Lock*
- Auto Unlock*
- Walk-Away Lock*
- Two-Press Unlock*
- Smart Trunk*

Cluster*

- Service Interval*
- Energy Consumption Reset*
- Content Selection*
- Cluster Voice Guidance Volume*
- Welcome Sound*
- Theme Selection*

Convenience*

- Rear Occupant Alert*
- Welcome Mirror Light*
- Wireless Charging System*
- Vehicle Auto Shut-Off*

QR CODE

Vehicle & User Settings Video



Refer to the inside front cover for more information on QR codes.
www.youtube.com/KiaFeatureVideos

Service Interval Mode

When Service Interval Mode is activated, set and vehicle service is required, the following message will be displayed on the LCD: Service Required, along with the remaining days/miles till service is due.

Service Interval Mode ON and Interval Setting

To activate Service Interval Mode and set the interval, press the Mode button **A**, scroll to User Settings  and press Select/Reset (OK) button **B** to enter. Then press the OK button **B** up/down to scroll to Service Interval Mode and again to enter. Press the OK button **B** up/down to select the option to set the interval. Adjust interval and press the OK button **B** to save. To reset the Service Interval Mode system, press and hold the OK button **B** for more than 1 second.

Service Interval Mode Off

To turn Service Required OFF, go to User Settings and scroll to Service Interval Mode, press the OK button **B** to enter. Select option to deactivate and press the OK button **B** to save.

See section 4 in the Owner's Manual for more information.

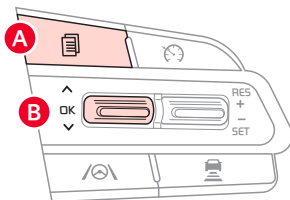
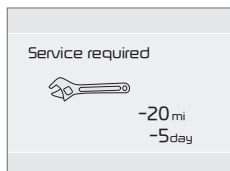

(Button layout on right of steering wheel)

Forward Collision-Avoidance Assist (FCA)^{† 6}

FCA is designed to detect and monitor a vehicle ahead or detect a pedestrian in the roadway through front view camera recognition and front radar signals to warn the driver that a collision is imminent, and if necessary, temporarily apply emergency braking. If FCA detects a potential collision, FCA emits an audible warning and visual alert on the instrument cluster **A**.

If the system detects that the collision risk has increased, Forward Collision-Avoidance Assist (FCA) automatically applies the brakes to reduce your speed, potentially helping to reduce the effects of a possible collision.



FCA User Settings:

- FCA is ON by default in most Kia models. FCA can be activated or deactivated by going to the User Settings in the Instrument Cluster
- To go to User Settings **⚙️**, press the Mode button **B** on the Steering Wheel when the vehicle is at a standstill, gear shift in Park and the ignition on or the Engine Start/Stop button* in the ON position
- Press the OK button **C** up/down and select User Settings **⚙️** then Driver Assistance, go to Forward Safety and select Active Assist, Warning Only or Off
- Active Assist:** Vehicle will provide a warning (audible & visual) and apply the brakes if needed
- Warning Only:** Vehicle will provide a warning only (audible & visual)
- Off:** FCA is off, no warnings or braking provided
- To adjust FCA initial Warning Timing, go to User Settings **⚙️**, Driver Assistance, Warning Timing, then select an option:
 - Early/Normal/Standard:** Maximizes the amount of distance between the vehicles before the initial warning occurs
 - Late:** Reduces the amount of distance between the vehicles before the initial warning occurs

The default settings for Warning Timing is set to Normal. If the Warning Timing is changed, the warning time of other Driver Assistance systems may also change.

FCA will become active when the:

- Ignition is on or the Engine Start/Stop button* is ON
- Vehicle is traveling faster than 5 mph
- Electronic Stability Control (ESC) is ON

QUICK TIP

- FCA Warning Volume can be adjusted in the User Settings **⚙️** in the Instrument Cluster or the Vehicle Settings* on the audio head unit. Go to Driver Assistance, then Warning Volume.

REMINDERS:

- FCA will be activated by default when the ignition is cycled ON, even when previous setting was OFF
- If FCA is operating and the ESC (Electronic Stability Control) is turned off, FCA is automatically turned off
- When FCA is off, the FCA warning indicator is on in the Instrument Cluster **🚗**

QR CODE

Forward Collision-Avoidance Assist (FCA) Video



Refer to the inside front cover for more information on QR codes.
www.youtube.com/KiaFeatureVideos

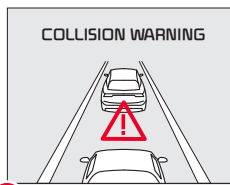

A

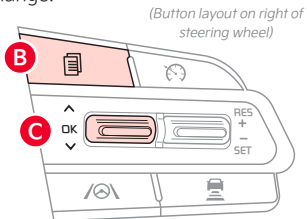
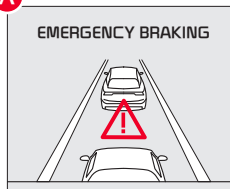



Forward Collision-Avoidance Assist (FCA) is not a substitute for safe driving and may not detect all objects in front of the vehicle. Always drive safely and use caution.

Actual User Settings steps may vary by model. For illustrative purposes only. Your actual display, buttons and/or features may vary. Refer to section 5 in the Owner's Manual for more information.

Lane Keeping Assist (LKA)^{† 6}

Lane Keeping Assist is designed to detect the lane markers on the road with a front view camera on the windshield, and may assist the driver's steering to help keep the vehicle in the lane. When turned on, the instrument cluster indicator  will initially illuminate white. It will remain white when the vehicle is traveling slower than 40 mph or when the system does not detect the lane markers. When the system detects the lane markers and can assist the steering, the LKA icon will illuminate green.

If LKA detects that you are moving outside of your lane, the system may give an audible warning and display Lane Departure Warning on the instrument cluster. If the vehicle continues to move outside of the lane, LKA may provide steering, trying to prevent the vehicle from moving outside its lane.

LKA is the operating mode by default when the Lane Safety button*  is depressed to ON. To activate/deactivate LKA, press .

There are three available modes:

- **Assist:** LKA will automatically assist the driver's steering when lane departure is detected to help prevent the vehicle from moving out of its lane
- **Warning Only:** LKA will warn the driver with an audible warning when lane departure is detected. The driver must steer the vehicle
- **Off:** LKA will turn off. The  indicator light will turn off on the cluster
- All systems will operate under the following conditions:
 - The vehicle speed exceeds approximately 40 mph
 - LKA recognizes both sides of the lane markers the vehicle is traveling in
 - The vehicle is between the lane markers

QR CODE

Lane Keeping Assist (LKA) Video



Refer to the inside front cover for more information on QR codes.
www.youtube.com/KiaFeatureVideos

ADAS

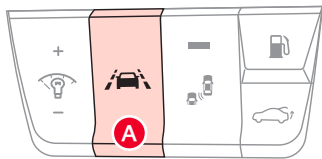

(Button located on driver's panel, left of the steering wheel)



When the front-view camera does not detect the lane traveling in, the lanes are not illuminated gray



When the front-view camera detects the lane traveling in, both lanes are illuminated gray



When the front-view camera detects the vehicle moving outside of the lane it is traveling in, a vehicle crossing lane indicator will blink, either on the left or right lane (as shown in both images above)



REMINDERS:

- LKA will not issue a warning if the turn signal or hazard signal is activated
- LKA will return to its previous state when the ignition is cycled
- LKA is not a substitute for safe and proper driving. Always drive safely and use caution
- LKA may not always alert the driver if the vehicle is about to be driven outside of its lane

Lane Keeping Assist is not a substitute for safe driving and may not always warn the driver if the vehicle is driven outside of its lane. Always drive safely and use caution.

For illustrative purposes only. Your actual display, buttons and/or features may vary. Actual User Settings steps may vary by model.

Refer to section 5 in the Owner's Manual for more information.





Blind-Spot Collision-Avoidance Assist (BCA)^{† 6}

BCA uses rear corner radar sensors in the rear bumper to monitor and warn the driver in certain situations if it detects an approaching vehicle in the driver's blind spot area and before changing lanes. Initially, BCA provides Blind-Spot Collision Warning (BCW) when it detects a potential collision with a vehicle, emitting an audible warning and visual alert on the outside rearview mirrors. If the system detects that the collision risk has increased, Blind-Spot Collision-Avoidance Assist (BCA) automatically applies the opposite side front brake to try and mitigate a potential collision.

ADAS

- **1st-stage:** When another vehicle is detected within BCW warning boundary **A**, an indicator will illuminate on the outside rearview mirrors **B**.
- **2nd-stage:** When 1st stage warning is on and the driver activates a turn signal, a flashing indicator will illuminate on the outside rearview mirrors and the system will sound a warning.
- **3rd-stage:** When 1st stage warning is on and the 2nd stage warning has already occurred, and the collision risk has increased, braking is applied to the opposite side front wheel and a visual warning occurs.



BCA User Settings:

To turn BCA on, go to the User Settings menu  in the Instrument Cluster, press the Mode button  **C** on the Steering Wheel when the vehicle is at a standstill, gear shift in Park and with the ignition switch or the Engine Start/Stop button* in the ON position, and select User Settings . Press the Move (OK) button  **D** up/down and select Driver Assistance, Blind-Spot Safety and then press the OK button  **D**.

Some models access settings through the Vehicle Settings in the audio head unit. Press the Setup hard key on the audio head unit, then Vehicle  on the screen to enter Vehicle Settings

To set BCA when in Blind-Spot Safety, select:

- **Active Assist:** BCA will provide a warning (audible & visual) and may activate Electronic Stability Control (ESC) and temporarily apply braking power
- **Warning Only:** Vehicle will provide a warning only (audible & visual)
- **Off:** System is off, no warnings provided

To set the initial warning activation time, go to User Settings , then Driver Assistance, Warning Time and press the OK button  **D**. Adjust the warning timing:

- **Early/Normal:** Maximizes the amount of distance between the vehicles before the initial warning occurs
- **Late:** Reduces the amount of distance between the vehicles before the initial warning occurs

QR CODE

Blind-Spot Collision-Avoidance Assist (BCA) Video



Refer to the inside front cover for more information on QR codes.
www.youtube.com/KiaFeatureVideos

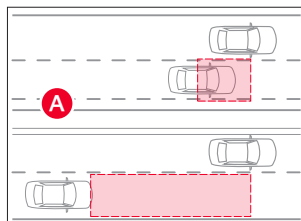

(Blind-spot area monitoring)

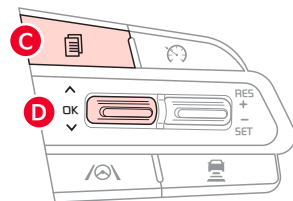
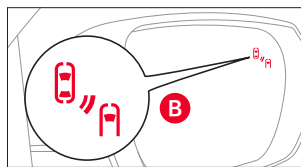

(Button layout on right of steering wheel)

Blind-Spot Collision-Avoidance Assist (BCA)^{† 6} (continued)

QUICK TIPS

- BCW Warning Volume can be adjusted in the User Settings  in the Instrument Cluster or the Vehicle Settings* on the audio head unit. Go to Driver Assistance, then Warning Volume
- BCW will activate when:
 - The system is turned on
 - Other vehicles are detected on the rear sides of the vehicle
 - Vehicle speed is above approximately 20 mph

REMINDERS:

- BCW will not issue a warning if the vehicle speed is 6 mph or more above the surrounding vehicles
- When BCW is ON and the ignition is cycled, BCW returns to its previous state
- BCW is a supplemental system. Do not solely rely on this system. Always pay attention to the road and drive safely

The BCA system is not a substitute for safe and proper driving. Always drive safely and use caution.

Refer to section 5 in the Owner's Manual for more information.

The images on this page are for illustrative purposes only and may not reflect actual feature or operation.

Safe Exit Assist (SEA)^{† 6}

Safe Exit Assist can help prevent passengers from opening their door by displaying a warning message on the Instrument Cluster and sounding an audible warning when a vehicle is detected, approaching from behind, after your vehicle has stopped.

SEA warns the driver of the risk of collision with a vehicle approaching the blind spot area.

To turn on SEA, go to User Settings in the Instrument cluster or press SETUP in the Vehicle Settings* in the audio head unit, then select Driver Assistance, Blind-Spot Safety, and select Safe Exit Assist.

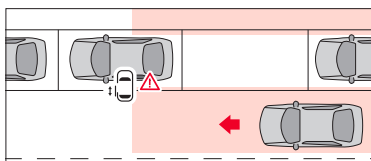

Images are for illustrative purposes only and may not reflect actual feature or operation.

See section 4 in the Owner's Manual for more information.

QR CODE

Safe Exit Assist (SEA) Video



Refer to the inside front cover for more information on QR codes.
www.youtube.com/KiaFeatureVideos



Driver Attention Warning (DAW)^{† 7}

Driver Attention Warning is designed to alert the driver if it detects inattentive driving practices and, in certain situations, can give a warning signal to take a break from driving.

- **Inattentive Driving Warning:** DAW will inform the driver of the driver's attention level and will recommend taking a break when it falls below a certain level
- **Leading Vehicle Departure Alert:** DAW will inform the driver when the front vehicle departs from a stop

If DAW is activated, the DAW information **A** will appear on the Instrument Cluster LCD when you select the Driving Assist menu in User Settings . A message, "Consider taking a break," **B** appears on the LCD and a warning sounds to suggest the driver take a break when the driver's attention level becomes low **C**.

DAW User Settings:

To turn DAW on/off, with the ignition on, press the Mode button  **D** on the Steering Wheel and go to User Settings  in the Instrument Cluster. Then go to Driver Assistance and select Driver Attention Warning.

- Some models access settings through the Vehicle Settings in the audio head unit. Press the Setup hard key on the audio head unit, then press Vehicle  on the screen to enter Vehicle Settings

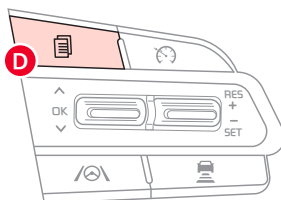
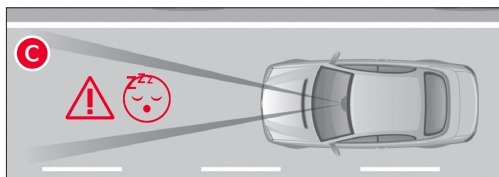
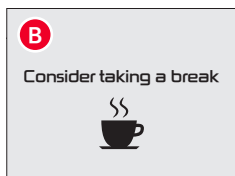

(Button layout on right of steering wheel)

REMINDERS:

- The set-up of DAW will be maintained, as selected, when the ignition is cycled
- When activated, DAW does not display the "Consider taking a break" message when the total trip driving time is less than 10 minutes
- DAW will enter a standby mode if the camera does not detect the lanes

Refer to section 5 in the Owner's Manual for more information.

QR CODE

Driver Attention Warning (DAW) Video



Refer to the inside front cover for more information on QR codes.
www.youtube.com/KiaFeatureVideos

Driver Attention Warning is not a substitute for safe driving and may not detect all instances of inattentive driving practices. Failure to pay attention to travel conditions and vehicle operation could result in loss of vehicle control. Always drive safely and use caution.

Cruise Control (CC)

- A Driving Assist button:** Press the  button to turn the cruise control ON/OFF
- B RES+ button:** Press up to resume or increase cruising speed
- B SET- button:** Press down to set or decrease cruising speed
- C PAUSE/RESUME button:** Press to pause Cruise Control. Press again to resume Cruise Control

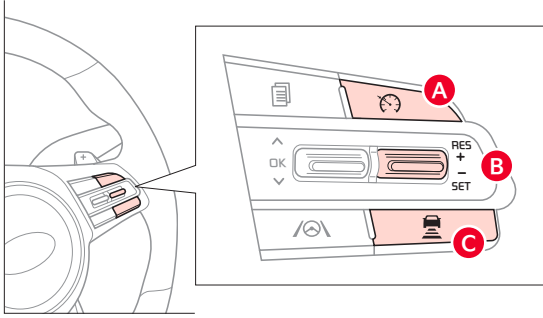

QUICK TIPS

- Cruise Control is designed to function above approximately 20 mph only
- Cruise Control will not activate until the brake pedal has been depressed at least once after ignition ON or engine start

REMINDER: Cruise Control will not activate until the brake pedal has been depressed at least once after the ignition is ON or engine starting

Your vehicle's steering wheel buttons may differ from those in the illustrations. Refer to section 5 in the Owner's Manual for more information.

Smart Cruise Control (SCC)^{† 6}

Smart Cruise Control is designed to maintain a predetermined distance from vehicles detected ahead by automatically adjusting the driving speed as needed. When traffic is detected, the vehicle will slow down to maintain a set distance behind traffic without depressing the accelerator or brake pedal.

With SCC on and activated, the vehicle distance set, and the system detects a vehicle slowing or stopping, the system can bring the vehicle to a complete stop. When the vehicle ahead starts to move forward, SCC re-engages. If the vehicle ahead stops for more than 3 seconds, the accelerator pedal or the RES+ button must be pressed to start moving the vehicle.

Smart Cruise Control will adjust acceleration based on the drive mode selected in the Drive Mode Integrated Control system.

Press the Driving Assist button*  on the Steering Wheel **A** to activate and the speed will be set to the current vehicle speed. SCC may decrease the speed to maintain the distance with the vehicle in front.

To set/adjust the SCC speed:

- Press the Driving Assist  button **A** to turn the system ON. The CRUISE indicator will illuminate on the instrument cluster
- Accelerate/decelerate to the desired speed
- Press the **RES+/SET-** button **B** to set the speed. Press the **RES+/SET-** button **B** up/down to increase/decrease the set speed

To set the vehicle distance:

- Press the Vehicle Distance button **C** on the steering wheel
- Each time you press **C** the vehicle distance will change **D**, indicated by the number of bars that appear on the display **E**

To pause/resume SCC operation: Depress the brake pedal or press the Pause/Resume button* **B**. The cruise indicator on the instrument cluster will change.

To turn SCC OFF: Press the Driving Assist  button **A**. The CRUISE indicator on the instrument cluster will turn OFF.

To adjust the sensitivity of SCC: Press the mode button **F** on the Steering Wheel. With the OK button **H**, select Drive Assistance, then SCC Response. Then select Fast, Normal or Slow.

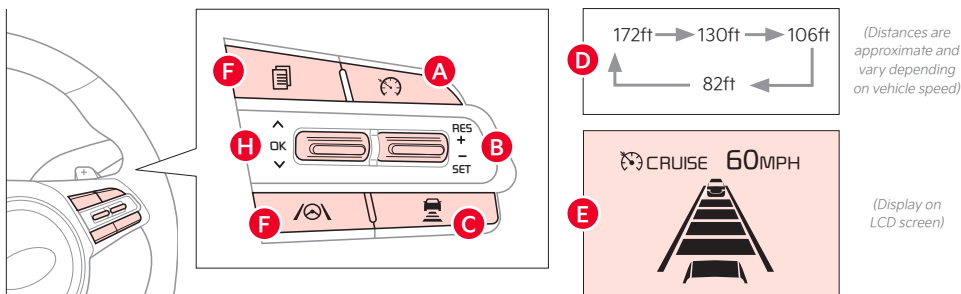

Images are for illustrative purposes only and may not reflect actual feature or operation.

See section 5 in the Owner's Manual for more information.

QR CODE

Smart Cruise Control
with Stop & Go Video



Refer to the inside front cover for more information on QR codes.
www.youtube.com/KiaFeatureVideos

Smart Cruise Control (SCC)^{† 6} (Continued)

QUICK TIPS

- If your vehicle speed is between 0-20 mph when you press the Driving Assist button to turn SCC on, the set speed will be set to 20 mph
- When following a vehicle, the system can automatically adjust your cruise speed based on the vehicle detected in front. It will even bring the vehicle to a complete stop if necessary. If the vehicle remains at a standstill for more than 3 seconds, you must depress the accelerator pedal or press the RES+/SET- button up/down to start the vehicle
- To change the cruise control mode from SCC to standard cruise control, press and hold button . Repeat to switch back to SCC mode. (SCC must not be activated to change modes)

REMINDERS:

- CRUISE indicator must be ON in order to operate SCC
- SCC remains ON when ignition is cycled. The speed setting will need to be reset when ignition is cycled
- The distance settings are approximations and may vary depending on vehicle speed. See the owner's manual for more information
- SCC is also canceled when the driver's door is opened, gear shift is changed out of D (Drive), Electronic Parking Brake (EPB) is activated and various other conditions. See owner's manual for other conditions
- If SCC is left on, it can be activated inadvertently. Keep the system off when not in use to avoid setting a speed which the driver is not aware of
- SCC is a supplemental system and is not a substitute for safe driving. It is the responsibility of the driver to always check the speed and distance to the vehicle ahead

Lane Following Assist (LFA)^{† 6}

Lane Following Assist is designed to help ensure that the vehicle stays centered in its lane **A** by monitoring the detected lane markings ahead and adjust the steering. When driving, LFA can be switched on and off by pressing the Driving Assist button **B**. When turned on, the instrument cluster indicator **C** will initially illuminate white when turned ON. It will remain white when the system does not detect the lane markers. When LFA detects the lane markers and can assist the steering, the LFA icon **C** will illuminate green **C**.

ADAS

LFA will operate only when these conditions are met:

- LFA recognizes both sides of the lane markers the vehicle is traveling in
- The vehicle is traveling slower than 120 mph

LFA User Settings:

- To go to User Settings **G** in the Instrument Cluster, press the Mode button **D** on the Steering Wheel when the vehicle is at a standstill, gear shift is in Park and with the ignition on or the Engine Start/Stop button* in the ON position, and select User Settings **G**
- To enable LFA, when in User Settings, press the Move (OK) button **E** up/down and Select Driver Assistance then Driving Assist, and select Lane Following Assist. Press the OK button **E**
- Some models access settings through the Vehicle Settings in the audio head unit. Press the Setup hard key on the audio head unit, then **VEHICLE** **G** on the screen to enter Vehicle Settings
- Some vehicles have a Lane Driving Assist / Lane Safety button* on the Driver's Panel or the Steering Wheel **B**. Press to activate Lane Following Assist

QR CODE

Lane Following Assist (LFA) Video



Refer to the inside front cover for more information on QR codes.
www.youtube.com/KiaFeatureVideos

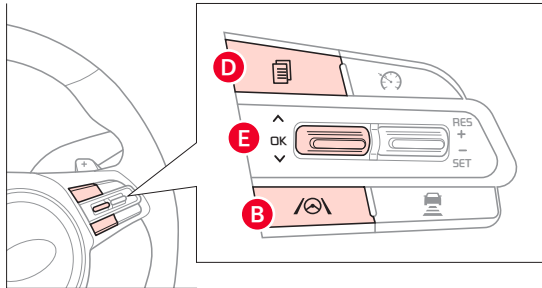
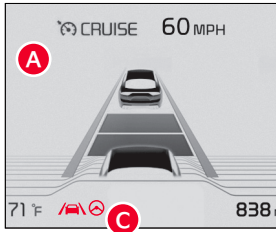

REMEMINDER: LFA is not a substitute for safe and proper driving. Always drive safely and use caution.

Images are for illustrative purposes only and may not reflect actual feature or operation.

LFA is supplemental. Do not solely rely on this system and always pay attention to the road and its conditions.

See section 5 in the Owner's Manual for more detailed information, limitations and conditions.

Rear View Monitor (RVM)^{† 6}

Rear View Monitor is a supplemental system that displays the view behind the vehicle through the audio head unit screen while the vehicle is in Reverse.

Rear View Monitor activates when the:

- Engine Start/Stop button is in the ON position
- Gear Shift Lever is in the R (Reverse) position

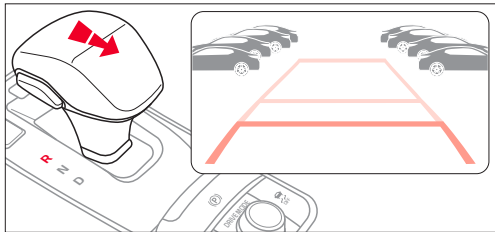

REMINDERS:

- Through normal use and after inclement weather or washing, the rear camera may become dirty. Use a clean, microfiber cloth to remove any dirt, debris or spots that may have accumulated on the lens
- RVM is not a substitute for proper and safe backing-up procedures
- RVM may not display every object behind the vehicle
- Always drive carefully and use caution when backing up

The Rear View Monitor is not a substitute for proper and safe backing-up procedures. The Rear View Monitor may not display every object behind the vehicle. Always drive safely and use caution when backing up.

Images are for illustrative purposes only and may not reflect actual feature or operation.

See section 4 in the Owner's Manual for more information.

Surround View Monitor (SVM)^{† 6}

Surround View Monitor (SVM) is a parking support system that shows the areas around the front, rear, left and right sides of the vehicle via four cameras displayed onto the audio head unit screen.

- Press the Parking/View button **A** to turn on Surround View Monitor. Press the button again to turn off the function
- Other view modes can be selected by touching the view icons **B** on the Surround View Monitor screen
- Surround View Monitor Auto On: With Driver Assistance > Parking Safety > Surround View Monitor Auto On selected from the Settings menu, the front parking assist view screen is displayed when Parking Distance Warning warns the driver while driving in D (Drive)

To change the SVM settings, press the onscreen settings icon **C**, while SVM is operating.

QR CODE

Surround View Monitor (SVM) Video



*Refer to the inside front cover for more information on QR codes.
www.youtube.com/KiaFeatureVideos*

QUICK TIP

- The Front View of SVM will turn off when the gear shift is moved into Park or Reverse or the Parking/View button is pressed.

REMINDER: The SVM camera is equipped with an optical lens to provide a wider range of vision and may appear different from the actual distance.

Images are for illustrative purposes only and may not reflect actual feature or operation. See section 4 in the Owner's Manual for more information.

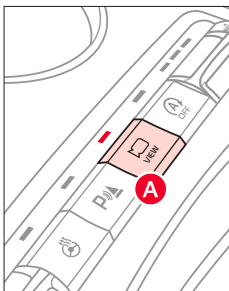

(Button located below gear shift)

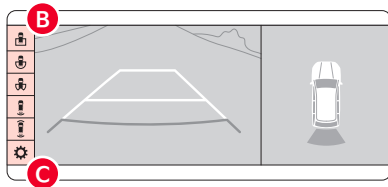

The Surround View Monitoring (SVM) is only a supplemental device. Drivers should not rely solely on the SVM information when parking and backing up. Drivers should always pay attention and directly check the left/right and rear.

Rear Cross-Traffic Collision-Avoidance Assist (RCCA)^{† 6}







Rear Cross-Traffic Collision-Avoidance Assist (RCCA) is designed to warn the driver under certain conditions. It may activate the Electronic Stability Control (ESC) and temporarily apply braking if it detects cross traffic approaching the vehicle when the vehicle is in reverse.

When the RCCA rear-corner radar sensors detect approaching vehicles from the rear left or rear right side of the vehicle **A**, RCCA will sound a warning, the warning indicators on the outside rearview mirror will illuminate and a message will appear on the Instrument Cluster LCD **B** and the audio head unit.* If RCCA detects that the collision risk has increased, RCCA automatically applies the brakes to reduce your speed, potentially helping to minimize the effects of a possible collision.

RCCA is designed to operate under the following conditions:

- When the gear shift is in Reverse
- When the vehicle is moving slower than 6 mph

RCCA User Settings:

- To go to the User Settings menu  in the Instrument Cluster, press the Mode button  **C** on the Steering Wheel when the vehicle is at a standstill, gear shift in Park and with the ignition on or the Engine Start/Stop button* in the ON position, and select User Settings 
- To turn RCCA on when in User Settings , press the Move (OK) button **D** up/down, select Driver Assistance, Parking Safety, Rear Cross-Traffic Safety and then press OK **D**
- To set the warning timing, go to User Settings , press the Move (OK) button **D** up/down, then go to Driver Assistance, Warning Timing and press the OK button **D**
- Select one of the settings:
 - **Early/Normal/Standard:** Maximizes the amount of distance between the vehicles before the initial warning occurs
 - **Late:** Reduces the amount of distance between the vehicles before the initial warning occurs
- The default Warning Timing is set to Normal. If the Warning Timing is changed, the warning time of other Driver Assistance systems may also change
- Some models access settings through the Vehicle Settings in the audio head unit. Press the Setup hard key on the audio head unit, then **VEHICLE**  on the screen to enter Vehicle Settings

QR CODE

Rear Cross-Traffic Collision-Avoidance Assist (RCCA) Video



Refer to the inside front cover for more information on QR codes.
www.youtube.com/KiaFeatureVideos

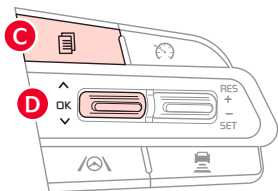
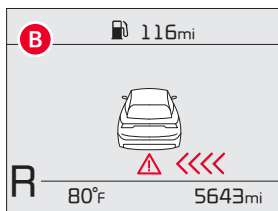
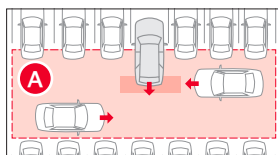

See section 5 in the Owner's Manual for more information.

QUICK TIP

- RCCA Warning Volume can be adjusted in the User Settings  in the Instrument Cluster or the Vehicle Settings on the audio head unit. Go to Driver Assistance, then Warning Volume

REMINDERS:

- The RCCA feature can be activated or deactivated in User Settings, under Driver Assistance, Parking Safety
- When vehicle power is cycled, RCCA will remain in the previous state
- When a vehicle is approaching within the sensing range, and traveling faster than 3 mph, the RCCA system will show a warning
- RCCA is a supplemental system. Do not solely rely on this system and always pay attention to the road and its conditions

Forward*/Reverse Parking Distance Warning (PDW)^{† 6}

Forward/Reverse Parking Distance Warning (PDW)* **A** is a supplemental system that is designed to assist the driver by chiming if an object is detected within the sensing areas in the front or rear of the vehicle when moving forward or backing up.

When the Engine Start/Stop button is ON and the shift lever is in R (Reverse), the system is activated and the Forward/Reverse Parking Distance Warning (PDW)* button indicator is illuminated.

REMINDERS:

- If the vehicle is moving at speeds over 6 mph, the system may not activate
- When more than two objects are sensed at the same time, the closest one will be recognized first
- Forward/Reverse Parking Distance Warning (PDW)* is not a substitute for proper and safe backing-up procedures. Always drive safely and use caution when backing up. Forward/Reverse Parking Distance Warning (PDW)* may not detect every object behind or in front of the vehicle

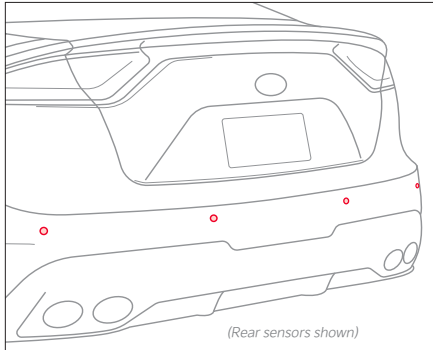
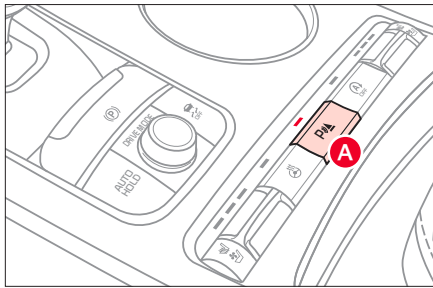

Forward/Reverse Parking Distance Warning is not a substitute for proper and safe backing-up procedures. Always drive safely and use caution when backing up. Forward*/Reverse Parking Distance Warning (PDW) may not detect every object in front of or behind the vehicle.*

See section 4 in the Owner's Manual for more information.

QR CODE

Forward*/Reverse Parking Distance Warning (PDW) VIDEO



*Refer to the inside front cover for more information on QR codes.
www.youtube.com/KiaFeatureVideos*

Head-Up Display (HUD)*† 13

The Head-Up Display (HUD) is a semi-transparent display that projects a snippet of information from the instrument cluster and navigation system* onto the windshield glass.

To turn HUD ON or OFF, go to User Settings in the LCD Modes.

The HUD displays:

- Turn By Turn (TBT) navigation information
- Road signs
- Speedometer
- SCC vehicle distance information
- Lane Departure Warning information
- Blind-Spot Safety information
- Warning lights (low fuel)
- AC mode information
- Lane Following Assist information
- Highway Driving Assist information (if equipped)
- Navigation-based Smart Cruise Control information*

Head-Up Display (HUD) User Settings

Drivers can adjust the HUD settings from the LCD Instrument Cluster modes in User Settings. HUD settings include:

- Enable Head-Up Display
- Display Height: Adjust the height of the HUD image on the windshield glass
- Rotation: Adjust the degree of HUD rotation
- Brightness: Adjust the intensity of the HUD brightness
- Contents Select: Activate or deactivate HUD content (TBT*, SCC, LKA, BCW)
- Speedometer Size: Choose the size of the HUD speedometer (Small, Medium, Large)
- Speedometer Color*: Choose the color of the HUD speedometer (White, Amber, Green*)

REMINDERS:

- The HUD image on the windshield glass may not be visible when:
 - The driver has poor sitting posture
 - The driver is wearing polarized sunglasses
 - There is an object covering the HUD
 - Driving on a wet road
 - Excessive lighting inside or outside the vehicle
- Modifications made to the windshield, such as tinting or other aftermarket treatments, could affect the HUD. When replacing the front windshield glass of vehicles equipped with the HUD, owners must replace it with windshield glass designed for HUD operation. Otherwise, duplicated images may be displayed on the windshield glass
- If Turn By Turn (TBT) navigation information is selected as HUD content, TBT information will not be displayed on the LCD

QR CODE

Head-Up Display (HUD) Video



Refer to the inside front cover for more information on QR codes.
www.youtube.com/KiaFeatureVideos

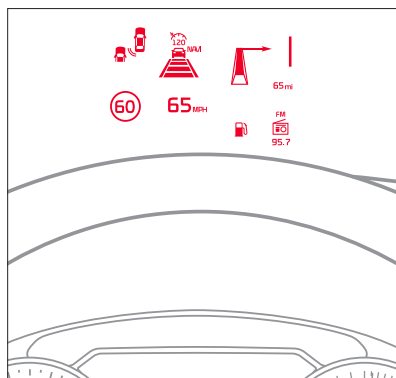

Head-Up Display is a supplemental system. Do not solely rely on the system, always drive safely, and pay attention to the driving conditions on the road.

Images are for illustrative purposes only and may not reflect actual feature or operation. See section 4 in the Owner's Manual for more information.

Electronic Stability Control (ESC)^{† 8} / Traction Control System (TCS)^{† 8}

Electronic Stability Control (ESC) is designed to help stabilize the vehicle during certain cornering maneuvers. Traction Control System (TCS) can help improve traction. It is a good idea to keep both ESC and TCS turned on for daily driving whenever possible.

Press the ESC button **A** to turn Traction Control System OFF/ON.

To turn both Electronic Stability Control and Traction Control System OFF, press and hold the ESC button for more than 3 seconds. Press again to turn ON.

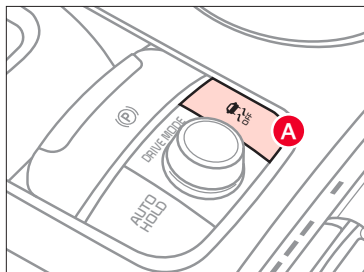

REMINDERS:

- ESC is active by default at vehicle start-up. When ignition is cycled, ESC will turn ON again
- The ESC indicator light in the instrument cluster will be lit momentarily whenever ESC is active

For more information on Electronic Stability Control (ESC) and its specific features and operations, please refer to section 5 in the Owner's Manual.

QR CODE

Electronic Stability Control Video



Refer to the inside front cover for more information on QR codes.
www.youtube.com/KiaFeatureVideos

Instrument Cluster Control (Instrument Panel Dimmer)

With parking lights/headlights ON, press **B** (+) or (-) to adjust the brightness of the Instrument panel illumination.

Refer to section 4 in the Owner's Manual for more information.

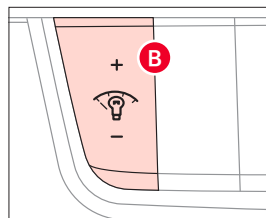

Hill-start Assist Control (HAC)^{† 8}

Hill-start Assist Control (HAC) is designed to prevent the vehicle from rolling backwards when accelerating from a stop while on a steep incline.

HAC automatically activates whether ESC is OFF or ON but does NOT activate when ESC has malfunctioned.

QUICK TIPS

- When HAC is active (e.g., during initial acceleration from a stop on an incline), you may notice that the brakes will momentarily remain engaged after you depress the accelerator. HAC does not replace the need to apply brakes while stopped on an incline
- HAC provides a two-second delay before the vehicle may start rolling backwards

REMINDERS:

- HAC does not operate when the gear shift is in P (Park) or N (Neutral) position
- HAC does not replace the need to apply brakes while the vehicle is stopped on an incline
- In the event of HAC system malfunction, see an Authorized Kia Dealer for service

Refer to section 5 in the Owner's Manual for more information.

Power Windows, Window Lock & Central Door Lock

- A** Pull/Press to operate driver and front passenger's window auto up/down
- B** Press to unlock/lock all doors
- C** Press to disable the rear passenger window controls

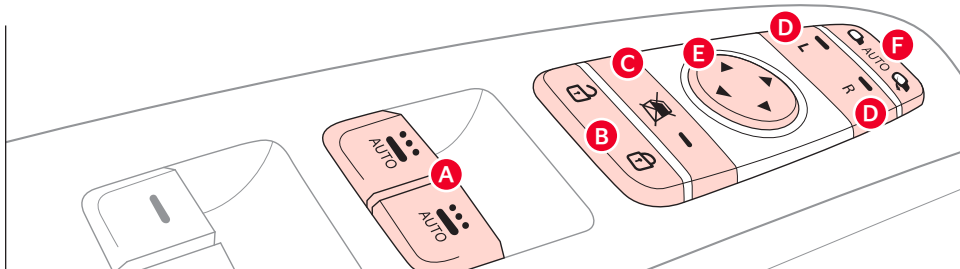

QUICK TIPS

- Press button **A** again to stop Auto Up/Down function
- Auto Door Lock/Unlock* will engage when gear shift is moved in to or out of the P (Park) position
- To turn Auto Door Lock/Unlock* OFF, go to User Settings* in the LCD Instrument Cluster Modes
- While driving with the rear windows down or with the sunroof* in an open or partially open position, a wind buffeting or pulsation noise may be heard. This noise is a normal occurrence and can be reduced or eliminated by the following:
 - If the noise occurs with one or both of the rear windows down, partially lower both front windows approximately 1 inch
 - If the noise occurs with the sunroof open, slightly reduce the size of the sunroof opening

REMINDER: When pressed **C**, the rear window controls for the Rear Passenger Windows are disabled.

Button configuration may vary depending on vehicle model.

See section 4 in the Owner's Manual for more information.

Power Folding Outside Mirrors

- D** Press the L or R buttons to select the mirror to adjust
- E** Press button arrows left/right or up/down to adjust mirror position
- F** Toggle button left/right to unfold/fold the outside rearview mirrors
- F** Toggle button to center to automatically fold/unfold mirrors when:
 - Smart Key lock/unlock buttons are pressed
 - Outside door handle button is pressed
 - Driver approaches the vehicle with the Smart Key (if activated in User Settings)

See section 4 in the Owner's Manual for more information.

QUICK TIP

- The mirrors will automatically unfold when the Smart Key is within close proximity to the vehicle (if activated in User Settings)

REMINDERS:

- When the mirror toggle button is in the center, press the lock button twice on the Smart Key to automatically fold mirrors when exiting vehicle
- To lock the mirror position, toggle button to the neutral (center) position

Reverse Parking Aid Function

When the gear shift lever is moved into R (Reverse) and the vehicle is moving backwards, the outside rearview mirrors will rotate downward to aid in reverse parking.

To turn Reverse Parking Aid Function ON, press the L (Left) **A** or R (Right) **B** outside rearview mirror button (LED lit).

To turn OFF, press button(s) again.

The outside rearview mirrors will automatically return to their original positions when:

- The Engine Start/Stop button is in the OFF position
- The gear shift lever is moved out of R (Reverse)
- The outside rearview mirror switches are OFF (LED not lit)

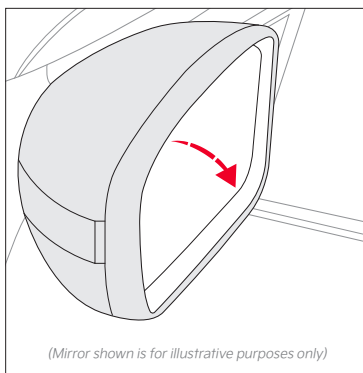
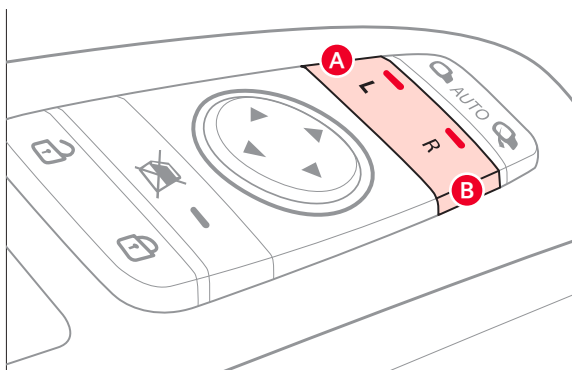

REMINDER: When the the buttons are not pressed, the Reverse Parking Aid Function will not operate and the outside rearview mirrors will not rotate downward.

See section 4 in the Owner's Manual for more information.

Heated Outside Mirrors

Mirror heaters automatically turn ON/OFF at the same time the Rear Window Defroster is turned ON/OFF. Rear Window Defroster button* is located on climate control system panel.

See section 4 in the Owner's Manual for more information.

Auto Door Lock/Unlock

Auto Door Lock/Unlock will engage when gear shift is moved into or out of the P (Park) position. Refer to the User Settings on how to turn Auto Door Lock/Unlock ON/OFF.

See section 4 in the Owner's Manual for more information.

Engine Start/Stop Button^{† 9}

To start the engine:

1. Depress the brake pedal
2. Press the ENGINE START/STOP button while gear shift is in P (Park) or N (Neutral)

To turn the engine OFF, press the ENGINE START/STOP button while the gear shift is in P (Park).

To use the ENGINE START/STOP button, you must have the Smart Key on your person or inside the vehicle.

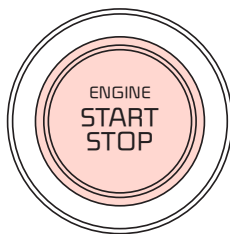

QUICK TIP

- To use electrical accessories:
 - ACC position
 - When in the OFF position and without depressing the brake pedal, press the ENGINE START/STOP button once.
 - ON position
 - When already in the ACC position and without depressing the brake pedal, press the ENGINE START/STOP button again.
 - When in the OFF position and without depressing the brake pedal, press the ENGINE START/STOP button twice.
- Keeping the vehicle in ACC or ON position too long can discharge the vehicle's battery

REMINDERS:

- If Smart Key fob battery is dead, you can still start the engine by pressing the ENGINE START/STOP button with the Lock-button end of the Smart Key. The Smart Key must contact the ENGINE START/STOP button directly, at a right angle
- In an emergency situation while the vehicle is in motion, you are able to turn the engine off and to the ACC position by pressing the ENGINE START/ STOP button for more than 2 seconds or 3 times successively within 3 seconds

QR CODE

Engine Start/Stop Button Video



Refer to the inside front cover for more information on QR codes.
www.youtube.com/KiaFeatureVideos

See section 5 in the Owner's Manual for more information.



Headlights & High Beams

AUTO Light - When the light switch is in the AUTO Light position, the tail lights and headlights will turn ON/OFF automatically depending on the amount of light outside the vehicle.

Low Beam Assist-Dynamic (LBA-D) / Dynamic Bending Light (DBL)* - LBA can help improve visibility during nighttime driving by aiming the low-beam headlights toward the direction the vehicle is moving. LBA controls the aiming direction based on steering angle and speed.

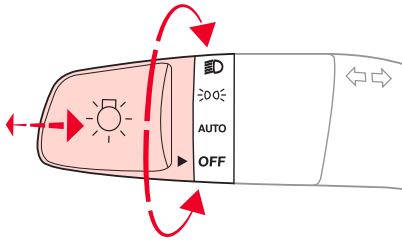
When the light switch is in the AUTO light position, LBA will activate.



-  Headlight position
-  Tail Light position
- AUTO Auto Light / LBA-D* / High Beam Assist*
- OFF OFF position



REMINDER: When the LBA indicator illuminates on the instrument cluster, the LBA is not working properly. See authorized Kia dealer for service.

Daytime Running Lights (DRL) - DRL can make it easier for others to see the front of your vehicle during the day. The lights will be on automatically unless one of the following occurs:

- Headlights are on
- Switch is in the DRL OFF position
- Parking brake is applied
- Engine is turned off

Headlight / High Beam Lever Operation

• Rotate lever switch to change the headlight function:

-  Headlight position
-  Parking light position
- AUTO* Auto Light* / LBA position
- DRL/OFF OFF or DRL OFF position

- Press lever away from you to turn high beam headlights ON
- Pull lever to flash headlights/high beams

High Beam Assist (HBA) - High Beam Assist is designed to automatically adjust the headlight range by switching between high and low beams based on light detected from other vehicles and road conditions.

To enable HBA, toggle the light switch to the AUTO Light position and turn on the high beams by pushing the lever away from you. The High Beam Assist indicator  will illuminate.

REMINDEERS:

- High Beam Assist does not operate below certain speeds, or in some lighting and driving conditions. Please be aware of your surroundings and exercise proper road etiquette when operating a vehicle using the high beams.
- HBA will operate when vehicle speed exceeds 25 mph
- If the lever is pushed away from you while HBA is operational, HBA will turn off and the high beams will be on continuously. If the lever is pulled toward you while HBA is operational, HBA will turn off
- If the light switch is switched to the headlight position, HBA will turn off and low beams will be on continuously
- DRL only operates during the daytime

See section 4 in the Owner's Manual for more information.

Turn Signals

To operate:

- Move lever up/down for right/left turn signal
- Slightly move lever up/down to activate one-touch lane change signal

For more information on the User Settings Mode, please refer to your Owner's Manual.

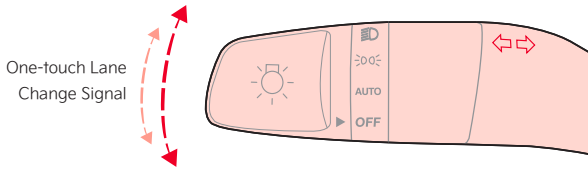

REMINDERS:

- One-touch lane change signal is activated by briefly pressing the turn signal lever slightly for less than 1 second and then releasing. The lane change signal will blink 3 times
- To change how many times the lane change signal blinks (3/5/7), go to User Settings in the LCD instrument cluster modes

Windshield Wipers & Washers

To operate:

- Move lever up/down to change wiper modes
 - **MIST**: Single wipe
 - **OFF**: Wiper off
 - **AUTO**: Auto Rain Sensing
 - **LO**: Slow wipe
 - **HI**: Fast wipe
- Pull to spray and wipe

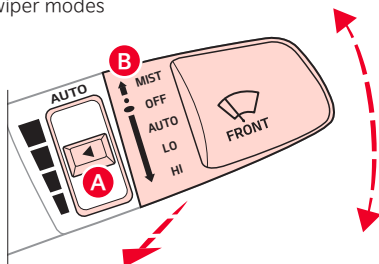

Auto Rain Sensing

The rain sensor located on the upper end of the windshield glass is designed to sense the amount of rainfall and control the wiping cycle for the proper interval. The more it rains, the faster the wiper operates. When the rain stops, the wiper stops.

To turn ON the auto rain sensing wipers, move lever up/down to AUTO.

To adjust the auto rain sensing wiper speed setting, move the speed control switch **A** up/down.

QUICK TIPS

- When the Engine Start/Stop button is in the ON position and the wiper switch is in AUTO mode, the wiper will automatically operate once to perform a self-check of the system
- Set the wiper to the OFF position when the wiper is not in use
- If going through a car wash, remind the attendant to keep the vehicle in Neutral (N) and keep the engine running. Also, disable the Smart Power Liftgate* lid control, turn off the auto rain sensing wipers and fold in the mirrors
- Moving lever to HI increases Intermittent wipe frequency and wipe speed. Moving lever to LO decreases frequency of wipes
- Pressing button **A** up increases Intermittent wipe frequency and wipe speed. Pressing button down decreases frequency of wipes

Lifting Wipers (Wiper Service Mode)

To lift the windshield wipers to clean windshield, inspect or replace wiper blades or raise wipers in snow/ice conditions without damaging the hood, the blades need to be moved to the service position **C**.

With the ignition ON, turn the ignition OFF, and within 20 seconds move the wiper switch to the MIST position **B** and hold the switch for more than two seconds until the wiper blade is in the fully up position.

To return wipers to normal position, turn the ignition ON, then activate MIST.

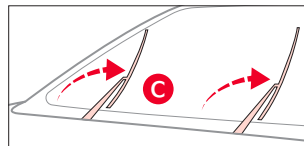

See section 4 in the Owner's Manual for more information.

QR CODES

Wipers and Wiper Stalk Video



Wiper Service Mode Video



Refer to the inside front cover for more information on QR codes.
www.youtube.com/KiaFeatureVideos

Power Tilt/Telescoping Steering Wheel*† 26

Adjust the steering wheel angle **B** and position **C** with the switch **A** on the steering column. Move the steering wheel so it points towards your chest, not toward your face. Make sure you can see the instrument panel warning lights and gauges.

After adjusting, push the steering wheel both up and down to be certain it is locked in position. Always adjust the position of the steering wheel before driving.

REMINDER: To prevent discharge from the battery, do not adjust when the engine is OFF.

Do not adjust the steering wheel while driving as this may cause you to lose control of the vehicle. See section 4 in the Owner's Manual for more information.

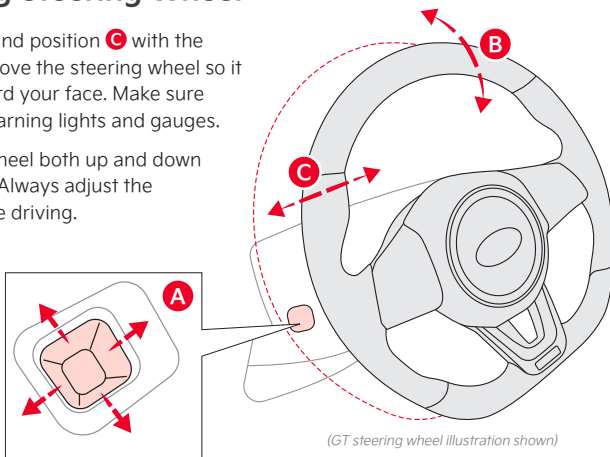

STEERING WHEEL CONTROLS

Manual Tilt/Telescoping Steering Wheel*† 26

To adjust the Steering Wheel manually, push the lock-release lever **D** down and adjust to the desired angle **B** and distance **C**.

When finished, pull the lock-release lever **D** up to lock Steering Wheel in place.

QUICK TIP

- It may be helpful to pull/push the bottom of the Steering Wheel towards/away from you to adjust desired distance prior to adjusting the angle

Do not adjust the steering wheel while driving as this may cause you to lose control of the vehicle. See section 4 in the Owner's Manual for more information.

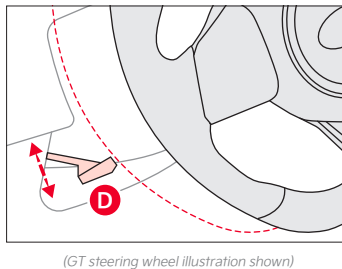

Heated Steering Wheel*

While the Engine Start/Stop button is in the ON position, press **E** to turn the steering wheel heater ON. The button indicator will illuminate.

The steering wheel heater will turn off automatically in 30 minutes, or when the button is pressed again to deactivate.

REMINDER: If the steering wheel becomes too warm, turn the system off. The heated steering wheel may cause burns even at low temperatures, especially if used for long periods of time.

See section 4 in the Owner's Manual for more information.

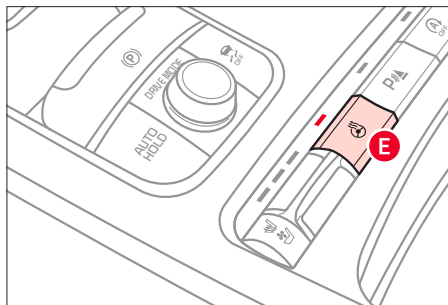

Audio Controls† 24

- A Audio System MODE button:** Press to cycle through FM/AM/SiriusXM®^{†23}/Media/*Bluetooth*®^{†15} Audio
Audio System ON/OFF: Press to turn power on; Press and hold to turn power off. Press and hold to go to Advanced Setting / Steering Wheel mode (UVO link with Navigation)
- B Seek/Preset buttons:**
- FM/AM/SiriusXM® Mode: Press to advance through preset stations. Press and hold to auto seek
 - Media Modes: Press to move track up/down. Press and hold to fast forward/rewind (except for *Bluetooth*® Audio)
- C Volume buttons:** Press up/down arrows to raise/lower volume
Mute button: Press to mute all audio (Media pauses in some Media modes when pressed)

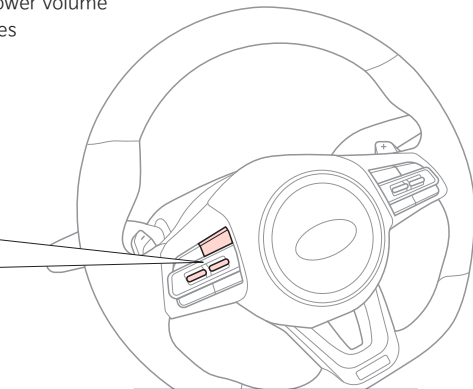
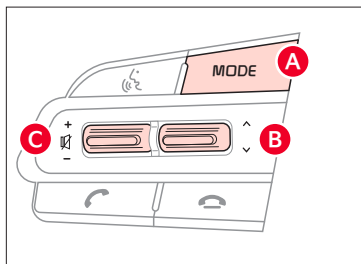

QUICK TIP

- Pressing the Audio System Mode button for more than 1 second will turn Audio Mode ON/OFF.

REMINDERS:

- Your vehicle's steering wheel buttons may differ from those in the images. See your Owner's Manual for more details
- Driving while distracted is dangerous and should be avoided. Drivers should remain attentive to driving and always exercise caution when using the steering-wheel-mounted controls while driving
- To help minimize driver distraction, some audio system functionalities have been modified while the vehicle is in Drive, Reverse or moved out of Park

Driving while distracted is dangerous and should be avoided. Drivers should remain attentive to driving and always exercise caution when using the steering-wheel-mounted controls while driving. To help minimize driver distraction, some audio system functionalities have been modified while the vehicle is in Drive, Reverse or moved out of Park.

For more information, refer to the Car Infotainment System User's Manual. For other audio system information, refer to pages 34-39.

Bluetooth® Wireless Technology† 5

- A Volume button:** Press up/down to raise/lower speaker volume
- Mute button:** Press to mute the microphone during a call and to mute the audio system speakers, or to pause Bluetooth® streaming media
- B Talk button:** Press to activate voice recognition / bring up menus/place calls with minimal voice command prompts from the system. Press and hold to exit voice recognition
- C Receive/Place Call button:** Press to place/receive/answer incoming calls. Press to pair a phone if not phone is paired
- D End Call button:** Press to end a call or cancel a function

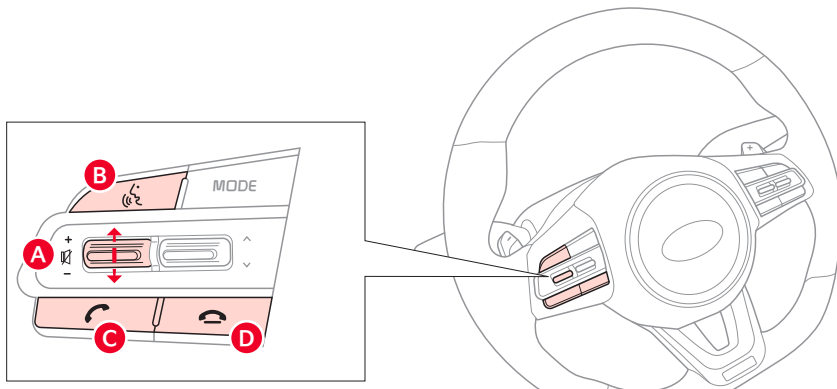

QUICK TIPS

- When using the voice command feature, wait for the system BEEP before speaking the command
- Phone book transfer upload time varies by phone model and with number of phone book entries
- Because of differences in phone quality, service providers and Bluetooth® wireless technology chip programming, functionality may differ from one phone to another
- Bluetooth® Wireless Technology audio and calling functions are supported when connected to a Bluetooth® enabled device

Your vehicle's steering wheel buttons may differ from those in the image. See your Owner's Manual for more details.

Driving while distracted is dangerous and should be avoided. Drivers should remain attentive to driving and always exercise caution when using the steering wheel mounted controls while driving.

For more information, refer to the Car Multimedia System User's Manual. For Bluetooth® wireless technology FAQs, go to www.kia.com, Owners section.

Bluetooth® Wireless Technology^{† 5} (Continued)

Pairing a Phone

For instructions on how to pair a phone, refer to the audio system's user's guide.

How to Place a Call

There are two options for placing a call:

- Option 1: Press the Receive/Place Call button **C** to place a call using the touchscreen
- Option 2: Press on the Talk button **B**. Then say the command "Call {name}" or "Dial {number}"

When using the voice command feature, wait for the system BEEP before speaking the command.

Voice Recognition and Phone Contact Tips

The system may have difficulty understanding some accents or uncommon names. Improve the performance by making a few simple changes to your phone contacts, listed below. To help optimize the Bluetooth® Wireless Technology Voice Recognition system, see other tips and reminders under Quick Tips.

- Use full names (first and last names) vs. short or single-syllable names ("John Smith" vs. "Dad," "Smith Residence" vs. "Home")
- Avoid using special characters, emojis or hyphenated names (@, &, #, /, -, *, +, etc.)
- Avoid using acronyms ("In Case of Emergency" vs. "ICE") or words with all capital letters
- Spell words completely, no abbreviations ("Doctor Smith" vs. "Dr. Smith")

QUICK TIPS

- The system can register or pair multiple Bluetooth® devices. See the Car Multimedia System User's Manual for more information on setup and limitations
- During the pairing process, be sure to accept the connection requests on the phone for phone book download and to allow acceptance of all future Bluetooth® connection requests
- When placing a call, speak in a natural, moderate tone, with clear pronunciation. The system may have trouble recognizing commands if you speak too softly or too loudly
- Always wait for the beep before speaking any commands
- Close windows and sunroof and turn off A/C; open windows, sunroof, weather (wind/rain), or an A/C fan operating at higher speeds can interfere with Voice Recognition
- Press the talk button and say "Help" to get a list of available commands

QR CODE

Voice Recognition Tips Video



Refer to the inside front cover for more information on QR codes.
www.youtube.com/KiaFeatureVideos

UVO link Activation*† 1

Follow these steps to activate your UVO link system:

1. Enter the activation screen on your vehicle's head unit:
 - a. Press SETUP key
 - b. Press UVO icon
 - c. Press Activate UVO
2. Read and agree to Terms of Service and Privacy Policy and press SUBMIT
3. Enter number or email address to receive a verification code, then press SUBMIT
4. Follow these steps to receive your verification code using your phone text message or e mail:
 - a. Check your phone text message or email for verification code
 - b. Open the link in your text message or email. A page will open requesting that you create your account

Note: If you already have a Kia Owners Portal account using the email or phone number as your login ID, you will need to provide your password prior to receiving the verification code

- c. Enter your first name, last name, email, phone number, and account password, and click CREATE ACCOUNT. A page will open displaying your verification code
- d. Enter the code in the head unit and press ACTIVATE
- e. Go back to the page with your verification code and press "I have entered my verification code." A link will be provided to download the Kia Access with UVO link app from your app store. After installing the app, log in and enjoy

REMINDER: This vehicle is not equipped with over-the-air system updates

Driving while distracted can result in a loss of vehicle control that may lead to an accident, severe bodily injury, and death. The driver's primary responsibility is in the safe and legal operation of a vehicle, and any handheld devices, other equipment, or vehicle systems which take the driver's eyes, attention and focus away from the safe operation of a vehicle or which are not permissible by law should never be used during operation of the vehicle.

UVO link is currently unavailable for model year 2022 vehicles sold or purchased in Massachusetts. See UVO Terms of Service at owners.kia.com for more information. For further UVO link operations, refer to the Car Infotainment System Quick Reference Guide.

UVO Assistance*

UVO Voice Local Search **A** - Press to connect to the search function to find points of interest or other locations, like "cafe"

Roadside Assist **B** - Press to connect to a Roadside Assistant where you can request vehicle towing services

For more information, refer to the Car Infotainment System Quick Reference Guide.

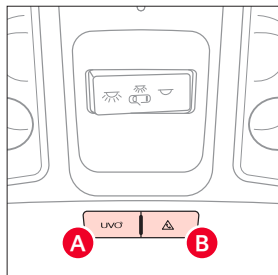

(Buttons located on the overhead room lamp console area)

QR CODES

Kia Access with UVO link App Video



UVO Assistance Video



Refer to the inside front cover for more information on QR codes.
www.youtube.com/KiaFeatureVideos

Kia Access with UVO link App Download

Go to an app marketplace to download the new Kia Access with UVO link App. Once you download, make sure you register your vehicle and start an account (refer to UVO link Activation page). Get to know your new Kia and the available convenient features on the app.

QUICK TIPS

- The smartphone and vehicle need to be connected to a cellular network with good wireless signal strength in order to use UVO. If these conditions are not met, remote command may not execute or takes a long time. It will also affect voice commands
- To use Remote Start or Remote Start with Climate Control feature, all doors, hood and trunk/liftgate must be closed and locked
- Activate Remote Start or Remote Start with Climate Control feature at least 10 minutes before getting into the vehicle, which will allow vehicle interior to reach a desired temperature. If the driver does not enter the vehicle within the 10 minutes, the Remote Start will turn off the engine
- The quickest way to obtain accurate vehicle status through the app is by pressing the refresh button on the app or refreshing the web page when using the customer web portal
- In order to preserve the vehicle battery, UVO will not turn on seven days after the last ignition was on. You will need to restart the vehicle with a key fob in order to use UVO again



QR CODES

Download the **Kia Access with UVO link App** by clicking this dynamic QR code. Some phone's operating systems may need to be updated to scan dynamic QR codes.



Kia Access with UVO link App Features Guide. Click this dynamic QR code to access the guide. Some phone's operating systems may need to be updated to scan dynamic QR codes.



Kia Access with UVO link App Features Guide

The Kia Access with UVO link App Features Guide is a step-by-guide helping you utilize the app to its full potential by detailing how to set up and use each feature and adjust various settings. Below are some of the topics included:

- Remote Commands
- Set Climate
- Schedule Service

Kia App Screen for illustrative purposes only. Actual App screen and functionality may vary.

UVO link is currently unavailable for model year 2022 vehicles sold or purchased in Massachusetts. See UVO Terms of Service at owners.kia.com for more information.

For further UVO link operations, refer to the Car Infotainment System Quick Reference Guide.

Android Auto™ † 3 / Apple CarPlay® Setup † 4

Android Auto™ compatible smartphone setup - Download the Android Auto™ app from the Google Play™ Store.^{†11} Open the Android Auto™ app and proceed with the onscreen instructions to complete setup on the mobile device.

Wireless Connection setup for Android Auto™ & Apple CarPlay® (Standard Audio System & Standard Audio System-Value with UVO link):

1. Press the SETUP key on the audio head unit
2. Press DEVICE CONNECTION SETTINGS
3. Press PHONE PROJECTION, then ADD NEW

Cable Connection setup for Android Auto™ (Standard Audio System, Standard Audio System-Value & UVO link with Navigation):

1. Press the SETUP key on the audio head unit
2. Press DEVICE CONNECTION, select Android Auto™ and then select ENABLE ANDROID AUTO. Review all terms, conditions and requests on the head unit and phone, and, if you agree, accept them in order to use Android Auto™
3. Connect the Android™ device with the vehicle's USB port using the manufacturer's cable provided with your phone
4. From the vehicle's home screen, select the Android Auto™ button, where you'll see all the Android Auto™ supported apps

Cable Connection setup for Apple CarPlay® (UVO link with Navigation only):

1. Connect the Apple CarPlay® compatible iPhone®^{†13} with the vehicle's USB port using the manufacturer's cable provided with your iPhone®^{†13}
2. Press the SETUP key on the audio head unit
3. Press DEVICE CONNECTION on the screen and select Apple CarPlay®
4. Select ENABLE APPLE CARPLAY®. Review all terms, conditions and requests on the head unit and phone, and, if you agree, accept them in order to use Apple CarPlay®
5. From the audio head unit home screen, select the Apple CarPlay® button, where you'll see all the Apple CarPlay® supported apps

QUICK TIPS

If Android Auto™ / Apple CarPlay® Randomly Disconnects:

- Ensure the USB cable is certified by the phone manufacturer for both power and data
- Clean the phone's port, which the USB cable connects to, with disposable compressed air
- The Phone should not be disturbed while driving as this can cause a disconnection at the phone's USB port
- Visit the phone manufacturer's website for Android Auto™ / Apple CarPlay® app concerns

REMINDERS:

- Android Auto™ compatibility requirements for connection:
 - UVO link with Navigation (USB cable connection only): OS Android™ 5.0 or higher, phone manufacturer's USB cable and data plan with applicable feature(s)
 - Standard Audio System-Value (USB cable & wireless connection)
 - USB cable connection - OS Android™ 5.0 or higher, phone manufacturer's USB cable and data plan with applicable feature(s)
 - Wireless connection - OS Android™ 9.0 or higher with data plan for applicable feature(s)
- Apple CarPlay® compatibility requirements for connection:
 - UVO link with Navigation (USB cable connection only): iOS software 8.0 or higher, phone manufacturer's USB cable and data plan for applicable feature(s)
 - Standard Audio System-Value (wireless connection only): iOS software 10.0 and higher with data plan for applicable feature(s)
- It is recommended to always update your phone to the latest operating system release
- Wireless Android Auto™ system only works for certain Android models. Use the manufacturer's USB cable when wireless feature is not available

QR CODE

Wireless Apple CarPlay® & Android Auto™ Video



Refer to the inside front cover for more information on QR codes.
www.youtube.com/KiaFeatureVideos

Driving while distracted can result in a loss of vehicle control that may lead to an accident, severe bodily injury, and death. The driver's primary responsibility is in the safe and legal operation of a vehicle, and any handheld devices, other equipment, or vehicle systems which take the driver's eyes, attention and focus away from the safe operation of a vehicle or which are not permissible by law should never be used during operation of the vehicle.

Refer to the Car Infotainment System Quick Reference Guide for more information.

UVO link⁺¹ with Navigation⁺¹⁵ — FM/AM/SiriusXM^{®+23}/Media (Multimedia USB, Bluetooth[®] Audio)

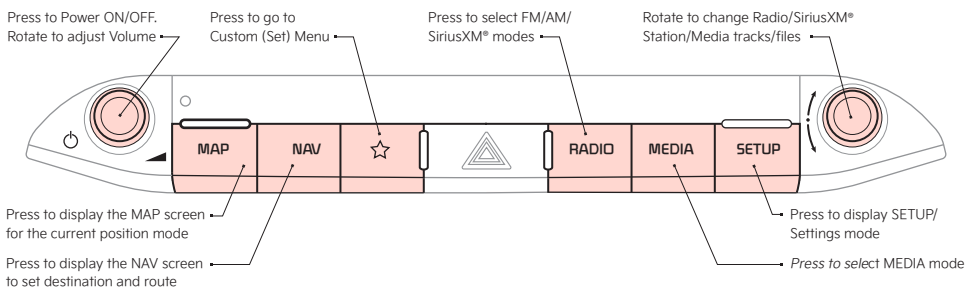

Sound Settings - To adjust the sound settings:

1. Press the SETUP key on the audio head unit
2. Select the on-screen SOUND button
3. Select the menu item (Position, Volume Levels, Tone, Priority, Navigation, Advanced, Default)
4. Use the onscreen buttons to adjust settings

Radio Presets - You can listen to FM, AM and SiriusXM radio and save frequently used stations.

How to Save a Preset - Press and hold the desired slot. This saves the current station in the selected slot

SiriusXM Smart Favorites - For the first 10 favorite SiriusXM channels, you may play live or repeat from the beginning of a song or a program segment.

In Radio mode, choose **SiriusXM**, then select any of the first ten favorites. During song or program play, tap the **Skip Backward** icon to start from the beginning of the song or program. Tap the **Play Live** icon to return to the live broadcast.

Custom Key ☆ is a programmable key to provide quick access to one of several available system features.

To Program the Custom Key: Press and hold the Custom Key. Select one of the available features you would like the Custom Key to open.

QUICK TIPS

- Volume level between different audio modes: When switching between audio modes (AM, FM, Bluetooth[®] Audio, etc.), the audio system saves the previous volume level you were listening to. For example, if you were listening to FM radio at volume level 20 then switched to Bluetooth[®] Audio and adjusted the volume level to 30, the volume level will be at 20 when you switch back to FM radio
- When connected to Android Auto[™] or Apple CarPlay[®] on your smartphone, the smartphone's navigation system may also be available
- This system supports Android Auto[™] and Apple CarPlay[®] (USB connection only)
- A warning screen may appear periodically to remind users that the navigation system should be operated when the engine is running to prevent battery discharge
- At any time, you can interrupt UVO link Command Feedback by pressing the TALK button on the steering wheel

QR CODE

UVO link with Navigation Video



Refer to the inside front cover for more information on QR codes.
www.youtube.com/KiaFeatureVideos

REMINDERS:

- To help minimize driver distraction, some audio system functionalities have been modified while the vehicle is in Drive, Reverse or moved out of Park.
- Prolonged use of the audio head unit in ACC mode may drain the vehicle's battery

Your vehicle's audio system may differ from that in the illustration.

UVO link is currently unavailable for model year 2022 vehicles sold or purchased in Massachusetts. See UVO Terms of Service at owners.kia.com for more information.

For further UVO link with Navigation operations, refer to the Car Infotainment System Quick Reference Guide.

For other audio system information, see pages 33-38.

Multimedia Ports, Power Outlets & USB Charger Ports

Power Outlets (A): Use the power outlets for mobile phones and other devices designed to operate on a 12V (180W max) power outlet.

Multimedia Ports (B): Use the Aux port to connect audio devices and the USB port to connect USB audio devices and smartphones.

USB Charger Ports (C): Devices can be recharged using a USB cable. The Engine Start/Stop button needs to be in the ACC/ON/START position to operate the USB Charger.

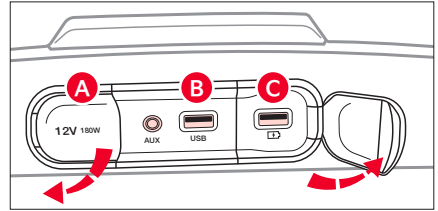

(Located in center console in front of gearshift)

QUICK TIPS

- The power outlets are inactive when ignition is in the OFF position
- USB data port is located next to the Power Outlets (B). USB Charger does not support data transfer

See section 4 in the Owner's Manual for more information.

REMINDERS:

- Using the power outlets (accessory plugs) for prolonged periods of time with the Engine Start/Stop button in the ACC position (Engine OFF) may cause the battery to discharge
- Only use manufacturer cables that came with your device as third party cables may cause damage to the device. It is recommended to always update your phone to the latest operating system release

Digital Clock

Select SETUP key on audio head unit. Then scroll to and select DATE/TIME, and adjust.

Refer to the Car Multimedia System User's Manual for more information.

REMINDERS:

- Daylight Saving must be enabled or disabled in the Clock Settings screen.
- To access manual date and time setting, turn GPS Time OFF in the Clock Settings (UVO eServices with Premium Navigation*)

Wireless Smartphone Charging System

1. Enable Wireless Charging in the User Settings, Convenience menu
2. Slide open tray cover **A**. Place compatible smartphone on the center of the charging pad **B**
3. Indicator light **C** may change to amber once the wireless charging begins
4. Once charging is complete, the orange light **C** may change to green

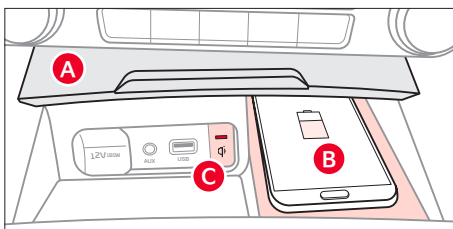

(Located in center console in front of gearshift)

QR CODE

Wireless Charging Video



Refer to the inside front cover for more information on QR codes.
www.youtube.com/KiaFeatureVideos

See section 4 in the Owner's Manual for more information.

QUICK TIPS

- For wireless charging to occur, all doors (excluding rear hatch) must be closed and the Smart Key Fob must be detected inside the vehicle
- For best results, place smart-phone on the center of the charging pad
- If wireless charging does not work, move smartphone around the pad until the charging indicator turns amber.
- Avoid placing other metal items in the bin while charging as to not impede the charging area

REMINDERS:

- If driver door is opened, charging will be disabled. All doors must be closed
- The smartphone must be a compatible phone with Qi function available
- Avoid placing other metal items in the bin while charging as to not impede the charging area
- Wireless charging technology allows for a device to be charged using inductive charging. See your Owner's Manual for more detailed information and the back page for legal disclaimers
- Inductive charging systems are less efficient than conventional charging through cable. As a result, higher device operating temperatures may be experienced during use
- Charging Performance - Device position on the wireless charging system can affect charging performance. Other factors that may affect the charging rate includes foreign objects, such as coins or pens, and phone case thickness

Idle, Stop and Go (ISG) System

The ISG system is designed to reduce fuel consumption by automatically shutting down the engine when the vehicle is at a standstill.

When the ISG system is ON and the vehicle is at a standstill the engine will stop, and the green AUTO STOP indicator (A) on the instrument cluster will illuminate.

The engine will restart when the brake pedal is released or the shift lever is moved from D (Drive) to the R (Reverse) position or to Manual Shift mode*. When the engine restarts, the green AUTO STOP indicator on the instrument cluster will turn off.

To deactivate the ISG System, press the ISG OFF button (B). If you press again, the system will be activated.

For more information on Idle, Stop and Go System, refer to section 5 in the Owner's Manual or contact your local dealership.

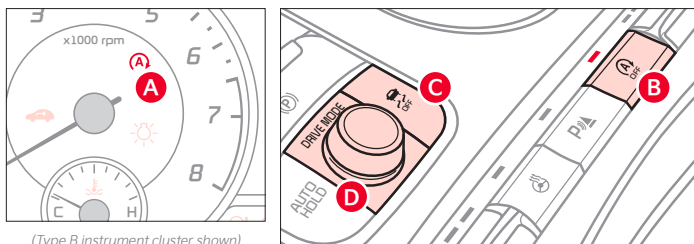

QUICK TIPS

- The ISG system is disabled when:
 - A seat belt is unfastened
 - The hood or a door is opened
 - Battery condition is poor
 - The front or rear defroster is turned on
 - Engine coolant temperature is low
 - The outside ambient temperature is too low/high
 - Emission control devices activate
 - The vehicle is on a steep slope

REMINDERS:

- ISG is active by default at vehicle start-up. When ignition is cycled, ISG will turn ON again
- Under certain conditions, the engine will restart automatically even if the brake pedal is still depressed
- If the AUTO STOP indicator (A) is continuously blinking yellow and the ISG button LED is on, please contact an authorized Kia dealer

Images are for illustrative purposes only and may not reflect actual feature or operation.

QR CODES

Idle, Stop and Go Video



Launch Control Video



Refer to the inside front cover for more information on QR codes.
www.youtube.com/KiaFeatureVideos

Launch Control*

Launch control aids in controlling acceleration to help the vehicle accelerate smoothly and quickly, while avoiding slipping of the drive wheels and other engine, clutch and gearbox issues.

To turn on, press and hold the ESC OFF button (C) for more than three seconds while DRIVE MODE (D) is in SPORT Mode.

To activate, with the left foot press brake firmly while gear shift is in D (Drive) and then press the accelerator pedal fully to the floor. The LCD will display a ready status.

Refer to section 5 in the Owner's Manual for more information.

REMINDERS:

- When launching, stop vehicle and keep steering wheel straight
- Brake pedal, EPB and Auto Hold must be released for smooth launching
- Always drive safely and use caution

Automatic Climate Control System

Front Climate Control

- A** AUTO (Automatic) Climate Control button
- B** Front Windshield Defrost button
- C** Rear Window Defrost button
- D** Air Conditioning button
- E** Recirculated Air button
- F** Fresh Air button
- G** System OFF button
- H** Fan Speed Control buttons
- I** Mode Select button
- J** Climate Control System button
- K** SYNC (Synchronize All Zones) Temperature Control button

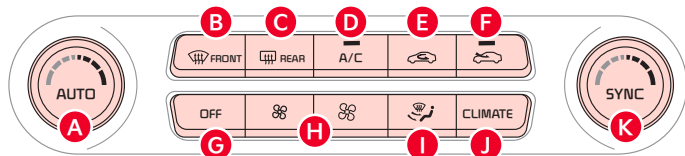

Climate Control Auto Function

Press AUTO **A** to select full auto operation. In AUTO mode the driver and front passenger have full control of their own temperature zones. The mode, fan speed, air intake and air conditioning will activate and adjust accordingly to achieve the temperature settings for each zone.

To set temperatures:

- Turn **A** to set the driver's zone temperature
- Turn **K** to set the front passenger's zone temperature

Dual-Zone Climate Control

Pressing the SYNC button **K** synchronizes both climate control zones (driver and passenger) to the driver's temperature control.

Air Flow Modes

To select air flow modes, press the Mode Select button **I**.

-  Face-Level
-  Floor-Level
-  Bi-Level
-  Floor/Defrost-Level

REMINDERS:

- Continuous use of the climate control system in the recirculated air position may allow humidity to increase inside the vehicle which may fog the glass and obscure visibility
- When in AUTO mode, Air Flow Mode and Fan Speed do not display on the Climate Control Display
- Warm or cold outside air may flow in through vents if Recirculated Air button is not pressed ON (LED lit)

See section 4 in the Owner's Manual for more information.

QR CODES

Automatic Climate Control Operation Video





Auto Defogging System (ADS) Video



Refer to the inside front cover for more information on QR codes.
www.youtube.com/KiaFeatureVideos

Auto Defogging System

Auto defogging is designed to reduce the fogging up of the inside of the windshield by automatically sensing the moisture of the inside of the windshield. The system will automatically change to defrost mode when needed.

Auto Defogging is set ON by default. To cancel Auto Defogging, press the Front Defrost button  for three seconds, when the ignition is in on (ADS OFF icon will illuminate). To turn Auto Defogging on again, press the Front Defrost button  for three seconds.

Defrost Outside Windshield

1. Set fan speed to the highest position **H**
2. Set temperature to hot **A**
3. Press the front defrost button **B**

Defog Inside Windshield

1. Set Fan Speed to highest position
2. Set Temperature to highest position
3. Press the front defrost button **B**

Automatic Transmission (Shift by Cable* / Shift by Wire*) and Manual Shift Mode (Shift by Cable only)

To shift into any gear from Park, depress the brake pedal, then press the Unlock button **A**, located on the side of the gear shift lever, and shift.

P: Park - To shift into Park from any gear, press the P button **B** on the gear shift while vehicle is stationary and the brake pedal is depressed (Shift by Wire only).

R: Reverse - To shift into Reverse from Drive, depress the brake pedal, press the Unlock button **A**, and move the shift lever forward twice to skip over Neutral and into Reverse.

N: Neutral

D: Drive

Paddle Shifters: With the gear shift in Drive, pull the paddle shifter to manually change gears.

[+]: Manual Mode Upshift*

[-]: Manual Mode Downshift*

QR CODE

Automatic Transmission Control (Shift by Wire) Video



Refer to the inside front cover for more information on QR codes.
www.youtube.com/KiaFeatureVideos

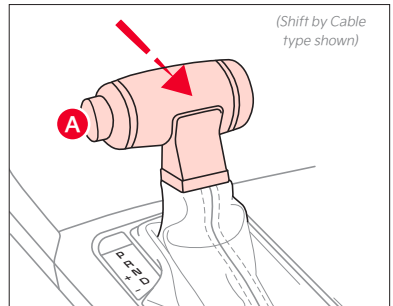
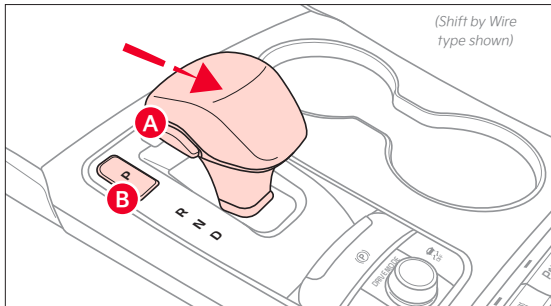

QUICK TIPS

- Press the Unlock button **A** when shifting from P (Park) to any gear
- The instrument cluster and the light on top of the shift lever identifies the gear the vehicle is currently in

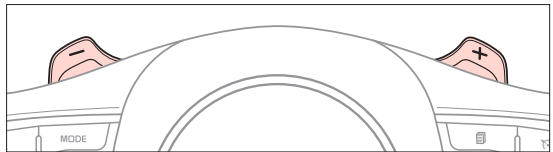

(Paddles on rear side of steering wheel)

REMINDERS:

- Press and hold the [+] right paddle shifter to return to Automatic mode (Shift by Wire* only)
- When in Manual Shift mode, pulling the left and right paddle shifters at the same time will NOT shift gears
- When in P (Park), if the Unlock button is not pressed while shifting, the transmission does not shift
- If the vehicle is turned off while in Neutral without shifting into Park, it will remain in Neutral until the driver's door is opened. At that point it will automatically shift into Park
- If going through a car wash, remind the attendant to keep the vehicle in Neutral (N) and keep the engine running. Also, disable the power liftgate lid control, turn off the auto rain sensing wipers and fold in the mirrors

See section 5 in the Owner's Manual for more information.

Auto Hold

Auto Hold temporarily maintains the vehicle at a standstill even if the brake pedal is not depressed after the driver brings the vehicle to a complete stop by depressing the brake pedal. Auto Hold can be turned On/Off using the AUTO HOLD switch **A** on the center panel. Before Auto Hold will operate, the driver's door, engine hood and liftgate must be closed and the driver's seat belt must be fastened.

Depress the brake pedal, start the engine and then press the AUTO HOLD switch **A**. The white Auto Hold indicator will come on indicating the system is in standby.

The Auto Hold indicator, which is in the instrument cluster, has four states:

White: Standby - When vehicle is in Park and at a standstill, and AUTO HOLD switch **A** turned ON, the indicator will illuminate white. While driving the vehicle (vehicle is not at a standstill), the Auto Hold indicator will remain white.

Green: Engaged - When coming to a complete stop by depressing the brake pedal, the Auto Hold indicator changes from white to green.

OFF (not illuminated) - The indicator will turn OFF when the AUTO HOLD switch **A** is manually turned OFF or when the EPB is manually turned ON.

Yellow: Malfunction - When the indicator is illuminated yellow, there may be a system malfunction. Take your vehicle to a local Kia dealer.

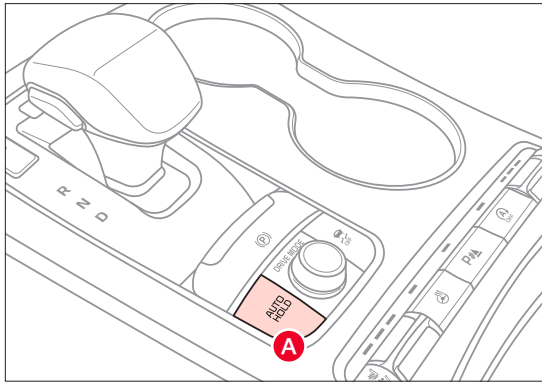

QR CODE

Electric Parking Brake / Auto Hold Video



Refer to the inside front cover for more information on QR codes.
www.youtube.com/KiaFeatureVideos

REMINDERS:

- To reduce the risk of an accident, do not activate Auto Hold while driving downhill, backing up or parking your vehicle
- Do not solely rely on the Auto Hold system to keep the vehicle stopped. Always pay attention to traffic and road conditions, and be prepared to depress the brakes

See section 5 in the Owner's Manual for more information.

Electric Parking Brake (EPB)*

The Electric Parking Brake (EPB) system utilizes an electric motor to engage the parking brake.

Applying the Parking Brake

Depress the brake pedal and pull up the EPB switch **A**. Ensure that the indicator light **EPB BRAKE** is illuminated on the instrument cluster.

Releasing the Parking Brake

The EPB will automatically release when the shifter is placed in Reverse or Drive. To release EPB manually, depress the brake pedal, then press the EPB switch **A**, with the ignition switch in the ON position. Ensure that the indicator light **EPB BRAKE** is OFF.

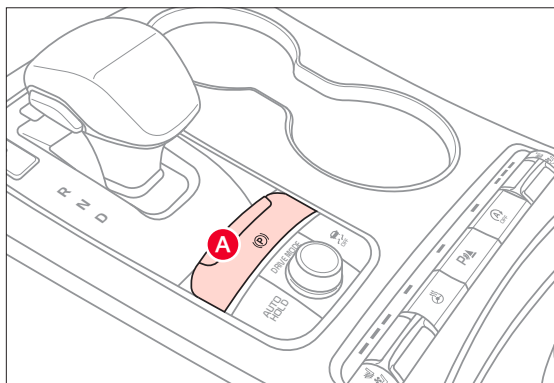

QR CODE

Electric Parking Brake / Auto Hold Video



Refer to the inside front cover for more information on QR codes.
www.youtube.com/KiaFeatureVideos

QUICK TIPS

- Pull up and hold EPB switch again to increase brake pressure if parked on a decline or incline
- When leaving your keys with parking lot attendants or valet, make sure to inform them how to operate the EPB
- If parked on a steep incline, pull up the EPB switch for more than 3 seconds for a firmer EPB application

REMINDERS:

- The EPB malfunction indicator will illuminate for approximately 3 seconds as a bulb check when the ignition switch is turned ON
- If the warning light does not illuminate temporarily or remains continuously lit, take your vehicle to an authorized Kia dealer and have the system checked
- The EPB should not be operated while the vehicle is moving
- A click or electric brake motor sound may be heard while operating or releasing the EPB. These conditions are normal and indicate that the EPB is functioning properly
- EPB will not release unless the hood, liftgate and all doors are closed and seat belts are fastened

See section 5 in the Owner's Manual for more information.

Seat Warmers^{† 22} / Ventilated Seats*

Front Seats

Seat Warmers:

- Press button **A** up once for high setting (3 LEDs lit)
- Press button twice for medium setting (2 LEDs lit)
- Press a third time for low setting (1 LED lit) and again to turn OFF

Ventilated Seats:

- Press button **B** down once for high setting (3 LEDs lit)
- Press twice for medium setting (2 LEDs lit)
- Press a third time for low setting (1 LED lit) and again to turn OFF

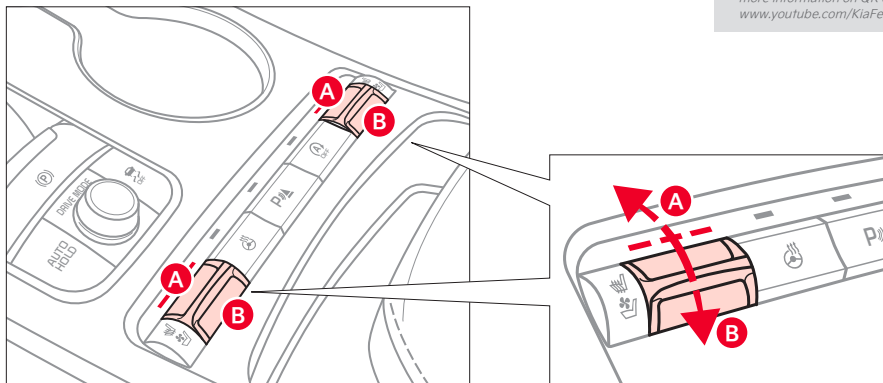

QUICK TIPS

- With the seat warmer switch in the ON position, the heating system in the seat turns OFF or ON automatically depending on the seat temperature
- When the Climate Control System's temperature is turned up to high heat, the Seat Warmers turn on automatically

QR CODE

Seat Warmers and
Ventilated Seats
Video



Refer to the inside front cover for
more information on QR codes.
www.youtube.com/KiaFeatureVideos

REMINDER: Use extreme caution when using the seat warmers to avoid burns. See section 4 in the Owner's Manual for more information.

See section 4 in the Owner's Manual for more information.

Power Adjustable Driver's Seat† 20

Move/Press controls to adjust Seat, Seat forward/backward, Seat Cushion tilt up/down, Seatback forward/backward, Lumbar up/down/forward/backward or Seat Cushion Extension forward/backward.

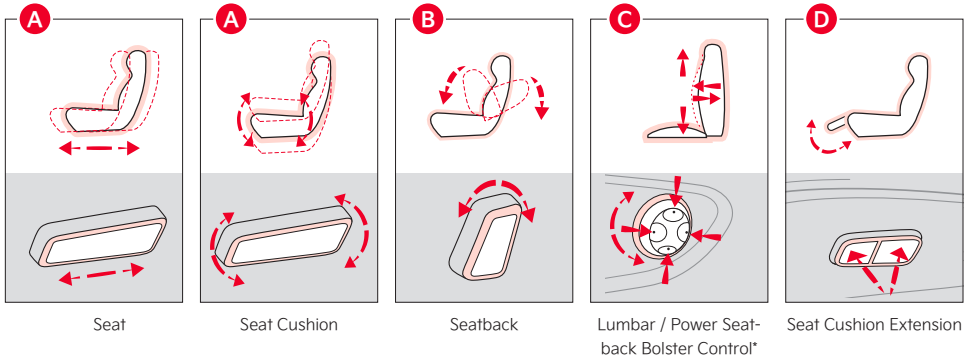
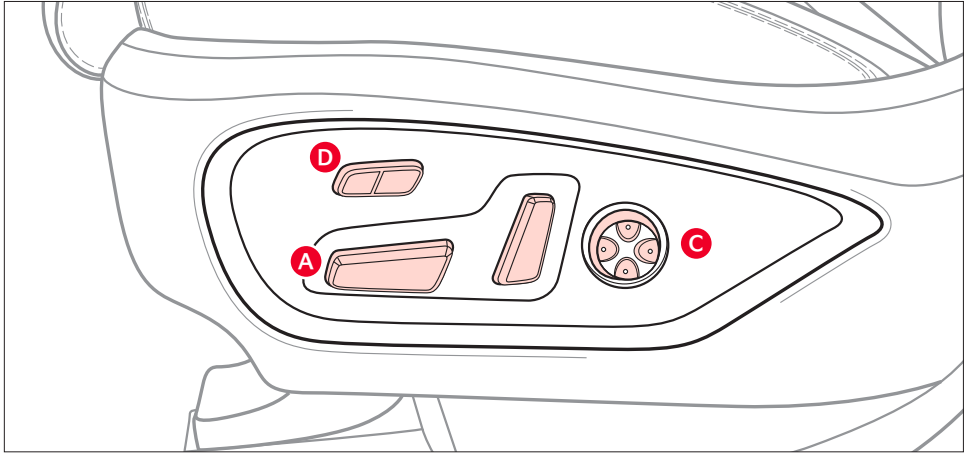

REMINDER: Do not attempt to adjust the seat while the vehicle is moving. This could result in loss of control of the vehicle.

See section 3 in the Owner's Manual for more information.

Front Seat Headrest Adjustment^{† 11}

To raise headrest: Pull headrest up.

To lower headrest: Press the lock button **A**, then press the headrest down.

QUICK TIP

- For easy adjustments, hold a headrest post with one hand while using the other hand to pull the headrest from underneath

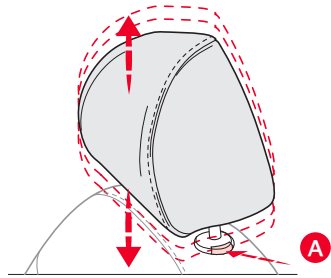

REMINDERS:

- Button may be hard to see if headrest is in its lowest position
- Do not operate the vehicle with the headrests removed. Headrests can provide critical neck and head support in an accident. Do not attempt to adjust the seat while the vehicle is moving. This could result in loss of control of the vehicle.

See section 3 in the Owner's Manual for more information.

Driver Position Memory System*

The integrated system stores into memory the position of the driver's seat, outside rearview mirrors, steering wheel positions and seat cushion extension*. To store positions into memory, first place the gear shift into P (Park) while the Engine Start/ Stop button is in the ON position. Then:

1. Adjust the driver's seat, outside rearview mirrors, settings and steering wheel positions
2. Press the SET button **B** on the control panel. System will beep once
3. Press one of the memory buttons 1 or 2 **C** within 4 seconds. The system will beep twice when memory has been stored

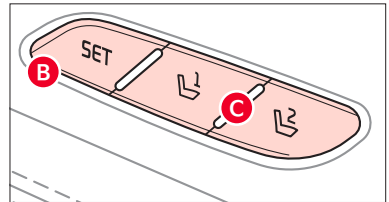

(Located on driver's door control panel)

REMANDER: Do not operate the vehicle with the headrests removed. Headrests can provide critical neck and head support in an accident.

See section 3 in the Owner's Manual for more information.

HomeLink® with Auto-Dimming Rearview Mirror*† 14

The HomeLink® / Auto-Dimming Rearview Mirror* is designed to reduce glare from a vehicle's headlights located in the rear and also connect up to three electronic transmitters into one location.

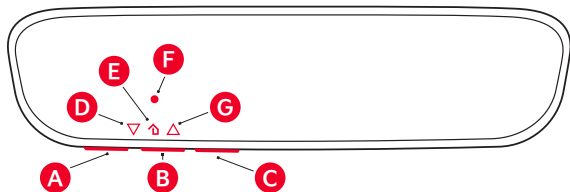

- | | |
|---|---|
| A HomeLink® Channel 1 | E HomeLink® Operation Indicator |
| B HomeLink® Channel 2 | F Garage Door Opener Status Indicator: Opening or Open |
| C HomeLink® Channel 3 | G HomeLink® User Interface Indicator |
| D Garage Door Opener Status Indicator: Closing or Closed | |

QUICK TIPS

- You can reprogram a single HomeLink button by repeating Step 2
- Erasing the programmed buttons will delete all trained transmitters

How to Sync Transmitter with HomeLink®

If programming for the first time, begin with Step 1 (repeating this step will delete all information).

To program non-rolling and rolling code garage door openers and other devices:

1. Press and hold the left **A** and center **C** buttons simultaneously until the indicator light **G** begins to flash (to reprogram buttons, skip this step)
2. Press and hold the desired button **A** **B** **C** and hold the button on the transmitter while it is approximately 1 to 3 inches away from the mirror. The HomeLink® Indicator light **F** will flash rapidly once the frequency signal has been successfully programmed

To finish programming rolling code garage door openers, complete these steps:

3. Locate the "learn" or "smart" button on the garage door's motor head unit. Press and release the button and complete Step 4 within 30 seconds
4. Firmly press and release the programmed HomeLink® button up to three times

Operating HomeLink®:

Press one of the programmed HomeLink® buttons.

Erasing programmed buttons:

Press and hold the **A** and **C** buttons simultaneously for approximately 20 seconds, and then release both buttons within 30 seconds.

QR CODE

HomeLink® Support



Refer to the inside front cover for more information on QR codes.
www.youtube.com/KiaFeatureVideos

Smart Key† 9

- A** Press to lock all doors
- B** Press to unlock driver's door. Press twice within 4 seconds to unlock all doors
- C** Press and hold for more than 1 second to unlock the Liftgate and open manually (the Smart Power Liftgate* will unlock and automatically open)

REMINDERS:

- Manual-Liftgate lid will partially open. To fully open, lift up manually
- The Liftgate unlocks when the Smart Key is within close proximity of the vehicle

- D** Press and hold more than a half a second for panic alarm. To turn off alarm, press any button
- E** Press to release mechanical key **F**

Remote Start **G:** Press for more than two (2) seconds within four (4) seconds after locking doors to start the vehicle. Press once to turn off

Driver's Door Lock/Unlock Button **H**:

To unlock door(s):

- Press button once to unlock driver's door
- Press again within 4 seconds to unlock all doors

To lock all doors:

- Press again to lock all doors

Mechanical Key:

- Use to unlock/lock driver's door:
 1. Remove door handle keyhole cover with mechanical key by pressing up into slot on bottom of cover as shown **I**
 2. Insert mechanical key **J** and turn left to unlock driver's door
 3. Insert mechanical key **J** and turn right to lock driver's door
 4. Reinsert the Mechanical Key inside the Smart Key fob
- Use to lock and unlock glove box

See section 4 in the Owner's Manual for more information.

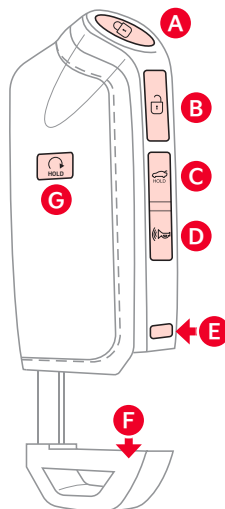

QR CODES

Kia Smart & Folding Key Fobs Video



Remote Start Video



Refer to the inside front cover for more information on QR codes.
www.youtube.com/KiaFeatureVideos

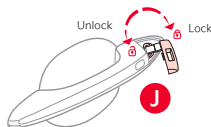

QUICK TIPS

- If the Smart Key battery is weak or not working properly, hold the Smart Key fob up to the Engine Start/Stop button (lock button side closest) and press to start engine
- The Smart Key's signal can be blocked by the normal operation of a cellular phone or smartphone. To help prevent this, store each device separately
- When reinserting the mechanical key into the fob, make sure it is pushed all the way in until there is a click sound

REMINDER: Remote button configuration may vary depending on vehicle options.

Smart Power Liftgate*† 18

The Smart Power Liftgate can be operated from several controls to either open, close or lock the Liftgate.

To turn the Smart Power Liftgate features ON, go to User Setting mode in the LCD Instrument Cluster Modes and set to ON.

The Smart Power Liftgate will close the Liftgate, lock all doors and Liftgate and then arm the vehicle.

Opening from Inside the Vehicle:

Press the Smart Power Liftgate Open/Close button* **A** to automatically open/close the Liftgate.

Opening from Outside the Vehicle:

To open the Smart Power Liftgate automatically, press the Liftgate Release handle switch **B** on exterior of the Liftgate.

Automatically close by pressing Smart Power Liftgate Close button* **C** located inside the Liftgate lid.

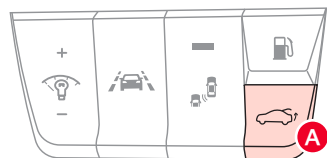

(Button located on driver's panel, left of the steering wheel)

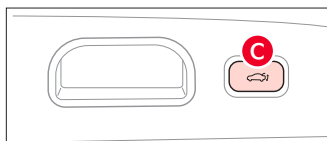

(Located inside Liftgate lid)

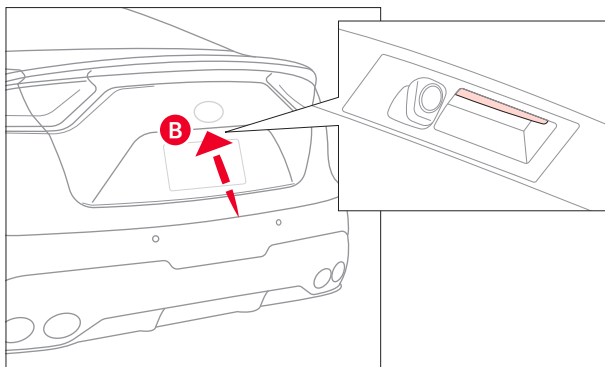

QR CODE

Smart Power Liftgate Video



Refer to the inside front cover for more information on QR codes.
www.youtube.com/KiaFeatureVideos

QUICK TIP

- To cancel the Smart Power Liftgate while automatically opening or closing, press any button on the Smart Key fob

REMINDERS:

- All doors are closed and locked after about 15 seconds
- The Smart Power Liftgate feature will not operate when the following occurs:
 - Doors are recently closed and locked
 - The Smart Key is still detected after 15 seconds near the vehicle or within 60 inches of the door handles
 - A door is not locked or closed
 - The Smart Key is in the vehicle
- Pulling the Liftgate upward by the handle or pressing the button a second time will interrupt the automatic opening of the Smart Power Liftgate

See section 4 in the Owner's Manual for more information.

Smart Power Liftgate**† 18 (Continued)

Opening with no-touch activation:

When the Smart Key fob is on your person and you are within close proximity of the back of the vehicle, the hazard lights will blink and a chime will sound for about 3 seconds as an alert that the Smart Power Liftgate is about to open.

Then the alert system will blink and chime two additional times before opening the Smart Power Liftgate.

The Smart Power Liftgate feature is OFF by default. To enable the Smart Power Liftgate, go to User Settings in the LCD Instrument Cluster modes.

Smart Key:

Using the Smart Key fob to automatically to open the Smart Power Liftgate*, press and hold the Smart Key Liftgate button **A**. Press again and hold to close.

QUICK TIPS

- The Liftgate must be unlocked before it can be opened by the Liftgate Release button
- The Liftgate unlocks automatically and then can be opened manually when the Smart Key is within close proximity to the back of the vehicle

REMINDERS:

- Smart Power Liftgate may be damaged if attempting to open or close manually
- If going through a car wash, remind the attendant to keep the vehicle in Neutral (N) and keep the engine running. Also, disable the Smart Power Liftgate lid control using the button inside the glove compartment, turn off the auto rain-sensing wipers and fold in the mirrors
- When not in use, keep the Liftgate Lid Control button in the OFF position
- Ensure all obstacles are out of the way of the Liftgate lid when operating the Smart Power Liftgate

See section 4 in the Owner's Manual for more information.

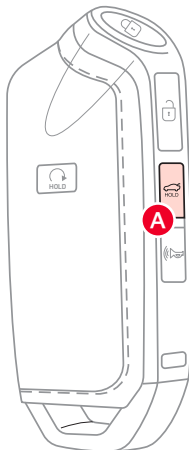

QR CODE

Kia Smart & Folding Key Fobs Video



Refer to the inside front cover for more information on QR codes.
www.youtube.com/KiaFeatureVideos

Map/Room Lamps

Automatic Turn Off Function

The interior lights automatically turn off approximately 20 seconds after the Engine Start/Stop button is turned OFF.

Map/Room Lamp Operation

Map Lamps - These lights produce spot beams for convenient use as map lamps or as personal lamps for the driver or the front passenger. Press the buttons **A** to turn the map lamps ON/OFF.

Room button - Press the button **B** to turn the front and rear lamps ON/OFF.

Door button - When the Door button **C** is pressed the front and rear lamps will turn ON as follows:

- When a door is opened or doors are unlocked with the Smart Key, the lamps will turn ON for approximately 30 seconds
- If the Engine Start/Stop button is in the ACC/OFF position and a door is open, the lamps will stay ON for approximately 20 minutes
- If the Engine Start/Stop button is in the ACC/ON position and a door is open, the lamps will stay ON

The lamps will turn OFF immediately if the Engine Start/Stop button is turned ON or all doors are locked.

QUICK TIPS

- When doors are unlocked by the Smart Key, the lamp turns ON for approximately 30 seconds
- If your vehicle is equipped with the theft alarm system, the interior lights automatically turn off approximately 3 seconds after the system is in armed stage
- Using interior lights for an extended period of time may cause battery discharge

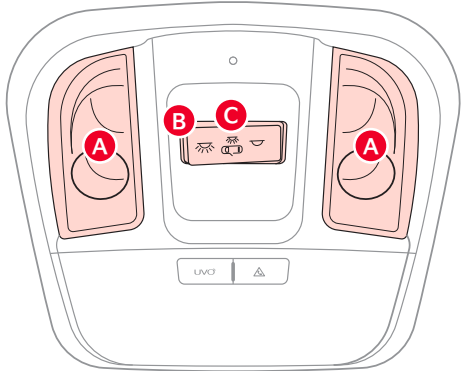

(Overhead lamp console)

REMINDER: When room lamp lens is pressed ON it will remain ON, even when the map lamp switch is in the OFF position.

See section 4 in the Owner's Manual for more information.

Sunroof Operation*

The sunroof and sunshade operation is controlled by a multi-directional switch/lever **A**. The ignition needs to be in the ON position to operate the sunroof/sunshade.

To slide the sunshade and sunroof:

Auto Open - Push the lever **A** backward to the second detent position and release.

Auto Close - Push the lever **A** forward to the second detent position and release.

To slide the sunshade only:

Auto Open - Push the lever **A** backward to the first detent position and release.

Auto Close - Push the lever **A** forward to the first detent position and release.

Slide the sunroof (with sunshade open):

Auto Open - Push the lever **A** backward to the first detent position and release.

Auto Close - Push the lever **A** forward to the first detent position and release to close sunroof glass only. Push the lever **A** forward to the second detent position and release to close sunroof glass and sunshade.

To tilt the sunroof:

Raise: Push and release lever **A** upward

Lower: Push and release lever **A** upward

Auto-close sunroof and sunshade:

Slide the lever forward to the farthest position.

QUICK TIP

- To stop the sunroof/sunshade at any position, press or pull the sunroof control lever in any direction

REMINDERS:

- Sunshade must remain OPEN while sunroof is open
- If the ignition is turned off with the Sunroof not fully closed, the Instrument Cluster LCD will display a warning message and a chime will sound for a few seconds
- Do not adjust the sunroof or sunshade while driving. This could result in loss of control of the vehicle

Your vehicle's sunroof controls may differ from that in the illustration.

See section 4 in the Owner's Manual for more information.

QR CODE

Sunroof Operation Video



Refer to the inside front cover for more information on QR codes.
www.youtube.com/KiaFeatureVideos

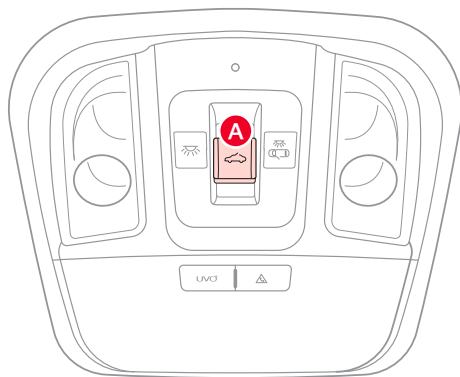

(Button located within overhead lamp console)

Sunvisor† 25

Use the sunvisor to shield direct light through the front or side windows.

Slide the sunvisor out and adjust as needed.

REMINDERS:

- Sunvisor may not shield all direct light
- Sunvisor may impair visibility if not adjusted properly
- Be aware of seating position when adjusting or swinging sunvisor around to or from the front or side windows
- Do not operate the vehicle if the sunvisor is impairing your visibility

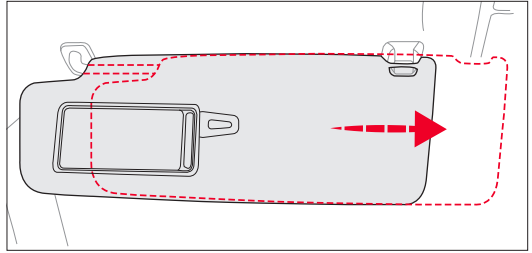

See section 4 in the Owner's Manual for more information.

Hood Release Lever and Latch

Opening the Hood:

1. Pull the hood release lever **A** to unlatch the hood
2. In the front of the vehicle, lift the hood slightly. Push the secondary latch **B** inside of the hood's center and lift the hood

Closing the Hood:

Lower the hood about halfway and then press down to securely lock in place.

See section 4 in the Owner's Manual for more information.



(Located on Driver side kick panel)

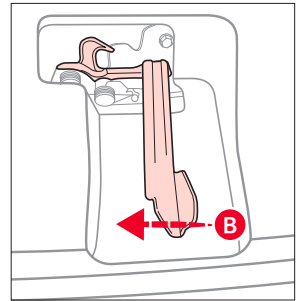

(Located inside of Hood's center)

Fuel Door Release Button

Press the Fuel Door Release button **C** to open the fuel door.

See section 4 in the Owner's Manual for more information.



(Button located on driver's panel, left of the steering wheel)

Fuel Cap / Malfunction Indicator (Check Engine Light)

Tighten for ONE CLICK to prevent malfunction indicator  from illuminating.

REMINDERS:

- The Fuel Filler Door Release button is located on the lower part of the driver's door sill
- It is normal to hear one click when tightening and for the Fuel Cap to click back when released

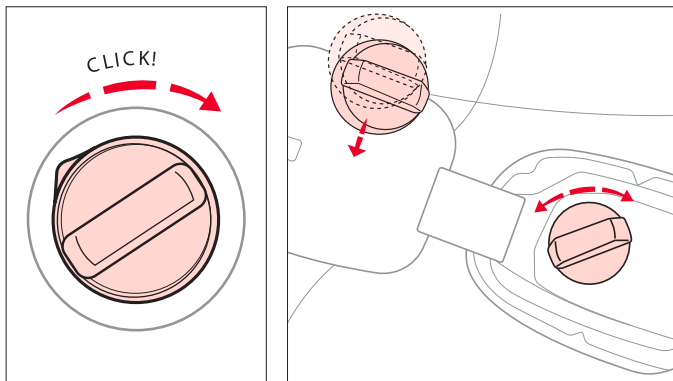

QUICK TIP

- Place the Fuel Cap on the inside of the Fuel Filler Lid when fueling

QR CODE

One-Click Fuel Cap Video



Refer to the inside front cover for more information on QR codes.
www.youtube.com/KiaFeatureVideos

See section 4 in the Owner's Manual for more information.

Seat Belts† 2,20

To properly fasten your safety belts:

Insert the belt tongue plate **A** into the buckle until it clicks

Position the lap portion of the belt across your lap as **LOW ON THE HIPS** as possible **C**. Adjust the belt to a **SNUG FIT** by pulling up on the shoulder portion **B**

Seat Belt Retractor Locks

Retractor locks allow lap/shoulder safety belts to remain unlocked during normal vehicle operation for freedom of movement and increased comfort.

During a **STRONG STOP, SUDDEN TURN OR CERTAIN COLLISIONS**, seat belt retractors will automatically lock the belts to help reduce the risk of injury.

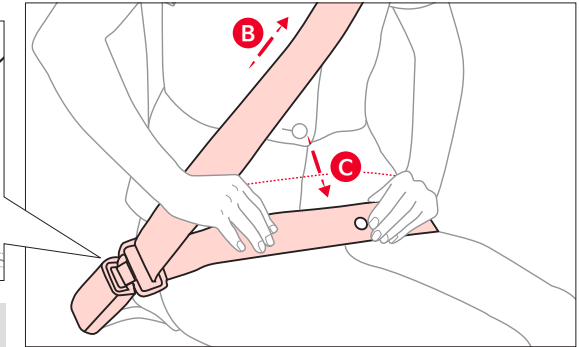
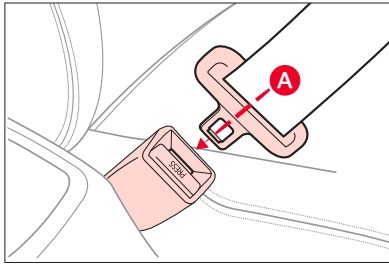

QUICK TIP

- The seat belt warning chime operates for the driver's seat only

REMINDER: For maximum protection, always wear your seatbelt

For more detailed information regarding your vehicle's safety belts, please refer to section 3 in the Owner's Manual and the separate brochure titled "Understanding Your Safety Belt & Supplemental Restraint System."

Child-Protector Rear Door Lock

Located on the rear edge of the rear passenger doors, move the Child-Protector Rear Door Lock located on the rear edge of the rear passenger doors to the lock position  to disable the inner door handles from opening the rear doors.

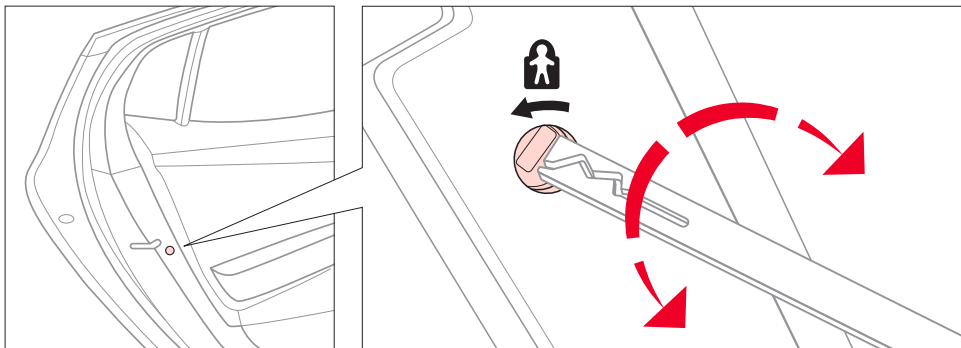

REMINDER: Child-Protector Rear Door Lock is located on rear passenger door jamb.

See section 4 in the Owner's Manual for more information.

Occupant Detection System (ODS) / Passenger Airbag Off Indicator ^{† 2,17}

ODS is designed to detect the presence and position of the front passenger and is designed to adjust or turn off airbag deployment accordingly.

Depending on the situation and type of accident, the system may:

- Deploy airbag (Adult)
- Not deploy the airbag (Unoccupied)

If the system determines that the airbag should not be deployed, the "PASSENGER AIRBAG OFF" light will illuminate .

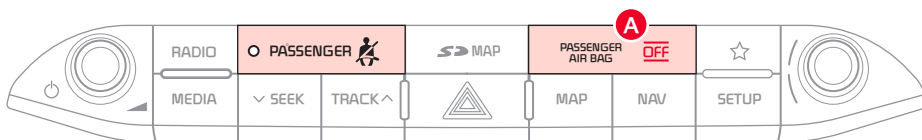

See section 3 in the Owner's Manual for more information.

STINGER SMARTSTREAM G2.5L TURBO-GDI

(up to 80,000 miles)^A

MAINTENANCE ITEMS	MAINTENANCE INTERVALS (MILES)			
	8,000	16,000	24,000	32,000
Add fuel additive ^C	P	P	P	P
Rotate tires	P	P	P	P
Engine oil and filter (Full Synthetic) ^D	R	R	R	R
Battery condition	I	I	I	I
Brake lines, hoses and connections	I	I	I	I
Brake discs and pads	I	I	I	I
Vacuum hoses	I	I	I	I
Steering gear rack, linkage & boots	I	I	I	I
Suspension ball joints	I	I	I	I
Air conditioner compressor/refrigerant	I	I	I	I
Exhaust system	I	I	I	I
Air cleaner filter (engine)	I	I	R	I
Climate control air filter	I	R	I	R
Brake fluid	I	I	I	I
Drive shafts and boots		I		I
Propeller shaft		I		I
Air intake hose	I		I	
Fuel tank air filter ^{† E}		I		I
Parking brake		I		I
Vapor hose, fuel filler cap		I		I
Fuel lines, fuel hoses and connections		I		I
Cooling System				I
Differential oil, rear (without LSD) ^F				
Differential oil, rear (with LSD) ^F				
Differential oil, front (AWD) ^F				
Spark Plugs				
Valve clearance ^G				
Drive belts ^H				

† If equipped.

- A. See the Owner's Manual for complete maintenance schedule.
- B. (next page). If necessary, adjust, correct, clean or replace
- C. Kia recommends that you use unleaded gasoline which has an octane rating of RON (Research Octane Number) 95/AKI (Anti Knock Index) 91 or higher. For owners who do not use good quality gasolines including fuel additives regularly, and have problems starting or the engine does not run smoothly, one bottle of additives should be added to the fuel tank at every 8,000 miles. Additives are available from an authorized Kia dealer. Do not mix with other additives.

- D. Check the engine oil level and leaks when stopping for fuel or before starting a long trip. As it is normal for engine oil to be consumed during driving, the engine oil level should be checked on regular basis. The engine oil change interval for normal operating conditions is based on the use of the recommended engine specification. If the recommended engine oil specification is not used, then replace the engine oil according to the maintenance schedule under severe operating conditions.

NORMAL MAINTENANCE SCHEDULE

MAINTENANCE INTERVALS (MILES)					
40,000	48,000	56,000	64,000	72,000	80,000
P	P	P	P	P	P
P	P	P	P	P	P
R	R	R	R	R	R
I	I	I	I	I	I
I	I	I	I	I	I
I	I	I	I	I	I
I	I	I	I	I	I
I	I	I	I	I	I
I	I	I	I	I	I
I	I	I	I	I	I
I	I	I	I	I	I
I	I	I	I	I	I
I	I	I	I	I	I
I	I	I	I	I	I
I	I	I	I	I	I
I	R	I	I	R	I
I	R	I	R	I	R
I	R	I	I	I	I
	I		I		I
	I		I		I
I		I		I	
	I		I		I
	I		I		I
	I		I		I
	I		I		I
	I		I		I
	I		I		I
I					I
R					R
I					I
	R				
					I
	I	I	I	I	I

P=Perform
R=Replace
I=Inspect[§]

- E. Fuel filter & fuel tank air filter are considered to be maintenance free but periodic inspection is recommended for this maintenance schedule depending on fuel quality. If there are some important safety matters like fuel flow restriction, surging, loss of power, hard starting problems, etc., replace the fuel filter immediately regardless of maintenance schedule and consult an authorized Kia dealer for details.
- F. Front/rear differential oil should be changed anytime they have been submerged in water. When replacing differential oil with LSD, use only specified LSD oil.
- G. Inspect for excessive tappet noise and/or engine vibration and adjust if necessary.
- H. Inspect alternator, water pump and air conditioner drive belt and if necessary, repair or replace. Inspect drive belt tensioner, idler and alternator pulley and if necessary correct or replace.

QUICK TIP

- Place the Fuel Cap on the inside of the Fuel Filler Lid when fueling

See your Owner's Manual for more details and complete maintenance information, including severe maintenance schedule. Warranty may be voided if maintenance schedule is not followed.

STINGER 3.3L TURBO-GDI

(up to 60,000 miles)^A

MAINTENANCE ITEMS	MAINTENANCE INTERVALS (MILES)			
	6,000	12,000	18,000	24,000
Add fuel additive ^C	P	P	P	P
Rotate tires	P	P	P	P
Engine oil and filter (Full Synthetic) ^D	R	R	R	R
Battery condition	I	I	I	I
Brake lines, hoses and connections	I	I	I	I
Brake discs and pads	I	I	I	I
Vacuum hoses	I	I	I	I
Steering gear rack, linkage & boots	I	I	I	I
Suspension ball joints	I	I	I	I
Air conditioner compressor/refrigerant	I	I	I	I
Exhaust system	I	I	I	I
Climate control air filter	I	R	I	R
Brake fluid	I	I	I	I
Air cleaner filter		I		R
Drive shafts and boots		I		I
Propeller shaft		I		I
Intercooler, in/out hose, air intake hose	I		I	
Fuel tank air filter ^{† E}		I		I
Parking brake		I		I
Vapor hose, fuel filler cap		I		I
Fuel lines, fuel hoses and connections		I		I
Cooling System				I
Differential oil, rear (without LSD) ^F				
Differential oil, rear (with LSD) ^F				
Differential oil, front (AWD) ^F				
Spark Plugs				
Valve clearance ^G				
Drive belts (first 60,000 miles, then every 12,000 miles) ^H				

[†] If equipped.

- A. See the Owner's Manual for complete maintenance schedule.
- B. (next page). If necessary, adjust, correct, clean or replace
- C. Kia recommends that you use unleaded gasoline which has an octane rating of RON (Research Octane Number) 95/AKI (Anti Knock Index) 91 or higher. For owners who do not use good quality gasolines including fuel additives regularly, and have problems starting or the engine does not run smoothly, one bottle of additives should be added to the fuel tank at every 8,000 miles. Additives are available from an authorized Kia dealer. Do not mix with other additives.

- D. Check the engine oil level and leaks when stopping for fuel or before starting a long trip. As it is normal for engine oil to be consumed during driving, the engine oil level should be checked on regular basis. The engine oil change interval for normal operating conditions is based on the use of the recommended engine specification. If the recommended engine oil specification is not used, then replace the engine oil according to the maintenance schedule under severe operating conditions.

NORMAL MAINTENANCE SCHEDULE

MAINTENANCE INTERVALS (MILES)					
30,000	36,000	42,000	48,000	54,000	60,000
P	P	P	P	P	P
P	P	P	P	P	P
R	R	R	R	R	R
I	I	I	I	I	I
I	I	I	I	I	I
I	I	I	I	I	I
I	I	I	I	I	I
I	I	I	I	I	I
I	I	I	I	I	I
I	I	I	I	I	I
I	I	I	I	I	I
I	R	I	R	I	R
I	I	I	R	I	I
	I		R		I
	I		I		I
	I		I		I
I		I		I	
	I		I		I
	I		I		I
	I		I		I
	I		I		I
	I		I		I
	I		I		I
	R				
	I				
		R			
					I
					I

P=Perform
R=Replace
I=Inspect⁸

- E. Fuel filter & fuel tank air filter are considered to be maintenance free but periodic inspection is recommended for this maintenance schedule depending on fuel quality. If there are some important safety matters like fuel flow restriction, surging, loss of power, hard starting problems, etc., replace the fuel filter immediately regardless of maintenance schedule and consult an authorized Kia dealer for details.
- F. Front/rear differential oil should be changed anytime they have been submerged in water. When replacing differential oil with LSD, use only specified LSD oil.
- G. Inspect for excessive tappet noise and/or engine vibration and adjust if necessary.
- H. Inspect alternator, water pump and air conditioner drive belt and if necessary, repair or replace. Inspect drive belt tensioner, idler and alternator pulley and if necessary correct or replace.

QUICK TIP

- Place the Fuel Cap on the inside of the Fuel Filler Lid when fueling

See your Owner's Manual for more details and complete maintenance information, including severe maintenance schedule. Warranty may be voided if maintenance schedule is not followed.

Driving while distracted is dangerous and should be avoided. Drivers should remain attentive to driving and always exercise caution when using the steering-wheel-mounted controls while driving.

Driving while distracted can result in a loss of vehicle control that may lead to an accident, severe personal injury and death. The driver's primary responsibility is in the safe and legal operation of a vehicle, and any handheld devices, other equipment or vehicle systems which take the driver's eyes, attention and focus away from the safe operation of a vehicle or that are not permissible by law should never be used during operation of the vehicle.

Safety Features: No system, no matter how advanced, can compensate for all driver error and/or driving conditions. Always drive safely.

1. **UVO link:** Purchase/lease of certain 2019 and newer Kia vehicles with UVO link includes a complimentary 1-year subscription starting from new vehicle retail sale/lease date as recorded by the dealer. After your complimentary 1-year UVO link subscription expires, continued access to the full suite of UVO link available on your Kia will require a paid subscription at the then current subscription rate or your use of certain UVO link features may immediately terminate. Use of UVO is subject to agreement to the UVO Privacy Policy (available at <https://owners.kia.com/us/en/privacy-policy.html>) and Terms of Service (available at <https://owners.kia.com/us/en/terms-of-service.html>). UVO link is transferable to subsequent owner during the original UVO link service term. Only use UVO link when safe to do so. Kia Access with UVO link App is available from the Apple® App Store® or Google Play™. Kia Motors America, Inc. reserves the right to change or discontinue UVO link at any time without prior notification or incurring any future obligation. Message and data rates may apply. Cellular and GPS coverage is required to use most features. UVO link features may vary by model, model year, and trim level. Features, specifications, and fees are subject to change. For more on details and limitations, visit <https://owners.kia.com> or your authorized Kia dealer. Apple and App Store are registered trademarks of Apple Inc. Google and logos are trademarks of Google, LLC.

UVO link is currently unavailable for model year 2022 vehicles sold or purchased in Massachusetts. See UVO Terms of Service at owners.kia.com for more information.

2. **Airbags:** For maximum protection, always wear your seat belt.
3. **Android Auto™:** Vehicle user interface is a product of Google and its terms and privacy statements apply. Requires the Android Auto app on Google Play and an Android compatible smartphone running Android™ 5.0 Lollipop or higher. Data plan rates apply. Android Auto is a trademark of Google LLC.
4. **Apple CarPlay®:** Apple® and Apple CarPlay® are trademarks of Apple, Inc., registered in the U.S. and other countries. Apple CarPlay® runs on your smartphone cellular data service. Normal data rates will apply.
5. **Bluetooth® Wireless Technology:** The Bluetooth® word mark and logos are registered trademarks owned by Bluetooth SIG Inc., and any use of such marks by Kia is pursuant to license. A Bluetooth® enabled cell phone is required to use Bluetooth® wireless technology.
6. **Driver Assist Features – Blind-Spot Collision-Avoidance Assist (BCA), Blind-Spot View Monitor (BVM), Safe Exit Assist (SEA), Rear Cross-Traffic Collision Avoidance Assist (RCCA), Lane Following Assist (LFA), Lane Keeping Assist (LKA), Forward Collision-Avoidance Assist (FCA), Forward/Reverse Parking Distance Warning (PDW), Rear View Monitor (RVM), Rear Occupant Alert, Smart Cruise Control (SCC) with Stop & Go:** These features are not substitutes for safe driving, and may not detect all objects surrounding vehicle. Always drive safely and use caution.
7. **Driver Attention Warning (DAW):** Driver Attention Warning is not a substitute for safe driving and may not detect all instances of inattentive driving practices. Failure to pay attention to travel conditions and vehicle operation could result in loss of vehicle control. Always drive safely and use caution.
8. **Electronic Stability Control (ESC)/ Traction Control System (TCS)/Hill-start Assist Control (HAC):** No system, no matter how advanced, can compensate for all driver error and/or driving conditions. Always drive safely.
9. **Engine Start/Stop Button with Smart Key:** Always come to a complete stop before turning the engine on or off. However, if you have an emergency while the vehicle is in motion and must turn the engine off, you can turn the engine off to the ACC position by pressing the Start/Stop button for more than 2 seconds or 3 times in succession. If the vehicle is still moving, you can restart the engine by pressing the Start/Stop button with the shift lever in Neutral (N). With the engine off, hydraulic power assist for steering and braking will be disabled and the vehicle will be more difficult to control.
10. **Forward Collision-Avoidance Assist (FCA) / Forward Collision Warning (FCW):** These systems are not substitutes for safe driving, and may not detect all objects in front of vehicle. Always drive safely and use caution.
11. **Front Seat Headrest Adjustment:** Never attempt to adjust headrests when vehicle is in motion.
12. **Google Play™ Store** is a trademark of Google, Inc. ©2021 Google Inc. All rights reserved. Google and the Google Logo are registered trademarks of Google Inc.
13. **Head-Up Display (HUD):** Failure to pay attention to travel conditions and vehicle operation could result in loss of vehicle control. Always drive safely and use caution.
14. **HomeLink®:** HomeLink® is a registered trademark of Gentex Corporation.
15. **iPhone®:** iPhone is a registered trademark of Apple Inc. Never use a handheld device or vehicle system that takes your focus away from safe vehicle operation.
16. **Navigation:** Distracted driving can result in a loss of vehicle control. When operating a vehicle, never use a vehicle system that takes your focus away from safe vehicle operation. Navigation is for information purposes only, and Kia does not make any warranties about the accuracy of the information.
17. **Occupant Detection System (ODS):** Kia vehicles use a number of different ODS types that vary by model.
18. **Power Liftgate* / Smart Liftgate*:** Driving with the liftgate open may be unlawful and can draw dangerous exhaust fumes into your vehicle; if you choose to do so, keep air vents and all windows open for proper ventilation.
19. **Roadside Assist:** 24-hour Enhanced Roadside Assistance is a service plan provided by Kia Motors America, Inc. Certain limitations apply. Coverage details are available in the Kia Warranty and Consumer Information Manual. For access to Enhanced Roadside Assistance, a connected mobile phone via Bluetooth® within the cellular service coverage area is required.
20. **Seat adjustments:** Reclining the passenger seats can reduce the effectiveness of the safety restraint system and may lead to additional injury in an accident.
21. **Seat belts:** For maximum protection, always wear your seatbelt.
22. **Seat warmers:** Use extreme caution when using the seat warmers to avoid burns. Refer to the Owner's Manual for more information.
23. **SiriusXM®:** SiriusXM Satellite Radio, SiriusXM Traffic and SiriusXM Travel Link each require a subscription sold separately, or as a package, by SiriusXM Radio Inc. **If you decide to continue your service at the end of your trial subscription, the plan you choose will automatically renew and bill at then-current rates until you call 1-866-635-2349 to cancel. See SiriusXM Customer Agreement for complete terms at www.siriusxm.com.** Other fees and taxes will apply. All fees and programming are subject to change. Not all vehicles or devices are capable of receiving all services offered by SiriusXM. Data displays and individual product availability vary by vehicle hardware. Current information and features may not be available in all locations, or on all receivers. Weather Forecast, Current Conditions may not be available in all locations. Images above are for representative purposes only and are not real products. For actual features and images of real products, consult the vehicle manufacturer. SiriusXM is not responsible for any errors or inaccuracies in the data services or their use in the vehicle. Travel Link Stocks displays current price and daily delta of around 7,000 actively reported securities traded on the NYSE®, NASDAQ® and AMEX®. The service is delayed approximately 20 minutes. SiriusXM satellite service is available only to those at least 18 years of age in the 48 contiguous USA, DC, and Puerto Rico (with coverage limitations). SiriusXM Internet Radio service is available throughout our satellite service area and in AK and HI. ©2021 SiriusXM Radio Inc. Sirius, XM and all related marks and logos are trademarks of SiriusXM Radio Inc.
24. **Steering-wheel-mounted controls:** Driving while distracted is dangerous and should be avoided. Remain attentive to driving and be cautious when using steering-wheel-mounted controls while driving.
25. **Sunvisors:** Sunvisor may not shield all direct light. Do not operate the vehicle if sunvisor is impairing your visibility.
26. **Tit/Telescoping Steering Wheel:** Never attempt to adjust steering wheel position when vehicle is in motion.
27. **Tire Pressure Monitoring System (TPMS):** Even with Tire Pressure Monitoring System, check tire pressure on a regular basis.

Key Feature Walkthrough

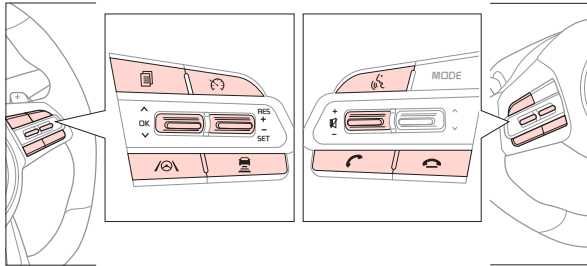

Smart Cruise Control (SCC)* - page 18-19
Demonstrate operation

Bluetooth® Wireless Technology - pages 34-35
Demonstrate operation

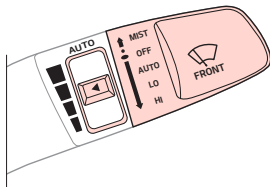

Windshield Wipers & Washers - page 31

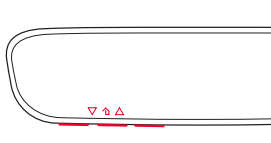

HomeLink® with Auto-Dimming Rearview Mirror - page 50

- Multimedia Ports, Power Outlets & USB Charger Port - page 40
- Blind-Spot Collision-Avoidance Assist (BCA) - page 14
- Digital Clock Setup - page 40
- Electric Parking Brake (EPB) / Auto Hold* - pages 45-46
- Engine Start/Stop Button - page 28
- Head-Up Display (HUD)* - page 24
- Sunroof Operation - page 55
- Forward/Reverse Parking Distance Warning (PDW)* - page 23
- Passenger Air Bag Off Indicator - page 59
- Front Seat Headrest Adjustment* - page 49
- Seat Warmers/Ventilated Seats - page 47
- Smart Key - page 51
- Sunvisor - page 56
- Tire Pressure Monitoring System (TPMS) - page 08

During Delivery

- Explain first service process and schedule first service appointment
- Tour Parts & Service departments, introduce staff and explain value of Kia Parts and Service
- Review recommended maintenance schedule and maintenance requirements to validate warranty
- Review business hours
- Review the Kia 10-year/100,000-mile warranty program
- Ensure 100% satisfaction with sales and delivery process and no problems with the vehicle
- Confirm time and best contact number for initial dealer follow-up

Sales Consultant: _____

Date: _____

Sales Manager: _____

Date: _____

Customer: _____

Date: _____

Owner's Name: _____ VIN: _____

Mileage: _____ Dealership Name: _____

Sales Consultant: _____ Date: _____

Before Delivery

- Confirm "Good Battery" with battery tester
- Verify all tire pressures are to spec (see driver's door label) LF _____ LR _____
RF _____ RR _____
- Verify proper operation of Smart Key* lock/unlock
- Ensure floor mats are snapped into place (if applicable)
- Verify vehicle is clean (interior and exterior), in good condition, free of chips and scratches
- Ensure all key documents are in the vehicle (Owner's Manual, Warranty and Consumer Information booklet, Tire Warranty booklet, Features & Functions Guide and any supplemental audio/video/navigation user's guides)

Key Feature Walkthrough

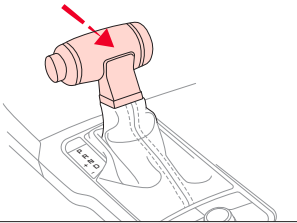

- Automatic Transmission / Manual Shift Mode*** - page 44

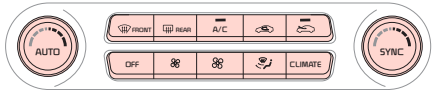

- Automatic Climate Control** - page 43
Demonstrate Air Flow Modes, Defog and Defrosting Windshield Fan Speed.

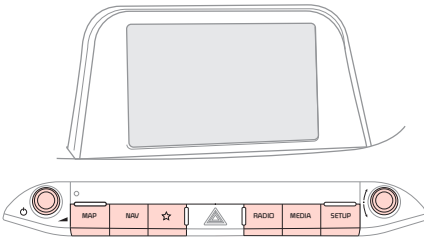

- UVO link with Navigation** - page 39
For further system operation, refer to the Car Multimedia System User's Manual.

- UVO link Activation*** - page 36
- Android Auto™ / Apple CarPlay® Setup*** - pages 38
- Kia Access with UVO link App Download** - page 37
- Kia Access with UVO link App Features Guide** - page 37

