

SORENTO

Hybrid

Features & Functions Guide



Delivery First

The priority that delivers more



WELCOME TO THE KIA FAMILY!

Your new Kia vehicle has been designed, engineered and manufactured to provide you with years of comfortable and dependable driving. Kia is committed to quality, innovation, safety and – above all – your satisfaction.

USING THIS FEATURES & FUNCTIONS GUIDE

The information contained in this guide is a brief overview of the operation and features of your new Kia vehicle.

This Features & Functions Guide and the specific operational and safety information it provides are not a substitute for your Owner's Manual. In the interest of your safety and that of the vehicle's occupants, and to help you avoid risks that may result in death or serious injury, Kia reminds you to carefully read the Owner's Manual in order to fully familiarize yourself with the important information and safety warnings it contains.

While Kia endeavors to ensure that the information contained in this guide is accurate at the time of printing, Kia may change vehicle specifications without notice in advance of or after the fact and assumes no liability in connection with such changes.

VIDEOS AND QR CODES

Kia provides a number of video resources to assist you with becoming familiar with the features and functions found in your Kia vehicle. You can access these resources by snapping the QR Codes with your mobile device using the built-in QR Code Reader or a downloaded QR Code Reader App.

After opening the QR Code Reader App on your mobile device, the app will utilize your device's camera. Center the code in the camera viewing area – with some apps, as soon as the app recognizes the code, it will launch the corresponding video.

With other apps, you will have to snap or “take a picture” of the code. The app will then launch the corresponding video.

For operation specifics, refer to the instructions that come with the QR Code Reader app. You can also view the videos by visiting the following website: www.youtube.com/KiaFeatureVideos.

QUICK TIPS

1. If you're having trouble scanning codes, check the following:
 - The code should be centered and focused in your mobile device's camera screen
 - Consider moving your device closer to or farther away from the code
 - The code should be well lit, without significant shadow
 - Avoid scanning from a significant angle
 - Confirm that the device's app supports 2D QR Code scanning
 - Try another QR Code Reader app; not all apps are created equal
2. After scanning, you may experience a “connection error” message or a “connecting” message with no subsequent response. These messages typically indicate that your device is having trouble connecting to the Internet

QR CODE

One-Click Fuel Cap Video

To view a video on your mobile device, snap this QR Code or visit the listed website.



www.youtube.com/KiaFeatureVideos

As you get to know your new Kia, you can explore this booklet to better understand how to operate its many features and systems. You can find the complete Table of Contents on the next two pages, but first, be sure to review the following to better understand some of your Kia's most used features:

1	Smart Key	53
3	Power Adjustable Driver's Seat / Front Seat Headrest Adjustment.	47-48
4	Seat Warmers*	46
5	Folding Rear Seats	50-51
6	Windshield Wipers & Washers	27
7	Smart Cruise Control (SCC)* with Stop & Go	28
8	Normal Maintenance Schedules	Back Cover
9	User Settings – Instrument Cluster	08
10	Bluetooth® Wireless Technology	30-31
11	UVO link Activation* / UVO Assistance*	34
12	Standard Audio System*	33
13	Standard Audio System - Value with UVO link*	36
14	UVO link with Navigation*	37
15	Kia Access with UVO link App Download	35
16	Kia Access with UVO link App Features Guide.	35
17	Android Auto™ / Apple CarPlay® Setup	32

Driving while distracted can result in a loss of vehicle control that may lead to an accident, severe personal injury and death. The driver's primary responsibility is in the safe and legal operation of a vehicle, and handheld devices, other equipment or vehicle systems which take the driver's eyes, attention and focus away from the safe operation of a vehicle or that are not permissible by law should never be used during operation of the vehicle.

Always check the Owner's Manual for complete operating information and safety warnings.

www.kia.com
 Consumer Affairs - Roadside Assistance¹⁸:
 1-800-333-4KIA (800-333-4542)



¹⁸IF EQUIPPED

VIDEOS & QR CODES Inside Front Cover

INSTRUMENT CLUSTER

Instrument Cluster Overview	03
Hybrid Indicators at Startup	03
Indicators & Warning Lights	04
Tire Pressure Monitoring System (TPMS)	05
Fuel Economy	05
Drive Mode Integrated Control System*	06

VEHICLE SETTINGS

Trip Modes / Trip Computer	07
LCD Instrument Cluster Modes	07
User Settings – Instrument Cluster	08
Vehicle Settings* – Audio Head Unit	08
Vehicle Auto-Shut Off*	09
Service Interval Mode	09

HYBRID (HEV) SYSTEM

Instrument Cluster LCD - Energy Flow	10
UVO link with Navigation Display*	12

ADVANCED DRIVER ASSISTANCE SYSTEMS (ADAS)

Blind-Spot Collision-Avoidance Assist (BCA)*	13
Rear Cross-Traffic Collision-Avoidance Assist (RCCA)*	14
Lane Following Assist (LFA)*	15
Lane Keeping Assist (LKA)	16
Safe Exit Assist (SEA)*	17
Forward Collision-Avoidance Assist (FCA)*	18
Leading Vehicle Departure Alert (LVDA)	19
Manual Speed Limit Assist (MSLA)*	20
Intelligent Speed Limit Assist (ISLA)	20
Driver Attention Warning (DAW)	21

DRIVER'S PANEL

Instrument Cluster Illumination Control	22
Electronic Stability Control (ESC)	22
Hill-Start Assist Control (HAC)	22

DRIVER'S PANEL (CONTINUED)

Reverse Parking Aid Function*	23
Engine Start/Stop Button*	23
Power Windows, Window Lock & Central Door Lock / Auto Door Lock/Unlock	24
Electronic Child Safety Lock System	24
Power/Heated Outside Mirrors*	24
Manual Folding Mirrors	24

STEERING WHEEL CONTROLS

Tilt/Telescoping Steering Wheel	25
Headlights & High Beams	26
High Beam Assist	26
Turn Signals & Fog Lights*	27
Windshield Wipers & Washers	27
Rear Wiper & Washer*	27
Smart Cruise Control (SCC)* with Stop & Go*	28
Cruise Control (CC)	29

AUDIO SYSTEMS

Bluetooth® Wireless Technology	30
Audio Controls	31
Android Auto™ / Apple CarPlay® Setup	32
Standard Audio System*	33
UVO link Activation* / UVO Assistance*	34
Kia Access with UVO link App Download	35
Kia Access with UVO link App Features Guide	35
Standard Audio System - Value with UVO link*	36
UVO link with Navigation*	37

CENTER PANEL

Digital Clock / Multimedia USB Port, Power Outlets & USB Charger Port	38
Wireless Smartphone Charging System*	39
Automatic Climate Control*	40
Manual Climate Control*	42
Rotary Dial Shifter Knob – Shift-by-Wire	43
Paddle Shifters*	
Dual Clutch Transmission (DCT)	43

CENTER PANEL (CONTINUED)

AWD (All-Wheel Drive) Lock*	44
Idle, Stop & Go (ISG) System	44
Electronic Parking Brake (EPB) / Auto Hold	45
Heated Steering Wheel	46
Seat Warmers*	46

SEATING

Front Seat Headrest Adjustment	47
Driver Position Memory System*	47
Power Adjustable Driver's Seat / Power Lumbar	48
Rear Occupant Alert (ROA) with Ultrasonic Sensors	49
2nd-Row Folding Seat / Auto-Folding Seat	50
One-Touch Slide & Fold / 3rd-Row Folding Seat	51

OTHER KEY FEATURES

Sunvisor	52
Remote Keyless Entry (Folding Key)*	52
Double-Turn Lock/Unlock All	52
Smart Key*	53
Power Liftgate*	54
Smart Liftgate with Auto Open*	55
Map/Room Lamps	56
Panoramic Sunroof with Power Sunshade*	56
HomeLink® with Auto-Dimming Rearview Mirror	57
Rear View Monitor (RVM)	58
Reverse Parking Distance Warning (PDW)	58
Hood Release Lever and Latch	59
Fuel Cap / Malfunction Indicator	59

SAFETY FEATURES

Occupant Detection System (ODS) / Passenger Airbag Off Indicator	60
Child-Protector Rear Door Locks*	60
Seat Belts	60

MAINTENANCE CHART-TURBO . Back Cover

LEGAL DISCLAIMERS Inside Back Cover

Instrument Cluster Overview

- A** Speedometer
- B** Power Gauge
- C** Hybrid battery SOC (State of Charge) gauge
- D** Indicators & Warning Lights
- E** LCD Display (including Trip computer)
- F** Fuel Gauge

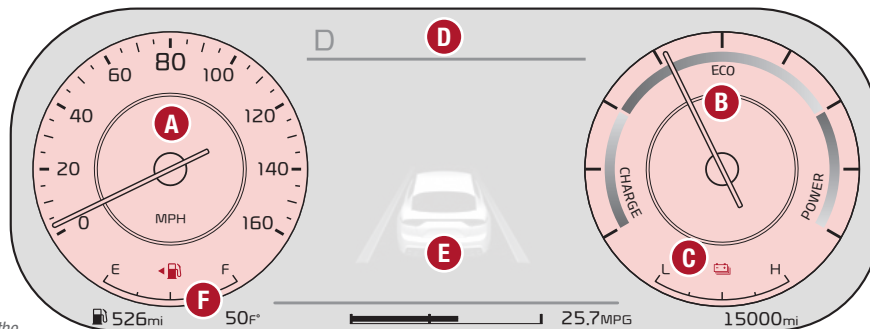

Full LCD cluster (Type B)

← Arrow direction indicates the side of the vehicle the fuel door is located

This illustration is for demonstration purposes only. Some indicators and warning lights may not appear in the illustration. On the vehicle, they may appear in the LCD.

Your vehicle's instrument cluster & indicator light locations may differ from those in the illustrations. Refer to Section 4 in the Owner's Manual for more information.

Hybrid Indicators at Startup

- G Power Gauge** - Indicates how economically the vehicle is being driven.
 - **CHARGE H** – Indicates that the energy made by the vehicle is being converted to electrical energy (regenerated energy)
 - **ECO I** – Indicates that the vehicle is being driven in an ECO-friendly manner
 - **POWER J** – Indicates that the vehicle is exceeding the ECO-friendly range
- K EV Mode** - Illuminates when only the electric motor is powering the vehicle
- L Ready** - Illuminates when the Hybrid system is operational. Even if the engine is off, the vehicle can be driven
- M Service Indicator** – Illuminates when a malfunction occurs in the vehicle's Hybrid system. Have an authorized Kia dealer address the concern as soon as possible

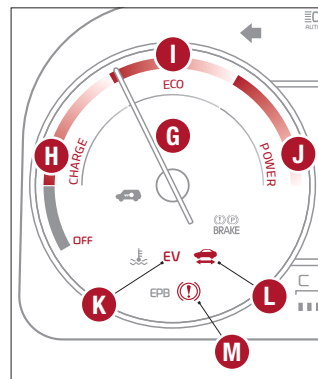

Conventional Cluster (Type A)

REMINDER: Avoid starting or driving the vehicle when the fuel tank is empty. As the engine will be incapable of charging the high-voltage Hybrid battery, the battery will lose its charge and may be damaged.

Your vehicle's instrument cluster & indicator light locations may differ from those in the illustrations. For more information on the instrument cluster, please refer to section 1 in the Owner's Manual.

This illustration is for demonstration purposes only. Some indicators and warning lights may not appear in illustration. On the vehicle, they may appear in the LCD.

Indicators & Warning Lights

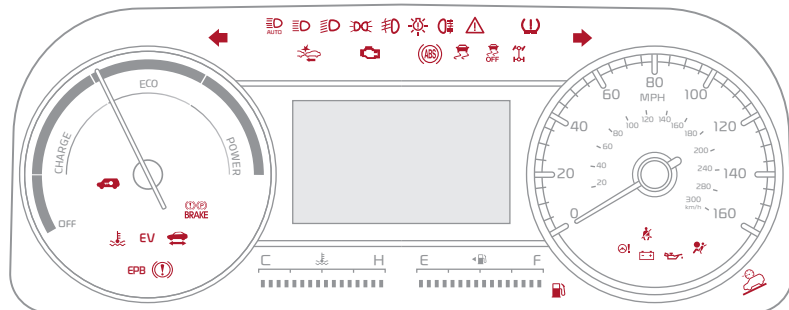
Conventional cluster
(Type A)

This illustration is for demonstration purposes only. Some indicators and warning lights may not appear in the illustration. On the vehicle, they may appear in the LCD.

Your vehicle's instrument cluster & indicator light locations may differ from those in the illustrations. Refer to Section 4 in the Owner's Manual for more information.

- | | | | | | |
|--|---|--|--|--|---|
| | READY Indicator | | All-Wheel Drive (AWD) Warning Light* | | Cruise Control Indicator Light* |
| | EV Mode Indicator | | All-Wheel Drive (AWD) Lock Indicator Light* | | Cruise Control ON/SET Indicator Light* |
| | Hybrid System Warning Light* | | Electronic Power Steering (EPS) Warning Light | | Washer Fluid Warning Light* |
| | Engine Oil Pressure Warning Light | | Charging System Warning Light* | | Master Warning Light |
| | Malfunction Indicator Light | | Airbag Warning Light | | Electronic Brake Force Distribution (EBD) System Warning Light (two separate indicators on Instrument Cluster lit at same time) |
| | Electric Parking Brake (EPB) Warning Light* | | Low Fuel Level Warning Light | | Lane Keeping Assist Indicator Light |
| | Seat Belt Warning Light | | Immobilizer Indicator Light* | | LED Headlamp Warning Indicator* |
| | Light ON Indicator Light | | Engine Coolant Temperature Warning Light* | | Downhill Brake Assist (DBC) Indicator* |
| | High Beam Indicator Light | | Icy Road Warning Indicator Light* | | Auto Stop Indicator Light* |
| | Low Beam Indicator Light* | | Low Tire Pressure Light / Tire Pressure Monitoring System (TPMS) Malfunction Indicator Light | | SPORT Mode Indicator Light |
| | Front Fog Light Indicator Light | | Anti-Lock Braking System (ABS) Warning Light | | ECO Mode Indicator Light |
| | High Beam Assist Indicator Light* | | Electronic Stability Control (ESC) OFF Indicator Light | | SMART Mode Indicator Light |
| | Parking Brake & Brake Fluid Warning Light | | Electronic Stability Control (ESC) Indicator Light | | |
| | Forward Collision-Avoidance Assist (FCA) Warning Light* | | AUTO HOLD Indicator* | | |

Tire Pressure Monitoring System (TPMS)^{†26}

 The TPMS indicator  functions as both the Low Tire Pressure Light and the TPMS Malfunction Indicator.

The TPMS indicator  is designed to illuminate if it detects one or more tires is significantly underinflated, the vehicle has a spare tire installed without TPMS or the outside temperature becomes significantly lower.

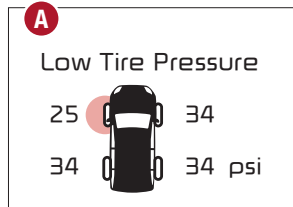

The Low Tire Pressure Position Indicator **A** is displayed on the LCD screen in the Instrument Cluster when the tire(s) is underinflated. Inflate the tire(s) to specifications using an accurate tire pressure gauge to turn off the Low Tire Pressure Indicator . See the front driver's door jamb for PSI specifications.

When there is a problem with the TPMS, the TPMS Malfunction Indicator  will blink for approximately one minute and then illuminate. See the dealer for service.

For illustrative purposes only. Your actual display, buttons and/or features may vary.

Fuel Economy

Several factors contribute to your vehicle's fuel economy, such as maintenance of your vehicle, driving style, environmental conditions, vehicle weight and vehicle aerodynamics. Below are some tips on how to help improve fuel economy:

- Keep your vehicle in good condition with regular maintenance
- Don't let the engine idle longer than necessary
- Drive at a moderate speed, accelerating smoothly and at a moderate rate
- Keep tires inflated to the recommended pressure
- Travel lightly, without carrying unnecessary weight in your vehicles
- Avoid placing large or heavy items on roof racks
- Avoid hilly, winding or poorly maintained roads

QUICK TIPS

- Even with TPMS, tire pressure should be checked manually at least once a month. Only adjust tire pressure on "cold tires" that have been sitting for approximately 20 minutes, and tires that are not hot in temperature from direct sunlight or heat
- For proper maintenance and optimal fuel economy, maintain the recommended tire inflation pressures and stay within the load limits and weight distribution recommended for your vehicle
- In winter or cold weather, the TPMS light may illuminate if the tire pressure was adjusted to the recommended tire inflation pressure during warm weather

REMINDERS:

- Check the recommended tire pressure label located on the left side of the driver's door jamb, visible when the door is opened.
- Consult your dealer for service if the Low Tire Pressure Light remains illuminated after inflating your tire(s).
- Personal electronic devices (such as laptops, wireless chargers, remote start systems, etc.) may interfere with the TPMS system, which may cause the Malfunction Warning Indicator (Check Engine Light) to illuminate.

QR CODES

Tire Pressure Monitoring System Video



Fuel Economy Video



Refer to the inside front cover for more information on QR codes.
www.youtube.com/KiaFeatureVideos

For more information on Fuel Economy, you can snap the QR Code above to view a video or refer to section 6 in the Owner's Manual.

Drive Mode Integrated Control System*

The drive modes may be changed according to the driver's preferences or road conditions. To cycle through the drive modes **A** or deactivate a drive mode, rotate the Drive Mode knob **B**.

When a drive mode is selected, the drive mode indicator will illuminate in the Instrument Cluster and illuminate next to the Drive Mode knob. The system's default mode is ECO mode and when selected, the indicator will not be illuminated.

- **SPORT Mode**
- **ECO Mode**
- **SMART Mode*** – When the SMART mode is activated, the system automatically selects the drive mode best suited to the current driving style (economic, average, spirited). The color of the SMART mode indicator (green, white, red) depends on the current driving style.

REMINDERS:

- When ECO mode is selected, the following may occur to help improve fuel economy:
 - Acceleration may be slightly reduced even when the accelerator is fully depressed
 - Air conditioner performance may be limited
 - Shift pattern of the automatic transmission may change
 - Engine noise may increase
 - System's power will be limited when driving uphill
- When SPORT mode is selected, fuel economy may decrease
- The system defaults to ECO mode when ignition is in the ON position
- Steering effort may be slightly increased in SPORT mode

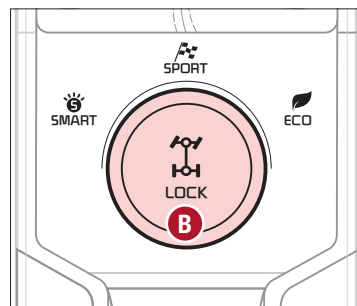
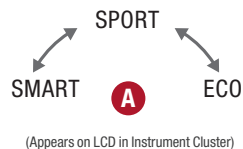

(Located on Center Panel below Gear Shift)*

QR CODES

Drive Mode Integrated Control Video



Refer to the inside front cover for more information on QR codes.
www.youtube.com/KiaFeatureVideos

See section 6 in the Owner's Manual for more information.

Trip Modes / Trip Computer

The Trip Computer is a driver information system that displays information related to driving on the display when the Engine Start/Stop button is in the ON position.

To cycle through the LCD Instrument Cluster modes, press the Mode button **A**.

To select and enter the Trip Computer mode , press the Move button **B** up/down and then press Set/Reset (OK) **B** to enter. To cycle through and select the different screens (Fuel Economy, Trip A, Trip B), press the Move button **B** up/down again and then press the OK button **B**. When displaying the TRIP A or TRIP B screens, press and hold the OK button **B** to reset the Tripmeter to zero.

Press the OK button **B** to go back to the previous mode/item.

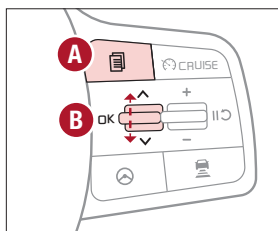

(Type A; Controls located on Steering Wheel)

REMINDERS:

- Appearance of the Trip Computer display may differ as equipped
- All stored driving information (except Odometer and Range) is reset if the battery is disconnected

Your vehicle's steering wheel buttons may differ from those in the illustrations.

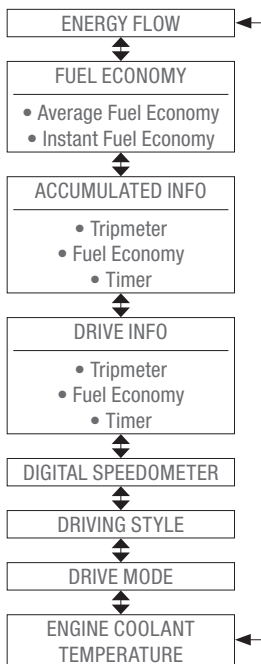

LCD Instrument Cluster Modes

Press the Mode button **A** to cycle through the different LCD Instrument Cluster Modes:



Trip Computer Mode: Displays driving information for accumulated info, fuel economy, drive info, drive mode, driving style, energy flow



Turn-by-Turn Mode*: Displays the route guidance and destination information



Driving Assist Mode: Displays information on Smart Cruise Control*, Lane Safety and Driver Attention Warning*. In AWD AUTO MODE, the cluster displays the traction force distribution status of the front and rear wheels. In AWD LOCK MODE, the cluster doesn't display the status



Information Mode*: Displays the speedometer, engine temperature, TPMS and AWD traction information



User Settings Mode: Change settings of the Driver Assistance, doors, lights, sound, convenience and other features



Master Warning Mode: Informs on low tire pressure warnings, Blind-Spot Collision Warning (BCW)* system malfunction and other systems

Driving while distracted is dangerous and should be avoided. Drivers should remain attentive to driving and always exercise caution when using the steering-wheel-mounted controls while driving.

Refer to section 4 in the Owner's Manual for more information.

QR CODES

Instrument Cluster's LCD Display Video



Refer to the inside front cover for more information on QR codes.
www.youtube.com/KiaFeatureVideos

User Settings – Instrument Cluster

To enter the User Settings mode in the LCD Instrument Cluster Modes, press the Mode button **A** when the vehicle is at a standstill, shift lever in Park, and with the Engine/Start Stop button in the ON position, select User Settings  by pressing the Move (OK) button **B** up/down.

You can navigate the selections on the display by pressing the Move (OK) button **B** up/down, and then selecting the item by pressing the OK button **B**.

Press the OK button **B** up/down to go back to the previous mode/item.

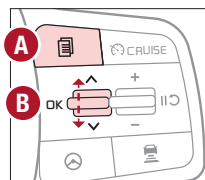

User Settings mode:

Driver Assistance

- Speed Limit
- Warning Timing
- Warning Volume
- Haptic Warning
- Driver Attention Warning
- Forward Safety
- Lane Safety
- Blind-Spot Safety
- Parking Safety

ECO Vehicle*

- Coasting Guide
- Start Coasting

Climate*

- Recirculate Air
- Automatic Ventilation
- Defog/Defrost Options

Lights

- Ambient Lighting*
- One-Touch Turn Signal
- Headlamp Delay
- High Beam Assist

Door/Liftgate

- Automatically Lock/Unlock*
- Two Press Unlock*
- Horn Feedback*
- Power Liftgate Speed*
- Power Liftgate Opening Height
- Smart Liftgate*

Cluster*

- Service Interval
- Energy Consumption Reset
- Content Selection
- Welcome Sound
- Theme Selection

Reset

- Reset the User Settings menus (except language and service interval)

Convenience

- Seat-Easy Access
- Rear Occupant Alert*
- Welcome Mirror/Light*
- Wireless Charging System*
- Auto Rear Wiper (when in Reverse)
- Heated/Ventilated Features
- Wipers/Lights Display*
- Gear Position Pop-Up*
- Icy Road Warning*
- Vehicle Auto-Shut Off*

Other Features

- Fuel Economy Auto Reset
- Speedometer Unit
- Fuel Economy Unit
- Temperature Unit
- Tire Pressure Unit

Vehicle Settings* – Audio Head Unit

To enter the Vehicle Settings mode in the audio head unit **A**, press the SETUP key on the audio head unit. Then press **VEHICLE** , which will take you to Vehicle Settings. Use the touchscreen to navigate through the menus.

Vehicle Settings:

Driver Assistance:

Driving Convenience*, Warning Time*, Warning Volume*, Driver Attention Warning*, Forward Safety*, Lane Safety*, Blind-Spot Safety*, Parking Safety*

Drive Mode: Drive Mode Alert*

Climate*: Recirculate Air*, Automatic Ventilation*, Defog/Defrost Options*, Climate Features*

Lights*: Ambient Light*, One Touch Turn Signal*, Headlight Display*, High Beam Assist*

Door*: Auto Lock*, Auto Unlock*, Walk-Away Lock*, Two-Press Unlock*, Smart Trunk*

Cluster*: Service Interval*, Energy Consumption Reset*, Content Selection*, Cluster Voice Guidance Volume*, Welcome Sound*, Theme Selection*

Convenience*: Rear Occupant Alert*, Welcome Mirror Light*, Wireless Charging System*, Vehicle Auto-Shut Off*

Seat*: Seat Position Change Alert*, Smart Posture Care*, Heated/Ventilated Features*, Seat Easy Access*, Rear Seat Heating Control*

Reset: Reset Vehicle Settings to Factory Defaults

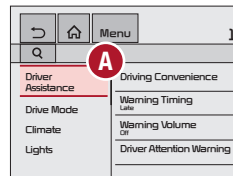

QR CODES

Vehicle & User Settings Video



Ambient, Mood & Theme Lighting Video



Refer to the inside front cover for more information on QR codes.
www.youtube.com/KiaFeatureVideos

See section 4 in the Owner's Manual for more information.

Vehicle Auto-Shut Off*





The Vehicle Auto-Shut Off, when certain conditions are met, will turn the vehicle off automatically after a pre-set time (30 or 60 minutes) in the User Settings .

A warning on the Instrument Cluster LCD will appear stating the “Vehicle will be turned off automatically in...” and a chime will sound when the timer starts .

QUICK TIP

The timer that appears on the Instrument Cluster’s LCD can be reset using the OK button on the right side of the Steering Wheel.

When timer ends, a continuous beep sounds for one minute before the vehicle shuts off.

Auto-Shut Off Settings – The system is on by default and timer is pre-set to 30 minutes. To change the pre-set time settings, go to User Settings  on the Instrument Cluster LCD by pressing the Mode button  on right side of the Steering Wheel. Select Convenience, then Vehicle Auto-Shut Off. Move through the selections by pressing the OK button  on the Steering Wheel. Select 30 minutes, 60 minutes or Disable for off .

REMINDERS:



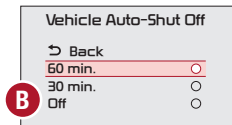
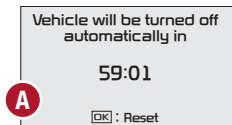

- When the vehicle is turned off then on again, the system defaults to on (30-minute pre-set time)
- The system will activate when the vehicle is on and these conditions are met:
 - The vehicle is in (P) Park
 - The driver’s seat belt is unfastened
 - The driver’s door is opened
 - The passenger seat is not occupied

Refer to section 5 in the Owner’s Manual for more information.

ALWAYS CHECK THE OWNER’S MANUAL FOR COMPLETE OPERATING INFORMATION AND SAFETY WARNINGS.



Service Interval Mode

To enter Service Interval Mode, press the Mode button , go to User Settings  and enter by pressing the OK button . Move up/down to Service Interval by pressing the OK button , then press the OK button  to enter. System will display the number of miles remaining until the next service is due, as well as the type of service due.

When service is required, the following will be displayed:

Service Required .





To reset the Service Interval Mode system, press and hold the OK button  for more than 1 second.

Press the OK button  up/down to go back to the previous mode/item.

To turn **Service Interval OFF** , go to User Settings.

Service Interval Setting .

To set the service interval in User Settings mode:

- Press the Mode button  to go to User Settings and press the OK button  to enter
- If Service Interval is OFF, press the OK button  to turn ON
- Press the OK button  up/down to select/change the interval setting
- Press the OK button  to select the interval

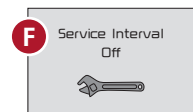
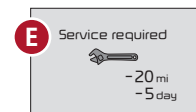
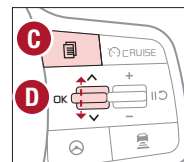

(Images are for illustration purposes only and may vary)

See section 4 in the Owner’s Manual for more information.

QR CODES

Vehicle Auto-Shut Off Video



LCD Display: Maintenance Video



Refer to the inside front cover for more information on QR codes.
www.youtube.com/KiaFeatureVideos

Instrument Cluster LCD – Energy Flow

Optima Hybrid/Plug-In's instrument cluster LCD screen displays the following Hybrid/Plug-In system modes to inform the driver of its status. To change modes, go to User Settings in the LCD Instrument Cluster modes.

EV Propulsion - The electric motor is moving the vehicle.

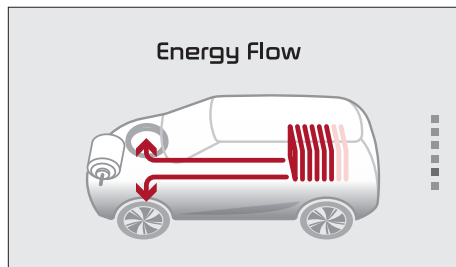

Engine-Only Propulsion - The engine is moving the vehicle.

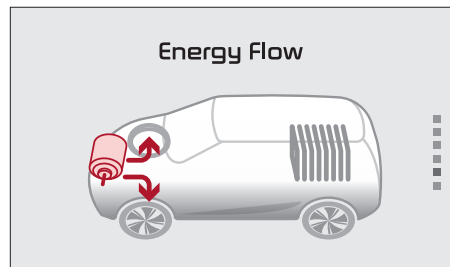

Power Assist - Both the electric motor AND the engine are moving the vehicle.

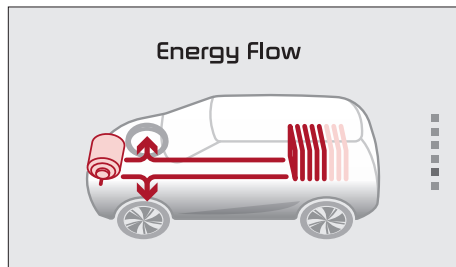

Engine Generation - While the vehicle is stopped, the engine is charging the Hybrid/Plug-In battery.

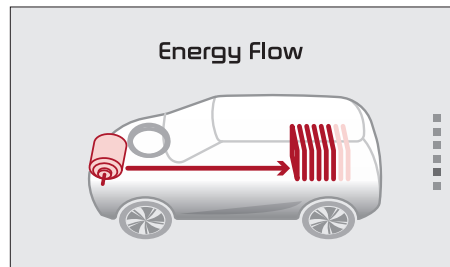

Your vehicle's instrument cluster & indicator light locations may differ from those in the illustrations. For more information on the instrument cluster, please refer to the Owner's Manual.

These illustrations are for demonstration purposes only. Some indicators and warning lights may not appear in illustration. On the vehicle, they may appear in the LCD.

Instrument Cluster LCD – Energy Flow (continued)

Optima Hybrid/Plug-In's instrument cluster LCD screen displays the following Hybrid/Plug-In system modes to inform the driver of its status. To change modes, go to User Settings in the LCD Instrument Cluster modes.

Power Reserve - While the engine powers the vehicle, it is also recharging the Hybrid/Plug-In battery.

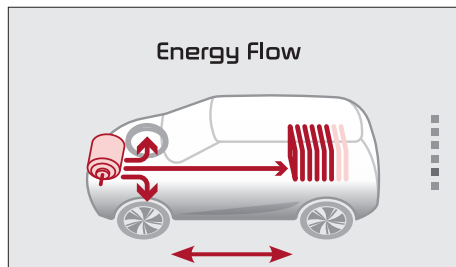

Engine Brake/Regeneration - The regenerative braking system is recharging the Hybrid/Plug-In battery.

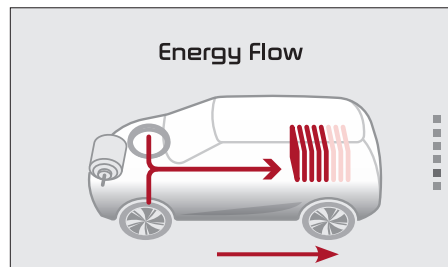

Vehicle Stop - The vehicle's Hybrid/Plug-In system is standing by.

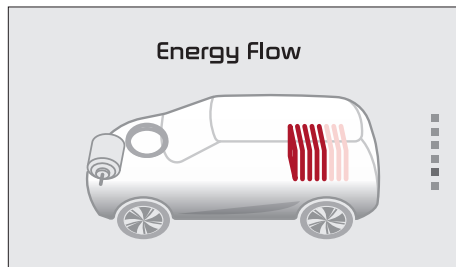

Engine Generation/Regeneration - The engine and the regenerative braking system are both recharging the Hybrid/Plug-In battery.

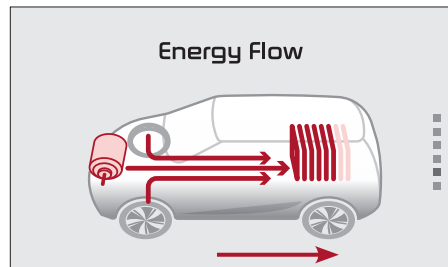



Your vehicle's instrument cluster & indicator light locations may differ from those in the illustrations. For more information on the instrument cluster, please refer to the Owner's Manual.

These illustrations are for demonstration purposes only. Some indicators and warning lights may not appear in illustration. On the vehicle, they may appear in the LCD.

UVO link⁺¹ with Navigation⁺¹⁴ Display*

When equipped, the UVO link with Navigation Display provides information on economical driving and system modes.

To enter the display mode to see this information, press the Home button  on the audio head unit screen. Press the HYBRID/PHEV button. Then select one of the menus .

System Home Screens

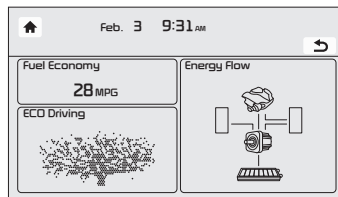

Hybrid Screen*

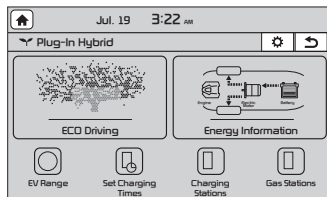

Plug-In Hybrid Screen*

Energy Flow - Displays the current flow of power between the Hybrid's/Plug-In Hybrid's main powertrain components.

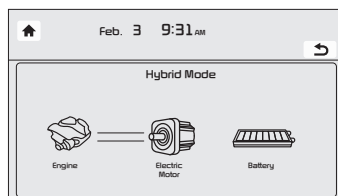

Hybrid Screen*

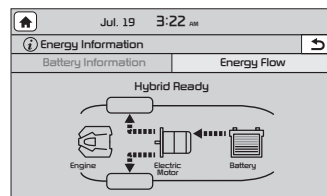

Plug-In Hybrid Screen*

Your vehicle's instrument cluster & indicator light locations may differ from those in the illustrations. For more information on the instrument cluster, please refer to refer to the Car Infotainment System Quick Start Guide.

ECO Level - The more economically you drive, the more the ECO Level increases.

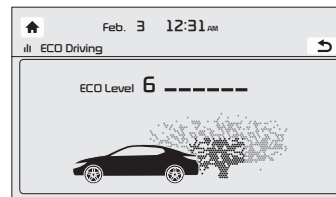

Hybrid Screen*

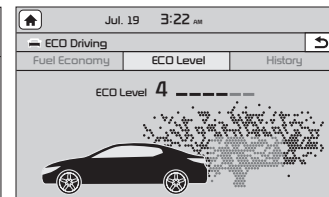

Plug-In Hybrid Screen*

ECO Driving - Displays the average fuel economy over the duration of a trip and the ECO level awarded based on the driving style.

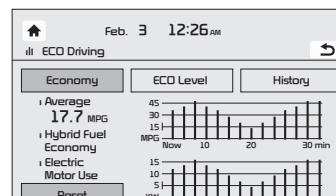

Hybrid Screen*

These illustrations are for demonstration purposes only. Some indicators and warning lights may not appear in illustration. On the vehicle, they may appear in the LCD.





Blind-Spot Collision-Avoidance Assist (BCA)^{†6}

BCW uses rear corner radar sensors in the rear bumper to monitor and warn the driver in certain situations if it detects an approaching vehicle in the driver's blind spot area and before changing lanes. When turned on, the system will activate when the vehicle is traveling faster than 20 mph and will alert the driver if another vehicle is detected by the rear-corner radar sensor.

1st-stage warning: When another vehicle is detected within BCW warning boundary **A**, an indicator will illuminate on the outside rearview mirrors **B**.

2nd-stage warning: When 1st stage warning is on and the driver activates a turn signal, a flashing yellow indicator will illuminate on the outside rearview mirrors and the system will sound a warning.

BCW User Settings:

- To turn BCA on, go to the User Settings menu  in the Instrument Cluster, press the Mode button  **C** on the Steering Wheel when the vehicle is at a standstill, gear shift in Park and with the ignition switch or the Engine Start/Stop button* in the ON position, and select User Settings . Press the Move (OK) button **D** up/down and select Driver Assistance, Blind-Spot Safety and then press the OK button **D**.
- Some models access settings through the Vehicle Settings in the audio head unit. Press the Setup hard key on the audio head unit, then **VEHICLE**  on the screen to enter Vehicle Settings
- To set BCW when in Blind-Spot Safety, select:
 - **Warning Only:** Vehicle will provide a warning only (audible & visual)
 - **Off:** System is off, no warnings provided
- To set the initial warning activation time, go to User Settings , then Driver Assistance, Warning Time and press the OK button **D**. Adjust the warning timing:
 - **Early/Normal:** Maximizes the amount of distance between the vehicles before the initial warning occurs
 - **Late:** Reduces the amount of distance between the vehicles before the initial warning occurs

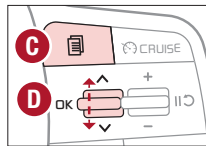
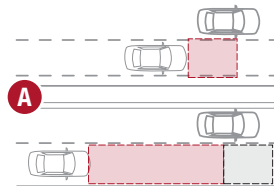

QUICK TIP

- BCW Warning Volume can be adjusted in the User Settings  in the Instrument Cluster or the Vehicle Settings* on the audio head unit. Go to Driver Assistance, then Warning Volume
- BCW will activate when:
 - The system is turned on
 - Other vehicles are detected on the rear sides of the vehicle
 - Vehicle speed is above approximately 20 mph

QR CODES

Blind-Spot Collision-Avoidance Assist Video



Refer to the inside front cover for more information on QR codes.
www.youtube.com/KiaFeatureVideos

The BCA system is not a substitute for safe and proper driving. Always drive safely and use caution.

Refer to section 5 in the Owner's Manual for more information.

The images on this page are for illustrative purposes only and may not reflect actual feature or operation.

REMINDERS:

- BCW will not issue a warning if the vehicle speed is 6 mph or more above the surrounding vehicles
- When BCW is ON and the ignition is cycled, BCW returns to its previous state
- BCW is a supplemental system. Do not solely rely on this system. Always pay attention to the road and drive safely

Rear Cross-Traffic Collision Avoidance Assist (RCCA)*†6

Rear Cross-Traffic Collision-Avoidance Assist (RCCA) is designed to warn the driver, under certain conditions, may activate the Electronic Stability Control (ESC) and temporarily apply braking if it detects cross traffic approaching the vehicle, when vehicle is in reverse.







Initially, RCCA provides Rear Cross-Traffic Collision Warning (RCCW) when the system sensors detect approaching vehicles or pedestrians from the rear left or rear right side of the vehicle **A**.

RCCA will sound a warning, the warning indicators on the outside rearview mirror will illuminate and a message will appear on the Instrument Cluster LCD **B**. If RCCA detects that the collision risk has increased, the system automatically applies the brakes to reduce your speed, potentially helping to minimize the effects of a possible collision.

RCCA is designed to operate under the following conditions:

- When the gear shift is in Reverse
- When the vehicle is moving slower than 6 mph

RCCA User Settings:

- To go to the User Settings menu  in the Instrument Cluster, press the Mode button  **C** on the Steering Wheel when the vehicle is at a standstill, gear shift in Park and with the ignition on or the Engine Start/Stop button* in the ON position, and select User Settings .
- To turn RCCA on when in User Settings , press the Move (OK) button **D** up/down, select Driver Assistance, Parking Safety, Rear Cross-Traffic Safety and then press OK **D**.
- To set the initial warning activation time, go to User Settings , press the Move (OK) button **D** up/down, then go to Driver Assistance, Warning Time and press the OK button **D**.
- There are two settings:
 - **Early/Normal:** Maximizes the amount of distance between the vehicles before the initial warning occurs
 - **Late:** Reduces the amount of distance between the vehicles before the initial warning occurs
- Some models access settings through the Vehicle Settings in the audio head unit. Press the Setup hard key on the audio head unit, then **VEHICLE**  on the screen to enter Vehicle Settings

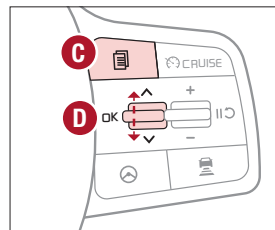
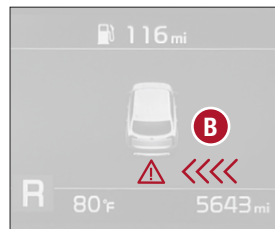
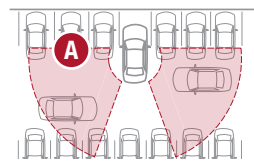

(Buttons located on steering wheel)

QUICK TIP

RCCA Warning Volume can be adjusted in the User Settings  in the Instrument Cluster or the Vehicle Settings on the audio head unit. Go to Driver Assistance, then Warning Volume

QR CODES

Rear Cross-Traffic Collision Avoidance Assist (RCCA) Video



Refer to the inside front cover for more information on QR codes.
www.youtube.com/KiaFeatureVideos

Refer to section 4 in the Owner's Manual for more information.

REMINDERS:

- The RCCA feature can be turned OFF/ON in User Settings, under Driver Assistance, Parking Safety
- When vehicle power is cycled, RCCA will remain in the previous state
- When a vehicle is approaching within the sensing range, and traveling faster than 3 mph, the RCCA system will show a warning
- The RCCA systems is a supplemental system. Do not solely rely on this system and always pay attention to the road and its conditions

Lane Following Assist (LFA)*†6

Lane Following Assist (LFA) is designed to help ensure that the vehicle stays centered in its lane **A** by monitoring the detected lane markings ahead and adjust the steering. When turned on, the instrument cluster indicator will initially illuminate white **B** when turned ON, and on some vehicles, when SCC is engaged. It will remain white when the system does not detect the lane markers. When the system detects the lane markers and can assist the steering, the LFA icon will illuminate green **B**.

LFA will operate only when these conditions are met:

- When the SCC is on and operating
- LKA recognizes both sides of the lane markers the vehicle is traveling in
- The vehicle is traveling slower than 95 mph

LFA User Settings:

- To go to User Settings **G** in the Instrument Cluster, press the Mode button **C** on the Steering Wheel when the vehicle is at a standstill, gear shift is in Park and with the ignition on or the Engine Start/Stop button* in the ON position, and select User Settings **G**
- To enable LFA, when in User Settings, press the Move (OK) button **D** up/down and Select Driver Assistance then Driving Assist, Select Lane Following Assist. Press the OK button **D**
- Some models access settings through the Vehicle Settings in the audio head unit. Press the SETUP hard key on the audio head unit, then **VEHICLE** **F** on the screen to enter Vehicle Settings
- Some vehicles have a Lane Driving Assist / Lane Safety button* on the Driver's Panel or the Steering Wheel **/OK**. Press to activate Lane Following Assist

REMINDERS:

- If the ignition is cycled, LFA returns to its previous state, on or off, if activated in the User Settings menu **G** and when combined with SCC. If using the Steering Wheel LKA button, then LKA defaults to off
- LFA is not a substitute for safe and proper driving. Always drive safely and use caution

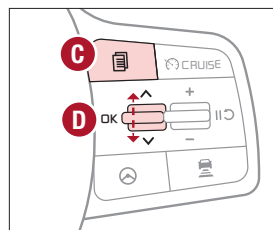
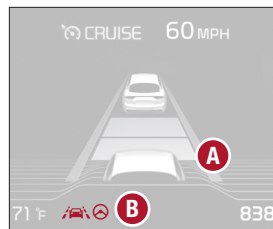

(Buttons located on steering wheel)

QR CODES

Lane Following Assist (LFA) Video



Refer to the inside front cover for more information on QR codes.
www.youtube.com/KiaFeatureVideos

Images are for illustrative purposes only and may not reflect actual feature or operation.

LFA is supplemental. Do not solely rely on this system and always pay attention to the road and its conditions.

Actual User Settings steps may vary by model. See section 5 in the Owner's Manual for more detailed information, limitations and conditions.

Lane Keeping Assist (LKA)^{†6}

Lane Keeping Assist (LKA) is designed to detect the lane markers on the road with a front view camera on the windshield, and may assist the driver's steering to potentially help keep the vehicle in the lane. When turned on, the instrument cluster indicator  will initially illuminate white when turned on. It will remain white when the vehicle is traveling slower than 40 mph or when the system does not detect the lane markers. When the system detects the lane markers and can assist the steering, the LKA icon will illuminate green.

If the LKA detects that you are moving outside of your lane, the system may give an audible warning and display Lane Departure Warning on the instrument cluster. If the vehicle continues to move outside of the lane, LKA may provide steering inputs, trying to prevent the vehicle from moving outside its lane.

LKA is the operating mode by default when the Lane Safety/LKA button*  is depressed to ON.

There are three available modes:

- **Active LKA** – Provides more frequent steering inputs than standard LKA
- **Lane Keeping Assist** – Guides driver to keep vehicle within lanes and provides steering inputs when vehicle is about to deviate from the lane
- **Lane Departure Warning** – Alerts driver when the system detects the vehicle leaving the lane. In this mode the system will not provide steering inputs

All systems will operate under the following conditions:

- The vehicle speed exceeds approximately 40 mph
- LKA recognizes both sides of the lane markers the vehicle is traveling in
- The vehicle is between the lane markers



When the front-view camera does not detect the lane traveling in, the lanes are not illuminated



When the front-view camera detects the lane traveling in, both lanes are illuminated



When the front-view camera detects the vehicle moving outside of the lane traveling in, a vehicle crossing lane indicator will blink, either on the left or right lane (as shown in both images above)

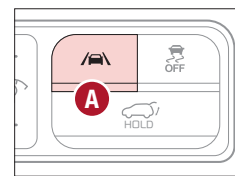

(Located on Driver's Panel to the left of the steering wheel)

QR CODES

Lane Keeping Assist (LKA) Video



Refer to the inside front cover for more information on QR codes.
www.youtube.com/KiaFeatureVideos







Lane Keeping Assist and Lane Departure Warning are not substitutes for safe driving and may not always alert the driver if the vehicle is driven outside of its lane. Always drive safely and use caution.

For illustrative purposes only. Your actual display, buttons and/or features may vary.

Actual User Settings steps may vary by model. Refer to section 4 in the Owner's Manual for more information.

Lane Keeping Assist (LKA)^{†6} (continued)

LKA User Settings:

- To turn LKA ON, with the ignition on or the Engine Start/Stop button* in the ON position, press the Lane Safety/LKA button* **A**. The instrument cluster indicator  will initially illuminate white indicating the system is on
- To turn LKA on in the user settings, go to the User Settings menu  in the Instrument Cluster, press the Mode button  **B** on the Steering Wheel when the vehicle is at a standstill, gear shift in Park and with the ignition on or the Engine Start/Stop button* in the ON position, and select User Settings 
- To switch between LKA modes (Lane Keep Assist, Lane Departure Warning), go to User Settings  in the Instrument Cluster. Press the Move (OK) button  **C** up/down and select desired setting and press the OK button  **C**

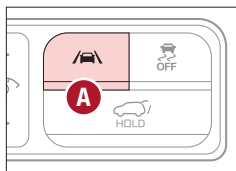

(Located on Panel to the left of the steering wheel)

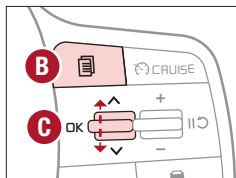

QUICK TIP

The LKA Warning Volume can be adjusted in the User Settings  in the Instrument Cluster or the Vehicle Settings* on the audio head unit

REMINDERS:

- LKA will not issue a warning if the turn signals or hazard lights are activated
- When the ignition is cycled, LKA will return to the previously set state
- Some models access settings through the Vehicle Settings in the audio head unit. Press the Setup hard key on the audio head unit, then **VEHICLE**  on the screen to enter Vehicle Settings

Lane Keeping Assist and Lane Departure Warning are not substitutes for safe driving and may not always alert the driver if the vehicle is driven outside of its lane. Always drive safely and use caution.

For illustrative purposes only. Your actual display, buttons and/or features may vary.

Actual User Settings steps may vary by model. Refer to section 4 in the Owner's Manual for more information.

Safe Exit Assist (SEA)^{*†6a}

Safe Exit Assist (SEA) can help prevent passengers from opening their door by displaying a warning message on the Instrument Cluster and sounding an audible warning when a vehicle is detected, approaching from behind, and after your vehicle has stopped.

To turn on SEA, go to User Settings in the Instrument cluster or the Vehicle Settings* in the audio head unit, select Driver Assistance, then Blind-Spot Safety, and select Safe Exit Assist.

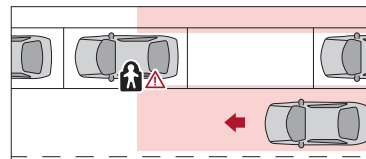

QR CODES

Safe Exit Assist (SEA) Video



Refer to the inside front cover for more information on QR codes.
www.youtube.com/KiaFeatureVideos

See section 4 in the Owner's Manual for more information.

Image is for illustrative purposes only and may not reflect actual feature or operation.





Forward Collision-Avoidance Assist (FCA)^{†6}

FCA is designed to detect and monitor a vehicle ahead or detect a pedestrian in the roadway through front view camera recognition and front radar signals to warn the driver that a collision is imminent, and if necessary, temporarily apply emergency braking. Initially, FCA provides Forward Collision Warning (FCW) when it detects a potential collision with a vehicle, pedestrian, or cyclist, emitting an audible warning and visual alert on the instrument cluster **A**.

If the system detects that the collision risk has increased, Forward Collision-Avoidance Assist (FCA) automatically applies the brakes to reduce your speed, potentially helping to reduce the effects of a possible collision.



FCA User Settings:

- FCA is ON by default in most Kia models. FCA can be turned ON/ OFF by going to the User Settings in the Instrument Cluster or the Audio Head Unit*
- To go to User Settings , press the Mode button  **B** on the Steering Wheel when the vehicle is at a standstill, gear shift in Park and with the ignition on or the Engine Start/Stop button* in the ON position
- Press the OK button **C** up/down and select User Settings  then Driver Assistance
 - In some models, go to Driving Assist, then Forward Collision-Avoidance Assist or Forward Collision Warning and press the OK button **C**
 - In other models, go to Forward Safety and select Active Assist, Warning Only or Off
- Active Assist: Vehicle will provide a warning (audible & visual) and apply the brakes if needed
- Warning Only: Vehicle will provide a warning only (audible & visual)
- Off: System is off, no warnings or braking provided
- To adjust the FCA initial warning activation time, go to User Settings , Driver Assistance, Warning Timing then select Normal, Early or Late, depending on your Kia model:
 - Early/Normal: Maximizes the amount of distance between the vehicles before the initial warning occurs
 - Late: Reduces the amount of distance between the vehicles before the initial warning occurs

FCA/FCW will become active when the:

- Ignition is on or the Engine Start/Stop button* is ON
- Vehicle is traveling faster than 5 mph
- Electronic Stability Control (ESC) is ON

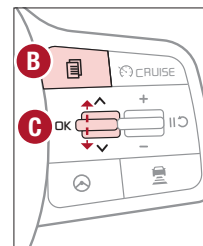

REMINDERS:

- FCA will be activated by default when the ignition is cycled ON, even when previous setting was OFF
- If FCA is operating and the ESC (Electronic Stability Control) is turned off, FCA system is automatically turned off
- When the FCA system is off, the FCA warning indicator is on in the Instrument Cluster 

Forward Collision-Avoidance Assist (FCA) is not a substitute for safe driving and may not detect all objects in front of the vehicle. Always drive safely and use caution.

Actual User Settings steps may vary by model. Refer to section 4 in the Owner's Manual for more information.

For illustrative purposes only. Your actual display, buttons and/or features may vary.

QR CODES

Forward Collision-Avoidance Assist (FCA) Video



*Refer to the inside front cover for more information on QR codes.
www.youtube.com/KiaFeatureVideos*



QUICK TIP

FCA Warning Volume can be adjusted in the User Settings  in the Instrument Cluster or the Vehicle Settings* on the audio head unit. Go to Driver Assistance, then Warning Volume

Leading Vehicle Departure Alert (LVDA)^{†6b}

Leading Vehicle Departure Alert is designed to inform the driver when the vehicle in front starts moving or departs from a stop. When LVDA is on, your vehicle is stopped and detects that the leading vehicle is driving away, LVDA sounds an alert to let you know you can start driving. If no action is taken after the vehicle in front drives away, then a message **A** will appear on the Instrument Cluster LCD.

LVDA User Settings:

- To turn LVDA on, press the Mode  button **B** on the Steering Wheel, and go to User Settings  in the Instrument Cluster. Press the Move (OK) button **C** up/down and select Drive Assistance, then press the OK button **C** to select. Go to Driver Attention Warning and then Leading Vehicle Departure Alert.
- Some models access settings through the Vehicle Settings in the audio head unit. Press the Setup hard key on the audio head unit, then press **VEHICLE**  on the screen to enter Vehicle Settings

REMINDERS:

- When the ignition is cycled, the system returns to its previous state, on or off
- Always check the front of the vehicle and road conditions before departure

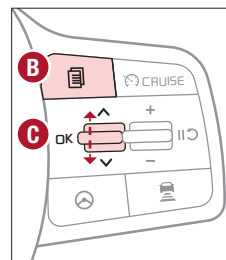

(Buttons located on steering wheel)

QR CODES

Leading Vehicle Departure Alert (LVDA) Video



Refer to the inside front cover for more information on QR codes.
www.youtube.com/KiaFeatureVideos

The Leading Vehicle Departure Alert system is not a substitute for safe and proper driving. Always drive safely and use caution.

Images are for illustrative purposes only and may not reflect actual feature or operation.

See section 5 in the Owner's Manual for more information.

Manual Speed Limit Assist (MSLA)*†6

Manual Speed Limit Assist monitors the vehicle speed and warns the driver when the vehicle surpasses the preset speed limit. A warning indicator will blink **A** on the Instrument Cluster LCD and a warning alert will sound until the vehicle speed returns to or is below the preset speed limit.

MSLA User Settings:

To activate MSLA, press and hold the Driving Assist **CRUISE** button* **B** on the Steering Wheel and the speed limit indicator **A** will illuminate.

Press the +/- button **C** up/down to set the speed. The speed limit will display on the LCD **A**.

To deactivate MSLA, press and hold the Driving Assist **CRUISE** **B** again.

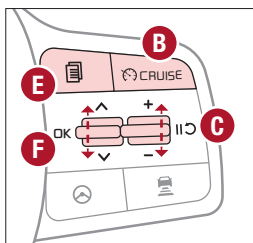
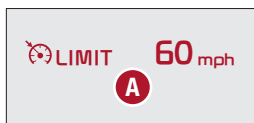

QUICK TIP

To pause MSLA, press the Pause/Resume button **C**.

REMINDERS:

- Set the vehicle speed within the posted speed limits
- When not in use, keep MSLA off, to avoid inadvertently setting the vehicle speed

MSLA/ISLA are not substitutes for safe and proper driving. Always drive safely and use caution. Refer to section 5 in the Owner's Manual for more information

Intelligent Speed Limit Assist (ISLA)†6

Intelligent Speed Limit Assist is designed to use the information from the posted speed limit and the navigation system to inform the driver of the speed limit.

When ISLA is on and active, the system will display an alert on the Instrument Cluster LCD **D** of the detected speed limit. If the vehicle's current speed exceeds the detected speed limit, a warning will sound and the vehicle's current speed will blink on the LCD.

ISLA User Settings:

To turn ISLA on, press the Mode button **E** on the Steering Wheel and go to User Settings **G** on the Instrument Cluster LCD. Press the Move (OK) button **F** up/down and select Driver Assistance by pressing the OK button **F**, then Intelligent Speed Limit Assist.

Select one of the three modes:

- **Speed Limit Assist:** Informs the driver of the detected speed limit, display a message change the set speed of the MSLA or SCC to help the driver stay within the posted speed limit
- **Speed Limit Warning:** Informs the driver of the detected speed limit and warn the driver when the vehicle is traveling faster than the posted speed limit
- **Off:** MSLA is disabled

QUICK TIP

You can set a speed limit offset to the posted speed limit by going to User Settings, Driver Assistance, Speed Limit, then Speed Limit Offset. Set the offset to "0" if you want the vehicle to travel at the detected speed limit, when ISLA is on

REMINDERS:

- Vehicle must be parked and in a safe location to change the speed settings
- Additional information may be displayed if additional road sign information is detected

Driver Attention Warning (DAW)*†7

Driver Attention Warning is designed to alert the driver if it detects inattentive driving practices and, in certain situations, can give a warning signal to take a break from driving. There are three modes:

- **Normal Sensitivity:** Driver Attention Warning warns the driver of his/her inattentive driving practices.
- **High Sensitivity:** Driver Attention Warning warns the driver of his/her inattentive driving practices faster than Normal mode.
- **Off:** Driver Attention Warning is deactivated

If DAW is activated, the DAW information **A** will appear on the Instrument Cluster LCD when you select the Driving Assist menu in User Settings . A message, “Consider taking a break,” **B** appears on the LCD and a warning sounds to suggest the driver to take a break when the driver’s attention level becomes low.

DAW User Settings:

To turn DAW on/off, with the ignition on, press the Mode button  **C** on the Steering Wheel and go to User Settings  in the Instrument Cluster. Then go to Driver Assistance and select Driver Attention Warning. Set DAW to Normal Sensitivity, High Sensitivity or Off.

- Some models access settings through the Vehicle Settings in the audio head unit. Press the Setup hard key on the audio head unit, then press **VEHICLE**  on the screen to enter Vehicle Settings

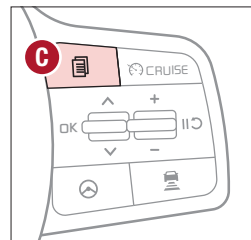
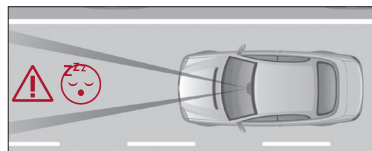

REMINDERS:

- The setup of DAW will be maintained, as selected, when the ignition is cycled
- When activated, DAW does not display “Consider taking a break” message when the total trip driving time is less than 10 minutes
- DAW will enter a standby mode if the camera does not detect the lanes and/or the driving speed remains under 40 mph

QR CODES

Driver Attention Warning (DAW) Video



Refer to the inside front cover for more information on QR codes.
www.youtube.com/KiaFeatureVideos

Driver Attention Warning is not a substitute for safe driving and may not detect all instances of inattentive driving practices. Failure to pay attention to travel conditions and vehicle operation could result in loss of vehicle control. Always drive safely and use caution.

See section 5 in the Owner's Manual for more information.

Instrument Cluster Illumination Control

With the parking lights/headlights ON, press the button **A** (+) or (-) to adjust the brightness of the instrument panel illumination.

REMINDER: The Instrument Cluster illumination Control does not adjust brightness on the audio head unit screens. Use the display settings in the Setup menu to adjust the brightness on the screen.

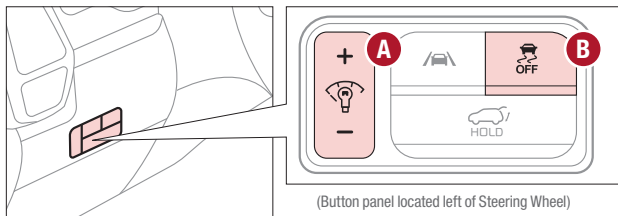

(Button panel located left of Steering Wheel)

See section 5 in the Owner's Manual for more information.

Electronic Stability Control (ESC)^{†8}

The ESC system is designed to help stabilize the vehicle during certain cornering maneuvers. It is a good idea to keep the ESC turned on for daily driving whenever possible.

Press the ESC OFF button **B** to turn Traction Control OFF/ON.

To turn OFF both the Traction Control and Stability Control, press and hold for more than 3 seconds. Press it again to turn ON.

REMINERS:

- ESC is active by default at vehicle startup. When the ignition is cycled, ESC will turn ON again
- The ESC Indicator Light  in the instrument cluster will illuminate whenever the ESC is in operation

See section 5 in the Owner's Manual for more information.

Hill-Start Assist Control (HAC)^{†8}

HAC helps prevent the vehicle from rolling backwards when accelerating from a stop while on a steep incline. The HAC automatically activates whether the ESC is OFF or ON but does NOT activate when the ESC has malfunctioned.

QUICK TIPS

- When HAC is active (e.g., during initial acceleration from a stop on an incline), you may notice that the brakes will momentarily remain engaged after you depress the accelerator – this is normal HAC operation.
- HAC provides a two-second delay before the vehicle may start rolling backwards

REMINERS:

- HAC does not operate when the gear shift is in the P (Park) or the N (Neutral) position.
- In the event of HAC system malfunction, see an Authorized Kia Dealer for service
- HAC does not replace the need to apply brakes while the vehicle is stopped on an incline

See section 5 in the Owner's Manual for more information.

Reverse Parking Aid Function*

When the gear shift lever is moved into R (Reverse) and while the vehicle is moving backward, the outside rearview mirrors **A** will rotate downward to aid in reverse parking.

When the left or right mirror buttons **B** are depressed, the Reverse Parking Aid Function will operate (LED lit).

To turn OFF the function, press the buttons to the center position.

The outside rearview mirrors will automatically return to their original positions when:

- The Engine Start/Stop Button is in the OFF position
- The gear shift lever is moved to any position except R (Reverse)
- Outside rearview mirror buttons are not depressed

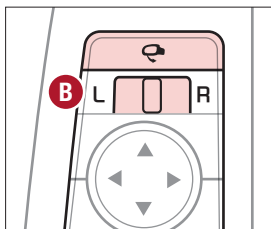
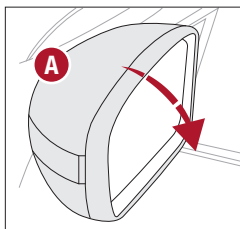

(Button/switch panel located on Driver's Door)

REMINDER: When one of the outside rearview mirror switches are not depressed (LED lit), the Reverse Parking Aid Function will not operate and the outside rearview mirrors will not rotate downward.

See section 4 in the Owner's Manual for more information.

Engine Start/Stop Button*†‡

To start the engine:

1. Depress the brake pedal
2. Press the Engine Start/Stop button while gear shift is in P (Park) or N (Neutral)

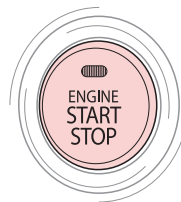

To turn the engine OFF: Press the Engine Start/Stop button.

To use the Engine Start/Stop button, you must have the Smart Key fob inside the vehicle.

QUICK TIPS

To use electrical accessories:

ACC position

- When in the OFF position and without depressing the brake pedal, press the Engine Start/Stop button once (amber light)

ON position

- When already in the ACC position (amber light) and without depressing the brake pedal, press the Engine Start/Stop button (red light)
- When in the OFF position and without depressing the brake pedal, press the Engine Start/Stop button twice (red light)

Keeping the vehicle in the ACC or ON position for extended periods of time without turning the engine on may discharge the vehicle's battery.

See section 5 in the Owner's Manual for more information.

QR CODES

Engine Start/Stop Button & Smart Key Video



Refer to the inside front cover for more information on QR codes.
www.youtube.com/KiaFeatureVideos

REMINERS:

- In an emergency situation while the vehicle is in motion, you are able to turn the engine off and to the ACC position by pressing the Engine Start/Stop button for more than 2 seconds or 3 times successively within 3 seconds
- If the Smart Key battery is weak or not working properly, hold the Smart Key fob up to the Engine Start/Stop button (Lock button side closest) and press to start engine

Power Windows, Window Lock & Central Door Lock

A Pull/Press to operate Front Windows Auto Up/Down*

QUICK TIP

Press button again to stop Auto Up/Down function.

B Press to Unlock/Lock All Doors

C Press to disable Rear Passenger Windows

REMINDER: When pressed **C**, window controls for the Rear Passenger Windows are disabled.

QUICK TIPS

While driving with the rear windows down or with the sunroof* in an open or partially open position, a wind buffeting or pulsation noise may be heard. This noise is a normal occurrence and can be reduced or eliminated by the following:

- If the noise occurs with one or both of the rear windows down, partially lower both front windows approximately 1 inch
- If the noise occurs with the sunroof open, slightly reduce the size of the sunroof opening

Automatic Door Lock/Unlock

Auto Door Lock/Unlock will engage when the gear shift is moved into or out of the P (Park) position. Refer to the User Settings mode in the LCD Instrument Cluster or the Audio Head Unit* on how to turn Auto Door Lock/Unlock ON/OFF.

Button configuration may vary depending on vehicle model. Refer to section 4 in the Owner's Manual for more information.

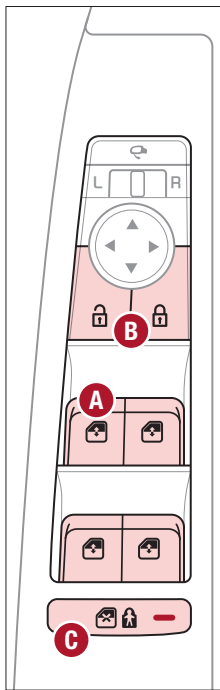

(Button/switch panel located on Driver's Door)

Electronic Child Safety Lock System

Press button **C** to lock the rear passenger doors. An indicator will illuminate showing the system is active.

This system is on by default, and then activated once the button **C** is pressed. To deactivate, press the button again.

See section 4 in the Owner's Manual for more information.

QR CODES

Electronic Child Safety Lock System Video



Refer to the inside front cover for more information on QR codes.
www.youtube.com/KiaFeatureVideos

Power/Heated Outside Mirrors*

Mirror heaters are activated when the Rear Defroster is turned on.

Refer to section 4 in the Owner's Manual for more information.

Manual Folding Mirrors*

To fold the mirrors in manually, pull the mirror towards the window.

QUICK TIP

If needed, pull the mirror firmly until it folds

Refer to section 4 in the Owner's Manual for more information.

Images are for illustrative purposes only and may not reflect actual feature or operation.

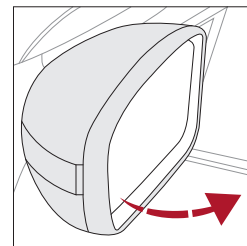

Tilt/Telescoping Steering Wheel†25

To adjust the Steering Wheel, press the Lock-Release Lever **A** down and adjust the desired angle **B** and distance **C**.

When finished, pull the Lock-Release Lever **A** up to lock the Steering Wheel in place.

QUICK TIP

To adjust the steering wheel angle, it may be helpful to first adjust the steering wheel's distance from the driver.

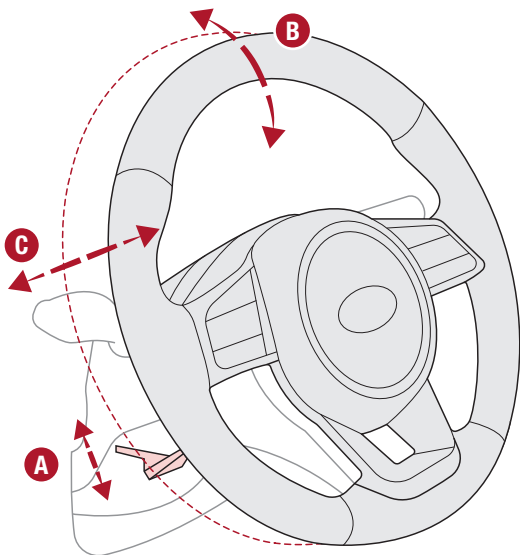

For illustrative purposes only. Your steering wheel may vary.

See section 4 in the Owner's Manual for more information.

Headlights & High Beams

To operate:

- Rotate the switch to change the Headlight function **A**
- Push the lever to turn the High Beams ON **B**
- Pull the lever to flash the Headlights/High Beams **C**

AUTO Light position* – When the light switch is in the AUTO Light position, the tail lights and headlights will turn ON/OFF automatically depending on the amount of light outside the vehicle.

High Beam Assist (HBA) – High Beam Assist is designed to automatically adjust the headlight range by switching between high and low beams based on light detected from other vehicles and road conditions.

To enable HBA, toggle the light switch to the AUTO Light position and turn on the high beams by pushing the lever away from you.

REMINDERS:

- High Beam Assist does not operate below certain speeds, or in some lighting and driving conditions. Please be aware of your surroundings and exercise proper road etiquette when operating a vehicle using the high beams
- HBA will operate when vehicle speed exceeds 25 mph
- If the lever is pushed away from you while HBA is operational, HBA will turn off and the high beams will be on continuously. If the lever is pulled toward you while HBA is operational, HBA will turn off
- If the light switch is switched to the headlight position, HBA will turn off and low beams will be on continuously
- When the HBA indicator illuminates on the instrument cluster, the HBA is not working properly. See an authorized Kia dealer for service

See section 4 in the Owner's Manual for more information.

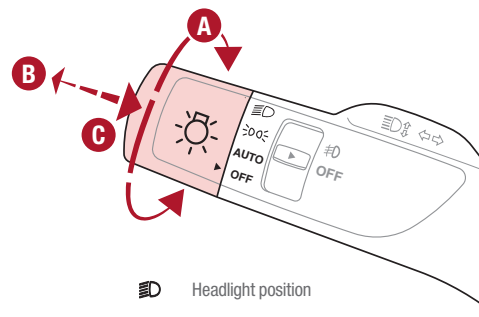

- Headlight position
- Parking light position
- AUTO** Auto Light / HBA*
- OFF** OFF position

Turn Signals & Fog Lights*

To operate:

- Slightly move lever up/down to activate One-Touch Lane Change Signal **A**
- Turn Signals – Move lever Up/Down for Right/Left Turn Signal **B**
- Fog Lights – Press toggle switch **C** to turn Fog Lights ON/OFF

REMINDER: Headlights must be ON for Fog Light operation

One-Touch Lane Change Signal

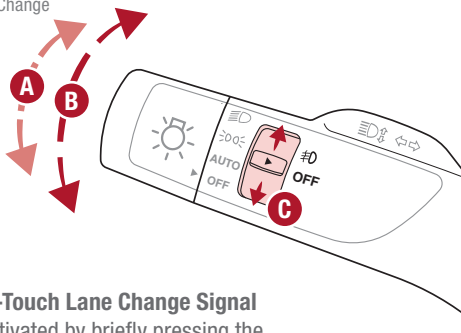

One-Touch Lane Change Signal

is activated by briefly pressing the Turn Signal Lever up/down slightly for less than 1 second and then releasing **A**. The lane change signal will blink 3 times.

To turn the One-Touch Lane Change Signal off/on, go to User Settings Mode in the LCD Instrument Cluster or the Audio Head Unit*.

Refer to section 4 in the Owner's Manual for more information. For illustrative purposes only. Your actual display, buttons and/or features may vary.

ALWAYS CHECK THE OWNER'S MANUAL FOR COMPLETE OPERATING INFORMATION AND SAFETY WARNINGS.

Windshield Wipers & Washers

To operate:

- Move lever Up/Down **D** to change Wiper modes
- Push switch **E** to adjust Intermittent Wipe Speed
- Pull lever to spray and wipe **F**

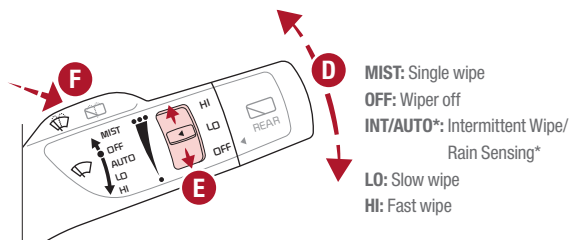

QUICK TIPS

- Moving switch **E** up increases intermittent wipe frequency and wipe speed. Moving switch down decreases frequency of wipes
- Set the wiper to the OFF position when the wiper is not in use

Rear Wiper & Washer*

To operate:

- Rotate Rear Wiper switch to change Wiper modes **G**
- Push to spray and wipe **H**

QUICK TIP

On Rear Wipers, the intermittent wipe function is not adjustable. LO and HI sets wiper speed.

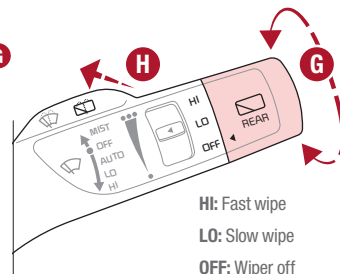

QR CODES

Wipers and Wipers Stalk Video



Refer to the inside front cover for more information on QR codes.
www.youtube.com/KiaFeatureVideos

Smart Cruise Control (SCC) with Stop & Go*†6

The Smart Cruise Control with Stop & Go* system is designed to maintain a predetermined distance from vehicles detected ahead by automatically adjusting the driving speed as needed. When traffic is detected, the vehicle will automatically slow to maintain a set distance between traffic without depressing the accelerator or brake pedal.

With the SCC on and activated, the vehicle distance set, and the system detects a vehicle slowing or stopping, the system can bring the vehicle to a complete stop. When the vehicle ahead starts to move forward, the SCC system re-engages. If the vehicle ahead stops for more than 3 seconds, the accelerator pedal or the RES+ button must be pressed to start moving the vehicle.

On some models, press the Driving Assist Mode  CRUISE button* on the Steering Wheel to activate and the speed will be set to the current vehicle speed. SCC may decrease the speed to maintain the distance with the vehicle in front.

To set/adjust the SCC speed:

- Push the Driving Assist **CRUISE** / Driving Assist Mode  CRUISE button* **A** to turn the system ON & set the current speed (One-Touch Set). The cruise indicator will illuminate on the instrument cluster
- Accelerate/decelerate to the desired speed and press lever **B** down to set the speed
- Press the RES+/SET- (+/-) button* **B** up/down to increase/decrease the set speed
- The SET indicator light, set speed and vehicle distance will illuminate on the instrument cluster's LCD screen **C**

To set the vehicle distance: Press the Vehicle Distance button **D** on the steering wheel. The image on the LCD screen **C** will change when scrolling through the settings. Each time the button is pressed, the vehicle distance changes.

To cancel or pause SCC operation: Press the CANCEL* or pause  button* **B**. The cruise indicator on the instrument cluster will turn OFF.

To turn SCC OFF: Press the Driving Assist **CRUISE** / Driving Assist Mode  CRUISE button **A**. The cruise indicator on the instrument cluster will turn OFF.

To adjust the sensitivity of the SCC system: Press the mode button  **E** on the Steering Wheel. With the OK button **F**, select Driver Assistance, then SCC Response or go to settings in the Audio Head Unit*. Then select Fast, Normal or Slow.

To change the cruise control mode from SCC to standard cruise control, press and hold button **A**. Repeat to switch back to SCC mode (The SCC system must not be activated to change modes. Some Kia models use the CRUISE button).

See section 5 in the Owner's Manual for more information. Images are for illustrative purposes only and may not reflect actual feature or operation.

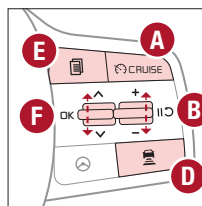

(Type B Steering Wheel shown; buttons located on right side of Steering Wheel)

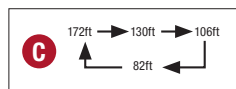

The distance settings are approximations and may vary depending on the vehicle speed at the time. See owner's manual for more information.

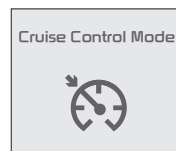

QR CODES

Smart Cruise Control with Stop & Go Video



Refer to the inside front cover for more information on QR codes.
www.youtube.com/KiaFeatureVideos

The SCC system is a supplemental system and is not a substitute for safe driving. It is the responsibility of the driver to always check the speed and distance to the vehicle ahead.

Smart Cruise Control (SCC) with Stop & Go*†6 (continued)

QUICK TIPS

- The speed setting for SCC can be adjusted under the following conditions:
- You must be travelling at a minimum speed of 20 mph (may vary on newer models)
- When following a vehicle, there is no minimum speed requirement
- When following a vehicle, the system can automatically adjust your cruise speed based on the vehicle detected ahead. If the vehicle detected ahead remains at a standstill and your vehicle is also stopped for longer than 3 seconds, the system will need to be reactivated by pressing the gas pedal or pressing the RES button

REMINDERS:

- The cruise control system will not activate until the brake pedal has been depressed at least once after the ignition is ON or engine starting
- When following a vehicle, the system will automatically adjust your cruise speed based on the vehicle detected in front
- SCC is also canceled when the driver's door is opened, gear shift is changed out of D (Drive), EPB is activated and various other conditions. See the Owner's Manual for other conditions
- If SCC is left on, it can be activated inadvertently. Keep the system off when not in use to avoid setting a speed which the driver is not aware of
- SCC is a supplemental system and is not a substitute for safe driving. It is the responsibility of the driver to always check the speed and distance to the vehicle ahead

Cruise Control (CC)†23

- A Driving Assist Mode  CRUISE button:** Press to turn the Cruise Control ON/OFF. The indicator will illuminate on the instrument cluster and the set speed will automatically activate at the vehicle's current speed
- B RES+ :** Press up to resume or increase cruising speed
SET- : Press down to set or decrease Cruising Speed
Pause/Resume button: Press to pause Cruise Control. Press again to resume Cruise Control

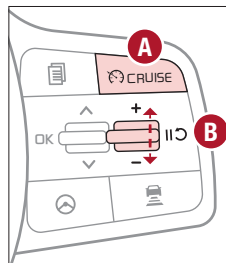

QUICK TIPS

- Cruise Control is designed to function at above 20 mph
- The Cruise Control system will not activate until the brake pedal has been depressed at least once after ignition ON or engine start

REMINDER: Cruise Control is a part of Smart Cruise Control with Stop & Go* and can be set as the operating mode. To switch from SCC to Cruise Control, press and hold the Driving Assist Mode  CRUISE button. Repeat to switch back to SCC mode.

Your vehicle's steering wheel buttons may differ from those in the illustrations. Refer to section 5 in the Owner's Manual for more information.

Bluetooth® Wireless Technology†5,23

- A Talk button:** Press to activate voice recognition/bring up menus/place calls with minimal voice command prompts from the system. Press and hold to exit voice recognition
- UVO link with Navigation system* –** When enrolled with a UVO link subscription, press this button to activate the UVO Voice Assist to use navigation guidance and search destinations
- B Volume button:** Press up/down to raise/lower speaker volume
- Mute button:** Press to mute the microphone during a call
- C Receive/Place Call button:** Press to place/answer calls. If no phone is paired, press the button to pair a phone
- D End Call button:** Press to end a call, reject an incoming call or cancel a function

QUICK TIPS

- When using the voice command feature, wait for the system BEEP before speaking the command
- Phone book transfer upload time varies by phone model and with number of phone book entries
- Because of differences in phone quality, service providers and *Bluetooth*® Wireless Technology chip programming, functionality may differ from one phone to another
- The system may register or pair multiple *Bluetooth*® devices. See the Car Multimedia System User's Manual for more information on setup and limitations

For more information, refer to the Car Infotainment System Quick Reference Guide or the Owner's Manual. For *Bluetooth*® Wireless Technology FAQs, go to www.kia.com, or call Consumer Information for *Bluetooth*® Technology at (800) 333-4KIA. Refer to your Owner's Manual for more specific *Bluetooth*® Wireless Technology phone pairing and operation instructions.

Your vehicle's steering wheel buttons may differ from those in the illustrations.

Driving while distracted is dangerous and should be avoided. Drivers should remain attentive to driving and always exercise caution when using the steering-wheel-mounted controls while driving.

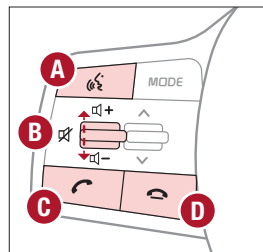

(Controls on left side of Steering Wheel)

Pairing a Phone

For instructions on how to pair a phone, refer to the Car Multimedia System User's Manual or your vehicle's Quick Start Guide.

QUICK TIP

During the pairing process, be sure to accept the connection requests on the phone for phone book download and to allow acceptance of all future *Bluetooth*® connection requests

How to Place a Call

When using the voice command feature, wait for the system BEEP before speaking the command.

There are two options for placing a call:

- Option 1: Press the Receive/Place Call button **C** (displays the phone screen with call history)
- Option 2: Press the Talk button* **A**. Then say the command "Call {name}" or "Dial {number}", followed by contact name or number

REMINDER: *Bluetooth*® Wireless Technology audio and calling functions are supported when connected to a *Bluetooth*® enabled device

Bluetooth® Wireless Technology^{†5,23} (continued)

Voice Recognition* and Phone Contact Tips

The system may have difficulty understanding some accents or uncommon names. Improve the performance by making a few simple changes to your phone contacts, listed below. To help optimize the *Bluetooth®* Wireless Technology Voice Recognition system, see other tips and reminders under Quick Tips.

- Use full names (first and last names) vs. short or single-syllable names (“John Smith” vs. “Dad,” “Smith Residence” vs. “Home”)
- Avoid using special characters, emojis or hyphenated names (@, &, #, /, -, *, +, etc.)
- Avoid using acronyms (“In Case of Emergency” vs. “ICE”) or words with all capital letters
- Spell words completely, no abbreviations (“Doctor Smith” vs. “Dr. Smith”)

QUICK TIPS

- *Bluetooth®* Music Streaming – If the *Bluetooth®* music is inaudible or too low, you may need to turn up the volume on the connected phone
- When placing a call, speak in a natural, moderate tone, with clear pronunciation. The system may have trouble recognizing commands if you speak too softly or too loudly
- Always wait for the beep before speaking any commands
- Close windows and sunroof and turn off A/C – Open windows, sunroof, weather (wind/rain), or an A/C fan operating at higher speeds can interfere with Voice Recognition
- Press the talk button and say “Help” to get a list of available commands
- The system may register or pair multiple *Bluetooth®* devices. See the Car Infotainment System Quick Reference Guide for more information on setup and limitations.

QR CODES

Voice Recognition Tips Video



Refer to the inside front cover for more information on QR codes.
www.youtube.com/KiaFeatureVideos

Audio Controls^{†23}

- A Audio MODE button:** Press to cycle through FM/AM/SiriusXM®* /Media modes. Press and hold to turn system on/off (Standard Audio Systems only)
- B Seek/Preset buttons:** *FM/AM/SiriusXM®* Modes: Press to advance through Preset Stations. Press and hold to auto seek
Media Modes: Press up/down to move track up/down. Press and hold to fast forward/rewind (except for *Bluetooth®* Audio)
- C Volume button:** Press up/down to raise/lower volume
Mute button: Press to mute all audio (Media pauses in some Media modes when pressed)

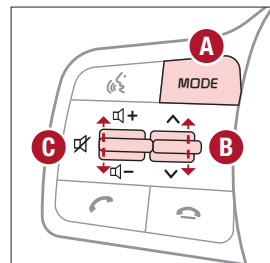

(Controls on left side of Steering Wheel)

For other audio system information, refer to pages 32-37.

For more information, refer to the Owner's Manual or the Car Infotainment System Quick Reference Guide.

Android Auto™^{†3} / Apple CarPlay®^{†4} Setup

Android Auto™ compatible smartphone setup – Download the Android Auto™ app from the Google Play™ Store^{†10}. Open the Android Auto™ app and proceed with the onscreen instructions to complete setup on the mobile device.

Wireless Connection setup for Android Auto™ & Apple CarPlay®
(*Standard Audio System & Standard Audio System-Value with UVO link*):

1. Press the SETUP key on the audio head unit
2. Press DEVICE CONNECTION SETTINGS
3. Press PHONE PROJECTION, then ADD NEW

Cable Connection setup for Android Auto™ (*Standard Audio System, Standard Audio System-Value with UVO link & UVO link with Navigation*):

1. Press the SETUP key on the audio head unit
2. Press DEVICE CONNECTION, select Android Auto™ and then select ENABLE ANDROID AUTO. Review all terms, conditions and requests on the head unit and phone, and, if you agree, accept them in order to use Android Auto™
3. Connect the Android™ device with the vehicle's USB port using the manufacturer's cable provided with your phone
4. From the vehicle's home screen, select the Android Auto™ button, where you'll see all the Android Auto™ supported apps

Cable Connection setup for Apple CarPlay®
(*UVO link with Navigation only*):

1. Connect the Apple CarPlay® compatible iPhone®^{†11} with the vehicle's USB port using the manufacturer's cable provided with your iPhone®^{†11}
2. Press the SETUP key on the audio head unit
3. Press DEVICE CONNECTION on the screen and select Apple CarPlay®
4. Select ENABLE APPLE CARPLAY. Review all terms, conditions and requests on the head unit and phone, and, if you agree, accept them in order to use Apple CarPlay®
5. From the audio head unit home screen, select the Apple CarPlay® button, where you'll see all the Apple CarPlay® supported apps

REMINDERS:

- Android Auto™ compatibility requirements for connection:
 - UVO link with Navigation (USB cable connection only): OS Android™ 5.0 or higher, phone manufacturer's USB cable and data plan with applicable feature(s)
 - Standard Audio System-Value (USB cable & wireless connection):
 - USB cable connection - OS Android™ 5.0 or higher, phone manufacturer's USB cable and data plan with applicable feature(s)
 - Wireless connection - OS Android™ 9.0 or higher with data plan for applicable feature(s)
- Apple CarPlay® compatibility requirements for connection:
 - UVO link with Navigation (USB cable connection only): iOS software 8.0 or higher, phone manufacturer's USB cable and data plan for applicable feature(s)
 - Standard Audio System-Value (Wireless connection only): iOS software 10.0 and higher with data plan for applicable feature(s)
- It is recommended to always update your phone to the latest operating system release
- Wireless Android Auto™ system only works for certain Android models. Use the manufacturer's USB cable when wireless feature is not available

QR CODES

Wireless Apple CarPlay
& Android Auto Video



Refer to the inside front cover for more information on QR codes.
www.youtube.com/KiaFeatureVideos

Refer to the Car Infotainment System Quick Reference Guide for more information.

QUICK TIPS

- If Android Auto™ / Apple CarPlay® randomly disconnects:
 - Ensure the USB cable is certified by the phone manufacture for both power and data
 - Clean the phones port, which the USB cable connects to, with disposable compressed air
 - The Phone should not be disturbed while driving as this can cause a disconnection at the phone's USB port
 - Visit the phone manufactures website for Android Auto/Apple CarPlay app concerns

Driving while distracted can result in a loss of vehicle control that may lead to an accident, severe bodily injury, and death. The driver's primary responsibility is in the safe and legal operation of a vehicle, and any handheld devices, other equipment, or vehicle systems which take the driver's eyes, attention and focus away from the safe operation of a vehicle or which are not permissible by law should never be used during operation of the vehicle.

Standard Audio System* — FM/AM/Media (USB, Aux, *Bluetooth*® Audio)*

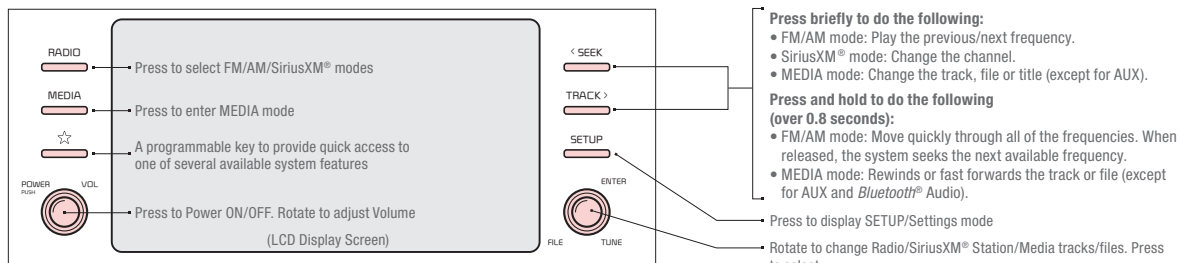

Audio System Setup Options – Press the SETUP key, then using the touchscreen, press the menu item to enter (Display, Sound, Clock/Calendar, Phone, System). Adjust the available settings for each equipped audio system setup option by pressing the onscreen buttons/arrows. Audio system setup options may include the following:

- **Display settings** – Adjusting the Brightness, Mode Popup, MP3 Information Display
- **Sound settings** – Sound Settings, Speed Dependent Volume Control, Voice Recognition Volume, Touchscreen Beep
- **Clock/Calendar settings** – Clock Settings, Time Format, Calendar Settings, Clock Display
- **System settings** – Memory Information, Prompt Feedback, Language

Presets: Press the favorite (star) button near the station information

Custom Key ☆: A programmable key to provide quick access to one of several available system features.

To Program the Custom Key: Press the SETUP key, then press the Custom button. Select one of the available features you would like the Custom button to open.

REMINDERS:

- To help minimize driver distraction, some audio system functionalities have been modified while the vehicle is in Drive, Reverse or moved out of Park.
- Prolonged use of the audio head unit in ACC mode may drain the vehicle's battery

Sound Settings – To adjust the Standard Audio Systems sound settings:

1. Press the SETUP key on the audio head unit or the onscreen MENU button, when in MEDIA mode
2. Select the onscreen SOUND button
3. Select the menu item (Position, Tone, Speed Dependent Volume, Beep)
4. Using the touchscreen, press arrows to adjust the settings

QUICK TIPS

- Volume level between different audio modes:
 - When switching between audio modes (AM, FM, *Bluetooth*® Audio, etc.), the audio system saves the previous volume level you were listening to. For example, if you were listening to FM radio at volume level 20 then switched to BT Audio and adjusted the volume level to 30, the volume level will be at 20 when you switch back to FM radio
 - When using *Bluetooth*® Audio, the overall volume is dependent on your device's volume. If the volume is turned down low on your device it will remain low even if the system volume is turned up
- This system supports Android Auto™ (USB & wireless connection) and Apple CarPlay® (wireless connection only)
- When connected to Android Auto™ or Apple CarPlay® on your smartphone, the smartphone's navigation system may also be available
- A warning screen may appear periodically to remind users that the audio system should be operated when the engine is running to prevent battery discharge

QR CODES

Standard Audio System Video



Refer to the inside front cover for more information on QR codes.
www.youtube.com/KiaFeatureVideos

Your vehicle's audio system may differ from that in the illustration. For further audio system operations, refer to the Car Infotainment System Quick Reference Guide

UVO link Activation^{*†1} (Systems equipped with UVO link only):

Follow these steps to activate your UVO link system:

1. Enter the activation screen on your vehicle's head unit:
 - a. Press SETUP key
 - b. Press UVO icon
 - c. Press Activate UVO
2. Read and agree to Terms of Service and Privacy Policy and press SUBMIT
3. Enter smartphone number or email address to receive a verification code, then press SUBMIT
4. Follow these steps to receive your verification code using your phone SMS or email:
 - a. Check your phone SMS or email for verification code
 - b. Open the link in your SMS or email. A page will open requesting that you create your account

Note: If you already have a Kia Owners Portal account using the email as your login ID, you will need to provide your password prior to receiving the verification code

- c. Enter your first name, last name, email, phone number, an account password, and click CREATE ACCOUNT. A page will open displaying your verification code
- d. Enter the code in the head unit and press ACTIVATE
- e. Go back to the page with your verification code and press "I have entered my PIN." A link will be provided to download the Kia Access with UVO link app from your app store. After installing the app, log in and enjoy

REMINDER: This vehicle is not equipped with over-the-air system updates.

Driving while distracted can result in a loss of vehicle control that may lead to an accident, severe bodily injury, and death. The driver's primary responsibility is in the safe and legal operation of a vehicle, and any handheld devices, other equipment, or vehicle systems which take the driver's eyes, attention and focus away from the safe operation of a vehicle or which are not permissible by law should never be used during operation of the vehicle.

For further UVO link operations, refer to the Car Infotainment System Quick Reference Guide.

QR CODES

UVO Assistance Video



Refer to the inside front cover for more information on QR codes.
www.youtube.com/KiaFeatureVideos

UVO Assistance*

- Virtual Assistant ⓘ ⓘ – Press to connect to the UVO Center to hear information about the UVO features
- UVO Voice Local Search UVO ⓘ ⓘ – Press to connect to the search function to find points of interest or other locations, like “cafe”
- Roadside Assist ⓘ ⓘ – Press to connect to the Kia Consumer Call Center where you can request vehicle towing services

REMINDER: Some Kia models have the UVO Assistance buttons on the front overhead console. Buttons may vary on Kia models.

For more information, refer to the Car Infotainment System Quick Reference Guide.

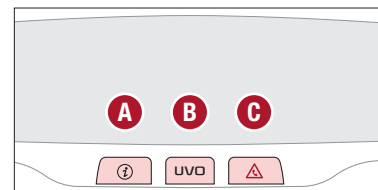

(Buttons on rearview mirror*)

Kia Access with UVO link App Download

Go to an app marketplace to download the new Kia Access with UVO link App. Once you download, make sure you register your vehicle and start an account (refer to UVO link Activation page). Get to know your new Kia and the available convenient features on the app.

QUICK TIPS

- The smartphone and vehicle need to be connected to a cellular network with a good wireless signal strength in order to use UVO. If these conditions are not met, remote command may not execute or takes long time. It will also effect voice commands
- To use Remote Start or Remote Start with Climate Control feature, all doors, hood and trunk/liftgate must be closed and locked
- Activate Remote Start or Remote Start with Climate Control feature at least 10 minutes before getting into the vehicle, which will allow vehicle interior to reach a desired temperature. If the driver does not enter the vehicle within the 10 minutes, the Remote Start will turn off the engine
- The quickest way to obtain accurate vehicle status through the app is by pressing the refresh button on the app or refreshing the web page when using the customer web portal
- In order to preserve the vehicle battery, UVO will not turn on seven days after the last ignition was on. You will need to restart the vehicle with a key fob in order to use UVO again



Kia Access with UVO link App Features Guide

The Kia Access with UVO link App Features Guide is a step-by-guide helping you utilize the app to its full potential by detailing how to set up and use each feature and adjust various settings. Below are some of the topics included:

- Remote Commands
- Set Climate
- Schedule Remote Start/Climate
- Schedule Charge
- Schedule Service
- Dealer Settings
- Manage Vehicles and Profiles

Kia App Screen for illustrative purposes only. Actual App screen and functionality may vary.

For further UVO link operations, refer to the Car Infotainment System Quick Reference Guide.

QR CODES

Download the **Kia Access with UVO link App** by clicking this dynamic QR code. Some phone's operating systems may need to be updated to scan dynamic QR codes.



Kia Access with UVO link App Features Guide. Click this dynamic QR code to access the guide. Some phone's operating systems may need to be updated to scan dynamic QR codes



Standard Audio System – Value with UVO link* — FM/AM/SiriusXM® †21/Media (USB, Bluetooth® Audio)*

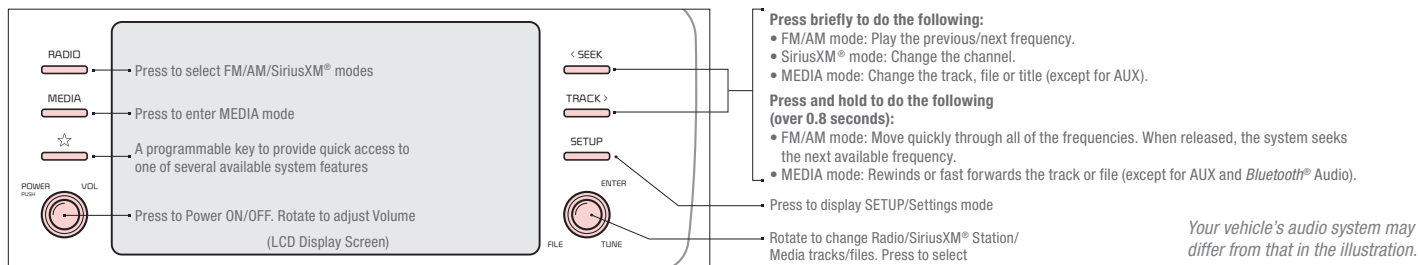

Sound Settings – To adjust the sound settings:

1. Press the SETUP key on the audio head unit or the onscreen MENU button, when in MEDIA mode. Select the onscreen SOUND button, or SOUND SETTINGS
2. Select the menu item (Position, Volume, Tone, Priority, Advanced, Default, FM Radio Noise Cancel*)
3. Use the onscreen buttons to adjust settings. Press the return button to save settings

Presets – Press the STAR button next to or below the Radio Station display. This saves the current station as a preset.

SiriusXM® Smart Favorites – For the first ten favorite SiriusXM® channels, you may play live or repeat from the beginning of a song or a program segment. In Radio mode, choose SiriusXM®, then select any of the first ten favorites. During song or program play, tap the Skip Backward icon to start from the beginning of the song or program. Tap the Play Live icon to return to the live broadcast.

Custom Key ☆: A programmable key to provide quick access to one of several available system features. **To Program the Custom Key**: Press and hold the Custom key. Select one of the available features you would like the Custom key to open.

REMINDERS:

- Driving while distracted is dangerous and should be avoided. Drivers should remain attentive to driving and always exercise caution when using the audio system controls while driving. To help minimize driver distraction, some audio system functionalities have been modified while the vehicle is in Drive, Reverse or moved out of Park.
- Prolonged use of the audio head unit in ACC mode may drain the vehicle's battery

For more information, refer to the Car Infotainment System Quick Reference Guide. For other audio system information, refer to pages 30-37.

QUICK TIPS

- Volume level between different audio modes:
 - When switching between audio modes (AM, FM, Bluetooth® Audio, etc.), the audio system saves the previous volume level you were listening to. For example, if you were listening to FM radio at volume level 20 then switched to BT Audio and adjusted the volume level to 30, the volume level will be at 20 when you switch back to FM radio
 - When using Bluetooth® Audio, the overall volume is dependent on your device's volume. If the volume is turned down low on your device it will remain low even if the system volume is turned up
- This system supports Android Auto™ (USB & wireless connection) and Apple CarPlay® (wireless connection only)
- Navigation may be available when connected to Android Auto™ or Apple CarPlay® supported smartphones
- When using the voice command feature, wait for the system to BEEP before speaking the command
- At any time, you can interrupt Command Feedback by pressing the TALK button
- Prolonged use of the audio head unit in ACC mode may drain the vehicle's battery. A warning message may appear periodically on the audio head unit screen

UVO link^{†1} with Navigation^{*†14} – FM/AM/SiriusXM^{®†21}/Media (USB, Aux, Bluetooth[®] Audio)

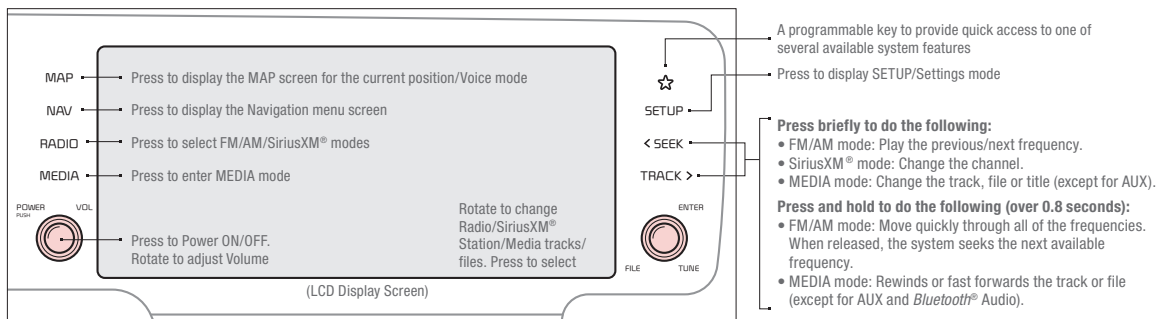

Sound Settings: To adjust the sound settings (Fader/Balance, Tone, Touch-Screen Beep ON/OFF and Speed-Dependent Volume Control ON/OFF) from any audio mode:

1. Press the SETUP button on the Audio Head Unit
2. Select the onscreen SOUND button
3. Select the menu item to change settings
4. Use the onscreen buttons to adjust settings

Radio Presets: You can listen to FM, AM and SiriusXM[®] radio and save frequently used stations

How to Save a Preset: Press the STAR button next to or below the Radio Station display. This saves the current station as a preset

SiriusXM[®] Smart Favorites: For the first ten favorite SiriusXM[®] channels, you may play live or repeat from the beginning of a song or a program segment. In Radio mode, choose SiriusXM[®], then select any of the first six favorites. During song or program play, tap the Skip Backward icon to start from the beginning of the song or program. Tap the Play Live icon to return to the live broadcast

Custom Key ☆: A programmable button to provide quick access to one of several available system features

To Program the Custom Key: Press and hold the Custom Key. Select one of the available features you would like the Custom Key to open

QUICK TIPS

- Volume level between different audio modes:
 - When switching between audio modes (AM, FM, Bluetooth[®] Audio, etc.), the audio system saves the previous volume level you were listening to. For example, if you were listening to FM radio at volume level 20 then switched to BT Audio and adjusted the volume level to 30, the volume level will be at 20 when you switch back to FM radio
- When connected to Android Auto™ or Apple CarPlay® on your smartphone, the smartphone's navigation system may also be available
- This system supports Android Auto™ and Apple CarPlay® (USB connection only)
- A warning screen may appear periodically to remind users that the navigation system should be operated when the engine is running to prevent battery discharge
- At any time, you can interrupt UVO link Command Feedback by pressing the TALK button on the steering wheel

For other audio system information, see pages 30-36.

QR CODE

UVO link with Navigation Video

To view a video on your mobile device, snap this QR Code or visit the listed website.

Refer to the inside front cover for more information on QR codes.



www.youtube.com/KiaFeatureVideos

REMINDERS:

- To help minimize driver distraction, some audio system functionalities have been modified while the vehicle is in Drive, Reverse or moved out of Park.
- Prolonged use of the audio head unit in ACC mode may drain the vehicle's battery

Your vehicle's audio system may differ from that in the illustration.

For further UVO link with Navigation operations, refer to the Car Infotainment System Quick Reference Guide.

Digital Clock

Press SETUP, then select General, scroll down and select Date/Time from the menu to adjust.

QUICK TIPS

- Press the Return button on the audio head unit to ensure changes are saved
- When needed, Daylight Savings must be enabled in the Clock Settings screen
- To access manual date and time setting, turn GPS time OFF in the Clock Settings (UVO link with Navigation*)

Refer to the Car Infotainment System Quick Reference Guide for more information.

Multimedia USB Ports, Power Outlets, & USB Charger Ports*

Multimedia USB Port*

- **A** Use the Multimedia USB port to connect USB audio devices and smartphones

Power Outlets

- **B** Use the power outlets for mobile phones and other devices designed to operate on a 12V (180W max) power outlet

USB Charger Ports*

- **C** USB charger ports* and power outlets are located in the Center Panel, inside and on the back of the Center Console

QUICK TIP

The power outlets are inactive when the Engine Start/Stop button is OFF.

REMINDERS:

- Using the Power Outlet (accessory plug) and USB charger for prolonged periods of time with the Engine Start/Stop button in the ACC position (Engine OFF) for prolonged period time could cause the battery to discharge
- Use only the charging cables that your device manufacturer supplied. Third party cables may cause damage to device
- The USB data port (Multimedia USB port) is located next to the Power Outlets. The USB Charger ports do not support data transfer

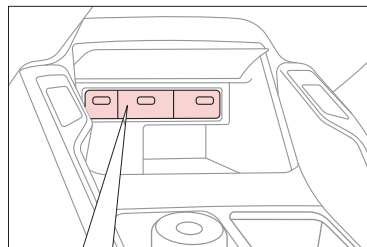

(Located on Center Console below Climate Controls)

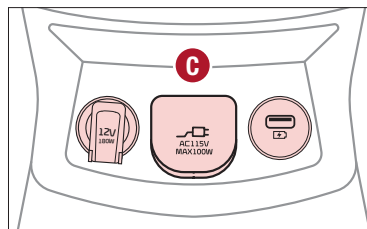

(Located on Back of Center Console)

Refer to section 4 in the Owner's Manual for more information.

For illustrative purposes only. Your actual display, buttons and/or features may vary.

Wireless Smartphone Charging System*

Charge a compatible smartphone wirelessly by placing it on the tray **B** at the front of the console, near the Multimedia USB ports and the charging indicator, while the ignition is on.

1. Enable Wireless Charging in the User Settings
2. Slide open cover **A**. Place the smartphone on the center of the charging pad **B**
3. Indicator light **C** may change to amber once wireless charging begins
4. Once charging is complete, the amber light may change to green

QUICK TIPS

- The smartphone must be a compatible phone with Qi function available
- Wireless charging must be enabled in user settings
- If wireless charging does not work, move the smartphone around the pad until the charging indicator turns amber. Avoid placing other metal items in the bin while charging as to not impede the charging area
- For wireless charging to occur, all doors (excluding the rear hatch) must be closed & the Smart Key Fob must be detected inside the vehicle

REMINDERS:

- If the driver door is opened, charging will be disabled
- Wireless charging technology allows for a device to be charged using inductive charging. See your Owner's Manual for more detailed information and the back page for legal disclaimers
- Inductive charging systems are less efficient than conventional charging through a cable. As a result, higher device operating temperatures may be experienced during use
- Charging Performance – Device position on the wireless charging system can affect charging performance. Other factor that may affect the charging rate includes foreign objects, such as coins or pens, and phone case thickness

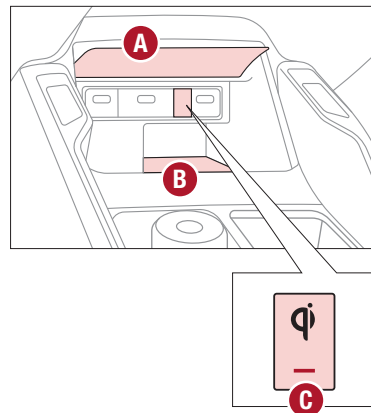

QR CODES

Wireless Charging Video



Refer to the inside front cover for more information on QR codes.
www.youtube.com/KiaFeatureVideos

Refer to section 4 in the Owner's Manual for more information.

Automatic Climate Control*

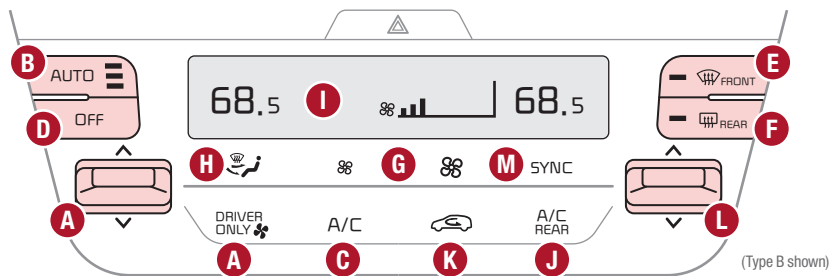

(Type B shown)

3rd Row Climate Control*

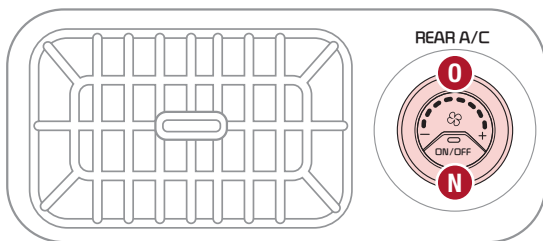

(Rear climate control)

- A Driver's temperature control
- B AUTO (automatic control) button (High, Medium, Low)
- C AUTO (automatic control) button (High, Medium, Low)
- D Turn the Auto Climate Control system OFF button
- E FRONT windshield defroster button
- F REAR window defroster button
- G Fan speed control button
- H MODE Selection button
- I CLIMATE information screen
- J A/C Rear Control ON/OFF button
- K Air intake control button
- L Passenger's temperature control knob
- M SYNC temperature control selection button*
- N 3rd Row air conditioning ON/OFF button
- O 3rd Row fan speed control knob

Climate Control Auto Function

1. Press AUTO **B** to select Full Auto Operation. Press once for the air flow high setting, twice for medium setting and once more for the lower setting. The Auto setting automatically controls the airflow modes, fan speeds, air intake and air conditioning according to the temperature setting selected
2. Set desired driver's Temperature **A**
3. Press SYNC* **M** to select Sync Temperature Control Operation*, which synchronizes the passenger's temperature to the driver's setting

Defrost Outside and/or Inside Windshield:

1. Set Front Fan Speed **G** to the highest position
2. Set Temperature **A** to Hot
3. Press the Front Defrost button  **E**

Automatic Climate Control* (continued)

Air Flow Modes

To select Air Flow Modes, press the mode button  to cycle through to the desired mode:



Face-Level



Floor-Level



Bi-Level



Floor/Defrost-Level

QUICK TIPS

- Defrost Mode  activates A/C and opens Fresh Air Vent to help dehumidify the air and improve Defroster performance
- During Auto Operation, the A/C indicator will NOT illuminate. The fan speed, air intake, air flow and air conditioning may automatically be engaged at any time to reach desired temperature and reduce humidity
- Keep inside glass as clean as possible to reduce window fogging

REMINDERS:



- Pressing any button during AUTO operation will deactivate the AUTO function and switch to manual mode, except for Temperature Control
- When in AUTO mode, Air Flow Mode and Fan Speed do not display on the Climate Control Display
- Warm air may flow in through the vents if the Recirculated Air button is not pressed ON (LED lit)
- Continuous use of the climate control system in the recirculated air position may allow humidity to increase inside the vehicle which may fog the glass and obscure visibility and/or cause smell/odor

Your Automatic Climate Control system may differ from those in the illustrations. Refer to section 4 in the Owner's Manual for more information.

For illustrative purposes only. Your actual display, buttons and/or features may vary.

Auto Defogging System (ADS)

Auto defogging is designed to reduce the fogging up of the inside of the windshield by automatically sensing the moisture of the inside of the windshield. The system will automatically change to defrost mode when needed.

Auto Defogging is set ON by default. To cancel Auto Defogging, press the Front Defrost button  for three seconds, when the ignition is in on (ADS OFF icon will illuminate). To turn Auto Defogging on again, press the Front Defrost button  for three seconds.

QR CODES

Automatic Climate Control Operation Video



Auto Defogging System (ADS) Video



Refer to the inside front cover for more information on QR codes.
www.youtube.com/KiaFeatureVideos

Manual Climate Control*

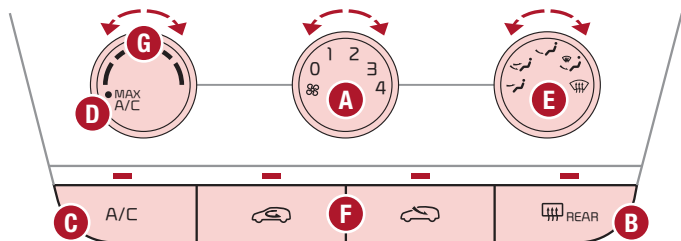

- A** Front fan speed control knob
- B** REAR window defroster button
- C** Air conditioning button
- D** MAX A/C button
- E** Mode selection knob
- F** Air intake control buttons
- G** Temperature control knob

Defrost Outside and/or Inside Windshield:

1. Set **Front Fan Speed A** to the highest position
2. Set **Temperature H** to Hot
3. Press the **Front Defrost** button **B**

QUICK TIPS

- Defrost Mode activates A/C and opens Fresh Air Vent
- MAX A/C Mode automatically engages Recirculated Air
- Keep inside glass as clean as possible to reduce window fogging

REMINDER: Warm air may flow in through vents if Recirculated Air button is not pressed ON (LED lit)

Your Manual Climate Control system may differ from those in the illustrations. Refer to section 4 in the Owner's Manual for more information.

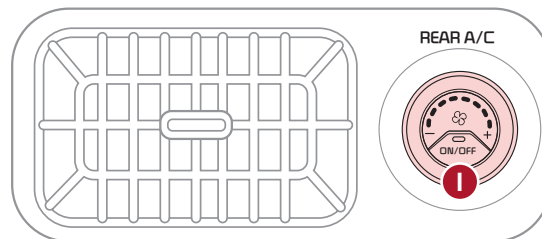

(Rear climate control)

3rd Row Climate Control*

- I** 3rd Row air conditioning ON/OFF button
- J** 3rd Row fan speed control knob

Air Flow Modes

To select Air Flow Modes, press the Mode selection buttons:

- Face-Level
- Bi-Level
- Floor-Level
- Floor/Defrost-Level

Rotary Dial Shifter Knob – Shift-by-Wire

P: Park – To shift into Park from any gear, press the Park (P) button **A** on the Rotary Dial Shifter Knob while the vehicle is stationary and the brake pedal is depressed

Rotate the Rotary Dial Shifter Knob for the following:

P: Park - Press to place in Park

R: Reverse

N: Neutral

D: Drive

Paddle Shifters

Paddle Shifters are operable when the shift lever is moved into the Drive (D) position.

Paddle Shifting: Pull the [+] or [-] paddle shifter **B** once to shift up or down one gear.

For illustrative purposes only. Your actual steering wheel and/or paddle shifters may vary.

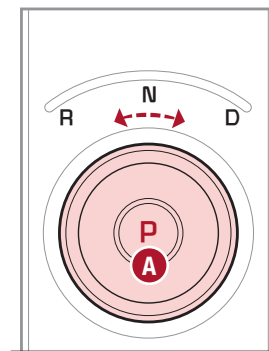
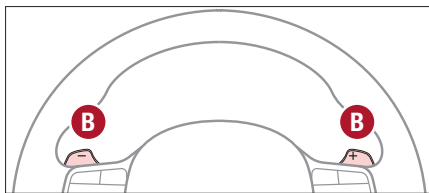

(Center Console)

QR CODES

Dual Clutch Transmission (DCT) Driving Experience Video



Refer to the inside front cover for more information on QR codes.
www.youtube.com/KiaFeatureVideos

Refer to section 5 in the Owner's Manual for additional information on Automatic Gear Shift or DCT operation or call Kia Consumer Affairs for additional information.

Dual Clutch Transmission (DCT)

Sorento HEV is equipped with Dual Clutch Transmission (DCT). The following are unique driving tips for the Dual Clutch Transmission:

- To hold the vehicle stationary on an incline, the service brake or parking brake **MUST** be used or the gear shift **MUST** be in the (P) Park position. If the vehicle is held stationary by applying the accelerator pedal on a slope, the clutch/transmission may overheat, resulting in damage
- Avoid aggressive launches on steep grades as this may result in an overheated clutch and transmission
- A slight time lag may be experienced at takeoff from standstill during aggressive acceleration maneuvers

If the clutch is overheating, an amber warning light*  will be displayed in the instrument cluster.

Should this condition occur, pull over and place the vehicle in Park and idle the engine.

AWD (All-Wheel Drive) Lock*

When you select AWD Lock mode by pressing the AWD LOCK button **A**, the AWD LOCK mode increases the drive power when driving on wet pavement, snow covered roads and/or off-road.

- This mode is used for climbing or descending sharp grades, off-road driving, driving on sandy and muddy roads, etc., to improve traction
- This mode automatically shifts back to AWD AUTO mode at speed above 19 mph. If the vehicle decelerates to speeds below approximate 25 mph, however, the transfer mode is shifted into AWD LOCK mode again

When the AWD LOCK mode is deactivated, a shock may be felt as the drive power is delivered entirely to the front wheels. This shock is not a mechanical failure.

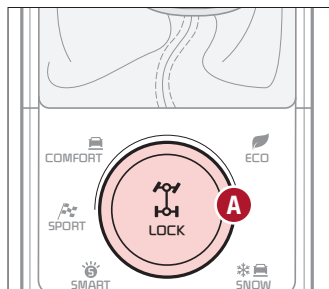

(Button on center console below gear shift)

Idle, Stop & Go (ISG) System

The ISG system is designed to reduce fuel consumption by automatically shutting down the engine when the vehicle is at a standstill.

When the ISG system is ON and the vehicle is at a standstill, the engine will stop, and the green AUTO STOP indicator **A** **B** on the instrument cluster will illuminate.

The engine will restart when the brake pedal is released or the shift lever is moved from D (Drive) to the R (Reverse) position or to Manual Shift mode. When engine restarts, the green AUTO STOP indicator on the instrument cluster will turn off.

To deactivate the ISG System, press the ISG OFF button **C**. If you press again, the system will be activated.

See section 5 in the Owner's Manual for more information.

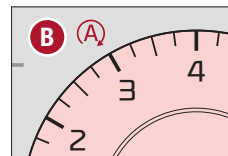

(LCD instrument panel Type B)

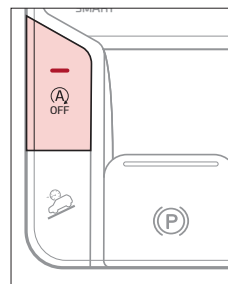

(Button on center console below gear shift)

QUICK TIPS

- If the AUTO STOP indicator **A** **A** is solid yellow, the system is functional, but just has not met all its enabling criteria to activate ISG at that time.
- The ISG system is disabled when:
 - A seat belt is unfastened
 - The hood or a door is opened
 - Battery condition is poor
 - The front or rear defroster is turned on
 - Engine coolant temperature is low
 - The outside ambient temperature is too low/high
 - Emission control devices activate
 - The vehicle is on a steep slope

QR CODES

ISG (Idle, Stop & Go) System Video



Refer to the inside front cover for more information on QR codes.
www.youtube.com/KiaFeatureVideos

Images are for illustrative purposes only and may not reflect actual feature or operation.

Refer to section 5 in the Owner's Manual for more information.

REMINDERS:

- ISG is active by default at vehicle startup. When ignition is cycled, ISG will turn ON again
- Under certain conditions, the engine will restart automatically even if the brake pedal is still depressed
- If the AUTO STOP indicator **A** is continuously blinking yellow and the ISG button LED is on, please contact an authorized Kia dealer

Electronic Parking Brake (EPB)*

The Electronic Parking Brake (EPB) system utilizes an electric motor to engage the parking brake.

Applying the Parking Brake

Depress the brake pedal and pull up the EPB switch **A**. Ensure that the indicator light is illuminated **(P) BRAKE** on the instrument cluster.

Releasing the Parking Brake

The EPB will automatically release when the shifter is placed in Reverse or Drive.

To release EPB manually, depress the brake pedal, then press the EPB switch **A**, with the ignition switch in the ON position. Ensure that the indicator light is OFF.

QUICK TIPS

- When leaving your keys with parking lot attendants or valet, make sure to inform them how to operate the EPB
- If parked on a steep incline/decline, pull up the EPB switch for more than 3 seconds for a firmer EPB application
- Pull up and hold EPB switch a second time to increase brake pressure if parked on a decline or incline

REMINDERS:

- As a bulb check, the EPB malfunction indicator will illuminate for approximately 3 seconds when the ignition switch is turned ON
- If the warning light does not illuminate temporarily, or continues to remain lit, take your vehicle to an authorized Kia dealer and have the system checked
- The EPB should not be operated while the vehicle is moving
- A click or electric brake motor sound may be heard while operating or releasing the EPB, but these conditions are normal and indicate that the EPB is functioning properly

Auto Hold*

Auto Hold temporarily maintains the vehicle at a standstill even though the brake pedal is not depressed after the driver brings the vehicle to a complete stop by depressing the brake pedal. Auto Hold can be turned On/Off using the AUTO HOLD button **B** on the center panel below the gear shift. Before Auto Hold will operate, the driver's door, engine hood and liftgate must be closed, and the driver's seat belt must be fastened.

The AUTO HOLD indicator on the Instrument Cluster has four states:

White: Standby – When vehicle is in Park and at a standstill, and AUTO HOLD button **B** is pressed ON, the indicator will illuminate white. While driving the vehicle (vehicle is not at a standstill), the Auto Hold indicator will remain white.

Green: Engaged – When coming to a complete stop by depressing the brake pedal, the Auto Hold indicator changes from white to green.

Off (not illuminated) – The indicator will turn Off when the AUTO HOLD button **B** is manually pressed Off or when the EPB is manually turned On.

Yellow: Malfunction – When the indicator is illuminated yellow, there may be a system malfunction. Take your vehicle to a local Kia dealer.

Image is for illustrative purposes only and may not reflect actual feature or operation.

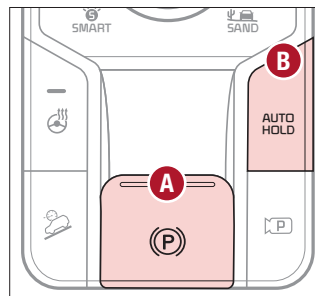

(Button on center console below gear shift)

QR CODES

Electric Parking Brake Video



Refer to the inside front cover for more information on QR codes.
www.youtube.com/KiaFeatureVideos

Refer to section 5 in the Owner's Manual for more information. Refer to page 4 for location of Instrument Cluster indicators.

REMINDERS:

- Auto Hold only operates when vehicle is in Drive or Neutral
- To reduce the risk of an accident, do not activate Auto Hold while driving downhill, backing up or parking your vehicle
- Do not solely rely on the Auto Hold system to keep the vehicle stopped. Always pay attention to traffic and road conditions, and be prepared to depress the brakes

Heated Steering Wheel*

Press Heated Steering Wheel button **A** to turn the Steering Wheel Heater on/off while the Engine Start/Stop button is in the ON position. The Steering Wheel Heater will turn off automatically in 30 minutes, or when button **A** is pressed again to deactivate.

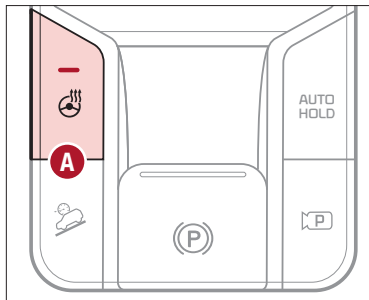

(Located below gear shift knob)

QUICK TIPS

- If ignition is turned OFF, then ON again within 30 minutes of the Steering Wheel Heater being turned ON, the system will return to its previous state
- The system returns to on when ignition is cycled. To turn off system, press the Heated Steering Wheel button **A**
- With the heated steering switch in the ON position, the heating system in the steering wheel turns OFF or ON automatically depending on the steering wheel temperature

REMINDER: If the steering wheel becomes too warm, turn the system off. The heated steering wheel may cause burns even at low temperatures, especially if used for long periods of time.

Image is for illustrative purposes only and may not reflect actual feature or operation.

Seat Warmers*†20

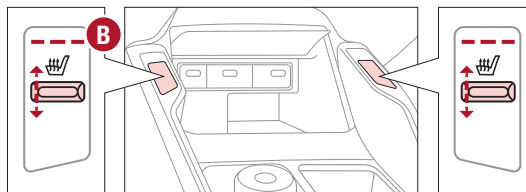

(Buttons located on top sides of center console)

B Seat Warmers

- Press the button up once for high setting (3 LEDs lit)
- Press the button twice for medium setting (2 LEDs lit)
- Press a third time for low setting (1 LED lit) and again to turn OFF

QUICK TIPS

- With the seat warmer switch in the ON position, the heating system in the seat turns OFF or ON automatically depending on the seat temperature
- System is OFF by default

REMINDER: Use extreme caution when using the seat warmers to avoid burns. Refer to the Owner's Manual for more information.

Refer to section 4 in the Owner's Manual for more information.

QR CODES

Heated and Ventilated Seats Video



Refer to the inside front cover for more information on QR codes.
www.youtube.com/KiaFeatureVideos

Front Seat Headrest Adjustment^{†10}

Type A*

- To raise the headrest, pull headrest up **A** to the desired position
- To lower the headrest, press the button **B**, then press the headrest down **C**

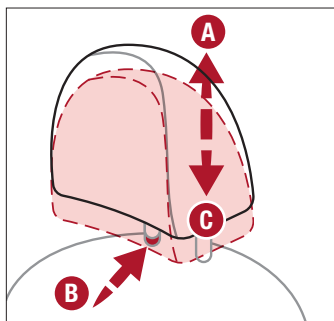

(Type A)

QUICK TIP

For easy adjustments, hold a headrest post with one hand while using the other hand to pull the headrest from underneath.

REMINDERS:

- The headrest only moves up and down as described above. It does not adjust forward or backward
- Do not operate the vehicle with the headrests removed. Headrests can provide critical neck and head support in an accident

Refer to section 3 in the Owner's Manual for more information.

Driver Position Memory System^{*†18}

The integrated system stores into memory the position of the Driver's Seat and the Outside Rearview Mirrors.

To store positions into memory, first place the Gear Shift into P (Park) while the Engine Start/Stop button is in the ON position. Then:

1. Adjust the Driver's Seat and the Outside Mirrors
2. Press the SET button **B** on the control panel. System will beep once
3. Press one of the memory buttons **C** within 5 seconds. The system will beep twice when memory has been stored

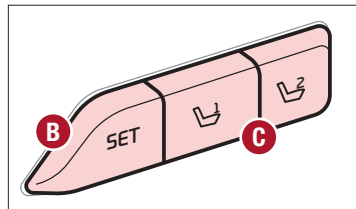

(Buttons located on Driver's Door Panel)

REMINDER: Do not attempt to operate the driver position memory system while the vehicle is moving. This could result in loss of control of the vehicle.

Refer to section 3 in the Owner's Manual for more information.

Power Adjustable Driver's Seat^{†18} / Power Lumbar^{†18}

Move/Press the controls to adjust the Seat forward/backward, the Seat Cushion height, the Seatback recline or the Lumbar forward/backward.

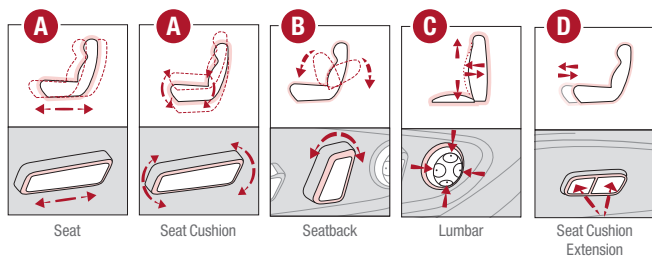
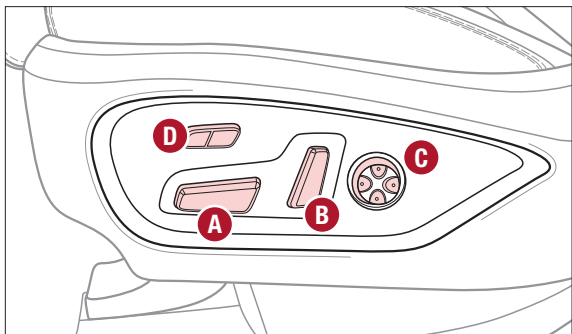

REMINDER: Do not attempt to adjust the seat while the vehicle is moving. This could result in loss of control of the vehicle.

Images are for illustrative purposes only and may not reflect actual feature or operation. Your seat controls may differ from those in the illustrations.

Do not attempt to adjust the seat while the vehicle is moving. This could result in loss of control of the vehicle.

Refer to section 3 in the Owner's Manual for more information.

Rear Occupant Alert (ROA) with Ultrasonic Sensors*†‡

Rear Occupant Alert (ROA) with Ultrasonic Sensors can help alert the driver when rear passenger(s) are left in the rear seats using the ultrasonic sensors and door monitoring. The system is designed to provide three separate alerts:

- The 1st alert is a message on the Instrument Cluster, “Check Rear Seats” **A**, and a chime will sound

After the 1st alert, when the doors are locked and there is movement detected in the rear seats, the horn will sound for about 25 seconds. This alert may activate up to eight times within 24 hours, if movement is still detected and system has not been disabled

- If you have installed the Kia Access with UVO Link app on your smartphone, logged in and activated the Rear Occupant Alert notification, a third alert (notification) will be sent to your phone

To turn the system on or off, in the Instrument Cluster or Audio Head Unit*, go to User Settings, select Convenience, and then Rear Occupant Alert.

Rear Occupant with Ultrasonic Sensors activates under the following conditions:

- A rear passenger door is opened and closed
- The ignition has been turned off
- The driver’s door has been opened, then closed
- The doors are locked with the Smart Key or the door lock button on the door handle

QUICK TIPS

- The 1st alert message will not display on Instrument Cluster if the rear doors are never opened. Either rear doors must be opened after unlocking the vehicle before the system will activate.
- To temporarily disable alerts, press the OK button **B** on the Steering Wheel while the message is displayed
- To turn the alert off while sounding, press the unlock button on the Smart Key or press the door lock button on the door handle
- Must be enrolled in UVO services and Kia Access app installed on the phone to receive ROA alert notifications on your smartphone

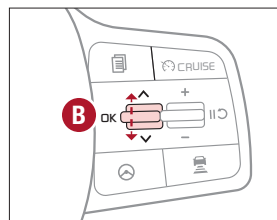
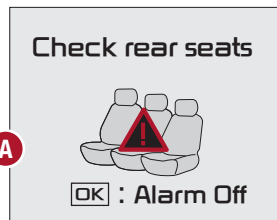

Images are for illustrative purposes only and may not reflect actual feature or operation.

REMINDERS:

- To avoid false alerts, make sure the vehicle’s windows are rolled up
- If objects such as boxes are stacked in front of the ultrasonic sensors, the system may not detect any movement
- The ultrasonic sensors may occasionally detect movement in the vehicle and cause false alerts, when there are no rear occupants present. False alerts can occur due to:
 - The presence of insects near the system sensor
 - Rushing air from a window that is rolled down
 - Movement around the exterior of the vehicle
 - Surrounding noise or vibration
 - Vehicle passing through a car wash
 - Movement in the driver or front passenger seat is detected
- The Rear Occupant Alert with Ultrasonic Sensors system may fail to detect movement and activate an alarm if:
 - Movement is subtle or does not continue
 - A small child sits directly in a seat without a car seat
 - A rear passenger is covered with an object such as a blanket, obstructing the sensor’s view

QR CODES

Rear Occupant Alert (ROA) with Ultrasonic Sensors Video



Refer to the inside front cover for more information on QR codes.
www.youtube.com/KiaFeatureVideos

This system is not a substitute for one’s attention and may not detect all movement within the vehicle. Always check the vehicle’s interior before exiting.

See section 4 in the Owner’s Manual for more information.

2nd-Row Folding Seat^{†18}

Folding 2nd-Row Seat

1. Lower the 2nd-Row Seat Headrest to the lowest position
2. Pull up on the Seatback folding lever **A** or strap* and fold the Seatback down

Unfolding 2nd-Row Seat

1. Lift the folding Seatback lever **A** and move the Seatback backward to the desired position **B**

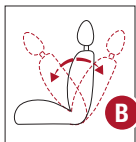
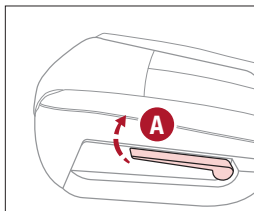

QUICK TIPS

- When you return the Seatback to its original position, ensure it locks (clicks) into place
- It may be necessary to slide the front Seat forward and adjust the front Seatbacks to fully lower rear seats
- Lower Rear Headrests to the lowest position

REMINDER: The lever must return to its original position for the Seatback to lock.

Refer to section 3 in the Owner's Manual for more information.

2nd-Row Auto-Folding Seat^{*†18}

Pull lever **D** to release and automatically fold 2nd-Row Seatback down.

For more information on 2nd-Row Auto Folding Seat operation, refer to the Owner's Manual.

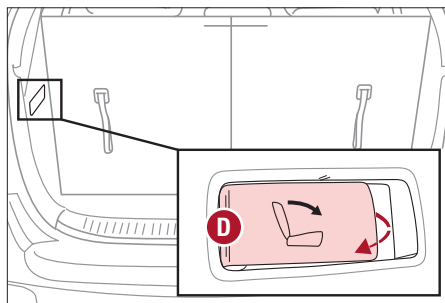

(Located on rear quarter-trim panels)

Refer to section 3 in the Owner's Manual for more information.

QR CODES

2nd & 3rd Row Folding Seats Video



Refer to the inside front cover for more information on QR codes.
www.youtube.com/KiaFeatureVideos

One-Touch Slide & Fold 2nd Row Seats

To get in and out of the 3rd Row Seat, adjust the 2nd Row Seat by pressing the One-Touch Slide & Fold 2nd Row Seats (located on top **A** and side **B** of the 2nd-row seatback):

1. Set the front seatback to the most upright position, and slide the seat forward, if needed
2. Lower the 2nd Row Seat Headrest to the lowest position
3. Insert the seatbelt buckle into the pocket between the rear seatback and the cushion
4. Press the One-Touch Slide & Fold buttons to slide the Seat forward

QUICK TIP

The strap can be used in the back of the 2nd Row Seat to slide and fold the 2nd Row Seats.

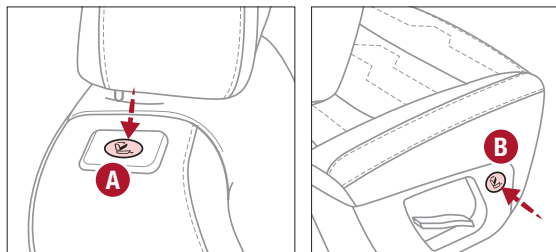

REMINDER: Do not use the One-Touch Slide & Fold buttons while the 2nd-row passenger seat is occupied.

3rd-Row Folding Seat^{*†18}

Folding 3rd-Row Seat

1. Fully lower the headrest **C**
2. Pull the Seat folding strap **D** located on the Seatback
3. Fold the Seat down

Refer to section 3 in the Owner's Manual for more information.

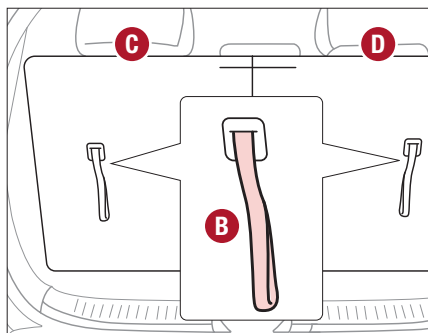

QR CODES

2nd & 3rd Row Folding Seats Video



One-Touch Slide & Fold 2nd-Row Seats Video



Refer to the inside front cover for more information on QR codes.
www.youtube.com/KiaFeatureVideos

Refer to section 3 in the Owner's Manual for more information.

Sunvisor†24

Use the Sunvisor to shield from direct light through the front or side windows. Slide or swing the Sunvisor out and adjust as needed.

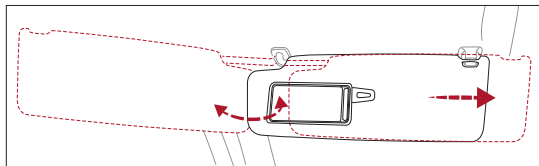

REMINDERS:

- Sunvisor may not shield from all direct light
- The Sunvisor may impair visibility if not adjusted properly
- Do not operate the vehicle if the Sunvisor is impairing your visibility
- Be aware of the seating position when adjusting or swinging Sunvisor around to and from the front or side windows

Refer to section 4 in the Owner's Manual for more information.

Remote Keyless Entry (Folding Key)*

- A** Press the release button to unfold the key
- B** Press to lock All Doors
- C** Press to unlock Driver's Door: Press twice in 4 seconds to unlock All Doors and Rear Hatch
- D** Press and hold for more than a half second for the Panic Alarm. To turn OFF the Alarm, press any button

Remote button configuration may vary depending on vehicle options.

Refer to section 4 in the Owner's Manual for more information.

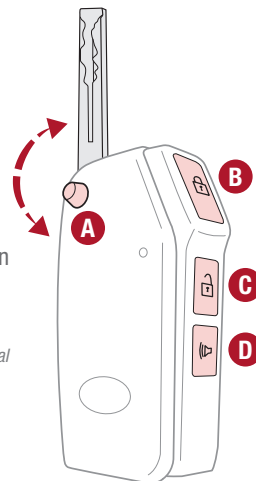

QR CODES

Kia Smart & Folding Key Fobs Video



Refer to the inside front cover for more information on QR codes.
www.youtube.com/KiaFeatureVideos

Double-Turn Lock/Unlock All

- Turn clockwise once to unlock the Driver's Door
- Turn clockwise again within 4 seconds to unlock All Doors
- Turn counterclockwise once to lock All Doors

Refer to section 4 in the Owner's Manual for more information.

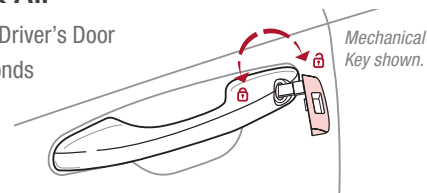

Mechanical Key shown.

Smart Key*†‡

- A** Press to lock All Doors
- B** Press to unlock the Driver's Door. Press twice within 4 seconds to unlock All Doors and the Liftgate
- C** **Manual Liftgate***: Press and hold for more than 1 second to unlock the Liftgate. Then lift by the handle to manually open the Liftgate

REMINDERS:

- The Liftgate does not automatically open when the **C** button is pressed
- The Liftgate unlocks when the Smart Key fob is within close proximity of the vehicle

Power Liftgate*: Press and hold for the Power Liftgate to open automatically. Press again at any time to stop. Press and hold again to automatically close

- D** **Remote Start***: Press for more than two (2) seconds within four (4) seconds after locking doors to start the vehicle. Press once to turn off
- E** Press and hold for more than a half second for the Panic Alarm. To turn OFF the Alarm, press any button
- F** Press to release Mechanical Key
- G** Mechanical Key

Driver's Door Lock/Unlock button **H**:

- Press button once to unlock the Driver's Door
- Press again within 4 seconds to unlock all doors
- Press again to lock all doors

Mechanical Key **G**:

- Press the button **F** on the back of the key fob to release the Mechanical Key
- Remove the key cover, using the mechanical key
- Use to lock/unlock the Driver's Door **I**
- Use to lock the glove box

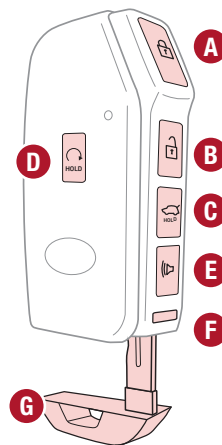

Remote button configuration may vary depending on vehicle options.

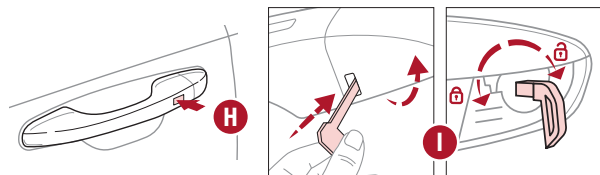

QUICK TIPS

- The Smart Key's signal can be blocked by the normal operation of a cellular phone or smartphone. To help prevent this, store each device separately
- If the Smart Key battery is weak or not working properly, hold the Smart Key fob up to the Engine Start/Stop button (Lock button side closest) and press to start the engine

QR CODES

Remote Start - Smart Key Video



Kia Smart & Folding Key Fobs Video



Refer to the inside front cover for more information on QR codes.
www.youtube.com/KiaFeatureVideos

Refer to section 4 in the Owner's Manual for more information.

REMINDER: When reinserting the mechanical key, make sure it is pushed all the way in until there is a click sound.

Power Liftgate*†16

Opening from Inside the Vehicle:

Press and hold the Power Liftgate Open/Close button **A** to automatically open/close the Liftgate.

Smart Key:

To open the Power Liftgate, press and hold the Liftgate button **B** until the Liftgate begins to open. Press and hold again to automatically close.

REMINDER: Pulling the Liftgate upward by the handle or pressing the button a second time will interrupt the automatic opening of the Power Liftgate.

Opening from Outside the Vehicle:

To open the Power Liftgate automatically, press the Rear Hatch Release button **C** on the exterior of the Liftgate.

Automatically close by pressing the Power Liftgate Close button **D**.

Power Liftgate Opening Height Adjustment

The height setting of a fully opened liftgate (tailgate) can be adjusted by the following steps:

1. Position the liftgate manually to the preferred height
2. Press the Power Liftgate Close button **D** more than 3 seconds
3. A system beep will sound twice indicating the height setting has been saved

The liftgate will then open to the set height. To change setting again, repeat steps 1-3.

See section 4 in the Owner's Manual for more information.

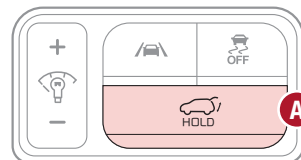

(Button located on Driver's Panel)

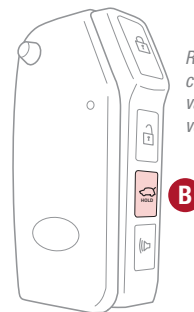

Remote button configuration may vary depending on vehicle options.

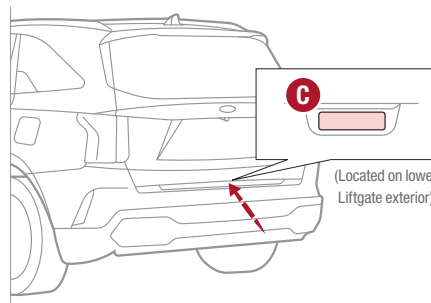

(Located on lower Liftgate exterior)

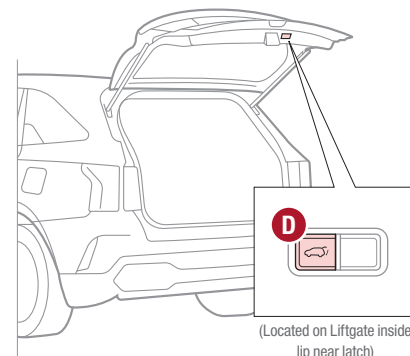

(Located on Liftgate inside lip near latch)

QR CODES

Power Liftgate Height Adjustment Video



Refer to the inside front cover for more information on QR codes.

www.youtube.com/KiaFeatureVideos

Smart Liftgate with Auto Open^{*†16}

The Smart Liftgate with Auto Open can be operated from several controls to either open, close or lock the Liftgate. The Smart Liftgate with Auto Open will close the Liftgate, lock all doors and Liftgate and then arm the vehicle.

When the Smart Key fob is on your person and you are near the back of the vehicle, within close proximity, the hazard lights will blink and a chime will sound for about 3 seconds as an alert that the Smart Power Liftgate is about to open. Then the alert system will blink and chime two additional times before opening the Smart Power Liftgate.

The Smart Liftgate with Auto Open feature is off by default. To enable the Smart Power Liftgate, go to User Settings mode in the LCD Instrument Cluster or the Audio Head Unit*.

QUICK TIPS

- During the Smart Liftgate with Auto Open alert, the Smart Liftgate with Auto Open can be deactivated with the Smart Key by pressing any button on the key fob or moving away from the detection area
- The open height and speed can be adjusted. For information on how to set the open height and speed, see your owner's manual

REMINDERS:

- All doors are closed and locked after about 15 seconds
- The Smart Liftgate with Auto Open feature will not operate when:
 - The doors are recently closed and locked, and the Smart Key is still detected after 15 seconds near the vehicle or within 60 inches of the door handles
 - A door is not locked or closed
 - The Smart Key is in the vehicle
- Press any button on the Smart Key fob during the Detect and Alert stage, or move out of the detection area, to deactivate the Smart Liftgate with Auto Open function
- When the ignition is on, the Smart Liftgate with Auto Open will only operate with the gear shift in the Park (P) position
- The Smart Key must be outside of the vehicle for the Smart Liftgate with Auto Open to operate
- Ensure obstacles and people are out of the way of the Liftgate

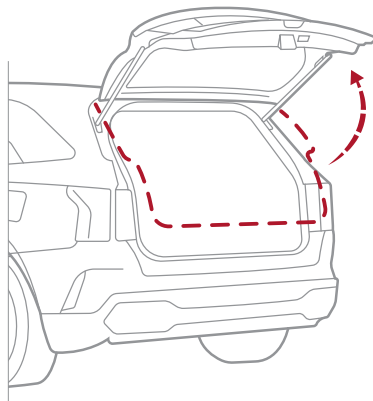

QR CODES

Smart Liftgate with Auto Open Video



Refer to the inside front cover for more information on QR codes.
www.youtube.com/KiaFeatureVideos

See section 4 in the Owner's Manual for more information.

Map/Room Lamps

Automatic turn off function*

The interior lights automatically turn off approximately 30 seconds after the Engine Start/Stop button is OFF.

Map/Room Lamp Operation

Press the button **A** to turn the Map Lamp ON/OFF. Press button **B** to turn the Driver's/Passenger's Map Lamps ON/OFF. This light produces a spot beam for convenient use as a map lamp or as a personal lamp for the driver or the front passenger.

The Map Lamp turns ON when any door is opened or the ignition is turned OFF. When all doors are locked or the ignition is ON, the Map Lamp will turn OFF immediately.

Map/Room Lamp button **C** – When pressed and a door is opened, or doors are unlocked from the Smart Key, the Map and Room Lamps turn ON for approximately 30 seconds.

Room Lamp – Press the lens **D** to turn the Room Lamp ON/OFF.

QUICK TIPS

- When doors are unlocked by the Smart Key*, the lamp turns ON for approximately 30 seconds
- If your vehicle is equipped with the theft alarm system, the interior lights automatically turn off approximately 5 seconds after the system is in the armed stage
- Using interior lights for an extended period of time may cause battery discharge

See section 4 in the Owner's Manual for more information.

Panoramic Sunroof with Power Sunshade*

The Sunroof and Sunshade operation is controlled through multidirectional lever & push button switches **E**. The ignition needs to be ON to operate the sunroof/sunshade.

REMINDER: The sunroof can be operated for approximately 30 seconds after the ignition is turned off. If the front doors are opened, the sunroof cannot be operated even within the 30-second period.

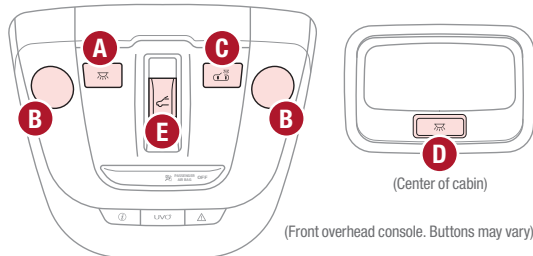

To slide the Sunshade and Sunroof:

- Auto Open: Slide the lever **E** backward to the farthest position and release
- Auto Close (Sunroof only): Slide the lever **E** forward to the first position (first detent) and release

Tilting the Sunroof open/closed:

- Open/Raise: Push lever **E** upward
- Close/Lower: Push lever **E** forward
- Auto Close Sunroof and Sunshade: Slide the Sunroof lever **E** forward to the farthest position

QUICK TIP

To stop the Sunroof/Sunshade at any position, push or pull the Sunroof control lever in any direction.

REMINERS:

- The Sunshade needs to remain OPEN while Sunroof is open and vehicle is moving
- Do not adjust the sunroof or sunshade while driving. This could result in loss of control of the vehicle

QR CODES

Sunroof Operation Video



Refer to the inside front cover for more information on QR codes.
www.youtube.com/KiaFeatureVideos

See section 4 in the Owner's Manual for more information.

HomeLink®†12 with Auto-Dimming Rearview Mirror*

The HomeLink® / Auto-Dimming Rearview Mirror* is designed to reduce glare from a vehicle's headlights located in the rear and also connect up to three electronic transmitters into one location.

- | | |
|---|---|
| A HomeLink® Channel 1 | E HomeLink® Operation Indicator |
| B HomeLink® Channel 2 | F Garage Door Opener Status Indicator: Opening or Open |
| C HomeLink® Channel 3 | G HomeLink® User Interface Indicator |
| D Garage Door Opener Status Indicator: Closing or Closed | |

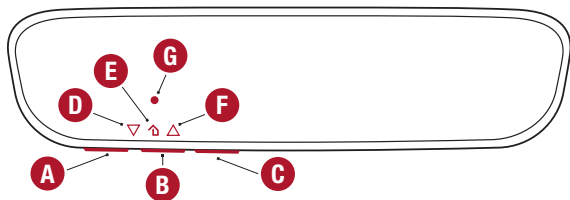

QUICK TIPS

- You can reprogram a single HomeLink® button by repeating Step 2
- Erasing the programmed buttons will delete all trained transmitters

How to Sync Transmitter with HomeLink®*

If programming for the first time, begin with Step 1 (repeating this step will delete all information).

To program non-rolling and rolling code garage door openers and other devices:

1. Press and hold the left **A** and **C** buttons simultaneously until the indicator light **G** begins to flash (to reprogram buttons, skip this step)
2. Press and hold the desired button **A**, **B** or **C** and hold the button on the transmitter while it is approximately 1 to 3 inches away from the mirror. The HomeLink® Indicator light **E** will flash rapidly once the frequency signal has been successfully programmed

To finish programming rolling code garage door openers, complete these steps:

3. Locate the “learn” or “smart” button on the garage door’s motor head unit. Press and release the button and complete Step 4 within 30 seconds
4. Firmly press and release the programmed HomeLink® button up to three times

Operating HomeLink®:

Press one of the programmed HomeLink® buttons.

Erasing programmed buttons:

Press and hold the **A** and **C** buttons simultaneously for approximately 20 seconds, and then release both buttons within 30 seconds.

If your garage door opener was manufactured in 2011 or later, and you're unable to program your vehicle's HomeLink® system, you may need to purchase a HomeLink Repeater Kit. For more information, go to www.HomeLink.com or call (800) 355-3515.

QR CODES

HomeLink® Support Video



Refer to the inside front cover for more information on QR codes.
www.youtube.com/KiaFeatureVideos

Rear View Monitor (RVM)^{†6}

Rear View Monitor is a supplemental system that displays the view behind the vehicle through the audio head unit screen.

RVM activates when the:

- Ignition or the Engine Start/Stop button* (Green Light) is in the ON position
- Gear Shift Lever is in the R (Reverse) position

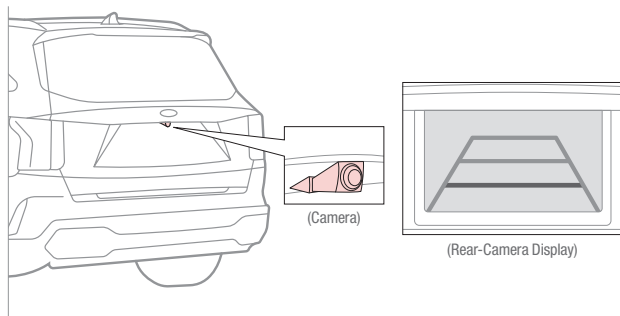

REMINDERS:

- RVM is ON by default when the ignition is cycled
- While the Rear View Monitor is active the volume will be lowered on all audio modes
- Through normal use and after inclement weather or washing, the rear camera may become dirty. Use a clean, microfiber cloth to remove any dirt, debris or spots that may have accumulated on the lens

Rear View Monitor is not a substitute for proper and safe backing-up procedures. Rear View Monitor may not display every object behind the vehicle. Always drive safely and use caution when backing up.

Images are for illustrative purposes only and may not reflect actual feature or operation.

See section 4 in the Owner's Manual for more information.

Reverse Parking Distance Warning (PDW)^{†6}

Reverse Parking Distance Warning (PDW) is a supplemental system that is designed to assist the driver by chiming if any object is detected within the sensing area to the front, rear and side of the vehicle when backing up.

Reverse Parking Distance Warning (PDW) is activated when the the ignition is on and the button **C** is depressed.

To deactivate Reverse Parking Distance Warning (PDW), press the button **C** (LED is lit).

REMINDERS:

- If the vehicle is moving at speeds over 3 mph, the system may not activate correctly
- When more than two objects are sensed at the same time, the closest one will be recognized first

Reverse Parking Distance Warning (PDW) is not a substitute for proper and safe backing-up procedures. Always drive safely and use caution when backing up. Reverse Parking Distance Warning (PDW) may not detect every object around the vehicle.

in the Owner's Manual for more information may not detect every object around the vehicle.

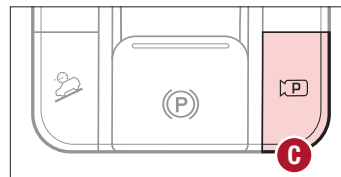

(Located below gear shift knob)

See section 4 in the Owner's Manual for more information.

QR CODES

Forward/Reverse Parking Distance Warning (PDW) Video



*Refer to the inside front cover for more information on QR codes.
www.youtube.com/KiaFeatureVideos*

Hood Release Lever and Latch

Opening the Hood:

1. Pull the Hood Release Lever **A** to unlatch the Hood
2. In the front of the vehicle, lift the Hood slightly, push the secondary Latch **B** to the left inside of the Hood's center and lift the Hood
3. It will open by itself after it has been raised about half way

REMINDER: Open the Hood only after turning the engine off, on a flat surface, with the gear shift in P (Park) position and setting the parking brake.

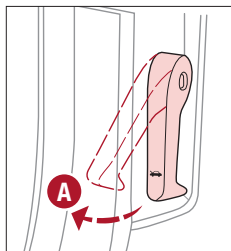

(Lever located near floor below Driver's Panel)

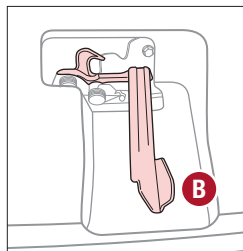

(Latch located inside hood)

Closing the Hood:

Lower the Hood about halfway and then press down to securely lock in place.

Images are for illustrative purposes only and may not reflect actual feature or operation.

See section 4 in the Owner's Manual for more information.

Fuel Cap / Malfunction Indicator (Check Engine Light)

Tighten for ONE CLICK to prevent the Malfunction Indicator  from illuminating.

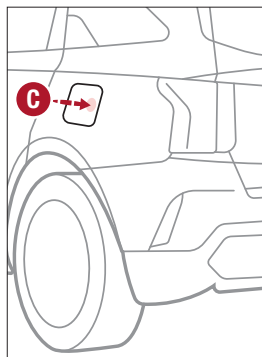
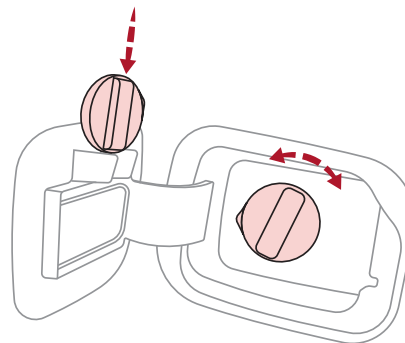

REMINERS:

- The Fuel Filler Door button is located on the driver's button panel, left of the Steering Wheel
- Ensure the engine is OFF, the driver's door is unlocked, and push the fuel door at the 3 o'clock position **C**
- It is normal operation when tightening to hear one click, and then when Fuel Cap is released, it clicks back

Images are for illustrative purposes only and may not reflect actual feature or operation.

QR CODES

One-Click Fuel Cap Video



Refer to the inside front cover for more information on QR codes.
www.youtube.com/KiaFeatureVideos

See section 4 in the Owner's Manual for more information.

Occupant Detection System (ODS)^{†15} / Passenger Airbag^{†2} Off Indicator

ODS is designed to detect the presence and position of the front passenger and adjusts or turns off airbag deployment accordingly.

Depending on the situation and type of accident, the system may:

- Deploy airbag (Adult)
- Not deploy the airbag (Unoccupied)

If the system determines that the airbag should not be deployed, the "PASSENGER AIR BAG OFF" light will illuminate.



(ODS light is located on map/room lamp ceiling console)

REMINDER: Do not allow an adult passenger to ride in the front seat when the Passenger Airbag Indicator is illuminated OFF because the airbag will not deploy in the event of a crash. The driver must instruct the passenger to reposition her/himself in the seat.

See section 3 in the Owner's Manual for more information.

Child-Protector Rear Door Locks*

Located on the rear edge of the rear passenger doors. Use the mechanical ignition key to the Child-Protector Rear Door Lock to the lock position  to disable the inner door handles from opening the rear doors.

REMINDER: Child-Protector Rear Door Locks are located on the rear passenger's door jamb.

See section 3 in the Owner's Manual for more information.

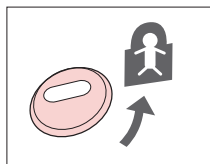

(Lock located on rear passenger inside door jamb)

Seat Belts^{†19}

To properly fasten your seat belts:

1. Insert the belt tongue plate **A** into the buckle **B** until it clicks
2. Position the lap portion of the belt across your lap as **LOW ON THE HIPS** as possible **C**. Adjust the belt to a **SNUG FIT** by pulling up on the shoulder portion **D**

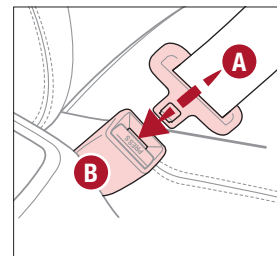

Seat Belt Retractor Locks

Retractor locks allow lap/shoulder safety belts to remain unlocked during normal vehicle operation for freedom of movement and increased comfort.

During a **STRONG STOP, SUDDEN TURN OR CERTAIN COLLISIONS**, seatbelt retractors will automatically lock the belts to reduce the risk of injury.

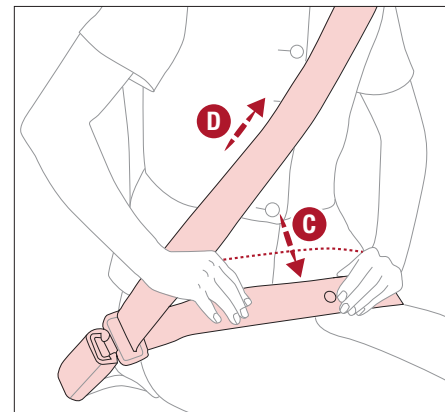

QUICK TIP

The seat belt warning chime operates for the driver's seat only.

REMINDER: For maximum protection, always wear your seat belt.

Images are for illustrative purposes only and may not reflect actual feature or operation.

See section 3 in the Owner's Manual for more information.

LEGAL DISCLAIMERS

Driving while distracted is dangerous and should be avoided. Drivers should remain attentive to driving and always exercise caution when using the steering-wheel-mounted controls while driving.

Driving while distracted can result in a loss of vehicle control that may lead to an accident, severe personal injury and death. The driver's primary responsibility is in the safe and legal operation of a vehicle, and any handheld devices, other equipment or vehicle systems which take the driver's eyes, attention and focus away from the safe operation of a vehicle or that are not permissible by law should never be used during operation of the vehicle.

Safety Features: No system, no matter how advanced, can compensate for all driver error and/or driving conditions. Always drive safely.

- UVO Link:** Purchase/lease of certain 2020 and newer Kia vehicles with UVO link includes a complimentary 1-year subscription to the UVO Ultimate package, starting from new vehicle retail sale/lease date as recorded by the dealer. After your complimentary 1-year subscription to UVO Ultimate expires, continued access to the full suite of UVO link services available on your Kia will require a paid subscription at the then-current subscription rate or your use of certain UVO link features may immediately terminate. Use of UVO is subject to agreement to the UVO Privacy Policy (available at owners.kia.com/us/en/privacy-policy.html) and Terms of Service (available at owners.kia.com/us/en/terms-of-service.html). UVO link is transferable to subsequent owner during the original UVO link service term. Only use UVO link when safe to do so. Kia Access with UVO link app is available from the Apple® App Store® or Google Play Store™. Kia Motors America, Inc. reserves the right to change or discontinue UVO link at any time without prior notification or incurring any future obligation. Message and data rates may apply. Cellular and GPS coverage is required to use most features. UVO link features may vary by model, model year, and trim level. Features, specifications, and fees are subject to change. For more on details and limitations, visit www.kia.com or your authorized Kia dealer. Apple and App Store are registered trademarks of Apple Inc. Google and logos are trademarks of Google LLC.
- Airbags:** For maximum protection, always wear your seat belt.
- Android Auto™:** Android Auto is a trademark of Google, Inc. Android™ is a registered trademark of Google, Inc. Distracted driving can result in a loss of vehicle control. Never use a handheld device or vehicle system that takes your focus away from safe vehicle operation.
- Apple CarPlay®:** Apple® and Apple CarPlay® are trademarks of Apple, Inc., registered in the U.S. and other countries. Apple CarPlay® runs on your smartphone cellular data service. Normal data rates will apply.
- Bluetooth® Wireless Technology:** The Bluetooth® word mark and logos are registered trademarks owned by Bluetooth SIG Inc., and any use of such marks by Kia is pursuant to license. A Bluetooth® enabled cell phone is required to use Bluetooth® wireless technology.
- Driver Assist Features – Blind-Spot Collision-Avoidance Assist (BCA), Rear Cross-Traffic Collision-Avoidance Assist (RCCA), Lane Keeping Assist (LKA), Safe Exit Assist (SEA), Lane Following Assist (LFA), Forward Collision-Avoidance Assist (FCA), Leading Vehicle Departure Alert (LVDA), Manual Speed Limit Assist (MSLA), Intelligent Speed Limit Assist (ISLA), Rear View Monitor (RVM), Reverse Parking Distance Warning (PDW), Rear View Monitor (RVM), Smart Cruise Control (SCC) with Stop & Go:** These features are not substitutes for safe driving, and may not detect all objects surrounding vehicle. Always drive safely and use caution.
- Driver Attention Warning (DAW):** Driver Attention Warning is not a substitute for safe driving and may not detect all instances of inattentive driving practices. Failure to pay attention to travel conditions and vehicle operation could result in loss of vehicle control. Always drive safely and use caution.
- Electronic Stability Control (ESC)/ Traction Control System (TCS)/Hill Start Assist Control (HAC):** No system, no matter how advanced, can compensate for all driver error and/or driving conditions. Always drive safely.
- Engine Start/Stop Button with Smart Key:** Always come to a complete stop before turning the engine on or off. However, if you have an emergency while the vehicle is in motion and must turn the engine off, you can turn the engine off to the ACC position by pressing the Start/Stop button for more than 3 seconds or 3 times in succession. If the vehicle is still moving, you can restart the engine by pressing the Start/Stop button with the shift lever in Neutral (N). With the engine off, hydraulic power assist for steering and braking will be disabled and the vehicle will be more difficult to control.
- Front Seat Headrest Adjustment:** Never attempt to adjust headrests when vehicle is in motion.
- Google Play™ Store** is a trademark of Google, Inc. ©2019 Google Inc. All rights reserved. Google and the Google Logo are registered trademarks of Google Inc.
- HomeLink®:** HomeLink® is a registered trademark of Gentex Corporation.
- iPhone®:** iPhone is a registered trademark of Apple Inc. Distracted driving can result in a loss of vehicle control. Never use a handheld device or vehicle system that takes your focus away from safe vehicle operation.
- Navigation:** Distracted driving can result in a loss of vehicle control. When operating a vehicle, never use a vehicle system that takes your focus away from safe vehicle operation. Navigation is for information purposes only, and Kia does not make any warranties about the accuracy of the information.
- Occupant Detection System (ODS):** Kia vehicles use a number of different ODS types that vary by model.
- Power Liftgate / Smart Power Liftgate:** Driving with the liftgate open may be unlawful and can draw dangerous exhaust fumes into your vehicle; if you choose to do so, keep air vents and all windows open for proper ventilation.
- Roadside Assist:** 24-hour Enhanced Roadside Assistance is a service plan provided by Kia Motors America, Inc. Certain limitations apply. Coverage details are available in the Kia Warranty and Consumer Information Manual. For access to Enhanced Roadside Assistance, a connected mobile phone via Bluetooth® within the cellular service coverage area is required.
- Seat adjustments:** Reclining the passenger seats can reduce the effectiveness of the safety restraint system and may lead to additional injury in an accident.
- Seat belts:** For maximum protection, always wear your seatbelt.
- Seat warmers:** Use extreme caution when using the seat warmers to avoid burns. Refer to the Owner's Manual for more information.
- SiriusXM®:** SiriusXM Satellite Radio, SiriusXM Traffic and SiriusXM Travel Link each require a subscription sold separately, or as a package, by SiriusXM Radio Inc. **If you decide to continue your service at the end of your trial subscription, the plan you choose will automatically renew and bill at then-current rates until you call 1-866-635-2349 to cancel. See SiriusXM Customer Agreement for complete terms at www.siriusxm.com.** Other fees and taxes will apply. All fees and programming are subject to change. Not all vehicles or devices are capable of receiving all services offered by SiriusXM. Data displays and individual product availability vary by vehicle hardware. Current information and features may not be available in all locations, or on all receivers. Weather Forecast, Current Conditions may not be available in all locations. Images above are for representative purposes only and are not real products. For actual features and images of real products, consult the vehicle manufacturer. SiriusXM is not responsible for any errors or inaccuracies in the data services or their use in the vehicle. Travel Link Stocks displays current price and daily delta of around 7,000 actively reported securities traded on the NYSE®, NASDAQ® and AMEX®. The service is delayed approximately 20 minutes. SiriusXM satellite service is available only to those at least 18 years of age in the 48 contiguous USA, DC, and Puerto Rico (with coverage limitations). SiriusXM Internet Radio service is available throughout our satellite service area and in AK and HI. © 2020 SiriusXM Radio Inc. Sirius, XM and all related marks and logos are trademarks of SiriusXM Radio Inc.
- Sportmatic®** is a registered trademark of Kia Motors America.
- Steering-wheel-mounted controls:** Driving while distracted is dangerous and should be avoided. Remain attentive to driving and be cautious when using steering-wheel-mounted controls while driving.
- Sunvisors:** Sunvisor may not shield all direct light. Do not operate the vehicle if sunvisor is impairing your visibility.
- Tilt/Telescoping Steering Wheel:** Never attempt to adjust steering wheel position when vehicle is in motion.
- Tire Pressure Monitoring System (TPMS):** Even with Tire Pressure Monitoring System, check tire pressure on a regular basis.



SORENTO HYBRID CUSTOMER DELIVERY CHECKLIST

KEY FEATURE WALKTHROUGH

Android Auto™ / Apple CarPlay® Setup*

UVO link Activation / UVO Assistance*

For further UVO operations, refer to the Car Infotainment System Quick Reference Guide.

Standard Audio System*

Standard Audio System - Value with UVO link*

For further operational information, refer to the Car Infotainment System Quick Reference Guide.

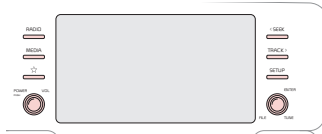

UVO link with Navigation*

For further operational information, refer to the Car Infotainment System Quick Reference Guide.



Smart Cruise Control with Stop & Go* Demonstrate operation

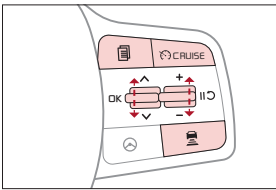

Bluetooth® Wireless Technology Demonstrate operation

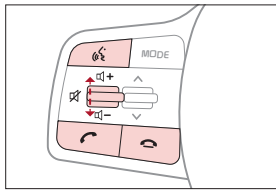

Kia Access with UVO link App Download

Kia Access with UVO link App Features Guide

- Multimedia USB Ports, Power Outlets*
- Blind-Spot Collision Avoidance-Assist (BCA)*
- Clock Setup
- Engine Start/Stop Button
- HomeLink® with Auto-Dimming Rearview Mirror
- Lane Keeping Assist (LKA)*
- Passenger Airbag Off Indicator

- Panoramic Sunroof Operation*
- Rear View Monitor (RVM)
- Seat Warmers*
- Smart Key
- Sunvisor
- Tire Pressure Monitoring System (TPMS)

DURING DELIVERY

- Explain first service process and schedule first service appointment
- Tour Parts & Service departments, introduce staff and explain value of Kia Parts and Service
- Review recommended maintenance schedule and maintenance requirements to validate warranty
- Review business hours
- Review the Kia 10-year/100,000-mile warranty program
- Ensure 100% satisfaction with sales and delivery process and no problems with the vehicle
- Confirm time and best contact number for initial dealer follow-up

*if equipped

Sales Consultant: _____ Date: _____

Sales Manager: _____ Date: _____

Customer: _____ Date: _____



SORENTO HYBRID CUSTOMER DELIVERY CHECKLIST

Owner's Name: _____ VIN: _____ Mileage: _____

Dealership Name: _____ Sales Consultant: _____ Date: _____

BEFORE DELIVERY

- Test and confirm "Good Battery" using a Kia battery tester
- Verify all tire pressures are to spec (see driver's door label) LF _____ LR _____ RF _____ RR _____
- Verify proper operation of Remote Keyless Entry and Smart Key lock/unlock
- Ensure floor mats are snapped into place (if applicable)
- Verify vehicle is clean (interior and exterior), in good condition and free of chips and scratches
- Ensure all key documents are in the vehicle (Owner's Manual, Warranty and Consumer Information booklet, Tire Warranty booklet and Features & Functions Guide and any audio system user's manual.)

KEY FEATURE WALKTHROUGH

- Air Conditioning / Climate Control
Demonstrate Air Flow Modes, Defog and Defrosting Windshield Fan Speed

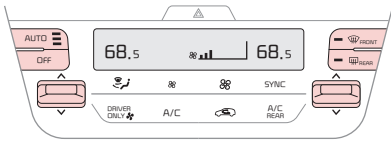

Automatic*

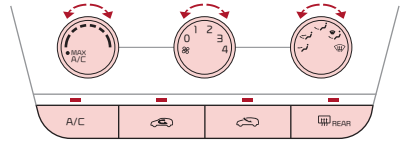

Manual*

- Front Seat Headrest Adjustment

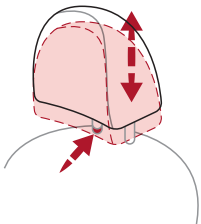

(Type A)

- Windshield/Rear Wipers & Washers

- Move lever Up/Down to change Wiper modes
- Push switch to adjust Intermittent Wipe
- Pull lever to spray and wipe

- Rotate Rear Wiper switch to change Wiper modes
- Push to spray and wipe

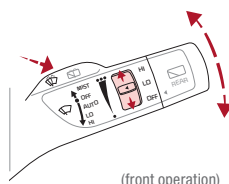

(front operation)

- MIST: Single wipe
- OFF: Wiper off
- INT/AUTO: Intermittent wipe/
Rain Sensing*
- LO: Slow wipe
- HI: Fast wipe

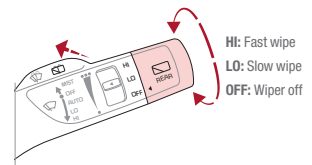

(rear operation)

- HI: Fast wipe
- LO: Slow wipe
- OFF: Wiper off



SORENTO HYBRID NORMAL MAINTENANCE SCHEDULE TURBO

P=Perform • R=Replace • I=Inspect⁹

(up to 60,000 miles)^A

MAINTENANCE INTERVALS (MILES)

MAINTENANCE ITEMS	6,000	12,000	18,000	24,000	30,000	36,000	42,000	48,000	54,000	60,000
Add fuel additive ^C	P	P	P	P	P	P	P	P	P	P
Rotate tires	P	P	P	P	P	P	P	P	P	P
Engine Oil & Oil Filter	R	R	R	R	R	R	R	R	R	R
Battery condition	I	I	I	I	I	I	I	I	I	I
Brake lines, hoses and connections	I	I	I	I	I	I	I	I	I	I
Brake discs and pads	I	I	I	I	I	I	I	I	I	I
Vacuum hose	I	I	I	I	I	I	I	I	I	I
Steering gear rack, linkage & boots	I	I	I	I	I	I	I	I	I	I
Driveshaft and boots	I	I	I	I	I	I	I	I	I	I
Suspension mounting joints	I	I	I	I	I	I	I	I	I	I
Air conditioner compressor/refrigerant	I	I	I	I	I	I	I	I	I	I
Exhaust system	I	I	I	I	I	I	I	I	I	I
Intercooler, in/out hose, air intake hose (Every 4,800 miles)	I	I	I	I	I	I	I	I	I	I
Air cleaner filter	I	I	I	R	I	I	I	R	I	I
Brake fluid	I	I	I	I	I	I	I	I	I	I
Climate control air filter		R		R		R		R		R
Propeller Shaft (AWD)		I		I		I		I		I
Parking brake		I		I		I		I		I
Fuel tank air filter/fuel tank, vapor hose and cap ^{†D}		I		I		I		I		I
Cooling System				I	I	I	I	I	I	I
Fuel lines, hoses and connections				I				I		
Dual clutch transmission fluid						I				
Rear Differential / Transfer case oil (AWD) (Every 36,000 miles) ^E						I				
Spark Plugs (Every 42,000 miles)							R			
Valve clearance ^F										I
Drive belts (First 60,000 miles, then every 15,000 miles) ^G										I

QUICK TIP Check your Maintenance Schedule or schedule an appointment with a dealer using your UVO link account by logging into your Kia Access with UVO link App or your account on <https://owners.Kia.com> (Vehicles equipped with UVO link only – See page 34 for setup information)

- A. See the Owner's Manual for complete maintenance schedule. These are approximate estimated intervals. Refer to vehicle mileage for maintenance item schedule.
- B. And, if necessary, adjust, correct, clean or replace.
- C. If TOP TIER detergent gasoline is not available, one bottle of additive is recommended. Additives are available from your authorized Kia dealer along with information on how to use them. Do not mix other additives.
- D. Both the fuel filter & fuel tank air filter are generally considered to be maintenance free, depending on fuel quality being used. However, periodic inspection is recommended. If your vehicle is having issues like fuel flow restriction, power surging, loss of power, difficulty starting, etc., replace the fuel filter immediately and consult an authorized Kia dealer for service.

- E. Transfer case oil and rear differential oil should be changed anytime they have been submerged in water.
- F. Inspect for excessive tappet noise and/or engine vibration and adjust if necessary.
- G. The drive belt should be replaced when cracks occur or tension is reduced excessively. See your Owner's Manual for more details and complete maintenance information, including severe maintenance schedule. Warranty may be voided if maintenance schedule is not followed.

© 2020 Kia Motors America, Inc. All rights reserved.
 Consumer - Roadside Assistance¹⁷: 1-800-333-4KIA (4542)

† If equipped.