

2021

**soul**

Owner's Manual



The Power to Surprise



**WARNING – California  
Proposition 65**

“Operating, servicing and maintaining a passenger vehicle or off-road vehicle can expose you to chemicals including engine exhaust, carbon monoxide, phthalates, and lead, which are known to the State of California to cause cancer and birth defects or other reproductive harm. To minimize exposure, avoid breathing exhaust, do not idle the engine except as necessary, service your vehicle in a well-ventilated area and wear gloves or wash your hands frequently when servicing your vehicle. For more information go to [www.P65Warnings.ca.gov/passenger-vehicle](http://www.P65Warnings.ca.gov/passenger-vehicle).”



## FOREWORD

Dear Customer,

Thank you for selecting your new Kia vehicle.

As a global car manufacturer focused on building high-quality vehicles with exceptional value, Kia Motors is dedicated to providing you with a customer service experience that exceeds your expectations.

If technical assistance is needed on your vehicle, authorized Kia dealerships factory-trained technicians, recommended special tools, and genuine Kia replacement parts.

This Owner's Manual will acquaint you with the operation of features and equipment that are either standard or optional on this vehicle, along with the maintenance needs of this vehicle. Therefore, you may find some descriptions and illustrations not applicable to your vehicle. You are advised to read this publication carefully and follow the instructions and recommendations. Please always keep this manual in the vehicle for your, and any subsequent owner's, reference.

All information contained in this Owner's Manual was accurate at the time of publication. However, as Kia continues to make improvements to its products, the company reserves the right to make changes to this manual or any of its vehicles at any time without notice and without incurring any obligations.

Please drive safely, and enjoy your Kia vehicle!

© 2020 KIA MOTORS AMERICA, Inc.

All rights reserved. May not be reproduced or translated in whole or in part without the written consent of Kia Motors America, Inc.

Printed in Korea

## How to use this manual

We want to help you get the greatest possible driving pleasure from your vehicle. Your Owner's Manual can assist you in many ways.

We strongly recommend that you read the entire manual. In order to minimize the chance of death or injury, you must read the WARNING and CAUTION sections in the manual.

Illustrations complement the words in this manual to best explain how to enjoy your vehicle. By reading your manual, you learn about features, important safety information, and driving tips under various road conditions.

The general layout of the manual is provided in the Table of Contents. Use the index when looking for a specific area or subject, it has an alphabetical listing of all information in your manual.

Chapters: This manual has nine chapters plus an index. Each chapter begins with a brief list of contents so you can tell at a glance if that chapter has the information you want.

You will find various WARNINGS, CAUTIONS, and NOTICES in this manual. These WARNINGS were prepared to enhance your personal safety. You should carefully read and follow ALL procedures and recommendations provided in these WARNINGS, CAUTIONS and NOTICES.

### **WARNING**

A WARNING indicates a situation in which harm, serious bodily injury or death could result if the warning is ignored.

---

### **CAUTION**

A CAUTION indicates a situation in which damage to your vehicle could result if the caution is ignored.

---

### **NOTICE**

A NOTICE indicates interesting or helpful information is being provided.

---



# Table of Contents

Introduction	1
Your vehicle at a glance	2
Safety features of your vehicle	3
Features of your vehicle	4
Driving your vehicle	5
What to do in an emergency	6
Maintenance	7
Specifications, Consumer information and Reporting safety defects	8
Abbreviation	A
Index	I

<b>Fuel requirements .....</b>	<b>1-2</b>
<b>Vehicle modifications .....</b>	<b>1-4</b>
<b>Vehicle break-in process .....</b>	<b>1-5</b>
<b>Vehicle handling instructions .....</b>	<b>1-5</b>
<b>Risk of burns when parking or stopping vehicle.....</b>	<b>1-6</b>
<b>Vehicle data collection and event data recorders .....</b>	<b>1-6</b>

## Introduction

### Fuel requirements

Your new vehicle is designed to use only unleaded fuel having a pump octane number  $((R+M)/2)$  of 87 (Research Octane Number 91) or higher. (Do not use methanol blended fuels.)

Your new vehicle is designed to obtain maximum performance with UNLEADED FUEL, as well as minimize exhaust emissions and spark plug fouling.

Never add any fuel system cleaning agents to the fuel tank other than what has been specified. (Consult an authorized Kia dealer for details.)

- Tighten the cap until it clicks one time, otherwise the Check Engine



light will illuminate.

### **⚠ WARNING**

#### Refueling

- Do not "top off" after the nozzle automatically shuts off. Attempts to force more fuel into the tank can cause fuel overflow onto you and the ground causing a risk of fire.
- Always check that the fuel cap is installed securely to prevent fuel spillage, especially in the event of an accident.

### Gasoline containing alcohol and methanol

Gasohol, a mixture of gasoline and ethanol (also known as grain alcohol), and gasoline or gasohol containing methanol (also known as wood alcohol) are being marketed along with or instead of leaded or unleaded gasoline.

Pursuant to EPA regulations, ethanol may be used in your vehicle.

Do not use gasohol containing more than 15% ethanol, and do not use gasoline or gasohol containing any methanol. Ethanol provides less energy than gasoline and it attracts water, and it is thus likely to reduce your fuel efficiency and could lower your MPG results.

Methanol may cause drivability problems and damage to the fuel system, engine control system and emission control system.

Discontinue using gasohol of any kind if drivability problems occur.

Vehicle damage or drivability problems may not be covered by the manufacturer's warranty if they result from the use of:

1. Gasoline or gasohol containing methanol.
2. Leaded fuel or leaded gasohol.
3. Gasohol containing more than 15% ethanol.

"E85" fuel is an alternative fuel comprised of 85% ethanol and 15% gasoline, and is manufactured exclusively for use in Flexible Fuel Vehicles. "E85" is not compatible with your vehicle. Use of "E85" may result in poor engine performance and damage to your vehicle's engine and fuel system. Kia recommends that customers do not use fuel with an ethanol content exceeding 15%.

### \* NOTICE

Your New Vehicle Limited Warranty does not cover damage to the fuel system or any performance problems caused by the use of "E85" fuel.

### \* NOTICE

Never use any fuel containing methanol. Discontinue use of any methanol containing product which may inhibit proper drivability.

### Other fuels

Using fuels that contain Silicone (Si), MMT (Manganese, Mn), Ferrocene (Fe), and Other metallic additives, may cause vehicle and engine damage or cause misfiring, poor acceleration, engine stalling, catalyst melting, clogging, abnormal corrosion, life cycle reduction, etc.

Also, the Malfunction Indicator Lamp (MIL) may illuminate.

### \* NOTICE

Damage to the fuel system or performance problem caused by the use of these fuels may not be covered by your New Vehicle Limited Warranty.

### Gasoline containing MMT

Some gasoline contains harmful manganese- based fuel additives Such as MMT (Methylcyclopentadienyl Manganese Tricarbonyl). Kia does not recommend the use of gasoline containing MMT. This type of fuel can reduce vehicle performance and affect your emission control system. The Malfunction Indicator Lamp on the cluster may come on.

### Do not use methanol

Fuels containing methanol (wood alcohol) should not be used in your vehicle. This type of fuel can reduce vehicle performance and damage components of the fuel system, engine control system and emission control system.

### Fuel Additives

Kia recommends that you use good quality gasolines treated with

detergent additives such as TOP TIER Detergent Gasoline, which help prevent deposit formation in the engine. These gasolines will help the engine run cleaner and enhance performance of the Emission Control System.

For more information on TOP TIER Detergent Gasoline, please go to the website ([www.toptiergas.com](http://www.toptiergas.com)) For customers who do not use TOP TIER Detergent Gasoline regularly, and have problems starting or the engine does not run smoothly, additives that you can buy separately may be added to the gasoline.

If TOP TIER Detergent Gasoline is not available, one bottle of additive should be added to the fuel tank at every 7,500 miles (12,000 km) or every engine oil change is recommended. Additives are available from your authorized Kia dealer along with information on how to use them. Do not mix other additives.

### **Operation in foreign countries**

If you are going to drive your vehicle in another country, be sure to:

- Observe all regulations regarding registration and insurance.
- Determine that acceptable fuel is available.

### **Vehicle modifications**

This vehicle should not be modified. Modification of your vehicle could affect its performance, safety or durability and may even violate governmental safety and emissions regulations.

In addition, damage or performance problems resulting from any modification may not be covered under warranty.

- If you use unauthorized electronic devices, it may cause the vehicle to operate abnormally, wire damage, battery discharge and fire. For your safety, do not use unauthorized electronic devices.

## Vehicle break-in process

No special break-in period is needed. By following a few simple precautions for the first 600 miles (1,000 km) you may add to the performance, economy and life of your vehicle.

- Do not race the engine.
- While driving, keep your engine speed (rpm, or revolutions per minute) between 2,000 rpm and 4,000 rpm.
- Do not maintain a single speed for long periods of time, either fast or slow. Varying engine speed is needed to properly break-in the engine.
- Avoid hard stops, except in emergencies, to allow the brakes to seat properly.
- Don't tow a trailer during the first 1,200 miles (2,000 km) of operation.

## Vehicle handling instructions

As with other vehicles of this type, failure to operate this vehicle correctly may result in loss of control, an accident or vehicle rollover.

Specific design characteristics (higher ground clearance, track, etc.) give this vehicle a higher center of gravity than other types of vehicles. In other words they are not designed for cornering at the same speeds as conventional 2-wheel drive vehicles.

Avoid sharp turns or abrupt maneuvers. Again, failure to operate this vehicle correctly may result in loss of control, an accident or vehicle rollover. **Be sure to read the "Reducing the risk of a rollover" driving guidelines, in chapter 5 of this manual.**

## Risk of burns when parking or stopping vehicle

- Do not park or stop the vehicle near flammable items such as leaves, paper, oil, and tires. Such items placed near the exhaust system can become a fire hazard.
- When an engine idles at a high rpm with the rear side of the vehicle in close proximity of the wall, heat of the exhaust gas can cause discoloration or fire. Keep enough space between the rear part of the vehicle and the wall.
- Be sure not to touch the exhaust/catalytic systems while the engine is running or right after the engine is turned off. There is a risk of burns since the systems are extremely hot.

## Vehicle data collection and event data recorders

**This vehicle is equipped with an event data recorder (EDR). The main purpose of an EDR is to record, in certain crash or near crash-like situations, such as an air bag deployment or hitting a road obstacle, data that will assist in understanding how a vehicle's systems performed. The EDR is designed to record data related to vehicle dynamics and safety systems for a short period of time, typically 30 seconds or less. The EDR in this vehicle is designed to record such data as:**

- **How various systems in your vehicle were operating;**
- **Whether or not the driver and passenger safety belts were buckled/ fastened;**
- **How far (if at all) the driver was depressing the accelerator and/or brake pedal; and,**
- **How fast the vehicle was traveling.**

**These data can help provide a better understanding of the circumstances in which crashes and injuries occur. NOTE: EDR data are recorded by your vehicle only if a non-trivial crash situation occurs; no data are recorded by the EDR under normal driving conditions and no personal data (e.g., name, gen-**

der, age, and crash location) are recorded. However, other parties, such as law enforcement, could combine the EDR data with the type of personally identifying data routinely acquired during a crash investigation.

To read data recorded by an EDR, special equipment is required, and access to the vehicle or the EDR is needed. In addition to the vehicle manufacturer, other parties, such as law enforcement, that have the special equipment, can read the information if they have access to the vehicle or the EDR.





<b>Exterior overview.....</b>	<b>2-2</b>
<b>Interior overview.....</b>	<b>2-5</b>
<b>Instrument panel overview .....</b>	<b>2-7</b>
<b>Engine compartment .....</b>	<b>2-9</b>

# Your vehicle at a glance

## Exterior overview

Front view



OSK3018001NR

\* The actual shape may differ from the illustration.

- 1. Hood 4-31
- 2. Head lamp (Features of your vehicle) 4-90  
Head lamp (Maintenance) 7-63
- 3. Front fog lamp (Features of your vehicle) 4-94  
Front fog lamp (Maintenance) 7-67
- 4. Wheel and tire (Maintenance) 7-34  
Wheel and tire (Specification) 8-5
- 5. Outside rearview mirror 4-46
- 6. Sunroof 4-36
- 7. Front windshield wiper blades (Features of your vehicle) 4-97

Front windshield wiper blades (Maintenance)	7-29
8. Windows	4-26
9. Front ultrasonic sensor	4-86

Rear view



OSK3010002NR

\* The actual shape may differ from the illustration.

- |   |             |
|---|-------------|
| 1. Door locks                           | 4-18        |
| 2. Fuel filler door                     | 4-33        |
| 3. Rear combination lamp (Maintenance)  | 7-68, 7-70  |
| 4. High mounted stop lamp (Maintenance) | 7-70        |
| 5. Rear window wiper blade              | 4-100, 7-30 |
| 6. Liftgate                             | 4-23        |
| 7. Antenna                              | 4-148       |
| 8. Rear view camera                     | 4-82        |
| 9. Rear ultrasonic sensor               | 4-83, 4-86  |

## Interior overview



OSK3018005NR

\* The actual shape may differ from the illustration.

1. Inside door handle	4-19
2. Power window switch	4-27
3. Central Door lock/unlock switch	4-20
4. Power window lock switch	4-29
5. Outside rearview mirror control	4-46
6. Outside rearview mirror folding	4-47
7. Fuel filler door open lever	4-33
8. Instrument panel illumination control switch	4-48
9. Lane Safety button	5-81
10. Blind-Spot Safety button	5-89
11. Head-Up Display shutter On/Off button	4-79
12. ISG Off button	5-49
13. Parking Safety button	4-83, 4-86

14.ESC Off button	5-43
15.Steering wheel	4-40
16.Tilt and telescopic steering control lever	4-42
17.Inner fuse panel	7-49
18.Hood release lever	4-31
19.Transmission shift lever	5- 19, 5-22, 5-29
20.Seat	3-5

## Instrument panel overview



OSK3018004NR

\* The actual shape may differ from the illustration.

- |   |              |
|---|--------------|
| 1. Audio remote control buttons   |              |
| Steering wheel audio controls (Refer to the "CAR MULTIMEDIA SYSTEM USER'S MANUAL".) |              |
| 2. Driver's front air bag   | 3-52         |
| 3. Horn   | 4-43         |
| 4. Cruise Control button  | 5-102, 5-106 |
| 5. Instrument cluster   | 4-48         |
| 6. Lighting control lever   | 4-91         |
| 7. Wiper and washer control lever   | 4-97         |
| 8. Ignition switch or ENGINE START/STOP button                                      | 5-10, 5-13   |
| 9. Audio (Refer to the "CAR MULTIMEDIA SYSTEM USER'S MANUAL".)                      |              |
| 10. Hazard warning flasher  | 6-3          |
| 11. Climate control system  | 4-117        |



12.Front seat warmer / Seat air ventilation	4-135, 4-137
13.Power outlet	4-138
14.Heated steering wheel On/Off button	4-42
15.Drive mode button	5-53
16.Center console storage box	4-131
17.Parking brake	5-39
18.Glove box	4-132
19.Passenger's front air bag	3-52
20.USB charger	4-139

## Engine compartment

Gasoline Engine (Gamma 1.6 T-GDI)

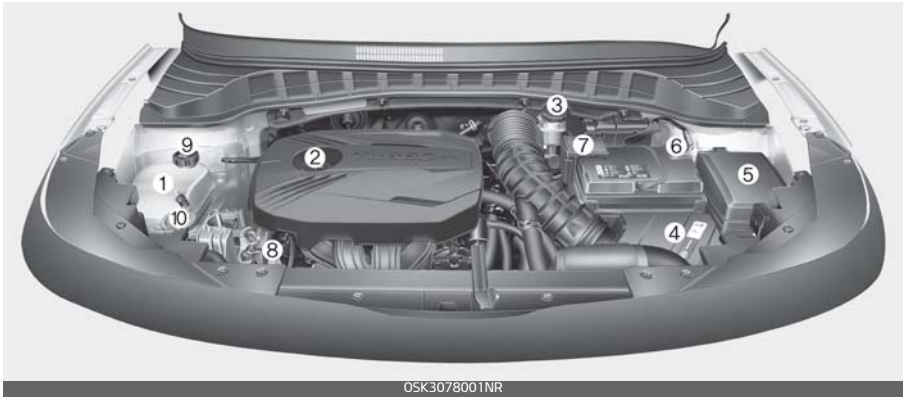

Gasoline Engine (Nu 2.0L MPI)



\* The actual engine cover in the vehicle may differ from the illustration.

1. Engine coolant reservoir	7-21
2. Engine oil filler cap	7-19
3. Brake / clutch fluid reservoir	7-24
4. Air cleaner	7-26
5. Fuse box	7-50
6. Negative battery terminal	6-7, 7-31
7. Positive battery terminal	6-7, 7-31
8. Engine oil dipstick	7-19
9. Radiator cap	6-8, 7-21
10. Windshield washer fluid reservoir	7-25



# Safety features of your vehicle **3**

<b>Important safety precautions</b> .....	<b>3-3</b>
<b>Seat</b> .....	<b>3-5</b>
• Feature of Seat Leather .....	3-7
• Front seat adjustment - manual seat .....	3-8
• Front seat adjustment - power seat .....	3-9
• Headrest for front seat .....	3-11
• Seatback pocket (if equipped) .....	3-13
• Headrest for rear seat .....	3-13
• Armrest .....	3-15
• Folding the rear seat .....	3-15
<b>Seat belts</b> .....	<b>3-18</b>
• Seat belt restraint system .....	3-18
• Driver's seat belt warning .....	3-19
• Front passenger's seat belt warning .....	3-20
• Seat belt - Driver's 3-point system with emergency locking retractor .....	3-21
• Seat belts - Front passenger and rear seat 3-point system with combination locking retractor .....	3-23
• Stowing the rear seat belt .....	3-25
• Pre-tensioner seat belt .....	3-25
• Seat belt precautions .....	3-28
• Care of seat belts .....	3-29
<b>Child Restraint System (CRS)</b> .....	<b>3-31</b>
• Children always in the rear .....	3-31
• Selecting a Child Restraint System (CRS) .....	3-32
• Installing a Child Restraint System (CRS) .....	3-34
<b>Air bag - advanced supplemental restraint system</b> .....	<b>3-41</b>
• How does the air bag system operate? .....	3-41

## 3 Safety features of your vehicle

- Do not install a child restraint on the front passenger's seat  
3-43
- Air bag warning light..... 3-44
- Supplemental Restraint System (SRS) components and  
functions ..... 3-44
- Occupant Detection System (ODS)..... 3-46
- Driver's and passenger's front air bag..... 3-52
- Side air bag ..... 3-55
- Curtain air bag..... 3-57
- Air bag collision sensors ..... 3-58
- Why didn't my air bag go off in a collision? (Inflation and  
non-inflation conditions of the air bag)..... 3-59
- Supplemental Restraint System (SRS) Care ..... 3-61
- Adding equipment to or modifying your air bag-equipped  
vehicle ..... 3-62
- Air bag warning label ..... 3-62

## Safety features of your vehicle

### Important safety precautions

You will find many safety precautions and recommendations throughout this section, and throughout this manual.

The safety precautions in this section are among the most important.

#### Always wear your seat belt

A seat belt is your best protection in all types of accidents. Air bags are designed to supplement seat belts, not replace them. So even though your vehicle is equipped with air bags, ALWAYS make sure you and your passengers wear your seat belts, and wear them properly.

#### Restrain all children

All children under age 13 should ride in your vehicle properly restrained in a rear seat, not the front seat. Infants and small children should be restrained in an appropriate child restraint. Larger children should use a booster seat with the lap/shoulder belt until they can use the seat belt properly without a booster seat.

#### Air bag hazards

While air bags can save lives, they can also cause serious or fatal inju-

ries to occupants who sit too close to them, or who are not properly restrained. Infants, young children, and shorter adults are at the greatest risk of being injured by an inflating air bag. Follow all instructions and warnings in this manual.

#### Driver distraction

Driver distraction presents a serious and potentially deadly danger, especially for inexperienced drivers. Safety should be the first concern when behind the wheel and drivers need to be aware of the wide array of potential distractions, such as drowsiness, reaching for objects, eating, personal grooming, other passengers, and using cellular phones.

Drivers can become distracted when they take their eyes and attention off the road or their hands off the wheel to focus on activities other than driving. To reduce your risk of distraction or getting into an accident:

- ALWAYS set up your mobile devices (i.e., MP3 players, phones, navigation units, etc.) when your vehicle is parked or safely stopped.
- ONLY use your mobile device when allowed by laws and when conditions permit safe use. NEVER text or email while driving.

Most states have laws prohibiting drivers from texting. Some states and cities also prohibit drivers from using handheld phones.

- NEVER let the use of a mobile device distract you from driving. You have a responsibility to your passengers and others on the road to always drive safely, with your hands on the wheel as well as your eyes and attention on the road.

**Control your speed**

Excessive speed is a major factor in crash injuries and deaths. Generally, the higher the speed, the greater the risk, but serious injuries can also occur at lower speeds. Never drive faster than is safe for current conditions, regardless of the maximum speed posted.

**Keep your vehicle in safe condition**

Having a tire blowout or a mechanical failure can be extremely hazardous. To reduce the possibility of such problems, check your tire pressures and condition frequently, and perform all regularly scheduled maintenance.

## Seat

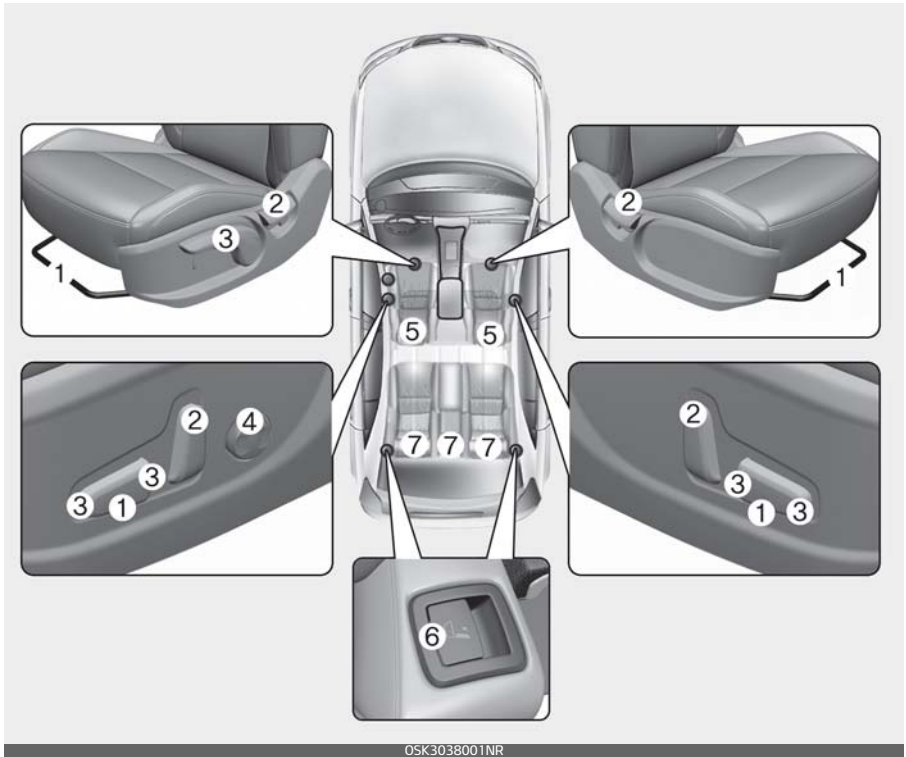

OSK3038001NR

### Front seat

1. Forward and backward
2. Seatback angle
3. Seat cushion height
4. Lumbar support (if equipped)
5. Head rest

### Rear seat

6. Seatback folding
7. Headrest

\*: if equipped

### **⚠ WARNING**

#### Loose objects

Do not place anything in the driver's footwell or under the front seats. Loose objects in the driver's foot area could interfere with the operation of the foot pedals.

### **⚠ WARNING**

#### Uprighting seat

Do not press the release lever on a manual seatback without holding and controlling the seatback. The



seatback will spring upright possibly impacting you or other passengers.

## ⚠ WARNING

### Driver responsibility for passengers



The driver must advise the passengers to keep the seatback in an upright position whenever the vehicle is in motion. If a seat is reclined during an accident, the restraint system's ability to restrain will be greatly reduced.

## ⚠ WARNING

### Seat cushion

Occupants should never sit on after-market seat cushions or sitting cushions. The passenger ODS system may not operate properly, or passenger's hips may slide under the lap portion of the seat belt during an accident or a sudden stop.

## ⚠ WARNING

### Driver's seat

- Never attempt to adjust the seat while the vehicle is moving. This could result in loss of control of your vehicle.
- Do not allow anything to interfere with the normal position of the seatback. Storing items against the seatback could result in serious or fatal injury in a sudden stop or collision.
- Sit as far back as possible from the steering wheel while still maintaining comfortable control of the your vehicle. A distance of at least 10 in (25 cm) from your chest to the steering wheel is recommended. Failure to do so can result in air bag inflation injuries to the driver.

## ⚠ WARNING

### Rear seatbacks

Always lock the rear seatback before driving. Failure to do so could result in passengers or objects being thrown forward injuring vehicle occupants.

## ⚠ WARNING

### Unexpected Seat Movement

After adjusting a manual seat, always check that it is locked by

shifting your weight to the front and back. Sudden or unexpected movement of the driver's seat could cause you to lose control of the vehicle.

### **⚠ WARNING**

#### **Seat adjustment**

- Do not adjust the seat while wearing seat belts. Moving the seat forward will cause strong pressure on the abdomen.
- Do not place your hand near the seat bottom or seat track while adjusting the seat. Your hand could get caught in the seat mechanism.

### **⚠ WARNING**

#### **Luggage and Cargo**

Do not stack pile or stack luggage or cargo higher than the seatback in the cargo area. In an accident the cargo could strike and injure a passenger. If objects are large, heavy or must be piled, they must be secured in the cargo area.

### **⚠ WARNING**

#### **Cargo Area**

Do not allow passengers to ride in the cargo area under any circumstance. The cargo area is solely for

the purpose of transporting luggage or cargo.

### **⚠ WARNING**

#### **Small Objects**

Use extreme caution when picking up small objects trapped under the seats or between the seat and the center console. Your hands might be cut or injured by the sharp edges of the seats mechanism.

#### **Feature of Seat Leather**

Leather is made from the outer skin of an animal, which goes through a special process to be available for use. Since it is a natural substance, each part differs in thickness or density.

- Wrinkles may appear as a natural result of stretching and shrinking depending on the temperature and humidity.
- The seat cover is made of stretchable material to improve comfort of passengers.
- The parts contacting the body are curved and the side supporting area is high which provides driving comfort and stability.

### **⚠ CAUTION**

- Belts with metallic accessories, zippers or keys inside the back

pocket may damage the seat fabric.

- Make sure not to wet the seat. It may change the nature of the natural leather.
- Jeans or clothes which could bleach may contaminate the surface of the seat covering fabric.

**\* NOTICE**

Wrinkles or abrasions may appear naturally from usage. It is not a fault of product. Wrinkles or abrasions are not covered by warranty.

**Front seat adjustment - manual seat**

The front seat can be adjusted by using the control levers located on the outside of the seat cushion.



**Forward and backward**

Adjust the seat before driving, and make sure the seat is locked securely by trying to move forward

and backward without using the lever. If the seat moves, it is not locked properly.

To move the seat forward or backward:

1. Pull the seat slide adjustment lever up and hold it.
2. Slide the seat to the position you desire.
3. Release the lever and make sure the seat is locked in place.

**Seatback angle**



To recline the seatback:

1. Lean forward slightly and lift up the seatback recline lever.
2. Carefully lean back on the seat and adjust the seatback of the seat to the position you desire.
3. Release the lever and make sure the seatback is locked in place. (The lever MUST return to its original position for the seatback to lock.)

**Seat cushion height (if equipped)**

To change the height of the seat cushion, push the lever upwards or downwards.

- To lower the seat cushion, push down the lever several times.
- To raise the seat cushion, pull up the lever several times.

**⚠ WARNING****Reclining seatback**

Sitting in a reclined position when the vehicle is in motion can be dangerous. Even when buckled up, the protections of your restraint system (seat belts and/or air bags) is greatly reduced by reclining your seatback.

Seat belts must be snug against your hips and chest to work properly. When the seatback is reclined, the shoulder belt cannot do its job because it will not be snug against your chest. Instead, it will be in front of you. During an accident, you could be thrown into the seat belt, causing neck or other injuries.

The more the seatback is reclined, the greater chance the passenger's hips will slide under the lap belt or the passenger's neck will strike the shoulder belt.

**Front seat adjustment - power seat (if equipped)**

The front seat can be adjusted by using the control switches located on the outside of the seat cushion.

Before driving, adjust the seat to the proper position so you can easily control the steering wheel, pedals and switches on the instrument panel.

**⚠ CAUTION****Power seating adjustments**

- The power seating controls function by electronic motor. Excessive operation may cause damage to the electrical equipment.
- Do not operate two or more power seat control switches at the same time. Doing so may damage the power seat motor or electrical components.

**Forward and backward**

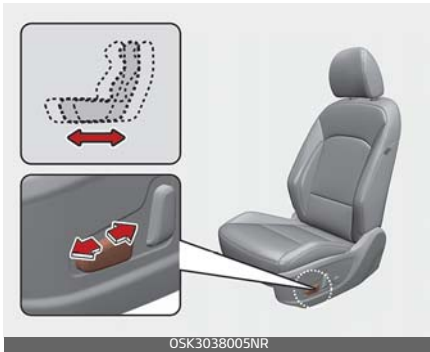

To move the seat forward or backward:

- Push the control switch forward or backward to move the seat to the desired position. Release the switch once the seat reaches the desired position.

**Seatback angle**

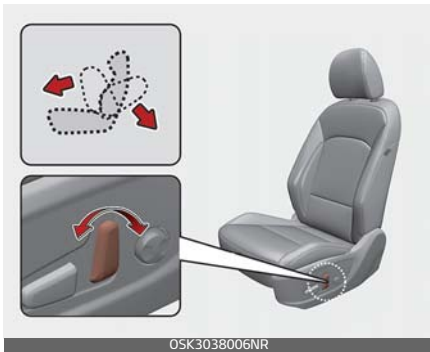

To recline the seatback:

- Push the control switch forward or backward to move the seatback to the desired angle. Release the switch once the seat reaches the desired position.

**Seat cushion height**

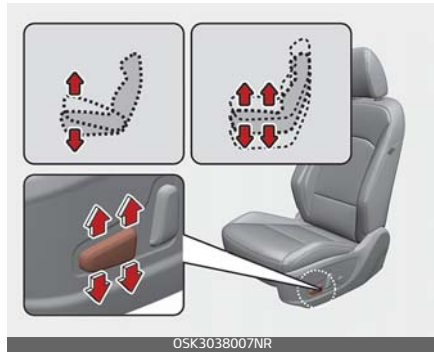

To change the height of the seat:

- Pull the front portion of the control switch up to raise or press down to lower the front part of the seat cushion. Pull the rear portion of the control switch up to raise or press down to lower the seat cushion. Release the switch once the seat reaches the desired position.

**Lumbar support for driver's seat (if equipped)**



The lumbar support can be adjusted by pressing the lumbar support switch on the side of the seat.

1. Press the front portion of the switch to increase support, or the rear portion of the switch, to decrease support.
2. Release the switch once it reaches the desired position.

### Headrest for front seat

The driver's and front passenger's seats are equipped with a headrest for the occupant's safety and comfort.



0DEEV058006NR

The headrest not only provides comfort for the driver and front passenger, but also helps protect the head and neck in the event of a rear collision.

For maximum effectiveness in case of an accident, the headrest should be adjusted so the middle of the headrest is at the same height of the center of gravity of an occupant's head. Generally, the center of gravity of most people's head is similar with the height of the top of their eyes.

Also, adjust the headrest as close to your head as possible. For this reason, the use of a cushion that holds the body away from the seatback is not recommended.

### **⚠ WARNING**

#### Headrest removal/adjustment

- Do not operate the vehicle with the headrests removed. Headrests can provide critical neck and head support in a crash.
- Do not adjust the headrest height while the vehicle is in motion. Driver may lose control of the vehicle.

### **⚠ CAUTION**

Excessive pulling or pushing may damage the headrest.

#### *Adjusting the height up and down*



OSK3038010NR

To raise the headrest:

1. Pull it up to the desired position (1).
2. To lower the headrest, push and hold the release button (2) on the headrest support.
3. Lower the headrest to the desired position (3).

**\* NOTICE**

If you recline the seatback towards the front with the headrest and seat cushion raised, the headrest may come in contact with the sun visor or other parts of the vehicle.



**Removal**



To remove the headrest:

1. Recline the seatback (2) with the recline lever or switch (1).
2. Raise headrest as far as it can go.
3. Press the headrest release button (3) while pulling the headrest up (4).

**⚠ WARNING**

**Headrest Removal**

NEVER allow anyone to ride in a seat with the headrest removed or reversed. Headrests can provide

critical neck and head support in a crash.

### Reinstallation

Type A



Type B



To reinstall the headrest:

1. Put the headrest poles (2) into the holes while pressing the release button (1).
2. Recline the seatback (4) with the recline lever or switch (3).
3. Adjust the headrest to the appropriate height.

## ⚠ WARNING

### Headrest Reinstallation

To reduce the risk of injury to the head or neck, always make sure the headrest is locked into position and adjusted properly after reinstalling.

### Seatback pocket (if equipped)

The seatback pocket is provided on the back of the front passenger's seatback.



## ⚠ WARNING

### Seatback pockets

Do not put heavy or sharp objects in the seatback pockets. In an accident they could come loose from the pocket and injure vehicle occupants.

### Headrest for rear seat

The rear seat is equipped with headrests in all the seating positions for the occupant's safety and comfort.





0DEEV058014NR

The headrest not only provides comfort for passengers, but also helps protect the head and neck in the event of a collision.

For maximum effectiveness in case of an accident, the headrest should be adjusted so the middle of the headrest is at the same height of the center of gravity of an occupant's head. Generally, the center of gravity of most people's heads is similar with the height as the top of their eyes.

Also, adjust the headrest as close to your head as possible. For this reason, the use of a cushion that holds the body away from the seatback is not recommended.

### ***Adjusting the height up and down***

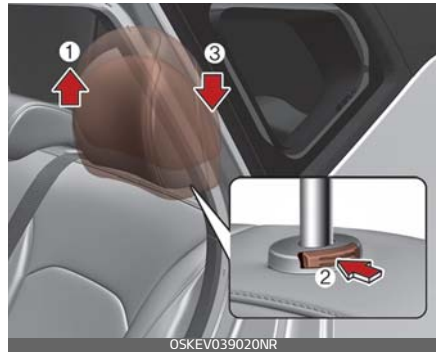

0SKEV039020NR

- To raise the headrest, pull it up to the desired position (1).
- To lower the headrest, push and hold the release button (2) on the headrest support and lower the headrest to the desired position (3).

### ***Removal and reinstallation***

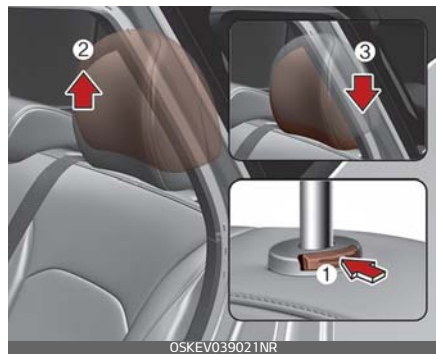

0SKEV039021NR

- To remove the headrest, raise it as far as it can go then press the release button (1) While pulling the headrest upward (2).
- To reinstall the headrest, put the headrest poles (3) into the holes

while pressing the release button (1).

Then adjust it to the appropriate height and ensure that it locks in position.

### Armrest (if equipped)

To use the armrest, pull it forward from the seatback.



### Folding the rear seat

The rear seatbacks may be folded to facilitate carrying long items or to increase the luggage capacity of the vehicle.

#### **⚠ WARNING**

#### **Folded Seatback**

The purpose of the fold-down rear seatbacks is to allow you to carry longer objects that could not otherwise be accommodated.

- Never allow a passenger to sit on top of the folded down seatback while the car is moving. This is not a proper seating position since no

seat belts are available for use. This could result in serious injury or death in case of an accident or sudden stop.

### *To fold down the rear seatback*

1. Set the front seatback to the upright position and if necessary, slide the front seat forward.
2. Lower the rear headrests to the lowest position.

#### **⚠ WARNING**

#### **Objects**

Objects carried on the folded down seatback should not extend higher than the top of the front seatbacks. This could allow cargo to slide forward and cause injury or damage during sudden stops.

3. When folding the seatback, insert the rear seat belt buckle in the pocket between the rear seatback and cushion then make sure both seat belts do not interfere with stowed luggage and cargo. Then, the seat belt webbing should be placed in the webbing guide to prevent the seat belt from being damaged by loaded cargo, etc. If the seat belt is loose, it may cause damage or noise. In that case, return the seatback to the upright position and put the webbing out from the guide to realign it.



4. Pull on the seatback folding lever, then fold the seat toward the front of the vehicle. When you return the seatback to its upright position, always be sure it has locked into position by pushing on the top of the seatback.



5. To use the rear seat, lift and pull the seatback backward by lifting up seatback. Pull the seatback firmly until it clicks into place. Make sure the seatback is locked in place.
6. Return the rear seat belt to the proper position.

### To unfold the rear seat



1. To use the rear seat, lift and pull the seatback backward. Pull the seatback firmly until it clicks into place. Make sure the seatback is locked in place. When you return the seatback to its upright position, always be sure it has locked into position by pushing on the top of the seatback. If you cannot see the red line at the bottom of folding lever, it means the seatback is locked completely.
2. Return the rear seat belt to the proper position.
3. When the seatback is completely installed, check the seatback folding lever again.

### **⚠ WARNING**

#### Uprighting seat

When you return the seatback to its upright position, hold the seatback and return it slowly. If the seatback is returned without holding it, the back of the seat could spring for-

ward, resulting in injury caused by being struck by the seatback.

### **⚠ WARNING**

#### **Rear Seatback**

To ensure maximum protection in the event of an accident or sudden stop, when returning the rear seat to the upright position:

- Be careful not to damage the seat belt webbing or buckle.
- Do not allow the seat belt webbing or buckle to become pinched or caught in the rear seat.
- Ensure the seatback is completely locked into its upright position by pushing on the top of the seatback.

Failure to adhere to any of these instructions could result in serious injury or death in the event of a crash.

### **⚠ CAUTION**

#### **Damaging rear seat belt buckles**

When you fold the rear seatback, insert the buckle between the rear seatback and cushion. Doing so can prevent the buckle from being damaged by the rear seatback.

### **⚠ CAUTION**

#### **Rear seat belts**

When returning the rear seatbacks to the upright position, remember to return the rear shoulder belts to their proper position.

### **⚠ WARNING**

Unless the driver's position is properly set according to the driver's physical figure, do not fold the rear seat. It may increase bodily injuries in a sudden stop or collision.

### **⚠ CAUTION**

Be careful when loading cargo through the rear passenger seats to prevent damage to the vehicle interior.

### **⚠ WARNING**

#### **Cargo**

Cargo should always be secured to prevent it from being thrown about the vehicle in a collision and causing injury to the vehicle occupants. Do not place objects in the rear seats, since they cannot be properly secured and may hit the front seat occupants in a collision.

#### **Cargo loading**

Make sure the engine is off, the transmission is in P (Park) and the parking brake is securely applied whenever loading or unloading

cargo. Failure to take these steps may allow the vehicle to move if the shift lever is inadvertently moved to another position.

## Seat belts

The following explains seat belts precautions and how to fasten seat belts.

### Seat belt restraint system

For maximum restraint system protection, the seat belts must always be used whenever the vehicle is moving.

- A properly positioned shoulder belt should be positioned midway over your shoulder across your collarbone.
- Never allow children to ride in the front passenger seat. See "Child Restraint System (CRS)" on page 3-31 for further discussion.

### WARNING

#### Twisted seat belt

Make sure your seat belt is not twisted when worn. A twisted seat belt may not properly protect you in an accident and could even cut into your body.

---

### WARNING

#### Shoulder Belt

- Never wear the shoulder belt under your arm or behind your back. An improperly positioned shoulder belt cannot protect the occupant in a crash.

- Always wear both the shoulder portion and lap portion of the lap/shoulder belt.

### **WARNING**

#### **Damaged seat belt**

Replace the entire seat belt assembly if any part of the webbing or hardware is damaged, as you can no longer be sure that a damaged seat belt will provide protection in a crash.

Seat belts are designed to bear upon the bony structure of the body, and should be worn low across the front of the pelvis, chest and shoulders, as applicable; wearing the lap section of the belt across the abdominal area must be avoided.

Seat belts should be adjusted as firmly as possible, consistent with comfort, to provide the protection for which they have been designed.

A slack belt will greatly reduce the protection afforded to the wearer.

Care should be taken to avoid contamination of the webbing with polishes, oils and chemicals, and particularly battery acid. Cleaning may safely be carried out using mild soap and water. The belt should be replaced if webbing becomes frayed, contaminated or damaged.

- No modifications or additions should be made by the user which would either prevent the seat belt adjusting devices from operating to remove slack, or prevent the seat belt assembly from being adjusted to remove slack.
- When you fasten the seat belt, be careful not to latch the seat belt in buckles of other seats. It is very dangerous and you may not be protected by the seat belt properly.
- Do not unfasten the seat belt and do not fasten and unfasten the seat belt repeatedly while driving. This could result in loss of control, and an accident causing death, serious injury, or property damage.
- When fastening the seat belt, make sure that the seat belt does not pass over objects that are hard or can break easily.

### **WARNING**

#### **Seat belt buckle**

Do not allow foreign material (gum, crumbs, coins, liquids, etc.) to obstruct the seat belt buckle. This may prevent the seat belt from fastening securely.

#### **Driver's seat belt warning**

As a reminder to the driver, the driver's seat belt warning lights will

illuminate for approximately 6 seconds each time you turn the ignition switch ON regardless of belt fastening. If the seatbelt is not fastened, the warning chime will sound for about 6 seconds.



If you start to drive without the seat belt fastened or you unfasten the seat belt when you drive over 5 mph (9 km/h) and less than 12 mph (20 km/h), the corresponding warning light will illuminate. The warning light will turn off when the vehicle speed drops below 5 mph (9 km/h).

If you start to drive without the seat belt fastened or you unfasten the seat belt when you drive 12 mph (20 km/h) and faster, the warning light will blink and warning chime will sound for approximately 100 seconds. When the seat belt is unfastened during driving, the warning light will illuminate when the speed is under 12 mph (20 km/h). When the speed is 12 mph (20 km/h) and faster, the warning light

will blink and warning chime will sound for approximately 100 seconds.

### Front passenger's seat belt warning



As a reminder to the front passenger, the front passenger's seat belt warning lights will illuminate for approximately 6 seconds each time you turn the ignition switch ON regardless of belt fastening. If you start to drive without the passenger seat belt fastened or the passenger unfastens the seat belt when you drive over 5 mph (9 km/h) and less than 12 mph (20 km/h), the corresponding warning light will illuminate. The warning light will turn off when the vehicle speed drops below 5 mph (9 km/h).

If you start to drive without the passenger seat belt fastened or you unfasten the seat belt when you drive 12 mph (20 km/h) and faster, the warning light will blink and

warning chime will sound for approximately 100 seconds. When the passenger seat belt is unfastened during driving, the warning light will illuminate when the speed is under 12 mph (20 km/h). When the speed is 12 mph (20 km/h) and faster, the warning light will blink and warning chime will sound for approximately 100 seconds.

### \* NOTICE

- Even if the front passenger seat is not occupied, the seat belt warning light will illuminate for 6 seconds.
- The front passenger's seat belt warning may operate when luggage is placed on the front passenger seat.

### Seat belt - Driver's 3-point system with emergency locking retractor

The following explains how to fasten and adjust the driver's seat belt.

### To fasten your seat belt:

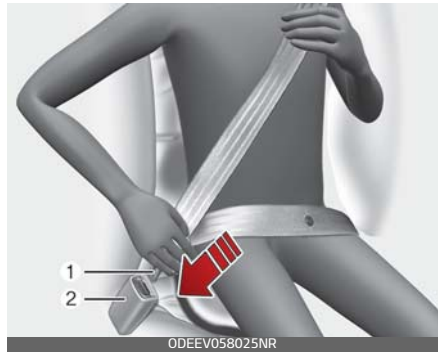

- Pull it out of the retractor and insert the metal tab (1) into the buckle (2). There will be an audible "click" when the tab locks into the buckle.



### ⚠ WARNING

You should place the lap belt portion as low as possible and snugly across your hips. If the lap belt is located too high on your waist, it may increase the chance of injury in the event of a collision.

The arm closest to the seat belt buckle should be over the belt while



the other arm should be under the belt as shown in the illustration. Never wear the seat belt under the arm closest to the door.

The seat belt automatically adjusts to the proper length only after the lap belt portion is adjusted manually so that it fits snugly around your hips. If you lean forward in a slow, easy motion, the belt will extend and let you move around. If there is a sudden stop or impact, however, the belt will lock into position. It will also lock if you try to lean forward too quickly.

### \* NOTICE

If you are not able to pull out the seat belt from the retractor, firmly pull the belt out and release it. Then you will be able to pull the belt out smoothly.

### **Height adjustment**

You can adjust the height of the shoulder belt anchor to one of the 4 positions for maximum comfort and safety.

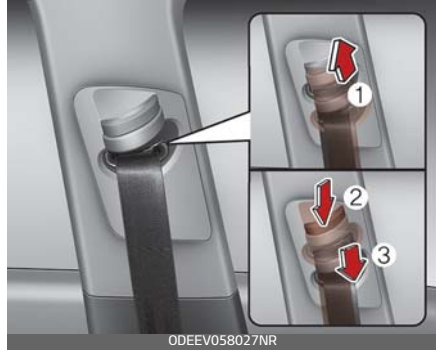

The height of the adjusting seat belt should not be too close to your neck. The shoulder portion should be adjusted so that it lies across your chest and midway over your shoulder near the door and not your neck.

To adjust the height of the seat belt anchor, lower or raise the height adjuster into an appropriate position.

- To raise the height adjuster, pull it up (1).
- To lower it, push it down (3) while pressing the height adjuster button (2).

Release the button to lock the anchor into position. Try sliding the height adjuster to make sure that it has locked into position.

Improperly positioned seat belts can cause serious injuries in an accident.

### ⚠ WARNING

### **Shoulder belt positioning**

Verify the shoulder belt anchor is locked into position at the appropriate height. Never position the shoulder belt across your neck or face. Improperly positioned seat belts can cause serious injuries in an accident.

### **▲ WARNING**

#### **Seat belt replacement**

Replace your seat belts after being in an accident. Failure to replace seat belts after an accident could leave you with damaged seat belts that will not provide protection in the event of another collision.

#### **Seat belts - Front passenger and rear seat 3-point system with combination locking retractor**

The following explains how to fasten the passenger's and rear seat belt.

##### ***To fasten your seat belt:***

Combination retractor type seat belts are installed in the rear seat positions to help accommodate the installation of child restraint systems. Although a combination retractor is also installed in the front passenger seat position, it is strongly recommended that children always be seated in the rear seat. NEVER place any infant restraint

system in the front seat of the vehicle.

This type of seat belt combines the features of both an emergency locking retractor seat belt and an automatic locking retractor seat belt.

- Pull it out of the retractor and insert the metal tab into the buckle. There will be an audible "click" when the tab locks into the buckle. When not securing a child restraint, the seat belt operates in the same way as the driver's seat belt (emergency locking retractor type).

It automatically adjusts to the proper length only after the lap belt portion of the seat belt is adjusted manually so that it fits snugly around your hips.

When the seat belt is fully extended from the retractor to allow the installation of a child restraint system, the seat belt operation changes to allow the belt to retract, but not to extend (automatic locking retractor type). Refer to "Securing a child restraint with a lap/shoulder belt" on page 3-38.

### **\* NOTICE**

Although the combination retractor provides the same level of protection for seated passengers in either emergency or automatic locking

modes, have the seated passengers use the emergency locking feature for improved convenience. The automatic locking function is intended to facilitate child restraint installation. To convert from the automatic locking feature to the emergency locking operation mode, allow the unbuckled seat belt to fully retract.

### ⚠ CAUTION

Do NOT fold down the left portion of the rear seatback when the rear center seat belt is buckled. ALWAYS UNBUCKLE the rear center seat belt before folding down the left portion of the rear seatback. If the rear center seat belt is buckled when the left portion of the rear seatback is folded down, distortion and damage to the top portion of the seatback and seat belt garnish may result, causing the seatback to lock into the folded down position.

The seat belt should be locked into the buckle on each seat cushion to be properly fastened.



1. Rear right seat belt fastening buckle
2. Rear center seat belt fastening buckle
3. Rear left seat belt fastening buckle

### ⚠ WARNING

Prior to fastening the rear seat belts, ensure the latch matches the seat belt buckle. Forcefully fastening the left or right seat belt to the center buckle can result in an improper fastening scenario that will not protect you in an accident.

When using the rear center seat belt, the buckle with the "CENTER" mark must be used.

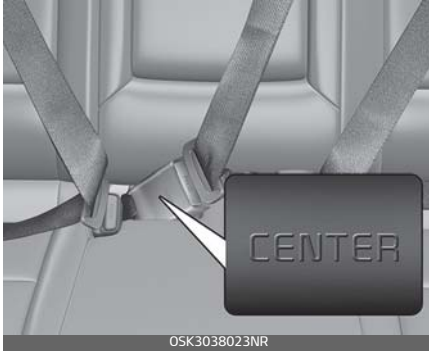

**To release the seat belt:**



- The seat belt is released by pressing the release button (1) on the locking buckle. When it is released, the belt should automatically draw back into the retractor. If this does not happen, check the belt to make sure it is not twisted, then try again.

**Stowing the rear seat belt**



If the center seat belt is not in use, always lock the latch plate into the buckle as above illustration.

The rear seat belt buckles can be stowed in the pocket between the rear seatback and cushion when not in use.

**⚠ WARNING**

**Rear center seat belt**

Do not separate the mini tongue (1) and mini buckle (2) even if there is not an occupant.

If it is separated, It may hit the rear seat occupants in a collision or sudden stops.

**Pre-tensioner seat belt**

Your vehicle is equipped with driver's and front passenger's pre-tensioner seat belts (retractor pre-tensioner and EFD (Emergency Fastening Device)).

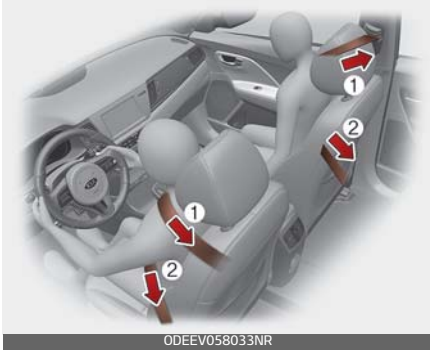

0DEEV058033NR

The pre-tensioner seat belts may be activated, when a frontal collision is severe enough, together with the air bags.

When the vehicle stops suddenly, or if the occupant tries to lean forward too quickly, the seat belt retractor may lock into position. In certain frontal collisions, the pre-tensioner will activate and pull the seat belt into tighter contact against the occupant's body.

1. Retractor Pre-tensioner

The purpose of the retractor pre-tensioner is to make sure that the shoulder belts fit in tightly against the occupant's upper body in certain frontal collisions.

2. EFD (Emergency Fastening Device)

The purpose of the EFD is to make sure that the pelvis belts fit in tightly against the occupant's lower body in certain frontal collisions.

If the system senses excessive tension on the driver or passenger's seat belt when the pre-tensioner system activates, the load limiter inside the retractor pre-tensioner will release some of the pressure on the affected seat belt.

**\* NOTICE**

When the pre-tensioner seat belts are activated, a loud noise may be heard and fine dust, which may appear to be smoke, may be visible in the passenger compartment. These are normal operating conditions and are not hazardous.

The seat belt pre-tensioner system consists mainly of the following components. Their locations are shown in the illustration:

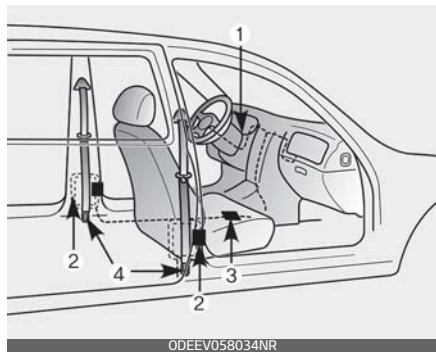

0DEEV058034NR

\* The actual position of seat belt pre-tensioner system components may differ from the illustration.

- 1. SRS air bag warning light

2. Retractor pre-tensioner assembly
3. SRS control module
4. Emergency fastening device (EFD)

### WARNING

#### Skin Irritation

Wash all exposed skin areas thoroughly after an accident in which the pre-tensioner seat belts were activated. The fine dust from the pre-tensioner activation may cause skin irritation and should not be inhaled for prolonged periods.

### \* NOTICE

- Both the driver's and front passenger's seat belt pre-tensioner systems may be activated, not only in certain frontal collisions, but also in certain side collisions or rollovers, if the vehicle is equipped with a side or curtain air bag.
- Because the sensor that activates the SRS air bag is connected with the pre-tensioner seat belt, the SRS air bag warning light  on the instrument panel will illuminate for approximately 6 seconds after the ignition switch has been turned to the ON position, and then it should turn off.
- If the pre-tensioner seat belt system is not working properly, this warning light will illuminate even

if there is not a malfunction with the SRS air bag. If the SRS air bag warning light does not illuminate when the ignition switch has been turned to the ON position, or if it remains illuminated after illuminating for approximately 6 seconds, or if it illuminates while the vehicle is being driven, have an authorized Kia dealer inspect the pre-tensioner seat belt and SRS air bag system as soon as possible.

### \* NOTICE

Do not attempt to service or repair the pre-tensioner seat belt system in any manner. Do not attempt to inspect or replace the pre-tensioner seat belts yourself. This must be done by an authorized Kia dealer.

### WARNING

#### Hot pre-tensioner

Do not touch the pre-tensioner seat belt assemblies for several minutes after they have been activated. When the pre-tensioner seat belt mechanism fires during a collision, the pre-tensioner becomes hot and can burn you.

Pre-tensioners are designed to operate only one time. After activation, pre-tensioner seat belts must

be replaced. If the pre-tensioner must be replaced, contact an authorized Kia dealer.

### Seat belt precautions

Take the following precautions when using seat belts.

#### *Infant or small child*

All 50 states have child restraint laws. You should be aware of the specific requirements in your state. Child and/or infant seats must be properly placed and installed in the rear seat. For more information about the use of these restraints, refer to "Child Restraint System (CRS)" on page 3-31.

#### **\* NOTICE**

Small children are best protected from injury in an accident when properly restrained in the rear seat by a child restraint system that meets the requirements of the Federal Motor Vehicle Safety Standards. Before buying any child restraint system, make sure that it has a label certifying that it meets Federal Motor Vehicle Safety Standard 213. The restraint must be appropriate for your child's height and weight. Check the label on the child restraint for this information. Refer to "Child

Restraint System (CRS)" on page 3-31.

#### *Larger children*

Children who are too large for child restraint systems should always occupy the rear seat and use the available lap/shoulder belts. The lap portion should be fastened and snug on the hips as low as possible. Check periodically to insure that the belt fits. A child's squirming could put the belt out of position. Children are given the most safety in the event of an accident when they are restrained by a proper restraint system in the rear seat. If a larger child (over age 13) must be seated in the front seat, the child should be securely restrained by the available lap/shoulder belt and the seat should be placed in the rearmost position. Children age 13 and under should be restrained securely in the rear seat. NEVER place a child age 13 and under in the front seat. NEVER place a rear facing child seat in the front seat of a vehicle.

If the shoulder belt portion slightly touches the child's neck or face, try placing the child closer to the center of the vehicle. If the shoulder belt still touches their face or neck they need to be returned to a child restraint system.

**⚠ WARNING****Small children**

Do not allow small children to ride in the vehicle without an appropriate child restraint system. If the shoulder belt comes in contact with your child's neck or face, your child is too small to ride in the vehicle. In a crash the seat belt will inflict injury to your child's neck, throat and face.

***Restraint of pregnant women***

Pregnant women should wear lap/shoulder belt assemblies whenever possible according to specific recommendations by their doctors. The lap portion of the belt should be worn **AS SECURELY AND LOW AS POSSIBLE**.

**⚠ WARNING****Pregnant women**

Pregnant women must never place the lap portion of the seat belt above or on the abdomen where the fetus is located. The force of the seat belt during a collision will crush the fetus.

***Injured person***

A seat belt should be used when an injured person is being transported. When this is necessary, you should

consult a physician for recommendations.

***One person per belt***

Two people (including children) should never attempt to use a single seat belt. This could increase the severity of injuries in case of an accident.

***Do not lie down***

To reduce the chance of injuries in the event of an accident and to achieve maximum effectiveness of the restraint system, all passengers should be sitting up and the front and rear seats should be in an upright position when the vehicle is moving. A seat belt cannot provide proper protection if the person is lying down in the rear seat or if the front and rear seats are in a reclined position.

**Care of seat belts**

Seat belt systems should never be disassembled or modified. In addition, care should be taken to assure that seat belts and belt hardware are not damaged by seat hinges, doors or other abuse.

**⚠ WARNING****Pinched seat belt**



Make sure that the webbing and/or buckle does not get caught or pinched in the rear seat when returning the rear seatback to its upright position. A caught or pinched webbing/buckle may become damaged and could fail during a collision or sudden stop.

---

### **WARNING**

Seatbelts can become hot in a vehicle that has been closed up in sunny weather. They could burn infants and children.

---

### ***Periodic inspection***

All seat belts should be inspected periodically for wear or damage of any kind. Any damaged parts should be replaced as soon as possible.

### ***Keep belts clean and dry***

Seat belts should be kept clean and dry. If belts become dirty, they can be cleaned by using a mild soap solution and warm water. Bleach, dye, strong detergents or abrasives should not be used because they may damage and weaken the fabric.

### ***When to replace seat belts***

The entire in-use seat belt assembly or assemblies should be replaced if the vehicle has been involved in an

accident. This should be done even if no damage is visible. Additional questions concerning seat belt operation should be directed to an authorized Kia dealer.

## Child Restraint System (CRS)

### Children always in the rear

Children under age 13 must always ride in the rear seats and must always be properly restrained to minimize the risk of injury in an accident, sudden stop or sudden maneuver.

#### WARNING

#### Restraint Location

Never install a child or infant seat in the front passenger's seat. A child riding in the front passenger seat can be forcefully struck by an inflating airbag and get seriously injured.

#### WARNING

#### Hot Child Restraint

A child restraint system can become very hot if it is left in a closed vehicle on a sunny day. Be sure to check the seat cover, buckles and latches before placing a child in the restraint system.

According to accident statistics, children are safer when properly restrained in the rear seats than in the front seat. Even with air bags, children can be seriously injured or killed. Children too large for a child restraint must use the seat belts provided.

All 50 states have child restraint laws which require children to travel in approved child restraint devices. The laws governing the age or height/weight restrictions at which seat belts can be used instead of child restraints differs among states, so you should be aware of the specific requirements in your state, and where you are travelling.

Child restraint systems must be properly placed and installed in the rear seat. You must use a commercially available child restraint system that meets the requirements of the Federal Motor Vehicle Safety Standards (FMVSS).

Child restraint systems are generally designed to be secured in a vehicle seat by lap belt portion of a lap/shoulder belt, or by a LATCH system in the rear seats of the vehicle.

#### *Child restraint system (CRS)*

Infants and younger children must be restrained in an appropriate rear-facing or forward-facing CRS that has first been properly secured to the rear seat of the vehicle. Read and comply with the instructions for installation and use provided by the manufacturer of the CRS.

**⚠ WARNING****Child Restraint Installation**

An improperly secured child restraint system can increase the risk of serious injury or death in an accident. Always take the following precautions when using a child restraint system:

- Always follow the child restraint system manufacturer's instructions for installation and use.
- Always properly restrain your child in the child restraint system.
- If the vehicle head restraint prevents proper installation of a child seat (as described in the child restraint system manual), the head restraint of the respective seating position should be readjusted or entirely removed.
- Do not use an infant carrier or a child safety seat that "hooks" over a seatback, as it may not provide adequate protection in an accident.

**\* NOTICE**

After an accident, have a Kia dealer check the child restraint system, seat belts, tether anchors and lower anchors.

**Selecting a Child Restraint System (CRS)**

When selecting a CRS for your child, always:

- Make sure the CRS has a label certifying that it meets applicable Federal Motor Vehicle Safety Standards (FMVSS 213).
- Select a child restraint based on your child's height and weight. The required label or the instructions for use typically provide this information.
- Select a child restraint that fits the vehicle seating position where it will be used.
- Read and comply with the warnings and instructions for installation and use provided with the child restraint system.

**⚠ WARNING****Holding Children**

Never hold a child in your arms or lap when riding in a vehicle. The violent forces created during a crash will tear the child from your arms and throw the child against the car's interior. Always use a child restraint system, which is appropriate for your child's height and weight.

**⚠ WARNING****Unattended Children**

Never leave children unattended in a vehicle. The car can heat up very

quickly, resulting in injuries to the child in the vehicle.

## **⚠ WARNING**

### **Seat Belt Use**

Do not use one seat belt for two occupants at the same time. This will eliminate any safety benefit provided by the seat belt to the occupants.

### ***Child restraint system types***

There are three main types of child restraint systems: rear-facing seats, forward-facing seats, and booster seats. They are classified according to the child's age, height and weight.

### **Rear-facing child seats**



ODEEV058035NR

A rear-facing child seat provides restraint with the seating surface against the back of the child. The harness system holds the child in place, and in an accident, acts to

keep the child positioned in the seat and reduces the stress to the neck and spinal cord.

All children under age one must always ride in a rear-facing infant child restraint.

Convertible and 3-in-1 child seats typically have higher height and weight limits for the rear-facing position, allowing you to keep your child rear-facing for a longer period of time.

Continue to use a rear-facing child seat for as long as your child will fit within the height and weight limits allowed by the child seat manufacturer. It's the best way to keep them safe. Once your child has outgrown the rear-facing child restraint, your child is ready for a forward-facing child restraint with a harness.

### **Forward-facing child restraints**



ODEEV058036NR

A forward-facing child seat provides restraint for the child's body with a harness. Keep children in a forward-facing child seat with a harness until they reach the top height or weight

limit allowed by your child restraint's manufacturer. Once your child outgrows the forward-facing child restraint, your child is ready for a booster seat.

### **Booster seats**

A booster seat is a restraint designed to improve the fit of the vehicle's seat belt system. A booster seat positions the seat belt so that it fits properly over the lap of your child.

Keep your child in a booster seat until they are big enough to sit in the seat without a booster and still have the seat belt fit properly. For a seat belt to fit properly, the lap belt must lie snugly across the upper thighs, not the stomach. The shoulder belt should lie snug across the shoulder and chest and not across the neck or face. Children under age 13 must always ride in the rear seats and must always be properly restrained to minimize the risk of injury.

### **Installing a Child Restraint System (CRS)**

After selecting a proper child seat for your child, check to make sure it fits properly in your vehicle.

Follow the instructions provided by the manufacturer when installing the child seat. Note these general steps when installing the seat to your vehicle:

- **Properly secure the child restraint to the vehicle.** All child restraints must be secured to the vehicle with the lap part of a lap/shoulder belt or with the LATCH system.
- **Make sure the child restraint is firmly secured.** After installing a child restraint to the vehicle, push and pull the seat forward and from side-to-side to verify that it is securely attached to the seat. A child restraint secured with a seat belt should be installed as firmly as possible. However, some side-to-side movement can be expected.
- **Secure the child in the child restraint.** Make sure the child is properly strapped in the child restraint according to the manufacturer instructions.

### ***Lower Anchors and Tether for Children (LATCH) System***

The LATCH system holds a child restraint during driving and in an accident. This system is designed to make installation of the child restraint easier and reduce the possibility of improperly installing your child restraint. The LATCH system uses anchors in the vehicle and attachments on the child restraint. The LATCH system eliminates the need to use seat belts to secure the child restraint to the rear seats.

Lower anchors are metal bars built into the vehicle. There are two lower anchors for each LATCH seating position that will accommodate a child restraint with lower attachments.

To use the LATCH system in your vehicle, you must have a child restraint with LATCH attachments.

The child seat manufacturer will provide you with instructions on how to use the child seat with its attachments for the LATCH lower anchors.



ODEEV058037NR

LATCH anchors have been provided in the left and right outboard rear seating positions. Their locations are shown in the illustration. There are no LATCH anchors provided for the center rear seating position.

**⚠ WARNING**

**LATCH Lower Anchors**

Never attempt to attach a LATCH equipped seat in the center seating

position. LATCH lower anchors are only to be used in the left and right rear outboard seating positions. You may damage the anchors or the anchors may fail and break in a collision if the seat is in the center seating position.

The lower anchor position indicator symbols are located on the left and right rear seatbacks to identify the position of the lower anchors in your vehicle (see arrows in illustration).

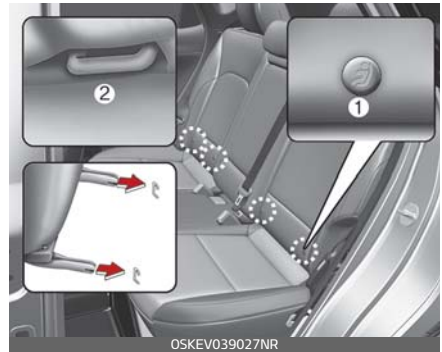

1. Lower Anchor position indicator
2. Lower Anchor

The LATCH anchors are located between the seatback and the seat cushion of the rear seat left and right outboard seating positions.

To use the lower anchor, push the upper portion of the lower anchor cover.

### ***Securing a child restraint with the LATCH anchors system***

To install a LATCH-compatible child restraint in either of the rear out-board seating positions:

1. Move the seat belt buckle away from the lower anchors.
2. Move any other objects away from the anchors that could prevent a secure connection between the child restraint and the lower anchors.
3. Place the child restraint on the vehicle seat, then attach the seat to the lower anchors according to the instructions provided by the child restraint manufacturer.
4. Follow the child restraint instructions for properly adjusting and tightening the lower attachments on the child restraint to the lower anchors.

#### **⚠ WARNING**

Take the following precautions when using the LATCH system:

- Read and follow all installation instructions provided with your child restraint system.
- To prevent the child from reaching and taking hold of the unused seat belts, buckle all unused rear seat belts before the child is placed into the vehicle. Lock each unused seatbelt following the instructions in the "automatic locking mode" subsection, and place the webbing behind the child

seat or against an unused seat-back. Children can be strangled if a shoulder belt becomes wrapped around their neck and the seat belt tightens.

- NEVER attach more than one child restraint to a single anchor. This could cause the anchor or attachment to come loose or break.
- Always have the LATCH system inspected by your authorized Kia dealer after an accident. An accident can damage the LATCH system and may not properly secure the child restraint.

#### **\* NOTICE**

The recommended maximum weight for the LATCH system is 65 lbs. (30 kg). When selecting a proper child restraint system, consider that the maximum total weight of the child plus the child restraint should be less than 65 lbs. (30 kg).

As a guide, the MAX child restraint weight should be determined by the following calculation:

Child Restraint System Weight = 65  
- (child's total weight in lbs.)

### Securing a child restraint seat with "Tether Anchor" system

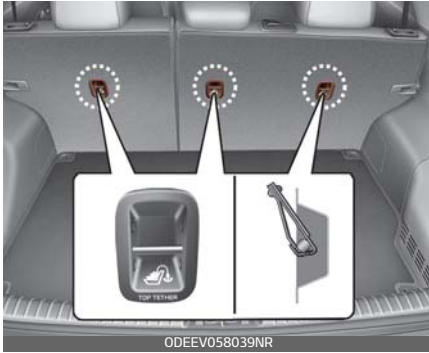

First secure the child restraint with the LATCH lower anchors or the seat belt. If the child restraint manufacturer recommends that the top tether strap be attached, attach and tighten the top tether strap to the top tether strap anchor.

Child restraint hook holders are located on the shelf behind the rear seats.

#### **⚠ WARNING**

Take the following precautions when installing the tether strap:

- Read and follow all installation instructions provided with your child restraint system.
- NEVER attach more than one child restraint to a single tether anchor. This could cause the anchor or attachment to come loose or break.
- Do not attach the tether strap to anything other than the correct

tether anchor. It may not work properly if attached to something else.

- Do not use the tether anchors for adult seat belts or harnesses, or for attaching other items or equipment to the vehicle.
- Always fasten the seat belts behind the child restraint seat when they are not used to secure the child seat. Failure to do so may result in child strangulation.

To install the tether anchor:



1. Route the child restraint tether strap over the child restraint seatback. Route the tether strap under the head restraint and between the head restraint posts, or route the tether strap over the top of the vehicle seatback. Make sure the strap is not twisted.
2. Connect the tether strap hook to the tether anchor, then tighten the tether strap according to the child seat manufacturer's instructions to firmly secure the child restraint to the seat.



3. Check that the child restraint is securely attached to the seat by pushing and pulling the seat forward and from side-to-side.

***Securing a child restraint with a lap/shoulder belt***

When not using the LATCH system, all child restraints must be secured to a vehicle rear seat with the lap part of a lap/shoulder belt.

**Automatic locking mode**



OSK3039060NR

Since all passenger seat belts move freely under normal conditions and only lock under extreme or emergency conditions (emergency locking mode), you must manually pull the seat belt all the way out to shift the retractor to the "automatic locking" mode to secure a child restraint.

The "automatic locking" mode will help prevent the normal movement of the child in the vehicle from causing the seat belt to loosen and compromise the child restraint system.

To install a child restraint system on the rear seats, do the following:

1. Place the child restraint system on a rear seat and route the lap/shoulder belt around or through the child restraint, following the restraint manufacturer's instructions. Be sure the seat belt webbing is not twisted.
2. Fasten the lap/shoulder belt latch into the buckle. Listen for the distinct "click" sound. Position the release button so that it is easy to access in case of an emergency.



ODEEV058042NR

3. Pull the shoulder portion of the seat belt all the way out. When the shoulder portion of the seat belt is fully extended, it will shift the retractor to the "automatic locking" (child restraint) mode.



4. Slowly allow the shoulder portion of the seat belt to retract and listen for an audible "clicking" or "ratcheting" sound. This indicates that the retractor is in the "automatic locking" mode. If no distinct sound is heard, repeat steps 3 and 4.



5. Remove as much slack from the belt as possible by pushing down on the child restraint system while feeding the shoulder belt back into the retractor.
6. Push and pull on the child restraint system to confirm that the seat belt is holding it firmly in place. If it is not, release the seat belt and repeat steps 2 through 6.

7. Double check that the retractor is in the "automatic locking" mode by attempting to pull more of the seat belt out of the retractor. If you cannot, the retractor is in the "automatic locking" mode.

If your CRS manufacturer instructs or recommends you to use a tether anchor with the lap/shoulder belt, refer to "Securing a child restraint with the LATCH anchors system" on page 3-36 for more information.

**\* NOTICE**

When the seat belt is allowed to retract to its fully stowed position, the retractor will automatically switch from the "automatic locking" mode to the emergency lock mode for normal adult usage.

**⚠ WARNING**

**Auto lock mode**

Set the retractor to Automatic Lock mode when installing any child restraint system. If the retractor is not in the automatic locking mode, the child restraint can move when your vehicle turns or stops suddenly. A child can be seriously injured or killed if the child restraint is not properly anchored in the car.

To remove the child restraint, press the release button on the buckle and then pull the lap/shoulder belt

out of the restraint and allow the seat belt to retract fully.

## Air bag – advanced supplemental restraint system

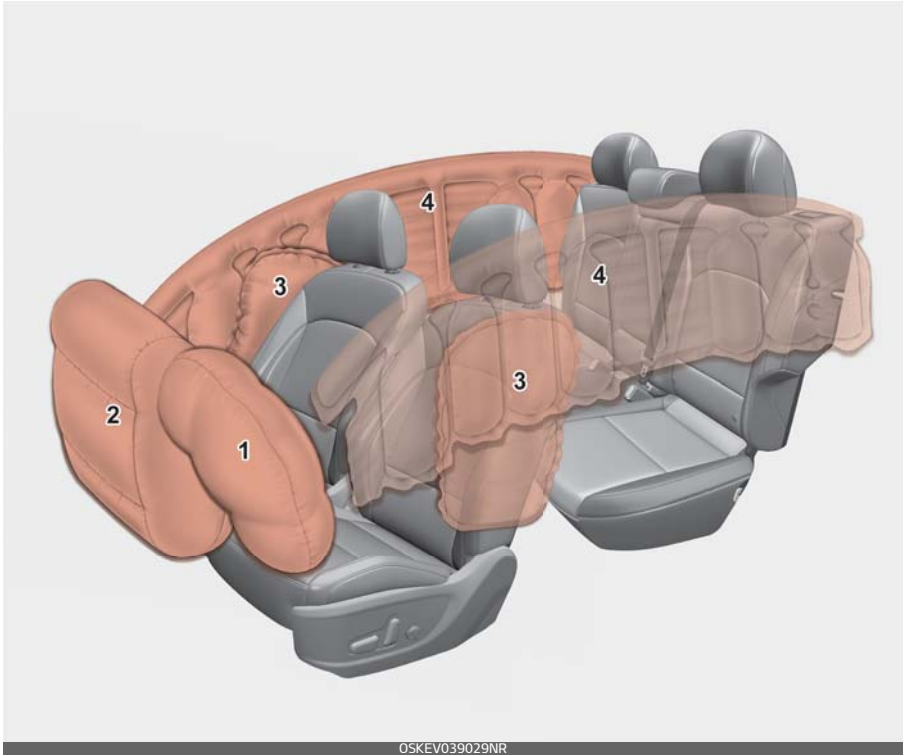

\* The actual air bags in the vehicle may differ from the illustration.

- |                              |                    |
|------------------------------|--------------------|
| 1. Driver's front air bag    | 3. Side air bag    |
| 2. Passenger's front air bag | 4. Curtain air bag |

Even in vehicles with air bags, you and your passengers must always wear the safety belts provided in order to minimize the risk and severity of injury in the event of a collision or rollover.

### How does the air bag system operate?

- Air bags are activated (able to inflate if necessary) only when the ignition switch has been turned to the ON position.
- The appropriate air bags inflate instantly in the event of a serious frontal collision or side collision in order to help protect the occupants from serious physical injury.

- Generally, air bags are designed to inflate based upon the severity of a collision and its direction, etc. These two factors determine whether the sensors produce an electronic deployment / inflation signal.
- Air bags will inflate based upon the severity of a collision and its direction, etc. But Air bags will not inflate in every crash or collision situation.
- The front air bags will completely inflate and deflate in an instant. It is virtually impossible for you to see the air bags inflate during an accident. It is much more likely that you will simply see the deflated air bags hanging out of their storage compartments after the collision.
- In addition to inflating in serious side collisions, side and/or curtain air bags will inflate if the sensing system detects a rollover.
- When a rollover is detected, side and/or curtain air bags will remain inflated longer to help provide protection from ejection, especially when used in conjunction with the seat belts.
- In order to help provide protection, the air bags must inflate rapidly. The speed of the air bag inflation is a consequence of extremely short time in which to inflate the air bag between the occupant and the vehicle struc-

tures before the occupant impacts those structures. This speed of inflation reduces the risk of serious or life-threatening injuries and is thus a necessary part of the air bag design. However, air bag inflation can also cause injuries which can include fascial abrasions, bruises and broken bones because the inflation speed also causes the air bags to expand with a great deal of force.

- **There are even circumstances under which contact with the steering wheel or passenger air bag can cause fatal injuries, especially if the occupant is positioned excessively close to the steering wheel or passenger air bag.**

**⚠ WARNING**

**Airbag inflation**

Sit as far back as possible from the steering wheel while still maintaining comfortable control of the vehicle. A distance of at least 10 in (25 cm) 25 cm (10 in) from your chest to the steering wheel is recommended. Failure to do so can result in airbag inflation injuries to the driver.

**Noise and smoke**

When inflated, the air bags make a loud noise and leave smoke and powder in the air inside the vehicle. This is normal and is a result of the

ignition of the air bag inflator. After the air bag inflates, you may feel substantial discomfort in breathing due to the contact of your chest with both the seat belt and the air bag, as well as from breathing the smoke and powder. **Open your doors and/or windows as soon as possible after impact in order to reduce discomfort and prevent prolonged exposure to the smoke and powder.**

Though smoke and powder are non-toxic, it may cause irritation to the skin (eyes, nose and throat, etc). If this is the case, wash and rinse with cold water immediately and consult a doctor if the symptom persists.

### **⚠ WARNING**

#### **Hot components**

Do not touch the air bag storage area's internal components immediately after airbag inflation. The air bag related parts in the steering wheel, instrument panel and the roof rails above the front and rear doors are very hot. Hot components can result in burn injuries.

### **⚠ WARNING**

Do not install or place any accessories near air bag deployment areas, such as the instrument panel, windows, pillars, and roof rails.

### **Do not install a child restraint on the front passenger's seat**

Never place a rear-facing child restraint in the front passenger's seat.



If the air bag deploys, it would impact the rear-facing child restraint, causing serious or fatal injury.

In addition, do not place front-facing child restraints in the front passenger's seat. If the front passenger air bag inflates, it could cause serious or fatal injuries to the child.

### **⚠ WARNING**

#### **Air bag deployment**

When children are seated in the rear outboard seats of a vehicle equipped with side and/or curtain air bags, install the child restraint system as far away from the door side as possible. Inflation of the side and/or curtain air bags could impact the child.

### Air bag warning light

The purpose of air bag warning light in your instrument panel is to alert you of a potential problem with your air bag system, which could include your side and/or curtain air bags used for rollover protection.

If the air bag warning light is illuminated for more than 6 seconds after the ignition switch has been turned to the ON position, or if it illuminates during vehicle operation, an SRS component may not be functioning properly and you should have your vehicle checked by an authorized Kia dealer.



If any of the following conditions occur, this indicates a malfunction in the air bag system. Have an authorized Kia dealer inspect the air bag system as soon as possible.

- The light does not turn on briefly when you turn the ignition switch to the ON position.
- The light stays on after illuminating for approximately 6 seconds.
- The light comes on while the vehicle is in motion.
- The light blinks when the ignition switch to the ON position.

### Supplemental Restraint System (SRS) components and functions

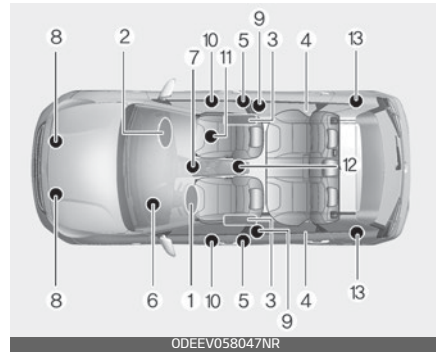

\* The actual position of SRS components may differ from the illustration.

The SRS consists of the following components:

1. Driver's front air bag module
2. Passenger's front air bag module
3. Side air bag modules
4. Curtain air bag modules
5. Retractor pre-tensioner assemblies (if equipped)
6. Air bag warning light
7. SRS control module (SRSCM)
8. Front impact sensors
9. Side impact sensors (if equipped)
10. Side pressure sensors (if equipped)
11. Occupant detection system (Front passenger's seat only)
12. Front passenger's seat belt buckle sensor
13. Retractor pre-tensioner assemblies (if equipped)

\*: if equipped

Driver's front air bag (1)



The front air bag modules are located both in the center of the steering wheel and in the front passenger's panel above the glove box. When the SRSCM detects a sufficiently severe impact to the front of the vehicle, it will automatically deploy the front air bags.

Driver's front air bag (2)



Upon deployment, tear seams molded directly into the pad covers will separate under pressure from the expansion of the air bags. Further opening of the covers then allows full inflation of the air bags.

Driver's front air bag (3)



A fully inflated air bag, in combination with a properly worn seat belt, slows the driver's or the passenger's forward motion, reducing the risk of head and chest injury.

After complete inflation, the air bag immediately starts deflating, enabling the driver to maintain forward visibility and the ability to steer or operate other controls.

Passenger's front air bag



**⚠ WARNING**

**Air bag obstructions**



Do not install or place any accessories on the steering wheel, instrument panel, or on the front passenger's panel above the glove box in a vehicle. Such objects may become dangerous projectiles if the air bag deploys.

**⚠ WARNING**

**Flying objects**

Do not place any objects (an umbrella, bag, etc.) between the front door and the front seat. Such objects may become dangerous projectiles if the side airbag inflates.

- If an air bag deploys, there may be a loud noise followed by a fine dust released in the vehicle. These conditions are normal and are not hazardous – the air bags are packed in this fine powder. The dust generated during air bag deployment may cause skin or eye irritation as well as aggravate asthma for some persons. Always wash all exposed skin areas thoroughly with cold water and a mild soap after an accident in which the air bags were deployed.
- The SRS can function only when the ignition switch is in the ON position. If the SRS air bag warning light does not illuminate, or continuously remains on after illuminating for about 6 seconds when the ignition switch is turned

to the ON position, or after the vehicle is in the ready mode, comes on while driving, the SRS is not working properly. If this occurs, have your vehicle immediately inspected by an authorized Kia dealer.

**\* NOTICE**

Before you replace a fuse or disconnect a battery terminal, change the ignition switch to the OFF position. Never remove or replace the air bag related fuse(s) when the ignition switch is the ON position. Failure to heed this warning will cause the SRS air bag warning light to illuminate.

**Occupant Detection System (ODS)**

Your vehicle is equipped with an occupant detection system in the front passenger's seat.



The occupant detection system is designed to detect the presence of a properly-seated front passenger

and determine if the passenger's front air bag should be enabled (may inflate) or not. Only the front passenger front air bag is controlled by the Occupant Detection System.

Do not put anything in front of the passenger air bag "OFF " indicator.

### ***Main components of the occupant detection system***

- An detection device located within the front passenger seat cushion.
- An electronic system which determines whether the passenger air bag systems should be activated or deactivated.
- An indicator light located on the instrument panel which illuminates the words PASSENGER AIR BAG "OFF " indicates the front passenger air bag system is deactivated.
- The instrument panel air bag warning light is interconnected with the occupant detection system.

If the front passenger seat is occupied by a person that the system determines to be of appropriate size, and he/she sits properly (sitting upright with the seatback in an upright position, centered on the seat cushion with their seat belt on, legs comfortably extended and their feet on the floor), the PASSENGER

AIR BAG "OFF " indicator will turn off and the front passenger's air bag will be able to inflate, if necessary, in frontal crashes.

You will find the PASSENGER AIR BAG "OFF " indicator on the center fascia panel. This system detects the conditions 1~4 in the following table and activates or deactivates the front passenger air bag based on these conditions.

Always be sure that you and all vehicle occupants are seated and restrained properly (sitting upright with the seat in an upright position, centered on the seat cushion, with the person's legs comfortably extended, feet on the floor, and wearing the safety belt properly) for the most effective protection by the air bag and the safety belt.

- The ODS (Occupant Detection System) may not function properly if the passenger takes actions which can defeat the detection system. These include:
  1. Failing to sit in an upright position.
  2. Leaning against the door or center console.
  3. Sitting towards the sides or the front of the seat.
  4. Putting legs on the dashboard or resting them on other locations which reduce the passenger weight on the front seat.

5. Improperly wearing the safety belt.

6. Reclining the seatback.

**Condition and operation in the front passenger occupant detection system**

Condition detected by the occupant classification system	Indicator/Warning light		Devices
	"PASSENGER AIR BAG OFF" indicator light	SRS warning light	Front passenger air bag
1. Adult* <sup>1</sup>	Off	Off	Activated
2. Child restraint system with child under 12 months old* <sup>2</sup> * <sup>3</sup> * <sup>4</sup>	On	Off	Deactivated
3. Unoccupied	On	Off	Deactivated
4. Malfunction in the system	Off	On	Activated

- \*1. The system judges a person of adult size as an adult. When a smaller adult sits in the front passenger seat, the system may recognize him/her as a child depending on his/her physique and posture.
- \*2. Do not allow children to ride in the front passenger seat. When a larger child who has outgrown a child restraint system sits in the front passenger seat, the system may recognize him/her as an adult depending upon his/her physique or sitting position.
- \*3. Never install a child restraint system on the front passenger seat.
- \*4. The PASSENGER AIR BAG "OFF"  indicator may turn on or off when a child above 12 months to 12 years old (with or without child restraint system) sits in the front passenger seat. This is a normal condition.

**⚠ WARNING**

- Do not install a child restraint system in the passenger seat when the seat is heavily soaked with any type of liquid.
- Do not alter or remodel the ODS (Occupant Detection System). This may damage the system and prevent its proper function in a collision.

**\* NOTICE**

- Do not use car seat cushions that cover up the surface of the seat and aftermarket manufactured passenger seat heaters.
- After conducting car interior cleaning using steam or detergent, the seat should be dried properly. Afterward, check for normal operation of the PASSENGER AIR BAG OFF indicator.

GER AIR BAG "OFF" and air bag warning lights.

- Any service related to the passenger seat and the ODS must be done at an authorized Kia service center.
- After the passenger seat has been removed or installed for repair purposes, check for normal operation of the PASSENGER AIR BAG "OFF"  and air bag warning lights with a person seated or not seated in the passenger seat.

**⚠ WARNING**

When the PASSENGER AIR BAG "OFF"  symbol is illuminated, the passenger air bag system will not operate. The passenger air bag system will operate when necessary if the symbol is not illuminated.

**\* NOTICE**

Do not modify or replace the front passenger seat. Do not place anything on or attach anything, such as a blanket, front seat cover or after market seat heater, to the front passenger seat. This can adversely affect the occupant detection system.

**⚠ WARNING**

**ODS System**

Riding in an improper position adversely affects the Occupant Detection System and may result in the deactivation of the front passenger airbag. It is important for the driver to instruct the passenger as to the proper seating instructions as contained in this manual.

- Do not place a heavy load in the front passenger seatback pocket or on the front passenger seat.



- Do not place feet on the front passenger seatback.



- Never sit with hips shifted towards the front of the seat.

**Safety features of your vehicle**

**Air bag - advanced supplemental restraint system**



- Never excessively recline the front passenger seatback.



- Never place feet on the dashboard.



- Never lean on the door or center console.

- Never sit on one side of the front passenger seat.



- Do not use car seat accessories, such as thick blankets and cushions, that cover up the car seat surface.
- Do not sit on the passenger seat wearing heavily padded clothes, such as ski wear and hip protector.



- Do not place electronic devices, such as laptops and DVD player, or conductive materials, such as water bottles, on the passenger seat.

## Safety features of your vehicle

- Do not use electronic devices, such as laptops and satellite radios, that use inverter chargers.



- Wet Passenger Seat  
Do not spill liquid in the passenger seat. Spilled liquid on the passenger seat may cause the air bag warning light to illuminate or malfunction. If any liquid is spilled, make sure the seat has been completely dried before driving the vehicle.



## Air bag – advanced supplemental restraint system

### Proper position





When an adult is seated in the front passenger seat, if the PASSENGER AIR BAG "OFF"  indicator is on, change the ignition switch to the OFF position and ask the passenger to sit properly (sitting upright with the seatback in an upright position, centered on the seat cushion with their seat belt on, legs comfortably extended and their feet on the floor). Restart the vehicle and have the person remain in that position. This will allow the system to detect the person and to enable the passenger air bag.

If the PASSENGER AIR BAG "OFF"  indicator is still on, ask the passenger to move to the rear seat.

### **WARNING**

### **PASSENGER AIR BAG "OFF" light**

Do not allow an adult passenger to ride in the front seat when the PASSENGER AIR BAG "OFF"  indicator

is illuminated, because the air bag will not deploy in the event of a crash. The driver must instruct the passenger to reposition himself in the seat. Failure to properly position himself may lead to air bag deactivation, resulting in air bag non-deployment in a collision. If the PASSENGER AIR BAG "OFF " indicator remains illuminated after the passenger repositions themselves properly and the car is restarted, it is recommended that the passenger move to the rear seat because the passenger's front air bag will not deploy.

#### \* NOTICE

The PASSENGER AIR BAG "OFF " indicator illuminates for about 4 seconds after the ignition switch is turned to the ON position after the vehicle is started. If the front passenger seat is occupied, the occupant detection sensor will then classify the front passenger after several more seconds.

- Even though your vehicle is equipped with the occupant detection system, never install a child restraint system in the front passenger's seat. A deploying air bag can forcefully strike a child resulting in serious injuries or death.

Any child age 12 and under should ride in the rear seat. Children too large for child restraints should use the available lap/shoulder belts. No matter what type of crash, children of all ages are safer when restrained in the rear seat.

If the occupant detection system is not working properly, the SRS air bag warning light on the instrument panel will illuminate because the passenger's front air bag is connected with the occupant detection system. If there is a malfunction of the occupant detection system, the PASSENGER AIR BAG "OFF " indicator will not illuminate and the passenger's front air bag will inflate in frontal impact crashes even if there is no occupant in the front passenger's seat.

#### Driver's and passenger's front air bag

Your vehicle is equipped with an Advanced Supplemental Restraint (Air Bag) System and lap/shoulder belts at both the driver and passenger seating position.

Driver's front air bag



Passenger's front air bag



The indication of the system's presence are the letters "AIR BAG" located on the air bag pad cover on the steering wheel and the passenger's side front panel pad above the glove box.

The SRS consists of air bags installed under the pad covers in the center of the steering wheel and the passenger's side front panel above the glove box.

The purpose of the SRS is to provide the vehicle's driver and/or the front passenger with additional protec-

tion than that offered by the seat belt system alone in case of a frontal impact of sufficient severity. The SRS uses sensors to gather information about the driver's and front passenger's seat belt usage and impact severity.

The seat belt buckle sensor determines if the front passenger's seat belt is fastened.

These sensors provide the ability to control the SRS deployment based on whether or not the seat belts are fastened, and how severe the impact is.

The advanced SRS offers the ability to control the air bag inflation with two levels. A first stage level is provided for moderate-severity impacts. A second stage level is provided for more severe impacts.

The passenger's front air bag is designed to help reduce the injury of children sitting close to the instrument panel in low speed collisions. However, children are safer if they are restrained in the rear seat.

According to the impact severity and seat belt usage, the SRSCM (SRS Control Module) controls the air bag inflation. Failure to properly wear seat belts can increase the risk or severity of injury in an accident.

Additionally, your vehicle is equipped with an occupant detection system



in the front passenger's seat. The occupant detection system detects the presence of a passenger in the front passenger's seat and will turn off the front passenger's air bag under certain conditions. For more detail, see "Occupant Detection System (ODS)" on page 3–46.

**⚠ WARNING**

Modification to the seat structure can cause the air bag to deploy at a different level than should be provided.

Manufacturers are required by government regulations to provide a contact point concerning modifications to the vehicle for persons with disabilities, which modifications may affect the vehicle's advanced air bag system. That contact is Kia's toll-free Customer Assistance center at 1-800-333-4Kia. However, Kia does not endorse nor will it support any changes to any part or structure of the vehicle that could affect the advanced air bag system, including the occupant detection system.

**⚠ WARNING**

**Replacement/modifications**

The front passenger seat, dashboard or door should not be replaced except by an authorized Kia dealer using original Kia parts designed for

this vehicle and model. Any other such replacement or modification could adversely affect the operation of the occupant detection system and your advanced air bags.

Advanced air bags are combined with pre-tensioner seat belts to help provide enhanced occupant protection in frontal crashes. Front air bags are not intended to deploy in collisions in which sufficient protection can be provided by the seat belt.

**\* NOTICE**

Air bags can only be used once – have an authorized Kia dealer replace the air bag immediately after deployment.

Front air bags are not intended to deploy in side-impact, rear-impact or rollover crashes. However, when frontal deployment threshold is satisfied at side-impact, front air bags may deploy. In addition, front air bags will not deploy in frontal crashes below the deployment threshold.

**⚠ WARNING**

**SRS Wiring**

Do not tamper with or disconnect SRS wiring or other components of the SRS system. Doing so could

result in injury, due to accidental deployment of the air bags or by rendering the SRS inoperative.

**⚠ WARNING**

**No attaching objects**

No objects (such as crash pad cover, cellular phone holder, cup holder, perfume or stickers) should be placed over or near the air bag modules on the steering wheel, instrument panel, windshield glass, and the front passenger's panel above the glove box. Such objects could cause harm if the vehicle is in a crash severe enough to cause the air bags to deploy.

Do not place any objects over the air bag or between the air bag and yourself.

Additionally, never place or insert any object into any small opening near side airbag labels attached to the vehicle seats.

When the air bag deploys, the object may affect the deployment and result in unexpected accident or bodily harm.

**Side air bag**

Your vehicle is equipped with a side air bag in each front seat.



3

\* The actual air bags in the vehicle may differ from the illustration.

The purpose of the air bag is to provide the vehicle's driver and/or the front passenger with additional protection than that offered by the seat belt alone.

- The side air bags are designed to deploy during certain side-impact collisions, depending on the crash severity of impact.
- The side air bags may deploy on the side of the impact or on both sides.
- The side and/or curtain air bags on both sides of the vehicle will

deploy if a rollover or possible rollover is detected.

- The side air bags are not designed to deploy in all side impact or roll-over situations.

**⚠ WARNING**

**Unexpected deployment**

Avoid impact to the side impact air-bag sensor when the ignition switch is ON to prevent unexpected deployment of the side air bag.

- The side air bag is supplemental to the driver's and the passenger's seat belt systems and is not a substitute for them. Therefore your seat belts must be worn at all times while the vehicle is in operation.
- For best protection from the side air bag system and to avoid being injured by the deploying side air bag, both front seat occupants should sit in an upright position with the seat belt properly fastened. The driver's hands should be placed on the steering wheel at the 9:00 and 3:00 positions. The passenger's arms and hands should be placed on their laps.

**⚠ WARNING**

**Deployment**

Do not install any accessories including seat covers, on the side or near the side air bag, as this may

adversely affect the deployment of the side air bags.

- If seat or seat cover is damaged, have the vehicle checked and repaired by an authorized Kia dealer. Inform the dealer that your vehicle is equipped with side air bags and an occupant detection system.

**⚠ WARNING**

**Flying objects**

Do not place any objects (an umbrella, bag, etc.) between the front door and the front seat. Such objects may become dangerous projectiles if the side airbag inflates.

**⚠ WARNING**

**No attaching objects**

- Do not place any objects over the air bag or between the air bag and yourself. Also, do not attach any objects around the area in which the air bag inflates, such as the door, side door glass, front and rear pillar.
- Do not put any objects between the side airbag label and seat cushion. It could cause harm if the vehicle is in a crash severe enough to cause the air bags to deploy.
- Never place or insert any object into any small opening near the side airbag labels attached to the

vehicle seats. When the air bag deploys, the object may adversely affect the deployment and result in an unexpected accident or bodily harm.

- Do not install any accessories on the side or near the side air bags.

### Curtain air bag

Curtain air bags are located along both sides of the roof rails above the front and rear doors.

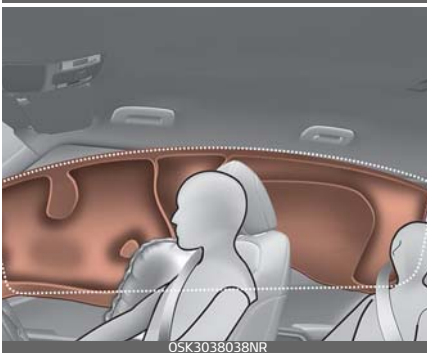

\* The actual air bags in the vehicle may differ from the illustration.

They are designed to help protect occupants in certain side impacts and to help prevent them from ejecting out of the vehicle as a result of a rollover, especially when the seatbelts are also in use.

- The curtain air bags are designed to deploy during certain side impact collisions, depending on the severity of impact. However, when side deployment threshold is satisfied at front-impact, side air bags may deploy.
- The curtain air bags may deploy on the side of the impact or on both sides.
- Also, the curtain air bags on both sides of the vehicle will deploy in certain rollover situations.
- The curtain air bags are not designed to deploy in all side impact or rollover situations.

Do not allow the passengers to lean their heads or bodies against the doors, put their arms on the doors, stretch their arms out of the window or place objects between the doors and passengers when they are seated on seats equipped with side impact and/or curtain air bags.

#### \* NOTICE

Never try to open or repair any components of the side and curtain air bag system. This should only be done by an authorized Kia dealer.

**⚠ WARNING**

**No attaching objects**

- Do not place any objects over the air bag. Also, do not attach any objects around the area in which the air bag inflates, such as the

door, side door glass, front and rear pillar, roof side rail.

- Do not hang hard, breakable, or heavy objects on the coat hooks for safety reasons.

**Air bag collision sensors**

The air bag collision sensors are located in the following positions





\* The actual shape and position of sensors may differ from the illustration.

1. SRS control module / Rollover sensor
2. Front impact sensor
3. Side impact sensor
4. Side pressure sensor

**⚠ WARNING**

**Air bag sensors**

- Do not hit or allow any objects to impact the locations where air bags or sensors are installed. This may cause unexpected air bag deployment, which could result in serious personal injury or death.
- If the installation location or angle of the sensors is altered in any way, the air bags may deploy when they should not or they may not deploy when they should. Therefore, do not try to perform maintenance on or around the air bag sensors. Have the vehicle checked and repaired by an authorized Kia dealer.

to the deformation of the front bumper, front end module, body or front doors where side collision sensors are installed. Have the vehicle checked and repaired by an authorized Kia dealer.

Installing bumper guards (or side step or running board) or replacing a bumper (or front door module) with non-genuine parts may adversely affect your vehicle's collision and air bag deployment performance.

**Why didn't my air bag go off in a collision? (Inflation and non-inflation conditions of the air bag)**

There are many types of accidents in which the air bag would not be expected to provide additional protection.

These include rear impacts, second or third collisions in multiple impact accidents, as well as low speed impacts.

Problems may arise if the sensor installation angles are changed due

## ***Air bag inflation conditions***

### **Front air bags**

Front air bags are designed to inflate in a frontal collision depending on the severity of impact of the front collision.

### **Side and/or curtain air bags**

Side and/or curtain air bags are designed to inflate when an impact is detected by side collision sensors depending on the severity of impact resulting from a side impact collision.

Also, the side and curtain air bags are designed to inflate when a roll-over is detected by a rollover sensor. Although the front air bags (driver's and front passenger's air bags) are primarily designed to inflate in frontal collisions, they may inflate in other types of collisions if the front impact sensors detect a sufficient frontal force in another type of impact.

Similarly, although side and curtain air bags are designed to inflate in certain side impact collisions, they may inflate in other types of collisions where a side force is detected by the sensors. For instance, side air bag and/or curtain air bags may inflate if rollover sensors indicate the possibility of a rollover occurring (even if none actually occurs) or in other situations, including when the vehicle is tilted while being towed. Even if side and/or curtain air bags do not provide impact protection in a rollover, they will deploy to pre-

vent ejection of occupants, especially those who are restrained with seat belts.

If the vehicle chassis is impacted by bumps or objects on unimproved roads, the air bags may deploy. Drive carefully on unimproved roads or on surfaces not designed for vehicle traffic to prevent unintended air bag deployment.

### ***Air bag non-inflation conditions***

- In certain low-speed collisions the air bags may not deploy. The air bags are designed not to deploy in such cases because they may not provide benefits beyond the protection of the seat belts in such collisions.
- Air bags are not designed to inflate in rear collisions, because occupants are moved backward by the force of the impact. In this case, inflated air bags would not be able to provide any additional benefit.
- Front air bags may not inflate in side impact collisions, because occupants move to the direction of the collision, and thus in side impacts, frontal air bag deployment would not provide additional occupant protection.
- In an angled collision, the force of impact may direct the occupants in a direction where the air bags would not be able to provide any additional benefit, and thus the

sensors may not deploy any air bags.

- Just before impact, drivers often brake heavily. Such heavy braking lowers the front portion of the vehicle causing it to "ride" under a vehicle with a higher ground clearance. Air bags may not inflate in this "under-ride" situation because deceleration forces that are detected by sensors may be significantly reduced by such "under-ride" collisions.
- Front air bags may not inflate in all rollover accidents when the SRSCM indicates that the front air bag deployment would not provide additional occupant protection.
- Air bags may not inflate if the vehicle collides with objects such as utility poles or trees, where the point of impact is concentrated to one area and the full force of the impact is not delivered to the sensors.

### Supplemental Restraint System (SRS) Care

The SRS is virtually maintenance-free and so there are no parts you can safely service by yourself.

If the SRS air bag warning light does not illuminate, or continuously remains on, have your vehicle immediately inspected by an authorized Kia dealer.

Any work on the SRS system, such as removing, installing, repairing, or any work on the steering wheel, the front passenger's panel, front seats and roof rails must be performed by an authorized Kia dealer. Improper handling of the SRS system may result in serious personal injury.

For cleaning the air bag pad covers, use only a soft, dry cloth or one which has been moistened with plain water. Solvents or cleaners could adversely affect the air bag covers and proper deployment of the system.

If components of the air bag system must be discarded, or if the vehicle must be scrapped, certain safety precautions must be observed. An authorized Kia dealer knows these precautions and can give you the necessary information. Failure to follow these precautions and procedures could increase the risk of personal injury.

### WARNING

#### Tampering with SRS

Do not tamper with or disconnect SRS wiring, or other components of the SRS system. Doing so could result in the accidental inflation of the air bags or render the SRS inoperative.



**⚠ WARNING**

**Towing Vehicle**

Always have the ignition off when your vehicle is being towed. The side air bags may inflate if the vehicle is tilted, such as when being towed, because of the rollover sensors in the vehicle.

---

**Adding equipment to or modifying your air bag-equipped vehicle**

If you modify your vehicle by changing your vehicle's frame, bumper system, front end or side sheet metal or ride height, this may affect the operation of your vehicle's air bag system.

**Air bag warning label**

Air bag warning labels, some required by the U.S. National Highway Traffic Safety Administration (NHTSA), are attached to the sun visor to alert the driver and passengers of potential risks of the air bag system.



<b>Keys</b> .....	<b>4-6</b>
<b>Smart key</b> .....	<b>4-7</b>
• This device complies with Part 15 of the FCC rules. ....	4-10
<b>Remote keyless entry</b> .....	<b>4-10</b>
• Transmitter precautions .....	4-12
• This device complies with Part 15 of the FCC rules. ....	4-12
• Battery replacement .....	4-13
• Immobilizer system (if equipped).....	4-13
• This device complies with Part 15 of the FCC rules. ....	4-15
<b>Theft-alarm system</b> .....	<b>4-15</b>
• Armed stage.....	4-15
• Theft-alarm stage .....	4-16
• Disarmed stage.....	4-17
<b>Door locks</b> .....	<b>4-18</b>
• Rear Occupant Alert (ROA) system.....	4-22
<b>Liftgate</b> .....	<b>4-23</b>
• Opening the liftgate .....	4-23
• Closing the liftgate.....	4-24
• Opening the liftgate in emergency .....	4-24
<b>Windows</b> .....	<b>4-26</b>
• Window opening and closing .....	4-27
• Power window lock switch.....	4-29
<b>Hood</b> .....	<b>4-31</b>
• Opening the hood .....	4-31
• Hood open warning .....	4-31
• Closing the hood .....	4-32
<b>Fuel filler door</b> .....	<b>4-33</b>
• Opening the fuel filler door .....	4-33

## 4 Features of your vehicle

• Closing the fuel filler door .....	4-33
<b>Sunroof .....</b>	<b>4-36</b>
• Sliding the sunroof .....	4-37
• Tilting the sunroof.....	4-38
• Sunshade.....	4-39
• Resetting the sunroof .....	4-39
• Sunroof open warning .....	4-39
<b>Steering wheel.....</b>	<b>4-40</b>
• Electronic power steering .....	4-40
• Tilt & telescopic steering wheel .....	4-41
• Adjusting steering wheel angle and height.....	4-42
• Heated steering wheel .....	4-42
• Horn .....	4-43
<b>Mirrors .....</b>	<b>4-44</b>
• Inside rearview mirror .....	4-44
• Outside rearview mirror .....	4-46
<b>Instrument cluster .....</b>	<b>4-48</b>
• Instrument cluster control.....	4-48
• Gauges.....	4-49
• Transmission shift indicator .....	4-52
<b>LCD display .....</b>	<b>4-53</b>
• LCD Display Control .....	4-53
• LCD Display Modes .....	4-53
<b>LCD displays .....</b>	<b>4-61</b>
• Trip information (Trip computer).....	4-61
• Service Mode .....	4-63
• Driving info display .....	4-64
• LCD display messages .....	4-64
<b>Warning and indicator lights .....</b>	<b>4-70</b>

• Warning lights .....	4-70
• Indicator lights .....	4-76
<b>Head-Up Display (HUD).....</b>	<b>4-79</b>
<b>Rear View Monitor (RVM).....</b>	<b>4-82</b>
<b>Reverse Parking Distance Warning (PDW) .....</b>	<b>4-83</b>
<b>Forward/Reverse Parking Distance Warning (PDW).....</b>	<b>4-86</b>
<b>Lighting.....</b>	<b>4-90</b>
• Battery saver function .....	4-90
• Headlight escort function .....	4-90
• Daytime running light.....	4-91
• Lighting control.....	4-91
• Operating high beam .....	4-92
• Operating turn signals and lane change signals .....	4-93
• Operating front fog light.....	4-94
• High Beam Assist (HBA) .....	4-94
<b>Wipers and washers .....</b>	<b>4-97</b>
• Operating windshield washer .....	4-99
• Operating rear window wiper and washer switch.....	4-100
<b>Interior lights .....</b>	<b>4-101</b>
• Automatic turn off function.....	4-101
• Room lamp .....	4-101
• Map lamp .....	4-102
• Liftgate room lamp .....	4-103
• Vanity mirror lamp .....	4-103
• Glove box lamp.....	4-103
<b>Welcome system .....</b>	<b>4-104</b>
<b>Defroster .....</b>	<b>4-105</b>
• Operating rear window defroster .....	4-105

## 4 Features of your vehicle

- Outside mirror defroster..... 4-106
- Manual climate control system..... 4-107**
- Heating and air conditioning..... 4-108
- System operation..... 4-112
- Climate control air filter..... 4-114
- Checking the amount of air conditioner refrigerant and compressor lubricant..... 4-115
- Air Conditioning refrigerant label..... 4-115
- Automatic climate control system..... 4-117**
- Heating and air conditioning automatically..... 4-117
- Manual heating and air conditioning..... 4-118
- Mode selection..... 4-120
- Temperature control..... 4-121
- Controlling air intake..... 4-122
- Controlling fan speed..... 4-122
- Air conditioning..... 4-123
- Turning off the front air climate control..... 4-123
- Automatic ventilation..... 4-124
- System operation..... 4-124
- Climate control air filter..... 4-126
- Checking the amount of air conditioner refrigerant and compressor lubricant..... 4-127
- Air Conditioning refrigerant label..... 4-127
- Windshield defrosting and defogging..... 4-128**
- Manual climate control system..... 4-129
- Automatic climate control system..... 4-129
- Defogging logic..... 4-130
- Storage compartment..... 4-131**
- Center console storage..... 4-131

• Glove box.....	4-132
• Sunglass holder.....	4-132
• Luggage net holder.....	4-133
• Increase cargo space.....	4-133
<b>Interior features .....</b>	<b>4-134</b>
• Cup holder.....	4-134
• Seat warmer.....	4-135
• Air ventilation seat.....	4-137
• Sun visor.....	4-137
• Power outlet.....	4-138
• USB charger.....	4-139
• Wireless smart phone charging system.....	4-140
• Coat hook.....	4-143
• Floor mat anchor(s).....	4-144
• Cargo area cover.....	4-145
<b>Exterior features .....</b>	<b>4-146</b>
• Roof rack.....	4-146
<b>Audio system.....</b>	<b>4-148</b>
• Shark fin antenna.....	4-148
• USB port.....	4-148
• How vehicle radio works.....	4-148
<b>Declaration of Conformity .....</b>	<b>4-151</b>
• FCC.....	4-151

## Features of your vehicle

### Keys

#### Record your key number



The key code number is stamped on the key code tag attached to the key set. Should you lose your keys, this number will enable an authorized Kia dealer to duplicate the keys easily. Remove the key code tag and store it in a safe place. Also, record the key code number and keep it in a safe and handy place, but not in the vehicle.

#### **⚠ WARNING**

#### Aftermarket keys

Use only Kia original parts for the ignition key in your vehicle. If an aftermarket key is used, the ignition switch may not return to ON after START. If this happens, the starter will continue to operate causing possible fire due to excessive current in the wiring.

#### Key operations

##### Folding key

To unfold the key, press the release button then the key will unfold automatically.

Folding key



To fold the key, fold the key manually while pressing the release button.

#### **⚠ CAUTION**

##### Key button operation

Do not fold the key without pressing the release button. This may damage the key.

### Smart key

To remove the mechanical key, press and hold the release button and remove the mechanical key.

Smart key

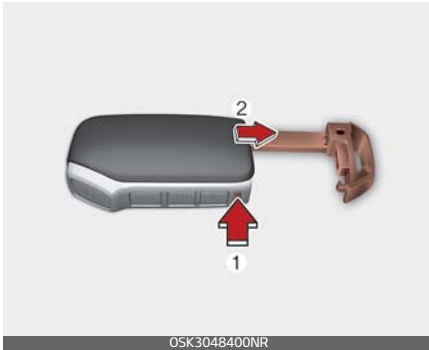

To reinstall the mechanical key, put the key into the hole and push it until a click sound is heard.

### **⚠ WARNING**

#### Ignition key

Never leave the keys in your vehicle with unsupervised children. Leaving children unattended in a vehicle with a manual ignition key or a smart key is dangerous.

Children copy adults and they could place the key in the ignition switch or press the start button. The key would enable children to operate power windows or other controls, or even make the vehicle move, which could result in serious bodily injury or death.

### Smart key (if equipped)

With a smart key, you can lock or unlock a door and even start the engine without inserting the key.



The functions of the buttons on a smart key are similar to the remote keyless entry. (Refer to "Remote keyless entry (if equipped)" on page 4-10)

#### Smart key functions

Carrying the smart key, you may lock and unlock the vehicle doors. Also, you may start the engine. Refer to the following, for more details.



## Locking



Pressing the button of the front outside door handles with all doors closed and any door unlocked, locks all the doors (and hood, liftgate). The hazard warning lights will blink once to indicate that all doors are locked. The button will only operate when the smart key is within 28~40 in (0.7~1 m) from the outside door handle. If you want to make sure that a door has locked or not, you should check the door lock button inside the vehicle or pull the outside door handle.

In some instances, when the outside door button is pressed the doors will not lock and the chime will sound for 3 seconds if any of the following occurs:

- The smart key is in the vehicle.
- The ignition switch is in the ACC or ON position.
- Any door except the liftgate is opened.

## Unlocking

Pressing the button of the driver's outside door handle with all doors closed and locked, unlocks the driver's door. The hazard warning lights will blink and the chime will sound twice to indicate that the driver's door is unlocked.

Pressing the button in the front passenger's outside door handle with all doors closed and locked, unlocks all the doors. The hazard warning lights will blink and the chime will sound twice to indicate that all doors are unlocked. The button will only operate when the smart key is within 28~40 in (0.7~1 m) from the outside door handle.

## Liftgate unlocking

If you are within 28~40 in (0.7~1 m) from the outside liftgate handle, with your smart key in possession, the liftgate will unlock and open when you press the liftgate handle switch.

The hazard warning lights will blink twice to indicate that the liftgate is unlocked.

Also, once the liftgate is opened and then closed, the liftgate will lock automatically.

### Smart key precautions

- If you lose your smart key, you will not be able to start the engine. Tow the vehicle, if necessary, and contact an authorized Kia dealer.
- A maximum of 2 smart keys can be registered to a single vehicle. If you lose a smart key, you should immediately take the vehicle and key to your authorized Kia dealer to protect it from potential theft.
- The smart key will not work if any of following occurs:
  - The smart key is close to a radio transmitter such as a radio station or an airport which can interfere with normal operation of the smart key.
  - The smart key is near a mobile two-way radio system or a cellular phone.
  - Another vehicle's smart key is being operated close to your vehicle.

When the smart key does not work correctly, open and close the door with the mechanical key. If you have a problem with the smart key, contact an authorized Kia dealer.

- If the smart key is in close proximity to your cell phone or smart phone, the signal from the smart key could be blocked by normal operation of your cell phone or smart phone. This is especially important when the phone is

active such as making calls, receiving calls, text messaging, and/or sending/receiving emails. Avoid placing the smart key and your cell phone or smart phone in the same pants or jacket pocket and maintain adequate distance between the two devices.

- Do not leave the smart key near metallic objects such as golf bags, metal cases and so on.
- Door Lock/Unlock failure or poor starting can occur when the smart key is placed near metallic objects.
- Always carry your smart key when you leave the car. An unattended smart key close to the vehicle can cause the vehicle battery to be discharged.
- Internal circuit damage may occur when the key comes into contact with moisture (beverage, water etc.) or heat. Damage to the smart key due to exposure to liquids or heat is not covered by the manufacturer's vehicle warranty.

### CAUTION

#### Transmitter

Keep the smart key away from water or any liquid as it can become damaged and not function properly.

**This device complies with Part 15 of the FCC rules.**

Operation is subject to the following two conditions:

1. This device may not cause harmful interference, and
2. This device must accept any interference received, including interference that may cause undesired operation.

**\* NOTICE**

Changes or modifications not expressly approved by the party responsible for compliance could void the user's authority to operate the equipment. If the keyless entry system is inoperative due to changes or modifications not expressly approved by the party responsible for compliance, it will not be covered by your manufacturer's vehicle warranty.

**Remote keyless entry (if equipped)**

Using the remote keyless entry, you can lock and unlock the doors remotely.

**Remote keyless entry system operations**

Type A



Type B



Type C



### Lock (1)

All doors are locked if the lock button is pressed. If all doors are closed, the hazard warning lights will blink and the chime will sound once (for Type B) to indicate that all doors are locked.

Also, if the lock button is pressed once more within 4 seconds, the hazard warning lights will blink and the chime will sound once to confirm that the door is locked. However, if any door remains open, the hazard warning lights (and/or the chime) will not operate. But if all doors are closed after the lock button is pressed, the hazard warning lights will blink once.

### Unlock (2)

The driver's door is unlocked if the unlock button is pressed once. The hazard warning lights will blink twice and the chime will sound twice (for Type B) to indicate that the driver's door is unlocked.

All doors are unlocked if the unlock button is pressed once more within

4 seconds. The hazard warning lights will blink (for smart key, the chime also sounds) twice again to indicate that all doors are unlocked. After pressing this button, the doors will lock automatically unless you open any door within 30 seconds. If you attempt to lock or unlock the door by pressing the door lock/unlock button in any of the following states, the door will not be locked or unlocked.

- When you want to lock or unlock the door in the ACC or ON state.
  - When you want to lock a door in a car with one or more doors open.
- Depending on the vehicle, the driver can turn off or set the 2-press unlock setting function.

### \* NOTICE

If the keyless entry system is inoperative due to exposure to water or liquids, it will not be covered by your manufacturer's vehicle warranty.

### Liftgate open (3)

The liftgate is opened if the button is pressed for more than 1 second. Once the liftgate is opened and then closed, the liftgate will lock automatically.

### Panic alarm (4)

The horn sounds and the hazard warning lights blink for about 30 seconds if this button is pressed for more than 0.5 seconds. To stop the

horn and lights, press any button on the transmitter.

### Remote start (5)

You can start the vehicle using the remote start button (5) of the smart key. To start the vehicle remotely:

- Lock the doors by pressing the door lock button (1) within 32 feet (10 m) distance from the vehicle.
- Press the remote start button (5) for over 2 seconds within 4 seconds after locking the doors.
- Press the remote start button (5) once to turn off the vehicle.
- Air conditioner/heater system maintains the status before turning off the vehicle. If no further action for operating/driving the vehicle is taken, the vehicle will be turned off 10 minutes after starting the vehicle remotely

### Transmitter precautions

The transmitter (or smart key) will not work if any of following occurs:

- The ignition key is in the ignition-switch.
- You exceed the operating distance limit (about 90 feet [30 m]).
- The battery in the transmitter (or smart key) is weak.
- Other vehicles or objects may be blocking the signal.
- The weather is extremely cold.

- The transmitter (or smart key) is close to a radio transmitter such as a radio station or an airport which can interfere with normal operation of the transmitter.

When the transmitter (or smart key) does not work properly, open and close the door with the ignition key. If you have a problem with the transmitter (or smart key), contact an authorized Kia dealer.

- If the transmitter is in close proximity to your cell phone or smart phone, the signal from the transmitter could be blocked by normal operation of your cell phone or smart phone. This is especially important when the phone is active such as making calls, receiving calls, text messaging, and/or sending/receiving emails. Avoid placing the transmitter and your cell phone or smart phone in the same pants or jacket pocket and maintain adequate distance between the two devices.

### This device complies with Part 15 of the FCC rules.

Operation is subject to the following two conditions:

1. This device may not cause harmful interference, and
2. This device must accept any interference received, including interference that may cause undesired operation.

## \* NOTICE

Changes or modifications not expressly approved by the party responsible for compliance could void the user's authority to operate the equipment. If the keyless entry system is inoperative due to changes or modifications not expressly approved by the party responsible for compliance, it will not be covered by your manufacturer's vehicle warranty.

### Battery replacement

A battery should last for several years, but if the transmitter or smart key is not working properly, try replacing the battery with a new one.



If you are unsure how to use or replace the battery, contact an authorized Kia dealer.

1. Pry open the transmitter cover.
2. Replace the battery with a new battery (CR2032). When replac-

ing the battery, make sure the battery position is correct.

3. Install the battery in the reverse order of removal.

The transmitter or smart key is designed to give you years of trouble-free use, however it can malfunction if exposed to moisture or static electricity. If you are unsure how to use or replace the battery, contact an authorized Kia dealer.

Using the wrong battery can cause the transmitter or smart key to malfunction. Be sure to use the correct battery.



An inappropriately disposed battery can be harmful to the environment and human health.

Dispose the battery according to your local law(s) or regulation.

## ⚠ CAUTION

### Transmitter damage

The transmitter or smart key can malfunction if dropped, exposed to moisture, static electricity, heat or direct sunlight.

### Immobilizer system (if equipped)

Your vehicle may be equipped with an electronic engine immobilizer system to reduce the risk of unauthorized vehicle use.

Your immobilizer system is comprised of a small transponder in the ignition key and electronic devices inside the vehicle.

With the immobilizer system, whenever you insert your ignition key into the ignition switch and turn it to ON, it checks and determines and verifies that the ignition key is valid.

If the key is determined to be valid, the engine will start.

If the key is determined to be invalid, the engine will not start.

***To deactivate the immobilizer system:***

Insert the ignition key into the key cylinder and turn it to the ON position.

***To activate the immobilizer system:***

Turn the ignition key to the OFF position. The immobilizer system activates automatically. Without a valid ignition key for your vehicle, the engine will not start.

Your Immobilizer password is a customer unique password and should be kept confidential. Do not leave this number anywhere in your vehicle.

**\* NOTICE**

Keep each key separately in order to avoid a starting malfunction.

**\* NOTICE**

In order to prevent theft of your vehicle, do not leave spare keys anywhere in your vehicle. Your immobilizer password is a customer unique password should be kept confidential. Do not leave this number anywhere in your vehicle.

Do not put metal accessories near the ignition switch.

Metal accessories may interrupt the transponder signal and may prevent the engine from being started.

If you need additional keys or lose your keys, consult an authorized Kia dealer.

**⚠ CAUTION**

**Immobilizer damage**

Do not expose your immobilizer system to moisture, static electricity or rough handling. This may damage your immobilizer.

**⚠ CAUTION****Immobilizer alterations**

Do not change, alter or adjust the immobilizer system because it could cause the immobilizer system to malfunction.

**This device complies with Part 15 of the FCC rules.**

Operation is subject to the following two conditions:

1. This device may not cause harmful interference, and
2. This device must accept any interference received, including interference that may cause undesired operation.

**\* NOTICE**

Changes or modifications not expressly approved by the party responsible for compliance could void the user's authority to operate the equipment. If the keyless entry system is inoperative due to changes or modifications not expressly approved by the party responsible for compliance, it will not be covered by your manufacturer's vehicle warranty.

**Theft-alarm system (if equipped)**

This system is designed to provide protection from unauthorized entry into the vehicle.

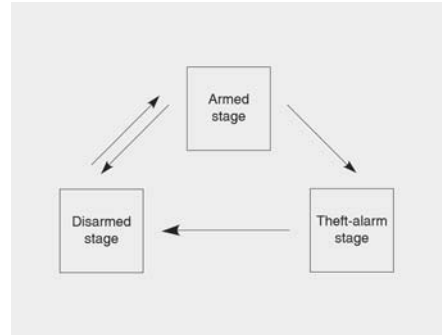

This system is operated in three stages: the first is the "Armed" stage, the second is the "Theft-alarm" stage, and the third is the "Disarmed" stage. If triggered, the system provides an audible alarm with blinking of the hazard warning lights.

**Armed stage*****Using the smart key***

Park the vehicle and stop the engine. Arm the system as described below.

1. Turn off the engine.
2. Make sure that all doors, the hood and liftgate are closed and latched.
3. Lock the doors by pressing the button of the front outside door



handle with the smart key in your possession.

After completion of the steps above, the hazard warning lights will operate once to indicate that the system is armed.

If any door (or liftgate) or hood remains open, the hazard warning lights and the chime will not operate and the theft-alarm will not arm. If all doors and liftgate and hood are closed after the lock button is pressed, the hazard warning lights blink once.

The system can also be armed by locking the doors with the key from the front doors; however, the hazard warning lights will not blink using this method.

4. Lock the doors by pressing the lock button on the smart key. After completion of the steps above, the hazard warning lights will operate once to indicate that the system is armed.

### ***Using the transmitter***

Park the vehicle and stop the engine. Arm the system as described below.

1. Turn off the engine and remove the ignition key from the ignition switch.
2. Make sure that all doors (and liftgate), the engine hood are closed and latched.
3. Lock the doors by pressing the lock button on the transmitter.

After completion of the steps above, the hazard warning lights will blink once to indicate that the system is armed.

If any door (and liftgate) or engine hood remains open, the hazard warning lights won't operate and theft-alarm will not arm. After this, if all doors (and liftgate) and engine hood are closed, the hazard warning lights blink once.

### **\* NOTICE**

Do not arm the system until all passengers have left the vehicle. If the system is armed while a passenger(s) remains in the vehicle, the alarm may be activated when the remaining passenger(s) leaves the vehicle. If any door (or liftgate) or hood is opened within 30 seconds after the system enters the armed stage, the system will be disarmed to prevent unnecessary alarm.

### **Theft-alarm stage**

The alarm will be activated if any of the following occurs while the system is armed.

- A front or rear door is opened without using the smart key.
- The liftgate is opened without using the smart key.
- The hood is opened.

The horn will sound and the hazard warning lights will blink continuously for approximately 27 seconds, and repeat the horn 3 times unless the system is disarmed. To turn off the system, unlock the doors with the transmitter (or smart key).

### Disarmed stage

The system will be disarmed when:

#### *Transmitter*

- The door unlock button is pressed.
- The engine is started. (within 3 seconds)
- The ignition switch is in the "ON" position for 30 seconds or more.

#### *Smart key*

- The door unlock button is pressed.
- The button of the front outside door is pressed while carrying the smart key.
- The engine is started. (within 3 seconds)

After pressing the unlock button, the hazard warning lights will blink and the chime will sound twice (in smart key) to indicate that the system is disarmed.

After pressing the unlock button, if any door (or liftgate) is not opened within 30 seconds, the system will be rearmed.

### \* NOTICE

- Avoid trying to start the engine while the alarm is activated. The vehicle starting motor is disabled during the theft-alarm stage. If the system is not disarmed with the transmitter, insert the key into the ignition switch, turn the ignition switch to the ON position and wait for 30 seconds. Then the system will be disarmed.
- If you lose your keys, consult your authorized Kia dealer.

### ⚠ CAUTION

#### Adjusting alarm system

Do not change, alter or adjust the theft alarm system in your vehicle. Improper installation of the alarm system could damage the vehicle or cause the system to malfunction.

### \* NOTICE

Malfunctions caused by improper alterations, adjustments or modifications to the theft-alarm system are not covered by your vehicle manufacturer warranty.

## Door locks

### Operating door locks from outside the vehicle

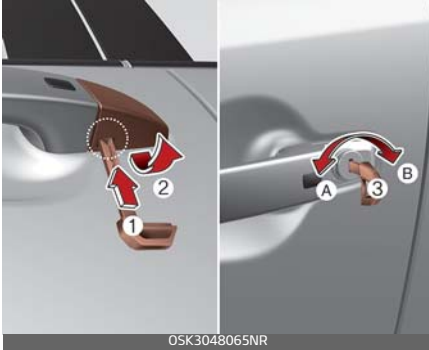

To remove the cover:

1. Pull out the door handle.
2. Press the lever (1) located inside the bottom part of the cover with a key or flat-head screwdriver.
3. Push out the cover (2) while pressing the lever.

Turn the key toward the rear of the vehicle to lock (A) and toward the front of the vehicle to unlock (B).

- If you lock the driver's door with a key, only the driver's door will lock/unlock.
- From the driver's door, turn the key toward the front of the vehicle once to unlock the driver's door and once more within 4 seconds to unlock all doors.
- Doors can also be locked and unlocked with the smart key.

- Once the doors are unlocked, they may be opened by pulling the door handle.
- When closing the door, push the door by hand. Make sure the doors are closed securely.

#### \* NOTICE

- In cold and wet climates, door lock and door mechanisms may not work properly due to freezing conditions.
- If the door is locked/unlocked multiple times in rapid succession with either the vehicle key or door lock switch, the system may stop operating temporarily in order to protect the circuit and prevent damage to system components.

#### ⚠ WARNING

- Securely close your door before you begin driving. Failure to fully close your door may cause it to open during vehicle operation.
- Keep your body out of the way of the closing door to prevent injuries.

#### ⚠ CAUTION

Do not unnecessarily open and close the door repeatedly or with excessive force. Such action can damage the vehicle door.

## \* NOTICE

Always turn the ignition switch to the OFF position, engage the parking brake, close all windows, and lock all doors when leaving your vehicle unattended.

### Operating door locks from inside the vehicle

#### With the door lock button

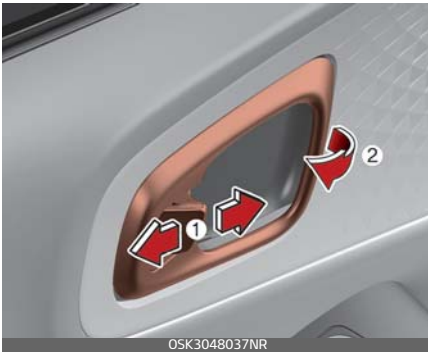

- To unlock a door, push the door lock button (1) to the "Unlock" position. The red mark on the door lock button will be visible.
- To lock a door, push the door lock button (1) to the "Lock" position. If the door is locked properly, the red mark on the door lock button will not be visible.
- To open a door, pull the door handle (2) outward.
- If the inner door handle of the driver's (or front passenger's) door is pulled when the door lock button is in the lock position, the

button will unlock and the door will open.

- Doors cannot be locked if the smart key is in the vehicle and a door is open.

#### Door lock malfunction

If a power door lock ever fails to function while you are in the vehicle, try one or more of the following techniques to exit:

- Operate the door unlock feature repeatedly (both electronic and manual) while simultaneously pulling on the door handle.
- Operate the other door locks and handles, front and rear.
- Lower a front window and use the key to unlock the door from outside.

## ⚠ WARNING

Do not pull the inner door handle of driver's (or passenger's) door while the vehicle is moving.

**With central door lock switch**

Driver side



Passenger side



Operate by pressing the central door lock switch.

- When pressing the right portion (1) for driver side or the upper portion (1) for passenger side of the switch, all vehicle doors will lock.
- When pressing the left portion (2) for driver side or the lower portion (2) for passenger side of the switch, all vehicle doors will unlock.

- If the smart key is in the vehicle and any door is opened, the doors will not lock even though the right portion (1) for driver side or upper portion (1) for passenger side of the central door lock switch is pressed.

**⚠ WARNING**

**Doors**

- The doors should always be fully closed and locked while the vehicle is in motion to prevent accidental opening of the door.
- Be careful when opening doors and watch for vehicles, motorcycles, bicycles or pedestrians approaching the vehicle in the path of the door. Opening a door when something is approaching can cause damage or injury.

**⚠ WARNING**

**Unattended children/animals**

Never leave children or animals unattended in your vehicle. An enclosed vehicle can become extremely hot, causing death or severe injury to unattended children or animals who cannot escape the vehicle.

## Door lock/unlock features

### Impact sensing door unlock system

All doors will automatically unlock when an impact causes the air bags to deploy.

### Speed sensing door lock system

All doors will automatically lock after the vehicle speed exceeds 10 mph (15 km/h).

You can activate or deactivate the auto door lock/unlock features in the vehicle. Refer to "User settings mode" on page 4-55.

### Child-protector rear door locks

The child safety lock is provided to help prevent children from accidentally opening the rear doors from inside the vehicle. The rear door safety locks should be used whenever children are in the vehicle.

The child safety lock is located on the edge of each rear door. When the child safety lock is in the lock position (1), the rear door will not open if the inner door handle (2) is pulled.



To lock the child safety lock, insert a key (or screwdriver) into the hole and turn it to the lock position.

To allow a rear door to be opened from inside the vehicle, unlock the child safety lock.

## **⚠ WARNING**

### Rear door locks

Use the rear door safety locks whenever children are in the vehicle. If a child accidentally opens the rear doors while the vehicle is moving, he or she may fall out.

## Rear Occupant Alert (ROA) system

The Rear Occupant Alert (ROA) is provided to help prevent exiting the vehicle with a rear passenger left in the vehicle.

- When you open the front door after opening and closing the rear door and turning off the engine, the "Check rear seats" warning message appears on the cluster.

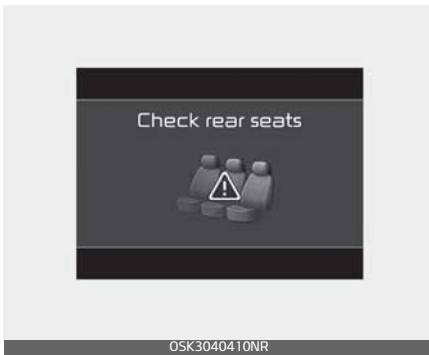

You can activate or deactivate the ROA from the User Settings mode in the cluster LCD display.

The option can be found under the following menu:

1. Press the MODE button (📄) several times on the steering wheel until 'User Settings' menu appears on the LCD.
2. Select 'Convenience → Rear Occupant Alert' with the MOVE switch (∧ / ∨) and the OK button on the steering wheel.

### ⚠ WARNING

The Rear Occupant Alert (ROA) system does not actually detect objects or people in the rear seat. By using a rear door opened and closed history, the system informs the driver that there may be something in the rear seat.

### ⚠ CAUTION

The Rear Occupant Alert (ROA) system uses a rear door opened and closed history.

The history is reset after the driver turns off ignition normally, gets off the vehicle and locks the door remotely using the remote keyless entry. So even if a rear door does not reopen, the ROA system alert can occur.

For example, after the ROA system alert occur, if the driver do not lock the door then ride and drive again, the alert can occur.

### ⚠ WARNING

The door lock system may not work if the electrical system is compromised. Accordingly, please train children passengers regarding how to open the car door manually before an emergency situation arises. That way, they would be able to open the

door manually in the event an emergency situation arises.

---

## Liftgate

When you open the liftgate, you will see a space where you can load the cargo.

### Opening the liftgate

The liftgate is locked or unlocked when all doors are locked or unlocked with the key, smart key or central door lock/unlock switch.

#### **⚠ CAUTION**

### Liftgate lift

Make sure that you close the liftgate before driving your vehicle. Possible damage may occur to the liftgate gas lifters and attached hardware if the liftgate is not closed prior to driving.

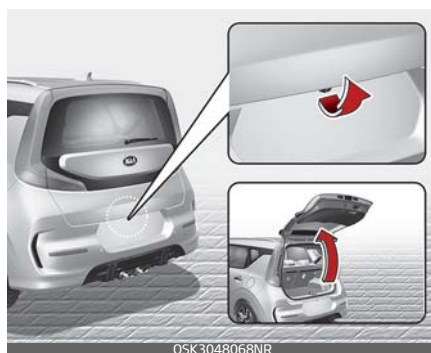

- Only the liftgate is unlocked if the liftgate unlock button on the transmitter or smart key is pressed for approximately 1 second.



- If unlocked, the liftgate can be opened by pressing the handle and pulling it up.
- Once the liftgate is opened and then closed, the liftgate locks automatically. (All doors must be locked.)

### \* NOTICE

In cold and wet climates, door lock and door mechanisms may not work properly due to freezing conditions.

### ⚠ WARNING

The liftgate swings upward. Make sure no objects or people are near the rear of the vehicle when opening the liftgate.

### Closing the liftgate

Lower and push down the liftgate firmly. Make sure that the liftgate is securely latched.



Make sure your hands, feet and other parts of your body are safely out of the way before closing the liftgate.

### ⚠ WARNING

#### Exhaust Fumes

The liftgate should always be kept completely closed while the vehicle is in motion. If it is left open or ajar, poisonous exhaust gases may enter the car and serious illness or death may result.

#### Opening the liftgate in emergency

Your vehicle is equipped with the emergency liftgate safety release lever located on the bottom of the liftgate. When someone is inadvertently locked in the luggage compartment.



The liftgate can be opened by doing as follows:

1. Input the mechanical key into the hole.
2. Push the mechanical key to the right (1).
3. Push up the liftgate.

### **⚠ WARNING**

- No one should be allowed to occupy the cargo area of the vehicle at any time. The cargo area is a very dangerous location in the event of a crash.
- Use the release lever for emergencies only. Use with extreme caution, especially while the vehicle is in motion.

### **⚠ CAUTION**

Make sure there are no people or objects around the liftgate before opening or closing the liftgate. Wait until the liftgate is open fully and stopped before loading or unloading cargo from the vehicle.

### **⚠ WARNING**

Do not grasp the part supporting the liftgate (gas lifter), as this may cause serious injury.



## Windows

The doors of this vehicle are equipped with power windows that can be operated by a switch.

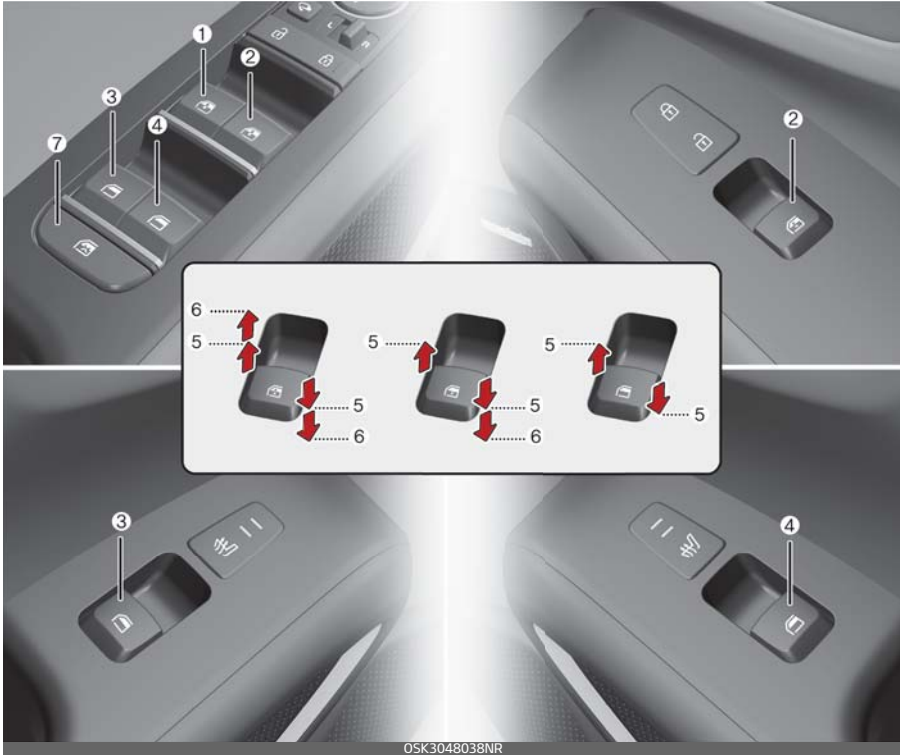

OSK3048038NR

- 1. Driver's door power window switch
- 2. Front passenger's door power window switch
- 3. Rear door (left) power window switch
- 4. Rear door (right) power window switch
- 5. Window opening and closing
- 6. Automatic power window up/down (if equipped)
- 7. Power window lock switch

\* if equipped

### \* NOTICE

In cold and wet climates, power windows may not work properly due to freezing conditions.

The ignition switch must be in the ON position for power windows to operate.

Each door has a power window switch that controls the door's window. The driver has a power window lock switch which can block the operation of rear passenger windows. The power windows can be operated for approximately 10 minutes after the ignition key is removed or set to the ACC or LOCK position. However, if the front doors are opened, the power windows cannot be operated even within the 10 minutes period.

The driver's door has a master power window switch that controls all the windows in the vehicle.

If the window cannot be closed because it is blocked by objects, remove the objects and close the window.

### \* NOTICE

While driving with the rear windows down or with the sunroof (if equipped) in an open (or partially open position), your vehicle may demonstrate a wind buffeting or

pulsation noise. This noise is a normal occurrence and can be reduced or eliminated by taking the following actions. If the noise occurs with one or both of the rear windows down, partially lower both front windows approximately 1 in (2.5 cm). If you experience the noise with the sunroof open, slightly reduce the size of the sunroof opening.

### ⚠ CAUTION

Do not install any accessories in the vehicle that extend into the open window area. Such objects will impact the proper functioning of the automatic reversal "jam protection" feature.

## Window opening and closing

### *Type A*

To open or close a window, press down or pull up the front portion of the corresponding switch to the first detent position (5).



**Type B - Auto down window (if equipped)**



Pressing the power window switch momentarily to the second detent position (6) completely lowers the window even when the switch is released. To stop the window at the desired position while the window is in operation, pull up the switch briefly to the opposite direction of the window movement.

**Type C - Auto up/down window (if equipped)**



Pressing or pulling up the power window switch momentarily to the second detent position (6) completely lowers or raises the window even when the switch is released. To stop the window at the desired position while the window is in operation, pull up or press down and release the switch.

If the power window does not operate normally, the automatic power window system must be reset as follows:

1. Turn the ignition switch to the ON position.
2. Close the window and continue pulling up the power window switch for at least 1 second after the window is completely closed.

**Automatic reversal for Type C**

If the upward movement of the window is blocked by an object or part of the body, the window will

detect the resistance and will stop upward movement. The window will then lower approximately 11.8 in (30 cm) to allow the object to be cleared.



If the window detects the resistance while the power window switch is pulled up continuously, the window will stop upward movement then lower approximately 1 in (2.5 cm).

If the power window switch is pulled up continuously again within 5 seconds after the window is lowered by the automatic window reversal feature, the automatic window reversal will not operate.

### \* NOTICE

The automatic reverse feature for the window is only active when the "auto up" feature is used by fully pulling up the switch. The automatic reverse feature will not operate if the window is raised using the half-

way position on the power window switch.

### ⚠ WARNING

Always check for obstructions before raising any window to avoid injuries or vehicle damage. If an object less than 0.16 in (4 mm) in diameter is caught between the window glass and the upper window channel, the automatic reverse window may not detect the resistance and will not stop and reverse direction.

### ⚠ WARNING

The automatic reverse feature doesn't activate while resetting power window system. Make sure body parts or other objects are safely out of the way before closing the windows to avoid injuries.

### ⚠ WARNING

Do not install any accessories in the vehicle that extend into the open window area. Such objects could prevent the automatic reverse feature from functioning.

### Power window lock switch

The driver can disable the power window switches on the rear pas-

sengers' doors by pressing the power window lock switch to the lock position (pressed).



When the power window lock switch is pressed:

- The driver's master control can operate the front passenger's power window and the rear passengers' power windows.
- The front passenger's control can operate the front passenger's power window.
- The rear passengers' control cannot operate the rear passengers' power window.

## ⚠ CAUTION

### Opening/closing Window

To prevent possible damage to the power window system, do not open or close two windows or more at the same time. This will also ensure the longevity of the fuse.

Always double check to make sure all arms, hands, head and other

obstructions are safely out of the way before closing a window.

If the window cannot be close because it is blocked by objects, remove the objects and close the window.

## ⚠ WARNING

### Power windows

- Do not allow children to play with the power windows. Keep the power window lock switch (on the driver's door) in the LOCK (pressed) position.
- Do not extend a face or arms outside the window opening while the vehicle is in motion. Doing so could result in significant bodily injury.

## Hood

The hood serves as a cover for the engine compartment. Open the hood if maintenance works needs to be performed in the engine compartment or if you need to look at the compartment.

### Opening the hood

1. Pull the release lever to unlatch the hood. The hood should pop open slightly.



### **⚠ WARNING**

Open the hood after turning off the engine on a flat surface, shifting the shift lever to the P (Park) position for Dual Clutch Transmission/Intelligent Variable Transmission and to the 1st (First) gear or R (Reverse) for Manual Transmission, and setting the parking brake.

2. Go to the front of the vehicle, raise the hood slightly, push the secondary latch (1) up side and lift the hood (2).



3. Raise the hood. It will completely rise by itself after it has been raised about halfway.

### Hood open warning

A warning message will appear on the LCD display when hood is open.



The warning chime will operate when the vehicle is being driven above 2 mph (3 km/h) with the hood open.



## Closing the hood

1. Before closing the hood, check the following:
  - All filler caps in the engine compartment must be correctly installed.
  - Gloves, rags or any other combustible material must be removed from the engine compartment.
2. Lower the hood halfway and push down to securely lock in place.
3. Then double check to be sure the hood is secure.
  - If the hood can be raise slightly, it is not properly engaged.
  - Open it again and close it with a little more force.

### CAUTION

#### Hood obstruction

Before closing the hood, ensure that all obstructions are removed from the hood opening. Closing the hood with an obstruction present in the hood opening may result in severe personal injury or property damage.

---

### WARNING

#### Fire risk

Do not leave gloves, rags or any other combustible material in the motor compartment. Doing so may cause a heat-induced fire.

---

### WARNING

#### Unsecured hood

Always double check to be sure that the hood is firmly latched before driving away. If it is not latched, the hood could fly open while the vehicle is being driven, causing a total loss of visibility, which might result in an accident.

---

## Fuel filler door

### Opening the fuel filler door

The fuel filler door must be opened from inside the vehicle by pulling up the fuel filler door opener.



If the fuel filler door does not open because ice has formed around it, tap lightly or push on the door to break the ice and release the door. Do not pry on the door. If necessary, spray around the door with an approved de-icer fluid (do not use radiator anti-freeze) or move the vehicle to a warm place and allow the ice to melt.

1. Stop the engine.
2. To open the fuel filler door, pull the fuel filler door opener up.
3. Pull open the fuel filler door (1) out to fully open.



4. To remove the cap turn the fuel filler cap (2) counterclockwise.
5. Refuel as needed.

### **⚠ WARNING**

Before refueling, be sure to check what type of fuel is used for your vehicle. If you put diesel fuel into a gasoline-powered vehicle or gasoline into a diesel-powered vehicle, it may affect the fuel system and cause serious damage to the vehicle.

### Closing the fuel filler door

1. To install the cap, turn it clockwise until it "clicks" one time. This indicates that the cap is securely tightened.
2. Close the fuel filler door and push it lightly and make sure that it is securely closed.

**⚠ WARNING****Refueling**

Always remove the fuel cap carefully and slowly. If the cap is venting fuel or if you hear a hissing sound, wait until the condition stops before completely removing the cap.

If pressurized fuel sprays out, it can cover your clothes or skin and subject you to the risk of fire and burns.

**\* NOTICE**

When refueling on unlevel ground, the fuel gauge may not point to the F position. It is not a malfunction. If you move your vehicle to a level ground, the fuel gauge will move to the full position.

**\* NOTICE**

Tighten the cap until it clicks one time, otherwise the fuel cap open warning indicator light will illuminate.

Always check that the fuel cap is installed securely to prevent fuel spillage in the event of an accident.

**⚠ WARNING****Fire/explosion risk**

Read and follow all warnings posted at the gas station facility. Failure to follow all warnings will result in

severe personal injury, severe burns or death due to fire or explosion.

**⚠ WARNING****Static electricity**

- Before touching the fuel nozzle, you should eliminate potentially dangerous static electricity discharge by touching another metal part of the vehicle, a safe distance away from the fuel filler neck, nozzle, or other gas source.
- Do not get back into a vehicle once you have begun refueling since you can generate static electricity by touching, rubbing or sliding against any item or fabric (polyester, satin, nylon, etc.) capable of producing static electricity. Static electricity discharge can ignite fuel vapors resulting in rapid burning. If you must reenter the vehicle, you should once again eliminate potentially dangerous static electricity discharge by touching a metal part of the vehicle, away from the fuel filler neck, nozzle or other gasoline source.

**⚠ WARNING****Portable fuel container**

When using an approved portable fuel container, be sure to place the container on the ground prior to refueling. Static electricity discharge

from the container can ignite fuel vapors causing a fire. Once refueling has begun, contact with the vehicle should be maintained until the filling is complete. Use only approved portable plastic fuel containers designed to carry and store gasoline.

### **⚠ WARNING**

#### **Cell phone fires**

Do not use cellular phones while refueling. Electric current and/or electronic interference from cellular phones can potentially ignite fuel vapors causing a fire.

### **⚠ WARNING**

#### **Refueling & Vehicle fires**

When refueling, always shut the engine off. Sparks produced by electrical components related to the engine can ignite fuel vapors causing a fire. Once refueling is complete, check to make sure the filler cap and filler door are securely closed, before starting the engine.

### **⚠ WARNING**

#### **Smoking**

DO NOT use matches or a lighter and DO NOT SMOKE or leave a lit cigarette in your vehicle while at a gas station especially during refueling. Automotive fuel is highly flammable and can, when ignited, result in fire.

Make sure to refuel your vehicle according to "Fuel requirements" on page 1-2.

If the fuel filler cap requires replacement, use only a genuine Kia cap or the equivalent specified for your vehicle. An incorrect fuel filler cap can result in a serious malfunction of the fuel system or emission control system.

### **⚠ CAUTION**

#### **Exterior paint**

Do not spill fuel on the exterior surfaces of the vehicle. Any type of fuel spilled on painted surfaces may damage the paint.

## Sunroof (if equipped)

If your vehicle is equipped with a sunroof, you can slide or tilt your sunroof with the sunroof control switch located on the overhead console.



The sunroof can only be opened, closed, or tilted when the ignition switch is in the ON position.

The sunroof can be operated for approximately 10 minutes after the ignition switch is turned to the ACC or OFF position.

However, if the front door is opened, the sunroof cannot be operated even within the 10 minutes period.

### \* NOTICE

In cold and wet climates, the sunroof may not work properly due to freezing conditions.

After the vehicle is washed or in a rainstorm, be sure to wipe off any water that is on the sunroof before operating it.

The sunroof cannot slide when it is in the tilt position nor can it be tilted while in an open or slide position.

### ⚠ CAUTION

To prevent damage to the sunroof, periodically remove any dirt that may accumulate on the guide rail.

### ⚠ CAUTION

#### Sunroof control lever

Do not continue to press the sunroof control lever after the sunroof is fully opened, closed, or tilted. Damage to the motor or system components could occur.

### ⚠ WARNING

#### Sunroof operation

When closing the sunroof, make sure there are no body parts in the movement range of the sliding roof. Parts of the body could become trapped or crushed.

### ⚠ WARNING

Never adjust the sunroof or sunshade while driving. This could result in loss of control and an accident that may cause death, serious injury, or property damage.

**⚠ CAUTION**

Make sure the sunroof is fully closed when leaving your vehicle. If the sunroof is opened, rain or snow may leak through the sunroof and wet the interior as well as increase the risk of theft.

**⚠ WARNING****Roof cargo**

Do not operate the sun roof while using the roof rack to transport cargo. This may cause the cargo to come loose and distract the driver.

**⚠ WARNING**

Do not sit on the top of the vehicle. It may cause vehicle damage.

**Sliding the sunroof**

- To open or close the sunroof (manual slide feature), push the sunroof control switch backward

or forward to the first detent position.

- To open the sunroof (autoslide feature), push the sunroof control switch backward to the second detent position.

The sunroof will slide to the recommended open position before the maximum slide open position. To stop the sunroof sliding at any point, push the sunroof control switch momentarily.

- To open the sunroof to the maximum slide open position, press the switch towards the rear of the vehicle once again and hold it until the sunroof slide all the way open.

**\* NOTICE**

To reduce wind noise while driving, we recommend you to drive at the recommended position before the maximum slide open position.

- To close the sunroof (autoslide feature), move the sunroof control switch forward to the second detent position.

The sunroof will close all the way. To stop the sunroof sliding at any point, pull or push the sunroof control switch momentarily.

**⚠ CAUTION**

Do not leave the engine running and the key in your vehicle with unsupervised children. Unattended chil-

dren could operate the sunroof, which could result in serious injury.

**Automatic reversal**

If an object or part of the body is detected while the sunroof is closing automatically, it will reverse direction, and then stop.

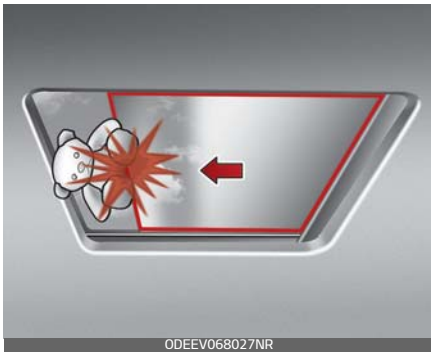

The auto reverse function will not work if a small obstacle is caught in the sunroof. You should always make sure that all passengers and objects are away from the sunroof before closing it.

**Tilting the sunroof**



- To tilt open the sunroof, push the sunroof control switch upward until the sunroof moves to the desired position.
- To close the sunroof, push the sunroof switch forward until the sunroof moves to the desired position.

**WARNING**

**Sunroof**

Do not extend the face, neck, arms or body outside through the sunroof opening while driving or operating the sunroof.

**CAUTION**

**Sunroof motor damage**

If you try to open the sunroof when the temperature is below freezing or when the sunroof is covered with snow or ice, the glass or the motor could be damaged.

**CAUTION**

**Sunroof Operation**

When closing the sunroof, make sure there are no body parts in the movement range of the sliding roof. Parts of the body could become trapped or crushed

## Sunshade

The sunshade will be opened with the glass panel automatically when the glass panel is opened. You will have to close it manually if you want it closed.



ODEEV068029NR

### ⚠ CAUTION

The sunroof is made to slide together with the sunshade. Do not pull or push the sunshade by hand, as such action may damage the sunshade or cause it to malfunction.

## Resetting the sunroof

Reset the sunroof when:

- The battery is discharged or disconnected or the sunroof fuse has been replaced or disconnected.
- The sunroof control switch is not operating correctly.

Reset the sunroof as described below.

1. The ignition switch must be in the ON position.

2. Close the sunroof completely.
3. Release the control switch.
4. Push the control switch forward until the sunroof tilts and slightly moves up. Then, release switch.
5. Push the control switch forward until the sunroof is operated as follows:
  - 1) TILT DOWN → SLIDE OPEN → SLIDE CLOSE
  - 2) Then, release the control switch.

### \* NOTICE

Do not release the switch until the operation is completed.

If you release the switch during operation, try again from step 2.

6. Release the sunroof control switch. (The sunroof system has been reset.)

\* For more detailed information, contact an authorized Kia dealer.

### \* NOTICE

If the sunroof is not reset when the vehicle battery is disconnected or discharged, or related fuse is blown, the sunroof may operate improperly.

## Sunroof open warning

If the driver turns off the ignition switch or START/STOP button when the sunroof is not fully closed, the



warning chime will sound for approximately a few seconds and a message will appear on the LCD window.



Close the sunroof securely when leaving your vehicle.

## Steering wheel

The steering wheel of this vehicle is equipped with electronic power steering.

### Electronic power steering

Power steering uses an electric motor to assist you in steering the vehicle.

If the vehicle is off or if the power steering system becomes inoperative, the vehicle may still be steered, but it will require increased steering effort.

Electronic power steering is controlled by the power steering control unit which senses the steering wheel torque and vehicle speed to command the motor.

The steering effort becomes heavier as the vehicle's speed increases and becomes lighter as the vehicle's speed decreases for better control of the steering wheel.

Should you notice any change in the effort required to steer during normal vehicle operation, have the power steering checked by an authorized Kia dealer.

### \* NOTICE

The following symptoms may occur during normal vehicle operation:

- The EPS warning light does not illuminate.
- The steering gets heavy immediately after turning the ignition switch in ON position. This happens as the system performs the EPS system diagnostics. When the diagnostics are completed, the steering wheel will return to its normal condition.
- A click noise may be heard from the EPS relay after turning the ignition switch is turned to the ON or LOCK position.
- A motor noise may be heard when the vehicle is at a stop or at a low driving speed.
- If the Electronic Power Steering System does not operate normally, the warning light will illuminate on the instrument cluster. The steering wheel may become difficult to control or operate abnormally. Take your vehicle to an authorized Kia dealer and have the vehicle checked as soon as possible.
- When the charging system warning light comes on due to the low voltage (when the alternator or battery does not operate normally or malfunctions), the steering wheel may require increased steering effort.

---

If the Electronic Power Steering System does not operate normally, the warning light will illuminate on

the instrument cluster. The steering wheel may become difficult to control or operate abnormally. In this case, have the system inspected by an authorized Kia dealer.

When you operate the steering wheel in low temperature, the steering effort may be high and abnormal noise could occur. If temperature rises, the noise will disappear. This is a normal condition.

When the vehicle is stationary, and the steering wheel is turned all the way to the left or right continuously, the steering wheel becomes harder to turn. The power assist is limited to protect the motor from overheating.

As time passes, the steering wheel will return to its normal condition.

### **Tilt & telescopic steering wheel**

A tilt and telescopic steering wheel allows you to adjust the steering wheel before you drive

You can also raise it to give your legs more room when you exit and enter the vehicle.

The steering wheel should be positioned so that it is comfortable for you to drive, while permitting you to see the instrument panel warning lights and gauges.

**⚠ WARNING****Steering wheel adjustment**

Never adjust the angle and height of the steering wheel while driving. You may lose steering control.

**Adjusting steering wheel angle and height**

1. To change the steering wheel angle, pull down the lock release lever (1).
2. Adjust the steering wheel to the desired angle (2) and height (3).
3. Pull up the lock-release lever to lock the steering wheel in place.
4. Be sure to adjust the steering wheel to the desired position before driving.

**\* NOTICE**

After adjustment, sometimes the lock-release lever may not lock the steering wheel.

It is not a malfunction. This occurs when two gears engage. In this case, adjust the steering wheel

again and then lock the steering wheel.

**Heated steering wheel (if equipped)**

With the ignition switch in the ON position, pressing the heated steering wheel button warms the steering wheel. The indicator on the button will illuminate.



To turn the heated steering wheel off, press the button once again. The indicator on the button will turn off.

**\* NOTICE**

The heated steering wheel will turn off automatically approximately 30 minutes after the heated steering wheel is turned on.

**⚠ CAUTION**

- Do not install any type of grip cover for the steering wheel, it

may impair the function of the heated steering wheel system.

- When cleaning the heated steering wheel, do not use an organic solvent, such as paint thinner, benzene, alcohol and gasoline. Doing so may damage the surface of the steering wheel.
- If the surface of the steering wheel is damaged by a sharp object, damage to the heated steering wheel components could occur.

### **⚠ WARNING**

If the steering wheel becomes too warm, turn the system off. The heated steering wheel may cause burns even at low temperatures, especially if used for long periods of time.

### **Horn**

To sound the horn, press the area indicated by the horn symbol on your steering wheel (see illustration).



The horn will operate only when this area is pressed. Check the horn regularly to be sure it operates properly.

## Mirrors

This vehicle is equipped with a rearview mirrors inside and outside to provide views of objects behind the vehicle.

### Inside rearview mirror

Adjust the rearview mirror so that the center view through the rear window is seen. Make this adjustment before you start driving.

Do not place objects in the rear seat or cargo area which would interfere with your vision through the rear window.

#### **⚠ WARNING**

### Mirror adjustment

Do not adjust the rearview mirror while the vehicle is moving. This could result in loss of control.

#### **⚠ WARNING**

Do not modify the inside mirror in any manner, including installing a wide mirror. Doing so could result in injury during an accident or deployment of the air bag.

#### **⚠ CAUTION**

### Cleaning mirror

When cleaning the mirror, use a paper towel or similar material

dampened with glass cleaner. Do not spray glass cleaner directly on the mirror. It may cause the liquid cleaner to enter the mirror housing.

### *Day/night rearview mirror (if equipped)*



\* (1): Day, (2): Night

Make this adjustment before you start driving and while the day/night lever is in the day position (1).

Pull the day/night lever toward you (2) to reduce the glare from the headlights of the vehicles behind you during night driving.

Remember that you lose some rearview clarity in the night position.

**Day/night rearview mirror with Telematics function (if equipped)**

For day and night function:

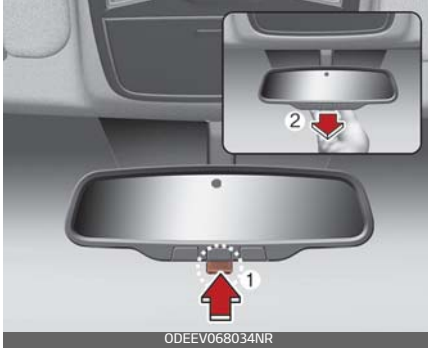

\* (1): Day, (2): Night

Make this adjustment before you start driving and while the day/night lever (1) is in the day position. Pull the day/night lever (2) toward you to reduce the glare from the headlights of the vehicles behind you during night driving. Remember that you lose some rearview clarity in the night position.

For Telematics button function:



Telematics buttons are also located on the mirror.

1. Virtual Assist button
2. UVO (Voice local search) button
3. Roadside assist button

**Electric chromic mirror (ECM) with UVO service (if equipped)**

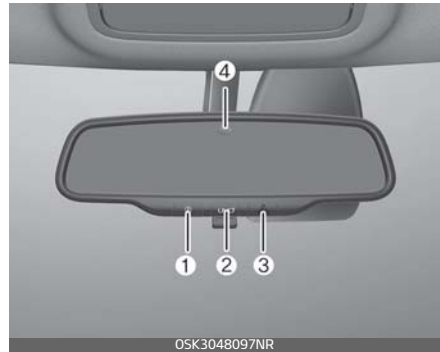

The electric rearview mirror automatically controls the glare from the headlights of the vehicles behind you in nighttime or low light driving conditions. The sensor (4) mounted in the mirror senses the light level around the vehicle, and automatically controls the headlight glare from the vehicles behind you.

When the engine is running, the glare is automatically controlled by the sensor mounted in the rearview mirror.

Telematics buttons are also located on the mirror.

1. Virtual Assist button
2. UVO (Voice local search) button
3. Roadside assist button

## Outside rearview mirror

Your vehicle is equipped with both left-hand and right-hand outside rearview mirrors.

Be sure to adjust the mirror angles before driving.

The mirrors can be adjusted remotely with the remote switch. The mirror heads can be folded back to prevent damage during an automatic car wash or when passing through a narrow street.

### ⚠ CAUTION

#### Rearview mirrors

Do not scrape ice off the mirror face; this may damage the surface of the glass. If ice should restrict the movement of the mirror, do not force the mirror for adjustment. To remove ice, use a de-icer spray, a sponge or soft cloth with very warm water.

If the mirror is jammed with ice, do not adjust the mirror by force. Use an approved spray de-icer (not radiator antifreeze) to release the frozen mechanism or move the vehicle to a warm place and allow the ice to melt.

### ⚠ WARNING

#### Mirror adjustment

Do not adjust or fold the outside rearview mirrors while the vehicle is moving. This could result in loss of control.

### Adjusting the outside rearview mirrors



Adjusting the rearview mirrors:

1. Move the L (Front left side) or R (Front right side) switch (1) to select the rearview mirror you would like to adjust.
2. Use the mirror adjustment control (2) to position the selected mirror up, down, left or right.

### ⚠ CAUTION

- The mirrors stop moving when they reach the maximum adjusting angles, but the motor continues to operate while the switch is pressed. Do not press the switch longer than necessary, the motor may be damaged.

- Do not attempt to adjust the outside rearview mirror by hand. Doing so may damage the parts.
- 

### ***Folding the outside rearview mirror***

Manual type

To fold the outside rearview mirror, grasp the housing of the mirror and then fold it toward the rear of the vehicle.





## Instrument cluster

Type A



Type B



\* The actual cluster and contents of the LCD display in the vehicle may differ from the illustration.

1. Tachometer
2. Speedometer
3. Engine coolant temperature gauge
4. Fuel gauge
5. Warning and indicator lights
6. LCD display

### Instrument cluster control

The brightness of the instrument panel illumination is changed by pressing the illumination control button ("+" or "-") when ignition switch is ON, or the taillights are turned on.



OSK3048048NR

- If you hold the illumination control button ("+" or "-"), the brightness will be changed continuously.

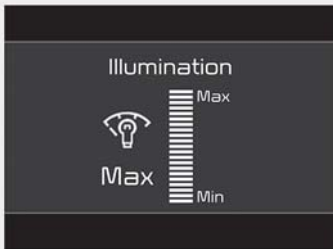

OSK3048104NR

- If the brightness reaches to the maximum or minimum level, an alarm will sound.

## Gauges

The gauges display various information such as the speed of the vehicle, the amount of charge of the battery, and so on.

## Speedometer

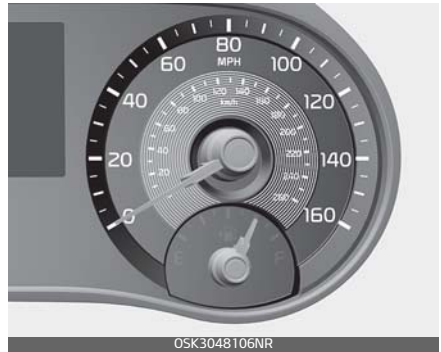

OSK3048106NR

The speedometer indicates the speed of the vehicle and is calibrated in miles per hour (mph) and/or kilometers per hour (km/h).

## Tachometer



OSK3048107NR

The tachometer indicates the approximate number of engine revolutions per minute (rpm).

Use the tachometer to select the correct shift points and to prevent lugging and/or over-revving the engine.

**⚠ CAUTION**

Do not operate the engine within the tachometer's RED ZONE. This may cause severe engine damage.

**Engine Coolant Temperature Gauge**

This gauge indicates the temperature of the engine coolant when the ignition switch or ENGINE START/STOP button is ON.

**⚠ CAUTION**

If the gauge pointer moves beyond the normal range area toward the "H" position, it indicates overheating that may damage the engine. Do not continue driving with an overheated engine. If your vehicle overheats, refer to "If the engine overheats" on page 6-8.

**⚠ WARNING**

Never remove the radiator cap when the engine is hot. The engine cool-

ant is under pressure and could severely burn. Wait until the engine is cool before adding coolant to the reservoir.

**Fuel Gauge**

This gauge indicates the approximate amount of fuel remaining in the fuel tank.

**\* NOTICE**

- The fuel tank capacity is given in "Recommended lubricants and capacities" on page 8-9.
- The fuel gauge is supplemented by a low fuel warning light, which will illuminate when the fuel tank is nearly empty.
- On inclines or curves, the fuel gauge pointer may fluctuate or the low fuel warning light may come on earlier than usual due to the movement of fuel in the tank.

## \* NOTICE

**Fuel Gauge**

Running out of fuel can expose vehicle occupants to danger.

You must stop and obtain additional fuel as soon as possible after the warning light comes on or when the gauge indicator comes close to the "E" level.

## ▲ CAUTION

Avoid driving with an extremely low fuel level. Running out of fuel could cause the engine to misfire damaging the catalytic converter.

## \* NOTICE

The fuel display may not be accurate if the vehicle is on an incline.

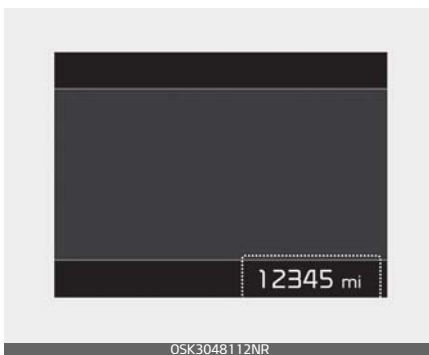
**Odometer**

The odometer indicates the total distance that the vehicle has been

driven and should be used to determine when periodic maintenance should be performed.

- Odometer range: 0-999,999 miles or 1,599,999 kilometers.

**Outside Temperature Gauge**

This gauge indicates the current outside air temperatures by 1 °F (1 °C).

- Temperature range: -40~211 °F (-40~85 °C)

The outside temperature on the display may not change immediately like a general thermometer to prevent the driver from being distracted.

To change the temperature unit (from °F to °C or from °C to °F)

The temperature unit can be changed by using the "User Settings" mode of the LCD display.

\* For more details, refer to "LCD display" on page 4-53.

### Transmission shift indicator

Transmission shift indicator displays gear information depending on your vehicle's transmission type.

#### ***Intelligent variable transmission shift indicator (if equipped)***

This indicator displays which automatic transmission shift lever is selected.

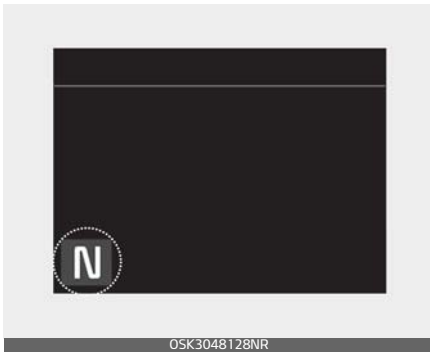

- Park: P
- Reverse: R
- Neutral: N
- Drive: D
- Sports Mode: 1, 2, 3, 4, 5, 6

#### ***Manual transmission shift Indicator (if equipped)***

This indicator informs which gear is desired while driving to save fuel.



- Shifting up: ▲2, ▲3, ▲4, ▲5, ▲6
- Shifting down: ▼1, ▼2, ▼3, ▼4, ▼5

For example

- ▲3: Indicates that shifting up to the 3rd gear is desired (currently the shift lever is in the 2nd or 1st gear).
- ▼4: Indicates that shifting down to the 4th gear is desired (currently the shift lever is in the 5th or 6th gear).

When the system is not working properly, the indicator is not displayed.

#### ***Dual clutch transmission shift indicator (if equipped)***

This indicator displays which shift lever is selected.

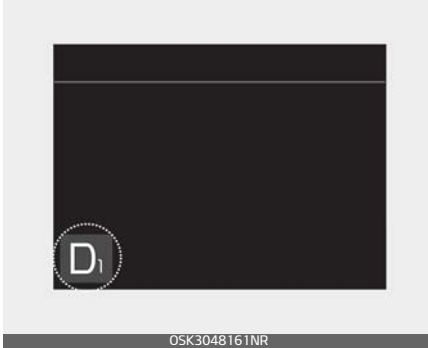

- Park: P
- Reverse: R
- Neutral: N
- Drive: D
- Sports Mode: S



## LCD display

The LCD display shows trip computer and other information.

### LCD Display Control







The LCD display modes can be changed by using the control buttons.



1. : MODE button for changing modes
2. : MOVE switch for changing items
3. : OK: SELECT/RESET button for setting or resetting the selected item

### LCD Display Modes

The LCD display provides 5 modes. You can switch modes by pressing the Mode button.

		Mode 				
		 Trip Computer	 Turn By Turn (TBT)	 Driving Assist.	 User Settings	 Master warning
 Up/Down	Fuel Economy	Route Guidance	Smart Cruise Control	Head-Up Display	The Master Warning mode displays warning messages related to the vehicle when one or more systems is not operating normally.	
	Accumulated Info	Destination Info	Lane Safety	Driver Assistance		
	Drive Info		Driver Attention Warning	Door		
	Speedometer			Lights		
			TPMS	Sound		Convenience
			Service Interval	Other features		
				Reset		

The information provided may differ depending on which functions are applicable to your vehicle.

**Trip computer mode**

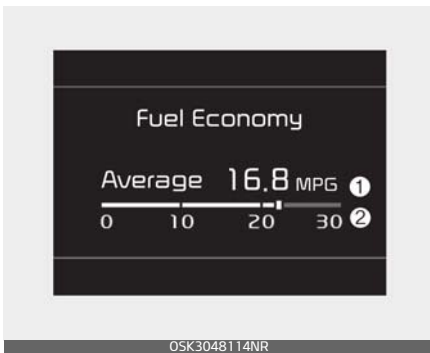

The trip computer mode displays information related to vehicle driving parameters including fuel economy, tripmeter information and vehicle speed.

\* For more details, refer to "Trip information (Trip computer)" on page 4-61.

**Turn By Turn (TBT) mode**

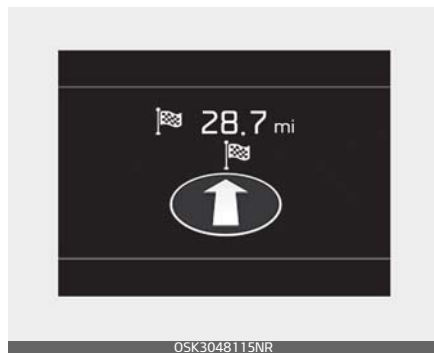

This mode displays the state of the navigation.

**Assist mode**

This mode displays the state of:

- Lane Safety system
- Driver Attention Warning
- Smart Cruise Control
- Tire Pressure

\* For more details, refer to each system information in "Driving your vehicle" on page 5–7.

**Tire pressure status**

\* For more details, refer to "Tire Pressure Monitoring System (TPMS)" on page 6–9.

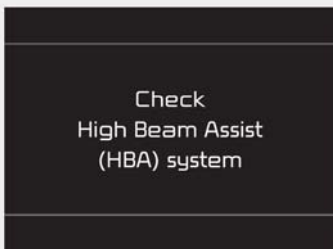
**Master warning mode**

This warning light informs the driver the following situations.

- Forward Collision-Avoidance Assist system malfunction (if equipped)
- Forward Collision-Avoidance Assist radar blocked (if equipped)
- Blind-Spot Collision Warning system malfunction (if equipped)
- Blind-Spot Collision Warning radar blocked (if equipped)
- LED headlamp malfunction (if equipped)
- Lamp malfunction
- High Beam Assist malfunction (if equipped)
- Smart Cruise Control malfunction (if equipped)
- Smart Cruise Control radar blocked (if equipped)

At this time, a Master Warning icon (⚠) will appear beside the User Settings icon (⚙), on the LCD display.

If the warning situation is resolved, the master warning light will be turned off and the Master Warning icon will disappear.

**User settings mode**

In this mode, you can change the settings of the instrument cluster, doors, lamps, etc.



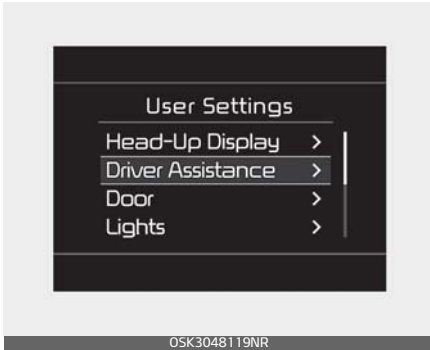

1. Head-Up Display
2. Driver Assistance
3. Door
4. Lights
5. Sound
6. Convenience
7. Service Interval
8. Other features
9. Reset

The information provided may differ depending on which functions are applicable to your vehicle.

### Shift to P to edit settings / Engage parking brake to edit settings

This warning message appears if you try to adjust the User Settings while driving.



- Dual Clutch Transmission / Intelligent Variable Transmission:  
For your safety, change the User Settings after parking the vehicle, applying the parking brake and moving the shift lever to P (Park).
- Manual Transmission:  
For your safety, change the User Settings after engaging the parking brake.

### 1. Head-Up Display (if equipped)

	Explanation
Display Height	Adjust the height (1~20) of the HUD image on the HUD screen.
Rotation	Adjust the degree (-5~+5) of the HUD rotation.
Brightness	Adjust the intensity (1~20) of the HUD brightness.
Contents Selection	If below items are checked, the items will be activated. <ul style="list-style-type: none"> <li>• Audio/Video info</li> <li>• Driving assist info</li> <li>• Blind-spot safety info</li> <li>• Turn By Turn</li> <li>• Traffic Info</li> </ul>

## 2. Driver Assistance (if equipped)

	Explanation
SCC Response	<ul style="list-style-type: none"> <li>• Slow/Normal/Fast</li> </ul> To adjust the sensitivity of the Smart Cruise Control system. * For more details, refer to "Smart Cruise Control (SCC) (if equipped)" on page 5-106.
Driver Attention Warning	<ul style="list-style-type: none"> <li>• High Sensitivity/Normal Sensitivity/Off</li> </ul> To adjust the sensitivity of the Driver Attention Warning. * For more details, refer to the "Driver Attention Warning (DAW) (if equipped)" on page 5-98.
Warning Timing	<ul style="list-style-type: none"> <li>• Normal/Late</li> </ul> To select the Warning time
Warning Volume	<ul style="list-style-type: none"> <li>• High/Medium/Normal/Off</li> </ul> To select the Warning volume
Forward Safety	<ul style="list-style-type: none"> <li>• Active Assist, Warning Only, Off</li> </ul> To select the functions.
Lane Safety	<ul style="list-style-type: none"> <li>• Lane Keeping Assist/Lane Departure Warning/Off</li> </ul> To select the functions.
Blind-Spot Safety	<ul style="list-style-type: none"> <li>• Rear Cross-Traffic Safety/Warning Only/Off</li> </ul> To select the functions.

\* The information provided may differ depending on which functions are applicable to your vehicle.

## 3. Door

	Explanation
Auto Lock	<ul style="list-style-type: none"> <li>• Disable: The auto door unlock operation will be canceled.</li> <li>• Enable on speed: All doors will be automatically locked when the vehicle speed exceeds 9.3 mph (15 km/h).</li> <li>• Enable on Shift (if equipped with Dual clutch transmission/Intelligent variable transmission) : All doors will be automatically locked if the vehicle is shifted from the P (Park) position to the R (Reverse), N (Neutral), or D (Drive) position.(With the Engine ON, it is activated.).</li> </ul>
Auto Unlock	<ul style="list-style-type: none"> <li>• Disable: The auto door unlock operation will be canceled.</li> <li>• Vehicle Off / Key out (if equipped): All doors will be automatically unlocked when the ignition key is removed from the ignition switch or the Engine Star/Stop button is set to the OFF position.</li> <li>• On shift to P (if equipped with Dual clutch transmission/ Intelligent variable transmission) : All doors will be automatically unlocked if the gear is shifted to the P (Park) position.(With the Engine ON, it is activated.)</li> </ul>

\* The information provided may differ depending on which functions are applicable to your vehicle.

#### 4. Lights

	Explanation
One touch turn indicator	<ul style="list-style-type: none"> <li>Off: The one touch turn signal function will be deactivated.</li> <li>3, 5, 7 Flashes: The turn signal indicator will blink 3, 5, or 7 times when the turn signal lever is moved slightly.</li> </ul> <p>* For more details, refer to "Lighting" on page 4–90.</p>
Head Lamp Delay	If this item checked, the head lamp delay function will be activated.

\* The information provided may differ depending on which functions are applicable to your vehicle.

#### 5. Sound

	Explanation
Welcome sound	If this item checked, the welcome sound function will be activated.

\* The information provided may differ depending on which functions are applicable to your vehicle.

#### 6. Convenience (if equipped)

	Explanation
Welcome Mirror	If this item checked, the welcome Mirror function will be activated.
Wiper/Lights Display	If this item checked, the Wiper/Lights Display will be activated.
Auto rear wiper (reverse)	If this item checked, the Auto rear wiper will be activated.
Gear Position Pop-up	If this item is checked, the Gear position pop-up display will be activated.
Icy road warning	If this item is checked, the Icy road warning display will be activated.

\* The information provided may differ depending on which functions are applicable to your vehicle.

#### 7. Service Interval

	Explanation
Enable Service Interval	If this item is checked, the Service Interval function will be activated.

	Explanation
Adjust Interval	If the service interval menu is activated, you may adjust the time and distance.
Reset	To reset the service interval function.

**\* NOTICE**

To use the service interval menu, consult an authorized Kia dealer.

If the service interval is activated and the time and distance is adjusted, messages are displayed in the following situations each time the vehicle is turned on.

- Service in: Displayed to inform the driver the remaining mileage and days to service.
- Service required: Displayed when the mileage and days to service has been reached or passed.

If any of the following conditions occur, the mileage and number of days to service may be incorrect.

- The battery cable is disconnected.
- The battery is discharged.

**8. Other features (if equipped)**

	Explanation
Fuel Economy Auto Reset	If this item checked, the average fuel economy will reset automatically after refueling or after ignition.
Fuel Economy Unit	<ul style="list-style-type: none"> <li>• US gallon, UK gallon</li> </ul> To select the Fuel economy unit. * For more details, refer to "Trip Computer" in this chapter.
Temperature Unit	<ul style="list-style-type: none"> <li>• °F / °C</li> </ul> To select the Temperature unit.
Tire Pressure Unit	<ul style="list-style-type: none"> <li>• psi, kPa, bar</li> </ul> To select the Tire Pressure Unit
Torque Unit	<ul style="list-style-type: none"> <li>• N·m, lbf·ft</li> </ul> To select the Torque Unit
Turbo boost pressure Unit	<ul style="list-style-type: none"> <li>• psi, kPa, bar</li> </ul> To select the Turbo boost pressure Unit

\* The information provided may differ depending on which functions are applicable to your vehicle.

**9. Reset**

	Explanation
Reset	You can reset the menus in the User Settings mode. All menus in the User Settings mode are reset to factory settings, except language and service interval.

## LCD displays (if equipped)

LCD displays show the following information to drivers.



- Trip information
- LCD modes
- Warning messages

### Trip information (Trip computer)

The trip computer is a microcomputer-controlled driver information system that displays information related to driving.

#### \* NOTICE

Some driving information stored in the trip computer resets if the battery is disconnected.

### Trip Modes

To change the trip mode, scroll the toggle the switch (∧ / ∨) on the steering wheel.

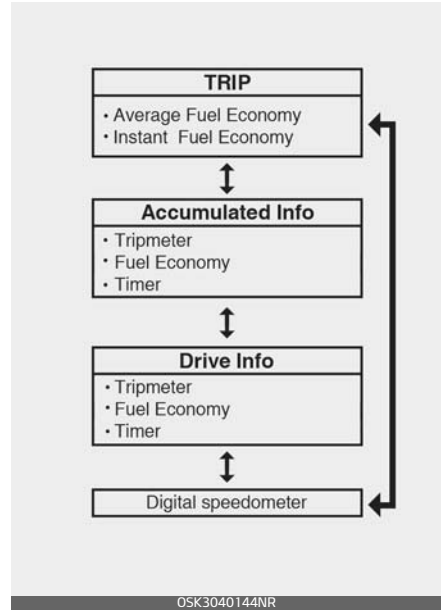

### Fuel Economy

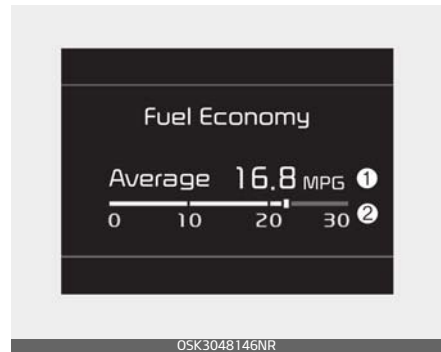

### Average Fuel Economy (1)

- The average fuel economy is calculated by the total driving distance and fuel consumption since the last average fuel economy reset.

- Fuel economy range: 0~99.9 mpg or L/100 km
- The average fuel economy can be reset both manually and automatically.

**Manual reset**

To clear the average fuel economy manually, press the OK button on the steering wheel for more than 1 second when the average fuel economy is displayed.

**Automatic reset**

To automatically reset the average fuel economy select either menu from the 'Fuel economy auto reset' in the User Settings mode on the LCD display.

- OFF - You may set to default manually by using the trip switch reset button.
- After ignition - The vehicle will automatically set to default once 4 hours pass after the Ignition is in OFF.
- After refueling - After refueling more than 1.6 gallons (6 liters) and driving over 1 mph (1 km/h), the vehicle will reset to default automatically.

**\* NOTICE**

The average fuel economy is not displayed for more accurate calculation if the vehicle does not drive more than 10 seconds or 0.03 miles (50 meters) since the ignition switch

or ENGINE START/STOP button is turned to ON.

**Instant Fuel Economy (2)**

- This mode displays the instant fuel economy during the last few seconds when the vehicle speed is more than 6.2 mph (10 km/h).
  - Fuel economy range: 0.0~50.0 mpg or 0.0~30 km/L, L/100 km

**Accumulated Info display**

This display shows the accumulated trip distance (1), the average fuel efficiency (2), and the total driving time (3).



- Accumulated information is calculated after the vehicle has run for more than 0.19 miles (300 meters).
- If you press "OK" button for more than 1 second after the Cumulative Information is displayed, the information will be reset.

- If the engine is running, even when the vehicle is not in motion, the information will be accumulated.

**\* NOTICE**

The vehicle must be driven for a minimum of 0.19 miles (300 meters) since the last ignition key cycle before the average accumulated driving information is recalculated.

**Drive Info display**

This display shows the trip distance (1), the average fuel efficiency (2), and the total driving time (3) information once per one ignition cycle.



- Fuel efficiency is calculated after the vehicle has run for more than 0.19 miles (300 meters).
- The Driving Information will be reset 4 hours after ignition has been turned off. So, when the vehicle ignition is turned on within

4 hours, the information will not be reset.

- If you press "OK" button for more than 1 second after the Driving Information is displayed, the information will be reset.
- If the engine is running, even when the vehicle is not in motion, the information will be accumulated.

**\* NOTICE**

The vehicle must be driven for a minimum of 0.19 miles (300 meters) since the last ignition key cycle before the driving information is recalculated.

**Digital speedometer**

This digital speedometer display shows the speed of the vehicle.

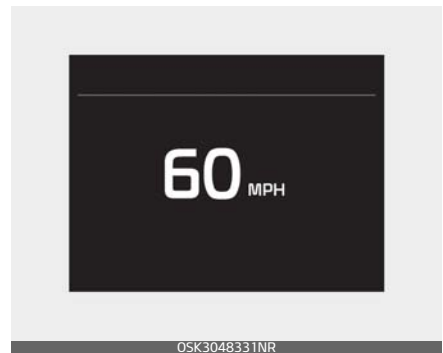

**Service Mode**

This mode reminds you of scheduled maintenance information.



### ***Service in***

It calculates and displays when you need a scheduled maintenance service (mileage or days).

If the remaining mileage or time reaches 900 miles (1,500 km) or 30 days, "Service in" message is displayed for several seconds each time you set the ignition switch or ENGINE START/STOP button to the ON position.

### ***Service required***

If you do not have your vehicle serviced according to the already inputted service interval, "Service required" message is displayed for several seconds each time you set the ignition switch or ENGINE START/STOP button to the ON position.

To reset the service interval to the mileage and days you inputted before:

- Press the OK button (Reset) for more than 1 second.

#### **\* NOTICE**

If any of the following conditions occurs, the mileage and days may be incorrect.

- The battery cable is disconnected.
- The battery is discharged.

### **Driving info display**

At the end of each driving cycle, the Driving Info message is displayed.



This display shows the trip distance (1), average energy consumption (2), driving time (3).

This information is displayed for a few seconds when you turn off the vehicle, and then goes off automatically. The information is calculated for each time the vehicle is turned on.

#### **\* NOTICE**

- If sunroof open warning is displayed in the cluster, the Driving Information message may not be displayed.

### **LCD display messages**

#### ***Engine has overheated***

This warning message illuminates when the engine coolant temperature is above 248 °F (120 °C). This

mean that the engine is overheated and may be damaged.

\* If your vehicle is overheated, refer to "If the engine overheats" on page 6-8.

### ***Low Key Battery for smart key system***

This warning message illuminates if the battery of the smart key is discharged when the ENGINE START/STOP button changes to the OFF position.

### ***Press START button while turning wheel for smart key system***

It means that you should press the ENGINE START/STOP button while turning the steering wheel right and left.

### ***Steering wheel unlocked for smart key system***

This warning message illuminates if the steering wheel is not lock when the ENGINE START/STOP button changes to the OFF position.

### ***Check Steering Wheel Lock System for smart key system***

This warning message illuminates if there is malfunction in steering wheel lock system when the ENGINE START/STOP button changes to the OFF position.

### ***Press clutch pedal to start engine for smart key system and manual transmission***

This warning message illuminates if the ENGINE START/STOP button changes to the ACC position twice by pressing the button repeatedly without depressing the clutch pedal.

It means that you should depress the clutch pedal to start the engine.

### ***Key not in vehicle for smart key system***

This warning message illuminates if the smart key is not in the vehicle when the ENGINE START/STOP button is in the ON position.

It means that you should always have the smart key with you.

### ***Key not detected for smart key system***

This warning message illuminates if the smart key is not detected when you press the ENGINE START/STOP button.

***Door, Hood, Liftgate open warning display***



This warning is displayed if any door or the hood or the liftgate is left open. The warning will indicate which door is open in the display.

**⚠ CAUTION**

Before driving the vehicle, you should confirm that the door/hood/liftgate is fully closed. Also, check that there is no door/hood/liftgate open warning light or message displayed on the instrument cluster.

***Sunroof open warning display (if equipped)***



This warning is displayed if you turn off the vehicle when the sunroof is open.

Close the sunroof securely before leaving your vehicle.

***Low Pressure warning display***



This warning message is displayed if the tire pressure is low. The corresponding tire on the vehicle will be illuminated.

\* For more details, refer to "Tire Pressure Monitoring System (TPMS)" on page 6-9.

**Lights mode**

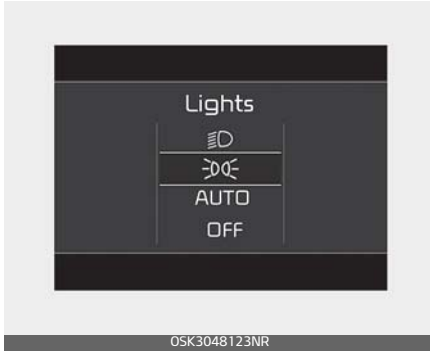

This indicator displays which exterior light is selected using the lighting control.

You can activate or deactivate Wiper/Lights Display function from the User Settings mode in the cluster LCD display.

**Wiper mode**



This indicator displays which wiper speed is selected using the wiper control.

You can activate or deactivate Wiper/Lights Display function from the User Settings mode in the cluster LCD display.

**Shift to P or N to start engine for smart key system**

This warning message illuminates if you try to start the engine with the shift lever not in the P (Park) or N (Neutral) position.

**Press brake pedal to start engine for smart key system**

This warning message illuminates if the ENGINE START/STOP button changes to the ACC position twice by pressing the button repeatedly without depressing the brake pedal.

It means that you should depress the brake pedal to start the engine.

**Battery discharging due to external electrical devices**

The vehicle can detect self-discharge of the battery due to over-current that is generated by unauthorized electrical devices such as dashboard camera(dash cam) mounting during parking.

Please note that functions such as Idle Stop and Go (ISG) are limited

and battery discharge problems may occur.

If the warning continues even after external electrical devices are removed, have your vehicle inspected by an authorized Kia dealer.

***Press START button again for smart key system***

This warning message illuminates if you cannot operate the ENGINE START/STOP button when there is a problem with the ENGINE START/STOP button system.

It means that you could start the engine by pressing the ENGINE START/STOP button once more.

If the warning illuminates each time you press the ENGINE START/STOP button, have the vehicle inspected by an authorized Kia dealer.

***Press START button with key for smart key system***

This warning message illuminates if you press the ENGINE START/STOP button while the warning message "Key not detected" is illuminating.

At this time, the immobilizer indicator light blinks.

***Check High Beam Assist (HBA) (if equipped)***

This warning message is displayed if there is a problem with the HBA. Have your vehicle inspected by an authorized Kia dealer.

\* For more details, refer to "High Beam Assist (HBA) (if equipped)" on page 4-94

***Check Forward Collision-avoidance Assist (FCA) (if equipped)***

This warning message is displayed if there is a problem with the FCA. Have your vehicle inspected by an authorized Kia dealer.

\* For more details, refer to "Forward Collision-Avoidance Assist (FCA) (Front view camera only) (if equipped)" on page 5-55

***Check Smart Cruise Control (SCC) System (if equipped)***

This warning message is displayed if there is a problem with the SCC. Have your vehicle inspected by an authorized Kia dealer.

\* For more details, refer to "Smart Cruise Control (SCC) (if equipped)" on page 5-106

***Check BCW System (if equipped)***

This warning message is displayed if there is a problem with the Blind-Spot Collision Warning system. In

this case, have the vehicle inspected by an authorized Kia dealer.

\* For more information, refer to "Blind-Spot Collision Warning (BCW) (if equipped)" on page 5-89.

### ***Check DAW System (if equipped)***

This warning message is displayed if there is a problem with the Driver Attention Alert system. In this case, have the vehicle inspected by an authorized Kia dealer.

\* For more information, refer to "Driver Attention Warning (DAW) (if equipped)" on page 5-98.

### ***Icy Road Warning (if equipped)***

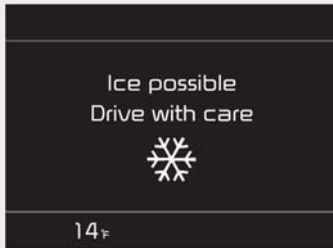

OSK3048141NR

This warning is to warn the driver the road may be icy.

When the following conditions occur, the warning light (including Outside Temperature Gauge) blinks 5 times and then illuminates, and also warning chime sounds once.

- The temperature on the Outside Temperature Gauge is below approximately 40 °F (4 °C).

### **\* NOTICE**

If the icy road warning appears while driving, you should drive more attentively and safely refraining from over-speeding, rapid acceleration, sudden braking or sharp turning, etc.

## Warning and indicator lights

The warning light and indicator light indicate a situation where the driver should be careful and whether the various functions are activated.

### Warning lights

The warning light indicates situations that require the driver to pay attention.

#### \* NOTICE

### Warning lights

Make sure that all warning lights are OFF after starting the vehicle. If any light is still ON, this indicates a situation that needs attention.

### Air bag Warning Light

#### This warning light illuminates:

- Once you set the ignition switch or ENGINE START/STOP button to the ON position.
  - It illuminates for approximately 6 seconds and then goes off.
- When there is a malfunction with the SRS.

In this case, have the vehicle inspected by an authorized Kia dealer.

### Seat Belt Warning Light

This warning light informs the driver that the seat belt is not fastened.

\* For more details, refer to "Seat belts" on page 3-18.

### Parking Brake & Brake Fluid Warning Light

#### This warning light illuminates:

- Once you set the ignition switch or ENGINE START/STOP button to the ON position.
  - It illuminates for approximately 3 seconds
  - It remains on if the parking brake is applied.
- When the parking brake is applied.
- When the brake fluid level in the reservoir is low.
  - If the warning light illuminates with the parking brake released, it indicates the brake fluid level in reservoir is low.

#### If the brake fluid level in the reservoir is low:

1. Drive carefully to the nearest safe location and stop your vehicle.
2. With the vehicle stopped, check the brake fluid level immediately and add fluid as required (For more details, refer to "Brake fluid" on page 7-24). Then check all brake components for fluid leaks. If any leak on the brake system is

still found, the warning light remains on, or the brakes do not operate properly, do not drive the vehicle.

In this case, have your vehicle towed to an authorized Kia dealer and inspected.

### Dual-diagonal braking system

Your vehicle is equipped with dual-diagonal braking systems. This means you still have braking on two wheels even if one of the dual systems should fail.

With only one of the dual systems working, greater pedal pressure are required to stop the vehicle.

Also, the vehicle will require increased stopping distance with only a portion of the brake system working.

## ⚠ WARNING

### Parking Brake & Brake Fluid Warning Light

Driving the vehicle with a warning light ON is dangerous. If the Parking Brake & Brake Fluid Warning Light illuminates with the parking brake released, it indicates that the brake fluid level is low.

In this case, have your vehicle inspected by an authorized Kia dealer.

### Anti-lock Brake System (ABS) Warning Light

#### This warning light illuminates:

- Once you set the ignition switch or ENGINE START/STOP button to the ON position.
  - It illuminates for approximately 3 seconds and then goes off.
- When there is a malfunction with the ABS (The normal braking system will still be operational without the assistance of the anti-lock brake system).

In this case, have your vehicle inspected by an authorized Kia dealer.

### Electronic Brake force Distribution (EBD) System Warning Light



#### These two warning lights illuminate at the same time while driving:

- When the ABS and regular brake system may not work normally. In this case, have your vehicle inspected by an authorized Kia dealer.

## ⚠ WARNING

### Electronic Brake force Distribution (EBD) System Warning Light

When both ABS and Parking Brake & Brake Fluid Warning Lights are on, the brake system will not work normally and you may experience an



unexpected and dangerous situation during sudden braking.

In this case, avoid high speed driving and abrupt braking.

Have your vehicle inspected by an authorized Kia dealer as soon as possible.

**Electronic Power Steering (EPS)**

**Warning Light** 

**This warning light illuminates:**

- Once you set the ignition switch or ENGINE START/STOP button to the ON position.
  - It remains on until the vehicle is started.
  - When there is a malfunction with the EPS.
- When there is a malfunction with the EPS.

In this case, have your vehicle inspected by an authorized Kia dealer.

**Charging System Warning Light**



**This warning light illuminates:**

- Once you set the ignition switch or ENGINE START/STOP button to the ON position.
- When there is a malfunction with either the alternator or electrical charging system.

**If there is a malfunction with either the alternator or electrical charging system:**

1. Drive carefully to the nearest safe location and stop your vehicle.
2. Turn the engine off and check the alternator drive belt for looseness or breakage.

In this case, have the vehicle inspected by an authorized Kia dealer.

**Malfunction Indicator Lamp (MIL)**



**This warning light illuminates:**

- Once you set the ignition switch or ENGINE START/STOP button to the ON position.
    - It remains on until the engine is started.
  - When there is a malfunction with the emission control system.
- In this case, have the vehicle inspected by an authorized Kia dealer.

**CAUTION**

**Malfunction Indicator Lamp (MIL)**

Driving with the Malfunction Indicator Lamp (MIL) on may cause damage to the emission control systems which could effect drivability and/or fuel economy.

**⚠ CAUTION**

If the Malfunction Indicator Lamp (MIL) illuminates, potential catalytic converter damage is possible which could result in loss of engine power. In this case, have the vehicle inspected by an authorized Kia dealer.

**Engine Oil Pressure Warning Light****This warning light illuminates:**

- Once you set the ignition switch or ENGINE START/STOP button to the ON position.
  - It remains on until the engine is started.
- When the engine oil pressure is low.

**If the engine oil pressure is low:**

1. Drive carefully to the nearest safe location and stop your vehicle.
2. Turn the engine off and check the engine oil level (For more details, refer to "Engine oil and filter" on page 7-19. If the level is low, add oil as required.

If the warning light remains on after adding oil or if oil is not available, have the vehicle inspected by an authorized Kia dealer.

**⚠ CAUTION****Engine Overheating**

Do not continue driving with the engine overheated. Otherwise the engine may be damaged.

**⚠ CAUTION****Engine damage**

If the engine is not stopped immediately after the engine oil pressure warning light is illuminated and stays on while the engine is running, serious engine damage may result.

**Low Fuel Level Warning Light** **This warning light illuminates:**

When the fuel tank is nearly empty.

**If the fuel tank is nearly empty:**

Add fuel as soon as possible.

**⚠ CAUTION****Low Fuel Level**

Driving with the Low Fuel Level warning light on or with the fuel level below "E" can cause the engine to misfire and damage the catalytic converter. (if equipped)

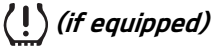
**Low Tire Pressure Warning Light***(if equipped)***This warning light illuminates:**

- Once you set the ignition switch or ENGINE START/STOP button to the ON position.
  - It illuminates for approximately 3 seconds and then goes off.
- When one or more of your tires are significantly under inflated. (The location of the underinflated tires are displayed on the LCD display).
- \* For more details, refer to "Tire Pressure Monitoring System (TPMS)" on page 6-9.

**This warning light remains on after blinking for approximately 60 seconds or repeats blinking on and off at the intervals of approximately 3 seconds:**

- When there is a malfunction with the TPMS.
 

In this case, have your vehicle inspected by an authorized Kia dealer.
- \* For more details, refer to "Tire Pressure Monitoring System (TPMS)" on page 6-9.

**⚠ WARNING****Low tire pressure**

- Significantly low tire pressure makes the vehicle unstable and can contribute to loss of vehicle

control and increased braking distances.

- Continued driving on low pressure tires will cause the tires to over-heat and fail.

**⚠ WARNING****Safe Stopping**

- The TPMS cannot alert you to severe and sudden tire damage caused by external factors.
- If you notice any vehicle instability, immediately take your foot off the accelerator pedal, apply the brakes gradually with light force, and slowly move to a safe position off the road.

**Master Warning Light** **This warning light informs the driver the following situations**

- Forward Collision-Avoidance Assist system malfunction (if equipped)
- Forward Collision-Avoidance Assist radar blocked (if equipped)
- Blind-Spot Collision Warning system malfunction (if equipped)
- Blind-Spot Collision Warning radar blocked (if equipped)
- LED headlamp malfunction (if equipped)
- Lamp malfunction

- High Beam Assist malfunction (if equipped)
- Smart Cruise Control malfunction (if equipped)
- Smart Cruise Control radar blocked (if equipped)

To identify the details of the warning, look at the LCD display.

### **LED Headlamp Warning Light** (if equipped)

#### **This warning light illuminates:**

- Once you set the ignition switch or ENGINE START/STOP button to the ON position.
  - It illuminates for approximately 3 seconds and then goes off.
- When there is a malfunction with the LED headlamp.

In this case, have your vehicle inspected by an authorized Kia dealer.

#### **This warning light blinks:**

- When there is a malfunction with a LED headlamp related part.

In this case, have your vehicle inspected by an authorized Kia dealer.

## CAUTION

### **LED Headlamp Warning Light**

Continuous driving with the LED Headlamp Warning Light on or blinking can reduce LED headlamp (low beam) life.

### **Forward Collision-Avoidance Assist system Warning Light** (if equipped)

#### **This indicator light illuminates:**

- Once you set the ignition switch or ENGINE START/STOP button to the ON position.
  - It illuminates for approximately 3 seconds and then goes off.
- When FCA system is turned off.
- When the radar sensor or cover is blocked with dirt or snow. Check the sensor and cover and clean them by using a soft cloth.
- When there is a malfunction with FCA. If this occurs, have your vehicle inspected by an authorized Kia dealer.

\* For more details, refer to "Forward Collision-Avoidance Assist (FCA) (Sensor fusion) (if equipped)" on page 5-66.

### **Door Ajar Warning Light** (if equipped)

#### **This warning light illuminates:**

When a door is not closed securely.

### **Liftgate Open Warning Light** (if equipped)

#### **This warning light illuminates:**

When the liftgate is not closed securely.

### **Washer Fluid Warning Light** (if equipped)

#### **This warning light illuminates:**

- When the washer fluid level in the reservoir is nearly empty.  
In this case, you should refill the washer fluid.

### **Indicator lights**

The indicator light indicates whether the various functions are activated.

### **Electronic Stability Control (ESC) Indicator Light**

#### **This indicator light illuminates:**

- Once you set the ignition switch or ENGINE START/STOP button to the ON position.
  - It illuminates for approximately 3 seconds and then goes off.
- When there is a malfunction with the ESC system.  
In this case, have your vehicle inspected by an authorized Kia dealer.

#### **This indicator light blinks:**

While the ESC is operating.

- \* For more details, refer to "Electronic stability control (ESC)" on page 5-43.

### **Electronic Stability Control (ESC) OFF Indicator Light**

#### **This indicator light illuminates:**

- Once you set the ignition switch or ENGINE START/STOP button to the ON position.
    - It illuminates for approximately 3 seconds and then goes off.
  - When you deactivate the ESC system by pressing the ESC OFF button.
- \* For more details, refer to "Electronic stability control (ESC)" on page 5-43.

### **Immobilizer Indicator Light (Without Smart Key)**

#### **This indicator light illuminates:**

- When the vehicle detects the immobilizer in your key properly while the ignition switch is ON.
  - At this time, you can start the engine.
  - The indicator light goes off after starting the engine.

#### **This indicator light blinks:**

When there is a malfunction with the immobilizer system.

In this case, have the vehicle inspected by an authorized Kia dealer.

### **Immobilizer Indicator Light (With Smart Key)**

#### **This indicator light illuminates for up to 30 seconds:**

- When the vehicle detects the smart key in the vehicle properly while the ENGINE START/STOP button is ACC or ON.
  - At this time, you can start the engine.
  - The indicator light goes off after starting the engine.

#### **This indicator light blinks for a few seconds:**

- When the smart key is not in the vehicle.
  - At this time, you cannot start the engine.

#### **This indicator light illuminates for 2 seconds and goes off:**

- When the vehicle cannot detect the smart key which is in the vehicle while the ENGINE START/STOP button is ON.  
In this case, have your vehicle inspected by an authorized Kia dealer.

#### **This indicator light blinks:**

- When the battery of the smart key is weak.
- When there is a malfunction with the immobilizer system.  
In this case, have your vehicle inspected by an authorized Kia dealer.

### **Auto stop indicator**

This indicator will illuminate when the engine enters the Idle Stop mode of the ISG (Idle Stop and Go) system.

When the automatic starting occurs, the auto stop indicator on the cluster will blink for 5 seconds.

- \* For more details, refer to "ISG (Idle Stop and Go) system" on page 5-49.

#### **\* NOTICE**

When the engine automatically starts by the ISG system, warning lights (ABS, ESC, ESC OFF, EPS or Parking brake warning light) may turn on for a few seconds.

This happens because of the low battery voltage. It does not mean the system is malfunctioning.

### **Turn Signal Indicator Light**

#### **This indicator light blinks:**

- When you turn the turn signal light on.

If any of the following occurs, there may be a malfunction with the turn signal system.

In this case, have your vehicle inspected by an authorized Kia dealer.

- The indicator light does not blink but illuminates.

- The indicator light blinks more rapidly.
- The indicator light does not illuminate at all.

**Low Beam Indicator Light**  (if equipped)

- This indicator light illuminates:**
- When the headlights are on.

**High Beam Indicator Light** 

- This indicator light illuminates:**
- When the headlights are on and in the high beam position.
  - When the turn signal lever is pulled into the Flash-to-Pass position.

**High beam assist indicator**  (if equipped)

- This warning light illuminates:**
- When the High-Beam is on with the light switch in the AUTO light position.
  - If your vehicle detects oncoming or preceding vehicles, the high beam assist system will switch the high beam to low beam automatically.
- \* For more details, refer to "High Beam Assist (HBA) (if equipped)" on page 4-94.

**Light ON Indicator Light** 

- This indicator light illuminates:**
- When the tail lights or headlights are on.

**Front Fog Indicator Light**  (if equipped)

- This indicator light illuminates:**
- When the front fog lights are on.

**Lane Keeping Assist system Indicator**  (if equipped)

The LKA indicator will illuminate when you turn the lane keeping assist system on by pressing the Lane Safety button.

If there is a problem with the system, the yellow LKA indicator will illuminate.

\* For more details, refer to "Lane Keeping Assist (LKA) (if equipped)" on page 5-81.

**Cruise Indicator Light**  (if equipped)

- This indicator light illuminates:**
- When the cruise control system is enabled.
- \* For more details, refer to "Smart Cruise Control (SCC) (if equipped)" on page 5-106.

**SPORT Mode Indicator Light****SPORT** (if equipped)**This indicator light illuminates:**

- When you select "SPORT" mode as drive mode.
- \* For more details, refer to "Drive mode integrated control system (if equipped)" on page 5-53.

**ECO Mode Indicator Light** **ECO**  
(if equipped)**This indicator light illuminates:**

- When you select "ECO" mode as drive mode.
- \* For more details, refer to "Drive mode integrated control system (if equipped)" on page 5-53.

**Head-Up Display (HUD) (if equipped)**

The Head-Up Display is a transparent display which projects a shadow of some information of the instrument cluster and navigation on the HUD screen.

**Head-Up Display screen operation**

The hidden screen will go up when you press the screen operation switch on the left side of the lower part of crash pad and if you press the switch again, the screen will return to its original hidden position.





- The Head-Up Display closes automatically when the door is locked with the smart key in the vehicle OFF state.
- For smart key vehicles, the lock/unlock button on the outside handle of the front door automatically closes the Head-Up Display when the door is locked.
- If you do not lock the door in the vehicle OFF state, the Head-Up Display closes automatically after about 5 minutes.
- The Head-Up Display image on the HUD screen may not be visible when:
  - Sitting posture is bad.
  - Wearing a polarized sunglasses.
  - There is an object on the cover of the Head-Up Display.
  - Driving on a wet road.
  - Lighting is turned on inside the vehicle.
  - Any light comes from the outside.
  - Wearing inadequate glasses for your eyesight.
- If the Head-Up Display image is not shown well, adjust the height, rotation or illumination of the Head-Up Display in the cluster.
- When the Head-Up Display needs inspection or repair, have your vehicle inspected or repaired by an authorized Kia dealer.

### WARNING

#### Head-Up Display

For safety, be sure to adjust the settings when vehicle stopped.

### CAUTION

- Do not place any accessories on the Head-Up Display shutter. It might fall into Head-Up Display and can damage to Head-Up Display.
- Do not attach stickers or accessories to the Head-Up Display and the crash pad.
- Do not manually adjust the shutter and combiner. The images may not be visible due to fingerprints. Excessive external force during operation may cause damage.
- Do not place any objects near the Head-Up Display. Interference with the object during operation may damage it.
- Do not place any objects around the Head-Up Display. It might enter the narrow gap of the cover and affects operation.
- Do not place any liquids around the Head-Up Display. Water or other liquids can break when it flows into the Head-Up Display.
- Do not expose the combiner to strong light. The combiner may be deformed.

- Do not use organic solvents, detergents or abrasive cloths to clean the Head-Up Display. Wipe it off with a soft cloth. Do not strongly wipe Head-Up Display shutter. it might be damaged.
- For safety, be sure to adjust the settings when vehicle stopped.
- When opening, closing and height adjusting the Head-Up Display, noise may be generated by the motor and gear.

\* Road Signs and Turn By Turn navigation information are available depending on the region.

### Head-Up Display Setting

On the LCD display, you can change the Head-Up Display settings as follows.

1. Display height
2. Rotation
3. Brightness
4. Content selection

\* For more details, refer to "LCD Display Modes" on page 4-53

### Head-Up Display Information

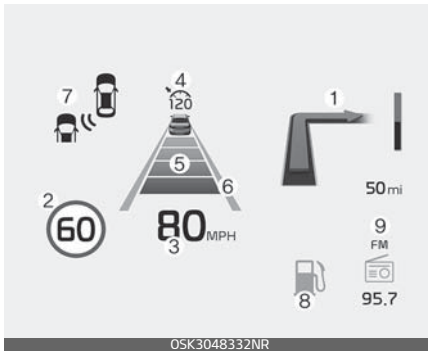

1. Turn By Turn navigation information
2. Road signs
3. Speedometer
4. Cruise setting speed
5. SCC headway information
6. Lane Safety information
7. Blind-Spot Safety information
8. Warning lights (Low fuel)
9. AV mode information

### Rear View Monitor (RVM)

Rear View Monitor system will activate with the ignition switch or START/STOP button in the ON and the shift lever in the R (Reverse) position.



\* If your vehicle is equipped with multimedia system, rearview display image will show behind the vehicle through the multimedia screen while backing-up. Refer to a separately supplied manual for detailed information.

### **⚠ WARNING**

#### **Backing up & using camera**

Never rely solely on the rear view camera when backing up. You must always use methods of viewing the area behind you, including looking over both shoulders, as well as continuously checking all three rear view mirrors. Due to the difficulty of ensuring that the area behind you remains clear, always back up slowly and stop immediately if you even suspect that a person, and especially a child, might be behind you.

- This system is a supplemental system only. It is the responsibility of the driver to always check the inside/outside rearview mirrors and the area behind the vehicle before and while backing up.
- Always keep the camera lens clean. If lens is covered with foreign matter, the camera may not operate normally.

## Reverse Parking Distance Warning (PDW) (if equipped)

Reverse Parking Distance Warning system assists the driver during backward movement of the vehicle by chiming if any object is sensed within a distance of 48 in (120 cm) behind the vehicle.



This system is a supplemental system and it is not intended to nor does it replace the need for extreme care and attention of the driver. The sensing range and objects detectable by the back sensors (1) are limited. Whenever backing-up, pay as much attention to what is behind you as you would in a vehicle without Reverse Parking Distance Warning system.

### **⚠ WARNING**

#### **Reverse Parking Distance Warning system**

Never rely solely on Reverse Parking Distance Warning system. Always perform a visual inspection to make

sure the vehicle is clear of all obstructions before moving the vehicle in any direction. Stop immediately if you are aware of a child anywhere near your vehicle. Some objects may not be detected by the sensors, due to the object's size or material.

#### **Operation of Reverse Parking Distance Warning system**

##### **Operating condition**

- This system will activate when the indicator on the Reverse Parking Distance Warning system OFF button is not illuminated. If you desire to deactivate Reverse Parking Distance Warning system, press the Reverse Parking Distance Warning system OFF button again. (The indicator on the button will illuminate.) To turn the system on, press the button again. (The indicator on the button will go off.)
- This system will activate when backing up with the ignition switch ON. If the vehicle is moving at a speed over 3 mph (5 km/h), the system may not be activated correctly.
- The sensing distance while the back-up warning system is in operation is approximately 48 in (120 cm) at the rear bumper cen-

ter area, 24 in (60 cm) at the rear bumper side area.

- When more than two objects are sensed at the same time, the closest one will be recognized first.

**Types of warning sound**

- When an object is 24 in to 48 in (60 cm to 120 cm) from the rear bumper: Buzzer beeps intermittently.
- When an object is 12 in to 24 in (30 cm to 60 cm) from the rear bumper: Buzzer beeps more frequently.
- When an object is within 12 in (30 cm) of the rear bumper: Buzzer sounds continuously.

**Non-operational conditions of Reverse Parking Distance Warning system**

**Reverse Parking Distance Warning system may not operate properly when:**

1. Moisture is frozen to the sensor. (It will operate normally once the moisture clears.)
2. The sensor is covered with foreign matter, such as snow or water, or the sensor cover is blocked. (It will operate normally when the material is removed or the sensor is no longer blocked.)

3. Driving on uneven road surfaces (unpaved roads, gravel, bumps, gradient).
4. Objects generating excessive noise (vehicle horns, loud motorcycle engines, or truck air brakes) are within range of the sensor.
5. Rain or water spray exists.
6. Wireless transmitters or mobile phones are within range of the sensor.
7. The sensor is covered with snow.
8. Trailer towing

**The detecting range may decrease when:**

1. The sensor is covered with foreign matter such as snow or water. (The sensing range will return to normal when removed.)
2. Outside air temperature is extremely hot or cold.

**The following objects may not be recognized by the sensor:**

1. Sharp or slim objects such as ropes, chains or small poles.
2. Objects which tend to absorb the sensor frequency such as clothes, sound absorbent material or snow.
3. Undetectable objects smaller than 40 in (100 cm) in height and narrower than 6 in (14 cm) in diameter.

### Reverse Parking Distance Warning system precautions

- Reverse Parking Distance Warning system may not sound consistently depending on the speed and shapes of the objects detected.
- Reverse Parking Distance Warning system may malfunction if the vehicle bumper height or sensor installation has been modified or damaged. Any non-factory installed equipment or accessories may also interfere with the sensor performance.
- The sensor may not recognize objects less than 12 in (30 cm) from the sensor, or it may sense an incorrect distance. Use caution.
- When the sensor is frozen or covered with snow, dirt, or water, the sensor may be inoperative until the material is removed using a soft cloth.
- To prevent damage, do not push, scratch or strike the sensor.

#### \* NOTICE

This system can only sense objects within the range and location of the sensors; it cannot detect objects in other areas where sensors are not installed. Also, small or slim objects, such as poles or objects located between sensors may not be detected by the sensors. Pay close attention when the vehicle is driven

close to objects on the road, particularly pedestrians, and especially children. Always visually check behind the vehicle when backing up. Be sure to inform any drivers of the vehicle that may be unfamiliar with the system regarding the system's capabilities and limitations.

### Self-diagnosis

If you don't hear an audible warning sound or if the buzzer sounds intermittently when shifting the gear to the R (Reverse) position, this may indicate a malfunction in Reverse Parking Distance Warning system. If this occurs, have your vehicle checked by an authorized Kia dealer as soon as possible.

#### \* NOTICE

Your new vehicle warranty does not cover any accidents or damage to the vehicle or injuries to its occupants. Always drive safely and cautiously.

### Forward/Reverse Parking Distance Warning (PDW) (if equipped)

Forward/Reverse Parking Distance Warning system assists the driver during movement of the vehicle by chiming if any object is sensed within the distance of 40 in (100 cm) in front and 48 in (120 cm) behind the vehicle.

Rear



Front



The sensing range and objects detectable by the sensors (1) are limited. Whenever moving pay as

much attention to what is in front and behind of you as you would in a vehicle without Forward/Reverse Parking Distance Warning system.

### ⚠ WARNING

Forward/Reverse Parking Distance Warning system is a supplemental system only.

The operation of Forward/Reverse Parking Distance Warning system can be affected by several factors (including environmental conditions).

It is the responsibility of the driver to always check the front and rear views before and while parking.

### Operation of Forward/Reverse Parking Distance Warning system

#### Operating condition

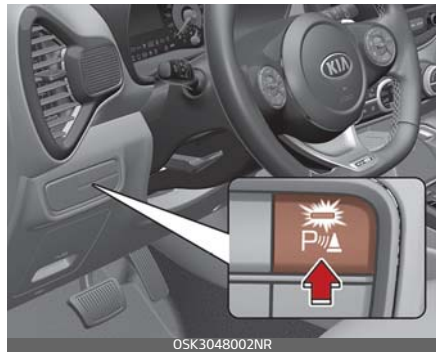

- This system activates when the Parking Safety button is pressed with the ignition switch or START/STOP button ON.

- The indicator of the Parking Safety button turns on automatically and activates Forward/Reverse Parking Distance Warning system when you shift the gear to the R (Reverse) position. It will turn off automatically when you drive above 6.2 mph (10 km/h).
- The sensing distance while backing up is approximately 48 in (120 cm) when you are driving less than 6.2 mph (10 km/h).
- The sensing distance while moving forward is approximately 40 in (100 cm) when you are driving less than 6.2 mph (10 km/h).
- When more than two objects are sensed at the same time, the







closest one will be recognized first.

- The side sensors are activated when you shift the gear to the R (Reverse) position.
- If the vehicle speed is above 6.2 mph (10 km/h) the system automatically turns off.

**\* NOTICE**

It may not operate if the vehicle's distance from the object is already less than approximately 10 in (25 cm) when the system is activated.

**Type of warning indicator and sound**

Distance from object		Warning indicator		Warning sound
		When driving forward	When driving backward	
24 ~ 40 in (60 ~ 100 cm)	Front		-	Buzzer beeps intermittently
24 ~ 48 in (60 ~ 120 cm)	Rear	-		Buzzer beeps intermittently
12 ~ 22 in (30 ~ 60 cm)	Front			Buzzer beeps frequently
	Rear	-		Buzzer beeps frequently
12 in (30 cm)	Front			Buzzer beeps continuously
	Rear	-		Buzzer beeps continuously



**\* NOTICE**

- The actual warning sound and indicator may differ from the illustration depending on the objects or sensor status.
  - Do not wash the vehicle's sensor with high pressure water.
- 

**\* NOTICE**

- This system can only sense objects within the range and location of the sensors; it cannot detect objects in other areas where sensors are not installed. Also, small or slim objects, such as poles, or objects located between sensors may not be detected by the sensors. Always visually check behind the vehicle when backing up.
  - Be sure to inform any drivers of the vehicle that may be unfamiliar with the system regarding the systems capabilities and limitations.
- 

**Non-operational conditions of Forward/Reverse Parking Distance Warning system**

**Forward/Reverse Parking Distance Warning system may not operate normally when:**

- Moisture is frozen to the sensor. (It will operate normally when moisture melts.)

- Sensor is covered with foreign matter, such as snow or water, or the sensor cover is blocked. (It will operate normally when the material is removed or the sensor is no longer blocked.)
- Sensor is stained with foreign matter such as snow or water. (Sensing range will return to normal when removed.)
- The Parking Safety button is off.

**There is a possibility of Forward/Reverse Parking Distance Warning system malfunction when:**

- Driving on uneven road surfaces such as unpaved roads, gravel, bumps, or gradient.
- Objects generating excessive noise such as vehicle horns, loud motorcycle engines, or truck air brakes can interfere with the sensor.
- Heavy rain or water spray.
- Wireless transmitters or mobile phones present near the sensor.
- Sensor is covered with snow.

**Detecting range may decrease when:**

- Outside air temperature is extremely hot or cold.
- Undetectable objects smaller than 4 in (100 cm) and narrower than 6 in (14 cm) in diameter.

**The following objects may not be recognized by the sensor:**

- Sharp or slim objects such as ropes, chains or small poles.
- Objects, which tend to absorb sensor frequency such as clothes, spongy material or snow.

**\* NOTICE**

1. The warning may not sound consistently depending on the speed and shapes of the objects detected.
2. Forward/Reverse Parking Distance Warning system may malfunction if the vehicle bumper height or sensor installation has been modified. Any non-factory installed equipment or accessories may also interfere with the sensor performance.
3. Sensor may not recognize objects less than 12 in (30 cm) from the sensor, or it may sense an incorrect distance. Use with caution.
4. When the sensor is frozen or stained with snow or water, the sensor may be inoperative until the stains are removed using a soft cloth.
5. Do not push, scratch or strike the sensor with any hard objects that could damage the surface of the sensor. Sensor damage could occur.

**\* NOTICE**

This system can only sense objects within the range and location of the sensors, it cannot detect objects in other areas where sensors are not installed. Also, small or slim objects, or objects located between sensors may not be detected.

Always visually check in front and behind the vehicle when driving. Be sure to inform any drivers in the vehicle that may be unfamiliar with the system regarding the systems capabilities and limitations.

**\* NOTICE**

Pay close attention when the vehicle is driven close to objects on the road, particularly pedestrians, and especially children. Be aware that some objects may not be detected by the sensors, due to the objects distance, size or material, all of which can limit the effectiveness of the sensor. Always perform a visual inspection to make sure the vehicle is clear of all obstructions before moving the vehicle in any direction.

**Self-diagnosis**

When you shift the gear to the R (Reverse) position and if one or more of the below occurs you may have a malfunction in Forward/

Reverse Parking Distance Warning system.

- You don't hear an audible warning sound or if the buzzer sounds intermittently.



(blinks) is displayed.

If this occurs, we recommend that the system be checked by an authorized Kia dealer.

### \* NOTICE

Your new vehicle warranty does not cover any accidents or damage to the vehicle or injuries to its occupants. Always drive safely and cautiously.

---

## Lighting

This vehicle is equipped with a variety of lights to illuminate the interior and exterior of the vehicle.

### Battery saver function

The purpose of this feature is to prevent the battery from being discharged if the lights are left in the ON position. The system automatically shuts off the parking lights 30 seconds after the vehicle is turned off and the driver's door is opened and closed.

With this feature, the parking lights will turn off automatically if the driver parks on the side of the road at night and opens the driver's side door.

If necessary, to keep the parking lights on when the vehicle is turned off, perform the following:

1. Open the driver-side door.
2. Turn the parking lights OFF and ON again using the light switch on the steering column.

### Headlight escort function (if equipped)

If you turn the ignition switch or START/STOP button to the ACC or OFF position with the headlights ON, the headlights remain on for about 5 minutes.

However, if the driver's door is opened and closed, the headlights are turned off after 15 seconds.

The headlights can be turned off by pressing the lock button on the transmitter (or smart key) one more or turning the light switch to the OFF position.

**Daytime running light (if equipped)**

The Daytime Running Lights (DRL) can make it easier for others to see the front of your vehicle during the day.

DRL can be helpful in many different driving conditions, and it is especially helpful after dawn and before sunset.

The DRL system will turn the dedicated lamp OFF when:

- The headlight switch is on.
- The taillight is in the ON position.
- The vehicle is off.
- The front fog light is on.
- Engaging the Parking Brake

**Lighting control**

The light switch has a Headlight and a Parking light position.



OSK3040411NR

To operate the lights, turn the knob at the end of the control lever to one of the following positions:

1. OFF position / DRL off position.
2. Auto light position
3. Parking & Tail light
4. Headlight position

4

**Parking Tail light**



OSK3040412NR

When the light switch is in the parking light position, the tail, license and instrument panel lights will turn ON.

**Headlight position** 



OSK3040413NR

When the light switch is in the headlight position, the head, tail, license lights will turn ON.

**\* NOTICE**

The ignition switch or START/STOP button must be in the ON position to turn on the headlights.

**Auto light (if equipped)**

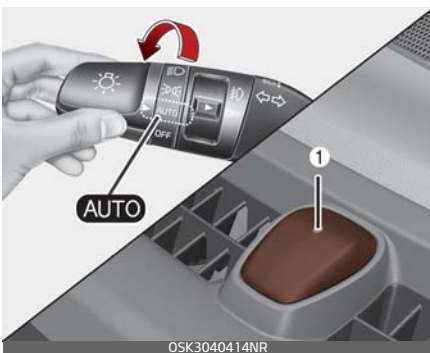

OSK3040414NR

When the light switch is in the AUTO light position, the taillights and headlights will turn ON or OFF auto-

matically depending on the amount of light outside the vehicle.

**⚠ CAUTION**

- Never place anything over the sensor (1) located on the instrument panel, as this will ensure better auto-light system control.
- Do not clean the sensor using a window cleaner. The cleaner may leave a light film which could interfere with sensor operations.
- If your vehicle has window tint or other types of metallic coating on the front windshield, the auto light system may not work properly.

**Operating high beam**



ODEEV068135NR

To turn on the high beam headlamp:

- Push the lever away from you. The lever will return to its original position. The high beam indicator will light when the headlight high beams are switched on.

To prevent the battery from being discharged, do not leave the lights on for a prolonged time while the vehicle is off.

## **⚠ WARNING**

### **High beams**

Do not use high beam when there are other vehicles in front of or approaching your vehicle. Using high beam could obstruct the other driver's vision.

To flash the headlights:

- Pull the lever towards you.



It will return to the normal (low beam) position when released. The headlight switch does not need to be on to use this flashing feature.

### **Operating turn signals and lane change signals**

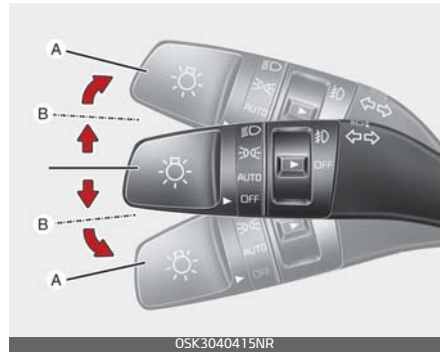

The ignition switch or START/STOP button in the must be on for the turn signals to function.

To turn on the turn signals:

- Move the lever up or down (A). The green arrow indicators on the instrument panel indicate which turn signal is operating. They will self-cancel after a turn is completed. If the indicator continues to flash after a turn, manually return the lever to the OFF position.

To signal a lane change:

- Move the turn signal lever slightly and hold it in position (B). The lever will return to the OFF position when released.

If an indicator stays on and does not flash or if it flashes abnormally, one of the turn signal bulbs may be burned out and will require replacement.

**\* NOTICE**

If an indicator flash is abnormally quick or slow, a bulb may be burned out or have a poor electrical connection in the circuit.

***One-touch lane change function***

To activate an one-touch lane change function, move the turn signal lever slightly and then release it. The lane change signals will blink 3 times.

**Operating front fog light (if equipped)**

Fog lights are designed to provide improved visibility when visibility is poor due to fog, rain or snow, etc.



The fog lights will turn on when the fog light switch (1) is turned to the on position after the headlight is turned on.

To turn off the fog lights:

- Turn the fog light switch (1) to the OFF position.

**High Beam Assist (HBA) (if equipped)**

High Beam Assist system is a system that automatically adjusts the headlamp range (switches between high beam and low beam) depending to the brightness of detected vehicles and certain road conditions.



***Operating High Beam Assist***

High Beam Assist system can be operated using the light switch.

1. Place the light switch in the AUTO position.
2. Turn on the high beam by pushing the lever away from you. The High Beam Assist system  indicator will illuminate.

High Beam Assist system will turn on when vehicle speed is above 25 mph (40 km/h).

The details of operation with the light switch while the High Beam Assist is on are below.

- If the light switch is pushed away, High Beam Assist system will turn off and the high beam will be on.
- If the light switch is pulled towards you when the high beam is off, the high beam will be on without canceling the operation of High Beam Assist system. (When you hands off, the lever will move to the middle and the high beam will turn off.)
- If the light switch is pulled towards you when the high beam is on by High Beam Assist system, the low beam will be on and High Beam Assist system will turn off.
- If the light switch is turned to the headlamp position (⊞D) from AUTO position, High Beam Assist system will turn off and the low beam will be on.

When High Beam Assist system is operating, the high beam switches to low beam in the following conditions.

- When the headlamp is detected from the on-coming vehicle.
- When the tail lamp is detected from the front vehicle.
- When headlamp / tail lamp of bicycle/motorcycle is detected.
- When the surrounding is so bright that high beams are not needed.

- When streetlights or other lights are detected.
- When the light switch is not in the AUTO position.
- When High Beam Assist system is off.
- When vehicle speed is below 15 mph (24 km/h).

### **High Beam Assist system warning light and message**

When High Beam Assist system is not working properly, a warning message "Check High Beam Assist (HBA) system" will come on for a few second.

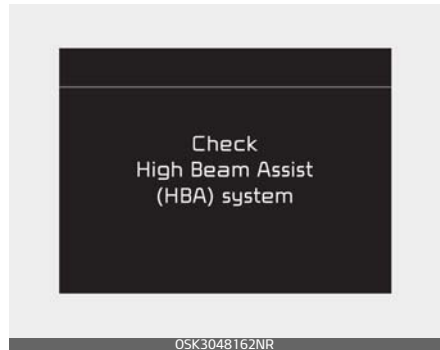

After the message disappears, the master warning light (⚠) will illuminate. Take your vehicle to an authorized Kia dealer and have the system checked.

### **⚠ CAUTION**

High Beam Assist system may not work properly in the following situations:



- When the light from a vehicle is poor
  - When the light from a vehicle is not detected because of lamp damage, or because it is hidden from sight, etc.
  - When the lamp of a vehicle is covered with dust, snow or water.
  - When a vehicle's headlamps are off but the fog lamps are on and etc.
- When external conditions intervene
  - When there is a lamp that has a similar shape as a vehicle's lamps.
  - When the headlamp is not repaired or replaced at an authorized Kia dealer.
  - When the headlamp aiming is not properly adjusted.
  - When driving on a narrow curved road, rough road, downhill or uphill.
  - When only part of the vehicle in front is visible on a crossroad or curved road.
  - When there is a traffic light, reflecting sign, flashing sign or mirror ahead.
  - When there is a temporary reflector or flash ahead (construction area).
  - When the road conditions are bad such as being wet, iced or covered with snow.
  - When a vehicle suddenly appears from a curve.
  - When the vehicle is tilted from a flat tire or being towed.
- When front visibility is poor
  - When the lamp of the on-coming or front vehicle is covered with dust, snow or water.
  - When the light from a vehicle is not detected because of exhaust fume, smoke, fog, snow, etc.
  - When the front window is covered with foreign substance.
  - When it is hard to see because of fog, heavy rain or snow and etc.

---

#### \* NOTICE

- Do not disassemble a front view camera temporarily for tinted window or attaching any types of coatings and accessories. If you disassemble the camera and assemble it again, take your vehicle to an authorized Kia dealer and have the system checked.
- When you replace or reinstall the windshield glass take your vehicle to an authorized Kia dealer and have the system checked.
- Be careful that water doesn't get into High Beam Assist system unit and do not remove or damage parts of High Beam Assist system.

- Do not place objects on the dash board that reflect light, such as mirrors, white paper, etc. The system may not be able to function if sunlight is reflected.
- At times High Beam Assist system may not operate due to system limitations. The system is for your convenience only. It is the responsibility of the driver to drive safely and always check the road conditions.
- When the system does not operate normally, change the lamp position manually between the high beam and low beam.

## Wipers and washers

The wipers and washers remove foreign substances from the windshield and rear window, helping to maintain visibility.

Front windshield wiper/washer

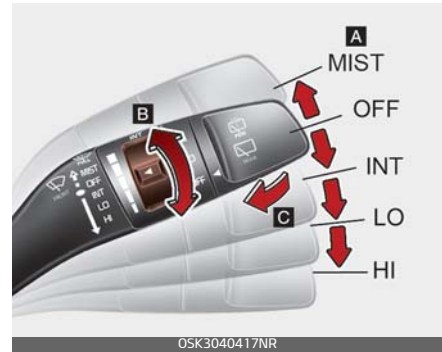

Rear windshield wiper/washer



### A: Wiper speed control (front)

- MIST – Single wipe
- OFF – Off
- INT – Intermittent wipe
- LO – Low wiper speed
- HI – High wiper speed

### B: Intermittent control wipe time adjustment

**C: Wash with brief wipes (front)**

**D: Rear wiper/washer control**

- HI – Continuous wipe
- LO – Intermittent wipe
- OFF – Off

**E: Wash with brief wipes (rear)**

**Windshield washers**

Operates as follows when the ignition switch or START/STOP button is turned ON.

**MIST:** For a single wiping cycle, move the lever to this (MIST) position and release it. The wipers will operate continuously if the lever is held in this position.

**OFF:** Wiper is not in operation

**INT:** Wiper operates intermittently at the same wiping intervals. Use this mode in light rain or mist. To vary the speed setting, turn the speed control switch.

**LO:** Normal wiper speed

**HI:** Fast wiper speed

**\* NOTICE**

If there is heavy accumulation of snow or ice on the windshield, defrost the windshield for about 10 minutes, or until the snow and/or ice is removed before using the windshield wipers to ensure proper operation. If you do not remove the snow and/or ice before using the

wiper and washer, it may damage the wiper and washer system.

**Auto control (if equipped)**

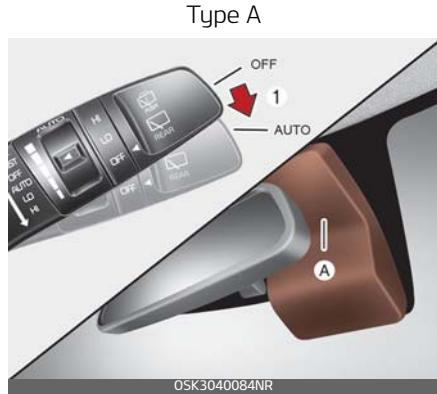

The rain sensor (A) located on the upper end of the windshield glass senses the amount of rainfall and controls the wiping cycle for the proper interval. The more it rains, the faster the wiper operates. When the rain stops, the wiper stops.

To vary the speed setting, turn the speed control knob (1).

If the wiper switch is set in AUTO mode when the ignition switch is ON, the wiper will operate once to perform a self-check of the system. Set the wiper to OFF position when the wiper is not in use.

**⚠ CAUTION**

When the ignition switch is ON and the windshield wiper switch is

placed in the AUTO mode, use caution in the following situations to avoid any injury to the hands or other parts of the body:

- Do not touch the upper end of the windshield glass facing the rain sensor.
- Do not wipe the upper end of the windshield glass with a damp or wet cloth.
- Do not put pressure on the windshield glass.

### ⚠ CAUTION

- When washing the vehicle, set the wiper switch in the OFF position to stop the auto wiper operation. The wiper may operate and be damaged if the switch is set in the AUTO mode while washing the vehicle.
- Do not remove the sensor cover located on the upper end of the passenger side windshield glass. Damage to system parts could occur and may not be covered by your vehicle warranty.
- When starting the vehicle in winter, set the wiper switch in the OFF position. Otherwise, wipers may operate and ice may damage the windshield wiper blades. Always remove all snow and ice and defrost the windshield properly prior to operating the windshield wipers.

### Operating windshield washer

Use this function when the windshield is dirty.

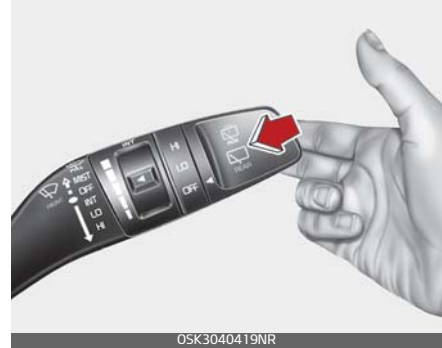

OSK3040419NR

4

1. Move the wiper speed control switch to the OFF position.
2. Pull the lever gently toward you to spray washer fluid on the windshield and to run the wipers 1–3 cycles.  
The spray and wiper operation will continue until you release the lever.

If the washer does not work, check the washer fluid level. If the fluid level is not sufficient, you will need to add appropriate non-abrasive windshield washer fluid to the washer reservoir.

The reservoir filler neck is located in the front of the motor compartment on the passenger side.

### ⚠ CAUTION

#### Washer pump

To prevent possible damage to the washer pump, do not operate the

washer when the fluid reservoir is empty.

**⚠ WARNING**

**Obscured visibility**

Do not use the washer in freezing temperatures without first warming the windshield with the defrosters; the washer solution could freeze on the windshield and obscure your vision.

**⚠ CAUTION**

**Wipers & windshields**

- To prevent possible damage to the wipers or windshield, do not operate the wipers when the windshield is dry.
- To prevent damage to the wiper blades, do not use gasoline, kerosene, paint thinner, or other solvents on or near them.
- To prevent damage to the wiper arms and other components, do not attempt to move the wipers manually.

**Operating rear window wiper and washer switch**

The rear window wiper and washer switch is located at the end of the wiper and washer switch lever.

- Turn the switch to the desired position to operate the rear wiper and washer.

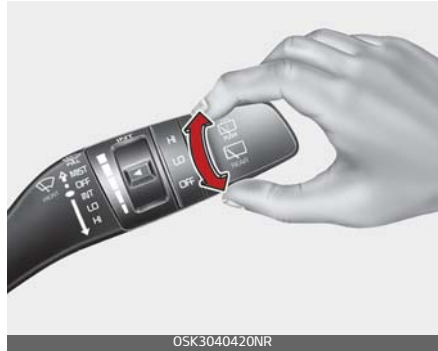

- HI: Continuous wipe
- LO: Intermittent wipe
- OFF: OFF
- Push the lever away from you to spray rear washer fluid and to run the rear wipers 1~3 cycles.

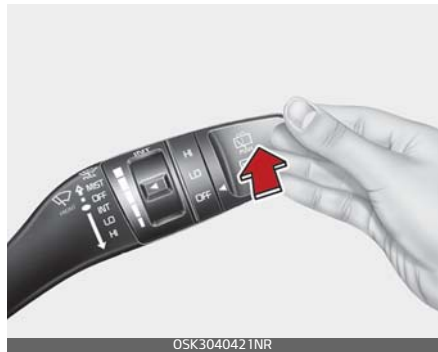

The spray and wiper operation will continue until you release the lever

## Interior lights

This vehicle is equipped with lights throughout the vehicle to illuminate the interior.

Do not use the interior lights for extended periods when the vehicle is off.

It may cause battery discharge.

### **⚠ WARNING**

#### Interior Lights

Do not use the interior lights when driving in the dark. Accidents could happen because the view may be obscured by interior lights.

#### Automatic turn off function (if equipped)

The interior lights automatically turn off approximately 20 minutes after the ignition switch or START/STOP button is turned off, if the lights are in the ON position.

If your vehicle is equipped with the theft alarm system, the interior lights automatically turn off approximately 5 seconds after the system is armed.

## Room lamp

Type A



Type B



- : The light stays on at all times.

## Map lamp

Type A



Type B



- Press the lens (1) to turn ON the map lamp.  
To turn the map lamp OFF press the lens (1) again.
-  (2): DOOR mode
  - The map lamp and room lamp come on when a door is opened. The lamps go out after approximately 30 seconds.
  - The map lamp and room lamp come on for approximately 30 seconds when doors are unlocked with a transmitter or



smart key as long as the doors are not opened.

- The map lamp and room lamp will stay on for approximately 20 minutes if a door is opened with the ignition switch or START/STOP button in the ACC or LOCK/OFF position.
- The map lamp and room lamp will stay on continuously if the door is opened with the ignition switch or START/STOP button in the ON position.
- The map lamp and room lamp will go out immediately if the ignition switch or START/STOP button is changed to the ON position or all doors are locked.
- To turn off the DOOR mode, press the DOOR button (2) once again (not pressed).

### \* NOTICE

The DOOR mode and ROOM mode cannot be selected at the same time.

### Front Room Lamp:

- Type A
  -  (3): Press this switch to turn the front and rear room lamps on.
  -  (4): Press this switch to turn the front and rear room lamps off.
- Type B

 (3): Press this switch to turn the front and rear room lamps on and off.

### Liftgate room lamp

The liftgate room lamp comes on when the liftgate is opened.





#### \* NOTICE

The liftgate lamp comes on as long as the liftgate lid is open. To prevent unnecessary charging system drain, close the liftgate lid securely after using the liftgate.

### Vanity mirror lamp (if equipped)



- Push the switch to turn the light on or off.
  - : The lamp will turn on if this button is pressed.
  - : The lamp will turn off if this button is pressed.

#### ⚠ CAUTION

### Vanity mirror lamp

Always have the switch in the off position when the vanity mirror lamp is not in use. If the sun visor is closed without the lamp off, it may discharge the battery or damage the sun visor.

### Glove box lamp (if equipped)

The glove box lamp comes on when the glove box is opened.



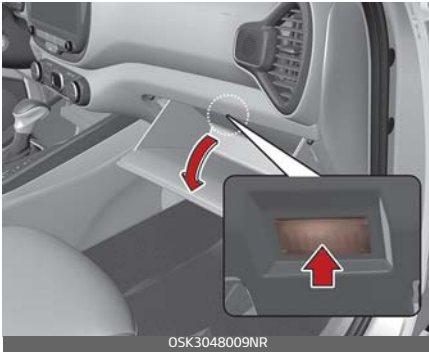

### ⚠ CAUTION

To prevent unnecessary charging system drain, close the glove box securely after using the glove box.

## Welcome system (if equipped)

The welcome system is a function that illuminates the surroundings or the interior when the driver approaches or exits the vehicle.

## Headlight (Headlamp) escort function

The headlights (and/or taillights) remain on for approximately 5 minutes after the vehicle is turned off. However, if the driver's door is opened and closed, the headlights are turned off after 15 seconds.

The headlights can be turned off by pressing the lock button on the transmitter or smart key twice or turning off the light switch from the headlight or Auto light position.

## Interior light

When the interior light switch is in the DOOR position and all doors (and liftgate) are locked and closed, the room lamp will come on for 30 seconds if any of the following occurs:

- With the smart key system
  - When the door unlock button is pressed on the smart key.
  - When the button of the outside door handle is pressed.

At this time, if you press the door lock button, the lamps will turn off immediately.

## Defroster

The vehicle is equipped with a defroster for removing frost or fog from the rear window.

### ⚠ CAUTION

#### Conductors

To prevent damage to the conductors bonded to the inside surface of the rear window, never use sharp instruments or window cleaners containing abrasives to clean the window.

If you want to defrost and defog the front windshield, refer to "Windshield defrosting and defogging" on page 4-128.

#### Operating rear window defroster

The defroster heats the window to remove frost, fog and thin ice from the rear window, while the vehicle is on.

If there is heavy accumulation of snow on the rear window, brush it off before operating the rear defroster.

Type A

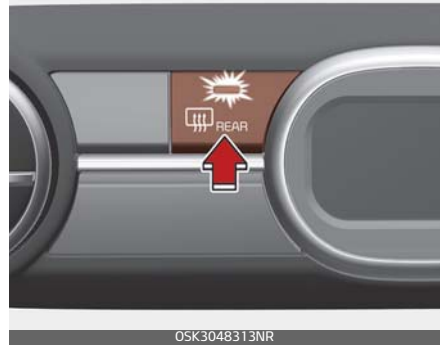

Type B



To activate the rear window defroster:

- Press the rear window defroster button located in the center fascia switch panel. The indicator on the rear window defroster button illuminates when the defroster is ON. The rear window defroster automatically turns off after approximately 20 minutes or when the ignition switch or START/STOP button is turned off.

To turn off the defroster:

- Press the rear window defroster button again.

### Outside mirror defroster

If your vehicle is equipped with the outside rearview mirror defrosters, they will operate at the same time you turn on the rear window defroster.

#### \* NOTICE

The rear window defroster may turn off in the below conditions.

- Engine temperature is less than 77 °F (25 °C) and the vehicle speed is from 1~6 mph (1~10 km/h) with the gear position in "D" or "R".

If the vehicle stops or the vehicle speed is over 6 mph (10 km/h) the rear window defroster turns on again.

---

## Manual climate control system



OSK3048301NR

1. Fan speed control knob
2. Air intake control button
3. Mode selection knob
4. Rear window defroster button
5. Temperature control knob
6. Air conditioning button (if equipped)

### **⚠ CAUTION**

Operating the blower when the ignition switch is in the ON position could cause the battery to discharge. Operate the blower when the engine is running.

### Heating and air conditioning



1. Start the engine.
2. Set the mode to the desired position.  
For improving the effectiveness of heating and cooling;
  - Heating:
  - Cooling:
3. Set the temperature control to the desired position.
4. Set the air intake control to the outside (fresh) air position.
5. Set the fan speed control to the desired speed.
6. If air conditioning is desired, turn the air conditioning (if equipped) system on.

#### **Mode selection**

The mode selection knob controls the direction of the air flow through the ventilation system.



Air can be directed to the floor, dashboard outlets, or windshield. Five symbols are used to represent Face, Bi-Level, Floor, Floor-Defrost and Defrost air position.

#### **Face-Level (B, D)**

Air flow is directed toward the upper body and face. Additionally, each outlet can be controlled to direct the air discharged from the outlet.

#### **Bi-Level (B, D, C, E)**

Air flow is directed towards the face and the floor.

#### **Floor-Level (C, E, A, D)**

Most of the air flow is directed to the floor, with a small amount of the air being directed to the windshield and side window defrosters.

#### **Floor/Defrost-Level (A, C, D, E)**

Most of the air flow is directed to the floor and the windshield with a small amount directed to the side window defrosters.

#### **Defrost-Level (A, D)**

Most of the air flow is directed to the windshield with a small amount of air directed to the side window defrosters.

### ***Instrument panel vents***

The outlet vents can be opened or closed separately using the thumbwheel. To close the vent, rotate it downward to the maximum position.



Also, you can adjust the direction of air delivery from these vents using the vent control lever as shown.

### ***Temperature control***

The temperature control knob allows you to control the temperature of the air flowing from the ventilation system.



OSK3048304NR

To change the air temperature in the passenger compartment, turn the knob to the right for warm and hot air or to the left for cooler air.

**MAX A/C selection**

To operate the MAX A/C, turn the temperature knob to extreme left. Air flow is directed toward the upper body and face.



OSK3048305NR

In this mode, the air conditioning and the recirculated air position will be selected automatically.

**Controlling air intake**

The air intake control is used to select the outside (fresh) air position or recirculated air position.

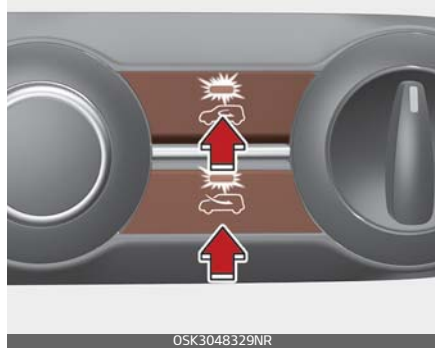

OSK3048329NR

To change the air intake control position.

- Put the control button

**Recirculated air position**



With the recirculated air position selected, air from the passenger compartment will be drawn through the heating system and heated or cooled according to the function selected.

**Outside (fresh) air position**



With the outside (fresh) air position selected, air enters the vehicle from outside and is heated or cooled according to the function selected.

**\* NOTICE**

Prolonged operation of the heater in the recirculated air position (without air conditioning selected) may cause

fogging of the windshield and side windows and the air within the passenger compartment may become stale.

In addition, prolonged use of the air conditioning with the recirculated air position selected will result in excessively dry air in the passenger compartment.

### **WARNING**

- Continue using the climate control system in the recirculated air position may allow humidity to increase inside the vehicle which may fog the glass and obscure visibility.
- Do not sleep in a vehicle with the air conditioning or heating system on. It may cause serious harm or death due to a drop in the oxygen level and/or body temperature.
- Continue using the climate control system in the recirculated air position can cause drowsiness or sleepiness, and loss of vehicle control. Set the air intake control to the outside (fresh) air position as much as possible while driving.

### **Controlling fan speed**

The fan speed control knob allows you to control the fan speed of the air flowing from the ventilation system.

The ignition switch must be in the ON position for fan operation.

To change the fan speed:

- Turn the knob to the right for higher speed or left for lower speed.



- Setting the fan speed control knob to the "0" position turns off the fan.

### **Turning off the blowers**

To turn off the blowers:

- Turn the fan speed control knob to the "0" position.





## Air conditioning (A/C)

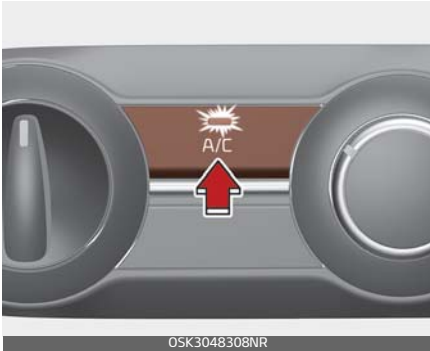

- Press the A/C button to turn the air conditioning system on (indicator light will illuminate).
- Press the button again to turn the air conditioning system off.

## System operation



### Ventilation

1. Set the mode to the  position.
2. Set the air intake control to the outside (fresh) air position.
3. Set the temperature control to the desired position.
4. Set the fan speed control to the desired speed.

### Heating

1. Set the mode to the  position.
2. Set the air intake control to the outside (fresh) air position.
3. Set the temperature control to the desired position.
4. Set the fan speed control to the desired speed.

5. If dehumidified heating is desired, turn the air conditioning system (if equipped) on.

- If the windshield fogs up, set the mode to the  or  position.

## Operation Tips

- To keep dust or unpleasant fumes from entering the vehicle through the ventilation system, temporarily set the air intake control to the recirculated air position. Be sure to return the control to the fresh air position when the irritation has passed to keep fresh air in the vehicle. This will help keep the driver alert and comfortable.
- Air for the heating/cooling system is drawn in through the grilles just ahead of the windshield. Care should be taken that these are not blocked by leaves, snow, ice or other obstructions.
- To prevent interior fog on the windshield, set the air intake control to the fresh air position and fan speed to the desired position, turn on the air conditioning system, and adjust the temperature control to desired temperature.

## Air conditioning

Kia Air Conditioning Systems are filled with environmentally friendly refrigerant\*.

1. Start the engine. Push the air conditioning button.
2. Set the mode to the  position.
3. Set the air intake control to the outside air or recirculated air position.
4. Adjust the fan speed control and temperature control to maintain maximum comfort.

\* : Your vehicle is filled with R-134a or R-1234yf according to the regulation in your country at the time of producing. You can find out which air conditioning refrigerant is applied your vehicle at the label inside of engine room. Refer to "Refrigerant label" on page 8-13 for more detail location of air conditioning refrigerant label.

### CAUTION

- The refrigerant system should only be serviced by trained and certified technicians to insure proper and safe operation.
- The refrigerant system should be serviced in a well-ventilated place.
- The air conditioning evaporator (cooling coil) shall never be repaired or replaced with one removed from a used or salvaged vehicle and new replacement MAC evaporators shall be certified (and labeled) as meeting SAE Standard J2842.

### \* NOTICE

- When using the air conditioning system, monitor the temperature gauge closely while driving up hills or in heavy traffic when outside temperatures are high. Air conditioning system operation may cause engine overheating. Continue to use the blower fan but turn the air conditioning system off if the temperature gauge indicates engine overheating.
- When opening the windows in humid weather air conditioning may create water droplets inside the vehicle. Since excessive water droplets may cause damage to electrical equipment, air conditioning should only be used with the windows closed.

### Air conditioning system operation tips

- If the vehicle has been parked in direct sunlight during hot weather, open the windows for a short time to let the hot air inside the vehicle escape.
- To help reduce moisture inside of the windows on rainy or humid days, decrease the humidity inside the vehicle by operating the air conditioning system.
- During air conditioning system operation, you may occasionally notice a slight change in engine speed as the air conditioning

compressor cycles. This is a normal system operation characteristic.

- Use the air conditioning system every month only for a few minutes to ensure maximum system performance.
- When using the air conditioning system, you may notice clear water dripping (or even puddling) on the ground under the passenger side of the vehicle. This is a normal system operation characteristic.
- Operating the air conditioning system in the recirculated air position provides maximum cooling, however, continual operation in this mode may cause the air inside the vehicle to become stale.
- During cooling operation, you may occasionally notice a misty air flow because of rapid cooling and humid air intake. This is a normal system operation characteristic.

**Climate control air filter (if equipped)**

The climate control air filter installed behind the glove box filters the dust or other pollutants that come into the vehicle from the outside through the heating and air conditioning system.

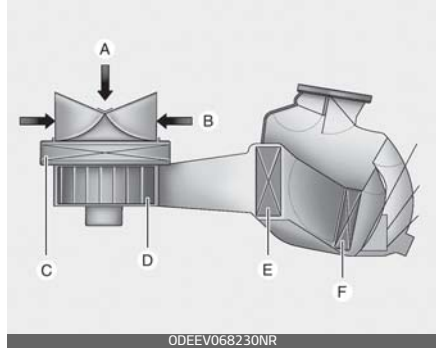

- A: Outside air
- B: Recirculated air
- C: Climate control air filter
- D: Blower
- E: Evaporator core
- F: Heater core

If dust or other pollutants accumulate in the filter over a period of time, the air flow from the air vents may decrease, resulting in moisture accumulation on the inside of the windshield even when the outside (fresh) air position is selected. If this happens, have the climate control air filter replaced by an authorized Kia dealer.

**\* NOTICE**

- Replace the filter according to the Maintenance Schedule. If the vehicle is being driven in severe conditions such as dusty or rough roads, more frequent air conditioner filter inspections and changes are required.

- When the air flow rate suddenly decreases, have the system checked by an authorized Kia dealer.

### Checking the amount of air conditioner refrigerant and compressor lubricant

When the amount of refrigerant is low, the performance of the air conditioning is reduced. Overfilling also has a negative impact on the air conditioning system.

Therefore, if abnormal operation is found, have the system inspected by an authorized Kia dealer.

### ⚠ WARNING

The oil and refrigerant in your vehicle's air conditioning system is under very high pressure. If proper service procedures are not followed an explosion may result. To reduce the risk of serious injury or death, the air conditioning system in your vehicle should only be serviced by trained and certified technicians.

### ⚠ CAUTION

It is important that the correct type and amount of oil and refrigerant is used, otherwise damage to the vehicle may occur. To prevent damage, the air conditioning system in

your vehicle should only be serviced by trained and certified technicians.

### ⚠ WARNING

#### Vehicles equipped with R-1234yf

 Since the refrigerant is mildly inflammable and operated at high pressure, the air conditioning system should only be serviced by trained and certified technicians. (Refer to the SAE J2845)

It is important that the correct type and amount of oil and refrigerant are used.

All refrigerants should be reclaimed with proper equipment. Venting refrigerants directly to the atmosphere is harmful to individuals and environment.

Failure to heed these warnings can lead to serious injuries.

#### Air Conditioning refrigerant label

Example

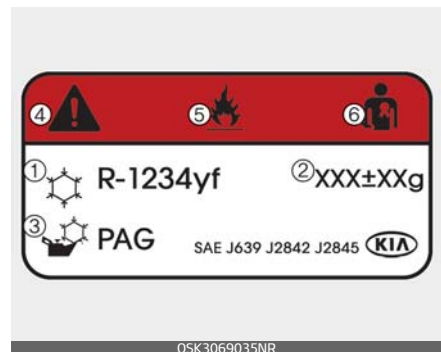

OSK3069035NR

\* The actual Air Conditioning refrigerant label in the vehicle may differ from the illustration.

Each symbol and specification on the air conditioning refrigerant label is represented below:

1. Classification of refrigerant
2. Amount of refrigerant
3. Classification of Compressor lubricant
4. Caution
5. Flammable Refrigerant
6. Requires Registered Technician to Service Air Conditioning system

Refer to "Refrigerant label" on page 8-13 for more detail on the location of air conditioning refrigerant label.

## Automatic climate control system



OSK3048302NR

1. Driver's temperature control knob
2. AUTO (automatic control) button
3. Front windshield defroster button
4. Rear window defroster button
5. Air conditioning button
6. Air intake control button
7. Blower OFF button
8. Fan speed control button
9. Mode selection button
10. Passenger's temperature control knob
11. SYNC button
12. A/C display

### \* NOTICE

Operating the blower when the ignition switch is in the ON position could cause the battery to discharge. Operate the blower when the engine is running.

### Heating and air conditioning automatically

1. Press the AUTO button.  
The modes, fan speeds, air intake and air-conditioning will be controlled automatically by setting the temperature.



OSK3048316NR

2. Turn the temperature control switch to the desired temperature.



- To turn the automatic operation off, select any button or switch of the following:
  - Mode selection button
  - Air conditioning button
  - Front windshield defroster button (Press the button one more time to deselect the front windshield defroster function. The 'AUTO' sign will illuminate on the information display once again.)
  - Air intake control button
  - Fan speed control switchThe selected function will be controlled manually while other

functions operate automatically.

- For your convenience and to improve the effectiveness of the climate control, use the AUTO button and set the temperature to 72 °F (22 °C).

**\* NOTICE**

Do not place anything over the sensor located on the instrument panel to ensure better control of the heating and cooling system.

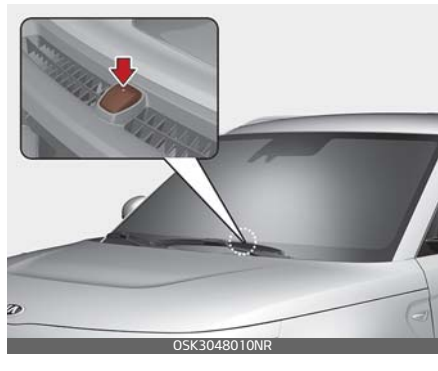

**Manual heating and air conditioning**

The heating and cooling system can be controlled manually by pressing buttons or turning knob(s) other than the AUTO button.



OSK3048314NR

In this case, the system works sequentially according to the order of buttons or knob(s) selected.

1. Start the vehicle.

2. Set the mode to the desired position.

For improving the effectiveness of heating and cooling;

- Heating:
- Cooling:

4. Set the air intake control to the outside (fresh) air position.

3. Set the temperature control to the desired position.

5. Set the fan speed control to the desired speed.

If air conditioning is desired, turn the air conditioning system on.

Press the AUTO button in order to convert to full automatic control of the system.



### Mode selection

The mode selection button controls the direction of the air flow through the ventilation system.



The air flow outlet port is converted as follows:



### Face-Level (B, D)

Air flow is directed toward the upper body and face. Additionally, each outlet can be controlled to direct the air discharged from the outlet.

### Bi-Level (B, C, D, E)

Air flow is directed towards the face and the floor.

### Floor-Level (A, C, D, E)

Most of the air flow is directed to the floor, with a small amount of the air being directed to the windshield and side window defrosters.

### Floor/Defrost-Level (A, C, D, E)

Most of the air flow is directed to the floor and the windshield with a small amount directed to the side window defrosters.

### Defrost-Level (A, D)



Most of the air flow is directed to the windshield with a small amount of air directed to the side window defrosters.

### Instrument panel vents



The outlet vents can be opened or closed separately using the thumb-wheel. (if equipped)

Also, you can adjust the direction of air delivery from these vents using the vent control lever as shown.

### Temperature control



The temperature will increase to the maximum (82 °F (28 °C)) by turning the knob to the extreme right.

The temperature will decrease to the minimum (62 °F (17 °C)) by turning the knob to the extreme left.

When turning the knob, the temperature will increase or decrease by 1 °F / 0.5 °C. When set to the lowest temperature setting, the air conditioning will operate continuously.

### *Adjusting the driver and passenger side temperature equally*



- Press the "SYNC" button to adjust the driver and passenger side temperature equally. The passenger side temperature will be set to the same temperature as the driver side temperature.
- Turn the driver side temperature control knob. The driver and passenger side temperature will be adjusted equally.

### *Adjusting the driver and passenger side temperature individually*

- Press the "SYNC" button again to adjust the driver and passenger side temperature individually. The illumination of button turns off.
- Operate the driver side temperature control knob to adjust the driver side temperature.
- Operate the passenger side temperature control knob to adjust the passenger side temperature.

### Temperature conversion

You can switch the temperature mode from Centigrade to Fahrenheit as follows:

While pressing the OFF button, press the AUTO button for 3 seconds or more. The display will change from Centigrade to Fahrenheit, or from Fahrenheit to Centigrade. If the battery has been discharged or disconnected, the temperature mode display will reset to Fahrenheit.

### Controlling air intake

This is used to select the outside (fresh) air position or recirculated air position.



To change the air intake control position:

- Push the control button.

### Outside (fresh) air position



With the outside (fresh) air position selected, air enters the vehicle from

outside and is heated or cooled according to the function selected.

### Recirculated air position



With the recirculated air position selected, air from the passenger compartment will be drawn through the heating system and heated or cooled according to the function selected.

Prolonged operation of the heater in the recirculated air position (without air conditioning selected) may cause fogging of the windshield and side windows and the air within the passenger compartment may become stale.

In addition, prolonged use of the air conditioning with the recirculated air position selected will result in excessively dry air in the passenger compartment.

### Controlling fan speed

The fan speed can be set to the desired speed by operating the fan speed control button.

To change the fan speed:

- Press button right for higher speed, or press button left for lower speed.

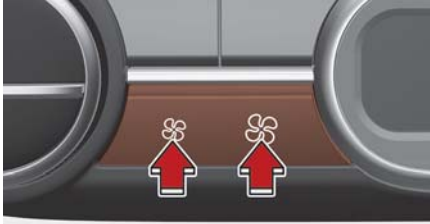

OSK3048321NR

- To turn the fan speed control off, press the front blower OFF button.

### Air conditioning



OSK3048322NR

- Press the A/C button to turn the air conditioning system on (indicator light will illuminate).
- Press the button again to turn the air conditioning system off.

### **WARNING**

#### Reduced Visibility

Continuous use of the climate control system in the recirculated air position may allow humidity to

increase inside the vehicle, which may fog the glass and obscure visibility.

### **WARNING**

#### Recirculated Air

Continued use of the climate control system in the recirculated air position can cause drowsiness or sleepiness, and loss of vehicle control. Set the air intake control to the outside (fresh) air position as much as possible while driving.

### **WARNING**

#### Sleeping with A/C on

Do not sleep in a vehicle with the air conditioning or heating on, as this may cause serious harm or death due to a drop in the oxygen level and/or body temperature.

#### Turning off the front air climate control



OSK3048323NR

- Press the front blower OFF button to turn off the front air climate control system. However, you can still operate the mode and air intake buttons as long as the ignition switch or START/STOP button is in the ON position.

### Automatic ventilation

The system automatically selects the outside (fresh) air position when the climate control system operates over a certain period of time (5 minutes) in low temperature with the recirculated air position selected.

#### *To cancel or reset the Automatic Ventilation*

When the air conditioning system is on, select Face Level  mode and press the recirculated air position more than five times within 3 seconds while pressing A/C button.

When the automatic ventilation is canceled, the indicator blinks 3 times. When the automatic ventilation is activated, the indicator blinks 6 times.



### System operation

#### *Ventilation*

1. Set the mode to the  position.
2. Set the air intake control to the outside (fresh) air position.

3. Set the temperature control to the desired position.
4. Set the fan speed control to the desired speed.

#### *Heating*

1. Set the mode to the  position.
2. Set the air intake control to the outside (fresh) air position.
3. Set the temperature control to the desired position.
4. Set the fan speed control to the desired speed.
5. If dehumidified heating is desired, turn the air conditioning system (if equipped) on.
  - If the windshield fogs up, set the mode to the  or  position.

#### **Operation Tips**

- To keep dust or unpleasant fumes from entering the vehicle through the ventilation system, temporarily set the air intake control to the recirculated air position. Be sure to return the control to the fresh air position when the irritation has passed to keep fresh air in the vehicle. This will help keep the driver alert and comfortable.
- Air for the heating/cooling system is drawn in through the grilles just ahead of the windshield. Care should be taken that these are not blocked by leaves, snow, ice or other obstructions.

- To prevent interior fog on the windshield, set the air intake control to the fresh air position and fan speed to the desired position, turn on the air conditioning system, and adjust the temperature control to desired temperature.

### ***Air conditioning (if equipped)***

All Kia Air Conditioning Systems are filled with R-1234yf refrigerant.

1. Start the vehicle. Press the air conditioning button.
2. Set the mode to the  position.
3. Set the air intake control to the outside-air or recirculated air position.
4. Adjust the fan speed control and temperature control to maintain maximum comfort.
  - When maximum cooling is desired, set the temperature control to the extreme left position, set the mode control to the MAX A/C position, then set the fan speed control to the highest speed.

### **CAUTION**

#### **Excessive A/C Use**

When using the air conditioning system, monitor the temperature gauge closely while driving up hills or in heavy traffic when outside temperatures are high. Air conditioning system operation may cause vehicle

overheating. Continue to use the blower fan but turn the air conditioning system off if the temperature gauge indicates vehicle overheating.

### **CAUTION**

When opening the windows in humid weather, air conditioning may create water droplets inside the vehicle. Since excessive water droplets may cause damage to electrical equipment, air conditioning should only be used with the windows closed.

#### **Air conditioning system operation tips**

- If the vehicle has been parked in direct sunlight during hot weather, open the windows for a short time to let the hot air inside the vehicle escape.
- To help reduce moisture inside of the windows on rainy or humid days, decrease the humidity inside the vehicle by operating the air conditioning system.
- During air conditioning system operation, you may occasionally notice a slight change in vehicle speed as the air conditioning compressor cycles. This is a normal system operation characteristic.

- Use the air conditioning system every month only for a few minutes to ensure maximum system performance.
- When using the air conditioning system, you may notice clear water dripping (or even puddling) on the ground under the passenger side of the vehicle. This is a normal system operation characteristic.
- Operating the air conditioning system in the recirculated air position provides maximum cooling; however, continual operation in this mode may cause the air inside the vehicle to become stale.
- During cooling operation, you may occasionally notice a misty air flow because of rapid cooling and humid air intake. This is a normal system operation characteristic.

**Climate control air filter (if equipped)**

The climate control air filter installed behind the glove box filters the dust or other pollutants that come into the vehicle from the outside through the heating and air conditioning system.

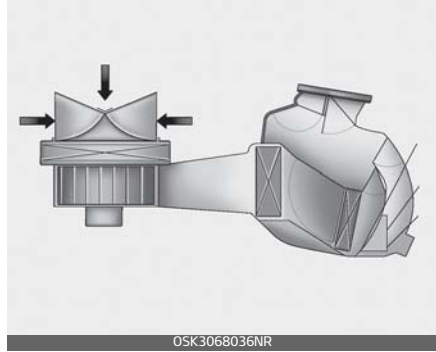

If dust or other pollutants accumulate in the filter over a period of time, the air flow from the air vents may decrease, resulting in moisture accumulation on the inside of the windshield even when the outside (fresh) air position is selected. If this happens, have the climate control air filter replaced by an authorized Kia dealer.

**\* NOTICE**

- Replace the filter every 15,000 miles or once a year. If the vehicle is being driven in severe conditions, such as dusty or rough roads, more frequent air conditioner filter inspections and changes are required.
- When the air flow rate suddenly decreases, the system should be checked at an authorized Kia dealer.

## Checking the amount of air conditioner refrigerant and compressor lubricant

When the amount of refrigerant is low, the performance of the air conditioning is reduced. Overfilling also has a negative impact on the air conditioning system.

Therefore, if abnormal operation is found, have the system inspected by an authorized Kia dealer.

### ⚠ WARNING

The oil and refrigerant in your vehicle's air conditioning system is under very high pressure. If proper service procedures are not followed an explosion may result. To reduce the risk of serious injury or death, the air conditioning system in your vehicle should only be serviced by trained and certified technicians.

### ⚠ CAUTION

It is important that the correct type and amount of oil and refrigerant is used, otherwise damage to the vehicle may occur. To prevent damage, the air conditioning system in your vehicle should only be serviced by trained and certified technicians.

### ⚠ WARNING

#### Vehicles equipped with R-1234yf

 Since the refrigerant is mildly inflammable and operated at high pressure, the air conditioning system should only be serviced by trained and certified technicians. (Refer to the SAE J2845)

It is important that the correct type and amount of oil and refrigerant are used.

All refrigerants should be reclaimed with proper equipment. Venting refrigerants directly to the atmosphere is harmful to individuals and environment.

Failure to heed these warnings can lead to serious injuries.

### Air Conditioning refrigerant label

Example

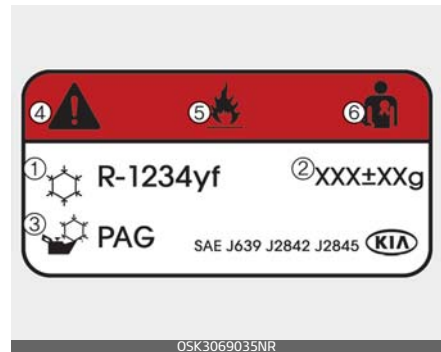

\* The actual Air Conditioning refrigerant label in the vehicle may differ from the illustration.

Each symbol and specification on the air conditioning refrigerant label is represented below:



1. Classification of refrigerant
2. Amount of refrigerant
3. Classification of Compressor lubricant
4. Caution
5. Flammable Refrigerant
6. Requires Registered Technician to Service Air Conditioning system



Refer to "Refrigerant label" on page 8–13 for more detail on the location of air conditioning refrigerant label.

## Windshield defrosting and defogging

When the windshield is covered with frost or moisture, the front view is blurred, so you should remove the frost and moisture.

### WARNING

#### Windshield heating

Do not use the  or  position during cooling operation in extremely humid weather. The difference between the temperature of the outside air and the windshield could cause the outer surface of the windshield to fog up, causing loss of visibility. In this case, set the mode selection to the  position and fan speed control to the lower speed.

- For maximum defrosting, set the temperature control to the extreme right/hot position and the fan speed control to the highest speed.
- If warm air to the floor is desired while defrosting or defogging, set the mode to the floor-defrost position.
- Before driving, clear all snow and ice from the windshield, rear window, outside rear view mirrors, and all side windows.
- Clear all snow and ice from the hood and air inlet in the cowl grill

to improve heater and defroster efficiency and to reduce the probability of fogging up the inside of the windshield.

**Manual climate control system**

You can defog or defrost using the manual climate control system.

**To defog inside windshield**



1. Select any fan speed except "0" position.
2. Select desired temperature.
3. Select the or position.
4. The outside (fresh) air and air conditioning will be selected automatically.

If the air conditioning and outside (fresh) air position are not selected automatically, press the corresponding button manually.

**To defrost outside windshield**





1. Set the fan speed to the highest (extreme right) position.
2. Set the temperature to the extreme hot position.
3. Select the position.
4. The outside (fresh) air and air conditioning will be selected automatically.

**Automatic climate control system**

You can defog or defrost using the automatic climate control system.

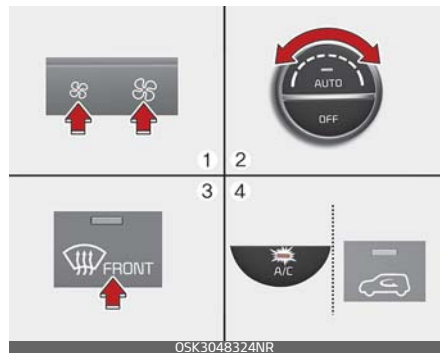
**Defogging inside windshield with the automatic climate control**



1. Set the fan speed to the desired position.
2. Select desired temperature.
3. Press the defroster button (  ).
4. The outside (fresh) air position will be selected automatically and the air conditioning will turn on according to the detected ambient temperature.

If the air conditioning and outside (fresh) air position are not selected automatically, adjust the corresponding button manually. If the  position is selected, lower fan speed is adjusted to a higher fan speed.



**Defrosting outside windshield with automatic climate control**



1. Set the fan speed to the highest position.
2. Set the temperature to the extreme hot (HI) position.
3. Press the defroster button (  ).
4. The outside (fresh) air position will be selected automatically and the air conditioning will turn on

according to the detected ambient temperature.

**Defogging logic (if equipped)**

To reduce the possibility of fogging up the inside of the windshield, the air intake or air conditioning is controlled automatically according to certain conditions such as  or  position.

To cancel automatic defogging logic or return to the automatic defogging logic, do the following.

**Manual climate control system**

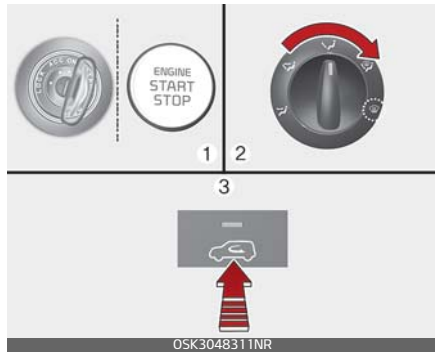

1. Turn the ignition switch to the ON position.
2. Turn the mode selection knob to the defrost position (  ).
3. Push the air intake control button at least 5 times within 3 seconds. The indicator light in the air intake control button will blink 3 times. It indicates that the defogging logic is canceled or returned to the programmed status.

If the battery has been discharged or disconnected, it resets to the defog logic status.

**Turning the defogging logic on or off**

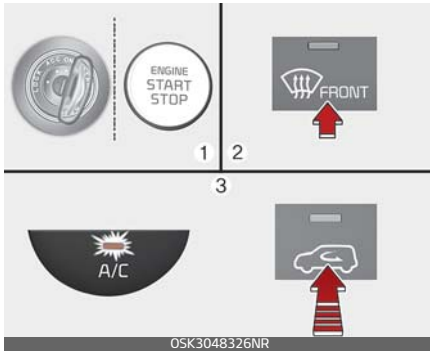

1. Turn the ignition switch or START/STOP button to the ON position.
2. Press the defroster button (FRONT).
3. While pressing the air conditioning button (A/C), press the air intake control button at least 5 times within 3 seconds.

The recirculation indicator blinks 3 times in 0.5 second of intervals. It indicates that the defogging logic is canceled or returned to the programmed status.

If the battery has been discharged or disconnected, it resets to the defog logic status.

**Storage compartment**

These compartments can be used to store small items required by the driver or passengers.

- To avoid possible theft, do not leave valuables in the storage compartment.
- Always keep the storage compartment covers closed while driving. Do not attempt to place so many items in the storage compartment that the storage compartment cover cannot close securely.

**WARNING**

**Flammable materials**

Do not store, propane cylinders or other flammable/explosive materials in the vehicle. These items may catch fire and/or explode if the vehicle is exposed to hot temperatures for extended periods.

**Center console storage**



To open the center console storage:

- Pull up the lever.

### Glove box



To open the glove box:

- Pull the handle and the glove box will automatically open.

Close the glove box after use.

### ⚠ WARNING

#### Glove Box

To reduce the risk of injury in an accident or sudden stop, always keep the glove box door closed while driving.

### \* NOTICE

If the temperature control switch is in the warm or hot position, warm or hot air will flow into the glove box.

### Sunglass holder

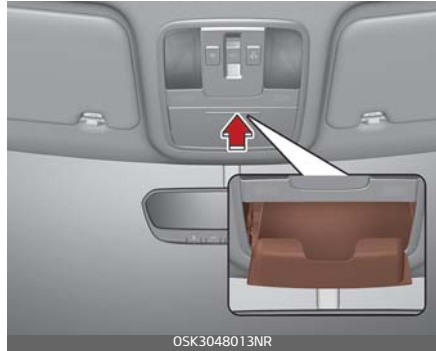

To open the sunglasses holder:

- Press the cover and the holder will slowly open.

Place your sunglasses with the lenses facing out. To close the sunglasses holder push it up.

### ⚠ WARNING

#### Sunglass holder

- Do not keep objects except sunglasses inside the sunglasses holder. Such objects can be thrown from the holder in the event of a sudden stop or an accident, possibly injuring the passengers in the vehicle.
- Do not open the sunglasses holder while the vehicle is moving. The rear view mirror of the vehicle can be blocked by an opened sunglasses holder.

### Luggage net holder (if equipped)



To keep items from shifting in the cargo area, you can use the 4 holders located in the cargo area to attach the luggage net.

If necessary, Kia recommends contacting an authorized Kia dealer.

#### **CAUTION**

To prevent damage to the goods or the vehicle, be careful when carrying fragile or bulky objects in the luggage compartment.

#### **WARNING**

Avoid eye injury. DO NOT overstretch the luggage net, ALWAYS keep your face and body out of the luggage net's recoil path. DO NOT use when the strap has visible signs of wear or damage.

### Increase cargo space (if equipped)

If you want to increase cargo space,

1. Grasp the handle on the top of the cover and lift it

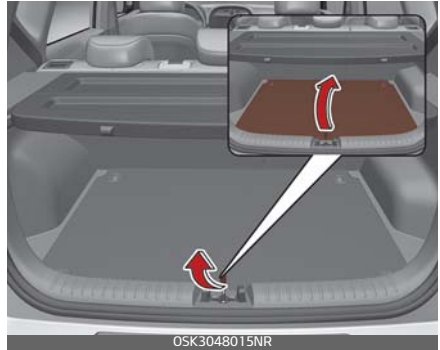

2. Fold the rear part of the luggage board frontward



3. Pull the luggage board hinge to the end of upper side sliding slot and it will fall down lower to increase cargo space.

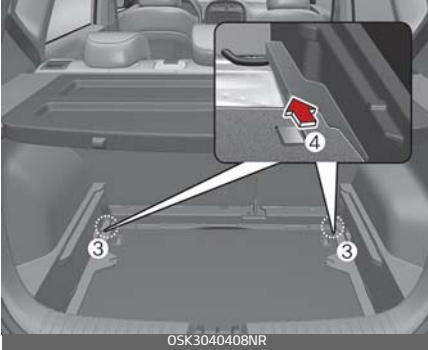

4. Slide it forward (refer to the above pictures)

## Interior features

There are various features inside the vehicle for the convenience of the occupants.

### Cup holder

The front and rear seats of the vehicle have cup holders to accommodate cups.

### **⚠ WARNING**

#### Hot liquids

Do not place uncovered cups with hot liquid in the cup holder while the vehicle is in motion. If the hot liquid spills, you may burn yourself. Such a burn to the driver could lead to loss of control of the vehicle.

### **⚠ CAUTION**

- Keep your drinks sealed while driving to prevent spilling your drink. If liquid spills, it may get into the vehicle's electrical/electronic system and damage electrical/electronic parts.
- When cleaning spilled liquids, do not use heat to dry the cup holders. This may damage the cup holder.

Front

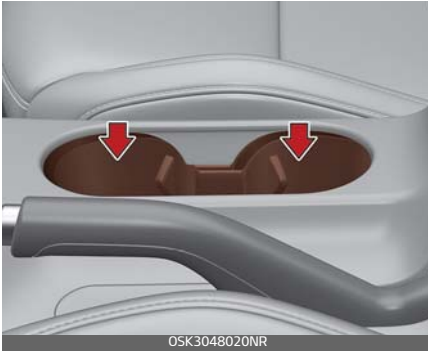

Center (if equipped)



Cups or small beverage cans may be placed in the cup holders.

**Seat warmer (if equipped)**

The seat warmer is provided to warm the front seats during cold weather.

Front seat (Type A)



Front seat (Type B)



Rear seat



With the ignition switch or START/STOP button in the ON position:



- Push either of the switches to warm the driver's seat or the front passenger's seat.

During mild weather or under conditions where the operation of the seat warmer is not needed, keep the switches in the "OFF" position.

**Temperature control (Manual)**

Each time you press the switch, the temperature setting of the seat will change as follows:

Front seat (Type A)

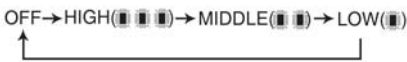

Front seat (Type B)

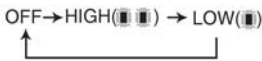

Rear seat

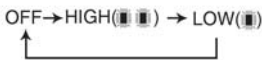

The seat warmer defaults to the OFF position whenever the ignition switch or START/STOP button is turned on.

**Temperature control (Automatic)**

The seat warmer starts to automatically control the seat temperature in order to prevent low-temperature burns after being manually turned ON.

Front seat



You may manually press the button to increase the seat temperature. However, it soon returns to the automatic mode again. When pressing the switch for more than 1.5 seconds with the seat warmer operating, the seat warmer will turn OFF. The seat warmer defaults to the OFF position whenever the ignition switch or START/STOP button is in the ON position.

**\* NOTICE**

With the seat warmer switch in the ON position, the heating system in the seat turns off or on automatically depending on the seat temperature.

**⚠ WARNING**

**Seat warmer burns**

The seat warmer may cause burns, even at low temperature, if used over a long period of time. Never allow passengers who may not be able to take care of themselves to be exposed to the risk of seat heater burns. These include:

1. Infants, children, elderly or disabled persons, or hospital outpatients

2. Persons with sensitive skin or those that burn easily
3. Fatigued individuals
4. Intoxicated individuals
5. Individuals taking medication that can cause drowsiness or sleepiness (sleeping pills, cold tablets, etc.)

**Air ventilation seat (if equipped)**



The temperature setting of the seat changes according to the switch position.

- To ventilate your seat cushion, press the switch (blue color). Each time you press the button, the airflow will change as follows:

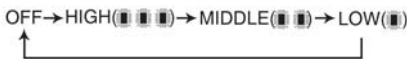

The seat warmer (with air ventilation) defaults to the OFF position whenever the ignition switch or START/STOP button is turned on.

**⚠ CAUTION**

**Seat damage**

- When cleaning the seats, do not use an organic solvent, such as paint thinner, benzene, alcohol and gasoline. Doing so may damage the air ventilation seat.
- Do not place heavy or sharp objects on the seat. Those things may damage the air ventilation seat.
- Be careful not to spill liquid, such as water or beverages, on the seat. If you spill some liquid, wipe the seat with a dry towel. Before using the air ventilation seat, dry the seat completely.

4

**Sun visor**

Use the sun visor to shield direct light through the front or side windows.

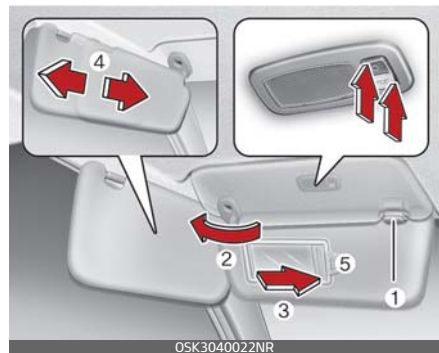

\* The actual sun visor lamp in the vehicle may differ from the illustration.

- To use the sun visor, pull it downward.
- To use the sun visor for the side window, pull it downward, unsnap it from sun visor retainer clip (1) and swing it to the side (2).
- To use the vanity mirror, pull down the visor and slide the mirror cover (3).  
Adjust the sun visor extension forward or backward (4).  
The ticket holder (5) is provided for holding a tollgate ticket (if equipped)

**CAUTION**

**Vanity mirror lamp**

If you use the vanity mirror lamp, turn off the lamp before returning the sun visor to its original position; otherwise, it could result in battery discharge and possible sun visor damage.

**Power outlet (if equipped)**

The power outlet is designed to provide power for mobile telephones or other devices designed to operate with vehicle electrical systems.

Type A



Type B



The devices should draw less than 10 amps with the vehicle on.

- Use the power outlet only when the vehicle is on and remove the accessory plug after use. Using the accessory plug for prolonged periods of time with the vehicle off could cause the battery to discharge.
- Only use 12 V electric accessories which are less than 10 A in electric capacity
- Adjust the air-conditioner or heater to the lowest operating level when using the power outlet.

- Close the cover when not in use.
- Some electronic devices can cause electronic interference when plugged into a vehicle's power outlet. These devices may cause excessive audio static and malfunctions in other electronic systems or devices used in your vehicle.
- Push the plug in as far as it will go. If good contact is not made, the plug may overheat and the fuse may open.
- Plug in battery equipped electronic devices with reverse current protection. The current from the battery may flow into the vehicle's electrical/electronic system and cause system malfunction.

## **⚠ WARNING**

### **Electric shock**

Do not put a finger or a foreign object (pen, etc.) into a power outlet and do not touch with a wet hand. You may get an electric shock.

### **USB charger (if equipped)**

The USB car charger allows drivers to charge their digital devices like smartphone, and PC tablets. Connect the cable to the USB port, charging will begin.

Front



Center



The USB car charger is available with either the ACC state or the ignition on. But we recommend you to connect the USB port and digital devices with the engine starting. See the display screen of the device to check its charging process completion. Your smartphone or table PC could get heated up while charging. This is no reason to worry, as it doesn't impact life or functions of the device. For the safety reason, charging can be stopped if the battery gets heated up to a certain

point of temperature that the devices can be negatively affected. Charging some digital devices is not available or requires special dedicated adapters if their charging methods don't fit the way the USB car charger works.

The smartphone or PC tablet without fast charging is charged at a regular speed.

Rated output:

- Digital devices with fast charging: - 9.0 V, 1.67 A
- Digital devices with normal charging: - 5.0 V, 2.1 A

### **⚠ CAUTION**

- Used the USB car charger with the ignition on. Otherwise, Vehicle battery can be discharged.
- Use the official USB cable of the manufacturer of the digital device to be charged.
- Make sure that any foreign object, drinks, and water do not come into contact with the USB car charger. Water or foreign object can damage the USB charger.
- Do not charge a device whose current consumption exceeds 2.1 A.
- Do not connect an electrical device that generates excessive electromagnetic noise to the USB car port. If you do so, noise can be caused or vehicle electronic

devices can be interrupted while audio or AV is on.

- If the charger is connected incorrectly, it can cause serious damage on the devices. Please note that damages due to incorrect usage are not covered by warranty service.

### **Wireless smart phone charging system (if equipped)**

A wireless smart phone charging system is located in front of the center console.



Firmly close all doors, and turn vehicle on. To start wireless charging, place the smart phone equipped with wireless charging function on the wireless charging pad.

For best wireless charging results, place the smart phone on the center of the charging pad.

The wireless charging system is designed for one smart phone equipped with Qi only. Please refer

to the smart phone accessory cover or the smart phone manufacturer homepage to check whether your smart phone supports Qi function.

### ***Charging wireless smart phone***

1. Remove any object on the smart phone charging pad including the smart key. If there is any foreign object on the pad other than a smart phone, the wireless charging function may not operate properly.
2. Place the smart phone on the center of the wireless charging pad.

The indicator light will change to orange once the wireless charging begins. After the charging is complete, the orange light will change to green.

You can choose to turn the wireless charging function to either ON or OFF by selecting the USM on the instrument cluster. (Please refer to "Instrument cluster" on page 4-48 for details).

If the wireless charging does not work, gently move your smart phone around the pad until the charging indicator light turns orange.

Depending on the smart phone, the charging indicator light may not turn green even after the charging is complete.

If the wireless charging is not functioning properly, the orange light will blink and flash for ten seconds then turn off. In such cases, remove the smart phone from the pad and replace it on the pad again, or double check the charging status.

If you leave the smart phone on the charging pad when the vehicle is turned off, the vehicle will alert you through warning messages and sound (applicable for vehicles with voice guidance function) after the 'Good bye' function on the instrument cluster ends.

### **⚠ WARNING**

#### **Distracted driving**

Driving while distracted can result in a loss of vehicle control that may lead to an accident, severe bodily injury, and death. The driver's primary responsibility is in the safe and legal operation of a vehicle, and use of any handheld devices, other equipment, or vehicle systems that take the driver's eyes, attention and focus away from the safe operation of a vehicle or that are not permissible by law should never be used during the operation of the vehicle.

### **⚠ CAUTION**

#### **Liquid in Wireless Smart Phone Charger**

To prevent liquid from damaging the wireless smart phone charging system in your vehicle, be sure not to spill liquid over the charging system when charging your phone.

### ⚠ CAUTION

#### **Metal in Wireless Charging System**

If any metallic object, such as a coin, is located between the wireless charging system and the smart phone, the charging may be disrupted. Also, the metallic object may heat up and potentially damage the charging system. If there is any metallic object between the smart phone and the charging pad, immediately remove the smart phone. Remove the metallic object after it has cooled down.

### \* NOTICE

- When the interior temperature of the wireless charging system rises above a set temperature, the wireless charging system will cease to function. After the interior temperature drops below the threshold, the wireless charging function will resume.
- The wireless charging system may not function properly when there is a heavy accessory cover on the smart phone.
- The wireless charging system will stop when using the wireless smart key search function to prevent radio wave disruption.
- The wireless charging system will stop when the smart key is moved out of the vehicle with the vehicle in ON.
- The wireless charging system will stop when any of the doors are opened (applicable for vehicles equipped with smart keys).
- The wireless charging system will stop when the vehicle is turned OFF.
- The wireless charging will stop when the smart phone is not in complete contact with the wireless charging pad.
- Items equipped with magnetic components, such as credit card, telephone card, bankbook or any transportation ticket, may become damaged during wireless charging.
- Place the smart phone on the center of the charge pad for best results. The smart phone may not charge when placed near the rim of the charging pad. When the smart phone does get charged, it may heat up excessively.
- For smart phones without a built-in wireless charging system, an appropriate accessory has to be equipped in order to use the vehicle's wireless charging system.

- Smart phones of some manufacturers may display messages on weak current. This is due to the particular characteristic of the smart phone and does not imply a malfunction on wireless charging function.
- The indicator light of some manufacturers' smart phones may still be orange after the smart phone is fully charged. This is due to the particular characteristic of the smart phone and not a malfunction of the wireless charging system.
- When any smart phone without a wireless charging function or a metallic object is placed on the charging pad, a small noise may sound. This small sound is due to the vehicle discerning compatibility of the object placed on the charging pad. It does not affect your vehicle or the smart phone in any way.
- The wireless cellular phone charging system may not support certain cellular phones, which are not verified for Qi specification **Qi**.
- When placing your cellular phone on the charging mat, position the phone in the middle of the mat for optimal charging performance. If your cell phone is off to the side, the charging rate may be less and in some cases the cell

phone may experience higher heat conduction.

- When charging some cellular phones with a self-protection feature, the wireless charging speed may decrease and the wireless charging may stop.

---

***This device complies with Part 15 of the FCC rules.***

Operation is subject to the following two conditions:

1. This device may not cause harmful interference, and
2. This device must accept any interference received, including interference that may cause undesired operation.

**Coat hook (if equipped)**

A Coat hook is next to the rear grab handle.



\* This actual feature may differ from the illustration.



**⚠ CAUTION**

**Hanging clothing**

Do not hang heavy clothes, since they may damage the hook.

**⚠ WARNING**

Do not hang other objects, such as hangers or hard objects except clothes. Also, do not put heavy, sharp or breakable objects in the clothing's pockets. In an accident or when the curtain air bag is inflated, it may cause vehicle damage or bodily injury.



**Floor mat anchor(s) (if equipped)**



When using a floor mat on the front floor carpet, make sure it attaches to the floor mat anchor(s) in your vehicle. This keeps the floor mat from sliding forward.

**⚠ WARNING**

**After market floor mat**

Do not install after market floor mats that are not capable of being securely attached to the vehicle's floor mat anchors.

Unsecured floor mats can interfere with pedal operation.

The following must be observed when installing ANY floor mat to the vehicle.

- Ensure that the floor mats are securely attached to the vehicle's floor mat anchor(s) before driving the vehicle.
- Do not use ANY floor mat that cannot be firmly attached to the vehicle's floor mat anchors.

- Do not stack floor mats on top of one another (e.g. all-weather rubber mat on top of a carpeted floor mat). Only a single floor mat should be installed in each position.

### Cargo area cover (if equipped)



Use the cargo area cover to hide items stored in the cargo area.

### Removal and installation



To remove the cargo area cover:

1. Fold the cargo area cover up in half.

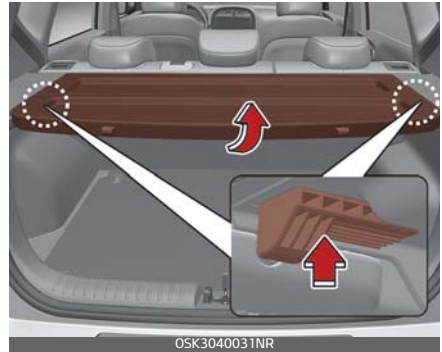

2. Firmly hold the folded part of the cover and lift it up.



3. While lifting the cover up, hold the area near the front slots. Then, pull up the cover at approximately 45 ° angle.

### **⚠ WARNING**

Folded cover may block the rear view. Put the folded cover in the appropriate position.

To install the cargo area cover:

1. To use the cargo area cover, insert the 4 edges into the slots.

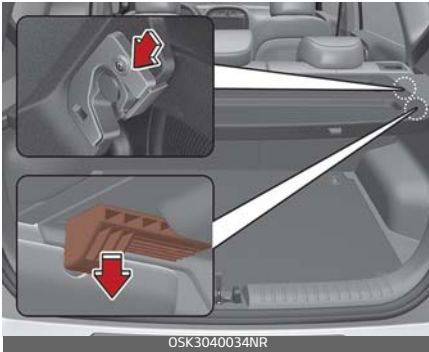

OSK3040034NR

### **⚠ WARNING**

Do not place objects on the cargo area cover. Such objects may be thrown about inside the vehicle and possibly injure vehicle occupants during an accident or when braking.

### **⚠ CAUTION**

Since the cargo area cover may be damaged or malformed, do not put luggage on it when it is used.

## **Exterior features**

If the vehicle has a roof rack, you can load cargo on top of your vehicle.

### **Roof rack (if equipped)**

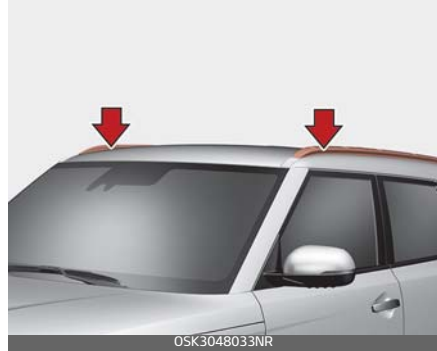

OSK3048033NR

Crossbars and fixing components needed to install the roof rack on your vehicle may be obtained from an authorized Kia dealer.

### **\* NOTICE**

- The crossbars (if equipped) should be placed in the proper load carrying positions prior to placing items onto the roof rack.
- If the vehicle is equipped with a sunroof, be sure not to position cargo onto the roof rack in such a way that it could interfere with sunroof operation.
- When the roof rack is not being used to carry cargo, the crossbars may need to be repositioned if wind noise is detected.

**⚠ CAUTION**

**Loading Roof Rack**

- When carrying cargo on the roof rack, take the necessary precautions to make sure the cargo does not damage the roof of the vehicle.
- When carrying large objects on the roof rack, make sure they do not exceed the overall roof length or width.
- When you are carrying cargo on the roof rack, do not operate the sunroof (if equipped). This can damage the sunroof.

- 
- The following specification is the maximum weight that can be loaded onto the roof rack. Distribute the load as evenly as possible across the crossbars (if equipped) and roof rack and secure the load firmly.

ROOF RACK	220 lbs. (100 kg) EVENLY DISTRIBUTED
-----------	---

Loading cargo or luggage in excess of the specified weight limit on the roof rack may damage your vehicle.

**⚠ WARNING**

- The vehicle center of gravity will be higher when items are loaded onto the roof rack. Avoid sudden starts, braking, sharp turns, abrupt maneuvers or high speeds

that may result in loss of vehicle control or rollover resulting in an accident.

- Always drive slowly and turn corners carefully when carrying items on the roof rack. Severe wind updrafts, caused by passing vehicles or natural causes, can cause sudden upward pressure on items loaded on the roof rack. This is especially true when carrying large, flat items, such as wood panels or mattresses. This could cause the items to fall off the roof rack and cause damage to your vehicle or others around you.

- 
- To prevent damage or loss of cargo while driving, check frequently before or while driving to make sure the items on the roof rack are securely fastened.

## Audio system

### \* NOTICE

If you install an after market HID head lamp, your vehicle's audio and electronic device may malfunction.

\* If your vehicle is equipped with multimedia system, refer to a separately supplied manual for detailed information.



### \* NOTICE

When using a portable audio device connected to the power outlet, noise may occur during playback. If this happens, use the power source of the portable audio device.

## Shark fin antenna



The shark fin antenna will receive the transmit data.

## USB port

You can use an USB port to plug in an USB.

## How vehicle radio works

### FM reception

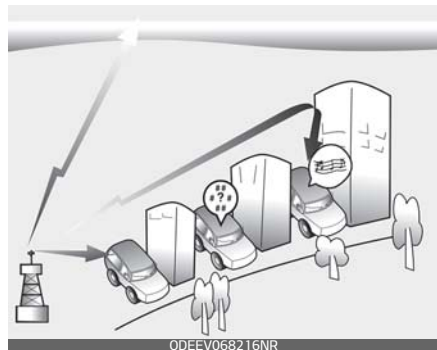

AM and FM radio signals are broadcast from transmitter towers located around your city. They are intercepted by the radio antenna on

your vehicle. This signal is then processed by the radio and sent to your vehicle speakers.

However, in some cases the signal coming to your vehicle may not be strong and clear.

This can be due to factors, such as the distance from the radio station, closeness of other strong radio stations or the presence of buildings, bridges or other large obstructions in the area.

### **AM reception**

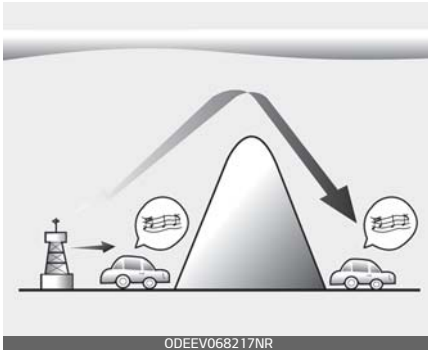

AM broadcasts can be received at greater distances than FM broadcasts. This is because AM radio waves are transmitted at low frequencies. These long distance, low frequency radio waves can follow the curvature of the earth rather than traveling straight. In addition, they curve around obstructions resulting in better signal coverage.

### **FM radio station**

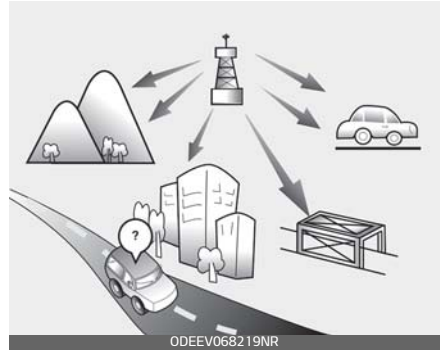

FM broadcasts are transmitted at high frequencies and do not bend to follow the earth's surface. Because of this, FM broadcasts generally begin to fade within short distances from the station. Also, FM signals are easily affected by buildings, mountains, and obstructions. This can lead to undesirable or unpleasant listening conditions which might lead you to believe a problem exists with your radio.

The following conditions are normal and do not indicate radio trouble:

- **Fading** - As your vehicle moves away from the radio station, the signal will weaken and sound will begin to fade. When this occurs, we suggest that you select another station with a stronger signal.



- Multi-Path Cancellation – Radio signals being received from several directions can cause distortion or fluttering. This can be caused by a direct and reflected signal from the same station, or by signals from two stations with close frequencies. If this occurs, select another station until the condition has passed.

- Flutter/Static – Weak FM signals or large obstructions between the transmitter and your radio can disturb the signal causing static or fluttering noises to occur. Reducing the treble level may lessen this effect until the disturbance clears.
- Station Swapping – As an FM signal weakens, another more powerful signal near the same frequency may begin to play. This is because your radio is designed to lock onto the clearest signal. If this occurs, select another station with a stronger signal.

**Using a cellular phone or a two-way radio**

When a cellular phone is used inside the vehicle, noise may be produced from the audio system. This does not mean that something is wrong with the audio equipment. In such a case, try to operate mobile devices as far from the audio equipment as possible.

When using a communication system such as a cellular phone or a radio set inside the vehicle, a separate external antenna must be fitted. When a cellular phone or a radio set is used with an internal antenna alone, it may interfere with the vehicle's electrical system and adversely affect safe operation of the vehicle.

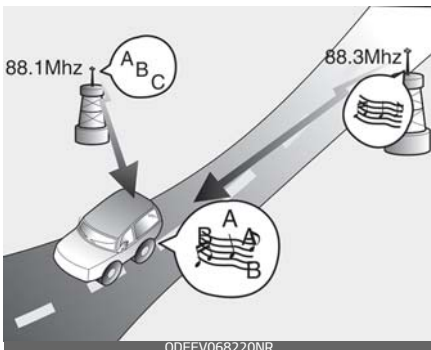

**⚠ WARNING****Cell phone use**

Do not use a cellular phone while driving. Stop at a safe location to use a cellular phone.

---

**⚠ WARNING****Distracted driving**

Driving while distracted can result in a loss of vehicle control that may lead to an accident, severe bodily injury, or death. The driver's primary responsibility is the safe and legal operation of the vehicle, and the use of any handheld devices, other equipment, or vehicle systems that take the driver's eyes, attention, and focus away from the safe operation of the vehicle, or that are not permissible by law, should never be used during the operation of the vehicle.

---

**Declaration of Conformity****FCC**

This equipment has been tested and found to comply with the limits for a Class B digital device, pursuant to part 15 of the FCC Rules. These limits are designed to provide reasonable protection against harmful interference in a residential installation.

This equipment generates, uses and can radiate radio frequency energy and, if not installed and used in accordance with the instructions, may cause harmful interference to radio communications. However, there is no guarantee that interference will not occur in a particular installation. If this equipment does cause harmful interference to radio or television reception, which can be determined by turning the equipment off and on, the user is encouraged to try to correct the interference by one or more of the following measures:

- Reorient or relocate the receiving antenna.
- Increase the separation between the equipment and receiver.
- Connect the equipment into an outlet on a circuit different from that to which the receiver is connected.



- Consult the dealer or an experienced radio/TV technician for help.

**⚠ CAUTION**

Any changes or modifications to this device not explicitly approved by the manufacturer could void your authority to operate this equipment.

---

This device complies with part 15 of the FCC Rules. Operation is subject to the following two conditions:

1. This device may not cause harmful interference, and
2. This device must accept any interference received, including interference that may cause undesired operation.

This equipment complies with FCC radiation exposure limits set forth for an uncontrolled environment.

This equipment should be installed and operated with minimum 8 in (20 cm) between the and your body. This transmitter must not be collocated or operating in conjunction with any other antenna or transmitter unless authorized to do so by the FCC.

<b>Be sure the exhaust system does not leak.</b> .....	<b>5-7</b>
<b>Before driving</b> .....	<b>5-8</b>
<b>Key positions</b> .....	<b>5-10</b>
• Illuminated ignition switch .....	5-10
• Ignition switch position.....	5-10
• Starting the engine .....	5-11
• Stopping the gasoline engine (Manual Transmission)....	5-12
<b>ENGINE START/STOP button</b> .....	<b>5-13</b>
• Illuminated ENGINE START/STOP button .....	5-13
• ENGINE START/STOP button position.....	5-13
• Starting the engine .....	5-16
• Stopping the engine (Manual Transmission) .....	5-18
<b>Manual transmission</b> .....	<b>5-19</b>
• Manual transmission operation .....	5-19
• Good driving practices .....	5-21
<b>Intelligent variable transmission (IVT)</b> .....	<b>5-22</b>
• Intelligent Variable Transmission (IVT) operation .....	5-22
• Shift lock system.....	5-26
• Ignition key interlock system .....	5-27
• Good driving practices .....	5-27
<b>Dual clutch transmission (DCT)</b> .....	<b>5-29</b>
• Dual clutch transmission operation .....	5-29
• LCD display for warning message .....	5-30
• Transmission ranges.....	5-33
• Paddle shifter .....	5-34
• Shift lock system.....	5-35
• Ignition key interlock system .....	5-36
• Good driving practices .....	5-36

# 5 Driving your vehicle

<b>Brake system</b> .....	<b>5-38</b>
• Power brakes .....	5-38
• Parking brake .....	5-39
• Anti-lock brake system (ABS) .....	5-41
• Electronic stability control (ESC).....	5-43
• Vehicle stability management (VSM) .....	5-46
• Hill-start Assist Control (HAC).....	5-48
• Good braking practices .....	5-48
<b>ISG (Idle Stop and Go) system</b> .....	<b>5-49</b>
• Auto stop .....	5-50
• Auto start .....	5-51
• Condition of ISG system operation.....	5-51
• ISG system deactivation.....	5-52
• ISG system malfunction .....	5-52
<b>Drive mode integrated control system</b> .....	<b>5-53</b>
<b>Forward Collision-Avoidance Assist (FCA) (Front view camera only)</b> .....	<b>5-55</b>
• Setting and activating FCA.....	5-55
• Setting the initial warning activation time.....	5-56
• Prerequisite for FCA activation .....	5-56
• FCA warning message and brake control.....	5-57
• Brake operation .....	5-58
• FCA front view camera sensor .....	5-58
• Warning message and warning light.....	5-59
• FCA malfunction .....	5-60
• Limitations of FCA .....	5-61
• This device complies with Part 15 of the FCC rules. ....	5-65
• Radio frequency radiation exposure information:.....	5-65

## **Forward Collision–Avoidance Assist (FCA) (Sensor fusion)...5-66**

- Setting and activating FCA ..... 5-66
- Setting the initial warning activation timeForward Collision–Avoidance Assist (FCA) (Sensor fusion)setting initial warning activation time..... 5-67
- Prerequisite for FCA activation..... 5-67
- FCA warning message and brake control..... 5-67
- Brake operation ..... 5-69
- FCA front view camera / front radar sensor..... 5-70
- Warning message and warning light..... 5-71
- FCA malfunction ..... 5-71
- Limitations of FCA..... 5-73
- Detecting pedestrians or cyclists ..... 5-78
- This device complies with Part 15 of the FCC rules. .... 5-80
- Radio frequency radiation exposure information:..... 5-80

## **Lane Keeping Assist (LKA) ..... 5-81**

- LKA operation ..... 5-82
- LKA activation ..... 5-82
- Warning message ..... 5-83
- The system will be canceled when:..... 5-85
- Driver's Attention ..... 5-86
- LKA malfunction ..... 5-87
- LKA function change ..... 5-88

## **Blind-Spot Collision Warning (BCW)..... 5-89**

- Setting and activating BCW ..... 5-90
- Setting the warning volume of Blind-Spot Collision Warning 5-90
- Operating Conditions ..... 5-91
- Blind-Spot Collision Warning alert ..... 5-91

## 5 Driving your vehicle

- BCW rear corner radar sensor ..... 5-92
- Warning message ..... 5-93
- Limitations of BCW ..... 5-94
- This device complies with Part 15 of the FCC rules. .... 5-98
- Driver Attention Warning (DAW) ..... 5-98**
  - Setting and activating the DAW ..... 5-98
  - Displaying the driver's attention level ..... 5-99
  - Taking a break ..... 5-99
  - Resetting Driver Attention Warning system ..... 5-100
  - DAW disabled ..... 5-100
  - DAW malfunction ..... 5-100
- Cruise Control (CC) ..... 5-102**
  - Cruise Control switch ..... 5-103
  - Setting Cruise Control speed ..... 5-103
  - Increasing Cruise Control set speed: ..... 5-104
  - Decreasing the cruising speed ..... 5-104
  - Accelerating temporarily with Cruise Control on ..... 5-105
  - Cancelling Cruise Control ..... 5-105
  - Resuming cruising speed at more than approximately 20 mph (30 km/h) ..... 5-105
  - Turning Cruise Control off ..... 5-106
- Smart Cruise Control (SCC) ..... 5-106**
  - Smart Cruise Control High Sensitivity/Normal Sensitivity/Off ..... 5-108
  - Setting Smart Cruise Control speed ..... 5-108
  - Increasing Smart Cruise Control set speed ..... 5-109
  - Decreasing Smart Cruise Control set speed ..... 5-109
  - Accelerating temporarily with Smart Cruise Control on.... 5-110

- Smart Cruise Control will be temporarily canceled when: .5-110
- Resuming Smart Cruise Control set speed .....5-112
- Turning Smart Cruise Control off .....5-112
- Setting headway .....5-112
- When the lane ahead is clear: .....5-113
- When there is a vehicle ahead of you in your lane:.....5-113
- Adjusting the sensitivity of Smart Cruise Control .....5-116
- Converting to Cruise Control mode .....5-117
- Limitations of the Smart Cruise Control .....5-117
- This device complies with Part 15 of the FCC rules. ....5-121
- Radio frequency radiation exposure information:.....5-122
- Rear Cross-Traffic Collision Warning (RCCW) / Rear Cross-Traffic Collision-Avoidance Assist (RCCA).....5-122**
- Rear Cross-Traffic Collision Warning system.....5-122
- Rear Cross-Traffic Collision-Avoidance Assist system5-122
- Setting and activating RCCW/RCCA.....5-123
- Setting the initial warning activation time .....5-123
- Setting the warning volume of Rear Cross-Traffic Collision Warning .....5-124
- Operating conditions.....5-124
- Rear Cross-Traffic Collision Warning alert.....5-124
- Rear Cross-Traffic Collision-Avoidance Assist alert.....5-125
- Detecting Sensor .....5-127
- Warning message .....5-128
- Limitations of the system .....5-129
- This device complies with Part 15 of the FCC rules. ....5-133
- Economical operation.....5-134**
- Special driving conditions special driving conditions.....5-136**
- Winter driving .....5-140**

## 5 Driving your vehicle

<b>Trailer towing .....</b>	<b>5-144</b>
<b>Vehicle load limit .....</b>	<b>5-144</b>
• Steps For Determining Correct Load Limit -.....	5-145
• Certification label.....	5-146
<b>Vehicle weight .....</b>	<b>5-148</b>

## Driving your vehicle

### Be sure the exhaust system does not leak.

The exhaust system should be checked whenever the vehicle is raised to change the oil or for any other purpose.

If you hear a change in the sound of the exhaust or if you drive over something that strikes the underneath side of the vehicle, have the exhaust system checked as soon as possible by an authorized Kia dealer.

#### **WARNING**

##### **Engine exhaust**

Do not inhale exhaust fumes or leave your engine running in a enclosed area for a prolonged time. Exhaust fumes contain carbon monoxide, a colorless, odorless gas that can cause unconsciousness and death by asphyxiation.

#### **WARNING**

##### **Open trunk**

Do not drive with the trunk open. Poisonous exhaust gases can enter the passenger compartment. If you must drive with the trunk open proceed as follows:

1. Close all windows.
2. Open side vents.

3. Set the air intake control at "Fresh", the air flow control at "Floor" or "Face" and the fan at the highest speed.
-



## Before driving

Before getting into the vehicle, you should examine the car and its surroundings. After getting into the vehicle, you should check a number of things before driving.

### Before entering vehicle

- Be sure that all windows, outside mirror(s), and outside lights are clean.
- Check the condition of the tires.
- Check under the vehicle for any sign of leaks.
- Be sure there are no obstacles behind you if you intend to back up.

### Necessary inspections

Fluid levels, such as engine oil, engine coolant, brake fluid, and washer fluid should be checked on a regular basis, at the exact interval depending on the fluid. Further details are provided in "Maintenance" on page 7-4.

#### WARNING

### Distracted driving

Focus on the road while driving. The driver's primary responsibility is in the safe and legal operation of the vehicle. Use of any handled devices, other equipment or vehicle systems

that distract the driver should not be used during vehicle operation.

---

### Before starting

- Close and lock all doors.
- Position the seat so that all controls are easily reached.
- Buckle your seat belt.
- Adjust the inside and outside rearview mirrors.
- Be sure that all lights work.
- Check all gauges.
- Check the operation of warning lights when the ignition switch is turned to the ON position.
- Release the parking brake and make sure the brake warning light goes out.

For safe operation, be sure you are familiar with your vehicle and its equipment.

#### WARNING

### Fire risk

When you intend to park or stop the vehicle with the engine on, be careful not to depress the accelerator pedal for a long period of time. It may overheat the engine or exhaust system and cause fire.

---

#### WARNING

### Check surroundings

Always check the surrounding areas near your vehicle for pedestrians, especially children, before putting a vehicle into D (Drive) or R (Reverse).

---

with your ability to use the brake and accelerator pedals.

---

### **WARNING**

#### **Loose objects**

Securely store items in your vehicle. When you make a sudden stop or turn the steering wheel rapidly; loose objects may drop on the floor and it could interfere with the operation of the foot pedals, possibly causing an accident.

---

### **WARNING**

#### **Driving while intoxicated**

Do not drive while intoxicated. Drinking and driving is dangerous. Even a small amount of alcohol will affect your reflexes, perceptions and judgment.

Driving while under the influence of drugs is as dangerous as or more dangerous than driving drunk.

---

### **WARNING**

#### **Proper footwear**

Always wear appropriate shoes when operating your vehicle. Unsuitable shoes (high heels, ski boots, sandals, etc.) may interfere

## Key positions (if equipped)

Your vehicle is equipped with four different ignition positions.

### Illuminated ignition switch

Whenever a front door is opened, the ignition switch will illuminate for your convenience, provided the ignition switch is not in the ON position.



The light will go off immediately when the ignition switch is turned on. It will also go off after about 30 seconds when the door is closed.

### Ignition switch position

Your vehicle is equipped with four different ignition positions.



#### ***LOCK (1)***

The ignition key can be removed only in the LOCK position.

#### ***ACC (Accessory) (2)***

The electrical accessories are operative. If difficulty is experienced turning the ignition switch to the ACC position, turn the key while turning the steering wheel right and left to release the tension.

#### ***ON (3)***

The warning lights can be checked before the engine is started. This is the normal running position after the engine is started.

Do not leave the ignition switch ON if the engine is not running to prevent battery discharge.

#### ***START (4)***

Turn the ignition switch to the START position to start the engine.

The engine will crank until you release the key; then it returns to the ON position. The brake warning light can be checked in this position.

The anti-theft steering column lock (if equipped) is not a substitute for the parking brake. Before leaving the driver's seat, always make sure the shift lever is engaged in P (Park) for intelligent variable transmission, set the parking brake fully and shut the engine off. Unexpected and sudden vehicle movement may occur if these precautions are not taken.

### WARNING

#### Ignition switch

Never turn the ignition switch to LOCK or ACC while the vehicle is moving. This would result in loss of directional control and braking function, which could cause an accident.

### NOTICE

If you leave the ignition switch to the ACC or ON position for a long time, the battery may discharge.

### WARNING

#### Key holder

Do not attach small purses, multiple keys, or any other heavy accessories to the driver's key chain used to start the vehicle. This may cause

the driver to accidentally make the key inserted in the vehicle to change the ignition position to the ACC position while the vehicle is moving thereby increasing the risk of an accident and causing the deactivation of several safety features.

### WARNING

#### Leaving the Vehicle

To avoid unexpected or sudden vehicle movement, never leave your vehicle if the transmission is not locked in the P (Park) position and the parking brake is fully engaged. Before leaving the driver's seat, always make sure the shift lever is engaged in P (Park), set the parking brake fully and shut the engine off.

#### Starting the engine

1. Make sure the parking brake is applied.
2. Depending on your vehicle's transmission type, follow the step below.
  - **Manual Transmission** – Depress the clutch pedal fully and shift the transmission into Neutral. Keep the clutch pedal and brake pedal depressed while turning the ignition switch to the start position.
  - **Intelligent Variable Transmission** – Place the transmission

shift lever in P (Park). Depress the brake pedal fully.

You can also start the engine when the shift lever is in the N (Neutral) position.

3. Turn the ignition switch to START and hold it there until the engine starts (a maximum of 10 seconds), then release the key. It should be started **without depressing the accelerator**.
4. Do not wait for the engine to warm up while the vehicle remains stationary. Start driving at moderate engine speeds. (Steep accelerating and decelerating should be avoided.)

### WARNING

#### Steering wheel

Never reach for any controls through the steering wheel while the vehicle is in motion. The presence of your hand or arm in this area could cause a loss of vehicle control.

If the engine stalls while you are in motion, do not attempt to move the shift lever to the P (Park) position. If traffic and road conditions permit, you may put the shift lever in the N (Neutral) position while the vehicle is still moving and turn the ignition switch to the START position in an attempt to restart the engine.

### CAUTION

#### Starter

Do not engage the starter for more than 10 seconds. If the engine stalls or fails to start, wait 5 to 10 seconds before reengaging the starter. Improper use of the starter may damage it.

#### Stopping the gasoline engine (Manual Transmission)

1. Make sure the vehicle is completely stopped and keep the clutch pedal and brake pedal depressed.
2. Shift the transmission into Neutral while depressing the clutch pedal and brake pedal.
3. Engage the parking brake while depressing the brake pedal.
4. Turn the ignition key to the LOCK position and remove it.

## ENGINE START/STOP button (if equipped)

Your vehicle is equipped with four different ignition positions.

### Illuminated ENGINE START/STOP button

Whenever the front door is opened, the ENGINE START/STOP button will illuminate for your convenience.



The light will go off after about 30 seconds when the door is closed. It will also go off immediately when the theft-alarm system is armed.

### ENGINE START/STOP button position

Your vehicle is equipped with four different ignition positions.

#### **OFF**

#### **With manual transmission**

To turn off the engine (START/RUN position), stop the vehicle then press the

ENGINE START/STOP button.

#### **With Intelligent Variable Transmission**

To turn off the engine (START/RUN position) or vehicle power (ON position), press the ENGINE START/STOP button with the shift lever in the P (Park) position. When you press the ENGINE START/STOP button without the shift lever in the P (Park) position, the ENGINE START/STOP button will not change to the OFF position but to the ACC position.

#### **Vehicles equipped with anti-theft steering column lock**

The steering wheel locks when the ENGINE START/STOP button is in the OFF position to protect you against theft. It locks when the door is opened.

If the steering wheel is not locked properly when you open the driver's door, the warning chime will sound. Try locking the steering wheel again. If the problem is not solved, have the system checked by an authorized Kia dealer.

In addition, if the ENGINE START/STOP button is in the OFF position after the driver's door is opened, the steering wheel will not lock and the warning chime will sound. In such a situation, close the door. Then the steering wheel will lock and the warning chime will stop.

**\* NOTICE**

If the steering wheel doesn't unlock properly, the ENGINE START/STOP button will not work. Press the ENGINE START/STOP button while turning the steering wheel right and left to release the tension.

**\* NOTICE**

You are able to turn off the engine (START/RUN) or vehicle power (ON), only when the vehicle is not in motion.

**⚠ CAUTION**

In an emergency situation while the vehicle is in motion, you are able to turn the engine off and to the ACC position by pressing the ENGINE START/STOP button for more than 2 seconds or 3 times successively within 3 seconds.

If the vehicle is still moving, to restart the vehicle:

- Manual transmission - Press the ENGINE START/STOP button with shift lever in neutral and clutch pedal depressed.
- Intelligent Variable Transmission - Press the ENGINE START/STOP button when vehicle speed is 3 mph (5 km/h) or over.

**ACC (Accessory)****With manual transmission**

Press the ENGINE START/STOP button when the button is in the OFF position

**With Intelligent Variable Transmission**

Press the ENGINE START/STOP button while it is in the OFF position without depressing the brake pedal. The steering wheel unlocks and electrical accessories are operational.

If the ENGINE START/STOP button is in the ACC position for more than 1 hour, the button is turned off automatically to prevent battery discharge.

**ON****With manual transmission**

Press the ENGINE START/STOP button when the button is in the ACC position without depressing the clutch pedal.

### With Intelligent Variable Transmission

Press the ENGINE START/STOP button while it is in the ACC position without depressing the brake pedal. The warning lights can be checked before the engine is started. Do not leave the ENGINE START/STOP button in the ON position for a long time. The battery may discharge, because the engine is not running.

### START/RUN

#### With manual transmission

To start the engine, depress the clutch pedal and brake pedal, then press the ENGINE START/STOP button with the shift lever in the N (Neutral) position.

#### With Intelligent Variable Transmission

To start the engine, depress the brake pedal and press the ENGINE START/STOP button with the shift lever in the P (Park) or the N (Neutral) position. For your safety, start the engine with the shift lever in the P (Park) position.

#### \* NOTICE

If you press the ENGINE START/STOP button without depressing the clutch pedal for manual transmission vehicles or without depressing the brake pedal for manual transmission / Intelligent Variable Transmission vehicles, the engine will not

start and the ENGINE START/STOP button changes as follow:  
OFF → ACC → ON → OFF or ACC

#### \* NOTICE

If you leave the ENGINE START/STOP button in the ACC or ON position for a long time, the battery will discharge.

#### ⚠ WARNING

- Never press the ENGINE START/STOP button while the vehicle is in motion. This would result in loss of directional control and braking function, which could cause an accident.
- The anti-theft steering column lock is not a substitute for the parking brake. Before leaving the driver's seat, always make sure the shift lever is engaged in P (Park), set the parking brake fully and shut the engine off. Unexpected and sudden vehicle movement may occur if these precautions are not taken.
- Never reach for the ENGINE START/STOP button or any other controls through the steering wheel while the vehicle is in motion. The presence of your hand or arm in the area could cause loss of vehicle control, an



accident and serious bodily injury or death.

- Do not place any movable objects around the driver's seat as they may move while driving, interfere with the driver and lead to an accident.

## Starting the engine

### WARNING

- Do not start the vehicle with the accelerator pedal depressed. The vehicle can move and lead to an accident.
- Wait until the engine rpm is normal. The vehicle may suddenly move if the brake pedal is released when the rpm is high.

### *Starting the engine*

1. Carry the smart key or place it inside the vehicle.
2. Make sure the parking brake is firmly applied.
3. Depending on your vehicle's transmission type, follow sub step below.
  - **Manual Transmission** – Depress the clutch pedal fully and shift the transmission into Neutral. Keep the clutch pedal and brake pedal depressed while turning the ignition switch to the start position.

- **Intelligent Variable Transmission/Dual clutch transmission** –

Place the transmission shift lever in P (Park). Depress the brake pedal fully.

You can also start the engine when the shift lever is in the N (Neutral) position.

4. Press the ENGINE START/STOP button.
 

It should be started without depressing the accelerator pedal.
5. Do not wait for the engine to warm up while the vehicle remains stationary. Start driving at moderate engine speeds. (Steep accelerating and decelerating should be avoided.)

### *Starting and stopping the engine for turbocharger intercooler*

1. Do not race or accelerate the engine immediately after starting.
 

If the engine is cold, idle for several seconds before sufficient lubrication is ensured in the turbocharger unit.
2. After high speed or extended driving, requiring a heavy engine load, idle the engine about 1 minute before turning it off.
 

This idle time will allow the turbocharger to cool prior to shutting the engine off.

### CAUTION

Do not turn the engine off immediately after it has been subjected to

a heavy load. Doing so may cause severe damage to the engine or turbocharger unit.

### ***Starting the engine with smart key***

Even if the smart key is in the vehicle, if it is far away from you, the engine may not start.

When the ENGINE START/STOP button is in the ACC position or above, if any door is opened, the system checks for the smart key. If the smart key is not in the vehicle, the "🔑" indicator and a message "Key is not in the vehicle" will appear on the instrument cluster and LCD window. And if all doors are closed, the chime will sound for 5 seconds. The indicator or warning will turn off while the vehicle is moving. Always have the smart key with you.

### **⚠️ WARNING**

The engine will start, only when the smart key is in the vehicle. Never allow children or any person who is unfamiliar with the vehicle touch the ENGINE START/STOP button or related parts. Pushing the ENGINE START/STOP button while the smart key is in the vehicle may result in unintended engine activation and/or unintended vehicle movement.

### **⚠️ CAUTION**

If the engine stalls while the vehicle is in motion, do not attempt to move the shift lever to the P (Park) position. If the traffic and road conditions permit, you may put the shift lever in the N (Neutral) position while the vehicle is still moving and press the ENGINE START/STOP button in an attempt to restart the engine.



### **\* NOTICE**

- If the battery is weak or the smart key does not work correctly, you can start the engine by pressing the ENGINE START/STOP button with the smart key. The side with the lock button should contact the ENGINE START/STOP button directly. When you press the ENGINE START/STOP button directly with the smart key, the smart key

should contact the button at a right angle.

- When the stop lamp fuse is blown, you cannot start the engine normally.

Replace the fuse with a new one. If it is not possible, you can start the engine by pressing the engine start/ stop button for 10 seconds while it is in the ACC position. The engine can start without depressing the brake pedal. But for your safety always depress the brake pedal and clutch pedal (if equipped) before starting the engine.

---

### CAUTION

- Do not press the ENGINE START/ STOP button for more than 10 seconds except when the stop lamp fuse is blown.
  - Do not turn the ignition switch to the START position with the engine running. It may damage the starter.
- 

### Stopping the engine (Manual Transmission)

1. Make sure the vehicle is completely stopped and keep the clutch pedal and brake pedal depressed.
2. Shift the transmission into Neutral while depressing the clutch pedal and brake pedal.

3. Engage the parking brake while depressing the brake pedal.
4. Turn the ignition key to the LOCK position and remove it.

## Manual transmission (if equipped)

The manual transmission has 6 forward gears.

### Manual transmission operation

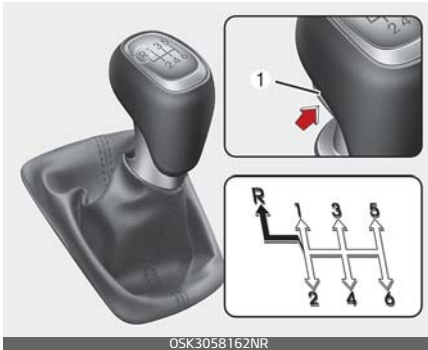

⇒ The shift lever can be moved without pulling the button (1).

➔ The button (1) should be pressed when moving the shift lever into reverse.

This shift pattern is imprinted on the shift knob. The transmission is fully synchronized in all forward gears so shifting to either a higher or a lower gear is easily accomplished.

Depress the clutch pedal down fully while shifting, then release it slowly. If your vehicle is equipped with an ignition lock switch, the engine will not start when starting the engine without depressing the clutch pedal.

The shift lever must be returned to the neutral position before shifting into R (Reverse).

Push the button located immediately below the shift knob and pull the gearshift lever to the left sufficiently, and then shift into reverse (R) gear position.

Make sure the vehicle is completely stopped before shifting into R (Reverse).

Never operate the engine with the tachometer (rpm) in the red zone.

### ⚠ CAUTION

- When downshifting from fifth gear to fourth gear, caution should be taken not to inadvertently press the shift lever sideways in such a manner that the second gear is engaged. Such a drastic downshift may cause the engine speed to increase to the point that the tachometer will enter the red-zone. Such over-revving of the engine and transmission may possibly cause engine damage.
- Do not downshift more than 2 gears or downshift the gear when the engine is running at high speed (5,000 rpm or higher). Such a downshifting may damage the engine, clutch and the transmission.

- During cold weather, shifting may be difficult until the transmission lubricant is warmed up. This is normal and not harmful to the transmission.
- If you've come to a complete stop and it's hard to shift into 1st or R (Reverse), leave the shift lever at N (Neutral) position and release the clutch. Press the clutch pedal back down, and then shift into 1st or R (Reverse) gear position.

### CAUTION

- To avoid premature clutch wear and damage, do not drive with your foot resting on the clutch pedal. Also, don't use the clutch to hold the vehicle stopped on an uphill grade, while waiting for a traffic light, etc.
- Do not use the shift lever as a hand rest during driving, as this can result in premature wear of the transmission shift forks.
- To prevent possible damage to the clutch system, do not start with the 2nd (second) gear engaged except when you start on a slippery road.

### CAUTION

On manual transmission vehicles, if you take your foot off the clutch pedal before the engine completely starts, it may not start. Therefore,

hold down the clutch pedal and brake pedal and remain until the engine is fully started.

### WARNING

- Before leaving the driver's seat, always set the parking brake fully and shut the engine off. Then make sure the transmission is shifted into 1st gear when the vehicle is parked on a level or uphill grade, and shifted into R (Reverse) on a downhill grade. Unexpected and sudden vehicle movement can occur if these precautions are not followed in the order identified.
- Do not use the engine brake (shifting from a high gear to lower gear) rapidly on slippery roads. The vehicle may slip causing an accident.
- The clutch pedal should be pressed all the way in, and when releasing the pedal, be careful not to press it again before the pedal returns to its original position. Repeated steps before the clutch pedal returns to its original position may cause clutch system failure.
- Do not overload the specified load weight. If the vehicle is starting and running in an overload condition, abnormally large clutch disc friction heat is generated, which

may cause the clutch cover and clutch disc to malfunction.

---

### ***Using the clutch***

The clutch should be pressed all the way to the floor before shifting, then released slowly. The clutch pedal should always be fully released while driving. Do not rest your foot on the clutch pedal while driving. This can cause unnecessary wear. Do not partially engage the clutch to hold the vehicle on an incline. This causes unnecessary wear. Use the foot brake or parking brake to hold the vehicle on an incline. Do not operate the clutch pedal rapidly and repeatedly.

#### **⚠ CAUTION**

When operating the clutch pedal, press the clutch pedal down fully. If you don't press the clutch pedal fully, the clutch may be damaged or noise may occur.

---

### ***Downshifting***

When you must slow down in heavy traffic or while driving up steep hills, downshift before the engine starts to labor. Downshifting reduces the chance of stalling and gives better acceleration when you again need to increase your speed. When the vehicle is traveling down steep hills,

downshifting helps maintain safe speed and prolongs brake life.

### **Good driving practices**

- Never take the vehicle out of gear and coast down a hill. This is extremely hazardous. Always leave the vehicle in gear.
- Don't "ride" the brakes. This can cause them to overheat and malfunction. Instead, when you are driving down a long hill, shift to a lower gear. When you do this, engine braking will help slow down the vehicle.
- Slow down before shifting to a lower gear. This will help avoid over-revving the engine, which can cause damage.
- Slow down when you encounter cross winds. This gives you much better control of your vehicle.
- Be sure the vehicle is completely stopped before you attempt to shift into reverse. The transmission can be damaged if you do not.

#### **⚠ WARNING**

Exercise extreme caution when driving on a slippery surface. Be especially careful when braking, accelerating or shifting gears. On a slippery surface, an abrupt change in vehicle speed can cause the drive

wheels to lose traction and the vehicle to go out of control.

**WARNING**

- Always buckle-up! In a collision, an unbelted occupant is significantly more likely to be seriously injured or killed than a properly belted occupant.
- Avoid high speeds when cornering or turning.
- Do not make quick steering wheel movements, such as sharp lane changes or fast, sharp turns.
- The risk of rollover is greatly increased if you lose control of your vehicle at highway speeds.
- In the event your vehicle leaves the roadway, do not steer sharply. Instead, slow down before pulling back into the travel lanes.
- Never exceed posted speed limits.

**Intelligent variable transmission (IVT) (if equipped)**

The Intelligent Variable Transmission (IVT) automatically shifts depending on speed, accelerate pedal position. The individual speeds are selected automatically, depending on the position of the shift lever.

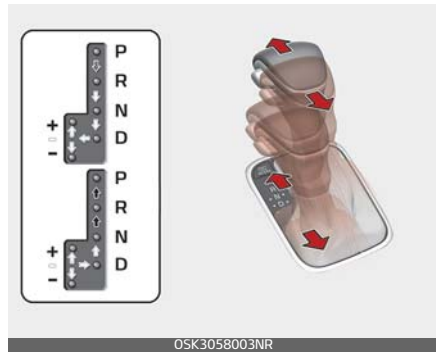

➡ Depress the brake pedal and the lock release button when shifting.

➡ Press the lock release button when shifting.

➡ The shift lever can be shifted freely.

**Intelligent Variable Transmission (IVT) operation**

For smooth operation, depress the brake pedal when shifting from N (Neutral) to a forward or reverse gear.

**⚠ WARNING****Intelligent Variable Transmission (IVT)**

- Always check the surrounding areas near your vehicle for people, especially children, before shifting a car into D (Drive) or R (Reverse).
- Before leaving the driver's seat, always make sure the shift lever is in the P (Park) position; then set the parking brake fully and shut the engine off. Unexpected and sudden vehicle movement can occur if these precautions are not followed in the order identified.
- Do not use the engine brake (shifting from a high gear to lower gear) rapidly on slippery roads. The vehicle may slip causing an accident.
- Engage the gear and check the gear position from the cluster before driving with D (drive) when driving forward on a hill or downhill, and R (reverse) when driving backwards. If you drive in the opposite direction of the gear position, the engine is off and brake does not work, which is in danger.

**⚠ CAUTION**

- To avoid damage to your transmission, do not accelerate the engine in R (Reverse) or any for-

ward gear position with the brakes on.

- When stopped on an incline, do not hold the vehicle stationary with engine power. Use the service brake or the parking brake.
- Do not shift from N (Neutral) or P (Park) into D (Drive), or R (Reverse) when the engine is above idle speed.

***Transmission ranges***

The indicator in the instrument cluster displays the shift lever position when the ignition switch is in the ON position.

***P (Park)***

Always come to a complete stop before shifting into P (Park). This position locks the transmission and prevents the front wheels from rotating.

**⚠ WARNING**

- Shifting into P (Park) while the vehicle is in motion will cause the drive wheels to lock which will cause you to lose control of the vehicle.
- Do not use the P (Park) position in place of the parking brake. Always make sure the shift lever is latched in the P (Park) position and set the parking brake fully.



- Never leave a child unattended in a vehicle.

### ⚠ CAUTION

The transmission may be damaged if you shift into P (Park) while the vehicle is in motion.

### ***R (Reverse)***

Use this position to drive the vehicle backward.

### ⚠ CAUTION

Always come to a complete stop before shifting into or out of R (Reverse); you may damage the transmission if you shift into R while the vehicle is in motion, except as explained in "Rocking the vehicle" in this section.

### ***N (Neutral)***

The wheels and transmission are not engaged. The vehicle will roll freely even on the slightest incline unless the parking brake or service brakes are applied.

### ⚠ WARNING

Do not drive with the shift lever in N (Neutral).

The engine brake will not work which could lead to an accident.

### ⚠ CAUTION

- Always park the vehicle in "P" (Park) for safety and engage the parking brake.

### ***D (Drive)***

This is the normal forward driving position. The transmission will automatically shift, providing the best fuel economy and power.

For extra power when passing another vehicle or climbing grades, depress the accelerator fully, at which time the transmission will automatically downshift to the next lower gear.

### \* NOTICE

Always come to a complete stop before shifting into D (Drive).

### ***Sports mode***

Whether the vehicle is stationary or in motion, sports mode is selected by pushing the shift lever from the D (Drive) position into the manual gate. To return to D (Drive) range operation, push the shift lever back into the main gate.



SPORT mode manages the driving dynamics by automatically adjusting the steering effort, and the engine and transmission control logic for enhanced driver performance.

In sports mode, moving the shift lever backwards or forwards will allow you to make gearshifts rapidly. In contrast to a manual transmission, the sports mode allows gearshifts with the accelerator pedal depressed.

- Up (+): Push the lever forward once to shift up one gear.
- Down (-): Pull the lever backwards once to shift down one gear.

#### \* NOTICE

- In sports mode, the driver must execute upshifts in accordance with road conditions, being careful to keep the engine speed below the red zone.
- In sports mode, only the 8 forward gears can be selected. To reverse or park the vehicle, move

the shift lever to the R (Reverse) or P (Park) position as required.

- In sports mode, downshifts are made automatically when the vehicle slows down. When the vehicle stops, 1st gear is automatically selected.
- In sports mode, when the engine rpm approaches the red zone, shift points are varied to upshift automatically.
- To maintain the required levels of vehicle performance and safety, the system may not execute certain gearshifts when the shift lever is operated.
- When driving on a slippery road, push the shift lever forward into the + (up) position. This causes the transmission to shift into the 2nd gear which is better for smooth driving on a slippery road. Push the shift lever to the - (down) side to shift back to the 1st gear.
- When SPORT mode is activated:
  - The engine rpm will tend to remain raised over a certain length of time even after releasing the accelerator.
  - Upshifts are delayed when accelerating.
- In SPORT mode, the fuel efficiency may decrease.

### Shift lock system (if equipped)

For your safety, the Intelligent Variable Transmission (IVT) has a shift lock system which prevents shifting the transmission from P (Park) into R (Reverse) unless the brake pedal is depressed.

To shift the transmission from P (Park) into R (Reverse):

1. Depress and hold the brake pedal.
2. Start the engine or turn the ignition switch to the ON position.
3. Move the shift lever.

If the brake pedal is repeatedly depressed and released with the shift lever in the P (Park) position, a chattering noise near the shift lever may be heard. This is a normal condition.

### ⚠ WARNING

Always fully depress the brake pedal before and while shifting out of the P (Park) position into another position to avoid inadvertent motion of the vehicle which could injure persons in or around the vehicle.

Your vehicle is designed to go into a protective mode if the driver inadvertently selects the R (Reverse) gear while the vehicle is being propelled forward. If this occurs, the engine, power brakes and power steering will all deactivate. This mode is designed to alert the driver

to the gear-selection error and prevent damage to the transmission.

### ⚠ WARNING

Confirm the desired gear position is selected when driving on a graded road. If the protective mode is triggered on an incline, the driver may not become aware that the power braking and steering have been turned off which can increase the risk of an accident.

### Shift-lock override



If the shift lever cannot be moved from the P (Park) position into R (Reverse) position with the brake pedal depressed, continue depressing the brake, then do the following:

1. Place the ignition switch in the LOCK/OFF position.
2. Apply the parking brake.
3. Carefully remove the cap covering the shift-lock release access hole.

4. Insert a tool (e.g. flathead screwdriver) into the access hole and press down on the tool.
5. Move the shift lever.
6. Remove the tool from the shift-lock override access hole then install the cap.
7. Have the system inspected by a professional workshop. Kia recommends to visit an authorized Kia dealer.

### Ignition key interlock system (if equipped)

The ignition key cannot be removed unless the shift lever is in the P (Park) position.

### Good driving practices

- Never move the shift lever from P (Park) or N (Neutral) to any other position with the accelerator pedal depressed.
- Never move the shift lever into P (Park) when the vehicle is in motion.
- Be sure the vehicle is completely stopped before you attempt to shift into R (Reverse) or D (Drive).
- Never take the vehicle out of gear and coast down a hill. This may be extremely hazardous. Always leave the vehicle in gear when moving.
- Do not "ride" the brakes. This can cause them to overheat and malfunction. Instead, when you are driving down a long hill, slow down

and shift to a lower gear. When you do this, engine braking will help slow down the vehicle.

- Slow down before shifting to a lower gear. Otherwise, the lower gear may not be engaged.
- Always use the parking brake. Do not depend on placing the transmission in P (Park) to keep the vehicle from moving.

### WARNING

Exercise extreme caution when driving on a slippery surface. Be especially careful when braking, accelerating or shifting gears. On a slippery surface, an abrupt change in vehicle speed can cause the drive wheels to lose traction and the vehicle to go out of control.

- Optimum vehicle performance and economy is obtained by smoothly depressing and releasing the accelerator pedal.

### WARNING

- When driving uphill or downhill, always shift to D (Drive) for driving forward or shift to R (Reverse) for driving backwards, and check the gear position indicated on the cluster before driving. Driving in the opposite direction of the selected gear can lead to a dangerous situation by shutting

off the engine and affecting the braking performance.

- Always buckle-up! In a collision, an unbelted occupant is significantly more likely to be seriously injured or killed than a properly belted occupant.
- Avoid high speeds when cornering or turning.
- Do not make quick steering wheel movements, such as sharp lane changes or fast, sharp turns.
- The risk of a rollover is greatly increased if you lose control of your vehicle at highway speeds.
- Losing control often occurs if two or more wheels drop off the roadway and the driver oversteers to reenter the roadway.
- In the event your vehicle leaves the roadway, do not steer sharply. Instead, slow down before pulling back into the travel lanes.
- Never exceed posted speed limits.

unstuck, causing injury or damage to nearby people or objects.

---

### ***Moving up a steep grade from a standing start***

To move up a steep grade from a standing start:

1. Depress the brake pedal, release the parking break, and shift the shift lever to D (Drive).
2. Select the appropriate gear depending on load weight and steepness of the grade, and release the parking brake.
3. Depress the accelerator gradually while releasing the service brakes.

**When accelerating from a stop on a steep hill, the vehicle may have a tendency to roll backwards. Shifting the shift lever into 2 (Second Gear) will help prevent the vehicle from rolling backwards.**

## **⚠ WARNING**

If your vehicle becomes stuck in snow, mud, sand, etc., then you may attempt to rock the vehicle free by moving it forward and backward. Do not attempt this procedure if people or objects are anywhere near the vehicle. During the rocking operation the vehicle may suddenly move forward or backward as it becomes

## Dual clutch transmission (DCT) (if equipped)

The dual clutch transmission has 7 forward speeds and one reverse speed.

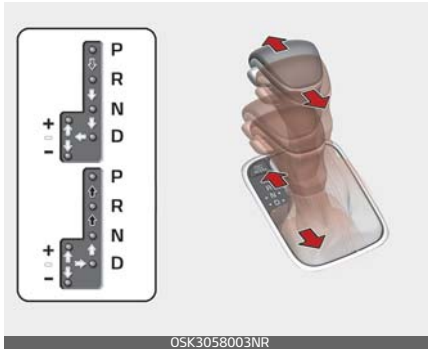

➡ Depress the brake pedal and the lock release button when shifting.

➡ Press the lock release button when shifting.

➡ The shift lever can be shifted freely.

\* To move the shift lever from/to P (Parking) or between R (Reverse) and D (Drive), you must depress the brake pedal for the vehicle to stand still.

### Dual clutch transmission operation

The individual speeds are selected automatically in the D (Drive) position.

## ⚠ WARNING

To reduce the risk of serious injury or death:

- ALWAYS check the surrounding areas near your vehicle for people, especially children, before shifting a vehicle into D (Drive) or R (Reverse).
- Before leaving the driver's seat, always make sure the shift lever is in the P (Park) position, then set the parking brake, and place the ignition switch in the LOCK/OFF position. Unexpected and sudden vehicle movement can occur if these precautions are not followed.
- When using Manual Shift Mode, use caution when shifting from a higher gear to a lower gear on slippery roads. This could cause the tires to slip and may result in an accident.

## ⚠ CAUTION

- To avoid damage to your transmission, do not try to accelerate with the shift lever in R (Reverse) or any forward gear position with the brake engaged.
- When stopped on a slope, do not hold the vehicle with accelerator pedal. Engage the service brake or the parking brake.

- The Dual Clutch Transmission gives the driving feel of a manual transmission, yet provides the ease of a fully automatic transmission. Unlike a traditional automatic transmission, the gear shifting can be felt (and heard) on the dual clutch transmission.
  - Think of it as an automatically shifting manual transmission.
  - Shift into Drive range and get fully automatic shifting, similar to a conventional automatic transmission.
- Dual clutch transmission adopts dry-type dual clutch, which is different from torque converter of automatic transmission, and shows better acceleration performance during driving. But, initial launch might be little bit slower than Automatic Transmission.
- The dry-type clutch transfers torque and provides a direct driving feeling which may feel different from a conventional automatic transmission with a torque converter. This may be more noticeable when starting from a stop or low vehicle speed.
- When rapidly accelerating at low vehicle speed, engine could rev at high rpm depending on vehicle drive condition.
- For smooth launch uphill, press down the accelerator pedal smoothly depending on the current conditions.
- If you release your foot from the accelerator pedal at low vehicle speed, you may feel strong engine brake, which is similar to manual transmission.
- When driving downhill, you may use Sports Mode to downshift to a lower gear in order to control your speed without using the brake pedal excessively.
- When you turn the engine on and off, you may hear clicking sounds as the system goes through a self test. This is a normal sound for the Dual Clutch Transmission.
- Always come to a complete stop before shifting into D (Drive) or R (Reverse).
- Do not put the shift lever in N (Neutral) while driving.

### CAUTION

Due to transmission failure, the vehicle may not move and the position indicator (D, R) will blink on the cluster. In this case, have the system checked by an authorized Kia dealer.

### LCD display for warning message

A warning message is displayed on the LCD when transmission is overheated or in a warning condition.

***DCT warning messages***

This warning message is displayed when vehicle is driven slowly on a grade and the vehicle detects that the brake pedal is not applied.

***Steep grade***

Driving up hills or on steep grades:

- To hold the vehicle on an incline use the foot brake or the parking brake.
- When in stop-and-go traffic on an incline, keep some distance ahead before moving the vehicle forward. Then hold the vehicle on the incline with the foot brake.
- If the vehicle is held on a hill by applying the accelerator pedal or by creeping with brake pedal disengaged, the clutch and transmission may overheat which can result in damage. At this time, a warning message will appear on the LCD display.
- If the LCD warning is active, the foot brake must be applied.

- Ignoring the warnings can lead to damage to the transmission.

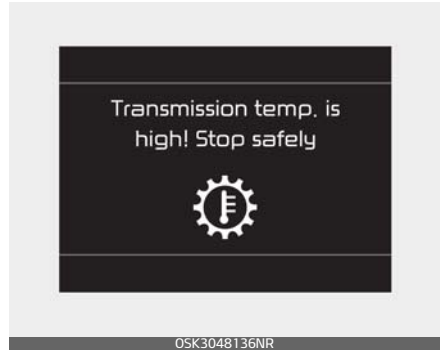
***Transmission high temperature***

- Under certain conditions, such as repeated stop-and-go launches on steep grades, sudden take off or acceleration, or other harsh driving conditions, the transmission clutch temperatures will increase excessively. Finally the clutch in transmission could be overheated.
- When the clutch is overheated, the safe protection mode engages and the gear position indicator on the cluster blinks with a chime. At this time, "Transmission temp. is high! Stop safely" warning message will appear on the LCD display and driving may not be smooth.
- If this occurs, pull over to a safe location, stop the vehicle with the engine running, apply the brakes and shift the vehicle to P (Park),



and allow the transmission to cool.

- If you ignore this warning, the driving condition may become worse. You may experience abrupt shifts, frequent shifts, or jerkiness. To return to the normal driving condition, stop the vehicle and apply the foot brake or shift into P (Park).

Then allow the transmission to cool for a few minutes with engine on, before driving off.

- When possible, drive the vehicle smoothly.

### ***Transmission overheated***

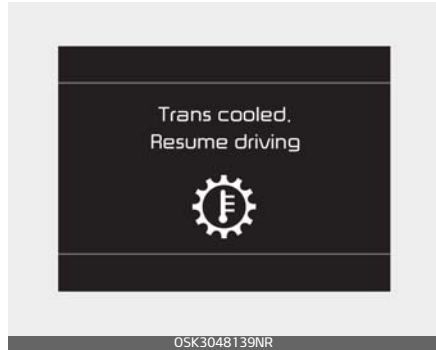
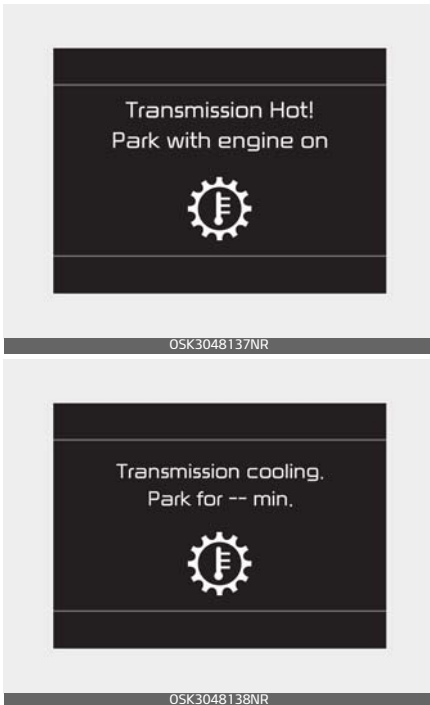

- If the vehicle continues to be driven and the clutch temperatures reach the maximum temperature limit, the "Transmission Hot! Park with engine on" warning will be displayed. When this occurs the clutch is disabled until the clutch cools to normal temperatures.
- The warning will display a time to wait for the transmission to cool.
- If this occurs, pull over to a safe location, stop the vehicle with the engine running, apply the brakes and shift the vehicle to P (Park), and allow the transmission to cool.
- When the message "Trans cooled. Resume driving." appears you can continue to drive your vehicle.
- When possible, drive the vehicle smoothly.

If any of the warning messages in the LCD display continue to blink, for your safety, have the system checked by an authorized Kia dealer.

## Transmission ranges

The indicator in the instrument cluster displays the shift lever position when the ignition switch is in the ON position.

### ***P (Park)***

Always come to a complete stop before shifting into P (Park).

To shift from P (Park), you must depress firmly on the brake pedal and make sure your foot is off the accelerator pedal.

The shift lever must be in P (Park) before turning the engine off.

#### **⚠ WARNING**

- Shifting into P (Park) while the vehicle is in motion may cause you to lose control of the vehicle.
- After the vehicle has stopped, always make sure the shift lever is in P (Park), apply the parking brake, and turn the engine off.
- Do not use the P (Park) position in place of the parking brake.

### ***R (Reverse)***

Use this position to drive the vehicle backward.

#### **⚠ CAUTION**

Always come to a complete stop before shifting into or out of R

(Reverse); you may damage the transmission if you shift into R (Reverse) while the vehicle is in motion.

### ***N (Neutral)***

The wheels and transmission are not engaged.

#### **⚠ WARNING**

Do not shift into gear unless your foot is firmly on the brake pedal. Shifting into gear when the engine is running at high speed can cause the vehicle to move very rapidly. You could lose control of the vehicle and hit people or objects.

#### **⚠ WARNING**

Do not drive with the shift lever in N (Neutral).

The engine brake will not work and lead to an accident.

#### **⚠ CAUTION**

- Always park the vehicle in P (Park) for safety and engage the parking brake.

### ***D (Drive)***

This is the normal driving position. The transmission will automatically

shift through a 7 gear sequence, providing the best fuel economy and power.

For extra power when passing another vehicle or driving uphill depress the accelerator pedal further until you feel the transmission downshift to a lower gear.

To stop the vehicle during driving, please press brake pedal fully to prevent unintended movement.

### **Manual mode**



Whether the vehicle is stationary or in motion, manual mode is selected by pushing the shift lever from the D (Drive) position into the manual gate.

To return to D (Drive) range operation, push the shift lever back into the main gate.

In manual mode, moving the shift lever backwards and forwards will allow you to select the desired

range of gears for the current driving conditions.

- + (Up): Push the lever forward once to shift up one gear.
- - (Down): Pull the lever backwards once to shift down one gear.

### **\* NOTICE**

- Only the 7 forward gears can be selected. To reverse or park the vehicle, move the shift lever to the R (Reverse) or P (Park) position as required.
- Downshifts are made automatically when the vehicle slows down. When the vehicle stops, 1st gear is automatically selected.
- When the engine rpm approaches the red zone the transmission will upshift automatically.
- If the driver presses the lever to + (Up) or - (Down) position, the transmission may not make the requested gear change if the next gear is outside of the allowable engine rpm range. The driver must execute upshifts in accordance with road conditions, taking care to keep the engine rpms below the red zone.

### **Paddle shifter (if equipped)**

The paddle shift function is available when the shift lever is in the D (Drive) position or the manual mode.

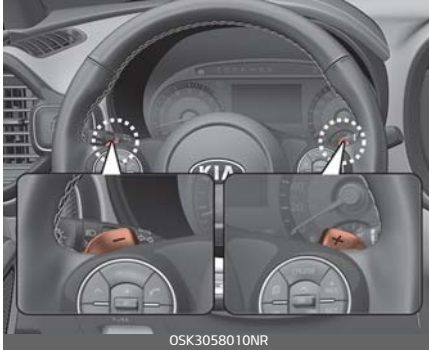

### ***With the shift lever in the D position***

The paddle shift function will operate when the vehicle speed is more than 6 mph (10 km/h).

Pull the [+] or [-] paddle shifter once to shift up or down one gear and the system changes from automatic mode to manual mode.

When the vehicle speed is lower than 6 mph (10 km/h), if you depress the accelerator pedal for more than 5 seconds or if you shift the shift lever from D (Drive) to manual mode and shift it from manual mode to D (Drive) again, the system changes from manual mode to automatic mode.

### ***With the shift lever in the manual mode***

Pull the [+] or [-] paddle shifter once to shift up or down one gear.

## **\* NOTICE**

If you pull the [+] and [-] paddle shifters at the same time, you cannot shift the gear.

### **Shift lock system (if equipped)**

For your safety, the Dual clutch transmission has a shift lock system which prevents shifting the transmission from P (Park) into R (Reverse) unless the brake pedal is depressed.

To shift the transmission from P (Park) into R (Reverse):

1. Depress and hold the brake pedal.
2. Start the engine or turn the ignition switch to the ON position.
3. Move the shift lever.

If the brake pedal is repeatedly depressed and released with the shift lever in the P (Park) position, a chattering noise & vibration near the shift lever may be heard. This is a normal condition.

## **⚠ WARNING**

Always fully depress the brake pedal before and while shifting out of the P (Park) position into another position to avoid inadvertent motion of the vehicle which could injure persons in or around the car.

**Shift-lock override**

Type A



Type B



If the shift lever cannot be moved from the P (Park) position into R (Reverse) position with the brake pedal depressed, continue depressing the brake, then do the following:

1. Place the ignition switch in the LOCK/OFF position.
2. Apply the parking brake.
3. Carefully remove the cap (1) covering the shift-lock release access hole.
4. Insert a tool (e.g. flathead screwdriver) into the access hole and press down on the tool.

5. Move the shift lever.
6. Remove the tool from the shift-lock override access hole then install the cap.
7. Have the system inspected by a professional workshop. Kia recommends to visit an authorized Kia dealer.

**Ignition key interlock system (if equipped)**

The ignition key cannot be removed unless the shift lever is in the P (Park) position.

**Good driving practices**

- Never move the shift lever from P (Park) or N (Neutral) to any other position with the accelerator pedal depressed.
- Never move the shift lever into P (Park) when the vehicle is in motion.
- Be sure the car is completely stopped before you attempt to shift into R (Reverse) or D (Drive).
- Never take the car out of gear and coast down a hill. This may be extremely hazardous. Always leave the car in gear when moving.
- Do not "ride" the brakes. This can cause them to overheat and malfunction. Instead, when you are driving down a long hill, slow down and shift to a lower gear. When you do this, engine braking will help slow the car.

- Slow down before shifting to a lower gear. Otherwise, the lower gear may not be engaged.
  - Always use the parking brake. Do not depend on placing the transmission in P (Park) to keep the car from moving.
  - Exercise extreme caution when driving on a slippery surface. Be especially careful when braking, accelerating or shifting gears. On a slippery surface, an abrupt change in vehicle speed can cause the drive wheels to lose traction and the vehicle to go out of control.
  - Optimum vehicle performance and economy is obtained by smoothly depressing and releasing the accelerator pedal.
- or killed than a properly belted occupant.
  - Avoid high speeds when cornering or turning.
  - Do not make quick steering wheel movements, such as sharp lane changes or fast, sharp turns.
  - The risk of rollover is greatly increased if you lose control of your vehicle at highway speeds.
  - Loss of control often occurs if two or more wheels drop off the roadway and the driver oversteers to reenter the roadway.
  - In the event your vehicle leaves the roadway, do not steer sharply. Instead, slow down before pulling back into the travel lanes.
  - Never exceed posted speed limits.

### WARNING

- When driving uphill or downhill, always shift to D (Drive) for driving forward or shift to R (Reverse) for driving backwards, and check the gear position indicated on the cluster before driving. Driving in the opposite direction of the selected gear can lead to a dangerous situation by shutting off the engine and affecting the braking performance.
- Always buckle-up! In a collision, an unbelted occupant is significantly more likely to be seriously injured

### WARNING

If your vehicle becomes stuck in snow, mud, sand, etc., then you may attempt to rock the vehicle free by moving it forward and backward. Do not attempt this procedure if people or objects are anywhere near the vehicle. During the rocking operation the vehicle may suddenly move forward or backward as it becomes unstuck, causing injury or damage to nearby people or objects.

## Brake system

Your vehicle has power-assisted brakes, parking brake, and various braking systems for safe driving.

### Power brakes

Your vehicle has power-assisted brakes that adjust automatically through normal usage.

In the event that the power-assisted brakes lose power because of a stalled engine or some other reason, you can still stop your vehicle by applying greater force to the brake pedal than you normally would. The stopping distance, however, will be longer.

When the engine is not running, the reserve brake power is partially depleted each time the brake pedal is applied. Do not pump the brake pedal when the power assist has been interrupted.

Pump the brake pedal only when necessary to maintain steering control on slippery surfaces.

### ⚠ CAUTION

#### Brake Pedal

Do not drive with your foot resting on the brake pedal. This will create abnormally high brake temperatures which can cause excessive brake lining and pad wear.

### ⚠ WARNING

#### Steep hill braking

Avoid continuous application of the brakes when descending a long or steep hill by increasing the regeneration level. Continuous brake application will cause the brakes to overheat and could result in a temporary loss of braking performance.

Wet brakes may impair the vehicle's ability to safely slow down; the vehicle may also pull to one side when the brakes are applied. Applying the brakes lightly will indicate whether they have been affected in this way. Always test your brakes in this fashion after driving through deep water. To dry the brakes, apply them lightly while maintaining a safe forward speed until brake performance returns to normal.

#### *In the event of brake failure*

If service brakes fail to operate while the vehicle is in motion, you can make an emergency stop with the parking brake. The stopping distance, however, will be much greater than normal.

### ⚠ WARNING

#### Parking brake

Avoid applying the parking brake to stop the vehicle while it is moving

except in an emergency situation. Applying the parking brake while the vehicle is moving at normal speeds can cause a sudden loss of control of the vehicle. If you must use the parking brake to stop the vehicle, use great caution in applying the brake.

---

### ***Disc brakes wear indicator***

When your brake pads are worn and new pads are required, you will hear a high-pitched warning sound from your front brakes or rear brakes. You may hear this sound come and go or it may occur whenever you depress the brake pedal.

Please remember that some driving conditions or climates may cause a brake squeal when you first apply (or lightly apply) the brakes. This is normal and does not indicate a problem with your brakes.

Always replace the front or rear brake pads as pairs.

## **⚠ CAUTION**

### **Replace brake pads**

Do not continue to drive with worn brake pads. Continuing to drive with worn brake pads can damage the braking system and result in costly brake repairs, and can also lead to a serious accident.

---

## **⚠ WARNING**

### **Brake wear**

Do not ignore high pitched wear sounds from your brakes. If you ignore this audible warning, you will eventually lose braking performance, which could lead to a serious accident.

---

### ***Rear drum brakes (if equipped)***

Your rear drum brakes do not have wear indicators. Therefore, have the rear brake linings inspected if you hear a rear brake rubbing noise. Also have your rear brakes inspected each time you change or rotate your tires and when you have the front brakes replaced.

### **Parking brake**

After parking the vehicle, apply the parking brake to prevent the vehicle from being moved by the external force.



**Applying the parking brake**

To engage the parking brake:

1. Apply the foot brake and then pull up the parking brake lever as far as possible.

In addition it is recommended that when parking the vehicle on a incline, the shift lever should be in a low gear on manual transmission vehicles.

**CAUTION**

- Driving with the parking brake applied will cause excessive brake pad and brake rotor wear.
- Do not operate the parking brake while the vehicle is moving except in an emergency situation. It could damage the vehicle system and make endanger driving safety.

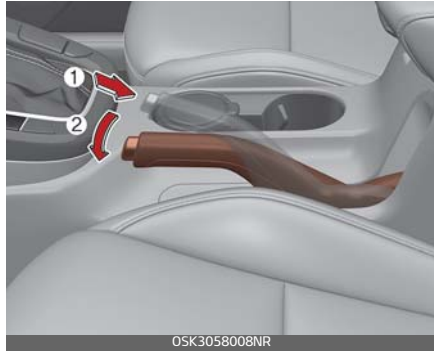
**Releasing the parking brake**

To release the parking brake:

1. Apply the foot brake and pull up the parking brake lever slightly.
2. Depress the release button (1) and lower the parking brake lever (2) while holding the button.

If the parking brake does not release or does not release all the way, have the system checked by a professional workshop. Kia recommends to visit an authorized Kia dealer.

- Be cautious when parking on a hill. Firmly engage the parking brake and place the shift lever in first or reverse gear (manual transmission). If your vehicle is facing downhill, turn the front wheels into the curb to help keep the vehicle from rolling. If your vehicle is facing uphill, turn the front wheels away from the curb to help keep the vehicle from rolling. If there is no curb or if it is required by other conditions to keep the vehicle from rolling, block the wheels.

- Under some conditions your parking brake can freeze in the engaged position. This is most likely to happen when there is an accumulation of snow or ice around or near the rear brakes or if the brakes are wet. If there is a risk that the parking brake may freeze, apply it only temporarily while you put the shift lever in first or reverse gear (manual transmission) and block the rear wheels so the vehicle cannot roll. Then release the parking brake.
- Do not hold the vehicle on the upgrade with the accelerator pedal. This can cause the transmission to overheat. Always use the brake pedal or parking brake.

### **WARNING**

- Never allow a passenger to touch the parking brake. If the parking brake is released unintentionally, serious injury may occur.
- All vehicles should always have the parking brake fully engaged when parking to avoid inadvertent movement of the vehicle which can injure occupants or pedestrians.



Check the brake warning light by turning the ignition switch ON (do not start the engine). This light will be illuminated when the parking brake is applied with the ignition switch in the START or ON position.

Before driving, be sure the parking brake is fully released and the brake warning light is off.

If the brake warning light remains on after the parking brake is released while engine is running, there may be a malfunction in the brake system. Immediate attention is necessary.

If at all possible, cease driving the vehicle immediately. If that is not possible, use extreme caution while operating the vehicle and only continue to drive the vehicle until you can reach a safe location or repair shop.

### **Anti-lock brake system (ABS)**

The ABS prevents the wheels from locking. So the vehicle remains stable and can still be steered.

ABS (or ESC) will not prevent accidents due to improper or dangerous driving maneuvers. Even though vehicle control is improved during emergency braking, always maintain a safe distance between you and objects ahead. Vehicle speeds should always be reduced during

extreme road conditions. The vehicle should be driven at reduced speeds in the following circumstances:

- When driving on rough, gravel or snow-covered roads
- When driving with tire chains installed
- When driving on roads where the road surface is pitted or has different surface heights.

Driving in these conditions increases the stopping distance for your vehicle.

The ABS continuously senses the speed of the wheels. If the wheels are going to lock, the ABS system repeatedly modulates the hydraulic brake pressure to the wheels.

When you apply your brakes under conditions which may lock the wheels, you may hear a "tik-tik" sound from the brakes, or feel a corresponding sensation in the brake pedal. This is normal and it means your ABS is active.

In order to obtain the maximum benefit from your ABS in an emergency situation, do not attempt to modulate your brake pressure and do not try to pump your brakes. Press your brake pedal as hard as possible to allow the ABS to control the force being delivered to the brakes.

## \* NOTICE

A click sound may be heard in the vehicle compartment when the vehicle begins to move after the vehicle is started. These conditions are normal and indicate that the anti-lock brake system is functioning properly.

Even with the anti-lock brake system, your vehicle still requires sufficient stopping distance. Always maintain a safe distance from the vehicle in front of you.

Always slow down when cornering. The anti-lock brake system cannot prevent accidents resulting from excessive speeds.

On loose or uneven road surfaces, operation of the anti-lock brake system may result in a longer stopping distance than for vehicles equipped with a conventional brake system.

The ABS warning light will stay on for approximately 3 seconds after the ignition switch or START/STOP button is ON.



During that time, the ABS will go through selfdiagnosis and the light will go off if everything is normal. If

the light stays on, you may have a problem with your ABS. Contact an authorized Kia dealer as soon as possible.

When you drive on a road having poor traction, such as an icy road, and have operated your brakes continuously, the ABS will be active continuously and the ABS warning light may illuminate. Pull your vehicle over to a safe place and stop the vehicle.

Restart the vehicle. If the ABS warning light goes off, then your ABS system is normal. Otherwise, you may have a problem with the ABS. Contact an authorized Kia dealer as soon as possible.

### \* NOTICE

When you jump start your vehicle because of a drained battery, the vehicle may not run as smoothly and the ABS warning light may turn on at the same time. This happens because of low battery voltage. It does not mean your ABS has malfunctioned.

- Do not pump your brakes!
- Have the battery recharged before driving the vehicle.

### Electronic stability control (ESC)

The ESC system is designed to stabilize the vehicle during cornering maneuvers.



ESC checks where you are steering and where the vehicle is actually going. ESC applies the brakes on individual wheels and intervenes with the vehicle management system to stabilize the vehicle.

ESC will not prevent accidents. Excessive speed in turns, abrupt maneuvers and hydroplaning on wet surfaces can still result in serious accidents.

Only a safe and attentive driver can prevent accidents by avoiding maneuvers that cause the vehicle to lose traction. Even with ESC installed, always follow all the normal precautions for driving – including driving at safe speeds for the conditions.

## ⚠ WARNING

For maximum protection, always wear your seat belt. No system, no matter how advanced, can compensate for all driver error and/or driving conditions. Always drive responsibly.

The ESC system is an electronic system designed to help the driver maintain vehicle control under adverse conditions. It is not a substitute for safe driving practices. Factors including speed, road conditions and driver steering input can all affect whether ESC will be effective in preventing a loss of control. It is still your responsibility to drive and corner at reasonable speeds and to leave a sufficient margin of safety.

When you apply your brakes under conditions which may lock the wheels, you may hear a "tik-tik" sound from the brakes, or feel a corresponding sensation in the brake pedal. This is normal and it means your ESC is active.

## \* NOTICE

A click sound may be heard in the vehicle compartment when the vehicle begins to move after the vehicle is started. These conditions are normal and indicate that the

Electronic Stability Control System is functioning properly.

### ***Electronic stability control (ESC) operation***

#### **ESC ON condition**

- When the ignition switch or START/STOP button is turned ON, ESC and ESC OFF indicator lights illuminate for approximately 3 seconds, then ESC is turned on.
- Press the ESC OFF button for at least half a second after turning the vehicle ON to turn ESC off. (ESC OFF indicator will illuminate). To turn the ESC on, press the ESC OFF button (ESC OFF indicator light will go off).
- When starting the vehicle, you may hear a slight ticking sound. This is the ESC performing an automatic system self-check and does not indicate a problem.

#### **When operating**



When the ESC is in operation, the ESC indicator light blinks. When the Electronic Stability Control is operating properly, you can feel a slight pulsation in the vehicle. This is only the effect of brake control and indicates nothing unusual.

When moving out of the mud or driving on a slippery road, pressing the accelerator pedal may not cause

the vehicle rpm (revolutions per minute) to increase.



### **Electronic stability control (ESC) operation off**





This car has 2 kinds of ESC off states.

If the vehicle stops when ESC is off, ESC remains off. Upon restarting the vehicle, the ESC will automatically turn on again.

#### **ESC off state 1 - Traction control disabled**

To turn off the traction control function and only operate the brake control function of the ESC, press the ESC OFF button (ESC OFF ) for less than 3 seconds and the ESC OFF indicator light (ESC OFF ) will illuminate.

#### **ESC off state 2 - Traction & stability control disabled**

To turn off the traction control function and the brake control function of the ESC, press the ESC OFF button (ESC OFF ) for more than 3 seconds. ESC OFF indicator light (ESC OFF ) will illuminate and ESC OFF warning chime will sound. At this state, the car stability control function does not operate any more.

### **Indicator light**

ESC indicator light



ESC OFF indicator light



When ignition switch or START/STOP button is turned to ON, the indicator light illuminates, then goes off if the ESC system is operating normally.

The ESC indicator light blinks whenever ESC is operating or illuminates when ESC fails to operate.

The ESC OFF indicator light comes on when the ESC is turned off with the button.

### **⚠ WARNING**

#### **Electronic stability control**

Drive carefully even though your vehicle has Electronic Stability Control. It can only assist you in maintaining control under certain circumstances.

#### **ESC OFF usage**

##### **When driving**

- ESC should be turned on for daily driving whenever possible.

- To turn ESC off while driving, press the ESC OFF button while driving on a flat road surface.

### WARNING

#### Operating ESC

Never press the ESC OFF button while ESC is operating (ESC indicator light blinks).

If ESC is turned off while ESC is operating, the vehicle may slip out of control.

### \* NOTICE

- When operating the vehicle on a dynamometer, ensure that the ESC is turned off (ESC OFF light illuminated). If the ESC is left on, it may prevent the vehicle speed from increasing, and result in false diagnosis.
- Turning the ESC off does not affect ABS or brake system operation.

#### Vehicle stability management (VSM)

This system provides further enhancements to vehicle stability and steering responses when a vehicle is driving on a slippery road or a vehicle detects changes in coefficient of friction between right wheels and left wheels when braking.

### WARNING

#### Tire/Wheel size

When replacing tires and wheels, make sure they are the same size as the original tires and wheels installed. Driving with varying tire or wheel sizes may diminish any supplemental safety benefits of the VSM system.

#### Vehicle stability management (VSM) operation

When the VSM is in operation, ESC indicator light  blinks.

When the vehicle stability management is operating properly, you can feel a slight pulsation in the vehicle and/or abnormal steering responses (EPS- Electronic Power Steering). This is only the effect of brake and EPS control and indicates nothing unusual.

#### The VSM does not operate when:

- Driving on a sloping road such as a gradient or incline
- Driving in reverse
- ESC OFF indicator light  remains on the instrument cluster
- EPS indicator light remains on the instrument cluster

### ***Vehicle stability management (VSM) operation off***

If you press the ESC OFF button to turn off the ESC, the VSM will also cancel and the ESC OFF indicator

light () illuminates.

To turn on the VSM, press the button again. The ESC OFF indicator light goes out.

### **▲ WARNING**

#### **Vehicle stability management**

Drive carefully even though your vehicle has vehicle stability management. It can only assist you in maintaining control of the vehicle under certain circumstances.

#### ***Malfunction indicator***

The VSM can be deactivated even if you don't cancel the VSM operation by pressing the ESC OFF button. It indicates that a malfunction has been detected somewhere in the Electric Power Steering system or VSM system. If the ESC indicator

light () or EPS warning light remains on, take your vehicle to an authorized Kia dealer and have the system checked.

### **\* NOTICE**

- The VSM is designed to function above approximately 13 mph (22 km/h) on curves.
- The VSM is designed to function above approximately 6 mph (10 km/h) when a vehicle is braking on a split-mu surface. A split-mu surface is made of two surfaces which have different friction forces.

The Vehicle Stability Management system is not a substitute for safe driving practices but a supplementary function only. It is the responsibility of the driver to always check the speed and the distance to the vehicle ahead. Always hold the steering wheel firmly while driving.

Your vehicle is designed to activate according to the driver's intention, even with installed VSM. Always follow all the normal precautions for driving at safe speeds for the conditions – including driving in clement weather and on a slippery road.

### **▲ WARNING**

For maximum protection, always wear your seat belt. No system, no matter how advanced, can compensate for all driver error and/or driving conditions. Always drive responsibly.



### Hill-start Assist Control (HAC)

A vehicle has the tendency to roll back on a steep hill when it starts to go after stopping. The Hill-start Assist Control (HAC) prevents the vehicle from rolling back by applying the brakes automatically for about 2 seconds.

The brakes are released when the accelerator pedal is depressed or after about 2 seconds.

The HAC is activated only for about 2 seconds, so when the vehicle is starting off always depress the accelerator pedal.

### WARNING

#### Maintaining Brake Pressure on Incline

HAC does not replace the need to apply brakes while stopped on an incline. While stopped, make sure you maintain brake pressure sufficient to prevent your vehicle from rolling backward and causing an accident. Don't release the brake pedal until you are ready to accelerate forward.

#### Good braking practices

Good braking practices help keep occupants safe and extend brake life.

- Check to be sure the parking brake is not engaged and the

parking brake indicator light is out before driving away.

- Driving through water may get the brakes wet. They can also get wet when the vehicle is washed. Wet brakes can be dangerous! Your vehicle will not stop as quickly if the brakes are wet. Wet brakes may cause the vehicle to pull to one side. To dry the brakes, apply the brakes lightly until the braking action returns to normal, taking care to keep the vehicle under control at all times. If the braking action does not return to normal, stop as soon as it is safe to do so and call an authorized Kia dealer for assistance.

- Don't coast down hills with the vehicle out of gear. This is extremely hazardous. Keep the vehicle in gear at all times, use the brakes to slow down, then shift to a lower gear so that vehicle braking will help you maintain a safe speed.
- Don't "ride" the brake pedal. Resting your foot on the brake pedal while driving can be dangerous because the brakes might overheat and lose their effectiveness. It also increases the wear of the brake components.
- If a tire goes flat while you are driving, apply the brakes gently and keep the vehicle pointed straight ahead while you slow

down. When you are moving slowly enough for it to be safe to do so, pull off the road and stop in a safe place.

- Be cautious when parking on a hill. Firmly engage the parking brake and place the shifter dial in P. If your vehicle is facing downhill, turn the front wheels into the curb to help keep the vehicle from rolling.  
If your vehicle is facing uphill, turn the front wheels away from the curb to help keep the vehicle from rolling. If there is no curb or if it is required by other conditions to keep the vehicle from rolling, block the wheels.
- Under some conditions your parking brake can freeze in the engaged position. This is most likely to happen when there is an accumulation of snow or ice around or near the rear brakes or if the brakes are wet. If there is a risk that the parking brake may freeze, apply it only temporarily while you put the shifter dial in P and block the rear wheels so the vehicle cannot roll. Then release the parking brake.
- Do not hold the vehicle on an incline with the accelerator pedal. This can cause the reduction gear to overheat. Always use the brake pedal or parking brake.

## ISG (Idle Stop and Go) system

Your vehicle may be equipped with the ISG system, which reduces fuel consumption by automatically shutting down the engine, when the vehicle is at a standstill. (For example: red light, stop sign and traffic jam)

The engine starts automatically as soon as the starting conditions are met.

The ISG system is ON whenever the engine is running.

### \* NOTICE

When the engine automatically starts by the ISG system, some warning lights (ABS, ESC, ESC OFF, EPS or Parking brake warning light) may turn on for a few seconds. This happens because of low battery voltage. It does not mean the system has malfunctioned.

## Auto stop

### *To stop the engine in idle stop mode*



Stop the vehicle completely by pressing the brake pedal when the shift lever is in the D (Drive) or N (Neutral) position.

The engine will stop and the green AUTO STOP (A) indicator on the instrument cluster will illuminate.



### \* NOTICE

If you open the engine hood in auto stop mode, the following will happen:

- The ISG system will deactivate (the light on the ISG OFF button will illuminate).
- A message will appear on the LCD display.



- If you move the transmission lever from N to D (manual mode) or R without depressing the brake pedal after stopping engine automatically, the engine does not restart automatically and a warning chime alarms. When this happens, press the brake pedal for auto start.

## Auto start

### *To restart the engine from idle stop mode*

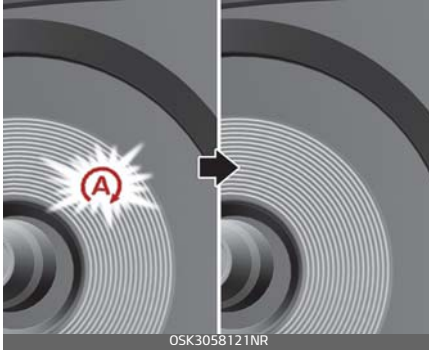

- Release the brake pedal.
- or
- Move the shift gear to the R (Reverse) position or the manual mode while depressing the brake pedal.

The engine will start and the green AUTO STOP indicator (A) on the instrument cluster will go out.

### **The engine will also restart automatically without any driver actions if the following occurs:**

- The brake vacuum pressure is low.
- The engine has stopped for about 5 minutes.
- The air conditioning is ON with the fan speed set to the highest position.
- The front defroster is ON
- The battery is weak.

- The cooling and heating performance of the climate control system is unsatisfactory.

## Condition of ISG system operation

### *The ISG system will operate under the following condition:*

- The driver's seatbelt is fastened
- The driver's door and hood are closed
- The brake vacuum pressure is adequate
- The battery sensor is activated and the battery is sufficiently charged
- Outside temperature is not too low or too high
- The vehicle is driven over a constant speed and stops
- The climate control system satisfies the conditions
- The vehicle is sufficiently warmed up
- The incline is gradual
- The steering wheel is turned less than 180 degrees and then the vehicle stops

### \* NOTICE

- If the ISG system does not meet the operation condition, the ISG system is deactivated. The light on the ISG OFF button will illuminate and a message "Auto Stop conditions not met" will appear on the LCD display.

- If the light or notice comes on continuously, please check the operation condition.

### ISG system deactivation



- If you wish to deactivate the ISG system, press the ISG OFF button (1). The light on the ISG OFF button will illuminate.
- If you press the ISG OFF button again, the system will be activated and the light on the ISG OFF button will turn off.

### ISG system malfunction

*The system may not operate when:*



The system may not operate when an ISG related sensor or system error occurs.

The following will happen:

- The AUTO STOP (A) indicator on the instrument cluster will stay on after blinking for 5 seconds.
- The light on the ISG OFF button will illuminate.

### \* NOTICE

If the ISG OFF button light is not turned off by pressing the ISG OFF button again or if the ISG system continuously does not work correctly, have your vehicle inspected by an authorized Kia dealer.

When the engine is in Idle Stop mode, it's possible to restart the engine without the driver taking any action. Before leaving the car or

doing anything in the engine compartment, stop the engine by turning the ignition switch to the LOCK/OFF position or removing the ignition key.

### \* NOTICE

If the AGM battery is reconnected or replaced, ISG function will not operate immediately. If you want to use the ISG function, the battery sensor needs to be calibrated for approximately 4 hours with the ignition off. After calibration, turn the engine on and off 2 or 3 times.

## Drive mode integrated control system (if equipped)

The drive mode may be selected according to the driver's preference or road condition.



The mode changes whenever the DRIVE MODE button is pressed.

- NORMAL mode: NORMAL mode provides smooth driving.
- SPORT mode: SPORT mode provides sporty driving.
- ECO mode: ECO mode improves fuel efficiency for eco-friendly driving.

The driving mode will be set to NORMAL or ECO mode when the engine is restarted. If it is in NORMAL mode this mode will be set, when the engine is restarted.

If it is in Eco mode, Eco mode will be set when the engine is restarted.

### SPORT mode

**SPORT** SPORT mode focuses on dynamic driving.

- When the DRIVE MODE button is pressed and the SPORT mode is selected, the SPORT indicator will illuminate.
- When the SPORT mode is activated, and the ENGINE START/ STOP button is turned off and on it will change to NORMAL mode. To turn on the SPORT mode press DRIVE MODE button again.
- If the system is activated:
  - After increasing speed and taking your foot off the accelerator pedal it maintains the gear and rpm for a short time even though the accelerator pedal is not depressed.
  - Up-shifting is delayed.

**\* NOTICE**

In Sport drive mode, the fuel efficiency may decrease.

**ECO mode**

- ECO** When the Drive Mode is set to ECO mode, the engine and transmission control logic are changed to maximize fuel efficiency.
- When ECO mode is selected by pressing the DRIVE MODE button, the ECO indicator will illuminate.
  - If the vehicle is set to ECO mode, when the engine is turned OFF and restarted the Drive Mode setting will remain in ECO mode.

**\* NOTICE**

Fuel efficiency depends on the driver's driving habit and road condition.

**When ECO mode is activated:**

- The acceleration response may be slightly reduced if the accelerator pedal is depressed moderately.
- The air conditioner performance may be limited.
- The shift pattern of the automatic transmission may change.
- The engine noise may get louder.

The above situations are activated to improve fuel efficiency.

**Limitation of ECO mode operation:**

If the following conditions occur while ECO mode is operating, the system operation will be limited:

- When the coolant temperature is low:
  - The system will be limited until engine performance becomes comfort.
- When driving up a hill:
  - The system will be limited to gain power when driving uphill because engine torque is restricted.
- When driving the vehicle with the automatic transmission gear shift lever in manual mode:
  - The system will be limited according to the shift location.

## Forward Collision-Avoidance Assist (FCA) (Front view camera only) (if equipped)

FCA system is designed to detect and monitor a vehicle ahead in the roadway through camera recognition to warn the driver that a collision is imminent, and if necessary, apply emergency braking.

Front view camera only FCA system does not operate for pedestrians and cyclists in front.

### WARNING

Take the following precautions when using Forward Collision-Avoidance Assist system:

- This system is only a supplemental system and it is not intended to, or does it replace the need for extreme care and attention of the driver. The sensing range and objects detectable by the sensors are limited. Pay attention to the road conditions at all times.
- NEVER drive too fast in accordance with the road conditions or while cornering.
- Always drive cautiously to prevent unexpected and sudden situations from occurring. FCA does not stop the vehicle completely and does not avoid all collisions due to system limitations.

## Setting and activating FCA

The driver can activate FCA by placing the ignition switch or START/STOP button to the ON position and by selecting:

- Go to the "User Settings in the cluster → Driver Assistance → Forward Safety"
- If you select "Active Assist", FCA system activates. FCA produces warning messages and warning alarms in accordance with the collision risk levels. Also, it controls the brakes in accordance with the collision risk levels.
- If you select "Warning Only", FCA system activates and produces only warning alarms in accordance with the collision risk levels. You should control the brake directly because FCA system do not control the brake.
- If you select "Off", FCA system deactivates.



The warning light illuminates on the LCD display, when you cancel FCA system. The driver can monitor the FCA ON/OFF status on the LCD display. Also, the warning light illuminates when the ESC (Electronic Stability Control) is turned off. If the warning light remains ON with FCA activated, take your vehicle to an authorized Kia dealer and have the system checked.



## Setting the initial warning activation time

The driver can select the initial warning activation time on the LCD display.

- Go to the "User Settings in the cluster → Driver Assistance → Warning timing → Normal/Late".

The options for the initial Forward Collision Warning includes the following:

- Normal: When this condition is selected, the initial Forward Collision Warning is activated normally.
- Late: When this condition is selected, the initial Forward Collision Warning is activated later than normal. This setting reduces the amount of distance between the vehicle ahead before the initial warning occurs.

Select 'Late' when traffic is light and when driving speed is slow. When the vehicle ahead brakes suddenly or you increase the speed of your vehicle, the driver can notice the warning alarm is early even though the later option is selected.

## Prerequisite for FCA activation

FCA gets ready to be activated, when the Active Assist or Warning Only under the Forward Safety is selected on the LCD display, and

when the following prerequisites are satisfied.

- The ESC is activated.
- The driving speed is over 6 mph (10 km/h). (However, FCA is activated within certain driving speed.)
- The system detects a vehicle in front. (However, FCA does not activate according to conditions in front and vehicle systems, but it notices only certain warnings.)
- FCA may not be activated or may only sound a warning alarm depending on the driving or vehicle conditions.
- If the 'Warning Only' under the Forward Safety is selected, FCA produces only warning alarms in accordance with the collision risk levels.
- FCA automatically activates upon placing the ignition switch or START/STOP button to the ON position. The driver can deactivate FCA by canceling the system setting on the LCD display. To avoid driver distractions, do not attempt to set or cancel FCA while driving the vehicle.
- FCA automatically deactivates upon canceling the ESC. When the ESC is canceled, FCA cannot be activated on the LCD display. In this situation, FCA warning light will illuminate, but it does not indicate a malfunction of the system.

## Driving your vehicle

- Set or cancel FCA with controlling switches on steering wheel after stopping the vehicle in a safe place for your safety.

### FCA warning message and brake control

FCA system produces warning messages, warning alarms, and emergency braking based on the level of risk of a frontal collision, such as when a vehicle ahead suddenly brakes.

#### *Collision Warning (1st warning)*



OSK3058064NR

The warning message appears on the LCD display with the warning alarms.

Additionally, some vehicle system intervention occurs by the engine management system to help decelerate the vehicle.

The Vehicle may slow down slightly.

- It will operate if the vehicle speed is greater than 6 mph (10 km/h) and less than or equal to 93 mph

## Forward Collision-Avoidance Assist (FCA) (Front view camera only)

(150 km/h) on a forward vehicle. (Depending on the condition of the vehicle ahead and the environment surrounding it, the possible maximum operating speed may be reduced.)

- If you select "Warning Only" for FCA system setting, FCA system activates and produces only warning alarms in accordance with the collision risk levels. You should control the brake directly because FCA system will not control the brake.

#### *Emergency braking (2nd warning)*



OSK3058065NR

The warning message appears on the LCD display with the warning alarms.

Additionally, some vehicle system intervention occurs by the engine management system to help decelerate the vehicle.

The brake control is maximized just before a collision, reducing impact when it strikes a forward vehicle.

- It will operate if the vehicle speed is greater than 6 mph (10 km/h) and less than or equal to 37 mph (60 km/h) on a forward vehicle. (Depending on the condition of the vehicle ahead and the environment surrounding it, the possible maximum operating speed may be reduced.)
- If you select "Warning Only" for FCA system setting, FCA system activates and produces only warning alarms in accordance with the collision risk levels. You should control the brake directly because FCA system will not control the brake.

### Brake operation

In an urgent situation, the braking system enters into the ready status for prompt reaction against the driver's depressing the brake pedal.

- FCA system provides additional braking power for optimum braking performance, when the driver depresses the brake pedal during warning.
- The braking control is automatically deactivated, when the driver sharply depresses the accelerator pedal, or when the driver abruptly operates the steering wheel.
- The braking control is automatically canceled, when risk factors disappear.

### ⚠ CAUTION

The driver should always use extreme caution when operating the vehicle, even though there is no warning message or warning alarm.

### ⚠ WARNING

FCA system cannot avoid all collisions nor completely stop the vehicle before collision. The driver is responsible to safely drive and control the vehicle.

### ⚠ WARNING

FCA system logic operates within certain parameters, such as the distance from the vehicle ahead, the speed of the vehicle ahead, and the driver's vehicle speed. Certain conditions such as inclement weather and road conditions may affect the operation of FCA system.

Never deliberately drive dangerously to activate the system.

### FCA front view camera sensor

In order for FCA system to operate properly, always make sure the sensor is clean and free of dirt, snow, and debris.

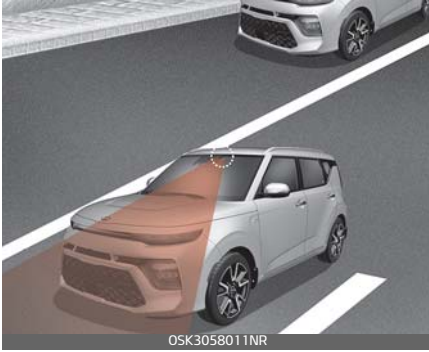

Dirt, snow, or foreign substances on the lens may adversely affect the sensing performance of the sensor.

### Warning message and warning light



When the camera is covered with dirt, snow, or debris, FCA operation may not be able to detect other vehicles. In this case, the warning message appears to warn the driver.

This is not a malfunction with FCA. To operate FCA again, remove the foreign substances.

FCA may not properly operate in an area (e.g. open terrain), where

objects or vehicles are not detected after turning ON the engine.

### **⚠ WARNING**

FCA system may not activate without any warning messages depending on driving and road conditions.

### **\* NOTICE**

- Doing so may adversely affect the sensing performance of the sensor.
- Always keep the sensor clean and free of dirt and debris.
- Be careful not to apply unnecessary force on the sensor. If the sensor is forcibly moved out of proper alignment, FCA system may not operate correctly. In this case, a warning message may not be displayed. In this case, take your vehicle to an authorized Kia dealer and have the system inspected.
- Use only genuine parts to repair or replace a damaged.
- Do not tint the window or install stickers, accessories around the inside mirror where the camera is installed.
- Make sure the frontal camera installation point does not get wet.
- Do not impact or arbitrarily remove any camera components.

- Do not place reflective objects (white paper or mirror etc.) on the dashboard.  
The system may activate unnecessarily due to reflect of the sunlight.
- Excessive audio volume may disturb the sound of the system warning alarm.
- For more precautions related to the camera sensor, refer to the "Lane Keeping Assist (LKA) (if equipped)" on page 5-81.

### FCA malfunction

When FCA is not working properly, FCA warning light (  ) will illuminate and the warning message will appear for a few seconds.

Type A



Type B



After the message disappears, the master warning light (  ) will illuminate. In this case, take your vehicle to an authorized Kia dealer and have the system inspected.

FCA system will also be deactivated for the sake of driver's safety when the ESC warning light comes on. FCA warning message will appear at the same time, too. But that doesn't necessarily mean the malfunction of FCA system.

Both FCA warning light and warning message will disappear once the ESC warning light issue is resolved.

- FCA is only a supplemental system for the driver's convenience. It is the driver's responsibility to control the vehicle operation. Do not solely depend on FCA system. Rather, maintain a safe braking distance, and, if necessary, depress the brake pedal to reduce the driving speed or to stop the vehicle.

- In certain instances and under certain driving conditions, FCA system may activate unintentionally. This initial warning message appears on the LCD display with a warning chime. Also, due to sensing limitations, in certain situations, the camera recognition system may not detect the vehicle ahead. FCA system may not activate and the warning message may not be displayed.
- FCA system may not activate if the driver applies the brake pedal before warning to avoid the risk of a collision.
- FCA system does not operate when the vehicle is in reverse.
- FCA system is not designed to detect other objects on the road such as animals.
- FCA system does not detect vehicles in the opposite lane.
- FCA system does not detect cross traffic vehicles that are approaching.
- FCA system cannot detect the driver approaching the side view of a parked vehicle (for example on a dead end street).  
In these cases, you must maintain a safe braking distance, and if necessary, depress the brake pedal to reduce the driving speed in order to maintain a safe distance or to stop the vehicle.

### Limitations of FCA

FCA system is designed to monitor the vehicle ahead in the roadway through camera recognition to warn the driver that a collision is imminent, and if necessary, apply emergency braking.

In certain situations, the camera may not be able to detect the vehicle ahead. In these cases, FCA system may not operate normally. The driver must pay careful attention in the following situations where FCA operation may be limited.

### *Limitations of the sensors*

The sensor may be limited when:

- The sensor is covered with foreign substances.
- It heavily rains or snows.
- The vehicle in front has a narrow body. (i.e. motor cycle and bicycle)
- The sensor view is unclear due to the backlight, the reflected light, or darkness.
- The sensor cannot contain the full image of the vehicle in front.
- The vehicle in front is a special vehicle, such as a heavily-loaded truck or a trailer.
- The outside brightness changes suddenly, such as entering/exiting the tunnel.
- The vehicle driving is unstable.
- The camera sensor recognition is limited.

## Driving your vehicle

- The sensor's field of view is not well illuminated (either too dark or too much reflection or too much backlight that obscures the field of view)
- The vehicle in front is driving erratically
- The vehicle is driven near areas containing metal substances such as a construction zone, railroad, etc.
- Backlight is reflected in the direction of the vehicle (including front light from the vehicle ahead)
- Moisture on the windshield is not completely removed or frozen.
- The weather is misty.
- The vehicle in front does not turn ON the rear lights, does not have rear lights, has asymmetric rear lights, or has rear lights out of angle.
- The vehicle is on unpaved or uneven rough surfaces, or roads with sudden gradient changes.
- The vehicle is moving under ground level or inside a building.
- A sudden change in the sensor recognition takes place while passing through the speed bump,
- The vehicle is severely shaken due to adverse road conditions.
- Driving around circular intersection with a vehicle in front,
- The front of the camera lens is contaminated by front glass tinting, film, water repellent coating,

## Forward Collision-Avoidance Assist (FCA) (Front view camera only)

- damage on glass, foreign matter (sticker, insect, etc.)
- The camera or camera lens is damaged.
- The headlights of the vehicle are not used at night or in the tunnel section, or the light is too weak.
- The street light or the light of the vehicle coming from the opposite is reflected or when sunlight is reflected by the water on the road surface.
- The back light is projected in the direction of the vehicle's motion (including the headlights of vehicles)
- Road sign, shadow on the road, tunnel entrance, toll gate, partial pavement
- The windshield has moisture on its surface or if windshield freezes,
- Driving in the fog.
- Objects are out of the sensing range of the camera.

### *Driving on a curve*

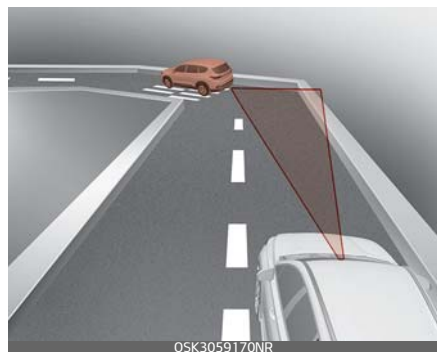

## Driving your vehicle

The performance of Forward Collision-Avoidance Assist system may be limited when driving on a curved road.

The front camera recognition system may not detect the vehicle traveling in front on a curved road. This may result in no alarm and braking when necessary.

Always pay attention to road and driving conditions, and if necessary, depress the brake pedal to reduce your driving speed in order to maintain a safe distance.

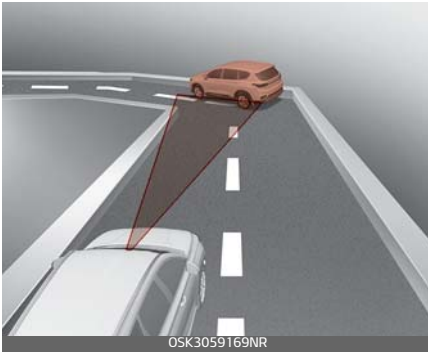

Forward Collision-Avoidance Assist system may recognize a vehicle in the next lane or outside the lane when driving on a curved road. If this occurs, the system may unnecessarily alarm the driver and apply the brake.

Always pay attention to road and driving conditions, while driving.

## Forward Collision-Avoidance Assist (FCA) (Front view camera only)

### *Driving on a slope*



The performance of Forward Collision-Avoidance Assist system may be decreased while driving upward or downward on a slope.

The front camera recognition may not detect the vehicle in front. This may result in unnecessary alarm and braking or no alarm and braking when necessary.

When the system suddenly recognizes the vehicle in front while passing over a slope, you may experience sharp deceleration.

Always keep your eyes forward while driving upward or downward on a slope, and, if necessary, depress the brake pedal to reduce your driving speed in order to maintain distance.



### Changing lanes

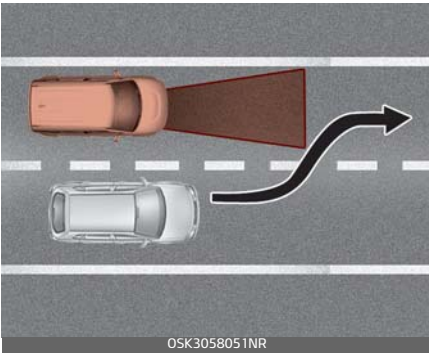

When a vehicle changes lanes in front of you, FCA system may not immediately detect the vehicle, especially if the vehicle changes lanes abruptly. In this case, you must maintain a safe braking distance, and if necessary, depress the brake pedal to reduce your driving speed in order to maintain a safe distance.

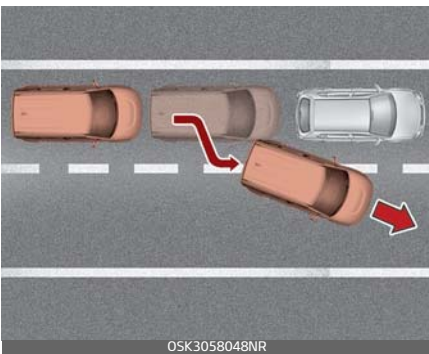

When driving in stop-and-go traffic, and a stopped vehicle in front of you merges out of the lane, FCA system may not immediately detect the new vehicle that is now in front of

you. In this case, you must maintain a safe braking distance, and if necessary, depress the brake pedal to reduce your driving speed in order to maintain a safe distance.

### Recognizing the vehicle

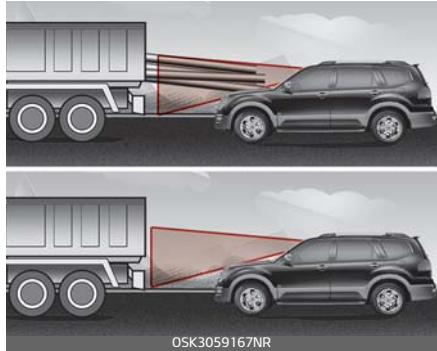

When the vehicle in front has heavy loading extended rearward, or when the vehicle in front has higher ground clearance, it may induce a hazardous situation. Always pay attention to road and driving conditions, while driving and, if necessary, depress the brake pedal to reduce your driving speed in order to maintain distance.

### **⚠ WARNING**

- Do not use the Forward Collision-Avoidance Assist system when towing a vehicle. Application of FCA system while towing may adversely affect the safety of your vehicle or the towing vehicle.

## Driving your vehicle

- Use extreme caution when the vehicle in front of you has cargo that extends rearward from the cab, or when the vehicle in front of you has higher ground clearance.
  - Never try to test the operation of FCA system. Doing so may cause severe injury or death.
- 
- FCA system is designed to detect and monitor the vehicle ahead in the roadway through camera recognition. It is not designed to detect pedestrians, bicycles, motorcycles, or smaller wheeled objects such as luggage bags, shopping carts, or strollers.
  - If the front glass or camera have been replaced or repaired, have your vehicle inspected by an authorized Kia dealer.

### \* NOTICE

In some instances, FCA system may be canceled when subjected to electromagnetic interference.

---

### **This device complies with Part 15 of the FCC rules.**

Operation is subject to the following three conditions:

1. This device may not cause harmful interference, and
2. This device must accept any interference received, including

## Forward Collision-Avoidance Assist (FCA) (Front view camera only)

- interference that may cause undesired operation.
3. Changes or modifications not expressly approved by the party responsible for compliance could void the user's authority to operate the device.

### **Radio frequency radiation exposure information:**

This equipment complies with FCC radiation exposure limits set forth for an uncontrolled environment.

This equipment should be installed and operated with minimum distance of 8 in (20 cm) between the radiator (antenna) and your body.

This transmitter must not be co-located or operating in conjunction with any other antenna or transmitter.

## Forward Collision–Avoidance Assist (FCA) (Sensor fusion) (if equipped)

FCA system is designed to detect and monitor a vehicle ahead or detect a pedestrian or a cyclist in the roadway through front view camera recognition and front radar signals to warn the driver that a collision is imminent, and if necessary, apply emergency braking.

### **⚠ WARNING**

#### **Forward Collision–Avoidance Assist system Limitations**

FCA system is a supplemental system and is not a substitute for safe driving practices.

It is the responsibility of the driver to always check the speed and distance to the vehicle ahead and to be prepared to apply the brakes.

### **⚠ WARNING**

Take the following precautions when using Forward Collision–Avoidance Assist system:

- This system is only a supplemental system and it is not intended to, or does it replace the need for extreme care and attention of the driver. The sensing range and objects detectable by the sensors are limited. Pay attention to the road conditions at all times.

## Forward Collision–Avoidance Assist (FCA) (Sensor fusion)

- NEVER drive too fast in accordance with the road conditions or while cornering.
- Always drive cautiously to prevent unexpected and sudden situations from occurring. FCA does not stop the vehicle completely and does not avoid all collisions due to system limitations.

### **Setting and activating FCA**

The driver can activate FCA by placing the ignition switch or START/STOP button to the ON position and by selecting:

- Go to the 'User Settings in the cluster', 'Driver Assistance', and 'Forward Collision–Avoidance Assist'.

FCA deactivates, when the driver cancels the system setting.



The warning light illuminates on the LCD display, when you cancel FCA system. The driver can monitor the FCA ON/OFF status on the LCD display. Also, the warning light illuminates when the ESC (Electronic Stability Control) is turned off (Traction & Stability control disabled.).

When the warning light remains ON with FCA activated, take your vehicle to an authorized Kia dealer and have the system checked.

### Setting the initial warning activation time

#### Forward Collision-Avoidance Assist (FCA) (Sensor fusion)

### Setting initial warning activation time

The driver can select the initial warning activation time in the User Settings in the instrument cluster LCD display.

The options for the initial Forward Collision Warning include the following:

- Normal: When this condition is selected, the initial Forward Collision Warning is activated normally.
- Late: When this condition is selected, the initial Forward Collision Warning is activated later than normal. This setting reduces the amount of distance between the vehicle, pedestrian or cyclist ahead before the initial warning occurs. Select this condition only when traffic is light, and you are driving slowly.

### Prerequisite for FCA activation

FCA will activate when FCA is selected on the LCD display, and when the following prerequisites are satisfied:

- The ESC (Electronic Stability Control) is activated.
- The driving speed is over 6 mph (10 km/h). (FCA only works within a certain range of vehicle speeds)

- When FCA recognizes a vehicle or the pedestrian in front.

### WARNING

FCA may not recognize every obstacle or provide warnings and braking in every situation, so do not rely on FCA to stop the vehicle in instances where the driver sees an obstacle and has the ability to apply the brakes.

- FCA automatically activates upon placing the ignition switch or START/STOP button to the ON position. The driver can deactivate FCA by canceling the system setting on the LCD display.
- FCA automatically deactivates upon canceling the ESC. When the ESC is canceled, FCA cannot be activated on the LCD display. FCA warning light will illuminate.
- To avoid driver distractions, do not attempt to set or cancel FCA while operating the vehicle.

### FCA warning message and brake control

FCA system produces warning messages, warning alarms, and emergency braking based on the level of risk of a frontal collision, such as when a vehicle ahead suddenly brakes, or when the system detects that a collision with a pedestrian is imminent.

The driver can select the initial warning activation time in the User Settings in the LCD display. The options for the initial Forward Collision Warning include Early, Normal or Late initial warning time.

### ***Collision Warning (1st warning)***



- The warning message appears on the LCD display with the warning alarms.

Additionally, some vehicle system intervention occurs by the engine management system to help decelerate the vehicle.

The Vehicle may slow down slightly.

- It will operate if the vehicle speed is greater than 6 mph (10 km/h) and less than or equal to 93 mph (150 km/h) on a forward vehicle. (Depending on the condition of the vehicle ahead and the environment surrounding it, the possible maximum operating speed may be reduced.)

- For pedestrians and cyclists, the vehicle speed is greater than or equal to 6 mph (10 km/h) and less than 53 mph (85 km/h). (Depending on the condition of pedestrians and bike riders and the surrounding environment the possible maximum operating speed may be reduced.)
  - If you select "Warning Only", FCA system activates and produces only warning alarms in accordance with the collision risk levels. You should control the brake directly because FCA system do not control the brake.

### ***Emergency braking (2nd warning)***



- The warning message appears on the LCD display with the warning alarms.

Additionally, some vehicle system intervention occurs by the engine management system to help decelerate the vehicle.

The Vehicle may slow down slightly.

- It will operate if the vehicle speed is greater than 6 mph (10 km/h) and less than or equal to 46 mph (75 km/h) on a forward vehicle. (Depending on the condition of the vehicle ahead and the environment surrounding it, the possible maximum operating speed may be reduced.)
- For pedestrians and cyclists, the vehicle speed is greater than or equal to 6 mph (10 km/h) and less than 40 mph (65 km/h). (Depending on the condition of pedestrians and bike riders and the surrounding environment the possible maximum operating speed may be reduced.)
  - If you select "Warning Only", FCA system activates and produces only warning alarms in accordance with the collision risk levels. You should control the brake directly because FCA system do not control the brake.

### Brake operation

In an urgent situation, the braking system enters into the ready status for prompt reaction to assist the driver in depressing the brake pedal.

- FCA provides additional braking power for optimum braking performance when the driver

depresses the brake pedal during warning.

- The braking control is automatically deactivated when the driver sharply depresses the accelerator pedal, or when the driver abruptly operates the steering wheel.
- The braking control is automatically canceled when risk factors disappear.

The driver should always exercise caution when operating the vehicle, even though there is no warning message or warning alarm.

### WARNING

FCA cannot avoid all collisions nor completely stop the vehicle before collision. The driver has the responsibility to drive safely and control the vehicle.

### WARNING

FCA is a supplemental system and cannot completely stop the vehicle in all situations or avoid all collisions. It is the responsibility of the driver to safely drive and control the vehicle.

### WARNING

Never deliberately drive dangerously to activate the system as such con-

duct increases the risk of an accident.

**\* NOTICE**

FCA system assesses the risk of a collision by monitoring several variables such as the distance to the vehicle/pedestrian ahead, the speed of the vehicle/pedestrian ahead, and the driver's operation of the vehicle. Certain conditions such as inclement weather and road conditions may affect the operation of FCA system. For the system operation, do not attempt risky driving.

**FCA front view camera / front radar sensor**

In order for FCA system to operate properly, always make sure the sensor or sensor cover is clean and free of dirt, snow, and debris. Dirt, snow, or foreign substances on the sensor or its external parts may adversely affect the sensing performance of the sensor.



**\* NOTICE**

- Do not apply foreign objects, such as a bumper sticker or a bumper guard, near the radar sensor. Doing so may adversely affect the sensing performance of the radar.
- Always keep the radar sensor and over clean and free of dirt and debris.
- Use only soft clothes to wash the vehicle. Do not spray pressurized water directly on the sensor or sensor cover.
- Be careful not to apply unnecessary force on the radar sensor or sensor cover. If the sensor is forc-

ibly moved out of proper alignment, FCA system may not operate correctly. In this case, a warning message may not be displayed. Have the vehicle inspected by an authorized Kia dealer.

- If the front bumper becomes damaged in the area around the radar sensor, FCA system may not operate properly. In this case, have your vehicle inspected by an authorized Kia dealer.
- Use only genuine parts to repair or replace a damaged sensor or sensor cover. Do not apply paint to the sensor cover.
- Do not tint the window or install stickers or accessories around the inside mirror where the camera is installed.
- Make sure the front view camera installation point does not get wet.
- Do not impact or remove any front view camera/front radar components.
- Do not place reflective objects (white paper or mirror etc.) on the dashboard. The system may activate unnecessarily due to reflection of the sunlight.
- Excessive audio system volume may prevent occupants from hearing FCA system warning alarm.

### Warning message and warning light

When the sensor is covered or the sensor lens is dirty with foreign substances, such as snow or rain, FCA system may not be able to detect vehicles or pedestrians.

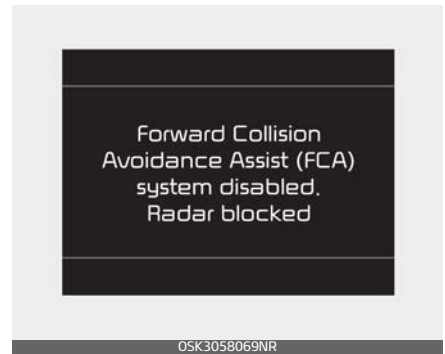

In this case, a warning message ("Forward Collision-Avoidance Assist (FCA) system disabled. Radar blocked") will appear to notify the driver. Remove the foreign substances to allow FCA system to function normally.

Remove any dirt, snow, or debris and clean the radar sensor cover before operating FCA system.

FCA may not properly operate in an area (e.g. open terrain), where any vehicles or objects are not detected after turning ON the vehicle.

### FCA malfunction

When FCA is not working properly, FCA warning light  will illumi-



nate and the warning message will appear for a few seconds.

Type A



Type B



After the message disappears, the master warning light (⚠️) will illuminate. In this case, take your vehicle to an authorized Kia dealer and have the system checked.

FCA system will also be deactivated for the sake of driver's safety when the ESC warning light comes on. FCA warning message will appear at the same time, too. But that doesn't

necessarily mean the malfunction of FCA system.

Both FCA warning light and warning message will disappear once the ESC warning light issue is resolved.

**⚠️ WARNING**

FCA is only a supplemental system for the driver's convenience. It is the driver's responsibility to control the vehicle operation. Do not solely depend on FCA system. Rather, maintain a safe braking distance, and, if necessary, depress the brake pedal to reduce the driving speed or stop the vehicle.

- In certain instances and under certain driving conditions, FCA system may activate unintentionally. This initial warning message appears on the LCD display with a warning chime. Also, due to sensing limitations, in certain situations, the front view camera recognition system or front radar may not detect the vehicle, pedestrian or cyclist (if equipped) ahead. FCA system may not activate and the warning message will not be displayed.
- FCA may unnecessarily produce the warning message and the warning alarms. Also, due to the sensing limitation, FCA may not produce the warning message and the warning alarm at all.

- When there is a malfunction with FCA, the autonomous emergency braking does not operate upon detecting a collision risk even with other braking systems normally operating.
- FCA operates only for the vehicle/ pedestrian in front, while driving forward. It does not operate for any animals or vehicles in the opposite direction.
- FCA system may not activate if the driver applies the brake pedal before warning to avoid risk of collision.
- FCA system does not operate when the vehicle is in reverse.
- FCA system is not designed to detect other objects on the road such as animals.
- FCA system does not detect vehicles in the opposite lane.
- FCA system does not detect cross traffic vehicles that are approaching.
- FCA system cannot detect the driver approaching the side view of a parked vehicle (for example on a dead end street). In these cases, you must maintain a safe braking distance, and if necessary, depress the brake pedal to reduce the driving speed in order to maintain a safe distance.
- FCA system may not activate depending on road or driving conditions.

- FCA system may not activate to all types of vehicles.

### Limitations of FCA

FCA system is designed to monitor the vehicle ahead in the roadway through front view camera recognition and front radar signals to warn the driver that a collision is imminent, and if necessary, apply emergency braking.

In certain situations, the front view camera or front radar sensor may not be able to detect the vehicle ahead. In these cases, FCA system may not operate normally. The driver must pay careful attention in the following situations where FCA operation may be limited.

### ***Detecting vehicle, pedestrian and cyclist***

The sensor may be limited when:

- The system may not operate for 15 seconds after the vehicle is started or the camera is initialized.
- The radar sensor or camera is covered with a foreign object or debris.
- The camera lens is contaminated due to tinted, filmed or coated windshield, damaged glass, or stuck of foreign matter (sticker, bug, etc.) on the glass.

## Driving your vehicle

- Inclement weather such as heavy rain or snow obscures the field of view of the radar sensor or camera.
- There is interference by electromagnetic waves.
- There is severe irregular reflection from the radar sensor.
- The radar/camera sensor recognition is limited
- The vehicle in front is too small to be detected. (for example a motorcycle etc.)
- The vehicle in front is an oversized vehicle or trailer that is too big to be detected by the camera recognition system. (for example a tractor trailer, etc.)
- The camera's field of view is not well illuminated (either too dark or too much reflection or too much backlight that obscures the field of view).
- The vehicle in front does not have their rear lights or their rear lights does not turned ON or their rear lights are located unusually.
- The outside brightness changes suddenly, for example when entering or exiting a tunnel.
- Light coming from a street light or an oncoming vehicle is reflected on a wet road surface such as a puddle in the road.
- The field of view in front is obstructed by sun glare or head light of oncoming vehicle.

## Forward Collision-Avoidance Assist (FCA) (Sensor fusion)

- The windshield glass is fogged up; a clear view of the road is obstructed .
- The vehicle in front is driving erratically.
- The vehicle is on unpaved or uneven rough. surfaces, or road with sudden gradient changes.
- There is severe irregular reflection from the radar sensor.
- The radar/camera sensor recognition is limited
- The vehicle in front is too small to be detected. (for example a motorcycle etc.)
- The vehicle in front is an oversized vehicle or trailer that is too big to be detected by the camera recognition system. (for example a tractor trailer, etc.)
- The camera's field of view is not well illuminated. (either too dark or too much reflection or too much backlight that obscures the field of view)
- The vehicle in front does not have their rear lights or their rear lights does not turned ON or their rear lights are located unusually.
- The outside brightness changes suddenly, for example when entering or exiting a tunnel.
- Light coming from a street light or an oncoming vehicle is reflected on a wet road surface such as a puddle in the road.

- The field of view in front is obstructed by sun glare or head light of oncoming vehicle.
- The windshield glass is fogged up; a clear view of the road is obstructed .
- The vehicle in front is driving erratically.
- The vehicle is on unpaved or uneven rough surfaces, or road with sudden gradient changes.
- The vehicle is driven near areas containing metal substances as a construction zone, railroad, etc.
- The vehicle drives inside a building, such as a basement parking lot .
- The camera does not recognize the entire vehicle in front.
- The camera is damaged.
- The brightness outside is too low such as when the headlamps are not on at night or the vehicle is going through a tunnel.
- The shadow is on the road by a median strip, trees, etc.
- The vehicle drives through a toll-gate.
- The windshield glass is fogged up; a clear view of the road is obstructed.
- The rear part of the vehicle in front is not normally visible. (the vehicle turns in other direction or the vehicle is overturned.)
- The adverse road conditions cause excessive vehicle vibrations while driving.

- The sensor recognition changes suddenly when passing over a speed bump.
- The vehicle in front is moving vertically to the driving direction .
- The vehicle in front is stopped vertically.
- The vehicle in front is driving towards your vehicle or reversing.
- You are on a roundabout and the vehicle in front circles.

**Driving on a curve**

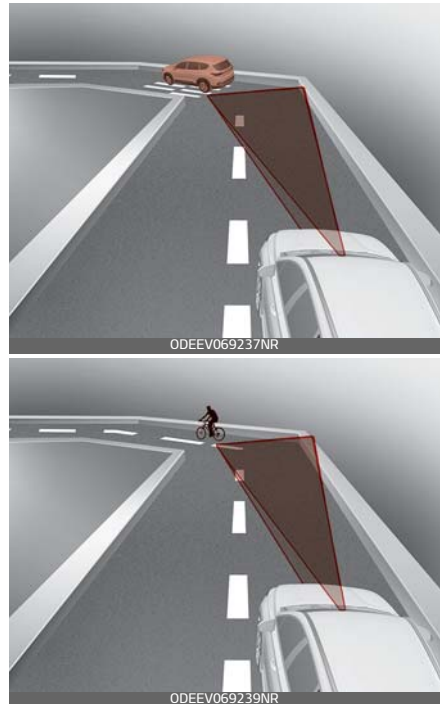

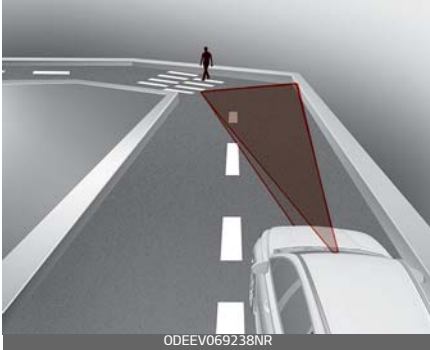

The performance of Forward Collision-Avoidance Assist system may be limited when driving on a curved road.

The front view camera or radar sensor recognition system may not detect the vehicle, pedestrian or cyclist traveling in front on a curved road.

This may result in no alarm and braking when necessary.

Always pay attention to road and driving conditions, and if necessary, depress the brake pedal to reduce your driving speed in order to maintain a safe distance.

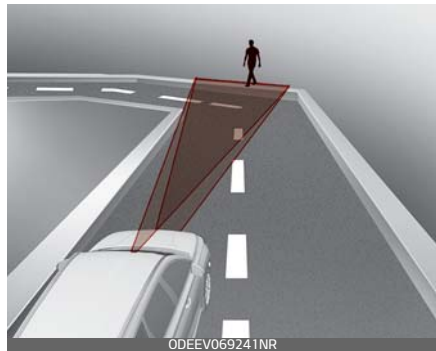
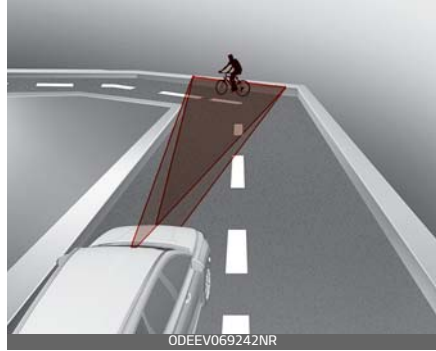
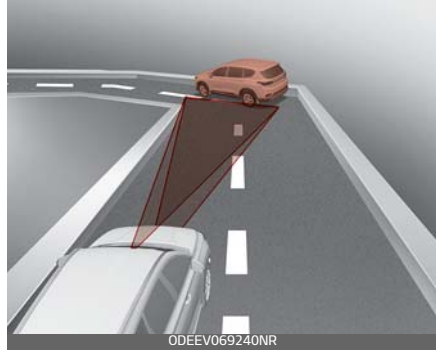

Forward Collision-Avoidance Assist system may recognize a vehicle or pedestrian or cyclist in the next lane or outside the lane when driving on a curved road.

If this occurs, the system may unnecessarily alarm the driver and apply the brake.

Always pay attention to road and driving conditions, while driving.

### *Driving on a slope*



The performance of Forward Collision-Avoidance Assist system may be decreased while driving upward or downward on a slope. The front view camera or front radar sensor recognition may not detect the vehicle, pedestrian or cyclist in front.

This may result in unnecessary alarm and braking or no alarm and braking when necessary.

When the system suddenly recognizes the vehicle, pedestrian or cyclist in front while passing over a slope, you may experience sharp deceleration.

Always keep your eyes forward while driving upward or downward on a slope, and, if necessary, depress the brake pedal to reduce your driving speed in order to maintain distance.

### Changing lanes

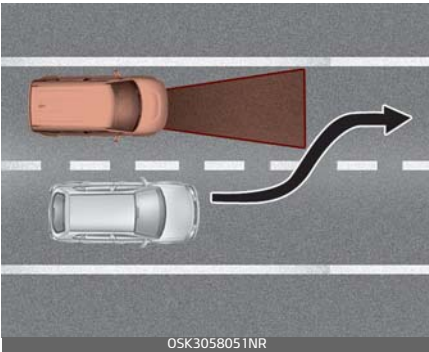

When a vehicle changes lanes in front of you, FCA system may not immediately detect the vehicle, especially if the vehicle changes lanes abruptly. In this case, you must maintain a safe braking distance, and if necessary, depress the brake pedal to reduce your driving speed in order to maintain a safe distance.

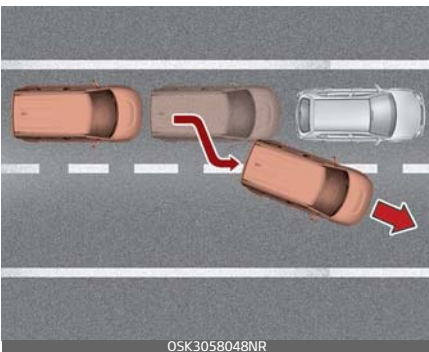

When driving in stop-and-go traffic, and a stopped vehicle in front of you merges out of the lane, FCA system may not immediately detect the new vehicle that is now in front of

you. In this case, you must maintain a safe braking distance, and if necessary, depress the brake pedal to reduce your driving speed in order to maintain a safe distance.

### Recognizing the vehicle

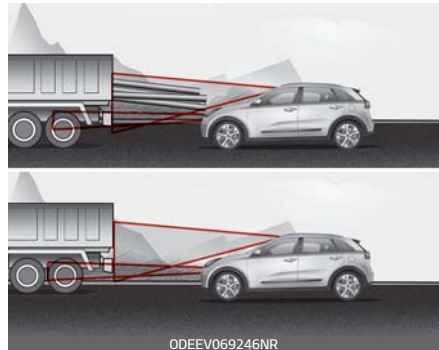

When the vehicle in front has heavy loading extended rearward, or when the vehicle in front has higher ground clearance, it may induce a hazardous situation. Always pay attention to road and driving conditions, while driving and, if necessary, depress the brake pedal to reduce your driving speed in order to maintain distance.

### Detecting pedestrians or cyclists

The sensor may be limited when:

- The pedestrian or cyclist is not fully detected by the camera recognition system, for example, if the pedestrian is leaning over or is not fully walking upright.

- The pedestrian or cyclist is moving very quickly or appears abruptly in the camera detection area.
- The pedestrian or cyclist is wearing clothing that easily blends into the background, making it difficult to be detected by the camera recognition system.
- The outside lighting is too bright (e.g. when driving in bright sunlight or in sun glare) or too dark. (e.g. when driving on a dark rural road at night)
- It is difficult to detect and distinguish the pedestrian or cyclist from other objects in the surroundings, for example, when there is a group of pedestrians, cyclists or a large crowd.
- There is an item similar to a person's body structure
- The pedestrian or cyclist is small.
- The pedestrian has impaired mobility.
- The sensor recognition is limited.
- The radar sensor or camera is blocked with a foreign object or debris.
- Inclement weather such as heavy rain or snow obscures the field of view of the radar sensor or camera.
- When light coming from a street light or an oncoming vehicle is reflected on a wet road surface such as a puddle in the road.
- The field of view in front is obstructed by sun glare.
- The windshield glass is fogged up; a clear view of the road is obstructed.
- The adverse road conditions cause excessive vehicle vibrations while driving.
- The sensor recognition changes suddenly when passing over a speed bump.
- You are on a roundabout.
- The pedestrian or cyclist suddenly interrupts in front of the vehicle.
- The cyclist in front is riding intersected with the driving direction.
- There is any other electromagnetic interference.
- The construction area, rail or other metal object is near the cyclist.
- The bicycle material is not reflected well on the radar.

**WARNING**

- Cancel FCA in the User Settings on the LCD display, before towing another vehicle. While towing, the brake application may adversely affect your vehicle safety.
- Exercise extreme caution to the vehicle in front, when it has heavy loading extended rearward, or when it has higher ground clearance.



- Never try to test the operation of FCA system. Doing so may cause severe injury or death.
- FCA system is designed to detect and monitor the vehicle ahead or detect a pedestrian in the roadway through front view camera recognition and front radar signals. It is not designed to detect bicycles, motorcycles, or smaller wheeled objects such as luggage bags, shopping carts, or strollers.
- When replacing or reinstalling the windshield, front bumper or front view camera recognition and front radar signals after removal, take your vehicle to an authorized Kia dealer and have the system checked.

**\* NOTICE**

In some instances, FCA system may be canceled when subjected to electromagnetic interference.

**This device complies with Part 15 of the FCC rules.**

Operation is subject to the following three conditions:

1. This device may not cause harmful interference, and
2. This device must accept any interference received, including interference that may cause undesired operation.

3. Changes or modifications not expressly approved by the party responsible for compliance could void the user's authority to operate the device.

**Radio frequency radiation exposure information:**

This equipment complies with FCC radiation exposure limits set forth for an uncontrolled environment. This equipment should be installed and operated with minimum distance of 8 in (20 cm) between the radiator (antenna) and your body.

This transmitter must not be co-located or operating in conjunction with any other antenna or transmitter.

## Lane Keeping Assist (LKA) (if equipped)

Lane Keeping Assist system is designed to detect the lane markers on the road with a front view camera at the front windshield, and assists the driver's steering to help keep the vehicle in the lanes.

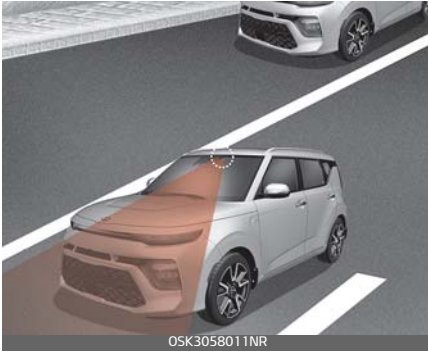

When the system detects the vehicle straying from its lane, it alerts the driver with a visual and audible warning, while applying a slight countersteering torque, trying to prevent the vehicle from moving out of its lane.

### **⚠ WARNING**

Lane Keeping Assist system is a supplemental system and is not a substitute for safe driving practices. It is the responsibility of the driver to always pay attention and drive safely.

### **⚠ WARNING**

- Driver is responsible for being aware of surroundings and steering the vehicle for safe driving practices.
- Do not turn the steering wheel suddenly when the steering wheel is being assisted by the system.

### **\* NOTICE**

- When you replace the windshield glass, front view camera or system, take your vehicle to an authorized Kia dealer and have the system checked to need a calibration.
- The system is designed to detect lane markers using a front view camera. If the lane markers are hard to detect, then the system may be limited. Always be cautious when using the system.
- When the lane markers are hard to detect, please refer to "Driver's Attention" on page 5-86.
- Do not remove or damage parts of LKA system.
- Do not place objects on the dashboard that reflects light such as mirrors, white paper, etc. This may prevent LKA system from functioning properly.
- You may not hear warning sound of LKA if the audio volume is high.
- If you drive with your hands off the steering wheel, LKA system

will stop controlling the steering wheel after the hands off alarm. If you drive with your hands on the steering wheel again, the control will be activated again.

- If the vehicle speed is high, steering torque for assistance may not be enough to keep your vehicle within the lane. If so, the vehicle may move out of its lane. Obey speed limit when using LKA.
- If you attach objects to the steering wheel, the system may not assist steering.
- If you attach objects to the steering wheel, hands off alarm may not work properly.

**LKA operation**

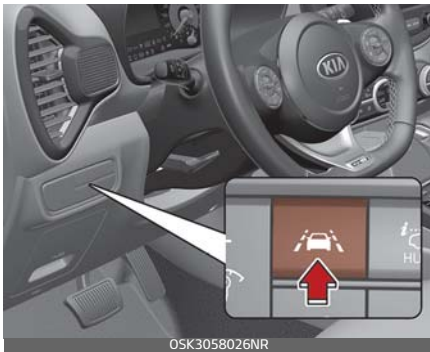

To activate/deactivate LKA, with the ignition switch or START/STOP button in the ON position, take the following steps:

- Press the Lane Safety button located on the instrument panel

on the lower left hand side of the driver.

The indicator in the cluster display will initially illuminate white.

If the indicator (white) was activated in the previous vehicle ON, the system turns on automatically.

If you press the Lane Safety button again, the indicator on the cluster display will go off.

The color of indicator will change depend on the condition of LKA.

- White: Sensor does not detect the lane marker or vehicle speed is less than 40 mph (64 km/h).
- Green: Sensor detects the lane marker and system is able to control the steering.
- If the function is turned off in User settings, the system will not operate. If you select Active LKA/LKA/LDW in User settings, the selected function will be activated.

**LKA activation**

To see LKA screen on the LCD display in the cluster, Tab to the Driving Assist mode (  ).

For further details, refer to "LCD Display Modes" on page 4-53.

After LKA is activated, if both lane markers are detected, vehicle speed is over 40 mph (64 km/h) and all the activation conditions are satisfied, a

green steering wheel indicator will illuminate and the steering wheel will be controlled.

**⚠ WARNING**

Lane Keeping Assist system is a system designed to help prevent the driver from leaving the lane. However, the driver should not solely rely on the system but always check the road conditions when driving.

When the conditions below are met, LKA will be enabled to assist steering.

- Vehicle speed is above 40 mph (64 km/h).
- The vehicle is between the lane markers.

If LKA can assist steering, a green steering wheel indicator will illuminate.

**Warning message**

If the vehicle leaves a lane, the lane marker you cross will blink on the LCD display.

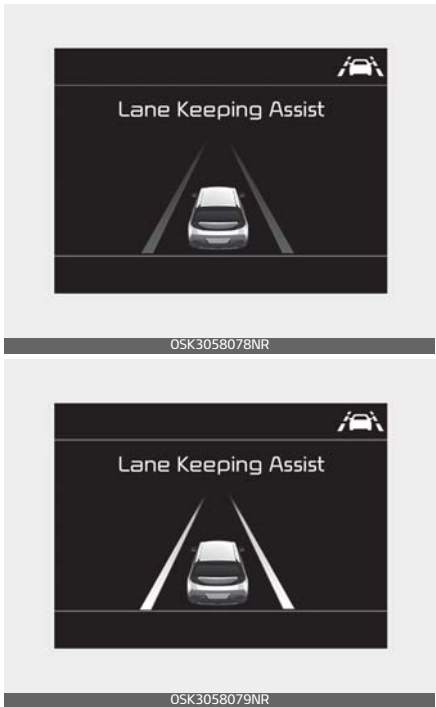

If the speed of the vehicle is over 40 mph (64 km/h) and the system detects lane markers, the color changes from gray to white.



If the vehicle moves out its lane because steering torque for assistance is not enough, the lane indicator will blink.

If all the conditions to activate LKA are not satisfied, the system will convert to Lane Departure Warning and warn the driver only when the driver crosses the lane markers. In this scenario, LDW does not provide any steering inputs into the vehicle for you. Accordingly, you must take the necessary steps to maintain control of the vehicle and keep it within the lanes.

***Keep hands on steering wheel  
(When Active LKA is activated, if equipped)***

If the driver takes hands off the steering wheel for several seconds while the Active LKA is activated, the system will warn the driver.

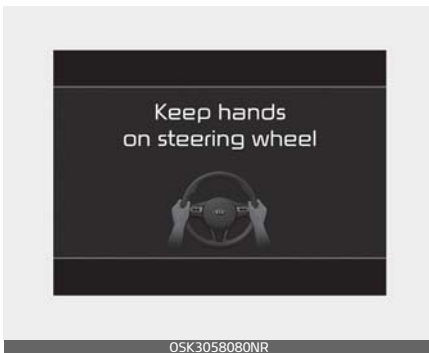

If the driver still does not have their hands on the steering wheel after several seconds, the system will

only warn the driver when the driver crosses the lane lines. In this scenario, the system does not provide any steering inputs into the vehicle for you. Accordingly, you must take the necessary steps to maintain control of the vehicle and keep it within the lanes.

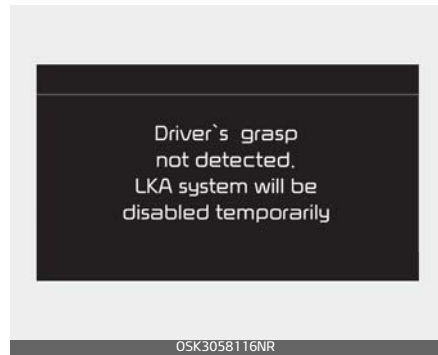

However, if the driver has their hands on the steering wheel again, the system will start controlling the steering wheel.

**\* NOTICE**

- Always keep your hands on the steering wheel while driving.
- If you hold the steering wheel with a light grip, the system may also generate hands off warning.

**\* NOTICE**

- LKA system is a supplemental system only. It is the responsibility of the driver to safely steer

the vehicle and to maintain it in its lane.

- Even though the steering is assisted by the system, the driver may control the steering wheel.
- Turn off LKA system and drive without using the system in the following situations:
  - In bad weather
  - In bad road conditions
  - When the steering wheel needs to be controlled by the driver frequently.
- The steering wheel may feel heavier when the steering wheel is assisted by the system than when it is not.

#### \* NOTICE

- Even though the steering is assisted by the system, the driver may control the steering.
- The steering wheel may feel heavier when the steering wheel is assisted by the system than when it is not.

#### ***Keep hands on steering wheel (When LKA is activated)***

If the driver takes hands off the steering wheel for several seconds while LKA is activated, the system will warn the driver.



#### ⚠ WARNING

- The warning message may appear late according to road conditions. Therefore, always have your hands on the steering wheel while driving.
- If you hold the steering wheel lightly, the system would generate hands off warning because LKA can treat the situation as you not grabbing the wheel.

#### **The system will be canceled when:**

- You change lanes with the turn signal.
  - Using the turn signal to change lanes.
  - If you change lanes without the turn signal on, the steering wheel might be controlled.
- LKA can transit to steering assist mode when the car is near to middle of the lane after system on or the lane was changed. LKA cannot assist steering if the vehi-

cle follows lane marker too closely.

- The control of ESC (Electronic Stability Control) or VSM (Vehicle Stability Management) is activated.
- The steering will not be assisted when you drive fast on a sharp curve.
- The steering will not be assisted when vehicle speed is below 40 mph (64 km/h). and over 110 mph (177 km/h). Always obey all traffic laws and drive safely.
- The steering will not be assisted when you change lanes quickly.
- The steering will not be assisted when you brake suddenly.
- The steering will not be assisted when the lane is very wide or narrow.
- The steering will not be assisted when only one side lane marker is detected.
- There are more than two lane markers such as a construction area.
- Radius of a curve is too small.
- When you turn the steering wheel suddenly, LKA will be disabled temporarily.
- Driving on a steep slope or hill.

### Driver's Attention

The driver must be cautious in the following situations because the

system is limited when recognition of the lane marker is poor or limited:

- When lane and road condition is poor
  - It is difficult to distinguish the lane marker from road when the lane marker is covered with dust or sand.
  - It is difficult to distinguish the color of the lane marker from road.
  - There is something that looks like a lane marker.
  - The lane marker is indistinct or damaged.
  - The number of lanes increases/ decreases or the lane lines are crossing (Driving through a toll plaza / toll gate, merged/ divided lane).
  - There are more than two lane markers.
  - The lane marker is very thick or thin.
  - The lane marker is not visible due to snow, rain, stain, a puddle or other factors.
  - A shadow is on the lane marker because of a median strip, guardrail, noise barriers or other objects.
  - When the lane markers are complicated or a structure substitutes for the lines such as a construction area.
  - There are crosswalk signs or other symbols on the road.

- The lane suddenly disappears such as at the intersection.
- The lane marker in a tunnel is covered with dirt or oil and etc.
- When external conditions intervene
  - The brightness of outside changes suddenly when entering/exiting a tunnel or passing under a bridge.
  - The headlamps are not on at night or in a tunnel, or light level is low.
  - There is a boundary structure in the roadway.
  - The light reflects from the water on the road.
  - When light shines brightly from behind the vehicle.
  - The distance from the vehicle ahead is very short or the vehicle ahead covers up the lane line.
  - You drive on a steep grade or a sharp curve.
  - The vehicle vibrates heavily.
  - The temperature near the rearview mirror is very high due to direct sun light and etc.
- When front visibility is poor
  - The lens or windshield is covered by foreign materials.
  - The sensor cannot detect the lane because of fog, heavy rain or snow.
  - The windshield is fogged by humid air in the vehicle.

## ⚠ WARNING

Lane Keeping Assist system is a system designed to help prevent the driver from leaving the lane. However, the driver should not solely rely on the system but always take the necessary actions for safe driving practices.

### LKA malfunction

If there is a problem with the system a message will appear. If the problem continues LKA fail indicator will illuminate.



### LKA fail indicator

LKA fail indicator (yellow) will illuminate with an audible warning if LKA is not working properly. In this case, have the system checked by authorized Kia dealer.

When there is a problem with the system do one of the following:

- Turn the system on after turning the vehicle off and on again.



- Check if the ignition switch or START/STOP button is in the ON position.
- Check if the system is affected by the weather. (ex: fog, heavy rain, etc.)
- Check if there is foreign matter covering the camera lens

If the problem is not solved, take your vehicle to an authorized Kia dealer and have the system checked.

### LKA function change

The driver can change LKA to Lane Departure Warning or change LKA mode between Active LKA, LKA, LDW, OFF from the User Settings Mode on the LCD display.



### Active LKA

The active LKA mode provides more frequent steering wheel control in comparison with LKA mode. Active LKA can reduce the driver's fatigue to assist the steering for maintain-

ing the vehicle in the middle of the lane.

### LKA

LKA mode guides the driver to keep the vehicle within the lanes. It rarely controls the steering wheel, when the vehicle drives well inside the lanes. However, it starts to control the steering wheel, when the vehicle is about to deviate from the lanes.

### Lane Departure Warning

LDW alerts the driver with a visual and acoustic warning when the system detects the vehicle leaving the lane. In this mode, the steering wheel will not be controlled. When the vehicle's front wheel contacts the inside edge of lane line, LKA issues the lane departure warning.

### OFF

LKA/LDW function is OFF.

## Blind-Spot Collision Warning (BCW) (if equipped)

Blind-Spot Collision Warning system uses radar sensors in the rear bumper to monitor and warn the driver of an approaching vehicle in the driver's blind spot area.

The system monitors the rear area of the vehicle and provides information to the driver with an audible alert and a indicator on the outside rearview mirrors.

### 1. Blind-Spot Area



The blind spot detection range varies relative to vehicle speed. Note that if your vehicle is traveling much faster than the vehicles around you, the warning will not occur.

### 2. Closing at high speed



BCW will alert you when it detects a vehicle is approaching in an adjacent lane at a high rate of speed. If the driver activates the turn signal when the system detects an oncoming vehicle, the system sounds an audible alert.

## ⚠ WARNING

- Always be aware of road conditions while driving and be alert for unexpected situations even though Blind-Spot Collision Warning system is operating.
- Blind-Spot Collision Warning system is a supplemental systems to assist you. Do not entirely rely on the systems. Always pay attention, while driving, for your safety.
- Blind-Spot Collision Warning system is not a substitute for proper and safe driving. Always drive safely and use caution when changing lanes or backing up the vehicle.

Blind-Spot Collision Warning system may not detect every object alongside the vehicle.

### Setting and activating BCW

The driver can activate the system by placing the ignition switch or START/STOP button to the ON position and by selecting:

- Go to the 'User Settings in the cluster → Driver Assistance → Blind-Spot Safety'.
  - BCW turns on and is ready to be activated when 'Warning Only' is selected. Then, if a vehicle approaches the driver's blind spot area a warning sounds but braking is not applied.
  - The system is deactivated and the indicator on the Blind-Spot Safety button is turned off when 'Off' is selected.



- If you press the Blind-Spot Safety button while 'Warning Only' is selected the indicator on the but-

ton will turn off and the system will deactivate.

- If you press the Blind-Spot Safety button while the system is canceled the indicator on the button illuminates and the system activates. In this case, the system returns to the state before the vehicle was turned off. When the system is initially turned on and when the vehicle is turned off then on again while the system is in activation, the warning light will illuminate for 3 seconds on the outer side view mirror.
- If the vehicle is turned off then on again, the system maintains the last setting.

### Setting the warning volume of Blind-Spot Collision Warning

The driver can select the warning volume of Blind-Spot Collision Warning in the User Settings in the LCD display by selecting

- Go to the 'User Settings → Driver Assistance → Warning Volume → High/Medium/Low'.

For more details, refer to "LCD display" on page 4-53.

#### \* NOTICE

If you change the warning volume, the warning volume of other systems may change. Always be aware

before changing the warning volume.

## Operating Conditions

The system enters the ready status, when 'Active Assist' or 'Warning Only' is selected and the following conditions are satisfied:

### *Warning Only*

Blind-Spot Collision Warning system will activate when:

- The vehicle speed is approximately 20 mph (30 km/h).

## Blind-Spot Collision Warning alert

BCW is designed to alert the driver if a vehicle is detected by the radar.

### *First stage alert*



If a vehicle is detected within the boundary of the system, a warning light will illuminate on the outer side view mirror and the Head-Up Display (if equipped).

If the detected vehicle is no longer within the blind spot area, the warning will turn off according to the driving conditions of the vehicle.

### *Second stage alert*



A warning chime to alert the driver will activate when:

1. A vehicle has been detected in the blind spot area by the radar system AND.
2. The turn signal is applied (same side as where the vehicle is being detected).

When this alert is activated, the warning light on the outer side view mirror and the Head-Up Display (if equipped) will also blink. And a warning chime will sound.

If you turn off the turn signal indicator, the second stage alert will be deactivated.

If the detected vehicle is no longer within the blind spot area, the

warning will turn off according to the driving conditions of the vehicle.

**⚠ WARNING**

- The warning light on the outer side view mirror will illuminate whenever a vehicle is detected at the rear side by the system. To avoid accidents, do not focus only on the warning light and neglect to see the surrounding of the vehicle.
- Drive safely even though the vehicle is equipped with a Blind-Spot Collision Warning system. Do not solely rely on the system but check your surroundings before changing lanes or backing the vehicle up.
- The system may not alert the driver in some situations due to system limitations so always check your surroundings while driving.
- The driver should always use extreme caution while operating the vehicle, whether or not the warning light on the outer side view mirror illuminates or there is a warning alarm.

**⚠ CAUTION**

- Playing the vehicle audio system at high volume may prevent occupants from hearing Blind-Spot

Collision Warning system warning sounds.

- If any other warning sound such as seat belt warning chime is already generated, Blind-Spot Collision Warning system warning may not sound.

**BCW rear corner radar sensor**

BCW operates based on data collected by the rear corner radars.

Rear radar



The rear corner radars are located inside the rear bumper for detecting the side and rear areas. Always keep the rear bumper clean for proper operation of the system.

**⚠ CAUTION**

- The system may not work properly when the bumper has been damaged, or if the rear bumper has been replaced or repaired.
- The sensing range differs somewhat according to the width of

the road. When the road is narrow, the system may detect other vehicles in the next lane.

- The system may turn off due to interference by electromagnetic waves.
- Always keep the sensors clean.
- NEVER arbitrarily disassemble the sensor component or apply any impact on the sensor component.
- Be careful not to apply unnecessary force on the radar sensor or sensor cover. If the sensor is forcibly moved out of proper alignment, the system may not operate correctly. In this case, a warning message may not be displayed. Have the vehicle inspected by an authorized Kia dealer.
- Do not apply foreign objects such as a bumper sticker or a bumper guard near the radar sensor or apply paint to the sensor area. Doing so may adversely affect the performance of the sensor.

### Warning message

If a warning message related to BCW appears, take the appropriate measures as detailed below.

### ***Blind-Spot Collision Warning system disabled. Radar blocked***



This warning message may appear when:

- One or both of the sensors on the rear bumper is blocked by dirt or snow or a foreign object.
- Driving in rural areas where the sensor does not detect another vehicle for an extended period of time.
- When there is inclement weather such as heavy snow or rain.

If any of these conditions occur, the light on the Blind-Spot Safety button and the system will turn off automatically.

When BCW canceled warning message is displayed in the cluster check to make sure that the rear bumper is free from any dirt or snow in the areas where the sensor is located. Remove any dirt, snow, or foreign material that could interfere with the radar sensors.

After any dirt or debris is removed, the system should operate normally after about 10 minutes of driving the vehicle.

If the system still does not operate normally have your vehicle inspected by an authorized Kia dealer.

**\* NOTICE**

Turn off BCW and RCCW system when a trailer or carrier is installed.

- Press the Blind-Spot Safety button (the indicator on the switch will turn off)
- Deactivate RCCW system by deselecting 'User Settings → Driver Assistance → Blind-Spot Safety → Rear Cross-Traffic Collision Warning' (if equipped)

**Check Blind-Spot Collision Warning system**

Type A



Type B



If there is a problem with BCW system, a warning message will appear and the light on the switch will turn off. The system will turn off automatically. Have your vehicle inspected by an authorized Kia dealer.

**Limitations of BCW**

The driver must be cautious in the below situations, because the system may not detect other vehicles or objects in certain circumstances:

- When a trailer or carrier is installed.
- The vehicle driven in inclement weather such as heavy rain or snow.
- The sensor is covered with rain, snow, mud, etc.
- The rear bumper where the sensor is located is covered with a foreign object such as a bumper sticker, a bumper guard, a bike rack, etc.

- The rear bumper is damaged, or the sensor is out of the original default position.
- The vehicle height gets lower or higher due to heavy loading in a trunk, abnormal tire pressure, etc.
- When the temperature of the rear bumper is high.
- When the sensors are blocked by other vehicles, walls or parking-lot pillars.
- The vehicle is driven on a curved road.
- The vehicle is driven through a tollgate.
- The road pavement (or the peripheral ground) abnormally contains metallic components (i.e. possibly due to subway construction).
- There is a fixed object near the vehicle, such as a guardrail.
- While going down or up a steep road where the height of the lane is different.
- Driving on a narrow road where trees or grass or overgrown.
- Driving in rural areas where the sensor does not detect another vehicle or structure for an extended period of time.
- Driving on a wet road.
- Driving on a road where the guardrail or wall is in double structure.
- A big vehicle is near such as a bus or truck.
- When the other vehicle approaches very close.
- When the other vehicle passes at a very fast speed.
- While changing lanes.
- If the vehicle has started at the same time as the vehicle next to you and has accelerated.
- When the vehicle in the next lane moves two lanes away from you OR when the vehicle two lanes away moves to the next lane from you.
- A motorcycle or bicycle is near.
- A flat trailer is near.
- If there are small objects in the detecting area such as a shopping cart or a baby stroller.
- If there is a low height vehicle such as a sports car.
- The brake pedal is depressed.
- ESC (Electronic Stability Control) is activated.
- ESC (Electronic Stability Control) malfunctions.
- The tire pressure is low or a tire is damaged.
- The brake is reworked.
- The vehicle abruptly changes driving direction.
- The vehicle makes sharp lane changes.
- The vehicle sharply stops.
- Temperature is extremely low around the vehicle.
- The vehicle severely vibrates while driving over an uneven/bumpy road, or concrete patch.



- The vehicle drives on a slippery surface due to snow, water puddle, or ice.
- The Lane Keeping Assist (LKA) or Lane Departure Warning (LDW) do not operate normally. (if equipped)  
For more information refer to "Lane Keeping Assist (LKA) (if equipped)" on page 5-81.

***Driving on a curve***



BCW systems may not operate properly when driving on a curved road. In certain instances, the system may not detect the vehicle in the next lane.

Always pay attention to road and driving conditions, while driving.



BCW systems may not operate properly when driving on a curved road. In certain instances, the system may recognize a vehicle in the same lane.

Always pay attention to road and driving conditions, while driving.

***Driving where the road is merging/dividing***

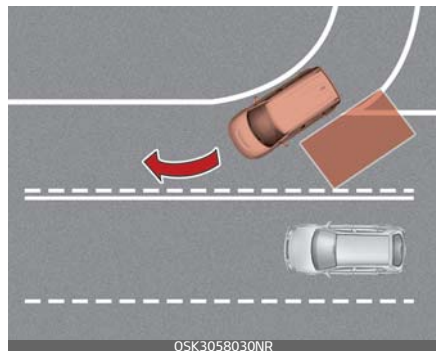

BCW systems may not operate properly when driving where the road is merging/dividing. In certain instances, the system may not detect the vehicle in the next lane.

Always pay attention to road and driving conditions, while driving.

***Driving on a slope***

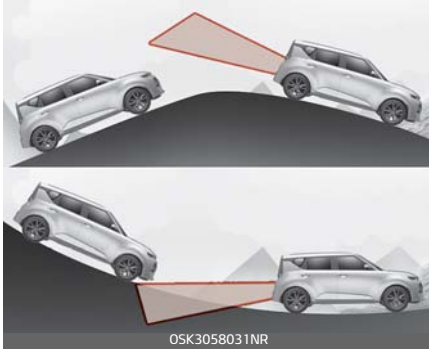

BCW systems may not operate properly when driving on a slope. In certain instances the system may not detect the vehicle in the next lane.

Also, in certain instances, the system may wrongly recognize the ground or structures.

Always pay attention to road and driving conditions, while driving.

***Driving where the heights of the lanes are different***

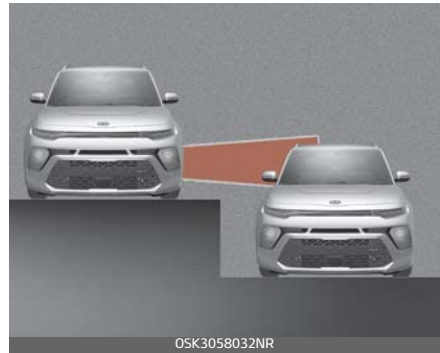

BCW systems may not operate properly when driving where the heights of the lanes are different.

In certain instances, the system may not detect the vehicle on a road with different lane heights (i.e. underpass joining section, grade separated intersections, etc.).

Always pay attention to road and driving conditions, while driving.

***Driving where there is a structure beside the road***



5

[A]: noise barrier, [B]: guardrail

BCW systems may not operate properly when driving where there is structure beside the road.

In certain instances, the system may wrongly recognize the structures (i.e. noise barriers, guardrail, double guardrail, median strip, bollard, street light, road sign, tunnel wall, etc.) beside the road.

Always pay attention to road and driving conditions, while driving.

**This device complies with Part 15 of the FCC rules.**

Operation is subject to the following two conditions:

1. This device may not cause harmful interference, and
2. This device must accept any interference received, including interference that may cause undesired operation.

**Driver Attention Warning (DAW) (if equipped)**

Driver Attention Warning system is designed to warn the driver of potentially hazardous driving situations if it detects inattentive driving practices.

**\* NOTICE**

Driver Attention Warning system does not detect actual driver fatigue or drowsiness. The system monitors driving and provides a warning if it detects inattentive driving practices.

**Setting and activating the DAW**

Driver Attention Warning system is in the Normal position, when your vehicle is first delivered to you from the factory.

To turn ON Driver Attention Warning system.

- Turn on the vehicle, and then select 'User Settings in the cluster → Driver Assistance → DAW (Driver Attention Warning) → High Sensitivity/Normal Sensitivity/Off on the LCD display.

The driver can select Driver Attention Warning system mode.

- High Sensitivity: Driver Attention Warning system alerts the driver of his/her fatigue level or inatten-

tive driving practices faster than Normal mode.

- Normal Sensitivity: Driver Attention Warning system alerts the driver of his/her fatigue level or inattentive driving practices.
- Off: Driver Attention Warning system is deactivated.

The set-up of Driver Attention Warning system will be applied when the vehicle is re-started.

### Displaying the driver's attention level

The driver can monitor his/her driving conditions on the LCD display.

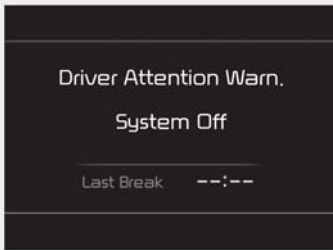

OSK3058106NR



OSK3058107NR



OSK3058085NR

- Select 'User Settings Mode' and then 'Driver Assistance' on the LCD display. (For more information, refer to "LCD display" on page 4-53.)

The driver's attention level is displayed on the scale of 1 to 5. The lower the number is, the more inattentive the driver is.

The number decreases when the driver does not take a break for a certain period of time.

The number increases when the driver attentively drives for a certain period of time.

When the driver turns on the system while driving, it displays 'Last Break time'.

### Taking a break

The "Consider taking a break" message appears on the LCD display and a warning sounds suggest that the driver take a break when the driver's attention level is below 1.



Driver Attention Warning system will not suggest a break, when the total driving time is shorter than 10 minutes.

**⚠ CAUTION**

When other warnings, such as the seat belt warning sound, are in operation, they override DAW alarming system and DAW warnings may not occur.

**Resetting Driver Attention Warning system**

The last break time is set to 00:00 and the driver's attention level is set to 5 (very attentive) when the driver resets Driver Attention Warning system.



Driver Attention Warning system resets in the following situations.

- The vehicle is turned OFF.
- The driver unfastens the seat belt and then opens the driver's door in stop.
- The vehicle is parked for more than 10 minutes.

The driver attention warning system operates again, when the driver restarts driving.

**DAW disabled**

Driver Attention Warning system enters the ready status and displays the 'Disabled' screen in the following situations.

- The front view camera sensor is unable to detect the lanes.
- Driving speed remains 110 mph (177 km/h) or under.

**DAW malfunction**

When the "Check System" warning message appears, the system is not working properly.

Type A

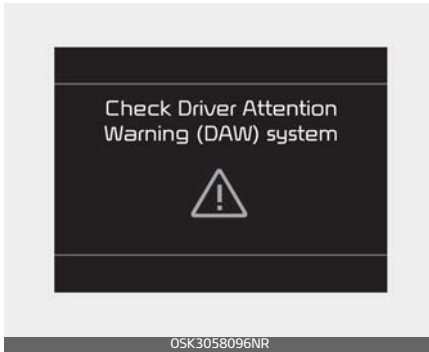

Type B

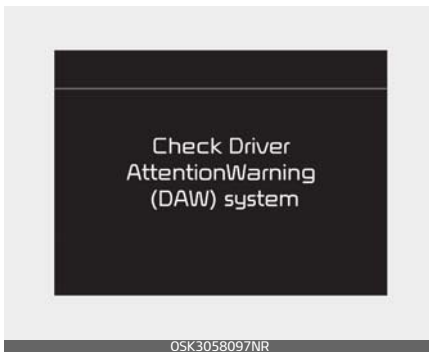

In this case, take your vehicle to an authorized Kia dealer and have the system checked.

### **⚠ WARNING**

- Driver Attention Warning system is not a substitute for safe driving practices. It is the responsibility of the driver to always drive cautiously to prevent unexpected and sudden situations from occurring. Pay attention to the road conditions at all times.

- It may suggest a break according to the driver's driving pattern or habits even if the driver doesn't feel fatigued.
- The driver, who feels fatigued, should take a break, even though there is no break suggestion by Driver Attention Warning system.

### **\* NOTICE**

Driver Attention Warning system utilizes the camera sensor on the front windshield for its operation. To keep the camera sensor in the best condition, you should observe the followings:

- Do not place any reflective objects (i.e. white paper, mirror) over the dashboard. Any light reflection may prevent Driver Attention Warning system from functioning properly.
- Pay extreme caution to keep the camera sensor dry.
- Do not arbitrarily disassemble the camera assembly, or apply any impact on the camera assembly.
- Playing the vehicle audio system at high volume may prevent occupants from hearing Driver Attention Warning system warning sounds.

**⚠ CAUTION**

Driver Attention Warning system may not provide alerts in the following situations:

- The lane detection performance is limited. (For more information, refer to "Lane Keeping Assist (LKA) (if equipped)" on page 5-81.)
- The vehicle is erratically driven or is abruptly turned for obstacle avoidance (e.g. construction area, other vehicles, fallen objects, bumpy road).
- Forward drivability of the vehicle is severely undermined (possibly due to wide variation in tire pressures, uneven tire wear-out, toe-in/toe-out alignment).
- The vehicle drives on a curvy road.
- The vehicle drives on a bumpy road.
- The vehicle drives through a windy area.
- The vehicle is controlled by the following driver assistance systems:
  - Forward Collision-Avoidance Assist system
  - Lane Keeping Assist system
  - Smart Cruise Control system

**Cruise Control (CC) (if equipped)**

Cruise Control system allows you to program the vehicle to maintain a constant speed without pressing the accelerator pedal.

This system is designed to function above approximately 20 mph (30 km/h).

- If Cruise Control is left on, (CRUISE indicator light in the instrument cluster illuminated) Cruise Control can be switched on accidentally. Keep Cruise Control system off (CRUISE indicator light OFF) when is not in use, to avoid inadvertently setting a speed.
- Use Cruise Control system only when traveling on open highways in good weather.
- Do not use Cruise Control when it may not be safe to keep the car at a constant speed, for instance, driving in heavy or varying traffic, or on slippery (rainy, icy or snow-covered) or winding roads or over 6% uphill or down-hill roads.
- Pay particular attention to the driving conditions whenever using Cruise Control system.

**⚠ CAUTION**

During cruise-speed driving of a manual transmission vehicle, do not shift into neutral without depressing the clutch pedal, since the engine will be overrevved. If this

happens, depress the clutch pedal or release the Cruise Control ON-OFF switch.

### \* NOTICE

During normal Cruise Control operation, when the SET switch is activated or reactivated after applying the brakes, Cruise Control will energize after approximately 3 seconds. This delay is normal.

### \* NOTICE

To activate Cruise Control, depress the brake pedal at least once after turning the ignition switch to the ON position or starting the engine.

### ▲ WARNING

#### Misuse of Cruise Control

Do not use Cruise Control if the traffic situation does not allow you to drive safely at a constant speed and with sufficient distance to the vehicle in front.

## Cruise Control switch



- CRUISE: Turns Cruise Control system on or off.
- RES+: Resumes or increases Cruise Control speed.
- SET-: Sets or decreases Cruise Control speed.
- CANCEL: Cancels Cruise Control operation.

5

## Setting Cruise Control speed



1. Press the CRUISE button on the steering wheel, to turn the system on. The cruise indicator light will illuminate.



2. Accelerate to the desired speed, which must be more than 20 mph (30 km/h).

**\* NOTICE**

**Manual transmission**

For manual transmission vehicles, you should depress the brake pedal at least once to set Cruise Control after starting the engine.



3. Push the SET- button, and release it at the desired speed. The cruise set indicator light will illuminate. Release the accelerator pedal at the same time. The desired speed will automatically be maintained.

On a steep grade, the vehicle may slow down or speed up slightly while going downhill.

**Increasing Cruise Control set speed:**



Follow either of these procedures:

- Push the RES+ button and hold it. Your vehicle will accelerate. Release the button at the speed you want.
- Push the RES+ button and release it immediately. The cruising speed will increase by 1.2 mph (2.0 km/h) each time you push the RES+ button in this manner.

**Decreasing the cruising speed**



Follow either of these procedures:

- Push the SET- button and hold it. Your vehicle will gradually slow

down. Release the button at the speed you want to maintain.

- Push the SET- button and release it immediately. The cruising speed will decrease by 1.2 mph (2.0 km/h) each time you push the SET- button in this manner.

### Accelerating temporarily with Cruise Control on

- If you want to speed up temporarily when Cruise Control is on, depress the accelerator pedal. Increased speed will not interfere with Cruise Control operation or change the set speed.
- To return to the set speed, take your foot off the accelerator pedal.

### Cancelling Cruise Control



Follow either of these procedures:

- Depress the brake pedal.
- Depress the clutch pedal if equipped with a manual transmission.
- Press the CANCEL button located on the steering wheel.

- Decrease the vehicle speed lower than the memory speed by 12 mph (20 km/h).
- Decrease the vehicle speed to less than approximately 20 mph (30 km/h).

Each of these actions will cancel Cruise Control operation (the cruise set indicator light will go off), but it will not turn the system off. If you wish to resume Cruise Control operation, push the RES+ button located on your steering wheel. You will return to your previously preset speed.

### Resuming cruising speed at more than approximately 20 mph (30 km/h)



If any method other than the CRUISE button was used to cancel cruising speed and the system is still activated, the most recent set speed will automatically resume when you push the RES+ button.

It will not resume, however, if the vehicle speed has dropped below approximately 20 mph (30 km/h).

### Turning Cruise Control off

Follow either of these procedures:

- Press the CRUISE button (the cruise indicator light will be turn off).
- Turn the ignition off.

Both of these actions cancel Cruise Control operation. If you want to resume Cruise Control operation, repeat the steps provided in "To set Cruise Control speed" on the previous page.

### Smart Cruise Control (SCC) (if equipped)

Smart Cruise Control system is designed to allow you to program the vehicle to maintain a constant speed and a predetermined distance to the vehicle ahead without depressing the accelerator or brake pedal.

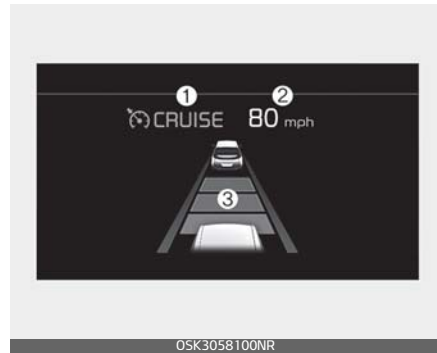

1. Cruise indicator
2. Set speed
3. Headway

#### **⚠ WARNING**

For your safety, please read the owner's manual before using Smart Cruise Control system.

#### **\* NOTICE**

To activate Smart Cruise Control, depress the brake pedal at least once after turning the ignition switch or START/STOP button to the ON position or starting the vehicle. This is to check if the brake switch

which is important part to cancel Smart Cruise Control is in normal condition.

### **⚠ WARNING**

#### **Smart Cruise Control system Limitations**

Smart Cruise Control system is a supplemental system and is not a substitute for safe driving practices. It is the responsibility of the driver to always check the speed and distance to the vehicle ahead.

### **\* NOTICE**

- If Smart Cruise Control is left on, (cruise indicator in the instrument cluster illuminated) Smart Cruise Control can be activated unintentionally. Keep Smart Cruise Control system off (cruise indicator off) when Smart Cruise Control is not being used.
- Use Smart Cruise Control system only when traveling on open highways in good weather.

### **⚠ WARNING**

- Do not use Smart Cruise Control when it may not be safe to keep the car at a constant speed. For instance.
  - Highway interchange and toll-gate

- Road surrounded by multiple steel constructions (subway construction, steel tunnel, etc)
- Parking lot
- Lanes beside guard rail on a road
- Slippery road with rain, ice, or snow
- Abrupt curved road
- Steep hills
- Windy roads
- Off roads
- Rods under construction
- Rumble strip
- When driving near crash barriers
- When driving on a sharp curve
- When the vehicle sensing ability decreases due to vehicle modification resulting level difference of the vehicle's front and rear
- When driving in heavy traffic or when traffic conditions make it difficult to drive at a constant speed
- Limited visibility (rain, snow, smog, etc.)
- Pay particular attention to the driving conditions whenever using Smart Cruise Control system.
- Be careful when driving downhill using SCC.
- Cruise function should not be used when the vehicle is being towed to prevent any damage.

- Always set the vehicle speed under the speed limit in your country.
- Always pay continuous attention to road and driving conditions even when Smart Cruise Control system is being operated.

### Smart Cruise Control High Sensitivity/Normal Sensitivity/Off

Smart Cruise Control High Sensitivity/Normal Sensitivity/Off has the following functions.



- CRUISE: Turns Smart Cruise Control system on or off.
- RES +: Resumes or increases Smart Cruise Control speed.
- SET -: Sets or decreases Smart Cruise Control speed.
- CANCEL: Cancels Smart Cruise Control operation.
- : Sets headway

### Setting Smart Cruise Control speed

1. Press the CRUISE button, to turn the system on. The CRUISE indicator in the instrument cluster will illuminate.



2. Accelerate to the desired speed. Smart Cruise Control speed can be set as follows:
  - 5 mph (10 km/h) ~ 100 mph (160 km/h)
3. Push the SET- button, and release it at the desired speed. The set speed and vehicle to vehicle distance on the LCD screen will illuminate.



4. Release the accelerator pedal.  
The desired speed will automatically be maintained.

**\* NOTICE**

If there is a vehicle in front of you, the speed may decrease to maintain the distance to the vehicle ahead. On a steep grade, the vehicle may slow down or speed up slightly while going uphill or downhill.

Vehicle speed may decrease on an upward slope and increase on a downward slope.

The speed will be set to 20 mph (30 km/h) when there is a vehicle ahead and your vehicle speed is 6 mph (10 km/h) ~ 20 mph (30 km/h).

- Release the lever at the speed you want.
- Push the RES+ button, and release it immediately. The cruising speed will increase by 1.0 mph (1.0 km/h) each time you Push the RES+ button in this manner.

You can set the speed to a maximum speed of 100 mph (160 km/h). However, all speed limit laws must be followed.

**⚠ CAUTION**

Check the traffic and driving conditions before using the button. Driving speed may sharply increase, when you push up and hold the toggle switch.

5

**Increasing Smart Cruise Control set speed**



- Follow either of these procedures:
- Push the RES+ button, and hold it. Your vehicle set speed will increase by 5 mph (10 km/h).

**Decreasing Smart Cruise Control set speed**



- Follow either of these procedures:
- Push the SET- button, and hold it. Your vehicle set speed will decrease by 5 mph (10 km/h).

Release the lever at the speed you want.

- Push the SET- button, and release it immediately. The cruising speed will decrease by 1.0 mph (1.0 km/h) each time you push the SET- button in this manner.

You can set the Cruise Control speed above 20 mph (30 km/h).

### Accelerating temporarily with Smart Cruise Control on

- If you want to speed up temporarily when Cruise Control is on, depress the accelerator pedal. Increased speed will not interfere with cruise control operation or change the set speed.
- To return to the set speed, take your foot off the accelerator.
- If you push the SET- button at increased speed, the cruising speed will be set again.

#### \* NOTICE

Be careful when accelerating temporarily, because the speed is not controlled automatically at this time even if there is a vehicle in front of you.

### Smart Cruise Control will be temporarily canceled when:

You are able to temporarily cancel Smart Cruise Control. In some cir-

cumstances, Smart Cruise Control will cancel automatically.

### Canceled manually

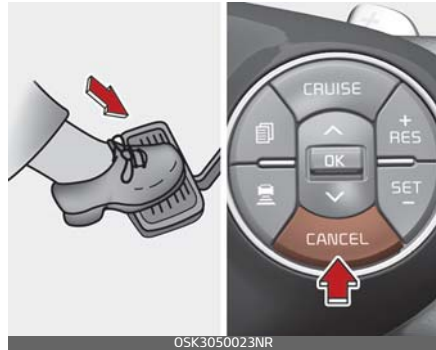

Smart Cruise Control is temporarily canceled when the brake pedal is depressed or the CANCEL button is pressed.

Depress the brake pedal and press the CANCEL button at the same time, when the vehicle is at a standstill. The speed and vehicle to vehicle distance indicator on the cluster is disappeared and the CRUISE indicator is illuminated continuously.

### Canceled automatically

Smart Cruise Control will automatically cancel in the following situations. (the set speed and vehicle to vehicle distance on the LCD display will go off.)

- The driver's door is opened.
- The shift lever is shifted to N (Neutral), R (Reverse) or P (Parking).

- The EPB (electronic parking brake) is applied.
- The vehicle speed is over 110 mph (170 km/h).
- The ESC, ABS or TCS is operating.
- The ESC is turned off.
- The sensor or the cover is dirty or blocked with foreign matter.
- The driver starts driving by pushing the RES+/ SET- button or depressing the accelerator pedal, after stopping the vehicle with a vehicle stopped far away in front.
- The accelerator pedal is continuously depressed for long time.
- SCC system has malfunctioned.
- When the braking control is operated for Forward Collision-Avoidance Assist.
- The driver starts driving by pushing the RES+/ SET- button or depressing the accelerator pedal, after the vehicle is stopped by Smart Cruise Control system with no other vehicle ahead.
- When the parking brake is locked.

If Smart Cruise Control is canceled automatically, Smart Cruise Control will not resume even though the RES+ or SET- button is pushed.

### \* NOTICE

If Smart Cruise Control is canceled during a situation that is not described above, take your vehicle

to an authorized Kia dealer and have the system checked.

### \* NOTICE

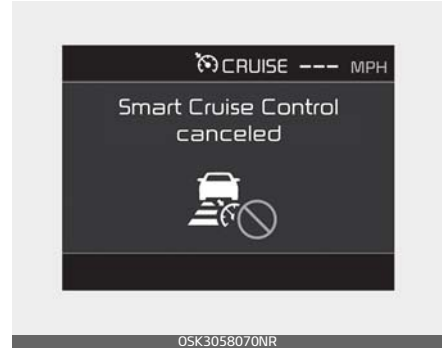

If the system is automatically canceled, the warning chime will sound and a message will appear for a few seconds.

You must adjust the vehicle speed by depressing the accelerator or brake pedal according to the road condition ahead and driving conditions.

Always check the road conditions. Do not rely on the warning chime.



### Resuming Smart Cruise Control set speed



- If any method other than the "RES+" or "SET-" button was used to cancel cruising speed and the system is still activated, the cruising speed will automatically resume when you push RES+ or SET- button.
- If you push the RES+ button, the speed will resume to the recently set speed. However, if vehicle speed drops 5 mph (10 km/h), it will not be resume.

### Turning Smart Cruise Control off



When Smart Cruise Control system is not needed, press the [CRUISE] switch and deactivate the system.

- Press the CRUISE button (The CRUISE indicator light will go off.).

### Setting headway

You can program the vehicle to maintain a predetermined distance to the vehicle ahead without depressing the accelerator pedal or brake pedal.



- The headway will automatically activate when Smart Cruise Control system is on.
- Select the appropriate distance according to road conditions and vehicle speed.
- Each time the button is pressed, the vehicle to vehicle distance changes as follows:

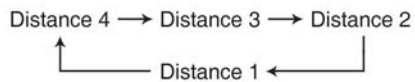

For example, if you drive at 56 mph (90 km/h), the distance maintain as follows;

- Distance 4 - approximately 172 ft (52.5 m)
- Distance 3 - approximately 131 ft (40 m)
- Distance 2 - approximately 107 ft (32.5 m)
- Distance 1 - approximately 82 ft (25 m)

- Always maintain sufficient braking distance and decelerate your vehicle by applying the brakes if necessary.

**\* NOTICE**

The distance is set to the last set distance when the system is used for the first time after starting the vehicle.

**When the lane ahead is clear:**



OSK3058105NR

The vehicle speed will maintain the set speed.

**⚠ WARNING**

**Following Distance**

- To avoid collisions, always be aware of the selected speed and vehicle to vehicle distance settings when activating your Smart Cruise Control system.

**When there is a vehicle ahead of you in your lane:**



OSK3058101NR



OSK3058102NR

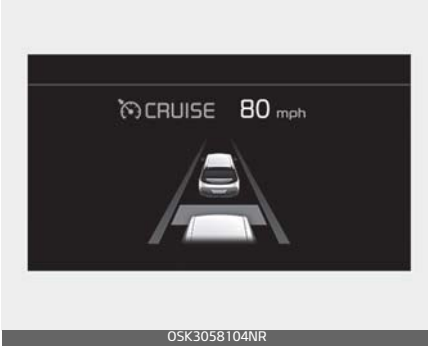

The vehicle will maintain the set speed, when the lane ahead is clear.

The vehicle will slow down or speed up to maintain the selected distance, when there is a vehicle ahead of you in the lane. (A vehicle will appear in front of your vehicle in the LCD display only when there is an actual vehicle in front of you)

If the vehicle ahead speeds up, your vehicle will travel at a steady cruising speed after accelerating to the selected speed.

**⚠ WARNING**



- The warning chime sounds and LCD display blinks if it is hard to maintain the selected distance to the vehicle ahead.
- If the warning chime sounds, actively adjust the vehicle speed by depressing the brake pedal according to the road and driving conditions.
- Even if the warning chime is not activated, always pay attention to the driving conditions to prevent dangerous situations from occurring.
- Be alert to road conditions as radio, loud sounds and outside conditions could prevent occupants from hearing a warning sound.



OSK3058071NR

If the vehicle ahead (vehicle speed: less than 20 mph (30 km/h)) moves to the next lane, the warning chime will sound and a message will appear. Adjust your vehicle speed for vehicles or objects that can suddenly appear in front of you by depressing the brake pedal according to the road and driving conditions.

### ***Radar to detect distance to the vehicle ahead***



OSK3058014NR

The sensor detects the distance to the vehicle ahead.

If the sensor is covered with dirt or other foreign matter, the vehicle to vehicle distance control may not operate correctly.

Always keep the area in front of the sensor clean.

### ***Warning message***

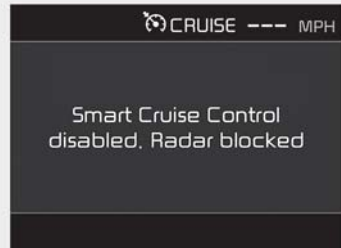

OSK3058072NR

When the sensor lens cover is blocked with dirt, snow, or debris, Smart Cruise Control system operation may stop temporarily. If this occurs, a warning message will appear on the LCD display. Remove any dirt, snow, or debris and clean the radar sensor lens cover before operating Smart Cruise Control system.

Smart Cruise Control system may not properly activate, if the radar is totally covered, or if any vehicles are not detected after turning ON the vehicle (e.g. in an open terrain).

### ***SCC (Smart Cruise Control) malfunction message***

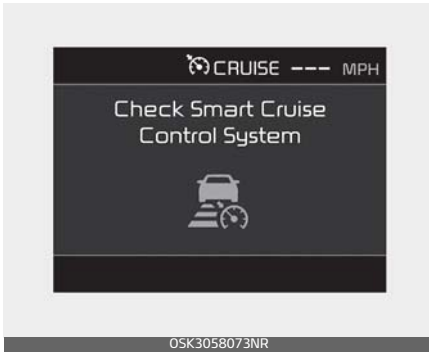

The message will appear when the vehicle to vehicle distance control system is not functioning normally.

In this case, take your vehicle to an authorized Kia dealer and have the system checked.

#### **CAUTION**

- Do not install accessories around the sensor and do not replace the bumper by yourself. It may interfere with the sensor performance.
- Always keep the sensor and bumper clean.
- Use only a soft cloth to wash the vehicle. Do not spray pressurized water directly on the sensor or sensor cover.
- Be careful not to apply unnecessary force on the radar sensor or sensor cover. If the sensor is forcibly moved out of proper alignment, Smart Cruise Control

system may not operate correctly. In this case, a warning message may not be displayed. Have the vehicle inspected by an authorized Kia dealer.

- Do not damage the sensor or sensor area by a strong impact. If the sensor moves slightly off position, Smart Cruise Control system will not operate correctly without any warning or indicator from the cluster. If this occurs, take your vehicle to an authorized Kia dealer and have the system checked.
- Use only a genuine Kia sensor cover for your vehicle. Do not paint anything on the sensor cover.
- If the front bumper becomes damaged in the area around the radar sensor, Smart Cruise Control system may not operate properly.

### **Adjusting the sensitivity of Smart Cruise Control**

The sensitivity of vehicle speed when following the front vehicle to maintain the set distance can be adjusted.

- Go to the 'User Settings in the cluster → Driver Assistance → SCC Reaction'.

You may select one of the three stages you prefer.

- Slow: Vehicle speed to the vehicle ahead to maintain the set distance is slower than normal speed.
- Normal: Vehicle speed to the vehicle ahead to maintain the set distance is normal
- Fast: Vehicle speed to the vehicle ahead to maintain the set distance is faster than normal speed.

**\* NOTICE**

The last selected mode remains in the system.

**Converting to Cruise Control mode**



The driver may choose to only use the Cruise Control mode (speed control function) by doing as follows:

1. Turn Smart Cruise Control system on (the cruise indicator light will be on but the system will not be activated).
2. Push the distance to distance switch for more than 2 seconds.
3. Choose between "Smart Cruise Control" and "Cruise Control".

When the system is canceled using the CRUISE button or the CRUISE button is used after the vehicle is turned on, the Smart Cruise Control mode will turn on.

**⚠ WARNING**

When using the Cruise Control mode, you must manually assess the distance to other vehicles as the system will not automatically brake to slow down for other vehicles.

**Limitations of the Smart Cruise Control**

Smart Cruise Control system may have limits to its ability to detect distance to the vehicle ahead due to road and traffic conditions.

***Driving on a curve***

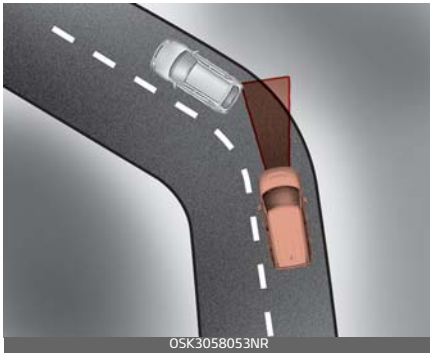

On curves, Smart Cruise Control system may not immediately detect a moving vehicle in your lane, and then your vehicle could accelerate to the set speed. Also, the vehicle speed will rapidly decrease when the vehicle ahead is recognized suddenly.

Select the appropriate set speed on curves and adjust your vehicle speed by depressing the accelerator or brake pedal according to the road and driving conditions ahead.



Your vehicle speed can be reduced due to a vehicle in the adjacent lane.

Adjust your vehicle speed by depressing the brake pedal according to the road and driving conditions ahead.

Adjust your speed by depressing the brake pedal or applying the accelerator pedal according to road and driving conditions ahead. Check to be sure that the road conditions permit safe operation of Smart Cruise Control.

***Driving on a slope***

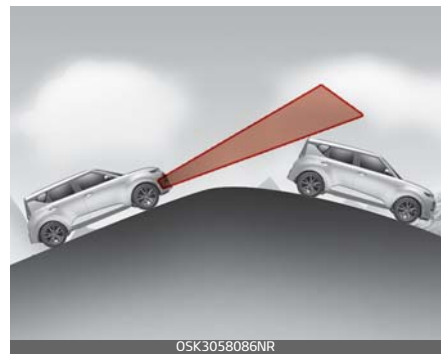

During uphill or downhill driving, Smart Cruise Control system may not immediately detect a moving vehicle in your lane, and may cause your vehicle to accelerate to the set speed.

Also, the vehicle speed will rapidly down when the vehicle ahead is recognized suddenly.

Select the appropriate set speed on inclines and adjust your vehicle speed by depressing the accelerator

or brake pedal according to the road and driving conditions ahead.

### ***Changing lanes***

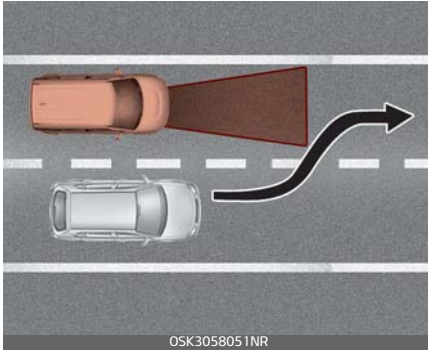

A vehicle which moves into your lane from an adjacent lane cannot be recognized by the sensor until it is in the sensor's detection range.

The sensor may not detect immediately when a vehicle cuts in suddenly. Always pay attention to the traffic, road and driving conditions.

If a vehicle which moves into your lane is slower than your vehicle, your speed may decrease to maintain the distance to the vehicle ahead.

If a vehicle which moves into your lane is faster than your vehicle, your vehicle will accelerate to the selected speed.

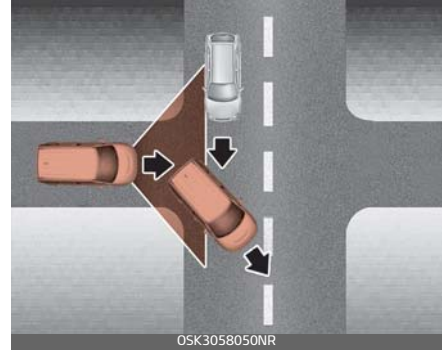

Your vehicle may accelerate when a vehicle ahead of you disappears.

When you are warned that the vehicle ahead of you is not detected, drive with caution.

### ***Recognizing the vehicle***

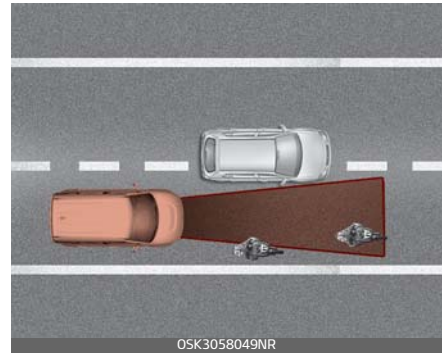

Some vehicles ahead in your lane cannot be recognized by the sensor as follows:

- Narrow vehicles such as motorcycles or bicycles
- Vehicles offset to one side
- Slow-moving vehicles or sudden-decelerating vehicles
- Stopped vehicles



- Vehicles with small rear profiles such as trailers with no loads

A vehicle ahead cannot be recognized correctly by the sensor if any of following occurs:

- When the vehicle is pointing upwards due to overloading in the trunk (liftgate)
- While making turns by steering
- When driving to one side of the lane
- When driving on narrow lanes or on curves

Adjust your vehicle speed by depressing the brake pedal according to the road and driving conditions ahead.



When vehicles are at a standstill and the vehicle in front of you changes to the next lane, be careful when your vehicle starts to move because it may not immediately recognize the stopped vehicle in front of you.

In this case, you must maintain a safe braking distance, and if necessary, depress the brake pedal to

reduce your driving speed in order to maintain a safe distance.

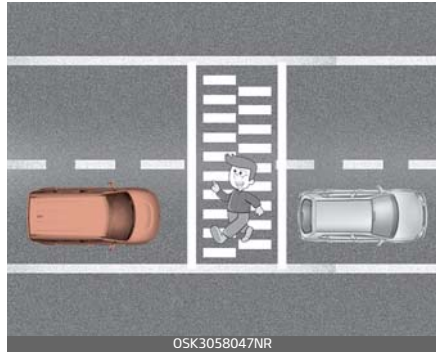

Always look out for pedestrians when your vehicle is maintaining a distance with the vehicle ahead.

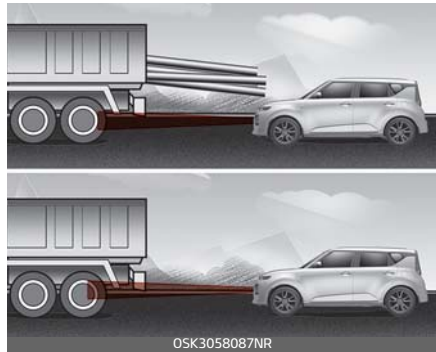

Always be cautious when approaching vehicles that are taller with higher clearance, or vehicles carrying loads that stick out of the back of the vehicle.

### **⚠ WARNING**

When using Smart Cruise Control take the following precautions:

- If an emergency stop is necessary, you must apply the brakes.

- Keep a safe distance according to road conditions and vehicle speed. If the vehicle to vehicle distance is too close during a high-speed driving, a serious collision may result.
- Always maintain sufficient braking distance and decelerate your vehicle by applying the brakes if necessary.
- Smart Cruise Control system cannot recognize a stopped vehicle, pedestrians or an oncoming vehicle.  
Always look ahead cautiously to prevent unexpected and sudden situations from occurring.
- Vehicles moving in front of you with a frequent lane change may cause a delay in the system's reaction or may cause the system to react to a vehicle actually in an adjacent lane.  
Always drive cautiously to prevent unexpected and sudden situations from occurring.
- Always be aware of the selected speed and vehicle to vehicle distance. The driver should not solely rely on the system but always pay attention to driving conditions and control your vehicle speed.
- Smart Cruise Control system may not recognize complex driving situations so always pay attention to driving conditions and control your vehicle speed.
- For safe operation, carefully read and follow the instructions in this manual before use.
- Do not use Smart Cruise Control system on steep inclines or when towing another vehicle or trailer since such extreme loading can interfere with your vehicle's ability to maintain the selected speed.

### \* NOTICE

Smart Cruise Control system may not operate temporarily due to:

- Electrical interference.
- A modified suspension.
- Differences of tire abrasion or tire pressure.
- Installing different type of tires.

### **This device complies with Part 15 of the FCC rules.**

Operation is subject to the following three conditions:

1. This device may not cause harmful interference, and
2. This device must accept any interference received, including interference that may cause undesired operation.
3. Changes or modifications not expressly approved by the party responsible for compliance could void the user's authority to operate the device.

**Radio frequency radiation exposure information:**

This equipment complies with FCC radiation exposure limits set forth for an uncontrolled environment.

This equipment should be installed and operated with minimum distance of 8 in (20 cm) between the radiator (antenna) and your body.

This transmitter must not be co-located or operating in conjunction with any other antenna or transmitter.

**Rear Cross-Traffic Collision Warning (RCCW) / Rear Cross-Traffic Collision-Avoidance Assist (RCCA)**

**Rear Cross-Traffic Collision Warning system**

Rear Cross-Traffic Collision Warning system uses radar sensors to monitor the approaching cross traffic from the left and right side of the vehicle when your vehicle is in reverse.

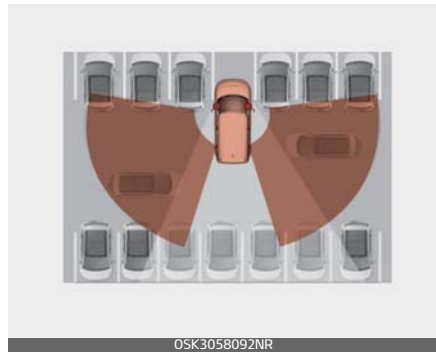

The blind spot detection range varies relative to the approaching vehicle speed.

**Rear Cross-Traffic Collision-Avoidance Assist system**

Rear Cross-Traffic Collision-Avoidance Assist system monitors approaching cross traffic from the left and right side of the vehicle when your vehicle is approaching.

Rear Cross-Traffic Collision-Avoidance Assist system may activate the Electronic Stability Control (ESC) in certain situations.

### **WARNING**

- Always be aware of road and traffic conditions while driving and be alert for unexpected situations even though Rear Cross-Traffic Collision Warning system and Rear Cross-Traffic Collision-Avoidance Assist system are operating.
- Rear Cross-Traffic Collision Warning system and Rear Cross-Traffic Collision-Avoidance Assist system are supplemental systems to assist you. Do not entirely rely on the systems. Always pay attention, while driving, for your safety.
- Rear Cross-Traffic Collision Warning system and Rear Cross-Traffic Collision-Avoidance Assist system are not substitutes for proper and safe driving. Always drive safely and use caution when backing up the vehicle.

### **Setting and activating RCCW/RCCA**

The driver can activate the systems by placing the ignition switch or START/STOP button to the ON position and by selecting:

- Go to the 'User Settings in the cluster → Driver Assistance → Blind-Spot Safety → Rear Cross-Traffic Safety'.

RCCA and RCCW is ready to be activated when 'Rear Cross-Traffic Safety' is selected.

When the vehicle is turned off then on again, the systems will be ready to be activated.

When the system is initially turned on and when the engine is turned off then on again, the warning light will illuminate for 3 seconds on the outer side view mirror.

### **Setting the initial warning activation time**

The driver can select the initial warning activation time in the User Settings in the LCD display by selecting:

- 'User Settings in the cluster → Driver Assistance → Warning Timing'.

The options for the initial Rear Cross-Traffic Collision Warning includes the following:

- Normal: When this option is selected, the initial Rear Cross-Traffic Collision Warning is activated normally. If this setting feels sensitive, change the option to 'Late'.

- Late: Select this warning activation time when the traffic is light and you are driving in a low speed.

**\* NOTICE**

If you change the warning timing, the warning time of other systems may change. Always be aware before changing the warning timing.

**Setting the warning volume of Rear Cross-Traffic Collision Warning**

The driver can select the warning volume of Rear Cross-Traffic Collision Warning by selecting:

- Go to the 'User Settings → Driver Assistance → Warning Volume → High/Medium/Low'.

**\* NOTICE**

If you change the warning volume, the warning volume of other systems may change. Always be aware before changing the warning volume.

For more details, refer to "LCD display" on page 4-53.

**Operating conditions**

The system will activate when vehicle speed is below 7 mph (10 km/h) and with the shift lever in R (Reverse).

- \* The system will not activate when the vehicle speed exceeds 7 mph (10 km/h). The system will activate again when the speed is below 5 mph (8 km/h).

The system's detecting range is approximately 1~82 ft (0.5~25 m). An approaching vehicle will be detected if the vehicle speed is within 5~26.5 mph (8~43 km/h).

Note that the detecting range may vary under certain conditions. As always, use caution and pay close attention to your surroundings when backing up your vehicle.

**Rear Cross-Traffic Collision Warning alert**

If the vehicle detected by the sensors approaches from the rear left/right side of your vehicle, the warning chime will sound, the warning light on the outer side view mirror will blink and a message will appear on the LCD display.

Left



OSK3058093NR

Left



Right



Right



If the rear view monitor system is in activation, a message will also

appear on the instrument cluster or multimedia screen.

The warning will stop when:

- the detected vehicle moves out of the sensing area or
- when the vehicle is right behind your vehicle or
- when the vehicle is not approaching your vehicle or
- when the other vehicle slows down.

### Rear Cross-Traffic Collision-Avoidance Assist alert

If the risk of collision is detected while RCCW is generated, brake control may be activated. The instrument cluster will inform the driver of the brake control. If the rear view monitor system is in activation, a message will also appear on the instrument cluster or multimedia screen.

Left



Left



Right



Right



After brake control is activated, the driver must immediately depress

the brake pedal and check the surroundings.

- The brake activation by the system lasts for about 2 seconds. The driver must pay attention as the brake is disengaged after 2 seconds.
- The brake control by the system is canceled if the driver depresses the brake pedal with sufficient power.
- Brake control is activated once for each right/left approach after shifting the shift lever to R (Reverse).

The brake control may not operate properly according to the status of the ESC (Electronic Stability Control). The same warning message is displayed on the instrument cluster when:

- The ESC (Electronic Stability Control) warning light is on.
- The ESC (Electronic Stability Control) is engaged in a different function.

**⚠ CAUTION**

- When the operation condition of Rear Cross-Traffic Collision Warning system is met, the warning will occur every time a vehicle approaches the side or rear of your stopped (0 mph (0 km/h) vehicle speed) vehicle.
- The system's warning or brake may not operate properly if the

## Driving your vehicle

left or right of your vehicle's rear bumper is blocked by a vehicle or obstacle.

- The driver should always use extreme caution while operating the vehicle, whether or not the warning light on the outer side view mirror illuminates or there is a warning alarm.
- Playing the vehicle audio system at high volume may prevent occupants from hearing the system's warning sounds.
- If any other warning sound, such as seat belt warning chime, is already generated, Rear Cross-Traffic Collision Warning system warning may not sound.

### **⚠ WARNING**

- Drive safely even though the vehicle is equipped with Rear Cross-Traffic Collision Warning system and Rear Cross-Traffic Collision-Avoidance Assist system. Do not solely rely on the system but check your surrounding when backing the vehicle up.
- The driver is responsible for accurate brake control.
- Always pay extreme caution while driving. Rear Cross-Traffic Collision Warning system and Rear Cross-Traffic Collision-Avoidance Assist system may not operate properly or unnecessarily operate

## Rear Cross-Traffic Collision Warning (RCCW) / Rear Cross-Traffic Collision-Avoidance Assist (RCCA)

depending on traffic and driving conditions.

- Rear Cross-Traffic Collision-Avoidance Assist system is not a substitute for safe driving practices, but a convenience function only. It is the responsibility of the driver to always drive cautiously to prevent unexpected and sudden situations from occurring. Pay attention to the road conditions at all times.

### Detecting Sensor

The rear corner radars are located inside the rear bumper for detecting the side and rear areas. Always keep the rear bumper clean for proper operation of the system.



### **⚠ CAUTION**

- The system may not work properly when the bumper has been damaged, or if the rear bumper has been replaced or repaired.



- The system may turn off if interfered by electromagnetic waves.
- Always keep the sensors clean.
- NEVER arbitrarily disassemble the sensor component or apply any impact on the sensor component.
- Be careful not to apply unnecessary force on the radar sensor or sensor cover. If the sensor is forcibly moved out of proper alignment, the system may not operate correctly. In this case, a warning message may not be displayed. Have the vehicle inspected by an authorized Kia dealer.
- Do not apply foreign objects, such as a bumper sticker or a bumper guard, near the radar sensor or apply paint to the sensor area. Doing so may adversely affect the performance of the sensor.

### Warning message

If a warning message related to RCCW/RCCA appears, take appropriate measures as detailed below.

### ***Blind-Spot Collision Warning (BCW) system disabled. Radar blocked***



This warning message may appear when:

- One or both of the sensors on the rear bumper is covered by dirt or snow or a foreign object.
- Driving in rural areas where the sensor does not detect another vehicle for an extended period of time.
- When there is inclement weather such as heavy snow or rain.

If any of these conditions occur, the light on the Blind-Spot Safety button and the system will turn off automatically. When BCW canceled warning message is displayed in the cluster, check to make sure that the rear bumper is free from any dirt or snow in the areas where the sensor is located. Remove any dirt, snow, or foreign material that could interfere with the radar sensors.

After any dirt or debris is removed, the system should operate normally

## Driving your vehicle

after about 10 minutes of driving the vehicle.

If the system still does not operate normally have your vehicle inspected by an authorized Kia dealer.

### \* NOTICE

Turn off BCW and RCCW system when a trailer or carrier is installed.

- Press the Blind-Spot Safety button (the indicator on the switch will turn off)
- Deactivate RCCW system by deselecting 'User Settings → Driver Assistance → Blind-Spot Safety → Rear Cross-Traffic Collision Warning'

## ***Check Blind-Spot Collision Warning (BCW) system***

Type A



## **Rear Cross-Traffic Collision Warning (RCCW) / Rear Cross-Traffic Collision-Avoidance Assist (RCCA)**

Type B



If there is a problem with BCW system, a warning message will appear and the light on the switch will turn off. The system will turn off automatically. RCCW and RCCA will not operate also if BCW system turns off due to malfunction. Have your vehicle inspected by an authorized Kia dealer.

## **Limitations of the system**

The driver must be cautious in the below situations, because the system may not detect other vehicles or objects in certain circumstances.

- When a trailer or carrier is installed.
- The vehicle drives in inclement weather such as heavy rain or snow.
- The sensor is covered with rain, snow, mud, etc.
- The rear bumper where the sensor is located is covered with a foreign object such as a bumper

sticker, a bumper guard, a bike rack, etc.

- The rear bumper is damaged, or the sensor is out of the original default position.
- The vehicle height gets lower or higher due to heavy loading in a trunk, abnormal tire pressure, etc.
- When the temperature of the rear bumper is high.
- When the sensors are blocked by other vehicles, walls or parking-lot pillars.
- The vehicle drives on a curved road.
- The road pavement (or the peripheral ground) abnormally contains metallic components (i.e. possibly due to subway construction).
- There is a fixed object near the vehicle, such as a guardrail.
- While going down or up a steep road where the height of the lane is different.
- Driving on a narrow road where trees or grass or overgrown.
- Driving in rural areas where the sensor does not detect another vehicle for an extended period of time.
- Driving on a wet road.
- Driving on a road where the guardrail or wall is in double structure.
- A big vehicle is near such as a bus or truck.
- When the other vehicle approaches very close.
- When the other vehicle passes at a very fast speed.
- While changing lanes.
- If the vehicle has started at the same time as the vehicle next to you and has accelerated.
- When the vehicle in the next lane moves two lanes away from you OR when the vehicle two lanes away moves to the next lane from you.
- A motorcycle or bicycle is near.
- A flat trailer is near.
- If there are small objects in the detecting area such as a shopping cart or a baby stroller.
- If there is a low height vehicle such as a sports car.
- The brake pedal is depressed.
- ESC (Electronic Stability Control) is activated.
- ESC (Electronic Stability Control) malfunctions.
- The tire pressure is low or a tire is damaged.
- The brake is reworked.
- The vehicle sharply stops.
- Temperature is extremely low around the vehicle.
- The vehicle severely vibrates while driving over an uneven/ bumpy road, or concrete patch.
- The vehicle drives on a slippery surface due to snow, water puddle, or ice.

***Driving where there is a vehicle or structure near***

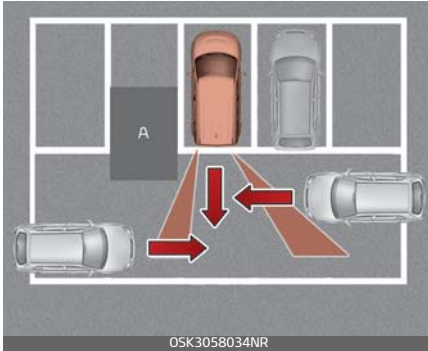

[A]: Structure

The system may not operate properly when driving where there is a vehicle or structure near.

In certain instances, the system may not detect the vehicle approaching from behind and the warning or brake may not operate properly.

Always pay attention to your surroundings while backing up.

***When the vehicle is in a complex parking environment***

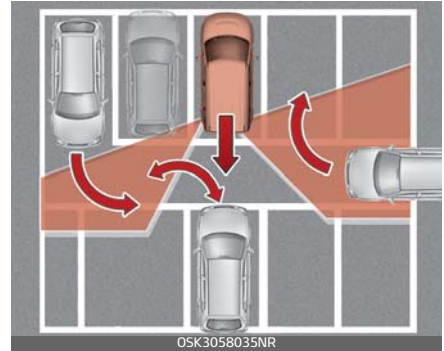

The system may not operate properly when the vehicle is in a complex parking environment.

In certain instances, the system may not be able to exactly determine the risk of collision for the vehicles which are parking or pulling out near your vehicle (e.g. a vehicle escaping beside your vehicle, a vehicle parking or pulling out in the rear area, a vehicle approaching your vehicle making a turn, etc.).

If this occurs, the warning or brake may not operate properly.

***When the vehicle is parked diagonally***

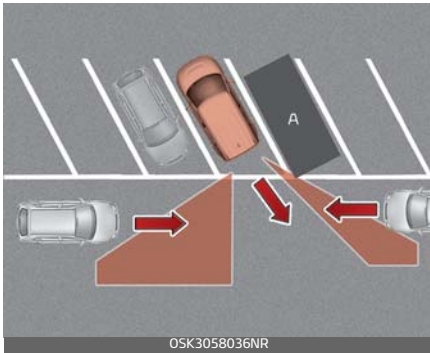

[A]: Vehicle

The system may not operate properly when the vehicle is parked diagonally.

In certain instances, when the diagonally parked vehicle is pulled out of the parking space, the system may not detect the vehicle approaching from the rear left/right of your vehicle. In this case, the warning or brake may not operate properly.

Always pay attention to your surroundings while backing up.

***When the vehicle is on/near a slope***

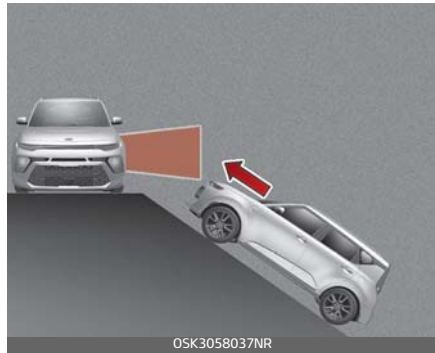

The system may not operate properly when the vehicle is on/near a slope.

In certain instances, the system may not detect the vehicle approaching from the rear left/right and the warning or brake may not operate properly.

Always pay attention to your surroundings while backing up.

***Pulling into the parking space where there is a structure***

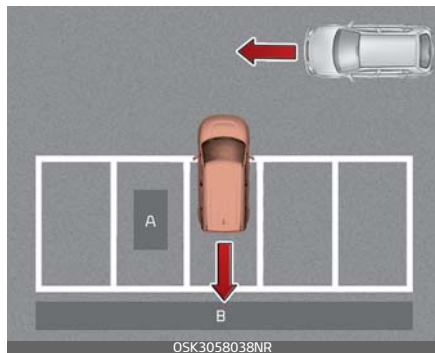

[A]: Structure, [B]: Wall

The system may not operate properly when pulling in the vehicle to the parking space where there is a structure at the back or side of your vehicle.

In certain instances, when backing into the parking space, the system may not detect the vehicle moving in front of your vehicle. In this case, the warning or brake may not operate properly.

Always pay attention to your surroundings while backing up.

***When the vehicle is parked rearward***



If the vehicle is parked rearward and the sensor detects the another vehicle in the rear area of the parking space, the system can warn or control braking.

Always pay attention to your surroundings while backing up.

**This device complies with Part 15 of the FCC rules.**

Operation is subject to the following two conditions:

1. This device may not cause harmful interference, and
2. This device must accept any interference received, including interference that may cause undesired operation.

## Economical operation

Your vehicle's fuel economy depends mainly on your style of driving, where you drive and when you drive.

Each of these factors affects how many miles (kilometers) you can get from a gallon (liter) of fuel. To operate your vehicle as economically as possible, use the following driving suggestions to help save money in both fuel and repairs:

- Drive smoothly. Accelerate at a moderate rate. Don't make "jack-rabbit" starts or full-throttle shifts and maintain a steady cruising speed. Don't race between stoplights. Try to adjust your speed to the traffic so you don't have to change speeds unnecessarily. Avoid heavy traffic whenever possible. Always maintain a safe distance from other vehicles so you can avoid unnecessary braking. This also reduces brake wear.
- Drive at a moderate speed. The faster you drive, the more fuel your vehicle uses. Driving at a moderate speed, especially on the highway, is one of the most effective ways to reduce fuel consumption.
- Don't "ride" the brake pedal. This can increase fuel consumption and also increase wear on these components. In addition, driving with your foot resting on the brake pedal may cause the brakes to overheat, which reduces their effectiveness and may lead to more serious consequences.
- Take care of your tires. Keep them inflated to the recommended pressure. Incorrect inflation, either too much or too little, results in unnecessary tire wear. Check the tire pressures at least once a month.
- Be sure that the wheels are aligned correctly. Improper alignment can result from hitting curbs or driving too fast over irregular surfaces. Poor alignment causes faster tire wear and may also result in other problems as well as greater fuel consumption.
- Keep your vehicle in good condition. For better fuel economy and reduced maintenance costs, maintain your vehicle in accordance with "Scheduled maintenance service" on page 7–8. If you drive your vehicle in severe conditions, more frequent maintenance is required (Refer to "Maintenance Under Severe Usage Conditions – Non Turbo Models" on page 7–11 for details).
- Keep your vehicle clean. For maximum service, your vehicle should be kept clean and free of corrosive materials. It is especially important that mud, dirt, ice, etc. not be allowed to accumulate on the underside of the vehicle. This

extra weight can result in increased fuel consumption and also contribute to corrosion.

- Travel lightly. Don't carry unnecessary weight in your vehicle. Weight reduces fuel economy.
- Don't let the engine idle longer than necessary. If you are waiting (and not in traffic), turn off your engine and restart only when you're ready to go.
- Remember, your vehicle does not require extended warm-up. After the engine has started, allow the engine to run for 10 to 20 seconds prior to placing the vehicle in gear. In very cold weather, however, give your engine a slightly longer warm-up period.
- Don't "lug" or "over-rev" the engine. Lugging is driving too slowly in a very high gear resulting in engine bucking. If this happens, shift to a lower gear. Over-revving is racing the engine beyond its safe limit. This can be avoided by shifting at the recommended speed.
- Use your air conditioning sparingly. The air conditioning system is operated by engine power so your fuel economy is reduced when you use it.
- Open windows at high speeds can reduce fuel economy.
- Fuel economy is less in crosswinds and headwinds. To help off-

set some of this loss, slow down when driving in these conditions.

Keeping a vehicle in good operating condition is important both for economy and safety. Therefore, have an authorized Kia dealer perform scheduled inspections and maintenance.

### **WARNING**

#### **Engine off during motion**

Never turn the engine off to coast down hills or anytime the vehicle is in motion. The power steering and power brakes will not function properly without the engine running. In addition, turning off the ignition while driving could engage the steering wheel lock resulting in loss of vehicle steering. Keep the engine on and downshift to an appropriate gear for engine braking effect.



## Special driving conditions special driving conditions

If driving conditions deteriorate due to poor weather or road conditions, you should pay even more attention than usual to your driving.

### Hazardous driving conditions

When hazardous driving conditions are encountered such as water, snow, ice, mud, sand, or similar hazards, follow these suggestions:

- Drive cautiously and allow extra distance for braking.
- Avoid sudden braking or steering.
- When braking with non-ABS brakes pump the brake pedal with a light up-and-down motion until the vehicle is stopped.
- Do not pump the brake pedal on a vehicle equipped with ABS.
- If stalled in snow, mud, or sand, use the second gear. Accelerate slowly to avoid spinning the drive wheels.
- Use sand, rock salt, or other non-slip material under the drive wheels to provide traction when stalled in ice, snow, or mud.

### Reducing the risk of a rollover

This multi-purpose passenger vehicle is defined as a Sports Utility Vehicle (SUV). Utility vehicles have a significantly higher rollover rate than other types of vehicles. SUV's

have higher ground clearance and a narrower track to make them capable of performing in a wide variety of offroad applications.

Specific design characteristics give them a higher center of gravity than ordinary vehicles. An advantage of the higher ground clearance is a better view of the road, which allows you to anticipate problems.

They are not designed for cornering at the same speeds as conventional passenger vehicles, any more than low-slung sports vehicles are designed to perform satisfactorily in off-road conditions. Due to this risk, driver and passengers are strongly recommended to buckle their seat belts.

In a rollover crash, an unbelted person is significantly more likely to die than a person wearing a seat belt. There are steps that a driver can make to reduce the risk of a rollover.

If at all possible, avoid sharp turns or abrupt maneuvers, do not load your roof rack with heavy cargo, and never modify your vehicle in any way.

## WARNING

### Rollover

As with other Sports Utility Vehicle (SUV), failure to operate this vehicle

correctly may result in loss of control, an accident or vehicle rollover.

- SUVs have a significantly higher rollover rate than other types of vehicles.
- Specific design characteristics (higher ground clearance, narrower track, etc.) give this vehicle a higher center of gravity than ordinary vehicles.
- A SUV is not designed for cornering at the same speeds as conventional vehicles.
- Avoid sharp turns or abrupt maneuvers.
- In a rollover crash, an unbelted person is significantly more likely to die than a person wearing a seat belt. Make sure everyone in the vehicle is properly buckled up.

### WARNING

Your vehicle is equipped with tires designed to provide safe riding and handling capability. Do not use a size and type of tire and wheel that is different from the one that is originally installed on your vehicle. It can affect the safety and performance of your vehicle, which could lead to steering failure or rollover and serious injury. When replacing the tires, be sure to equip all four tires with the tire and wheel of the same size, type, tread, brand and load-carrying capacity.

## Rocking the vehicle

If it is necessary to rock the vehicle to free it from snow, sand, or mud, first turn the steering wheel right and left to clear the area around your front wheels. Then, shift back and forth between R (Reverse) and any forward gear.

Do not race the vehicle, and spin the wheels as little as possible. If you are still stuck after a few tries, have the vehicle pulled out by a tow vehicle to avoid vehicle overheating and possible damage to the reduction gear.

### WARNING

#### Sudden Vehicle Movement

Do not attempt to rock the vehicle if people or objects are nearby. The vehicle may suddenly move forward or backwards as it becomes unstuck.

### CAUTION

#### Vehicle rocking

Prolonged rocking may cause vehicle overheating, reduction gear damage or failure, and tire damage.

### WARNING

#### Spinning tires

Do not spin the wheels, especially at speeds more than 35 mph (56 km/

h). Spinning the wheels at high speeds when the vehicle is stationary could cause tires to overheat, which could result in tire damage that may injure bystanders.

---

The ESC system should be turned OFF prior to rocking the vehicle.

### Smooth cornering

Avoid braking or gear changing in corners, especially when roads are wet. Ideally, corners should always be taken under gentle acceleration. If you follow these suggestions, tire wear will be held to a minimum.

### Driving at night

Because night driving presents more hazards than driving in the daylight, here are some important tips to remember:

- Slow down and keep more distance between you and other vehicles, as it may be more difficult to see at night, especially in areas where there may not be any street lights.
- Adjust your mirrors to reduce the glare from other driver's headlights.
- Keep your headlights clean and properly aimed. (On vehicles not equipped with the automatic headlight aiming feature.) Dirty or improperly aimed headlights will

make it much more difficult to see at night.

- Avoid staring directly at the headlights of oncoming vehicles. You could be temporarily blinded, and it will take several seconds for your eyes to readjust to the darkness.

### Driving in the rain

Rain and wet roads can make driving dangerous, especially if you're not prepared for the slick pavement.

Here are a few things to consider when driving in the rain:

- A heavy rainfall will make it harder to see and will increase the distance needed to stop your vehicle, so slow down.
- Keep your windshield wiping equipment in good shape. Replace your windshield wiper blades when they show signs of streaking or missing areas on the windshield.
- If your tires are not in good condition, making a quick stop on wet pavement can cause a skid and possibly lead to an accident. Be sure your tires are in good shape.
- Turn on your headlights to make it easier for others to see you.
- Driving too fast through large puddles can affect your brakes. If you must go through puddles, try to drive through them slowly.

- If you believe you may have gotten your brakes wet, apply them lightly while driving until normal braking operation returns.

### Driving in flooded areas

Avoid driving through flooded areas unless you are sure the water is no higher than the bottom of the wheel hub. Drive through any water slowly. Allow adequate stopping distance because brake performance may be affected.

After driving through water, dry the brakes by gently applying them several times while the vehicle is moving slowly.

### Driving off-road

Drive carefully off-road because your vehicle may be damaged by rocks or roots of trees. Become familiar with the off-road conditions where you are going to drive before you begin driving.

### Highway driving

#### Tires

Adjust the tire inflation pressures to specification. Low tire inflation pressures will result in overheating and possible failure of the tires.

Avoid using worn or damaged tires which may result in reduced traction or tire failure.

Never exceed the maximum tire inflation pressure shown on the tires.

### WARNING

#### Under/over inflated tires

Always check the tires for proper inflation before driving. Underinflated or overinflated tires can cause poor handling, loss of vehicle control, and sudden tire failure leading to accidents, injuries, and even death. For proper tire pressures, refer to "Tires and wheels" on page 8-5.

### WARNING

#### Tire tread

Always check the tire tread before driving your vehicle. Worn-out tires can result in loss of vehicle control. Worn-out tires should be replaced as soon as possible. For further information and tread limits, refer to "Tires and wheels" on page 7-34.

#### Fuel, engine coolant and engine oil

High speed travel consumes more fuel than urban motoring. Do not forget to check both the engine coolant and engine oil.

#### Drive belt

A loose or damaged drive belt may result in overheating of the engine.

## Winter driving

Severe weather conditions in the winter result in greater wear and other problems.

To minimize the problems of winter driving, you should follow these suggestions:

### Snowy or icy conditions

To drive your vehicle in deep snow, it may be necessary to use snow tires or to install tire chains on your tires.

If snow tires are needed, it is necessary to select tires equivalent in size and type of the original equipment tires. Failure to do so may adversely affect the safety and handling of your vehicle. Furthermore, speeding, rapid acceleration, sudden brake applications, and sharp turns are potentially very hazardous practices.

During deceleration, use vehicle braking to the fullest extent. Sudden brake applications on snowy or icy roads may cause skids to occur. You need to keep sufficient distance between the vehicle in operation in front of your vehicle. Also, apply the brake gently. It should be noted that installing tire chains on the tire will provide a greater driving force, but will not prevent side skids.

Tire chains are not legal in all states. Check state laws before fitting tire chains.

### Snow tires

If you mount snow tires on your vehicle, make sure they are radial tires of the same size and load range as the original tires. Mount snow tires on all four wheels to balance your vehicle's handling in all weather conditions. Keep in mind that the traction provided by snow tires on dry roads may not be as high as your vehicle's original equipment tires. You should drive cautiously even when the roads are clear. Check with the tire dealer for maximum speed recommendations.

Do not install studded tires without first checking local, state and municipal regulations for possible restrictions against their use.

## WARNING

### Snow tire size

Snow tires should be equivalent in size and type to the vehicle's standard tires. Otherwise, the safety and handling of your vehicle may be adversely affected.

---

### Tire chains

When using tire chains, install tire chains only on the front tires.



Since the sidewalls of radial tires are thinner, they can be damaged by mounting some types of snow chains on them. Therefore, the use of snow tires is recommended instead of snow chains. Do not mount tire chains on vehicles equipped with aluminum wheels; snow chains may cause damage to the wheels. If snow chains must be used, use wire-type chains with a thickness of less than 0.47 in (12 mm). Damage to your vehicle caused by improper snow chain use is not covered by your vehicle manufacturer's warranty.

Install tire chains only on the front tires.

Always check chain installation for proper mounting after driving approximately 0.3 to 0.6 miles (0.5 to 1 km) to ensure safe mounting. Retighten or remount the chains if they are loose.

### Chain installation

When installing chains, follow the manufacturer's instructions and mount them as tightly possible. Make sure the snow chains are SAE class "S" certified. Drive slowly (less than 20 mph (30 km/h) with chains installed. If you hear the chains contacting the body or chassis, stop and tighten them. If they still make contact, slow down until it stops. Remove the chains as soon as you begin driving on cleared roads. When mounting snow chains, park the vehicle on level ground away from traffic. Turn on the vehicle Hazard Warning flashers and place a triangular emergency warning device behind the vehicle if available. Always place the vehicle in P (Park), apply the parking brake and turn off the vehicle before installing snow chains.

- The use of chains may adversely affect vehicle handling.
- Do not exceed 20 mph (30 km/h) or the chain manufacturer's recommended speed limit, whichever is lower.
- Drive carefully and avoid bumps, holes, sharp turns, and other road hazards, which may cause the vehicle to bounce.
- Avoid sharp turns or locked-wheel braking.

### **⚠ CAUTION**

#### **Snow chains**

- Chains that are the wrong size or improperly installed can damage your vehicle's brake lines, suspension, body and wheels.
- Stop driving and retighten the chains any time you hear them hitting the vehicle.

---

### **Use high quality ethylene glycol coolant**

Your vehicle is delivered with high quality ethylene glycol coolant in the cooling system. It is the only type of coolant that should be used because it helps prevent corrosion in the cooling system, lubricates the water pump and prevents freezing. Be sure to replace or replenish your coolant refer to "Normal maintenance schedule - Non Turbo Models" on page 7-9. Before winter, have your coolant tested to assure that its freezing point is sufficient for the temperatures anticipated during the winter.

### **Check battery and cables**

Winter puts additional burdens on the battery system. Visually inspect the battery and cables (refer to "For best battery service" on page 7-31). The level of charge in your battery can be checked by an authorized Kia dealer or a service station.

### **Check spark plugs and ignition system**

Inspect your spark plugs as described in "Scheduled maintenance service" on page 7-8 and replace them if necessary. Also check all ignition wiring and components to be sure they are not cracked, worn or damaged in any way.

### **To keep locks from freezing**

To keep the locks from freezing, squirt an approved de-icer fluid or glycerine into the key opening. If a lock is covered with ice, squirt it with an approved de-icing fluid to remove the ice. If the lock is frozen internally, you may be able to thaw it out by using a heated key. Handle the heated key with care to avoid injury.

### **Use approved window washer anti-freeze in system**

To keep the water in the window washer system from freezing, add an approved window washer anti-freeze solution in accordance with instructions on the container. Window washer anti-freeze is available from an authorized Kia dealer and most auto parts outlets. Do not use vehicle coolant or other types of anti-freeze as these may damage the paint finish.

**Don't let your parking brake freeze**

Under some conditions your parking brake can freeze in the engaged position. This is most likely to happen when there is an accumulation of snow or ice around or near the rear brakes or if the brakes are wet. If there is a risk the parking brake may freeze, apply it only temporarily while you put the gear shift dial in P (Park) and block the rear wheels so the vehicle cannot roll. Then release the parking brake.

scraper, gloves, ground cloth, coveralls, blanket, etc.

**Don't let ice and snow accumulate underneath**

Under some conditions, snow and ice can build up under the fenders and interfere with the steering. When driving in severe winter conditions where this may happen, you should periodically check underneath the vehicle to be sure the movement of the front wheels and the steering components are not obstructed.

**Carry emergency equipment**

Depending on the severity of the weather, you should carry appropriate emergency equipment. Some of the items you may want to carry include tow straps or chains, flashlight, emergency flares, sand, shovel, jumper cables, window



## Trailer towing

We do not recommend using this vehicle for trailer towing.

## Vehicle load limit

The vehicle load limit is displayed on the tire and loading information label on the driver's door.

## Tire and loading information label

The label located on the driver's door sill gives the original tire size, cold tire pressures recommended for your vehicle, the number of people that can be in your vehicle and vehicle capacity weight.

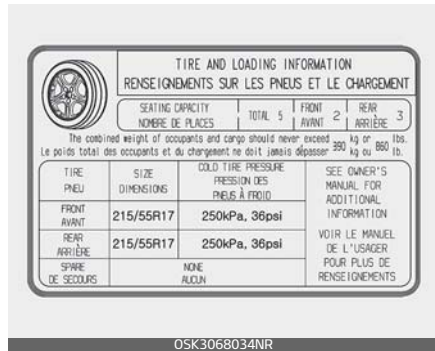

### Vehicle capacity weight:

860 lbs. (390 kg)

Vehicle capacity weight is the maximum combined weight of occupants and cargo. If your vehicle is equipped with a trailer, the combined weight includes the tongue load.

### Seating capacity:

Total: 5 persons (Front seat: 2 persons, Rear seat: 3 persons)

Seating capacity is the maximum number of occupants including a driver, your vehicle may carry.

However, the seating capacity may be reduced based upon the weight of all of the occupants, and the weight of the cargo being carried or towed.

Do not overload the vehicle as there is a limit to the total weight, or load limit including occupants and cargo, the vehicle can carry.

### Towing capacity:

**We do not recommend using this vehicle for trailer towing.**

### Cargo capacity:

The cargo capacity of your vehicle will increase or decrease depending on the weight and the number of occupants.

## Steps For Determining Correct Load Limit -

1. Locate the statement "The combined weight of occupants and cargo should never exceed XXX lbs. or XXX kg" on your vehicle's placard.
2. Determine the combined weight of the driver and passengers that will be riding in your vehicle.
3. Subtract the combined weight of the driver and passengers from XXX lbs. or XXX kg.
4. The resulting figure equals the available amount of cargo and luggage load capacity. For example, if the "XXX" amount equals 1400 lbs. (635 kg) and there will be five 150 lbs. (68 kg) passengers in your vehicle, the amount

of available cargo and luggage load capacity is 650 lbs. (295 kg).  
(1400-750 (5x150) = 650 lbs. or  
635-340 (5x68) = 295 kg)

5. Determine the combined weight of luggage and cargo being loaded on the vehicle. That weight may not safely exceed the available cargo and luggage load capacity calculated in Step 4.
6. If your vehicle will be towing a trailer, load from your trailer will be transferred to your vehicle. Consult this manual to determine how this reduces the available cargo and luggage load capacity of your vehicle.

## ⚠ WARNING

### Loose cargo

Do not travel with unsecured blunt objects in the passenger compartment of your vehicle (e.g. suit cases or unsecured child seats). These items may strike occupant during a sudden stop or crash.

Example 1

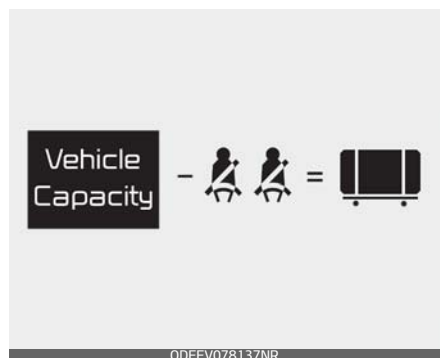

ODEEV078137NR

Item	Description	Total
A	Vehicle Capacity Weight	849 lbs. (385 kg)
B	Subtract Occupant Weight 150 lbs. (68 kg)×2	300 lbs. (136 kg)
C	Available Cargo and Luggage weight	549 lbs. (249 kg)

Example 2

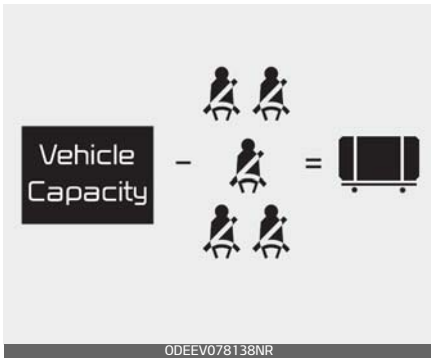

Item	Description	Total
A	Vehicle Capacity Weight	849 lbs. (385 kg)
B	Subtract Occupant Weight 150 lbs. (68 kg)×5	750 lbs. (340 kg)
C	Available Cargo and Luggage weight	99 lbs. (45 kg)

Example 3

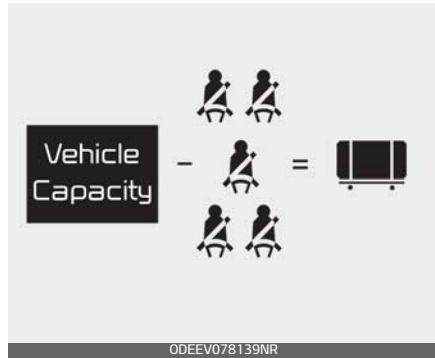

Item	Description	Total
A	Vehicle Capacity Weight	849 lbs. (385 kg)
B	Subtract Occupant Weight 161 lbs. (73 kg)×5	805 lbs. (365 kg)
C	Available Cargo and Luggage weight	44 lbs. (20 kg)

Refer to your vehicle's tire and loading information label for specific information about your vehicle's capacity weight and seating positions. The combined weight of the driver, passengers and cargo should never exceed your vehicle's capacity weight.

**Certification label**

The certification label is located on the driver's door sill at the center pillar.



This label shows the maximum allowable weight of the fully loaded vehicle. This is called the GVWR (Gross Vehicle Weight Rating). The GVWR includes the weight of the vehicle, all occupants and cargo.

This label also tells you the maximum weight that can be supported by the front and rear axles, called Gross Axle Weight Rating (GAWR).

To find out the actual loads on your front and rear axles, you need to go to a weigh station and weigh your vehicle. Your dealer can help you with this. Be sure to spread out your load equally on both sides of the centerline.

### **⚠ WARNING**

#### **Over loading**

Never exceed the GVWR for your vehicle, the GAWR for either the front or rear axle and vehicle capacity weight. Exceeding these ratings can affect your vehicle's handling and braking ability.

The label will help you decide how much cargo and installed equipment your vehicle can carry.

If you carry items inside your vehicle – like suitcases, tools, packages, or anything else – they are moving as fast as the vehicle. If you have to stop or turn quickly, or if there is a crash, the items will keep going and can cause an injury if they strike the driver or a passenger.

### **⚠ WARNING**

#### **Over loading**

Do not overload your vehicle. Overloading your vehicle can cause heat buildup in your vehicle's tires and possible tire failure, increased stopping distances and poor vehicle handling--all of which may result in a crash.

### **\* NOTICE**

Overloading your vehicle may cause damage. Repairs would not be covered by your warranty. Do not overload your vehicle.

## Vehicle weight

This chapter will guide you in the proper loading of your vehicle and/or trailer, to keep your loaded vehicle weight within its design rating capability, with or without a trailer.

Properly loading your vehicle will provide maximum return of the vehicle design performance. Before loading your vehicle, familiarize yourself with the following terms for determining your vehicle's weight ratings, with or without a trailer, from the vehicle's specifications and the compliance label:

**Base curb weight** This is the weight of the vehicle including a full tank of fuel and all standard equipment. It does not include passengers, cargo, or optional equipment.

**Vehicle curb weight** This is the weight of your new vehicle when you picked it up from your dealer plus any aftermarket equipment.

**Cargo weight** This figure includes all weight added to the Base Curb Weight, including cargo and optional equipment.

**GAW (Gross axle weight)** This is the total weight placed on each axle (front and rear) – including vehicle curb weight and all payload.

**GAWR (Gross axle weight rating)**  
This is the maximum allowable

weight that can be carried by a single axle (front or rear). These numbers are shown on the compliance label. The total load on each axle must never exceed its GAWR.

**GVW (Gross vehicle weight)** This is the Base Curb Weight plus actual Cargo Weight plus passengers.

**GVWR (Gross vehicle weight rating)**  
This is the maximum allowable weight of the fully loaded vehicle (including all options, equipment, passengers and cargo). The GVWR is shown on the certification label located on the driver's door sill.

<b>Road warning</b> .....	<b>6-3</b>
• Hazard warning flasher .....	6-3
<b>In case of an emergency while driving</b> .....	<b>6-4</b>
• If the Vehicle Stalls While Driving .....	6-4
• If the engine stalls at a crossroad or crossing .....	6-4
• If you have a flat tire while driving.....	6-4
<b>If the engine will not start</b> .....	<b>6-5</b>
• If engine doesn't turn over or turns over slowly .....	6-5
• If engine turns over normally but does not start.....	6-5
<b>Emergency starting</b> .....	<b>6-6</b>
• Jump starting.....	6-6
• Push-starting.....	6-7
<b>If the engine overheats</b> .....	<b>6-8</b>
<b>Tire Pressure Monitoring System (TPMS)</b> .....	<b>6-9</b>
• Effective Use of the Tire Pressure Monitoring System (TPMS).....	6-10
• Low tire pressure telltale .....	6-11
• Low tire pressure position telltale.....	6-11
• Tire Pressure Monitoring System (TPMS) malfunction indicator .....	6-12
• Tire replacement with TPMS.....	6-13
• This device complies with Part 15 of the FCC rules. ....	6-14
<b>If you have a flat tire</b> .....	<b>6-15</b>
• Jack and tools.....	6-15
• Removing and storing the spare tire .....	6-16
• Changing tires .....	6-16
• Important - use of compact spare tire .....	6-20
• Jack label.....	6-21

## 6 What to do in an emergency

### **Towing.....6-22**

- Towing without Wheel Dollies when using a Towing Service.  
6-24
- Using removable towing hook .....6-24
- Emergency towing .....6-25

## What to do in an emergency

### Road warning

When in an emergency situation occurs while driving or when you park by the edge of the roadway, you must alert approaching or passing vehicles to be careful as they pass. For this, you should use the hazard warning flasher.

### Hazard warning flasher

The hazard warning flasher serves as a warning to other drivers to exercise extreme caution when approaching, overtaking, or passing your vehicle.

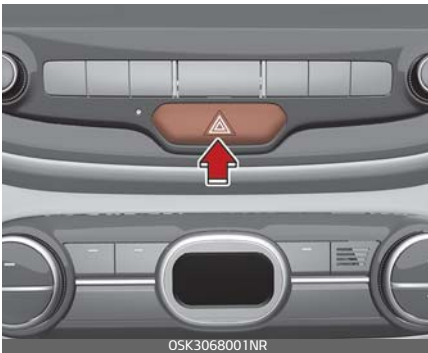

It should be used whenever emergency repairs are being made or when the vehicle is stopped near the edge of a roadway.

Depress the flasher switch with the ignition switch in any position. The flasher switch is located in the cen-

ter fascia panel. All turn signal lights will flash simultaneously.

- The hazard warning flasher operates whether your vehicle is running or not.
- The turn signals do not work when the hazard flasher is on.
- Care must be taken when using the hazard warning flasher while the vehicle is being towed.



## **In case of an emergency while driving**

If an emergency situation occurs while driving, stay calm and take the following steps.

### **If the Vehicle Stalls While Driving**

1. Reduce your speed gradually, keeping a straight line.
2. Move cautiously off the road to a safe place.
3. Turn on your hazard warning flasher.
4. Try to start the vehicle again. If your vehicle will not start, contact an authorized Kia dealer or seek other qualified assistance.

### **If the engine stalls at a crossroad or crossing**

- If the engine stalls at a crossroad or crossing, set the shift lever in the N (Neutral) position and then push the vehicle to a safe place.
- If your vehicle has a manual transmission not equipped with a ignition lock switch, the vehicle can move forward by shifting to the 2 (second) or 3 (third) gear and then turning the starter without depressing the clutch pedal.

### **If you have a flat tire while driving**

- Take your foot off the accelerator pedal and let the vehicle slow down while driving straight ahead. Do not apply the brakes immediately or attempt to pull off the road as this may cause a loss of control.
- When the vehicle has slowed to such a speed that it is safe to do so, brake carefully and pull off the road.
- Drive off the road as far as possible and park on firm level ground. If you are on a divided highway, do not park in the median area between the two traffic lanes.
- When the vehicle is stopped, turn on your emergency hazard flashers, set the parking brake and put the transmission in P (for Intelligent Variable Transmission) or in reverse (Manual Transmission).
- Have all passengers get out of the vehicle. Be sure they all get out on the side of the vehicle that is away from traffic.
- When changing a flat tire, follow the instruction provided later in this section.

## If the engine will not start

### If engine doesn't turn over or turns over slowly

1. If your vehicle has an Intelligent Variable Transmission, be sure the shift lever is in N (Neutral) or P (Park) and the emergency brake is set.
2. Check the battery connections to be sure they are clean and tight.
3. Turn on the interior light. If the light dims or goes out when you operate the starter, the battery is discharged.
4. Check the starter connections to be sure they are securely tightened.

Do not push or pull the vehicle to start it. This could cause damage to your vehicle. Refer to "Jump starting" on page 6-6.

### **WARNING**

#### **Push/pull start**

Do not push or pull the vehicle to start it. Push or pull starting may cause the catalytic converter to overload and create a fire hazard.

### If engine turns over normally but does not start

1. Check the fuel level.
2. With the ignition switch in the LOCK position, check all connectors at the ignition coils and spark plugs. Reconnect any that may be disconnected or loose.
3. Check the fuel line in the engine compartment.
4. If the engine still does not start, call an authorized Kia dealer or seek other qualified assistance.

## Emergency starting

When the vehicle will not start because of low battery power, you may need to jump start the vehicle.

### Jump starting

Connect cables in numerical order and disconnect in reverse order.

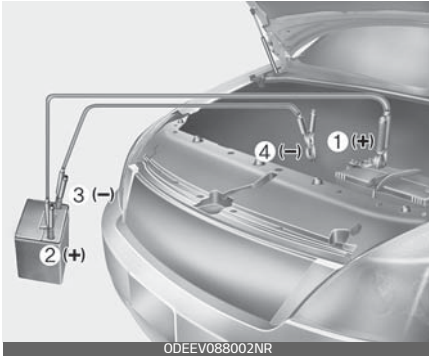

Jump starting can be dangerous if done incorrectly. Therefore, to avoid harm to yourself or damage to your vehicle or battery, follow these jump starting procedures. If in doubt, we strongly recommend that you have a competent technician or towing service jump start your vehicle.

### ⚠ WARNING

#### Battery

Never attempt to check the electrolyte level of the battery as this may cause the battery to rupture or explode.

### ⚠ WARNING

#### Frozen batteries

Do not attempt to jump start the vehicle if the discharged battery is frozen, as the battery may rupture or explode.

### ⚠ WARNING

#### Battery

Keep all flames or sparks away from the battery. The battery produces hydrogen gas which will explode if exposed to flame or sparks.

### ⚠ WARNING

#### Battery cables

Do not connect the jumper cable from the negative terminal of the booster battery to the negative terminal of the discharged battery, directly. This can cause the discharged battery to overheat crack, and degrade.

Make sure to connect one end of the jumper cable to the negative terminal of the booster battery, and the other end to a metallic point, far away from the battery.

**⚠ WARNING****Sulfuric acid risk**

Automobile batteries contain sulfuric acid. When jump starting your vehicle, be careful not to get sulfuric acid on yourself, your clothing, or on the vehicle. This acid is poisonous and highly corrosive.

***Jump-starting***

1. Make sure the booster battery is 12-volt and that its negative terminal is grounded.
2. If the booster battery is in another vehicle, do not allow the vehicles to come in contact.
3. Turn off all unnecessary electrical loads.
4. Connect the jumper cables in the exact sequence shown in the illustration. First connect one end of a jumper cable to the positive terminal of the discharged battery (1), then connect the other end to the positive terminal of the booster battery (2).

Proceed to connect one end of the other jumper cable to the negative terminal of the booster battery (3), then the other end to a solid, stationary, metallic point away from the battery (4).

Do not allow the jumper cables to contact anything except the correct battery terminals or the correct ground. Do not lean over the battery when making connections.

5. Start vehicle with the booster battery and let it run at 2,000 rpm, then start the vehicle with the discharged battery.

**If the cause of your battery discharging is not apparent, you should have your vehicle checked by an authorized Kia dealer.**

**\* NOTICE**

Make sure to connect one end of the jumper cable to the negative terminal of the booster battery, and the other end to a metallic point, far away from the battery.

**Push-starting**

Your Manual Transmission-equipped vehicle should not be push-started because it might damage the emission control system. Vehicles equipped with Dual Clutch Transmission/Intelligent Variable Transmission cannot be push-started. Follow the directions in this section for jump-starting.

**⚠ WARNING****Tow starting vehicle**

Never tow a vehicle to start it. When the engine starts, the vehicle can suddenly surge forward and could cause a collision with the tow vehicle.

## If the engine overheats

If your temperature gauge indicates overheating, you experience a loss of power, or hear loud pinging or knocking, the engine will probably be too hot.

If this happens, you should:

1. Pull off the road and stop as soon as it is safe to do so.
2. Place the shift lever in P (for Intelligent Variable Transmission) or in Neutral for (Manual Transmission) and set the parking brake.
3. If the air conditioning is on, turn it off.
4. If engine coolant is running out under the vehicle or steam is coming out from underneath the hood, stop the engine. Do not open the hood until the coolant has stopped running or the steaming has stopped.
5. If there is no visible loss of engine coolant and no steam, leave the engine running and check to be sure the engine cooling fan is operating.
  - 1) If the fan is not running, turn the engine off.
6. Check to see if the water pump drive belt is missing.
  - 1) If it is not missing, check to see that it is tight.
  - 2) If the drive belt seems to be satisfactory, check for coolant leaking from the radiator, hoses or under the vehicle. (If the air conditioning had been in use, it

is normal for cold water to be draining from it when you stop).

### WARNING

#### Under the hood



While the engine is running, keep hair, hands and clothing away from moving parts such as the fan and drive belts to prevent injury.

7. If the water pump drive belt is broken or engine coolant is leaking out, stop the engine immediately and call the nearest authorized Kia dealer for assistance.
8. If you cannot find the cause of the overheating, wait until the engine temperature has returned to normal. If coolant has been lost, carefully add coolant to the reservoir to bring the fluid level in the reservoir up to the halfway mark.
9. Proceed with caution, keeping alert for further signs of overheating. If overheating happens again, call an authorized Kia dealer for assistance.

### WARNING

#### Radiator cap



Do not remove the radiator cap when the engine is hot. This may result in coolant

being blown out of the opening and cause serious burns.

Serious loss of coolant indicates there is a leak in the cooling system and this should be checked as soon as possible by an authorized Kia dealer.

## Tire Pressure Monitoring System (TPMS)

The tire pressure monitoring system detects the pressure of vehicle's tires and displays it on the LCD display.



1. Low tire pressure telltale / TPMS malfunction indicator
2. Low tire pressure position telltale (Shown on the LCD display)

### Tire Pressure Indicator

- You can check the tire pressure in the assist mode on the cluster.
  - Refer to "User settings mode" on page 4-55.

- Tire pressure is displayed 1~2 minutes later after driving.
- If tire pressure is not displayed when the vehicle is stopped, "Drive to display" message displays. After driving, check the tire pressure.
- You can change the tire pressure unit in the user settings mode on the cluster.
  - psi, kPa, bar (Refer to "User settings mode" on page 4-55).

**\* NOTICE**

- The tire pressure may change due to factors such as parking condition, driving style, and altitude above sea level.
- The tire pressure shown on the dashboard may differ from the tire pressure measured by tire pressure gauge.

**Effective Use of the Tire Pressure Monitoring System (TPMS)**

Each tire, including the spare (if provided), should be checked monthly when cold and inflated to the inflation pressure recommended by the vehicle manufacturer on the vehicle placard or tire inflation pressure label.

(If your vehicle has tires of a different size than the size indicated on the vehicle placard or tire inflation pressure label, you should deter-

mine the proper tire inflation pressure for those tires.)

As an added safety feature, your vehicle has been equipped with a tire pressure monitoring system (TPMS) that illuminates a low tire pressure telltale when one or more of your tires is significantly under-inflated. Accordingly, when the low tire pressure telltale illuminates, you should stop and check your tires as soon as possible, and inflate them to the proper pressure. Driving on a significantly under-inflated tire causes the tire to overheat and can lead to tire failure. Under-inflation also reduces fuel efficiency and tire tread life, and may affect the vehicle's handling and stopping ability.

Please note that the TPMS is not a substitute for proper tire maintenance, and it is the driver's responsibility to maintain correct tire pressure, even if under-inflation has not reached the level to trigger illumination of the TPMS low tire pressure telltale.

Your vehicle has also been equipped with a TPMS malfunction indicator to indicate when the system is not operating properly. The TPMS malfunction indicator is combined with the low tire pressure telltale. When the system detects a malfunction, the telltale will flash for approximately one minute and then remain

continuously illuminated. This sequence will continue upon subsequent vehicle start-ups as long as the malfunction exists. When the malfunction indicator is illuminated, the system may not be able to detect or signal low tire pressure as intended. TPMS malfunctions may occur for a variety of reasons, including the installation of replacement or alternate tires or wheels on the vehicle that prevent the TPMS from functioning properly.

Always check the TPMS malfunction telltale after replacing one or more tires or wheels on your vehicle to ensure that the replacement or alternate tires and wheels allow the TPMS to continue to function properly.

**\* NOTICE**

If any of the below happens, have the system checked by an authorized Kia dealer.

1. The low tire pressure telltale / TPMS malfunction indicator does not illuminate for 3 seconds when the ignition switch is turned to the ON position or engine is running.
2. The TPMS malfunction indicator remains illuminated after blinking for approximately 1 minute.
3. The Low tire pressure position telltale remains illuminated.

**Low tire pressure telltale (!)**

**Low tire pressure position telltale**

When the tire pressure monitoring system warning indicators are illuminated, one or more of your tires is significantly under-inflated.



If the telltale illuminates, immediately reduce your speed, avoid hard cornering and anticipate increased stopping distances. You should stop and check your tires as soon as possible.

Inflate the tires to the proper pressure as indicated on the vehicle's placard or tire inflation pressure label located on the driver's side center pillar outer panel. If you cannot reach a service station or if the tire cannot hold the newly added air, replace the low pressure tire with the spare tire.

Then the TPMS malfunction indicator and the Low Tire Pressure telltale may turn on and illuminate



after restarting and about 20 minutes of continuous driving before you have the low pressure tire repaired and replaced on the vehicle.

In winter or cold weather, the low tire pressure telltale may be illuminated if the tire pressure was adjusted to the recommended tire inflation pressure in warm weather. It does not mean your TPMS is malfunctioning because the decreased temperature leads to a proportional lowering of tire pressure.

When you drive your vehicle from a warm area to a cold area or from a cold area to a warm area, or the outside temperature is greatly higher or lower, you should check the tire inflation pressure and adjust the tires to the recommended tire inflation pressure.

When filling tires with more air, conditions to turn off the low tire pressure telltale may not be met. This is because a tire inflator has a margin of error in performance. The low tire pressure telltale will be turned off if the tire pressure is above the recommended tire inflation pressure.

**⚠ WARNING**

**Low pressure damage**

Do not drive on low pressure tires. Significantly low tire pressure can

cause the tires to overheat and fail making the vehicle unstable resulting in increased braking distances and a loss of vehicle control.

**Tire Pressure Monitoring System (TPMS) malfunction indicator **

The low tire pressure telltale will illuminate after it blinks for approximately one minute when there is a problem with the Tire Pressure Monitoring System.

If the system is able to correctly detect an underinflation warning at the same time as system failure then it will illuminate both the TPMS malfunction and low tire pressure position telltales e.g. if Front Left sensor fails, the TPMS malfunction indicator illuminates, but if the Front Right, Rear Left, or Rear Right tire is under-inflated, the low tire pressure position telltales may illuminate together with the TPMS malfunction indicator.

Have the system checked by an authorized Kia dealer as soon as possible to determine the cause of the problem.

- The TPMS malfunction indicator may be illuminated if the vehicle is moving around electric power supply cables or radios transmitters such as at police stations, government and public offices,

broadcasting stations, military installations, airports, or transmitting towers, etc. This can interfere with normal operation of the Tire Pressure Monitoring System (TPMS).

- The TPMS malfunction indicator may be illuminated if snow chains are used or some separate electronic devices such as notebook computer, mobile charger, remote starter or navigation etc., are used in the vehicle. This can interfere with normal operation of the Tire Pressure Monitoring System (TPMS).

### Tire replacement with TPMS

If you have a flat tire, the Low Tire Pressure telltale will come on. Have the flat tire repaired by an authorized Kia dealer as soon as possible or replace the flat tire with the spare tire.

#### CAUTION

#### Repair Agents

Never use a puncture-repairing agent not approved by Kia to repair and/or inflate a low pressure tire. The sealant not approved by Kia may damage the tire pressure sensor.

Each wheel is equipped with a tire pressure sensor mounted inside the tire behind the valve stem. You

must use TPMS specific wheels. It is recommended that you always have your tires serviced by an authorized Kia dealer.

Even if you replace the low pressure tire with the spare tire, the Low Tire Pressure telltale will remain on until the low pressure tire is repaired and placed on the vehicle.

After you replace the low pressure tire with the spare tire, the TPMS malfunction indicator may illuminate after a few minutes because the TPMS sensor mounted on the spare wheel is not initiated.

Once the low pressure tire is inflated again to the recommended pressure and installed on the vehicle or the TPMS sensor mounted on the replaced spare wheel is initiated by an authorized Kia dealer, the TPMS malfunction indicator and the low tire pressure telltale will turn off within a few minutes of driving.

If the indicator has not disappeared after a few minutes of driving, please visit an authorized Kia dealer.

If an original mounted tire is replaced with the spare tire, the TPMS sensor on the replaced spare wheel should be initiated and the TPMS sensor on the original mounted wheel should be deactivated. If the TPMS sensor on the original mounted wheel located in

the spare tire carrier still activates, the tire pressure monitoring system may not operate properly. Have the tire with TPMS serviced or replaced by an authorized Kia dealer.

You may not be able to identify a low tire by simply looking at it. Always use a good quality tire pressure gauge to measure the tire's inflation pressure. Please note that a tire that is hot (from being driven) will have a higher pressure measurement than a tire that is cold (from sitting stationary for at least 3 hours and driven less than 1 mile (1.6 km) during that 3 hour period).

Allow the tire to cool before measuring the inflation pressure. Always be sure the tire is cold before inflating to the recommended pressure.

A cold tire means the vehicle has been sitting for 3 hours and driven for less than 1 mile (1.6 km) in that 3 hour period.

Never use tire sealant if your vehicle is equipped with a Tire Pressure Monitoring System. The liquid sealant can damage the tire pressure sensors.

- The TPMS cannot alert you to severe and sudden tire damage caused by external factors such as nails or road debris.
- If you feel any vehicle instability, immediately take your foot off the accelerator, apply the brakes

gradually and with light force, and slowly move to a safe position off the road.

**\* NOTICE**

**Protecting TPMS**

Tampering with, modifying, or disabling the Tire Pressure Monitoring System (TPMS) components may interfere with the system's ability to warn the driver of low tire pressure conditions and/or TPMS malfunctions. Tampering with, modifying, or disabling the Tire Pressure Monitoring System (TPMS) components may void the warranty for that portion of the vehicle.

**This device complies with Part 15 of the FCC rules.**

Operation is subject to the following two conditions:

1. This device may not cause harmful interference, and
2. This device must accept any interference received, including interference that may cause undesired operation.
3. Changes or modifications not expressly approved by the party responsible for compliance could void the user's authority to operate the device.

## If you have a flat tire

If you have a flat tire, you can change the flat tire to a spare tire using tools.

### Jack and tools (if equipped)

The jack and wheel lug nut wrench are stored in the luggage compartment.



Remove the panel indicated in the illustration.

1. Jack handle
2. Jack
3. Wheel lug nut wrench

### Jacking instructions

The jack is provided for emergency tire changing only.

Follow jacking instructions to reduce the possibility of personal injury.

## ⚠ WARNING

### Tire Jack

Do not place any portion of your body under a vehicle that is only

supported by a jack since the vehicle can easily roll off the jack. Use vehicle support stands.

## ⚠ WARNING

### Changing tires

Never attempt vehicle repairs in the traffic lanes of a public road or highway.

- Always move the vehicle completely off the road and onto the shoulder before trying to change a tire. The jack should be used on a firm level ground. If you cannot find a firm, level place off the road, call a towing service company for assistance.
- Be sure to use the correct front and rear jacking positions on the vehicle; never use the bumpers or any other part of the vehicle for jack support.
- Do not allow anyone to remain in the vehicle while it is on the jack.
- Make sure any children present are in a secure place away from the road and from the vehicle to be raised with the jack.

## ⚠ WARNING

### Running vehicle on jack

Do not start or run the engine of the vehicle while the vehicle is on the jack as this may cause the vehicle to fall off the jack.

To prevent the jack from "rattling" while the vehicle is in motion, store it properly.

### Removing and storing the spare tire (if equipped)



- Turn the tire hold-down wing bolt counterclockwise to remove.
- Store the tire in the reverse order of removal.
- To prevent the spare tire and tools from "rattling" while the vehicle is in motion, store them properly.

### **⚠ WARNING**

#### Touching surface of the luggage room floor

Do not touch the metal surface of the luggage room floor while the engine is operating or hot. Doing so could result in serious bodily injury. Turn the engine off and wait until it cools down or wear gloves to remove the spare tire from the luggage room.

### Changing tires (if equipped)

1. Park on a level surface and apply the parking brake firmly.
2. Place the transmission shift lever in P (Park) with intelligent variable transmission and R (Reverse) with manual transmission.
3. Activate the hazard warning flashers.

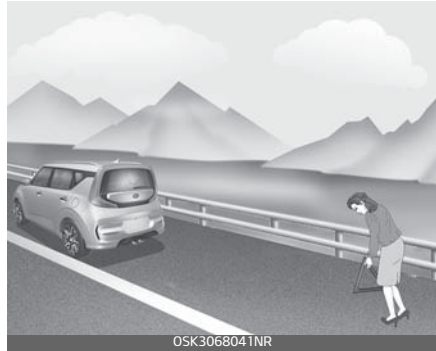

4. Remove the wheel lug nut wrench, jack and spare tire from the vehicle.



5. Block both the front and rear of the wheel that is diagonally opposite from the jack position.

**⚠ WARNING**

**Jack location**

To reduce the possibility of injury, be sure to use only the jack provided with the vehicle in the correct jack position; never use any other part of the vehicle for jack support.

**⚠ WARNING**

**Changing a tire**

- To prevent vehicle movement while changing a tire, always set the parking brake fully, and always block the wheel diagonally opposite the wheel being changed.
- We recommend that the wheels of the vehicle be blocked, and that no person remain in a vehicle that is being jacked.

6. Loosen the wheel lug nuts counterclockwise one turn each, but do not remove any nut until the tire has been raised off the ground.



7. Place the jack at the front (1) or rear (2) jacking position closest to the tire you are changing. Place the jack at the designated locations under the frame. The jacking positions are plates welded to the frame with two tabs and a raised dot to line up with the jack.

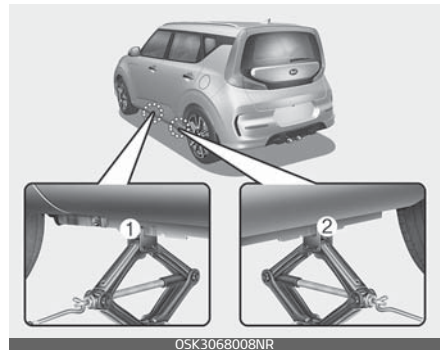
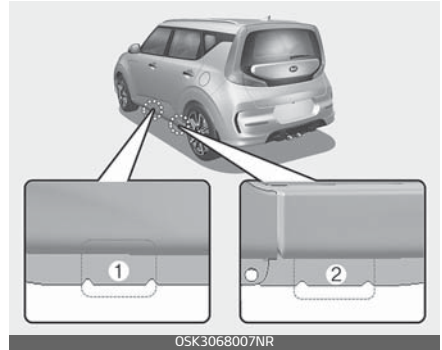

8. Insert the wheel lug nut wrench into the jack and turn it clockwise, raising the vehicle until the tire just clears the ground. This measurement is approximately 1 in (30 mm).



**⚠ WARNING**

**Installing a wheel**

Make sure the wheel makes good contact with the hub when installed. If the contact of the mounting surface between the wheel and hub is not good, the wheel nuts could come loose and cause the loss of a wheel. Loss of a wheel may result in loss of control of the vehicle.

- Before removing the wheel lug nuts, make sure the vehicle is stable and that there is no chance for movement or slippage.
9. Loosen the wheel nuts and remove them with your fingers.
  10. Slide the wheel off the studs and lay it flat so it cannot roll away.
  11. To put the wheel on the hub, pick up the spare tire, line up the holes with the studs and slide the wheel onto them. If this is difficult, tip the wheel slightly and get the top hole in the wheel lined up with the top stud.
  12. Jiggle the wheel back and forth until the wheel can slide over the other studs.  
Wheels may have sharp edges. Handle them carefully to avoid possible severe injury. Before putting the wheel into place, be sure that there is nothing on the hub or wheel (such as mud, tar, gravel, etc.) that prevents the wheel from fitting solidly against the hub.

13. To install the wheel, hold it on the studs, put the wheel nuts on the studs and tighten them finger tight.
14. Jiggle the tire to be sure it is completely seated, then tighten the nuts as much as possible with your fingers again.
15. Insert the wrench into the jack and lower the vehicle to the ground by turning the wheel nut wrench counterclockwise.
16. Position the wrench as shown in the drawing and tighten the wheel nuts. Be sure the socket is seated completely over the nut. Do not stand on the wrench handle or use an extension pipe over the wrench handle.
17. Go around the wheel, tightening every nut following the numerical sequence shown in the image until they are all tight. Double-check each nut for tightness.



OSK3068010NR

18. After changing wheels, have an authorized Kia dealer tighten the wheel nuts to their proper torque as soon as possible.
19. To prevent the jack, wheel lug nut wrench and spare tire from rattling while the vehicle is in motion, store them properly.
20. Check the inflation pressures as soon as possible after installing the spare tire. Adjust it to the specified pressure, if necessary. Refer to "Tires and wheels" on page 8-5.

### Wheel nut tightening torque:

79~94 lbf·ft (11~13 kgf·m)

If you have a tire gauge, remove the valve cap and check the air pressure. If the pressure is lower than recommended, drive slowly to the nearest service station and inflate to the correct pressure. If it is too high, adjust it until it is correct. Always reinstall the valve cap after checking or adjusting the tire pressure. If the cap is not replaced, dust and dirt may get into the tire valve and air

may leak from the tire. If you lose a valve cap, buy another and install it as soon as possible.

After you have changed the wheels, always secure the flat tire in its place and return the jack and tools to their proper storage locations.

### ⚠ CAUTION

#### Reusing lug nuts

Make certain during wheel removal that the same nuts that were removed are reinstalled - or, if replaced, that nuts with metric threads and the same chamfer configuration are used. Your vehicle has metric threads on the wheel studs and nuts. Installation of a non-metric thread nut on a metric stud will not secure the wheel to the hub properly and will damage the stud so that it must be replaced.

Note that most lug nuts do not have metric threads. Be sure to use extreme care in checking for thread style before installing aftermarket lug nuts or wheels. If in doubt, consult an authorized Kia dealer.

### ⚠ WARNING

#### Wheel studs

If the studs are damaged, they may lose their ability to retain the wheel. This could lead to the loss of the



wheel and a collision resulting in serious injuries.

---

### Important – use of compact spare tire

Your vehicle is equipped with a compact spare tire. This compact spare tire takes up less space than a regular-size tire. This tire is smaller than a conventional tire and is designed for temporary use only.

- You should drive carefully when the compact spare is in use. The compact spare should be replaced by the proper conventional tire and rim at the first opportunity.
- The operation of this vehicle is not recommended with more than one compact spare tire in use at the same time.

### WARNING

#### Spare tire

The compact spare tire is for emergency use only. Do not operate your vehicle on this compact spare at speeds over 50 mph (80 km/h). The original tire should be repaired or replaced as soon as possible to avoid failure of the spare possibly leading to bodily injury or death.

---

The compact spare should be inflated to 60 psi (420 kPa).

### \* NOTICE

Check the inflation pressure after installing the spare tire. Adjust it to the specified pressure, as necessary.

---

When using a compact spare tire, observe the following precautions:

- Under no circumstances should you exceed 50 mph (80 km/h); a higher speed could damage the tire.
- Ensure that you drive slowly enough for the road conditions to avoid all hazards. Any road hazard, such as a pothole or debris, could seriously damage the compact spare.
- Any continuous road use of this tire could result in tire failure, loss of vehicle control, and possible personal injury.
- Do not exceed the vehicle's maximum load rating or the load-carrying capacity shown on the sidewall of the compact spare tire.
- Avoid driving over obstacles. The compact spare tire diameter is smaller than the diameter of a conventional tire and reduces the ground clearance approximately 1 inch (25 mm), which could result in damage to the vehicle.
- Do not take this vehicle through an automatic vehicle wash while the compact spare tire is installed.

- Do not use tire chains on the compact spare tire. Because of the smaller size, a tire chain will not fit properly. This could damage the vehicle and result in loss of the chain.
- Do not use the compact spare tire on any other vehicle because this tire has been designed especially for your vehicle.
- The compact spare tire's tread life is shorter than a regular tire. Inspect your compact spare tire regularly and replace worn compact spare tires with the same size and design, mounted on the same wheel.
- The compact spare tire should not be used on any other wheels, nor should standard tires, snow tires, wheel covers or trim rings be used with the compact spare wheel. If such use is attempted, damage to these items or other vehicle components may occur.
- Do not use more than one compact spare tire at a time.
- Do not tow a trailer while the compact spare tire is installed.

Jack label

Type A

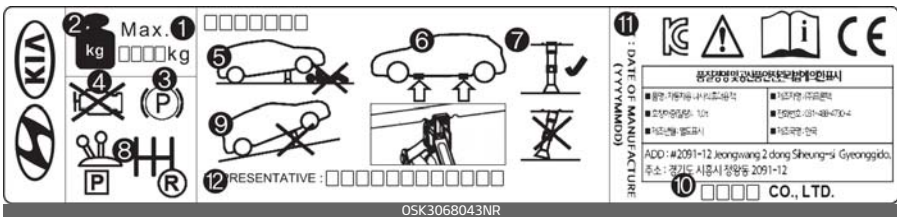

Type B

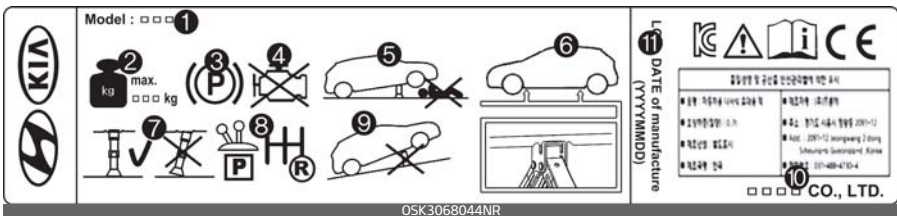

Type C



\* The actual Jack label in the vehicle may differ from the illustration. For more detailed specifications, refer to the label attached to the jack.

1. Model Name
2. Maximum allowable load
3. When using the jack, set your parking brake.
4. When using the jack, stop the engine.
5. Do not get under a vehicle that is supported by a jack.
6. The designated locations under the frame
7. When supporting the vehicle, the base plate of jack must be vertical under the lifting point.
8. Move the shift lever to the P position on vehicles with intelligent variable transmission.
9. The jack should be used on firm level ground.
10. Jack manufacturer
11. Production date
12. Representative company and address

**Towing**

If emergency towing is necessary, we recommend having it done by an authorized Kia dealer or a commercial tow-truck service.

**Towing service**

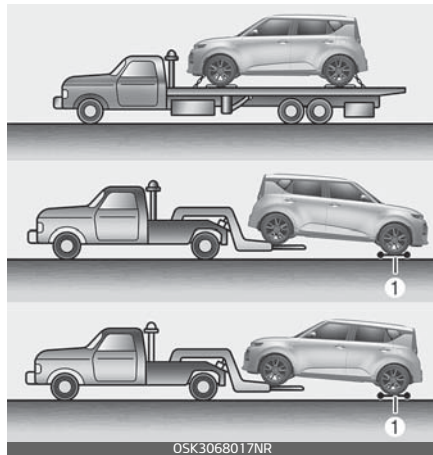

Proper lifting and towing procedures are necessary to prevent damage to the vehicle. The use of wheel dollies (1) or flatbed is recommended.

On FWD vehicles, it is acceptable to tow the vehicle with the rear wheel on the ground (without dollies) and the front wheels off the ground. If any of the loaded wheels or suspension components are damaged or the vehicle is being towed with the front wheels on the ground, use a towing dolly under the front wheels. When being towed by a commercial tow truck and wheel dollies are not used, the front of the vehicle should always be lifted, not the rear.

**⚠ WARNING**

**Side and curtain Air bag**

If your vehicle is equipped with side and curtain air bag, ignition switch to LOCK or ACC position when the vehicle is being towed.

The side and curtain air bag may deploy when the ignition switch is ON, and the rollover sensor detects the situation as a rollover.

**⚠ CAUTION**

**Towing**



- Do not tow the vehicle backwards with the front wheels on the ground as this may cause damage to the transmission.
- Do not tow with sling-type equipment. Use wheel lift or flatbed equipment.
- Do not tow the vehicle with four wheels in contact with the ground if it is the vehicle equipped with DCT or IVT. Otherwise, the transmission will be seriously damaged. Also, make sure not to tow the vehicle connecting it with other vehicles including camper vans.

**⚠ WARNING**

- If you tow the vehicle while the front wheels are touching the ground, the vehicle motor may generate electricity and the motor components may be damaged or a fire may occur.
- When a vehicle fire occurs due to the battery, there is a risk of a second fire. Contact the fire department when towing the vehicle.

### Dinghy towing



Your vehicle is not designed to be dinghy towed (with 4 wheels on the ground) behind a motor home. To avoid serious damage to your vehicle, do not tow your vehicle with four wheels on the ground.

### Towing without Wheel Dollies when using a Towing Service

When towing your vehicle in an emergency without wheel dollies:

1. Set the ignition switch in the ACC position
2. Place the transmission shift lever in N (Neutral).
3. Release the parking brake.

**CAUTION**

### Towing gear position

Failure to shift to N (Neutral) may cause internal damage to the vehicle.

### Using removable towing hook (if equipped)



Front



Rear



1. Open the liftgate, and remove the towing hook from the tool case.

2. Remove the hole cover pressing the lower part of the cover on the bumper.
3. Install the towing hook by turning it clockwise into the hole until it is fully secured.
4. Remove the towing hook and install the cover after use.

### Emergency towing

If towing service is not available in an emergency, your vehicle may be temporarily towed using a cable or chain secured to the emergency towing hook under the front (or rear) of the vehicle.

Front



Rear



**If towing is necessary, have it done by an authorized Kia dealer or a commercial tow truck service.**

Use extreme caution when towing the vehicle. A driver must be in the vehicle to steer it and operate the brakes.

Towing in this manner may be done only on hard-surfaced roads for a short distance and at low speed. Also, the wheels, axles, power train, steering and brakes must all be in good condition.

- Do not use the tow hooks to pull a vehicle out of mud, sand or other conditions from which the vehicle cannot be driven out under its own power.
- Avoid towing a vehicle heavier than the vehicle doing the towing.
- The drivers of both vehicles should communicate with each other frequently.

**CAUTION**

Using a portion of the vehicle other than the tow hooks for towing may damage the body of your vehicle.

- Accelerate or decelerate the vehicle in a slow and gradual manner while maintaining tension on the tow rope or chain to start or drive the vehicle, otherwise tow hooks and the vehicle may be damaged.
- Attach a towing strap to the tow hook.
- Use only a cable or chain specifically intended for use in towing vehicles. Securely fasten the cable or chain to the towing hook provided.
- Before emergency towing, check if the hook is not broken or damaged.
- Fasten the towing cable or chain securely to the hook.
- Do not jerk the hook. Apply it steadily and with even force.
- To avoid damaging the hook, do not pull from the side or at a vertical angle. Always pull straight ahead.
- Use a towing strap less than 16 feet (5 m) long. Attach a white or red cloth (about 12 inches (30 cm) wide) in the middle of the strap for easy visibility.

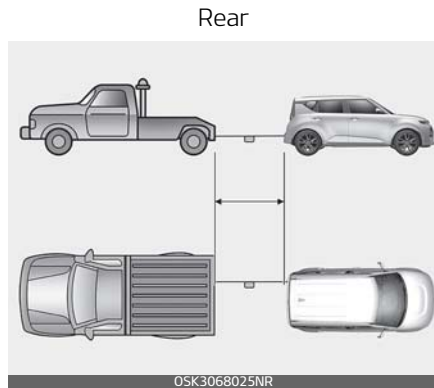
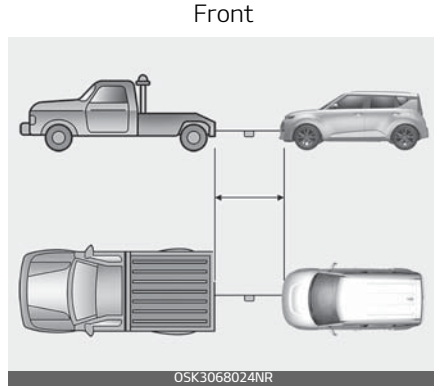

- Drive carefully so that the towing strap is not loosened during towing.
- The driver must be in the vehicle for steering and braking operations when the vehicle is towed and passengers other than the driver must not be allowed to be on board.

**WARNING**

**Emergency Towing Precautions**

Use extreme caution when towing the vehicle.

- Avoid sudden starts or erratic driving maneuvers which would place excessive stress on the emergency towing hook and towing cable or chain. The hook and towing cable or chain may break and cause serious injury or damage.
- If the disabled vehicle is unable to be moved, do not forcibly continue the towing. We recommend that you contact an authorized Kia dealer or a commercial tow truck service for assistance.
- Tow the vehicle as straight ahead as possible.
- Keep away from the vehicle during towing.

---

### ***Emergency towing precautions***

1. Turn the ignition switch to ACC so the steering wheel isn't locked.
2. Release the parking brake.
3. Press the brake pedal with more force than normal since you will have reduced brake performance.
4. More steering effort will be required because the power steering system will be disabled.
5. If you are driving down a long hill, the brakes may overheat and brake performance will be reduced. Stop often and let the brakes cool off.
6. If the car is being towed with all four wheels on the ground, it can be towed only from the front. Be

sure that the reduction gear is in neutral. Be sure the steering is unlocked by the ignition switch in the ACC position. A driver must be in the towed vehicle to operate the steering and brakes.

7. The vehicle should be towed at a speed of 16 mph (25 km/h) or less within the distance of 12.4 mile (20 km).

### **⚠ CAUTION**

#### **Dual clutch transmission**

- If the car is being towed with all four wheels on the ground, it can be towed only from the front. Be sure that the transmission is in neutral. Be sure the steering is unlocked by placing the ignition switch in the ACC position. A driver must be in the towed vehicle to operate the steering and brakes.
  - To avoid serious damage to the dual clutch transmission, limit the vehicle speed to 10 mph (15 km/h) and drive less than 1 mile (1.5 km) when towing.
  - Before towing, check the dual clutch transmission for fluid leaks under your vehicle. If the dual clutch transmission fluid is leaking, flatbed equipment or a towing dolly must be used.
-



**⚠ CAUTION****Intelligent Variable Transmission (IVT)**

Vehicles with Intelligent Variable Transmission (IVT) can only be towed to an ordinary vehicle when there is no IVT transmission oil leakage. If towing to an ordinary vehicle in the event of oil leakage, the transmission may be damaged. If towing to an ordinary vehicle in the event of oil leakage, the transmission may be damaged.

---

ment or a towing dolly must be used.

---

**⚠ CAUTION****Intelligent Variable Transmission**

- If the car is being towed with all four wheels on the ground, it can be towed only from the front. Be sure that the transmission is in neutral. Be sure the steering is unlocked by placing the ignition switch in the ACC position. A driver must be in the towed vehicle to operate the steering and brakes.
- To avoid serious damage to the Intelligent Variable Transmission limit the vehicle speed to 10 mph (15 km/h) and drive less than 1 mile (1.5 km) when towing.
- Before towing, check the Intelligent Variable Transmission for fluid leaks under your vehicle. If the Intelligent Variable Transmission fluid is leaking, flatbed equip-

<b>Engine compartment</b> .....	7-4
<b>Maintenance services</b> .....	7-5
<b>Owner maintenance</b> .....	7-7
<b>Scheduled maintenance service</b> .....	7-8
<b>Explanation of scheduled maintenance items</b> .....	7-15
<b>Engine oil and filter</b> .....	7-19
• Checking the engine oil level.....	7-19
<b>Engine coolant</b> .....	7-21
• Checking the coolant level.....	7-22
• Changing the coolant .....	7-23
<b>Brake fluid</b> .....	7-24
• Checking the brake fluid level.....	7-24
<b>Washer fluid</b> .....	7-25
• Checking the washer fluid level.....	7-25
<b>Parking brake</b> .....	7-26
• Checking the parking brake .....	7-26
<b>Air cleaner filter</b> .....	7-26
• Replacing air cleaner filter .....	7-26
<b>Climate control air filter</b> .....	7-27
• Inspecting and replacing climate control air filter .....	7-27
<b>Wiper blades</b> .....	7-29
• Replacing front windshield wiper blade.....	7-29
• Replacing rear window wiper blade.....	7-30
<b>Battery</b> .....	7-31
<b>Tires and wheels</b> .....	7-34
• Checking tire inflation pressure .....	7-35

# 7 Maintenance

• Tire rotation .....	7-36
• Wheel alignment and tire balance .....	7-36
• Tire replacement .....	7-37
• Wheel replacement .....	7-37
• Tire traction.....	7-38
• Tire maintenance.....	7-38
• Tire sidewall labeling .....	7-38
• Tire terminology and definitions .....	7-41
• All season tires .....	7-44
• Summer tires .....	7-44
• Snow tires .....	7-44
• Tire chains.....	7-45
• Radial-ply tires.....	7-45
• Low aspect ratio tire.....	7-46
<b>Fuses .....</b>	<b>7-47</b>
• Replacing inner panel fuse .....	7-49
• Replacing engine compartment fuse .....	7-50
• Fuse/relay panel description .....	7-52
<b>Light bulbs.....</b>	<b>7-62</b>
• Headlamp bulb .....	7-65
• Replacing Headlamp (High/Low beam) bulb (Headlamp Type A,B) .....	7-66
• Replacing Position lamp/DRL/Front turn signal lamp bulb (Type A, B).....	7-66
• Position lamp / Day time running lamp (LED type) replacement (Headlamp Type B) .....	7-67
• Replacing Headlamp (LED type) (Headlamp Type C) .....	7-67
• Replacing front fog lamp bulb .....	7-67
• Replacing side repeater lamp (LED type) bulb .....	7-68

- Replacing stop/tail and turn signal lamp (bulb type) bulb (Rear combination lamp Type A) ..... 7-68
- Replacing tail/back-up lamp bulb (Rear combination lamp Type A) ..... 7-69
- Replacing stop and tail lamp (LED type) bulb (Rear combination lamp Type B) ..... 7-70
- Replacing high mounted stop lamp (LED type) bulb ..... 7-70
- Replacing high mounted stop lamp (bulb type) bulb ..... 7-70
- Replacing license plate lamp bulb ..... 7-71
- Replacing map lamp (bulb type) bulb ..... 7-72
- Replacing map lamp (LED type) bulb ..... 7-72
- Replacing vanity mirror lamp bulb ..... 7-72
- Replacing room lamp (bulb type) bulb ..... 7-73
- Replacing room lamp (LED type) bulb ..... 7-74
- Replacing glove box lamp ..... 7-74
- Replacing liftgate room lamp bulb ..... 7-74
- Appearance care ..... 7-75**
  - Exterior care ..... 7-75
  - Interior care ..... 7-81
- Emission control system ..... 7-83**
- California perchlorate notice ..... 7-86**

# Maintenance

## Engine compartment

Gasoline Engine (Gamma 1.6 T-GDI)

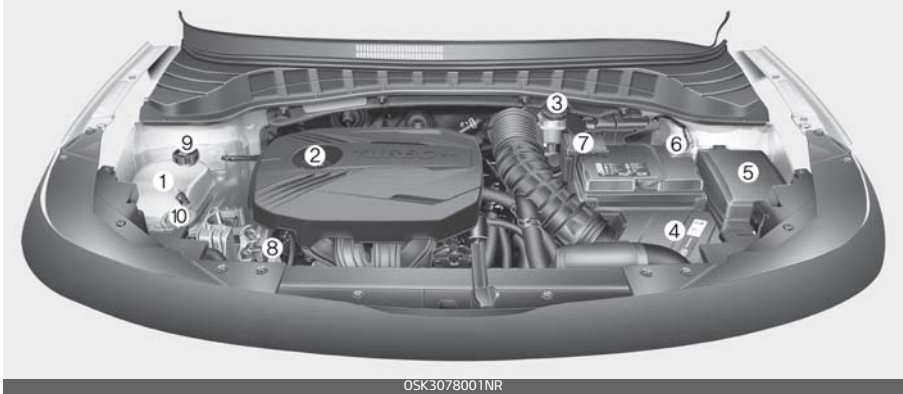

OSK3078001NR

Gasoline Engine (Nu 2.0L MPI)

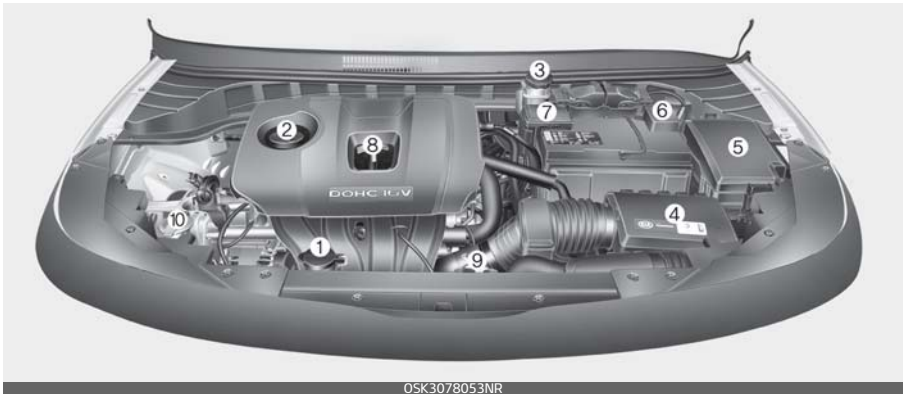

OSK3078053NR

\* The actual engine cover in the vehicle may differ from the illustration.

- 1. Engine coolant reservoir
- 2. Engine oil filler cap
- 3. Brake / clutch fluid reservoir
- 4. Air cleaner
- 5. Fuse box
- 6. Negative battery terminal
- 7. Positive battery terminal
- 8. Engine oil dipstick
- 9. Radiator cap
- 10. Windshield washer fluid reservoir

## Maintenance services

You should exercise the utmost care to prevent damage to your vehicle and injury to yourself whenever performing any maintenance or inspection procedures.

Should you have any doubts concerning the inspection or servicing of your vehicle, we strongly recommend that you have an authorized Kia dealer perform this work.

An authorized Kia dealer has factory-trained technicians and genuine Kia parts to service your vehicle properly. For expert advice and quality service, see an authorized Kia dealer.

Inadequate, incomplete or insufficient servicing may result in operational problems with your vehicle that could lead to vehicle damage, an accident, or personal injury.

### Owner's responsibility

#### \* NOTICE

Maintenance Service and Record Retention are the owner's responsibility.

You should retain documents that show proper maintenance has been performed on your vehicle in accordance with the scheduled maintenance service charts shown on the following pages. You need this

information to establish your compliance with the servicing and maintenance requirements of your vehicle warranties.

Detailed warranty information is provided in your Warranty & Consumer Information manual.

Repairs and adjustments required as a result of improper maintenance or a lack of required maintenance are not covered.

We recommend you have your vehicle maintained and repaired by an authorized Kia dealer. An authorized Kia dealer meets Kia's high service quality standards and receives technical support from Kia in order to provide you with a high level of service satisfaction.

#### \* NOTICE

### NHTSA Safety Corrosion Alert

The National Highway Traffic Safety Administration (NHTSA) has issued a general warning to all vehicle owners of all brands regarding the risks associated with vehicle underbody corrosion. From your initial purchase, take the following steps to prevent unsafe corrosion damage to your vehicle:

- Wash the undercarriage of your vehicle regularly during the winter and whenever your vehicle has

been exposed to such salts or chemicals.

- Do a thorough washing of the undercarriage at the end of the winter.
- Use professional service technicians or governmental inspection stations to annually inspect for corrosion.
- Immediately seek an inspection of your vehicle if you become visually aware of corrosion flaking or scaling or if you become aware of a change in vehicle performance, such as soft or spongy brakes, fluids leaking, impairment of directional control, suspension noises or rattling metal straps.
- NHTSA further advises that after a vehicle is 7 years old, it is essential that you take these indicated maintenance steps to ensure that you protect yourself from unsafe corrosion conditions.

### Owner maintenance precautions

Improper or incomplete service may result in problems. This section gives instructions only for the maintenance items that are easy to perform.

As explained earlier in this section, several procedures can be done only by an authorized Kia dealer with special tools.

### \* NOTICE

Improper owner maintenance during the warranty period may affect warranty coverage. For details, read the separate Warranty & Consumer Information manual provided with the vehicle. If you're unsure about any servicing or maintenance procedure, have it done by an authorized Kia dealer.

### ⚠ WARNING

#### Maintenance work

Do not wear jewelry or loose clothing while working under the hood of your vehicle with the engine running. These items can become entangled in moving parts, if you must run the vehicle in the engine while working under the hood, make certain that you remove all jewelry (especially rings, bracelets, watches, and necklaces) and all neckties, scarves, and similar loose clothing before getting near cooling fans.

### ⚠ WARNING

#### Touching metal parts

Do not touch metal parts (including strut bars) while the vehicle is operating or hot. Doing so could result in serious bodily injury. Turn the vehicle off and wait until the metal parts cool down to perform maintenance work on the vehicle.

## Owner maintenance

The following lists are vehicle checks and inspections that should be performed by the owner or an authorized Kia dealer at the frequencies indicated to help ensure safe, dependable operation of your vehicle.

Any adverse conditions should be brought to the attention of your dealer as soon as possible.

These Owner Maintenance Checks are generally not covered by warranties and you may be charged for labor, parts and lubricants used.

### When you stop for fuel:

- Check the engine oil level.
- Check the coolant level in coolant reservoir.
- Check the windshield washer fluid level.
- Look for low or under-inflated tires. Check if the front of the radiator and condenser are clean and not blocked with leaves, dirt or insects etc. If any of the above parts are extremely dirty or you are not sure of their condition, take your vehicle to an authorized Kia dealer.

### WARNING

#### Hot coolant

Be careful when checking your engine coolant level when the

engine is hot. Scalding hot coolant and steam may blow out under pressure.

---

### While operating your vehicle:

- Check for vibrations in the steering wheel. Notice any increased steering effort or looseness in the steering wheel, or change in its straight-ahead position.
- Notice if your vehicle constantly turns slightly or "pulls" to one side when traveling on smooth, level road.
- When stopping, listen and check for unusual sounds, pulling to one side, increased brake pedal travel or "hard-to-push" brake pedal.
- If any slipping or changes in the operation of your transmission occurs, check the transmission fluid level.
- Check the automatic transmission P (Park) function.
- Check the parking brake.
- Check for fluid leaks under your vehicle (water dripping from the air conditioning system during or after use is normal).

### At least monthly:

- Check the coolant level in the coolant reservoir.
- Check the operation of all exterior lights, including the stoplights, turn signals and hazard warning flashers.



- Check the inflation pressures of all tires including the spare for tires that are worn, show uneven wear, or are damaged.
- Check for loose wheel lug nuts.

### **At least twice a year (i.e., every Spring and Fall):**

- Check the radiator, heater and air conditioning hoses for leaks or damage.
- Check the windshield washer spray and wiper operation. Clean the wiper blades with clean cloth dampened with washer fluid.
- Check the headlight alignment.
- Check the lap/shoulder belts for wear and function.

### **At least once a year:**

- Clean the body and door drain holes.
- Lubricate the door hinges and check the hood hinges.
- Lubricate the door and hood locks and latches.
- Lubricate the door rubber weatherstrips.
- Check the air conditioning system.
- Inspect and lubricate automatic transmission linkage and controls.
- Clean the battery and terminals.
- Check the brake fluid level.

## **Scheduled maintenance service**

Follow the Normal Maintenance Schedule if the vehicle is usually operated where none of the following conditions apply.

If any of the following conditions apply, follow the Maintenance Under Severe Usage Conditions.

- Repeated driving short distance of less than 5 miles (8 km) in normal temperature or less than 10 miles (16 km) in freezing temperature.
- Extensive engine idling or low speed driving for long distances.
- Driving on rough, dusty, muddy, unpaved, graveled or salt-spread roads.
- Driving in areas using salt or other corrosive materials or in very cold weather.
- Driving in heavy dust condition.
- Driving in heavy traffic area.
- Driving on uphill, downhill, or mountain road repeatedly.
- Towing a trailer or using a camper, or roof rack.
- Driving as a patrol car, taxi, other commercial use of vehicle towing.
- Driving over 106 mph (170 km/h).
- Frequently driving in stop-and-go condition.

If your vehicle is operated in any of the prior listed conditions, you should inspect, replace or refill more frequently, using the severe usage maintenance schedule instead of the normal usage maintenance schedule.

### Normal maintenance schedule - Non Turbo Models

The following maintenance services must be performed to ensure good emission control and performance. Keep receipts for all vehicle emission services to protect your warranty. Where both mileage and time are shown, the frequency of service is determined by whichever occurs first.

I: Inspect and if necessary, adjust, correct, clean or replace.

R: Replace or change

Number of months or driving distance, whichever comes first																
Months	12	24	36	48	60	72	84	96	108	120	132	144	156	168	180	
Miles×1,000	7.5	15	22.5	30	37.5	45	52.5	60	67.5	75	82.5	90	97.5	105	112.5	
Km×1,000	12	24	36	48	60	72	84	96	108	120	132	144	156	168	180	
Drive belts <sup>*1</sup>	At first, inspect at 60,000 miles (96,000 km) or 72 months, after that, inspect every 15,000 miles (24,000 km) or 24 months															
Engine oil and engine oil filter	Nu 2.0L MPI	R	R	R	R	R	R	R	R	R	R	R	R	R	R	R
Fuel additives <sup>**2</sup>	Add every 7,500 miles (12,000 km) or 12 months															
Air cleaner filter	I	I	I	R	I	I	I	R	I	I	I	R	I	I	I	
Spark plugs	Replace every 100,000miles (160,000 km)															
Rotate tires	Rotate every 7,500 miles (12,000 km)															
Climate control air filter	R	R	R	R	R	R	R	R	R	R	R	R	R	R	R	
Vacuum hose	I	I	I	I	I	I	I	I	I	I	I	I	I	I	I	
Coolant (Engine)	At first, replace at 120,000 miles (192,000 km) or 10 years, after that, replace every 30,000 miles (48,000 km) or 24 months															
Battery condition	I	I	I	I	I	I	I	I	I	I	I	I	I	I	I	
Brake lines, hoses and connections	I	I	I	I	I	I	I	I	I	I	I	I	I	I	I	
Brake discs and pads	I	I	I	I	I	I	I	I	I	I	I	I	I	I	I	
Steering gear rack, linkage and boots	I	I	I	I	I	I	I	I	I	I	I	I	I	I	I	
Drive shaft and boots	I	I	I	I	I	I	I	I	I	I	I	I	I	I	I	
Suspension ball joints and mounting bolts	I	I	I	I	I	I	I	I	I	I	I	I	I	I	I	
Air conditioner compressor/refrigerant	I	I	I	I	I	I	I	I	I	I	I	I	I	I	I	
Exhaust system	I	I	I	I	I	I	I	I	I	I	I	I	I	I	I	
Cooling system	-	-	-	I	-	I	-	I	-	I	-	I	-	I	-	
Intelligent Variable Transmission (IVT) fluid	No check, No service required															

Number of months or driving distance, whichever comes first																
Months	12	24	36	48	60R	72	84	96	108	120	132	144	156	168	180	
Miles×1,000	7.5	15	22.5	30	37.5	45	52.5	60	67.5	75	82.5	90	97.5	105	112.5	
Km×1,000	12	24	36	48	60	72	84	96	108	120	132	144	156	168	180	
Manual transmission fluid*3	-	-	-		-		-		-		-		-		-	
Vapor hose and fuel filler cap	-		-		-		-		-		-		-		-	
Fuel tank air filter*4	-		-		-		-		-		-		-		-	
Fuel lines, hoses and connections																
Parking brake																
Brake fluid	Inspect every 7,500 miles (12,000 km) or 12 months, Repect every 60,000 miles (96,000 km) or 48 months															

- \*1. The drive belt should be replaced when cracks occur or tension is reduced.
- \*2. If TOP TIER Detergent Gasoline is not available, one bottle of additive is recommended. Additives are available from your authorized Kia dealer along with information on how to use them. Do not mix other additives.
- \*3. Manual transmission fluid should be changed anytime it has been submerged in water.
- \*4. Fuel tank air filter is considered to be maintenance free but periodic inspection is recommended as the level of maintenance will be dependent upon the quality fuel used in the vehicle.

## Maintenance Under Severe Usage Conditions – Non Turbo Models

The following items must be serviced more frequently on cars mainly used under severe driving conditions. Refer to the chart below for the appropriate maintenance intervals.

R: Replace

I: Inspect and if necessary, adjust, correct, clean or replace

Maintenance item		Maintenance operation	Maintenance intervals	Driving condition
Engine oil and engine oil filter	Nu 2.0L MPI	R	Every 3,750 miles (6,000 km) or 6 months	A, B, C, D, E, F, G, H, I, J, K
Air cleaner filter		R	More frequently	C, E
Spark plugs		R	More frequently	A, B, F, G, H, I, K
Automatic transmission fluid		R	Every 60,000 miles (100,000 km)	A, C, D, E, F, G, H, I, J
Dual clutch transmission fluid		R	Every 75,000 miles (120,000 km)	C, D, E, F, G, H, I, J
Manual transmission fluid		R	Every 75,000 miles (120,000 km)	C, D, E, F, G, H, I, J
Brake discs and pads, calipers and rotors		I	More frequently	C, D, E, G, H
Parking brake		I	More frequently	C, D, G, H
Steering gear rack, linkage and boots		I	More frequently	C, D, E, F, G
Suspension ball joints and mounting bolts		I	More frequently	C, D, E, F, G
Drive shafts and boots		I	More frequently	C, D, E, F, G, H, I, J
Climate control air filter		I	More frequently	C, E, G

### Severe Driving Conditions

A: Repeatedly driving short distance of less than 5 miles (8 km) in normal temperature or less than 10 miles (16 km) in freezing temperature.  
 B: Extensive low speed driving for long distances.  
 C: Driving on rough, dusty, muddy, unpaved, graveled or salt-spread roads.  
 D: Driving in areas using salt or other corrosive materials or in very cold weather.

E: Driving in heavy dust condition.

F: Driving in heavy traffic area.

G: Driving on uphill, downhill, or mountain roads.

H: Towing a trailer or using a camper on roof rack.

I: Driving for patrol car, taxi, commercial car or vehicle towing.

J: Driving over 106 mph (170 km/h)

K: Frequently driving in stop-and-go conditions

### Normal maintenance schedule – Turbo Models

The following maintenance schedule services must be performed to ensure good emission control and performance. Keep receipts for all vehicle emission services to protect your warranty. Where both mileage and time are shown, the frequency of service is determined by whichever occurs first.

I: Inspect and if necessary, adjust, correct, clean or replace.

R: Replace or change

Number of months or driving distance, whichever comes first																
Months		12	24	36	48	60	72	84	96	108	120	132	144	156	168	180
Miles×1,000		6	12	18	24	30	36	42	48	54	60	66	72	78	84	90
Km×1,000		10	20	30	40	50	60	70	80	90	100	110	120	130	140	150
Drive belts *1		At first, inspect at 60,000 miles (100,000 km) or 72 months, after that, inspect every 12,000 miles (20,000 km) or 24 months														
Engine oil and engine oil filter	Gamma 1.6L T-GDI	R	R	R	R	R	R	R	R	R	R	R	R	R	R	R
Fuel additives *2		Add every 6,000 miles (10,000 km) or 12 months														
Air cleaner filter		I	I	I	R	I	I	I	R	I	I	I	R	I	I	I
Spark plugs		Replace every 42,000 miles (70,000 km)														
Rotate tires		Rotate every 6,000 miles (10,000 km)														
Valve clearance *3	Gamma 1.6L T-GDI	Inspect every 60,000 miles (96,000 km) or 72 months														
Climate control air filter		R	R	R	R	R	R	R	R	R	R	R	R	R	R	R
Vacuum hose		I	I	I	I	I	I	I	I	I	I	I	I	I	I	I
Coolant (Engine)		At first, replace at 120,000 miles (192,000 km) or 10 years, after that, replace every 30,000 miles (48,000 km) or 24 months														
Battery condition		I	I	I	I	I	I	I	I	I	I	I	I	I	I	I
Brake lines, hoses and connections		I	I	I	I	I	I	I	I	I	I	I	I	I	I	I
Brake discs and pads		I	I	I	I	I	I	I	I	I	I	I	I	I	I	I
Steering gear rack, linkage and boots		I	I	I	I	I	I	I	I	I	I	I	I	I	I	I
Drive shaft and boots		I	I	I	I	I	I	I	I	I	I	I	I	I	I	I
Suspension ball joints and mounting bolts		I	I	I	I	I	I	I	I	I	I	I	I	I	I	I
Air conditioner compressor/ refrigerant		I	I	I	I	I	I	I	I	I	I	I	I	I	I	I
Exhaust system		I	I	I	I	I	I	I	I	I	I	I	I	I	I	I

Number of months or driving distance, whichever comes first																
Months	12	24	36	48	60	72	84	96	108	120	132	144	156	168	180	
Miles×1,000	6	12	18	24	30	36	42	48	54	60	66	72	78	84	90	
Km×1,000	10	20	30	40	50	60	70	80	90	100	110	120	130	140	150	
Intercooler, in/out hose, air intake hose	Gamma 1.6L T-GDI															
Cooling system																
Automatic transmission fluid		No check, No service required														
Dual clutch transmission fluid		Inspect every 37,500 miles (60,000 km) or 30 months														
Vapor hose and fuel filler cap		-		-		-		-		-		-		-		
Fuel tank air filter <sup>*4</sup>		-		-		-		-		-		-		-		
Fuel lines, hoses and connections																
Parking brake																
Brake fluid		Inspect every 6,000 miles (10,000 km) or 12 months, Repect every 48,000 miles (80,000 km) or 48 months														

- \*1. The drive belt should be replaced when cracks occur or tension is reduced.
- \*2. If TOP TIER Detergent Gasoline is not available, one bottle of additive is recommended. Additives are available from your authorized Kia dealer along with information on how to use them. Do not mix other additives.
- \*3. Inspect for excessive valve noise and/or engine vibration and adjust if necessary. Have an authorized Kia dealer perform the operation.
- \*4. Fuel tank air filter are considered to be maintenance free but periodic inspection is recommended for this maintenance schedule depends on fuel quality.

### Maintenance Under Severe Usage Conditions – Turbo Models

The following items must be serviced more frequently on cars mainly used under severe driving conditions. Refer to the chart below for the appropriate maintenance intervals.

R: Replace

I: Inspect and if necessary, adjust, correct, clean or replace

Maintenance item		Maintenance operation	Maintenance intervals	Driving condition
Engine oil and engine oil filter	Gamma 1.6L T-GDI	R	Every 3000 miles (5,000 km) or 6 months	A, B, C, D, E, F, G, H, I, J, K
Air cleaner filter		R	More frequently	C, E
Spark plugs		R	More frequently	A, B, H, I, K
Automatic transmission fluid		R	Every 60,000 miles (96,000 km)	A, C, D, E, F, G, H, I, J
Dual clutch transmission fluid		R	Every 75,000 miles (120,000 km)	C, D, E, F, G, H, I, J
Brake discs and pads, calipers and rotors		I	More frequently	C, D, E, G, H
Parking brake		I	More frequently	C, D, G, H
Steering gear rack, linkage and boots		I	More frequently	C, D, E, F, G
Suspension ball joints and mounting bolts		I	More frequently	C, D, E, F, G
Drive shafts and boots		I	More frequently	C, D, E, F, G, H, I, J
Climate control air filter		R	More frequently	C, E, G

#### Severe Driving Conditions

- A: Repeatedly driving short distance of less than 5 miles (8 km) in normal temperature or less than 10 miles (16 km) in freezing temperature.
- B: Extensive low speed driving for long distances.
- C: Driving on rough, dusty, muddy, unpaved, graveled or salt-spread roads.
- D: Driving in areas using salt or other corrosive materials or in very cold weather.
- E: Driving in heavy dust condition.

- F: Driving in heavy traffic area.
- G: Driving on uphill, downhill, or mountain roads.
- H: Towing a trailer or using a camper on roof rack.
- I: Driving for patrol car, taxi, commercial car or vehicle towing.
- J: Driving over 106 mph (170 km/h)
- K: Frequently driving in stop-and-go conditions

## Explanation of scheduled maintenance items

The following parts require scheduled maintenance.

### Engine oil and filter

The engine oil and filter should be changed at the intervals specified in the maintenance schedule. If the vehicle is being driven in severe conditions, more frequent oil and filter changes are required.

### Drive belts

Inspect all drive belts for evidence of cuts, cracks, excessive wear or oil saturation and replace if necessary. Drive belts should be checked periodically for proper tension and adjusted as necessary.

### Fuel filter

Kia gasoline vehicle is equipped with a lifetime fuel filter that is integrated with the fuel tank. Regular maintenance or replacement is generally not needed. This may vary depending on fuel quality. If you experience any of the following: fuel flow restriction, surging, loss of power, or a hard starting issue, inspection and, if necessary, replacement may be needed. Have the fuel filter inspected or replaced by an authorized Kia dealer.

### Fuel lines, fuel hoses and connections

Check the fuel lines, fuel hoses and connections for leakage and damage. Have an authorized Kia dealer replace any damaged or leaking parts immediately.

### Vapor hose and fuel filler cap

The vapor hose and fuel filler cap should be inspected at those intervals specified in the maintenance schedule. Make sure that a new vapor hose or fuel filler cap is correctly replaced.

### Vacuum crankcase ventilation hoses (if equipped)

Inspect the surface of hoses for evidence of heat and/or mechanical damage. Hard and brittle rubber, cracking, tears, cuts, abrasions, and excessive swelling indicate deterioration. Particular attention should be paid to examine those hose surfaces nearest to high heat sources, such as the exhaust manifold. Inspect the hose routing to assure that the hoses do not come in contact with any heat source, sharp edges or moving components which might cause heat damage or mechanical wear. Inspect all hose connections, such as clamps and couplings, to make sure they are secure, and that no leaks are pres-



ent. Hoses should be replaced immediately if there is any evidence of deterioration or damage.

### **Air cleaner filter**

A Genuine Kia air cleaner filter is recommended when the filter is replaced.

### **Spark plugs**

Make sure to install new spark plugs of the correct heat range.

### **Valve clearance (if equipped)**

Inspect for excessive valve noise and/or engine vibration and adjust if necessary. An authorized Kia dealer should perform the operation.

### **Cooling system**

Check the cooling system components, such as the radiator, coolant reservoir, hoses and connections for leakage and damage. Replace any damaged parts.

### **Coolant**

The coolant should be changed at the intervals specified in the maintenance schedule.

### **Manual transmission fluid (if equipped)**

Inspect the manual transmission fluid according to the maintenance schedule.

### **Automatic transmission fluid (if equipped)**

Automatic transmission fluid should not be checked under normal usage conditions. But in severe conditions, the fluid should be changed at an authorized Kia dealer in accordance to the scheduled maintenance at the beginning of this section.

#### **\* NOTICE**

Automatic transmission fluid color is usually red. As the vehicle is driven, the automatic transmission fluid will begin to look darker.

It is the normal condition and you should not judge the need to replace the fluid based upon the changed color.

#### **⚠ CAUTION**

### **Transmission fluids**

The use of a non-specified fluid could result in transmission malfunction and failure. Use only specified automatic transmission fluid. (Refer to "Recommended lubricants and capacities" on page 8-9.)

### Dual clutch transmission Fluid

Inspect the dual clutch transmission fluid according to the maintenance schedule.

### Brake hoses and lines

Visually check for proper installation, chafing, cracks, deterioration and any leakage. Replace any deteriorated or damaged parts immediately.

#### \* NOTICE

#### NHTSA Safety Corrosion Alert

NHTSA has warned all vehicle owners of all brands that they must maintain their vehicles in a manner which will prevent brake hose and brake line failures due to corrosion when such vehicles are exposed to winter road salt and related chemicals. While serious corrosion conditions typically only manifest themselves as safety issues after 7 years of vehicle use, the corrosion process starts immediately and thus underbody cleaning maintenance must commence from your vehicle's first exposure to road salts and chemicals. NHTSA urges vehicle owners to take the following steps to prevent corrosion:

1. Wash the undercarriage of your vehicle regularly throughout the winter and do a thorough washing

in the spring to remove road salt and other de-icing chemicals.

2. Monitor the brake system for signs of corrosion by having regular professional inspections and watching for signs of problems, including loss of brake fluid, unusual leaks and soft or spongy feel in the brake pedal.
3. Replace the entire brake pipe assembly if you find severe corrosion that causes scaling or flaking of brake components.

### Brake/clutch fluid

Check the brake fluid level in the brake fluid reservoir. The level should be between "MIN" and "MAX" marks on the side of the reservoir. Use only hydraulic brake fluid conforming to DOT 3 or DOT 4 specification.

### Parking brake

Inspect the parking brake system including the parking brake lever (or pedal) and cables.

### Exhaust pipe and muffler

Visually inspect the exhaust pipes, muffler and hangers for cracks, deterioration, or damage. Start the engine and listen carefully for any exhaust gas leakage. Tighten con-

nections or replace parts as necessary.

### **Brake discs, pads, calipers and rotors**

Check the pads for excessive wear, discs for run out and wear, and calipers for fluid leakage.

### **Suspension mounting bolts**

Check the suspension connections for looseness or damage. Retighten to the specified torque.

### **Steering gear box, linkage & boots/lower arm ball joint**

With the vehicle stopped and off, check for excessive free-play in the steering wheel.

Check the linkage for bends or damage. Check the dust boots and ball joints for deterioration, cracks, or damage. Replace any damaged parts.

### **Drive shafts and boots**

Check the drive shafts, boots and clamps for cracks, deterioration, or damage. Replace any damaged parts and, if necessary, repack the grease.

### **Air conditioning refrigerant**

Check the air conditioning lines and connections for leakage and damage.

### **Checking fluid levels**

When checking engine oil, engine coolant, brake fluid, and washer fluid, always be sure to clean the area around any filler plug, drain plug, or dipstick before checking or draining any lubricant or fluid. This is especially important in dusty or sandy areas and when the vehicle is used on unpaved roads. Cleaning the plug and dipstick areas will prevent dirt and grit from entering the engine and other mechanisms that could be damaged.

## Engine oil and filter

The engine oil and filter should be changed at the intervals specified in the maintenance schedule. If the vehicle is being driven in severe conditions, more frequent oil and filter changes are required.

### Checking the engine oil level

1. Be sure the vehicle is on level ground.
2. Start the engine and allow it to reach normal operating temperature.

### **⚠ WARNING**

#### Radiator hose

Be very careful not to touch the radiator hose when checking or adding the engine oil as it may be hot enough to burn you.

3. Turn the engine off and wait for a few minutes (about 5 minutes) for the oil to return to the oil pan.
4. Pull the dipstick out, wipe it clean, and re-insert it fully.

### **⚠ CAUTION**

- Do not overfill the engine oil. It may damage the engine.
- Do not spill engine oil, when adding or changing engine oil. If you drop the engine oil on the engine room, wipe it off immediately.
- When you wipe the oil level gauge, you should wipe it with a clean

cloth. When mixed with debris, it can cause engine damage.

5. Pull the dipstick out again and check the level. The level should be between F and L.

Gamma 1.6L T-GDI

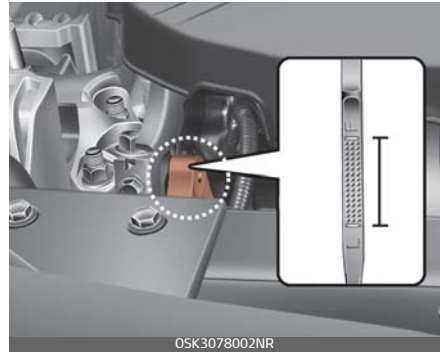

Nu 2.0L MPI

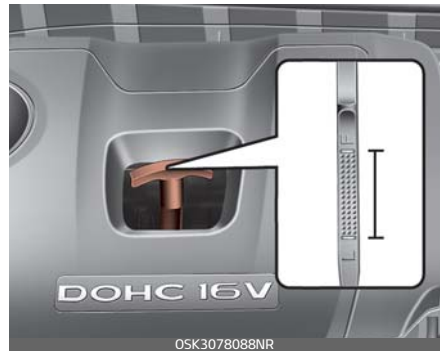

6. If it is near or at L, add enough oil to bring the level to F.

Gamma 1.6L T-GDI

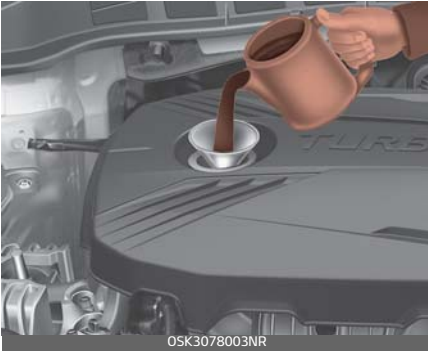

Nu 2.0L MPI



**Do not overfill. Use a funnel to help prevent oil from being spilled on engine components. Use only the specified engine oil.** (Refer to "Recommended lubricants and capacities" on page 8-9.)

### ***Changing the engine oil and filter***

Have engine oil and filter changed by an authorized Kia dealer according to the Maintenance Schedule at the beginning of this chapter.

### **⚠ WARNING**

Used engine oil may cause irritation or cancer of the skin if left in contact with the skin for prolonged periods of time. Used engine oil contains chemicals that have caused cancer in laboratory animals. Always protect your skin by washing your hands thoroughly with soap and warm water as soon as possible after handling used oil.

## Engine coolant

The high-pressure cooling system has a reservoir filled with year round antifreeze coolant. The reservoir is filled at the factory.

Check the antifreeze protection and coolant level at least once a year, at the beginning of the winter season, and before traveling to a colder climate.

### **⚠ WARNING**

#### Radiator

Never attempt to remove the radiator or inverter cap while the engine is operating or hot. Doing so might lead to cooling system and engine damage and could result in serious personal injury from escaping hot coolant or steam.

#### Recommended coolant

When adding coolant, use only deionized water or soft water for your vehicle and never mix hard water in the coolant filled at the factory. An improper coolant mixture can result in serious malfunction or damage.

- Do not use alcohol or methanol coolant or mix them with the specified coolant.
- Do not use a solution that contains more than 60% antifreeze or less than 35% antifreeze,

which would reduce the effectiveness of the solution.

- The cooling circuit of a vehicle equipped with a heat pump system may freeze in extremely low temperature when the concentration of the antifreezing liquid is below 45%.

For mixture percentage, refer to the following table.

Ambient Temperature	Mixture Percentage (volume)	
	Antifreeze	Water
5 °F (-15 °C)	35	65
-13 °F (-25 °C)	40	60
-31 °F (-35 °C)	50	50
-49 °F (-45 °C)	60	40

### **⚠ WARNING**



#### Radiator cap

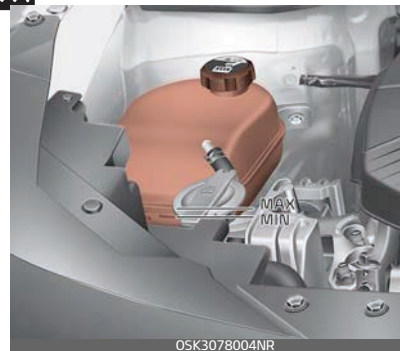

Do not remove the radiator cap when the engine and radiator are hot. Scalding hot coolant and steam

may blow out under pressure which may result in serious injury.

**\* NOTICE**

Make sure the coolant cap is properly closed after refill or coolant. Otherwise the engine could be overheated while driving.

1. Check if the radiator cap label is straight In front.

Engine room front view



2. Make sure that the tiny protrusions inside the coolant cap are securely interlocked.

Engine room rear view

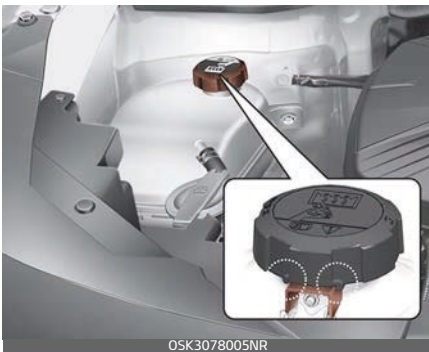

**Checking the coolant level**

**⚠ WARNING**

 Removing radiator cap  
Never attempt to remove the radiator cap while the engine is operating or hot. Doing so might lead to cooling system damage and could result in serious personal injury from escaping hot coolant or steam.

1. Turn the vehicle off and wait until it cools down.
2. Use extreme care when removing the radiator cap. Wrap a thick towel around it, and turn it counterclockwise slowly to the first stop.

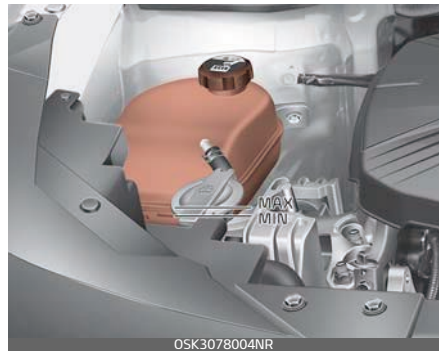

3. Step back while the pressure is released from the cooling system.
4. When you are sure all the pressure has been released, press down on the cap, using a thick towel, and continue turning counterclockwise to remove it.

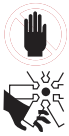
**⚠ WARNING****Cooling fan**

Use caution when working near the blade of the cooling fan. The electric motor (cooling fan) is controlled by coolant temperature, refrigerant pressure and vehicle speed. It may sometimes operate even when the vehicle is not running.

5. Check the condition and connections of all cooling system hoses and heater hoses.
6. Replace any swollen or deteriorated hoses.
7. Check the coolant level. The coolant level should be filled between F and L marks on the side of the coolant reservoir when the engine room is cool.
8. If the coolant level is low, add enough specified coolant to provide protection against freezing and corrosion. Bring the level to F, but do not overfill.

If frequent additions are required, see an authorized Kia dealer for a cooling system inspection.

**Changing the coolant**

Have the coolant changed by an authorized Kia dealer according to the Maintenance Schedule at the beginning of this chapter.

**⚠ CAUTION**

Put a thick cloth or fabric around the radiator cap before refilling the coolant in order to prevent the coolant from overflowing into engine parts such as the alternator.



## Brake fluid

The brake fluid acts to transmit force to the brake when the driver depresses the brake pedal. Brake fluid must be maintained periodically to ensure that the brakes operate smoothly.

### Checking the brake fluid level

Check the fluid level in the reservoir periodically. The fluid level should be between MAX and MIN marks on the side of the reservoir.

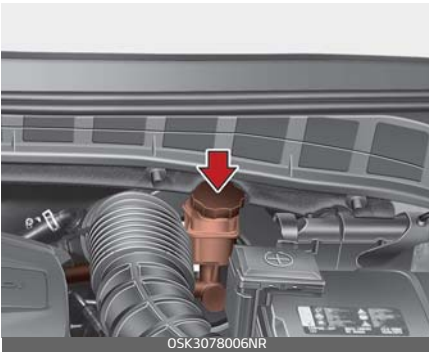

1. Before removing the reservoir cap and adding brake fluid, clean the area around the reservoir cap thoroughly to prevent brake fluid contamination.

#### ⚠ CAUTION

### Proper fluid

Only use brake fluid in the brake system. Small amounts of improper fluids can cause damage to the brake system.

2. If the level is low, add fluid to the MAX level. The level will fall with accumulated mileage. This is a normal condition associated with the wear of the brake linings. If the fluid level is excessively low, have the brake system checked by an authorized Kia dealer.

Use only the specified brake fluid. (Refer to "Recommended lubricants and capacities" on page 8–9.)

Never mix different types of fluid.

In the event the brake system requires frequent additions of fluid, the vehicle should be inspected by an authorized Kia dealer.

When changing and adding brake fluid, handle it carefully. Do not let it come in contact with your eyes. If brake fluid should come in contact with your eyes, immediately flush them with a large quantity of fresh tap water. Have your eyes examined by a doctor as soon as possible.

#### ⚠ CAUTION

### Brake fluid

Do not allow brake fluid to contact the vehicle's body paint, as paint damage will result.

Brake fluid, which has been exposed to open air for an extended time should never be used as its quality cannot be guaranteed. It should be disposed of properly.

## Washer fluid

Washer fluid is used when wiping the windshield of the vehicle with a windshield wiper. You should check and refill washer fluid periodically to make sure that it doesn't run out.

### Checking the washer fluid level

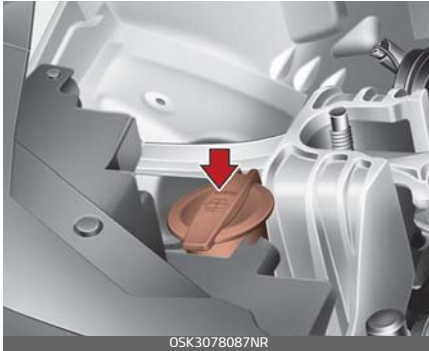

The reservoir is translucent so that you can check the level with a quick visual inspection.

- Check the fluid level in the washer fluid reservoir and add fluid if necessary. Plain water may be used if washer fluid is not available. However, use washer solvent with antifreeze characteristics in cold climates to prevent freezing.

### **WARNING**

#### Flammable Fluid

Do not allow the washer fluid to come in contact with open flames or sparks. The windshield washer fluid reservoir is flammable under certain

circumstances. This can result in a fire.

### **WARNING**

#### Coolant

- Do not use radiator coolant or antifreeze in the washer fluid reservoir.
- Radiator coolant can severely obscure visibility when sprayed on the windshield and may cause loss of vehicle control.

### **WARNING**

#### Windshield fluid

Do not drink the windshield washer fluid. The windshield washer fluid is poisonous to humans and animals.

## Parking brake

Inspect the parking brake system including the parking brake lever (or pedal) and cables.

### Checking the parking brake

1. Check the stroke of the parking brake by counting the number of "clicks" heard while fully applying it from the released position.



Also, the parking brake alone should securely hold the vehicle on a fairly steep grade.

2. If the stroke is more or less than specified, have the parking brake adjusted by an authorized Kia dealer.

**Stroke: 5~7 "clicks" at a force of 44 lbs. (20 kg, 196 N)**

## Air cleaner filter

A Genuine Kia air cleaner filter is recommended when the filter is replaced.

### Replacing air cleaner filter

Air cleaner filter must be replaced when necessary, and should not be washed.

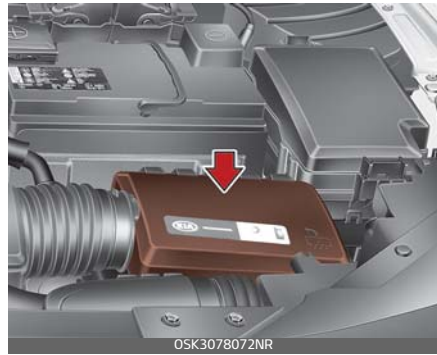

You can clean the filter when inspecting the air cleaner element. Clean the filter by using compressed air.

1. Loosen the air cleaner cover attaching clips and open the cover.

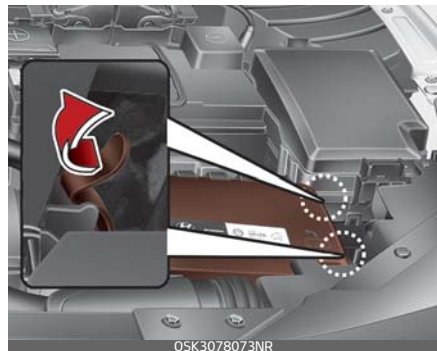

2. Wipe the inside of the air cleaner.

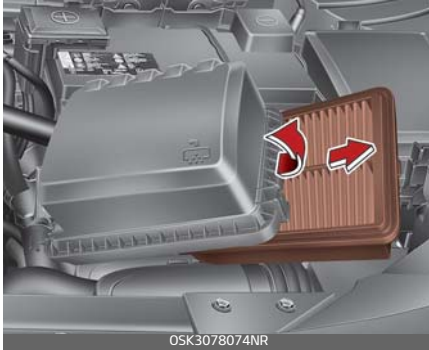

3. Replace the air cleaner filter.
4. Lock the cover with the cover attaching clips.

Replace the filter according to the Maintenance Schedule.

If the vehicle is operated in extremely dusty or sandy areas, replace the element more often than the usual recommended intervals. (Refer to "Maintenance Under Severe Usage Conditions - Non Turbo Models" on page 7-11.)

### **CAUTION**

#### **Air filter maintenance**

- Do not drive with the air cleaner removed; this will result in excessive engine wear.
- When removing the air cleaner filter, be careful that dust or dirt does not enter the air intake, or damage may result.
- Use a Kia genuine part. Use of a non-genuine part could damage the air flow sensor.

## **Climate control air filter**

The climate control air filter should be replaced according to the maintenance schedule. If the vehicle is operated in severely air-polluted cities or on dusty rough roads for a long period, it should be inspected more frequently and replaced earlier.

### **Inspecting and replacing climate control air filter**

When you replace the climate control air filter, replace it performing the following procedure, and be careful to avoid damaging other components.

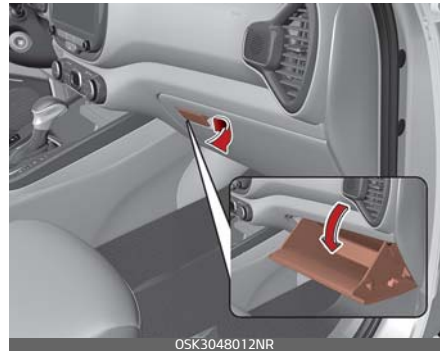

1. Open the glove box.



2. With the glove box open, pull the support strap (1). Push in Both sides (2) of the glove box as shown.



3. Replace the climate control air filter.



4. Reassemble in the reverse order of disassembly.

When replacing the climate control air filter install it properly. Otherwise, the system may produce noise and the effectiveness of the filter may be reduced.

## Wiper blades

When the wipers no longer clean adequately, the blades may be worn or cracked, and require replacement.

To prevent damage to the wiper arms or other components, do not attempt to move the wipers manually.

The use of a non-specified wiper blade could result in wiper malfunction and failure.

## Blade inspection

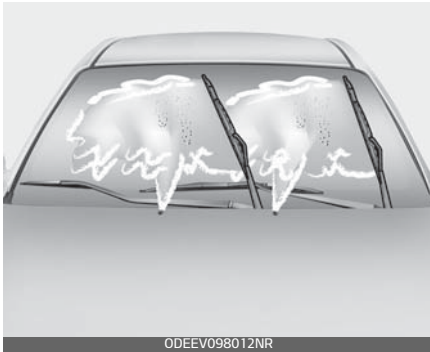

ODEEV098012NR

Commercial hot waxes applied by automatic vehicle washes have been known to make the windshield difficult to clean.

Contamination of either the windshield or the wiper blades with foreign matter can reduce the effectiveness of the windshield wipers. Common sources of contamination are insects, tree sap, and hot wax treatments used by some commercial vehicle washes. If the blades

are not wiping properly, clean both the window and the blades with a good cleaner or mild detergent, and rinse thoroughly with clean water.

## ⚠ CAUTION

### Wiper blades

To prevent damage to the wiper blades, do not use gasoline, kerosene, paint thinner, or other solvents on or near them.

## Replacing front windshield wiper blade

Type A

1. Raise the wiper arm and turn the wiper blade assembly to expose the plastic locking clip.



ODEEV098013NR

## ⚠ CAUTION

### Wiper arms

- Do not allow the wiper arm to fall against the windshield, since it may chip or crack the windshield.

- Do not pull wiper arm forward, since it could chip the hood paint.

2. Compress the clip and slide the blade assembly downward.

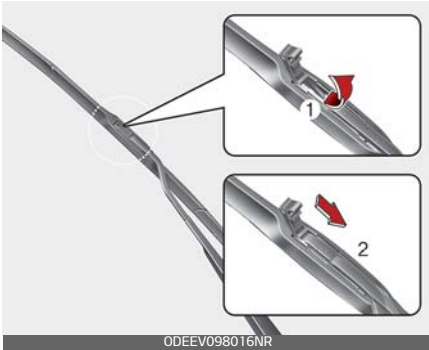

3. Lift it off the arm.

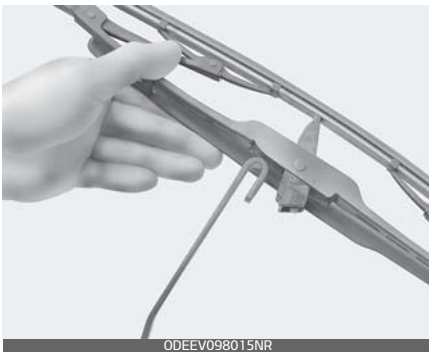

4. Install the blade assembly in the reverse order of removal.

Type B

1. Raise the wiper arm.
2. Lift up the wiper blade clip. Then pull down the blade assembly and remove it.

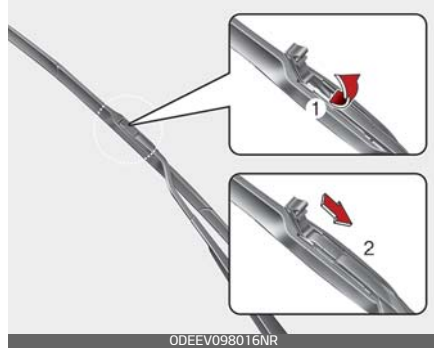

3. Install the new blade assembly.



4. Return the wiper arm on the windshield.

5. Turn ignition to the ON position and wiper arms will return to the normal operating position.

### Replacing rear window wiper blade

1. Raise the wiper arm and pull out the wiper blade assembly.

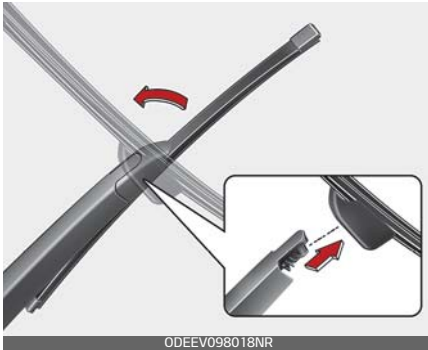

2. Install the new blade assembly by inserting the center part into the slot in the wiper arm until it clicks into place.

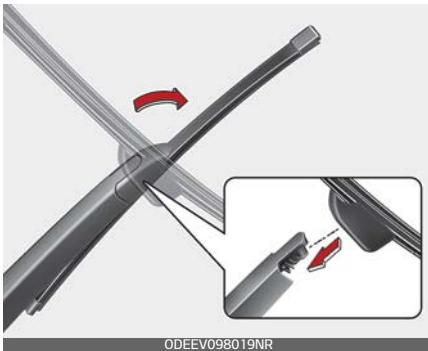

3. Make sure the blade assembly is installed firmly by trying to pull it slightly.

To prevent damage to the wiper arms or other components, have an authorized Kia dealer replace the wiper blade.

## Battery

The battery powers the engine in order to move the vehicle as well as supplying power to the various devices installed in the vehicle.

### For best battery service

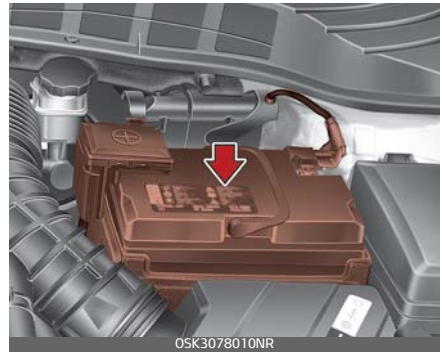

- Keep the battery securely mounted.
- Keep the battery top clean and dry.
- Keep the terminals and connections clean, tight, and coated with petroleum jelly or terminal grease.
- Rinse any spilled electrolyte from the battery immediately with a solution of water and baking soda.
- If the vehicle is not going to be used for an extended time, disconnect the battery cables.

### **⚠ WARNING**

**Risk of explosion**





Keep lit cigarettes and all other flames or sparks away from the battery.



The battery contains hydrogen -- a highly combustible gas which will explode if it comes in contact with a flame or spark.



Keep batteries out of the reach of children because batteries contain highly corrosive SULFURIC ACID and electrolytes. Do not allow battery acid to contact your skin, eyes, clothing or paint finish.



Wear eye protection when charging or working near a battery. Always provide ventilation when working in an enclosed space.



Always read the following instructions carefully when handling a battery.



If any electrolyte gets into your eyes, flush your eyes with clean water for at least 15 minutes and get immediate medical attention. If electrolyte gets on your skin, thoroughly wash the contacted area. If you feel pain or burning sensation, get medical attention immediately.



An inappropriately disposed battery can be harmful to the environ-

ment and human health. Dispose the battery according to your local law(s) or regulation.



The battery contains lead. Do not dispose of it after use. Please return the battery to an authorized Kia dealer to be recycled.

Never attempt to recharge the battery when the battery cables are connected.

### **WARNING**

#### **Risk of electrocution**

Never touch the electrical ignition system while the vehicle is running. This system works with high voltage which can "zap" you.

### **\* NOTICE**

If you connect unauthorized electronic devices to the battery, the battery may be discharged. Never use unauthorized devices.

### **WARNING**

#### **Recharging battery**

Never attempt to recharge the battery when the battery cables are connected.

## **WARNING**

### **Battery lead compound**

Battery posts, terminals, and related accessories contain lead and lead compounds. Wash hands after handling.

### **Battery recharging**

Your vehicle has a maintenance-free, calcium-based battery

- If the battery becomes discharged in a short time (because, for example, the headlights or interior lights were left on while the vehicle was not in use), recharge it by slow charging (trickle) for 10 hours.
- If the battery gradually discharges because of high electric load while the vehicle is being used, recharge it at 20~30 A for two hours.

When recharging the battery, observe the following precautions:

- The battery must be removed from the vehicle and placed in an area with good ventilation.
- Do not allow cigarettes, sparks, or flame near the battery.
- Watch the battery during charging, and stop or reduce the charging rate if the battery cells begin gassing (boiling) violently or if the temperature of the electro-

lyte of any cell exceeds 120 °F (49 °C).

- Wear eye protection when checking the battery during charging.
- Disconnect the battery charger in the following order.
  1. Turn off the battery charger main switch.
  2. Unhook the negative clamp from the negative battery terminal.
  3. Unhook the positive clamp from the positive battery terminal.
- Before performing maintenance or recharging the battery, turn off all accessories and stop the vehicle.
- The negative battery cable must be removed first and installed last when the battery is disconnected.

### **Reset items**

The following items should be reset after the battery has been discharged or the battery has been disconnected.

- Auto up/down window (Refer to "Window opening and closing" on page 4-27)
- Trip computer (Refer to "Trip information (Trip computer)" on page 4-61)
- Climate control system (Refer to "Automatic climate control system" on page 4-117)

## Tires and wheels

For proper maintenance, safety, and maximum fuel economy, you must always maintain recommended tire inflation pressures and stay within the load limits and weight distribution recommended for your vehicle.

### Recommended cold tire inflation pressures

All tire pressures should be checked when the tires are cold. "Cold Tires" means the vehicle has not been driven for at least three hours or driven less than 1 mile (1.6 km).

Recommended pressures must be maintained for the best ride, vehicle handling, and minimum tire wear.

For recommended inflation pressure, refer to "Tires and wheels" on page 8-5.

All specifications (sizes and pressures) can be found on a label attached to the driver's side center pillar.



0DEEV098028NR

## ⚠ WARNING

### Tire underinflation

Inflate your tires consistent with the instructions provided in this manual. Regularly check the tire inflation pressure, and correct it as needed: at least twice a month and before any long trips on the road. If you fail to observe this precaution, you may be driving on underinflated tires, which may not only compromise your vehicle's driving stability, but also lead to tire damage and the risk of an accident. This risk is much higher on hot days and when driving for long periods at high speeds.

Failure to maintain specified pressure may result in excessive wear, poor handling, reduced fuel economy, deformation of tire and/or wheel, harsh ride conditions, possibility for additional damage from road hazards, or result in tire failure.

### Tire pressure

Always observe the following:

- Check tire pressure when the tires are cold. (After vehicle has been parked for at least three hours or hasn't been driven more than 1 mile (1.6 km) since startup.)
- Check the pressure of your spare tire each time you check the pressure of other tires.

- Never overload your vehicle. Be careful not to overload a vehicle luggage rack if your vehicle is equipped with one.
- Warm tires normally exceed recommended cold tire pressures by 4 to 6 psi (28 to 41 kPa). Do not release air from warm tires to adjust the pressure or the tires will be underinflated.

### **WARNING**

#### **Tire Inflation**

Overinflation or underinflation can reduce tire life, adversely affect vehicle handling, and lead to sudden tire failure. This could result in loss of vehicle control and potential injury.

#### **Checking tire inflation pressure**

Check your tires once a month or more.

Use a good quality gauge to check tire pressure. You cannot tell if your tires are properly inflated simply by looking at them. Radial tires may look properly inflated even when they're underinflated.

Check the tire's inflation pressure when the tires are cold. "Cold" means your vehicle has been sitting or at least three hours or driven no more than 1 mile (1.6 km).

1. Remove the valve cap from the tire valve stem.
2. Press the tire gauge firmly onto the valve to get a pressure measurement. If the cold tire inflation pressure matches the recommended pressure on the tire and loading information label, no further adjustment is necessary.
3. If the pressure is low, add air until you reach the recommended amount.
4. If you overfill the tire, release air by pushing on the metal stem in the center of the tire valve.
5. Recheck the tire pressure with the tire gauge.
6. Be sure to put the valve caps back on the valve stems. They help prevent leaks by keeping out dirt and moisture.

Inspect your tires frequently for proper inflation as well as wear and damage. Always use a tire pressure gauge.

Tires with too much or too little pressure wear unevenly causing poor handling, loss of vehicle control, and sudden tire failure leading to accidents, injuries, and even death. The recommended cold tire pressure for your vehicle can be found in this manual and on the tire label located on the driver's side center pillar.

## Tire rotation

To equalize tread wear, it is recommended that the tires be rotated every 6,000 miles (10,000 km) (For Turbo engine), 7,500 miles (12,000 km) (For Non Turbo engine) or sooner if irregular wear develops.

During rotation, check the tires for correct balance.

When rotating tires, check for uneven wear and damage. Abnormal wear is usually caused by incorrect tire pressure, improper wheel alignment, out of-balance wheels, severe braking or severe cornering. Look for bumps or bulges in the tread or side of tire. Replace the tire if you find either of these conditions. Replace the tire if fabric or cord is visible. After rotation, be sure to bring the front and rear tire pressures to specification and check lug nut tightness.

Refer to "Tires and wheels" on page 8-5.

Disc brake pads should be inspected for wear whenever tires are rotated.

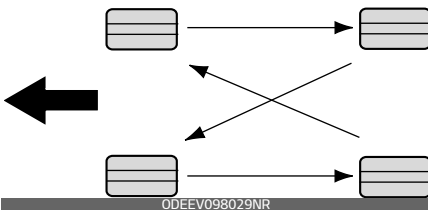

Rotate radial tires that have an asymmetric tread pattern only from front to rear and not from right to left.

## ⚠ WARNING

### Mixing tires

Do not mix bias ply and radial ply tires under any circumstances. This may cause unusual handling characteristics.

### Wheel alignment and tire balance

The wheels on your vehicle were aligned and balanced carefully at the factory to give you the longest tire life and best overall performance.

In most cases, you will not need to have your wheels aligned again. However, if you notice unusual tire wear or your vehicle pulling one way or the other, the alignment may need to be reset.

If you notice your vehicle vibrating when driving on a smooth road, your wheels may need to be rebalanced.

## ⚠ CAUTION

### Wheel weight

Improper wheel weights can damage your vehicle's aluminum wheels. Use only approved wheel weights.

## Tire replacement

If the tire is worn evenly, a tread wear indicator will appear as a solid band across the tread.



This shows there is less than 1/16 inch (1.6 mm) of tread left on the tire. Replace the tire when this happens.

Do not wait for the band to appear across the entire tread before replacing the tire.

The ABS (Anti-lock Brake System) works by comparing the speed of the wheels. The tire size affects wheel speed. When replacing tires, all 4 tires must use the same size originally supplied with the vehicle. Using tires of a different size can cause the ABS (Anti-lock Brake System) and ESC (Electronic Stability Control) to work irregularly.

It is best to replace all four tires at the same time. If that is not possible, or necessary, then replace the two front or two rear tires as a pair.

Replacing just one tire can seriously affect your vehicle's handling.

### \* NOTICE

We recommend that when replacing tires, use the same originally supplied with the vehicles. If not, that affects driving performance.

## Wheel replacement

When replacing the metal wheels for any reason, make sure the new wheels are equivalent to the original factory units in diameter, rim width and offset.

A wheel that is not the correct size may adversely affect wheel and bearing life, braking and stopping abilities, handling characteristics, ground clearance, body-to-tire clearance, snow chain clearance, speedometer and odometer calibration, headlight aim and bumper height.

### ⚠ CAUTION

## Wheels

Wheels that do not meet Kia specifications may fit poorly and result in damage to the vehicle or unusual handling and poor vehicle control.

## Tire traction

Tire traction can be reduced if you drive on worn tires, tires that are improperly inflated or on slippery road surfaces.

Tires should be replaced when tread wear indicators appear. Slow down whenever there is rain, snow or ice on the road to reduce the possibility of losing control of the vehicle.

## Tire maintenance

In addition to proper inflation, correct wheel alignment helps to decrease tire wear.

If you find a tire is worn unevenly, have your dealer check the wheel alignment.

When you have new tires installed, make sure they are balanced. This will increase vehicle ride comfort and tire life. Additionally, a tire should always be rebalanced if it is removed from the wheel.

## Tire sidewall labeling

This information identifies and describes the fundamental characteristics of the tire and also provides the tire identification number (TIN) for safety standard certification.

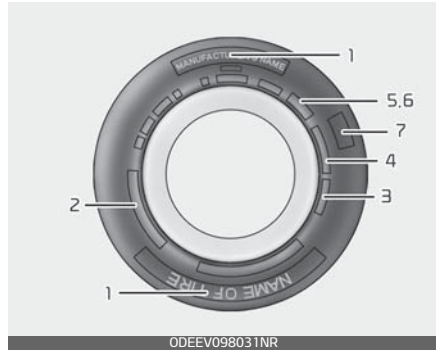

The TIN can be used to identify the tire in case of a recall.

### 1. *Manufacturer or brand name*

Manufacturer or Brand name is shown.

### 2. *Tire size designation*

A tire's sidewall is marked with a tire size designation. You will need this information when selecting replacement tires for your vehicle. The following explains what the letters and numbers in the tire size designation mean.

Example tire size designation:

(These numbers are provided as an example only; your tire size designator could vary depending on your vehicle.)

### **P235/65R17 108T**

- P: Applicable vehicle type (tires marked with the prefix "P" are intended for use on passenger

vehicles or light trucks; however, not all tires have this marking).

- 235: Tire width in millimeters.
- 65: Aspect ratio. The tire's section height as a percentage of its width.
- R: Tire construction code (Radial).
- 17: Rim diameter in inches.
- 108: Load Index, a numerical code associated with the maximum load the tire can carry.
- T: Speed Rating Symbol. See the speed rating chart in this section for additional information.

### Wheel size designation

Wheels are also marked with important information that you need if you ever have to replace one. The following explains what the letters and numbers in the wheel size designation mean.

Example wheel size designation:

#### **7.0JX17**

- 7.0: Rim width in inches.
- J: Rim contour designation.
- 17: Rim diameter in inches.

### Tire speed ratings

The chart below lists many of the different speed ratings currently being used for passenger vehicle tires. The speed rating is part of the tire size designation on the sidewall of the tire. This symbol corresponds to that tire's designed maximum safe operating speed.

Speed Rating Symbol	Maximum Speed
S	112 mph (180 km/h)
T	118 mph (190 km/h)
H	130 mph (210 km/h)
V	149 mph (240 km/h)
Z	Above 149 mph (240 km/h)

### **3. Checking tire life (TIN: Tire Identification Number)**

Any tires that are over 6 years old, based on the manufacturing date, should be replaced by new ones. You can find the manufacturing date on the tire sidewall (possibly on the inside of the wheel), displaying the DOT Code. The DOT Code is a series of numbers on a tire consisting of numbers and English letters. The manufacturing date is designated by the last four digits (characters) of the DOT code.

#### **DOT: XXXX XXXX 0000**

The front part of the DOT means a plant code number, tire size and tread pattern and the last four numbers indicate week and year manufactured.

For example:

DOT XXXX XXXX 1620 represents that the tire was produced in the 16th week of 2020.



**WARNING**

### Tire age

Replace tires within the recommended time frame. Failure to replace tires as recommended can result in sudden tire failure, which could lead to a loss of control and an accident.

---

### ***4. Tire ply composition and material***

The number of layers or plies of rubber-coated fabric in the tire. Tire manufacturers also must indicate the materials in the tire, which include steel, nylon, polyester, and others. The letter "R" means radial ply construction; the letter "D" means diagonal or bias ply construction; and the letter "B" means belted-bias ply construction.

### ***5. Maximum permissible inflation pressure***

This number is the greatest amount of air pressure that should be put in the tire. Do not exceed the maximum permissible inflation pressure. Refer to "Tire and loading information label" on page 5-144 for recommended inflation pressure.

### ***6. Maximum load rating***

This number indicates the maximum load in kilograms and pounds that

can be carried by the tire. When replacing the tires on the vehicle, always use a tire that has the same load rating as the factory installed tire.

### ***7. Uniform tire quality grading***

Quality grades can be found where applicable on the tire sidewall between tread shoulder and maximum section width.

For example:

- TREADWEAR 200
- TRACTION AA
- TEMPERATURE A

Tires degrade over time, even when they are not being used. Regardless of the remaining tread, we recommend that tires be replaced after approximately six (6) years of normal service. Heat caused by hot climate or frequent high loading conditions can accelerate the aging process.

### **Tread wear**

The tread wear grade is a comparative rating based on the wear rate of the tire when tested under controlled conditions on a specified government test course. For example, a tire graded 150 would wear one-and-a-half times ( $1\frac{1}{2}$ ) as well on the government course as a tire graded 100.

The relative performance of tires depends upon the actual conditions

of their use, however, and may depart significantly from the norm due to variations in driving habits, service practices and differences in road characteristics and climate. These grades are molded on the side-walls of passenger vehicle tires. The tires available as standard or optional equipment on your vehicle may vary with respect to grade.

### **Traction – AA, A, B & C**

The traction grades, from highest to lowest, are AA, A, B and C. Those grades represent the tire's ability to stop on wet pavement as measured under controlled conditions on specified government test surfaces of asphalt and concrete. A tire marked C may have poor traction performance.

The traction grade assigned to this tire is based on straight-ahead braking traction tests, and does not include acceleration, cornering, hydroplaning, or peak traction characteristics.

### **Temperature –A, B & C**

The temperature grades are A (the highest), B and C representing the tire's resistance to the generation of heat and its ability to dissipate heat when tested under controlled conditions on a specified indoor laboratory test wheel.

Sustained high temperature can cause the material of the tire to degenerate and reduce tire life, and excessive temperature can lead to sudden tire failure. The grade C cor-

responds to a level of performance which all passenger vehicle tires must meet under the Federal Motor Vehicle Safety Standard No. 109. Grades B and A represent higher levels of performance on the laboratory test wheel than the minimum required by law.

### **Tire terminology and definitions**

Refer to the following for detailed definitions of the terms that are found in the tire description.

**Air Pressure** The amount of air inside the tire pressing outward on the tire. Air pressure is expressed in pounds per square inch (psi) or kilopascal (kPa).

**Accessory Weight** This means the combined weight of optional accessories. Some examples of optional accessories are automatic transmission, power seats, and air conditioning.

**Aspect Ratio** The relationship of a tire's height to its width.

**Belt** A rubber coated layer of cords that is located between the plies and the tread. Cords may be made from steel or other reinforcing materials.

**Bead** The tire bead contains steel wires wrapped by steel cords that hold the tire onto the rim.

**Bias Ply Tire** A pneumatic tire in which the plies are laid at alternate angles less than 90 degrees to the centerline of the tread.

**Cold Tire Pressure** The amount of air pressure in a tire, measured in pounds per square inch (psi) or kilopascals (kPa) before a tire has built up heat from driving.

**Curb Weight** This means the weight of a motor vehicle with standard and optional equipment including the maximum capacity of fuel, oil and coolant, but without passengers and cargo.

**DOT Markings** A code molded into the sidewall of a tire signifying that the tire is in compliance with the U.S. Department of Transportation motor vehicle safety standards. The DOT code includes the Tire Identification Number (TIN), an alphanumeric designator which can also identify the tire manufacturer, production plant, brand and date of production.

**GVWR** Gross Vehicle Weight Rating

**GAWR FRT** Gross Axle Weight Rating for the Front Axle.

**GAWR RR** Gross Axle Weight Rating for the Rear axle.

**Intended Outboard Sidewall** The side of an asymmetrical tire that must

always face outward when mounted on a vehicle.

**Kilopascal (kPa)** The metric unit for air pressure.

**Light truck (LT) tire** A tire designated by its manufacturer as primarily intended for use on lightweight trucks or multipurpose passenger vehicles.

**Load ratings** The maximum load that a tire is rated to carry for a given inflation pressure.

**Load Index** An assigned number ranging from 1 to 279 that corresponds to the load carrying capacity of a tire.

**Maximum Inflation Pressure** The maximum air pressure to which a cold tire may be inflated. The maximum air pressure is molded onto the sidewall.

**Maximum Load Rating** The load rating for a tire at the maximum permissible inflation pressure for that tire.

**Maximum Loaded Vehicle Weight**

The sum of curb weight; accessory weight; vehicle capacity weight; and production options weight.

**Normal Occupant Weight** The number of occupants a vehicle is designed to seat multiplied by 150 pounds (68 kg).

**Occupant Distribution** Designated seating positions.

**Outward Facing Sidewall** The side of an asymmetrical tire that has a particular side that faces outward when mounted on a vehicle. The outward facing sidewall bears white lettering or bears manufacturer, brand, and/or model name molding that is higher or deeper than the same moldings on the inner facing sidewall.

**Passenger (P-Metric) Tire** A tire used on passenger cars and some light duty trucks and multipurpose vehicles.

**Ply** A layer of rubber-coated parallel cords.

**Pneumatic tire** A mechanical device made of rubber, chemicals, fabric and steel or other materials, that, when mounted on an automotive wheel, provides the traction and contains the gas or fluid that sustains the load.

**Production options weight** The combined weight of installed regular production options weighing over 5 lbs. (2.3 kg) in excess of the standard items which they replace, not previously considered in curb weight or accessory weight, including heavy duty brakes, ride levelers, roof rack, heavy duty battery, and special trim.

### **Recommended Inflation Pressure**

Vehicle manufacturer's recommended tire inflation pressure and shown on the tire placard.

**Radial Ply Tire** A pneumatic tire in which the ply cords that extend to the beads are laid at 90 degrees to the centerline of the tread.

**Rim** A metal support for a tire and upon which the tire beads are seated.

**Sidewall** The portion of a tire between the tread and the bead.

**Speed Rating** An alphanumeric code assigned to a tire indicating the maximum speed at which a tire can operate.

**Traction** The friction between the tire and the road surface. The amount of grip provided.

**Tread** The portion of a tire that comes into contact with the road.

**Treadwear Indicators** Narrow bands, sometimes called "wear bars," that show across the tread of a tire when only 2/32 inch (1.6 mm) of tread remains.

**UTQGS** Uniform Tire Quality Grading Standards, a tire information system that provides consumers with ratings for a tire's traction, temperature and treadwear. Ratings are determined by tire manufacturers using government testing proce-

dures. The ratings are molded into the sidewall of the tire.

**Vehicle Capacity Weight** The number of designated seating positions multiplied by 150 lbs. (68 kg) plus the rated cargo and luggage load.

**Vehicle Maximum Load on the Tire** Load on an individual tire due to curb and accessory weight plus maximum occupant and cargo weight.

**Vehicle Normal Load on the Tire** Load on an individual tire that is determined by distributing to each axle its share of the curb weight, accessory weight, and normal occupant weight and driving by 2.

**Vehicle Placard** A label permanently attached to a vehicle showing the original equipment tire size and recommended inflation pressure.

### All season tires

Kia specifies all season tires on some models to provide good performance for use all year round, including snowy and icy road conditions.

All season tires are identified by ALL SEASON and/or M+S (Mud and Snow) on the tire sidewall. Snow tires have better snow traction than all season tires and may be more appropriate in some areas.

### Summer tires

Kia specifies summer tires on some models to provide superior performance on dry roads.

Summer tire performance is substantially reduced in snow and ice. Summer tires do not have the tire traction rating M+S (Mud and Snow) on the tire side wall. If you plan to operate your vehicle in snowy or icy conditions, Kia recommends the use of snow tires or all season tires on all four wheels.

### Snow tires

If you equip your vehicle with snow tires, they should be the same size and have the same load capacity as the original tires.

Snow tires should be installed on all four wheels; otherwise, poor handling may result.

Snow tires should carry 4 psi (28 kPa) more air pressure than the pressure recommended for the standard tires on the tire label on the driver's side of the center pillar, or up to the maximum pressure shown on the tire sidewall, whichever is less.

Do not drive faster than 75 mph (120 km/h) when your vehicle is equipped with snow tires.

## **WARNING**

Do not use summer tires at temperatures below 45 °F (7 °C) or when driving on snow or ice. At temperatures below 45 °F (7 °C), summer tires can lose elasticity, and therefore traction and braking power as well. Change the tires on your vehicle to winter or all-weather tires of the same size as the standard tires of the vehicle. Both types of tires are identified by the M+S (Mud and Snow) marking. Using summer tires at very cold temperatures could cause cracks to form, thereby damaging the tires permanently.

### **Tire chains**

Tire chains, if necessary, should be installed on the front wheels.

Be sure that the chains are installed in accordance with the manufacturer's instructions.

To minimize tire and chain wear, do not continue to use tire chains when they are no longer needed.

- When driving on roads covered with snow or ice, drive at less than 20 mph (30 km/h).
- Use the SAE "S" class or wire chains.
- If you hear noise caused by chains contacting the body, retighten the

chain to avoid contact with the vehicle body.

- To prevent body damage, retighten the chains after driving 0.3~0.6 miles (0.5~1.0 km).
- Do not use tire chains on vehicles equipped with aluminum wheels. In unavoidable circumstance, use a wire type chain.
- Use wire chains less than 0.47 inches (12 mm) to prevent damage to the chain's connection.

### **Radial-ply tires**

Radial-ply tires provide improved tread life, road hazard resistance and smoother high speed ride.

The radial-ply tires used on this vehicle are of belted construction, and are selected to complement the ride and handling characteristics of your vehicle. Radial-ply tires have the same load carrying capacity, as bias-ply or bias belted tires of the same size, and use the same recommended inflation pressure.

Mixing of radial-ply tires with bias-ply or bias belted tires is not recommended. Any combinations of radial-ply and bias-ply or bias belted tires when used on the same vehicle will seriously deteriorate vehicle handling. The best rule to follow is: Identical radial-ply tires should always be used as a set of four.

Longer wearing tires can be more susceptible to irregular tread wear. It is very important to follow the tire rotation interval shown in this section to achieve the tread life potential of these tires. Cuts and punctures in radial-ply tires are repairable only in the tread area, because of sidewall flexing. Consult your tire dealer for radial-ply tire repairs.

### Low aspect ratio tire (if equipped)

Low aspect ratio tires, whose aspect ratio is lower than 50, are provided for sporty looks.

Because the low aspect ratio tires are optimized for handling and braking, it may be more uncomfortable to ride in and there is more noise compare with normal tires.

### CAUTION

Because the sidewall of the low aspect ratio tire is shorter than the normal, the wheel and tire of the low aspect ratio tire is easier to be damaged. So, follow the instructions below.

- When driving on a rough road or off road, drive cautiously because tires and wheels may be damaged. And after driving, inspect tires and wheels.
- When passing over a pothole, speed bump, manhole, or curb

stone, drive slowly so that the tires and wheels are not damaged.

- If the tire is impacted, we recommend that you inspect the tire condition or contact an authorized Kia dealer.
  - To prevent damage to the tire, inspect the tire condition and pressure every 1,900 miles (3,000 km).
- 
- It is not easy to recognize the tire damage with your own eyes. But if there is the slightest hint of tire damage, even though you cannot see the tire damage with your own eyes, have the tire checked or replaced because the tire damage may cause air leakage from the tire.
  - If the tire is damaged by driving on a rough road, off road, pothole, manhole, or curb stone, it will not be covered by the warranty.
  - You can find out the tire information on the tire sidewall.

## Fuses

A vehicle's electrical system is protected from electrical overload damage by fuses.

Blade type



Cartridge type



Multi fuse

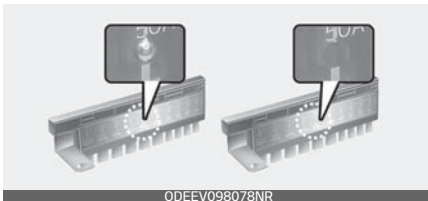

BFT



\* Left side: Normal, Right side: Blown

This vehicle has 2 (or 3) fuse panels, one located in the driver's side panel bolster, the other in the engine compartment near the battery.

If any of your vehicle's lights, accessories, or controls do not work, check the appropriate circuit fuse. If a fuse has blown, the element inside the fuse will melt.

If the electrical system does not work, first check the driver's side fuse panel.

If the replacement fuse blows, this indicates an electrical problem. Avoid using the system involved and immediately consult an authorized Kia dealer.

Three kinds of fuses are used: blade type for lower amperage rating, cartridge type, and multi fuse for higher amperage ratings.

### **⚠ WARNING**

#### Fuse replacement

- Never replace a fuse with anything but another fuse of the same rating.
- A higher capacity fuse could cause damage and possibly a fire.
- Never install a wire or aluminum foil instead of the proper fuse - even as a temporary repair. It may cause extensive wiring damage and a possible fire.



- Do not arbitrarily modify or add-on electric wiring to the vehicle.

### \* NOTICE

- When replacing a fuse, Turn ignition to the OFF position and turn off switches of all electrical devices; then remove the battery (-) terminal.
- The actual fuse/relay panel label may differ from equipped items.

### ⚠ WARNING

#### Electrical Fire

Always ensure replacements fuses and relays are securely fastened when installed. Failure to do so can result in a vehicle fire.

Do not remove fuses, relays and terminals fastened with bolts or nuts. The fuses, relays and terminals may be fastened incompletely, and it may cause a possible fire. If fuses, relays and terminals fastened with bolts or nuts are blown, we recommend that you consult with an authorized Kia dealer.

### ⚠ CAUTION

When replacing a blown fuse or relay, make sure the new fuse or relay fits tightly into the clips. Failure to tightly install the fuse or

relay may cause damage to the wiring and electric systems.

### ⚠ CAUTION

- Do not input any other objects except fuses or relays into fuse/relay terminals, such as a screwdriver or wiring. It may cause contact failure and system malfunction.
- Do not plug in screwdrivers or aftermarket wiring into the terminal originally designed for fuses and relays only. The electrical system and wiring of the vehicle interior may be damaged or burned due to contact failure.
- If you directly connect the wire on the taillight or replace the bulb which is over the regulated capacity to install trailers etc., the inner junction block can get burned.

### ⚠ WARNING

#### Electrical wiring repairs

All electrical repairs should be performed by authorized Kia dealerships using approved Kia parts. Using other wiring components, especially when retrofitting multimedia or theft alarm system, car phone or radio may cause vehicle damage and increase the risk of a vehicle fire.

## \* NOTICE

**Remodeling Prohibited**

Do not rewire your vehicle in any way as doing so may affect the performance of several safety features in your vehicle. Rewiring your vehicle may also void your warranty and cause you to be responsible for any subsequent vehicle damage which may result.

**Replacing inner panel fuse**

1. Turn the ignition switch and all other switches off.
2. Open the fuse panel cover.



3. Pull the suspected fuse straight out. Use the removal tool provided on the engine fuse panel cover.

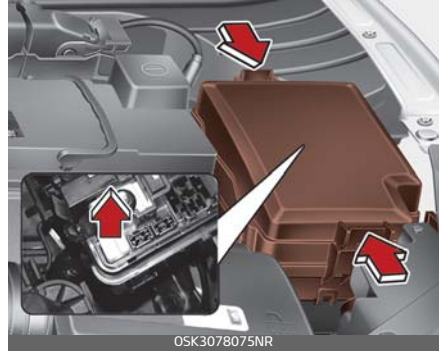

4. Check the removed fuse; replace it if it is blown.
5. Push in a new fuse of the same rating, and make sure it fits tightly in the clips.

If it fits loosely, consult an authorized Kia dealer.

If you do not have a spare, use a fuse of the same rating from a circuit you may not need for operating the vehicle, such as the power outlet fuse.

If the head lamp, turn signal lamp, stop signal lamp, fog lamp, DRL, tail lamp, HMSL do not work and the fuses are OK, check the fuse panel in the engine compartment. If a fuse is blown, it must be replaced.

## \* NOTICE

If the headlamp, fog lamp, turn signal lamp, or tail lamp malfunctions even without any problem to the lamps, have the vehicle checked by an authorized Kia dealer for assistance.

## Replacing engine compartment fuse

1. Turn the Turn ignition and all other switches off.
2. Remove the fuse panel cover by pressing the tab and pulling the cover up.

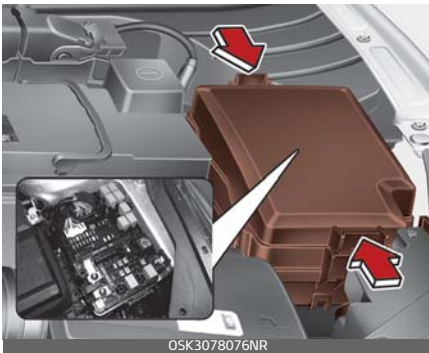

3. Check the removed fuse; replace it if it is blown. To remove or insert the fuse, use the fuse puller in the engine compartment fuse panel.
4. Push in a new fuse of the same rating, and make sure it fits tightly in the clips. If it fits loosely, consult an authorized Kia dealer.

## ⚠ CAUTION

Always securely install the fuse panel cover in the engine compartment to protect against electrical failure which may occur from water contact. Listen for the audible clicking sound to ensure fuse panel cover is securely fastened.

## Multi fuse

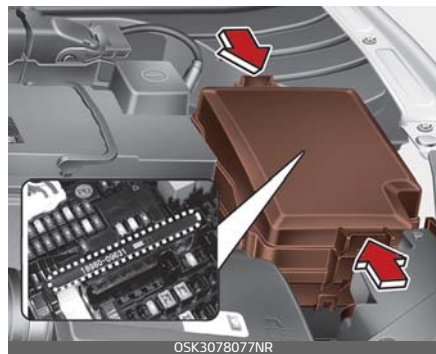

If the multi fuse is blown, it must be removed as follows:

1. Turn the ignition switch and all other switches off.
2. Disconnect the negative battery cable.
3. Remove the nuts shown in the picture above.
4. Replace the fuse with a new one of the same rating.
5. Reverse these steps to reinstall the multi fuse.

### \* NOTICE

Do not disassemble nor assemble the multi fuse when it is secured with nuts and bolts. Incorrect or partial assembly torque may cause a fire. Have the vehicle checked by an authorized Kia dealer.

### Main fuse

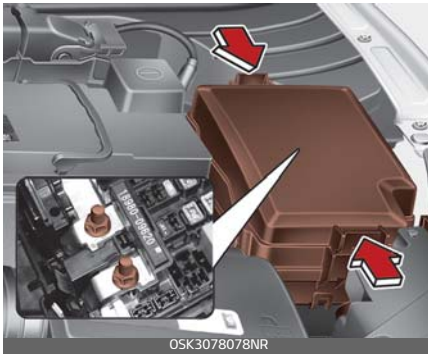

If the main fuse is blown, it must be removed as follows:

1. Turn the ignition switch and all other switches off.
2. Disconnect the negative battery cable.
3. Remove the nuts shown in the picture above.
4. Replace the fuse with a new one of the same rating.
5. Reverse these steps to reinstall the multi fuse.

### \* NOTICE

The electronic system may not function correctly even when the engine compartment and internal fuse box's individual fuses are not disconnected. In such a case, the cause of the problem may be disconnection of the main fuse (BFT type), which is located inside the positive battery terminal (+) cap. Since the main fuse is designed more intricately than other parts, have the vehicle checked by an authorized Kia dealer.

### \* NOTICE

Do not disassemble nor assemble the multi fuse when it is secured with nuts and bolts. Incorrect or partial assembly torque may cause a fire. Have the vehicle checked by an authorized Kia dealer.

### **Battery fuse**

If the battery fuse is blown, it must be removed as follows:

1. Disconnect the negative battery cable.
2. Remove the nuts shown in the picture below.

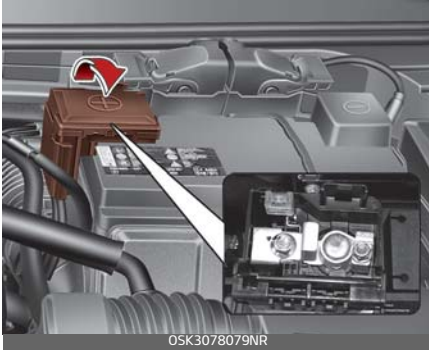

3. Replace the fuse with a new one of the same rating.
4. Reinstall in the reverse order of removal.

#### **\* NOTICE**

If the battery fuse is blown, have the vehicle checked by an authorized Kia dealer.

#### **⚠ CAUTION**

Visually inspect the battery cap to ensure it is securely closed. If the battery cap is not securely closed, moisture may enter the system and damage the electrical components.

### **Fuse/relay panel description**

Inside the fuse/relay panel covers, you can find the fuse/relay label describing fuse/relay name and capacity.

**Driver's side fuse panel**



OSK3078012NR

**\* NOTICE**

Not all fuse panel descriptions in this manual may be applicable to your vehicle. It is accurate at the time of printing. When you inspect the fuse panel in your vehicle, refer to the fuse panel label on the inside of the fuse cover. This diagram will provide you with the specific information for your vehicles.

SPARE	4A	MIDDLE	15A	MULTI MEDIA	10A	IGL	20A	WASHER	15A	MOPS	10A	CLUSTER	10A	2	10A	1	10A	AR BAG	10A		
1	MEMORY	10A	SPARE	5	MIDDLE	10A	1	WIPER FRT	10A	7	MIDDLE	8	MIDDLE	10A	AV BAG ND	10A	SPARE	10A	10A		
1	MIDDLE	2	MEMORY	10A	WIPER RR	15A	1	A/C	15A	2	WIPER FRT	20A	SUNROOF	START	6	MIDDLE	2	A/C	10A		
TALGATE OPEN	20A	1	HEATER RR	20A	DOOR LOCK	20A	2	AR BAG	10A	SPARE	20A	SPARE	20A	SPARE	15A	2	MIDDLE	10A	SPARE	15A	
R WINDOW RH	15A	HEATED MIRROR	10A	1	BU	15A														POWER OUTLET	20A
R WINDOW LH	15A	1	HEATER FRT	20A	1	BRAKE SWITCH	10A														
P/SEAT DRV	15A	AMP	15A	P/SEAT PASS	15A																

91990-K0030  
 USE THE DESIGNATED FUSE ONLY  
 UTILISEZ SEULEMENT LE FUSIBLE DÉSIGNÉS 

OSK3070068NR

Refer to the following table for a description of the fuse.

Description	Fuse rating	Protected component
POWER OUTLET	20 A	Front Power Outlet LH
MODULE2	10 A	Sound Mood Lamp, E/R Junction Block (Power Outlet Relay), Audio, Front/Rear USB Charger, Wireless Charger, AMP, Driver/Passenger Door Mood Range Lamp, Power Outside Mirror Switch, A/V & Navigation Head Unit, IBU
HEATED MIRROR	10 A	Driver/Passenger Power Outside Mirror, A/C Control Module, ECM
IG1	25 A	PCB Block (Fuse – ABS3, ECU5, SENSOR4, TCU2)
AIR BAG1	15 A	Occupant Detection Sensor, SRS Control Module
A/BAG IND	7.5 A	Instrument Cluster, A/C Control Module
IBU2	7.5 A	IBU
CLUSTER	7.5 A	HUD, Instrument Cluster
MDPS	7.5 A	MDPS Unit
MODULE3	7.5 A	ATM Shift Lever, Stop Lamp Switch
MODULE4	7.5 A	Multifunction Camera, IBU, Smart Cruise Control Radar, Crash Pad Switch, Blind-Spot Collision Warning Unit LH/RH
MODULE5	10 A	Front Air Ventilation Seat Control Module, A/C Control Module, A/V & Navigation Head Unit, Front Seat Warmer Control Module, ATM Shift Lever Indicator, Rear Seat Warmer Module, Audio, ECM (Electric chromic mirror)
A/C1	7.5 A	E/R Junction Block (Blower Relay, PTC Heater #1/#2 Relay), A/C Control Module
WIPER FRT2	25 A	Front Wiper Motor, PCB Block (Front Wiper (Low) Relay)
WIPER RR	15 A	Rear Wiper Motor, ICM Relay Box (Rear Wiper Relay)
WASHER	15 A	Multifunction Switch
MODULE6	7.5 A	IBU
MODULE7	7.5 A	Front/Rear Seat Warmer Control Module, Front Air Ventilation Seat Control Module, Front Heated Box (Front Heated LH Relay)
WIPER FRT1	10 A	Front Wiper Motor, PCB Block (Front Wiper (Low) Relay), IBU, ECM/PCM
A/C2	10 A	ECM/PCM, A/C Control Module, Blower Resistor, Blower Motor, E/R Junction Block (Blower Relay)
START	7.5 A	[W/O Smart Key & IMMO.] ICM Relay Box (Burglar Alarm Relay), [With Smart Key or IMMO.] Transmission Range Switch, IBU, ECM/PCM, E/R Junction Block (Start Relay)
P/WINDOW LH	25 A	Power Window LH Relay, Driver Safety Power Window Module

Description	Fuse rating	Protected component
P/WINDOW RH	25 A	Power Window RH Relay, Passenger Safety Power Window Module
TAILGATE OPEN	10 A	Tail Gate Open Relay
SUNROOF	20 A	Sunroof Motor
AMP	25 A	[W/O ISG] AMP, [With ISG] DC-DC Converter
S/HEATER FRT	20 A	Front Seat Warmer Control Module, Front Air Ventilation Seat Control Module
P/SEAT (DRV)	25 A	POWER SEAT MODULE (DRV)
P/SEAT (PASS)	25 A	POWER SEAT MODULE (PASS)
S/HEATER RR	20 A	Rear Seat Warmer Control Module
DOOR LOCK	20 A	Door Lock/Unlock Relay, ICM Relay Box (T/Turn Unlock Relay)
BRAKE SWITCH	10 A	Stop Lamp Switch, IBU
IBU1	15 A	IBU
AIR BAG2	10 A	SRS Control Module
MODULE1	7.5 A	Hazard Switch, Key Interlock Solenoid, Rain Sensor, Data Link Connector
MEMORY1	10 A	Instrument Cluster, A/C Control Module, HUD
MULTI MEDIA	15 A	Audio, A/V & Navigation Head Unit, DC-DC Converter





Refer to the following table for a description of the fuse.

Fuse Name	Fuse rating	Circuit Protected
ALT	150 A (G4FJ) 180 A (G4NH)	Alternator, E/R Junction Block (Fuse - VACUUM PUMP, OIL PUMP, POWER OUTLET 1), ESC (Electronic Stability Control)1, ESC (Electronic Stability Control)2)
MDPS	80 A	MDPS (Motor Driven Power Steering) Unit
B+5	60 A	PCB (Printed Circuit Board) Block (Engine Control Relay, Fuse - ECU3, ECU4, HORN, A/C)
B+2	60 A	ICU Junction Block (IPS Control Module)
B+3	60 A	ICU Junction Block (IPS Control Module)
B+4	50 A	ICU Junction Block (Fuse - P/WINDOW LH, P/WINDOW RH, TAILGATE OPEN, SUNROOF, AMP, S/HEATER FRT, P/SEAT (DRV), P/SEAT (PASS)
COOLING FAN	60 A	[G4FH] Cooling Fan #1 Relay
REAR HEATER	40 A	Rear Heater Relay
BLOWER	40 A	Blower Relay
IG1	40 A	[W/O Smart Key] Ignition Switch, [With Smart Key] E/R Junction Block (PDM (ACC) #2 Relay, PDM (IG1) #3 Relay)
IG2	40 A	[W/O Smart Key] Ignition Switch, Start #1 Relay, [With Smart Key] E/R Junction Block (PDM (IG2) #4 Relay), Start #1 Relay
PTC HEATER 1	50 A	PTC Heater #1 Relay
PTC HEATER 2	50 A	PTC Heater #2 Relay
ABS1	40 A	ESC (Electronic Stability Control) Module, ABS (Anti-lock Brake System) Control Module
ABS2	40 A	ESC (Electronic Stability Control) Module, ABS (Anti-lock Brake System) Control Module
POWER OUTLET 1	40 A	Power Outlet Relay
POWER OUTLET 2	20 A	Front Power Outlet RH
POWER OUTLET 3	20 A	Rear Power Outlet
OIL PUMP	40 A	Electronic Oil Pump
VACUUM PUMP	20 A	Electric Vacuum Pump
TCU1	15 A	TCM (Transmission Control Module)
H/LAMP HI	10 A	Head Lamp (High) Relay
FUEL PUMP	20 A	Fuel Pump Relay
COOLING FAN	40 A	[G4NH] Cooling Fan #1/#2 Relay
B+1	40 A	ICU Junction Block (Long Term Load Latch Relay, Fuse - BRAKE SWITCH, MODULE 1, IBU 1, AIR BAG2, DOOR LOCK, S/HEATER RR)
DCT1	40 A	TCM (Transmission Control Module)

Fuse Name	Fuse rating	Circuit Protected
DCT2	40 A	TCM (Transmission Control Module)
ECU1	20A	[GAMMA 1.6L T-GDI] ECM (Engine Control Module) [NU 2.0L MPI] PCM (Power train Control Module)
ECU3	15 A	[GAMMA 1.6L T-GDI] ECM (Engine Control Module) [NU 2.0L MPI] PCM (Power train Control Module)
ECU4	15 A	[GAMMA 1.6L T-GDI] ECM (Engine Control Module) [NU 2.0L MPI] PCM (Power train Control Module)
HORN	15 A	Horn Relay
A/C	10 A	A/C COMP Relay
IGN COIL	20 A	Ignition Coil #1/#2/#3/#4
SENSOR3	10 A	E/R Junction Block (Fuel Pump Relay)
INJECTOR	15 A	[NU 2.0L MPI] Injector #1/#2/#3/#4
ECU2	10 A	[GAMMA 1.6L T-GDI] ECM (Engine Control Module)
SENSOR1	15 A	Oxygen Sensor (Up/Down)
SENSOR2	10 A	A/C COMP Relay, Canister Close Valve, [GAMMA 1.6L T-GDI] Oil Control Valve #1/#2, Purge Control Solenoid Valve, E/R Junction Block (Cooling Fan #1 Relay), Turbo Recirculation Valve [NU 2.0L MPI] Oil Control Valve #1/ #2/ #3, Purge Control Solenoid Valve, Variable Intake Solenoid Valve, Elec Thermostat, E/R Junction Block (Cooling Fan #1/#2)
ABS3	10 A	ESC (Electronic Stability Control) Module, ABS (Anti-lock Brake System) Control Module, Data Link Connector, Multipurpose Check Connector
ECU5	10 A	[GAMMA 1.6L T-GDI] ECM (Engine Control Module) [NU 2.0L MPI] PCM (Power train Control Module)
SENSOR4	15 A	[GAMMA 1.6L T-GDI] Electric Vacuum Pump [NU 2.0L MPI] Electronic Oil Pump
TCU2	15 A	[GAMMA 1.6L T-GDI] TCM (Transmission Control Module), Transmission Range Switch [NU 2.0L MPI] Transmission Range Switch

Refer to the following table for the relay type.

Relay Name	Type
PTC HEATER 2 Relay	MICRO
COOLING FAN 2 Relay	MICRO
PDM 3 (IG1) Relay	MICRO
START #1 Relay	MICRO
HEAD LAMP HI Relay	MICRO
PDM 4 (IG2) Relay	MICRO
FUEL PUMP Relay	MICRO
PDM 2 (ACC) Relay	MICRO
COOLING FAN 1 Relay	MINI
BLOWER Relay	MINI
PTC HEATER 1 Relay	MICRO
REAR DEFPGGER Relay	MICRO
POWER OUTLET Relay	MICRO

**Battery terminal cover**



OSK3078015NR



### \* NOTICE

Not all fuse panel descriptions in this manual may be applicable to your vehicle. It is accurate at the time of printing. When you inspect the fuse panel in your vehicle, refer to the fuse panel label.

## Light bulbs

Light bulbs are installed in various parts of the vehicle to provide lighting inside and outside the vehicle as well as to alert other vehicles.

### Bulb replacement precaution

Please keep extra bulbs on hand with appropriate wattage ratings in case of emergencies.

Refer to "Bulb wattage" on page 8-4.

When changing lamps, first turn off the vehicle at a safe place, firmly apply the parking brake and detach the battery's negative (-) terminal.

### WARNING

#### Working on the lights

Prior to working on the light, firmly apply the parking brake, ensure that the vehicle start/stop button is in OFF position and turn off the lights to avoid sudden movement of the vehicle and burning your fingers or receiving an electric shock.

Use only bulbs of the specified wattage.

### CAUTION

#### Light replacement

Be sure to replace the burned-out bulb with one of the same wattage

rating. Otherwise, it may cause damage to the fuse or electric wiring system.

### CAUTION

#### Headlamp Lens

To prevent damage, do not clean the headlamp lens with chemical solvents or strong detergents.

### NOTICE

- If the light bulb or lamp connector is removed while the lamp is still on, the fuse box's electronic system may log it as a malfunction. Therefore, a lamp malfunction incident may be recorded as a Diagnostic Trouble Code (DTC) in the fuse box.
- It is normal for an operating lamp to flicker momentarily. This is due to a stabilization function of the vehicle's electronic control device. If the lamp lights up normally after momentarily blinking, then it is functioning as normal. However, if the lamp continues to flicker several times or turns off completely, there may be an error in the vehicle's electronic control device. Please have the vehicle checked by an authorized Kia dealer immediately.

### \* NOTICE

We recommend that the headlight aiming be adjusted by an authorized Kia dealer after an accident or after the headlight assembly is reinstalled.

### \* NOTICE

You can find moisture inside the lens of lamps after a car wash or driving in the rain. It is a natural event caused by the temperature difference between the inside and the outside of the lamp and does not mean a problem with its functions. The moisture inside the lamp would disappear if you drive the vehicle with the headlamp turned on, however, the level at which the moisture is removed may differ depending on the size/location/condition of the lamp. If the moisture continues to stay inside the lamp, have the vehicle checked by an authorized Kia dealer.

If you don't have the necessary tools, the correct bulbs and the expertise, consult an authorized Kia dealer. In many cases, it is difficult to replace vehicle light bulbs because other parts of the vehicle must be removed before you can get to the bulb. This is especially true if you have to remove the

headlamp assembly to get to the bulb(s).

Removing/installing the headlamp assembly can result in damage to the vehicle. If non-genuine parts or substandard bulbs are used, it may lead to blowing a fuse or other wiring damages.

Do not install extra lamps or LEDs to the vehicle. If additional lights are installed, it may lead to lamp malfunctions and flickering. Additionally, the fuse box and other wiring may be damaged.

### Light bulb position (Front)

Head lamp - Type A





Head lamp - Type B



- 3. Position lamp/Daytime running lamp (Bulb Type)
- 4. Side marker (Bulb/LED Type)
- 5. Front turn signal lamp (LED Type)
- 6. Headlamp (LED) (High/ Sub Low)
- 7. Headlamp (LED) (Low)
- 8. Position lamp/Daytime running lamp (LED Type)
- 9. Front fog lamp (LED Type)
- 10. Front fog lamp (Bulb Type)

Head lamp - Type C

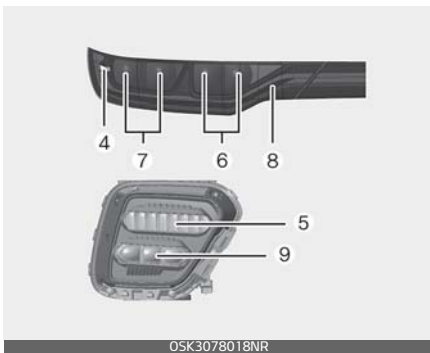

**Light bulb position (Rear)**

Rear combination lamp - Type A



Fog lamp

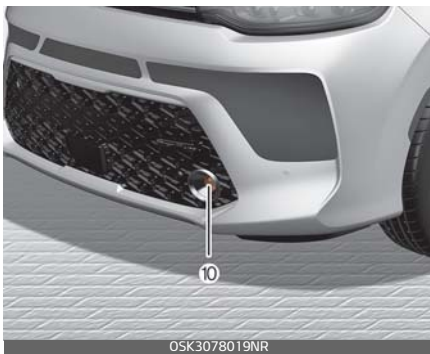

Rear combination lamp - Type B



- 1. Front turn signal lamp (Bulb Type)
- 2. Headlamp (Low/High)

License plate lamp



High mounted stop lamp



1. Tail lamp (Bulb type)
2. Tail and stop lamp (Bulb type)
3. Rear turn signal lamp (Bulb type)
4. Back-up lamp (Bulb type)
5. Side marker (Bulb/LED Type)
6. Tail lamp (LED type)
7. Stop lamp (LED type)
8. License plate lamp (Bulb type)
9. High mounted stop lamp (Bulb or LED type)

Light bulb position (Side)



1. Side repeater lamp (LED type)

Headlamp bulb



**⚠ WARNING**

**Halogen bulbs**

Handle halogen bulbs with care.

- Halogen bulbs contain pressurized gas that will produce flying pieces of glass if broken.
- Always handle them carefully, and avoid scratches and abrasions. If the bulbs are lit, avoid contact with liquids. Never touch the glass with bare hands. Residual oil may

cause the bulb to overheat and burst when lit. A bulb should be operated only when installed in a headlamp.

- If a bulb becomes damaged or cracked, replace it immediately and carefully dispose of it.
- Wear eye protection when changing a bulb. Allow the bulb to cool down before handling it.

### Replacing Headlamp (High/Low beam) bulb (Headlamp Type A,B)

If the Headlamp (High/Low) (1) does not operate, have the vehicle checked by an authorized Kia dealer.

Type A / Type B



### Replacing Position lamp/DRL/Front turn signal lamp bulb (Type A, B)

Type A

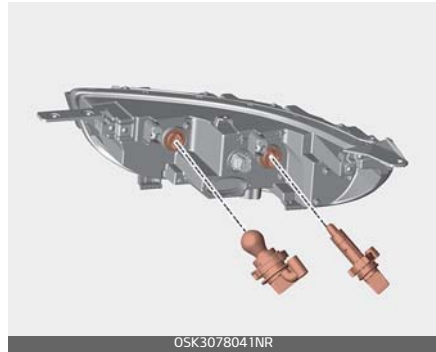

Type B



1. Open the hood.
2. Remove the bulb socket-connector by turning it counterclockwise.
3. Remove the bulb from the lamp assembly.
4. Install a new bulb.
5. Connect the bulb socket-connector.

### Position lamp / Day time running lamp (LED type) replacement (Headlamp Type B)

If the position lamp + DRL (LED) (1) does not operate, have the vehicle checked by an authorized Kia dealer.



The LED lamps cannot be replaced as a single component because it is an integrated unit. The LED lamps have to be replaced with the unit. A skilled technician should check or repair the position lamp + DRL (LED), for it may damage related parts of the vehicle.

### Replacing Headlamp (LED type) (Headlamp Type C)

If the Low/High beam lamp, Day time running lamp/Position lamp does not operate, have the vehicle checked by an authorized Kia dealer.



The LED lamps cannot be replaced as a single component because it is an integrated unit. The LED lamps have to be replaced with the unit.

A skilled technician should check or repair the head lamp (LED), for it may damage related parts of the vehicle.

### Replacing front fog lamp bulb (if equipped)

If the front fog lamp (1) does not operate, have the vehicle checked by an authorized Kia dealer.

Type A

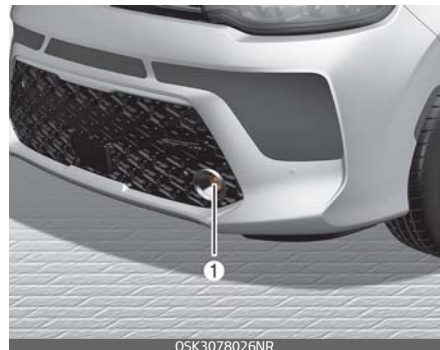

Type B



**Replacing side repeater lamp (LED type) bulb**

If the side repeater lamp (LED), does not operate, have the vehicle checked by an authorized Kia dealer.



The LED lamps cannot be replaced as a single component because it is an integrated unit. The LED lamps have to be replaced with the unit.

A skilled technician should check or repair the side repeater lamp (LED), for it may damage related parts of the vehicle.

**Replacing stop/tail and turn signal lamp (bulb type) bulb (Rear combination lamp Type A)**

1. Open the liftgate.
2. Loosen the lamp assembly retaining screws with a screwdriver.



3. Remove the rear combination lamp assembly from the body of the vehicle.
4. Remove the socket from the assembly by turning the socket counterclockwise until the tabs on the socket align with the slots on the assembly.

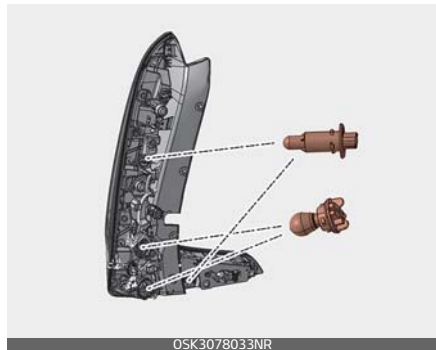

5. Remove the bulb from the socket by pressing it in and rotating it counterclockwise until the tabs on

the bulb align with the slots in the socket.

6. Insert a new bulb by inserting it into the socket and rotating it until it locks into place.
7. Install the socket in the assembly by aligning the tabs on the socket with the slots in the assembly and turning the socket clockwise.
8. Reinstall the lamp assembly to the body of the vehicle.

### Replacing tail/back-up lamp bulb (Rear combination lamp Type A)

1. Open the liftgate.
2. Remove the service cover assembly to the body of the vehicle. (Loosen the lamp assembly retaining screws and remove the lamp assembly from the body of the vehicle for back-up lamp)

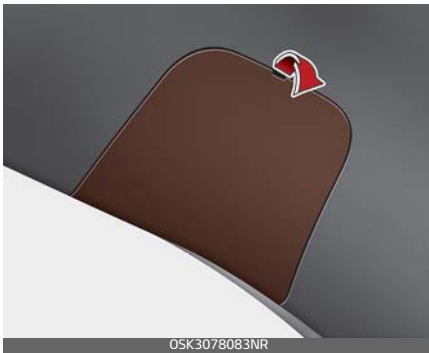

3. Remove the socket from the assembly by turning the socket counterclockwise until the tabs on the socket align with the slots on the assembly.

Tail lamp



Back-up lamp



4. Remove the bulb from the socket by pressing it in and rotating it counterclockwise until the tabs on the bulb align with the slots in the socket. Pull the bulb out of the socket.
5. Insert a new bulb by inserting it into the socket and rotating it until it locks into place.
6. Install the socket in the assembly by aligning the tabs on the socket with the slots in the assembly. Push the socket into the assembly and turn the socket clockwise.
7. Install the service cover by putting it into the service hole.

### Replacing stop and tail lamp (LED type) bulb (Rear combination lamp Type B)

If the stop and tail lamp (LED) (1,2), does not operate, have the vehicle checked by an authorized Kia dealer.



The LED lamps cannot be replaced as a single component because it is an integrated unit. The LED lamps have to be replaced with the unit.

A skilled technician should check or repair the stop and tail lamp (LED), for it may damage related parts of the vehicle.

### Replacing high mounted stop lamp (LED type) bulb

If the high mounted stop lamp (LED) (1), does not operate, have the vehicle checked by an authorized Kia dealer.



The LED lamps cannot be replaced as a single component because it is an integrated unit. The LED lamps have to be replaced with the unit.

A skilled technician should check or repair the high mounted stop lamp (LED), for it may damage related parts of the vehicle.

### Replacing high mounted stop lamp (bulb type) bulb

1. Open the liftgate.
2. Remove the cover.



3. Loosen the retaining bolts and remove the hose (1).



4. Pull out the bulb-socket from the high mounted stop lamp assembly using the driver.



5. Replace the bulbs by pulling it out from the socket.

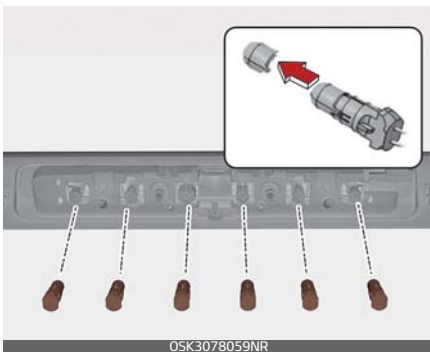

6. Reinstall in the reverse order.

### Replacing license plate lamp bulb

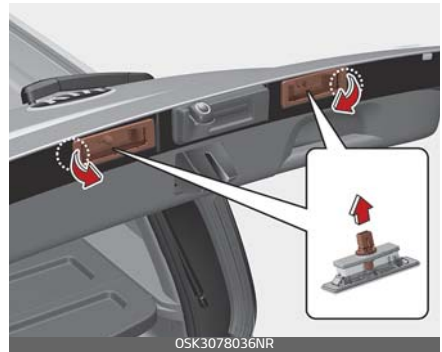

1. Remove the lamp assembly by using a flat-blade screwdriver.
2. Remove the socket from the assembly by turning the socket counterclockwise until the tabs on the socket align with the slots on the assembly.
3. Remove the bulb from bulb-socket by pulling it out.
4. Insert a new bulb by inserting it into the bulb-socket.
5. Install the socket in the assembly by aligning the tabs on the socket with the slots in the assembly. Push the socket into the assembly and turn the socket clockwise.
6. Install the lamp assembly to the body of the vehicle.



## Replacing map lamp (bulb type) bulb



OSK3078084NR

1. Using a flat-blade screwdriver, gently pry the lens cover from lamp housing.
2. Remove the bulb by pulling it straight out.
3. Install a new bulb in the socket.
4. Align the lens cover tabs with the lamp housing notches and snap the lens into place.

### \* NOTICE

Be careful not to dirty or damage the lens, lens tab, and plastic housings.

## Replacing map lamp (LED type) bulb

If the map lamp (LED) does not operate, have the vehicle checked by an authorized Kia dealer.



OSK3078085NR

The LED lamps cannot be replaced as a single component because they are part of an integrated unit. The LED lamps have to be replaced with the unit.

A skilled technician should check or repair the map lamp (LED), for it may damage related parts of the vehicle.

## Replacing vanity mirror lamp bulb



ODEEV098065NR

**⚠ WARNING****Interior lamps**

Prior to working on the Interior lamps, ensure that the "OFF" button is depressed to avoid burning your fingers or receiving an electric shock.

1. Using a flat-blade screwdriver, gently pry the lamp assembly from interior.
2. Remove the bulb by pulling it straight out.
3. Install a new bulb in the socket.
4. Install the lamp assembly to interior.

**\* NOTICE**

Be careful not to dirty or damage the lens, lens tab, and plastic housings.

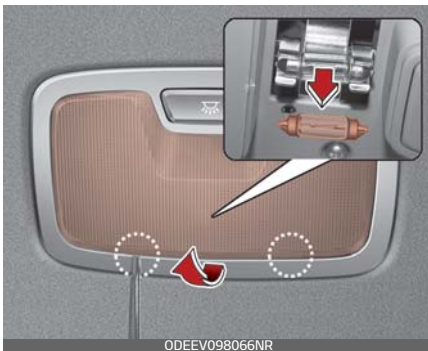
**Replacing room lamp (bulb type) bulb****⚠ WARNING****Interior lamps**

Prior to working on the Interior lamps, ensure that the "OFF" button is depressed to avoid burning your fingers or receiving an electric shock.

1. Using a flat-blade screwdriver, gently pry the lens cover from lamp housing.
2. Remove the bulb by pulling it straight out.
3. Install a new bulb in the socket.
4. Align the lens cover tabs with the lamp housing notches and snap the lens into place.

**\* NOTICE**

Be careful not to dirty or damage the ODE076049 lens, lens tab, and plastic housings.

## Replacing room lamp (LED type) bulb

If the Room lamp (LED) does not operate, have the vehicle checked by an authorized Kia dealer.



The LED lamps cannot be replaced as a single component because they are part of an integrated unit. The LED lamps have to be replaced with the unit.

A skilled technician should check or repair the Room lamp (LED), for it may damage related parts of the vehicle.

## Replacing glove box lamp



1. Using a flat-blade screwdriver, gently pry the lamp assembly from interior.
2. Remove the bulb by pulling it straight out.
3. Install a new bulb in the socket.
4. Install the lamp assembly to interior.

### ⚠ CAUTION

Be careful not to dirty or damage the lens, lens tab, and plastic housings.

## Replacing liftgate room lamp bulb



1. Using a flat-blade screwdriver, gently pry the lens cover from lamp housing.
2. Remove the bulb by pulling it straight out.
3. Install a new bulb in the socket.
4. Align the lens cover tabs with the lamp housing notches and snap the lens into place.

If the Liftgate room lamp (LED) does not operate, have the vehicle checked by an authorized Kia dealer.

The LED lamps cannot be replaced as a single component because they are part of an integrated unit. The LED lamps have to be replaced with the unit.

A skilled technician should check or repair the Liftgate room lamp (LED), for it may damage related parts of the vehicle.

### \* NOTICE

Be careful not to dirty or damage the lens, lens tab, and plastic housings.

## Appearance care

Use the information in the following sections to keep the exterior and interior of your vehicle clean.

### Exterior care

Use the information in the following sections to maintain the exterior of your vehicle. Keeping the exterior clean is not only aesthetically pleasing, but it also helps to prolong the life of the vehicle.

#### *Exterior general caution*

It is very important to follow the label directions when using any chemical cleaner or polish. Read all warning and caution statements that appear on the label.

### *Finish maintenance*

#### Washing

To help protect your vehicle's finish from rust and deterioration, wash it thoroughly and frequently at least once a month with lukewarm or cold water.

If you use your vehicle for off-road driving, you should wash it after each off-road trip. Pay special attention to the removal of any accumulation of salt, dirt, mud, and other foreign materials. Make sure the drain holes in the lower edges of the doors and rocker panels are kept clear and clean.

Insects, tar, tree sap, bird droppings, industrial pollution and similar deposits can damage your vehicle's finish if not removed immediately. Even prompt washing with plain water may not completely remove all these deposits. A mild soap, safe for use on painted surfaces, may be used.

After washing, rinse the vehicle thoroughly with lukewarm or cold water. Do not allow soap to dry on the finish.

After washing the vehicle, test the brakes while driving slowly to see if they have been affected by water. If braking performance is impaired, dry the brakes by applying them lightly while maintaining a slow forward speed.

### CAUTION

- Do not use strong soap, chemical detergents or hot water, and do not wash the vehicle in direct sunlight or when the body of the vehicle is warm.
- Be careful when washing the side windows of your vehicle, especially with high-pressure water. Water may leak through the windows and wet the interior.
- To prevent damage to the plastic parts and lamps, do not clean with chemical solvents or strong detergents.

### High-pressure washing

When using high-pressure washers, make sure to maintain sufficient distance from the vehicle.

Insufficient clearance or excessive pressure can lead to component damage or water penetration.

Do not spray the camera, sensors or its surrounding area directly with a high pressure washer. Shock applied from high pressure water may cause the device to not operate normally.

Do not bring the nozzle tip close to boots (rubber or plastic covers) or connectors as they may be damaged if they come into contact with high pressure water.

### WARNING

After washing the vehicle, test the brakes while driving slowly to see if they have been affected by water. If braking performance is impaired, dry the brakes by applying them lightly while maintaining a slow forward speed.

**⚠ CAUTION****Wetting engine compartment**

- Water washing in the engine compartment including high pressure water washing may cause the failure of electrical circuits located in the engine compartment.
- Never allow water or other liquids to come in contact with electrical/electronic components inside the vehicle as this may damage them.
- To prevent damage to the charging door, make sure to close and lock the vehicle doors when washing (high-pressure washing, automatic car washing, etc.) the vehicle.

**Waxing**

Wax the vehicle when water will no longer bead on the paint. Always wash and dry the vehicle before waxing. Use a good quality liquid or paste wax, and follow the manufacturer's instructions. Wax all

metal trim to protect it and to maintain its luster.

Removing oil, tar, and similar materials with a spot remover will usually strip the wax from the finish. Be sure to re-wax these areas even if the rest of the vehicle does not yet need waxing.

**⚠ CAUTION****Drying vehicle**

- Wiping dust or dirt off the body with a dry cloth will scratch the finish.
- Do not use steel wool, abrasive cleaners, acid detergents or strong detergents containing high alkaline or caustic agents on chrome-plated or anodized aluminum parts. This may result in damage to the protective coating and cause discoloration or paint deterioration.

***Finish damage repair***

Deep scratches or stone chips in the painted surface must be repaired promptly. Exposed metal will quickly rust and may develop into a major repair expense.

**\* NOTICE**

If your vehicle is damaged and requires any metal repair or replacement, be sure the body shop

applies anti-corrosion materials to the parts repaired or replaced.

---

### ***Bright-metal maintenance***

To remove road tar and insects, use a tar remover, not a scraper or other sharp object.

To protect the surfaces of bright metal parts from corrosion, apply a coating of wax or chrome preservative and rub to a high luster.

During winter weather or in coastal areas, cover the bright metal parts with a heavier coating of wax or preservative. If necessary, coat the parts with non-corrosive petroleum jelly or other protective compound.

### ***Underbody maintenance***

Road salt and other corrosive chemicals are used in cold weather states to melt snow and prevent ice accumulation. If these chemicals are not regularly removed, they will corrode the vehicle underbody and over time damage fuel lines, the fuel tank retention system, the vehicle suspension, the exhaust system, and even the body frame.

The National Highway Traffic Safety Administration has warned all vehicle owners of all brands of the need to take the following steps:

- Wash the undercarriage of your vehicle regularly during the winter

and whenever your vehicle has been exposed to such salts or chemicals.

- Do a thorough washing of the undercarriage at the end of the winter.
- Use professional service technicians or governmental inspection stations to annually inspect for corrosion.
- Immediately seek an inspection of your vehicle if you become visually aware of corrosion flaking or scaling or if you become aware of a change in vehicle performance, such as soft or spongy brakes, fluids leaking, impairment of directional control, suspension noises or rattling metal straps.

### ***Aluminum wheel maintenance***

The aluminum wheels are coated with a clear protective finish.

- Do not use any abrasive cleaner, polishing compound, solvent, or wire brushes on aluminum wheels. They may scratch or damage the finish.
- Clean the wheel when it has cooled.
- Use only a mild soap or neutral detergent, and rinse thoroughly with water. Also, be sure to clean the wheels after driving on salted roads. This helps prevent corrosion.

- Avoid washing the wheels with high speed vehicle wash brushes.
- Do not use any alkaline or acid detergents. It may damage and corrode the aluminum wheels coated with a clear protective finish.

### ***Corrosion protection***

#### **Protecting your vehicle from corrosion**

By using the most advanced design and construction practices to combat corrosion, we produce vehicles of the highest quality. However, this is only part of the job. To achieve the long-term corrosion resistance your vehicle can deliver, the owner's cooperation and assistance is also required.

#### **Common causes of corrosion**

The most common causes of corrosion on your vehicle are:

- Road salt, dirt and moisture that is allowed to accumulate underneath the vehicle.
- Removal of paint or protective coatings by stones, gravel, abrasion or minor scrapes and dents which leave unprotected metal exposed to corrosion.

#### **High-corrosion areas**

If you live in an area where your vehicle is regularly exposed to corrosive materials, corrosion protection is particularly important. Some

of the common causes of accelerated corrosion are road salts, dust control chemicals, ocean air and industrial pollution.

#### **Moisture breeds corrosion**

Moisture creates the conditions in which corrosion is most likely to occur. For example, corrosion is accelerated by high humidity, particularly when temperatures are just above freezing. In such conditions, the corrosive material is kept in contact with the vehicle's surface by moisture that evaporates slowly. Mud is particularly corrosive because it dries slowly and holds moisture in contact with the vehicle. Although the mud appears to be dry, it can still retain the moisture and promote corrosion.

High temperatures can also accelerate corrosion of parts that are not properly ventilated so the moisture can be dispersed. For all these reasons, it is particularly important to keep your vehicle clean and free of mud or accumulations of other materials. This applies not only to the visible surfaces but particularly to the underside of the vehicle.

#### **To help prevent corrosion**

You can help prevent corrosion from beginning by observing the following:

#### ***Keep your vehicle clean***

The best way to prevent corrosion is to keep your vehicle clean and free



of corrosive materials. Attention to the underside of the vehicle is particularly important.

If you live in a high-corrosion area — where road salts are used, near the ocean, areas with industrial pollution, acid rain, etc.—, you should take extra care to prevent corrosion. In winter, hose off the underside of your vehicle at least once a month and be sure to clean the underside thoroughly when winter is over.

When cleaning underneath the vehicle, give particular attention to the components under the fenders and other areas that are hidden from view. Do a thorough job; just dampening the accumulated mud rather than washing it away will accelerate corrosion rather than prevent it. Water under high pressure and steam are particularly effective in removing accumulated mud and corrosive materials.

When cleaning lower door panels, rocker panels and frame members, be sure that drain holes are kept open so that moisture can escape and not be trapped inside to accelerate corrosion.

### ***Keep your garage dry***

Don't park your vehicle in a damp, poorly ventilated garage. This creates a favorable environment for corrosion. This is particularly true if

you wash your vehicle in the garage or drive it into the garage when it is still wet or covered with snow, ice or mud. Even a heated garage can contribute to corrosion unless it is well ventilated so moisture is dispersed.

### ***Keep paint and trim in good condition***

Scratches or chips in the finish should be covered with "touch-up" paint as soon as possible to reduce the possibility of corrosion. If bare metal is showing through, the attention of a qualified body and paint shop is recommended.

Bird droppings: Bird droppings are highly corrosive and may damage painted surfaces in just a few hours. Always remove bird droppings as soon as possible.

### ***Don't neglect the interior***

Moisture can collect under the floor mats and carpeting and cause corrosion. Check under the mats periodically to be sure the carpeting is dry. Use particular care if you carry fertilizers, cleaning materials or chemicals in the vehicle.

These should be carried only in proper containers and any spills or leaks should be cleaned up, flushed with clean water and thoroughly dried.

## Interior care

Use the information in the following sections to maintain the interior of your vehicle.

### *Interior general precautions*

Prevent chemicals such as perfume, cosmetic oil, sun cream, hand cleaner, and air freshener from contacting the interior parts because they may cause damage or discoloration. If they do contact the interior parts, wipe them off immediately. If necessary, use a vinyl cleaner, see product instructions for correct usage.

### CAUTION

#### **Electrical components**

Never allow water or other liquids to come in contact with electrical/electronic components inside the vehicle as this may damage them.

### CAUTION

#### **Leather**

When cleaning leather products (steering wheel, seats etc.), use neutral detergents or low alcohol content solutions. If you use high alcohol content solutions or acid/alkaline detergents, the color of the leather may fade or the surface may get stripped off.

### *Taking care of leather seats*

- Vacuum the seat periodically to remove dust and sand on the seat. It will prevent abrasion or damage of the leather and maintain its quality.
- Wipe the natural leather seat cover often with dry or soft cloth.
- Sufficient use of a leather protective may prevent abrasion of the cover and helps maintain the color. Be sure to read the instructions and consult a specialist when using leather coating or protective agents.
- Leather with bright colors (beige, cream beige) is easily contaminated and clear in appearance. Clean the seats frequently.
- Avoid wiping with wet cloth. It may cause the surface to crack.

### *Cleaning the leather seats*

Remove all contaminations instantly. Refer to instructions below for removal of each contaminant.

- Cosmetic products (sunscreen, foundation, etc.)
  - Apply cleansing cream on a cloth and wipe the contaminated point. Wipe off the cream with a wet cloth and remove water with a dry cloth.
- Beverages (coffee, soft drink, etc.)

- Apply a small amount of neutral detergent and wipe until contaminations do not smear.
- Oil
  - Remove oil instantly with absorbable cloth and wipe with stain remover for natural leather only.
- Chewing gum
  - Harden the gum with ice and remove gradually.

### ***Fabric seat cover (if equipped)***

Please clean the fabric seats regularly with a vacuum cleaner in consideration of fabric material characteristics. If they are heavily soiled with beverage stains, etc., use a suitable interior cleaner. To prevent damage to seat covers, wipe off the seat covers down to the seams with a large wiping motion and moderate pressure using a soft sponge or microfiber cloth.

Velcro closures on clothing or sharp objects may cause snagging or scratches on the surface of the seats.

Make sure not to rub such objects against the surface.

### ***Cleaning the upholstery and interior trim***

#### **Vinyl**

Remove dust and loose dirt from vinyl with a whisk broom or vacuum cleaner. Clean vinyl surfaces with a vinyl cleaner.

#### **Fabric**

Remove dust and loose dirt from fabric with a whisk broom or vacuum cleaner. Clean with a mild soap solution recommended for upholstery or carpets. Remove fresh spots immediately with a fabric spot cleaner. If fresh spots do not receive immediate attention, the fabric can be stained and its color can be affected. Also, its fire-resistant properties can be reduced if the material is not properly maintained. Using anything but recommended cleaners and procedures may affect the fabric's appearance and fire-resistant properties.

### ***Cleaning the lap/shoulder belt webbing***

Clean the belt webbing with any mild soap solution recommended for cleaning upholstery or carpet. Follow the instructions provided with the soap. Do not bleach or re-dye the webbing because this may weaken it.

### ***Cleaning the interior window glass***

If the interior glass surfaces of the vehicle become fogged (that is, covered with an oily, greasy or waxy film), they should be cleaned with a glass cleaner. Follow the directions on the glass cleaner container.

### **⚠ CAUTION**

#### **Rear window**

Do not scrape or scratch the inside of the rear window. This may result in damage of the rear window defroster grid.

### **Emission control system**

The emission control system of your vehicle is covered by a written limited warranty. Please see the warranty information contained in the Warranty & Consumer Information manual in your vehicle.

Your vehicle is equipped with an emission control system to meet all applicable emission regulations.

There are three emission control systems, as follows.

1. Crankcase emission control system
2. Evaporative emission control system
3. Exhaust emission control system

In order to assure the proper function of the emission control systems, it is recommended that you have your vehicle inspected and maintained by an authorized Kia dealer in accordance with the maintenance schedule in this manual.

#### **Caution for the Inspection and Maintenance Test (With Electronic Stability Control (ESC) system)**

- **To prevent the vehicle from misfiring during dynamometer testing, turn the Electronic Stability Control (ESC) system off by pressing the ESC switch.**
- **After dynamometer testing is completed, turn the ESC system**

**back on by pressing the ESC switch again.**

### 1. Crankcase emission control system

The positive crankcase ventilation system is employed to prevent air pollution caused by blow-by gases being emitted from the crankcase. This system supplies fresh filtered air to the crankcase through the air intake hose. Inside the crankcase, the fresh air mixes with blow-by gases, which then pass through the PCV valve into the induction system.

### 2. Evaporative emission control (including ORVR: Onboard Refueling Vapor Recovery) system

The Evaporative Emission Control System is designed to prevent fuel vapors from escaping into the atmosphere. (The ORVR system is designed to allow the vapors from the fuel tank to be loaded into a canister while refueling at the gas station, preventing the escape of fuel vapors into the atmosphere.)

#### Canister

Fuel vapors generated inside the fuel tank are absorbed and stored in the onboard canister. When the engine is running, the fuel vapors absorbed in the canister are drawn into the surge tank through the purge control solenoid valve.

### Purge Control Solenoid Valve (PCSV)

The purge control solenoid valve is controlled by the Engine Control Module (ECM); when the engine coolant temperature is low during idling, the PCSV closes so that evaporated fuel is not taken into the engine. After the engine warms up during ordinary driving, the PCSV opens to introduce evaporated fuel to the engine.

### 3. Exhaust emission control system

The Exhaust Emission Control System is a highly effective system which controls exhaust emissions while maintaining good vehicle performance.

#### Engine exhaust gas precautions (carbon monoxide)

- Carbon monoxide can be present with other exhaust fumes. Therefore, if you smell exhaust fumes of any kind inside your vehicle, have it inspected and repaired immediately. If you ever suspect exhaust fumes are coming into your vehicle, drive it only with all the windows fully open. Have your vehicle checked and repaired immediately.

#### **WARNING**

#### Exhaust

Engine exhaust gases contain carbon monoxide (CO). Though colorless and odorless, it is dangerous

and could be lethal if inhaled. Follow the instructions on this page to avoid CO poisoning.

- Do not operate the engine in confined or closed areas (such as garages) any more than what is necessary to move the vehicle in or out of the area.
- When the vehicle is stopped in an open area for more than a short time with the engine running, adjust the ventilation system (as needed) to draw outside air into the vehicle.
- Never sit in a parked or stopped vehicle for any extended time with the engine running.
- When the engine stalls or fails to start, excessive attempts to restart the engine may cause damage to the emission control system.

### Operating precautions for catalytic converters

#### **⚠ WARNING**

#### **Catalytic converter**

Keep away from the catalytic converter and exhaust system while the vehicle is running or immediately thereafter. The exhaust and catalytic systems are very hot and may burn you.

#### **⚠ WARNING**

#### **Fire**

- Do not park, idle or drive the vehicle over or near flammable objects, such as grass, vegetation, paper, leaves, etc. A hot exhaust system can ignite flammable items under your vehicle.
- Also, do not remove the heat sink around the exhaust system, do not seal the bottom of the vehicle or do not coat the vehicle for corrosion control. It may present a fire risk under certain conditions.

Your vehicle is equipped with a catalytic converter emission control device.

Therefore, the following precautions must be observed:

- Use only UNLEADED FUEL for gasoline engines.
- Do not operate the vehicle when there are signs of engine malfunction, such as misfire or a noticeable loss of performance.
- Do not misuse or abuse the engine. Examples of misuse are coasting with the ignition off and descending steep grades in gear with the ignition off.
- Do not operate the engine at high idle speed for extended periods (5 minutes or more).
- Do not modify or tamper with any part of the engine or emission control system. All inspections

and adjustments must be made by an authorized Kia dealer.

- Avoid driving with an extremely low fuel level. Running out of fuel could cause the engine to misfire, damaging the catalytic converter.

Failure to observe these precautions could result in damage to the catalytic converter and to your vehicle. Additionally, such actions could void your warranties.

### California perchlorate notice

Perchlorate Material-special handling may apply, See [www.dtsc.ca.gov/hazardouswaste/perchlorate](http://www.dtsc.ca.gov/hazardouswaste/perchlorate).

Notice to California Vehicle Dismantlers: Perchlorate containing materials, such as air bag inflators, seatbelt pre-tensioners and keyless remote entry batteries, must be disposed of according to Title 22 California Code of Regulations Section 67384.10 (a).

# Specifications, Consumer information and Reporting safety defects

Dimensions.....	8-2
Engine .....	8-3
Bulb wattage .....	8-4
Tires and wheels.....	8-5
Gross vehicle weight .....	8-6
Luggage volume.....	8-7
Air conditioning system.....	8-8
Recommended lubricants and capacities .....	8-9
Recommended SAE viscosity number.....	8-10
Vehicle identification number (VIN).....	8-11
Vehicle certification label .....	8-11
Tire specification and pressure label.....	8-12
Engine number .....	8-12
Air conditioner compressor label .....	8-13
Refrigerant label.....	8-13
Consumer Assistance (U.S. only).....	8-14
Electrical Equipment (U.S. only) .....	8-16
Reporting Safety Defects (U.S. only) .....	8-17
Online factory authorized manuals (U.S. only).....	8-18



## Specifications, Consumer information and Reporting safety defects

### Dimensions

Item		Size: in (mm)		
Overall length		165.2 (4,195)		
Overall width		70.9 (1,800)		
Overall height	Without Roof rack	205/60R16	63.0 (1,600)	
		215/55R17	63.5 (1,613)	
		235/45R18	63.6 (1,615)	
	With Roof rack	205/60R16	63.0 (1,600)	
		215/55R17	63.5 (1,613)	
		235/45R18	63.6 (1,615)	
Tread	Front	Gasoline 2.0 MPI	205/60R16	62.0 (1,575)
			215/55R17	61.5 (1,563)
			235/45R18	61.4 (1,559)
		Gasoline 1.6 T-GDI	205/60R16	62.0 (1,576)
			215/55R17	61.6 (1,565)
			235/45R18	61.5 (1,561)
	Rear	205/60R16	62.4 (1,584)	
		215/55R17	61.9 (1,572)	
		235/45R18	61.7 (1,568)	
Wheelbase		102.4 (2,600)		

## Engine

Item	Gasoline 1.6 (T-GDI)	Gasoline 2.0 (MPI)
Displacement: cu in (cc)	97.08 (1591)	121.9 (1999)
Bore x Stroke: in (mm)	3.03 x 3.36 (77 x 85.4)	3.18 x 3.81 (81 x 97.0)
Firing order	1-3-4-2	1-3-4-2
No. of cylinders	4, In-line	4, In-line

## Bulb wattage

Light Bulb		Wattage	Bulb type	
Front	Type A	Headlamp (Low/High)	55/60	H19
	Type B	Headlamp (Low/High)	60	HB3LL
	Type C	Headlamp (Low/High)	LED	LED
	Type A, B	Front turn signal lamps (Bulb)	28W	28/8W
		Front position lamps	5 (LED*)	PY21/5W (LED*)
		Daytime running lamps	21 (LED*)	PY21/5W (LED*)
	Type C	Front fog lamps	LED	LED
		Front turn signal lamps	LED	LED
	Front fog lamps*		55W	HB4
	Side repeater lamps (Outside Mirror)*		5	WY5W
Side repeater lamps (Side Panel)*		5	WY5W	
Rear	Bulb Type	Rear tail/stop lamps	8/28	P28/8W
		Rear tail lamps	5	W5W
	LED Type	Rear stop lamps	LED	LED
		Rear tail lamps	LED	LED
	Rear turn signal lamps		27	PY27W
	Back-up lamps		16	W16W
	High mounted stop lamps		5 (LED*)	W5W (LED*)
	License plate lamps		5	W5W
Interior	Map lamps		10 (LED*)	W10W (LED*)
	Room lamps		10 (LED*)	FESTOON (LED*)
	Vanity mirror lamps		5	FESTOON
	Luggage lamp		10 (LED*)	FESTOON (LED*)

\* If equipped

## Tires and wheels

Item	Tire size	Wheel size	Load Capacity		Speed capacity		Inflation pressure [bar (psi, kPa)]				Wheel lug nut torque lbf.ft (kgf·m, N·m)
			LJ <sup>*2</sup>	kg	SS <sup>*3</sup>	km/h	Normal load <sup>*1</sup>		Maximum load		
							Front	Rear	Front	Rear	
Full size tire	205/60R16	6.5Jx16	92	630	H	210	2.3 (33/230)	2.3 (33/230)	2.5 (36/260)	2.5 (36/260)	79-94 (11-13, 107-127)
	215/55R17	7.0Jx17	94	670	V	240					
	235/45R18	7.5Jx18	94	670	V	240					
Compact spare tire	T125/80D16	4.0Tx16	97	730	M	130	4.2 (60, 420)	4.2 (60, 420)	4.2 (60, 420)	4.2 (60, 420)	

\*1. Normal load: Up to 3 persons

\*2. Load Index

\*3. Speed Symbol

### ⚠ CAUTION

When replacing tires, use the same size as those originally supplied with the vehicle.

Using tires of a different size can damage the related parts or make them work irregularly.

### \* NOTICE

- It is permissible to add 3 psi (21 kPa) to the standard tire pressure specification if colder temperatures are expected soon. Tires typically loose 1 psi (7 kPa) for every 12 °F (-11 °C) temperature drop. If extreme temperature variations are expected, recheck your tire pressure as necessary to keep them properly inflated.

- We recommend that when replacing tires, use the same originally supplied with the vehicles. If not, that affects driving performance.
- When driving in high altitude grades, it is natural for the atmospheric pressure to decrease. Therefore, please check the tire pressure and add more air when necessary. Additionally required tire air pressure per km above sea level: 1.5 psi(10.5 kPa)/km

## Gross vehicle weight

Item	G1.6 (T-GDI)	G2.0 MPI
Gross vehicle weight	7DCT	IVT
lbs. (kg)	4,101 (1,860)	4,023 (1,825)

## Luggage volume

Item	1.6 Engine	2.0 Engine
Luggage volume (SAE) cu ft (l)	Min: 24.2 cu ft (686 l) MAX: 62 cu ft (1,758 l)	

MIN: Behind seat upright with out luggage under tray

MAX: Behind seat folded with out luggage under tray

## Air conditioning system

Items	Weight of Volume oz (g)	Classification
Refrigerant	15.87±0.88 (450±25)	R-1234yf
Compressor lubricant	4.23±0.35 (120±10)	PAG

Have your vehicle inspected by an authorized Kia dealer.

## Recommended lubricants and capacities

To help achieve proper engine and powertrain performance and durability, use only lubricants of the proper quality.

The correct lubricants also help promote engine efficiency that results in improved fuel economy.

These lubricants and fluids are recommended for use in your vehicle.

Lubricant		Volume	Classification	
Engine oil*1*2 Recommends 	Gasoline Engine	1.6 L T-GDI	4.75 US qt. (4.5 l) ACEA C2/C5	
		2.0 L MPI	4.23 US qt. (4.0 l) SAE 5W20 / API Latest (ILSAC Latest)	
Manual transmission fluid	Gasoline Engine	2.0 L	1.8-1.9 US qt. (1.7-1.8 l) API GL-4, SAE 70W (Recommended SK HK MTF 70W, SHELL SPIRAX S6 GHME 70W MTF, GS CALTEX GS MTF HD 70W)	
Dual clutch transmission fluid	1.6 L T-GDI		2.01 ~ 2.11 US qt. (1.9l-2.0 l) API GL-4, SAE 70W HK DCTF 70W (SK) SPIRAX S6 GHME 70W DCTF (H.K.SHELL) GS DCTF HD 70W (GS CALTEX)	
Intelligent Variable Transmission (IVT)		6.9 US qt. (6.5 l)	genuine SP-CVT1*3	
Coolant	Gasoline Engine	1.6 T-GDI	DCT	6.2 US qt. (5.9 l)
		2.0 L	IVT	5.8 US qt. (5.5 l)
			M/T	5.8 US qt. (5.5 l)
Brake/Clutch fluid*4		Required amount	SAE J1703, FMVSS116 DOT-3 or DOT-4	
Fuel		14.27 US gal. (54 l)	Refer to "Fuel requirements" on page 1-2.	

\*1. Refer to "Recommended SAE viscosity number" on page 8-10.

\*2. Engine oils labeled Energy Conserving Oil are now available. Along with other additional benefits, they contribute to fuel economy by reducing the amount of fuel necessary to overcome engine friction. Often, these improvements are difficult to measure in everyday driving, but in a year's time, they can offer significant cost and energy savings.

\*3. Use only specified genuine Continuously variable Transmission fluid. The use of non-specified fluid (even marked as compatible with genuine) could result in shift quality deterioration and vibrations, eventually, the transmission failure.

\*4. To maintain your vehicle's best brake and ABS/ESC performance, use Kia genuine brake fluid as in the specification.



## Recommended SAE viscosity number

### ⚠ CAUTION

Always be sure to clean the area around any filler plug, drain plug, or dipstick before checking or draining any lubricant. This is especially important in dusty or sandy areas and when the vehicle is used on unpaved roads. Cleaning the plug and dipstick areas will prevent dirt and grit from entering the engine and other mechanisms that could be damaged.

Engine oil viscosity (thickness) has an effect on fuel economy and cold

weather operating (engine start and engine oil flowability). Lower viscosity engine oils can provide better fuel economy and cold weather performance, however, higher viscosity engine oils are required for satisfactory lubrication in hot weather.

Using oils of any viscosity other than those recommended could result in engine damage.

When choosing an oil, consider the range of temperature your vehicle will be operated in before the next oil change. Proceed to select the recommended oil viscosity from the chart.

		Temperature Range for SAE Viscosity Numbers									
Temperature	°C	-30	-20	-10	0	10	20	30	40	50	
	(°F)	-10	0	20	40	60	80	100	120		
Gasoline Engine Oil		20W-50									
		15W-40									
		10W-30									
		5W-30, 5W-40									



An engine oil displaying this API Certification Mark conforms to the international Lubricant Specification Advisory Committee (ILSAC). It is recommended to only use engine oils that uphold this API Certification Mark.

## Vehicle identification number (VIN)

The vehicle identification number (VIN) is the number used in registering your vehicle and in all legal matters pertaining to its ownership, etc.

Frame number

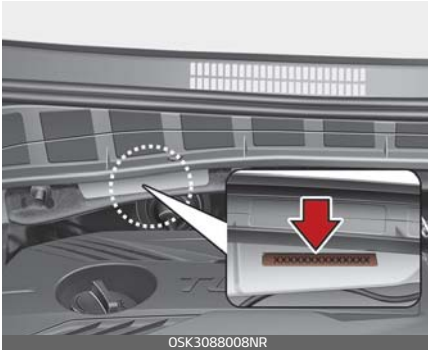

The VIN is also on a plate attached to the top of the dashboard. The number on the plate can easily be seen through the windshield from outside.

VIN label



## Vehicle certification label

The vehicle certification label attached on the driver's side center pillar gives the vehicle identification number (VIN).



### Tire specification and pressure label

The tire label located on the driver's side center pillar gives the tire pressures recommended for your vehicle.



The tires supplied on your new vehicle are chosen to provide the best performance for normal driving.

### Engine number

The engine number is stamped on the engine block as shown in the drawing.

1.6 T-GDI engine

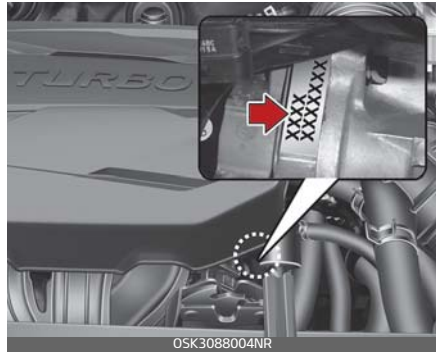

2.0 Gasoline engine

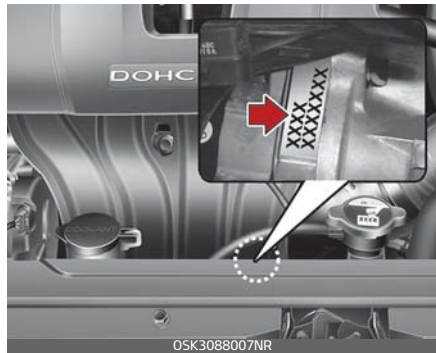

### Air conditioner compressor label

A compressor label informs you the type of compressor your vehicle is equipped with such as model, supplier part number, production number, refrigerant (1) and refrigerant oil (2).



### Refrigerant label

The refrigerant label is located on the front body trim.

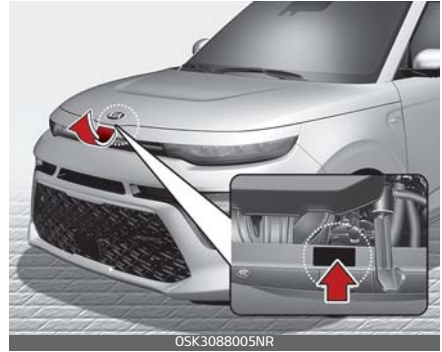

## Consumer Assistance (U.S. only)

Roadside Assistance is provided on all new current model year Kia Vehicles from the date the vehicle is delivered to the first retail buyer or otherwise put into use (in-service date), whichever is earlier, for a period of 60 months or 60,000 miles, whichever is earlier, subject to the terms, conditions and exclusions set forth in the Kia Warranty and Consumer Information Manual applicable to your model year vehicle.

KMA reserves the right to limit or deny services or other benefits to any owner or driver when, in KMA's judgment, the claims and/or service requests are excessive in frequency or type of occurrence.

### Toll free consumer assistance

from 5:00 AM to 6:00 PM PST, Monday through Friday and is accessible by dialing 1-800-333-4Kia (4542).

For more information regarding assistance available, please refer to your Kia Warranty & Consumer Information Manual.

### Emergency roadside assistance

hours a day, 365 days a year and is accessible by dialing 1-800-333-4Kia (4542).

Please note that you must provide your Vehicle Identification Number (VIN) to verify coverage at the time of your call. The VIN can be found on the dash of your vehicle on the driver's side, on the door jamb of the driver's door, your vehicle's registration or proof of insurance card.

Kia utilizes a network of over 30,000 roadside assistance providers.

Should you accidentally run out of fuel, require a battery jump, or need help changing a tire, a Kia Roadside Assistance Representative will dispatch someone to deliver a small quantity of gas, change a flat tire with your inflated spare, or arrange a battery jump to allow you to proceed to your destination. We have access to a network of over 10,000 locksmiths to help you should you become locked out of your Kia.

In the event that mechanical difficulty renders your vehicle undrivable due to a warranty-related concern, Kia's Roadside Assistance Representative will arrange to transport your vehicle to the nearest Kia dealer or to an authorized Kia alternative service location.

Your vehicle must be accessible to our dispatch transport vehicle, as determined by our driver, to receive this service.

## \* NOTICE

Roadside Assistance benefits are not available for any Kia vehicle that has ever been or should have been issued a "salvage" title or similar "branded" title under any state's law, or has been declared a "total loss" or equivalent by a financial institution or insurance company.

### Trip interruption

Trip interruption expense benefits are provided in the event that a warranty-related disablement occurs more than 150 miles from your home, and the repairs require more than 24 hours to complete. Reasonable reimbursement is included for meals, lodging, or rental vehicle expenses. Trip interruption coverage is limited to \$100 per day subject to a three day maximum limit per incident. You must contact the Kia Roadside Assistance Center to obtain pre-authorization of expenses. Once the Kia Roadside Assistance Center gives authorization for trip interruption benefits, they will assist you in making the necessary arrangements. Insurance deductibles, expenses, and claims paid by your insurance company or other providers are not eligible for reimbursement.

Fleet vehicles are excluded from reimbursement under Kia's Trip Interruption Policy.

### Registering your vehicle in a foreign country

If you plan to register your vehicle in a foreign country, you should confirm that it conforms to the regulations in that country. Even if you successfully register the vehicle in a foreign country, you may experience the following problems and should therefore consider the possibility of having to deal with them:

1. The fuel specified for your vehicle may be unavailable. If other than the specified fuel is used, it could cause damage to the engine, the fuel injection system, and other fuel-related parts which may not be covered under your New Vehicle Emissions Limited Warranty.
2. We must, therefore, clearly state that when you leave the country in which you purchased your Kia new and register it in another country, problems arising from the use of fuel other than the specified fuel are not subject to manufacturer's warranty. Because vehicles like yours may not be marketed in the new country of registration, parts, servicing techniques and tools necessary to maintain and repair your vehicle may be unavailable.

Even if vehicles like yours are sold there, mechanical specifications required by the government may vary enough from the country of purchase to cause additional problems.

3. There may not be an Authorized Kia Dealer in the area in which you plan to register your vehicle. You may additionally experience difficulty in obtaining services in a foreign country for any number of reasons.

Further, we cannot assume any responsibility for problems that result from unsatisfactory service or lack of service outside of the United States.

### **Electrical Equipment (U.S. only)**

The electrical system of your vehicle is designed to perform under all reasonably expected operating conditions.

However, before any additional electrical equipment is installed in your vehicle, consult an Authorized Kia Dealer, in order to ensure that you do not void your warranty.

Certain electrical equipment, or the way in which it is installed, may adversely affect the operation of your vehicle, including such systems as the engine control system, the audio system and the electrical charging system and thus potentially void all or part of your warranty.

We assume no responsibility for any expense you may incur or for any malfunction of your vehicle or any of its components or systems that may result from the installation of additional electrical equipment that is not supplied, or recommended for installation by, Kia.

### **Installation of a mobile two-way radio system**

If a mobile two-way radio system is installed improperly, or if an excessively powerful type of system is used, other electronic systems may be adversely affected. To avoid

damage to your vehicle, consult an Authorized Kia Dealer concerning the proper equipment and installation.

Kia motor vehicles are designed and manufactured to meet or exceed all applicable safety standards.

For your safety, however, we strongly urge you to read and follow all directions in this Owner's Manual, particularly the information under the headings "NOTICE", "CAUTION" and "WARNING".

If, after reading this manual, you have any questions regarding the operation of your vehicle, safety issues and defects please contact your Kia's toll-free Consumer Assistance hot line as below:  
National Consumer Affairs Manager  
Kia Motors America, Inc.  
P.O. Box 52410  
Irvine, CA 92619-2410  
1-800-333-4Kia (4542)

## **Reporting Safety Defects (U.S. only)**

If you believe that your vehicle has a defect which could cause a crash or could cause injury or death, you should immediately inform the National Highway Traffic Safety Administration (NHTSA) in addition to notifying Kia Motors America, Inc.

If NHTSA receives similar complaints, it may open an investigation, and if it finds that a safety defect exists in a group of vehicles, it may order a recall and remedy campaign. However, NHTSA cannot become involved in individual problems between you, your dealer, or Kia Motors America, Inc.

To contact NHTSA, you may call the Vehicle Safety Hotline toll-free at 1-888-327-4236 (TTY: 1-800-424-9153); go to <http://www.safercar.gov>; download the SaferCar mobile application; or write to: Administrator, NHTSA, 1200 New Jersey Ave. SE., Washington, DC 20590. You can also obtain other information about motor vehicle safety from <http://www.safercar.gov>.



## **Online factory authorized manuals (U.S. only)**

The following publications are available on [www.KiaTechinfo.com](http://www.KiaTechinfo.com).

### **Service manual**

This manual covers maintenance and recommended procedures for repair to engine and chassis components. It is written for the Journeyman mechanic, but is simple enough for most mechanically inclined owners to understand.

### **Electrical troubleshooting manual**

This manual complements the Service Manual by providing indepth troubleshooting information for each electrical circuit in your vehicle.

### **Owner's manual**

This manual describes the overall features and operating procedures for the vehicle.

Abbreviation..... A-2

**Abbreviation****Abbreviation****ABS**

Anti-lock Brake System

**AGM**

Absorbent Glass Mat

**AKI**

Anti Knock Index

**BCW**

Blind-Spot Collision Warning

**CRS**

Child Restraint System

**DAW**

Driver Attention Warning

**DCT**

Dual Clutch Transmission

**DRL**

Daytime Running Light

**DTC**

Diagnostic Trouble Code

**EBD**

Electronic Brake force Distribution

**ECM**

Electric Chromic Mirror

**EDR**

Event Data Recorder

**EFD**

Emergency Fastening Device

**EPA**

Environmental Protection Agency

**EPS**

Electronic Power Steering

**ESC**

Electronic Stability Control

**FCA**

Forward Collision-Avoidance Assist

**FCC**

Federal Communications Commission

**FMVSS**

Federal Motor Vehicle Safety Standards

**FRT**

Front

**GAW**

Gross Axle Weight

**GAWR**

Gross Axle Weight Rating

**GVW**

Gross Vehicle Weight

**GVWR**

Gross Vehicle Weight Rating

**HAC**

Hill-start Assist Control

**HBA**

High Beam Assist

**HMSL**

High Mounted Stop Lamp

**HUD**

Head-Up Display

**ILSAC**

International Lubricant Specification Advisory Committee

**IPS**

Intelligent Power Switch

**ISG**

Idle Stop and Go

**IVT**

Intelligent Variable Transmission

**KMA**

Kia Motors America

**LATCH**

Lower Anchors and Tether for Children

**LDW**

Lane Departure Warning

**LH**

Left Hand

**LI**

Load Index

**LKA**

Lane Keeping Assist

**LT**

Light Truck

**MDPS**

Motor Driven Power Steering

**MIL**

Malfunction Indicator Lamp

**MMT**

Manganese, Mn

**NHTSA**

National Highway Traffic Safety Administration

**ODS**

Occupant Detection System

**ORVR**

Onboard Refueling Vapor Recovery

**PCB**

Printed Circuit Board

**PCM**

Power train Control Module

**PCSV**

Purge Control Solenoid Valve

**PCV**

Positive Crankcase Ventilation

**RCCA**

Rear Cross-Traffic Collision-Avoidance Assist

**RCCW**

Rear Cross-Traffic Collision Warning

**RH**

Right Hand

**RR**

Rear

**SCC**

Smart Cruise Control

**SRS**

Supplemental Restraint System

**SRSCM**

SRS Control Module

**SS**

Speed Symbol

**TBT**

Turn By Turn

**TCM**

Transmission Control Module

**TCS**

Traction Control System

**TIN**

Tire Identification Number

**TPMS**

Tire Pressure Monitoring System

**VIN**

Vehicle Identification Number

**VSM**

Vehicle Stability Management

**W/O**

without

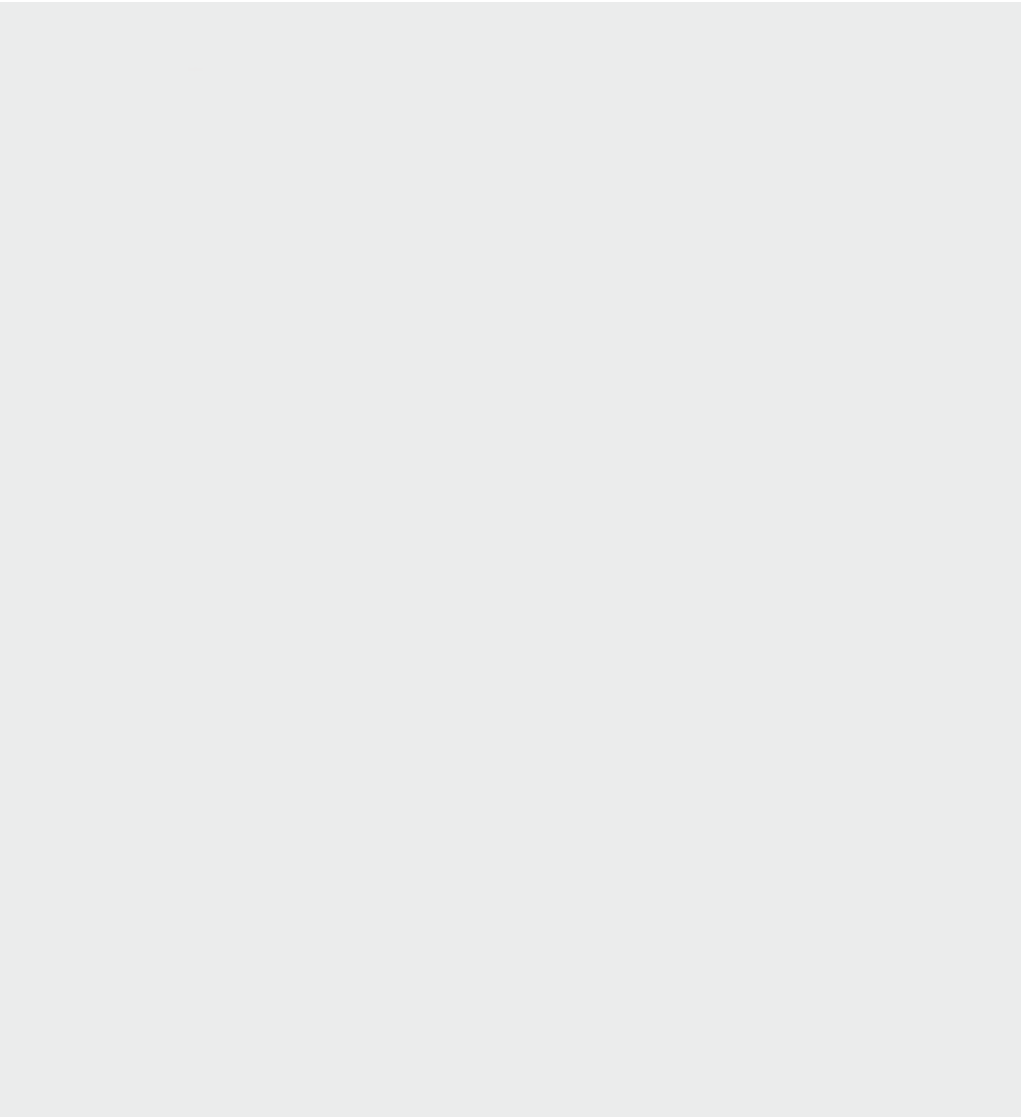

## Index

---

### A

**adjusting steering wheel angle and height** 4-42  
**air bag collision sensors** 3-58  
**air bag warning label** 3-62  
**air bag warning light** 3-44  
**air bags** 3-41  
air bag collision sensors 3-58  
air bag warning label 3-62  
air bag warning light 3-44  
curtain air bag 3-57  
driver's and passenger's front air bag 3-52  
inflation conditions 3-60  
inflation conditions of the air bag 3-59  
non-inflation conditions 3-60  
occupant detection system 3-46  
operation 3-41  
side air bag 3-55  
SRS care 3-61  
SRS components and functions 3-44  
**air cleaner filter** 7-26  
**air conditioner compressor label** 8-13  
**air conditioning system** 8-8  
**air ventilation seat** 4-137  
**anti-lock brake system (ABS)** 5-41  
**appearance care** 7-75  
exterior care 7-75  
interior care 7-81  
**applying the parking brake** 5-40  
**armed stage** 4-15  
**armrest (rear)** 3-15  
**assist mode** 4-55  
**audio system** 4-148  
antenna 4-148  
USB port 4-148  
**auto light** 4-92

**automatic climate control system** 4-117

air conditioning 4-123  
air conditioning refrigerant label 4-115, 4-127  
automatic ventilation 4-124  
checking the amount of air conditioner refrigerant and compressor lubricant 4-115, 4-127  
climate control air filter 4-126  
controlling air intake 4-122  
controlling fan speed 4-122  
heating and air conditioning automatically 4-117  
manual heating and air conditioning 4-118  
mode selection 4-120  
system operation 4-124  
temperature control 4-121  
turning off the front air climate control 4-123

---

### B

**battery** 7-31  
for best battery service 7-31  
recharging the battery 7-33  
reset items 7-33  
**battery saver function** 4-90  
**before driving** 5-8  
**blind-spot collision warning (BCW)**  
BCW alert 5-91  
limitations 5-94  
operating conditions 5-91  
rear corner radar sensor 5-92  
setting and activating 5-90  
setting the warning volume of the blind-spot collision warning 5-90  
warning message 5-93  
**bonnet, see the hood** 4-31  
**brake fluid** 7-24  
checking the brake fluid level 7-24  
**brake system** 5-38  
anti-lock brake system (ABS) 5-41

applying the parking brake	5-40	replacing filter	7-27
electronic stability control (ESC)	5-43	<b>clothes hanger</b>	4-143
good braking practices	5-48	<b>combined instrument, see instrument cluster</b>	4-48
hill-start assist control (HAC)	5-48	<b>consumer assistance</b>	8-14
parking brake	5-39	<b>coolant</b>	7-21
power brakes	5-38	changing the coolant	7-23
releasing the parking brake	5-40	checking the coolant level	7-22
vehicle stability management (VSM)	5-46	recommended coolant	7-21
<b>bulb replacement precaution</b>	7-62	<b>cooling fluid, see coolant</b>	7-21
<b>bulb wattage</b>	8-4	<b>cruise control switch</b>	5-103

## C

<b>California Perchlorate notice</b>	7-86	<b>cruise control system</b>	5-102
<b>camera (rear view)</b>	4-82	accelerating temporarily with the cruise control on	5-105
<b>capacities (lubricants)</b>	8-9	cancelling cruise control	5-105
<b>care</b>		cruise control switch	5-103
care of seat belts	3-29	decreasing the cruising speed	5-104
exterior care	7-75	increasing cruise control set speed	5-104
interior care	7-81	resuming cruising speed at more than approximately 30 km/h (20 mph)	5-105
SRS care	3-61	setting cruise control speed	5-103
tire care	7-34	turning cruise control off	5-106
<b>care of seat belts</b>	3-29	<b>cup holder</b>	4-134
<b>cargo area cover</b>	4-145	<b>curtain air bag</b>	3-57
<b>center console storage</b>	4-131		
<b>central door lock switch</b>	4-20		
<b>certification label</b>	5-146		
<b>chains - tire</b>	5-140		
<b>check exhaust system</b>	5-7		
<b>checking tire inflation pressure</b>	7-35		
<b>child restraint system</b>	3-31		
securing a child restraint seat with tether anchor	3-37		
securing a child restraint with a lap/shoulder belt	3-38		
securing a child restraint with the LATCH anchors	3-36		
<b>child-protector rear door lock</b>	4-21		
<b>climate control air filter</b>	7-27		
filter inspection	7-27		

## D

<b>dashboard illumination, see instrument cluster control</b>	4-48
<b>dashboard, see instrument cluster</b>	4-48
<b>day/night rearview mirror</b>	4-44, 4-45
<b>daytime running light</b>	4-91
<b>defogging (windshield)</b>	4-128
<b>defroster (rear window)</b>	4-105
<b>dimensions</b>	8-2
<b>disarmed stage</b>	4-17
<b>displays, see instrument cluster</b>	4-48



<b>door lock</b>	
rear occupant alert (ROA) system	4-22
<b>door locks</b>	4-18
central door lock switch	4-20
child-protector rear door lock	4-21
from inside the vehicle	4-19
from outside the vehicle	4-18
<b>drinks holders, see cup holders</b>	4-134
<b>drive mode integrated control system</b>	5-53
SPORT mode	5-53
<b>driver attention warning (DAW)</b>	5-98
DAW disabled	5-100
displaying the driver's attention level	5-99
malfunction	5-100
resetting	5-100
setting and activating	5-98
taking a break	5-99
<b>driver's 3-point system with emergency locking retractor</b>	3-21
<b>driver's and passenger's front air bag</b>	3-52
<b>driver's seat belt</b>	
adjusting height	3-22
fastening seat belt	3-21
<b>driver's seat belt warning</b>	3-19
<b>driving at night</b>	5-138
<b>driving in flooded areas</b>	5-139
<b>driving in the rain</b>	5-138
<b>driving off-road</b>	5-139
<b>dual clutch transmission (DCT)</b>	5-29
ignition key interlock system	5-36
operation	5-29
paddle shifter	5-34
shift lock system	5-35
shift-lock override	5-36
transmission ranges	5-33
warning message	5-30
warning messages	5-31
<b>dual clutch transmission shift indicator</b>	4-52

---

<b>E</b>	
<b>electric chromic mirror (ECM) with UVO service</b>	4-45
<b>electrical equipment</b>	8-16
<b>electronic power steering</b>	4-40
<b>electronic stability control (ESC)</b>	5-43
<b>emergency starting</b>	6-6
jump starting	6-6
jump-starting	6-7
push-starting	6-7
<b>emergency while driving</b>	6-4
engine stalls at a crossroad or crossing	6-4
flat tire while driving	6-4
vehicle stalls while driving	6-4
<b>emission control system</b>	7-83
<b>engine</b>	8-3
<b>engine compartment</b>	2-9
<b>engine coolant temperature gauge</b>	4-50
<b>engine number</b>	8-12
<b>engine oil</b>	7-19
<b>engine oil filter</b>	7-19
<b>engine overheats</b>	6-8
<b>engine start/stop button</b>	5-13
illuminated engine start/stop button	5-13
position	5-13
starting and stopping the engine for turbocharger intercooler	5-16
starting the engine	5-16
starting the engine with smart key	5-17
stopping the engine (manual transmission)	5-18
<b>explanation of scheduled maintenance items</b>	7-15

air conditioning refrigerant	7-18	warning message and brake control	5-57
brake discs, pads, calipers and rotors	7-18	warning message and warning light	5-59
brake fluid	7-17	<b>Forward Collision-Avoidance Assist (FCA) (Sensor fusion)</b>	5-66
brake hoses and lines	7-17	brake operation	5-69
coolant	7-16	front view camera / front radar sensor	5-70
cooling system	7-16	limitations	5-73
drive shafts and boots	7-18	malfunction	5-71
steering gear box, linkage and boots/ lower arm ball joint	7-18	prerequisite for activation	5-67
suspension mounting bolts	7-18	setting and activation	5-66
<b>exterior care</b>	7-75	warning message and brake control	5-67
<b>exterior features</b>	4-146	warning message and warning light	5-71
roof rack	4-146	<b>Forward/Reverse Parking Distance Warning (PDW)</b>	4-86
<b>exterior overview</b>	2-2	non-operational conditions	4-88

## F

<b>FCC</b>	4-151	operation	4-86
<b>flat tire</b>	6-15	self-diagnosis	4-89
changing tires	6-16	<b>front passenger and rear seat belt</b>	
jack and tools	6-15	fastening seat belt	3-23
jack label	6-21	releasing seat belt	3-25
jacking instructions	6-15	<b>front passenger's seat belt warning</b>	3-20
removing and storing the spare tire	6-16	<b>front seat adjustment for manual seat</b>	3-8
use of compact spare tire	6-20	forward and backward	3-8
<b>floor mat anchor(s)</b>	4-144	seatback angle	3-8
<b>fog light (front)</b>	4-94	<b>front seat adjustment for power seat</b>	3-9
<b>folding the outside rearview mirror</b>	4-47	forward and backward	3-10
<b>folding the rear seat</b>	3-15	lumbar support for driver's seat	3-10
<b>Forward Collision-Avoidance Assist (FCA) (Front view camera only)</b>	5-55	seat height	3-10
brake operation	5-58	seatback angle	3-10
front view camera sensor	5-58	<b>fuel filler lid</b>	4-33
limitations	5-61	<b>fuel gauge</b>	4-50
malfunction	5-60	<b>fuel requirements</b>	1-2
prerequisite for activation	5-56	<b>fuses</b>	7-47
setting and activation	5-55	battery fuse	7-52
setting initial warning activation time	5-56	fuse/relay panel description	7-52

main fuse	7-51
multi fuse	7-50
replacing inner panel fuse	7-49
replacing motor compartment fuse	7-50

## G

<b>gauges</b>	4-49
<b>glove box</b>	4-132
<b>good braking practices</b>	5-48
<b>gross vehicle weight</b>	8-6

## H

<b>hazard warning flasher</b>	6-3
<b>head up display (HUD)</b>	4-79
<b>headlight (headlamp) escort function</b>	4-90
<b>headlight position</b>	4-92
<b>headrest (front)</b>	3-11
adjusting the height up and down	3-11
reinstalling the headrest	3-13
removing the headrest	3-12
<b>headrest (rear)</b>	3-13
adjusting the height up and down	3-14
removal and reinstallation	3-14
<b>heated steering wheel</b>	4-42
<b>heating and air conditioning automatically</b>	4-117
<b>High Beam Assist (HBA)</b>	4-94
<b>highway driving</b>	5-139
<b>hill-start assist control (HAC)</b>	5-48
<b>hood</b>	4-31
closing the hood	4-32
hood open warning	4-31
opening the hood	4-31
<b>horn</b>	4-43

## I

<b>ignition switch position</b>	5-10
<b>illuminated engine start/stop button</b>	5-13
<b>illuminated ignition switch</b>	5-10
<b>immobilizer</b>	4-13
<b>indicator lights</b>	4-76
<b>inside rearview mirror</b>	4-44
<b>instrument cluster</b>	4-48
gauges	4-49
instrument cluster control	4-48
<b>instrument panel overview</b>	2-7
<b>intelligent variable transmission (IVT)</b>	5-22
good driving practices	5-27
ignition key interlock system	5-27
moving up a steep grade from a standing start	5-28
operation	5-22
shift lock system	5-26
shift-lock override	5-26
transmission ranges	5-23
<b>intelligent variable transmission shift indicator</b>	4-52
<b>interior care</b>	7-81
<b>interior features</b>	4-134
air ventilation seat	4-137
cargo area cover	4-145
clothes hanger	4-143
cup holder	4-134
floor mat anchor(s)	4-144
power outlet	4-138
seat warmer	4-135
sun visor	4-137
USB charger	4-139
wireless smart phone charging system	4-140
<b>interior light</b>	4-101
automatic turn off function	4-101
liftgate room lamp	4-103
map lamp	4-102
room lamp	4-101

vanity mirror lamp	4-103
<b>interior overview</b>	2-5

---

## J

<b>jump starting</b>	6-6
<b>jump-starting</b>	6-7

---

## K

<b>key</b>	4-6
folding key	4-6
smart key	4-7
<b>key positions</b>	5-10
ignition switch position	5-10
starting the engine	5-11
stopping the gasoline engine (manual transmission)	5-12

---

## L

<b>label</b>	
air conditioner compressor label	8-13
refrigerant label	8-13
tire sidewall labeling	7-38
tire specification and pressure label	8-12
vehicle certification label	8-11
<b>lane keeping assist (LKA)</b>	5-81
activation	5-82
driver's attention	5-86
function change	5-88
malfunction	5-87
operation	5-82
warning message	5-83
<b>LCD display</b>	4-53
assist mode	4-55
LCD display control	4-53
LCD display modes	4-53
master warning mode	4-55
trip computer mode	4-54
turn by turn (TBT) mode	4-54
user settings mode	4-55
<b>LCD display modes</b>	4-53

<b>LCD displays</b>	4-61
trip information (trip computer)	4-61
<b>liftgate</b>	4-23
closing the liftgate	4-24
emergency liftgate safety release	4-24
opening the liftgate	4-23
<b>liftgate room lamp</b>	4-103
<b>light bulbs</b>	7-62
bulb replacement precaution	7-62
position lamp/DRL (LED type)	
replacement (Headlamp Type B)	7-67
replacing back-up lamp bulb (Rear combination lamp Type A)	7-69
replacing front fog lamp bulb	7-67
replacing glove box lamp	7-74
replacing headlamp (High/Low beam) bulb (headlamp Type A,B)	7-66
replacing headlamp (LED type) (headlamp Type C)	7-67
replacing high mounted stop lamp (bulb type) bulb	7-70
replacing high mounted stop lamp (LED type) bulb	7-70
replacing license plate lamp bulb	7-71
replacing liftgate room lamp bulb	7-74
replacing map lamp (bulb type) bulb	7-72
replacing map lamp (LED type) bulb	7-72
replacing position lamp/DRL/front turn signal lamp bulb (Type A, B)	7-66
replacing room lamp (bulb type) bulb	7-73
replacing room lamp (LED type) bulb	7-74
replacing side repeater lamp (LED type) bulb	7-68
replacing stop and tail lamp (LED type) bulb (Rear combination lamp Type B)	7-70
replacing stop/tail and turn signal lamp (bulb type) bulb (Rear combination	

lamp Type A)	7-68
replacing vanity mirror lamp bulb	7-72
<b>lighting</b>	4-90
auto light	4-92
battery saver function	4-90
daytime running light	4-91
front fog light	4-94
headlight (headlamp) escort function	4-90
headlight position	4-92
high beam assist	4-94
operating high beam	4-92
parking tail light	4-91
turn signals	4-93
<b>lubricants and capacities</b>	8-9
<b>luggage volume</b>	8-7

---

## M

<b>maintenance</b>	
engine oil	7-19
engine oil filter	7-19
parking brake	7-26
<b>maintenance</b>	
air cleaner filter	7-26
appearance care	7-75
battery	7-31
brake fluid	7-24
climate control air filter	7-27
coolant	7-21
emission control system	7-83
engine compartment	7-4
explanation of scheduled maintenance items	7-15
fuses	7-47
light bulbs	7-62
maintenance services	7-5
owner maintenance	7-7
scheduled maintenance service	7-8
tire maintenance	7-38
washer fluid	7-25
wiper blades	7-29
<b>maintenance schedule</b>	

maintenance under severe usage conditions	7-11, 7-14
normal maintenance schedule	7-9, 7-12
<b>maintenance services</b>	7-5
owner maintenance precautions	7-6
owner's responsibility	7-5
<b>manual transmission</b>	5-19
good driving practices	5-21
<b>manual transmission shift indicator</b>	4-52
<b>map lamp</b>	4-102
<b>master warning mode</b>	4-55
<b>mirrors</b>	4-44
day/night rearview mirror	4-44, 4-45
electric chromic mirror (ECM) with UVO service	4-45
folding the outside rearview mirror	4-47
inside rearview mirror	4-44
outside rearview mirror	4-46

---

## O

<b>occupant detection system</b>	3-46
<b>odometer</b>	4-51
<b>online factory authorized manuals</b>	8-18
<b>operating high beam</b>	4-92
<b>outside rearview mirror</b>	4-46
<b>outside temperature gauge</b>	4-51
<b>overheats</b>	6-8
<b>owner maintenance</b>	7-7

---

## P

<b>parking brake</b>	5-39, 7-26
<b>parking tail light</b>	4-91
<b>position lamp/DRL (LED type) replacement (Headlamp Type B)</b>	7-67
<b>power brakes</b>	5-38
<b>power outlet</b>	4-138

<b>power window lock button</b>	4-29
<b>pre-tensioner seat belt</b>	3-25
<b>push-starting</b>	6-7

## R

<b>rear cross-traffic collision avoidance assist (RCCA)</b>	5-122
detecting sensor	5-127
limitations	5-129
setting and activating	5-123
warning message	5-128
<b>rear cross-traffic collision warning (RCCW)</b>	5-122
detecting sensor	5-127
limitations	5-129
operating conditions	5-124
RCCW alert	5-124
setting and activating	5-123
setting the initial warning activation time	5-123
setting the warning volume of the rear cross-traffic collision warning	5-124
warning message	5-128
<b>rear cross-traffic collision-avoidance assist (RCCA)</b>	
RCCA alert	5-125
<b>rear occupant alert (ROA) system</b>	4-22
<b>Rear View Monitor (RVM)</b>	4-82
<b>recommended lubricants and capacities</b>	8-9
<b>record your key number</b>	4-6
<b>refrigerant label</b>	8-13
<b>releasing the parking brake</b>	5-40
<b>remote keyless entry</b>	4-10
battery replacement	4-13
immobilizer	4-13
<b>replacing back-up lamp bulb (Rear combination lamp Type A)</b>	7-69
<b>replacing front fog lamp bulb</b>	7-67
<b>replacing glove box lamp</b>	7-74

<b>replacing headlamp (High/Low beam) bulb (headlamp Type A,B)</b>	7-66
<b>replacing headlamp (LED type) (headlamp Type C)</b>	7-67
<b>replacing high mounted stop lamp (bulb type) bulb</b>	7-70
<b>replacing high mounted stop lamp (LED type) bulb</b>	7-70
<b>replacing license plate lamp bulb</b>	7-71
<b>replacing liftgate room lamp bulb</b>	7-74
<b>replacing map lamp (bulb type) bulb</b>	7-72
<b>replacing map lamp (LED type) bulb</b>	7-72
<b>replacing position lamp/DRL/front turn signal lamp bulb (Type A, B)</b>	7-66
<b>replacing room lamp (bulb type) bulb</b>	7-73
<b>replacing room lamp (LED type) bulb</b>	7-74
<b>replacing side repeater lamp (LED type) bulb</b>	7-68
<b>replacing stop and tail lamp (LED type) bulb (Rear combination lamp Type B)</b>	7-70
<b>replacing stop/tail and turn signal lamp (bulb type) bulb (Rear combination lamp Type A)</b>	7-68
<b>replacing vanity mirror lamp bulb</b>	7-72
<b>reporting safety defects</b>	8-17
<b>resetting the sunroof</b>	4-39
<b>Reverse Parking Distance Warning (PDW)</b>	4-83
non-operational conditions	4-84
operation	4-83
precautions	4-85

self-diagnosis	4-85	seatback pocket (front)	3-13
<b>risk of burns when parking or stopping vehicle</b>	1-6	<b>securing a child restraint seat with tether anchor</b>	3-37
<b>road warning</b>	6-3	<b>securing a child restraint with a lap/shoulder belt</b>	3-38
<b>rocking the vehicle</b>	5-137	<b>securing a child restraint with the LATCH anchors</b>	3-36
<b>roof rack</b>	4-146	<b>sliding the sunroof</b>	4-37
<b>room lamp</b>	4-101	<b>smart cruise control (SCC)</b>	5-106
<b>rotation (tire)</b>	7-36	accelerating temporarily with smart cruise control on	5-110

## S

<b>SAE viscosity number</b>	8-10	adjusting the sensitivity	5-116
<b>scheduled maintenance service</b>	7-8	converting to cruise control mode	5-117
maintenance under severe usage conditions	7-11, 7-14	decreasing smart cruise control set speed	5-109
normal maintenance schedule	7-9, 7-12	increasing smart cruise control set speed	5-109
<b>seat belt precautions</b>	3-28	limitations	5-117
<b>seat belt restraint system</b>	3-18	resuming smart cruise control	5-112
<b>seat belts</b>	3-18	setting headway	5-112
care of seat belts	3-29	smart cruise control switch	5-108
driver's 3-point system with emergency locking retractor	3-21	smart cruise control temporarily canceled	5-110
driver's seat belt warning	3-19	speed setting	5-108
front passenger's seat belt warning	3-20	turning smart cruise control off	5-112
pre-tensioner seat belt	3-25	<b>smart key</b>	4-7
seat belt precautions	3-28	battery replacement	4-13
seat belt restraint system	3-18	functions	4-7
<b>seat warmer</b>	4-135	immobilizer	4-13
<b>seatback pocket (front)</b>	3-13	precautions	4-9
<b>seats</b>	3-5	<b>smooth cornering</b>	5-138
armrest (rear)	3-15	<b>snow tires</b>	5-140
feature of seat leather	3-7	<b>snowy or icy conditions</b>	5-140
folding the rear seat	3-15	<b>special driving conditions</b>	
front seat adjustment for manual seat	3-8	driving at night	5-138
front seat adjustment for power seat	3-9	driving in flooded areas	5-139
headrest (front)	3-11	driving in the rain	5-138
headrest (rear)	3-13	driving off-road	5-139
important safety precautions	3-3	hazardous driving conditions	5-136
		highway driving	5-139
		reducing the risk of a rollover	5-136

rocking the vehicle	5-137	<b>tilting the sunroof</b>	4-38
smooth cornering	5-138	<b>tire and loading information label</b>	5-144
<b>speedometer</b>	4-49	<b>tire chains</b>	5-140
<b>SRS care</b>	3-61	<b>tire pressure indicator</b>	6-9
<b>SRS components and functions</b>	3-44	<b>tire pressure monitoring system (TPMS)</b>	6-9
<b>starting and stopping the engine for turbocharger intercooler</b>	5-16	effective use of TPMS	6-10
<b>starting difficulties, see vehicle will not start</b>	6-5	low tire pressure position telltale	6-11
<b>starting the engine with smart key</b>	5-17	malfunction indicator	6-12
<b>steering wheel</b>	4-40	tire pressure indicator	6-9
adjusting steering wheel angle and height	4-42	tire replacement with TPMS	6-13
electronic power steering	4-40	<b>tire replacement</b>	7-37
heated steering wheel	4-42	<b>tire rotation</b>	7-36
horn	4-43	<b>tire specification and pressure label</b>	8-12
tilt and telescopic steering	4-41	<b>tires and wheels</b>	7-34, 8-5
<b>storage compartment</b>	4-131	all season tires	7-44
center console storage	4-131	checking tire inflation pressure	7-35
glove box	4-132	low aspect ratio tire	7-46
sunglass holder	4-132	radial-ply tires	7-45
<b>sun visor</b>	4-137	recommended cold tire inflation pressures	7-34
<b>sunglass holder</b>	4-132	snow tires	7-44
<b>sunroof</b>	4-36	summer tires	7-44
resetting the sunroof	4-39	tire care	7-34
sliding the sunroof	4-37	tire chains	7-45
sunroof open warning	4-39	tire maintenance	7-38
sunshade	4-39	tire pressure	7-34
tilting the sunroof	4-38	tire replacement	7-37
<b>sunroof open warning</b>	4-39	tire rotation	7-36
<b>sunshade</b>	4-39	tire sidewall labeling	7-38
		tire terminology and definitions	7-41
		tire traction	7-38
		wheel alignment and tire balance	7-36
		wheel replacement	7-37
		<b>towing</b>	6-22
		emergency towing	6-25
		removable towing hook	6-24
		towing service	6-22
		without wheel dollies	6-24
		<b>transmission shift indicator</b>	4-52

---

## T

<b>tachometer</b>	4-49
<b>theft-alarm stage</b>	4-16
<b>theft-alarm system</b>	4-15
armed stage	4-15
disarmed stage	4-17
theft-alarm stage	4-16
<b>tilt and telescopic steering</b>	4-41



dual clutch transmission shift indicator	4-52	indicator lights	4-76
intelligent variable transmission shift indicator	4-52	warning lights	4-70
manual transmission shift indicator	4-52	<b>warning lights</b>	4-70
<b>transmitter, see remote keyless entry</b>	4-10	<b>washer fluid</b>	7-25
<b>trip computer mode</b>	4-54	checking the washer fluid level	7-25
<b>trip information (trip computer)</b>	4-61	<b>welcome system</b>	4-104
<b>turn by turn (TBT) mode</b>	4-54	<b>wheel alignment and tire balance</b>	7-36
<b>turn signals</b>	4-93	<b>wheel replacement</b>	7-37
<hr/>		<b>window opening and closing</b>	4-27
<b>U</b>		<b>windows</b>	4-26
<b>USB charger</b>	4-139	power window lock button	4-29
<b>user settings mode</b>	4-55	window opening and closing	4-27
<hr/>		<b>windshield defrosting and defogging</b>	4-128
<b>V</b>		<b>windshield washers</b>	4-98
<b>vanity mirror lamp</b>	4-103	<b>winter driving</b>	5-140
<b>vehicle break-in process</b>	1-5	snow tires	5-140
<b>vehicle certification label</b>	8-11	snowy or icy conditions	5-140
<b>vehicle data collection and event data recorders</b>	1-6	tire chains	5-140
<b>vehicle handling instructions</b>	1-5	<b>wiper blades</b>	7-29
<b>vehicle identification number (VIN)</b>	8-11	blade inspection	7-29
<b>vehicle load limit</b>	5-144	replacing blade	7-29
certification label	5-146	replacing rear window wiper blade	7-30
tire and loading information label	5-144	<b>wipers and washers</b>	
<b>vehicle modifications</b>	1-4	operating windshield washer	4-99
<b>vehicle stability management (VSM)</b>	5-46	rear window wiper and washer	4-100
<b>vehicle weight</b>	5-148	windshield washers	4-98
<b>vehicle will not start</b>	6-5	windshield wipers	4-97
<hr/>		<b>wireless smart phone charging system</b>	4-140

## W

<b>warning and indicator lights</b>	4-70
-------------------------------------	------

2020 KIA MOTORS AMERICA, INC.



The Power to Surprise