

SELTOS

Features & Functions Guide



Delivery First
The priority that delivers more

WELCOME TO THE KIA FAMILY!

Your new Kia vehicle has been designed, engineered and manufactured to provide you with years of comfortable and dependable driving. Kia is committed to quality, innovation, safety and – above all – your satisfaction.

USING THIS FEATURES & FUNCTIONS GUIDE

The information contained in this guide is a brief overview of the operation and features of your new Kia vehicle.

This Features & Functions Guide and the specific operational and safety information it provides are not a substitute for your Owner's Manual. In the interest of your safety and that of the vehicle's occupants, and to help you avoid risks that may result in death or serious injury, Kia reminds you to carefully read the Owner's Manual in order to fully familiarize yourself with the important information and safety warnings it contains.

While Kia endeavors to ensure that the information contained in this guide is accurate at the time of printing, Kia may change vehicle specifications without notice in advance of or after the fact and assumes no liability in connection with such changes.

VIDEOS AND QR CODES

Kia provides a number of video resources to assist you with becoming familiar with the features and functions found in your Kia vehicle. You can access these resources by snapping the QR Codes with your mobile device using the built-in QR Code Reader or a downloaded QR Code Reader App.

After opening the QR Code Reader App on your mobile device, the app will utilize your device's camera. Center the code in the camera viewing area – with some apps, as soon as the app recognizes the code, it will launch the corresponding video.

With other apps, you will have to snap or “take a picture” of the code. The app will then launch the corresponding video.

For operation specifics, refer to the instructions that come with the QR Code Reader app. You can also view the videos by visiting the following website: www.youtube.com/KiaFeatureVideos.

QUICK TIPS

1. If you're having trouble scanning codes, check the following:
 - The code should be centered and focused in your mobile device's camera screen
 - Consider moving your device closer to or farther away from the code
 - The code should be well lit, without significant shadow
 - Avoid scanning from a significant angle
 - Confirm that the device's app supports 2D QR Code scanning
 - Try another QR Code Reader app; not all apps are created equal
2. After scanning, you may experience a “connection error” message or a “connecting” message with no subsequent response. These messages typically indicate that your device is having trouble connecting to the Internet

QR CODE

One-Click Fuel Cap Video

To view a video on your mobile device, snap this QR Code or visit the listed website.



www.youtube.com/KiaFeatureVideos

As you get to know your new Kia, you can explore this booklet to better understand how to operate its many features and systems. You can find the complete Table of Contents on the next two pages, but first, be sure to review the following to better understand some of your Kia's most used features:

1	Smart Key	46
2	Fuel Filler Lid Release.	48
3	Power Adjustable Driver's Seat* / Front Seat Headrest Adjustment	43-45
4	Seat Warmers*	42
5	Folding Rear Seats	44
6	Windshield Wipers & Washers	23
7	Smart Cruise Control (SCC)*	24
8	Normal Maintenance Schedules	56, Back Cover
9	User Settings – Instrument Cluster	09
10	Bluetooth® Wireless Technology	26-27
11	UVO link Activation* / UVO Assistance*	31
12	UVO link with Navigation*	33
13	Kia Access with UVO link App Download	32
14	Kia Access with UVO link App Features Guide.	32
15	Android Auto™ / Apple CarPlay® Setup	29

Driving while distracted can result in a loss of vehicle control that may lead to an accident, severe personal injury and death. The driver's primary responsibility is in the safe and legal operation of a vehicle, and handheld devices, other equipment or vehicle systems which take the driver's eyes, attention and focus away from the safe operation of a vehicle or that are not permissible by law should never be used during operation of the vehicle.

www.kia.com
 Consumer Affairs - Roadside Assistance¹¹⁸:
 1-800-333-4KIA (800-333-4542)

Always check the Owner's Manual for complete operating information and safety warnings.



VIDEOS & QR CODES Inside Front Cover

INSTRUMENT CLUSTER

Instrument Cluster Overview 03
 Indicators & Warning Lights 04
 Tire Pressure Monitoring System (TPMS) 05
 Fuel Economy 05
 Drive Mode Integrated Control System* 06

VEHICLE SETTINGS

LCD Instrument Cluster Modes 07
 Trip Modes / Trip Computer 07
 Instant Fuel Economy 07
 Service Interval Mode* 08
 Sound Mood Lamp 08
 User Settings – Instrument Cluster 09
 Vehicle Settings* – Audio Head Unit 09
 Vehicle Auto-Shut Off* 10

ADVANCED DRIVER ASSISTANCE SYSTEMS (ADAS)

Blind-Spot Collision-Avoidance Assist (BCA)* 11
 Rear Cross-Traffic Collision-Avoidance Assist (RCCA)* 12
 Forward Collision-Avoidance Assist (FCA)* 13
 Lane Keeping Assist (LKA)* 14
 Driver Attention Warning (DAW) 15
 Lane Following Assist (LFA)* 16
 Safe Exit Assist (SEA)* 17
 Highway Driving Assist (HDA)* 17

DRIVER'S PANEL

Instrument Cluster Control* 18
 Electronic Stability Control (ESC) 18
 Hill-Start Assist Control (HAC) 18
 Engine Start/Stop Button* 19
 Power Windows, Window Lock & Central Door Lock 20
 Rear Door Locks – Double Pull to Open 20

DRIVER'S PANEL CONTINUED

Auto Door Lock/Unlock 20
 Rear Door Locks 20
 Power Outside Mirrors 21
 Heated Outside Mirrors* 21
 Manual Folding Mirrors* 21

STEERING WHEEL CONTROLS

Tilt/Telescoping Steering Wheel 21
 Headlights & High Beams 22
 Daytime Running Lights (DRL)* 22
 Turn Signals & Fog Lights* 22
 Windshield Wipers & Washers 23
 Rear Wiper & Washer* 23
 Smart Cruise Control (SCC)* 24
 Cruise Control (CC) 25

AUDIO SYSTEMS

Bluetooth® Wireless Technology 26
 Audio Controls 28
 Android Auto™ / Apple CarPlay® Setup 29
 Standard Audio System* 30
 UVO link Activation* 31
 UVO Assistance* 31
 Kia Access with UVO link App Download 32
 Kia Access with UVO link App Features Guide 32
 UVO link with Navigation* 33

CENTER PANEL

Digital Clock 34
 Multimedia USB Port, Power Outlets & USB Charger Port 34
 Wireless Smartphone Charging System* 35
 Automatic Climate Control 36
 Manual Climate Control* 37
 Idle, Stop & Go (ISG) 38
 Automatic Gear Shift / Sportmatic® Shifting 38
 Dual Clutch Transmission (DCT)* 38

CENTER PANEL CONTINUED

Electronic Parking Brake (EPB) 40
 Auto Hold 40
 Downhill Brake Control 41
 All Wheel Drive (AWD) System* 41
 Seat Warmers* 42

SEATING

Power Adjustable Driver's Seat* 43
 6-Way Manual Adjustable Driver's Seat* 43
 Folding Rear Seats 44
 Rear Occupant Alert (ROA) with Door Monitoring 44
 Front Seat Headrest Adjustment 45
 Unfastening Center Seat Belt 45

OTHER KEY FEATURES

Smart Key* 46
 Remote Keyless Entry (Folding Key)* 47
 Double-Turn Lock/Unlock All 47
 Fuel Cap / Malfunction Indicator 48
 Fuel Filler Lid Release 48
 Hood Release Lever and Latch 48
 Map/Room Lamps 49
 Sunroof Operation* 50
 Sunvisor 50
 Liftgate Release Button 51
 Rear View Monitor (RVM) 51

SAFETY FEATURES

Seat Belts 52
 Occupant Detection System (ODS) / Passenger Airbag Off Indicator 52
 Child-Protector Rear Door Lock 52

TURBO MAINTENANCE CHART 56

NON-TURBO MAINTENANCE CHART Back Cover

LEGAL DISCLAIMERS Inside Back Cover

Instrument Cluster Overview

- A** Tachometer
- B** Turn Signal Indicators
- C** Speedometer
- D** Engine Coolant Temperature Gauge
- E** Indicator & Warning Lights
- F** Gear Shift Position Indicator, Odometer, Trip Modes / Trip Computer
- G** Fuel Gauge

 Arrow direction indicates the side of the vehicle the fuel door is located

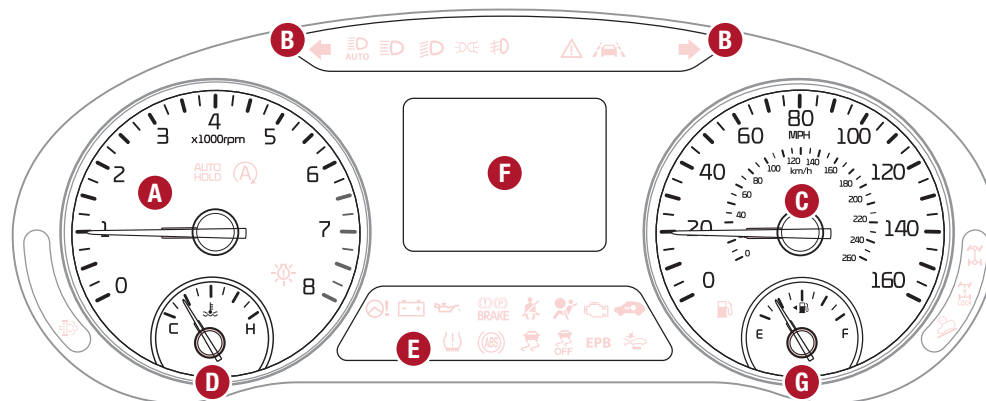

(Type A Cluster)

This illustration is for demonstration purposes only. Some indicators and warning lights may not appear in illustration. On the vehicle, they may appear in the LCD.

Your vehicle's instrument cluster & indicator light locations may differ from those in the illustrations.

For more information on the instrument cluster and the function of all indicator and warning lights, please refer to the Owner's Manual.

Refer to section 4 in the Owner's Manual for more information.

Indicators & Warning Lights

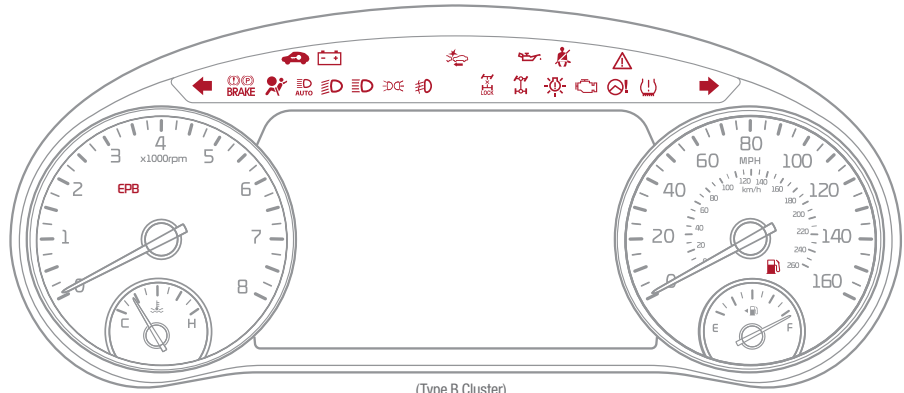

(Type B Cluster)

This illustration is for demonstration purposes only. Some indicators and warning lights may not appear in illustration. On the vehicle, they may appear in the LCD.

Your vehicle's instrument cluster & indicator light locations may differ from those in the illustrations.

Refer to section 4 in the Owner's Manual for more information.

- | | | | | | |
|--|---|--|--|--|---|
| | Turn Signal Indicator Lights | | Forward Collision-Avoidance Assist (FCA) Warning Light* | | Downhill Brake Control (DBC) Indicator Light |
| | Low Engine Oil Level Warning Light | | Lane Keeping Assist (LKA) System Indicator Light* | | Low Tire Pressure Light /Tire Pressure Monitoring System (TPMS) Malfunction Indicator |
| | ECO Indicator Light | | Electric Power Steering (EPS) Warning Indicator | | Anti-lock Braking System (ABS) Warning Light |
| | Sport Mode Indicator Light* | | Charging System Warning Light | | Electronic Stability Control (ESC) Indicator Light |
| | High Beam Assist Indicator Light* | | Engine Oil Pressure Warning Light | | Electronic Stability Control (ESC) OFF Indicator Light |
| | High Beam Indicator Light | | Parking Brake & Brake Fluid Warning Light | | All Wheel Drive (AWD) Warning Light* |
| | Light ON Indicator Light | | Seat Belt Warning Light | | AWD LOCK Indicator Light* |
| | Front Fog Light Indicator | | Airbag Warning Light | | Low Fuel Level Warning Light |
| | Master Warning Light* | | Malfunction Indicator Light | | Auto Hold Indicator Light* |
| | Electric Parking Brake (EPB) Warning Light* | | Cruise Indicator Light* | | Icy Road Warning Indicator Light* |
| | Cruise Control SET Indicator* | | Electronic Brakeforce Distribution (EBD) System Warning Light (Two separate indicators on Instrument Cluster lit at same time) | | Immobilizer Indicator Light* |
| | Door Ajar Warning Light | | Idle, Stop & Go (ISG) | | LED Headlamp Warning Light* |

Tire Pressure Monitoring System (TPMS)^{†24}

The TPMS indicator  functions as both Low Tire Pressure Light and TPMS Malfunction Indicator.

The indicator  will illuminate if it detects one or more tires is significantly underinflated, the vehicle has a spare tire installed without TPMS or the outside temperature becomes significantly lower.

Inflate tire(s) to specifications using an accurate digital tire pressure gauge to turn off Low Tire Pressure Indicator . See front driver's door

jamb for PSI specification. The Low Tire Pressure Position Indicator  is displayed on the LCD screen in the Instrument Cluster when the tire(s) is underinflated.

When there is a problem with the TPMS, the TPMS Malfunction Indicator  will blink for approximately one minute and then illuminate. See dealer for service.

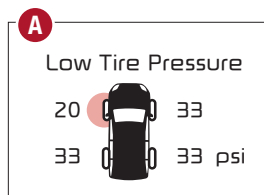

The above images are for illustration purposes only and may not reflect actual display

Refer to section 6 in the Owner's Manual for more information.

Fuel Economy

There are several factors that contribute to your vehicle's fuel economy, such as maintenance of your vehicle, driving style, environmental conditions, vehicle weight and vehicle aerodynamics. Below are some tips on how to help improve fuel economy:

- Keep your vehicle in good condition with regular maintenance
- Don't let the engine idle longer than necessary
- Drive at a moderate speed, accelerating smoothly and at a moderate rate
- Keep tires inflated to the recommended pressure
- Travel lightly, without carrying unnecessary weight in your vehicles
- Avoid placing large or heavy items on roof racks
- Avoid hilly, winding or poorly maintained roads

Refer to section 4 in the Owner's Manual for more information or snap the QR Code above to view a video.

QUICK TIPS

- Even with TPMS, tire pressure should be checked manually at least once a month. Only adjust tire pressure on "cold tires" that have been sitting for 20 minutes, and tires that are not hot in temperature from direct sunlight or heat
- For proper maintenance and optimal fuel economy, maintain recommended tire inflation pressures and stay within the load limits and weight distribution recommended for your vehicle
- In winter or cold weather, the TPMS light may illuminate if the tire pressure was adjusted to the recommended tire inflation pressure during warm weather

REMINDERS:

- Check the recommended tire pressure label located on the left side of driver's door jamb, visible when the door is opened
- Consult your dealer for service if Low Tire Pressure Light remains illuminated after inflating your tire(s)
- Personal electronic devices (such as laptops, wireless chargers, remote start systems, etc.) may interfere with the TPMS system, which may cause the Malfunction Warning Indicator (Check Engine Light) to illuminate

QR CODES

Tire Pressure Monitoring System Video



Fuel Economy Video



Refer to the inside front cover for more information on QR codes.
www.youtube.com/KiaFeatureVideos

Drive Mode Integrated Control System

The drive modes may be changed according to the driver's preferences or road conditions. To cycle through the drive modes **A** or deactivate a drive mode, rotate the DRIVE MODE knob **B**.

When a drive mode is selected, the drive mode indicator will illuminate in the Instrument Cluster (except for NORMAL). The system's default mode is NORMAL mode and when selected, the indicator will not be illuminated.

- **NORMAL Mode**
- **SPORT Mode**
- **SMART Mode*** – When the SMART mode is activated, the system automatically selects the drive mode best suited to the current driving style (economic, average, spirited). The color of the SMART mode indicator (green, white, red) depends on the current driving style

REMINDERS:

- The system is turned ON and in NORMAL mode when ignition is in the ON position
- Steering effort may be slightly increased in Sport mode
- When SPORT mode is selected, fuel economy may decrease

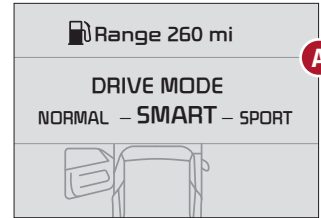

(Instrument Cluster LCD shown. Actual images may vary)

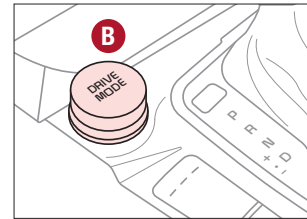

(Type A shown. Located above gear shift)

QR CODES

Drive Mode Integrated Control Video



Refer to the inside front cover for more information on QR codes.
www.youtube.com/KiaFeatureVideos

LCD Instrument Cluster Modes*

Press the Mode button **A** to cycle through different LCD Instrument Cluster Modes:



Trip Computer Mode: Displays driving information for fuel economy, accumulated info, speedometer, etc.



Turn-by-Turn Mode*: Displays the route guidance and destination info



Driving Assist: Displays the Lane Safety, Driver Attention Warning, Smart Cruise Control* and TPMS info



User Settings Mode*: Change settings of Driver Assistance, doors, lights, sound, convenience, service and other features



Master Warning Mode: Displays warning messages related to the vehicle when one or more systems is not operating normally

Driving while distracted is dangerous and should be avoided. Drivers should remain attentive to driving and always exercise caution when using the steering-wheel-mounted controls while driving.

Refer to section 4 in the Owner's Manual for more information.

Instant Fuel Economy

Press the Mode button **A** and cycle to the Fuel Economy screen in the Trip Computer to display Instant Fuel Consumption, which calculates fuel consumption during the past few seconds.

REMINDERS:

- Instant Fuel Consumption Mode is not to be used in calculation of or as a reference for AVERAGE fuel economy
- If the vehicle speed exceeds 1 mph (1.6 km/h) after being refueled with more than 1.6 gallons (6 liters), the average fuel economy will be cleared to zero (---)

Refer to section 4 in the Owner's Manual for more information.

Trip Modes / Trip Computer

The Trip Computer is a driver information system that displays information related to driving. It appears on the display when the ignition switch or the Engine Start/Stop button* is in the ON position.

To cycle through the different LCD Instrument Cluster modes, press the Mode button **A**.

When in Trip Computer mode , press the Move/Reset/OK button **B** up/down to cycle through the screens. When displaying TRIP A or TRIP B screens, press and hold the OK button **B** to reset the Tripmeter to zero.

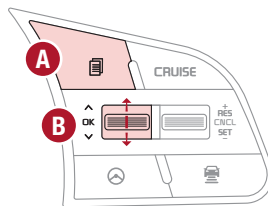

(Type A; Controls located on right side of Steering Wheel)

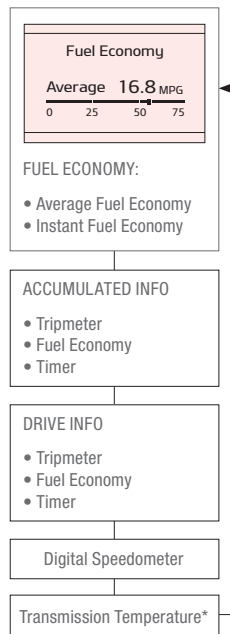

QR CODES

Instrument Cluster's LCD Display Video



*Refer to the inside front cover for more information on QR codes.
www.youtube.com/KiaFeatureVideos*

REMINDERS:

- Appearance of Tripmeter display may differ, as equipped
- All stored driving information (except Odometer and Range) is reset if the battery is disconnected

Your vehicle's steering wheel buttons may differ from those in the illustrations.

Refer to section 4 in the Owner's Manual for more information.

Service Interval Mode*

To enter Service Interval Mode, go to User Settings in the Instrument Cluster or the Vehicle Settings* in the audio head unit. When in Service Interval Mode, the system will display the tire pressure status, number of miles remaining until next service is due, as well as the type of service due.

When service is required, the following will be displayed: **Service Required**.

In User Settings, to reset the Service Interval Mode system, press and hold the OK button **B** for more than 1 second.

To turn **Service In** OFF, go to User Settings.

Service Interval Setting

When in the User Settings, in the **Service In** screen, set the service interval in User Settings mode:

- Press the Mode button **A** to cycle to User Settings*
- Scroll down to Service Interval and select
- If Service Interval is not checked, press the OK button **B** to turn ON
- Press the OK button **B** up/down to select/change the interval setting
- Press the OK button **B** to select the interval

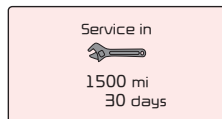
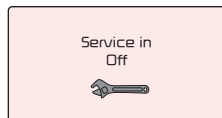
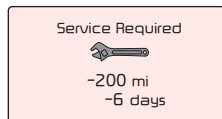

(Images are for illustration purposes only and may vary)

Sound Mood Lamp

The vehicle's speaker lights can be customized, including setting the lights to change according to the mood of the music playing.

To change the settings, go to All Menus in the audio head unit. Select Sound Mood Lamp and adjust the different settings.

QUICK TIP

To reset back to the default settings, press the Reset button on the audio head unit screen.

REMINDERS:

- Mood Lights cannot be changed while vehicle is moving
- Park vehicle in a safe location before changing the settings
- When any door is opened, the lighting turns off

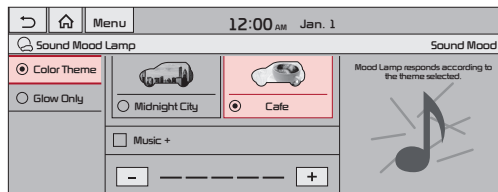

Refer to the Infotainment System Quick Start Guide for more information. Image is for illustrative purposes only and may vary on your vehicle.

QR CODES

Ambient, Theme, Mood Lighting Video



LCD Display: Maintenance Video



Refer to the inside front cover for more information on QR codes.
www.youtube.com/KiaFeatureVideos

User Settings – Instrument Cluster

To enter the User Settings in the LCD Instrument Cluster, ensure that the vehicle is at a stand still, shift lever in Park, and have the Engine Start/Stop button or Key in the ON position. Then press the Mode button **A** and select User Settings  by pressing the Move/Reset (OK) button **B**.

You can navigate the selections on the display by pressing the OK button **B** up/down. Select the item by pressing the OK button **B**.

User Settings Modes:

Driving Assistance*

- Driving Assist
- Warning Timing
- Warning Volume*
- Driver Attention Warning (DAW)*
- Forward Safety
- Lane Safety*
- Blind-Spot Safety
- Parking Safety

Door/Liftgate

- Automatically Lock
- Automatically Unlock

Lights

- One-Touch Turn Signal
- Headlight Delay
- High Beam Assist

Convenience

- Welcome Mirror
- Wireless Charging System
- Wiper/Lights Display
- Auto Rear Wiper (in R)
- Gear Position Pop-up
- Ice Road Warning

Service Interval

- Enable Service Interval
- Adjust Interval
- Reset

Other Features

- Fuel Economy Auto Reset
- Speedometer Unit
- Fuel Economy Unit
- Temperature Unit
- Torque Unit
- Tire Pressure Unit

Reset

- All menus in the User Settings mode are reset back to factory settings, except language and service interval

Language*

- Choose the language

REMINDER: Some settings appear in Vehicle Settings* in the audio head unit. Check your Car Infotainment System Quick Start Guide for more information or section 4 in the Owner's Manual

Vehicle Settings – Audio Head Unit*

(Vehicles with wide-screen navigation system)

To enter the Vehicle Settings mode in the audio head unit screen **C**, press the SETUP key on the audio head unit. Then press the Vehicle icon **D**, which will take you to the Vehicle Settings screen. Use the touchscreen to navigate through the menus.

Vehicle Settings modes:

Driver Assistance: Driving Assist, Warning Time, Warning Volume, Driver Attention Warning, Forward Safety, Blind-Spot Safety, Parking Safety

Climate: Recirculate Air, Automatic Ventilation, Defog/Defrost Options

Lights: One Touch Turn Signal, Headlight Display, High Beam Assist

Door: Auto Lock, Auto Unlock, Two-Press Unlock

Cluster: Energy Consumption Reset, Content Selection, Cluster Voice Guidance Volume, Welcome Sound

Convenience: Rear Occupant Alert, Wireless Charging System, Auto Rear Wiper (in R)

Seat: Rear Seat Heating Control

Reset: Reset Vehicle Settings to Factory Defaults

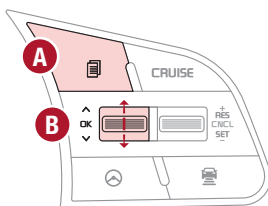

(Type A; Controls located on right side of Steering Wheel)

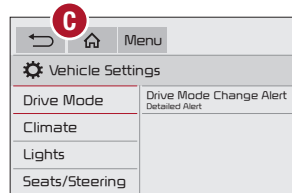

REMINDER: Some settings appear in User Settings in the Instrument Cluster. Check section 4 in the Owner's Manual or the Car Infotainment System Quick Start Guide for more information.

QR CODES

Vehicle & User Settings Video



Instrument Cluster's LCD Display Video



Refer to the inside front cover for more information on QR codes.
www.youtube.com/KiaFeatureVideos

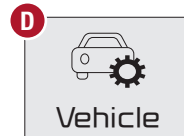

Vehicle Auto-Shut Off*

The Vehicle Auto-Shut Off, when certain conditions are met, will turn the vehicle off automatically after a pre-set time (30 or 60 minutes) in the User Settings.

A warning on the Instrument Cluster LCD will appear stating the “Vehicle will be turned off automatically in...” and a chime will sound when the timer starts **C**.

QUICK TIP

The timer that appears on the Instrument Cluster’s LCD can be reset using the OK button on the right side of the Steering Wheel.

When timer ends, a continuous beep sounds for one minute before the vehicle shuts off.

Auto-Shut Off Settings – The system is on by default and timer is pre-set to 30 minutes. To change the pre-set time settings, go to User Settings* on the Instrument Cluster LCD or the audio head unit Vehicle Settings* and select 30 minutes, 60 minutes or off **D**.

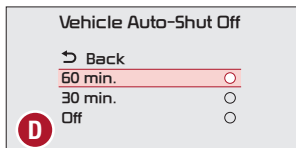
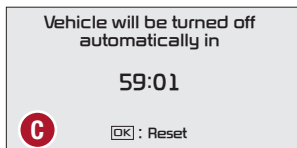

REMINDERS:

- When the vehicle is turned off then on again, the system defaults to on (30-minute pre-set time)
- The system will activate when the vehicle is on and these conditions are met:
 - The vehicle is in (P) Park
 - The driver’s seat belt is unfastened
 - The driver’s door is opened
 - The passenger seat is not occupied

Refer to the Owner’s Manual for more information.

QR CODES

Vehicle Auto-Shut Off Video



Refer to the inside front cover for more information on QR codes.
www.youtube.com/KiaFeatureVideos





Blind-Spot Collision-Avoidance Assist (BCA)^{†6}

BCW uses rear corner radar sensors in the rear bumper to monitor and warn the driver in certain situations if it detects an approaching vehicle in the driver's blind spot area and before changing lanes. When turned on, the system will activate when the vehicle is traveling faster than 20 mph and will alert the driver if another vehicle is detected by the rear-corner radar sensor.

1st-stage warning: When another vehicle is detected within BCW warning boundary **A**, an indicator will illuminate on the outside rearview mirrors **B**.

2nd-stage warning: When 1st stage warning is on and the driver activates a turn signal, a flashing yellow indicator will illuminate on the outside rearview mirrors and the system will sound a warning.

BCW User Settings:

- To turn BCA on, go to the User Settings menu  in the Instrument Cluster, press the Mode button  **C** on the Steering Wheel when the vehicle is at a standstill, gear shift in Park and with the ignition switch or the Engine Start/Stop button* in the ON position, and select User Settings . Press the Move (OK) button **D** up/down and select Driver Assistance, Blind-Spot Safety and then press the OK button **D**.
- Some models access settings through the Vehicle Settings in the audio head unit. Press the Setup hard key on the audio head unit, then **VEHICLE**  on the screen to enter Vehicle Settings.
- To set BCW when in Blind-Spot Safety, select:
 - **Warning Only:** Vehicle will provide a warning only (audible & visual)
 - **Off:** System is off, no warnings provided
- To set the initial warning activation time, go to User Settings , then Driver Assistance, Warning Time and press the OK button **D**. Adjust the warning timing:
 - **Early/Normal:** Maximizes the amount of distance between the vehicles before the initial warning occurs
 - **Late:** Reduces the amount of distance between the vehicles before the initial warning occurs

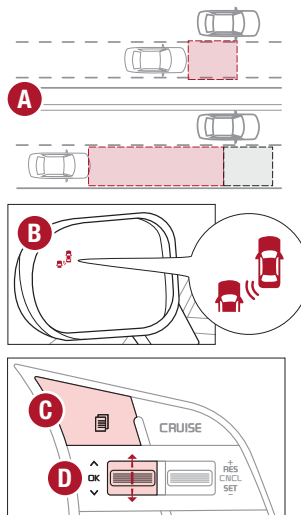

(Type A; Controls located on right side of Steering Wheel)

QUICK TIP

- BCW Warning Volume can be adjusted in the User Settings  in the Instrument Cluster or the Vehicle Settings* on the audio head unit. Go to Driver Assistance, then Warning Volume
- BCW will activate when:
 - The system is turned on
 - Other vehicles are detected on the rear sides of the vehicle
 - Vehicle speed is above approximately 20 mph

QR CODES

Blind-Spot Collision-Avoidance Assist Video



Refer to the inside front cover for more information on QR codes.
www.youtube.com/KiaFeatureVideos

The BCA system is not a substitute for safe and proper driving. Always drive safely and use caution.

Refer to section 5 in the Owner's Manual for more information.

The images on this page are for illustrative purposes only and may not reflect actual feature or operation.

REMINDERS:

- BCW will not issue a warning if the vehicle speed is 6 mph or more above the surrounding vehicles
- When BCW is ON and the ignition is cycled, BCW returns to its previous state
- BCW is a supplemental system. Do not solely rely on this system. Always pay attention to the road and drive safely

ADAS

Rear Cross-Traffic Collision Avoidance Assist (RCCA)*†6

Rear Cross-Traffic Collision-Avoidance Assist (RCCA) is designed to warn the driver, under certain conditions, may activate the Electronic Stability Control (ESC) and temporarily apply braking if it detects cross traffic approaching the vehicle, when vehicle is in reverse.







Initially, RCCA provides Rear Cross-Traffic Collision Warning (RCCW) when the system sensors detect approaching vehicles or pedestrians from the rear left or rear right side of the vehicle **A**.

RCCA will sound a warning, the warning indicators on the outside rearview mirror will illuminate and a message will appear on the Instrument Cluster LCD **B**. If RCCA detects that the collision risk has increased, the system automatically applies the brakes to reduce your speed, potentially helping to minimize the effects of a possible collision.

RCCA is designed to operate under the following conditions:

- When the gear shift is in Reverse
- When the vehicle is moving slower than 6 mph

RCCA User Settings:

- To go to the User Settings menu  in the Instrument Cluster, press the Mode button  **C** on the Steering Wheel when the vehicle is at a standstill, gear shift in Park and with the ignition on or the Engine Start/Stop button* in the ON position, and select User Settings .
- To turn RCCA on when in User Settings , press the Move (OK) button **D** up/down, select Driver Assistance, Parking Safety, Rear Cross-Traffic Safety and then press OK **D**.
- To set the initial warning activation time, go to User Settings , press the Move (OK) button **D** up/down, then go to Driver Assistance, Warning Time and press the OK button **D**.
- There are two settings:
 - **Early/Normal:** Maximizes the amount of distance between the vehicles before the initial warning occurs
 - **Late:** Reduces the amount of distance between the vehicles before the initial warning occurs
- Some models access settings through the Vehicle Settings in the audio head unit. Press the Setup hard key on the audio head unit, then **VEHICLE**  on the screen to enter Vehicle Settings

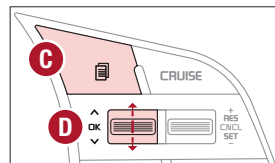
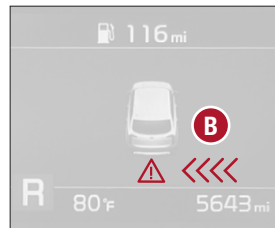
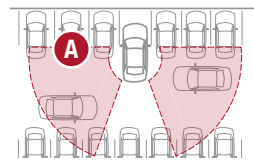

(Type A: Controls located on right side of Steering Wheel)

QUICK TIP

RCCA Warning Volume can be adjusted in the User Settings  in the Instrument Cluster or the Vehicle Settings on the audio head unit. Go to Driver Assistance, then Warning Volume

QR CODES

Rear Cross-Traffic Collision Avoidance Assist (RCCA) Video



Refer to the inside front cover for more information on QR codes.
www.youtube.com/KiaFeatureVideos

Refer to section 4 in the Owner's Manual for more information.

REMINDERS:

- The RCCA feature can be turned OFF/ON in User Settings, under Driver Assistance, Parking Safety
- When vehicle power is cycled, RCCA will remain in the previous state
- When a vehicle is approaching within the sensing range, and traveling faster than 3 mph, the RCCA system will show a warning
- The RCCA systems is a supplemental system. Do not solely rely on this system and always pay attention to the road and its conditions





Forward Collision-Avoidance Assist (FCA)^{†6}

FCA is designed to detect and monitor a vehicle ahead or detect a pedestrian in the roadway through front view camera recognition and front radar signals to warn the driver that a collision is imminent, and if necessary, temporarily apply emergency braking. Initially, FCA provides Forward Collision Warning (FCW) when it detects a potential collision with a vehicle, pedestrian, or cyclist, emitting an audible warning and visual alert on the instrument cluster **A**.

If the system detects that the collision risk has increased, Forward Collision-Avoidance Assist (FCA) automatically applies the brakes to reduce your speed, potentially helping to reduce the effects of a possible collision.



FCA User Settings:

- FCA is ON by default in most Kia models. FCA can be turned ON/ OFF by going to the User Settings in the Instrument Cluster
- To go to User Settings , press the Mode button  **B** on the Steering Wheel when the vehicle is at a standstill, gear shift in Park and with the ignition on or the Engine Start/Stop button* in the ON position
- Press the OK button **C** up/down and select User Settings  then Driver Assistance
 - In some models, go to Driving Assist, then Forward Collision-Avoidance Assist or Forward Collision Warning and press the OK button **C**
 - In other models, go to Forward Safety and select Active Assist, Warning Only or Off
- Active Assist: Vehicle will provide a warning (audible & visual) and apply the brakes if needed
- Warning Only: Vehicle will provide a warning only (audible & visual)
- Off: System is off, no warnings or braking provided
- To adjust the FCA initial warning activation time, go to User Settings , Driver Assistance, Warning Timing then select Normal, Early or Late, depending on your Kia model:
 - Early/Normal: Maximizes the amount of distance between the vehicles before the initial warning occurs
 - Late: Reduces the amount of distance between the vehicles before the initial warning occurs

FCA/FCW will become active when the:

- Ignition is on or the Engine Start/Stop button* is ON
- Vehicle is traveling faster than 5 mph
- Electronic Stability Control (ESC) is ON

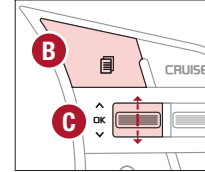

(Type A; Controls located on right side of Steering Wheel)

REMINDERS:

- FCA will be activated by default when the ignition is cycled ON, even when previous setting was OFF
- If FCA is operating and the ESC (Electronic Stability Control) is turned off, FCA system is automatically turned off
- When the FCA system is off, the FCA warning indicator is on in the Instrument Cluster 

Forward Collision-Avoidance Assist (FCA) is not a substitute for safe driving and may not detect all objects in front of the vehicle. Always drive safely and use caution.

Actual User Settings steps may vary by model. Refer to section 4 in the Owner's Manual for more information. For illustrative purposes only. Your actual display, buttons and/or features may vary.

QR CODES

Forward Collision-Avoidance Assist (FCA) Video



Refer to the inside front cover for more information on QR codes.
www.youtube.com/KiaFeatureVideos

QUICK TIP

FCA Warning Volume can be adjusted in the User Settings  in the Instrument Cluster or the Vehicle Settings* on the audio head unit. Go to Driver Assistance, then Warning Volume

Lane Keeping Assist (LKA)*†6

Lane Keeping Assist (LKA) is designed to detect the lane markers on the road with a front view camera on the windshield, and may assist the driver's steering to potentially help keep the vehicle in the lane. When turned on, the instrument cluster indicator  will initially illuminate white when turned on. It will remain white when the vehicle is traveling slower than 40 mph or when the system does not detect the lane markers. When the system detects the lane markers and can assist the steering, the LKA icon will illuminate green.

If the LKA detects that you are moving outside of your lane, the system may give an audible warning and display Lane Departure Warning on the instrument cluster. If the vehicle continues to move outside of the lane, LKA may provide steering inputs, trying to prevent the vehicle from moving outside its lane.

LKA is the operating mode by default when the Lane Safety/LKA button* **A** is depressed to ON.

There are three available modes:

- **Active LKA** – Provides more frequent steering inputs than standard LKA
- **Lane Keeping Assist** – Guides driver to keep vehicle within lanes and provides steering inputs when vehicle is about to deviate from the lane
- **Lane Departure Warning** – Alerts driver when the system detects the vehicle leaving the lane. In this mode the system will not provide steering inputs

All systems will operate under the following conditions:

- The vehicle speed exceeds approximately 40 mph
- LKA recognizes both sides of the lane markers the vehicle is traveling in
- The vehicle is between the lane markers

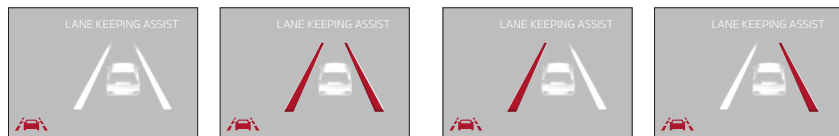

When the front-view camera does not detect the lane traveling in, the lanes are not illuminated

When the front-view camera detects the lane traveling in, both lanes are illuminated

When the front-view camera detects the vehicle moving outside of the lane traveling in, a vehicle crossing lane indicator will blink, either on the left or right lane (as shown in both images above)

QR CODES

Lane Keeping Assist (LKA) Video



Refer to the inside front cover for more information on QR codes.
www.youtube.com/KiaFeatureVideos

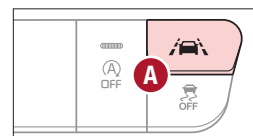

(Buttons located on left of Steering Wheel)

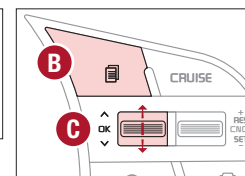

(Type A; Controls located on right side of Steering Wheel)

QUICK TIP

The LKA Warning Volume can be adjusted in the User Settings  in the Instrument Cluster or the Vehicle Settings* on the audio head unit





Lane Keeping Assist and Lane Departure Warning are not substitutes for safe driving and may not always alert the driver if the vehicle is driven outside of its lane. Always drive safely and use caution.

For illustrative purposes only. Your actual display, buttons and/or features may vary.

Actual User Settings steps may vary by model. Refer to section 4 in the Owner's Manual for more information.

Lane Keeping Assist (LKA)*†6 (continued)

LKA User Settings:

- To turn LKA ON, with the ignition on or the Engine Start/Stop button* in the ON position, press the Lane Safety/LKA button* **A**. The instrument cluster indicator  will initially illuminate white indicating the system is on
- To turn LKA on in the user settings, go to the User Settings menu  in the Instrument Cluster, press the Mode button  **B** on the Steering Wheel when the vehicle is at a standstill, gear shift in Park and with the ignition on or the Engine Start/Stop button* in the ON position, and select User Settings 
- To switch between LKA modes (Lane Keep Assist, Lane Departure Warning), go to User Settings  in the Instrument Cluster. Press the Move (OK) button **C** up/down and select desired setting and press the OK button **C**

REMINDERS:

- LKA will not issue a warning if the turn signals or hazard lights are activated
- When the ignition is cycled, LKA will return to the previously set state
- Some models access settings through the Vehicle Settings in the audio head unit. Press the Setup hard key on the audio head unit, then **VEHICLE**  on the screen to enter Vehicle Settings

Lane Keeping Assist and Lane Departure Warning are not substitutes for safe driving and may not always alert the driver if the vehicle is driven outside of its lane. Always drive safely and use caution.

For illustrative purposes only. Your actual display, buttons and/or features may vary.

Actual User Settings steps may vary by model. Refer to section 4 in the Owner's Manual for more information.

Driver Attention Warning (DAW)*†7

The DAW system is designed to alert the driver if it detects inattentive driving practices and, in certain situations, can give a warning signal to take a break from driving. To turn the DAW System ON/OFF, turn the ignition on and then select User Settings in the Instrument Cluster or the Vehicle Settings* in the audio head unit. Go to Driving Assistance, then Driver Attention Warning and, if equipped, select Inattentive Driving Warning.

Driver Attention Warning modes:

OFF: Driver Attention Warning is deactivated **D**

Normal (Default): Driver Attention Warning warns the driver of his/her inattentive driving practices

Late: Driver Attention Warning warns the driver of his/her inattentive driving practices later than Normal mode

If DAW is activated, the DAW information will appear on the LCD Display **E** when you select the Driving Assist mode . A message, "Consider taking a break," appears on the LCD display and a warning sounds to suggest the driver to take a break when the driver's attention level is below one bar **F**.

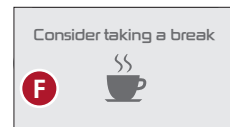
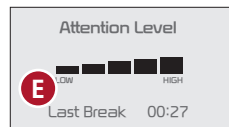
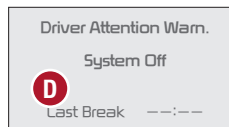

REMINDERS:

- The setup of DAW will be maintained, as selected, when the ignition is cycled
- When activated, DAW does not display "Consider taking a break" message when the total trip driving time is less than 10 minutes
- DAW will enter a standby mode if the camera does not detect the lanes and/or the driving speed remains under 40 mph

Driver Attention Warning is not a substitute for safe driving and may not detect all instances of inattentive driving practices. Failure to pay attention to travel conditions and vehicle operation could result in loss of vehicle control. Always drive safely and use caution. Refer to section 5 in the Owner's Manual for more information.

QR CODES

Driver Attention Warning (DAW) Video



Refer to the inside front cover for more information on QR codes.
www.youtube.com/KiaFeatureVideos





Lane Following Assist (LFA)*†6

Lane Following Assist (LFA) is designed to help ensure that the vehicle stays centered in its lane **A** by monitoring the detected lane markings ahead and adjust the steering. When turned on, the instrument cluster indicator will initially illuminate white **A** when turned ON, and on some vehicles, when SCC is engaged. It will remain white when the system does not detect the lane markers. When the system detects the lane markers and can assist the steering, the LFA icon will illuminate green **B**.

LFA will operate only when these conditions are met:

- When the SCC is on and operating
- LKA recognizes both sides of the lane markers the vehicle is traveling in
- The vehicle is traveling slower than 95 mph

LFA User Settings:

- To go to User Settings  in the Instrument Cluster, press the Mode button  **C** on the Steering Wheel when the vehicle is at a standstill, gear shift is in Park and with the ignition on or the Engine Start/Stop button* in the ON position, and select User Settings .
- To enable LFA, when in User Settings, press the Move (OK) button **D** up/down and Select Driver Assistance then Driving Assist, Select Lane Following Assist. Press the OK button **D**.
- Some models access settings through the Vehicle Settings in the audio head unit. Press the SETUP hard key on the audio head unit, then **VEHICLE**  on the screen to enter Vehicle Settings
- Some vehicles have a Lane Driving Assist / Lane Safety button* on the Driver's Panel or the Steering Wheel . Press to activate Lane Following Assist

REMINDERS:

- If the ignition is cycled, LFA returns to its previous state, on or off, if activated in the User Settings menu  and when combined with SCC. If using the Steering Wheel LKA button, then LKA defaults to off
- LFA is not a substitute for safe and proper driving. Always drive safely and use caution

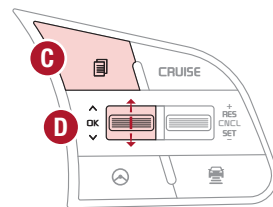
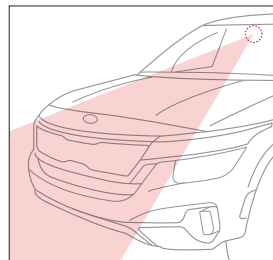
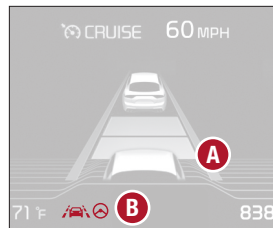

(Controls on right side of Steering Wheel if LFA/SCC equipped)

QR CODES

Lane Following Assist (LFA) Video



Refer to the inside front cover for more information on QR codes.
www.youtube.com/KiaFeatureVideos

Images are for illustrative purposes only and may not reflect actual feature or operation.

LFA is supplemental. Do not solely rely on this system and always pay attention to the road and its conditions.

Actual User Settings steps may vary by model. See section 5 in the Owner's Manual for more detailed information, limitations and conditions.

Safe Exit Assist (SEA) System*†6

Safe Exit Assist (SEA) can help prevent passengers from opening their door by displaying a warning message on the Instrument Cluster **A** and sounding an audible warning when a vehicle is detected, approaching from behind, and after your vehicle has stopped.

To turn on SEA, go to User Settings in the Instrument Cluster or the Vehicle Settings* in the audio head unit, select Driver Assistance, then Blind-Spot Safety, and select Safe Exit Assistance.

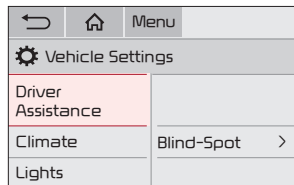
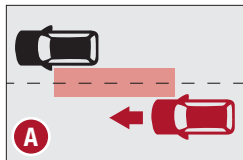

Images are for illustrative purposes only and may not reflect actual feature or operation.

See section 5 in the Owner's Manual for more information.

Highway Driving Assist (HDA)*

Highway Driving Assist (HDA) is designed to adjust the speed of the vehicle when driving on federal highways. The system can adjust the vehicle's speed based on available highway speed information. The automatic speed setting mode is designed to set the speed automatically by adjusting to the current speed limits of the highway the vehicle is traveling on.

To turn HDA on, go to **User Settings** in the Instrument Cluster or the Vehicle Settings* in the audio head unit. Go to Drive Assistance > Driving Assist > Highway Driving Assist and press the OK button **B** on the Steering Wheel.

HDA will operate only when these conditions are met:

- The vehicle is traveling slower than 95 mph
- When driving on federal highways
- When the SCC is on and operating
- When the SCC speed is set to current federal highway speed

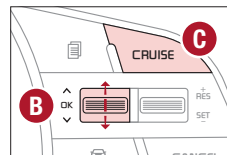

To activate HDA, turn Smart Cruise Control (SCC) on by pressing the Driving Assist **CRUISE** button **C** on the Steering Wheel. When HDA is activated and the conditions are met, the Instrument Cluster indicator light **D** will illuminate green. If the conditions are not met, HDA will be in standby mode and the indicator light **D** will illuminate white.

When in operation, and if both lanes are recognized, a display **E** will show the lanes illuminated white and the steering wheel indicator illuminated green.

If HDA is activated, conditions are met and the SCC speed is set by the driver (at the posted highway speed limit or slower), HDA will enter the automatic speed setting mode. The set speed and AUTO will be displayed **F** in green and an audible alert will sound.

REMINDERS:

- If the driver changes the speed while in automatic speed setting mode, it deactivates and enters a manual mode
- When the ignition is cycled, the system returns to its previous state, on or off

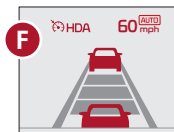

QR CODES

Highway Driving Assist (HDA) Video



Refer to the inside front cover for more information on QR codes.
www.youtube.com/KiaFeatureVideos



Highway Driving Assist is not a substitute for safe driving, may not detect all objects around the vehicle, and only functions on certain federal highways.

Always drive safely and use caution. See section 5 in the Owner's Manual for more detailed information, limitations and conditions. Images are for illustrative purposes only and may not reflect actual feature or operation.

Instrument Cluster Control

With parking lights/headlights ON, toggle switch **A** up (+) or down (-) to adjust the brightness of the instrument panel illumination.



(Buttons located on left of Steering Wheel)

See section 4 in the Owner's Manual for more information.

Electronic Stability Control (ESC)^{†8}

ESC is designed to help stabilize the vehicle during certain cornering maneuvers. It is a good idea to keep the ESC turned ON for daily driving whenever possible.

Press the ESC OFF button **B** to turn ESC OFF.

REMINDERS:

- ESC is turned ON by default at vehicle startup. When ignition is cycled, ESC will turn ON again
- The ESC Indicator Light in the instrument cluster will illuminate whenever the ESC is in operation

See section 5 in the Owner's Manual for more information.

Hill-Start Assist Control (HAC)^{†8}

HAC is designed to help prevent the vehicle from rolling backward when accelerating from a stop while on a steep incline.

The HAC automatically activates whether the ESC is OFF or ON but does NOT activate when the ESC has malfunctioned.

REMINDERS:

- The HAC does not operate when the gear shift is in the P (Park) or the N (Neutral) position
- HAC does not replace the need to apply brakes while the vehicle is stopped on an incline
- In the event of HAC system malfunction, see an Authorized Kia Dealer for service

QUICK TIPS

- When HAC is active (e.g., during initial acceleration from a stop on an incline), you may notice that the brakes will momentarily remain engaged after you depress the accelerator – this is normal operation
- HAC provides a two-second delay before the vehicle may start rolling backward

See section 5 in the Owner's Manual for more information.

Engine Start/Stop Button*†9

To start the engine:

1. Depress the brake pedal
2. Press the Engine Start/Stop button while in P (Park) or N (Neutral)

To turn the engine OFF, press the Engine Start/Stop button.

To use the Engine Start/Stop button, you must have the Smart Key fob on your person or inside the vehicle.

QUICK TIPS

To use electrical accessories:

ACC position

- When in the OFF position and without depressing the brake pedal, press the Engine Start/Stop button once (amber light **A**)

On position

- When already in the ACC position (amber light **A**) and without depressing the brake pedal, press the Engine Start/Stop button again (red light **A**)

When in the OFF position (no light) and without depressing the brake pedal, press the ENGINE START/STOP button twice (reddish-orange light **A**)

Keeping the vehicle in ACC or the ON position for extended periods of time without turning the engine on may discharge the vehicle's battery

REMINDERS:

- In an emergency situation while the vehicle is in motion, you are able to turn the engine off and to the ACC position by pressing the Engine Start/Stop button for more than 2 seconds or 3 times successively within 3 seconds
- If Smart Key fob battery is dead, with the lock button facing the Engine Start/Stop button, hold the fob up against the Engine Start/Stop button and press and hold until the engine starts

Refer to section 5 in the Owner's Manual for more information.

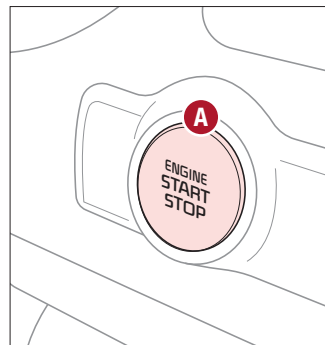

(Button located on right of Steering Wheel)

QR CODES

Engine Start/Stop Button and Smart Key Video



Refer to the inside front cover for more information on QR codes.
www.youtube.com/KiaFeatureVideos

Power Windows, Window Lock & Central Door Lock

- A** Pull/Press to operate Driver's Window Auto Up/Down*

QUICK TIP

Press the button again to stop Auto Up/Down function

- B** Press to Lock/Unlock All Doors (also unlocks Fuel Door)

- C** Press to disable Rear Passenger Windows

QUICK TIPS

While driving with the rear windows down or with the sunroof* in an open or partially open position, a wind buffeting or pulsation noise may be heard. This noise is a normal occurrence and can be reduced or eliminated by the following:

- If the noise occurs with one or both of the rear windows down, partially lower both front windows approximately 1 inch
- If the noise occurs with the sunroof open, slightly reduce the size of the sunroof opening

REMINDERS:

- When the button **C** is pressed, the rear passengers cannot operate the window controls
- If the inner rear door handle is pulled once when the door is locked, the door will unlock. If the inner rear door handle is pulled once more, the door will open

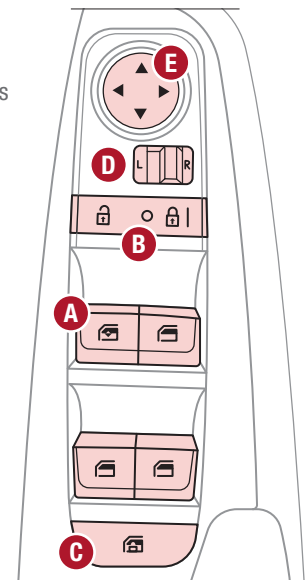

Button configuration may vary depending on vehicle model.

Refer to section 4 in the Owner's Manual for more information.

Rear Door Locks – Double Pull to Open

If the inner door handle is pulled once when the door is locked, the door will unlock. If the inner door handle is pulled once more, the door will open.

QUICK TIP

To open the Rear Doors, pull the inner door handles two times

Automatic Door Lock/Unlock

Auto Door Lock/Unlock will engage when the gear shift is moved into or out of the P (Park) position. Refer to the User Settings* in the LCD Instrument Cluster modes on how to turn Auto Door Unlock ON/OFF.

Refer to section 4 in the Owner's Manual for more information.

Rear Door Locks

If the inner door handle is pulled once when the door is locked, the door will unlock. If the inner door handle is pulled once more, the door will open.

Refer to section 4 in the Owner's Manual for more information.

QUICK TIP

To open the Rear Doors when locked, pull the inner door handles two times

QR CODES

Rear Door Locks -
Double Pull to Open
Video



*Refer to the inside front cover for more information on QR codes.
www.youtube.com/KiaFeatureVideos*

Power Outside Mirrors

- A** Press the L or R buttons to select the mirror to adjust
- B** Press button arrows left/right or up/down to adjust mirror position

Refer to section 4 in the Owner's Manual for more information.

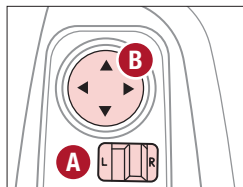

Heated Outside Mirrors*

Mirror heaters automatically turn ON/OFF at the same time the Rear Window Defroster is turned ON/OFF. The Rear Window Defroster button* is located on climate control system panel.

Refer to section 4 in the Owner's Manual for more information.

Manual Folding Mirrors*

To fold the mirrors in manually, pull the mirror towards the window.

QUICK TIP

If needed, pull the mirror firmly until it folds

Refer to section 4 in the Owner's Manual for more information.

Images are for illustrative purposes only and may not reflect actual feature or operation.

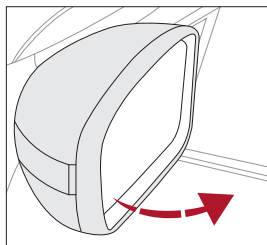

Tilt/Telescoping Steering Wheel†‡

To adjust the Steering Wheel, press the lock-release lever **C** down and adjust to the desired angle **D** and then the distance **E**.

When finished, pull the lock-release lever **C** up to lock Steering Wheel in place.

QUICK TIP

It may be helpful to pull/push bottom of Steering Wheel towards/away from you to adjust desired distance prior to adjusting the angle.

Do not adjust the steering wheel while driving as this may cause you to lose control of the vehicle.

See section 4 in the Owner's Manual for more information.

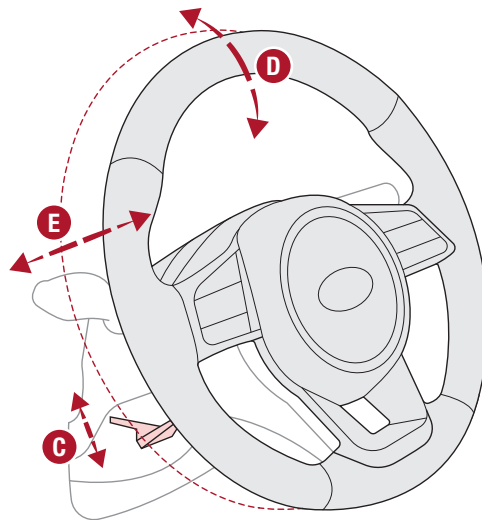

Headlights & High Beams

To operate:

- Rotate lever switch to change the Headlight function
- Push lever to turn High Beams ON
- Pull lever to flash Headlights / High Beams

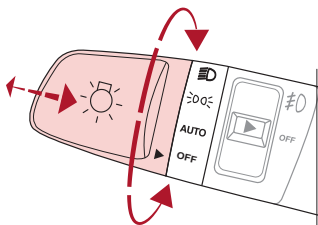

- Headlight ON position
- Parking light position
- AUTO** Auto Light* / DRL / HBA
- OFF** Lights OFF

AUTO Light* — When the light switch is in the AUTO Light position, the tail lights and headlights will turn ON/OFF automatically, depending on the amount of light outside the vehicle.

Refer to section 4 in the Owner's Manual for more information.

Daytime Running Lights (DRL)*

DRL may help others to see the front of your vehicle during the day. The lights will be on automatically when the ignition or Engine Start/Stop button is ON and the headlight switch is in the AUTO position, unless one of the following occurs:

- Headlights are on
- Parking brake is applied
- Fog lights are on
- Engine is turned off
- Switch is in the OFF position

REMINDER: DRL only operates during the daytime

Refer to section 4 in the Owner's Manual for more information.

High Beam Assist (HBA)

High Beam Assist is designed to automatically adjust the headlight range by switching between high and low beams based on light detected from other vehicles and road conditions.

To enable HBA, toggle the light switch to the AUTO Light position and turn on the high beams by pushing the lever away from you. The High Beam Assist indicator will illuminate.

REMINDEES:

- HBA will operate when vehicle speed exceeds 25 mph
- If the lever is pushed away from you while HBA is operational, HBA will turn off and the high beams will be on continuously. If the lever is pulled toward you while HBA is operational, HBA will turn off
- If the light switch is switched to the headlight position, HBA will turn off and the low beams will be on continuously

High Beam Assist does not operate below certain speeds, or in some lighting and driving conditions. Please be aware of your surroundings and exercise proper road etiquette when operating a vehicle using the high beams.

Turn Signals & Fog Lights*

To operate:

- Turn Signals - Move lever Up/Down for Right/Left Turn Signal
- Fog Lights - Press switch **A** up/down to turn Fog Lights ON/OFF

REMINDER: Headlights must be ON for fog light operation.

One-Touch Lane Change Signal

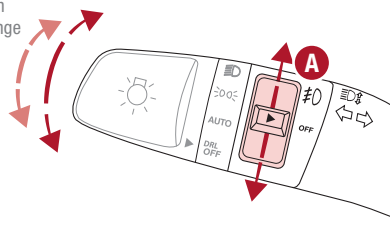

One-Touch Lane Change Signal

is activated by briefly pressing the Turn Signal Lever up/down slightly for less than 1 second and then releasing. The lane change signal will blink 3 times.

To change how many times (3/5/7) the Lane Change Signal blinks, go to User Settings Mode* in the LCD Instrument Cluster modes.

See section 4 in the Owner's Manual for more information.

Windshield Wipers & Washers

Front Wiper & Washer

To operate front wipers and washers:

- Move lever Up/Down to change Wiper modes
- Press INT switch **B** up/down to adjust Intermittent Wipe Speed
- Pull lever to spray and wipe

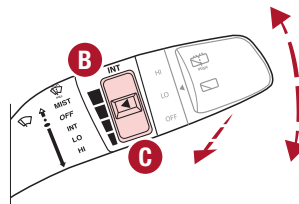

- MIST:** Single wipe
- OFF:** Wiper off
- INT/AUTO:** Intermittent Auto Wipe
- LO:** Slow Wiper Speed
- HI:** High Wiper Speed

QUICK TIPS

- Moving switch **B** up increases intermittent wipe frequency and wipe speed.
Moving switch **B** down decreases frequency of wipes
- Set the wiper to OFF position when the wiper is not in use

Auto Rain Sensing*

The rain sensor located on the upper end of the windshield glass is designed to sense the amount of rainfall and control the wiping cycle for the proper interval. The more it rains, the faster the wiper operates. When the rain stops, the wiper stops.

To turn ON the auto rain sensing wipers, move lever up/down to AUTO.

To adjust the auto rain sensing wiper speed setting, move the speed control switch **C** up/down.

See section 4 in the Owner's Manual for more information.

Rear Wiper & Washer*

To operate rear wipers and washers:

- Rotate Rear Wiper switch to change Wiper modes
- Push lever to spray and wipe

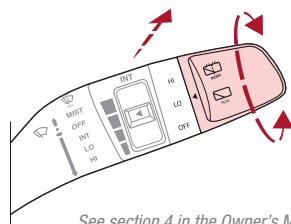

- HI:** Continuous wipe
- LO:** Slow wipe
- OFF:** Wiper off

See section 4 in the Owner's Manual for more information.

QR CODES

Wipers and Wiper Stalk Video



Refer to the inside front cover for more information on QR codes.
www.youtube.com/KiaFeatureVideos

Smart Cruise Control (SCC)^{†6}

Smart Cruise Control (SCC) is designed to maintain a speed and predetermined distance from vehicles detected ahead by automatically adjusting the driving speed as needed. When traffic is detected, the vehicle will slow down to maintain a set distance behind traffic without depressing the accelerator or brake pedal.

With SCC on and activated, the vehicle distance set, and the system detects a vehicle slowing or stopping, the system can bring the vehicle to a complete stop. When the vehicle ahead starts to move forward, SCC re-engages. If the vehicle ahead stops for more than 3 seconds, the accelerator pedal or the RES+ button must be pressed to start moving the vehicle.

To set/adjust SCC speed:

- Accelerate/decelerate to the desired speed
- Press the Driving Assist **CRUISE** button **A** to turn system ON. The CRUISE indicator will illuminate on the instrument cluster
- Press SET- button **B** down to set speed. The SET indicator light will illuminate. The set speed and vehicle distance will illuminate on the LCD screen
- Press button **B** up or down to adjust the set speed

To set the vehicle distance **C:** Press the Vehicle Distance button **D** on the steering wheel. The image on the LCD screen **E** will change when scrolling through the settings. Each time the button is pressed, the vehicle distance changes **E**.

To cancel SCC operation: Press button **B** or press the brake pedal. The LCD screen will display a message that the SCC operation is canceled.

To turn SCC OFF: Press the Driving Assist **CRUISE** button **A**. The CRUISE indicator on the instrument cluster will turn OFF.

To adjust the sensitivity of SCC (if equipped): Press the Mode/Menu button **F** on the Steering Wheel. When in User Settings, select Driver Assistance, then SCC Reaction. Then select Slow, Normal or Fast.

SCC is a supplemental system and is not a substitute for safe driving. It is the responsibility of the driver to always check the speed and distance to the vehicle ahead.

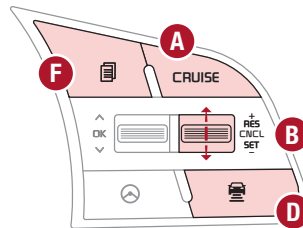

(Type B; buttons located on right side of Steering Wheel)

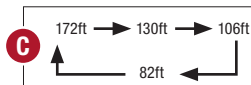

REMINDER: Above are approximate distances based on 56 mph vehicle speed. The SCC vehicle distance increments are based on vehicle speed.

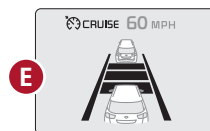

QR CODES

Smart Cruise Control (SCC) with Stop & Go Videoa



Refer to the inside front cover for more information on QR codes.
www.youtube.com/KiaFeatureVideos

Images are for illustrative purposes only and may vary on actual vehicle.

See section 5 in the Owner's Manual for more information.

Smart Cruise Control (SCC)*†6 (continued)

QUICK TIPS

To change the Cruise Control mode from SCC to standard Cruise Control, press and hold button **D**. Repeat to switch modes again (SCC must not be activated to change modes).

If your vehicle speed is between 5~20 mph when you press the Driving Assist **CRUISE** button, the Smart Cruise Control speed will be set to 20 mph

When following a vehicle, the system will automatically adjust your cruise speed based on the vehicle detected ahead. If the vehicle detected remains at a standstill for more than 3 seconds, the system will disable.

REMINDERS:

- Cruise Control button must be ON in order to turn SCC ON/OFF
- SCC can operate when the vehicle is driving faster than 6 mph
- SCC is activated when ignition is turned on. Speed will need to be reset when ignition is cycled on
- SCC is turned ON again when the ignition is cycled off, then on again. The speed setting will need to be reset when ignition is cycled
- SCC is also canceled when the driver's door is opened, gear shift is changed out of D (Drive), EPB is activated and various other conditions. See Owner's Manual for other conditions
- In standard Cruise Control, the driver needs to manually assess the distance from other vehicles as the system will not automatically apply brakes
- If SCC is left on, it can be activated inadvertently. Keep the system off when not in use to avoid setting a speed that the driver is not aware of
- When following a vehicle, the system will automatically adjust your cruise speed based on the vehicle detected in front

Cruise Control (CC)†21

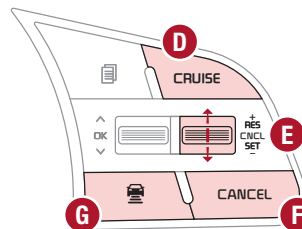

- D Driving Assist CRUISE button:** Press to turn the Cruise Control ON/OFF
- E RES+ button:** Press up to resume or increase cruising speed
- SET- button:** Press down to set or decrease cruising speed
- F CANCEL button:** To cancel Cruise Control, do one of the following:
 - Press the brake pedal
 - Press the CANCEL button
- G Switch Modes*:** To switch between standard Cruise Control and Smart Cruise Control, press and hold for more than two seconds

QUICK TIPS

- Cruise Control is designed to function at above approximately 20 mph
- The Cruise Control system will not activate until the brake pedal has been depressed at least once after ignition ON or engine starting

REMINER: Standard Cruise Control is a part of Smart Cruise Control (SCC)* and can be set as the operating mode. To switch from SCC to Standard Cruise Control, press and hold the CRUISE button (the SCC system must not be activated to change modes). Repeat to switch back to SCC mode

See section 5 in the Owner's Manual for more information.

Bluetooth® Wireless Technology†5,21

- A Talk button:** Press to activate voice recognition/bring up menus/place calls with minimal voice command prompts from the system. Press and hold to exit voice recognition
- UVO link with Navigation*** – When enrolled with a UVO link subscription, press this button to activate the UVO Voice Assist to use navigation guidance and search destinations
- B Volume button:** Press up/down to raise/lower speaker volume
- Mute button:** Press to mute the microphone during a call and to mute the audio system speakers, or to pause *Bluetooth*® streaming media
- C Receive/Place Call button:** Press to place/receive incoming calls. Press to pair a phone (If no phone is paired)
- D End Call button:** Press to end a call, reject an incoming call or cancel a function

For more information, refer to the Car Infotainment System Quick Reference Guide. For *Bluetooth*® wireless technology FAQs, go to www.kia.com, Owners section.

Your vehicle's steering wheel buttons may differ from those in the illustrations. See your Owner's Manual for more details.

Driving while distracted is dangerous and should be avoided. Drivers should remain attentive to driving and always exercise caution when using the steering-wheel-mounted controls while driving.

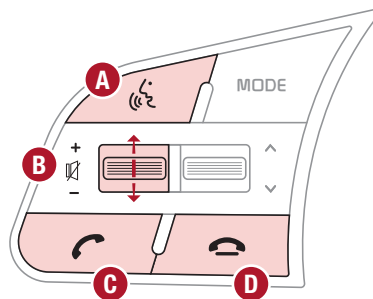

QUICK TIPS

- The system can register or pair multiple *Bluetooth*® devices. See the Car Infotainment System Quick Reference Guide for more information on setup and limitations
- When using the voice command feature, wait for the system BEEP before speaking the command
- Phone book transfer upload time varies by phone model and with number of phone book entries
- Because of differences in phone quality, service providers and *Bluetooth*® Wireless Technology chip programming, functionality may differ from one phone to another

REMINDER: *Bluetooth*® Wireless Technology audio and calling functions are supported when connected to a *Bluetooth*® enabled device

Bluetooth® Wireless Technology†5,21 (continued)

Pairing a Phone

For instructions on how to pair a phone, refer to the audio system's user's guide or your vehicle's Quick Start Guide.

QUICK TIPS

- During the pairing process, be sure to accept the connection requests on the phone for phone book download and to allow acceptance of all future *Bluetooth*® connection requests
- The system can register or pair multiple *Bluetooth*® devices. See the Car Infotainment System Quick Reference Guide for more information on setup and limitations

How to Place a Call

When using the voice command feature, wait for the system BEEP before speaking the command.

There are two options for placing a call using the Steering Wheel controls:

- Option 1: Press the Receive/Place Call button **C** (system displays the call history with the most recent calls)
- Option 2*: Press the Talk button **A** (system will BEEP to indicate it is ready for call placement). Then say the command "Call {name}" or "Dial {number}"

Voice Recognition and Phone Contact Tips

The system may have difficulty understanding some accents or uncommon names. Improve the performance by making a few simple changes to your phone contacts, listed below. To help optimize the *Bluetooth*® Wireless Technology Voice Recognition system, see other tips and reminders under Quick Tips:

- Use full names (first and last names) vs. short or single-syllable names ("John Smith" vs. "Dad," "Smith Residence" vs. "Home")
- Avoid using special characters, emojis or hyphenated names (@, &, #, /, -, *, +, etc.)
- Avoid using acronyms ("In Case of Emergency" vs. "ICE") or words with all capital letters
- Spell words completely, no abbreviations ("Doctor Smith" vs. "Dr. Smith")

QUICK TIPS

- *Bluetooth*® Music Streaming: If the *Bluetooth*® music is inaudible or too low, turn up the volume on the connected phone
- When placing a call, speak in a natural, moderate tone, with clear pronunciation. The system may have trouble recognizing commands if you speak too softly or too loudly
- Always wait for the beep before speaking any commands
- Close windows and sunroof and turn off A/C. The noise from an A/C fan operating at higher speeds or wind noise from open windows or sunroof can interfere with Voice Recognition
- Press the talk button and say "Help" to get a list of available commands

QR CODES

Voice Recognition Tips Video



Refer to the inside front cover for more information on QR codes.
www.youtube.com/KiaFeatureVideos

Audio Controls†21

- A Audio MODE button:** Press to cycle through FM/AM/SiriusXM®*/ Media modes. Press to turn power on; Press and hold to turn power off; Press and hold to go to Advanced Setting / Steering Wheel mode (UVO link with Navigation).
- B Seek/Preset button**
Radio Mode (FM/AM/SiriusXM®):* Press to advance through Preset Stations. Press and hold to Auto Seek
Media Modes: Press to move Track Forward/Back. Press & hold to Fast Forward/Rewind (except for *Bluetooth®* Audio)
- C Volume button:** Press up/down to raise/lower volume
Mute button: Press to mute all audio (Media pauses in some Media modes when pressed)

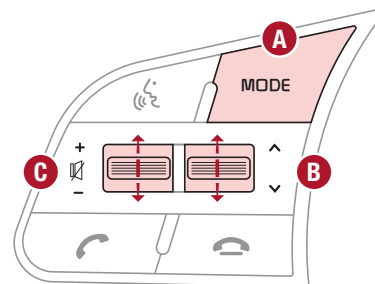

QUICK TIP

Pressing the Audio Mode button for more than 1 second will turn Audio Mode ON/OFF.

Your vehicle's steering wheel buttons may differ from those in the illustrations. For further audio system operation, refer to pages 26-33. For more information, refer to the Car Infotainment System Quick Reference Guide.

Driving while distracted is dangerous and should be avoided. Drivers should remain attentive to driving and always exercise caution when using the steering-wheel-mounted controls while driving.

To help minimize driver distraction, some audio system functionalities have been modified while the vehicle is in Drive, Reverse or moved out of Park.

Android Auto™†3 / Apple CarPlay®†4 Setup

Android Auto™ compatible smartphone setup – Download the Android Auto™ app from the Google Play™ Store†10. Open the Android Auto™ app and proceed with the onscreen instructions to complete setup on the mobile device.

Wireless Connection setup for Android Auto™ & Apple CarPlay®
(*Standard Audio System & Standard Audio System-Value with UVO link*):

1. Press the SETUP key on the audio head unit
2. Press DEVICE CONNECTION SETTINGS
3. Press PHONE PROJECTION, then ADD NEW

Cable Connection setup for Android Auto™ (*Standard Audio System, Standard Audio System-Value with UVO link & UVO link with Navigation*):

1. Press the SETUP key on the audio head unit
2. Press DEVICE CONNECTION, select Android Auto™ and then select ENABLE ANDROID AUTO. Review all terms, conditions and requests on the head unit and phone, and, if you agree, accept them in order to use Android Auto™
3. Connect the Android™ device with the vehicle's USB port using the manufacturer's cable provided with your phone
4. From the vehicle's home screen, select the Android Auto™ button, where you'll see all the Android Auto™ supported apps

QUICK TIPS

- If Android Auto™ / Apple CarPlay® randomly disconnects:
 - Ensure the USB cable is certified by the phone manufacture for both power and data
 - Clean the phones port, which the USB cable connects to, with disposable compressed air
 - The Phone should not be disturbed while driving as this can cause a disconnection at the phone's USB port
 - Visit the phone manufactures website for Android Auto/ Apple CarPlay app concerns

Driving while distracted can result in a loss of vehicle control that may lead to an accident, severe bodily injury, and death. The driver's primary responsibility is in the safe and legal operation of a vehicle, and any handheld devices, other equipment, or vehicle systems which take the driver's eyes, attention and focus away from the safe operation of a vehicle or which are not permissible by law should never be used during operation of the vehicle.

Cable Connection setup for Apple CarPlay®
(*UVO link with Navigation only*):

1. Connect the Apple CarPlay® compatible iPhone®†11 with the vehicle's USB port using the manufacturer's cable provided with your iPhone®†11
2. Press the SETUP key on the audio head unit
3. Press DEVICE CONNECTION on the screen and select Apple CarPlay®
4. Select ENABLE APPLE CARPLAY. Review all terms, conditions and requests on the head unit and phone, and, if you agree, accept them in order to use Apple CarPlay®
5. From the audio head unit home screen, select the Apple CarPlay® button, where you'll see all the Apple CarPlay® supported apps

REMINDERS:

- Android Auto™ compatibility requirements for connection:
 - UVO link with Navigation (USB cable connection only): OS Android™ 5.0 or higher, phone manufacturer's USB cable and data plan with applicable feature(s)
 - Standard Audio System-Value (USB cable & wireless connection):
 - USB cable connection - OS Android™ 5.0 or higher, phone manufacturer's USB cable and data plan with applicable feature(s)
 - Wireless connection - OS Android™ 9.0 or higher with data plan for applicable feature(s)
- Apple CarPlay® compatibility requirements for connection:
 - UVO link with Navigation (USB cable connection only): iOS software 8.0 or higher, phone manufacturer's USB cable and data plan for applicable feature(s)
 - Standard Audio System-Value (Wireless connection only): iOS software 10.0 and higher with data plan for applicable feature(s)
- It is recommended to always update your phone to the latest operating system release
- Wireless Android Auto™ system only works for certain Android models. Use the manufacturer's USB cable when wireless feature is not available

QR CODES

Wireless Apple CarPlay & Android Auto Video



Refer to the inside front cover for more information on QR codes.
www.youtube.com/KiaFeatureVideos

Refer to the Car Infotainment System Quick Reference Guide for more information.

Standard Audio System* – FM/AM/Media (USB, Bluetooth®†5.2.1 Audio)*

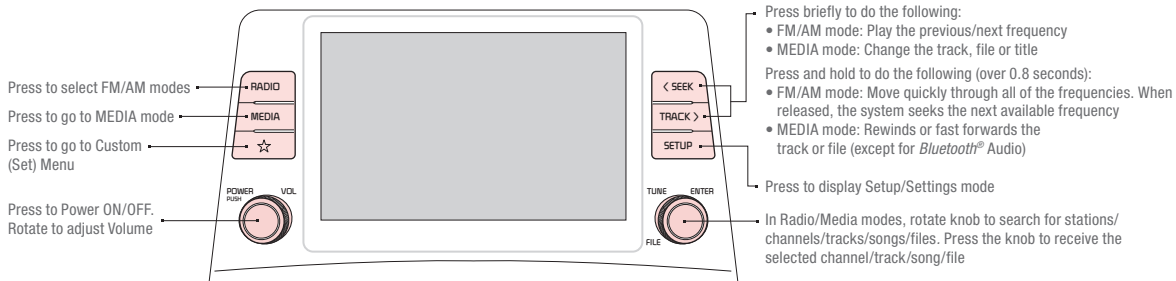

Radio Presets: You can listen to FM and AM radio and save frequently used stations. To Save a Preset, press and hold the desired slot. This saves the current station in the selected slot.

Custom Key ☆ – A programmable button to provide quick access to one of several available system features. To Program the Custom Key:

1. Press and hold the SETUP button, then press the Custom Key
2. Select one of the available features you would like the Custom Key to open

Sound Settings – To adjust the Standard Audio Systems sound settings:

1. Press the SETUP key on the audio control unit or the onscreen MENU button, when in MEDIA mode
2. Select the onscreen SOUND button
3. Select the menu item (Position, Volume, Tone, Priority, Advanced)
4. Using the touchscreen, press arrows to adjust the settings

QUICK TIPS

- The system can register or pair multiple Bluetooth® devices. See the Car Infotainment System Quick Reference Guide for more information on setup and limitations
- Volume level between different audio modes:
 - When switching between audio modes (AM, FM, Bluetooth® Audio, etc.), the audio system saves the previous volume level you were listening to. For example, if you were listening to FM radio at volume level 20 then switched to BT Audio and adjusted the volume level to 30, the volume level will be at 20 when you switch back to FM radio
 - When using Bluetooth® Audio, the overall volume is dependent on your device's volume. If the volume is turned down low on your device it will remain low even if the system volume is turned up
- This system supports Android Auto™ (USB & wireless connection) and Apple CarPlay® (wireless connection only)
- When connected to Android Auto™ or Apple CarPlay® on your smartphone, the smartphone's navigation system may also be available
- A warning screen may appear periodically to remind users that the audio system should be operated when the engine is running to prevent battery discharge

QR CODES

Standard Audio System Video



Refer to the inside front cover for more information on QR codes.
www.youtube.com/KiaFeatureVideos

REMINDERS:

- To help minimize driver distraction, some audio system functionalities have been modified while the vehicle is in Drive, Reverse or moved out of Park/phone to the latest operating system release
- Prolonged use of the audio control unit in ACC mode may drain the vehicle's battery

Your vehicle's audio system may differ from that in the illustration. For further audio system operation, refer to pages 26-33. For more information, refer to the Car Infotainment System Quick Reference Guide.

Driving while distracted can result in a loss of vehicle control that may lead to an accident, severe personal injury and death. The driver's primary responsibility is in the safe and legal operation of a vehicle, any handheld devices, other equipment or vehicle systems which take the driver's eyes, attention and focus away from the safe operation of a vehicle or that are not permissible by law should never be used during operation of the vehicle.

UVO link Activation*†1

Follow these steps to activate your UVO link system:

1. Enter the activation screen on your vehicle's head unit:
 - a. Press SETUP key
 - b. Press UVO icon
 - c. Press Activate UVO
2. Read and agree to Terms of Service and Privacy Policy and press SUBMIT
3. Enter smartphone number or email address to receive a verification code, then press SUBMIT
4. Follow these steps to receive your verification code using your phone SMS or email:
 - a. Check your phone SMS or email for verification code
 - b. Open the link in your SMS or email. A page will open requesting that you create your account

Note: If you already have a Kia Owners Portal account using the phone number as your login ID, you will need to provide your password prior to receiving the verification code

- c. Enter your first name, last name, email, phone number, an account password, and click CREATE ACCOUNT. A page will open displaying your verification code
- d. Enter the code in the head unit and press ACTIVATE
- e. Go back to the page with your verification code and press "I have entered my PIN." A link will be provided to download the Kia Access with UVO link app from your app store. After installing the app, log in and enjoy

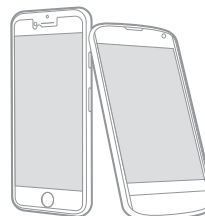

QR CODES

UVO Assistance Video



Refer to the inside front cover for more information on QR codes.
www.youtube.com/KiaFeatureVideos

REMINDER: This vehicle is not equipped with over-the-air system updates.

For further UVO link operations, refer to the Car Infotainment System Quick Reference Guide. For other audio system information, refer to pages 26-33.

Driving while distracted can result in a loss of vehicle control that may lead to an accident, severe bodily injury, and death. The driver's primary responsibility is in the safe and legal operation of a vehicle, and any handheld devices, other equipment, or vehicle systems which take the driver's eyes, attention and focus away from the safe operation of a vehicle or which are not permissible by law should never be used during operation of the vehicle.

UVO Assistance*†1

Virtual Assistant ⓘ **A** – Press to connect to the UVO Center to hear information about the UVO features

UVO Voice Local Search UVO 🔍 **B** – Press to connect to the search function to find points of interest or other locations, like "cafe"

Roadside Assist ⚠️ **C** – Press to connect to the UVO Center where you can request vehicle towing services

REMINDER: These buttons may be located in the rearview mirror or the overhead console.

For more information, refer to the Car Infotainment System Quick Reference Guide. On certain models, UVO Assistance buttons are located on the Rearview Mirror.

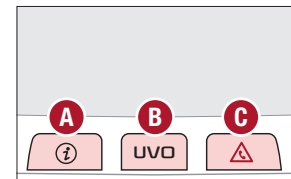

(Buttons on rearview mirror*)

Kia Access with UVO link App Download

Go to an app marketplace to download the new Kia Access with UVO link App. Once you download, make sure you register your vehicle and start an account (refer to UVO link Activation page). Get to know your new Kia and the available convenient features on the app.

QUICK TIPS

- The smartphone and vehicle need to be connected to a cellular network with a good wireless signal strength in order to use UVO. If these conditions are not met, voice commands may fail or take a long time to execute
- To use Remote Start or Remote Start with Climate Control feature, all doors, hood and trunk/liftgate must be closed and locked
- Activate Remote Start or Remote Start with Climate Control feature at least 10 minutes before getting into the vehicle, which will allow vehicle interior to reach a desired temperature. If the driver does not enter the vehicle within the 10 minutes, the Remote Start will turn off the engine
- The quickest way to obtain accurate vehicle status through the app is by pressing the refresh button on the app or refreshing the web page when using the customer web portal
- In order to preserve the vehicle battery, UVO will not turn on seven days after the last ignition was on. You will need to restart the vehicle with a key fob in order to use UVO again



QR CODES

Download the **Kia Access with UVO link App** by clicking this dynamic QR code. Some phone's operating systems may need to be updated to scan dynamic QR codes.



Kia Access with UVO link App Features Guide. Click this dynamic QR code to access the guide. Some phone's operating systems may need to be updated to scan dynamic QR codes



Kia Access with UVO link App Features Guide

The Kia Access with UVO link App Features Guide is a step-by-guide helping you utilize the app to its full potential by detailing how to set up and use each feature and adjust various settings. Below are some of the topics included:

- Remote Commands
- Set Climate
- Schedule Climate
- Schedule Charge
- Schedule Service
- Dealer Settings
- Manage Vehicles and Profiles

Kia App Screen for illustrative purposes only. Actual App screen and functionality may vary.

For further UVO link operations, refer to the Car Infotainment System Quick Reference Guide.

UVO link^{†1} with Navigation^{*†13} — FM/AM/SiriusXM^{®†21}/Media (USB, *Bluetooth*[®] Audio)

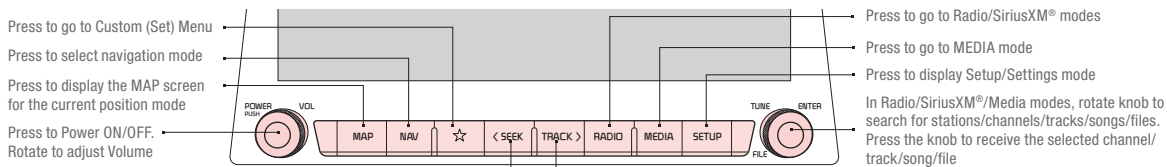

Press briefly to do the following:

- FM/AM mode: Play the previous/next frequency
- SiriusXM[™] mode: Change the channel
- MEDIA mode: Change the track, file or title

Press and hold to do the following (over 0.8 seconds):

- FM/AM mode: Move quickly through all of the frequencies. When released, the system seeks the next available frequency
- MEDIA mode: Rewinds or fast forwards the track or file (except for *Bluetooth*[®] Audio)

REMINDER: To help minimize driver distraction, some audio system functionalities have been modified while the vehicle is in Drive, Reverse or moved out of Park.

To adjust the sound settings (Position, Volume Tone, Priority, Navigation Volume, Reset) from any audio mode:

1. Press the SETUP key on the audio control unit or the onscreen SETUP button in ALL MENUS
2. Select the onscreen SOUND button, or SOUND SETTINGS. Select the menu item to change settings
3. Use the onscreen buttons to adjust settings. Press the Return button to save settings

Radio Presets: You can listen to FM, AM and SiriusXM[™] radio and save frequently used stations. **How to Save a Preset:** Press and hold the desired slot. This saves the current station in the selected slot

SiriusXM[™] Smart Favorites: For the first ten favorite SiriusXM[™] channels, you may play live or repeat from the beginning of a song or a program segment. In Radio mode, choose SiriusXM[™], then select any of the first ten favorites. During song or program play, tap the Skip Backward icon to start from the beginning of the song or program. Tap the Play Live icon to return to the live broadcast

Custom Key ☆ – A programmable button to provide quick access to one of several available system features. To Program the Custom Key:

1. Press and hold the SETUP button, then press the Custom Key ☆
2. Select one of the available features you would like the Custom Key to open

QUICK TIPS

- The system can register or pair multiple *Bluetooth*[®] devices
- Volume level between different audio modes:
 - When switching between audio modes (AM, FM, *Bluetooth*[®] Audio, etc.), the audio system saves the previous volume level you were listening to. For example, if you were listening to FM radio at volume level 20 then switched to BT Audio and adjusted the volume level to 30, the volume level will be at 20 when you switch back to FM radio
 - When using *Bluetooth*[®] Audio, the overall volume is dependent on your device's volume. If the volume is turned down low on your device it will remain low even if the system volume is turned up
- This system supports Android Auto[™] and Apple CarPlay[®] (USB connection only)
- A warning screen may appear periodically to remind users that the navigation system should be operated when the engine is running to prevent battery discharge
- At any time, you can interrupt the Voice Command Feedback by pressing the TALK button on the steering wheel

QR CODES

UVO link with Navigation Video



Refer to the inside front cover for more information on QR codes.
www.youtube.com/KiaFeatureVideos

Your vehicle's audio system may differ from that in the illustration. For further audio system operation, refer to pages 26-32. For more information, refer to the Car Infotainment System Quick Reference Guide.

Driving while distracted can result in a loss of vehicle control that may lead to an accident, severe personal injury and death. The driver's primary responsibility is in the safe and legal operation of a vehicle, any handheld devices, other equipment or vehicle systems which take the driver's eyes, attention and focus away from the safe operation of a vehicle or that are not permissible by law should never be used during operation of the vehicle.

Digital Clock

Press the SETUP button on the audio head unit, and the onscreen Date/Time button to enter the clock settings. Then use the onscreen buttons to navigate through setup and return to exit.

QUICK TIPS

- When needed, Daylight Savings must be enabled in the Clock Settings screen (UVO link with Navigation*)
- To access manual date and time setting, turn GPS time OFF in the Clock Settings (UVO link with Navigation*)

Refer to the Car Infotainment System Quick Reference Guide for more information.

Multimedia USB Port, Power Outlets & USB Charger Port

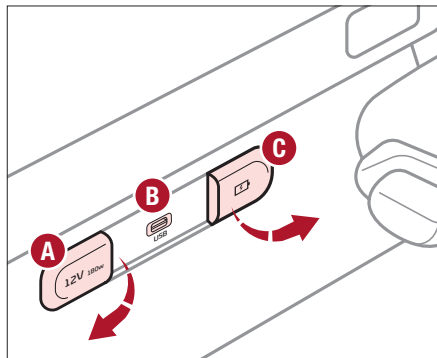

(Located on center panel in front of gear shift)

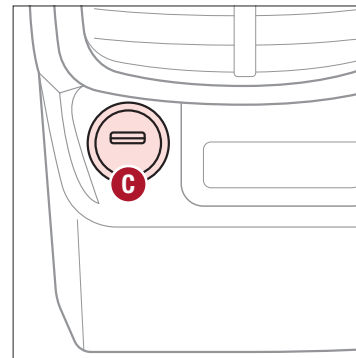

(Located on back of center console)

Power Outlets A: Use the power outlets for mobile phones and other devices designed to operate on a 12V (180W max) power outlet

Multimedia USB Port B: Use Multimedia USB port to connect USB audio devices and smartphones

USB Charger Port C: Devices can be recharged using a USB cable. The Engine Start/Stop button needs to be in the ACC/ON/START position to operate the USB Charger Port

QUICK TIPS

- The power outlets are inactive when ignition is in the OFF position
- The Multimedia USB data port is located next to the Power Outlets. The USB Charger Port does not support data transfer

For more information on the Aux/USB Ports and Power Outlets, refer to section 4 in the Owner's Manual.

REMINDERS:

- Using the power outlets and the USB ports for prolonged periods of time with the Engine Start/Stop button in the ACC position (Engine OFF) could cause the battery to discharge
- Kia recommends that you only use USB cables made by your device's manufacturer. Third-party USB cables may cause damage to your device
- The Multimedia USB Port B in the center panel charges slower than the USB Chargers C throughout the vehicle

Wireless Smartphone Charging System*

1. Enable Wireless Charging in the User Settings in the Instrument Cluster or the Vehicle Settings* in the audio head unit
2. Place a compatible smartphone on the center of the charging pad
3. Indicator light **A** may change to amber once wireless charging begins
4. Once charging is complete, the amber light may change to green

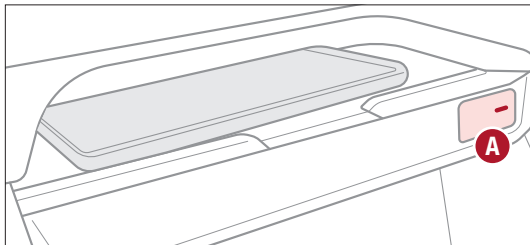

(Located in front of Gear Shift)

REMINDERS:

- The smartphone must be a compatible phone with Qi function available
- Avoid placing other metal items in the bin while charging as to not impede the charging area
- This vehicle is equipped with wireless charging technology which allows for a device to be charged using inductive charging; however, device compatibility varies. See your Owner's Manual for more detailed information and the back page for legal disclaimers
- Inductive charging systems are less efficient than conventional charging through cable. As a result, higher device operating temperatures may be experienced during use
- Charging Performance – Your device's position on the wireless charging system can affect charging performance. Other factors that may affect the charging rate include foreign objects, such as coins or pens, and phone case thickness
- If driver door is opened, charging will be disabled

See section 4 in the Owner's Manual for more information.

QUICK TIPS

- For wireless charging to occur, all doors (excluding rear hatch) must be closed & the Smart Key Fob must be detected inside the vehicle
- For best results, place smart-phone on the center of the charging pad
- If wireless charging does not work, move smartphone around the pad until the charging indicator turns amber. Avoid placing other metal items in the bin while charging as to not impede the charging area.

QR CODE

Wireless Charging Video

To view a video on your mobile device, snap this QR Code or visit the listed website.

Refer to inside front cover for more information.



www.youtube.com/KiaFeatureVideos

Automatic Climate Control*

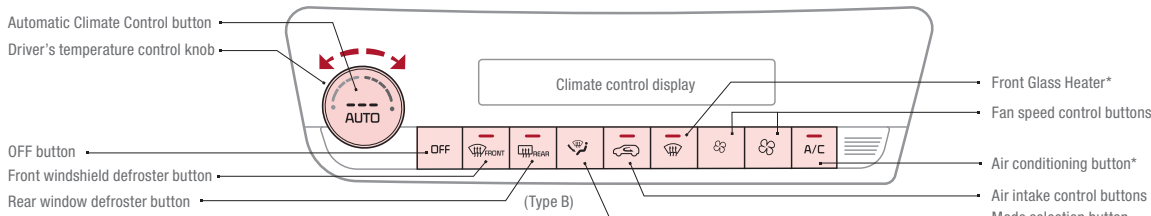

Climate Control Auto Function

1. Press AUTO to select Full Auto Operation – the Auto setting automatically controls the airflow modes, fan speeds, air intake and air conditioning according to the temperature setting selected and the ambient condition. The first setting is high fan speed or air flow (Three LEDs lit). Press again for medium fan speed (Two LEDs lit). Press a third time for the lowest fan speed (One LED lit)
2. Set desired Temperature

Defrost Outside Windshield:

1. Set **Temperature to Hot**
2. Press the **Front Defrost** button

Defog Inside Windshield:

1. Set **Fan Speed** to highest position
2. Set **Temperature** to highest position
3. Press the **Front Defrost** button

Air Flow Modes

To select Air Flow Modes, press the mode selection button to cycle to the desired mode:



Auto Defogging System (ADS):

Auto defogging is designed to reduce the fogging up of the inside of the windshield by automatically sensing the moisture of the inside of the windshield. The system will automatically change to defrost mode when needed.

Auto Defogging is set ON by default and will operate when the Climate Control system is ON. To cancel Auto Defogging, press the Front Defrost button for three seconds, when the ignition is in on (ADS OFF icon will illuminate). To turn Auto Defogging on again, press the Front Defrost button for three seconds.

QUICK TIPS

- Defrost mode activates A/C and opens Fresh Air vent to help dehumidify the air and improve Defroster performance
- During Auto Operation, the A/C indicator may NOT illuminate. The fan speed, air intake, air flow and air conditioning may automatically be engaged at any time to reach desired temperature and reduce humidity
- Keep inside glass as clean as possible to reduce window fogging

Your Automatic Climate Control system may differ from those in the illustrations. See section 4 in the Owner's Manual for more information.

QR CODES

Automatic Climate Control Operation Video



Auto Defogging System (ADS) Video



Refer to the inside front cover for more information on QR codes.
www.youtube.com/KiaFeatureVideos

REMINDERS:

- Continuous use of the climate control system in the recirculated air position may allow humidity to increase inside the vehicle which may fog the glass and obscure visibility
- When in AUTO mode, Air Flow mode and Fan Speed do not display on the Climate Control Display
- Cold or warm ambient air may flow in through vents if Recirculated Air button is not pressed ON (LED lit)
- Pressing any button during AUTO operation will deactivate the AUTO function and switch to manual mode, except for Temperature Control or SYNC Temperature Control

Manual Climate Control*

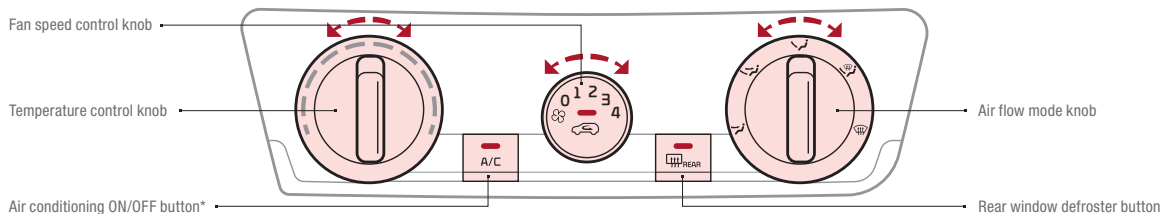

Defrost Outside Windshield:

1. Set **Fan Speed** to the highest position
2. Set **Temperature** to **Hot**
3. Press the **Front Defrost** button

Defog Inside Windshield:

1. Set **Fan Speed** to desired position
2. Set **Temperature** to desired position
3. Press the **Front Defrost** button

Air Flow Modes

To select Air Flow modes, press the Mode selection buttons:

- Face-Level
- Bi-Level
- Floor-Level
- Floor/Defrost-Level
- Defrost-Level

QUICK TIPS

- Set the mode to the desired position. To defrost mode activates A/C and opens Fresh Air vent to help dehumidify the air and improve Defroster performance
- MAX A/C mode automatically engages Recirculated Air
- Keep inside glass as clean as possible to reduce window fogging

REMINDERS:

- Warm air may flow in through vents if Recirculated Air button is not pressed ON (LED lit)
- Continuous use of the climate control system in the recirculated air position may allow humidity to increase inside the vehicle which may fog the glass and obscure visibility

Your Manual Climate Control system may differ from those in the illustrations. See section 4 in the Owner's Manual for more information.

Idle, Stop & Go (ISG) System

The ISG system is designed to help reduce fuel consumption by automatically shutting down the engine when the vehicle is at a standstill.

When the ISG system is ON and the vehicle is at a standstill, the engine will stop, and the green AUTO STOP indicator (A) on the instrument cluster will illuminate green.

The engine will restart when the brake pedal is released or the shift lever is moved from D (Drive) to the R (Reverse) position or to Manual Shift mode. When engine restarts, the green AUTO STOP indicator on the instrument cluster will turn off.

To deactivate the ISG System, press the ISG OFF button (B). If you press again, the system will be activated.

QUICK TIPS

- The ISG system will not activate when:
 - A seat belt is unfastened
 - The hood or a door is opened
 - Battery condition is not adequate
 - The front or rear defroster is turned on
 - Engine coolant temperature is low
 - The outside ambient temperature is too low/high
 - Emission control devices activate
 - The vehicle is on a steep slope

See section 5 in the Owner's Manual for more information.

REMINDERS:

- When the ISG system is on and the vehicle is at a standstill, the engine may not stop and the AUTO STOP indicator on the instrument cluster will illuminate YELLOW. This indicates the system is functional but not all enabling criteria have been met.
- ISG is active by default at vehicle startup. When ignition is cycled, ISG will turn ON again
- Under certain conditions, the engine will restart automatically even if the brake pedal is still depressed
- If the AUTO STOP indicator (A) is continuously blinking yellow and the ISG button LED is on, please contact an authorized Kia dealer

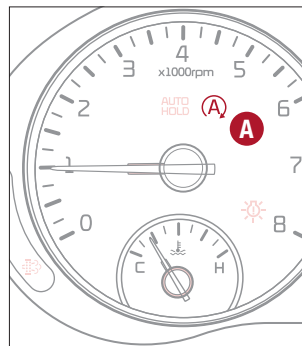

(Cluster B shown)

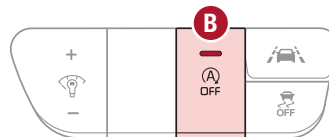

(Buttons located on left of Steering Wheel)

QR CODES

Idle, Stop & Go (ISG) Video



Refer to the inside front cover for more information on QR codes.
www.youtube.com/KiaFeatureVideos

Automatic Gear Shift with Sportmatic® Shifting†20

- P:** Park **[+]:** Manual Mode Upshift
R: Reverse **[-]:** Manual Mode Downshift
N: Neutral
D: Drive

Manual Mode:

To enter Manual mode, move shift lever from D to left gate **A**

To shift while in Manual mode, move shift lever up [+] to upshift or down [-] to downshift **A**

QUICK TIPS

- Press brake pedal and depress release button to move gear shift from N to P, N to R or from P to any gear
- Manual mode downshifts are made automatically when the vehicle slows down. When the vehicle stops, 1st gear is automatically selected
- If going through a car wash, remind the attendant to keep the vehicle in Neutral (N) and keep the engine running. Also, disable the power liftgate lid control, turn off the auto rain sensing wipers and fold in the mirrors

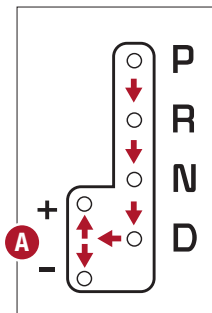

See section 5 in the Owner's Manual for more information.

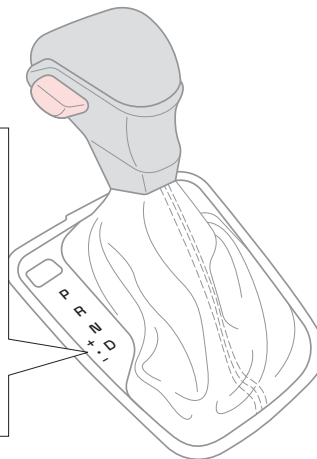

QR CODES

Sportmatic® Shifting Video



Dual Clutch Transmission (DCT) Driving Experience Video



Refer to the inside front cover for more information on QR codes.
www.youtube.com/KiaFeatureVideos

Dual Clutch Transmission (DCT)*

Some Kia vehicles are equipped with Dual Clutch Transmission (DCT) for automatic transmissions. The following are unique driving tips for the Dual Clutch Transmission:

- To hold the vehicle stationary on an incline, the service brake or parking brake **MUST** be used or the gear shift **MUST** be in the (P) Park position. If the vehicle is held stationary by applying the accelerator pedal on a slope, the clutch/transmission may overheat, resulting in damage
- Avoid aggressive launches on steep grades as this may result in an overheated clutch and transmission
- A slight time lag may be experienced at takeoff from standstill during aggressive acceleration maneuvers

If the clutch is overheating, an amber warning light*  will be displayed in the instrument cluster. **Should this condition occur, pull over and place the vehicle in Park and idle the engine.**

Refer to section 5 in the Owner's Manual for additional information on DCT operation or call Kia Consumer Affairs for additional information.

Electronic Parking Brake (EPB)*

The Electronic Parking Brake (EPB) system utilizes an electric motor to engage the parking brake.

Applying the Parking Brake

Depress the brake pedal and pull up the EPB switch **A**. Ensure that the indicator light is illuminated on the instrument cluster.

If parked on a steep incline/decline, pull up the EPB switch for more than 3 seconds for a firmer EPB application.

Releasing the Parking Brake

The EPB will automatically release when the shifter is placed in Reverse or Drive. To release EPB manually, depress the brake pedal, then press the EPB switch **A**, with the ignition switch in the ON position. Ensure that the indicator light is OFF.

QUICK TIPS

- When leaving your keys with parking lot attendants or valet, make sure to inform them how to operate the EPB
- Pull up and hold EPB switch a second time to increase brake pressure if parked on a decline or incline
- If parked on a steep incline, pull up the EPB switch for more than 3 seconds for a firmer EPB application

REMINDERS:

- As a bulb check, the EPB malfunction indicator will illuminate for approximately 3 seconds when the ignition switch is turned ON
- If the warning light does not illuminate temporarily, or continues to remain lit, take your vehicle to an authorized Kia dealer and have the system checked
- The EPB should not be operated while the vehicle is moving
- A click or electric brake motor sound may be heard while operating or releasing the EPB, but these conditions are normal and indicate that the EPB is functioning properly

See section 5 in the Owner's Manual for more information.

Auto Hold*

Auto Hold temporarily maintains the vehicle at a standstill even though the brake pedal is not depressed after the driver brings the vehicle to a complete stop by depressing the brake pedal. Auto Hold can be turned On/Off using the AUTO HOLD button **B** on the center panel below the gear shift. Before Auto Hold will operate, the driver's door, engine hood and liftgate must be closed, and the driver's seat belt must be fastened.

The AUTO HOLD indicator on the Instrument Cluster has four states:

White: Standby – With vehicle at a standstill and AUTO HOLD button **B** pressed ON, the indicator will illuminate white. While driving the vehicle (vehicle is not at a standstill), the Auto Hold indicator will remain white.

Green: Engaged – When coming to a complete stop by depressing the brake pedal, the Auto Hold indicator changes from white to green.

Off (not illuminated) – The indicator will turn off when the AUTO HOLD button **B** is manually pressed off or when the EPB is manually turned on.

Yellow: Malfunction - When the indicator is illuminated yellow, there may be a system malfunction. Take your vehicle to a local Kia dealer.

REMINDERS:

- Auto Hold only operates when vehicle is in Drive or Neutral
- To reduce the risk of an accident, do not activate Auto Hold while driving downhill, backing up or parking your vehicle
- Do not solely rely on the Auto Hold system to keep the vehicle stopped. Always pay attention to traffic and road conditions, and be prepared to depress the brakes

Refer to page 4 for location of Instrument Cluster indicators.

See section 5 in the Owner's Manual for more information.

QR CODES

Electric Parking Brake Video



Refer to the inside front cover for more information on QR codes.
www.youtube.com/KiaFeatureVideos

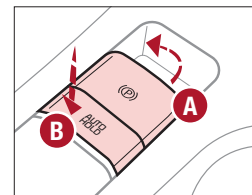

(Type B shown. Located below gear shift)

Downhill Brake Control (DBC)⁺⁸

DBC helps drivers maneuver down steep hills by automatically applying braking inputs, allowing drivers to concentrate on steering.

Press button **A** to turn DBC ON/OFF.

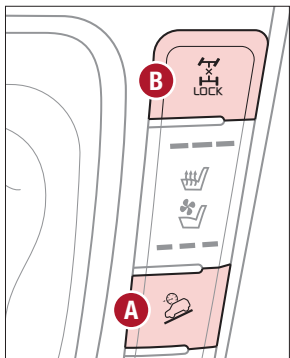

(Type A shown. Located below gear shift)

QUICK TIPS

- When on, DBC will turn OFF when button is pressed again or vehicle speed is over 38 mph
- If the red indicator illuminates, the DBC system may have malfunctioned. Take your vehicle to an authorized Kia dealer and have the system checked

REMINDER: DBC defaults to OFF when ignition is cycled.

The DBC system is a supplemental system and does not replace the need for the driver to apply the brakes. Pay attention to road and traffic conditions and be prepared to depress the brakes.

See section 5 in the Owner's Manual for more information.

All Wheel Drive (AWD) System*

When you select AWD LOCK mode  (indicator is illuminated) by pressing the AWD LOCK button **B**, the AWD LOCK mode increases the drive power when driving on wet pavement, snow-covered roads and/or on unpaved roads.

- This mode is used for climbing or descending sharp grades, driving on unpaved roads, driving on sandy and muddy roads, etc., to improve traction
- This mode automatically begins to deactivate at speeds above 38 mph and is shifted to AWD AUTO mode at speeds above 38 mph. If the vehicle decelerates to speeds below approximately 38 mph, however, the transfer mode is shifted into AWD LOCK mode again

When the AWD LOCK mode is deactivated, a shock may be felt as the drive power is delivered entirely to the front wheels. This shock is not a mechanical failure.

The AWD system is a supplemental system only. It is the driver's responsibility to drive carefully depending on road and traffic conditions.

See section 5 in the Owner's Manual for more information.

Seat Warmers*†18

A Seat Warmers:

- Press button once for high setting (3 LEDs lit)
- Press button twice for medium setting (2 LEDs lit)
- Press a third time for low setting (1 LED lit) and again to turn OFF

QUICK TIPS

- System is OFF by default. To turn system ON, press the seat warmer switch
- With the seat warmer switch in the ON position, the heating system in the seat turns off or on automatically depending on the seat temperature
- When the Climate Control System's temperature is turned up to high heat, the Seat Warmers turn on automatically

REMINDERS:

- Use extreme caution when using the seat warmers to avoid burns. Refer to the Owner's Manual for more information
- If the Auto Climate Control is on, the seat warmers or ventilated seats may turn on automatically based on the set temperature and ambient temperature

See section 4 in the Owner's Manual for more information.

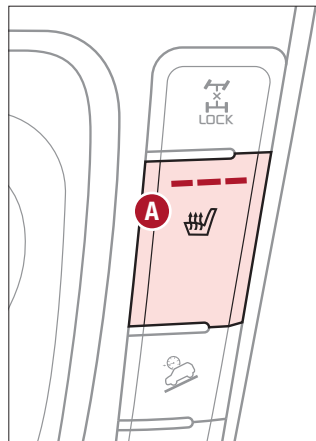

(Buttons located on center panel.
Passenger side shown.)

QR CODES

Heated and Ventilated Seats Video



Refer to the inside front cover for more information on QR codes.
www.youtube.com/KiaFeatureVideos

Power Adjustable Driver's Seat*†16

Move/Press controls to adjust Seat forward/backward, Seat Cushion height, Seatback recline or Lumbar* forward/backward.

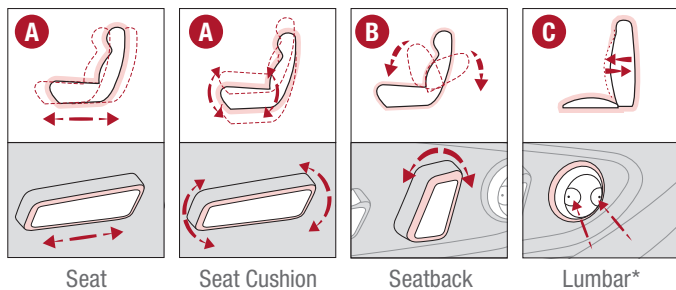
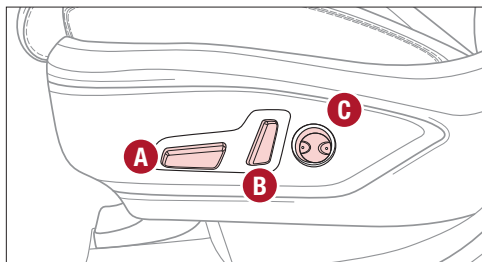

Do not attempt to adjust the seat while the vehicle is moving. This could result in loss of control of the vehicle.

See section 3 in the Owner's Manual for more information.

6-Way Manual Adjustable Driver's Seat*†16

Pull lever **D** to slide seat forward/backward.

Pull lever **E** up several times to raise Seat Height. Push lever **E** down several times to lower Seat Height.

Pull lever **F** to adjust seatback recline.

QUICK TIPS

When adjusting seat forward or backward, ensure seat clicks or locks into place before driving vehicle.

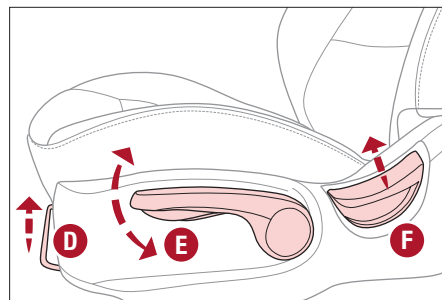

Do not attempt to adjust the seat while the vehicle is moving. This could result in loss of control of the vehicle.

See section 3 in the Owner's Manual for more information.

QR CODES

Manual Adjustable Driver's Seat Video



Refer to the inside front cover for more information on QR codes.
www.youtube.com/KiaFeatureVideos

Folding Rear Seats^{†16}

To fold the Rear Seatback:

1. Set the front seatback in the most upright position and if needed, slide the seat forward.
2. Lower the headrest to the lowest position
3. Insert the rear seat belt buckle into the pocket between the rear seatback and cushion. Insert the seatbelt webbing in the guide which prevents the seat belt from being damaged in the latch when seatbacks are placed back to the upright position
4. Pull the seatback folding lever to unlock seat
5. Fold Seatback toward the front of the vehicle

REMINDERS:

- When you return the seatback to its upright position, always be sure it has locked into position by pushing on the top of the seatback
- When adjusting seat forward or backward, ensure seat clicks or locks into place before driving the vehicle

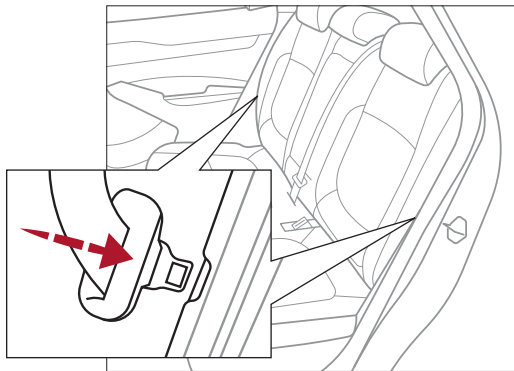

See section 3 in the Owner's Manual for more information.

Rear Occupant Alert (ROA) with Door Monitoring

Rear Occupant Alert (ROA) can help alert the driver when a rear passenger may be left in the vehicle. The alert will be a message on the Instrument Cluster stating to "Check rear seats" **A** and a chime will sound.

The factory default is set to OFF. To turn the system ON or OFF, go to User Settings in the Instrument Cluster or the Vehicle Settings* in the audio head unit, select Convenience, then Rear Occupant Alert and check/uncheck the box to enable/disable by pressing the OK button on the Steering Wheel.



REMANDER: Always be sure to check the passenger areas before leaving the vehicle.

Rear Occupant Alert is not a substitute for one's attention. Always check the vehicle's interior before exiting.

Image is for illustrative purposes only and may not reflect actual feature or operation.

See section 4 in the Owner's Manual for more information.

QR CODES

Rear Occupant Alert (ROA) with Door Monitoring Video



Refer to the inside front cover for more information on QR codes.
www.youtube.com/KiaFeatureVideos

Front Seat Headrest Adjustment^{†10}

To raise headrest — Pull headrest up to the desired position.

To lower headrest — Press lock **A**, then press the headrest down.

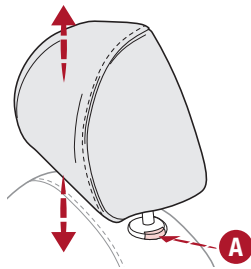

QUICK TIP

For easy adjustments, hold a headrest post with one hand while using the other hand to pull the headrest from underneath.

REMINDERS:

- The headrest only moves up and down as described above. It does not adjust forward or backward
- Do not operate the vehicle with the headrests removed. Headrests can provide critical neck and head support in an accident
- Button may be hard to see if headrest is in its lowest position

See section 3 in the Owner's Manual for more information.

Unfastening Center Seat Belt

1. If Seat Belt is buckled, press the release button on the buckle
2. To retract the center seatbelt webbing **B** in the 2nd row, use the lap belt tongue plate **C** to push the "release button" in the small slot on the center belt buckle **D**

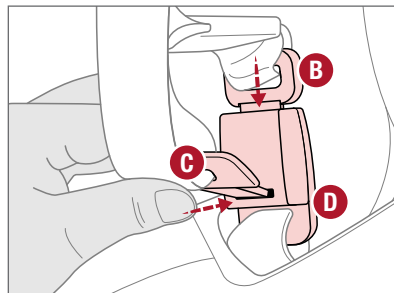

See section 3 in the Owner's Manual for more information. Images are for illustrative purposes only. Actual belt buckle/tongue plate may vary.

QR CODES

Unfastening Center Seat Belt Video



Refer to the inside front cover for more information on QR codes.
www.youtube.com/KiaFeatureVideos

Smart Key*

- A** Press to lock All Doors (all doors must be closed to lock)
- B** Press to unlock Driver's Door. Press twice in 4 seconds to unlock All Doors and Liftgate
- C Remote Start***: Press for more than two (2) seconds within four (4) seconds after locking doors to start the vehicle. Press once to turn off.
- D** Press and hold for more than a half-second for Panic Alarm. To turn off Alarm, press any button
- E** Press to release Mechanical Key

Remote button configuration may vary depending on vehicle options. For more information on the Mechanical Key, please refer to section 4 in the Owner's Manual.

Driver's Door Lock/Unlock button **G**:

- Press button once to unlock Driver's Door
- Press again within 4 seconds to unlock all Doors
- Press again to lock all Doors

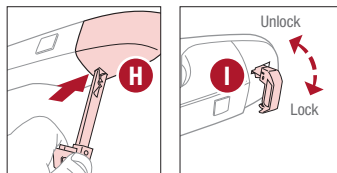
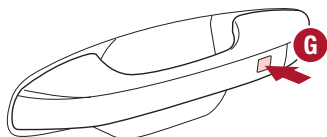

Mechanical Key **F**:

1. Use to unlock/lock driver's door
2. Pull out door handle
3. Remove door handle keyhole cover with Mechanical Key by pressing up into slot as shown **H**
4. Insert Mechanical Key **I** and turn right to unlock Driver's Door. Turn twice within 4 seconds to unlock all doors
5. Insert Mechanical Key and turn left to lock Driver's Door
6. Return keyhole cover to its original position

Use to turn Child-Protector Rear Door Lock.

QUICK TIPS

- If the Smart Key battery is weak or not working properly, hold the Smart Key fob up to the Engine Start/Stop button (Lock button side closest) and press to start engine
- The Smart Key's signal can be blocked by the normal operation of a cell or smartphone. To help prevent this, store each device separately
- When reinserting the mechanical key into the fob, make sure it is pushed all the way in until there is a click sound

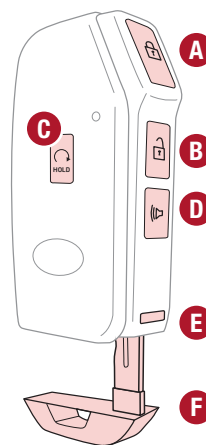

QR CODES

Remote Start - Smart Key Video



Kia Smart & Folding Key Fobs Video



Refer to the inside front cover for more information on QR codes.
www.youtube.com/KiaFeatureVideos

Remote button configuration may vary depending on vehicle options.

Remote Keyless Entry (Folding Key)*

- A** Press the release button to unfold the key
- B** Press to lock all doors (all doors must be closed to lock)
- C** Press to unlock driver's door. Press twice in 4 seconds to unlock all doors and Liftgate
- D** Press and hold more than 1 second for Panic Alarm. To turn OFF Alarm, press any button

REMINDERS:

- Remote button configuration may vary depending on vehicle options
- The Liftgate does not automatically open when the button is pressed

Refer to section 4 in the Owner's Manual for more information.

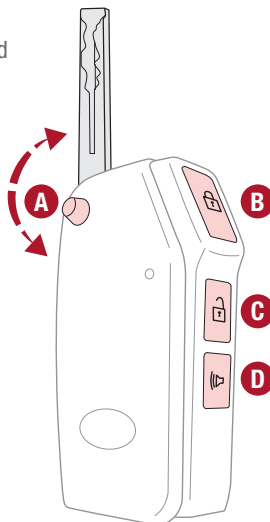

Double-Turn Lock/Unlock All

- Turn clockwise once to unlock driver's door
- Turn clockwise again within 4 seconds to unlock all doors
- Turn counterclockwise once to lock all doors

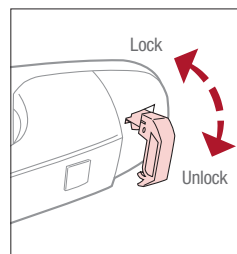

(Using Smart Key Mechanical Key shown)

QR CODES

Kia Smart & Folding Key Fobs Video



Refer to the inside front cover for more information on QR codes.
www.youtube.com/KiaFeatureVideos

Refer to section 4 in the Owner's Manual for more information.

Fuel Cap / Malfunction Indicator (Check Engine Light)

To access the Fuel Cap, pull the Fuel Filler Door Open Lever **A** inside the vehicle (on floor left of Driver's Seat). Tighten for ONE CLICK to prevent Malfunction Indicator  from illuminating.

REMEMBER: It is normal operation when tightening to hear one click, and then when Fuel Cap is released, it clicks back

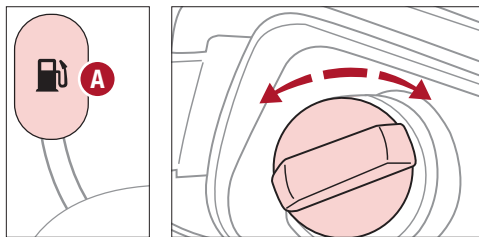

See section 4 in the Owner's Manual for more information.

Hood Release Lever and Latch

Opening the Hood:

1. Pull the Hood Release Lever **E** to unlatch the Hood
2. In the front of the vehicle, lift the Hood slightly, push the secondary Latch to the front inside of the Hood's center and lift the Hood

Closing the Hood:

Lower the Hood by pressing the front center of the Hood. Then, press down to securely lock in place.

Fuel Filler Lid Release

To open the Fuel Filler lid:

1. Pull the Fuel Filler Door Open Lever **A** inside the vehicle (on floor left of Driver's Seat)
2. Pull the Fuel Filler door to fully open **B**

To open the Fuel Cap, turn it counterclockwise **C**

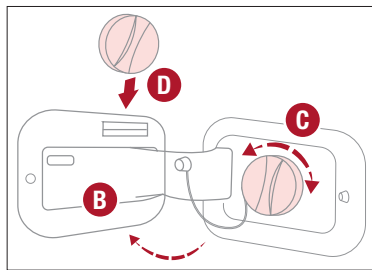

QUICK TIP

Place the Fuel Cap on the inside of the Fuel Filler Lid when fueling **D**

See section 4 in the Owner's Manual for more information.

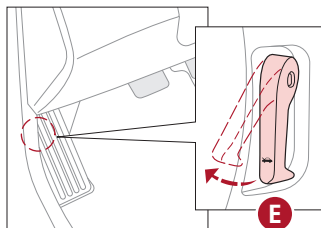

REMEMINDERS:

- While lowering and closing, keep hands away from under the Hood
- Open the Hood only after turning the engine off, on a flat surface, with the gear shift in P (Park) position and setting the parking brake
- Make sure the hood is securely closed before driving

See section 4 in the Owner's Manual for more information.

QR CODES

One-Click Fuel Cap Video



Refer to the inside front cover for more information on QR codes.
www.youtube.com/KiaFeatureVideos

Map/Room Lamps

Automatic turn off function*

The interior lights automatically turn off approximately 30 seconds after the ignition or Engine Start/Stop button* is OFF.

Map Lamp/Room Lamp Operation

Push the button **A** to turn the map lamp ON/OFF. This light produces a spot beam for convenient use as a map lamp or as a personal lamp for the driver or the front passenger.

Front/Rear Room Lamps Button  – Press button **B** to turn the front and rear room lamps on and off.

Door Mode Button – Press button  **C**, to enable or disable Door Mode. In Door Mode, the map and room lamps turn on when any door is opened. When all doors are locked or the ignition is on, the map and room lamp will turn off immediately.

Rear Room Lamps – Press the button **D** to turn the rear passenger lamp ON/OFF.

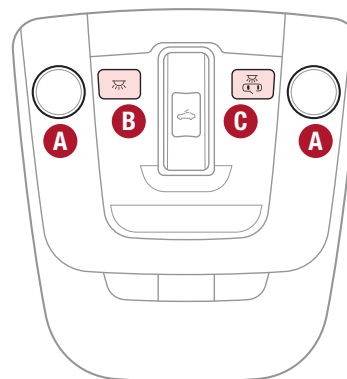

(Type B)

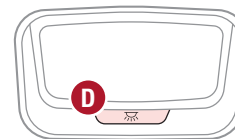

(Type A)

QUICK TIP

- When doors are unlocked by the Smart Key, the lamp turns ON for approximately 30 seconds
- If your vehicle is equipped with the theft alarm system, the interior lights automatically turn off approximately 3 seconds after the system is in armed stage
- Using interior lights for an extended period of time may cause battery discharge

Refer to section 4 in the Owner's Manual for more information.

Sunroof Operation*

The sunroof operation is controlled through a multidirectional switch/lever. The ignition or Engine Start/Stop button* needs to be in the ON position to operate the sunroof.

To slide the sunshade and sunroof:

- Auto Open: Slide the lever **A** backward to the farthest position and release
- Auto Close (sunroof only): Slide the lever **A** forward to the farthest position and release

To slide the sunshade only, manually slide the sunshade open and closed by the sunshade handle

To tilt the sunroof:

- Raise: Push lever **A** upward
- Lower: Push lever **A** forward

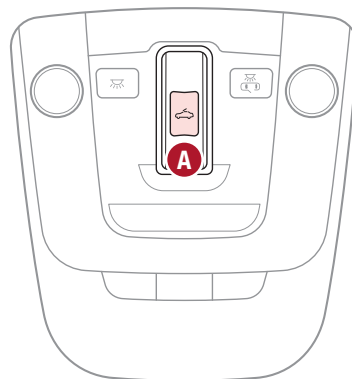

QR CODES

Sunroof Operation Video



Refer to the inside front cover for more information on QR codes.
www.youtube.com/KiaFeatureVideos

QUICK TIP

To stop the sunroof at any position, push or pull the sunroof control lever in any direction

Refer to section 4 in the Owner's Manual for more information.

REMINDERS:

- Sunshade needs to remain OPEN while sunroof is open
- Do not adjust the sunroof or sunshade while driving. This could result in loss of control of the vehicle

Sunvisor*†22

Use the sunvisor to shield direct light through the front or side windows. Slide the Sunvisor out and adjust as needed.

REMINDERS:

- Sunvisor may not shield all direct light
- The sunvisor may impair visibility if not adjusted properly
- Do not operate the vehicle if the sunvisor is impairing your visibility
- Be aware of seating position when adjusting or swinging sunvisor around to or from the front or side windows

Refer to section 4 in the Owner's Manual for more information.

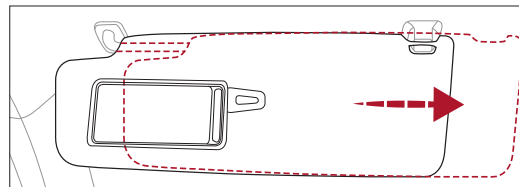

Liftgate Release Button

Located underneath the rear liftgate hatch. With liftgate unlocked, press the Liftgate Release Button **A** and pull the liftgate up by the handle to open.

QUICK TIP

The liftgate unlocks automatically when the Smart Key fob* is within close proximity to the vehicle, then can then be opened manually

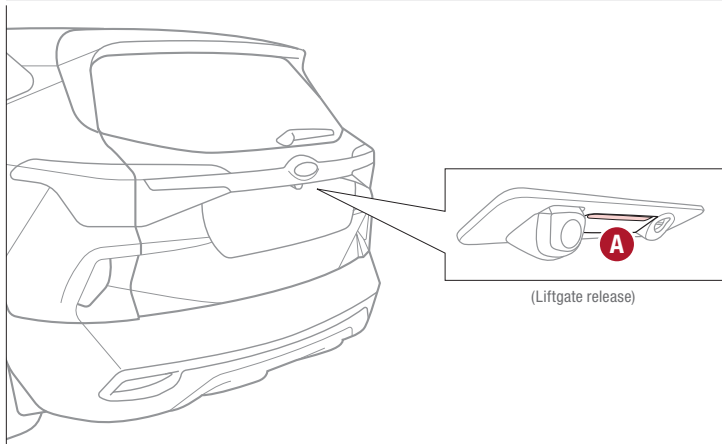

Refer to section 4 in the Owner's Manual for more information.

Rear View Monitor (RVM)^{†6}

Rear View Monitor is a supplemental system that displays the view behind the vehicle through the audio control unit screen while the vehicle is in Reverse.

Rear View Monitor activates when the:

1. Engine Start/Stop* button is in the ON (Red light) position
2. Gear Shift Lever is in the R (Reverse) position

To change views on the audio system screen, press the icon-switches from top view to back view.

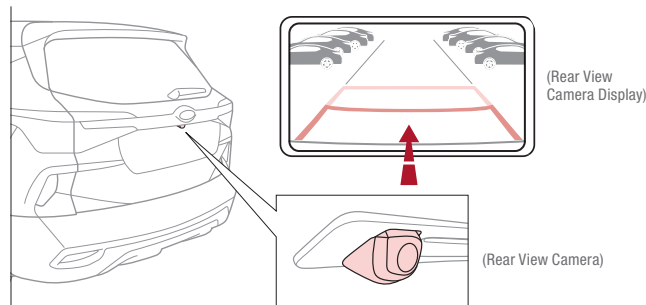

REMINDERS:

- Through normal use and after inclement weather or washing, the rear camera may become dirty. Use a clean, microfiber cloth to remove any dirt, debris or spots that may have accumulated on the lens
- While Rear View Monitor is active the volume will be lowered on all audio modes
- The screen image above is for illustrative purposes only. The actual image or graphics may differ in your vehicle
- The vehicle speed needs to be slower than 9 mph for the system to operate

Rear View Monitor is not a substitute for proper and safe backing-up procedures. Always drive safely and use caution when backing up. The Rear View Monitor may not display every object behind the vehicle.

Refer to section 4 in the Owner's Manual for more information.

Seat Belts^{†17}

To properly fasten your seat belts:

1. Insert the belt tongue plate **A** into the buckle **B** until it clicks
2. Position the lap portion of the belt across your lap as LOW ON THE HIPS as possible **C**. Adjust the belt to a SNUG FIT by pulling up on the shoulder portion **D**

REMINDER: For maximum protection, always wear your seat belt.

For more information about the seat belts and airbags in the vehicle, please refer to the Owner's Manual.

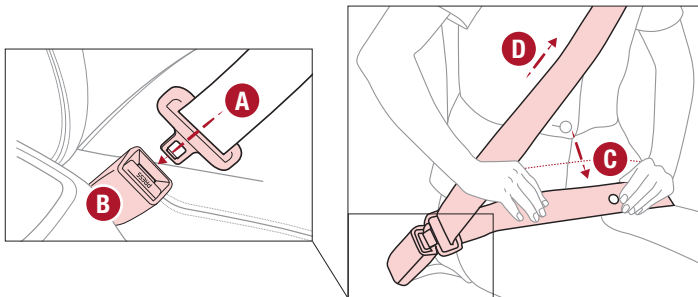

QUICK TIP

The Seat Belt warning chime operates for driver's seat only.

Seat Belt Retractor Locks

Retractor locks allow lap/shoulder seat belts to remain unlocked during normal vehicle operation for freedom of movement and increased comfort.

During a STRONG STOP, SUDDEN TURN OR CERTAIN COLLISIONS, seat belt retractors will automatically lock the belts to reduce the risk of injury.

Refer to section 3 in the Owner's Manual for more information.

Occupant Detection System (ODS)^{†14} / Passenger Airbag Off Indicator^{†2}

ODS is designed to detect the presence of the front passenger and adjusts or turns off airbag deployment accordingly.

Depending on the situation and type of accident, the system may:

- Deploy airbag (Adult)
- Not deploy the airbag (Unoccupied)

If the system determines that the airbag should not be deployed, the "PASSENGER AIR BAG OFF" indicator will illuminate.



REMINDER: Do not allow an adult passenger to ride in the front seat when the Passenger Airbag Indicator is illuminated OFF because the airbag will not deploy in the event of a crash. The driver must instruct the passenger to reposition her/himself in the seat

Refer to section 3 in the Owner's Manual for more information.

Child-Protector Rear Door Lock

Located on the rear edge of the rear passenger doors. Insert the ignition key into the hole and turn the key to the LOCK position to disable the inner door handles from opening the rear doors.

REMINDEMS:

- Child-Protector Rear Door Lock is located on rear passenger's door jamb
- To allow the door to be opened from inside the vehicle, unlock the Child-Protector Rear Door Lock
- To open the Rear Door, pull the outside door handle

Refer to section 4 in the Owner's Manual for more information.

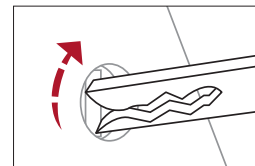

(Located on rear edge of rear passenger doors)



SELTOS NORMAL MAINTENANCE SCHEDULE TURBO

P=Perform • R=Replace • I=Inspect*

(up to 60,000 miles)^A For Non-Turbo maintenance, see back cover

MAINTENANCE ITEMS - TURBO	MAINTENANCE INTERVALS (MILES)									
	6,000	12,000	18,000	24,000	30,000	36,000	42,000	48,000	54,000	60,000
Add fuel additive ^E	P	P	P	P	P	P	P	P	P	P
Rotate tires	P	P	P	P	P	P	P	P	P	P
Engine Oil & Filter	R	R	R	R	R	R	R	R	R	R
Climate control air filter	R	R	R	R	R	R	R	R	R	R
Battery condition	I	I	I	I	I	I	I	I	I	I
Brake lines, hoses and connections	I	I	I	I	I	I	I	I	I	I
Disc brakes and pads	I	I	I	I	I	I	I	I	I	I
Vacuum hose	I	I	I	I	I	I	I	I	I	I
Steering gear rack, linkage & boots	I	I	I	I	I	I	I	I	I	I
Drive shafts and boots	I	I	I	I	I	I	I	I	I	I
Suspension mounting joints	I	I	I	I	I	I	I	I	I	I
Air conditioner compressor/refrigerant	I	I	I	I	I	I	I	I	I	I
Propeller shaft	I	I	I	I	I	I	I	I	I	I
Exhaust system	I	I	I	I	I	I	I	I	I	I
Intercooler, in/out hose, air intake hose	I	I	I	I	I	I	I	I	I	I
Air cleaner filter	I	I	I	R	I	I	I	R	I	I
Brake fluid	I	I	I	I	I	I	I	I	I	I
Fuel tank air filter ^{†D}	I	I	I	I	I	I	I	I	I	I
Parking brake	I	I	I	I	I	I	I	I	I	I
Vapor hose, fuel filler cap and fuel tank	I	I	I	I	I	I	I	I	I	I
Cooling System	I	I	I	I	I	I	I	I	I	I
Fuel lines, hoses and connections	I	I	I	I	I	I	I	I	I	I
Dual clutch transmission fluid (at and every 37,500)						I				
Spark Plugs (at 42,000 miles)							R			
Valve clearance ^E										I
Drive belts (First 60,000 miles, then every 12,000 miles) ^F										I

QUICK TIP

Check your Maintenance Schedule or schedule an appointment with a dealer using your UVO link account by logging into the Kia Access with UVO link app (Vehicles equipped with UVO link only – See page 31 for setup information)

† If equipped.

A. See the Owner's Manual for complete maintenance schedule. These are approximate estimated intervals. Refer to vehicle mileage for maintenance item schedule.

B. And, if necessary, adjust, correct, clean or replace.

C. If TOP TIER detergent gasoline is not available, one bottle of additive is recommended. Additives are available from your authorized Kia dealer along with information on how to use them. Do not mix other additives.

D. Both the fuel filter & fuel tank air filter are generally considered to be maintenance free, depending on fuel quality being used. However, periodic inspection is recommended. If your vehicle is having issues like fuel flow restriction, power surging, loss of power, difficulty starting, etc., replace the fuel filter immediately and consult an authorized Kia dealer for service.

E. Inspect for excessive tappet noise and/or engine vibration and adjust if necessary. Have an authorized Kia dealer perform the operation.

F. The drive belt should be replaced when cracks occur or tension is reduced excessively.

See your Owner's Manual for more details and complete maintenance information, including severe maintenance schedule. Warranty may be voided if maintenance schedule is not followed.

LEGAL DISCLAIMERS

Driving while distracted is dangerous and should be avoided. Drivers should remain attentive to driving and always exercise caution when using the steering-wheel-mounted controls while driving.

Driving while distracted can result in a loss of vehicle control that may lead to an accident, severe personal injury and/or death. The driver's primary responsibility is in the safe and legal operation of a vehicle, and any handheld devices, other equipment or vehicle systems which take the driver's eyes, attention and focus away from the safe operation of the vehicle or that are not permissible by law should never be used during operation of the vehicle.

Safety Features: No system, no matter how advanced, can compensate for all driver error and/or driving conditions. Always drive responsibly.

- 1. UVO link:** Purchase/lease of certain 2019 and newer Kia vehicles with UVO link includes a complimentary 1-year subscription starting from new vehicle retail sale/lease date as recorded by the dealer. After your complimentary 1-year UVO link subscription expires, continued access to the full suite of UVO link available on your Kia will require a paid subscription at the then current subscription rate or your use of certain UVO link features may immediately terminate. Use of UVO link is subject to agreement to the UVO Privacy Policy (available at <https://owners.kia.com/us/en/privacy-policy.html>) and Terms of Service (available at <https://owners.kia.com/us/en/terms-of-service.html>). UVO link is transferable to subsequent owner during the original UVO link service term. Only use UVO link when safe to do so. Kia Access with UVO link App is available from the Apple® App Store® or Google Play™. Kia Motors America, Inc. reserves the right to change or discontinue UVO link at any time without prior notification or incurring any future obligation. Message and data rates may apply. Cellular and GPS coverage is required to use most features. UVO link features may vary by model, model year, and trim level. Features, specifications, and fees are subject to change. For more on details and limitations, visit <https://owners.kia.com> or your authorized Kia dealer. Apple and App Store are registered trademarks of Apple Inc. Google and logos are trademarks of Google, LLC.
- 2. Airbags:** For maximum protection, always wear your seat belt.
- 3. Android Auto™:** Android Auto is a trademark of Google, Inc. Android™ is a registered trademark of Google, Inc. Distracted driving can result in a loss of vehicle control. Never use a handheld device or vehicle system that takes your focus away from safe vehicle operation.
- 4. Apple CarPlay®:** Apple® and Apple CarPlay® are trademarks of Apple, Inc., registered in the U.S. and other countries. Apple CarPlay® runs on your smartphone cellular data service. Normal data rates will apply.
- 5. Bluetooth® Wireless Technology:** A compatible Bluetooth® wireless technology-enabled cell phone is required to use Bluetooth® wireless technology. The Bluetooth® word mark and logos are registered trademarks owned by Bluetooth SIG, Inc. and any use of such marks by Kia is under license. Other trademarks and trade names are those of their respective owners. A Bluetooth® enabled cell phone is required to use Bluetooth® wireless technology.
- 6. Driver Assist Features – Blind-Spot Collision-Avoidance Assist (BCA), Rear Cross-Traffic Collision-Avoidance Assist (RCCA), Lane Keeping Assist, Lane Following Assist (LFA), Rear View Monitor, Forward Collision-Avoidance Assist (FCA), Smart Cruise Control, Safe Exit Assist (SEA), Highway Driving Assist (HDA):** These features are not substitutes for safe driving, and may not detect all objects surrounding vehicle. Always drive safely and use caution.
- 7. Driver Attention Warning (DAW) –** Driver Attention Warning is not a substitute for safe driving and may not detect all instances of inattentive driving practices. Failure to pay attention to travel conditions and vehicle operation could result in loss of vehicle control. Always drive safely and use caution.
- 8. Electronic Stability Control (ESC)/Traction Control System (TCS)/Hill-start Assist Control (HAC), Downhill Brake Control (DBC):** No system, no matter how advanced, can compensate for all driver error and/or driving conditions. Always drive safely.
- 9. Engine Start/Stop Button with Smart Key:** Always come to a complete stop before turning the engine on or off. However, if you have an emergency while the vehicle is in motion and must turn the engine off, you can turn the engine off to the ACC position by pressing the Start/Stop button for more than 3 seconds or 3 times in succession. If the vehicle is still moving, you can restart the engine by pressing the Start/Stop button with the shift lever in Neutral (N). With the engine off, power assist for steering and braking will be disabled, and the vehicle will be more difficult to control.
- 10. Front Seat Headrest Adjustment:** Never attempt to adjust headrests when vehicle is in motion.
- 11. Google Play™ Store** is a trademark of Google, Inc. ©2020 Google LLC. All rights reserved. Google and the Google Logo are registered trademarks of Google LLC.
- 12. Head-Up Display (HUD):** Failure to pay attention to travel conditions and vehicle operation could result in loss of vehicle control. Always drive safely and use caution.
- 13. Navigation:** Distracted driving can result in a loss of vehicle control. When operating a vehicle, never use a handheld device or vehicle system that takes your focus away from safe vehicle operation. Navigation is for information purposes only, and Kia does not make any warranties about the accuracy of the information.
- 14. Occupant Detection System (ODS):** Kia vehicles use a number of different ODS types that vary by model.
- 15. Roadside Assist:** 24-hour Enhanced Roadside Assistance is a service plan provided by Kia Motors America, Inc. Certain limitations apply. Coverage details are available in the Kia Warranty and Consumer Information Manual. For access to Enhanced Roadside Assistance, a connected mobile phone via Bluetooth® within the cellular service coverage area is required.
- 16. Seat adjustments:** Reclining the passenger seats can reduce the effectiveness of the safety restraint system and may lead to additional injury in an accident.
- 17. Seat Belts / Airbags:** For maximum protection, always wear your seatbelt.
- 18. Seat warmers:** Use extreme caution when using the seat warmers to avoid burns. Refer to the Owner's Manual for more information.
- 19. SiriusXM®:** SiriusXM Satellite Radio, SiriusXM Traffic and SiriusXM Travel Link each require a subscription sold separately, or as a package, by SiriusXM Radio Inc. **If you decide to continue your service at the end of your trial subscription, the plan you choose will automatically renew and bill at then-current rates until you call 1-866-635-2349 to cancel. See SiriusXM Customer Agreement for complete terms at www.siriusxm.com.** Other fees and taxes will apply. All fees and programming are subject to change. Not all vehicles or devices are capable of receiving all services offered by SiriusXM. Data displays and individual product availability vary by vehicle hardware. Current information and features may not be available in all locations, or on all receivers. Weather Forecast, Current Conditions may not be available in all locations. Images above are for representative purposes only and are not real products. For actual features and images of real products, consult the vehicle manufacturer. SiriusXM is not responsible for any errors or inaccuracies in the data services or their use in the vehicle. Travel Link Stocks displays current price and daily delta of around 7,000 actively reported securities traded on the NYSE®, NASDAQ® and AMEX®. The service is delayed approximately 20 minutes. SiriusXM satellite service is available only to those at least 18 years of age in the 48 contiguous USA, DC, and Puerto Rico (with coverage limitations). SiriusXM Internet Radio service is available throughout our satellite service area and in AK and HI. © 2020 SiriusXM Radio Inc. Sirius, XM and all related marks and logos are trademarks of SiriusXM Radio Inc.
- 20. Sportmatic®** is a registered trademark of Kia Motors America.
- 21. Steering Wheel Controls:** Driving while distracted is dangerous and should be avoided. Remain attentive to driving and be cautious when using steering-wheel-mounted controls while driving.
- 22. Sunvisors:** Sunvisor may not shield all direct light. Do not operate the vehicle if Sunvisor is impairing your visibility.
- 23. Tilt/Telescoping Steering Wheel:** Never attempt to adjust steering wheel position when vehicle is in motion.
- 24. Tire Pressure Monitoring System (TPMS):** Even with Tire Pressure Monitoring System, check tire pressure on a regular basis.



KEY FEATURE WALKTHROUGH

Demonstrate the following with the customer

Android Auto™ / Apple CarPlay® Setup

UVO link Activation* / UVO Assistance*

For further UVO link operation, refer to the Car Infotainment System Quick Reference Guide.

Standard Audio System*
For more information, refer to the Car Infotainment System Quick Reference Guide.



UVO link with Navigation*
For more information, refer to the Car Infotainment System Quick Reference Guide.

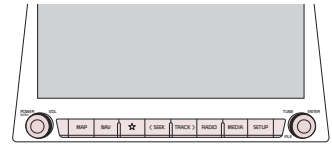

Cruise Control
Demonstrate operation

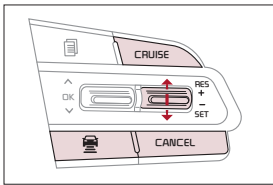

Bluetooth® Wireless Technology
Demonstrate operation

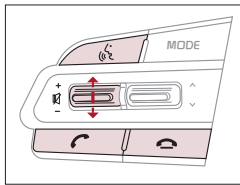

Kia Access with UVO link App Download
 Kia Access with UVO link App Features Guide

- Digital Clock
- Engine Start/Stop Button*
- Sunroof Operation*
- Passenger Airbag Off Indicator
- Rear View Monitor
- Folding Rear Seats

- Seat Warmers
- Smart Key*
- Sunvisor
- Tire Pressure Monitoring System (TPMS)
- Multimedia USB Port, Power Outlets & USB Charger Port

DURING DELIVERY

*if equipped

- Explain first service process and schedule first service appointment
- Tour Parts & Service departments, introduce staff & explain value of Kia Parts and Service
- Review recommended maintenance schedule and maintenance requirements to validate warranty
- Review business hours
- Review the Kia 10-year/100,000-mile warranty program
- Ensure 100% satisfaction with sales and delivery process and no problems with the vehicle
- Confirm time and best contact number for initial dealer follow-up

Sales Consultant: _____ Date: _____

Sales Manager: _____ Date: _____

Customer: _____ Date: _____



SELTOS CUSTOMER DELIVERY CHECKLIST

Owner's Name: _____ VIN: _____ Mileage: _____

Dealership Name: _____ Sales Consultant: _____ Date: _____

BEFORE DELIVERY

- Test and confirm "Good Battery" using a Kia battery tester and affix Results Label
- Verify all tire pressures are to spec (see driver's door label) LF_____ LR_____ RF_____ RR_____
- Verify proper operation of Remote Keyless Entry and Smart Key lock/unlock
- Ensure floor mats are snapped into place (if applicable)
- Verify vehicle is clean (interior and exterior), in good condition and free of chips and scratches
- Ensure all key documents are in the vehicle (Owner's Manual, Warranty and Consumer Information booklet, Tire Warranty booklet and Features & Functions Guide and any Audio System User's Manual)

KEY FEATURE WALKTHROUGH

- Air Conditioning / Climate Control
Demonstrate Air Flow modes, Defogging and Defrosting Windshield

Automatic*

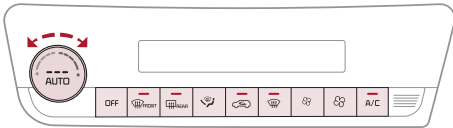

Manual*

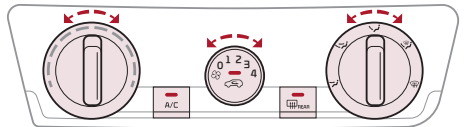

- Windshield Wipers & Washers

To operate:

- Move lever Up/Down to change Wiper modes
- Rotate INT switch to adjust Intermittent Wipe Speed
- Pull lever to spray and wipe

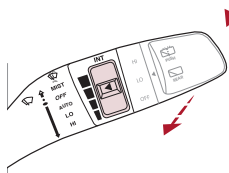

- MIST: Single wipe
- OFF: Wiper off
- INT: Intermittent wipe
- LO: Slow wiper speed
- HI: Fast wiper speed

- Rear Wiper & Washer

To operate:

- Rotate Rear Wiper switch to change Wiper modes
- Push lever to spray and wipe

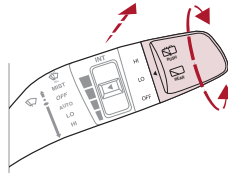

- ON: Normal wipe
- INT: Intermittent wipe*
- OFF: Wiper off

*IF EQUIPPED



SELTOS NORMAL MAINTENANCE SCHEDULE **NON-TURBO**

P=Perform • R=Replace • I=Inspect[‡]

(up to 60,000 miles)^A

For Turbo maintenance, see inside

MAINTENANCE INTERVALS (MILES)

MAINTENANCE ITEMS	7,500	15,000	22,500	30,000	37,500	45,000	52,500	60,000
Add fuel additive ^C	P	P	P	P	P	P	P	P
Rotate tires	P	P	P	P	P	P	P	P
Engine Oil & Filter	R	R	R	R	R	R	R	R
Climate control air filter	R	R	R	R	R	R	R	R
Battery condition	I	I	I	I	I	I	I	I
Brake lines, hoses and connections	I	I	I	I	I	I	I	I
Brake discs and pads	I	I	I	I	I	I	I	I
Vacuum hose	I	I	I	I	I	I	I	I
Steering gear rack, linkage & boots	I	I	I	I	I	I	I	I
Drive shafts and boots	I	I	I	I	I	I	I	I
Suspension ball joints and mounting bolts	I	I	I	I	I	I	I	I
Air conditioner compressor/refrigerant	I	I	I	I	I	I	I	I
Exhaust system	I	I	I	I	I	I	I	I
Air cleaner filter	I	I	I	R	I	I	I	R
Brake fluid	I	I	I	I	I	I	I	I
Parking brake	I	I	I	I	I	I	I	I
Fuel tank air filter ^{†D}		I		I		I		I
Vapor hose and fuel filler cap		I		I		I		I
Cooling System				I		I		I
Fuel lines, fuel hoses and connections				I				I
Drive belts (First 60,000 miles, then every 15,000 miles) ^E								I

QUICK TIP

Check your Maintenance Schedule or schedule an appointment with a dealer using your UVO link account by logging into the Kia Access with UVO link app (Vehicles equipped with UVO link only – See inside for setup information)

[‡] If equipped

A. See the Owner's Manual for complete maintenance schedule. These are approximate estimated intervals.

Refer to vehicle mileage for maintenance item schedule. For Turbo Maintenance intervals, see inside.

B. And, if necessary, adjust, correct, clean or replace

C. If TOP TIER detergent gasoline is not available, one bottle of additive is recommended. Additives are available from your authorized Kia dealer along with information on how to use them. Do not mix other additives

D. Both the fuel filter & fuel tank air filter are generally considered to be maintenance free, depending on fuel quality being used. However, periodic inspection is recommended. If your vehicle is having issues like fuel flow restriction, power surging, loss of power, difficulty starting, etc., replace the fuel filter immediately and consult an authorized Kia dealer for service.

E. The drive belt should be replaced when cracks occur or tension is reduced excessively
See your Owner's Manual for more details and complete maintenance information, including severe maintenance schedule. Warranty may be voided if maintenance schedule is not followed.

© 2020 Kia Motors America, Inc. All rights reserved.
Consumer - Roadside Assistance^{†15}: 1-800-333-4KIA (4542)

Part Number: SP210-PS-004R2

†LEGAL DISCLAIMERS ON BACK INSIDE COVER