

2021 OWNER'S MANUAL

RIO



The Power to Surprise



**WARNING – California
Proposition 65**

“Operating, servicing and maintaining a passenger vehicle or off-road vehicle can expose you to chemicals including engine exhaust, carbon monoxide, phthalates, and lead, which are known to the State of California to cause cancer and birth defects or other reproductive harm. To minimize exposure, avoid breathing exhaust, do not idle the engine except as necessary, service your vehicle in a well-ventilated area and wear gloves or wash your hands frequently when servicing your vehicle. For more information go to www.P65Warnings.ca.gov/passenger-vehicle.”



FOREWORD

Dear Customer,

Thank you for selecting your new Kia vehicle.

As a global car manufacturer focused on building high-quality vehicles with exceptional value, Kia Motors is dedicated to providing you with a customer service experience that exceeds your expectations.

If technical assistance is needed on your vehicle, authorized Kia dealerships can provide you with factory-trained technicians, recommended special tools, and genuine Kia replacement parts.

This Owner's Manual will acquaint you with the operation of features and equipment that are either standard or optional on this vehicle, along with the maintenance needs of this vehicle. Therefore, you may find some descriptions and illustrations not applicable to your vehicle. You are advised to read this publication carefully and follow the instructions and recommendations. Please always keep this manual in the vehicle for your, and any subsequent owner's, reference.

All information contained in this Owner's Manual was accurate at the time of publication. However, as Kia continues to make improvements to its products, the company reserves the right to make changes to this manual or any of its vehicles at any time without notice and without incurring any obligations.

Please drive safely, and enjoy your Kia vehicle!

© 2020 Kia Motors America, Inc.

All rights reserved. May not be reproduced or translated in whole or in part without the written consent of Kia Motors America, Inc.

Printed in MEXICO

TABLE OF CONTENTS ■

Introduction	1
Your vehicle at a glance	2
Safety features of your vehicle	3
Features of your vehicle	4
Driving your vehicle	5
What to do in an emergency	6
Maintenance	7
Specifications, Consumer information and Reporting safety defects	8
Index	I

Introduction

- How to use this manual 1-2
- Fuel requirements 1-3
 - Gasoline containing alcohol and methanol..... 1-3
 - Do not use methanol 1-4
 - Fuel Additives 1-5
- Vehicle modifications 1-6
- Vehicle break-in process 1-6
- Vehicle data collection and event data recorders.. 1-7

HOW TO USE THIS MANUAL

We want to help you get the greatest possible driving pleasure from your vehicle. Your Owner's Manual can assist you in many ways. We strongly recommend that you read the entire manual. In order to minimize the chance of death or injury, you must read the **WARNING** and **CAUTION** sections in the manual.

Illustrations complement the words in this manual to best explain how to enjoy your vehicle. By reading your manual, you will learn about features, important safety information, and driving tips under various road conditions.

The general layout of the manual is provided in the Table of Contents. Use the index when looking for a specific area or subject; it has an alphabetical listing of all located in the back of this manual.

Sections: This manual has nine sections plus an index. Each section begins with a brief list of contents so you can tell at a glance if that section has the information you want.

You will find various types of safety instructions in this manual. These instructions were prepared to enhance your personal safety.

Carefully read and follow ALL procedures and recommendations provided in these instructions.

WARNING

A WARNING indicates a situation in which harm, serious bodily injury or death could result if the warning is ignored.

CAUTION

A CAUTION indicates a situation in which damage to your vehicle could result if the caution is ignored.

*** NOTICE**

A NOTICE indicates interesting or helpful information is being provided.

FUEL REQUIREMENTS

Your new vehicle is designed to use only unleaded fuel having a pump octane number $((R+M)/2)$ of 87 (Research Octane Number 91) or higher. (Do not use methanol blended fuels.)

Your new vehicle is designed to obtain maximum performance with UNLEADED FUEL, as well as minimize exhaust emissions and spark plug fouling.

Never add any fuel system cleaning agents to the fuel tank other than what has been specified. (Consult an authorized Kia dealer for details.)

- Tighten the cap until it clicks one time, otherwise the Check Engine  light will illuminate.

WARNING - Refueling

- **Do not "top off" after the nozzle automatically shuts off. Attempts to force more fuel into the tank can cause fuel overflow onto you and the ground, causing a risk of fire.**
- **Always check that the fuel cap is installed securely to prevent fuel spillage, especially in the event of an accident.**

Gasoline containing alcohol and methanol

Gasohol, a mixture of gasoline and ethanol (also known as grain alcohol), and gasoline or gasohol containing methanol (also known as wood alcohol) are being marketed along with or instead of leaded or unleaded gasoline.

Pursuant to EPA regulations, ethanol may be used in your vehicle.

Do not use gasohol containing more than 15% ethanol, and do not use gasoline or gasohol containing any methanol. Ethanol provides less energy than gasoline and it attracts water, and it is thus likely to reduce your fuel efficiency and could lower your MPG results.

Methanol may cause drivability problems and damage to the fuel system, engine control system and emission control system.

Discontinue using gasohol of any kind if drivability problems occur.

Vehicle damage or drivability problems may not be covered by the manufacturer's warranty if they result from the use of:

1. Gasoline or gasohol containing methanol.
2. Leaded fuel or leaded gasohol.
3. Gasohol containing more than 15 percent ethanol

"E85" fuel is an alternative fuel comprised of 85 percent ethanol and 15 percent gasoline, and is manufactured exclusively for use in Flexible Fuel Vehicles. "E85" is not compatible with your vehicle. Use of "E85" may result in poor engine performance and damage to your vehicle's engine and fuel system. Kia recommends that customers do not use fuel with an ethanol content exceeding 15 percent.

*** NOTICE**

Your New Vehicle Limited Warranty does not cover damage to the fuel system or any performance problems caused by the use of "E85" fuel.

*** NOTICE**

Never use any fuel containing methanol. Discontinue use of any methanol containing product which may inhibit proper drivability.

Other fuels

Using fuels that contain Silicone (Si), MMT (Manganese, Mn), Ferrocene (Fe), and Other metallic additives, may cause vehicle and engine damage or cause misfiring, poor acceleration, engine stalling, catalyst melting, clogging, abnormal corrosion, life cycle reduction, etc.

Also, the Malfunction Indicator Lamp (MIL) may illuminate.

*** NOTICE**

Damage to the fuel system or performance problem caused by the use of these fuels may not be covered by your New Vehicle Limited Warranty.

Gasoline containing MMT

Some gasoline contains harmful manganese-based fuel additives Such as MMT (Methylcyclopentadienyl Manganese Tricarbonyl). Kia does not recommend the use of gasoline containing MMT. This type of fuel can reduce vehicle performance and affect your emission control system. The Malfunction Indicator Lamp on the cluster may come on.

Do not use methanol

Fuels containing methanol (wood alcohol) should not be used in your vehicle. This type of fuel can reduce vehicle performance and damage components of the fuel system, engine control system and emission control system.

Fuel Additives

Kia recommends that you use good quality gasolines treated with detergent additives such as TOP TIER Detergent Gasoline, which help prevent deposit formation in the engine. These engine gasolines will help the engine run cleaner and enhance performance of the Emission Control System. For more information on TOP TIER Detergent Gasoline, please go to the website (www.toptiergas.com)

For customers who do not use TOP TIER Detergent Gasoline regularly, and have problems starting or the engine does not run smoothly, additives that you can buy separately may be added to the gasoline.

If TOP TIER Detergent Gasoline is not available, one bottle of additive should be added to the fuel tank at every 7,500 miles (12,000 km) or every engine oil change is recommended. Additives are available from your authorized Kia dealer along with information on how to use them. Do not mix other additives.

Operation in foreign countries

If you are going to drive your vehicle in another country, be sure to:

- Observe all regulations regarding registration and insurance.
- Determine that acceptable fuel is available.

VEHICLE MODIFICATIONS

This vehicle should not be modified. Modification of your vehicle could affect its performance, safety or durability and may even violate governmental safety and emissions regulations.

In addition, damage or performance problems resulting from any modification may not be covered under warranty.

- If you use unauthorized electronic devices, it may cause the vehicle to operate abnormally, wire damage, battery discharge and fire. For your safety, do not use unauthorized electronic devices.

VEHICLE BREAK-IN PROCESS

No special break-in period is needed. By following a few simple precautions for the first 600 miles (1,000 km) you may add to the performance, economy and life of your vehicle.

- Do not race the engine.
- While driving, keep your engine speed (rpm, or revolutions per minute) between 2,000 rpm and 4,000 rpm.
- Do not maintain a single speed for long periods of time, either fast or slow. Varying engine speed is needed to properly break-in the engine.
- Avoid hard stops, except in emergencies, to allow the brakes to seat properly.
- Don't tow a trailer during the first 1,200 miles (2,000 km) of operation.
- Fuel economy and engine performance may vary depending on vehicle break-in process and stabilize after driving about 3,750 miles (6,000 km) Engines may consume more oil during the vehicle break-in period.

VEHICLE DATA COLLECTION AND EVENT DATA RECORDERS

This vehicle is equipped with an event data recorder (EDR). The main purpose of an EDR is to record, in certain crash or near crash-like situations, such as an air bag deployment or hitting a road obstacle, data that will assist in understanding how a vehicle's systems performed. The EDR is designed to record data related to vehicle dynamics and safety systems for a short period of time, typically 30 seconds or less. The EDR in this vehicle is designed to record such data as:

- * How various systems in your vehicle were operating;
- * Whether or not the driver and passenger safety belts were buckled/ fastened;
- * How far (if at all) the driver was depressing the accelerator and/or brake pedal; and,
- * How fast the vehicle was traveling.

These data can help provide a better understanding of the circumstances in which crashes and injuries occur. NOTE: EDR data are recorded by your vehicle only if a non-trivial crash situation occurs; no data are recorded by the EDR under normal driving conditions and no personal data (e.g., name, gender, age, and crash location) are recorded. However, other parties, such as law enforcement, could combine the EDR data with the type of personally identifying data routinely acquired during a crash investigation.

To read data recorded by an EDR, special equipment is required, and access to the vehicle or the EDR is needed. In addition to the vehicle manufacturer, other parties, such as law enforcement, that have the special equipment, can read the information if they have access to the vehicle or the EDR.

Your vehicle at a glance

Exterior overview	2-2
Interior overview	2-5
Instrument panel overview	2-6
Engine compartment	2-7

EXTERIOR OVERVIEW

■ Front view



- 1. Hood.....4-39
- 2. Head lamp (Features of your vehicle) ...4-93
Head lamp (Maintenance).....7-74
- 3. Front fog lamp
(Features of your vehicle).....4-99
Front fog lamp (Maintenance)7-74
- 4. Wheel and tire7-42, 8-5
- 5. Outside rearview mirror4-49
- 6. Windows4-33
- 7. Front windshield wiper blades
(Features of your vehicle).....4-100
Front windshield wiper blades
(Maintenance)7-35

* The actual shape may differ from the illustration.

OSC010001N

■ Rear view (4 DOOR)

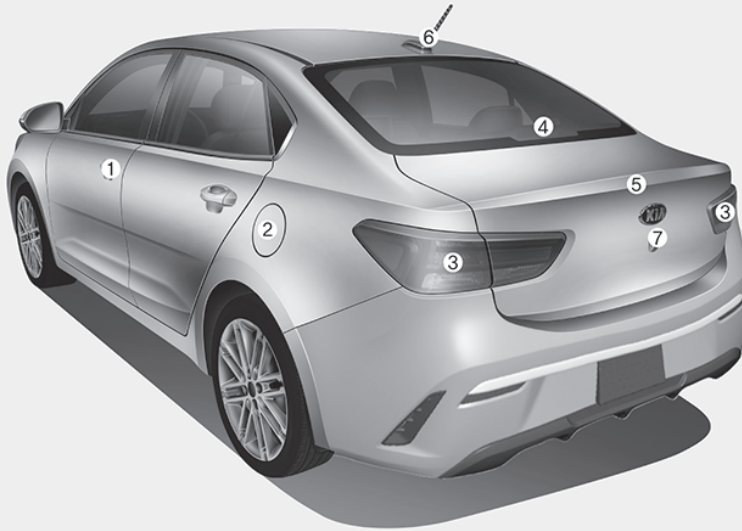

- 1. Door locks4-18
- 2. Fuel filler door4-42
- 3. Rear combination lamp
(Maintenance)7-76
- 4. High mounted stop lamp
(Maintenance)7-76
- 5. Trunk.....4-24
- 6. Antenna4-150
- 7. Rear view camera4-91

* The actual shape may differ from the illustration.

■ Rear view (5 DOOR)



- 1. Door locks4-18
- 2. Fuel filler door4-42
- 3. Rear combination lamp
(Maintenance)7-75
- 4. High mounted stop lamp
(Maintenance)7-75
- 5. Liftgate.....4-30
- 6. Antenna4-150
- 7. Rear view camera4-91
- 8. Rear window wiper blade
(Features of your vehicle).....4-100
Rear window wiper blade (Maintenance)...7-35

* The actual shape may differ from the illustration.

INTERIOR OVERVIEW

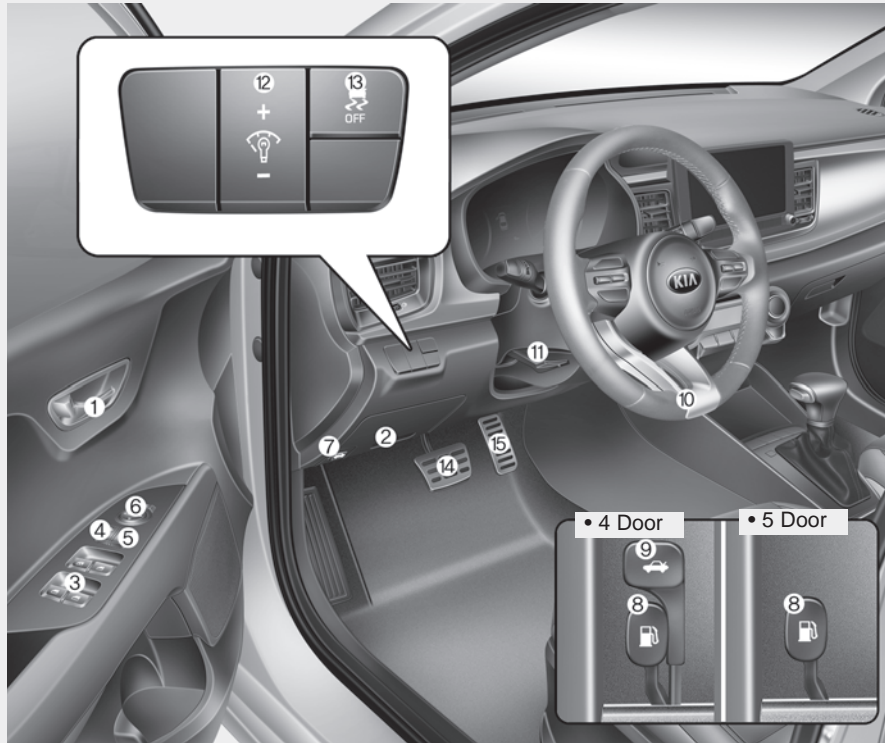

- 1. Inside door handle4-19
- 2. Inner fuse panel7-57
- 3. Power window switches4-33
- 4. Central door lock switch.....4-20
- 5. Power window lock button4-37
- 6. Outside rearview mirror control switch4-50
- 7. Hood release lever.....4-39
- 8. Fuel filler door release lever4-42
- 9. Trunk open lever4-24
- 10. Steering wheel4-45
- 11. Steering wheel tilt control4-46
- 12. Instrument panel illumination control switch4-52
- 13. ESC OFF button5-35
- 14. Brake pedal.....5-29
- 15. Accelerator pedal

OSC010003N

INSTRUMENT PANEL OVERVIEW



1. Instrument cluster.....4-51
2. Horn4-47
3. Driver's front air bag.....3-49
4. Light control/Turn signals4-94
5. Wiper/Washer4-100
6. Ignition switch or ENGINE START/STOP button5-7, 5-10
7. Hazard warning flasher switch6-2
8. Infotainment system
Refer to "Car Infotainment System Quick Reference Guide".
9. Driving Assist button5-87
10. Climate control system4-111, 4-123
11. USB port4-151
12. Manual Transmission.....5-17
Intelligent Variable Transmission5-21
13. Parking brake lever5-31
14. Passenger's front air bag3-49
15. Power outlet4-145
16. Glove box4-141
17. Sport mode system5-44
18. USB charger.....4-146
19. Center console storage.....4-141

OSC010004N

ENGINE COMPARTMENT

■ Smartstream G1.6

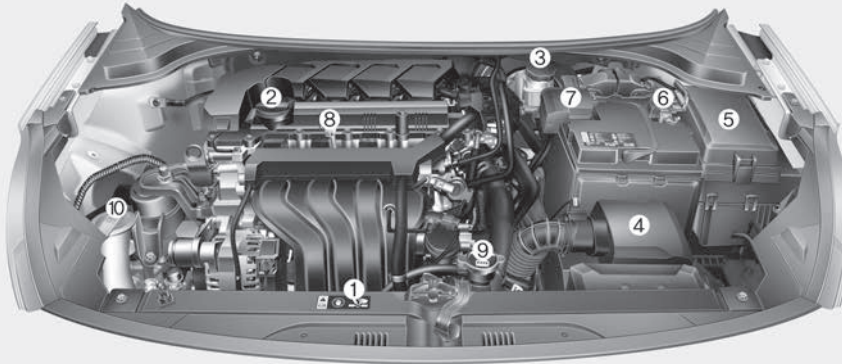

- 1. Engine coolant reservoir7-24
- 2. Engine oil filler cap7-22
- 3. Brake / clutch fluid reservoir7-27
- 4. Air cleaner.....7-31
- 5. Fuse box7-57
- 6. Negative battery terminal.....7-39
- 7. Positive battery terminal7-39
- 8. Engine oil dipstick7-21
- 9. Radiator cap7-26
- 10. Windshield washer fluid reservoir ...7-29

* The actual engine compartment in the vehicle may differ from the illustration.

OSC078047N

Safety features of your vehicle

Important safety precautions 3-2

- Always wear your seat belt 3-2
- Restrain all children 3-2
- Air bag hazards 3-2
- Driver distraction 3-2
- Control your speed 3-3
- Keep your vehicle in safe condition 3-3

Seat. 3-4

- Driver's seat. 3-4
- Front passenger's seat. 3-4
- Rear seat. 3-4
- Front seat adjustment. 3-7
- Headrest (for front seat). 3-8
- Seatback pocket. 3-10
- Rear seat adjustment. 3-11

Seat belts 3-15

- Seat belt restraint system 3-15
- Pre-tensioner seat belt 3-21
- Seat belt precautions. 3-23
- Care of seat belts. 3-25

Child Restraint System (CRS) 3-27

- Using a child restraint system 3-28

Air bag - advanced supplemental restraint

- system 3-34
- How does the air bag system operate 3-35
- Air bag warning light 3-38
- SRS components and functions 3-38
- Occupant detection system. 3-41
- Driver's and passenger's front air bag 3-49
- Side air bag 3-52
- Curtain air bag 3-54
- Why didn't my air bag go off in a collision?
(Inflation and non-inflation conditions of the
air bag) 3-56
- SRS Care 3-61
- Adding equipment to or modifying your
air bag-equipped vehicle. 3-62
- Air bag warning label. 3-62

IMPORTANT SAFETY PRECAUTIONS

You will find many safety precautions and recommendations throughout this section, and throughout this manual. The safety precautions in this section are among the most important.

Always wear your seat belt

A seat belt is your best protection in all types of accidents. Air bags are designed to supplement seat belts, not replace them. So even though your vehicle is equipped with air bags, ALWAYS make sure you and your passengers wear your seat belts, and wear them properly.

Restrain all children

All children under age 13 should ride in your vehicle properly restrained in a rear seat, not the front seat. Infants and small children should be restrained in an appropriate child restraint. Larger children should use a booster seat with the lap/shoulder belt until they can use the seat belt properly without a booster seat.

Air bag hazards

While air bags can save lives, they can also cause serious or fatal injuries to occupants who sit too close to them, or who are not properly restrained. Infants, young children, and shorter adults are at the greatest risk of being injured by an inflating air bag. Follow all instructions and warnings in this manual.

Driver distraction

Driver distraction presents a serious and potentially deadly danger, especially for inexperienced drivers. Safety should be the first concern when behind the wheel and drivers need to be aware of the wide array of potential distractions, such as drowsiness, reaching for objects, eating, personal grooming, other passengers, and using cellular phones.

Drivers can become distracted when they take their eyes and attention off the road or their hands off the wheel to focus on activities other than driving. To reduce your risk of distraction or getting into an accident:

- ALWAYS set up your mobile devices (i.e., MP3 players, phones, navigation units, etc.) when your vehicle is parked or safely stopped.

- **ONLY** use your mobile device when allowed by laws and when conditions permit safe use. **NEVER** text or email while driving. Most states have laws prohibiting drivers from texting. Some states and cities also prohibit drivers from using handheld phones.
- **NEVER** let the use of a mobile device distract you from driving. You have a responsibility to your passengers and others on the road to always drive safely, with your hands on the wheel as well as your eyes and attention on the road.

Control your speed

Excessive speed is a major factor in crash injuries and deaths. Generally, the higher the speed, the greater the risk, but serious injuries can also occur at lower speeds. Never drive faster than is safe for current conditions, regardless of the maximum speed posted.

Keep your vehicle in safe condition

Having a tire blowout or a mechanical failure can be extremely hazardous. To reduce the possibility of such problems, check your tire pressures and condition frequently, and perform all regularly scheduled maintenance.

SEAT

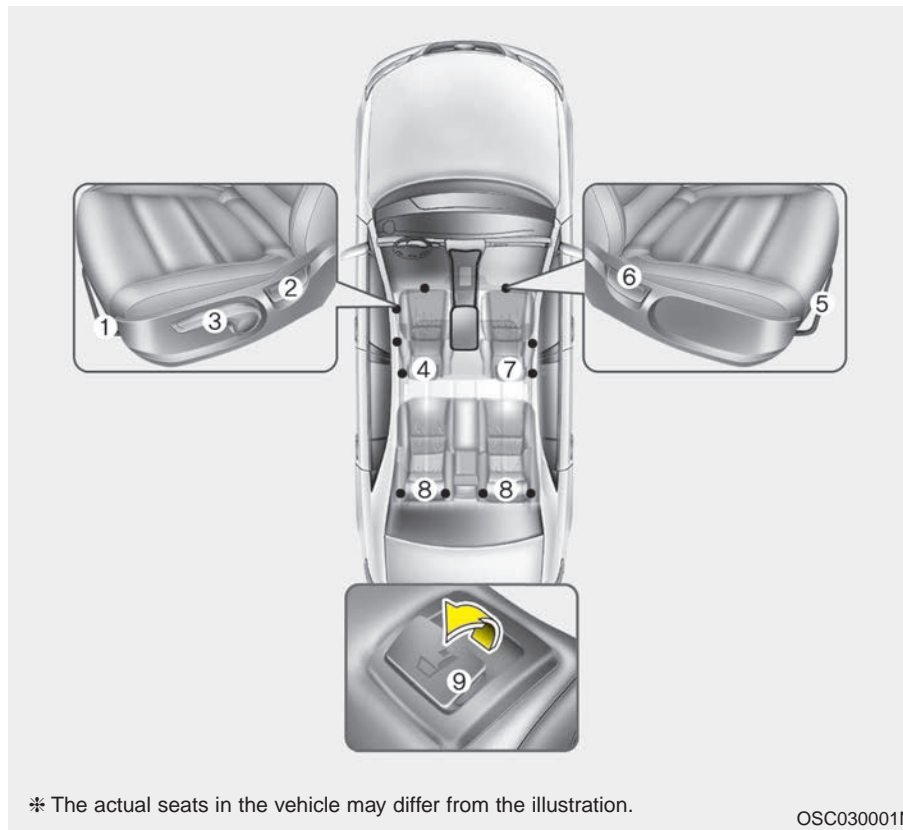

Driver's seat

- (1) Forward and backward
- (2) Seatback angle
- (3) Seat height adjustment*
- (4) Headrest

Front passenger's seat

- (5) Forward and backward
- (6) Seatback angle
- (7) Headrest

Rear seat

- (8) Headrest
- (9) Seatback folding*

* : if equipped

⚠ WARNING - Loose objects
Do not place anything in the driver's foot well or under the front seats. Loose objects in the driver's foot area could interfere with the operation of the foot pedals.

⚠ WARNING - Uprighting seat
Do not press the release lever on a manual seatback without holding and controlling the seatback. The seatback will spring upright possibly impacting you or other passengers.

⚠ WARNING - Seat cushion
Occupants should never sit on aftermarket seat cushions or sitting cushions. The passenger's hips may slide under the lap portion of the seat belt during an accident or a sudden stop.

⚠ WARNING
- Driver responsibility for passengers

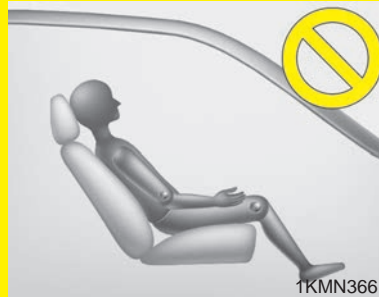

The driver must advise the passenger to keep the seatback in an upright position whenever the vehicle is in motion. If a seat is reclined during an accident, the restraint system's ability to restrain will be greatly reduced.

⚠ WARNING - Driver's seat

- Never attempt to adjust the seat while the vehicle is moving. This could result in loss of control of your vehicle.
- Do not allow anything to interfere with the normal position of the seatback and seatback adjustment.
- Sit as far back as possible from the steering wheel while still maintaining comfortable control of your vehicle. A distance of at least 10" from your chest to the steering wheel is recommended. Failure to do so could result in air bag inflation injuries to the driver.

WARNING - Seat adjustment

- Do not adjust the seat while wearing seat belts. Moving the seat forward will cause strong pressure on the abdomen.
- Do not place your hand near the seat bottom or seat track while adjusting the seat. Your hand could get caught in the seat mechanism.

WARNING - Small Objects

Use extreme caution when picking up small objects trapped under the seats or between the seat and the center console. Your hands might be cut or injured by the sharp edges of the seats mechanism.

Feature of Seat Leather

- Leather is made from the outer skin of an animal, which goes through a special process to be available for use. Since it is a natural substance, each part differs in thickness or density.

Wrinkles may appear as a natural result of stretching and shrinking depending on the temperature and humidity.

- The seat cover is made of stretchable material to improve comfort of passengers.
- The parts contacting the body are curved and the side supporting area is high which provides driving comfort and stability.
- Wrinkles may appear naturally from usage. It is not a fault of the product.

CAUTION

- *Belts with metallic accessories, zippers or keys inside your back pants pocket may damage the seat fabric.*
- *Make sure not to wet the seat. It may change the nature of natural leather.*
- *Jeans or clothes which contain bleach may contaminate the surface of the seat covering fabric and cause damage or discoloration.*

*** NOTICE**

Wrinkles or abrasions which appear naturally from usage are not covered by warranty.

Front seat adjustment

Forward and backward

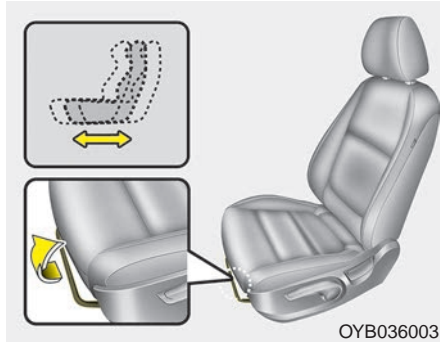

To move the seat forward or backward:

1. Pull the seat slide adjustment lever up and hold it.
2. Slide the seat to the position you desire.
3. Release the lever and make sure the seat is locked in place.

Adjust the seat before driving, and make sure the seat is locked securely by trying to move forward and backward without using the lever. If the seat moves, it is not locked properly.

⚠ WARNING - Unexpected seat movement

After adjusting a manual seat, always check that it is locked by shifting your weight to the front and back. Sudden or unexpected movement of the driver's seat could cause you to lose control of the vehicle.

Seatback angle

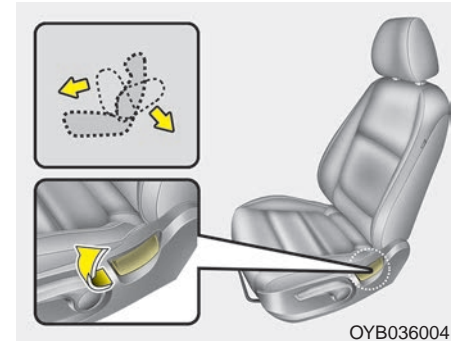

To recline the seatback:

1. Lean forward slightly and lift up the seatback recline lever.
2. Carefully lean back on the seat and adjust the seatback of the seat to the position you desire.
3. Release the lever and make sure the seatback is locked in place. (The lever **MUST** return to its original position for the seatback to lock.)

Seat Cushion height (for driver's seat)

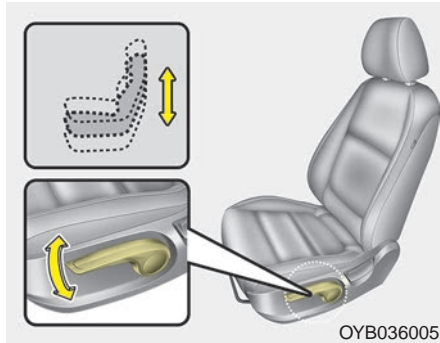

To change the height of the seat cushion, push the lever upwards or downwards.

- To lower the seat, push the lever down several times until the seat reaches the desired position.
- To raise the seat, push the lever up several times until the seat reaches the desired position.

Headrest (for front seat)

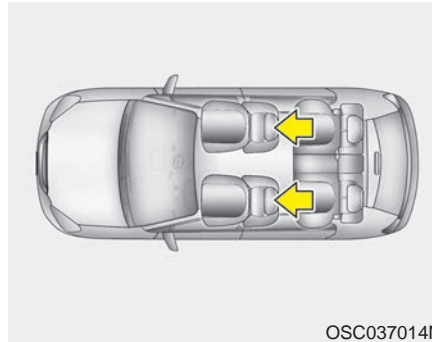

The driver's and front passenger's seats are equipped with a headrest for the occupant's safety and comfort. The headrest not only provides comfort for the driver and front passenger, but also helps protect the head and neck in the event of a collision.

For maximum effectiveness in case of an accident, the headrest should be adjusted so the middle of the headrest is at the same height of the center of gravity of an occupant's head. Generally, the center of gravity of most people's head is similar with the height of the top of their eyes. Also, adjust the headrest as close to your head as possible.

For this reason, the use of a cushion that holds the body away from the seatback is not recommended.

⚠ WARNING - Headrest removal/adjustment

- **Do not operate the vehicle with the headrests removed. Headrests can provide critical neck and head support in a crash.**
- **Do not adjust the headrest height while the vehicle is in motion. Driver may lose control of the vehicle.**

**Adjusting the height up and down
(if equipped)**

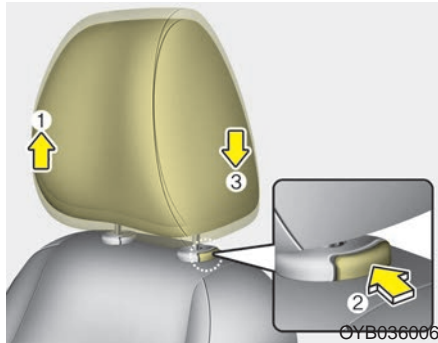

To raise the headrest, pull it up to the desired position (1). To lower the headrest, push and hold the release button (2) on the headrest support and lower the headrest to the desired position (3).

⚠ CAUTION

Excessive pulling or pushing may damage the headrest.

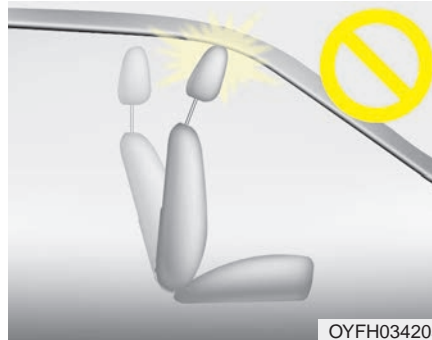

OYFH034205

*** NOTICE**

If you recline the seatback towards the front with the headrest and seat cushion raised, the headrest may come in contact with the sunvisor or other parts of the vehicle.

**Removal and installation
(if equipped)**

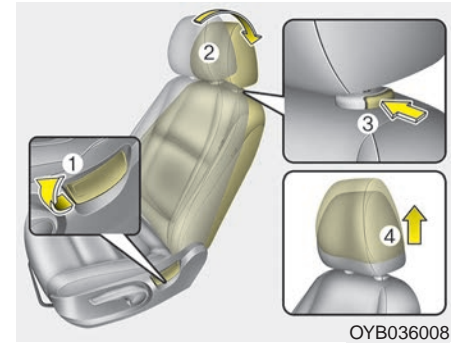

OYB036008

To remove the headrest:

1. Recline the seatback (2) with the recline lever(1).
2. Raise headrest as far as it can go.
3. Press the headrest release button (3) while pulling the headrest up (4).

⚠ WARNING - Headrest Removal

NEVER allow anyone to ride in a seat with the headrest removed. Headrests can provide critical neck and head support in a crash.

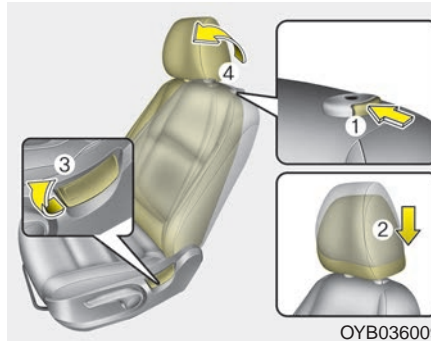

To reinstall the headrest :

1. Put the headrest poles (2) into the holes while pressing the release button (1).
2. Recline the seatback (4) with the recline lever (3).
3. Adjust the headrest to the appropriate height.

⚠ WARNING - Headrest Reinstallation

To reduce the risk of injury to the head or neck, always make sure the head rest is locked into position and adjusted properly after reinstalling.

Seatback pocket

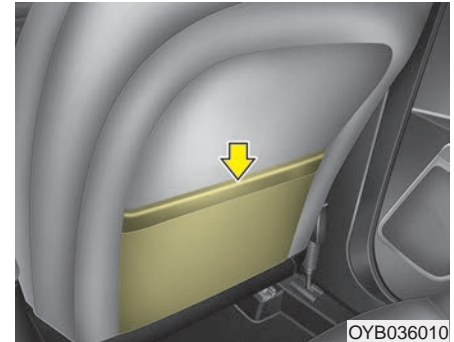

The seatback pocket is provided on the back of the front passenger's seatback.

⚠ WARNING - Seatback pocket

Do not put heavy or sharp objects in the seatback pocket. An occupant could contact such objects in a crash. Heavy objects in the front passenger seatback could also interfere with the air bag sensing system.

Rear seat adjustment

Headrest (for rear seat)

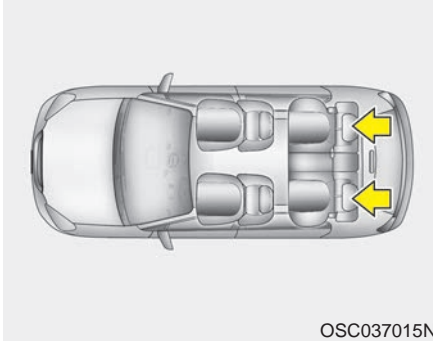

The rear seat is equipped with headrests in left and right side seating positions for the occupant's safety and comfort.

The headrest not only provides comfort for passengers, but also helps protect the head and neck in the event of a collision.

For maximum effectiveness in case of an accident, the headrest should be adjusted so the middle of the headrest is at the same height of the center of gravity of an occupant's head. Generally, the center of gravity of most people's head is similar with the height as the top of their eyes.

Also adjust the headrest as close to your head as possible. For this reason, the use of a cushion that holds the body away from the seatback is not recommended.

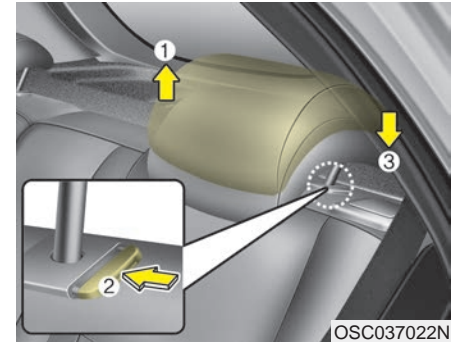

Adjusting the height up and down (if equipped)

To raise the headrest, pull it up to the desired position (1). To lower the headrest, push and hold the release button (2) on the headrest support and lower the headrest to the desired position (3).

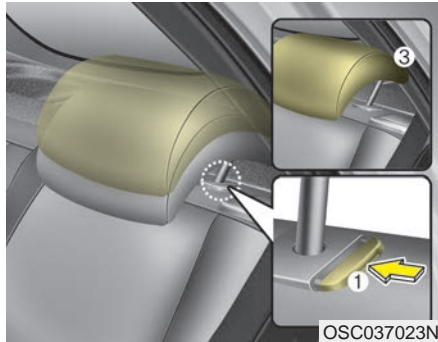

Removal and installation

To remove the headrest, raise it as far as it can go then press the release button (1) while pulling the headrest upward (2).

To reinstall the headrest, put the headrest poles (3) into the holes while pressing the release button (1). Then adjust it to the appropriate height and ensure that it locks in position.

Folding the rear seat

The rear seatbacks may be folded to facilitate carrying long items or to increase the luggage capacity of the vehicle.

⚠ WARNING - Folded Seatback

Never allow passengers to sit on top of the folded down seatback while the vehicle is moving. This is not a proper seating position and no seat belts are available for use. This could result in serious injury or death in case of an accident or sudden stop.

⚠ WARNING - Objects

Objects carried on the folded down seatback should not extend higher than the top of the front seatbacks. This could allow cargo to slide forward and cause injury or damage during sudden stops.

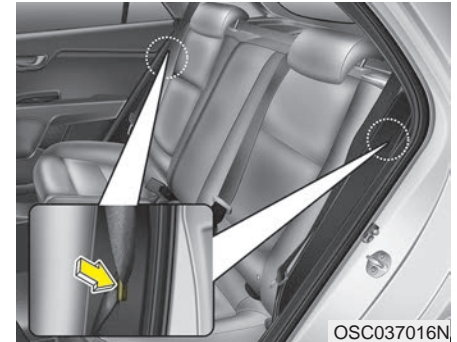

To fold down the rear seatback (if equipped):

1. When folding the seat back, insert the rear seat belt buckle in the pocket between the rear seatback and cushion then make sure both seatbelts do not interfere with stowed luggage and cargo. Then, insert the seat belt into the two holes located on both sides.
2. Set the front seatback to the upright position and if necessary, slide the front seat forward.
3. Lower the rear headrests to lowest position.

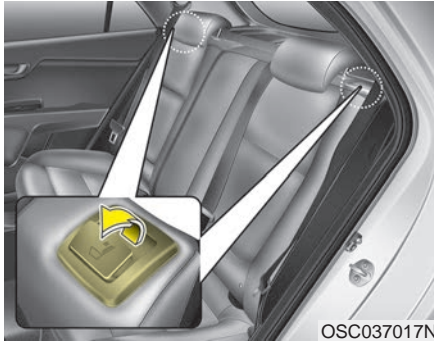

4. Pull the lock release lever and fold the rear seatback forward and down firmly.

To unfold the rear seat (if equipped):

1. To use the rear seat, lift and pull the seatback rearward. Pull the seatback firmly until it clicks into place. Make sure the seatback is locked in place. When you return the seatback to its upright position, always be sure it has locked into position by pushing on the top of the seatback.
2. Return the rear seat belt to the proper position.
3. When the seatback is completely installed, check the seatback folding lever again.

When returning the rear seatbacks to the upright position, remember to return the rear shoulder belts to their proper position.

⚠ CAUTION

Be careful when loading cargo through the rear passenger seats to prevent damage to the vehicle interior.

⚠ WARNING

Unless the driver's position is properly set according to the driver's physical figure, do not fold the rear seat. It may increase body injuries in a sudden stop or collision.

⚠ WARNING - Uprighting seat

When you return the seatback to its upright position, hold the seatback and return it slowly. If the seatback is returned without holding it, the back of the seat could spring forward resulting in injury caused by being struck by the seatback.

⚠ WARNING

When you return the rear seatback to its upright position after being folded down:

Ensure that the seatback is completely locked into its upright position by pushing on the top of the seatback. Otherwise, in an accident or sudden stop, the seat could fold down and allow cargo to enter the passenger compartment, which could result in serious injury or death.

⚠ CAUTION

Do not damage the seat belt webbing or buckle. Do not allow the seat belt webbing or buckle to get caught or pinched in the rear seat when returning your seat to the upright position.

⚠ WARNING - Cargo

Cargo should always be secured to prevent it from being thrown about the vehicle in a collision and causing injury to the vehicle occupants. Do not place objects in the rear seats, since they cannot be properly secured and may hit the front seat occupants in a collision.

⚠ WARNING - Objects

Objects carried on the folded down seatback should not extend higher than the top of the front seatbacks. This could allow cargo to slide forward and cause injury or damage during sudden stops.

SEAT BELTS

Seat belt restraint system

Seat belts are designed to bear upon the bony structure of the body, and should be worn low across the front of the pelvis, chest and shoulders, as applicable; wearing the lap section of the belt across the abdominal area must be avoided.

Seat belts should be adjusted as firmly as possible, consistent with comfort, to provide the protection for which they have been designed.

A slack belt will greatly reduce the protection afforded to the wearer.

Care should be taken to avoid contamination of the webbing with polishes, oils and chemicals, and particularly battery acid. Cleaning may safely be carried out using mild soap and water. The belt should be replaced if webbing becomes frayed, contaminated or damaged.

- For maximum restraint system protection, the seat belts must always be used whenever the vehicle is moving. A properly positioned shoulder belt should be positioned midway over your shoulder across your collarbone.
- Never allow children to ride in the front passenger seat. See child restraint system section for further discussion.
- No modifications or additions should be made by the user which would either prevent the seat belt adjusting devices from operating to remove slack, or prevent the seat belt assembly from being adjusted to remove slack.
- When you fasten the seat belt, be careful not to latch the seat belt in buckles of other seats. It's very dangerous and you may not be protected by the seat belt properly.
- Do not unfasten the seat belt and do not fasten and unfasten the seat belt repeatedly while driving. This could result in loss of control, and an accident causing death, serious injury, or property damage.
- When fastening the seat belt, make sure that the seat belt does not pass over objects that are hard or can break easily.

⚠ WARNING - Shoulder belt
Never wear the shoulder belt under your arm or behind your back. An improperly positioned shoulder belt cannot protect the occupant in a crash.

⚠ WARNING - Damaged seat belt
Replace the entire seat belt assembly if any part of the webbing or hardware is damaged as you can no longer be sure that a damaged seat belt will provide protection in a crash.

⚠ WARNING - Twisted seat belt

Make sure your seat belt is not twisted when worn. A twisted seat belt may not properly protect you in an accident and could even cut into your body.

⚠ WARNING - Seat belt buckle

Do not allow foreign material (gum, crumbs, coins, etc.) to obstruct the seat belt buckle. This may prevent the seat belt from fastening securely.



Driver's seat belt warning

As a reminder to the driver, the Driver's seat belt warning lights will illuminate for approximately 6 seconds each time you turn the ignition switch or ENGINE START/STOP button ON regardless of belt fastening.

If the seatbelt is not fastened, the warning chime will sound for about 6 seconds. If you start to drive without the seat belt fastened or you unfasten the seat belt when you drive under 12 mph (20 km/h) or stop, the corresponding warning light will illuminate.

If you start to drive without the seat belt fastened or you unfasten the seat belt when you drive 12 mph (20 km/h) and faster, the warning light will blink and warning chime will sound for approximately 100 seconds.

When the seat belt is unfastened during driving, the warning light will illuminate when the speed is under 12 mph (20 km/h).

When the speed is 12 mph (20 km/h) and faster, the warning light will blink and warning chime will sound for approximately 100 seconds.

Seat belt - Driver's 3-point system with emergency locking retractor

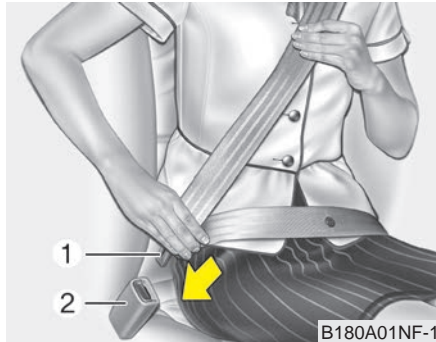

To fasten your seat belt:

To fasten your seat belt, pull it out of the retractor and insert the metal tab (1) into the buckle (2). There will be an audible "click" when the tab locks into the buckle.

The seat belt automatically adjusts to the proper length only after the lap belt portion is adjusted manually so that it fits snugly around your hips. If you lean forward in a slow, easy motion, the belt will extend and let you move around. If there is a sudden stop or impact, however, the belt will lock into position. It will also lock if you try to lean forward too quickly.

If you are unable to pull out the seat belt from the retractor, firmly pull the belt out and release it. Then you will be able to pull the belt out smoothly.

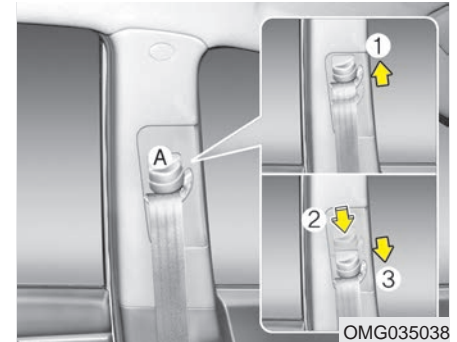

Height adjustment

You can adjust the height of the shoulder belt anchor to one of the 3 positions for maximum comfort and safety.

The height of the adjusting seat belt should not be too close to your neck. The shoulder portion should be adjusted so that it lies across your chest and midway over your shoulder nearest the door and not your neck.

To adjust the height of the seat belt anchor, lower or raise the height adjuster into an appropriate position.

To raise the height adjuster, pull it up (1). To lower it, push it down (3) while pressing the height adjuster button (2). Release the button to lock the anchor into position. Try sliding the height adjuster to make sure that it has locked into position. Never position the shoulder belt across your neck or face. Improperly positioned seat belts can cause serious injuries in an accident.

⚠ WARNING - Seat belt replacement

Replace your seat belts after being in an accident. Failure to replace seat belts after an accident could leave you with damaged seat belts that will not provide protection in the event of another collision.

⚠ WARNING - Shoulder belt positioning

Never position the shoulder belt across your neck or face.

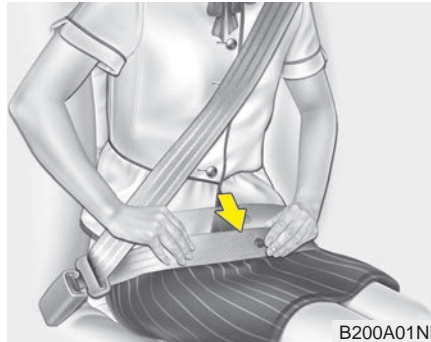

⚠ WARNING

You should place the lap belt portion as low as possible and snugly across your hips, not on your waist. If the lap belt is located too high on your waist, it may increase the chance of injury in the event of a collision. Both arms should not be under or over the belt. Rather, one should be over and the other under, as shown in the illustration.

Never wear the seat belt under the arm near the door.

Seat belts - Front passenger and rear seat 3-point system with combination locking retractor

To fasten your seat belt

Combination retractor type seat belts are installed in the rear seat positions to help accommodate the installation of child restraint systems. Although a combination retractor is also installed in the front passenger seat position, it is strongly recommended that children always be seated in the rear seat. NEVER place an infant restraint system in the front seat of the vehicle.

This type of seat belt combines the features of both an emergency locking retractor seat belt and an automatic locking retractor seat belt. To fasten your seat belt, pull it out of the retractor and insert the metal tab into the buckle. There will be an audible "click" when the tab locks into the buckle. When not securing a child restraint, the seat belt operates in the same way as the driver's seat belt (Emergency Locking Retractor Type).

It automatically adjusts to the proper length only after the lap belt portion of the seat belt is adjusted manually so that it fits snugly around your hips. When the seat belt is fully extended from the retractor to allow the installation of a child restraint system, the seat belt operation changes to allow the belt to retract, but not to extend (Automatic Locking Retractor Type). Refer to “Using a child restraint system” in this section.

To convert from the automatic locking feature to the emergency locking operation mode, allow the unbuckled seat belt to fully retract.

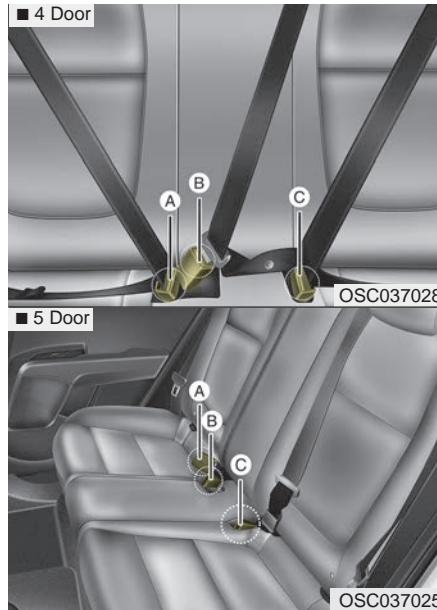

- * A : Rear right seat belt fastening buckle
- B : Rear center seat belt fastening buckle
- C : Rear left seat belt fastening buckle

The seat belt should be locked into the buckle on each seat cushion to be properly fastened.

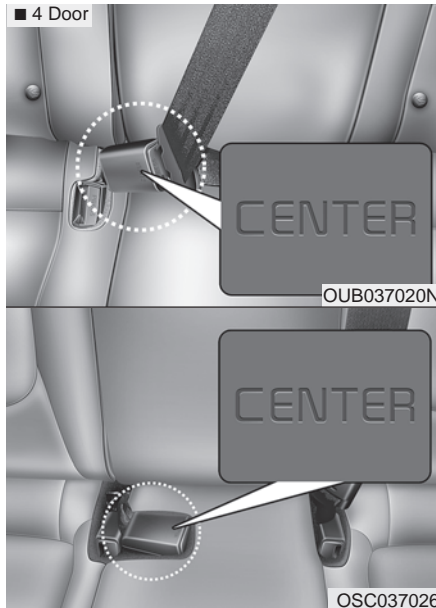

When using the rear center seat belt, the buckle with the “CENTER” mark must be used.

⚠ CAUTION

Do not force or lock the left or right seat belt latch into the center seat belt buckle. This may cause damage to the center buckle and prevent the buckle from properly latching in the future.

⚠ WARNING

Be sure you are using the correct latch for the center seat belt buckle. Forcing the left or right seat belt latch into the center buckle can create the appearance of a secure seat belt when in fact the passenger is not properly fastened in the seat belt.

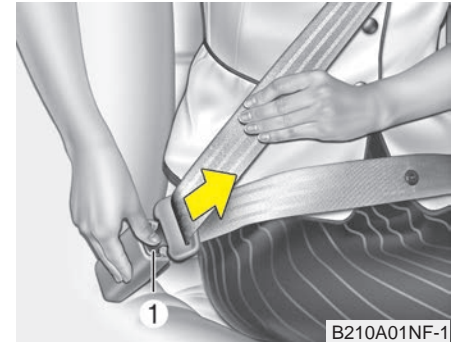

To release the seat belt

The seat belt is released by pressing the release button (1) of the locking buckle. When it is released, the belt should automatically draw back into the retractor.

If this does not happen, check the belt to be sure it is not twisted, then try again.

Pre-tensioner seat belt



Your vehicle is equipped with driver's and front passenger's pre-tensioner seat belts.

1. Retractor pre-tensioner

The retractor pre-tensioner is a supplemental system of the seat belts. The purpose of the retractor pre-tensioner is to tighten the shoulder belt against the occupant's upper body in certain frontal collisions.

The pre-tensioner seat belts may be activated, when a collision is severe enough, together with the air bags.

When the vehicle stops suddenly, or if the occupant tries to lean forward too quickly, the seat belt retractor may lock into position. In certain frontal collisions (or side collisions), the pre-tensioner may activate and pull the seat belt into tighter contact against the occupant's body.

If the system senses excessive tension on the driver or passenger's seat belt when the pre-tensioner activates, the load limiter inside the retractor pre-tensioner will release some of the pressure on the affected seat belt.

2. Emergency Fastening Device (EFD)

The Emergency Fastening Device (EFD) is a supplemental system of the seat belts. The purpose of the EFD is to tighten the lap belt against the occupant's pelvis in certain collisions.

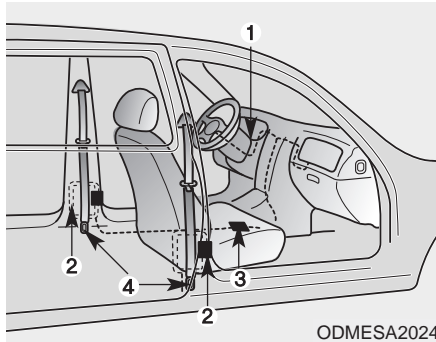

The seat belt pre-tensioner system consists mainly of the following components. Their locations are shown in the illustration:

1. SRS air bag warning light
2. Retractor pre-tensioner assembly
3. SRS control module
4. Emergency fastening device (EFD)

To obtain maximum benefit from a pre-tensioner seat belt:

1. The seat belt must be worn correctly and adjusted to the proper position. Please read and follow all of the important information and precautions about your vehicle's occupant safety features - including seat belts and air bags - that are provided in this manual.
2. Be sure you and your passengers always wear seat belts properly.

* NOTICE

When the pre-tensioner seat belts are activated, a loud noise may be heard and fine dust, which may appear to be smoke, may be visible in the passenger compartment. These are normal operating conditions and are not hazardous.

⚠ WARNING - Skin irritation
Wash all exposed skin areas thoroughly after an accident in which the pre-tensioner seat belts were activated. The fine dust from the pre-tensioner activation may cause skin irritation and should not be breathed for prolonged periods.

Because the sensor that activates the SRS air bag is connected with the pre-tensioner seat belt, the SRS air bag warning light () on the instrument panel will illuminate for approximately 6 seconds after the ignition switch has been turned to the ON position, and then it should turn off. If the pre-tensioner seat belt does not work properly, this warning light will illuminate even if the SRS air bag has not malfunctioned. If the SRS air bag warning light does not illuminate when the ignition switch is turned ON, or if it remains illuminated after illuminating for approximately 6 seconds, or if it illuminates while the vehicle is being driven, please have an authorized Kia dealer inspect the pre-tensioner seat belt or SRS air bag system as soon as possible.

* NOTICE

Do not attempt to service or repair the pre-tensioner seat belt system in any manner. Do not attempt to inspect or replace the pre-tensioner seat belts yourself. This must be done by an authorized Kia dealer.



WARNING - Hot pre-tensioner

Do not touch the pre-tensioner seat belt assemblies for several minutes after they have been activated. When the pre-tensioner seat belt mechanism fires during a collision, the pre-tensioner becomes hot and can burn you.

Pre-tensioners are designed to operate only one time. After activation, pre-tensioner seat belts must be replaced. If the pre-tensioner must be replaced, contact an authorized Kia dealer.

Seat belt precautions

Infant or small child

All 50 states have child restraint laws. You should be aware of the specific requirements in your state. Child and/or infant seats must be properly placed and installed in the rear seat. For more information about the use of these restraints, refer to “Child restraint system” in this section.

* NOTICE

Small children are best protected from injury in an accident when properly restrained in the rear seat by a child restraint system that meets the requirements of the Federal Motor Vehicle Safety Standards. Before buying any child restraint system, make sure that it has a label certifying that it meets Federal Motor Vehicle Safety Standard 213. The restraint must be appropriate for your child's height and weight. Check the label on the child restraint for this information. Refer to “Child restraint system” in this section.

Larger children

Children who are too large for child restraint systems should always occupy the rear seat and use the available lap/shoulder belts. The lap portion should be fastened snug on the hips and as low as possible. Periodically check belt fit. A child's squirming could put the belt out of position. Children are given the most safety in the event of an accident when they are restrained by a proper restraint system in the rear seat. If a larger child (over age 13) must be seated in the front seat, the child should be securely restrained by the available lap/shoulder belt and the seat should be placed in the rearmost position. Children age 13 and under should be restrained securely in the rear seat. NEVER place a child age 13 and under in the front seat. NEVER place a rear facing child seat in the front seat of a vehicle.

If the shoulder belt portion slightly touches the child's neck or face, try placing the child closer to the center of the vehicle. If the shoulder belt still touches their face or neck, they need to be returned to a child restraint system.

WARNING - Small children

Do not allow small children to ride in the vehicle without an appropriate child restraint system. If the shoulder belt comes in contact with your child's neck or face, your child is too small to ride in the vehicle. In a crash, the seat belt will inflict injury to your child's neck, throat and face.

Restraint of pregnant women

Pregnant women should wear lap/shoulder belt assemblies whenever possible according to specific recommendations by their doctors. The lap portion of the belt should be worn AS SNUGLY AND LOW AS POSSIBLE on the hips, not across the abdomen.

WARNING - Pregnant women

Pregnant women must never place the lap portion of the seat belt above or on the abdomen where the fetus is located. The force of the seat belt during a collision will crush the fetus.

Injured person

A seat belt should be used when an injured person is being transported. When this is necessary, you should consult a physician for recommendations.

One person per belt

Two people (including children) should never attempt to use a single seat belt. This could increase the severity of injuries in case of an accident.

Do not lie down

To reduce the chance of injuries in the event of an accident and to achieve maximum effectiveness of the restraint system, all passengers should be sitting up and the front seats should be in an upright position when the vehicle is moving. A seat belt cannot provide proper protection if the person is lying down in the rear seat or if the front seat is in a reclined position.

Care of seat belts

Seat belt systems should never be disassembled or modified. In addition, care should be taken to assure that seat belts and belt hardware are not damaged by seat hinges, doors or other abuse.

Periodic inspection

All seat belts should be inspected periodically for wear or damage of any kind. Any damaged parts should be replaced as soon as possible.

Keep belts clean and dry

Seat belts should be kept clean and dry. If belts become dirty, they can be cleaned by using a mild soap solution and warm water. Bleach, dye, strong detergents or abrasives should not be used because they may damage and weaken the fabric.

When to replace seat belts

The entire in-use seat belt assembly or assemblies should be replaced if the vehicle has been involved in an accident. This should be done even if no damage is visible. Additional questions concerning seat belt operation should be directed to an authorized Kia dealer.

WARNING - Pinched Seat belts

Make sure that the webbing and/or buckle does not get caught or pinched in the rear seat when returning the rear seatback to its upright position. A caught or pinched webbing/buckle may become damaged and could fail during a collision or sudden stop.

WARNING

Seatbelts can become hot in a closed vehicle on a sunny day. They could burn occupants, including infants and children.

CHILD RESTRAINT SYSTEM (CRS)

Children under age 13 must always ride in the rear seats and must always be properly restrained to minimize the risk of injury in an accident, sudden stop or sudden maneuver. According to accident statistics, children are more safe when properly restrained in the rear seats than in the front seat. Larger children who are not in a child restraint should use one of the seat belts provided.

All 50 states have child restraint laws which require children to travel in approved child restraint devices. The laws governing the age or height/weight restrictions at which seat belts can be used instead of child restraints differs among states, so you should be aware of the specific requirements in your state, and where you are travelling.

Child and/or infant safety seats must be properly placed and installed in the rear seat. You must use a commercially available child restraint system that meets the requirements of the Federal Motor Vehicle Safety Standards (FMVSS).

Child restraint systems are generally designed to be secured in vehicle seats by seat belt, or by a tether anchor and/or LATCH anchors.

Children could be injured or killed in a crash if their restraints are not properly secured. For small children and babies, a child seat or infant seat must be used. Before buying a particular child restraint system, make sure it fits your car seat and seat belts, and fits your child. Follow all the instructions provided by the manufacturer when installing the child restraint system.

WARNING - Restraint location

Never install a child or infant seat on the front passenger's seat.

A child riding in the front passenger seat can be forcefully struck by an inflating air bag.

WARNING - Hot child restraint

A child restraint system can become very hot if it is left in a closed vehicle on a sunny day. Be sure to check the seat cover, buckles and latches before placing a child in the restraint system.

When the child restraint system is not in use, store it in the luggage area or fasten it with a seat belt so that it will not be thrown forward in case of a sudden stop or an accident.

⚠ WARNING - Holding children

Never hold a child in your arms or lap when riding in a vehicle. The violent forces created during a crash will tear the child from your arms and throw the child against the car's interior.

Always use a child restraint system which is appropriate for your child's height and weight.

⚠ WARNING - Seat belt use

Do not use one seat belt for two occupants at the same time. This will eliminate or greatly reduce the safety benefit provided by the seat belt to the occupants.

Using a child restraint system

Rear-facing child restraint system

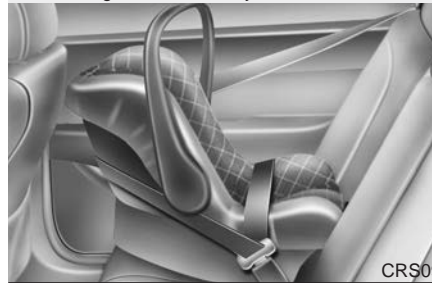

Forward-facing child restraint system



For small children and babies, the use of a child seat or infant seat is required. This child seat or infant seat should be of appropriate size for the child and should be installed in accordance with the manufacturer's instructions.

For safety reasons, we recommend that the child restraint system be used in the rear seats.

Since all passenger seat belts move freely under normal conditions and only lock under extreme or emergency conditions (emergency lock mode), you must manually change these seat belts to the auto lock mode to secure a child restraint.

If the seat belt does not operate as described in this section, have the system checked immediately by your authorized Kia dealer.

⚠ WARNING - Unattended Children

Never leave children unattended in a vehicle. The vehicle can heat up very quickly, resulting in injuries and possibly even death of the child in the vehicle.

⚠ WARNING - Child seat installation

- Always follow the instructions provided by the child restraint system manufacturer. Child restraint system manufacturers know their products best.
- Failure to observe this manual's instructions regarding child restraint system and the instructions provided with the child restraint system could result in the improper installation of the child restraint system which may reduce the protection to your child in a crash or a sudden stop.

*** NOTICE**

If the vehicle headrest prevents proper installation of a child seat (as described in the child seat system manual), the headrest of the respective seating position shall be readjusted or entirely removed.

Placing a passenger seat belt into the auto lock mode

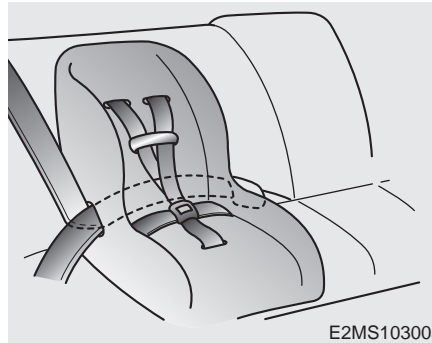

The auto lock mode will help prevent the normal movement of the child in the vehicle from causing the seat belt to loosen and compromise the child restraint system. To secure a child restraint system, use the following procedure.

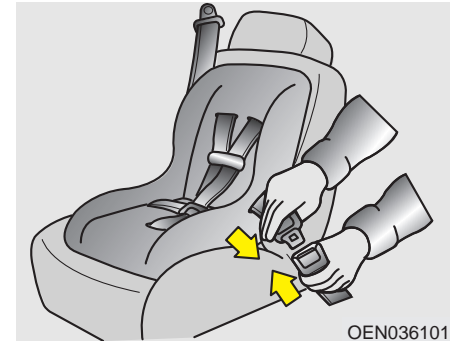

To install a child restraint system on the outboard or center rear seats, do the following:

1. Place the child restraint system in the seat and route the lap/shoulder belt around or through the restraint, following the restraint manufacturer's instructions. Be sure the seat belt webbing is not twisted.
2. Fasten the lap/shoulder belt latch into the buckle. Listen for the distinct "click" sound.

Position the release button so that it is easy to access in case of an emergency.

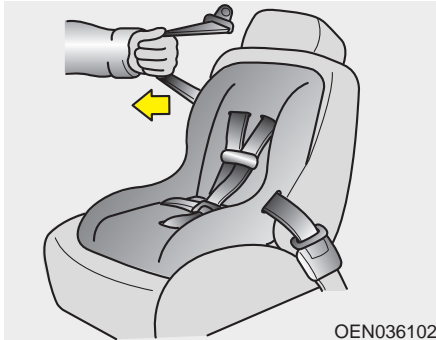

3. Pull the shoulder portion of the seat belt all the way out. When the shoulder portion of the seat belt is fully extended, it will shift the retractor to the “Auto Lock” (child restraint) mode.

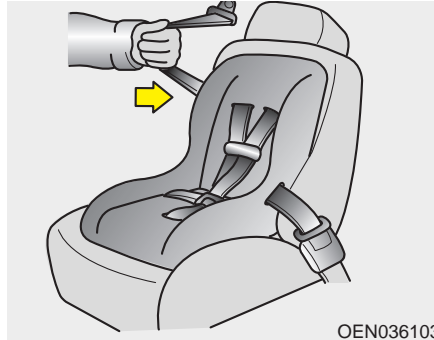

4. Slowly allow the shoulder portion of the seat belt to retract and listen for an audible “clicking” or “ratcheting” sound. This indicates that the retractor is in the “Auto Lock” mode. If no distinct sound is heard, repeat steps 3 and 4.

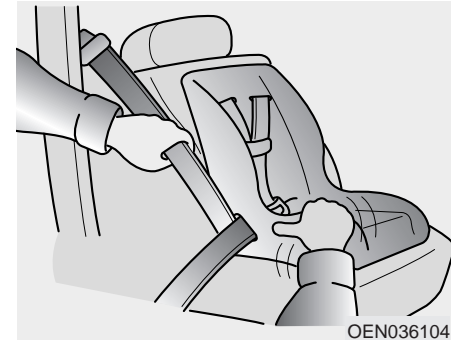

5. Remove as much slack from the belt as possible by pushing down on the child restraint system while feeding the shoulder belt back into the retractor.

6. Push and pull on the child restraint system to confirm that the seat belt is holding it firmly in place. If it is not, release the seat belt and repeat steps 2 through 6.

7. Double check that the retractor is in the “Auto Lock” mode by attempting to pull more of the seat belt out of the retractor. If you cannot, the retractor is in the “Auto Lock” mode.

The lap/shoulder belt automatically returns to the “emergency lock mode” whenever the belt is allowed to retract fully.

Therefore, the preceding seven steps must be followed each time a child restraint is installed.

To remove the child restraint, press the release button on the buckle and then pull the lap/shoulder belt out of the restraint and allow the seat belt to retract fully.



This symbol indicates the position of the tether anchor.

⚠ WARNING - Auto lock mode

Set the retractor to Automatic Lock mode when installing any child restraint system.

If the retractor is not in the Auto Lock mode, the child restraint can move when your vehicle turns or stops suddenly.

Securing a child restraint seat with tether anchorage system

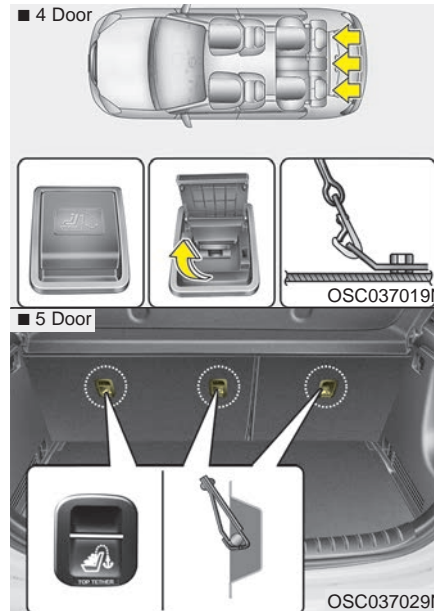

Child restraint hook holders are located on the package tray (4 Door) or the floor behind the rear seat (5 Door).



1. Route the child restraint seat tether strap over the seatback.

For vehicles with adjustable headrests, route the tether strap under the headrest (remove the headrest and the re-install it) and between the headrest posts, otherwise route the tether strap over the top of the seatback.

2. Connect the tether strap hook to the appropriate child restraint hook holder and tighten to secure the child restraint seat.

⚠ WARNING - Tether strap
Never mount more than one child restraint to a single tether or to a single lower anchorage point. The increased load caused by multiple seats may cause the tethers or anchorage points to break.

Check that the child restraint system is secure by pushing and pulling it in different directions. Incorrectly fitted child restraints may swing, twist, tip or separate causing death or serious injury.

Securing a child restraint seat with child seat lower anchor system

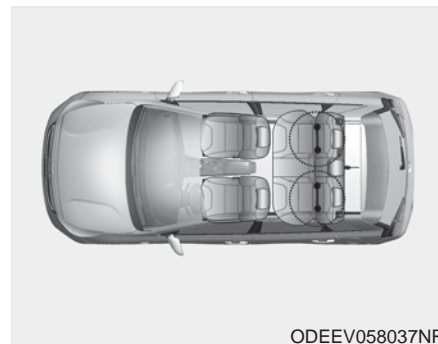

Some child seat manufacturers make child restraint seats that are labeled as LATCH or LATCH-compatible child restraint seats. LATCH stands for "Lower Anchors and Tethers for Children". These seats include two rigid or webbing mounted attachments that connect to two LATCH anchors at specific seating positions in your vehicle. This type of child restraint seat eliminates the need to use seat belts to attach the child seat in the rear seats.

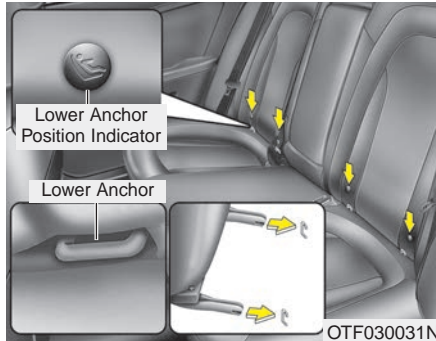

Child restraint symbols are located on the left and right rear seat backs to indicate the position of the lower anchors for child restraints.

⚠ WARNING - Unused rear seatbelts

Always fasten the seatbelts behind the child restraint seat when they are not used to secure the child seat. Failure to do so may result in child strangulation.

LATCH anchors have been provided in your vehicle. The LATCH anchors are located in the left and right outboard rear seating positions. Their locations are shown in the illustration. There is no LATCH anchor provided for the center rear seating position.

The LATCH anchors are located between the seatback and the seat cushion of the rear seat left and right outboard seating positions.

When you install your child's restraint system using the LATCH anchors buckle the shoulder lap belt, then lock the retractor and pull the belt to remove the slack in the belt so it lies flat against the vehicle seat.

Follow the child seat manufacturer's instructions to properly install child restraint seats with LATCH or LATCH-compatible attachments.

Once you have installed the LATCH child restraint, assure that the seat is properly attached to the LATCH and tether anchors.

Also, test the child restraint seat before you place the child in it. Tilt the seat from side to side. Also try to tug the seat forward. Check to see if the anchors hold the seat in place.

⚠ WARNING - LATCH lower anchors

Never attempt to attach a LATCH equipped seat in the center seating position. LATCH lower anchors are only to be used with the left and right rear outboard seating positions. You may damage the anchors or the anchors may fail and break in a collision.

*** NOTICE**

The recommended weight for the LATCH system is under 65 lb (30 kg). How to calculate the child restraint weight :

$$\text{Child restraint weight} = 65 \text{ lb (30 kg)} - \text{Child weight}$$

AIR BAG - ADVANCED SUPPLEMENTAL RESTRAINT SYSTEM

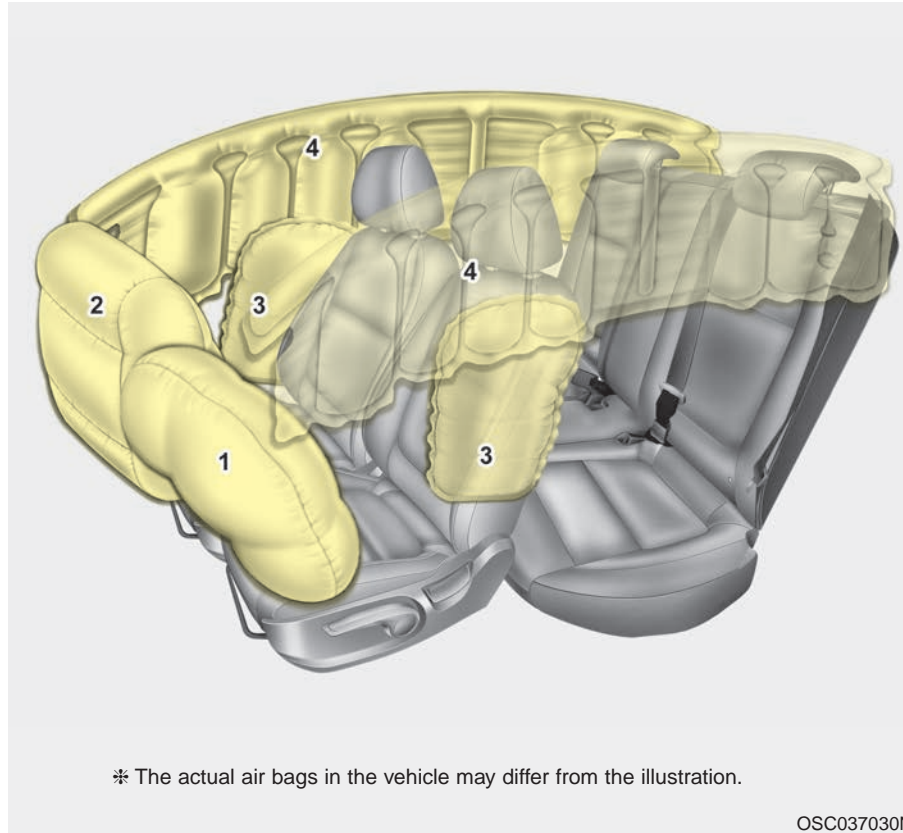

- (1) Driver's front air bag
- (2) Passenger's front air bag
- (3) Side air bag
- (4) Curtain air bag

Even in vehicles with air bags, you and your passengers must always wear the safety belts provided in order to minimize the risk and severity of injury in the event of a collision or rollover.

* The actual air bags in the vehicle may differ from the illustration.

OSC037030N

How does the air bag system operate

- Air bags are activated (able to inflate if necessary) only when the ignition switch is turned to the ON or START the appropriate position.
- Air bags inflate instantly in the event of serious frontal or side collision (if equipped with side air bag or curtain air bag) in order to help protect the occupants from serious physical injury.

Generally, air bags are designed to inflate based upon the severity of a collision and its direction. These two factors determine whether the sensors produce an electronic deployment/ inflation signal.

- Air bag deployment depends on a number of complex factors including vehicle speed, angles of impact and the density and stiffness of the vehicles or objects which your vehicle hits in the collision. Though, factors are not limited to those mentioned above. Airbags deploy depending on the severity and angle of the impact.

Airbags do not deploy in every impact situation.

- The front air bags will completely inflate and deflate in an instant.

It is virtually impossible for you to see the air bags inflate during an accident. It is much more likely that you will simply see the deflated air bags hanging out of their storage compartments after the collision.

- In addition to inflating in certain side collisions, vehicles equipped with a rollover sensor, side and curtain air bags will inflate if the sensing system detects a rollover.

When a rollover is detected, side and curtain air bags will remain inflated longer to help provide protection from ejection, especially when used in conjunction with the seat belts.

- In order to help provide protection in a severe collision, the air bags must inflate rapidly. The speed of air bag inflation is a consequence of the extremely short time in which a collision occurs and the need to get the air bag between the occupant and the vehicle structures before the occupant impacts those structures. This speed of inflation reduces the risk of serious or life-threatening injuries in a severe collision and is thus a necessary part of air bag design.

However, air bag inflation can also cause injuries which can include facial abrasions, bruises and broken bones because the inflation speed also causes the air bags to expand with a great deal of force.

- **There are even circumstances under which contact with the steering wheel or passenger air bag can cause fatal injuries, especially if the occupant is positioned excessively close to the steering wheel or passenger air bag.**

 **WARNING - Airbag Inflation**

Sit as far back as possible from the steering wheel while still maintaining comfortable control of the your vehicle. A distance of at least 10" (25cm) from your chest to the steering wheel is recommended. Failure to do so can result in airbag inflation injuries to the driver.

Noise and smoke

When the air bags inflate, they make a loud noise and they leave smoke and powder in the air inside of the vehicle. This is normal and is a result of the ignition of the air bag inflator. After the air bag inflates, you may feel substantial discomfort in breathing due to the contact of your chest to both the seat belt and the air bag, as well as from breathing the smoke and powder. **Open your doors and/or windows as soon as possible after the impact in order to reduce discomfort and prevent prolonged exposure to smoke and powder.**

Though the smoke and powder are non-toxic, they may cause irritation to the skin, eyes, nose and throat, etc. If this is the case, wash and rinse with cold water immediately and consult a doctor if the symptom persists.

⚠ WARNING

- Hot components

Do not touch the air bag storage area's internal components immediately after air bag inflation. The air bag related parts in the steering wheel, instrument panel and the roof rails above the front and rear doors are very hot. Hot components can result in burn injuries.

⚠ WARNING

Do not install or place any accessories near air bag deployment areas, such as the instrument panel, windows, pillars, and roof rails.

Installing a child restraint on a front passenger's seat is forbidden



1JBH3051

Never place a rear-facing child restraint in the front passenger's seat. If the air bag deploys, it would impact the rear-facing child restraint, causing serious or fatal injury.

In addition, do not place front-facing child restraint in the front passenger's seat either. If the front passenger air bag inflates, it would cause serious or fatal injuries to the child.

⚠ WARNING - Air bag

deployment

When children are seated in the rear outboard seats of a vehicle equipped with side and/or curtain air bags, install the child restraint system as far away from the door side as possible. Inflation of the side and/or curtain air bags could impact the child.

⚠ WARNING

Do not install or place any accessories new air bag deployment areas.

Air bag warning light



The purpose of air bag warning light in your instrument panel is to alert you of a potential problem with your air bag system, which could include your side and/or curtain air bags used for rollover protection.

Have the system checked by an authorized Kia dealer if:

- Air bag warning light does not turn on briefly when you turn the ignition ON.
- Air bag warning light stays on after illuminating for approximately 6 seconds.
- Air bag warning light comes on while the vehicle is in motion.

SRS components and functions

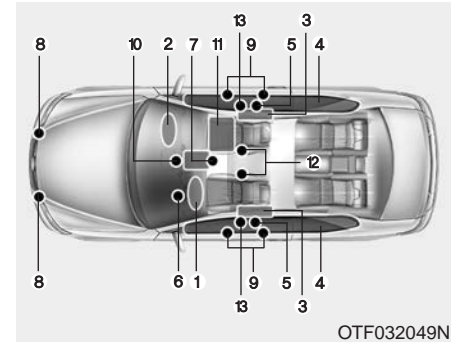

The SRS consists of the following components:

1. Driver's front air bag module
2. Passenger's front air bag module
3. Side air bag modules
4. Curtain air bag modules
5. Retractor pre-tensioner assemblies*
6. Air bag warning light
7. SRS control module (SRSCM) / Rollover sensor

8. Front impact sensors
9. Side impact sensors
10. PASSENGER AIR BAG "OFF" indicator (Front passenger's seat only)
11. Occupant detection system (Front passenger's seat only)
12. Driver's and front passenger's seat belt buckle sensors
13. Emergency fastening device (EFD)

* : if equipped

The SRSCM continually monitors all SRS components while the ignition switch is ON to determine if a crash impact is severe enough to require air bag deployment or pre-tensioner seat belt deployment.

The SRS air bag warning light on the instrument panel will illuminate for about 6 seconds after the ignition switch is turned to the ON position, after which the air bag warning light should go out.

If any of the following conditions occurs, this indicates a malfunction of the SRS. Have an authorized Kia dealer inspect the air bag system as soon as possible.

- The light does not turn on briefly when you turn the ignition ON.
- The light stays on after illuminating for approximately 6 seconds.
- The light comes on while the vehicle is in motion.

Driver's front air bag (1)



B240B01L

The air bag modules are located both in the center of the steering wheel and in the front passenger's panel above the glove box. When the SRSCM detects a sufficiently severe impact to the front of the vehicle, it will automatically deploy the front air bags.

Driver's front air bag (2)



Upon deployment, tear seams molded directly into the pad covers will separate under pressure from the expansion of the air bags. Further opening of the covers then allows full inflation of the air bags.

Driver's front air bag (3)



A fully inflated air bag, in combination with a properly worn seat belt, slows the driver's or the passenger's forward motion, reducing the risk of head and chest injury.

After complete inflation, the air bag immediately starts deflating, enabling the driver to maintain forward visibility and the ability to steer or operate other controls.

Passenger's front air bag



⚠ WARNING - Air bag obstructions

Do not install or place any accessories on the steering wheel, instrument panel, or on the front passenger's panel above the glove box in a vehicle. Such objects may become dangerous projectiles if the air bag deploys.

⚠ WARNING - Flying objects
Do not place any objects (an umbrella, bag, etc.) between the front door and the front seat. Such objects may become dangerous projectiles if the side airbag inflates.

- If an air bag deploys, there may be a loud noise followed by a fine dust released in the vehicle. These conditions are normal and are not hazardous - the air bags are packed in this fine powder. The dust generated during air bag deployment may cause skin or eye irritation as well as aggravate asthma for some persons. Always wash all exposed skin areas thoroughly with cold water and a mild soap after an accident in which the air bags were deployed.

- The SRS can function only when the ignition switch is in the ON position. If the SRS air bag warning light does not illuminate, or continuously remains on after illuminating for about 6 seconds when the ignition switch is turned to the ON position, or after the engine is started, comes on while driving, the SRS is not working properly. If this occurs, have your vehicle immediately inspected by an authorized Kia dealer.

*** NOTICE**

Before you replace a fuse or disconnect a battery terminal, turn the ignition switch to the LOCK position and remove the ignition key. Never remove or replace the air bag related fuse(s) when the ignition switch is in the ON position. Failure to heed this warning will cause the SRS air bag warning light to illuminate.

Occupant detection system

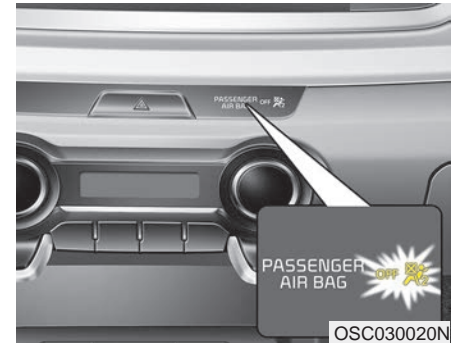

Your vehicle is equipped with an occupant detection system in the front passenger's seat.

The occupant detection system is designed to detect the presence of a properly-seated front passenger and determine if the passenger's front air bag should be enabled (may inflate) or not. Only the front passenger front air bag is controlled by the Occupant Detection System.

Do not put anything in front of the passenger air bag OFF indicator.

Main components of occupant detection system

- A detection device located within the front passenger seat cushion.
- An electronic system which determines whether the passenger air bag systems should be activated or deactivated.
- An indicator light located on the instrument panel which illuminates the words PASSENGER AIR BAG “OFF” indicating the front passenger air bag system is deactivated.
- The instrument panel air bag warning light is interconnected with the occupant detection system.

If the front passenger seat is occupied by a person that the system determines to be of adult size, and he/she sits properly (sitting upright with the seatback in an upright position, centered on the seat cushion with their seat belt on, legs comfortably extended and their feet on the floor), the PASSENGER AIR BAG “OFF” indicator will turn off and the front passenger's air bag will be able to inflate, if necessary, in frontal crashes.

You will find the PASSENGER AIR BAG “OFF” indicator on the center fascia panel. This system detects the conditions 1~4 in the following table and activates or deactivates the front passenger air bag based on these conditions.

Always be sure that you and all vehicle occupants are seated and restrained properly (sitting upright with the seat in an upright position, centered on the seat cushion, with the person's legs comfortably extended, feet on the floor, and wearing the safety belt properly) for the most effective protection by the air bag and the safety belt.

- The ODS (Occupant Detection System) may not function properly if the passenger takes actions which can defeat the detection system. These include:

- (1) Failing to sit in an upright position.
- (2) Leaning against the door or center console.
- (3) Sitting towards the sides or the front of the seat.
- (4) Putting legs on the dashboard or resting them on other locations which reduce the passenger weight on the front seat.
- (5) Improperly wearing the safety belt.
- (6) Reclining the seat back.

Condition and operation in the front passenger occupant detection system

Condition detected by the occupant detection system	Indicator/Warning light		Devices
	PASSENGER AIR BAG "OFF" indicator light	SRS warning light	Front passenger air bag
1. Adult *1 or child age 13 and up*2	Off	Off	Activated
2. Infant or child restraint system with 12 months old*3*4	On	Off	Deactivated
3. Unoccupied	On	Off	Deactivated
4. Malfunction in the system	Off	On	Activated

- *1) The system judges a person of adult size as an adult. When a smaller adult sits in the front passenger seat, the system may recognize him/her as a child depending on his/her physique and posture.
- *2) Do not allow children to ride in the front passenger seat. When a smaller child than the same age sits in the front passenger seat, the system may recognize him/her as an infant depending on his/her physique or posture.
- *3) Never install a child restraint system on the front passenger seat.
- *4) The PASSENGER AIR BAG "OFF" indicator may turn on or off when a child above 12 months to 12 years old (with or without child restraint system) sits in the front passenger seat. This is a normal condition.

⚠ CAUTION

- **Do not install a child restraint seat in the passenger seat when the seat is heavily soaked with any type of liquid.**
- **Do not alter or remodel the ODS (Occupant Detection System). This may damage the system and prevent its proper function in a collision.**

⚠ WARNING - ODS System
Riding in an improper position adversely affects the Occupant Detection System and may result in the deactivation of the front passenger airbag. It is important for the driver to instruct passengers as to the proper seating instructions as contained in this manual.

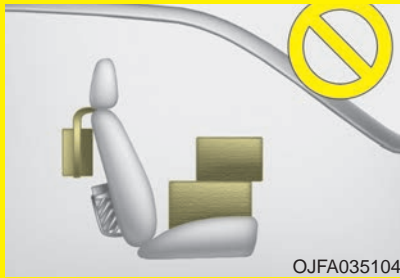

- Do not place a heavy load in the front passenger seatback pocket or on the front passenger seat.

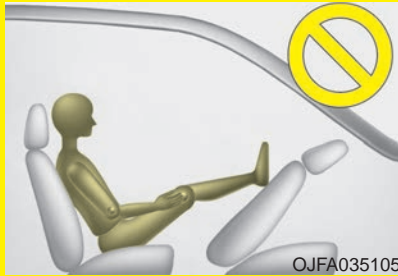

- Do not place feet on the front passenger seatback.



- Never sit with hips shifted towards the front of the seat.

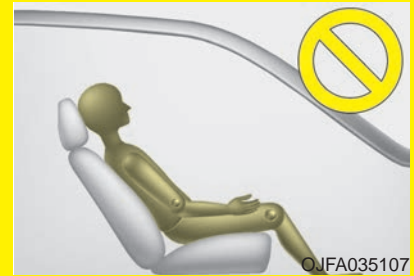

- Never excessively recline the front passenger seatback.



- Do not sit on the passenger seat wearing heavily padded clothes such as ski wear and hip protector.

(Continued)

(Continued)



- Never place feet on the dashboard.



- Never lean on the door or center console.
- Never sit on one side of the front passenger seat.

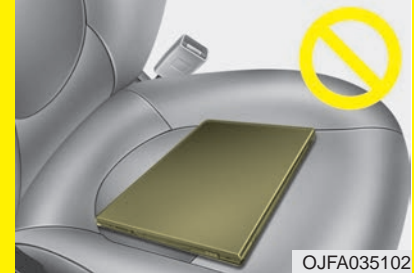

- Do not place electronic devices such as laptops, DVD player, or conductive materials such as water bottles on the passenger seat.

Do not use electronic devices such as laptops and satellite radios which use inverter chargers.



- Do not use car seat accessories such as thick blankets and cushions which cover up the car seat surface.

⚠ WARNING

- Wet Passenger Seat

Do not spill liquid on the passenger seat. Spilled liquid on the passenger seat may cause the air bag warning light to illuminate or malfunction. If any liquid is spilled, make sure the seat has been completely dried before driving the vehicle.

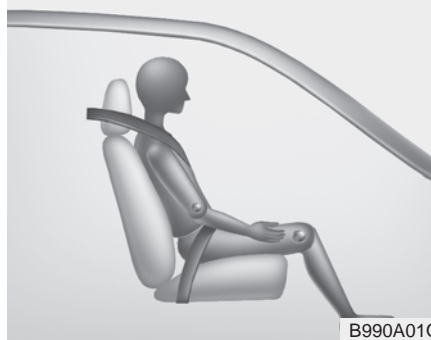

When an adult is seated in the front passenger seat, if the PASSENGER AIR BAG “OFF” indicator is on, turn the ignition switch to the LOCK position and ask the passenger to sit properly (sitting upright with the seat back in an upright position, centered on the seat cushion with their seat belt on, legs comfortably extended and their feet on the floor). Restart the engine and have the person remain in that position. This will allow the system to detect the person and to enable the passenger air bag.

If the PASSENGER AIR BAG “OFF” indicator is still on, ask the passenger to move to the rear seat.

⚠ WARNING - “AIR BAG OFF” light

Do not allow an adult passenger to ride in the front seat when the PASSENGER AIR BAG “OFF” indicator is illuminated, because the air bag will not deploy in the event of a crash. The driver must instruct the passenger to reposition himself in the seat. Failure to properly position yourself may lead to air bag deactivation resulting in air bag non-deployment in a collision. If the PASSENGER AIR BAG “OFF” indicator remains illuminated after the passenger repositions themselves properly and the car is restarted, it is recommended that the passenger move to the rear seat because the passenger's front air bag will not deploy.

*** NOTICE**

- Do not use car seat cushions that cover up the surface of the seat and aftermarket manufactured passenger seat heaters.
- After cleaning the car interior using steam or detergents, the seat should be dried properly. Afterward, check for normal operation of the PASSENGER AIR BAG “OFF” and air bag warning lights.
- Any service related to the passenger seat and the ODS must be done at a Kia service center.
- After the passenger seat has been removed or installed for repair purposes, check for normal operation of the PASSENGER AIR BAG “OFF” and air bag warning lights with a person seated or not seated in the passenger seat.

⚠ WARNING - ODS System
Riding in an improper position adversely affects the Occupant Detection System and may result in the deactivation of the front passenger airbag. It is important for the driver to instruct the front passenger as to the proper seating instructions as contained in this manual.

*** NOTICE**

When the PASSENGER AIR BAG “OFF” symbol is illuminated, the passenger air bag system will not operate. The passenger air bag system will operate when necessary if the symbol is not illuminated.

*** NOTICE**

Do not modify or replace the front passenger seat. Don't place anything on or attach anything such as a blanket, front seat cover or after market seat heater to the front passenger seat. This can adversely affect the occupant detection system.

*** NOTICE**

The PASSENGER AIR BAG “OFF” indicator illuminates for about 4 seconds after the ignition switch is turned to the ON position or after the engine is started. If the front passenger seat is occupied, the occupant detection sensor will then classify the front passenger after several more seconds.

Any child age 13 and under should ride in the rear seat. Children too large for child restraints should use the available lap/shoulder belts. No matter what type of crash, children of all ages are safer when restrained in the rear seat.



WARNING - ODS Interference

- Do not place a heavy load or an active electronic device (ex. laptop computer, after market DMB/navigation/satellite audio, video game machine, MP3, etc.) in the front passenger seatback pocket or on the front passenger seat.
- Do not hang any items such as seatback table on the front passenger seatback.
- Do not place feet on the front passenger seatback.
- Do not place any items under the front passenger seat.
- Do not place sharp objects on the front passenger seat. These may damage the occupant detection system, if they puncture the seat cushion.
- Do not spill any liquids on the seat.

(Continued)

(Continued)

Any of the above could interfere with the proper operation of the ODS sensor thereby increasing the risk of an injury in an accident.

If the occupant detection system is not working properly, the SRS air bag warning light  on the instrument panel will illuminate because the passenger's front air bag is connected with the occupant detection system. If there is a malfunction of the occupant detection system, the PASSENGER AIR BAG “OFF” indicator will not illuminate and the passenger's front air bag will inflate in frontal impact crashes even if there is no occupant in the front passenger's seat.

*** NOTICE**

Air bags can only be used once - have an authorized Kia dealer replace the air bag immediately after deployment.

- Even though your vehicle is equipped with the occupant detection system, never install a child restraint system in the front passenger's seat. A deploying air bag can forcefully strike a child resulting in serious injuries or death. Any child age 13 and under should ride in the rear seat. Children too large for child restraints should use the available lap/shoulder belts. No matter what type of crash, children of all ages are safer when restrained in the rear seat.
- If the PASSENGER AIR BAG "OFF" indicator is illuminated when the front passenger's seat is occupied by an adult and he/she sits properly (sitting upright with the seatback in an upright position, centered on the seat cushion with their seat belt on, legs comfortably extended and their feet on the floor), have that person sit in the rear seat.

Driver's and passenger's front air bag



Your vehicle is equipped with an Advanced Supplemental Restraint (Air Bag) System and lap/shoulder belts at both the driver and passenger seating position.

The indications of the system's presence are the letters "AIR BAG" embossed on the air bag pad cover in the steering wheel and the passenger's side front panel pad above the glove box.

The SRS consists of air bags installed under the pad covers in the center of the steering wheel and the passenger's side front panel above the glove box.

The purpose of the SRS is to provide the vehicle's driver and/or the front passenger with additional protection than that offered by the seat belt system alone in case of a frontal impact of sufficient severity. The SRS uses sensors to gather information about the driver's seat position, the driver's and front passenger's seat belt usage and impact severity.

The seat belt buckle sensors determine if the driver and front passenger's seat belts are fastened.

These sensors provide the ability to control the SRS deployment based on whether or not the seat belts are fastened, and how severe the impact is.

The advanced SRS offers the ability to control the air bag inflation with two levels. A first stage level is provided for moderate-severity impacts. A second stage level is provided for more severe impacts.

The passenger's front air bag is designed to help reduce the injury of children sitting close to the instrument panel in low speed collisions. However, children are safer if they are restraint in the rear seat.

According to the impact severity, seating position and seat belt usage, the SRSCM (SRS Control Module) controls the air bag inflation. Failure to properly wear seat belts can increase the risk or severity of injury in an accident.

Additionally, your vehicle is equipped with an occupant detection system in the front passenger's seat. The occupant detection system detects the presence of a passenger in the front passenger's seat and will turn off the front passenger's air bag under certain conditions. For more detail, see "Occupant detection system" in this section.

Do not place any objects that may cause magnetic fields near the front seat. These may cause a malfunction of the seat track position sensor.

Modification to the seat structure can cause the air bag to deploy at a different level than should be provided.

Manufacturers are required by government regulations to provide a contact point concerning modifications to the vehicle for persons with disabilities, which modifications may affect the vehicle's advanced air bag system. That contact is Kia's toll-free Customer Assistance center at 1-800-333-4Kia. However, Kia does not endorse nor will it support any changes to any part or structure of the vehicle that could affect the advanced air bag system, including the occupant detection system.

⚠ WARNING
- Replacement
/Modifications

The front passenger seat, dashboard or door should not be replaced except by an authorized Kia dealer using original Kia parts designed for this vehicle and model. Any other such replacement or modification could adversely affect the operation of the occupant detection system and your advanced air bags.

Advanced air bags are combined with pre-tensioner seat belts to help provide enhanced occupant protection in frontal crashes. Front air bags are not intended to deploy in collisions in which sufficient protection can be provided by the pre-tensioner seat belt alone.

⚠ WARNING - SRS Wiring

Do not tamper with or disconnect SRS wiring or other components of the SRS system. Doing so could result in injury, due to accidental deployment of the air bags or by rendering the SRS inoperative.

Front air bags are not intended to deploy in side-impact, rear-impact or rollover crashes. However, when frontal deployment threshold is satisfied in a side-impact crash, front air bags may deploy. In addition, front air bags will not deploy in frontal crashes below the deployment threshold.

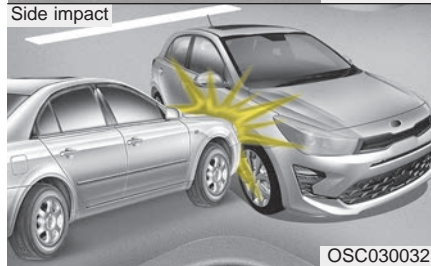
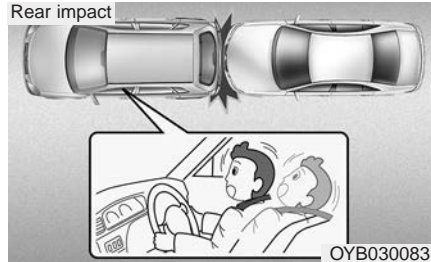

⚠ WARNING - No attaching objects

No objects (such as a crash pad cover, cellular phone holder, cup holder, perfume or stickers) should be placed over or near the air bag modules on the steering wheel, instrument panel, windshield glass, and the front passenger's panel above the glove box. Such objects could cause harm if the vehicle is in a crash severe enough to cause the air bags to deploy. Do not place any objects over the air bag or between the air bag and yourself.

⚠ WARNING

Never place or insert any object into any small opening near side airbag labels attached to the vehicle seats. When the air bag deploys, the object may affect the deployment and result in an unexpected accident or bodily harm.

Side air bag

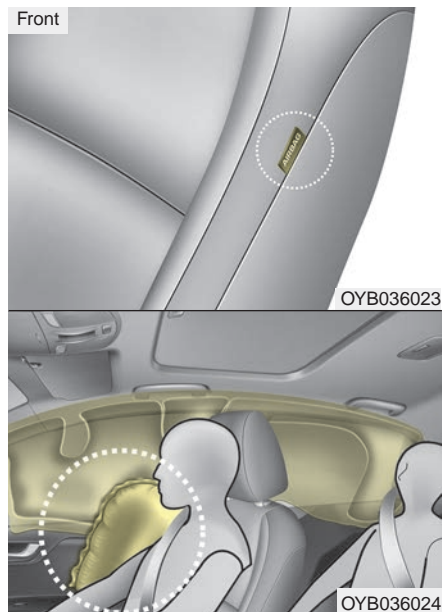

* The actual air bags in the vehicle may differ from the illustration.

The purpose of the air bag is to provide the vehicle's driver and/or the front passenger with additional protection than that offered by the seat belt alone.

- The side air bags are designed to deploy during certain side-impact collisions, depending on the crash severity, angle, speed and point of impact. However, when side deployment threshold is satisfied in a front-impact crash, the side air bags may deploy.
- The side air bags may deploy on the side of the impact or on both sides.
- The side and/or curtain air bags on both sides of the vehicle will deploy if a rollover or possible rollover is detected.
- The side air bags are not designed to deploy in all side impact or rollover situations.

Your vehicle is equipped with a side air bag in each front seat.

⚠ WARNING - Unexpected deployment

Avoid impact to the side air bag sensor when the ignition switch is ON to prevent unexpected deployment of the side air bag.

The side air bag is supplemental to the driver's and the passenger's seat belt systems and is not a substitute for them. Therefore your seat belts must be worn at all times while the vehicle is in operation.

For best protection from the side air bag system and to avoid being injured by the deploying side air bag, both front seat occupants should sit in an upright position with the seat belt properly fastened. The driver's hands should be placed on the steering wheel at the 9:00 and 3:00 positions. The passenger's arms and hands should be placed on their laps.

⚠ WARNING - Deployment

Do not install any accessories including seat covers, on the side or near the side air bag as this may affect the deployment of the side air bags.

If the seat or seat cover is damaged, have the vehicle checked and repaired by an authorized Kia dealer. Inform that your vehicle is equipped with side air bags and an occupant detection system.

⚠ WARNING - Flying objects

Do not place any objects (an umbrella, bag, etc.) between the front door and the front seat. Such objects may become dangerous projectiles if the side air bag inflates.

⚠ WARNING - No attaching objects

- **Do not place any objects over the air bag or between the air bag and yourself. Also, do not attach any objects around the area in which the air bag inflates such as the door, side door glass, front and rear pillar.**
- **Do not place any objects between the door and the seat. They may become dangerous projectiles if the side air bag inflates.**
- **Do not install any accessories on the side or near the side air bags.**
- **Do not hang heavy items on the coat hooks for safety reasons.**

(Continued)

(Continued)

- Never place or insert any object into any small opening near side airbag labels attached to the vehicle seats. When the air bag deploys, the object may affect the deployment and result in an unexpected accident or bodily harm.

Curtain air bag

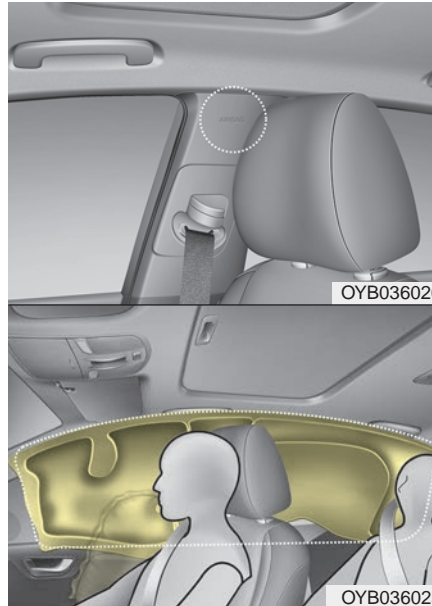

* The actual air bags in the vehicle may differ from the illustration.

Curtain air bags are located along both sides of the roof rails above the front and rear doors.

They are designed to help protect occupants in certain side impacts and to help prevent them from ejecting out of the vehicle as a result of a rollover, especially when the seatbelts are also in use.

- The curtain air bags are designed to deploy during certain side impact collisions, depending on the crash severity, angle, speed and point of impact. However, when side deployment threshold is satisfied in a front-impact crash, the curtain air bags may deploy.
- The curtain air bags may deploy on the side of the impact or on both sides.
- Also, the curtain air bags on both sides of the vehicle will deploy in certain rollover situations.
- The curtain air bags are not designed to deploy in all side impact or rollover situations.

Do not allow the passengers to lean their heads or bodies onto doors, put their arms on the doors, stretch their arms out of the window, or place objects between the doors and passengers when they are seated on seats equipped with side and/or curtain air bags.

*** NOTICE**

Never try to open or repair any components of the side curtain air bag system. This should only be done by an authorized Kia dealer.

⚠ WARNING - No attaching objects

- Do not place any objects over the air bag. Also, do not attach any objects around the area the air bag inflates such as the door, side door glass, front and rear pillar, roof side rail.
- Do not hang hard or breakable objects on the clothes hanger.

Why didn't my air bag go off in a collision? (Inflation and non-inflation conditions of the air bag)

There are many types of accidents in which the air bag would not be expected to provide additional protection.

These include rear impacts, second or third collisions in multiple impact accidents, as well as low speed impacts.

In these situations, the air bags may not deploy.

Air bag collision sensors

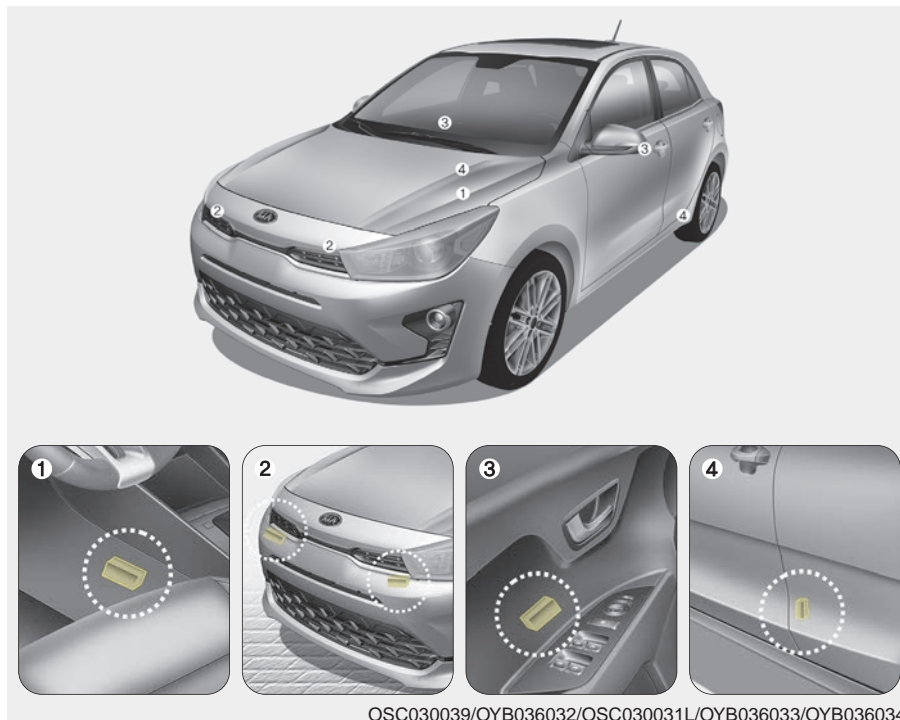

- (1) SRS control module/
Rollover sensor
- (2) Front impact sensor

- (3) Side impact sensor
- (4) Pressure side impact sensor

⚠ WARNING - Air bag sensors

- Do not hit or allow any objects to impact the locations where air bag or sensors are installed. This may cause unexpected air bag deployment, which could result in serious personal injury or death.
- If the installation location or angle of the sensors is altered in any way, the air bags may deploy when they should not or they may not deploy when they should.

Therefore, do not try to perform maintenance on or around the air bag sensors. Have the vehicle checked and repaired by an authorized Kia dealer.

Problems may arise if the sensor installation angles are changed due to the deformation of the front bumper, body or B pillar where side collision sensors are installed. Have the vehicle checked and repaired by an authorized Kia dealer.

Installing aftermarket bumper guards or replacing a bumper with non-genuine parts may adversely affect your vehicle's collision and air bag deployment performance.

Air bag inflation conditions



Front air bags

Front air bags are designed to inflate in a frontal collision depending on the severity of impact of the front collision.

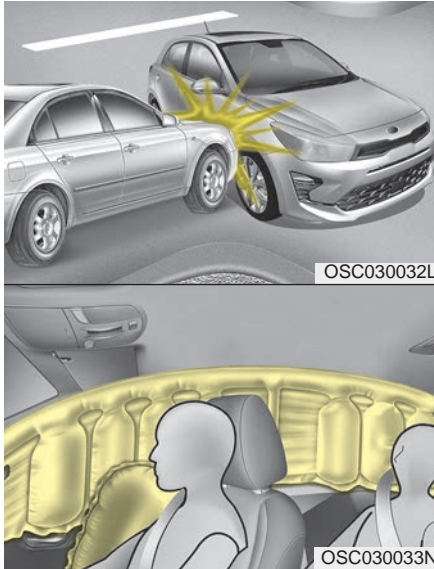

* The actual air bags in the vehicle may differ from the illustration.

Side air bags

Side air bags (side and/or curtain air bags) are designed to inflate when an impact is detected by side collision sensors depending on the severity of impact resulting from a side impact collision.

Also, the side and/or curtain air bags are designed to inflate when a rollover is detected by a rollover sensor.

Although the front air bags (driver's and front passenger's air bags) are designed to inflate in frontal collisions, they also may inflate in other types of collisions if the front impact sensors detect a sufficient frontal force in another type of impact. Side and curtain air bags are designed to inflate in certain side impact collisions. They may inflate in other types of collisions where a side force is detected by the sensors. Side air bag and/or curtain air bags may also inflate where rollover sensors indicate the possibility of a rollover occurring (even if none actually occurs) or in other situations, including when the vehicle is tilted while being towed.

Even where side and/or curtain air bags would not provide impact protection in a rollover, however, they will deploy to prevent ejection of occupants, especially those who are restrained with seat belts.

If the vehicle chassis is impacted by bumps or objects on unimproved roads or sidewalks, air bags may deploy. Drive carefully on unimproved roads or on surfaces not designed for vehicle traffic to prevent unintended air bag deployment.

Air bag non-inflation conditions



- In certain low-speed collisions, the air bags may not deploy. The air bags are designed not to deploy in such cases because they may not provide benefits beyond the protection of the seat belts in such collisions.

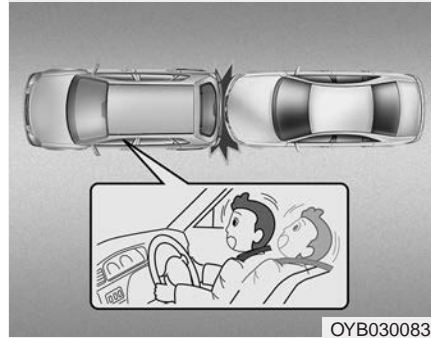

- Air bags are not designed to inflate in rear collisions, because occupants are moved backward by the force of the impact. In this case, inflated air bags would not be able to provide any additional benefit.



- Front air bags may not inflate in side impact collisions, because occupants move to the direction of the collision, and thus in side impacts, front air bag deployment would not provide additional occupant protection.

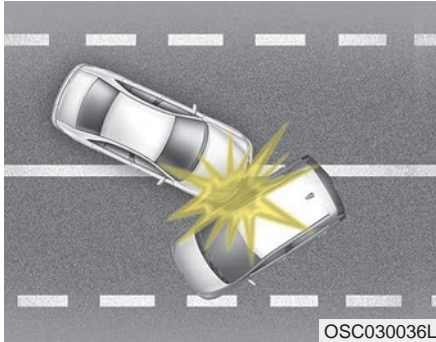

- In a slant or angled collision, the force of impact may direct the occupants in a direction where the air bags would not be able to provide any additional benefit, and thus the sensors may not deploy any air bags.

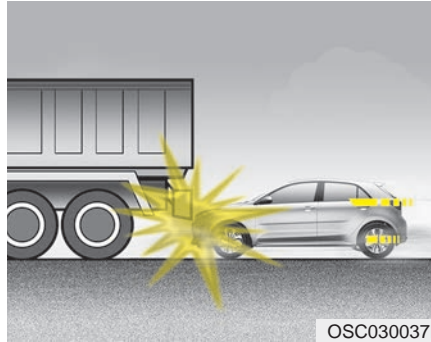

- Just before impact, drivers often brake heavily. Such heavy braking lowers the front portion of the vehicle causing it to “ride” under a vehicle with a higher ground clearance. Air bags may not inflate in this “under-ride” situation because deceleration forces that are detected by sensors may be significantly replaced by such “under-ride” collisions.

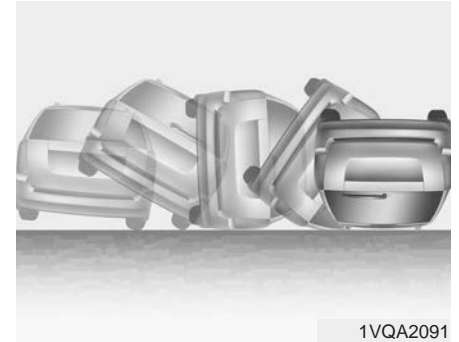

- Front air bags may not inflate in rollover accidents because front air bag deployment would not provide additional occupant protection. However, side and curtain air bags may inflate when the vehicle is rolled over.

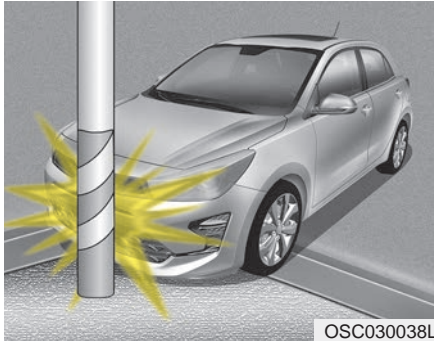

OSC030038L

- Air bags may not inflate if the vehicle collides with objects such as utility poles or trees, where the point of impact is concentrated to one area and the full force of the impact is not delivered to the sensors.

SRS Care

The SRS is virtually maintenance-free and there are no parts you can safely service by yourself. If the SRS air bag warning light does not illuminate, or continuously remains on, have your vehicle immediately inspected by an authorized Kia dealer.

Any work on the SRS system, such as removing, installing, repairing, or any work on the steering wheel, the front passenger's panel, and front seats must be performed by an authorized Kia dealer. Improper handling of the SRS system may result in serious personal injury.

For cleaning the air bag pad covers, use only a soft, dry cloth or one which has been moistened with plain water. Solvents or cleaners could adversely affect the air bag covers and proper deployment of the system.

⚠ WARNING - Tampering with SRS

Do not tamper with or disconnect SRS wiring, or other components of the SRS system.

Doing so could result in the accidental inflation of the air bags or render the SRS inoperative.

⚠ WARNING - Towing Vehicle

Always have the ignition switch in the LOCK position when your vehicle is being towed. The side air bags may inflate if the vehicle is tilted (such as when being towed) because of the rollover sensors in the vehicle.

If components of the air bag system must be discarded, or if the vehicle must be scrapped, certain safety precautions must be observed. An authorized Kia dealer knows these precautions and can give you the necessary information. Failure to follow these precautions and procedures could increase the risk of personal injury.

Adding equipment to or modifying your air bag-equipped vehicle

If you modify your vehicle by changing your vehicle's frame, bumper system, front end or side sheet metal or ride height, this may affect the operation of your vehicle's air bag system

Air bag warning label

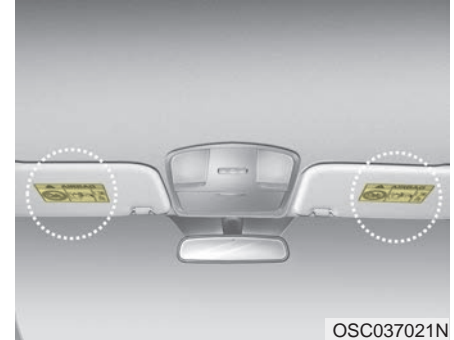

Air bag warning labels, some required by the U.S. National Highway Traffic Safety Administration (NHTSA), are attached to alert the driver and passengers of potential risks of the air bag system.

*** NOTICE**

Be sure to read all of the information about the air bags that are installed on your vehicle in this Owner's Manual.

Features of your vehicle

Keys	4-4	Trunk (for 4 door)	4-24
• Record your key number	4-4	• Opening the trunk	4-24
• Key operations	4-4	• Closing the trunk	4-24
• Remote keyless entry system operations	4-5	• Emergency trunk safety release	4-25
• Transmitter precautions	4-7	Smart trunk release (4 door)	4-26
• Battery replacement	4-8	Liftgate (for 5 door)	4-30
• Immobilizer system	4-9	• Opening the liftgate	4-30
Smart key	4-11	• Closing the liftgate	4-30
• Smart key functions	4-11	• Emergency liftgate safety release	4-31
• Smart key precautions	4-13	Windows	4-33
• Smart key immobilizer system	4-14	• Power windows	4-34
Theft-alarm system	4-15	• Manual windows	4-38
• Armed stage	4-15	Hood	4-39
• Theft-alarm stage	4-16	• Opening the hood	4-39
• Disarmed stage	4-17	• Closing the hood	4-40
Door locks	4-18	• Hood open warning	4-40
• Operating door locks from outside the vehicle	4-18	Fuel filler door	4-42
• Operating door locks from inside the vehicle	4-19	• Opening the fuel filler door	4-42
• Impact sensing door unlock system	4-21	• Closing the fuel filler door	4-43
• Auto door lock/unlock feature	4-21	Steering wheel	4-45
• Speed sensing door lock system	4-21	• Electric power steering (EPS)	4-45
• Child-protector rear door lock	4-22	• Tilt steering	4-46
• Rear Occupant Alert (ROA) system	4-22	• Horn	4-47

Mirrors	4-48	• High beam operation.....	4-96
• Inside rearview mirror	4-48	• High Beam Assist (HBA)	4-97
• Outside rearview mirror.....	4-49	• Turn signals and lane change signals	4-98
Instrument cluster	4-51	• Front fog light	4-99
• Instrument Cluster Control	4-52	Wipers and washers	4-100
• LCD Display Control	4-52	• Windshield wipers.....	4-101
• Gauges	4-53	• Windshield washers (front)	4-102
• Transmission Shift Indicator	4-57	• Rear window wiper and washer switch (for 5 door).....	4-104
Trip computer	4-59	Interior light	4-105
• Trip information (Trip computer).....	4-59	• Automatic turn off function.....	4-105
• Service Mode (for type A cluster)	4-64	• Map lamp	4-105
LCD display (for type B cluster)	4-65	• Room lamp.....	4-106
• LCD Display Mode	4-65	• Trunk/Liftgate room lamp	4-108
• Driving Assist mode.....	4-66	• Glove box lamp	4-108
• User Settings Mode (for type B cluster)	4-67	• Vanity mirror lamp	4-109
• Warning messages (for type B cluster)	4-75	Defroster	4-110
Warning and indicator lights	4-79	• Rear window defroster	4-110
• Warning lights	4-79	Manual climate control system	4-111
• Indicator Lights.....	4-87	• Heating and air conditioning	4-112
Rear View Monitor (RVM)	4-91	• System operation	4-117
Lighting	4-93	• Climate control air filter.....	4-119
• Battery saver function.....	4-93	• Checking the amount of air conditioner refrigerant and compressor lubricant.....	4-120
• Headlight escort function.....	4-93	• Air Conditioning refrigerant label	4-121
• Headlight welcome function.....	4-93		
• Lighting control.....	4-94		

• Activate upon washer fluid use	4-122	• Floor mat anchor(s)	4-147
Automatic climate control system	4-123	• Shopping bag holder	4-148
• Automatic heating and air conditioning	4-124	• Covering shelf (for 5 door)	4-148
• Manual heating and air conditioning	4-125	Infotainment system	4-150
• System operation	4-130	• Antenna	4-150
• Climate control air filter	4-132	• USB port	4-151
• Checking the amount of air conditioner refrigerant and compressor lubricant	4-132	• How vehicle audio works	4-151
• Air Conditioning refrigerant label	4-134	Declaration of conformity	4-155
• Activate upon washer fluid use	4-134	• FCC	4-155
Windshield defrosting and defogging	4-136		
• Manual climate control system	4-136		
• Automatic climate control system	4-137		
• Defogging logic	4-138		
Storage compartment	4-141		
• Center console storage	4-141		
• Glove box	4-141		
• Sunglass holder	4-142		
• Luggage net holder	4-142		
Interior features	4-144		
• Cup holder	4-144		
• Sunvisor	4-144		
• Power outlet	4-145		
• USB charger	4-146		
• Clothes hanger	4-147		

KEYS

Record your key number



The key code number is stamped on the key code tag attached to the key set. Should you lose your keys, this number will enable an authorized Kia dealer to duplicate the keys easily. Remove the key code tag and store it in a safe place. Also, record the key code number and keep it in a safe and handy place, but not in the vehicle.

⚠ WARNING - Aftermarket keys

Use only Kia original parts for the ignition key in your vehicle. If an aftermarket key is used, the ignition switch may not return to ON after START. If this happens, the starter will continue to operate causing possible fire due to excessive current in the wiring.

Key operations

Folding key

■ Folding key

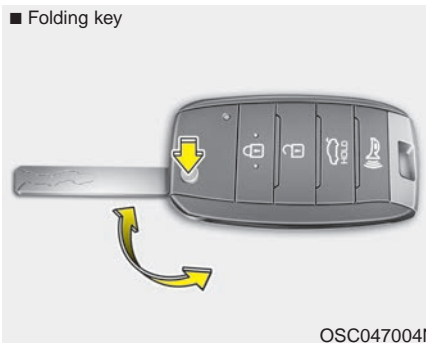

OSC047004N

To unfold the key, press the release button then the key will unfold automatically.

To fold the key, fold the key manually while pressing the release button

⚠ CAUTION - Key button operation

Do not fold the key without pressing the release button. This may damage the key.

Smart key



OYDDCO2002

To remove the mechanical key, press and hold the release button (1) and remove the mechanical key (2).

To reinstall the mechanical key, put the key into the hole and push it until a click sound is heard.

⚠ WARNING - Ignition key (Smart key)

Never leave the keys in your vehicle with unsupervised children. Leaving children unattended in a vehicle with a manual ignition key or a smart key is dangerous.

Children copy adults and they could place the key in the ignition switch or press the start button. The key would enable children to operate power windows or other controls, or even make the vehicle move, which could result in serious bodily injury or death.

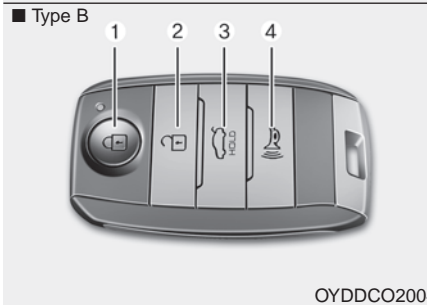
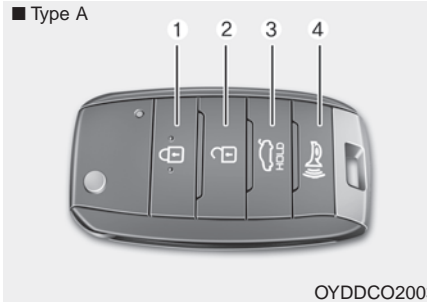
Remote keyless entry system operations**Lock (1)**

All doors (and hood, trunk/liftgate) are locked if the lock button is pressed. If all doors (and hood, trunk/liftgate) are closed, the hazard warning lights will blink and the chime will sound once to indicate that all doors (and hood, trunk/liftgate) are locked.

Also, if the lock button is pressed once more within 4 seconds, the hazard warning lights will blink and the chime will sound once to confirm that the door is locked (If equipped).

However, if any door remains open, the hazard warning lights (and/or the chime) will not operate. But if all doors are closed after the lock button is pressed, the hazard warning lights will blink once.

Unlock (2)

The driver's door is unlocked if the unlock button is pressed once. The hazard warning lights will blink twice and the chime will sound twice to indicate that the driver's door is unlocked.

All doors are unlocked if the unlock button is pressed once more within 4 seconds. The hazard warning lights will blink twice again to indicate that all doors are unlocked. After pressing this button, the doors will lock automatically unless you open any door within 30 seconds.

If you attempt to lock or unlock the door by pressing the door lock/unlock button in any of the following states, the door will not be locked or unlocked.

- When you want to lock or unlock the door in the ACC or ON state.
- When you want to lock a door in a car with one or more doors open.

Depending on the vehicle, the driver can turn off or set the TWO PRESS UNLOCK setting function.

*** NOTICE**

If the keyless entry system is inoperative due to exposure to water or liquids, it will not be covered by your manufacturer's vehicle warranty.

Trunk open (3)

The trunk is opened if the button is pressed for more than 1 second.

Liftgate unlock (3)

The liftgate is unlocked if the button is pressed for more than 1 second.

However, after pressing this button, the liftgate will lock automatically unless you open the liftgate within 30 seconds.

Also, once the liftgate is opened and then closed, the liftgate will lock automatically.

Alarm (4)

The horn sounds and the hazard warning lights blink for about 30 seconds if this button is pressed for more than 0.5 seconds. To stop the horn and lights, press any button on the transmitter.

Transmitter precautions

The transmitter (or smart key) will not work if any of following occurs:

- The ignition key is in the ignition switch.
- You exceed the operating distance limit (about 90 feet [30 m]).
- The battery in the transmitter (or smart key) is weak.
- Other vehicles or objects may be blocking the signal.
- The weather is extremely cold.
- The transmitter (or smart key) is close to a radio transmitter such as a radio station or an airport which can interfere with normal operation of the transmitter.

When the transmitter (or smart key) does not work properly, open and close the door with the ignition key. If you have a problem with the transmitter (or smart key), contact an authorized Kia dealer.

- If the transmitter (or smart key) is in close proximity to your cell phone or smart phone, the signal from the transmitter (or smart key) could be blocked by normal operation of your cell phone or smart phone. This is especially important when the phone is active such as making calls, receiving calls, text messaging, and/or sending/receiving emails.

Avoid placing the transmitter (or smart key) and your cell phone or smart phone in the same pants or jacket pocket and maintain adequate distance between the two devices.

This device complies with Part 15 of the FCC rules.

Operation is subject to the following two conditions:

1. This device may not cause harmful interference, and
2. This device must accept any interference received, including interference that may cause undesired operation.

* NOTICE

Changes or modifications not expressly approved by the party responsible for compliance could void the user's authority to operate the equipment. If the keyless entry system is inoperative due to changes or modifications not expressly approved by the party responsible for compliance, it will not be covered by your manufacturer's vehicle warranty.

Battery replacement

■ Folding key - Type A



OYDDCO2005

■ Folding key - Type B



OFB040443L

■ Smart key

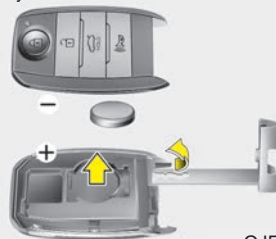

OJF045400L

A battery should last for several years, but if the transmitter is not working properly, try replacing the battery with a new one. If you are unsure how to use or replace the battery, contact an authorized Kia dealer.

Folding key

1. Insert a slim tool into the slot and gently pry open the transmitter cover.
2. Using a slim tool, gently pry open the battery cover (Type B).
3. Replace the battery with a new battery (CR2032). When replacing the battery, make sure the battery position is correct.
4. Install the battery in the reverse order of removal.

Smart key

1. Remove the mechanical key.
2. Insert a slim tool into the slot and gently pry open the rear cover.
3. Replace the battery with a new battery (CR2032). When replacing the battery, make sure the battery position is correct.
4. Install the battery in the reverse order of removal.

- The transmitter is designed to give you years of trouble-free use, however it can malfunction if exposed to moisture or static electricity. If you are unsure how to use or replace the battery, contact an authorized Kia dealer.
- Using the wrong battery can cause the transmitter to malfunction. Be sure to use the correct battery.
-  An inappropriately disposed battery can be harmful to the environment and human health. Dispose the battery according to your local law(s) or regulation.



CAUTION - Transmitter damage

The transmitter can malfunction if dropped, exposed to moisture, static electricity, heat or direct sunlight.

Immobilizer system

Your vehicle may be equipped with an electronic engine immobilizer system to reduce the risk of unauthorized vehicle use.

Your immobilizer system is comprised of a small transponder in the ignition key and electronic devices inside the vehicle.

With the immobilizer system, whenever you insert your ignition key into the ignition switch and turn it to ON, it checks and determines and verifies that the ignition key is valid.

If the key is determined to be valid, the engine will start.

If the key is determined to be invalid, the engine will not start.

To deactivate the immobilizer system:

Insert the ignition key into the key cylinder and turn it to the ON position.

To activate the immobilizer system:

Turn the ignition key to the OFF position. The immobilizer system activates automatically. Without a valid ignition key for your vehicle, the engine will not start.

Your Immobilizer password is a customer unique password and should be kept confidential. Do not leave this number anywhere in your vehicle.

*** NOTICE**

Keep each key separately in order to avoid a starting malfunction.

Do not put metal accessories near the ignition switch.

Metal accessories may interrupt the transponder signal and may prevent the engine from being started.

If you need additional keys or lose your keys, consult an authorized Kia dealer.



CAUTION - Immobilizer damage

Do not expose your immobilizer system to moisture, static electricity or rough handling. This may damage your immobilizer.



CAUTION - Immobilizer alterations

Do not change, alter or adjust the immobilizer system because it could cause the immobilizer system to malfunction.

This device complies with Part 15 of the FCC rules.

Operation is subject to the following two conditions:

1. This device may not cause harmful interference, and
2. This device must accept any interference received, including interference that may cause undesired operation.

*** NOTICE**

Changes or modifications not expressly approved by the party responsible for compliance could void the user's authority to operate the equipment.

SMART KEY (IF EQUIPPED)



With a smart key, you can lock or unlock a door and even start the engine without inserting the key.

The functions of the buttons on a smart key are similar to the remote keyless entry. (Refer to the “Remote keyless entry” in this chapter.)

Smart key functions

Carrying the smart key, you may lock and unlock the vehicle doors. Also, you may start the engine. Refer to the following, for more details.

Locking



Pressing the button of the front outside door handles with all doors (and trunk, liftgate) closed and any door unlocked, locks all the doors (and trunk, liftgate).

The hazard warning lights will blink once to indicate that all doors (and trunk, liftgate) are locked. The button will only operate when the smart key is within 28 ~ 40 in. (0.7 ~ 1m) from the outside door handle. If you want to make sure that a door has locked or not, you should check the door lock button inside the vehicle or pull the outside door handle.

Even though you press the button, the doors will not lock and the chime will sound for 3 seconds if any of the following occurs:

- The smart key is in the vehicle.
- The ENGINE START/STOP button is in the ACC or ON position.
- Any door except the trunk (liftgate) is open.

Unlocking

Pressing the button of the driver's (or front passenger's) outside door handle with all doors closed and locked, unlocks the driver's door.

The hazard warning lights will blink twice to indicate that the driver's door is unlocked.

The button will only operate when the smart key is within 28 ~ 40 in. (0.7 ~ 1 m) from the outside door handle.

When Two press unlock function is activated,

- If you press the driver's outside door handle button, the driver's door will unlock.
- If you press the driver's outside door handle button within four seconds again, then all the doors and trunk will unlock.

Trunk (Liftgate) unlocking

If you are within 28 ~ 40 in (0.7 ~ 1 m) from the outside trunk (liftgate) handle, with your smart key in possession, the trunk (liftgate) will unlock and open when you press the trunk (liftgate) handle switch.

The hazard warning lights will blink twice to indicate that the trunk (liftgate) is unlocked.

Also, once the trunk (liftgate) is opened and then closed, the trunk (liftgate) will lock automatically.

Smart key precautions

- If you lose your smart key, you will not be able to start the engine. Tow the vehicle, if necessary, and contact an authorized Kia dealer.
- A maximum of 2 smart keys can be registered to a single vehicle. If you lose a smart key, you should immediately take the vehicle and key to your authorized Kia dealer to protect it from potential theft.
- The smart key will not work if any of following occurs:
 - The smart key is close to a radio transmitter such as a radio station or an airport which can interfere with normal operation of the smart key.
 - The smart key is near a mobile two-way radio system or a cellular phone.
 - Another vehicle's smart key is being operated close to your vehicle.

When the smart key does not work correctly, open and close the door with the mechanical key. If you have a problem with the smart key, contact an authorized Kia dealer.

- If the smart key is in close proximity to your cell phone or smart phone, the signal from the smart key could be blocked by normal operation of your cell phone or smart phone. This is especially important when the phone is active such as making calls, receiving calls, text messaging, and/or sending/receiving emails. Avoid placing the smart key and your cell phone or smart phone in the same pants or jacket pocket and maintain adequate distance between the two devices.
- Do not leave the smart key near metallic objects such as golf bags, metal cases and so on.
- Door Lock/Unlock failure or poor starting can occur when the smart key is placed near metallic objects.
- Always carry your smart key when you leave the car. An unattended smart key close to the vehicle can cause the vehicle battery to be discharged.
- Internal circuit damage may occur when the key comes into contact with moisture (beverage, water etc.) or heat. Damage to the smart key due to exposure to liquids or heat is not covered by the manufacturer's vehicle warranty.



CAUTION - Transmitter

Keep the smart key away from water or any liquid as it can become damaged and not function properly.

Smart key immobilizer system

Your vehicle is equipped with an electronic engine immobilizer system to reduce the risk of unauthorized vehicle use.

Your immobilizer system is comprised of a small transponder in the smart key and electronic devices inside the vehicle.

With the immobilizer system, whenever you turn the ENGINE START/STOP button to the ON position by pressing the button while carrying the smart key, it verifies if the smart key is valid. If the key is determined to be valid, the engine will start.

If the key is determined to be invalid, the engine will not start.

To deactivate the immobilizer system:

Turn the ENGINE START/STOP button to the ON position by pressing the button while carrying the smart key.

In order to prevent theft of your vehicle, do not leave spare keys anywhere in your vehicle.

To activate the immobilizer system:

Turn the ENGINE START/STOP button to the OFF position. The immobilizer system activates automatically. Without a valid smart key for your vehicle, the engine will not start.

*** NOTICE**

When starting the engine, do not use the key with other immobilizer keys around. Otherwise the engine may not start or may stop soon after it starts. Keep each key separate in order to avoid a starting malfunction.

*** NOTICE**

If you need additional keys or lose your keys, contact an authorized Kia dealer.

This device complies with Part 15 of the FCC rules.

Operation is subject to the following two conditions:

1. This device may not cause harmful interference, and
2. This device must accept any interference received, including interference that may cause undesired operation.

*** NOTICE**

Changes or modifications not expressly approved by the party responsible for compliance could void the user's authority to operate the equipment. If the keyless entry system is inoperative due to changes or modifications not expressly approved by the party responsible for compliance, it will not be covered by your manufacturer's vehicle warranty.

THEFT-ALARM SYSTEM (IF EQUIPPED)

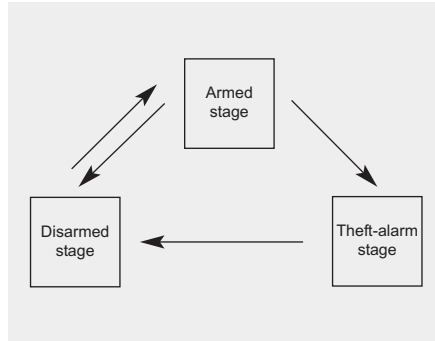

This system is designed to provide protection from unauthorized entry into the vehicle. This system is operated in three stages: the first is the "Armed" stage, the second is the "Theft-alarm" stage, and the third is the "Disarmed" stage. If triggered, the system provides an audible alarm with blinking of the hazard warning lights.

Armed stage

Using the transmitter

Park the vehicle and stop the engine. Arm the system as described below.

1. Turn off the engine and remove the ignition key from the ignition switch.
2. Make sure that all doors (and lift-gate), the engine hood are closed and latched.
3. Lock the doors by pressing the lock button on the transmitter.

After completion of the steps above, the hazard warning lights will blink once to indicate that the system is armed.

If any door (and liftgate) or engine hood remains open, the hazard warning lights won't operate and the theft-alarm will not arm. After this, if all doors (and liftgate) and engine hood are closed, the hazard warning lights blink once.

Using the smart key

Park the vehicle and stop the engine. Arm the system as described below.

1. Turn off the engine.
2. Make sure that all doors (and lift-gate) and the engine hood are closed and latched.
3. Lock the doors by pressing the button of the front outside door handle with the smart key in your possession or by pressing the button on the smart key.

After completion of the steps above, the hazard warning lights operate once to indicate that the system is armed.

If any door remains open, the doors won't lock and the chime will sound for 3 seconds. Close the door and try again to lock the doors.

If liftgate or engine hood remains open, the hazard warning lights won't operate and theft-alarm will not arm. After this, if the liftgate and engine hood are closed, the hazard warning lights will blink once and the theft-alarm will arm.

Do not arm the system until all passengers have left the vehicle. If the system is armed while a passenger(s) remains in the vehicle, the alarm may be activated when the remaining passenger(s) leave the vehicle. If any door, liftgate or engine hood is opened within 30 seconds after entering the armed stage, the system is disarmed to prevent unnecessary alarm.

Theft-alarm stage

The alarm will be activated if any of the following occurs while the system is armed.

- A front or rear door is opened without using the ignition key or transmitter (or smart key).
- The trunk/liftgate is opened without using the ignition key or transmitter (or smart key).
- The engine hood is opened.

The horn will sound and the hazard warning lights will blink continuously for approximately 27 seconds. To turn off the system, unlock the doors with the ignition key or transmitter (or smart key).

Disarmed stage

The system will be disarmed when:

Transmitter

- The door unlock button is pressed.
- The engine is started. (within 3 seconds)
- The ignition switch is in the "ON" position for 30 seconds or more.

Smart key

- The door unlock button is pressed.
- The button of the front outside door is pressed while carrying the smart key.
- The engine is started. (within 3 seconds)

After the doors are unlocked, the hazard warning lights will blink twice to indicate that the system is disarmed.

After pressing the unlock button, if any door (or trunk/liftgate) is not opened within 30 seconds, the system will be rearmed.

* NOTICE

- Avoid trying to start the engine while the alarm is activated. The vehicle starting motor is disabled during the theft-alarm stage.
 - If the system is not disarmed with the transmitter, insert the key into the ignition switch, turn the ignition switch to the ON position and wait for 30 seconds. Then, the system will be disarmed.
 - If the system is not disarmed with the smart key, press the ENGINE START/STOP button with the smart key. The side with the lock button should contact the ENGINE START/STOP button directly.
- If you lose your keys, consult your authorized Kia dealer.



CAUTION - Adjusting alarm system

Do not change, alter or adjust the theft-alarm system because it could cause the theft-alarm system to malfunction and should only be serviced by an authorized Kia dealer.

* NOTICE

Malfunctions caused by improper alterations, adjustments or modifications to the theft-alarm system are not covered by your vehicle manufacturer warranty.

DOOR LOCKS

Operating door locks from outside the vehicle

Mechanical key

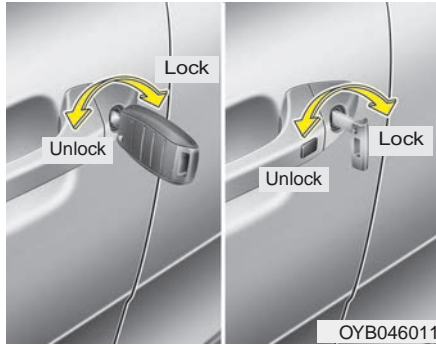

- Turn the key toward the rear of the vehicle to lock and toward the front of the vehicle to unlock.
- If you lock/unlock the driver's door with a key, only the driver's door will lock/unlock.
- From the driver's door, turn the key toward the front of the vehicle once to unlock the driver's door and once more within 4 seconds to unlock all doors.

- Once the doors are unlocked, they may be opened by pulling the door handle.
- When closing the door, push the door by hand. Make sure the doors are closed securely.

Transmitter/Smart key

- Doors can be locked and unlocked with the transmitter (or smart key). (if equipped)
- Doors can be locked and unlocked pressing the button of the outside door handle with the smart key in your possession.
- Once the doors are unlocked, they may be opened by pulling the door handle.
- When closing the door, push the door by hand. Make sure that doors are closed securely.

* NOTICE

- In cold and wet climates, door lock and door mechanisms may not work properly due to freezing conditions.
- If the door is locked/unlocked multiple times in rapid succession with either the vehicle key or door lock switch, the system may stop operating temporarily in order to protect the circuit and prevent damage to system components.

⚠ WARNING

If people must spend a longer time in the vehicle while it is very hot or cold outside, there is risk of severe personal injuries or death. Do not lock the vehicle from the outside when there are people in it.

⚠ CAUTION

Do not open and close the door repeatedly if unnecessary or with excessive force. Such action can damage the vehicle door.

Operating door locks from inside the vehicle

With the door lock button



- To unlock a door, pull the door lock button (1) to the “Unlock” position. The red mark on the button will be visible.
- To lock a door, push the door lock button (1) to the “Lock” position. If the door is locked properly, the red mark on the door lock button will not show.
- To open a door, pull the door handle (2) outward.

- If the inner door handle of the front door is pulled when the door lock button is in the lock position, the button will unlock and the door will open.
- Front doors cannot be locked if the ignition key is in the ignition switch and any front door is opened.
- Doors cannot be locked if the smart key is in the vehicle and a door is open.

If a power door lock ever fails to function while you are in the vehicle, try one or more of the following techniques to exit:

- Operate the door unlock feature repeatedly (both electronic and manual) while simultaneously pulling on the door handle.
- Operate the other door locks and handles, front and rear.
- Lower a front window and use the key to unlock the door from outside.
- Move to the cargo area and open the liftgate (5 door).

⚠ WARNING

Do not pull the inner door handle of driver's (or passenger's) door while the vehicle is moving.

With central door lock switch

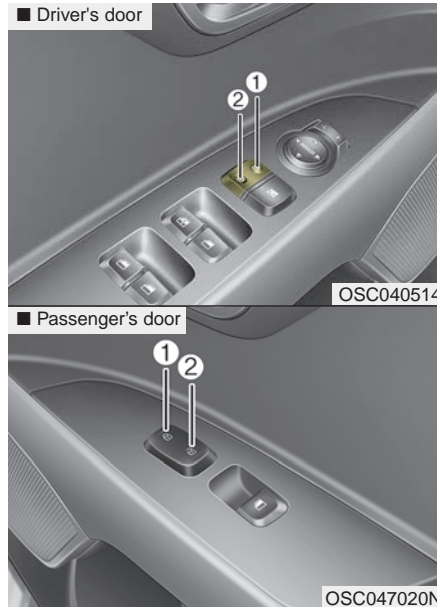

Operate by pressing the central door lock switch.

- Press the switch to the “Lock” position (1), all vehicle doors will lock.

- Press the switch to the “Unlock” position (2), all vehicle doors will unlock.
- If the key is in the ignition switch (or if the smart key is in the vehicle) and any front door is opened, the doors will not lock when the “Lock” position (1) of the central door lock switch is pressed.

⚠ WARNING - Doors

The doors should always be fully closed and locked while the vehicle is in motion to prevent the accidental opening of the door, which could lead to serious injuries or death.

⚠ WARNING - Unattended children/animals

Never leave children or animals unattended in your vehicle. An enclosed vehicle can become extremely hot, causing death or severe injury to unattended children or animals who cannot escape the vehicle.

Impact sensing door unlock system (if equipped)

All doors will automatically unlock when an impact causes the air bags to deploy.

Auto door lock/unlock feature (if equipped)

- All doors will automatically lock when the Intelligent Variable Transmission shift lever is shifted out of P(Park) (with engine ON, it is activated).
- All doors will automatically unlock when the Intelligent Variable Transmission shift lever is shifted into P(Park) (with engine ON, it is activated).

Speed sensing door lock system (if equipped)

All doors will be automatically locked after the vehicle speed exceeds 9 mph. And all doors will be automatically unlocked when you turn the engine off or when you remove the ignition key.

An authorized Kia dealer can activate or deactivate some auto door lock/ unlock features as follows;

- Auto door unlock by using the driver's door lock button.
- Auto door lock/unlock by shifting the transmission shift lever out of P (Park) or into P (Park).
- Auto door unlock when the ignition key is removed from the ignition switch or the ENGINE STAR/STOP button is set to the OFF position.

If you want to activate or deactivate some door lock/unlock feature, consult an authorized Kia dealer.

Child-protector rear door lock

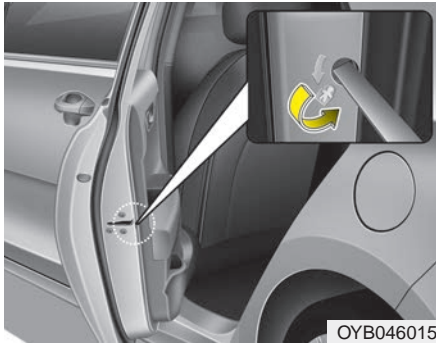

The child safety lock is provided to help prevent children from accidentally opening the rear doors from inside the vehicle. The rear door safety locks should be used whenever children are in the vehicle.

1. Open the rear door.
2. Insert a key (or screwdriver) into the hole and turn it to the lock (🔒) position. The child safety lock located on the rear edge of the door to the lock position. When the child safety lock is in the lock position, the rear door will not open even when the inner door handle is pulled.

3. Close the rear door.

To open the rear door, pull the outside door handle.

Even though the doors may be unlocked, the rear door will not open by pulling the inner door handle until the rear door child safety lock is unlocked.

⚠ WARNING - Rear door locks

Use the rear door safety locks whenever children are in the vehicle. If a child accidentally opens the rear doors while the vehicle is moving, the child could suffer severe injuries or death if they fall out of a moving vehicle.

Rear Occupant Alert (ROA) system (if equipped)

The Rear Occupant Alert (ROA) system is provided to help prevent exiting the vehicle with the rear passenger left in the vehicle.

- When you open the front door after opening and closing the rear door and turning off the engine, the “Check rear seats” warning message appears on the cluster.

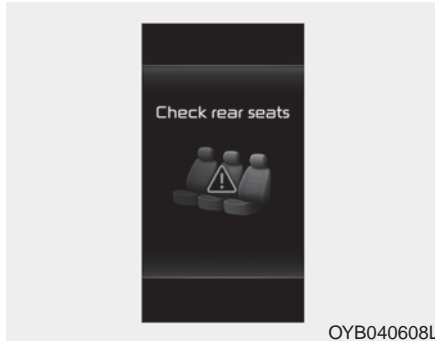

OYB040608L

You can activate or deactivate the ROA from the Use Settings mode in the cluster LCD display.

The option can be found under the following menu:

1. Press the MODE button several times on the steering wheel until 'User Settings' menu appears on the LCD.
2. Select 'Convenience → Rear Occupant Alert' with the MODE Switch and the OK button on the steering wheel.

⚠ WARNING

The Rear Occupant Alert (ROA) system does not actually detect objects or people in the rear seat. By using a rear door opened and closed history, the system informs the driver that there may be something in the rear seat.

*** NOTICE**

The Rear Occupant Alert (ROA) system uses a rear door opened and closed history.

The history is reset after the driver turns off ignition normally, gets off the vehicle and locks the door remotely using the remote keyless entry. So even if a rear door does not reopen, the ROA system alert can occur.

For example, after the ROA system alert occur, if the driver do not lock the door then ride and drive again, the alert can occur.

TRUNK (FOR 4 DOOR)

Opening the trunk



- To open the trunk from inside the vehicle, pull the trunk lid release lever.

Once the trunk is opened and then closed, the trunk locks automatically.

* NOTICE

In cold and wet climates, trunk lock and trunk mechanisms may not work properly due to freezing conditions.

⚠ WARNING

The trunk swings upward. Make sure no objects or people are near the rear of the vehicle when opening the trunk.

⚠ CAUTION

Make certain that you close the trunk before driving your vehicle. Possible damage may occur to attached hardware if the trunk is not closed prior to driving.

Closing the trunk

To close, lower the trunk lid, then press down on it until it locks. To be sure the trunk lid is securely fastened, always check by trying to pull it up again.

⚠ WARNING - Exhaust Fumes

The trunk lid should always be kept completely closed while the vehicle is in motion. If it is left open or ajar, poisonous exhaust gases may enter the car and serious illness or death may result.

⚠ WARNING

No one should be allowed to occupy the trunk at any time. The trunk is a very dangerous location in the event of a crash.

Emergency trunk safety release

■ Type A

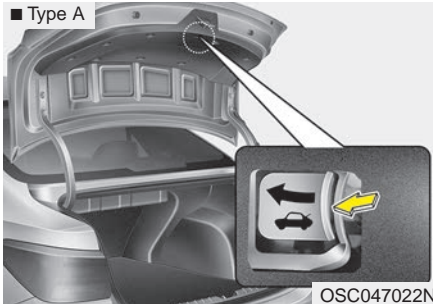

OSC047022N

■ Type B

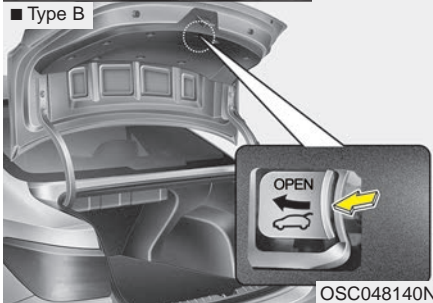

OSC048140N

No one should be allowed to occupy the trunk at any time. The trunk is a very dangerous location in the event of a crash.

Use the release lever for emergencies only. Use extreme caution, especially while the vehicle is in motion.

Your vehicle is equipped with an emergency trunk release lever located inside the trunk. If someone is inadvertently locked in the trunk, moving the handle in the direction of the arrow will release the trunk latch mechanism and open the trunk.

SMART TRUNK RELEASE (4 DOOR, IF EQUIPPED)

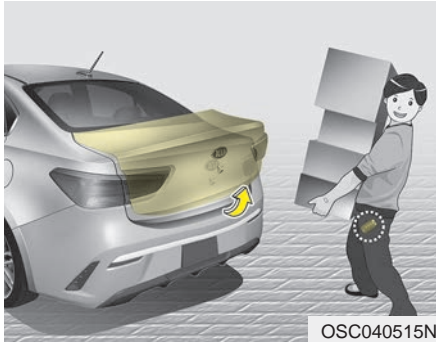

On a vehicle equipped with a smart key, the trunk can be opened with no-touch activation using the Smart Trunk Release system.

How to use the Smart Trunk Release

The trunk can be opened with no-touch activation satisfying all the conditions below.

- After 15 seconds when all doors are closed and locked
- Positioned in the detecting area for more than 3 seconds.

*** NOTICE**

- **The Smart Trunk Release does not operate when:**
 - **The smart key is detected within 15 seconds after the doors are closed and locked, and is continuously detected.**
 - **The smart key is detected within 15 seconds after the doors are closed and locked, and 60 inches (1.5m) from the front door handles. (for vehicles equipped with Welcome Light)**
 - **A door is not locked or closed.**
 - **The smart key is in the vehicle.**
- **When smart key is left in the range of detection within 15 seconds after the doors are closed and locked, the function will automatically turn off after 10 minutes.**

1. Setting

To activate the Smart Trunk Release,
(1) Change the LCD modes to User setting mode

(2) Select the Door mode

(3) Check the Smart Trunk.

*For more details, refer to “LCD Display” in this chapter

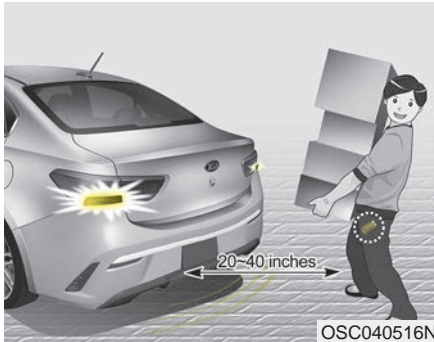

2. Detect and Alert

If you are positioned in the detecting area 20 ~ 40 inches (50 ~ 100 cm) behind the vehicle) carrying a smart key, the hazard warning lights will blink and chime will sound for about 3 seconds to alert you the smart key has been detected and the trunk will open.

* NOTICE

Do not approach the detecting area if you do not want the trunk to open. If you have unintentionally entered the detecting area and the hazard warning lights and chime starts to operate, leave the detecting area with the smart key. The trunk will stay closed.



3. Automatic opening

The hazard warning lights will blink and chime will sound 2 times and then the trunk will open.

⚠ WARNING

- Make sure objects in the rear cargo area do not come out when opening the trunk on the slope way. It may cause serious injury.
- The key should be kept out of reach of children. Children may inadvertently open the Smart Trunk Release while playing around the rear area of the vehicle.

- Make certain that you close the trunk before driving your vehicle.
- Make sure there are no people or objects around the trunk before opening or closing the trunk.
- Make sure to deactivate the Smart Trunk Release function when washing your vehicle.

Otherwise, the trunk may open inadvertently.

How to deactivate the Smart Trunk Release function using the smart key



1. Door lock
2. Door unlock
3. Trunk open
4. Panic

If you press any button of the smart key during the Detect and Alert stage, the Smart Trunk Release function will be deactivated.

Make sure to be aware of how to deactivate the Smart Trunk Release function for emergency situations.

* NOTICE

- If you press the door unlock button (2), the Smart Trunk Release function will be deactivated temporarily. But, if you do not open any door for 30 seconds, the Smart Trunk Release function will be activated again.
- If you press the trunk open button (3) for more than 1 second, the trunk opens.
- If you press the door lock button (1) or trunk open button (3) when the Smart Trunk Release function is not in the Detect and Alert stage, the Smart Trunk Release function will not be deactivated.
- In case you have deactivated the Smart Trunk Release function by pressing the smart key button and opened a door, the Smart Trunk Release function can be activated again by closing and locking all doors.

Detecting area



- The Smart Trunk Release operates with a welcome alert if the smart key is detected within 20 ~ 40 inches (50 ~ 100 cm) from the trunk.
- The alert stops at once if the smart key is positioned outside the detecting area during the Detect and Alert stage.

*** NOTICE**

- **The Smart Trunk Release function will not work if any of the following occurs:**
 - **The smart key is close to a radio transmitter such as a radio station or an airport which can interfere with normal operation of the transmitter.**
 - **The smart key is near a mobile two way radio system or a cellular phone.**
 - **Another vehicle's smart key is being operated close to your vehicle.**
- **The detecting range may decrease or increase when :**
 - **One side of the tire is raised to replace a tire or to inspect the vehicle.**
 - **The vehicle is slantingly parked on a slope or unpaved road, etc.**

LIFTGATE (FOR 5 DOOR)

Opening the liftgate

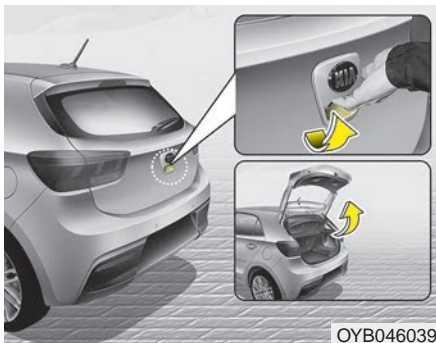

- The liftgate is locked or unlocked when all doors are locked or unlocked with the transmitter (or smart key) or central door lock switch.
- If unlocked, the liftgate can be opened by pressing the handle and pulling it up.
- When all doors are locked if the liftgate unlock button on the transmitter (or smart key) is pressed for more than 1 second, the liftgate is unlocked. Once the liftgate is opened and then closed, the liftgate is locked automatically.

※ There is no key hole.

* NOTICE

In cold and wet climates, liftgate lock and liftgate mechanisms may not work properly due to freezing conditions.

⚠ WARNING

The liftgate swings upward. Make sure no objects or people are near the rear of the vehicle when opening the liftgate.

⚠ CAUTION - Liftgate lift

Make certain that you close the liftgate before driving your vehicle. Possible damage may occur to the liftgate gas lifters and attached hardware if the liftgate is not closed prior to driving.

Closing the liftgate



To close the liftgate, lower and push down the liftgate firmly. Make sure that the liftgate is securely latched.

Make sure your hands, feet and other parts of your body are safely out of the way before closing the liftgate.

⚠ CAUTION - Closing liftgate

Make sure nothing is near the liftgate latch and striker while closing the liftgate. It may damage the liftgate's latch.

⚠ WARNING - Exhaust fumes

If you drive with the liftgate open, you will draw dangerous exhaust fumes into your vehicle which can cause serious injury or death to vehicle occupants.

If you must drive with the liftgate open, keep the air vents and all windows open so that additional outside air comes into the vehicle.

⚠ WARNING - Riding in cargo area

Occupants should never ride in the rear cargo area where no restraints are available. To avoid injury in the event of an accident or sudden stops, occupants should always be properly restrained.

Emergency liftgate safety release



Your vehicle is equipped with the emergency liftgate safety release lever located on the bottom of the liftgate. If someone is inadvertently locked in the luggage compartment. The liftgate can be opened by doing as follows:

1. Input the mechanical key into the hole.
2. Push the mechanical key to the right.
3. Push up the liftgate.

WARNING

- **No one should be allowed to occupy the luggage compartment of the vehicle at any time. The luggage compartment is a very dangerous location in the event of a crash.**
- **Use the release lever for emergencies only. Use with extreme caution, especially while the vehicle is in motion.**

WINDOWS

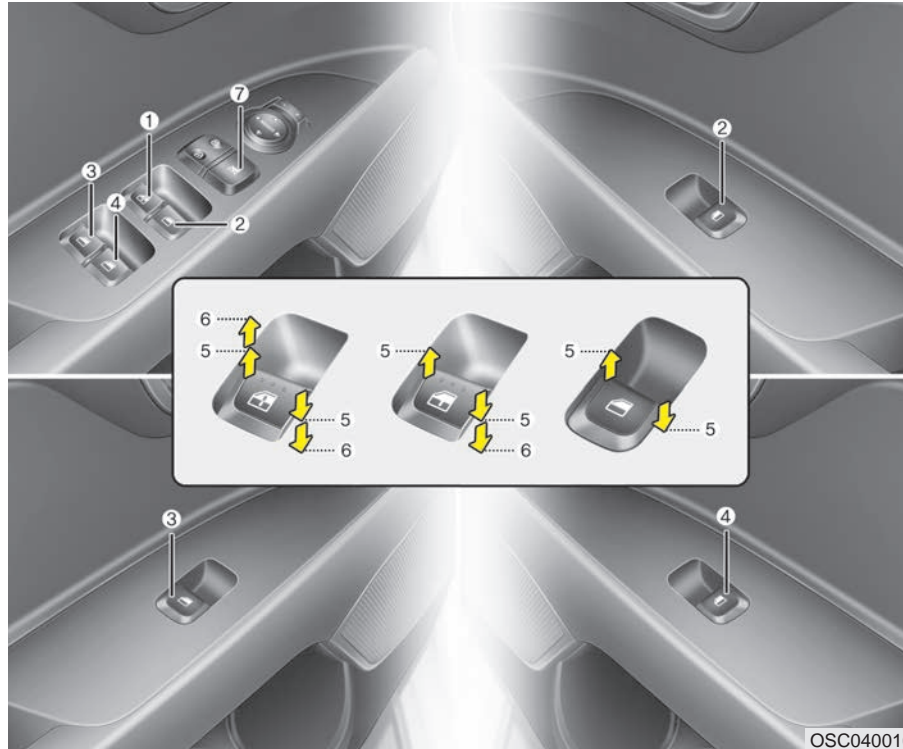

- (1) Driver's door power window switch
- (2) Front passenger's door power window switch
- (3) Rear door (left) power window switch*
- (4) Rear door (right) power window switch*
- (5) Window opening and closing
- (6) Automatic power window UP*/DOWN* (Driver's window)
- (7) Power window lock button*

*: if equipped

* NOTICE

In cold and wet climates, power windows may not work properly due to freezing conditions.

OSC040016

Power windows (if equipped)

The ignition switch or ENGINE START/STOP button must be in the ON position for power windows to operate. Each door has a power window switch that controls the door's window. The driver has a power window lock switch which can block the operation of rear passenger windows.

The power windows can be operated for approximately 30 seconds after the ignition key is removed or is set to the ACC or LOCK/OFF position. However, if the front doors are opened, the power windows cannot be operated even within the 30 second period.

If a window cannot be closed because it is blocked by objects, remove the objects and close the window.



WARNING - Power Windows

Do not extend your face or arms outside of the window opening while the vehicle is in motion. Doing so could result in serious injuries.

* NOTICE

While driving with the rear windows down, your vehicle may demonstrate a wind buffeting or pulsation noise. This noise is a normal occurrence and can be reduced or eliminated by taking the following actions. If the noise occurs with one or both of the rear windows down, partially lower both front windows approximately one inch.



CAUTION

Do not install any accessories in the area of windows. It may impact jam protection.

**Window opening and closing
(if equipped)**



The driver's door has a master power window switch that controls all the windows in the vehicle.

To open or close a window, press down or pull up the front portion of the corresponding switch to the first detent position (5).

**Auto down window (if equipped)
(Driver's window)**

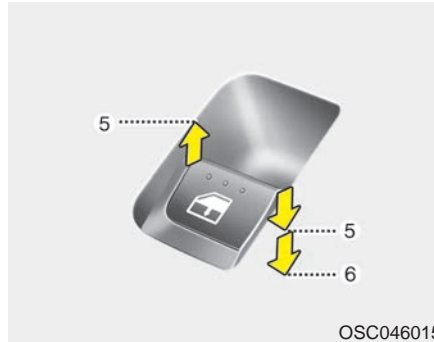

Pressing the power window switch momentarily to the second detent position (6) completely lowers the driver's window even when the switch is released. To stop the window at the desired position while the window is in operation, briefly pull up the switch to the opposite direction of the window movement.

**Auto up/down window (if equipped)
(Driver's window)**

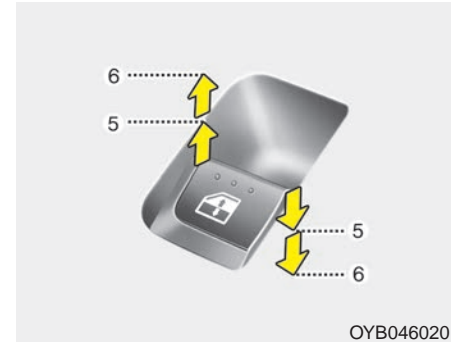

Pressing or pulling up the power window switch momentarily to the second detent position (6) completely lowers or lifts the window even when the switch is released. To stop the window at the desired position while the window is in operation, pull up or press and release the switch to the opposite direction of the movement.

If the power window is not operated correctly, the automatic power window system must be reset as follows:

1. Place the ignition switch or ENGINE START/STOP button to the ON position.
2. Close the window and continue pulling up on the driver's power window switch for at least 1 second after the window is completely closed.

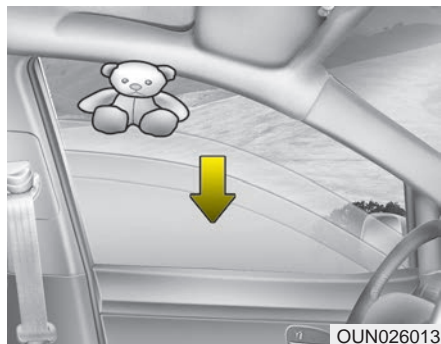

Automatic reversal (if equipped)

If the upward movement of the window is blocked by an object or part of the body, the window will detect the resistance and will stop upward movement. The window will then lower approximately 11.8 in. (30 cm) to allow the object to be cleared.

If the window detects the resistance while the power window switch is pulled up continuously, the window will stop upward movement then lower approximately 1 in. (2.5 cm).

And if the power window switch is pulled up continuously again within 5 seconds after the window is lowered by the automatic window reversal feature, the automatic window reversal will not operate.

The automatic reverse feature for the driver's window is only active when the "auto up" feature is used by fully pulling up the switch. The automatic reverse feature will not operate if the window is raised using the halfway position on the power window switch.

⚠ WARNING

Always check for obstructions before raising any window to avoid injuries or vehicle damage. If an object less than 0.16 in. (4 mm) in diameter is caught between the window glass and the upper window channel, the automatic reverse window may not detect the resistance and will not stop and reverse direction.

⚠ WARNING

The automatic reverse feature doesn't activate while resetting the power window system. Make sure body parts or other objects are safely out of the way before closing the windows to avoid injuries or vehicle damage.

⚠ WARNING

Do not install any accessories in the vehicle that extend into the open window area. Such objects could prevent the automatic reverse feature from functioning.

Power window lock button (if equipped)

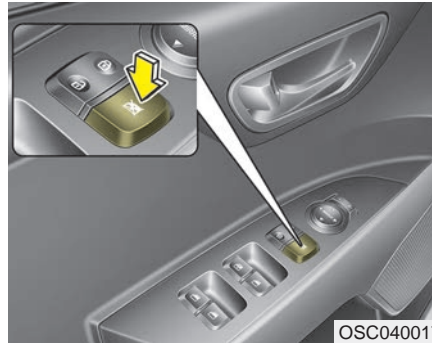

The driver can disable the power window switches on the rear passengers' doors by pressing the power window lock switch to the lock position (pressed).

When the power window lock switch is pressed:

- The driver's master control can operate all the power windows.
- The front passenger's control can operate the front passenger's power window.
- The rear passenger's control cannot operate the rear passenger's power window.

⚠ CAUTION

- Opening/Closing Window

To prevent possible damage to the power window system, do not open or close two windows or more at the same time. This will also ensure the longevity of the fuse.

⚠ WARNING - Power windows

Do not allow children to play with the power windows. Keep the power window lock button (on the driver's door) in the LOCK (pressed) position.

Always double check to make sure all arms, hands, head and other obstructions are safely out of the way before closing a window.

Manual windows (if equipped)

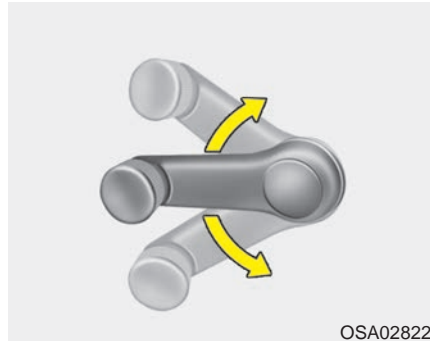

To raise or lower the window, turn the window regulator handle clockwise or counterclockwise.

⚠ WARNING

When opening or closing the windows, make sure your passenger's arms, hands and body are safely out of the way.

HOOD

Opening the hood

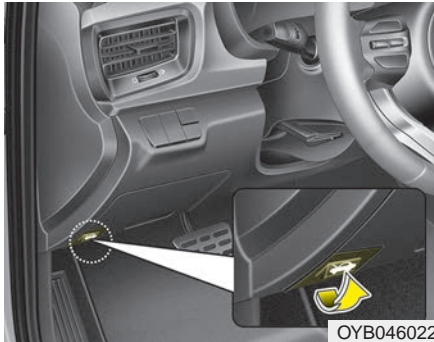

1. Pull the release lever to unlatch the hood. The hood should pop open slightly.

Open the hood after turning off the engine on a flat surface, shifting the shift lever to the P (Park) position for Intelligent Variable Transmission and to the 1st (First) gear or R (Reverse) for Manual Transmission, and setting the parking brake.

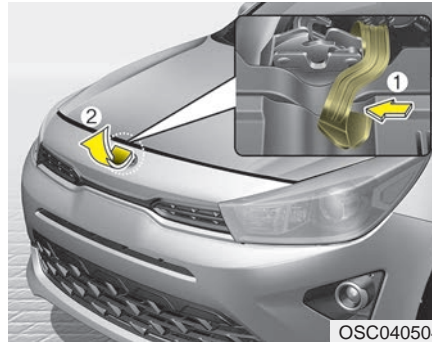

2. Go to the front of the vehicle, raise the hood slightly, push the secondary latch (1) inside of the hood center and lift the hood (2).



3. Pull out the support rod.
4. Hold the hood open with the support rod.

⚠ WARNING - Hot parts
Grasp the support rod in the area wrapped in rubber. The rubber will help prevent you from being burned by hot metal when the engine is hot.

Closing the hood

1. Before closing the hood, check the following:
 - All filler caps in the engine compartment must be correctly installed.
 - Gloves, rags or any other combustible material must be removed from the engine compartment.
2. Return the support rod to its clip to prevent it from rattling.
3. Lower the hood until it is about 12 inches(30 cm) above the closed position and let it drop. Make sure that it locks into place.
4. Check that the hood has engaged properly. If the hood can be raised slightly, it is not properly engaged. Open it again and close it with a little more force.



WARNING - Fire risk

Do not leave gloves, rags or any other combustible material in the engine compartment. Doing so may cause a heat-induced fire.

Hood open warning (if equipped)

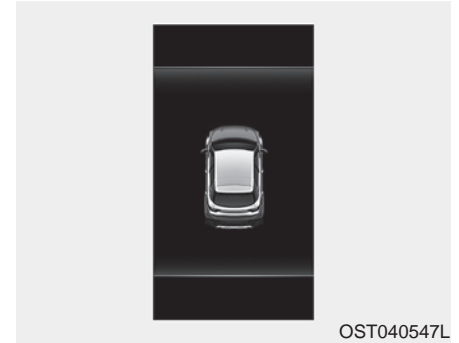

The warning message will appear on the LCD display when hood is open. The warning chime will operate when the vehicle is being driven at or above 2 mph (3 km/h) with the hood open.

⚠ WARNING - Unsecured engine hood

Always double check to be sure that the hood is firmly latched before driving away. If it is not latched, the hood could fly open while the vehicle is being driven, causing a total loss of visibility, which might result in an accident.

⚠ WARNING

The support rod must be inserted completely into the hole whenever you inspect the engine compartment. This will prevent the hood from falling and possibly injuring you.

⚠ CAUTION - Hood obstruction

Before closing the hood, ensure that all obstructions are removed from the hood opening. Closing the hood with an obstruction present in the hood opening may result in vehicle damage.

FUEL FILLER DOOR

Opening the fuel filler door

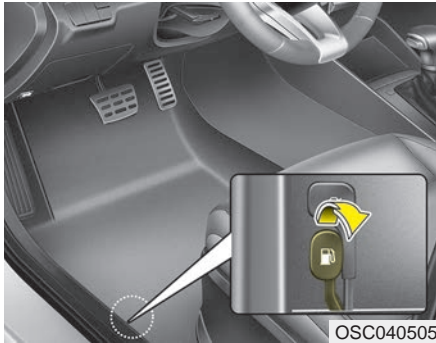

The fuel filler door must be opened from inside the vehicle by pulling up the fuel filler door opener.

If the fuel filler door does not open because ice has formed around it, tap lightly or push on the lid to break the ice and release the lid. Do not pry on the lid. If necessary, spray around the lid with an approved de-icer fluid (do not use radiator anti-freeze) or move the vehicle to a warm place and allow the ice to melt.

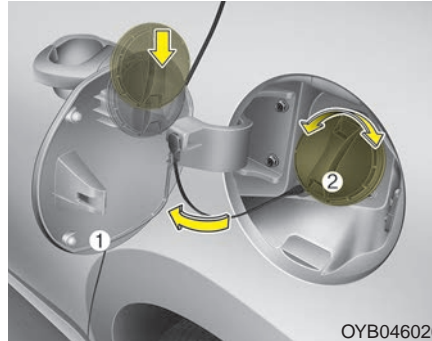

1. Stop the engine.
2. To open the fuel filler door, pull the fuel filler door opener up.
3. Pull open the fuel filler door (1) out to fully open.
4. To remove the cap turn the fuel filler cap (2) counterclockwise.
5. Refuel as needed.

⚠ WARNING

Before refueling, be sure to check what type of fuel is used for your vehicle.

If you put diesel fuel into a gasoline-powered vehicle or gasoline into a diesel-powered vehicle, it may affect the fuel system and cause serious damage to the vehicle.

Closing the fuel filler door

1. To install the cap, turn it clockwise until it “clicks” one time. This indicates that the cap is securely tightened.
2. Close the fuel filler door and push it lightly and make sure that it is securely closed.

WARNING - Refueling

Always remove the fuel cap carefully and slowly. If the cap is venting fuel or if you hear a hissing sound, wait until the condition stops before completely removing the cap.

If pressurized fuel sprays out, it can cover your clothes or skin and subject you to the risk of fire and burns.

* NOTICE

When refueling on unlevel ground, the fuel gauge may not point to the F position.

It is not a malfunction. If you move your vehicle to level ground, the fuel gauge will move to the full position.

* NOTICE

Tighten the cap until it clicks one time, otherwise the check engine warning indicator light will illuminate.

Always check that the fuel cap is installed securely to prevent fuel spillage in the event of an accident.

WARNING - Fire/ explosion risk

Read and follow all warnings posted at the gas station facility. Failure to follow all warnings will result in severe personal injury, severe burns or death due to fire or explosion.

WARNING - Static electricity

- Before touching the fuel nozzle, you should eliminate potentially dangerous static electricity discharge by touching another metal part of the vehicle, a safe distance away from the fuel filler neck, nozzle, or other gas source.
- Do not get back into a vehicle once you have begun refueling since you can generate static electricity by touching, rubbing or sliding against any item or fabric (polyester, satin, nylon, etc.) capable of producing static electricity. Static electricity discharge can ignite fuel vapors resulting in rapid burning. If you must re-enter the vehicle, you should once again eliminate potentially dangerous static electricity discharge by touching a metal part of the vehicle, away from the fuel filler neck, nozzle or other gasoline source.

⚠ WARNING - Portable fuel container

When using an approved portable fuel container, be sure to place the container on the ground prior to refueling. Static electricity discharge from the container can ignite fuel vapors causing a fire. Once refueling has begun, contact with the vehicle should be maintained until the filling is complete. Use only approved portable plastic fuel containers designed to carry and store gasoline.

⚠ WARNING - Cell phone fires

Do not use cellular phones while refueling. Electric current and/or electronic interference from cellular phones can potentially ignite fuel vapors causing a fire.

⚠ WARNING - Refueling & Vehicle fires

When refueling, always shut the engine off. Sparks produced by electrical components related to the engine can ignite fuel vapors, causing a fire. Once refueling is complete, check to make sure the filler cap and filler door are securely closed, before starting the engine.

⚠ WARNING - Smoking

DO NOT use matches or a lighter and DO NOT SMOKE or leave a lit cigarette in your vehicle while at a gas station especially during refueling. Automotive fuel is highly flammable and can, when ignited, result in fire.

Make sure to refuel your vehicle according to the “Fuel requirements” suggested in chapter 1.

If the fuel filler cap requires replacement, use only a genuine Kia cap or the equivalent specified for your vehicle. An incorrect fuel filler cap can result in a serious malfunction of the fuel system or emission control system.

⚠ CAUTION - Exterior paint

Do not spill fuel on the exterior surfaces of the vehicle. Any type of fuel spilled on painted surfaces may damage the paint.

STEERING WHEEL

Electric power steering (EPS)

Power steering uses a motor to assist you in steering the vehicle. If the engine is off or if the power steering system becomes inoperative, the vehicle may still be steered, but it will require increased steering effort.

The electric power steering is controlled by the power steering control unit which senses the steering wheel torque and vehicle speed to command the motor.

The steering wheel becomes heavier as the vehicle's speed increases and becomes lighter as the vehicle's speed decreases for better control of the steering wheel.

Should you notice any change in the effort required to steer during normal vehicle operation, have the power steering checked by an authorized Kia dealer.

* NOTICE

The following symptoms may occur during normal vehicle operation:

- The EPS warning light does not illuminate.
- The steering effort is increased immediately after turning the ignition switch or ENGINE START/STOP button to the ON position. This happens as the system performs the EPS system diagnostics. When the diagnostics are completed, the steering wheel will return to its normal condition
- A click noise may be heard from the EPS relay after the ignition switch is turned to the ON or LOCK position or ENGINE START/STOP button to the ON or OFF position.
- Motor noise may be heard when the vehicle is at a stop or at a low driving speed.

(Continued)

(Continued)

- When abnormality is detected in the electric power steering system, to prevent a deadly accident, the steering assist function will stop. At this time, the warning light turns on or blinks on the cluster. The steering wheel may become difficult to control or operate. Have your vehicle checked immediately, after moving the vehicle to a safe zone.
- The steering effort increases if the steering wheel is rotated continuously when the vehicle is not in motion. However, after a few minutes, it will return to its normal condition.
- When you operate the steering wheel in low temperature, noise may occur. If the temperature rises, the noise will likely disappear. This is a normal condition.
- When the charging system warning light comes on or the battery voltage is low (when the alternator or battery does not operate normally), the steering wheel may get heavy and become difficult to control or operate abnormally.

If the Electric Power Steering System does not operate normally, the warning light will illuminate on the instrument cluster. The steering wheel may require increased steering effort. Take your vehicle to an authorized Kia dealer and have the vehicle checked as soon as possible.

Tilt steering (if equipped)

Tilt steering allows you to adjust the steering wheel before you drive. You can also raise it to give your legs more room when you exit and enter the vehicle.

The steering wheel should be positioned so that it is comfortable for you to drive, while permitting you to see the instrument panel warning lights and gauges.

⚠ WARNING - Steering wheel adjustment

Never adjust the angle and height of the steering wheel while driving. You may lose steering control



To change the steering wheel angle, pull down the lock release lever (1), adjust the steering wheel to the desired angle (2), then pull up the lock-release lever to lock (3) the steering wheel in place. Be sure to adjust the steering wheel to the desired position before driving.

* NOTICE

After adjustment, sometimes the lock release lever may not lock the steering wheel. It is not a malfunction. This occurs when two gears are not engaged correctly. In this case, adjust the steering wheel again and then lock the steering wheel.

Horn

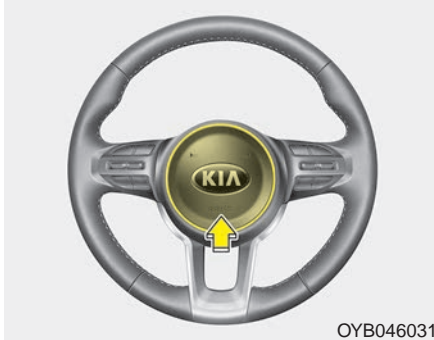

To sound the horn, press the horn symbols on your steering wheel. Check the horn regularly to be sure it operates properly.

* NOTICE

To sound the horn, press the area indicated by the horn symbol on your steering wheel (see illustration). The horn will operate only when this area is pressed.

MIRRORS

Inside rearview mirror

Adjust the rearview mirror so that the center view through the rear window is seen. Make this adjustment before you start driving.

Do not place objects in the rear seat which would interfere with your vision through the rear window.

⚠ WARNING - Mirror adjustment

Do not adjust the rearview mirror while the vehicle is moving. This could result in loss of control.

⚠ WARNING

Do not modify the inside mirror in any manner including installing a wider mirror. Doing so could result in injury during an accident or deployment of the air bag.

Day/night rearview mirror

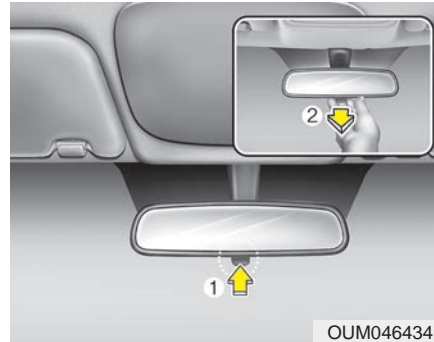

Make this adjustment before you start driving and while the day/night lever is in the day position (1).

Pull the day/night lever toward you (2) to reduce the glare from the headlights of the vehicles behind you during night driving.

Remember that you lose some rearview clarity in the night position.

* (1) : Day, (2) : Night

Day/night rearview mirror with Telematics function (if equipped)



For day and night function:

Make this adjustment before you start driving and while the day/night lever (1) is in the day position.

Pull the day/night lever (2) toward you to reduce the glare from the headlights of the vehicles behind you during night driving.

Remember that you lose some rearview clarity in the night position.

* (1) : Day, (2) : Night



OSC040588N

For Telematics button function:

1. Virtual Assistant button
2. UVO button
3. Roadside Assist button

Telematics buttons are also located on the mirror.

Outside rearview mirror

Be sure to adjust mirror angles before driving.

Your vehicle is equipped with both left-hand and right-hand outside rearview mirrors. The mirrors can be adjusted remotely with the remote switch (if equipped). The mirror heads can be folded to prevent damage during an automatic car wash or when passing through a narrow street.

The right outside rearview mirror is convex. Objects seen in the mirror are closer than they appear.

Use your interior rearview mirror or direct observation to determine the actual distance of following vehicles when changing lanes.

⚠ CAUTION - Rearview mirror

Do not scrape ice off the mirror face; this may damage the surface of the glass. If ice should restrict movement of the mirror, do not force the mirror for adjustment. To remove ice, use a deicer spray, or a sponge or soft cloth with very warm water.

⚠ WARNING - Mirror adjustment

Do not adjust or fold the outside rearview mirrors while the vehicle is moving. This could result in loss of control.

⚠ CAUTION

When cleaning the mirror, use a paper towel or similar material dampened with glass cleaner. Do not spray glass cleaner directly on the mirror. It may cause the liquid cleaner to enter the mirror housing.

Remote control

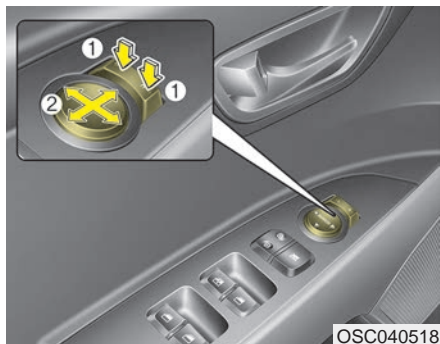

Electric type

The electric remote control mirror switch allows you to adjust the position of the left and right outside rearview mirrors. To adjust the position of either mirror, the ignition switch or ENGINE START/STOP button should be in the ACC or ON position.

To adjust the position of either mirror, press the R or L button (1) to select the right side mirror or the left side mirror, then press a corresponding point (▲) on the mirror adjustment control to position the selected mirror up, down, left or right.

After adjustment, press the R or L button again to prevent any inadvertent adjustment.

⚠ CAUTION - Outside mirror

- ***The mirrors stop moving when they reach the maximum adjusting angles, but the motor continues to operate while the switch is pressed. Do not press the switch longer than necessary as the motor may be damaged.***
- ***Do not attempt to adjust the outside rearview mirror by hand. Doing so may damage the parts.***
- ***When the mirror control, press exactly "▲"(2) marking area. Otherwise, the mirror will move to unintended direction or malfunction.***

Folding the outside rearview mirror

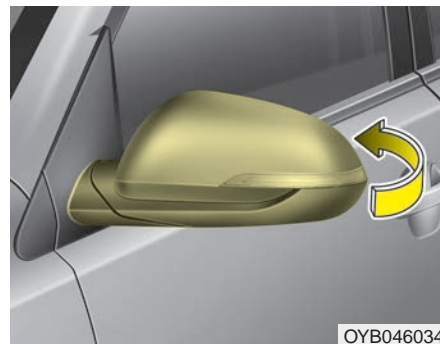

Manual type

To fold the outside review mirror, grasp the housing of the mirror and then fold it toward the rear of the vehicle.

INSTRUMENT CLUSTER

■ Type A



1. Tachometer
2. Speedometer
3. Engine coolant temperature gauge
4. Fuel gauge
5. Warning and indicator lights
6. LCD display

■ Type B



* The actual cluster and contents of the LCD display in the vehicle may differ from the illustration.

OSC040101/OSC040102

Instrument Cluster Control

Adjusting Instrument Cluster Illumination

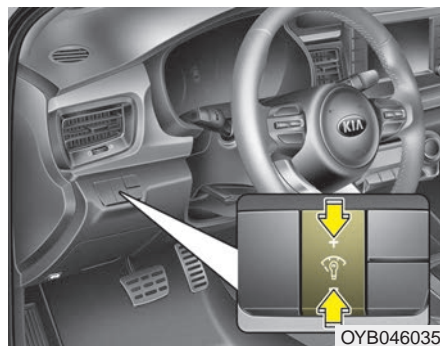

The instrument panel illumination intensity can be adjusted by pressing the control switch with the headlight switch in any position when the ignition switch or ENGINE START/STOP button is in the ON position.

■ Type A

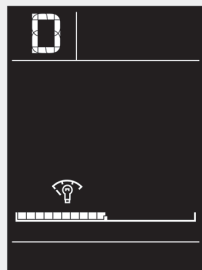

■ Type B



- If you hold the illumination control button (“+” or “-”), the brightness will be changed continuously.
- If the brightness reaches the maximum or minimum level, an alarm will sound.

LCD Display Control

■ Type A



■ Type B

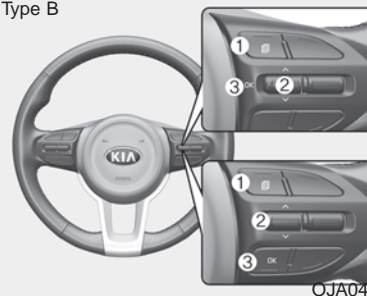

The LCD Display modes can be changed by using the control buttons on the steering wheel.

[Type A]

- (1) TRIP : TRIP button for changing trip modes
- (2) RESET : RESET button for resetting items

[Type B]

- (1)  : MODE button for changing LCD modes
- (2) \wedge/\vee : MOVE scroll switch to select items
- (3) OK : SET/RESET button for setting or resetting items

* For the LCD modes, refer to “LCD Display” in this chapter.

Gauges

Speedometer



The speedometer indicates the forward speed of the vehicle.

The speedometer is calibrated in miles per hour and/or kilometers per hour.

Tachometer



The tachometer indicates the approximate number of engine revolutions per minute (rpm).

Use the tachometer to select the correct shift points and to prevent lugging and/or over-revving the engine.



CAUTION - Red zone

Do not operate the engine within the tachometer's RED ZONE. This may cause severe engine damage.

Engine coolant temperature gauge



OSC047104N

This gauge shows the temperature of the engine coolant when the ignition switch or ENGINE START/STOP button is ON.

If the gauge pointer moves beyond the normal range area toward the “H” position, it indicates overheating that may damage the engine.

Do not continue driving with an overheated engine. If your vehicle overheats, refer to “If the engine overheats” in chapter 6.

⚠ WARNING - Hot radiator
Never remove the radiator cap when the engine is hot. The engine coolant is under pressure and could cause severe burns. Wait until the engine is cool before adding coolant to the reservoir.

Fuel gauge



OSC047105N

The fuel gauge indicates the approximate amount of fuel remaining in the fuel tank.

*** NOTICE**

- The fuel tank capacity is given in chapter 8.
- The fuel gauge is supplemented by a distance to empty mileage, and/or a low fuel warning light which will illuminate when the fuel tank is nearly empty.
- On inclines or curves, the fuel gauge pointer may fluctuate or the low fuel warning light may come on earlier than usual due to the movement of fuel in the tank.

*** NOTICE - Fuel gauge**

Running out of fuel can expose vehicle occupants to danger. You must stop and obtain additional fuel as soon as possible after the warning light comes on or when the gauge indicator comes close to the “E” (Empty) level.

⚠ CAUTION - Low fuel

Avoid driving with an extremely low fuel level. Running out of fuel could cause the engine to misfire, damaging the catalytic converter.

*** NOTICE**

The fuel display may not be accurate if the vehicle is on an incline.

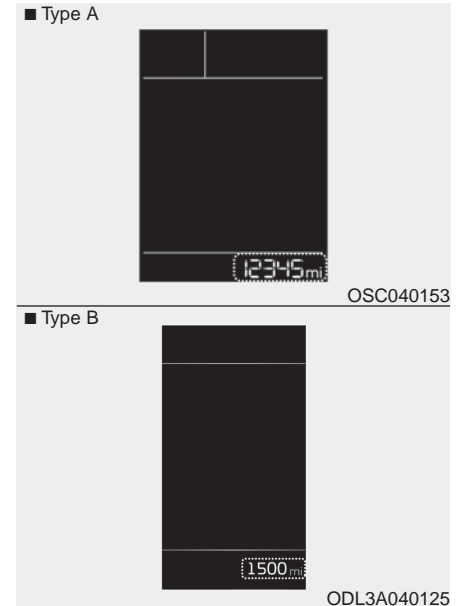
Odometer

The odometer indicates the total distance the vehicle has been driven.

You will also find the odometer useful to determine when periodic maintenance should be performed.

- Odometer range :
0 ~ 999,999 miles or 0 ~ 1,599,999 km.

Outside Temperature Gauge

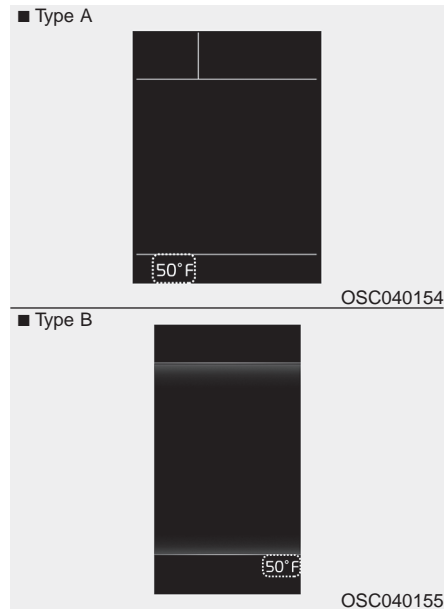

- Temperature range :
- Type A Cluster : -40°F ~ 199°F
(-40°C ~ 85°C)
- Type B Cluster : - 40°F ~ 211°F
(- 40°C ~ 85°C)

This gauge indicates the current outside air temperatures by 1°F (1°C).

The outside temperature on the display may not change immediately like a general thermometer to prevent the driver from being inattentive. To change the temperature unit (from °C to °F or from °F to °C)

- Type A Cluster

Press the TRIP button for 5 seconds, the temperature unit is blink. And then press the RESET button, the temperature unit is changed. Press the TRIP button for more than one second.

- Type B Cluster

The temperature unit can be changed by using the “User Settings” mode of the LCD Display.

* For more details, refer to “LCD Display” in this chapter.

Transmission Shift Indicator

Intelligent Variable Transmission (if equipped)

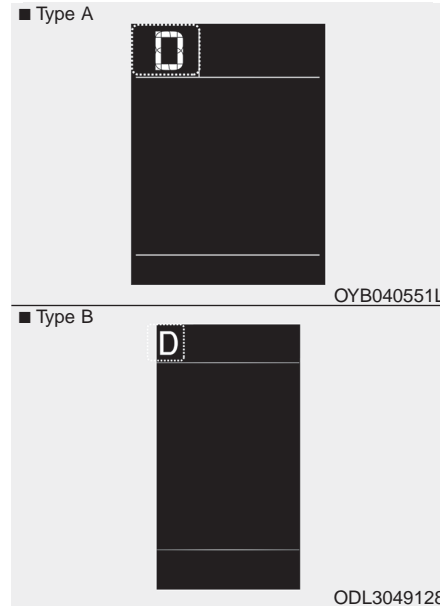

- Park : P
- Reverse : R
- Neutral : N
- Drive : D
- Manual Mode : 1, 2, 3, 4, 5, 6, 7, 8

This indicator displays which intelligent variable transmission shift lever is selected.

Manual Transmission shift indicator (if equipped)

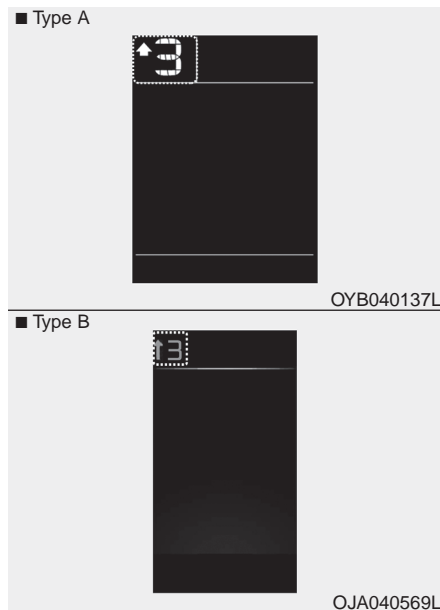

For example

- ▲3: Indicates that shifting up to the 3rd gear is desired (currently the shift lever is in the 2nd or 1st gear).
- ▼3: Indicates that shifting down to the 3rd gear is desired (currently the shift lever is in the 4th, 5th, or 6th gear).

When the system is not working properly, the indicator is not displayed.

This indicator informs which gear is desired while driving to save fuel.

- Shifting up : ▲2, ▲3, ▲4, ▲5, ▲6
- Shifting down : ▼3, ▼4, ▼5

TRIP COMPUTER

Trip information (Trip computer)

The trip computer is a microcomputer-controlled driver information system that displays information related to driving.

* NOTICE

Some driving information stored in the trip computer (for example Average Vehicle Speed) resets if the battery is disconnected.

Trip Modes

- For Type A cluster

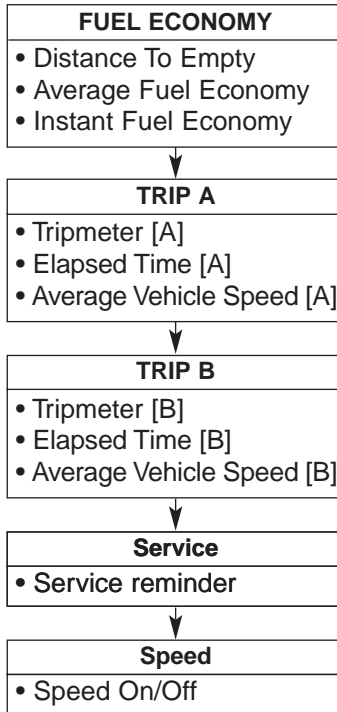

To change the trip mode, press the TRIP button.

- For Type B cluster

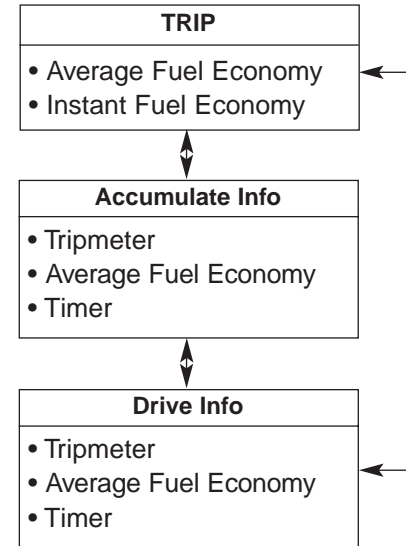

To change the trip mode, scroll the MOVE scroll switch (^/∨) in the trip computer mode.

Fuel Economy

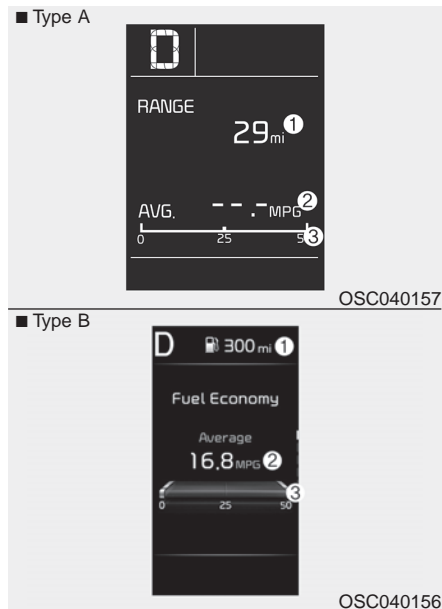

Distance To Empty (1)

- The range is the estimated distance the vehicle can be driven with the remaining fuel.

- Distance range : 1~9,999 mi or km

- If the estimated distance is below 1 mi. (1 km), the trip computer will display “---” as distance to empty.

* NOTICE

- If the vehicle is not on level ground or the battery power has been interrupted, the distance to empty function may not operate correctly.
- The distance to empty may differ from the actual driving distance as it is an estimate of the available driving distance.
- The trip computer may not register additional fuel if less than 1.6 gallons (6 liters) of fuel are added to the vehicle.
- The fuel economy and distance to empty may vary significantly based on driving conditions, driving habits, and condition of the vehicle.

Average Fuel Economy (2)

- The average fuel economy is calculated by the total driving distance and fuel consumption since the last average fuel economy reset.
- Fuel economy range: 0.0 ~ 99.9 MPG or L/100 km, km/L
- The average fuel economy can be reset both manually and automatically.

Manual reset

To clear the average fuel economy manually, press the RESET (for Type A cluster), OK (reset) (for Type B cluster) on the steering wheel for more than 1 second when the average fuel economy is displayed.

Automatic reset (for type B cluster)

To make the average fuel economy be reset automatically whenever refueling, select the "Fuel Econ. Reset" mode in User Setting menu of the LCD display (Refer to "User settings mode" on this chapter).

- OFF - You may set to default manually by using the trip switch reset button.
- After Vehicle On – The vehicle is automatically set to default, if opening the driver's door after turning off the engine or 3 minutes passes after restarting the engine.
- After refueling - After refueling more than 1.6 gallons (6 liters) and driving over 1 mph (1 km/h), the vehicle will reset to default automatically.

*** NOTICE**

The average fuel economy is not displayed for more accurate calculation if the vehicle does not drive more than 10 seconds or 0.19 miles (300 meters) since the ignition or ENGINE STRAT/STOP button is turned to ON.

Instant Fuel Economy (3)

- This mode displays the instant fuel economy during the last few seconds when the vehicle speed is more than 5 MPH (8 km/h).
 - Fuel economy range: 0.0 ~ 50.0 MPG or 0.0 ~ 30.0 L/100km

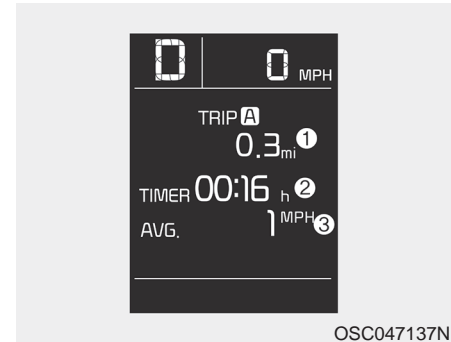
Trip A/B (for type A cluster)**Tripmeter (1)**

- The tripmeter is the total driving distance since the last tripmeter reset.
 - Distance range: 0.0~ 9999.9 mi. or km
- To reset the tripmeter, press the RESET button on the steering wheel for more than 1 second when the tripmeter is displayed.

Elapsed Time (2)

- The elapsed time is the total driving time since the last elapsed time reset.
 - Time range (hh:mm) : 00:00 ~ 99:59
- To reset the elapsed time, press the RESET button on the steering wheel for more than 1 second when the elapsed time is displayed.

* NOTICE

Even if the vehicle is not in motion, the elapsed time keeps going while the engine is running.

Average Vehicle Speed (3)

- The average vehicle speed is calculated by the total driving distance and driving time since the last average vehicle speed reset.
 - Speed range : 0 ~ 999 mph or km/h
- To reset the average vehicle speed, press the RESET button on the steering wheel for more than 1 second when the average vehicle speed is displayed.

* NOTICE

- The average vehicle speed is not displayed if the driving distance is less than 0.19 miles (300 meters) since the ignition or ENGINE STRAT/STOP button is turned to ON, or the driving time is less than 10 seconds since the ignition switch is turned to ON.
- Even if the vehicle is not in motion, the average vehicle speed keeps going while the engine is running.

Digital speedometer

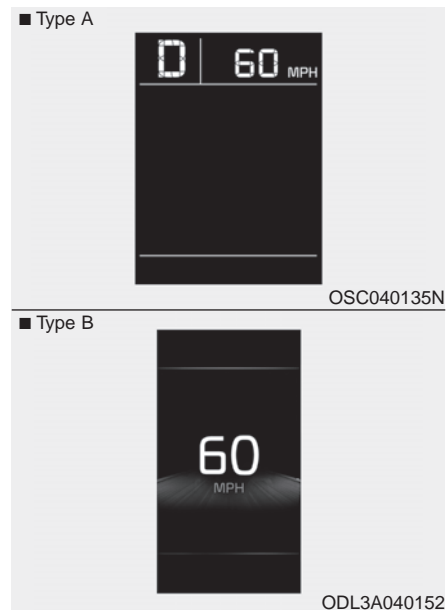

This mode displays the current speed of the vehicle.

■ For Type A cluster



OSC040158N

■ For Type A cluster



OFB047121

Digital speed ON/OFF mode (For Type A cluster)

Switch to Speed Mode using the trip switch in Trip mode, and press and hold the RESET button for more than 1 second. Then it will be switched from SPEED ON to SPEED OFF or the other way around.

Accumulated driving information mode (for type B cluster)

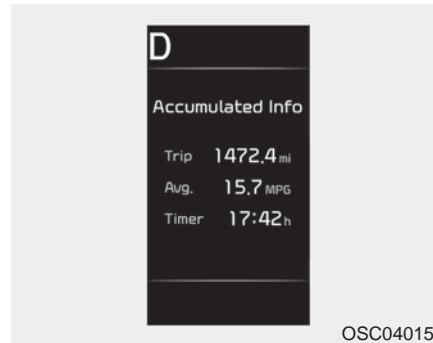

OSC040159

Displays accumulated information starting from a mileage/fuel efficiency/time default point.

- Accumulated information is calculated after the vehicle has run for more than 0.2 miles (300 meters).
- If you press the “OK” button for more than 1 second after the Cumulative Information is displayed, the information will be reset.
- If the engine is running, even when the vehicle is not in motion, the information will be accumulated.

Driving Information display mode (for type B cluster)

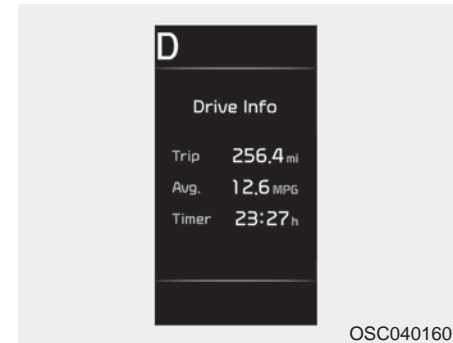

OSC040160

The vehicle will display Driving Information once per each ignition cycle.

- Fuel efficiency is calculated after the vehicle has run for more than 0.2 miles (300 meters).
- If opening the driver's door after turning off the engine or 3 minutes passes after restarting the engine, the Driving Information is reset.
- If you press the “OK” button for more than 1 second after the Driving Information is displayed, the information will be reset.

- If the engine is running, the information will be accumulated even when the vehicle is not in motion.

Service Mode (for Type A cluster)

Service in

If the remaining mileage or time reaches 900 miles (1,500 km) or 30 days, the service symbol (🔧) will blink for several seconds each time you set the ignition switch or ENGINE START/STOP button to the ON position.

Service required

If you exceed the specified service interval, the service symbol (🔧) will blink each time you turn ON the vehicle.

To reset the service interval, press the RESET button for more than 5 seconds and then when the miles and days blink press the RESET button for more than 1 second.

If the service interval is not set, the service symbol (🔧) will not be displayed.

*** NOTICE**

To change or deactivate the service interval, consult an authorized Kia dealer.

LCD DISPLAY (FOR TYPE B CLUSTER)

LCD Display Mode

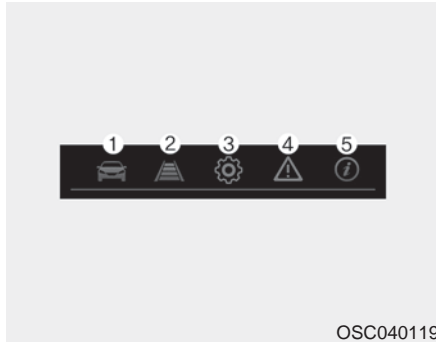

(1) Trip Computer mode

This mode displays driving information like the tripmeter, fuel economy, and so on.

For more details, refer to “Trip Computer” in this chapter.

(2) Driving Assist mode

This mode displays the state of the below functions.

- Lane Departure Warning (if equipped)
- Lane Keeping Assist (if equipped)
- Lane Following Assist (if equipped)
- Driver Attention Warning (if equipped)

(3) User Settings mode

On this mode, you can change the settings of the doors, lamps and so on.

(4) Master Warning mode

This mode informs the driver the following situations:

- Forward Collision-Avoidance Assist malfunction (if equipped)
- Forward Collision-Avoidance Assist radar blocked (if equipped)
- Blind-Spot Collision Warning malfunction (if equipped)
- Blind-Spot Collision Warning radar blocked (if equipped)
- High Beam Assist malfunction (if equipped)
- LED headlamp malfunction (if equipped)
- TPMS failure, low pressure (if equipped), etc.

At this time, a Master Warning icon () will appear on the LCD display. If the warning situations is solved, the master warning light will be turned off and the Master warning icon will disappear.

(5) Information mode

This mode informs of the digital speedometer.

* For controlling the LCD modes, refer to “LCD Display Control” in this chapter.

Driving Assist mode (if equipped)

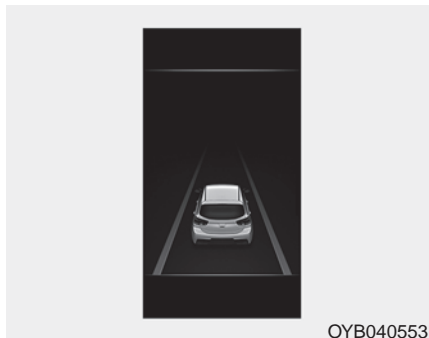

This mode displays the state of :

- Lane Departure Warning (if equipped)
Lane Keeping Assist (if equipped)
Lane Following Assist (if equipped)
- Driver Attention Warning (if equipped)

* For more details, refer to each system information in chapter 5.

Settings

To change the Driver Assistance settings, press the OK button on the steering wheel for more than 1 second when the Driving Assist mode is displayed.

⚠ WARNING

While driving, please do not change the setting mode. It may distract your attention and cause the accident.

Item	Explanation
Warning Timing	Normal/Late
Driver Attention Warning	Leading Vehicle Departure Alert/Inattentive Driving Warning
Forward Safety	Active Assist/Warning Only/Off
Lane Safety	Standard LKA/Lane Departure Warning/Off
Blind-Spot Safety	Warning Only/Off
Parking Safety	Rear Cross-Traffic Safety

*** NOTICE**

The information provided may differ depending on which functions are applicable to your vehicle.

User Settings Mode (for type B cluster)

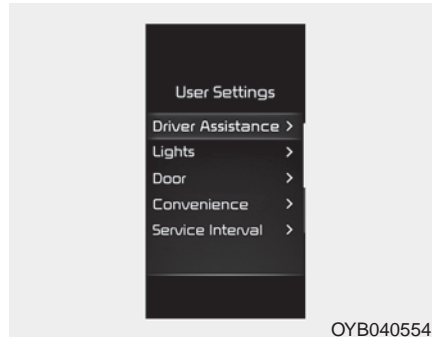

On this mode, you can change setting of the doors, lamps, and so on.

⚠ WARNING

Do not adjust the User Settings while driving. You may lose steering control and/or cause an accident or serious personal injury or death.

Shift to P to edit settings/Engage parking brake to edit settings

This warning message appears if you try to adjust the User Settings while driving.

- Intelligent Variable Transmission
For your safety, change the User Settings after parking the vehicle, applying the parking brake and moving the shift lever to P (Park).

- Manual Transmission
For your safety, change the User Settings after engaging the parking brake and moving the shift lever to N (Neutral).

1. Driver Assistance (if equipped)

Items	Explanation
Warning Timing (if equipped)	<ul style="list-style-type: none"> • Normal/Late To select the Warning timing.
Driver Attention Warning (if equipped)	<ul style="list-style-type: none"> • Leading Vehicle Departure Alert/Inattentive Driving Warning To select the function. ※ For more details, refer to “Driver Attention Warning (DAW)” in chapter 5.
Forward Safety (if equipped)	<ul style="list-style-type: none"> • Active Assist/Warning Only/Off To select the function. ※ For more details, refer to “Forward Collision-Avoidance Assist (FCA)” in chapter 5.
Lane Safety (if equipped)	<ul style="list-style-type: none"> • Standard LKA/Lane Departure Warning/Off To select the function. ※ For more details, refer to “Lane Keeping Assist (LKA)” in chapter 5.
Blind-Spot Safety (if equipped)	<ul style="list-style-type: none"> • Warning Only/Off To select the function. ※ For more details, refer to “Blind-Spot Collision Warning (BCW)” in chapter 5.
Parking Safety (if equipped)	<ul style="list-style-type: none"> • Rear Cross-Traffic Safety To select the function. ※ For more details, refer to “Rear Cross-Traffic Collision Warning (RCCW)” in chapter 5.

※ The information provided may differ depending on which functions are applicable to your vehicle.

2. Lights (if equipped)

Items	Explanation
One Touch Turn Signal	<ul style="list-style-type: none">• Off : The one touch turn signal function will be deactivated.• 3, 5, 7 Flashes : The turn signal indicator will blink 3, 5, or 7 times when the turn signal lever is moved slightly. <p>※ For more details, refer to “Lighting” in this chapter.</p>
Headlight Delay	<ul style="list-style-type: none">• To activate or deactivate the headlight delay function.
High Beam Assist	<ul style="list-style-type: none">• To activate or deactivate High Beam Assist.

※ The information provided may differ depending on which functions are applicable to your vehicle.

3. Door

Items	Explanation
Auto Lock	<ul style="list-style-type: none"> • Enable on shift (if equipped with Intelligent Variable Transmission): All doors will be automatically locked if the vehicle is shifted from the P (Park) position to the R (Reverse), N (Neutral), or D (Drive) position. (with the engine ON, it is activated) • Enable on speed: All doors will be automatically locked when the vehicle speed exceeds 9.3 mph (15 km/h).
Auto Unlock	<ul style="list-style-type: none"> • On shift to P (if equipped with Intelligent Variable Transmission): All doors will be automatically unlocked if the gear is shifted to the P (Park) position. (with the engine ON, it is activated) • Vehicle off/On key out : All doors will be automatically unlocked when the ENGINE START/STOP button is set to the OFF position or the ignition key is removed from the ignition switch. • Off : The auto door unlock operation will be canceled.
2 Press Unlock (if equipped)	<ul style="list-style-type: none"> • If this item is checked, the two press unlock will be activated. The driver's door will unlock if the door unlock button is pressed. When the door unlock button is pressed again within 4 seconds, the remaining doors will unlock.
Horn Feedback (if equipped)	<ul style="list-style-type: none"> • If this item is checked, the horn feedback will be activated. After locking the door by pressing the lock button on the transmitter, if you press the lock button again within 4 seconds, the warning sound will operate once to indicate that all doors are locked.

※ The information provided may differ depending on which functions are applicable to your vehicle.

4. Convenience (if equipped)

Items	Explanation
Rear Occupant Alert (if equipped)	<ul style="list-style-type: none">• If this item checked, the Rear Occupant Alert will be activated.
Wiper/Lights Display (if equipped)	<ul style="list-style-type: none">• If this item checked, the Wiper/Lights Display will be activated.
Icy road warning (if equipped)	<ul style="list-style-type: none">• If this item is checked, the Icy road warning display will be activated.

※ The information provided may differ depending on which functions are applicable to your vehicle.

5. Service Interval (if equipped)

Items	Explanation
Enable Service Interval	<ul style="list-style-type: none">• If this item is checked, the Service Interval function will be activated.
Adjust Interval	<ul style="list-style-type: none">• If the service interval menu is activated, you may adjust the time and distance.
Reset	<ul style="list-style-type: none">• To reset the service interval function.

* NOTICE

To use the service interval menu, consult an authorized **Kia** dealer.

If the service interval is activated and the time and distance is adjusted, messages are displayed in the following situations each time the vehicle is turned on.

- Service in: Displayed to inform the driver the remaining mileage and days to service.
- Service required: Displayed when the mileage and days to service has been reached or passed.

If any of the following conditions occur, the mileage and number of days to service may be incorrect.

- The battery cable is disconnected.
- The battery is discharged.

6. Theme Selection (if equipped)

Items	Explanation
Theme Selection	<ul style="list-style-type: none"> • Theme A/Theme B/Theme C To select the theme of instrument cluster LCD.

7. Other (if equipped)

Items	Explanation
Fuel Econ. Reset	<ul style="list-style-type: none"> • Off: The average fuel economy will not reset. • After Vehicle On/After refueling: The average fuel economy will reset automatically after vehicle on/refueling. ※ For more details, refer to “Trip Computer” in this chapter.
Speed Unit	<ul style="list-style-type: none"> • km/h, MPH To select Speed unit.
Fuel Econ. Unit	<ul style="list-style-type: none"> • US gallon, UK gallon To select the Fuel economy unit.
Temperature Unit	<ul style="list-style-type: none"> • °C, °F To select the Temperature unit.
Tire Pressure Unit (if equipped)	<ul style="list-style-type: none"> • psi, kPa, bar To select the Tire Pressure Unit.

※ The information provided may differ depending on which functions are applicable to your vehicle.

8. Language (if equipped)

Items	Explanation
Language	<ul style="list-style-type: none">• To select language.

9. Reset

Items	Explanation
Reset	You can reset the menus in the User Settings mode. All menus in the User Settings mode are reset to factory settings, except language and service interval.

Warning messages (for type B cluster)

Warning messages appear on the LCD to warn the driver. It is located in the center of the instrument cluster.

The warning message may appear differently depending on the type of instrument cluster and some may not show the warning message at all.

The warning message is shown in either symbol, symbol and text, or text type only.

Door, hood, trunk (liftgate) open

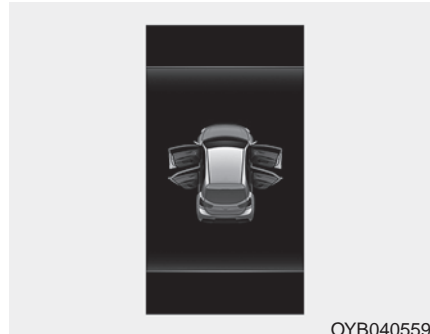

- This warning is displayed indicating which door, the hood, or the trunk (liftgate) is open.

Lights mode (if equipped)

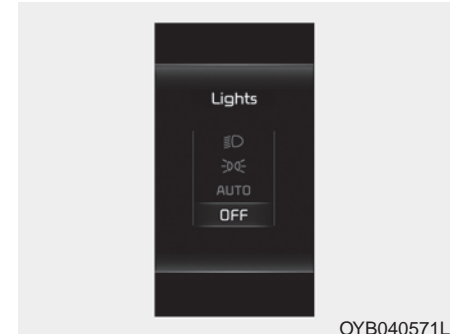

This indicator displays which exterior light is selected using the lighting control.

You can activate or deactivate Wiper/Lights Display function from the User Settings mode in the cluster LCD display.

Wiper mode (if equipped)

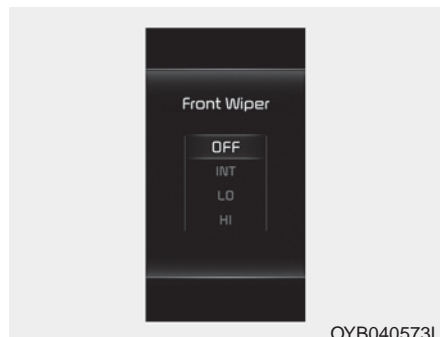

This indicator displays which wiper speed is selected using the wiper control.

You can activate or deactivate Wiper/Lights Display function from the User Settings mode in the cluster LCD display.

Engine Overheated

This warning message illuminates when the engine coolant temperature is above 248°F (120°C). This means that the engine is overheated and may be damaged.

If your vehicle is overheated, refer to “Overheating” in chapter 6.

Shift to P (for smart key system and Intelligent Variable Transmission)

- This warning message illuminates if you try to turn off the engine without the shift lever in P (Park) position.
- At this time, the ENGINE START/STOP button turns to the ACC position (If you press the ENGINE START/STOP button once more, it will turn to the ON position).

Low key battery (for smart key system)

- This warning message illuminates if the battery of the smart key is discharged when the ENGINE START/STOP button changes to the OFF position.

Press brake pedal to start engine (for smart key system and Intelligent Variable Transmission)

- This warning message illuminates if the ENGINE START/STOP button changes to the ACC position twice by pressing the button repeatedly without depressing the brake pedal.
- It means that you should depress the brake pedal to start the engine.

Press clutch pedal to start engine (for smart key system and Manual Transmission)

- This warning message illuminates if the ENGINE START/STOP button changes to the ACC position twice by pressing the button repeatedly without depressing the clutch pedal.
- It means that you should depress the clutch pedal to start the engine.

Key not in vehicle (for smart key system)

- This warning message illuminates if the smart key is not in the vehicle when you press the ENGINE START/STOP button.
- It means that you should always have the smart key with you.

Key not detected (for smart key system)

- This warning message illuminates if the smart key is not detected when you press the ENGINE START/STOP button.

Press START button again (for smart key system)

- This warning message illuminates if you can not operate the ENGINE START/STOP button when there is a problem with the ENGINE START/STOP button system.
- It means that you could start the engine by pressing the ENGINE START/STOP button once more.
- If the warning illuminates each time you press the ENGINE START/STOP button, have your vehicle inspected by an authorized Kia dealer.

Press START button with key (for smart key system)

- This warning message illuminates if you press the ENGINE START/STOP button while the warning message "Key not detected" is illuminating.
- At this time, the immobilizer indicator light blinks.

Check BRAKE SWITH fuse (for smart key system and Intelligent Variable Transmission)

- This warning message illuminates if the brake switch fuse is disconnected.
- It means that you should replace the fuse with a new one. If that is not possible, you can start the engine by pressing the ENGINE START/STOP button for 10 seconds in the ACC position.

Shift to P or N to start engine (for smart key system and Intelligent Variable Transmission)

- This warning message illuminates if you try to start the engine with the shift lever not in the P (Park) or N (Neutral) position.

*** NOTICE**

You can start the engine with the shift lever in the N (Neutral) position. But, for your safety, we recommend that you start the engine with the shift lever in the P (Park) position.

Check headlight LED (if equipped)

- This warning message is displayed if there is a problem with the LED headlight.

In this case, have your vehicle inspected by an authorized Kia dealer.

WARNING AND INDICATOR LIGHTS

Warning lights

* NOTICE - Warning lights

Make sure that all warning lights are OFF after starting the engine. If any light is still ON, this indicates a situation that needs attention.

Air bag Warning Light



This warning light illuminates:

- Once you set the ignition switch or ENGINE START/STOP button to the ON position.
 - It illuminates for approximately 6 seconds and then goes off.
- When there is a malfunction with the SRS.

In this case, have your vehicle inspected by an authorized Kia dealer.

Seat Belt Warning Light



This warning light informs the driver that the seat belt is not fastened.

* For more details, refer to the “Seat Belts” in chapter 3.

Parking Brake & Brake Fluid Warning Light



This warning light illuminates:

- Once you set the ignition switch or ENGINE START/STOP button to the ON position.
 - It illuminates for approximately 3 seconds
- When the parking brake is applied.
- When the brake fluid level in the reservoir is low.
 - If the warning light illuminates with the parking brake released, it indicates the brake fluid level in reservoir is low.

If the brake fluid level in the reservoir is low:

1. Drive carefully to the nearest safe location and stop your vehicle.
2. With the engine stopped, check the brake fluid level immediately and add fluid as required (For more details, refer to "Brake Fluid" in chapter 7).

Then check all brake components for fluid leaks. If any leak on the brake system is still found, the warning light remains on, or the brakes do not operate properly, do not drive the vehicle.

In this case, have your vehicle towed to an authorized Kia dealer and inspected.

Dual-diagonal braking system

Your vehicle is equipped with dual-diagonal braking systems. This means you still have braking on two wheels even if one of the dual systems should fail.

With only one of the dual systems working, greater pedal pressure will be required to stop the vehicle.

Also, the vehicle will require increased stopping distance with only a portion of the brake system working.

If the brakes fail while you are driving, shift to a lower gear for additional engine braking and stop the vehicle as soon as it is safe to do so.

Driving the vehicle with a warning light ON is dangerous. If the Parking Brake & Brake Fluid Warning Light illuminates with the parking brake released, it indicates that the brake fluid level is low.

In this case, have your vehicle inspected by an authorized Kia dealer.

**Anti-lock Brake System
(ABS) Warning Light****This warning light illuminates:**

- Once you set the ignition switch or ENGINE START/STOP button to the ON position.
 - It illuminates for approximately 3 seconds and then goes off.
- When there is a malfunction with the ABS (The normal braking system will still be operational without the assistance of the anti-lock brake system).

In this case, have your vehicle inspected by an authorized Kia dealer.

**Electronic Brake force
Distribution
(EBD) System
Warning Light****These two warning lights illuminate at the same time while driving:**

- When the ABS and regular brake system may not work normally. In this case, have your vehicle inspected by an authorized Kia dealer.

**⚠ WARNING - ABS/Brake
Light**

When both ABS and Parking Brake & Brake Fluid Warning Lights are on, the brake system will not work normally and you may experience an unexpected and dangerous situation during sudden braking thereby increasing the risk of a crash or injury.

In this case, avoid high speed driving and abrupt braking. Have your vehicle inspected by an authorized Kia dealer as soon as possible.

* **NOTICE** - Electronic Brake force Distribution (EBD) System Warning Light

When the ABS Warning Light is on or both ABS and Parking Brake & Brake Fluid Warning Lights are on, the speedometer, odometer, or trip-meter may not work. Also, the EPS Warning Light may illuminate and the steering effort may increase or decrease.

In this case, have your vehicle inspected by an authorized Kia dealer as soon as possible.

Electric Power Steering (EPS) Warning Light (if equipped)



This warning light illuminates:

- Once you set the ignition switch or ENGINE START/STOP button to the ON position.
 - It remains on until the engine is started.
- When there is a malfunction with the EPS.

In this case, have your vehicle inspected by an authorized Kia dealer.

Malfunction Indicator Lamp (MIL)



This warning light illuminates:

- Once you set the ignition switch or ENGINE START/STOP button to the ON position.
 - It remains on until the engine is started.
- When there is a malfunction with the emission control system.

In this case, have your vehicle inspected by an authorized Kia dealer.

⚠ CAUTION

If the Malfunction Indicator Lamp (MIL) illuminates, potential catalytic converter damage is possible, which could result in loss of engine power.

In this case, have your vehicle inspected by an authorized Kia dealer as soon as possible.

⚠ CAUTION - Malfunction Indicator Lamp (MIL)

Driving with the Malfunction Indicator Lamp (MIL) on may cause damage to the emission control systems, which could affect drivability and/or fuel economy.

Charging System Warning Light

This warning light illuminates:

- When there is a malfunction with either the alternator or electrical charging system.

If there is a malfunction with either the alternator or electrical charging system:

1. Drive carefully to the nearest safe location and stop your vehicle.
2. Turn the engine off and check the alternator drive belt for looseness or breakage.

If the belt is adjusted properly, there may be a problem in the electrical charging system.

In this case, have your vehicle inspected by an authorized Kia dealer as soon as possible.

Engine Oil Pressure Warning Light

This warning light illuminates:

- When the engine oil pressure is low.

If the engine oil pressure is low:

1. Drive carefully to the nearest safe location and stop your vehicle.
2. Turn the engine off and check the engine oil level (For more details, refer to "Engine Oil" in chapter 7). If the level is low, add oil as required.

If the warning light remains on after adding oil or if oil is not available, have your vehicle inspected by an authorized Kia dealer as soon as possible.

 **CAUTION - Engine Overheating**

Do not continue driving with the engine overheated. Otherwise the engine may be damaged.

 **CAUTION - Engine damage**

If the engine is not stopped immediately after the engine oil pressure warning light is illuminated and stays on while the engine is running, serious engine damage may result.

If the warning light stays on while the engine is running, there may be serious engine damage. In this case,

1. Stop the vehicle as soon as it is safe to do so.
2. Turn off the engine and check the oil level. If the oil level is low, fill the engine oil to the proper level.
3. Start the engine again. If the warning light stays on after the engine is started, turn the engine off immediately. In this case, have your vehicle inspected by an authorized Kia dealer.

Low Fuel Level Warning Light



This warning light illuminates:

- When the fuel tank is nearly empty. Add fuel as soon as possible.

 **CAUTION - Low Fuel Level**

Driving with the Low Fuel Level warning light on or with the fuel level below “E” can cause the engine to misfire and damage the catalytic converter (if equipped).

Low Tire Pressure Warning Light



This warning light illuminates:

- Once you set the ignition switch or ENGINE START/STOP button to the ON position.
 - It illuminates for approximately 3 seconds and then goes off.
- When one or more of your tires are significantly underinflated.
- ✳For more details, refer to “Tire Pressure Monitoring System (TPMS)” in chapter 6.

This warning light remains on after blinking for approximately 70 seconds or repeats blinking on and off at intervals of approximately 3 seconds:

- When there is a malfunction with the TPMS.

In this case, have your vehicle inspected by an authorized Kia dealer as soon as possible.
- ✳For more details, refer to “Tire Pressure Monitoring System (TPMS)” in chapter 6.

⚠ WARNING

- Low tire pressure

- **Significantly low tire pressure makes the vehicle unstable and can contribute to loss of vehicle control and increased braking distances.**
- **Continued driving on tires with low tire pressure can cause the tires to overheat and fail, which may cause an accident.**

The TPMS cannot alert you to severe and sudden tire damage caused by external factors.

If you notice any vehicle instability, immediately take your foot off the accelerator pedal, apply the brakes gradually with light force, and slowly move to a safe position off the road.

Door Ajar Warning Light (if equipped)



This warning light illuminates:
When a door is not closed securely.

Trunk (liftgate) Open Warning Light (if equipped)



This warning light illuminates:
When the trunk (liftgate) is not closed securely.

Master Warning Mode (if equipped)



- This warning light informs the driver of the following situations:
 - Forward Collision-Avoidance Assist malfunction (if equipped)
 - Forward Collision-Avoidance Assist radar blocked (if equipped)
 - Blind-Spot Collision Warning malfunction (if equipped)
 - Blind-Spot Collision Warning radar blocked (if equipped)
 - High Beam Assist malfunction (if equipped)
 - LED headlamp malfunction (if equipped)
 - TPMS failure, low pressure (if equipped), etc.

If the warning situation is solved, the master warning light will turn off.

LED Headlamp Warning Light (if equipped)



This warning light illuminates:

- When there is a malfunction with the LED headlamp.

In this case, have the vehicle inspected by an authorized Kia dealer.

*** NOTICE**

Continuous driving with the LED Headlamp Warning Light on can reduce LED headlamp (low beam) life.

Ice Warning Light (if equipped)



This warning light blinks 5 times and then illuminates, and a warning chime also sounds 1 time:

- When the temperature on the Outside Temperature Gauge is below approximately 39°F (4°C) with the ignition switch or ENGINE START/STOP button in the ON position.

* NOTICE

If the ice warning light appears while driving, you should drive more attentively and safely refraining from over-speeding, rapid acceleration, sudden braking or sharp turning, etc.

Indicator Lights

Electronic Stability Control (ESC) Indicator Light



This indicator light illuminates:

- Once you set the ignition switch or ENGINE START/STOP button to the ON position.
 - It illuminates for approximately 3 seconds and then goes off.
- When there is a malfunction with the ESC system.

In this case, have your vehicle inspected by an authorized Kia dealer.

This indicator light blinks:

- While the ESC is operating.

*For more details, refer to “Electronic Stability Control (ESC)” in chapter 5.

Electronic Stability Control (ESC) OFF Indicator Light



This indicator light illuminates:

- Once you set the ignition switch or ENGINE START/STOP button to the ON position.
 - It illuminates for approximately 3 seconds and then goes off.
- When you deactivate the ESC system by pressing the ESC OFF button.

*For more details, refer to “Electronic Stability Control (ESC)” in chapter 5.

Immobilizer Indicator Light (without Smart key) (if equipped)



This indicator light illuminates:

- When the vehicle detects the immobilizer in your key while the ignition switch is ON.
 - At this time, you can start the engine.
 - The indicator light goes off after starting the engine.

This indicator light blinks:

- When there is a malfunction with the immobilizer system.

In this case, have your vehicle inspected by an authorized Kia dealer.

Immobilizer Indicator Light (with Smart Key)



This indicator light illuminates for up to 30 seconds:

- When the vehicle detects the smart key in the vehicle properly while the ENGINE START/STOP Button is ACC or ON.
 - At this time, you can start the engine.
 - The indicator light goes off after starting the engine.

This indicator light blinks for a few seconds:

- When the smart key is not in the vehicle.
 - In this situation, you can not start the engine.

This indicator light illuminates for 2 seconds and goes off:

- When the vehicle can not detect a smart key which is in the vehicle while the ENGINE START/STOP Button is ON.

In this situation, have your vehicle inspected by an authorized Kia dealer.

This indicator light blinks:

- When the battery of the smart key is weak.
 - In this situation, you can not start the engine. However, you can start the engine if you press the ENGINE START/STOP Button with the smart key. (For more details, refer to the “Starting the Engine” section in Chapter 5.).
- When there is a malfunction with the immobilizer system.

In this situation, have your vehicle inspected by an authorized Kia dealer.

Turn Signal Indicator Light

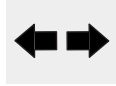

This indicator light blinks:

- When you turn the turn signal light on.

If any of the following occurs, there may be a malfunction with the turn signal system. In this case, have your vehicle inspected by an authorized Kia dealer.

- The indicator light does not blink but illuminates.
- The indicator light blinks more rapidly.
- The indicator light does not illuminate at all.

High Beam Indicator Light



This indicator light illuminates:

- When the headlights are on and in the high beam position
- When the turn signal lever is pulled into the Flash-to-Pass position.

Light ON Indicator Light



This indicator light illuminates:

- When the tail lights or headlights are on.

Front Fog Indicator Light (if equipped)



This indicator light illuminates:

- When the front fog lights are on.

High Beam Assist Indicator Light



This warning light illuminates :

- When the high beam is on with the light switch in the AUTO light position.
- If your vehicle detects oncoming or preceding vehicles, High Beam Assist will switch the high beam to low beam automatically.

*For more details, refer to “High Beam Assist (HBA)” in chapter 4.

Cruise Indicator Light (if equipped)

CRUISE

This indicator light illuminates:

- When the cruise control system is enabled.

✳For more details, refer to “Cruise Control System” in chapter 5.

Cruise SET Indicator Light (if equipped)

SET

This indicator light illuminates:

- When the cruise control speed is set.

✳For more details, refer to “Cruise Control System” in chapter 5.

SPORT Mode Indicator Light (if equipped)

SPORT

This indicator light illuminates:

- When you select “SPORT” mode as drive mode.

✳For more details, refer to “Sport Mode” in chapter 5.

REAR VIEW MONITOR (RVM) (IF EQUIPPED)

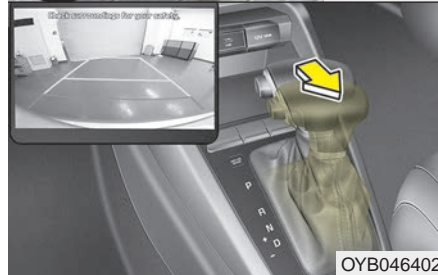

Rear View Monitor will show the area behind the vehicle to assist you when parking or backing up.

This function is a supplemental that shows behind the vehicle through the navigation display while backing-up.

⚠ WARNING

This function is a supplementary function only. It is the responsibility of the driver to always check the inside/outside rearview mirror and the area behind the vehicle before and while backing up because there is a dead zone that can't be seen through the camera.

⚠ CAUTION

Always keep the rear view camera lens clean. If the lens is covered with foreign material, it may adversely affect camera performance and Rear View Monitor may not operate normally.

Function malfunction and limitations

Function malfunction

- When Rear View Monitor is not working properly, or the screen flickers, or the camera image does not display normally, have the system inspected by an authorized Kia dealer.

Limitations of the function

- When the vehicle is stopped for a long time in winter or when the vehicle is parked in an indoor parking lot, the exhaust fumes may temporarily blur the image

WARNING

- **Rear View Monitor is not a safety device. It only serves to assist the driver in identifying objects directly behind the middle of the vehicle. The camera does not cover the complete area behind the vehicle.**
- **Never rely solely on the rear view monitor. As there are blind spots that do not appear on the camera while backing up and parking, You must always use methods of viewing the area behind you including looking over both shoulders as well as continuously checking all three rear view mirrors.**

(Continued)

(Continued)

- **Always look around your vehicle to make sure there are no objects or obstacles before moving the vehicle in any direction to prevent a collision.**
- **Always pay close attention when the vehicle is driven close to objects, particularly pedestrians, and especially children.**
- **Always keep the camera lens clean. If lens is covered with foreign matter, the camera may not operate normally.**
- **When stopping for a long time in winter or parking in an indoor parking lot, the image may temporarily be blurry due to the exhaust gas.**

LIGHTING

Battery saver function

- The purpose of this feature is to prevent the battery from being discharged. The system automatically turns off the parking lights when the driver removes the ignition key and opens the driver-side door.
- With this feature, the parking lights will turn off automatically if the driver parks on the side of the road at night.

If necessary, to keep the lights on when the ignition key is removed, perform the following:

- 1) Open the driver-side door.
- 2) Turn the parking lights OFF and ON again using the light switch on the steering column.

Headlight escort function (if equipped)

The headlights (and/or taillights) will remain on for approximately 5 minutes after the ignition key is removed or turned to the ACC or LOCK position. However, if the driver's door is opened and closed, the headlights are turned off after 15 seconds.

The headlights can be turned off by pressing the lock button on the transmitter twice or turning off the light switch from the headlight or Auto light position.

If the driver gets out of the vehicle through other doors (except driver's door), the battery saver function does not operate and the headlight escort function does not turn off automatically. Therefore, It causes the battery to be discharged. In this case, make sure to turn off the lamp before getting out of the vehicle.

If the headlights are not working properly have your vehicle inspected by an authorized Kia dealer.

Don't attempt to inspect or replace the wiring yourself to prevent malfunction.

Headlight welcome function (if equipped)

When the headlight switch is in the ON or AUTO position and all doors (and liftgate) are closed and locked, if you press the door unlock button on the transmitter, the headlights will come on for about 15 seconds.

If the headlight switch is in the AUTO position, the function can only operate at night.

At this time, if you press the door unlock button again or door lock button on the transmitter, the headlights will turn off immediately.

Lighting control

■ Type A



OSC046400

■ Type B



OSC040414N

The light switch has a Headlight and a Parking light position.

To operate the lights, turn the knob at the end of the control lever to one of the following positions:

- (1) OFF position
- (2) Auto light position
- (3) Parking light position
- (4) Headlight position

Parking light position (㊦)

■ Type A



OSC047401N

■ Type B



OSC040415N

When the light switch is in the parking light position (3rd position), the tail, position, license and instrument panel lights will turn ON.

Headlight position (㊦)

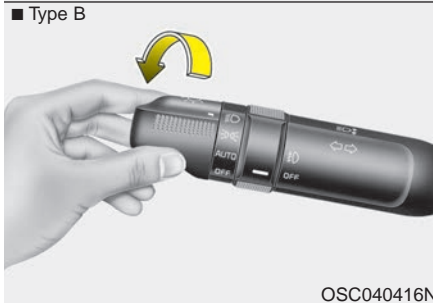
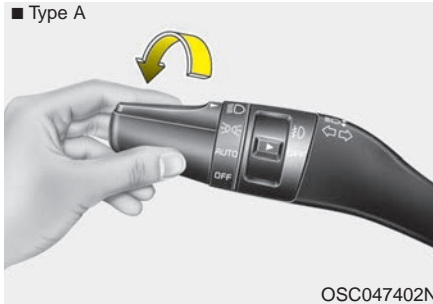

When the light switch is in the headlight position (4th position) the head, tail, position, license and instrument panel lights will turn ON.

The ignition switch must be in the ON position to turn on the headlights.

Auto light position

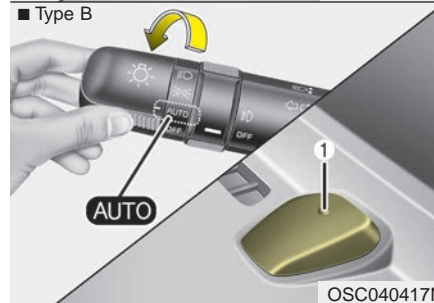
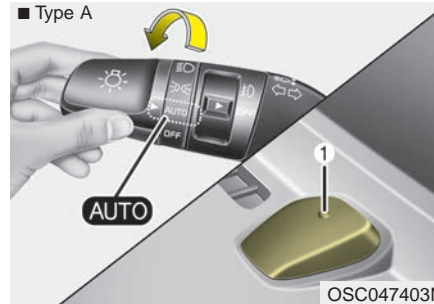

When the light switch is in the AUTO light position, the taillights and headlights will turn ON or OFF automatically depending on the amount of light outside the vehicle.

⚠ CAUTION

Never place anything over the sensor (1) located on the instrument panel. This will ensure better auto-light system control.

Do not clean the sensor using a window cleaner, the cleaner may leave a light film which could interfere with sensor operation.

If your vehicle has window tint or other types of metallic coating on the front windshield, the Auto light system may not work properly.

High beam operation

■ Type A

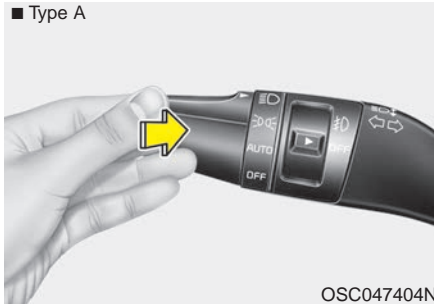

■ Type B

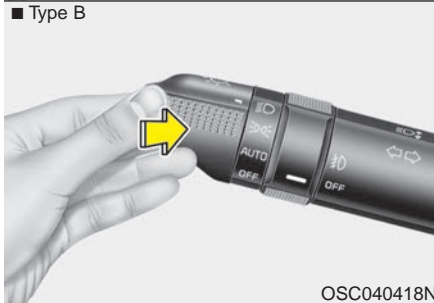

To turn on the high beam headlights, push the lever away from you. Pull it back for normal (low beam) position. The high beam indicator light will illuminate when the headlight high beams are switched on.

To prevent the battery from being discharged, do not leave the lights on for a prolonged time while the engine is not running.

⚠ WARNING - High beams
Do not use high beam when there are other vehicles. Using high beam could obstruct the other driver's vision.

■ Type A

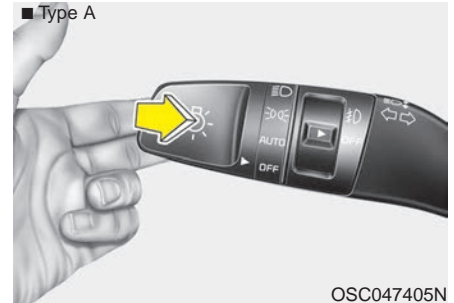

■ Type B

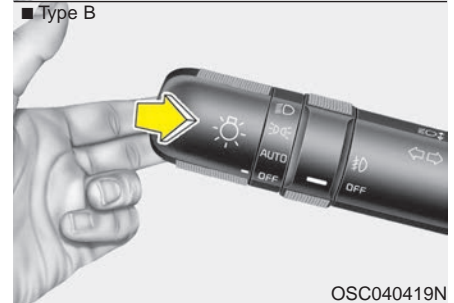

To flash the headlights, pull the lever towards you. It will return to the normal (low-beam) position when released. The headlight switch does not need to be on to use this flashing feature.

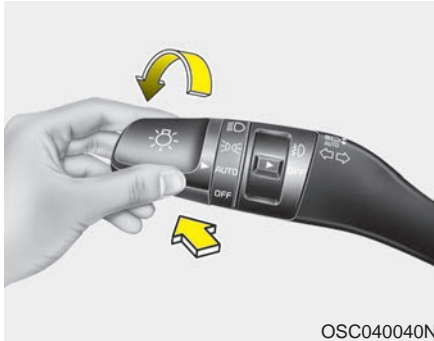

High Beam Assist (HBA) (if equipped)



OSC040040N

High Beam Assist is a function that automatically adjusts the headlamp range (switches between high beam and low beam) according to the brightness of other vehicles and road conditions.

Operating condition

1. Place the light switch in the AUTO position.
2. Turn on the high beam by pushing the switch away from you. High Beam Assist () indicator will illuminate.
3. High Beam Assist will turn on when vehicle speed is above 28 mph (45 km/h).
 - If the switch is pushed away when High Beam Assist is operating, High Beam Assist will turn off and the high beam will be on continuously. High Beam Assist () indicator will turn off.
 - If the switch is pulled towards you when the high beam is on with operating High Beam Assist, High Beam Assist will turn off.
4. If the light switch is placed to the headlamp position, High Beam Assist will turn off and the low beam will be on continuously.

The high beam switches to low beam in the below conditions.

- When High Beam Assist is off.
- When the light switch is not in the AUTO position.
- When the headlamp is detected from the on-coming vehicle.
- When the tail lamp is detected from the front vehicle.
- When the surrounding is bright enough high beams are not needed.
- When streetlights or other lights are detected.
- When vehicle speed is below 22 mph (35 km/h).
- When headlamp / taillamp of bicycle/motorcycle is detected.

Turn signals and lane change signals

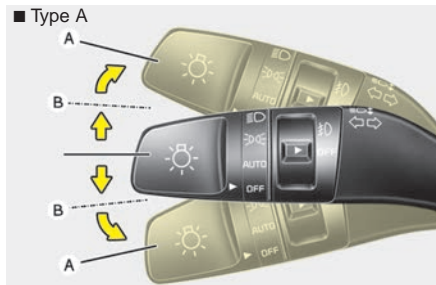

OSC047406N

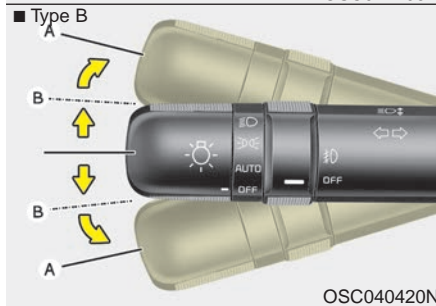

OSC040420N

The ignition switch must be on for the turn signals to function. To turn on the turn signals, move the lever up or down (A). The green arrow indicators on the instrument panel indicate which turn signal is operating.

They will self-cancel after a turn is completed. If the indicator continues to flash after a turn, manually return the lever to the OFF position.

To signal a lane change, move the turn signal lever slightly and hold it in position (B). The lever will return to the OFF position when released.

If an indicator stays on and does not flash or if it flashes abnormally, one of the turn signal bulbs may be burned out and will require replacement.

One-touch lane change function

To activate a one-touch lane change function, move the turn signal lever slightly and then release it. The lane change signals will blink 3, 5 or 7 times.

You can choose one-touch lane change blinking function in “One touch turn signal” of “User setting”. Refer to “User setting” in chapter 4. (if equipped)

*** NOTICE**

If an indicator flash is abnormally quick or slow, the bulb may be burned out or have a poor electrical connection in the circuit.

Front fog light (if equipped)

■ Type A



■ Type B



Fog lights are used to provide improved visibility when visibility is poor due to fog, rain or snow, etc.

The fog lights will turn on when the fog light switch (1) is turned on after the parklight is turned on.

To turn off the fog lights, turn the fog light switch (1) to the OFF position.

CAUTION

When in operation, the fog lights consume large amounts of vehicle electrical power. Only use the fog lights when visibility is poor.

WIPERS AND WASHERS

Front

■ Type A

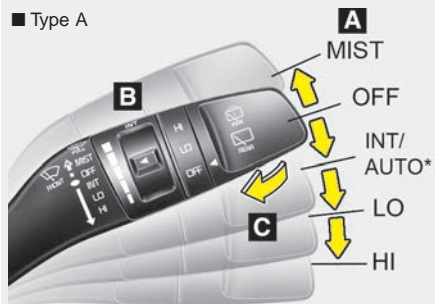

■ Type B

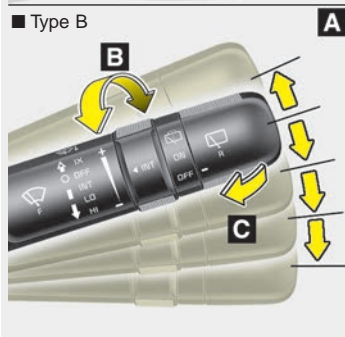

Rear (5 Door, if equipped)

■ Type A



■ Type B



A : Wiper speed control (front)

- HI – High wiper speed
- LO – Low wiper speed
- INT – Intermittent wipe
- AUTO* – Automatic control wipe
- OFF – Off
- MIST – Single wipe

B : Intermittent control wipe time adjustment

C : Wash with brief wipes (front)*

D : Rear wiper/washer control

- O/OFF – Off
- HI – High wiper speed
- ON/LO – Low wiper speed

E : Wash with brief wipes (rear)

* : if equipped

OSC040428N/OSC040422N/OSC047427N/OSC040446N

Windshield wipers

Operates as follows when the ignition switch is turned ON.

MIST : For a single wiping cycle, push the lever upward and release it. The wipers will operate continuously if the lever is held in this position.

OFF : Wiper is not in operation

INT : Wiper operates intermittently at the same wiping intervals. Use this mode in a light rain or mist. To vary the speed setting, turn the speed control knob.

ON/LO : Normal wiper speed

HI : Fast wiper speed

* NOTICE

If there is heavy accumulation of snow or ice on the windshield, defrost the windshield for about 10 minutes, or until the snow and/or ice is removed, before using the windshield wipers in order to ensure proper operation.

If you do not remove the snow and/or ice before using the wiper and washer, the wiper and washer system may be damaged.

AUTO (Automatic) control (if equipped)

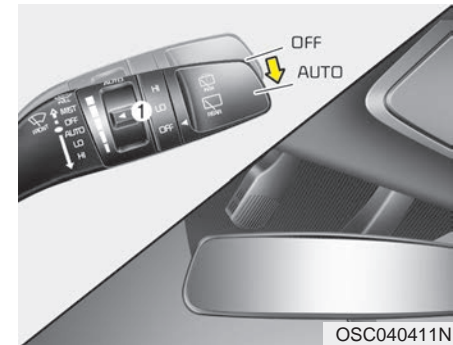

The rain sensor located on the upper end of the windshield glass senses the amount of rainfall and controls the wiping cycle for the proper interval. The more it rains, the faster the wiper operates. When the rain stops, the wiper stops.

To vary the speed setting, turn the speed control knob (1).

If the wiper switch is set in AUTO mode when the ignition switch is ON, the wiper will operate once to perform a self-check of the system. Set the wiper to off position when the wiper is not in use.

CAUTION

When the ignition switch is ON and the windshield wiper switch is placed in the AUTO mode, use caution in the following situations to avoid any injury to the hands or other parts of the body:

- Do not touch the upper end of the windshield glass facing the rain sensor.
- Do not wipe the upper end of the windshield glass with a damp or wet cloth.
- Do not put pressure on the windshield glass.

CAUTION

When washing the vehicle, set the wiper switch in the off position to stop the auto wiper operation.

The wiper may operate and be damaged if the switch is set in the AUTO mode while washing the vehicle.

Do not remove the sensor cover located on the upper end of the passenger side windshield glass. Damage to system parts could occur and may not be covered by your vehicle warranty.

When starting the vehicle in winter, set the wiper switch in the off position. Otherwise, wipers may operate and ice may damage the windshield wiper blades. Always remove all snow and ice and defrost the windshield properly prior to operating the windshield wipers.

Windshield washers (front)

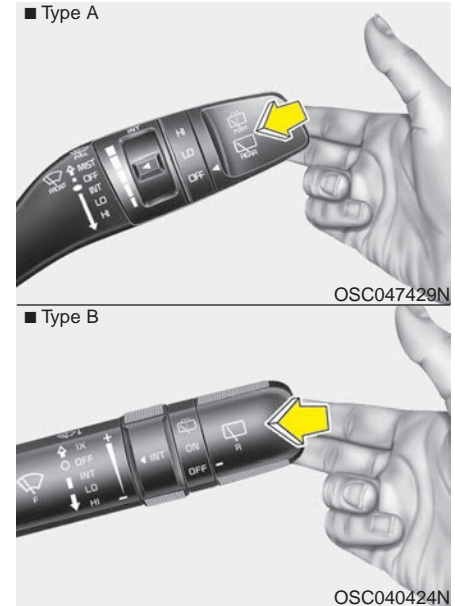

In the OFF position, pull the lever gently toward you to spray washer fluid on the windshield and to run the wipers 1-3 cycles.

Use this function when the windshield is dirty.

The spray and wiper operation will continue until you release the lever. If the washer does not work, check the washer fluid level.

If the fluid level is not sufficient, you add appropriate non-abrasive windshield washer fluid to the washer reservoir.

The reservoir filler neck is located in the front of the engine compartment on the passenger side.

 **CAUTION - Washer pump**

To prevent possible damage to the washer pump, do not operate the washer when the fluid reservoir is empty.

 **WARNING - Obscured visibility**

Do not use the washer in freezing temperatures without first warming the windshield with the defrosters; the washer solution could freeze on the windshield and obscure your vision.

 **CAUTION - Wiper position**

When washing the vehicle, set the wiper switch in the off position to stop the auto wiper operation. The wiper may operate and be damaged if the switch is set in the AUTO mode while washing the vehicle.

 **CAUTION - Wipers & windshields**

- *To prevent possible damage to the wipers or windshield, do not operate the wipers when the windshield is dry.*
- *To prevent damage to the wiper blades, do not use gasoline, kerosene, paint thinner, or other solvents on or near them.*
- *To prevent damage to the wiper arms and other components, do not attempt to move the wipers manually.*

Rear window wiper and washer switch (for 5 door)

■ Type A



OSC047430N

■ Type B

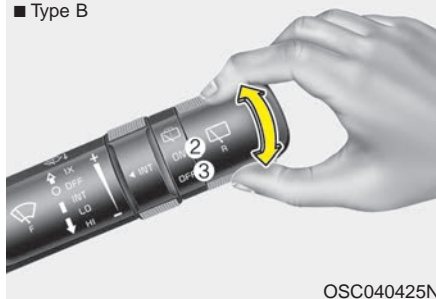

OSC040425N

The rear window wiper and washer switch is located at the end of the wiper and washer switch lever. Turn the switch to operate the rear wiper and washer.

- (1) HI - High wiper speed
- (2) ON/LO - Low wiper speed
- (3) OFF - Wiper is not in operation

■ Type A

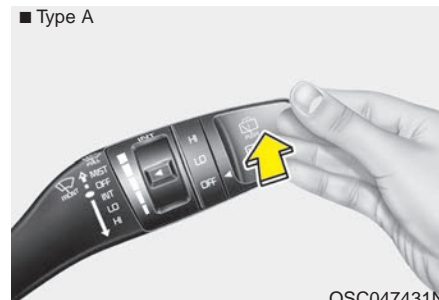

OSC047431N

■ Type B

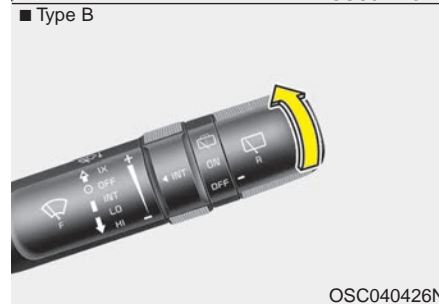

OSC040426N

Push the lever away from you or turn the wiper lever switch upwards fully to spray rear washer fluid and to run the rear wipers 1~3 cycle. The spray and wiper operation will continue until you release the lever.

INTERIOR LIGHT

Do not use the interior lights for extended periods when the engine is not running as this may cause battery discharge.

⚠ WARNING - Interior light
Do not use the interior lights when driving in the dark. The glare from the interior lights may obstruct your view and cause an accident.

Automatic turn off function (if equipped)

The interior lights automatically turn off approximately 20 minutes after the ignition switch is turned off.

If your vehicle is equipped with the theft alarm system, the interior lights automatically turn off approximately 5 seconds after the system is in armed stage.

Map lamp (if equipped)

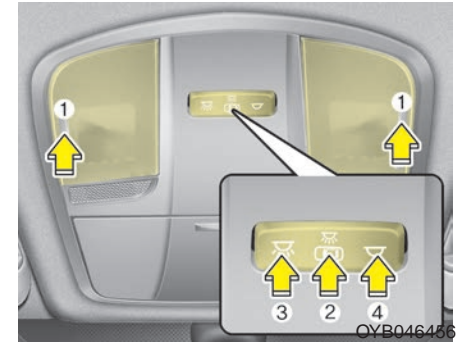

Push the lens (1) to turn the map lamp on or off. This light produces a spot beam for convenient use as a map lamp at night or as a personal lamp for the driver and front passenger.

- DOOR (2) :

In the DOOR position, the map lamp and the room lamp come on when any door is opened regardless of the ignition switch position. When doors are unlocked by the transmitter, the map lamp and the room lamp come on for approximately 30 seconds as long as any door is not open.

The map lamp and the room lamp turn off gradually after approximately 30 seconds if the door is closed.

However, if the ignition switch is ON or all doors are locked, the map lamp and the room lamp will turn off immediately. If a door is opened with the ignition switch in the ACC or LOCK position, the map lamp and the room lamp stays on for about 20 minutes. However, if a door is opened with the ignition switch in the ON position, the map lamp and the room lamp stays on continuously. If the type B room lamp switch is OFF, it doesn't work.

- ON (3) : The map lamp and the room lamp stay on at all times.
- OFF (4) : The lights turn off even if a door is opened.

* NOTICE

When the lamp is turned ON by pressing the lens (1), the lamp does not turn off even if the switch (2) is in the OFF position.

Room lamp

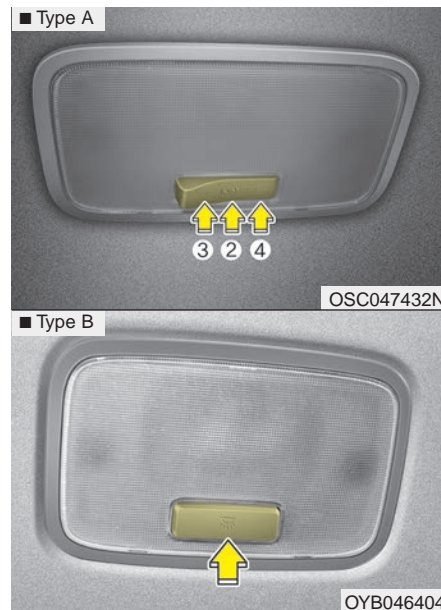

To turn the room lamp ON or OFF, push the switch.

If your vehicle is not equipped with a map lamp, the room lamp will also turn on or off as follows.

- The room lamp comes on when a door is opened. The lamps go out after approximately 30 seconds.
- The room lamp comes on for approximately 30 seconds when doors are unlocked with a transmitter as long as the doors are not opened.
- The room lamp will stay on for approximately 20 minutes if a door is opened with the ignition switch in the ACC or LOCK/OFF position.
- The room lamp will stay on continuously if the door is opened with the ignition switch in the ON position.
- The room lamp will go out immediately if the ignition switch is changed to the ON position or all doors are locked.

• DOOR (2) :

In the DOOR position, the map lamp and the room lamp come on when any door is opened regardless of the ignition switch position. When doors are unlocked by the transmitter, the map lamp and the room lamp come on for approximately 30 seconds as long as any door is not open.

The map lamp and the room lamp turn off gradually after approximately 30 seconds if the door is closed.

However, if the ignition switch is ON or all doors are locked, the map lamp and the room lamp will turn off immediately. If a door is opened with the ignition switch in the ACC or LOCK position, the map lamp and the room lamp stays on for about 20 minutes. However, if a door is opened with the ignition switch in the ON position, the map lamp and the room lamp stays on continuously. If the type B room lamp switch is OFF, it doesn't work.

- ON (3) : The map lamp and the room lamp stay on at all times.
- OFF (4) : The lights turn off even if a door is opened.

*** NOTICE**

When the lamp is turned ON by pressing the lens (1), the lamp does not turn off even if the switch (2) is in the OFF position.

Trunk/Liftgate room lamp

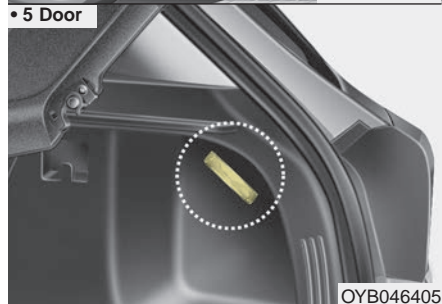
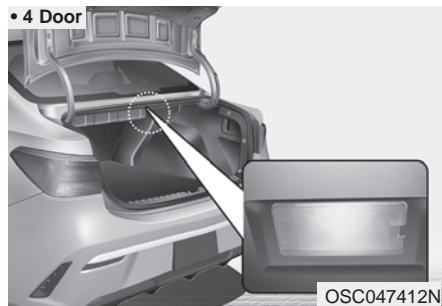

The trunk/liftgate room lamp comes on when the trunk/liftgate is opened.

The trunk/liftgate room lamp comes on as long as the trunk/liftgate lid is open. To prevent unnecessary charging system drain, close the trunk/liftgate lid securely after using the trunk/liftgate room lamp.

Glove box lamp

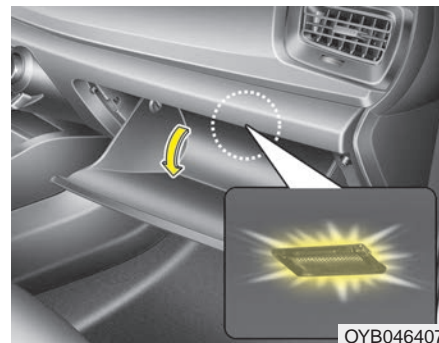

The glove box lamp comes on when the glove box is opened. To prevent unnecessary charging system drain, close the glove box securely after use.

Vanity mirror lamp (if equipped)

Push the switch to turn the light on or off.

- ☀ : The lamp will turn on if this button is pressed.
- ○ : The lamp will turn off if this button is pressed.

⚠ CAUTION

Always have the switch in the off position when the vanity mirror lamp is not in use. If the sunvisor is closed without turning the lamp off, it may discharge the battery or damage the sunvisor.

DEFROSTER

CAUTION - Conductors

To prevent damage to the conductors bonded to the inside surface of the rear window, never use sharp instruments or window cleaners containing abrasives to clean the window.

If you want to defrost and defog the front windshield, refer to “Windshield Defrosting and Defogging” in this section.

Rear window defroster

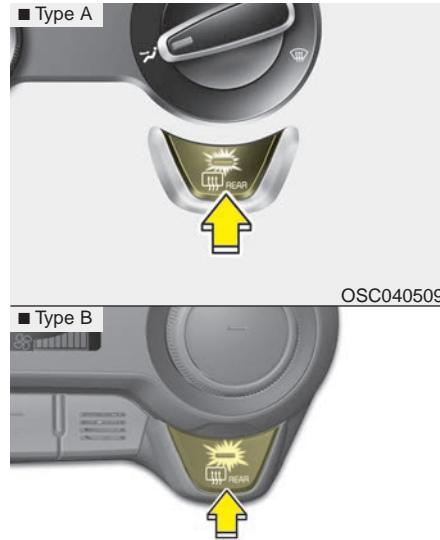

The defroster heats the window to remove frost, fog and thin ice from the interior and exterior of the rear window, while the engine is running.

To activate the rear window defroster, press the rear window defroster button located in the center facia switch panel. The indicator on the rear window defroster button illuminates when the defroster is on.

If there is heavy accumulation of snow on the rear window, brush it off before operating the rear defroster.

The rear window defroster automatically turns off after approximately 20 minutes or when the ignition switch is turned off. To turn off the defroster manually, press the rear window defroster button again.

Outside mirror defroster (if equipped)

If your vehicle is equipped with the outside rearview mirror defrosters, they will operate at the same time you turn on the rear window defroster.



MANUAL CLIMATE CONTROL SYSTEM



1. Fan speed control knob
2. Mode selection knob
3. Temperature control knob
4. Air conditioning button
5. Rear window defroster button
6. Air intake control button

OSC040300N

Heating and air conditioning

1. Start the engine.
2. Set the mode to the desired position.
To improve the effectiveness of heating and cooling :
 - Heating: 
 - Cooling: 
3. Set the temperature control to the desired position.
4. Set the air intake control to the outside (fresh) air or recirculated air position.
5. Set the fan speed control to the desired speed.
6. If air conditioning is desired, turn the air conditioning system on.

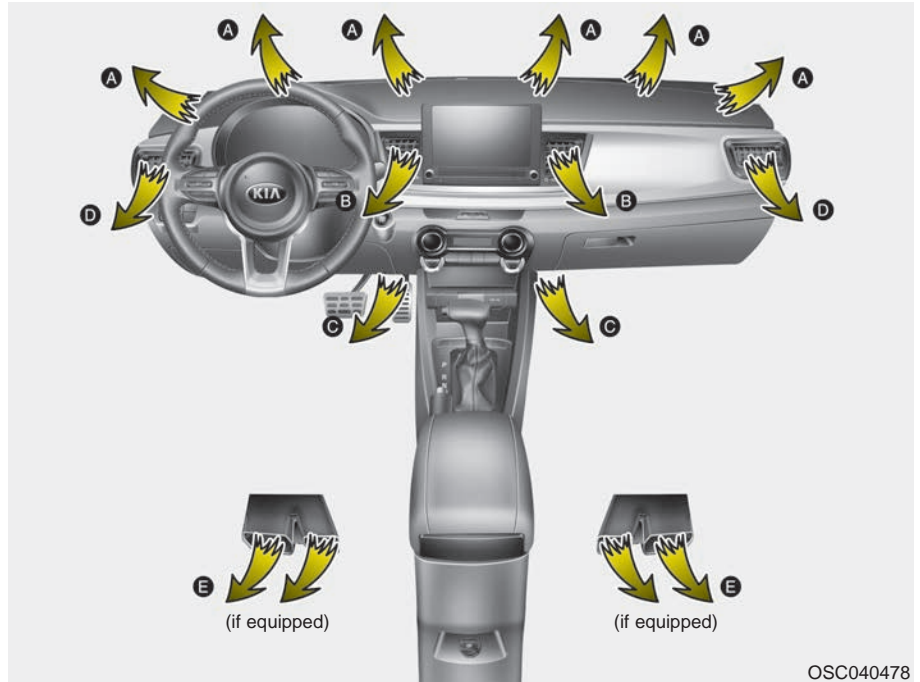

Mode selection

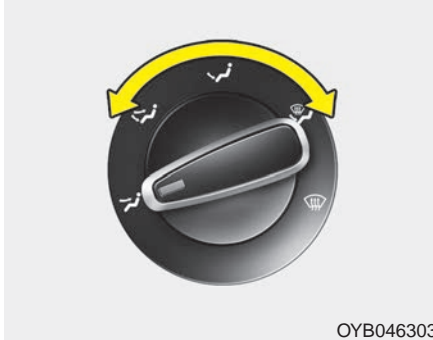

OYB046303

The mode selection knob controls the direction of the air flow through the ventilation system.

Air can be directed to the floor, dashboard outlets, or windshield. Five symbols are used to represent Face, Bi-Level, Floor, Floor-Defrost and Defrost air position.



Face-Level (B, D)

Air flow is directed toward the upper body and face. Additionally, each outlet can be controlled to direct the air discharged from the outlet.



Bi-Level (B, C, D, E)

Air flow is directed towards the face and the floor.



Floor-Level (A, C, D, E)

Most of the air flow is directed to the floor, with a small amount of the air being directed to the windshield and side window defrosters.



Floor/Defrost-Level (A, C, D, E)

Most of the air flow is directed to the floor and the windshield with a small amount directed to the side window defrosters.



Defrost-Level (A, D)

Most of the air flow is directed to the windshield with a small amount of air directed to the side window defrosters.

MAX A/C-Level (B, D) (if equipped)



The MAX A/C mode is used to cool the inside of the vehicle faster. Air flow is directed toward the upper body and face.

In this mode, the air conditioning and the recirculated air position will be selected automatically.

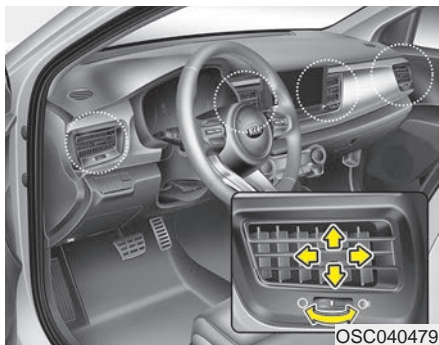

Instrument panel vents

The outlet vents can be opened or closed separately using the thumb-wheel.

Also, you can adjust the direction of air delivered from these vents using the vent control lever as shown.

Temperature control



The temperature control knob allows you to control the temperature of the air flowing from the ventilation system. To change the air temperature in the passenger compartment, turn the knob to the right for warmer and hot air, or to the left for cooler air.

Air intake control



OSC040312N

This is used to select outside (fresh) air position or recirculated air position. To change the air intake control position, push the control button.

Recirculated air position



With the recirculated air position selected, air from the passenger compartment will be drawn through the heating system and heated or cooled according to the function selected.

Outside (fresh) air position



If the recirculated air position is not selected or turned off, air enters the vehicle from outside and is heated or cooled according to the function selected.

Prolonged operation of the heater in the recirculated air position (without air conditioning selected) may cause fogging of the windshield and side windows and the air within the passenger compartment may become stale.

In addition, prolonged operation of the air conditioning with the recirculated air position selected will result in excessively dry air in the passenger compartment.

⚠ WARNING - Reduced Visibility

Continuous use of the climate control system in the recirculated air position may allow humidity to increase inside the vehicle which may fog the glass and obscure visibility.

⚠ WARNING - Recirculated Air

Continue using the climate control system in the recirculated air position can cause drowsiness or sleepiness, and loss of vehicle control. Set the air intake control to the outside (fresh) air position as much as possible while driving.

⚠ WARNING - Sleeping with A/C on

Do not sleep in a vehicle with the air conditioning or heating on as this may cause serious harm or death due to a drop in the oxygen level and/or body temperature.

Fan speed control



The ignition switch must be in the ON position for fan operation.

The fan speed control knob allows you to control the fan speed of the air flowing from the ventilation system. To change the fan speed, turn the knob to the right for higher speed or left for lower speed.

To turn off the blowers



To turn off the blowers, turn the fan speed control knob to the "0" position.

Air conditioning

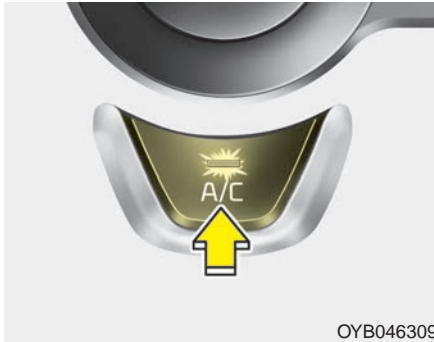

OYB046309



Press the A/C button to turn the air conditioning system on (indicator light will illuminate). Press the button again to turn the air conditioning system off.

System operation

Ventilation

1. Set the mode to the  position.
2. Set the air intake control to the outside (fresh) air position.
3. Set the temperature control to the desired position.
4. Set the fan speed control to the desired speed.

Heating

1. Set the mode to the  position.
2. Set the air intake control to the outside (fresh) air position.
3. Set the temperature control to the desired position.
4. Set the fan speed control to the desired speed.
5. If dehumidified heating is desired, turn the air conditioning system (if equipped) on.
 - If the windshield fogs up, set the mode to the ,  position.

Operation Tips

- To prevent dust or unpleasant fumes from entering the vehicle through the ventilation system, temporarily set the air intake control to the recirculated air position. Be sure to return the control to the fresh air position when the dust or fumes has passed to keep fresh air in the vehicle. This will help keep the driver alert and comfortable.
- Air for the heating/cooling system is drawn in through the grilles just ahead of the windshield. Care should be taken that these are not blocked by leaves, snow, ice or other obstructions.
- To prevent interior fog on the windshield, set the air intake control to the fresh air position and fan speed to the desired position, turn on the air conditioning system, and adjust the temperature control to the desired temperature.

Air conditioning

Kia Air Conditioning Systems are filled with R-1234yf refrigerant.

1. Start the engine. Push the air conditioning button.
 2. Set the mode to the  position.
 3. Set the air intake control to the recirculated air position. However, prolonged operation in the recirculated air position will excessively dry the air. In this case, change the air position.
 4. Adjust the fan speed control and temperature control to maintain maximum comfort.
- The refrigerant system should only be serviced by trained and certified technicians to ensure proper and safe operation.
 - The refrigerant system should be serviced in a well-ventilated place.
 - The air conditioning evaporator (cooling coil) shall never be repaired or replaced with one removed from a used or salvaged vehicle and new replacement MAC evaporators should be certified (and labeled) as meeting SAE Standard J2842.



CAUTION - Excessive A/C

While using the air conditioning system, monitor the temperature gauge closely while driving up hills or in heavy traffic when outside temperatures are high. Air conditioning system operation may cause engine overheating and potential engine damage. Continue to use the blower fan but turn the air conditioning system off if the temperature gauge indicates engine overheating.

*** NOTICE**

When opening the windows in humid weather, air conditioning may create water droplets inside the vehicle. Since excessive water droplets may cause damage to electrical equipment, air conditioning should only be used with the windows closed.

Air conditioning system operation tips

- If the vehicle has been parked in direct sunlight during hot weather, open the windows for a short time to let the hot air inside the vehicle escape.
- To help reduce moisture inside of the windows on rainy or humid days, decrease the humidity inside the vehicle by operating the air conditioning system.
- During air conditioning system operation, you may occasionally notice a slight change in engine speed as the air conditioning compressor cycles. This is a normal system operation characteristic.
- Use the air conditioning system every month for a few minutes to ensure maximum system performance.
- When using the air conditioning system, you may notice clear water dripping (or even puddling) on the ground under the passenger side of the vehicle. This is a normal operating characteristic of the system.

- Operating the air conditioning system in the recirculated air position provides maximum cooling, however, continual operation in this mode may cause the air inside the vehicle to become stale.
- During cooling operation, you may occasionally notice a misty air flow because of rapid cooling and humid air intake. This is a normal operating characteristic of the system.

Climate control air filter

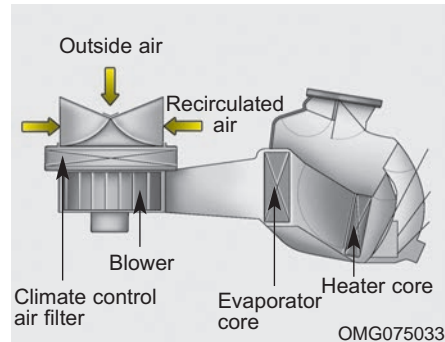

The climate control air filter installed behind the glove box filters the dust or other pollutants that come into the vehicle from the outside through the heating and air conditioning system. If dust or other pollutants accumulate in the filter over a period of time, the air flow from the air vents may decrease, resulting in moisture accumulation on the inside of the windshield even when the outside (fresh) air position is selected. If this happens, have the climate control air filter replaced by an authorized Kia dealer.

* NOTICE

- Replace the filter according to the Maintenance Schedule. If the vehicle is being driven in severe conditions such as dusty, rough roads, more frequent climate control air filter inspections and changes are required.
- When the air flow rate suddenly decreases, the system be checked at an authorized Kia dealer.

Checking the amount of air conditioner refrigerant and compressor lubricant

When the amount of refrigerant is low, the performance of the air conditioning is reduced. Overfilling also has a negative influence on the air conditioning system.

Therefore, if abnormal operation is found, have the system inspected by an authorized Kia dealer.

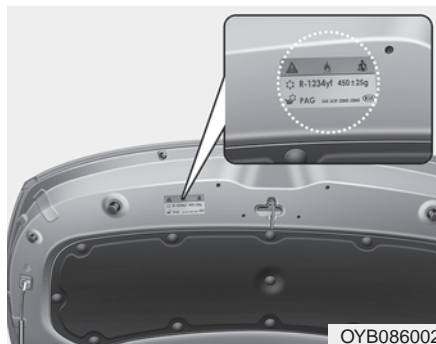

OYB086002

The refrigerant label is located on the underside of the hood.

⚠ WARNING - Vehicles equipped with R-1234yf



Since the refrigerant is mildly flammable and operated at high pressure, the air conditioning system should only be serviced by trained and certified technicians. (Refer to the SAE J2845)

It is important that the correct type and amount of oil and refrigerant are used.

All refrigerants should be reclaimed with proper equipment.

Venting refrigerants directly to the atmosphere is harmful to individuals and environment.

Failure to heed these warnings can lead to serious injuries.

⚠ WARNING

The oil and refrigerant in your vehicle's air conditioning system is under very high pressure. If proper service procedures are not followed an explosion may result. To reduce the risk of serious injury or death, the air conditioning system in your vehicle should only be serviced by trained and certified technicians.

⚠ CAUTION - AC Repair

It is important that the correct type and amount of oil and refrigerant is used, otherwise damage to the vehicle may occur. To prevent damage, the air conditioning system in your vehicle should only be serviced by trained and certified technicians.

The air conditioning system should be serviced by an authorized Kia dealer.

Air Conditioning refrigerant label

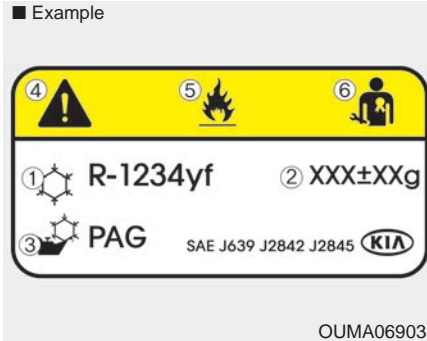

* The actual Air Conditioning refrigerant label in the vehicle may differ from the illustration.

Each symbol and specification on the air conditioning refrigerant label is represented below :

1. Classification of refrigerant
2. Amount of refrigerant
3. Classification of Compressor lubricant
4. Caution

5. Flammable Refrigerant
6. To requires Registered Technician to Service Air Conditioning system

* Refer to chapter 8 for more detail on the location of air conditioning refrigerant label.

Activate upon Washer Fluid Use

To prevent the odor from entering to inside the vehicle, the ventilation system changes to Recirculated Air Mode for a while when the windshield washer fluid sprayed. However, at low outside temperature, to prevent from windshield fogging, the system continues to outside air mode.

System setting

1. ENGINE START/STOP button is ON.
2. Select Floor-Level () air flow direction by pressing Mode Selection button.
3. With pressing Air Conditioning button, press the Recirculated Air button more than 4 times within 2 seconds.
4. If the system is set up, the indicator on Recirculated Air button will blinks 6 times.

System cancellation

1. ENGINE START/STOP button is ON.
2. Select Floor-Level () air flow direction by pressing Mode Selection button.
3. With pressing Air Conditioning button, press the Recirculated Air button more than 4 times within 2 seconds.
4. If the system is cancelled, the indicator on Recirculated Air button will blinks 3 times.

AUTOMATIC CLIMATE CONTROL SYSTEM (IF EQUIPPED)

1. Temperature control knob
2. AUTO (automatic control) button
3. Climate control display
4. Fan speed control knob
5. OFF button
6. Front windshield defroster button
7. Rear window defroster button
8. Mode selection button
9. Air conditioning button
10. Air intake control button

⚠ CAUTION

Operating the blower when the ignition switch is in the ON position could cause the battery to discharge. It is best to operate the blower when the engine is running.

OSC040511N

Automatic heating and air conditioning



1. Push the AUTO button. The modes, fan speeds, air intake and air-conditioning will be controlled automatically by temperature setting.



2. Turn the temperature control knob to set the desired temperature.

* NOTICE

- To turn the automatic operation off, select any button or switch of the following:
 - Mode selection button
 - Air conditioning button
 - Front windshield defroster button (Press the button one more time to deselect the front windshield defroster function. The 'AUTO' sign will illuminate on the information display once again.)
 - Air intake control button
 - Fan speed control knobThe selected function will be controlled manually while other functions operate automatically.
- For your convenience and to improve the effectiveness of the climate control, use the AUTO button and set the temperature to 73°F (23°C).

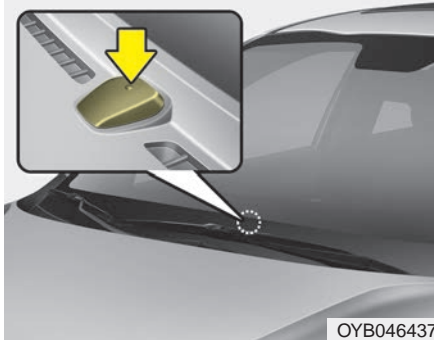

OYB046437

*** NOTICE**

Never place anything over the sensor located on the instrument panel to ensure better control of the heating and cooling system.

Manual heating and air conditioning

The heating and cooling system can be controlled manually by pushing buttons other than the AUTO button. In this case, the system works sequentially according to the order of buttons selected.

1. Start the engine.
2. Set the mode to the desired position.

To improve the effectiveness of heating and cooling :

- Heating:
- Cooling:

3. Set the temperature control to the desired position.
4. Set the air intake control to the outside (fresh) air or recirculated air position.
5. Set the fan speed control to the desired speed.
6. If air conditioning is desired, turn the air conditioning system on.

Press the AUTO button in order to convert to full automatic control of the system.

Mode selection



OSC040512N

The mode selection button controls the direction of the air flow through the ventilation system.

Every time you press the mode selection button, the mode will change as follows:



Refer to the illustration in the "Manual climate control system".



Face-Level (B, D)

Air flow is directed toward the upper body and face. Additionally, each outlet can be controlled to direct the air discharged from the outlet.



Bi-Level (B, C, D, E)

Air flow is discharged towards the face and floor.



Floor-Level (C, A, D, E)

Most of the air flow is directed to the floor, with a small amount of the air being directed to the windshield and side window defroster.



Floor/Defrost-Level (A, C, D, E)

Most of the air flow is directed to the floor and the windshield with a small amount directed to the side window defrosters.



Defrost-level

Most of the air flow is directed to the windshield with a small amount of air directed to the side window defrosters.

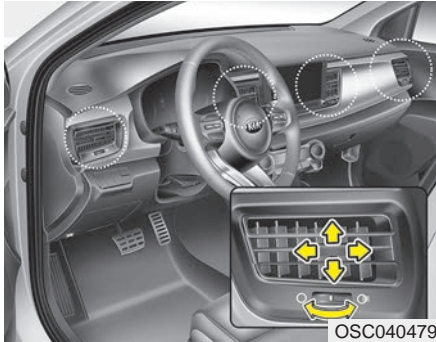

Instrument panel vents

The outlet vents can be opened or closed separately using the thumb-wheel.

Also, you can adjust the direction of air delivered from these vents using the vent control lever as shown.

Temperature control



The temperature control knob allows you to control the temperature of the air flowing from the ventilation system. To change the air temperature in the passenger compartment, turn the knob to the right for warm air or left for cooler air.

Air intake control



The air intake control is used to select outside (fresh) air position or recirculated air position.

To change the air intake control position, push the control button.

Recirculated air position



With the recirculated air position selected, air from the passenger compartment will be drawn through the heating system and heated or cooled according to the function selected.

Outside (fresh) air position



If the recirculated air position is not selected or turned off, air enters the vehicle from outside and is heated or cooled according to the function selected.

Prolonged operation of the heater in the recirculated air position (without air conditioning selected) may cause fogging of the windshield and side windows, and the air within the passenger compartment may become stale.

In addition, prolonged operation of the air conditioning with the recirculated air position selected will result in excessively dry air in the passenger compartment.

⚠ WARNING - Reduced Visibility

Continuous use of the climate control system in the recirculated air position may allow humidity to increase inside the vehicle which may fog the glass and obscure visibility.

⚠ WARNING - Sleeping with A/C on

Do not sleep in a vehicle with the air conditioning or heating system on as this may cause serious harm or death due to a drop in the oxygen level and/or body temperature.

⚠ WARNING - Recirculated air

Continued use of the climate control system in the recirculated air position can cause drowsiness or sleepiness, and loss of vehicle control. Set the air intake control to the outside (fresh) air position as much as possible while driving.

Fan speed control



The fan speed can be set to the desired speed by operating the fan speed control knob.

The higher the fan speed is, the more air is delivered.

Pressing the OFF button turns off the fan.

Air conditioning



Press the A/C button to turn the air conditioning system on (indicator light will illuminate).

Press the button again to turn the air conditioning system off.

OFF mode

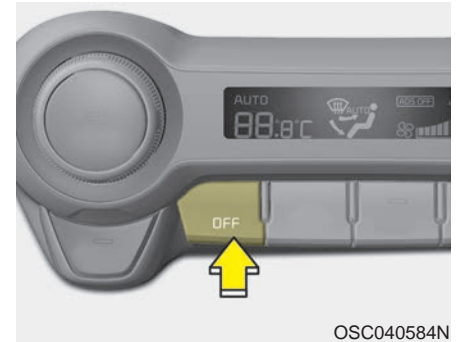



Press the OFF button to turn off the air climate control system. However you can still operate the mode and air intake buttons as long as the ignition switch is in the ON position.

System operation

Ventilation

1. Set the mode to the  position.
2. Set the air intake control to the outside (fresh) air position.
3. Set the temperature control to the desired position.
4. Set the fan speed control to the desired speed.

Heating

1. Set the mode to the  position.
2. Set the air intake control to the outside (fresh) air position.
3. Set the temperature control to the desired position.
4. Set the fan speed control to the desired speed.
5. If dehumidified heating is desired, turn the air conditioning system (if equipped) on.
 - If the windshield fogs up, set the mode to the  or  position.

Operation Tips

- To keep dust or unpleasant fumes from entering the vehicle through the ventilation system, temporarily set the air intake control to the recirculated air position. Be sure to return the control to the fresh air position when the dust or fumes has passed to keep fresh air in the vehicle. This will help keep the driver alert and comfortable.
- Air for the heating/cooling system is drawn in through the grilles just ahead of the windshield. Care should be taken that these are not blocked by leaves, snow, ice or other obstructions.
- To prevent interior fog on the windshield, set the air intake control to the fresh air position and fan speed to the desired position, turn on the air conditioning system, and adjust the temperature control to the desired temperature.

Air conditioning

Kia Air Conditioning Systems are filled with R-1234yf refrigerant.

1. Start the engine. Press the air conditioning button.
 2. Set the mode to the  position.
 3. Set the air intake control to the outside air or recirculated air position.
 4. Adjust the fan speed control and temperature control to maintain maximum comfort.
- The refrigerant system should only be serviced by trained and certified technicians to insure proper and safe operation.
 - The refrigerant system should be serviced in a well-ventilated place.
 - The air conditioning evaporator (cooling coil) shall never be repaired or replaced with one removed from a used or salvaged vehicle and new replacement MAC evaporators should be certified (and labeled) as meeting SAE Standard J2842.

 **CAUTION**

- *When using the air conditioning system, monitor the temperature gauge closely while driving up hills or in heavy traffic when outside temperatures are high. Air conditioning system operation may cause engine overheating. Continue to use the blower fan but turn the air conditioning system off if the temperature gauge indicates engine overheating.*
- *When opening the windows in humid weather air conditioning may create water droplets inside the vehicle. Since excessive water droplets may cause damage to electrical equipment, air conditioning should only be used with the windows closed.*

Air conditioning system operation tips

- If the vehicle has been parked in direct sunlight during hot weather, open the windows for a short time to let the hot air inside the vehicle escape.
- To help reduce moisture inside of the windows on rainy or humid days, decrease the humidity inside the vehicle by operating the air conditioning system.
- During air conditioning system operation, you may occasionally notice a slight change in engine speed as the air conditioning compressor cycles. This is a normal operating characteristic of the system.
- Use the air conditioning system every month for a few minutes to ensure maximum system performance.
- When using the air conditioning system, you may notice clear water dripping (or even puddling) on the ground under the passenger side of the vehicle. This is a normal operating characteristic of the system.
- Operating the air conditioning system in the recirculated air position provides maximum cooling, however, continual operation in this mode may cause the air inside the vehicle to become stale.
- During cooling operation, you may occasionally notice a misty air flow because of rapid cooling and humid air intake. This is a normal operating characteristic of the system.
- If you operate air conditioner excessively, the difference between the temperature of the outside air and that of the windshield could cause the outer surface of the windshield to fog up, causing loss of visibility. In this case, set the mode selection knob or button to the  position and fan speed control to the lower speed.

Climate control air filter

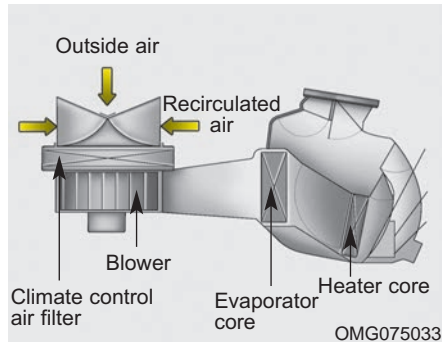

The climate control air filter installed behind the glove box filters the dust or other pollutants that come into the vehicle from the outside through the heating and air conditioning system. If dust or other pollutants accumulate in the filter over a period of time, the air flow from the air vents may decrease, resulting in moisture accumulation on the inside of the windshield even when the outside (fresh) air position is selected. If this happens, have the climate control air filter replaced by an authorized Kia dealer.

* NOTICE

- Replace the filter according to the Maintenance Schedule. If the vehicle is being driven in severe conditions such as dusty, rough roads, more frequent climate control air filter inspections and changes are required.
- When the air flow rate suddenly decreases, the system be checked at an authorized Kia dealer.

Checking the amount of air conditioner refrigerant and compressor lubricant

When the amount of refrigerant is low, the performance of the air conditioning is reduced. Overfilling also has a negative influence on the air conditioning system.

Therefore, if abnormal operation is found, have the system inspected by an authorized Kia dealer.

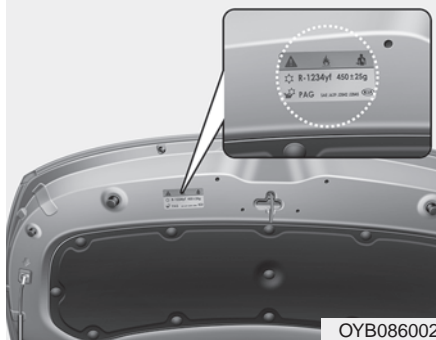

OYB086002

The refrigerant label is located on the underside of the hood.

⚠ WARNING - Vehicles equipped with R-1234yf



Since the refrigerant is mildly flammable and operated at high pressure, the air conditioning system should only be serviced by trained and certified technicians. (Refer to the SAE J2845)



It is important that the correct type and amount of oil and refrigerant are used.

All refrigerants should be reclaimed with proper equipment.

Venting refrigerants directly to the atmosphere is harmful to individuals and environment.

Failure to heed these warnings can lead to serious injuries.

⚠ WARNING

The oil and refrigerant in your vehicle's air conditioning system is under very high pressure. If proper service procedures are not followed an explosion may result. To reduce the risk of serious injury or death, the air conditioning system in your vehicle should only be serviced by trained and certified technicians.

⚠ CAUTION

It is important that the correct type and amount of oil and refrigerant is used, otherwise damage to the vehicle may occur.

To prevent damage, the air conditioning system in your vehicle should only be serviced by trained and certified technicians.

The air conditioning system should be serviced by an authorized Kia dealer.

Air Conditioning refrigerant label

■ Example



OUMA069035

✳ The actual Air Conditioning refrigerant label in the vehicle may differ from the illustration.

Each symbol and specification on the air conditioning refrigerant label is represented below :

1. Classification of refrigerant
2. Amount of refrigerant
3. Classification of Compressor lubricant
4. Caution
5. Flammable Refrigerant
6. To requires Registered Technician to Service Air Conditioning system

✳ Refer to chapter 8 for more detail on the location of air conditioning refrigerant label.

Activate upon Washer Fluid Use

To prevent the odor from entering to inside the vehicle, the ventilation system changes to Recirculated Air Mode for a while when the windshield washer fluid sprayed. However, at low outside temperature, to prevent from windshield fogging, the system continues to outside air mode.

System setting

1. ENGINE START/STOP button is ON.
2. Select Floor-Level () air flow direction by pressing Mode Selection button.
3. With pressing Air Conditioning button, press the Recirculated Air button more than 4 times within 2 seconds.
4. If the system is set up, the indicator on Recirculated Air button will blinks 6 times.

System cancellation

1. ENGINE START/STOP button is ON.
2. Select Floor-Level () air flow direction by pressing Mode Selection button.
3. With pressing Air Conditioning button, press the Recirculated Air button more than 4 times within 2 seconds.
4. If the system is cancelled, the indicator on Recirculated Air button will blinks 3 times.

WINDSHIELD DEFROSTING AND DEFOGGING

⚠ WARNING - Windshield heating

Do not use the (👤) or (👤) position during cooling operation in extremely humid weather. The difference between the temperature of the outside air and the windshield could cause the outer surface of the windshield to fog up, causing loss of visibility.

- For maximum defrosting, set the temperature control all the way to the right/hot position and the fan speed control to the highest speed.
- If warm air to the floor is desired while defrosting or defogging, set the mode to the floor-defrost position.
- Before driving, clear all snow and ice from the windshield, rear window, outside rear view mirrors, and all side windows.
- Clear all snow and ice from the hood and air inlet in the cowl grill to improve heater and defroster efficiency and to reduce the probability of fogging up the inside of the windshield.

Manual climate control system

To defog inside windshield

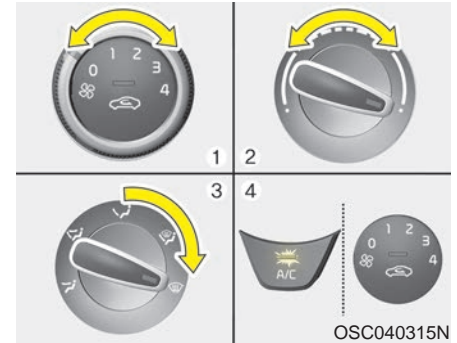

1. Select any fan speed except "0" position.
2. Select desired temperature.
3. Select the (👤) or (👤) position.
4. The outside (fresh) air will be selected automatically.

If the outside (fresh) air position is not selected automatically, press the corresponding button manually.

To defrost outside windshield

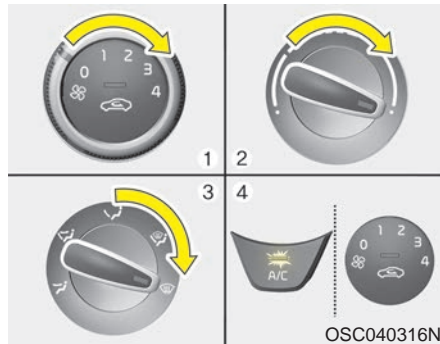

1. Set the fan speed to the highest (extreme right) position.
2. Set the temperature to the highest (HI) position.
3. Select the  position.
4. The outside (fresh) air will be selected automatically.

Automatic climate control system

To defog inside windshield

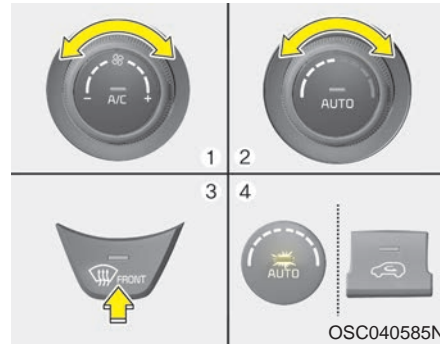



1. Select desired fan speed.
2. Select desired temperature.
3. Press the defroster button ().
4. The outside (fresh) air position will be selected automatically.

If the outside (fresh) air position is not selected automatically, adjust the corresponding button manually.

If the  position is selected, lower fan speed is adjusted to a higher fan speed.

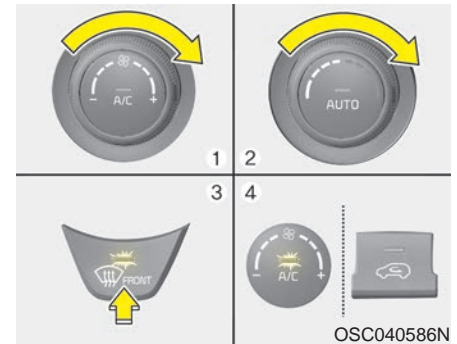

To defrost outside windshield



1. Set the fan speed to the highest position.
2. Set the temperature to the highest (HI) position.
3. Press the defroster button ().
4. The outside (fresh) air position will be selected automatically.



If the  position is selected, lower fan speed is adjusted to a higher fan speed.

Defogging Logic

To reduce the probability of fogging up inside of the windshield, the air intake or air conditioning are controlled automatically according to certain conditions such as  or  position. Logic can be disabled and enabled by doing following :

Manual climate control system



1. Turn the ignition switch to the ON position.
2. Turn the mode selection knob to the defrost position (.
3. Select any fan speed except "0" position.
4. While pressing the air conditioning button (A/C), press the air intake control button () at least 5 times within 3 seconds.

The indicator light in the air intake control button will blink 3 times with 0.5 second of interval. It indicates that the defogging logic is canceled or returned to the programmed status.

If the battery has been discharged or disconnected, it resets to the defog logic status.

Automatic climate control system

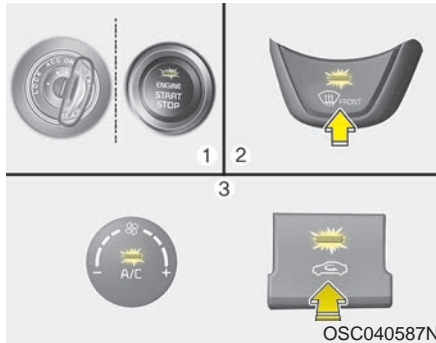

1. Turn the ignition switch to the ON position.
2. Select the defroster position before pressing the defroster button (☀️).
3. While pressing the air conditioning button (A/C), press the air intake control button (🌬️) at least 5 times within 3 seconds.

The indicator on the air intake button blinks 3 times with 0.5 second of interval. It indicates that the defogging logic is canceled or returned to the programmed status.

If the battery has been discharged or disconnected, it resets to the defog logic status.

Auto defogging system (if equipped)

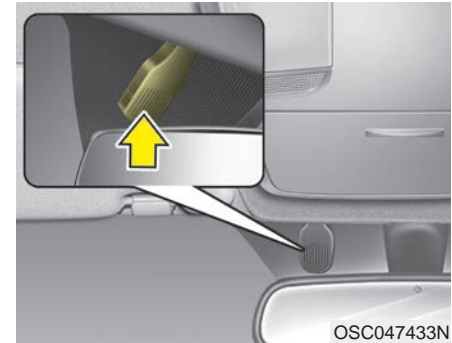

Auto defogging reduces the possibility of fogging up the inside of the windshield by automatically sensing the moisture inside the windshield and air flow toward the windshield can increase.

The auto defogging system operates when the AUTO mode is on.



This indicator illuminates when the auto defogging system senses moisture on the inside of the windshield and is activated.

If more moisture is in the vehicle, the auto defogging system addresses excess moisture on the inside of the windshield in stages as follows:

- Step 1 : Operating the air conditioning
- Step 2 : Outside air position
- Step 3 : Blowing air flow toward the windshield
- Step 4 : Increasing air flow toward the windshield

If your vehicle is equipped with the auto defogging system, it is automatically activated when the conditions are met.

However, if you would like to deactivate the auto defogging system, keep the front defroster button pressed longer than 3 seconds.

The “ADS OFF” symbol will be shown in the climate display to inform you that the system is deactivated.

To re-activate the auto defogging system again, follow the procedure mentioned above and the “ADS OFF” symbol will disappear.

If the battery has been disconnected or discharged, it resets to the auto defogging status.

* NOTICE

- **When the air conditioning is turned on by Auto defogging system, if you try to turn off the air conditioning, the indicator will blink 3 times and the air conditioning will not be turned off.**
- **For efficiency, do not select recirculated air position while Auto defogging system is operating.**

CAUTION

Do not remove the sensor cover located on the upper end of the driver side windshield glass. Damage to the system parts could occur and may not be covered by your vehicle warranty.

STORAGE COMPARTMENT

These compartments can be used to store small items.

To avoid possible theft, do not leave valuables in the storage compartment. Always keep the storage compartment covers closed while driving.

⚠ WARNING - Flammable materials

Do not store flammable/explosive materials in the vehicle. These items may catch fire and/or explode if the vehicle is exposed to hot temperatures for extended periods.

Center console storage (if equipped)

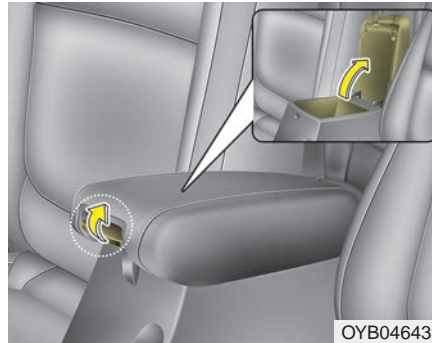

To open the center console storage, pull up the lever.

Glove box

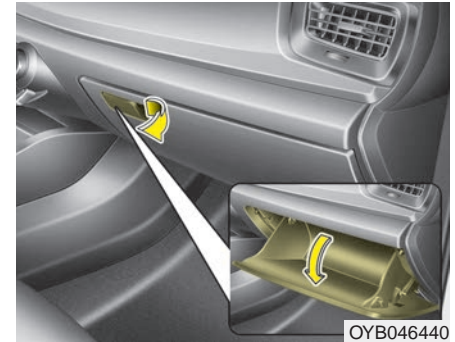

To open the glove box, pull the handle, and the glove box will automatically open. Close the glove box after use.

Always keep the glove box closed while the vehicle is in motion.

⚠ WARNING - Glove box

To reduce the risk of injury in an accident or sudden stop, always keep the glove box door closed while driving.

Sunglass holder (if equipped)

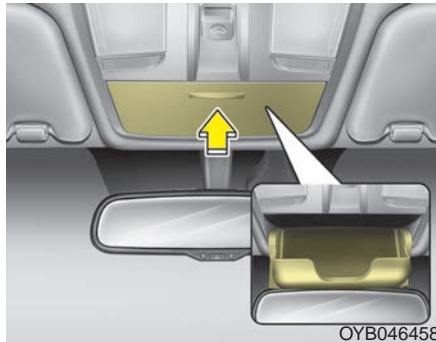

To open the sunglass holder, press the cover and the holder will slowly open. Place your sunglasses with the lenses facing out. To close the sunglass holder, push it up.

⚠ WARNING

Do not open the sunglass holder while the vehicle is moving. The rear view mirror of the vehicle can be blocked by an open sunglass holder.

⚠ WARNING - Sunglass holder

Do not keep objects except sunglasses inside the sunglass holder. Heavier objects can be thrown from the holder in the event of a sudden stop or an accident, possibly injuring the passengers.

Luggage net holder

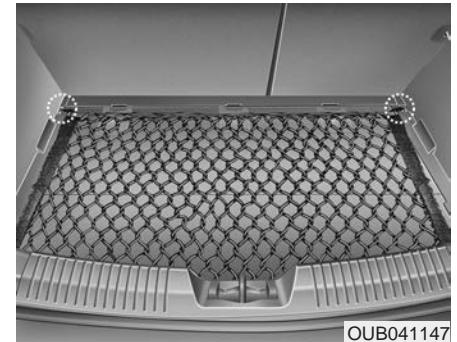

To keep items from shifting in the cargo area, you can use the 4 holders located in the cargo area to attach the luggage net (if equipped). If necessary, we recommend that you contact an authorized Kia dealer.

 **CAUTION**

To prevent damage to the goods or the vehicle, care should be taken when carrying fragile or bulky objects in the luggage compartment.

 **WARNING**

To avoid bodily injury, **DO NOT** overstretch the luggage net and **ALWAYS** keep your face and body out of the luggage net's recoil path. **DO NOT** use when the strap has visible signs of wear or damage.

INTERIOR FEATURES

Cup holder

⚠ WARNING - Hot liquids

Do not place uncovered cups of hot liquid in the cup holder while the vehicle is in motion. If the hot liquid spills, you may burn yourself. Such a burn to the driver could lead to loss of control of the vehicle.

⚠ CAUTION

Keep your drinks sealed while driving to prevent spilling your drink. If liquid spills, it may get into the vehicle's electrical/electronic system and damage electrical/electronic parts.

*** NOTICE**

When cleaning spilled liquids, do not dry the cup holder at high temperature. This may damage the cup holder.

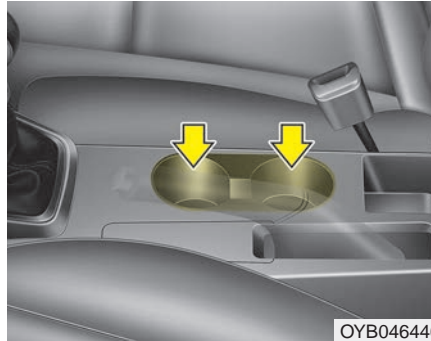

Cups or small beverage cans may be placed in the cup holders.

Sunvisor

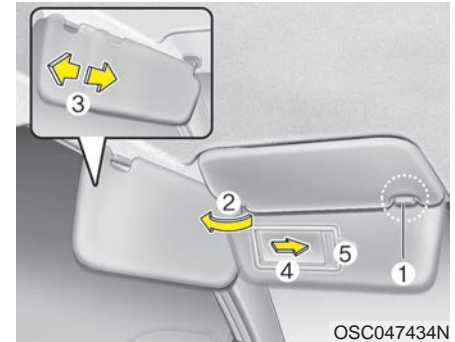

Use the sunvisor to shield direct light through the front or side windows.

To use the sunvisor, pull it downward.

To use the sunvisor for the side window, pull it downward, unsnap it from the bracket (1) and swing it to the side (2).

Adjust the sunvisor extension forward or backward (3).

To use the vanity mirror, pull down the visor and slide the mirror cover (4).

The ticket holder (5) is provided for holding a tollgate ticket.

⚠ CAUTION - Vanity mirror lamp

Close the vanity mirror cover securely and return the sunvisor to its original position after use. If the vanity mirror is not closed securely, the lamp will stay on and could result in battery discharge and possible sunvisor damage.

Power outlet



The power outlet is designed to provide power for mobile telephones or other devices designed to operate with vehicle electrical systems. The devices should draw less than 12V, 15A with the engine running.

Use the power outlet only when the engine is running and remove the accessory plug after use. Using the accessory plug for prolonged periods of time with the engine off could cause the battery to discharge.

Only use 12V electric accessories which are less than 15A in electric capacity.

Close the cover when not in use.

Some electronic devices can cause electronic interference when plugged into a vehicle's power outlet. These devices may cause excessive audio static and malfunctions in other electronic systems or devices used in your vehicle.

Using electrical products which exceed the limited capacity might cause heating to the power outlet and wiring that could lead to an electrical breakdown. Always make sure the electrical part is firmly plugged into the power outlet. Incomplete plugging may cause electrical breakdown.

Electrical products with a built-in battery might cause current flow, which could lead to malfunction of the electric/electronic device in your vehicle. Only use electrical products which include reverse current prevention

⚠ WARNING - Electric shock
Do not put a finger or a foreign object (pen, etc.) into a power outlet and do not touch with a wet hand. You may receive an electric shock.

USB charger (if equipped)



The USB charger is designed to recharge batteries of small size electrical devices using a USB cable. The electrical devices can be recharged when the ignition switch is in ACC/ON/START position.

The battery charging state may be monitored on the electrical device.

Disconnect the USB cable from the USB port after use.

- Some devices are not supported for fast charging but will be charged with normal speed.
- Use the USB charger when the engine is running to prevent battery discharge.
- Only devices that fit the USB port can be used.
- The USB charger can be used only for battery charging purposes.
- Battery chargers cannot be charged.

Clothes hanger (if equipped)

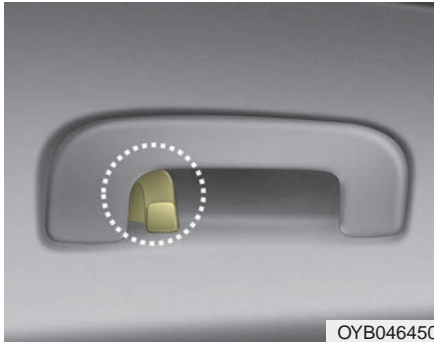

The clothes hanger is located on the roof of the rear seats.

CAUTION - Hanging clothing

Do not hang heavy clothes, since those may damage the hook.

WARNING



Do not hang other objects such as hangers or hard objects except clothes. Also, do not put heavy, sharp or breakable objects in the clothe pockets. In an accident or when the curtain air bag is inflated, it may cause vehicle damage or personal injury.

Floor mat anchor(s)

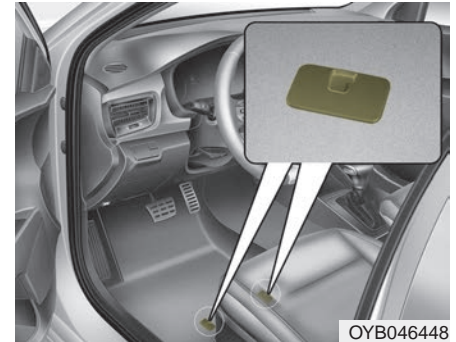

When using a floor mat on the floor carpet, make sure it attaches to the floor mat anchor(s) in the front and rear floor carpet of your vehicle. This keeps the floor mat from sliding forward.

WARNING - Aftermarket floor mat

Do not install aftermarket floor mats that are not capable of being securely attached to the vehicle's floor mat anchors. Unsecured floor mats can interfere with pedal operation.

The following must be observed when installing ANY floor mat in the vehicle.

- Ensure that the floor mats are securely attached to the vehicle's floor mat anchor(s) before driving the vehicle.
- Do not use ANY floor mat that cannot be firmly attached to the vehicle's floor mat anchors.
- Do not stack floor mats on top of one another (e.g., all-weather rubber mat on top of a carpeted floor mat). Only a single floor mat should be installed in each position.

* NOTICE

Your vehicle was manufactured with driver's side floor mat anchors that are designed to securely hold the floor mat in place. To avoid any interference with pedal operation, Kia recommends that only the Kia floor mat designed for use in your vehicle be installed.

Shopping bag holder (if equipped)

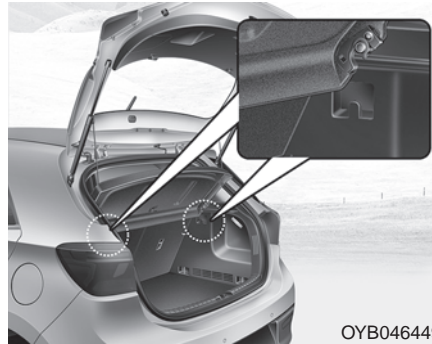

⚠ CAUTION

- **Do not hang a bag weighing more than 7 lbs. (3 kg). It may cause damage to the shopping bag holder.**
- **Do not hang a bag with frail objects when you drive on a rough road as the objects may be damaged.**

Covering shelf (for 5 door)

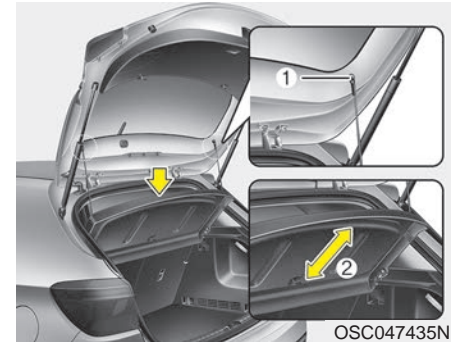

Use the cover to hide items stored in the cargo area.

The covering shelf will be lifted when the liftgate is opened. Disconnect the strap (1) from holder if you want to return the cover to original position. To remove the covering shelf completely, lift the cover to a 43-degree angle and pull it out to the full (2). For installation of the cover, reverse the removal procedure.

When you return the covering shelf to its original position, hold the cover and lower it.

 **CAUTION**

- *Do not operate the vehicle with the cover removed. It may damage the cover.*
- *Since the covering shelf may be damaged or malformed, do not apply excessive force to the cover.*

 **WARNING**

Do not place objects on the covering shelf while driving. Such objects may be thrown about inside the vehicle and possibly injure vehicle occupants during an accident or when braking.

Never allow anyone to ride in the luggage compartment. It is designed for luggage only.

Maintain the balance of the vehicle and locate the weight as far forward as possible.

INFOTAINMENT SYSTEM

* NOTICE

If you install an aftermarket HID head lamp, your vehicle's audio and electronic device may malfunction.

* If your vehicle is equipped with Infotainment system, refer to a separately supplied manual for detailed information.

Antenna

Micro pole antenna

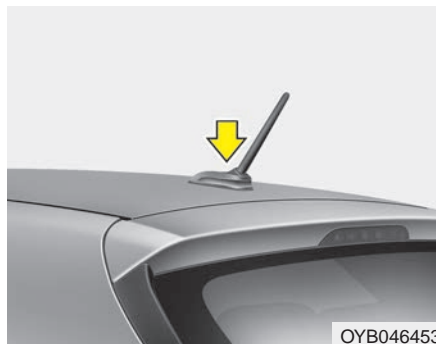

The micro pole antenna receives data transmitted from base stations and satellites (e.g. AM/FM, SXM, GPS, LTE) and also transmits to base stations (e.g. LTE). The antenna pole is removable type.

To remove the antenna, turn it counterclockwise. To install the antenna, turn it clockwise.

When reinstalling your antenna, it is important that it is fully tightened and adjusted to the upright position to ensure proper reception. But it could be removed when parking the vehicle or when loading cargo on the roof rack.

When cargo is loaded on the roof rack, do not place the cargo near the antenna pole to ensure proper reception.



CAUTION

Before entering a place with a low height clearance or a car wash, remove surely the antenna by rotating it counterclockwise. If not, the antenna may be damaged.

USB port



OSC040519

You can use an USB port to plug in an USB.

How vehicle audio works

FM reception

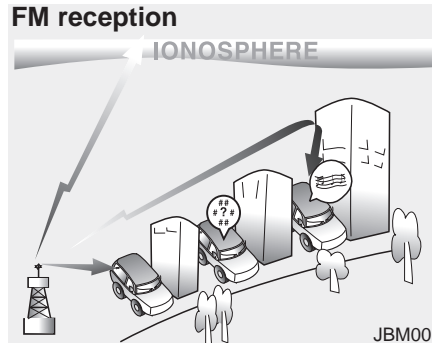

AM and FM radio signals are broadcast from transmitter towers located around your city. They are intercepted by the radio antenna on your vehicle. This signal is then received by the radio and sent to your vehicle speakers.

When a strong radio signal has reached your vehicle, the precise engineering of your audio system ensures the best possible quality reproduction. However, in some cases the signal coming to your vehicle may not be strong and clear.

This can be due to many factors, such as the distance from the radio station, closeness of other strong radio stations or the presence of buildings, bridges or other large obstructions in the area.

AM reception

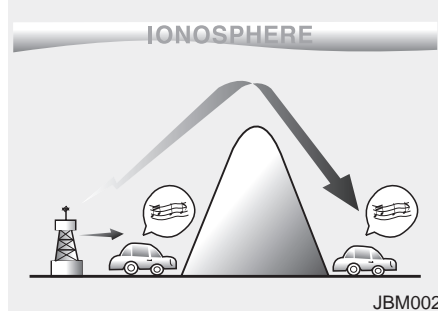

AM broadcasts can be received at greater distances than FM broadcasts. This is because AM radio waves are transmitted at low frequencies. These long, low frequency radio waves can follow the curvature of the earth rather than travelling straight out into the atmosphere. In addition, they curve around obstructions so that they can provide better signal coverage.

FM radio station

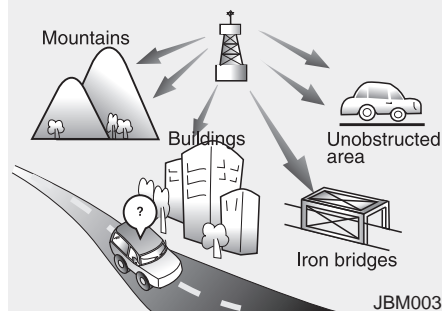

FM broadcasts are transmitted at high frequencies and do not bend to follow the earth's surface. Because of this, FM broadcasts generally begin to fade at short distances from the station. Also, FM signals are easily affected by buildings, mountains, or other obstructions. These can result in certain listening conditions which might lead you to believe a problem exists with your radio. The following conditions are normal and do not indicate radio trouble:

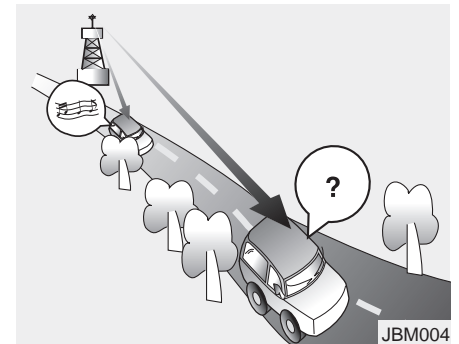

- **Fading** - As your vehicle moves away from the radio station, the signal will weaken and sound will begin to fade. When this occurs, we suggest that you select another stronger station.
- **Flutter/Static** - Weak FM signals or large obstructions between the transmitter and your radio can disturb the signal causing static or fluttering noises to occur. Reducing the treble level may lessen this effect until the disturbance clears.

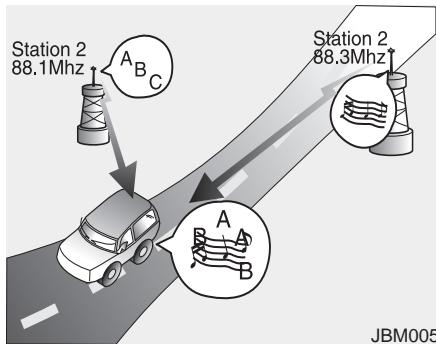

- **Station Swapping** - As a FM signal weakens, another more powerful signal near the same frequency may begin to play. This is because your radio is designed to lock onto the clearest signal. If this occurs, select another station with a stronger signal.
- **Multi-Path Cancellation** - Radio signals being received from several directions can cause distortion or fluttering. This can be caused by a direct and reflected signal from the same station, or by signals from two stations with close frequencies. If this occurs, select another station until the condition has passed.

Using a cellular phone or a two-way radio

When a cellular phone is used inside the vehicle, noise may be produced from the audio system. This does not mean that something is wrong with the audio equipment. If this occurs, try using the cellular phone as far away as possible from the audio equipment.

When using a communication system such as a cellular phone or a radio set inside the vehicle, a separate external antenna must be fitted. When a cellular phone or a radio set is used with an internal antenna alone, it may interfere with the vehicle's electrical system and adversely affect safe operation of the vehicle.

⚠ WARNING

Do not use a cellular phone while driving. Stop at a safe location to use a cellular phone.

⚠ WARNING

Driving while distracted can result in a loss of vehicle control that may lead to an accident, severe personal injury, and death. The driver's primary responsibility is in the safe and legal operation of the vehicle, and any handheld devices, other equipment, or vehicle systems which take the driver's eyes, attention, and focus away from the safe operation of the vehicle, or which are not permissible by law, should never be used during operation of the vehicle.

⚠ WARNING - Audio System

Do not disassemble, assemble, or modify this audio system. Such acts could result in fire or electric shock.

⚠ WARNING - Antenna

Do not touch the antenna during thunder or lightning as such acts may lead to lightning induced electric shock.

Declaration of Conformity

FCC

This equipment has been tested and found to comply with the limits for a Class B digital device, pursuant to part 15 of the FCC Rules. These limits are designed to provide reasonable protection against harmful interference in a residential installation.

This equipment generates, uses and can radiate radio frequency energy and, if not installed and used in accordance with the instructions, may cause harmful interference to radio communications. However, there is no guarantee that interference will not occur in a particular installation. If this equipment does cause harmful interference to radio or television reception, which can be determined by turning the equipment off and on, the user is encouraged to try to correct the interference by one or more of the following measures :

- Reorient or relocate the receiving antenna.
- Increase the separation between the equipment and receiver.
- Connect the equipment into an outlet on a circuit different from that to which the receiver is connected.
- Consult the dealer or an experienced radio/TV technician for help.

Caution: Any changes or modifications to this device not explicitly approved by manufacturer could void your authority to operate this equipment.

This device complies with part 15 of the FCC Rules. Operation is subject to the following two conditions :

(1) This device may not cause harmful interference, and (2) this device must accept any interference received, including interference that may cause undesired operation.

This equipment complies with FCC radiation exposure limits set forth for an uncontrolled environment.

This equipment should be installed and operated with minimum 20cm between the and your body. This transmitter must not be collocated or operating in conjunction with any other antenna or transmitter unless authorized to do so by the FCC.

Driving your vehicle

Before driving	5-5	• Good braking practices	5-42
• Before entering vehicle	5-5	Sport mode integrated control system	5-44
• Necessary inspections	5-5	• SPORT mode	5-44
• Before starting	5-5	Forward Collision-Avoidance Assist (FCA)	
Key positions	5-7	(Front view camera only)	5-45
• Ignition switch position	5-7	• Detecting sensor	5-45
• Starting the engine	5-9	• Function settings	5-46
ENGINE START/STOP button	5-10	• FCA warning message and function control	5-48
• Illuminated ENGINE START/STOP button	5-10	• Brake operation	5-50
• ENGINE START/STOP button position	5-10	• Warning message and warning light	5-51
• Starting the engine	5-13	• Function malfunction	5-52
• Stopping the engine(Manual Transmission)	5-16	• Limitations of FCA	5-53
Manual Transmission	5-17	• Situation in which the function may not detect	
• Manual transmission operation	5-17	pedestrian properly.	5-58
• Good driving practices	5-20	Lane Keeping Assist (LKA)	5-61
Intelligent Variable Transmission (IVT)	5-21	• Detecting sensor	5-61
• Intelligent Variable Transmission (IVT) operation	5-21	• Function settings	5-62
• Good driving practices	5-26	• Function operation	5-63
Brake system	5-29	• Function malfunction and limitations	5-66
• Power brakes	5-29	Blind-Spot Collision Warning (BCW)	5-68
• Parking brake	5-31	• Detecting sensor	5-69
• Anti-lock Brake System (ABS)	5-34	• Function settings	5-70
• Electronic Stability Control (ESC)	5-35	• Function operation	5-72
• Hill-start Assist Control (HAC)	5-39	• Function malfunction and limitations	5-73
• Vehicle Stability Management (VSM)	5-40		

Driver Attention Warning (DAW)	5-78
• Basic function.....	5-78
• Leading Vehicle Departure Alert function	5-78
• Detecting sensor.....	5-78
• Function settings	5-79
• Function operation	5-81
• Function malfunction and limitations.....	5-84
Cruise Control (CC)	5-87
• Function operation	5-87
• To increase set speed.....	5-88
• To decrease speed	5-88
• To temporarily pause the function	5-89
• To resume the function	5-89
Lane Following Assist (LFA)	5-91
• Detecting sensor.....	5-91
• Function settings	5-92
• Function operation	5-92
• Function malfunction and limitations.....	5-95
Rear Cross-Traffic Collision Warning (RCCW)	5-96
• Detecting sensor.....	5-97
• Functions settings	5-97
• Function operation	5-98
• Function malfunction and limitations.....	5-99
Declaration of Conformity	5-104
• The radio frequency components (Rear Corner Radar) complies	5-104
Economical operation	5-105
Special driving conditions	5107
• Hazardous driving conditions	5-107
• Rocking the vehicle	5-107
• Smooth cornering	5-108
• Driving at night	5-108
• Driving in the rain.....	5-109
• Driving in flooded areas	5-110
• Driving off-road.....	5-110
• Highway driving	5-110
Winter driving	5-112
• Snowy or Icy conditions	5-112
• Use high quality ethylene glycol coolant	5-114
• Check battery and cables	5-114
• Change to "winter weight" oil if necessary	5-115
• Check spark plugs and ignition system.....	5-115
• To keep locks from freezing	5-115
• Use approved window washer anti-freeze in system.....	5-115
• Don't let your parking brake freeze	5-115
• Don't let ice and snow accumulate underneath ...	5-115
• Carry emergency equipment	5-116

Trailer towing 5-116

Vehicle load limit 5-117

- **Tire and loading information label 5-117**
- **Certification label 5-120**

Vehicle weight 5-122

- **Base curb weight 5-122**
- **Vehicle curb weight 5-122**
- **Cargo weight 5-122**
- **GAW (Gross axle weight) 5-122**
- **GAWR (Gross axle weight rating) 5-122**
- **GVW (Gross vehicle weight) 5-122**
- **GVWR (Gross vehicle weight rating) 5-122**

Be sure the exhaust system does not leak.

The exhaust system should be checked whenever the vehicle is raised to change the oil or for any other purpose. If you hear a change in the sound of the exhaust or if you drive over something that strikes the underneath side of the vehicle, have the exhaust system checked as soon as possible by an authorized Kia dealer.

⚠ WARNING - Engine exhaust

Do not inhale exhaust fumes or leave your engine running in an enclosed area for a prolonged time.

Exhaust fumes contain carbon monoxide, a colorless, odorless gas that can cause unconsciousness and death by asphyxiation.

⚠ WARNING - Open trunk/liftgate

Do not drive with the trunk/liftgate open.

Poisonous exhaust gases can enter the passenger compartment. If you must drive with the trunk/liftgate open proceed as follows:

- 1. Close all windows.**
- 2. Open side vents.**
- 3. Set the air intake control at "Fresh", the air flow control at "Floor" or "Face" and the fan at the highest speed.**

BEFORE DRIVING

Before entering vehicle

- Be sure that all windows, outside mirror(s), and outside lights are clean.
- Check the condition of the tires.
- Check under the vehicle for any sign of leaks.
- Be sure there are no obstacles behind you if you intend to back up.

Necessary inspections

Fluid levels, such as engine oil, engine coolant, brake fluid, and washer fluid should be checked on a regular basis, with the exact interval depending on the fluid. Further details are provided in chapter 7, "Maintenance".



WARNING - Distracted driving

Focus on the road while driving. The driver's primary responsibility is in the safe and legal operation of the vehicle. Use of any hand held devices, other equipment or vehicle systems that distract the driver should not be used during vehicle operation.

Before starting

- Close and lock all doors.
- Position the seat so that all controls are easily reached.
- Buckle your seat belt.
- Adjust the inside and outside rearview mirrors.
- Be sure that all lights work.
- Check all gauges.
- Check the operation of warning lights when the ignition switch or ENGINE START/STOP button is turned to the ON position.
- Release the parking brake and make sure the brake warning light goes off.

For safe operation, be sure you are familiar with your vehicle and its equipment.

⚠ WARNING - Fire risk

When you intend to park or stop the vehicle with the engine on, be careful not to depress the accelerator pedal for a long period of time. It may overheat the engine or exhaust system and cause fire.

⚠ WARNING - Check surroundings

Always check the surrounding areas near your vehicle for people, especially children, before putting a vehicle into D (Drive) or R (Reverse).

⚠ WARNING - Loose objects

Securely store items in your vehicle. When you make a sudden stop or turn the steering wheel rapidly, loose objects may drop on the floor and could interfere with the operation of the foot pedals, possibly causing an accident.

⚠ WARNING - Proper footwear

Always wear appropriate shoes when operating your vehicle. Unsuitable shoes (high heels, ski boots, sandals, etc.) may interfere with your ability to use the brake and accelerator pedals.

⚠ WARNING - Driving while intoxicated

Do not drive while intoxicated. Drinking and driving is dangerous. Even a small amount of alcohol will affect your reflexes, perceptions and judgment.

Driving while under the influence of drugs is as dangerous as or more dangerous than driving drunk.

KEY POSITIONS

Ignition switch position

LOCK

■ Type A

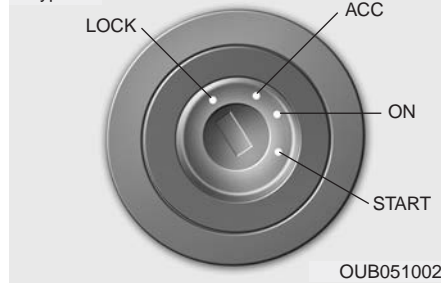

■ Type B



The steering wheel locks to protect against theft.

The ignition key can be removed only in the LOCK position.

The anti-theft steering column lock is not a substitute for the parking brake.

Before leaving the driver's seat, always make sure the shift lever is engaged in 1st gear for the Manual Transmission or P (Park) for the Intelligent Variable Transmission, set the parking brake fully and shut the engine off.

ACC (Accessory)

The steering wheel is unlocked and electrical accessories are operative.

If difficulty is experienced turning the ignition switch to the ACC position, turn the key while turning the steering wheel right and left to release the tension.

ON

The warning lights can be checked before the engine is started. This is the normal running position after the engine is started.

Do not leave the ignition switch ON if the engine is not running to prevent battery discharge.

START

Turn the ignition switch to the START position to start the engine. The engine will crank until you release the key; then it returns to the ON position. The brake warning light can be checked in this position.

*** NOTICE**

If you leave the ignition switch to the ACC or ON position for a long time, the battery may discharge.

⚠ WARNING - Ignition switch

Never turn the ignition switch to LOCK or ACC while the vehicle is moving. This would result in loss of directional control and braking function, which could cause an accident.

⚠ WARNING - Steering wheel

Never reach for any controls through the steering wheel while the vehicle is in motion. The presence of your hand or arm in this area could cause a loss of vehicle control.

⚠ WARNING - Key holder

Do not attach small purses, multiple keys, or any other heavy accessories to the driver's key chain used to start the vehicle. This may cause the inserted key to inadvertently change the ignition position to the ACC position while the vehicle is moving, thereby increasing the risk of an accident and deactivating several safety features.

⚠ WARNING - Leaving the vehicle

To avoid unexpected or sudden vehicle movement, never leave your vehicle if the transmission is not locked in the P (Park) position and the parking brake is not fully engaged. Before leaving the driver's seat, always make sure the shift lever is engaged in P (Park), set the parking brake fully and shut the engine off.

Starting the engine

 **WARNING** - Proper footwear

Always wear appropriate shoes when operating your vehicle. Unsuitable shoes (high heels, ski boots, sandals, etc.) may interfere with your ability to use the brake and accelerator pedals.

Starting the engine with an ignition key

1. Make sure the parking brake is applied.
2. **Manual Transmission** - Depress the clutch pedal fully and shift the transmission into Neutral. Keep the clutch pedal and brake pedal depressed while turning the ignition switch to the start position.

Intelligent Variable Transmission

- Place the transmission shift lever in P (Park). Depress the brake pedal fully.

You can also start the engine when the shift lever is in the N (Neutral) position.

3. Turn the ignition switch to START and hold it there until the engine starts (a maximum of 10 seconds), then release the key.

*It should be started **without depressing the accelerator.***

4. Do not wait for the engine to warm up while the vehicle remains stationary.

Start driving at moderate engine speeds. (Extreme and/or excessive accelerating and decelerating should be avoided.)

If the engine stalls while the vehicle is in motion, do not attempt to move the shift lever to the P (Park) position. If traffic and road conditions permit, you may put the shift lever in the N (Neutral) position while the vehicle is still moving and turn the ignition switch to the START position in an attempt to restart the engine.

 **CAUTION** - Starter

Do not engage the starter for more than 10 seconds. If the engine stalls or fails to start, wait 5 to 10 seconds before re-engaging the starter. Improper use of the starter may damage it.

ENGINE START/STOP BUTTON (IF EQUIPPED)

Illuminated ENGINE START/STOP button



Whenever the front door is opened, the ENGINE START/STOP button will illuminate for your convenience. The light will go off after about 30 seconds when the door is closed. It will also go off immediately when the theft-alarm system is armed.

ENGINE START/STOP button position

OFF

With Manual Transmission

To turn off the engine (START/RUN position) or vehicle power (ON position), stop the vehicle, then press the ENGINE START/STOP button.

With Intelligent Variable Transmission

To turn off the engine (START/RUN position) or vehicle power (ON position), press the ENGINE START/STOP button with the shift lever in the P (Park) position. When you press the ENGINE START/STOP button without the shift lever in the P (Park) position, the ENGINE START/STOP button will not change to the OFF position but to the ACC position.

Vehicles equipped with anti-theft steering column lock

The steering wheel locks when the ENGINE START/STOP button is in the OFF position to protect you against theft. It locks when the door is opened.

If the steering wheel is not locked properly when you open the driver's door, the warning chime will sound. Try locking the steering wheel again. If the problem is not solved, have the system checked by a professional workshop. Kia recommends to visit an authorized Kia dealer/service partner.

In addition, if the ENGINE START/STOP button is in the OFF position after the driver's door is opened, the steering wheel will not lock and the warning chime will sound. If that occurs, close the door. Then the steering wheel will lock and the warning chime will stop.

*** NOTICE**

If the steering wheel doesn't unlock properly, the ENGINE START/STOP button will not work. Press the ENGINE START/STOP button while turning the steering wheel right and left to release the tension.

*** NOTICE**

You are able to turn off the engine (START/RUN) or vehicle power (ON), only when the vehicle is not in motion.

*** NOTICE**

In an emergency situation while the vehicle is in motion, you are able to turn the engine off and to the ACC position by pressing the ENGINE START/STOP button for more than 2 seconds or 3 times successively within 3 seconds.

If the vehicle is still moving, to restart the vehicle:

- **Manual Transmission** - Press the ENGINE START/STOP button with shift lever in neutral and clutch pedal depressed.
- **Intelligent Variable Transmission** - Press the ENGINE START/STOP button when vehicle speed is 3 mph (5 km/h) or over.

ACC(Accessory)**With Manual Transmission**

Press the ENGINE START/STOP button when the button is in the OFF position without depressing the clutch pedal.

With Intelligent Variable Transmission

Press the ENGINE START/STOP button while it is in the OFF position without depressing the brake pedal.

The steering wheel unlocks and electrical accessories are operational.

If the ENGINE START/STOP button is in the ACC position for more than 1 hour, the button is turned off automatically to prevent battery discharge.

ON

With Manual Transmission

Press the ENGINE START/STOP button when the button is in the ACC position without depressing the clutch pedal.

With Intelligent Variable Transmission

Press the ENGINE START/STOP button while it is in the ACC position without depressing the brake pedal.

The warning lights can be checked before the engine is started. Do not leave the ENGINE START/STOP button in the ON position for a long time. The battery may discharge, because the engine is not running.

START/RUN

With Manual Transmission

To start the engine, depress the clutch pedal and brake pedal, then press the ENGINE START/STOP button with the shift lever in the N (Neutral) position.

With Intelligent Variable Transmission

To start the engine, depress the brake pedal and press the ENGINE START/STOP button with the shift lever in the P (Park) or the N (Neutral) position. For your safety, start the engine with the shift lever in the P (Park) position.

*** NOTICE**

If you press the ENGINE START/STOP button without depressing the clutch pedal for manual transmission vehicles or without depressing the brake pedal for manual transmission/Intelligent Variable Transmission vehicles, the engine will not start and the ENGINE START/STOP button changes as follow:

OFF → ACC → ON → OFF or ACC

*** NOTICE**

If you leave the ENGINE START/STOP button in the ACC or ON position for a long time, the battery will discharge.

⚠ WARNING

- Never press the ENGINE START/STOP button while the vehicle is in motion. This could result in loss of directional control and braking function, which could cause an accident.
- The anti-theft steering column lock is not a substitute for the parking brake. Before leaving the driver's seat, always make sure the shift lever is engaged in P (Park), set the parking brake fully and shut the engine off. Unexpected and sudden vehicle movement may occur if these precautions are not taken.

(Continued)

(Continued)

- Never reach for the ENGINE START/STOP button or any other controls through the steering wheel while the vehicle is in motion. The presence of your hand or arm in the area could cause loss of vehicle control, an accident and serious bodily injury or death.
- Do not place any movable objects around the driver's seat as they may move while driving, interfere with the driver and lead to an accident.

Starting the engine**⚠ WARNING**

- Always wear appropriate shoes when operating your vehicle. Unsuitable shoes (high heels, ski boots, etc.) may interfere with your ability to use the brake, accelerator and clutch pedal.
- Do not start the vehicle with the accelerator pedal depressed. The vehicle can move and lead to an accident.
- Wait until the engine rpm is normal. The vehicle may suddenly move if the brake pedal is released when the rpm is high.

Starting the engine

1. Carry the smart key or place it inside the vehicle.
2. Make sure the parking brake is firmly applied.
3. **Manual Transmission** - Depress the clutch pedal fully and shift the transmission into Neutral. Keep the clutch pedal and brake pedal depressed while starting the engine.

Intelligent Variable Transmission

- Place the transmission shift lever in P (Park). Depress the brake pedal fully.

You can also start the engine when the shift lever is in the N (Neutral) position.

4. Press the ENGINE START/STOP button.

It should be started without depressing the accelerator pedal.

5. Do not wait for the engine to warm up while the vehicle remains stationary. Start driving at moderate engine speeds. (Extreme and/or excessive accelerating and decelerating should be avoided.)

Starting and stopping the engine for turbocharger intercooler

1. Do not race or accelerate the engine immediately after starting.
If the engine is cold, idle for several seconds to ensure sufficient lubrication in the turbocharger unit.
2. After high speed or extended driving, requiring a heavy engine load, idle the engine about 1 minute before turning it off.

This idle time will allow the turbocharger to cool prior to shutting the engine off.

CAUTION

Do not turn the engine off immediately after it has been subjected to a heavy load. Doing so may cause severe damage to the engine or turbocharger unit.

Starting the engine with smart key

- Even if the smart key is in the vehicle, if it is far away from you, the engine may not start.
- When the ENGINE START/STOP button is in the ACC position or above, if any door is opened, the system checks for the smart key. If the smart key is not in the vehicle, the “” indicator and a message “Key is not in the vehicle” will appear on the instrument cluster and LCD Display. And if all doors are closed, the chime will sound for 5 seconds. The indicator or warning will turn off while the vehicle is moving. Always have the smart key with you.

⚠ WARNING

The engine will start only when the smart key is in the vehicle. Never allow children or any person who is unfamiliar with the vehicle touch the ENGINE START/STOP button or related parts. Pushing the ENGINE START/STOP button while the smart key is in the vehicle may result in unintended engine activation and/or unintended vehicle movement.

*** NOTICE**

If the engine stalls while the vehicle is in motion, do not attempt to move the shift lever to the P (Park) position. If the traffic and road conditions permit, you may put the shift lever in the N (Neutral) position while the vehicle is still moving and press the ENGINE START/STOP button in an attempt to restart the engine.

*** NOTICE**

- If the battery is weak or the smart key does not work correctly, you can start the engine by pressing the ENGINE START/STOP button with the smart key.

The side with the lock button should contact the ENGINE START/STOP button directly. When you press the ENGINE START/STOP button directly with the smart key, the smart key should contact the button at a right angle.

(Continued)

(Continued)

- When the stop lamp fuse is blown, you cannot start the engine normally.

Replace the fuse with a new one. If it is not possible, you can start the engine by pressing the ENGINE START/STOP button for 10 seconds while it is in the ACC position. The engine can start without depressing the brake pedal. But for your safety, always depress the brake pedal and clutch pedal before starting the engine.

CAUTION

- *Do not press the ENGINE START/STOP button for more than 10 seconds except when the stop lamp fuse is blown.*
- *Do not turn the ignition switch to the START position with the engine running. It may damage the starter.*

Stopping the engine (Manual Transmission)

1. Make sure the vehicle is completely stopped and keep the clutch pedal and brake pedal depressed.
2. Shift the transmission into Neutral while depressing the clutch pedal and brake pedal.
3. Engage the parking brake while depressing the brake pedal.
4. Turn the ignition key to the LOCK position and remove it.

MANUAL TRANSMISSION (IF EQUIPPED)

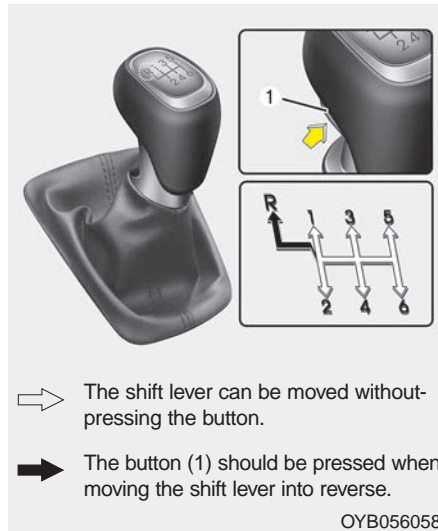

Manual transmission operation

The manual transmission has 6 forward gears.

This shift pattern is imprinted on the shift knob. The transmission is fully synchronized in all forward gears so shifting to either a higher or a lower gear is easily accomplished.

Depress the clutch pedal down fully while shifting, then release it slowly.

If your vehicle is equipped with an ignition lock switch, the engine will not start when starting the engine without depressing the clutch pedal.

The shift lever must be returned to the neutral position before shifting into R (Reverse). The button (1) located below the shift knob must be pulled upward while moving the shift lever to the R (Reverse) position.

Make sure the vehicle is completely stopped before shifting into R (Reverse).

Never operate the engine with the tachometer (rpm) in the red zone.

CAUTION - Downshifting

- ***When downshifting from fifth gear to fourth gear, caution should be taken not to inadvertently press the shift lever sideways in such a manner that the second gear is engaged. Such a drastic downshift may cause the engine speed to increase to the point that the tachometer will enter the red-zone. Such over-revving of the engine and transmission may possibly cause engine damage.***
- ***Do not downshift more than 2 gears or downshift the gear when the engine is running at high speed (5,000 RPM or higher). Such a downshifting may damage the engine, clutch and the transmission.***

- During cold weather, shifting may be difficult until the transmission lubricant is warmed up. This is normal and not harmful to the transmission.
- If you've come to a complete stop and it's hard to shift into 1st or R (Reverse), leave the shift lever at the N (Neutral) position and release the clutch. Depress the clutch pedal and then shift into 1st or R (Reverse) gear position.

 **CAUTION - Premature wear**

Do not use the shift lever as a handrest during driving, as this can result in premature wear of the transmission shift forks.

 **CAUTION**

- *To prevent possible damage to the clutch system, do not start with the 2nd (second) gear engaged except when you start on a slippery road.*
- *If the clutch pedal is released rapidly after shifting into 1st or R(Reverse), it could cause the engine to stall and lead to an accident.*
- *The clutch pedal should be fully depressed. When the pedal is released, make sure not to depress the pedal again before it returns to the normal position. Failure to do so repeatedly may cause damage to the clutch system.*
- *Do not overload the vehicle. Driving with the vehicle overloaded could cause abnormal friction heat to the clutch disk and damage the clutch cover and disk.*

 **WARNING - Shift lever position**

- **Before leaving the driver's seat, always set the parking brake fully and shut the engine off. Then make sure the transmission is shifted into 1st gear when the vehicle is parked on a level or uphill grade, and shifted into R (Reverse) on a downhill grade. Unexpected and sudden vehicle movement can occur if these precautions are not followed in the order identified.**
- **Do not use the engine brake (shifting from a high gear to lower gear) rapidly on slippery roads. The vehicle may slip, causing an accident.**

Using the clutch

The clutch should be depressed all the way to the floor before shifting, then released slowly. The clutch pedal should always be fully released while driving. Do not rest your foot on the clutch pedal while driving. This can cause unnecessary wear. Do not partially engage the clutch to hold the vehicle on an incline. This causes unnecessary wear. Use the foot brake or parking brake to hold the vehicle on an incline. Do not operate the clutch pedal rapidly and repeatedly.

WARNING - Using the clutch

Depress the clutch pedal as far as possible. Be aware not to apply the pedal again before it returns to the normal position.

If the pedal is repeatedly depressed before returning to its normal position, the clutch system might be damaged.

Do not overload the vehicle. Starting or driving a vehicle in this situation generates too much frictional heat to the clutch disk which might cause damage to the clutch cover and disk.

When starting the vehicle or driving backwards, releasing the clutch pedal too soon after shifting the lever might turn off the engine and lead to an accident.

Downshifting

When you must slow down in heavy traffic or while driving up steep hills, downshift before the engine starts to labor. Downshifting reduces the chance of stalling and gives better acceleration when you need to increase your speed again. When the vehicle is traveling down steep hills, downshifting helps maintain safe speed and prolongs brake life.

Good driving practices

- Never take the vehicle out of gear and coast down a hill. This is extremely hazardous. Always leave the vehicle in gear.
- Don't "ride" the brakes. This can cause them to overheat and malfunction. Instead, when you are driving down a long hill, shift to a lower gear. When you do this, engine braking will help slow down the vehicle.
- Slow down before shifting to a lower gear. This will help avoid over-revving the engine, which can cause damage.
- Slow down when you encounter cross winds. This gives you much better control of your vehicle.
- Be sure the vehicle is completely stopped before you attempt to shift into R (Reverse). The transmission can be damaged if you do not.

WARNING



- **Exercise extreme caution when driving on a slippery surface. Be especially careful when braking, accelerating or shifting gears. On a slippery surface, an abrupt change in vehicle speed can cause the drive wheels to lose traction and the vehicle to lose control.**
- **Always buckle-up! In a collision, an unbelted occupant is significantly more likely to be seriously injured or killed than a properly belted occupant.**
- **Never exceed posted speed limits.**
- **Avoid high speeds when cornering or turning. High speed cornering and turning increases the risk of vehicle rollover due to loss of vehicle control. Rollover accidents are extremely violent and unpredictable.**

INTELLIGENT VARIABLE TRANSMISSION (IVT) (IF EQUIPPED)

Intelligent Variable Transmission (IVT) operation

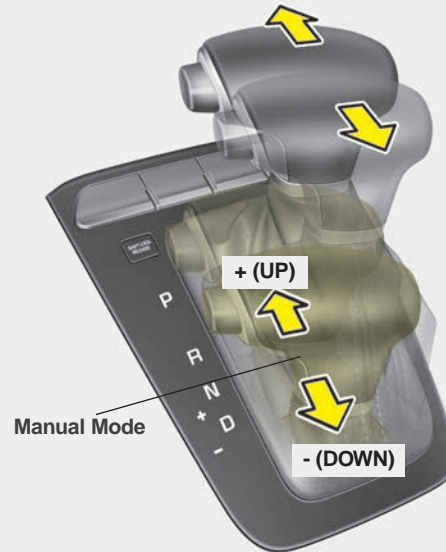
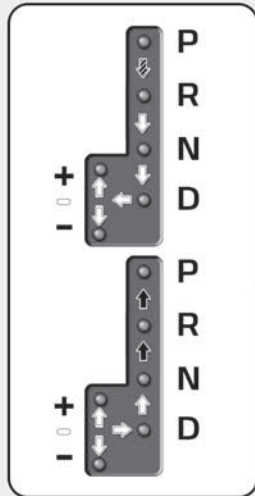
The Intelligent Variable Transmission (IVT) automatically shifts depending on speed and accelerator pedal position. The individual speeds are selected automatically, depending on the position of the shift lever.



-  Depress the brake pedal and the lock release button when shifting.
-  Press the lock release button when shifting.
-  The shift lever can be shifted freely.

OYB056071

For smooth operation, depress the brake pedal when shifting from N (Neutral) to a forward or reverse gear.

WARNING

- Intelligent Variable Transmission (IVT)

- Always check the surrounding areas near your vehicle for people, especially children, before shifting a car into D (Drive) or R (Reverse).
- Before leaving the driver's seat, always make sure the shift lever is in the P (Park) position; then set the parking brake fully and shut the engine off. Unexpected and sudden vehicle movement can occur if these precautions are not followed in the order identified.
- Do not use the engine brake (shifting from a high gear to lower gear) rapidly on slippery roads.
The vehicle may slip, causing an accident.

CAUTION

- *To avoid damage to your transmission, do not accelerate the engine in R (Reverse) or any forward gear position with the brakes on.*
- *When stopped on an incline, do not hold the vehicle stationary with engine power. Use the service brake or the parking brake.*
- *Do not shift from N (Neutral) or P (Park) into D (Drive), or R (Reverse) when the engine is above idle speed.*

Transmission ranges

The indicator in the instrument cluster displays the shift lever position when the ignition switch or ENGINE START/STOP button is in the ON position.

P (Park)

Always come to a complete stop before shifting into P (Park). This position locks the transmission and prevents the front wheels from rotating.

WARNING

- **Shifting into P (Park) while the vehicle is in motion will cause the drive wheels to lock which will cause you to lose control of the vehicle.**
- **Do not use the P (Park) position in place of the parking brake. Always make sure the shift lever is latched in the P (Park) position and set the parking brake fully.**
- **Never leave a child unattended in a vehicle.**

CAUTION

The transmission may be damaged if you shift into P (Park) while the vehicle is in motion.

R (Reverse)

Use this position to drive the vehicle backward.

⚠ CAUTION

Always come to a complete stop before shifting into or out of R (Reverse); you may damage the transmission if you shift into R while the vehicle is in motion, except as explained in “Rocking the vehicle” in this chapter.

N (Neutral)

The wheels and transmission are not engaged. The vehicle will roll freely even on the slightest incline unless the parking brake or service brakes are applied.

⚠ WARNING

**Do not drive with the shift lever in N (Neutral).
The engine brake may not work, which may lead to an accident.**

-Parking in N (Neutral) gear

Follow the steps below when parking if you want the vehicle to move when pushed.

1. After parking your vehicle, step on the brake pedal and move the shift lever to “P” with the ignition switch or ENGINE START/STOP button in “ON” or while the engine is running.
2. If the parking brake is applied unlock the parking brake.
3. While pressing the brake pedal, turn the ignition switch or ENGINE START/STOP button “OFF”.
 - For smart key equipped vehicles, the ignition switch or ENGINE START/STOP button can be moved to “OFF” only when the shift lever is in “P”.
4. Change the gear shift lever to “N” (Neutral) while pressing the brake pedal and pushing “SHIFT LOCK RELEASE” button or inserting, a tool (e.g. flathead screw-driver) into the “SHIFT LOCK RELEASE” access hole at the same time. Then, the vehicle will move when external force is applied.

⚠ WARNING

- **With the exception of parking in neutral gear, always park the vehicle in “P” (Park) for safety and engage the parking brake.**
- **Before parking in “N” (Neutral) gear, first make sure the parking ground is level and flat. Do not park in “N” gear on any slopes or gradients.
If parked and left in “N”, the vehicle may move and cause serious damage and injury.**

D (Drive)

This is the normal forward driving position. The transmission will automatically shift, providing the best fuel economy and power.

For extra power when passing another vehicle or climbing grades, depress the accelerator fully, at which time the transmission will automatically downshift to the next lower gear.

*** NOTICE**

Always come to a complete stop before shifting into D (Drive).

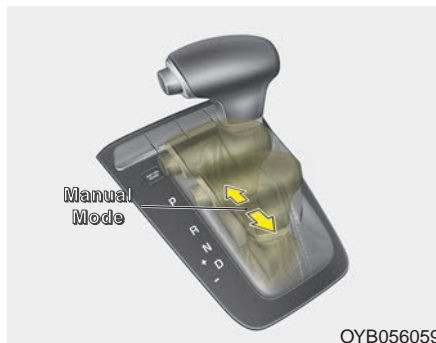

Manual Mode

Whether the vehicle is stationary or in motion, Manual Mode is selected by pushing the shift lever from the D (Drive) position into the manual gate. To return to D (Drive) range operation, push the shift lever back into the main gate.

Manual Mode manages the driving dynamics by automatically adjusting the steering effort and the engine and transmission control logic for enhanced driver performance.

In Manual Mode, moving the shift lever backwards or forwards will allow you to make gearshifts rapidly. In contrast to a manual transmission, the Manual Mode allows gearshifts with the accelerator pedal depressed.

Up (+) : Push the lever forward once to shift up one gear.

Down (-) : Pull the lever backwards once to shift down one gear.

*** NOTICE**

- In Manual Mode, the driver must execute upshifts in accordance with road conditions, being careful to keep the engine speed below the red zone.
- In Manual Mode, only the 8 forward gears can be selected. To reverse or park the vehicle, move the shift lever to the R (Reverse) or P (Park) position as required.
- In Manual Mode, downshifts are made automatically when the vehicle slows down. When the vehicle stops, 1st gear is automatically selected.
- In Manual Mode, when the engine rpm approaches the red zone, shift points are varied to upshift automatically.
- To maintain the required levels of vehicle performance and safety, the system may not execute certain gearshifts when the shift lever is operated.

(Continued)

(Continued)

- When driving on a slippery road, push the shift lever forward into the +(up) position. This causes the transmission to shift into the 2nd gear which is better for smooth driving on a slippery road. Push the shift lever to the -(down) side to shift back to the 1st gear.
- When Manual Mode is activated:
 - The engine rpm will tend to remain raised over a certain length of time even after releasing the accelerator
 - Upshifts are delayed when accelerating
- In Manual Mode, the fuel efficiency may decrease.

Shift lock system

For your safety, the Intelligent Variable Transmission (IVT) has a shift lock system which prevents shifting the transmission from P (Park) into R (Reverse) unless the brake pedal is depressed.

To shift the transmission from P (Park) into R (Reverse):

1. Depress and hold the brake pedal.
2. Start the engine or turn the ignition switch or ENGINE START/STOP button to the ON position.
3. Move the shift lever.

If the brake pedal is repeatedly depressed and released with the shift lever in the P (Park) position, a chattering noise near the shift lever may be heard. This is a normal condition.

 WARNING

Always fully depress the brake pedal before and while shifting out of the P (Park) position into another position to avoid inadvertent motion of the vehicle, which could injure persons in or around the vehicle.

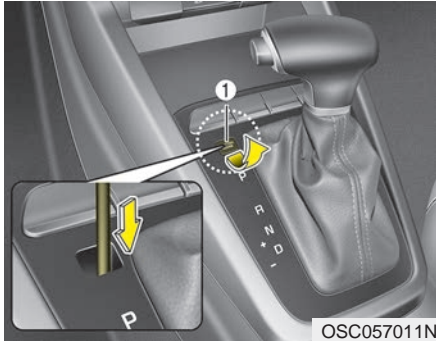

Shift-lock override

If the shift lever cannot be moved from the P (Park) position into R (Reverse) position with the brake pedal depressed, continue depressing the brake, then do the following:

1. Place the ignition switch or ENGINE START/STOP button in the LOCK/OFF position.
2. Apply the parking brake.
3. Carefully remove the cap covering the shift-lock release access hole.
4. Insert a tool (e.g. flathead screwdriver) into the access hole and press down on the tool.
5. Move the shift lever.
6. Remove the tool from the shiftlock override access hole then install the cap.
7. Have the system inspected by an authorized Kia dealer.

Ignition key interlock system

The ignition key cannot be removed unless the shift lever is in the P (Park) position.

Good driving practices

- Never move the shift lever from P (Park) or N (Neutral) to any other position with the accelerator pedal depressed.
- Never move the shift lever into P (Park) when the vehicle is in motion.
- Be sure the vehicle is completely stopped before you attempt to shift into R (Reverse) or D (Drive).
- Never take the vehicle out of gear and coast down a hill. This may be extremely hazardous. Always leave the vehicle in gear when moving.
- Do not "ride" the brakes. This can cause them to overheat and malfunction. Instead, when you are driving down a long hill, slow down and shift to a lower gear. When you do this, engine braking will help slow down the vehicle.
- Slow down before shifting to a lower gear. Otherwise, the lower gear may not be engaged.

- Always use the parking brake. Do not depend on placing the transmission in P (Park) to keep the vehicle from moving.

⚠ WARNING

Exercise extreme caution when driving on a slippery surface. Be especially careful when braking, accelerating or shifting gears. On a slippery surface, an abrupt change in vehicle speed can cause the drive wheels to lose traction and the vehicle to lose control.

- Optimum vehicle performance and economy is obtained by smoothly depressing and releasing the accelerator pedal.

⚠ WARNING

- When driving uphill or downhill, always shift to D (Drive) for driving forward or shift to R (Reverse) for driving backwards, and check the gear position indicated on the cluster before driving.

Driving in the opposite direction of the selected gear can lead to a dangerous situation by shutting off the engine and affecting the braking performance.

- Always buckle-up! In a collision, an unbelted occupant is significantly more likely to be seriously injured or killed than a properly belted occupant.
- Avoid high speeds when cornering or turning.
- Do not make quick steering wheel movements, such as sharp lane changes or fast, sharp turns.

(Continued)

(Continued)

- The risk of a rollover is greatly increased if you lose control of your vehicle at highway speeds.
- Losing control often occurs if two or more wheels drop off the roadway and the driver oversteers to reenter the roadway.
- In the event your vehicle leaves the roadway, do not steer sharply. Instead, slow down before pulling back into the travel lanes.
- Never exceed posted speed limits.

⚠ WARNING

If your vehicle becomes stuck in snow, mud, sand, etc., then you may attempt to rock the vehicle free by moving it forward and backward. Do not attempt this procedure if people or objects are anywhere near the vehicle. During the rocking operation, the vehicle may suddenly move forward or backward as it becomes unstuck, causing injury or damage to nearby people or objects.

Moving up a steep grade from a standing start

To move up a steep grade from a standing start, depress the brake pedal, release the parking brake, and shift the shift lever to D (Drive). Select the appropriate gear depending on load weight and steepness of the grade, and release the parking brake. Depress the accelerator gradually while releasing the service brakes.

When accelerating from a stop on a steep hill, the vehicle may have a tendency to roll backwards. Shifting the shift lever into 2 (Second Gear) will help prevent the vehicle from rolling backwards.

BRAKE SYSTEM

Power brakes

Your vehicle has power-assisted brakes that adjust automatically through normal usage.

In the event that the power-assisted brakes lose power because of a stalled engine or some other reason, you can still stop your vehicle by applying greater force to the brake pedal than you normally would. The stopping distance, however, will be longer.

When the engine is not running, the reserve brake power is partially depleted each time the brake pedal is applied. Do not pump the brake pedal when the power assist has been interrupted.

Pump the brake pedal only when necessary to maintain steering control on slippery surfaces.



CAUTION - Brake pedal

Do not drive with your foot resting on the brake pedal. This will create abnormally high brake temperatures which can cause excessive brake lining and pad wear.



WARNING - Steep hill braking

Avoid continuous application of the brakes when descending a long or steep hill by shifting to a lower gear. Continuous brake application will cause the brakes to overheat and could result in a temporary loss of braking performance.

Wet brakes may impair the vehicle's ability to safely slow down; the vehicle may also pull to one side when the brakes are applied. Applying the brakes lightly will indicate whether they have been affected in this way. Always test your brakes in this fashion after driving through deep water. To dry the brakes, apply them lightly while maintaining a safe forward speed until brake performance returns to normal.

In the event of brake failure

If service brakes fail to operate while the vehicle is in motion, you can make an emergency stop with the parking brake. The stopping distance, however, will be much greater than normal.

⚠ WARNING - Parking brake
Avoid applying the parking brake to stop the vehicle while it is moving, except in an emergency situation. Applying the parking brake while the vehicle is moving at normal speeds can cause a sudden loss of control of the vehicle. If you must use the parking brake to stop the vehicle, use great caution in applying the brake.

Disc brakes wear indicator

When your brake pads are worn and new pads are required, you will hear a high-pitched warning sound from your front brakes or rear brakes (if equipped). You may hear this sound come and go or it may occur whenever you depress the brake pedal.

Please remember that some driving conditions or climates may cause a brake squeal when you first apply (or lightly apply) the brakes. This is normal and does not indicate a problem with your brakes.

Always replace the front or rear brake pads as pairs.

⚠ CAUTION - Replace brake pads

Do not continue to drive with worn brake pads. Continuing to drive with worn brake pads can damage the braking system and result in costly brake repairs.

⚠ WARNING - Brake wear
Do not ignore high pitched wear sounds from your brakes. If you ignore this audible warning, you will eventually lose braking performance, which could lead to a serious accident.

Rear drum brakes (if equipped)

Your rear drum brakes do not have wear indicators. Therefore, have the rear brake linings inspected if you hear a rear brake rubbing noise. Also have your rear brakes inspected each time you change or rotate your tires and when you have the front brakes replaced.

Parking brake

Applying the parking brake

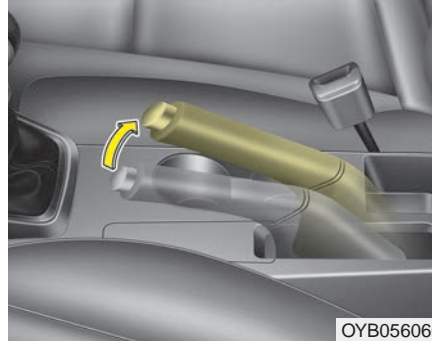

To engage the parking brake, first apply the foot brake and then without pressing the release button in, pull the parking brake lever up as far as possible. In addition it is recommended that when parking the vehicle on a gradient, the shift lever should be positioned in the appropriate low gear for Manual Transmission vehicles or in the P (Park) position for Intelligent Variable Transmission vehicles.

⚠ CAUTION - Parking brake
Driving with the parking brake applied will cause excessive brake pad (or lining) and brake rotor wear.

Releasing the parking brake

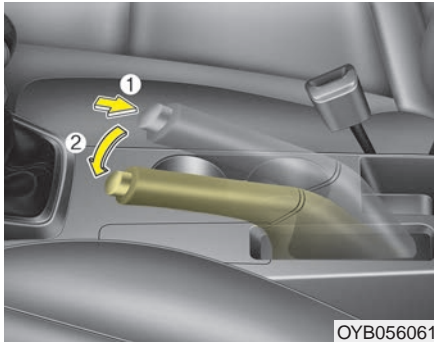

To release the parking brake, first apply the foot brake and pull up the parking brake lever slightly. Secondly, press the release button (1) and lower the parking brake lever (2) while holding the button.

⚠ WARNING - Parking brake use

- **Never allow a passenger to touch the parking brake. If the parking brake is released unintentionally, serious injury may occur.**
- **All vehicles should always have the parking brake fully engaged when parking to avoid inadvertent movement of the vehicle which can injure occupants or pedestrians.**

- If your vehicle is equipped with an intelligent variable transmission, don't let your vehicle creep forward. To avoid creeping forward, keep your foot firmly on the brake pedal when the vehicle is stopped.
- Be cautious when parking on a hill. Firmly engage the parking brake and place the shift lever in P (Intelligent Variable Transmission) or in first or reverse gear (Manual Transmission). If your vehicle is facing downhill, turn the front wheels into the curb to help keep the vehicle from rolling. If your vehicle is facing uphill, turn the front wheels away from the curb to help keep the vehicle from rolling. If there is no curb or if it is required by other conditions to keep the vehicle from rolling, chock the wheels.

- Under some conditions, your parking brake can freeze in the engaged position. This is most likely to happen when there is an accumulation of snow or ice around or near the rear brakes or if the brakes are wet. If there is a risk that the parking brake may freeze, apply it only temporarily while you put the shift lever in P (Intelligent Variable Transmission) or in first or reverse gear (Manual Transmission) and chock the rear wheels so the vehicle cannot roll. Then release the parking brake.
- Do not hold the vehicle on an incline with the accelerator pedal. This can cause the transmission to overheat. Always use the brake pedal or parking brake.



Check the brake warning light by turning the ignition switch or ENGINE START/STOP button ON (do not start the engine). This light will illuminate when the parking brake is applied with the ignition switch or ENGINE START/STOP button in the START or ON position.

Before driving, be sure the parking brake is fully released and the brake warning light is off.

If the brake warning light remains on after the parking brake is released while the engine is running, there may be a malfunction in the brake system. Immediate attention is necessary.

If at all possible, stop driving the vehicle immediately. If that is not possible, use extreme caution while operating the vehicle and only continue to drive the vehicle until you can reach a safe location or repair shop.

Anti-lock Brake System (ABS)

ABS (or ESC) will not prevent accidents due to improper or dangerous driving maneuvers. Even though ABS (or ESC) helps improve vehicle control during emergency braking, always maintain a safe distance between you and objects ahead. Vehicle speeds should always be reduced during extreme road conditions.

The vehicle should be driven at reduced speeds in the following circumstances:

- When driving on rough, gravel or snow-covered roads
- When driving with tire chains installed
- When driving on roads where the road surface is pitted or has different surface heights.

Driving in these conditions increases the stopping distance for your vehicle.

The ABS continuously senses the speed of the wheels. If the wheels are going to lock, the ABS system repeatedly modulates the hydraulic brake pressure to the wheels.

When you apply your brakes under conditions which may lock the wheels, you may hear a “tik-tik” sound from the brakes, or feel a corresponding sensation in the brake pedal. This is normal and means your ABS is active.

In order to obtain the maximum benefit from your ABS in an emergency situation, do not attempt to modulate your brake pressure and do not try to pump your brakes. Press your brake pedal as hard as possible or as hard as the situation allows the ABS to control the force being delivered to the brakes.

* NOTICE

A click sound may be heard in the engine compartment when the vehicle begins to move after the engine is started. These conditions are normal and indicate that the anti-lock brake system is functioning properly.

- Even with the anti-lock brake system, your vehicle still requires sufficient stopping distance. Always maintain a safe distance from the vehicle in front of you.
- Always slow down when cornering. The anti-lock brake system cannot prevent accidents resulting from excessive speeds.
- On loose or uneven road surfaces, operation of the anti-lock brake system may result in a longer stopping distance than for vehicles equipped with a conventional brake system.



W-78

The ABS warning light will stay on for approximately 3 seconds after the ignition switch or ENGINE START/STOP button is ON. During that time, the ABS will go through self-diagnosis and the light will go off if everything is normal. If the light stays on, you may have a problem with your ABS but your regular brakes will work normally. Contact an authorized Kia dealer as soon as possible.

- When you drive on a road with poor traction, such as an icy road, and operated your brakes continuously, the ABS will be active continuously and the ABS warning light may illuminate. Pull your vehicle over to a safe place and stop the engine.
- Restart the engine. If the ABS warning light goes off, then your ABS system is normal. Otherwise, you may have a problem with the ABS. Contact an authorized Kia dealer as soon as possible.

* NOTICE

When you jump start your vehicle because of a drained battery, the engine may not run as smoothly and the ABS warning light may turn on at the same time. This happens because of the low battery voltage. It does not mean your ABS has malfunctioned.

- **Do not pump your brakes!**
- **Have the battery recharged before driving the vehicle.**

Electronic Stability Control (ESC)

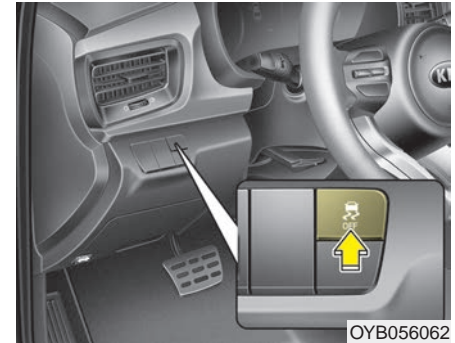

OYB056062

The Electronic Stability Control (ESC) system is designed to stabilize the vehicle during cornering maneuvers. ESC checks where you are steering and where the vehicle is actually going. ESC applies the brakes on individual wheels and intervenes with the engine management system to stabilize the vehicle.

Electronic Stability Control (ESC) will not prevent accidents. Excessive speed in turns, abrupt maneuvers and hydroplaning on wet surfaces can still result in serious accidents. Only a safe and attentive driver can prevent accidents by avoiding maneuvers that cause the vehicle to lose traction. Even with ESC installed, always follow all the normal precautions for driving - including driving at safe speeds for the conditions.

The Electronic Stability Control (ESC) system is an electronic system designed to help the driver maintain vehicle control under adverse conditions. It is not a substitute for safe driving practices. Factors including speed, road conditions and driver steering input can all affect whether ESC will be effective in preventing a loss of control. It is still your responsibility to drive and corner at reasonable speeds and to leave a sufficient margin of safety.

When you apply your brakes under conditions which may lock the wheels, you may hear a “tik-tik” sound from the brakes, or feel a corresponding sensation in the brake pedal. This is normal and means your ESC is active.

WARNING

For maximum protection, always wear your seat belt. No system, no matter how advanced, can compensate for all driver error and/or driving conditions. Always drive responsibly.

ESC operation

ESC ON condition

-

- When the ignition is turned ON, ESC and ESC OFF indicator lights illuminate for approximately 3 seconds, then ESC is turned on.
- Press the ESC OFF button for at least half a second after turning the ignition ON to turn ESC off. (ESC OFF indicator will illuminate). To turn the ESC on, press the ESC OFF button (ESC OFF indicator light will go off).
- When starting the engine, you may hear a slight ticking sound. This is the ESC performing an automatic system self-check and does not indicate a problem.

When operating

When the ESC is in operation, ESC indicator light blinks.

- When the Electronic Stability Control is operating properly, you can feel a slight pulsation in the vehicle. This is only the effect of brake control and indicates nothing unusual.
- When moving out of the mud or slippery road, pressing the accelerator pedal may not cause the engine rpm (revolutions per minute) to increase.



ESC operation off**ESC OFF state**

This car has 2 kinds of ESC off states.

If the engine stops when ESC is off, ESC remains off. Upon restarting the engine, the ESC will automatically turn on again.



- **ESC off state 1 : “Traction Control disabled”**

To turn off the traction control function and only operate the brake control function of the ESC, press the ESC OFF button () for less than 3 seconds and the ESC OFF indicator light () will illuminate. At this state, only the brake function will operate.

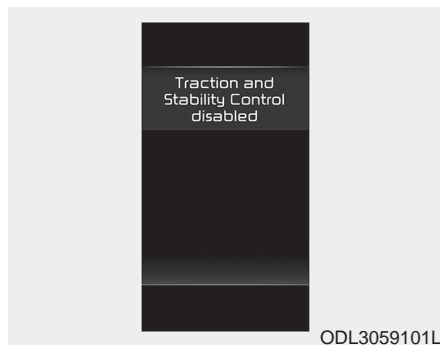

- **ESC off state 2 : “Traction & Stability Control disabled”**

To turn off the traction control function and the brake control function of the ESC, press the ESC OFF button (OFF) for more than 3 seconds. ESC OFF indicator light (OFF) will illuminate and ESC OFF warning chime will sound. In this state, the car stability control function will not operate.

Indicator light

- ESC indicator light



- ESC OFF indicator light



When the ignition switch or ENGINE START/STOP button is turned ON, the indicator light illuminates, then goes off if ESC system is operating normally.

The ESC indicator light blinks whenever ESC is operating or illuminates when ESC fails to operate.

The ESC OFF indicator light comes on when the ESC is turned off with the button.

⚠ WARNING

Driving with varying tire or wheel sizes may cause the ESC system to malfunction. When replacing tires, make sure they are the same size as your original tires.

⚠ WARNING - Electronic stability control

Drive carefully even though your vehicle has Electronic Stability Control. It can only assist you in maintaining control under certain circumstances.

ESC OFF usage

When driving

- It's a good idea to keep the ESC turned on for daily driving whenever possible.
- To turn ESC off while driving, press the ESC OFF button while driving on a flat road surface.

 **WARNING - Operating ESC**

Never press the ESC OFF button while ESC is operating.

If the ESC is turned off while ESC is operating, the vehicle may go out of control.

Hill-start Assist Control (HAC)

The Hill-start Assist Control (HAC) is designed to prevent the vehicle from rolling back by applying the brakes automatically for about 2 seconds. The brakes are released when the accelerator pedal is depressed or after about 2 seconds.

The HAC is activated only for about 2 seconds, so when the vehicle is starting off always depress the accelerator pedal.

 **WARNING - Maintaining Brake Pressure on Incline**

HAC does not replace the need to apply brakes while stopped on an incline. While stopped, make sure you maintain brake pressure sufficient to prevent your vehicle from rolling backward and causing an accident. Don't release the brake pedal until you are ready to accelerate forward.

 **CAUTION**

- *The HAC does not operate when the transmission shift lever is in the P (Park) or N (Neutral) position.*
- *The HAC activates even though the ESC is off but it does not activate when the ESC has malfunctioned.*

Vehicle Stability Management (VSM)

This system is designed to provide further enhancements to vehicle stability and steering responses when a vehicle is driving on a slippery road or a vehicle detected changes in coefficient of friction between the right wheels and left wheels when braking.

VSM operation

When the VSM is in operation, the ESC indicator light () blinks.

When the vehicle stability management is operating properly, you can feel a slight pulsation in the vehicle and/or abnormal steering responses (EPS). This is only the effect of brake and EPS control and indicates nothing unusual.

The VSM does not operate when:

- Driving on bank roads such as gradient or incline
- Driving in reverse
- ESC OFF indicator light () remains on the instrument cluster
- EPS indicator light remains on the instrument cluster

VSM operation off

If you press the ESC OFF button to turn off the ESC, the VSM will also cancel and the ESC OFF indicator light () illuminates.

To turn on the VSM, press the button again. The ESC OFF indicator light will turn off.

 **WARNING - Vehicle stability management**

Drive carefully even though your vehicle has Vehicle stability management. It can only assist you in maintaining control under certain circumstances.

Malfunction indicator

The VSM can be deactivated even if you don't cancel the VSM operation by pressing the ESC OFF button. It indicates that a malfunction has been detected somewhere in the Electric Power Steering system or VSM system. If the ESC indicator light (🚗) or EPS warning light remains on, take your vehicle to an authorized Kia dealer and have the system checked.

- Your vehicle is designed to activate according to the driver's intention, even with installed VSM. Always follow all the normal precautions for driving at safe speeds for the conditions – including driving in inclement weather and on a slippery road.

⚠ WARNING

The Vehicle Stability Management system is not a substitute for safe driving practices but a supplementary function only. It is the responsibility of the driver to always check the speed and the distance to the vehicle ahead. Always hold the steering wheel firmly while driving.

⚠ WARNING - Tire/Wheel size

When replacing tires and wheels, make sure they are the same size as the original tires and wheels installed. Driving with varying tire or wheel sizes may affect the vehicle's handling.

⚠ WARNING

For maximum protection, always wear your seat belt. No system, no matter how advanced, can compensate for all driver error and/or driving conditions. Always drive responsibly.

Good braking practices

- Check to be sure the parking brake is not engaged and that the parking brake indicator light is out before driving away.
- Driving through water may get the brakes wet. They can also get wet when the vehicle is washed. Wet brakes can be dangerous! Your vehicle will not stop as quickly if the brakes are wet. Wet brakes may cause the vehicle to pull to one side.

To dry the brakes, apply the brakes lightly until the braking action returns to normal, taking care to keep the vehicle under control at all times. If the braking action does not return to normal, stop as soon as it is safe to do so and call an authorized Kia dealer for assistance.

- Don't coast down hills with the vehicle out of gear. This is extremely hazardous. Keep the vehicle in gear at all times, use the brakes to slow down, then shift to a lower gear so that engine braking will help you maintain a safe speed.

- Don't "ride" the brake pedal. Resting your foot on the brake pedal while driving can be dangerous because the brakes might overheat and lose their effectiveness. It also increases the wear of the brake components.
- If a tire goes flat while you are driving, apply the brakes gently and keep the vehicle pointed straight ahead while you slow down. When you are moving slowly enough for it to be safe to do so, pull off the road and stop in a safe place.
- If your vehicle is equipped with an intelligent variable transmission, don't let your vehicle creep forward. To avoid creeping forward, keep your foot firmly on the brake pedal when the vehicle is stopped.
- Be cautious when parking on a hill. Firmly engage the parking brake and place the shift lever in P (Intelligent Variable Transmission) or in first or reverse gear (Manual Transmission). If your vehicle is facing downhill, turn the front wheels into the curb to help keep the vehicle from rolling. If your vehicle is facing uphill, turn the front wheels away from the curb to help keep the vehicle from rolling. If there is no curb or if it is required by other conditions to keep the vehicle from rolling, chock the wheels.

- Under some conditions, your parking brake can freeze in the engaged position. This is most likely to happen when there is an accumulation of snow or ice around or near the rear brakes or if the brakes are wet. If there is a risk that the parking brake may freeze, apply it only temporarily while you put the shift lever in P (Intelligent Variable Transmission) or in first or reverse gear (Manual Transmission) and chock the rear wheels so the vehicle cannot roll. Then release the parking brake.
- Do not hold the vehicle on an incline with the accelerator pedal. This can cause the transmission to overheat. Always use the brake pedal or parking brake.

SPORT MODE INTEGRATED CONTROL SYSTEM

SPORT mode

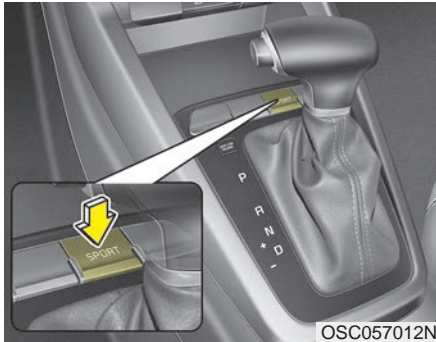

The sport mode may be selected according to the driver's preference or road condition.

The mode changes whenever the SPORT MODE button is pressed.

NORMAL \longleftrightarrow SPORT

* When normal mode is selected, it is not displayed on the cluster.

SPORT mode

SPORT

SPORT mode focuses on dynamic driving by automatically adjusting the steering effort, engine and transmission system.

- When the SPORT MODE button is pressed, the SPORT indicator (yellow or white) will illuminate.
- If the system is activated:
 - While holding vehicle speed, it maintains the gear and RPM for some time even though the accelerator pedal is not depressed.
 - Up-shifting is delayed.
- When the SPORT mode is activated, and the ignition switch or ENGINE START/STOP button is turned off and on, it will change to NORMAL mode. To turn on the SPORT mode, press the SPORT MODE button again.

* NOTICE

In Sport drive mode, the fuel efficiency may decrease.

FORWARD COLLISION-AVOIDANCE ASSIST (FCA) (FRONT VIEW CAMERA ONLY) (IF EQUIPPED)

FCA is designed to detect and monitor a vehicle ahead or detect a pedestrian or in the roadway through front view camera recognition to warn the driver that a collision is imminent, and if necessary, apply emergency braking.

* NOTICE

FCA stands for Forward Collision-Avoidance Assist.

Detecting sensor

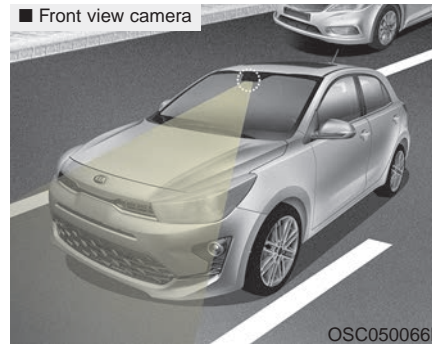

Refer to the picture above for the detailed location of the detecting sensor.

⚠ WARNING - Forward Collision-Avoidance Assist Limitations

FCA is a supplemental function and is not a substitute for safe driving practices. It is the responsibility of the driver to always check the speed and distance to the vehicle ahead and to be prepared to apply the brakes.

⚠ WARNING

Take the following precautions when using Forward Collision-Avoidance Assist :

- This function is only a supplemental function and it is not intended to, or does it replace the need for extreme care and attention of the driver. The sensing range and objects detectable by the sensors are limited. Pay attention to the road conditions at all times.
- NEVER drive too fast in accordance with the road conditions or while cornering.
- Always drive cautiously to prevent unexpected and sudden situations from occurring. FCA does not stop the vehicle completely and does not avoid all collisions due to function limitations.

Function settings

Setting

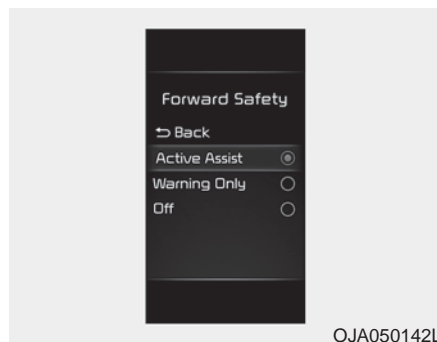

Forward Safety

The driver can activate FCA by placing the ignition switch or ENGINE START/STOP button to the ON position and by selecting on 'User Settings → Driver Assistance → Forward Safety'.

- If you select "Active Assist", FCA activates. FCA produces warning messages and warning alarms in accordance with the collision risk levels. Also, it controls the brakes in accordance with the collision risk levels.

- If you select "Warning Only", FCA activates and produces only warning alarms in accordance with the collision risk levels. You should control the brake directly because FCA do not control the brake.
- If you select "Off", FCA deactivates.



The warning light illuminates on the LCD display, when you cancel FCA. The driver can monitor FCA ON/OFF status on the LCD display. Also, the warning light illuminates when the ESC (Electronic Stability Control) is turned off (Traction & Stability control disabled.).

When the warning light remains ON with FCA activated, have your vehicle inspected by an authorized Kia dealer.

Warning Timing

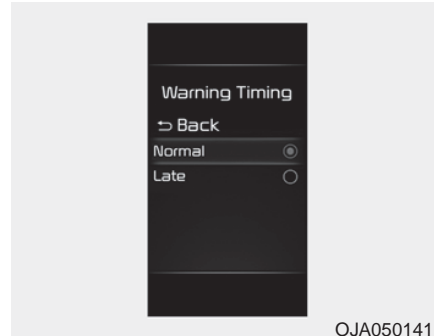

The driver can select the initial warning activation time in the User Settings in the instrument cluster LCD display.

The options for the initial Forward Collision Warning include the following:

- Normal: When this condition is selected, the initial Forward Collision Warning is activated normally.

- Late: When this condition is selected, the initial Forward Collision Warning is activated later than normal. This setting reduces the amount of distance between the vehicle or pedestrian ahead before the initial warning occurs. Select this condition only when traffic is light, and you are driving slowly.

Prerequisite for activation

FCA will activate when FCA is selected on the LCD display, and when the following prerequisites are satisfied:

- The ESC (Electronic Stability Control) is activated.
- When FCA recognizes a vehicle or the pedestrian in front.

WARNING

FCA may not recognize every obstacle or provide warnings and braking in every situation, so do not rely on FCA to stop the vehicle in instances where the driver sees an obstacle and has the ability to apply the brakes

- **FCA automatically activates upon placing the ignition switch or ENGINE START/STOP button to the ON position. The driver can deactivate FCA by canceling the function setting on the LCD display.**
- **FCA automatically deactivates upon canceling the ESC. When the ESC is canceled, FCA cannot be activated on the LCD display. FCA warning light will illuminate.**

FCA warning message and function control

FCA produces warning messages, warning alarms, and emergency braking based on the level of risk of a frontal collision, such as when a vehicle ahead suddenly brakes, or when the function detects that a collision with a pedestrian is imminent.

The driver can select the initial warning activation time in the User Settings in the LCD display. The options for the initial Forward Collision Warning include Early, Normal or Late initial warning time.

Collision Warning

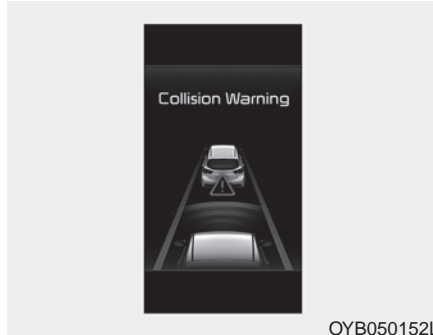

Additionally, some vehicle function intervention occurs by the engine management function to help decelerate the vehicle.

The vehicle may slow down slightly.

- It will operate if the vehicle speed is greater than 3 mph (5 km/h) and less than or equal to 110 mph (180 km/h) on a forward vehicle. (Depending on the condition of the vehicle ahead and the environment surrounding it, the possible maximum operating speed may be reduced.)

- For the pedestrian, the vehicle speed is greater than or equal to 3 mph (5 km/h) and less than 50 mph (80 km/h). (Depending on the condition of pedestrian and the surrounding environment the possible maximum operating speed may be reduced.)

- If you select "Warning Only", FCA activates and produces only warning alarms in accordance with the collision risk levels. You should control the brake directly because FCA do not control the brake.

Emergency Braking

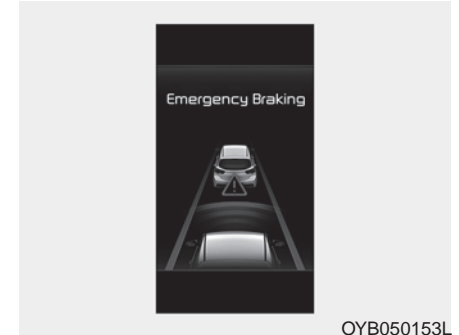

Additionally, some vehicle function intervention occurs by the engine management function to help decelerate the vehicle.

The vehicle may slow down slightly.

- It will operate if the vehicle speed is greater than 3 mph (5 km/h) and less than or equal to 37 mph (60 km/h) on a forward vehicle. (Depending on the condition of the vehicle ahead and the environment surrounding it, the possible maximum operating speed may be reduced.)

- For the pedestrian, the vehicle speed is greater than or equal to 3 mph (5 km/h) and less than 50 mph (80 km/h). (Depending on the condition of pedestrian and the surrounding environment the possible maximum operating speed may be reduced.)
 - If you select "Warning Only", FCA activates and produces only warning alarms in accordance with the collision risk levels. You should control the brake directly because FCA do not control the brake.

Brake operation

In an urgent situation, the braking system enters into the ready status for prompt reaction to assist the driver in depressing the brake pedal.

- FCA provides additional braking power for optimum braking performance when the driver depresses the brake pedal during warning.
- The braking control is automatically deactivated when the driver sharply depresses the accelerator pedal, or when the driver abruptly operates the steering wheel.
- The braking control is automatically canceled when risk factors disappear.

The driver should always exercise caution when operating the vehicle, even though there is no warning message or warning alarm.

WARNING

FCA cannot avoid all collisions nor completely stop the vehicle before collision. The driver has the responsibility to drive safely and control the vehicle.

WARNING

FCA is a supplemental function and cannot completely stop the vehicle in all situations or avoid all collisions. It is the responsibility of the driver to safely drive and control the vehicle.

⚠ WARNING

Never deliberately drive dangerously to activate the function as such conduct increases the risk of an accident.

*** NOTICE**

FCA assesses the risk of a collision by monitoring several variables such as the distance to the vehicle/pedestrian ahead, the speed of the vehicle/pedestrian ahead, and the driver's operation of the vehicle. Certain conditions such as inclement weather and road conditions may affect the operation of FCA. For the function operation, do not attempt risky driving.

*** NOTICE**

- Use only soft clothes to wash the vehicle. Do not spray pressurized water directly on the sensor or sensor cover.
- Use only genuine parts to repair or replace a damaged sensor or sensor cover. Do not apply paint to the sensor cover.
- Do not tint the window or install stickers or accessories around the inside mirror where the camera is installed.
- Make sure the front view camera installation point does not get wet.
- Do not impact or remove any front view camera components.
- Do not place reflective objects (white paper or mirror etc.) on the dashboard. The function may activate unnecessarily due to reflection of the sunlight.

Warning message and warning light

In this case, a warning message will appear to notify the driver. Remove the foreign substances to allow FCA to function normally.

FCA may not properly operate in an area (e.g. open terrain), where any vehicles or objects are not detected after turning ON the vehicle.

Function malfunction

When FCA is not working properly, FCA warning light () will illuminate and the warning message will appear for a few seconds.



After the message disappears, the master warning light () will illuminate. In this case, take your vehicle to an authorized Kia dealer and have the system checked.

WARNING

FCA is only a supplemental function for the driver's safety. It is the driver's responsibility to control the vehicle operation. Do not solely depend on FCA. Rather, maintain a safe braking distance, and, if necessary, depress the brake pedal to reduce the driving speed or stop the vehicle.

- In certain instances and under certain driving conditions, FCA may activate unintentionally. This initial warning message appears on the LCD display with a warning chime. Also, due to sensing limitations, in certain situations, the front view camera recognition function may not detect the vehicle or pedestrian ahead. FCA may not activate and the warning message will not be displayed.

(Continued)

(Continued)

- FCA may unnecessarily produce the warning message and the warning alarms. Also, due to the sensing limitation, FCA may not produce the warning message and the warning alarm at all.
- When there is a malfunction with FCA, the autonomous emergency braking does not operate upon detecting a collision risk even with other braking systems normally operating.
- FCA may not activate if the driver applies the brake pedal before warning to avoid risk of collision.
- FCA does not operate when the vehicle is in reverse.
- FCA is not designed to detect other objects on the road such as animals.

(Continued)**(Continued)**

- FCA does not detect vehicles in the opposite lane.
- FCA does not detect cross traffic vehicles that are approaching.
- FCA cannot detect the driver approaching the side view of a parked vehicle (for example on a dead end street). In these cases, you must maintain a safe braking distance, and if necessary, depress the brake pedal to reduce the driving speed in order to maintain a safe distance.
- FCA may not activate depending on road or driving conditions.
- FCA may not activate to all types of vehicles.

Limitations of FCA

FCA is designed to monitor the vehicle ahead in the roadway through front view camera recognition to warn the driver that a collision is imminent, and if necessary, apply emergency braking.

In certain situations, the front view camera may not be able to detect the vehicle ahead. In these cases, FCA may not operate normally. The driver must pay careful attention in the following situations where FCA operation may be limited.

The sensor may be limited when:

- The function may not operate for 15 seconds after the vehicle is started or the camera is initialized.
- Front view camera contaminated or blocked.
- The camera lens is contaminated due to tinted, filmed or coated windshield, damaged glass, or stuck of foreign matter (sticker, bug, etc.) on the glass.
- Inclement weather such as heavy rain or snow obscures the field of view of the camera.
- There is interference by electromagnetic waves.
- The camera sensor recognition is limited
- The vehicle in front is too small to be detected. (for example a motorcycle etc.)
- The vehicle in front is an oversize vehicle or trailer that is too big to be detected by the camera recognition function. (for example a tractor trailer, etc.)
- The camera's field of view is not well illuminated (either too dark or too much reflection or too much backlight that obscures the field of view).
- The vehicle in front does not have their rear lights or their rear lights does not turned ON or their rear lights are located unusually.
- The outside brightness changes suddenly, for example when entering or exiting a tunnel.
- Light coming from a street light or an oncoming vehicle is reflected on a wet road surface such as a puddle in the road.
- The field of view in front is obstructed by sun glare or head light of oncoming vehicle.
- The windshield glass is fogged up; a clear view of the road is obstructed.
- The vehicle in front is driving erratically.
- The vehicle is on unpaved or uneven rough. surfaces, or road with sudden gradient changes.
- The camera sensor recognition is limited
- The vehicle in front is too small to be detected. (for example a motorcycle etc.)
- The vehicle in front is an oversize vehicle or trailer that is too big to be detected by the camera recognition function. (for example a tractor trailer, etc.)
- The camera's field of view is not well illuminated. (either too dark or too much reflection or too much backlight that obscures the field of view)
- The vehicle in front does not have their rear lights or their rear lights does not turned ON or their rear lights are located unusually.
- The outside brightness changes suddenly, for example when entering or exiting a tunnel.
- Light coming from a street light or an oncoming vehicle is reflected on a wet road surface such as a puddle in the road.
- The field of view in front is obstructed by sun glare or head light of oncoming vehicle.

- The windshield glass is fogged up; a clear view of the road is obstructed.
- The vehicle in front is driving erratically.
- The vehicle is on unpaved or uneven rough surfaces, or road with sudden gradient changes.
- The vehicle is driven near areas containing metal substances as a construction zone, railroad, etc.
- The vehicle drives inside a building, such as a basement parking lot.
- The camera does not recognize the entire vehicle in front.
- The camera is damaged.
- The brightness outside is too low such as when the headlamps are not on at night or the vehicle is going through a tunnel.
- The shadow is on the road by a median strip, trees, etc.
- The vehicle drives through a toll-gate.
- The windshield glass is fogged up; a clear view of the road is obstructed.
- The rear part of the vehicle in front is not normally visible. (The vehicle turns in other direction or the vehicle is overturned.)
- The adverse road conditions cause excessive vehicle vibrations while driving.
- The sensor recognition changes suddenly when passing over a speed bump.
- The vehicle in front is moving vertically to the driving direction.
- The vehicle in front is stopped vertically.
- The vehicle in front is driving towards your vehicle or reversing.
- You are on a roundabout and the vehicle in front circles.

Driving on a curve

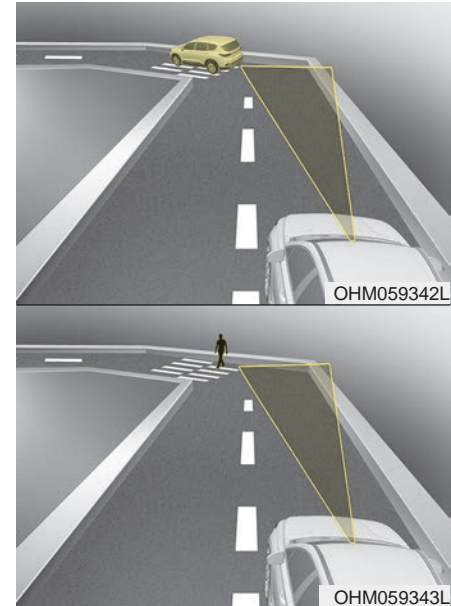

Forward Collision- Avoidance Assist may be limited when driving on a curved road.

The front view camera recognition function may not detect the vehicle or pedestrian traveling in front on a curved road. This may result in no alarm and braking when necessary.

Always pay attention to road and driving conditions, and if necessary, depress the brake pedal to reduce your driving speed in order to maintain a safe distance.

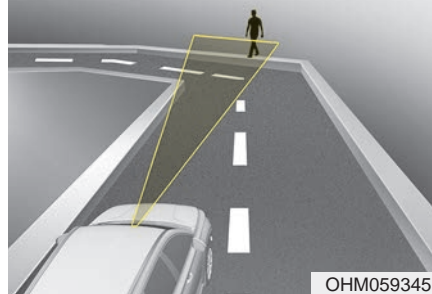
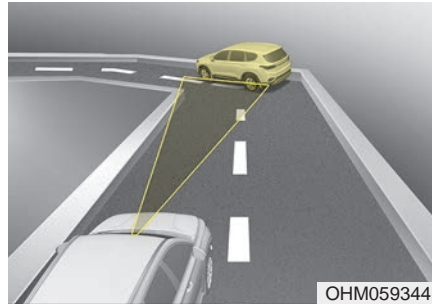

Always pay attention to road and driving conditions, while driving.

Forward Collision-Avoidance Assist may recognize a vehicle or pedestrian in the next lane or outside the lane when driving on a curved road.

If this occurs, the function may unnecessarily alarm the driver and apply the brake.

Driving on a slope

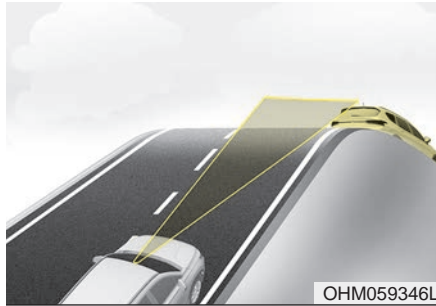

The performance of Forward Collision-Avoidance Assist may be decreased while driving upward or downward on a slope.

The front view camera recognition may not detect the vehicle or pedestrian in front.

This may result in unnecessary alarm and braking or no alarm and braking when necessary.

When the function suddenly recognizes the vehicle or pedestrian in front while passing over a slope, you may experience sharp deceleration.

Always keep your eyes forward while driving upward or downward on a slope, and, if necessary, depress the brake pedal to reduce your driving speed in order to maintain distance.

Changing lanes



[A]: Your vehicle, [B]: Lane changing vehicle

When a vehicle changes lanes in front of you, FCA may not immediately detect the vehicle, especially if the vehicle changes lanes abruptly.

In this case, you must maintain a safe braking distance, and if necessary, depress the brake pedal to reduce your driving speed in order to maintain a safe distance.



[A]: Your vehicle, [B]: Lane changing vehicle, [C]: Same lane vehicle

When driving in stop-and-go traffic, and a stopped vehicle in front of you merges out of the lane, FCA may not immediately detect the new vehicle that is now in front of you. In this case, you must maintain a safe braking distance, and if necessary, depress the brake pedal to reduce your driving speed in order to maintain a safe distance.

Recognizing the vehicle

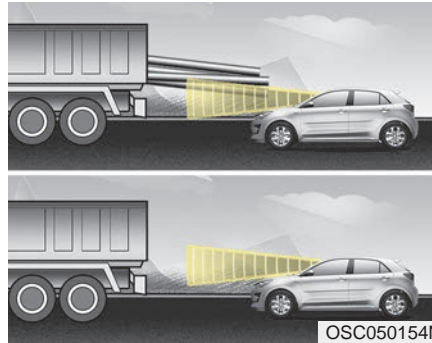

When the vehicle in front has heavy loading extended rearward, or when the vehicle in front has higher ground clearance, it may induce a hazardous situation. Always pay attention to road and driving conditions, while driving and, if necessary, depress the brake pedal to reduce your driving speed in order to maintain distance.

Situation in which the function may not detect pedestrian properly.

The sensor may be limited when:

- The pedestrian is not fully detected by the camera recognition function, for example, if the pedestrian is leaning over or is not fully walking upright.
- The pedestrian is moving very quickly or appears abruptly in the camera detection area.
- The pedestrian is wearing clothing that easily blends into the background, making it difficult to be detected by the camera recognition function.
- The outside lighting is too bright (e.g. when driving in bright sunlight or in sun glare) or too dark. (e.g. when driving on a dark rural road at night)
- It is difficult to detect and distinguish the pedestrian from other objects in the surroundings, for example, when there is a group of pedestrians, or a large crowd.

- There is an item similar to a person's body structure
- The pedestrian is small.
- The pedestrian has impaired mobility.
- The sensor recognition is limited.
- The camera is blocked with a foreign object or debris.
- Inclement weather such as heavy rain or snow obscures the field of view of the camera.
- When light coming from a street light or an oncoming vehicle is reflected on a wet road surface such as a puddle in the road.
- The field of view in front is obstructed by sun glare.
- The windshield glass is fogged up; a clear view of the road is obstructed.
- The adverse road conditions cause excessive vehicle vibrations while driving.
- The sensor recognition changes suddenly when passing over a speed bump.
- You are on a roundabout.
- The pedestrian suddenly interrupts in front of the vehicle.
- There is any other electromagnetic interference.

⚠ WARNING

- **Cancel FCA in the User Settings on the LCD display, before towing another vehicle. While towing, the brake application may adversely affect your vehicle safety.**
- **Exercise extreme caution to the vehicle in front, when it has heavy loading extended rearward, or when it has higher ground clearance.**
- **Never try to test the operation of FCA. Doing so may cause severe injury or death.**
- **FCA is designed to detect and monitor the vehicle ahead or detect a pedestrian in the roadway through front view camera recognition. It is not designed to detect bicycles, motorcycles, or smaller wheeled objects such as luggage bags, shopping carts, or strollers.**

(Continued)

(Continued)

- **When replacing or reinstalling the windshield, front bumper or front view camera recognition after removal, take your vehicle to an authorized Kia dealer and have the system checked.**

*** NOTICE**

In some instances, FCA may be canceled when subjected to electromagnetic interference.

This device complies with Part 15 of the FCC rules.

Operation is subject to the following three conditions:

1. This device may not cause harmful interference, and
2. This device must accept any interference received, including interference that may cause undesired operation.
3. Changes or modifications not expressly approved by the party responsible for compliance could void the user's authority to operate the device.

Radio frequency radiation exposure information:

This equipment complies with FCC radiation exposure limits set forth for an uncontrolled environment.

This equipment should be installed and operated with minimum distance of 8 in (20 cm) between the radiator (antenna) and your body.

This transmitter must not be co-located or operating in conjunction with any other antenna or transmitter.

LANE KEEPING ASSIST (LKA) (IF EQUIPPED)

Lane Keeping Assist is designed to help detect the lane markers while driving over a certain speed. The function will warn the driver if the vehicle leaves the lane without using the turn signal, or will automatically assist the driver's steering to help prevent the vehicle from departing the lane.

* NOTICE

LKA stands for Lane Keeping Assist.

Detecting sensor

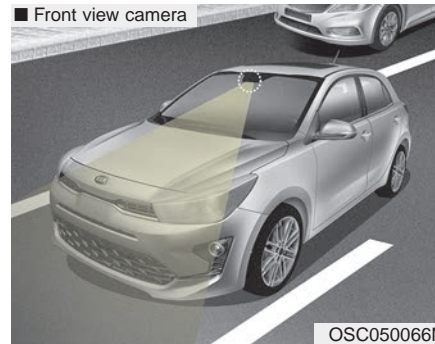

The front view camera is used as a detecting sensor to detect lane markings.

Refer to the picture above for the detailed location of the detecting sensor.

CAUTION

For more details on the precautions of the front view camera, refer to "Forward Collision-Avoidance Assist (FCA) (Front view camera only) (if equipped)" in chapter 5.

Function settings

Setting

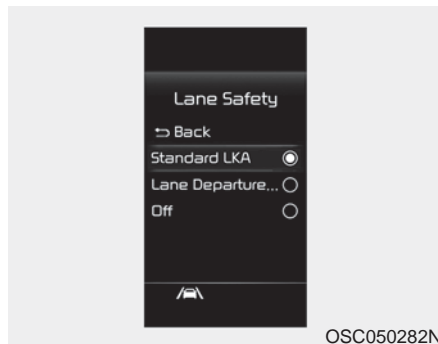

Lane Safety

With the ignition switch or ENGINE START/STOP button in the ON position, select or deselect 'Driver Assistance → Lane Safety' from the User Settings.

- If 'Standard LKA' is selected, the function will automatically assist the driver's steering when lane departure is detected to help prevent the vehicle from moving out of its lane.

- If 'Lane Departure Warning' is selected, the function will warn the driver with an audible warning when lane departure is detected. The driver must steer the vehicle.
- If 'Off' is selected, the function will turn off. The indicator light will turn off on the cluster.

⚠ WARNING

- **If 'Lane Departure Warning' is selected, steering is not assisted.**
- **Lane Keeping Assist does not control the steering wheel when the vehicle is driven in the middle of the lane.**
- **The driver should always be aware of the surroundings and steer the vehicle if 'Off' is selected.**

Turning the function ON/OFF



To activate/deactivate LKA :

With ignition switch or ENGINE START/STOP button in the ON position, press and hold the Lane Driving Assist button (/⊗\) located on the steering wheel to turn on Lane Keeping Assist.

The white indicator light (/⊗\) will illuminate on the cluster. If you press and hold the Lane Driving Assist button located on the steering wheel, LKA will be turned off and the indicator on the cluster display will go off.

*** NOTICE**

- If the engine is restarted, Lane Keeping Assist will maintain the last setting.
- When Lane Keeping Assist is turned off with the Lane Driving Assist button, Lane Safety settings will turn off.

Function operation***Warning and control***

Lane Keeping Assist will warn and control the vehicle with Lane Departure Warning and Lane Keeping Assist.

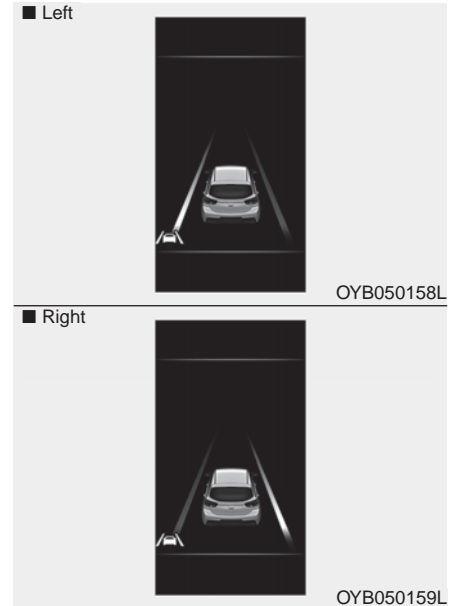
Lane Departure Warning

- To warn the driver that the vehicle is departing from the projected lane in front, the green () indicator light will blink on the cluster, the lane line will blink on the cluster depending on which direction the vehicle is veering, and an audible warning will sound.
- The function will operate when your vehicle speed is between approximately 40~120 mph (60~200 km/h).

Lane Keeping Assist

- To warn the driver that the vehicle is departing from the projected lane in front, the green () indicator light will blink on the cluster, and the steering wheel will make adjustments to keep vehicle inside the lane.
- The function will operate when your vehicle speed is between approximately 40~120 mph (60~200 km/h).

Hands-off warning



If the driver takes their hands off the steering wheel for several seconds, the 'Keep hands on steering wheel' warning message will appear on the cluster, and an audible warning will sound in stages.

⚠ WARNING

- The steering wheel may not be assisted if the steering wheel is held very tight or the steering wheel is steered over a certain degree.
- Lane Keeping Assist does not operate at all times. It is the responsibility of the driver to safely steer the vehicle and to maintain the vehicle in its lane.
- The hands-off warning message may appear late depending on road conditions. Always have your hands on the steering wheel while driving.
- If the steering wheel is held very lightly, the hands off warning message may appear because the function may not recognize that the driver has their hands on the steering wheel.

(Continued)

(Continued)

- If you attach objects to the steering wheel, the hands-off warning may not work properly.

*** NOTICE**

- For more details on setting the functions, refer to "LCD Display Mode" in chapter 4.
- When lane markings are detected, the lane lines on the cluster will change from gray to white and the green () indicator light will illuminate.

■ Lane undetected

OYB050156L

■ Lane detected

OYB050157L

- Even though the steering is assisted by Lane Keeping Assist, the driver may control the steering wheel.
- The steering wheel may feel heavier or lighter when the steering wheel is assisted by Lane Keeping Assist than when it is not.

Function malfunction and limitations

Function malfunction



When Lane Keeping Assist is not working properly, the 'Check Lane Keeping Assist (LKA) system', warning message will appear and the yellow (🚗) indicator light will illuminate on the cluster. In this case, have your vehicle inspected by an authorized Kia dealer.

Limitations of the function

Lane Keeping Assist may not operate normally or may operate unexpectedly under the following circumstances:

- The lane is contaminated or difficult to distinguish because,
 - The lane markings is covered with rain, snow, dirt, oil, etc.
 - The color of the lane marking is not distinguishable from the road
 - There are markings on the road near the lane or the markings on the road looks similar to the lane markings
 - The lane marking is indistinct or damaged
 - The shadow is on the lane marking by a median strip, trees, guardrail, noise barriers, etc.
- There are more than two lane markings on the road

- The lane number increases or decreases, or the lane markings are crossing
- The lane markings are complicated or a structure substitutes for the lines, such as a construction area
- There are road markings, such as zigzag lanes, crosswalk markings and road signs
- The lane suddenly disappears, such as at the intersection
- The lane is very wide or narrow
- There is a road edge without a lane
- There is a boundary structure in the roadway, such as a tollgate, sidewalk, curb, etc.
- The distance to the front vehicle is extremely short or the vehicle in front is covering the lane marking

For more details on the limitations of the front view camera, refer to "Forward Collision-Avoidance Assist (FCA) (Front view camera only) (if equipped)" in chapter 5.

⚠ WARNING

Take the following precautions when using Lane Keeping Assist:

- The driver should hold the responsibility to safely drive and control the vehicle. Do not solely rely on the function and drive dangerously.
- The operation of Lane Keeping Assist can be cancelled or not work properly depending on road conditions and surroundings. Always be cautious while driving.
- Refer to "Limitations of the function" in chapter 5, if the lane is not detected properly.
- When you are towing a trailer or another vehicle, we recommend that Lane Keeping Assist is turned off due to safety reasons.

(Continued)

(Continued)

- If the vehicle is driven at high speed, the steering wheel will not be controlled. The driver must always follow the speed limit when using the function.
- If any other function's warning message is displayed or audible warning is generated, Lane Keeping Assist warning message may not be displayed and audible warning may not be generated.
- You may not hear the warning sound of Lane Keeping Assist if the surrounding is noisy.
- If you attach objects to the steering wheel, steering may not be assisted properly.
- Lane Keeping Assist may not operate for 15 seconds after the vehicle is started, or the front view camera is initialized.
- Lane Keeping Assist will not operate when:

(Continued)

(Continued)

- The turn signal or hazard warning flasher is turned on
- The vehicle is not driven in the center of the lane when the function is turned on or right after changing a lane
- ESC (Electronic Stability Control) or VSM (Vehicle Stability Management) is activated
- The vehicle is driven on a sharp curve
- Vehicle speed is below 35 mph (55 km/h) or above 130 mph (210 km/h)
- The vehicle makes sharp lane changes
- The vehicle is suddenly stopped

BLIND-SPOT COLLISION WARNING (BCW) (IF EQUIPPED)

Blind-Spot Collision Warning is designed to help detect and monitor approaching vehicles in the driver's blind spot area and warn the driver of a possible collision with a warning message and audible warning.

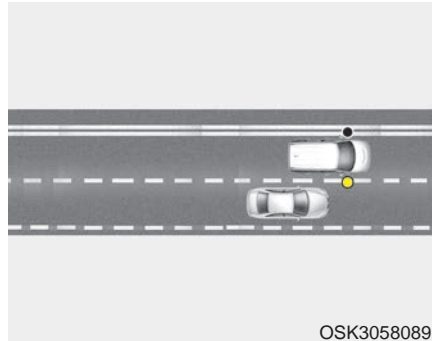

Blind-Spot Collision Warning help detects and informs the driver that a vehicle is in the blind spot.

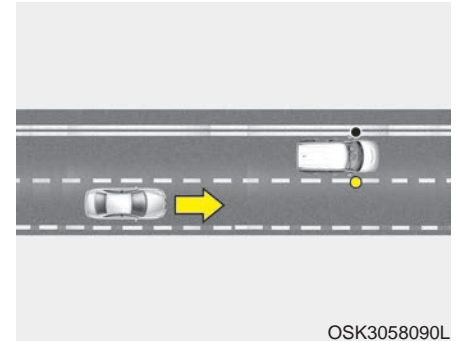

Blind-Spot Collision Warning help detects and informs the driver that a vehicle is approaching at high speed from the blind spot area.

CAUTION

The detecting range may vary depending on the speed of your vehicle. However, even if there is a vehicle in the blind spot, the function may not warn you when you pass by at high speed.

⚠ CAUTION

Warning timing may vary depending on the speed of the vehicle approaching at high speed.

*** NOTICE**

- BCW stands for Blind-Spot Collision Warning.
- In the following text, Blind-Spot Collision Warning will be referred as Blind-Spot Safety system.

Detecting sensor

Refer to the picture above for the detailed location of the detecting sensor.

⚠ CAUTION

- *Never disassemble the rear corner radar or radar assembly, or apply any impact on it.*
- *If the rear corner radar have been replaced or repaired, have your vehicle inspected by an authorized Kia dealer.*
- *If there is impact on the rear corner radar or near the radar, even though the warning message does not appear on the cluster, Blind-Spot Safety system may not operate properly. In this case, have your vehicle inspected by an authorized Kia dealer.*
- *Use only genuine parts to repair the rear bumper parts where the rear corner radar is located.*
- *Do not apply license plate frame or object, such as a bumper sticker, film or a bumper guard near the rear corner radar.*

(Continued)

(Continued)

- *The function may not work properly if the bumper has been replaced, or the surroundings of the rear corner radar has been damaged or paint has been applied.*
- *If a trailer, carrier, etc. is installed, it may adversely affect the performance of the rear corner radar or the function may not operate.*

Function settings

Setting

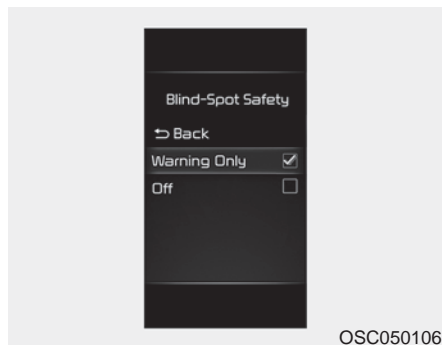

Blind-Spot Safety

With the ignition switch or ENGINE START/STOP button in the ON position, select or deselect "User Settings → Driver Assistance → Blind-Spot Safety" to set whether or not to use each function.

- If 'Warning Only' is selected, the function will warn the driver with a warning message, an audible warning depending on the collision risk levels.
- If 'Off' is selected, the function will turn off.

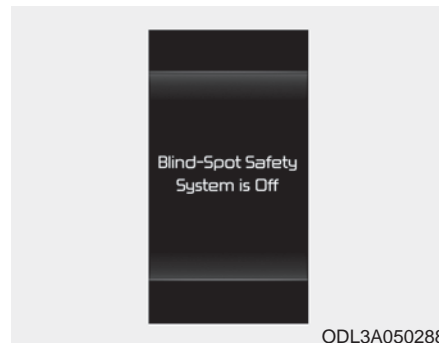

When the engine is restarted with the function off, the 'Blind-Spot Safety System is Off' message will appear on the cluster.

If you change the setting from 'Off' to 'Warning Only', the warning light on the outside rearview mirror will blink for three seconds.

In addition, if the engine is turned on, when the function is set to 'Warning Only', the warning light on the outside rearview mirror will blink for three seconds.

⚠ WARNING

- If 'Warning Only' is selected, steering is not assisted.
- If 'Off' is selected, the driver should always be aware of the surroundings and drive safely.

*** NOTICE**

If the engine is restarted, Blind-Spot Safety system will maintain the last setting.

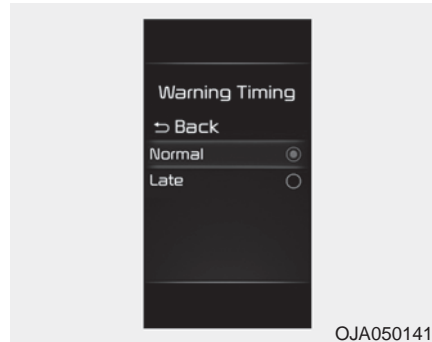
Warning Timing

With the ignition switch or ENGINE START/STOP button in the ON position, select 'Driver Assistance → Warning Timing' from the User Settings to change the initial warning activation time for Blind-Spot Safety system.

When the vehicle is first delivered, Warning Timing is set to 'Normal'. If you change the Warning Timing, the warning time of other Driver Assistance systems may change.

⚠ CAUTION

- *The setting of the Warning Timing applies to all functions of the Blind-Spot Safety system.*
- *Even though 'Normal' is selected for Warning Timing, if the vehicles approaches at high speed, the initial warning activation time may seem late.*
- *Select 'Late' for Warning Timing when traffic is light and when driving speed is slow.*

Function operation

Function warning

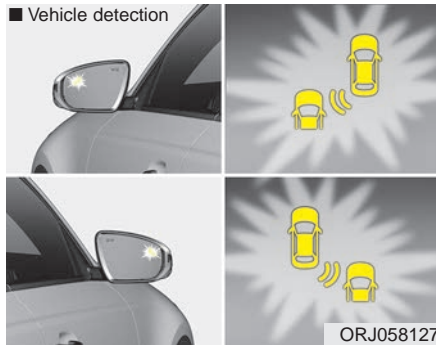

- To warn the driver a vehicle is detected, the warning light on the outside rearview mirror and head-up display (if equipped) will illuminate
- The function will operate when your vehicle speed is above 12 mph (20 km/h) and the speed of the vehicle in the blind spot area is above 7 mph (10 km/h).

Collision warning

- Collision warning will operate when the turn signal is turned on in the direction of the detected vehicle.
- To warn the driver of a collision, the warning light on the outside rearview mirror and head-up display (if equipped) will blink.
- When the turn signal is turned off or you move away from the lane, the collision warning will be canceled and the function will return to vehicle detection state.

⚠ WARNING

- **The detecting range of the rear corner radar is determined by the standard road width, therefore, on a narrow road, the function may detect other vehicles in the next lane and warn you. In contrast, on a wide road, the function may not be able to detect a vehicle driving in the next lane and may not warn you.**
- **When the hazard warning light is on, the collision warning by the turn signal will not operate.**
- **For your safety, change the Settings after parking the vehicle at a safe location.**
- **If any other function's warning message is displayed or audible warning is generated, Blind-Spot Safety system's warning message may not be displayed and audible warning may not be generated.**

(Continued)

(Continued)

- You may not hear the warning sound of Blind-Spot Safety system if the surrounding is noisy.
- Blind-Spot Safety system may warn the driver late or may not warn the driver depending on the road and driving conditions.
- Driver should maintain control of the vehicle at all times. Do not depend on Blind-Spot Safety system. Maintain a safe braking distance, and if necessary, depress the brake pedal to reduce driving speed or to stop the vehicle.

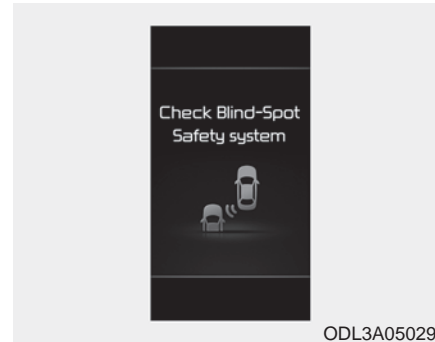
Function malfunction and limitations***Function malfunction***

When Blind-Spot Safety system is not working properly, the 'Check Blind-Spot Safety system' warning message will appear on the cluster, and the function will turn off automatically, or the function will be limited. In this case, have your vehicle inspected by an authorized Kia dealer.

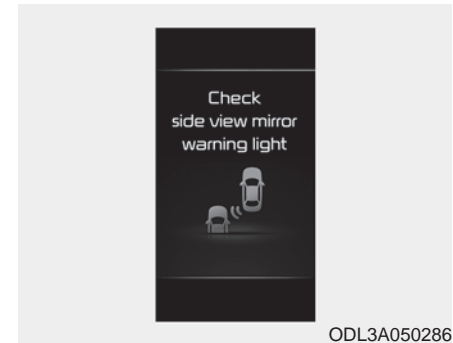

When the outside rearview mirror warning light is not working properly, the 'Check side view mirror warning light' warning message will appear on the cluster.

In this case, have your vehicle inspected by an authorized Kia dealer.

Function disabled

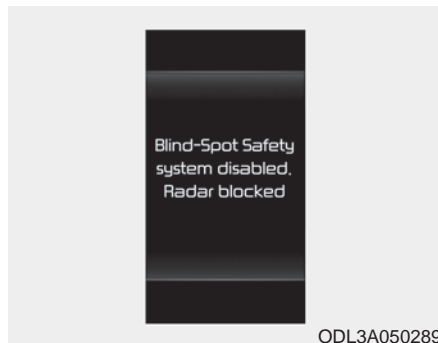

When the rear bumper around the rear corner radar or sensor is covered with foreign material, such as snow or rain, or installing a trailer or carrier, it can reduce the detecting performance and temporarily limit or disable Blind-Spot Safety system.

If this occurs, the 'Blind-Spot Safety system disabled. Radar blocked' warning message will appear on the cluster.

The function will operate normally when such foreign material or trailer, etc. is removed, and then the engine is restarted.

If the function does not operate normally after it is removed, have your vehicle inspected by an authorized Kia dealer.

⚠ WARNING

- Even though the warning message does not appear on the cluster, Blind-Spot Safety system may not properly operate.
- Blind-Spot Safety system may not properly operate in an area (e.g. open terrain), where any substance are not detected right after the engine is turned on, or when the detecting sensor is blocked with foreign material right after the engine is turned on.

⚠ CAUTION

Turn off Blind-Spot Safety system to install a trailer, carrier, etc., or remove the trailer, carrier, etc. to use Blind-Spot Safety system.

Limitations of the function

Blind-Spot Safety system may not operate normally, or the function may operate unexpectedly under the following circumstances:

- There is inclement weather, such as heavy snow, heavy rain, etc.
- The rear corner radar is covered with snow, rain, dirt, etc.
- The temperature around the rear corner radar is high or low
- Driving on a highway (or motorway) ramp
- The road pavement (or the peripheral ground) abnormally contains metallic components (i.e. possibly due to subway construction).
- There is a fixed object near the vehicle, such as sound barriers, guardrails, central dividers, entry barriers, street lamps, signs, tunnels, walls, etc. (including double structures)
- Driving in large areas where there are few vehicles or structures (i.e. desert, meadow, suburb, etc.)
- Driving through a narrow road where trees or grass are overgrown
- Driving on a wet road surface, such as a puddle on the road
- The other vehicle drives very close behind your vehicle, or the other vehicle passes by your vehicle in close proximity
- The speed of the other vehicle is very fast that it passes by your vehicle in a short time
- Your vehicle passes by the other vehicle
- Your vehicle change lane
- Your vehicle has started at the same time as the vehicle next to you and has accelerated
- The vehicle in the next lane moves two lanes away from you, or when the vehicle two lanes away moves to the next lane from you
- A trailer or carrier is installed around the rear corner radar
- The bumper around the rear corner radar is covered with objects, such as a bumper sticker, bumper guard, bike rack, etc.
- The bumper around the rear corner radar is impacted, damaged or the radar is out of position
- Your vehicle height is low or high due to heavy loads, abnormal tire pressure, etc.

Blind-Spot Safety system may not operate normally, or the function may operate unexpectedly when the following objects are detected:

- A motorcycle or bicycle is detected
- A vehicle such as a flat trailer is detected
- A big vehicle such as a bus or truck is detected
- A moving obstacle such as a pedestrian, animal, shopping cart or a baby stroller is detected
- A vehicle with low height such as a sports car is detected

⚠ WARNING

- Driving on a curve



Blind-Spot Safety system may not operate properly when driving on a curved road. The function may not detect the vehicle in the next lane.

Always pay attention to road and driving conditions while driving.

(Continued)

(Continued)



Blind-Spot Safety system may not operate properly when driving on the curved road. The function may recognize the vehicle in the same lane.

Always pay attention to road and driving conditions while driving.

(Continued)

(Continued)

- Driving where the road is merging/dividing

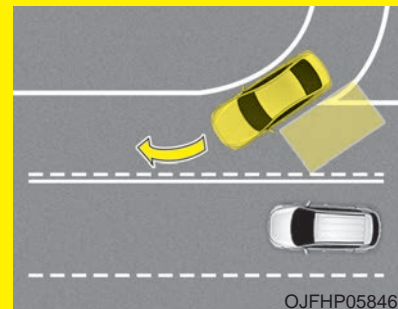

Blind-Spot Safety system may not operate properly when driving where the road merges or divides. The function may not detect the vehicle in the next lane.

Always pay attention to road and driving conditions while driving.

(Continued)

(Continued)

- Driving on a slope

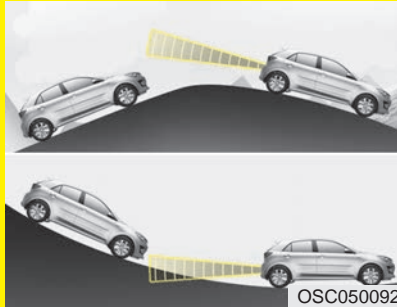

Blind-Spot Safety system may not operate properly when driving on a slope. The function may not detect the vehicle in the next lane or may incorrectly detect the ground or structure.

Always pay attention to road and driving conditions while driving.

(Continued)

(Continued)

- Driving where the heights of the lanes are different

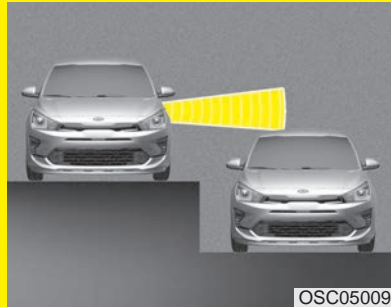

Blind-Spot Safety system may not operate properly when driving where the heights of the lanes are different. The function may not detect the vehicle on a road with different lane heights (underpass joining section, grade separated intersections, etc.).

Always pay attention to road and driving conditions while driving.

⚠ WARNING

- Blind-Spot Safety system may not operate normally if interfered by strong electromagnetic waves.
- Blind-Spot Safety system may not operate for 3 seconds after the vehicle is started, or the rear corner radars are initialized.

This device complies with Part 15 of the FCC rules.

Operation is subject to the following two conditions:

1. This device may not cause harmful interference, and
2. This device must accept any interference received, including interference that may cause undesired operation.

DRIVER ATTENTION WARNING (DAW) (IF EQUIPPED)

Basic function

Driver Attention Warning will determine the driver's attention level by analyzing driving pattern, driving time, etc. while driving. The function will recommend a break when the driver's attention level falls below a certain level to help drive safely.

Leading Vehicle Departure Alert function

Leading Vehicle Departure Alert function will inform the driver when the front vehicle departs from a stop.

* NOTICE

DAW stands for Driver Attention Warning.

Detecting sensor

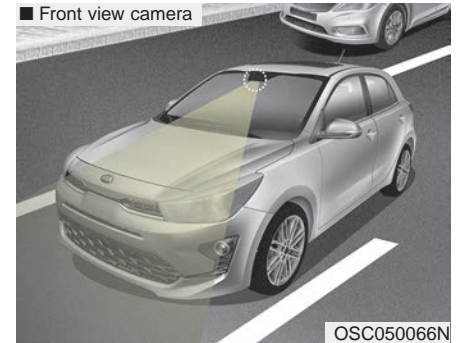

The front view camera is used as a detecting sensor to detect driving patterns and front vehicle departure while vehicle is being driven.

Refer to the picture above for the detailed location of the detecting sensor.

⚠ CAUTION

Always keep the front view camera in good condition to maintain optimal performance of Driver Attention Warning.

For more details on the precautions of the front view camera, refer to "Forward Collision-Avoidance Assist (FCA) (Front view camera only) (if equipped)" in chapter 5.

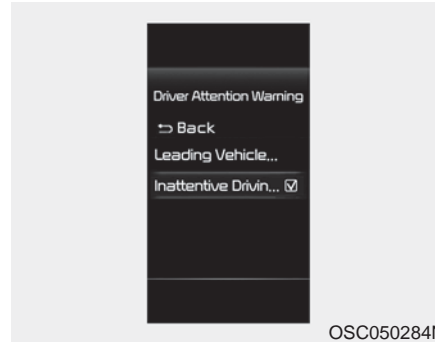
Function settings**Settings****Driver Attention Warning**

- Driver Attention Warning is set to be in the OFF position, when your vehicle is first delivered to you from the factory.

To turn ON Driver Attention Warning, turn on the engine, and then select "User Settings → Driver Assistance → Driver Attention Warning" on the LCD display.

- If 'Inattentive Driving Warning' is selected, the function will inform the driver the driver's attention level and will recommend taking a break when the level falls below a certain level.

⚠ CAUTION

When the engine is restarted, Driver Attention Warning will always turn on.

Leading Vehicle Departure Alert

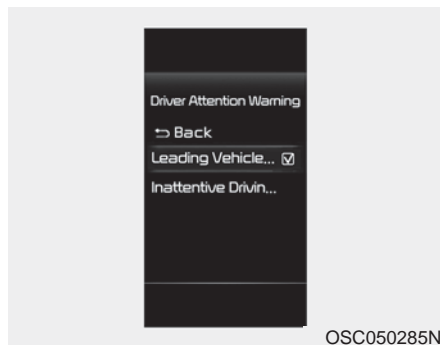

If 'Leading Vehicle Departure Alert's is selected, the function will inform the driver when the front vehicle departs from a stop.

Warning Timing

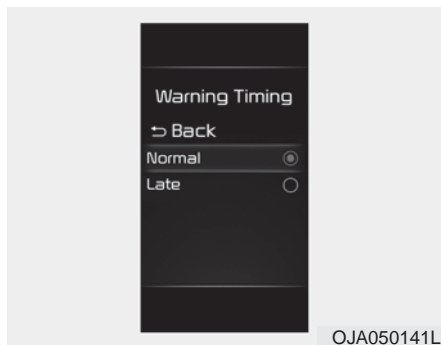

The driver can select the initial warning activation time in the User Settings in the LCD display by selecting "User Settings → Driver Assistance → Warning Timing". When the vehicle is first delivered, warning timing is set to 'Normal'. If you change the warning timing, the warning time of other Driver Assistance functions may change. Make sure to check the warning timing before changing it.

* NOTICE

If the engine is restarted, Driver Attention Warning will maintain the last setting.

Function operation

Basic function

Function display and warning

The basic function of Driver Attention Warning is to inform the driver the 'Attention Level' and to alert the driver 'Consider taking a break'.

Attention level

■ Attentive driving



ODL3059145L

■ Inattentive driving



ODL3059146L

■ System off

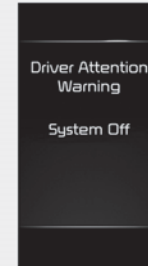

ODL3059144L

■ Standby



ODL3059148L

- The driver can monitor his/her driving conditions on the cluster.
 - When the 'Inattentive Driving Warning' is deselected from the User Settings 'System Off' is displayed.
 - The function will operate when vehicle speed is between 0~130 mph (0 ~ 210 km/h).
 - When vehicle speed is not within the operating speed, the message 'Standby' will be displayed.
- The driver's attention level is displayed on the scale of 1 to 5. The lower the level is, the more inattentive the driver is.
- The level decreases when the driver does not take a break for a certain period of time.

Taking a break



- The 'Consider taking a break' message will appear on the cluster and an audible warning will sound to suggest that the driver take a break, when the driver's attention level is below 1.
- Driver Attention Warning will not suggest a break when the total driving time is shorter than 10 minutes or 10 minutes has not passed after the last break was suggested.

WARNING

For your safety, change the Settings after parking the vehicle at a safe location.

CAUTION

- *Driver Attention Warning may suggest a break depending on the driver's driving pattern or habits, even if the driver doesn't feel fatigue.*
- *Driver Attention Warning is a supplemental function and may not be able to determine whether the driver is inattentive.*
- *The driver who feels fatigued should take a break at a safe location, even though there is no break suggestion by Driver Attention Warning.*

*** NOTICE**

- For more details on setting the functions in the infotainment system, refer to "Instrument cluster" in chapter 4.
- Driver Attention Warning will reset the last break time to 00:00 in the following situations:
 - The engine is turned off
 - The driver unfastens the seat belt and opens the driver's door.
 - The vehicle is stopped for more than 10 minutes.
- When the driver resets Driver Attention Warning, the last break time is set to 00:00 and the driver's attention level is set to High.

Leading Vehicle Departure Alert

This reminds the driver the leading vehicle's driving departure after stopping.

 WARNING

- If any other function's warning message is displayed or audible warning is generated, Leading Vehicle Departure Warning message may not be displayed and audible warning may not be generated.
- The driver should hold the responsibility to safely drive and control the vehicle.

 CAUTION

- *Leading Vehicle Departure Warning is a supplemental function and may not alert the driver whenever the front vehicle departs from a stop.*
- *Always check the front of the vehicle and road conditions before departure.*

Function malfunction and limitations

Function malfunction

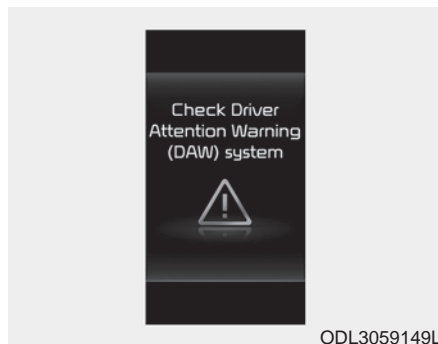

When Driver Attention Warning is not working properly, the 'Check Driver Attention Warning (DAW) system' warning message will appear on the cluster. If this occurs, have your vehicle inspected by an authorized Kia dealer.

Limitations of the function

Driver Attention Warning may not work properly in the following situations:

- The vehicle is driven violently.
- The vehicle intentionally crosses over lanes frequently.
- The vehicle is controlled by Driver Assistance system, such as Lane Keeping Assist.

Leading vehicle departure alert feature

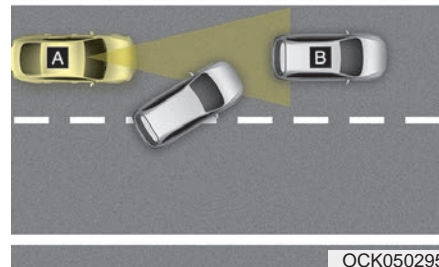
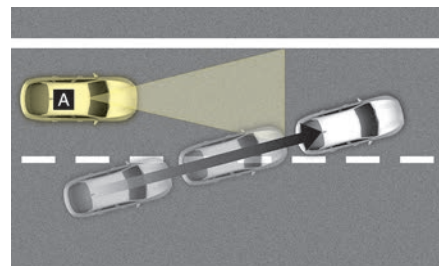

[A]: Your vehicle, [B]: Front vehicle

- When the vehicle cuts in

If a vehicle cuts in front of your vehicle, Leading Departure Alert may not operate properly.

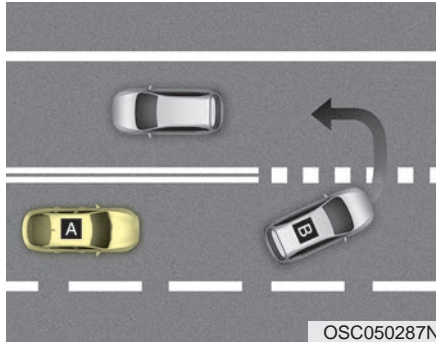

[A] : Your vehicle, [B] : Front vehicle

- When the vehicle ahead sharply steers

If the vehicle in front makes a sharp turn, such as to turn left or right or make a U-turn, etc., Leading Vehicle Departure Alert may not operate properly.

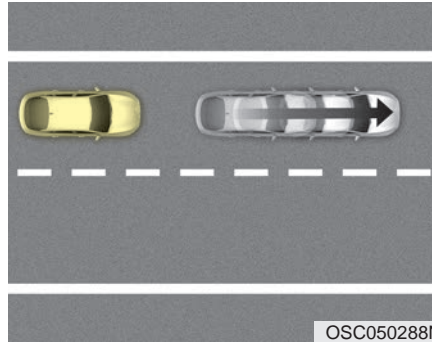

- When the vehicle ahead abruptly departs

If the vehicle in front abruptly departs, Leading Vehicle Departure Alert may not operate properly.



- When a pedestrian is between you and the vehicle ahead

If there is a pedestrian(s) in between you and the vehicle in front, Leading Vehicle Departure Alert may not operate properly.

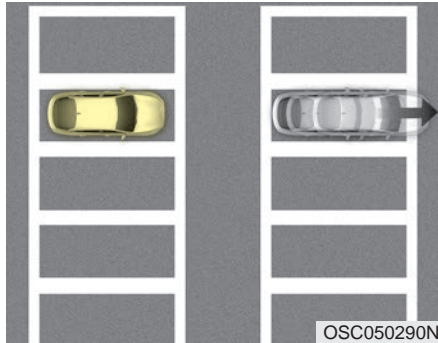

- When in a parking lot
If a vehicle parked in front of you, Leading Vehicle Departure Alert may alert you that the parked vehicle is driving away.

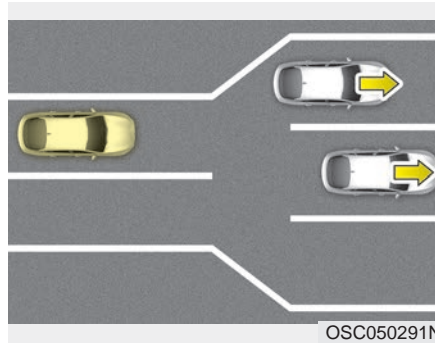

- When driving at a tollgate or intersection, etc.
If you pass a tollgate or intersection with lots of vehicles or you drive where lanes are merged or divided frequently, Leading Vehicle Departure Alert may not operate properly.

CRUISE CONTROL (CC) (IF EQUIPPED)



ODL3A050124

- (1) CRUISE indicator ( CRUISE)
- (2) Set speed



Cruise Control allows you to drive at speeds above 20 mph (30 km/h) without depressing the accelerator pedal.

Function operation

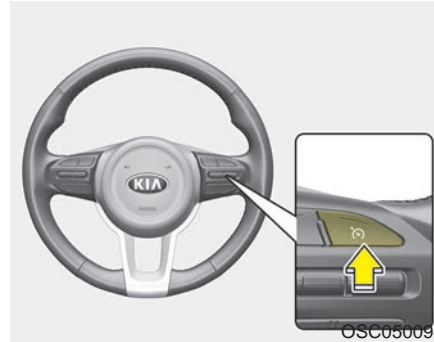
To set cruise control speed



OSC050094

1. Press the Driving Assist () button on the steering wheel to turn the function on. The ( CRUISE) indicator will illuminate.
2. Accelerate to the desired speed, which must be more than 20 mph (30 km/h).
3. Push the SET- switch down and release it. The set speed on the LCD screen will illuminate.
4. Release the accelerator pedal.

On a steep slope, the vehicle may slightly slow down or speed up while driving uphill or downhill.

To increase set speed:

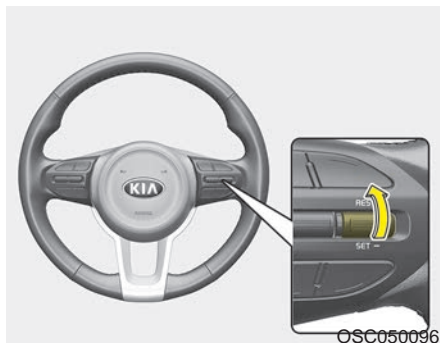

- Push the RES+ switch up and release it immediately. The cruising speed will increase by 1 mph (1 km/h) each time the switch is operated in this manner.
- Push the RES+ switch up and hold it while monitoring the set speed on the cluster. The cruising speed will increase to the nearest multiple of ten (multiple of five in mph) at first, and then increase by 5 mph (10 km/h) each time the switch is operated in this manner.

Release the switch when the desired speed is shown and the vehicle will accelerate to that speed.

To decrease speed:



- Push the SET- switch down and release it immediately. The cruising speed will decrease by 1 mph (1 km/h) each time the switch is operated in this manner.
- Push the SET- switch down and hold it while monitoring the set speed on the cluster. The cruising speed will decrease to the nearest multiple of ten (multiple of five in mph) at first, and then decrease by 5 mph (10 km/h) each time the switch is operated in this manner. Release the switch at the speed you want to maintain.

To temporarily pause the function

Manually

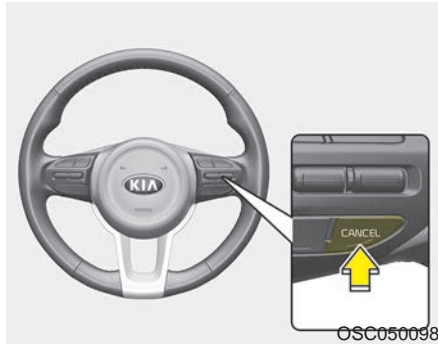

If you want to pause temporarily when Cruise Control is on, push the CANCEL button.

The set speed will turn off but the Cruise (Ⓢ CRUISE) indicator will stay on.

Automatically

Cruise Control will be paused when:

- Depress the brake pedal.
- Shift into N (Neutral)
- ESC (Electronic Stability Control) is operating.
- Decrease the vehicle speed to less than approximately 20 mph (30 km/h).

The set speed will turn off but the Cruise (Ⓢ CRUISE) indicator will stay on.

To resume the function

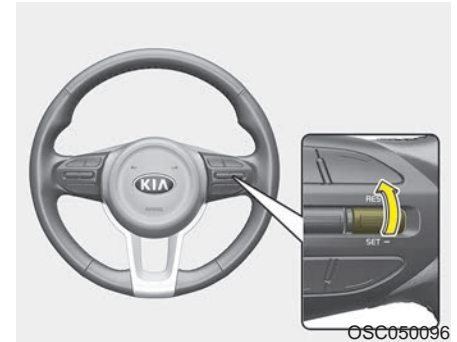

Push the RES+ or SET- switch.



If you push the SET- switch down, vehicle speed will be set to the current speed on the cluster.

If you push the RES+ switch up, vehicle speed will resume to the preset speed.

Vehicle speed must be above 20 mph (30 km/h) for the function to resume.

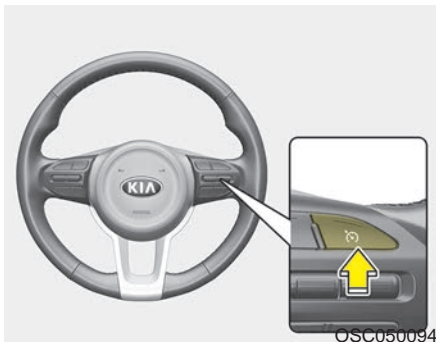
To Turn Off Cruise Control



Press the Driving Assist  button to turn Cruise Control off. The Cruise  (CRUISE) indicator will go off. Always press the Driving Assist  button to turn Cruise Control off when not in use.

WARNING

Take the following precautions when using Cruise Control:

- Always set the vehicle speed under the speed limit in your country. Keep Cruise Control off when the function is not in use, to avoid inadvertently setting a speed. Check that the Cruise  (CRUISE) indicator is off.
- Cruise Control does not substitute for proper and safe driving. It is the responsibility of the driver to always drive safely and should always be aware of unexpected and sudden situations from occurring.
- Always drive cautiously to prevent unexpected and sudden situations from occurring. Pay attention to the road conditions at all times.
- Do not use Cruise Control when it may be unsafe to keep the vehicle at a constant speed:

(Continued)

(Continued)

- When driving in heavy traffic, or when traffic conditions make it difficult to drive at a constant speed
- When driving on rainy, icy, or snow-covered roads
- When driving on hilly or windy roads
- When driving in windy areas
- When driving with limited view (possibly due to bad weather, such as fog, snow, rain and sandstorm)
- Do not use Cruise Control when towing a trailer.

LANE FOLLOWING ASSIST (LFA) (IF EQUIPPED)

Lane Following Assist is designed to detect lane markings or vehicles on the road, and assists the driver's steering to help keep the vehicle between lanes.

* NOTICE

LFA stands for Lane Following Assist.

Detecting sensor

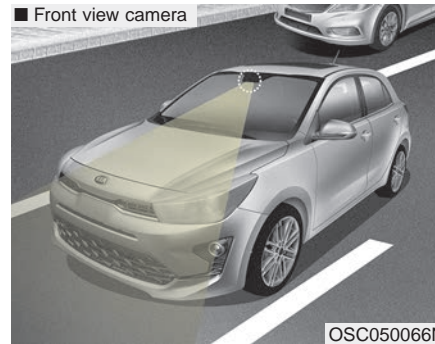

The front view camera is used as a detecting sensor to detect lane markings and front vehicles.

Refer to the picture above for the detailed location of the detecting sensor.

CAUTION



For more details on the precautions of the front view camera, refer to "Forward Collision-Avoidance Assist (FCA) (Front view camera only) (if equipped)" in chapter 5.

Function settings

Settings



Turning the function ON/OFF

With the ignition switch or ENGINE START/STOP button in the ON position, press the Lane Driving Assist button  located on the steering wheel to turn on Lane Following Assist. The white or green () indicator light will illuminate on the cluster.

Press the  button again to turn off the function.

* NOTICE

If the engine is restarted, Lane Following Assist will maintain the last setting.

Function operation

Warning and control

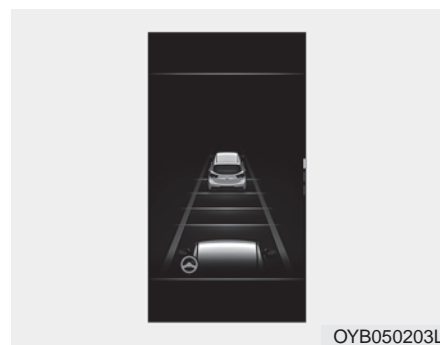

Lane Following Assist

If the vehicle ahead or both lane markings are detected and your vehicle speed is below 120 mph (190 km/h), the green () indicator light will illuminate on the cluster, and the function will help the vehicle stay in lane by controlling the steering wheel.

⚠ CAUTION

When the steering wheel is not controlled, the green (🚘) indicator light will blink and change to white.

**Hands-off warning**

If the driver takes their hands off the steering wheel for several seconds, the 'Keep hands on steering wheel' warning message will appear and an audible warning will sound in stages.

- First stage: Warning message
- Second stage: Warning message (red steering wheel) and audible warning

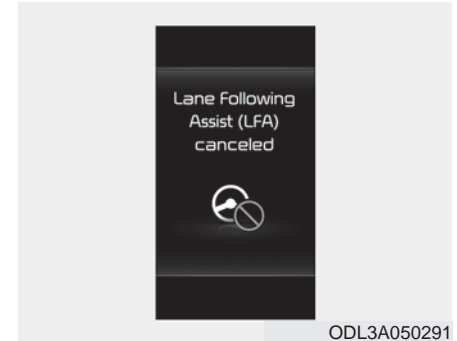

If the driver still does not have their hands on the steering wheel after the hands-off warning, the 'Lane Following Assist (LFA) canceled' warning message will appear and Lane Following Assist will be automatically canceled.

⚠ WARNING

- The steering wheel may not be assisted if the steering wheel is held very tight or the steering wheel is steered over a certain level.
- Lane Following Assist does not operate at all times. It is the responsibility of the driver to safely steer the vehicle and to maintain the vehicle in its lane.
- The hands-off warning message may appear late depending on road conditions. Always have your hands on the steering wheel while driving.
- If the steering wheel is held very lightly the hands-off warning message may appear because the function may not recognize that the driver has their hands on the steering wheel.
- If you attach objects to the steering wheel, the hands-off warning may not work properly.

*** NOTICE**

- For more details on setting the functions, refer to "LCD Display Mode" in chapter 4.
- When both lane markings are detected, the lane lines on the cluster will change from gray to white.

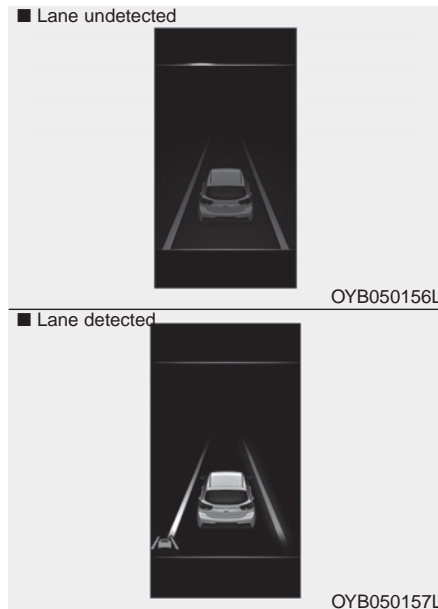

- If lane markings are not detected, steering wheel control by Lane Following Assist can be limited depending on whether a vehicle is in front or the driving conditions of the vehicle.

- Even though the steering is assisted by Lane Following Assist, the driver may control the steering wheel.
- The steering wheel may feel heavier or lighter when the steering wheel is assisted by the function than when it is not.

Function malfunction and limitations

Function malfunction

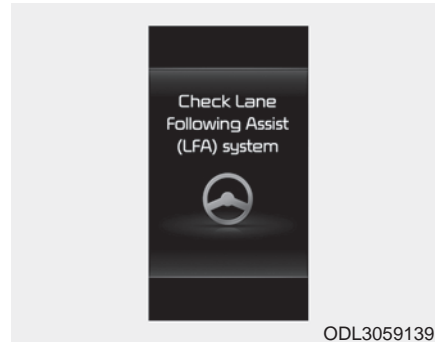

When Lane Following Assist is not working properly, the 'Check Lane Following Assist (LFA) system' warning message will appear on the cluster.

If this occurs, have your vehicle inspected by an authorized Kia dealer.

Limitations of the function

For more details on "Limitations of the function", refer to "Lane Keeping Assist (LKA) (if equipped)" in chapter 5.

⚠ WARNING

For more details on the function precautions, refer to "Lane Keeping Assist (LKA) (if equipped)" in chapter 5.

REAR CROSS-TRAFFIC COLLISION WARNING (RCCW) (IF EQUIPPED)

Rear Cross-Traffic Collision Warning is designed to detect vehicles approaching from the left and right side while your vehicle is reversing, and warning the driver that a collision is imminent with a warning message and an audible warning.

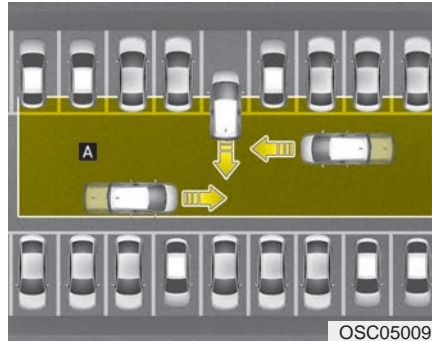

[A]: Rear Cross-Traffic Collision Warning operating range

CAUTION

The time of warning may vary depending on vehicle speed of the approaching vehicle.

* NOTICE

- RCCW stands for Rear Cross-Traffic Collision Warning.
- In the following text, Rear Cross-Traffic Collision Warning will be referred as Rear Cross-Traffic Safety.

Detecting sensor

■ Rear corner radar



OSC050091

Refer to the picture above for the detailed location of the detecting sensor.

⚠ CAUTION

For more details on the precautions of the rear corner radar, refer to "Blind-Spot Collision Warning (BCW) (if equipped)" in chapter 5.

Functions settings

Setting

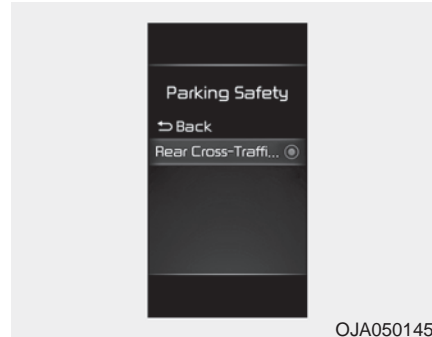

OJA050145L

Rear Cross-Traffic Safety

With the ignition switch or ENGINE START/STOP button in the ON position, select 'Driver Assistance → Parking Safety → Rear Cross-Traffic Safety' from the User Settings menu to turn on Rear Cross-Traffic Safety and deselect to turn off the function.

⚠ WARNING

When the engine is restarted, Rear Cross-Traffic Safety will always turn on. However, if 'Off' is selected after the engine is restarted, the driver should always be aware of the surroundings and drive safely.

* NOTICE

Settings for Rear Cross-Traffic Safety include Rear Cross-Traffic Collision Warning and Rear Cross-Traffic Collision-Avoidance Assist.

* NOTICE

If the engine is restarted, Warning Timing will maintain the last setting.

Warning Timing

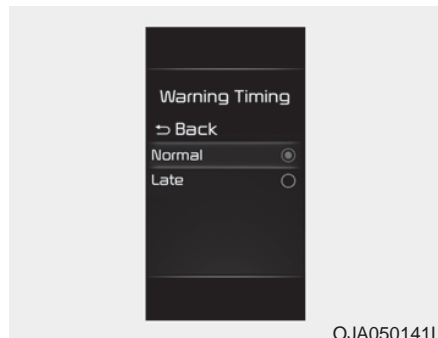

With the ignition switch or ENGINE START/STOP button in the ON position, select 'Driver Assistance → Warning Timing' from the User Settings menu to change the initial warning activation time for Rear Cross-Traffic Safety.

When the vehicle is first delivered, warning timing is set to 'Normal'. If you change the warning timing, the warning time of other Driver Assist functions may change.

CAUTION

- *The setting of the Warning Timing applies to all functions of the Blind-Spot Safety system.*
- *Even though 'Normal' is selected for Warning Timing, if the vehicle approaches at high speed, the initial warning activation time may seem late.*
- *Select 'Late' for Warning Timing when traffic is light and when driving speed is slow.*

Function operation

Function warning

Rear Cross-Traffic Safety will warn the driver when a collision is imminent.

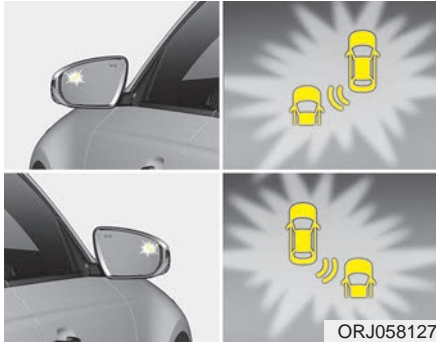

Collision warning

To warning the driver of an approaching vehicle from the rear left/right side of your vehicle, the outside rearview mirror will blink and a warning will appear on the cluster. At the same time, an audible warning will sound. If Rear view camera is operating, a warning will also appear on the infotainment screen.

The function will operate when the following conditions are satisfied:

- Your vehicle gear is shifted to R (Reverse)
- Your vehicle speed is below 5 mph (8 km/h)
- The approaching vehicle is within approximately 82 feet (25 m) from the left and right side of your vehicle
- The speed of the vehicle approaching from the left and right is above 3 mph (5 km/h)

* NOTICE

If the operating conditions are satisfied, there will be a warning whenever the vehicle approaches from the left or right side even though your vehicle speed is 0 mph (0 km/h).

Function malfunction and limitations

Function malfunction

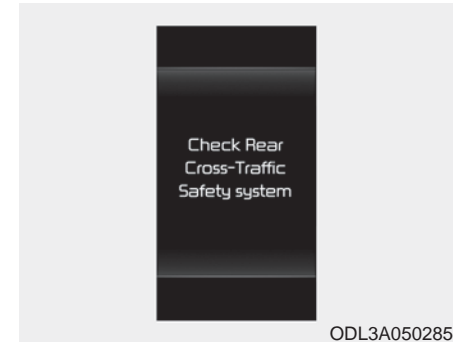

ODL3A050285

When Rear Cross-Traffic Safety is not working properly, the 'Check Rear Cross-Traffic Safety system' warning message will appear on the cluster, and the function will turn off automatically, or the function will be limited. In this case, have your vehicle inspected by an authorized Kia dealer.

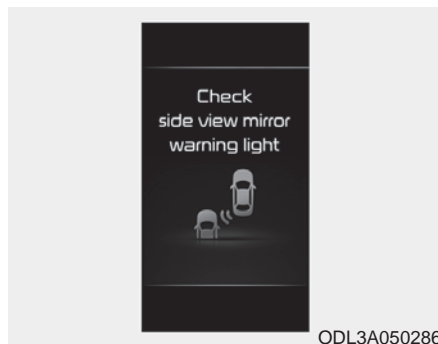

When the outside rearview mirror warning light is not working properly, the 'Check side view mirror warning light' warning message will appear on the cluster. In this case, have your vehicle inspected by an authorized Kia dealer.

Function disabled

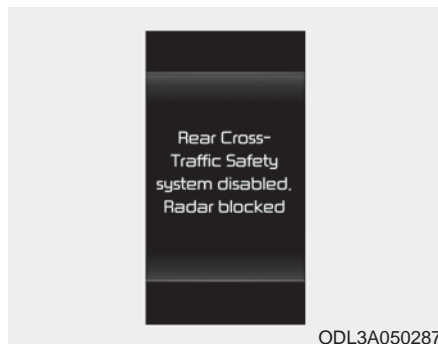

When the rear bumper around the rear-side radar or sensor is covered with foreign matters, such as snow or rain, or installing a trailer or carrier, it can reduce the detecting performance and temporarily limit or disable Rear Cross-Traffic Safety.

If this occurs, the 'Rear Cross-Traffic Safety disabled. Radar blocked' warning message will appear on the cluster.

The function will operate normally when such foreign matters or trailer, etc. is removed.

If the function does not operate normally after it is removed, have your vehicle inspected by an authorized Kia dealer.

⚠ WARNING

- Even though the warning message does not appear on the cluster, Rear Cross-Traffic Safety system may not properly operate.
- Rear Cross-Traffic Safety system may not properly operate in an area (e.g. open terrain), where any substance are not detected after turning ON the engine.

⚠ CAUTION

Turn off Rear Cross-Traffic Safety system to install a trailer, carrier, etc., or remove the trailer, carrier, etc. to use Rear Cross-Traffic Safety system.

Limitations of the function

Rear Cross-Traffic Safety system may not operate normally, or the function may operate unexpectedly under the following circumstances:

- Departing from where trees or grass is overgrown
- Departing from where roads are wet
- Speed of the approaching vehicle is fast or slow

*** NOTICE**

For more details on the limitations of the rear corner radar, refer to "Blind-Spot Collision Warning (BCW) (if equipped)" in chapter 5.

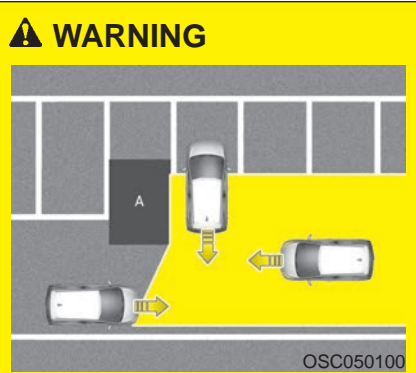

[A]: Structure

- Driving near a vehicle or structure

Rear Cross-Traffic Safety system may be limited when driving near a vehicle or structure, and may not detect the vehicle approaching from the left or right. If this occurs, the function may not warn the driver when necessary.

Always check your surroundings while backing up.

(Continued)

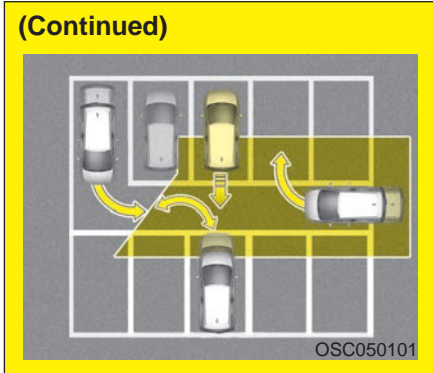

(Continued)

- When the vehicle is in a complex parking environment

Rear Cross-Traffic Safety system may detect vehicles which are parking or pulling out near your vehicle (e.g. a vehicle leaving beside your vehicle, a vehicle parking or pulling out in the rear area, a vehicle approaching your vehicle making a turn, etc.). If this occurs, the function may unnecessarily warn the driver.

Always check your surroundings while backing up.

(Continued)

(Continued)

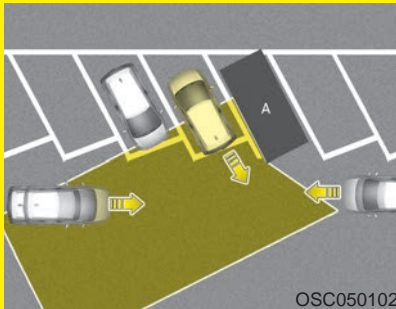

[A]: Vehicle

- When the vehicle is parked diagonally

Rear Cross-Traffic Safety system may detect vehicles which are parking or pulling out near your vehicle (e.g. a vehicle leaving beside your vehicle, a vehicle parking or pulling out in the rear area, a vehicle approaching your vehicle making a turn, etc.). If this occurs, the function may unnecessarily warn the driver.

Always check your surroundings while backing up.

(Continued)

(Continued)

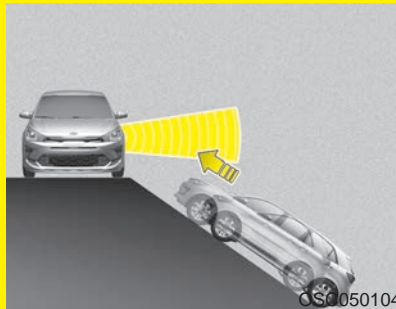

- When the vehicle is on or near a slope

Rear Cross-Traffic Safety system may be limited when the vehicle is on an uphill or downhill slope, or near it, and may not detect the vehicle approaching from the left or right. If this occurs, the function may not warn the driver when necessary.

Always check your surroundings while backing up.

(Continued)

(Continued)

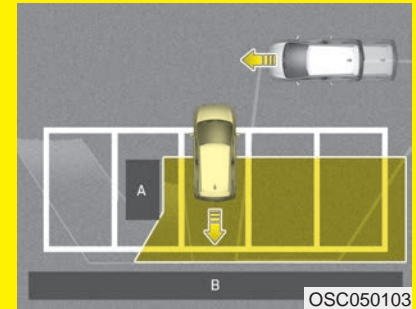

[A]: Structure, [B]: Wall

- Pulling into the parking space where there is a structure

Rear Cross-Traffic Safety system may detect vehicles passing by in front of you when parking backwards into a parking space with a wall or structure in the rear or side area. If this occurs, the function may unnecessarily warn the driver.

Always check your surroundings while backing up.

(Continued)

(Continued)

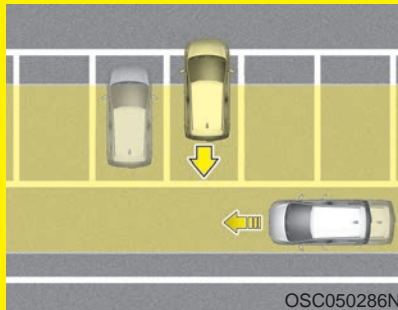

- When the vehicle is parked rearward

Rear Cross-Traffic Safety system may detect vehicles passing by behind you when parking backwards into a parking space. If this occurs, the function may unnecessarily warn the driver. Always check your surroundings while backing up.

⚠ WARNING

- Rear Cross-Traffic Safety system may not operate normally if interfered by strong electromagnetic waves.
- Rear Cross-Traffic Safety system may not operate for 3 seconds after the vehicle is started, or the rear corner radars are initialized.

This device complies with Part 15 of the FCC rules.

Operation is subject to the following two conditions:

1. This device may not cause harmful interference, and
2. This device must accept any interference received, including interference that may cause undesired operation.

DECLARATION OF CONFORMITY (IF EQUIPPED)

The radio frequency components (Rear Corner Radar) complies :

For United States



OYB060040L

This device complies with Part 15 of the FCC Rules. Operation is subject to the following two conditions:

- (1) this device may not cause harmful interference, and
- (2) this device must accept any interference received, including interference that may cause undesired operation.

CAUTION TO USERS

Changes or modifications not expressly approved by the party responsible for compliance could void the user's authority to operate the equipment.

OYB060041L

ECONOMICAL OPERATION

Your vehicle's fuel economy depends mainly on your style of driving, where you drive and when you drive.

Each of these factors affects how many miles (kilometers) you can get from a gallon (liter) of fuel. To operate your vehicle as economically as possible, use the following driving suggestions to help save money in both fuel and repairs:

- Drive smoothly. Accelerate at a moderate rate. Don't make "jack-rabbit" starts or full-throttle shifts and maintain a steady cruising speed. Don't race between stoplights. Try to adjust your speed to the traffic so you don't have to change speeds unnecessarily. Avoid heavy traffic whenever possible. Always maintain a safe distance from other vehicles so you can avoid unnecessary braking. This also reduces brake wear.
- Drive at a moderate speed. The faster you drive, the more fuel your vehicle uses. Driving at a moderate speed, especially on the highway, is one of the most effective ways to reduce fuel consumption.
- Don't "ride" the brake pedal. This can increase fuel consumption and also increase wear on these components. In addition, driving with your foot resting on the brake pedal may cause the brakes to overheat, which reduces their effectiveness and may lead to more serious consequences.
- Take care of your tires. Keep them inflated to the recommended pressure. Incorrect inflation, either too much or too little, results in unnecessary tire wear. Check the tire pressures at least once a month.
- Be sure that the wheels are aligned correctly. Improper alignment can result from hitting curbs or driving too fast over irregular surfaces. Poor alignment causes faster tire wear and may also result in other problems as well as greater fuel consumption.
- Keep your vehicle in good condition. For better fuel economy and reduced maintenance costs, maintain your vehicle in accordance with the maintenance schedule in section 7. If you drive your vehicle in severe conditions, more frequent maintenance is required (see section 7 for details).
- Keep your vehicle clean. For maximum service, your vehicle should be kept clean and free of corrosive materials. It is especially important that mud, dirt, ice, etc. not be allowed to accumulate on the underside of the vehicle. This extra weight can result in increased fuel consumption and also contribute to corrosion.
- Travel lightly. Don't carry unnecessary weight in your vehicle. Weight reduces fuel economy.
- Don't let the engine idle longer than necessary. If you are waiting (and not in traffic), turn off your engine and restart only when you're ready to go.

- Remember, your vehicle does not require extended warm-up. After the engine has started, allow the engine to run for 10 to 20 seconds prior to placing the vehicle in gear. In very cold weather, however, give your engine a slightly longer warm-up period.
 - Don't "lug" or "over-rev" the engine. Lugging is driving too slowly in a very high gear resulting in engine bucking. If this happens, shift to a lower gear. Over-revving is racing the engine beyond its safe limit. This can be avoided by shifting at the recommended speed.
 - Use your air conditioning sparingly. The air conditioning system is operated by engine power so your fuel economy is reduced when you use it.
 - Open windows at high speeds can reduce fuel economy.
 - Fuel economy is reduced by crosswinds and headwinds. To help offset some of this loss, slow down when driving in these conditions.
- Keeping a vehicle in good operating condition is important both for economy and safety. Therefore, have an authorized Kia dealer perform scheduled inspections and maintenance.

 **WARNING - Engine off during motion**

Never turn the engine off to coast down hills or anytime the vehicle is in motion. The power steering and power brakes will not function properly without the engine running. In addition, turning off the ignition while driving could engage the steering wheel lock resulting in loss of vehicle steering. Keep the engine on and downshift to an appropriate gear for engine braking effect.

SPECIAL DRIVING CONDITIONS

Hazardous driving conditions

When hazardous driving conditions are encountered such as water, snow, ice, mud, sand, or similar hazards, follow these suggestions:

- Drive cautiously and allow extra distance for braking.
- Avoid sudden braking or steering.
- When braking with non-ABS brakes, pump the brake pedal with a light up-and-down motion until the vehicle is stopped.

Do not pump the brake pedal on a vehicle equipped with ABS.

- If stalled in snow, mud, or sand, use second gear. Accelerate slowly to avoid spinning the drive wheels.
- Use sand, rock salt, tire chains, or other non-slip material under the drive wheels to provide traction when stalled in ice, snow, or mud.

 **WARNING - Downshifting**
Do not downshift with an intelligent variable transmission while driving on slippery surfaces. The sudden change in tire speed could cause the tires to skid and result in an accident.

Rocking the vehicle

If it is necessary to rock the vehicle to free it from snow, sand, or mud, first turn the steering wheel right and left to clear the area around your front wheels. Then, shift back and forth between 1st (First) and R (Reverse) in vehicles equipped with a Manual Transmission or R (Reverse) and any forward gear in vehicles equipped with an Intelligent Variable Transmission. Do not race the engine, and spin the wheels as little as possible. If you are still stuck after a few tries, have the vehicle pulled out by a tow vehicle to avoid engine overheating and possible damage to the transmission.

The ESC system should be turned OFF prior to rocking the vehicle.

 **CAUTION - Vehicle rocking**

Prolonged rocking may cause engine overheating, transmission damage or failure, and tire damage.

⚠ CAUTION - Spinning tires

Do not spin the wheels, especially at speeds more than 35 mph (56 km/h). Spinning the wheels at high speeds when the vehicle is stationary could cause a tire to overheat which could result in tire damage.

⚠ WARNING - Sudden vehicle movement

Do not attempt to rock the vehicle if people or objects are nearby. The vehicle may suddenly move forward or backwards as it becomes unstuck.

Smooth cornering



Avoid braking or gear changing in corners, especially when roads are wet. Ideally, corners should always be taken under gentle acceleration. If you follow these suggestions, tire wear will be held to a minimum.

Driving at night



Because night driving presents more hazards than driving in the daylight, here are some important tips to remember:

- Slow down and keep more distance between you and other vehicles, as it may be more difficult to see at night, especially in areas where there may not be any street lights.

- Adjust your mirrors to reduce the glare from other driver's headlights.
- Keep your headlights clean and properly aimed on vehicles not equipped with the automatic headlight aiming feature. Dirty or improperly aimed headlights will make it much more difficult to see at night.
- Avoid staring directly at the headlights of oncoming vehicles. You could be temporarily blinded, and it will take several seconds for your eyes to readjust to the darkness.

Driving in the rain



Rain and wet roads can make driving dangerous, especially if you're not prepared for the slick pavement. Here are a few things to consider when driving in the rain:

- A heavy rainfall will make it harder to see and will increase the distance needed to stop your vehicle, so slow down.
- Keep your windshield wiping equipment in good shape. Replace your windshield wiper blades when they show signs of streaking or missing areas on the windshield.

- If your tires are not in good condition, making a quick stop on wet pavement can cause a skid and possibly lead to an accident. Be sure your tires are in good shape.
- Turn on your headlights to make it easier for others to see you.
- Driving too fast through large puddles can affect your brakes. If you must go through puddles, try to drive through them slowly.
- If you believe you may have gotten your brakes wet, apply them lightly while driving until normal braking operation returns.

Driving in flooded areas

Avoid driving through flooded areas unless you are sure the water is no higher than the bottom of the wheel hub. Drive through any water slowly. Allow adequate stopping distance because brake performance may be affected.

After driving through water, dry the brakes by gently applying them several times while the vehicle is moving slowly.

Driving off-road

Drive carefully off-road because your vehicle may be damaged by rocks or roots of trees. Become familiar with the off-road conditions where you are going to drive before you begin driving.

Highway driving

Tires

Adjust the tire inflation pressures to specification. Low tire inflation pressures will result in overheating and possible failure of the tires.

Avoid using worn or damaged tires which may result in reduced traction or tire failure.

Never exceed the maximum tire inflation pressure shown on the tires.

WARNING - Tire tread

Always check the tire tread before driving your vehicle. Worn-out tires can result in loss of vehicle control. Worn-out tires should be replaced as soon as possible. For further information and tread limits, refer to “Tires and wheels” in section 7.

WARNING - Under/Over Inflated Tires

Always check the tires for proper inflation before driving. Underinflated or overinflated tires can cause poor handling, loss of vehicle control, and sudden tire failure leading to accidents, injuries, and even death.

Fuel, engine coolant and engine oil

High speed travel consumes more fuel than urban motoring. Do not forget to check both the engine coolant and engine oil.

Drive belt

A loose or damaged drive belt may overheat the engine.

WINTER DRIVING



Severe weather conditions in the winter result in greater wear and other problems. To minimize the problems of winter driving, you should follow these suggestions:

Snowy or Icy conditions

To drive your vehicle in deep snow, it may be necessary to use snow tires or to install tire chains on your tires. If snow tires are needed, it is necessary to select tires equivalent in size and type of the original equipment tires. Failure to do so may adversely affect the safety and handling of your car. Furthermore, speeding, rapid acceleration, sudden brake applications, and sharp turns are potentially very hazardous practices.

During deceleration, use engine braking to the fullest extent. Sudden brake applications on snowy or icy roads may cause skids. You need to keep sufficient distance between the vehicle in operation in front and your vehicle. Also, apply the brake gently. It should be noted that installing tire chains on the tire will provide greater driving force, but will not prevent side skids.

Tire chains are not legal in all states. Check state laws before installing tire chains.

Snow tires

If you mount snow tires on your vehicle, make sure they are radial tires of the same size and load range as the original tires. Mount snow tires on all four wheels to balance your vehicle's handling in all weather conditions. Keep in mind that the traction provided by snow tires on dry roads may not be as high as your vehicle's original equipment tires. You should drive cautiously even when the roads are clear. Check with the tire dealer for maximum speed recommendations.

Do not install studded tires without first checking local, state and municipal regulations for possible restrictions against their use.

⚠ WARNING - Snow tire size
Snow tires should be equivalent in size and type to the vehicle's standard tires. Otherwise, the safety and handling of your vehicle may be adversely affected.

Tire chains



OYB050171L

Since the sidewalls of radial tires are thinner, they can be damaged by mounting some types of snow chains on them. Therefore, the use of snow tires is recommended instead of snow chains. Do not mount tire chains on vehicles equipped with aluminum wheels; snow chains may cause damage to the wheels. If snow chains must be used, use wire-type chains with a thickness of less than 0.59 in (15 mm). Damage to your vehicle caused by improper snow chain use is not covered by your vehicle manufacturer's warranty.

Install tire chains only on the front tires.

⚠ CAUTION - Snow chains

- ***Make sure the snow chains are the correct size and type for your tires. Incorrect snow chains can cause damage to the vehicle body and suspension and may not be covered by your vehicle manufacturer's warranty.***
- ***Even with the appropriate chain installed, do not make a full turn (turn the steering wheel fully to one side) when driving the vehicle. (If you are making a full turn, drive with the speed below 6.2 mph (10 km/h)).***

The snow chain connecting hooks may be damaged from contacting vehicle components, causing the snow chains to come loose from the tire. Make sure the snow chains are SAE class "S" certified.

Always check chain installation for proper mounting after driving approximately 0.3 to 0.6 miles (0.5 to 1 km) to ensure safe mounting. Retighten or remount the chains if they are loose.

Chain installation

When installing chains, follow the manufacturer's instructions and mount them as tightly as you can. Drive slowly with chains installed. If you hear the chains contacting the body or chassis, stop and tighten them. If they still make contact, slow down until it stops. Remove the chains as soon as you begin driving on cleared roads.

When mounting snow chains, park the vehicle on level ground away from traffic. Turn on the vehicle Hazard Warning flashers and place a triangular emergency warning device behind the vehicle if available.

Always place the vehicle in P (Park), apply the parking brake and turn off the engine before installing snow chains.

- The use of chains may adversely affect vehicle handling.
- Do not exceed 20 mph (30 km/h) or the chain manufacturer's recommended speed limit, whichever is lower.
- Drive carefully and avoid bumps, holes, sharp turns, and other road hazards, which may cause the vehicle to bounce.
- Avoid sharp turns or locked-wheel braking.

CAUTION - Snow chains

- ***Chains that are the wrong size or improperly installed can damage your vehicle's brake lines, suspension, body and wheels.***
- ***Stop driving and retighten the chains any time you hear them hitting the vehicle.***

Use high quality ethylene glycol coolant

Your vehicle is delivered with high quality ethylene glycol coolant in the cooling system. It is the only type of coolant that should be used because it helps prevent corrosion in the cooling system, lubricates the water pump and prevents freezing. Be sure to replace or replenish your coolant in accordance with the maintenance schedule in section 7. Before winter, have your coolant tested to assure that its freezing point is sufficient for the temperatures anticipated during the winter.

Check battery and cables

Winter puts additional burdens on the battery system. Visually inspect the battery and cables as described in section 7. The level of charge in your battery can be checked by an authorized Kia dealer or a service station.

Change to "winter weight" oil if necessary

In some climates, it is recommended that a lower viscosity "winter weight" oil be used during cold weather. See section 8 for recommendations. If you aren't sure what weight oil you should use, consult an authorized Kia dealer.

Check spark plugs and ignition system

Inspect your spark plugs as described in section 7 and replace them if necessary. Also check all ignition wiring and components to be sure they are not cracked, worn or damaged in any way.

To keep locks from freezing

To keep the locks from freezing, squirt an approved de-icer fluid or glycerine into the key opening. If a lock is covered with ice, squirt it with an approved de-icing fluid to remove the ice. If the lock is frozen internally, you may be able to thaw it out by using a heated key. Handle the heated key with care to avoid injury.

Use approved window washer anti-freeze in system

To keep the water in the window washer system from freezing, add an approved window washer anti-freeze solution in accordance with instructions on the container. Window washer anti-freeze is available from an authorized Kia dealer and most auto parts outlets. Do not use engine coolant or other types of anti-freeze as these may damage the paint finish.

Don't let your parking brake freeze

Under some conditions, your parking brake can freeze in the engaged position. This is most likely to happen when there is an accumulation of snow or ice around or near the rear brakes or if the brakes are wet. If there is a risk the parking brake may freeze, apply it only temporarily while you put the shift lever in P (Intelligent Variable Transmission) or in first or reverse gear (Manual Transmission) and chock the rear wheels so the vehicle cannot roll. Then release the parking brake.

Don't let ice and snow accumulate underneath

Under some conditions, snow and ice can build up under the fenders and interfere with the steering. When driving in severe winter conditions where this may happen, you should periodically check underneath the car to be sure the movement of the front wheels and the steering components is not obstructed.

Carry emergency equipment

Depending on the severity of the weather you should carry appropriate emergency equipment. Some of the items you may want to carry include tire chains, tow straps or chains, flashlight, emergency flares, sand, a shovel, jumper cables, a window scraper, gloves, ground cloth, coveralls, a blanket, etc.

TRAILER TOWING

We do not recommend using this vehicle for trailer towing.

VEHICLE LOAD LIMIT

Tire and loading information label

TIRE AND LOADING INFORMATION RENSEIGNEMENTS SUR LES PNEUS ET LE CHARGEMENT					
SEATING CAPACITY NOMBRE DE PLACES		TOTAL 5	FRONT AVANT 2	REAR ARRIERE 3	
The combined weight of occupants and cargo should never exceed 385 kg or 845 lbs. Le poids total des occupants et du chargement ne doit jamais dépasser 385 kg ou 845 lbs.					
TIRE PNEU	SIZE DIMENSION	COLD TIRE PRESSURE PRESSION DES PNEUS A FROID	SEE OWNER'S MANUAL FOR ADDITIONAL INFORMATION		
FRONT AVANT	185-65R15	230kPa, 33psi	VOIR LE MANUEL DE L'USAGER POUR PLUS DE RENSEIGNEMENTS		
REAR ARRIERE	185-65R15	230kPa, 33psi			
SPARE DE SECOURS	T125-80D15	420kPa, 60psi			
NONE AUCUN					

OSC067003N

TIRE AND LOADING INFORMATION RENSEIGNEMENTS SUR LES PNEUS ET LE CHARGEMENT					
SEATING CAPACITY NOMBRE DE PLACES		TOTAL 5	FRONT AVANT 2	REAR ARRIERE 3	
The combined weight of occupants and cargo should never exceed 385 kg or 845 lbs. Le poids total des occupants et du chargement ne doit jamais dépasser 385 kg ou 845 lbs.					
TIRE PNEU	SIZE DIMENSION	COLD TIRE PRESSURE PRESSION DES PNEUS A FROID	SEE OWNER'S MANUAL FOR ADDITIONAL INFORMATION		
FRONT AVANT	205-45R17	230kPa, 33psi	VOIR LE MANUEL DE L'USAGER POUR PLUS DE RENSEIGNEMENTS		
REAR ARRIERE	205-45R17	230kPa, 33psi			
SPARE DE SECOURS	T125-80D15	420kPa, 60psi			
NONE AUCUN					

OSC067004N

TIRE AND LOADING INFORMATION RENSEIGNEMENTS SUR LES PNEUS ET LE CHARGEMENT					
SEATING CAPACITY NOMBRE DE PLACES		TOTAL 5	FRONT AVANT 2	REAR ARRIERE 3	
The combined weight of occupants and cargo should never exceed 385 kg or 845 lbs. Le poids total des occupants et du chargement ne doit jamais dépasser 385 kg ou 845 lbs.					
TIRE PNEU	SIZE DIMENSION	COLD TIRE PRESSURE PRESSION DES PNEUS A FROID	SEE OWNER'S MANUAL FOR ADDITIONAL INFORMATION		
FRONT AVANT	185-65R15	230kPa, 33psi	VOIR LE MANUEL DE L'USAGER POUR PLUS DE RENSEIGNEMENTS		
REAR ARRIERE	185-65R15	230kPa, 33psi			
SPARE DE SECOURS	NONE AUCUN				
NONE AUCUN					

OSC067005N

TIRE AND LOADING INFORMATION RENSEIGNEMENTS SUR LES PNEUS ET LE CHARGEMENT					
SEATING CAPACITY NOMBRE DE PLACES		TOTAL 5	FRONT AVANT 2	REAR ARRIERE 3	
The combined weight of occupants and cargo should never exceed 385 kg or 845 lbs. Le poids total des occupants et du chargement ne doit jamais dépasser 385 kg ou 845 lbs.					
TIRE PNEU	SIZE DIMENSION	COLD TIRE PRESSURE PRESSION DES PNEUS A FROID	SEE OWNER'S MANUAL FOR ADDITIONAL INFORMATION		
FRONT AVANT	205-45R17	230kPa, 33psi	VOIR LE MANUEL DE L'USAGER POUR PLUS DE RENSEIGNEMENTS		
REAR ARRIERE	205-45R17	230kPa, 33psi			
SPARE DE SECOURS	NONE AUCUN				
NONE AUCUN					

OSC067006N

The label located on the driver's door sill gives the original tire size, cold tire pressures recommended for your vehicle, the number of people that can be in your vehicle and vehicle capacity weight.

Vehicle capacity weight:

849 lbs. (385 kg)

Vehicle capacity weight is the maximum combined weight of occupants and cargo. If your vehicle is equipped with a trailer, the combined weight includes the tongue load.

Seating capacity:

Total : 5 persons
(Front seat : 2 persons,
Rear seat : 3 persons)

Seating capacity is the maximum number of occupants, including a driver, your vehicle may carry.

However, the seating capacity may be reduced based upon the weight of all of the occupants and the weight of the cargo being carried or towed.

Do not overload the vehicle as there is a limit to the total weight, or load limit including occupants and cargo, the vehicle can carry.

Towing capacity:

We do not recommend using this vehicle for trailer towing.

Cargo capacity:

The cargo capacity of your vehicle will increase or decrease depending on the weight and the number of occupants.

Steps for Determining Correct Load Limit -

- (1) Locate the statement "The combined weight of occupants and cargo should never exceed XXX kg or XXX lbs." on your vehicle's placard.
- (2) Determine the combined weight of the driver and passengers that will be riding in your vehicle.
- (3) Subtract the combined weight of the driver and passengers from XXX kg or XXX lbs.

- (4) The resulting figure equals the available amount of cargo and luggage load capacity. For example, if the "XXX" amount equals 1400 lbs. and there will be five 150 lb passengers in your vehicle, the amount of available cargo and luggage load capacity is 650 lbs.

(1400-750 (5 x 150) = 650 lbs.)

- (5) Determine the combined weight of luggage and cargo being loaded on the vehicle. That weight may not safely exceed the available cargo and luggage load capacity calculated in Step 4.
- (6) If your vehicle will be towing a trailer, load from your trailer will be transferred to your vehicle. Consult this manual to determine how this reduces the available cargo and luggage load capacity of your vehicle.

Example 1

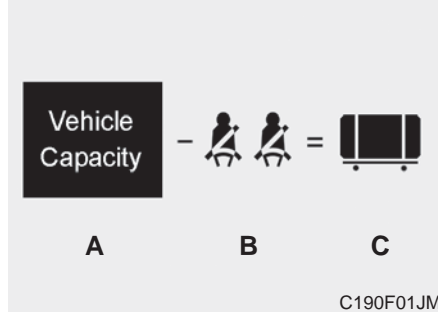

Item	Description	Total
A	Vehicle Capacity Weight	849 lbs (385 kg)
B	Subtract Occupant Weight 150 lbs (68 kg) × 2	300 lbs (136 kg)
C	Available Cargo and Luggage weight	549 lbs (249 kg)

Example 2

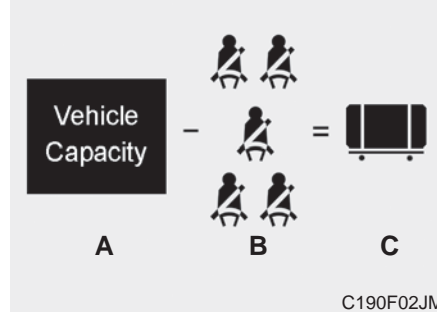

Item	Description	Total
A	Vehicle Capacity Weight	849 lbs (385 kg)
B	Subtract Occupant Weight 150 lbs (68 kg) × 5	750 lbs (340 kg)
C	Available Cargo and Luggage weight	99 lbs (45 kg)

Example 3

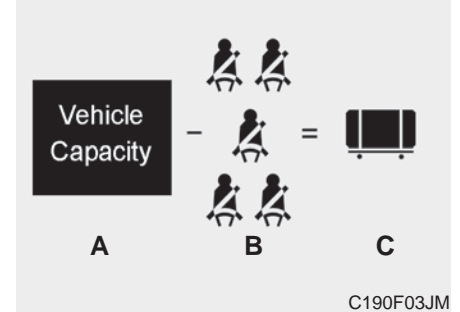

Item	Description	Total
A	Vehicle Capacity Weight	849 lbs (385 kg)
B	Subtract Occupant Weight 161 lbs (73 kg) × 5	805 lbs (365 kg)
C	Available Cargo and Luggage weight	44 lbs (20 kg)

Refer to your vehicle's tire and loading information label for specific information about your vehicle's capacity weight and seating positions. The combined weight of the driver, passengers and cargo should never exceed your vehicle's capacity weight.

Certification label

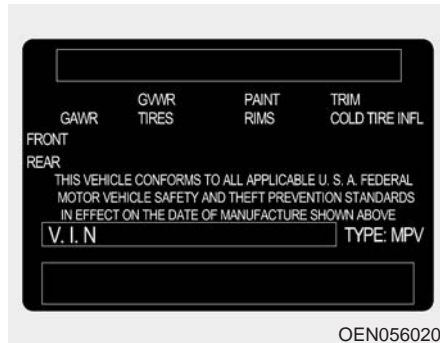

The certification label is located on the driver's door sill at the center pillar.

This label shows the maximum allowable weight of the fully loaded vehicle. This is called the GVWR (Gross Vehicle Weight Rating). The GVWR includes the weight of the vehicle, all occupants, fuel and cargo.

This label also tells you the maximum weight that can be supported by the front and rear axles, called Gross Axle Weight Rating (GAWR).

To find out the actual loads on your front and rear axles, you need to go to a weigh station and weigh your vehicle. Your dealer can help you with this. Be sure to spread out your load equally on both sides of the centerline.

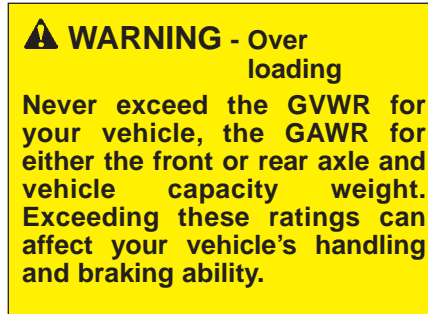

The label will help you decide how much cargo and installed equipment your vehicle can carry.

If you carry items inside your vehicle - like suitcases, tools, packages, or anything else - they are moving as fast as the vehicle. If you have to stop or turn quickly, or if there is a crash, the items will keep going and can cause an injury if they strike the driver or a passenger.

⚠ WARNING - Over loading

Do not overload your vehicle. Overloading your vehicle can cause heat buildup in your vehicle's tires and possible tire failure, increased stopping distances and poor vehicle handling, all of which may result in a crash.

⚠ WARNING - Loose cargo

Do not travel with unsecured blunt objects in the passenger compartment of your vehicle (e.g. suit cases or unsecured child seats). These items may strike occupants during a sudden stop or crash.

*** NOTICE**

Overloading your vehicle may cause damage. Repairs would not be covered by your warranty. Do not overload your vehicle.

VEHICLE WEIGHT

This section will guide you in the proper loading of your vehicle and/or trailer, to keep your loaded vehicle weight within its design rating capability, with or without a trailer. Properly loading your vehicle will provide maximum return of the vehicle design performance. Before loading your vehicle, familiarize yourself with the following terms for determining your vehicle's weight ratings, with or without a trailer, from the vehicle's specifications and the compliance label:

Base curb weight

This is the weight of the vehicle including a full tank of fuel and all standard equipment. It does not include passengers, cargo, or optional equipment.

Vehicle curb weight

This is the weight of your new vehicle when you picked it up from your dealer plus any aftermarket equipment.

Cargo weight

This figure includes all weight added to the Base Curb Weight, including cargo and optional equipment.

GAW (Gross axle weight)

This is the total weight placed on each axle (front and rear) - including vehicle curb weight and all payload.

GAWR (Gross axle weight rating)

This is the maximum allowable weight that can be carried by a single axle (front or rear). These numbers are shown on the compliance label.

The total load on each axle must never exceed its GAWR.

GVW (Gross vehicle weight)

This is the Base Curb Weight plus actual Cargo Weight plus passengers.

GVWR (Gross vehicle weight rating)

This is the maximum allowable weight of the fully loaded vehicle (including all options, equipment, passengers and cargo). The GVWR is shown on the certification label located on the driver's door sill.

What to do in an emergency

Road warning	6-2
• Hazard warning flasher	6-2
In case of an emergency while driving.	6-3
• If the engine stalls at a crossroad or crossing.	6-3
• If you have a flat tire while driving.	6-3
• If engine stalls while driving	6-3
If the engine will not start	6-4
• If the engine doesn't turn over or turns over slowly.	6-4
• If engine turns over normally but does not start.	6-4
Emergency starting	6-5
• Jump starting.	6-5
• Push-starting	6-6
If the engine overheats.	6-7
Tire Pressure Monitoring System (TPMS - Type A)	6-8
• Low tire pressure telltale	6-9
• TPMS (Tire Pressure Monitoring System) malfunction indicator	6-10
• Changing a tire with TPMS	6-11
Tire Pressure Monitoring System (TPMS - Type B)	6-13
• Check tire pressure	6-13
• Low tire pressure telltale	6-15
• Low tire pressure position telltale	6-15
• Changing a tire with TPMS	6-17

If you have a flat tire (with spare tire).	6-19
• Jack and tools	6-19
• Removing and storing the spare tire.	6-20
• Changing tires	6-21
• Jack label	6-28
Towing	6-29
• Towing service	6-29
• Removable towing hook (front)	6-30
• Emergency towing.	6-31

ROAD WARNING

Hazard warning flasher

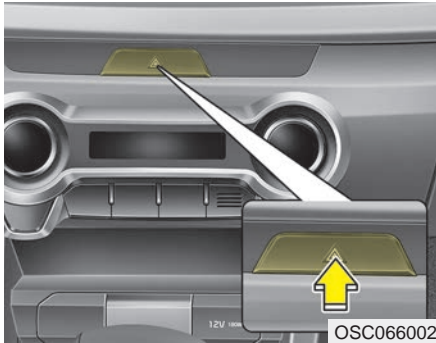

The hazard warning flasher serves as a warning to other drivers to exercise extreme caution when approaching, overtaking, or passing your vehicle.

It should be used whenever emergency repairs are being made or when the vehicle is stopped near the edge of a roadway.

Depress the flasher switch with the ignition switch in any position. The flasher switch is located in the center console switch panel. All turn signal lights will flash simultaneously.

- The hazard warning flasher operates whether your vehicle is running or not.
- The turn signals do not work when the hazard flasher is on.
- Care must be taken when using the hazard warning flasher while the vehicle is being towed.

IN CASE OF AN EMERGENCY WHILE DRIVING

If the engine stalls at a cross-road or crossing

If the engine stalls at a crossroad or crossing, set the shift lever in the N (Neutral) position and then push the vehicle to a safe place.

If you have a flat tire while driving

If a tire goes flat while you are driving:

1. Take your foot off the accelerator pedal and let the vehicle slow down while driving straight ahead. Do not apply the brakes immediately or attempt to pull off the road as this may cause a loss of control. When the vehicle has slowed down to such a speed that it is safe to do so, brake carefully and pull off the road. Drive off the road as far as possible and park on a firm level ground. If you are on a divided highway, do not park in the median area between the two traffic lanes.
2. When the vehicle is stopped, turn on your emergency hazard flashers, set the parking brake and put the transmission in P (Intelligent Variable Transmission) or reverse (Manual Transmission).

3. Have all passengers get out of the vehicle. Be sure they all get out on the side of the vehicle that is away from traffic.
4. When changing a flat tire, follow the instruction provided later in this section.

If engine stalls while driving

1. Reduce your speed gradually, keeping a straight line. Move cautiously off the road to a safe place.
2. Turn on your emergency flashers.
3. Try to start the engine again. If your vehicle will not start, contact an authorized Kia dealer or seek other qualified assistance.

IF THE ENGINE WILL NOT START

If the engine doesn't turn over or turns over slowly

1. If your vehicle has an intelligent variable transmission, be sure the shift lever is in N (Neutral) or P (Park) and the emergency brake is set.
2. Check the battery connections to be sure they are clean and tight.
3. Turn on the interior light. If the light dims or goes out when you operate the starter, the battery is discharged.
4. Check the starter connections to be sure they are securely tightened.
5. Do not push or pull the vehicle to start it. See instructions for "Jump starting".

 **WARNING - Push/
pull start**

Do not push or pull the vehicle to start it. Push or pull starting may cause the catalytic converter to overload and create a fire hazard.

If engine turns over normally but does not start

1. Check fuel level.
2. With the ignition switch in the LOCK position, check all connectors at the ignition coil and spark plugs. Reconnect any that may be disconnected or loose.
3. Check the fuel line in the engine compartment.
4. If the engine still does not start, call an authorized Kia dealer or seek other qualified assistance.

EMERGENCY STARTING

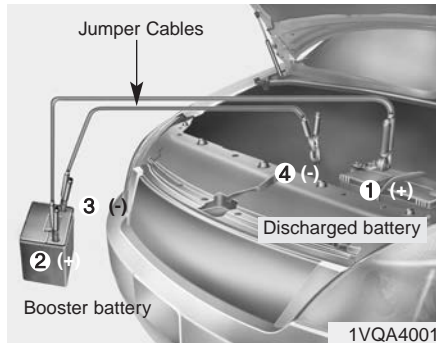

Connect cables in numerical order and disconnect in reverse order.

Jump starting

Jump starting can be dangerous if done incorrectly. Therefore, to avoid harm to yourself or damage to your vehicle or battery, follow these jump starting procedures. If in doubt, we strongly recommend that you have a competent technician or towing service jump start your vehicle.

⚠ CAUTION - 12 volt battery
Use only a 12-volt jumper system. You can damage a 12-volt starting motor, ignition system, and other electrical parts beyond repair by use of a 24-volt power supply (either two 12-volt batteries in series or a 24-volt motor generator set).

⚠ WARNING - Battery
Never attempt to check the electrolyte level of the battery as this may cause the battery to rupture or explode.

⚠ WARNING - Frozen batteries
Do not attempt to jump start the vehicle if the discharged battery is frozen or if the electrolyte level is low, as the battery may rupture or explode.

⚠ WARNING - Battery
Keep all flames or sparks away from the battery. The battery produces hydrogen gas which will explode if exposed to flame or sparks.

⚠ WARNING - Sulfuric acid risk
When jump starting your vehicle be careful not to get acid on yourself, your clothing or on the vehicle. Automobile batteries contain sulfuric acid. This is poisonous and highly corrosive.

Jump starting procedure

1. Make sure the booster battery is 12-volt and that its negative terminal is grounded.
2. If the booster battery is in another vehicle, do not allow the vehicles to come in contact.
3. Turn off all unnecessary electrical loads.
4. Connect the jumper cables in the exact sequence shown in the illustration. First connect one end of a jumper cable to the positive terminal of the discharged battery (1), then connect the other end to the positive terminal of the booster battery (2).

Proceed to connect one end of the other jumper cable to the negative terminal of the booster battery (3), then the other end to a solid, stationary, metallic point (for example, the engine lifting bracket) away from the battery (4). Do not connect it to or near any part that moves when the engine is cranked.

Do not allow the jumper cables to contact anything except the correct battery terminals or the correct ground. Do not lean over the battery when making connections.

WARNING - Battery cables

Do not connect the jumper cable from the negative terminal of the booster battery to the negative terminal of the discharged battery. This can cause the discharged battery to overheat and crack, releasing battery acid.

Make sure to connect one end of the jumper cable to the negative terminal of the booster battery, and the other end to a metallic point, far away from the battery.

5. Start the engine of the vehicle with the booster battery and let it run at 2,000 rpm, then start the engine of the vehicle with the discharged battery.

If the cause of your battery discharging is not apparent, you should have your vehicle checked by an authorized Kia dealer.

Push-starting

Your manual transmission-equipped vehicle should not be push-started because it might damage the emission control system.

Vehicles equipped with intelligent variable transmission cannot be push-started.

Follow the directions in this section for jump-starting.

WARNING - Tow starting vehicle

Never tow a vehicle to start it. When the engine starts, the vehicle can suddenly surge forward and could cause a collision with the tow vehicle.

IF THE ENGINE OVERHEATS

If your temperature gauge indicates overheating, you will experience a loss of power, or hear loud pinging or knocking, the engine is probably too hot. If this happens, you should:

1. Pull off the road and stop as soon as it is safe to do so.
2. Place the shift lever in P (Intelligent Variable Transmission) or neutral (Manual Transmission) and set the parking brake. If the air conditioning is on, turn it off.
3. If engine coolant is running out under the vehicle or steam is coming out from underneath the hood, stop the engine. Do not open the hood until the coolant has stopped running or the steaming has stopped. If there is no visible loss of engine coolant and no steam, leave the engine running and check to be sure the engine cooling fan is operating. If the fan is not running, turn the engine off.

4. Check to see if the water pump drive belt is missing. If it is not missing, check to see that it is tight. If the drive belt seems to be satisfactory, check for coolant leaking from the radiator, hoses or under the vehicle. (If the air conditioning had been in use, it is normal for cold water to be draining from it when you stop).

⚠ WARNING - Under the hood

While the engine is running, keep hair, hands and clothing away from moving parts such as the fan and drive belts.

5. If the water pump drive belt is broken or engine coolant leaks, stop the engine immediately and call the nearest authorized Kia dealer for assistance.

⚠ WARNING - Radiator cap
Do not remove the radiator cap when the engine is hot. This can allow coolant to be blown out of the opening and cause serious burns.

6. If you cannot find the cause of the overheating, wait until the engine temperature has returned to normal. Then, if coolant has been lost, carefully add coolant to the reservoir to bring the fluid level in the reservoir up to the halfway mark.
7. Proceed with caution, keeping alert for further signs of overheating. If overheating happens again, call an authorized Kia dealer for assistance.

Serious loss of coolant indicates there is a leak in the cooling system and this should be checked as soon as possible by an authorized Kia dealer.

TIRE PRESSURE MONITORING SYSTEM (TPMS - TYPE A)



(1) Low tire pressure telltale/
TPMS malfunction indicator

Each tire, including the spare (if provided), should be checked monthly when cold and inflated to the inflation pressure recommended by the vehicle manufacturer on the vehicle placard or tire inflation pressure label. (If your vehicle has tires of a different size than the size indicated on the vehicle placard or tire inflation pressure label, you should determine the proper tire inflation pressure for those tires.)

As an added safety feature, your vehicle has been equipped with a tire pressure monitoring system (TPMS) that illuminates a low tire pressure telltale when one or more of your tires is significantly under-inflated. Accordingly, when the low tire pressure telltale illuminates, you should stop and check your tires as soon as possible, and inflate them to the proper pressure. Driving on a significantly under-inflated tire causes the tire to overheat and can lead to tire failure. Under-inflation also reduces fuel efficiency and tire tread life, and may affect the vehicle's handling and stopping ability.

Please note that the TPMS is not a substitute for proper tire maintenance, and it is the driver's responsibility to maintain correct tire pressure, even if under-inflation has not reached the level to trigger illumination of the TPMS low tire pressure telltale.

Your vehicle has also been equipped with a TPMS malfunction indicator to indicate when the system is not operating properly. The TPMS malfunction indicator is combined with the low tire pressure telltale. When the system detects a malfunction, the telltale will flash for approximately one minute and then remain continuously illuminated. This sequence will continue upon subsequent vehicle start-ups as long as the malfunction exists. When the malfunction indicator is illuminated, the system may not be able to detect or signal low tire pressure as intended. TPMS malfunctions may occur for a variety of reasons, including the installation of replacement or alternate tires or wheels on the vehicle that prevent the TPMS from functioning properly. Always check the TPMS malfunction telltale after replacing one or more tires or wheels on your vehicle to ensure that the replacement or alternate tires and wheels allow the TPMS to continue to function properly.

*** NOTICE**

If the TPMS indicator does not illuminate for 3 seconds when the ignition switch is turned to the ON position or engine is running, or if it comes on after blinking for approximately one minute, take your car to your nearest authorized Kia dealer and have the system checked.

**Low tire pressure telltale**

When the tire pressure monitoring system warning indicator is illuminated, one or more of your tires is significantly under-inflated.

If the telltale illuminates, immediately reduce your speed, avoid hard cornering and anticipate increased stopping distances. You should stop and check your tires as soon as possible. Inflate the tires to the proper pressure as indicated on the vehicle's placard or tire inflation pressure label located on the driver's side center pillar outer panel. If you cannot reach a service station or if the tire cannot hold the newly added air, replace the low pressure tire with the spare tire.

Then the Low Tire Pressure telltale may flash for approximately one minute and then remain continuously illuminated after restarting and about 20 minutes of continuous driving before you have the low pressure tire repaired and replaced on the vehicle.

In winter or cold weather, the low tire pressure telltale may be illuminated if the tire pressure was adjusted to the recommended tire inflation pressure in warm weather. It does not mean your TPMS is malfunctioning because the decreased temperature leads to a proportional lowering of tire pressure.

When you drive your vehicle from a warm area to a cold area or from a cold area to a warm area, or the outside temperature is greatly higher or lower, you should check the tire inflation pressure and adjust the tires to the recommended tire inflation pressure.

When filling tires with more air, conditions to turn off the low tire pressure telltale may not be met. This is because a tire inflator has a margin of error in performance. The low tire pressure telltale will be turned off if the tire pressure is above the recommended tire inflation pressure.

⚠ WARNING - Low pressure damage

Do not drive on low pressure tires. Significantly low tire pressure can cause the tires to overheat and fail making the vehicle unstable resulting in increased braking distances and a loss of vehicle control.



TPMS (Tire Pressure Monitoring System) malfunction indicator

The TPMS malfunction indicator will illuminate after it blinks for approximately one minute when there is a problem with the Tire Pressure Monitoring System. If the system is able to correctly detect an Under-inflation warning at the same time as system failure then it will illuminate the TPMS malfunction indicator.

Have the system checked by an authorized Kia dealer as soon as possible to determine the cause of the problem.

The TPMS malfunction indicator may be illuminated if the vehicle is moving around electric power supply cables or radio transmitters such as at police stations, government and public offices, broadcasting stations, military installations, airports, or transmitting towers, etc. This can interfere with normal operation of the Tire Pressure Monitoring System (TPMS).

The TPMS malfunction indicator may illuminate if snow chains or some separately purchased devices such as notebook computers, mobile charger, remote starter, navigation etc. are used in the vehicle. This can interfere with normal operation of the Tire Pressure Monitoring System (TPMS).

Changing a tire with TPMS

If you have a flat tire, the Low Tire Pressure will come on. Have the flat tire repaired by an authorized Kia dealer as soon as possible or replace the flat tire with the spare tire.

CAUTION - Repair Agents

Never use a puncture-repairing agent not approved by Kia to repair and/or inflate a low pressure tire. The tire sealant not approved by Kia may damage the tire pressure sensor.

Each wheel is equipped with a tire pressure sensor mounted inside the tire behind the valve stem. You must use TPMS specific wheels. It is recommended that you always have your tires serviced by an authorized Kia dealer.

Even if you replace the low pressure tire with the spare tire, the Low Tire Pressure telltale will blink or remain on until the low pressure tire is repaired and placed on the vehicle. After you replace the low pressure tire with the TPMS spare tire, the Low Tire Pressure telltale may blink or illuminate after a few minutes because the TPMS sensor mounted on the spare wheel is not initiated.

Once the low pressure tire is reinflated to the recommended pressure and installed on the vehicle or the TPMS sensor mounted on the replaced spare wheel is initiated by an authorized Kia dealer, the TPMS malfunction indicator and the low tire pressure telltale will extinguish within a few minutes of driving.

If the indicator is not extinguished after a few minutes of driving, please visit an authorized Kia dealer.

If an original mounted tire is replaced with the spare tire, the TPMS sensor on the replaced spare wheel should be initiated and the TPMS sensor on the original mounted wheel should be deactivated. If the TPMS sensor on the original mounted wheel located in the spare tire carrier still activates, the tire pressure monitoring system may not operate properly. Have the tire with TPMS serviced or replaced by an authorized Kia dealer.

You may not be able to identify a low tire by simply looking at it. Always use a good quality tire pressure gauge to measure the tire's inflation pressure. Please note that a tire that is hot (from being driven) will have a higher pressure measurement than a tire that is cold.

A cold tire means the vehicle has been sitting for 3 hours and driven for less than 1 mile (1.6 km) in that 3 hour period.

Allow the tire to cool before measuring the inflation pressure. Always be sure the tire is cold before inflating to the recommended pressure.

The TPMS cannot alert you to severe and sudden tire damage caused by external factors such as nails or road debris.

If you feel any vehicle instability, immediately take your foot off the accelerator, apply the brakes gradually and with light force, and slowly move to a safe position off the road.

*** NOTICE**

Tampering with, modifying, or disabling the Tire Pressure Monitoring System (TPMS) components may interfere with the system's ability to warn the driver of low tire pressure conditions and/or TPMS malfunctions. Tampering with, modifying, or disabling the Tire Pressure Monitoring System (TPMS) components may void the warranty for that portion of the vehicle.

This device complies with Part 15 of the FCC rules.

Operation is subject to the following two conditions:

1. This device may not cause harmful interference, and
2. This device must accept any interference received, including interference that may cause undesired operation.

TIRE PRESSURE MONITORING SYSTEM (TPMS - TYPE B, IF EQUIPPED)

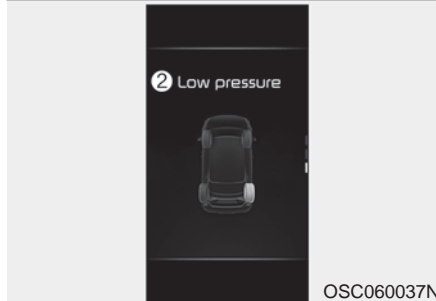

- (1) Low tire pressure telltale / TPMS malfunction indicator
- (2) Low tire pressure position telltale (Shown on the LCD display)

Check tire pressure



- You can check the tire pressure in the information mode on the cluster.
 - Refer to “User settings mode” in chapter 4.
- If tire pressure is not displayed when the vehicle is stopped, “Drive to display” message displays. After driving, check the tire pressure.
- You can change the tire pressure unit in the user settings mode on the cluster.
 - psi, kpa, bar (Refer to “User settings mode” in chapter 4).

* NOTICE

- The tire pressure may change due to factors such as parking condition, driving style, and altitude above sea level.
- Low tire pressure warning may sound when a tire’s pressure unit is equal or higher than nearby tires. This is a normal occurrence, which is due to the change in tire pressure along with tire temperature.

Each tire, including the spare (if provided), should be checked monthly when cold and inflated to the inflation pressure recommended by the vehicle manufacturer on the vehicle placard or tire inflation pressure label. (If your vehicle has tires of a different size than the size indicated on the vehicle placard or tire inflation pressure label, you should determine the proper tire inflation pressure for those tires.)

As an added safety feature, your vehicle has been equipped with a tire pressure monitoring system (TPMS) that illuminates a low tire pressure telltale when one or more of your tires is significantly under-inflated. Accordingly, when the low tire pressure telltale illuminates, you should stop and check your tires as soon as possible, and inflate them to the proper pressure. Driving on a significantly under-inflated tire causes the tire to overheat and can lead to tire failure. Under-inflation also reduces fuel efficiency and tire tread life, and may affect the vehicle's handling and stopping ability.

Please note that the TPMS is not a substitute for proper tire maintenance, and it is the driver's responsibility to maintain correct tire pressure, even if under-inflation has not reached the level to trigger illumination of the TPMS low tire pressure telltale.

Your vehicle has also been equipped with a TPMS malfunction indicator to indicate when the system is not operating properly. The TPMS malfunction indicator is combined with the low tire pressure telltale. When the system detects a malfunction, the telltale will flash for approximately one minute and then remain continuously illuminated. This sequence will continue upon subsequent vehicle start-ups as long as the malfunction exists. When the malfunction indicator is illuminated, the system may not be able to detect or signal low tire pressure as intended. TPMS malfunctions may occur for a variety of reasons, including the installation of replacement or alternate tires or wheels on the vehicle that prevent the TPMS from functioning properly.

Always check the TPMS malfunction telltale after replacing one or more tires or wheels on your vehicle to ensure that the replacement or alternate tires and wheels allow the TPMS to continue to function properly.

*** NOTICE**

If the TPMS, Low Tire Pressure indicator does not illuminate for 3 seconds when the ignition switch is turned to the ON position or engine is running, or if they remain illuminated after coming on for approximately 3 seconds, take your vehicle to your nearest authorized Kia dealer and have the system checked.



Low tire pressure telltale

Low tire pressure position telltale



OSC060038N

When the tire pressure monitoring system warning indicators are illuminated, one or more of your tires is significantly under-inflated.

If the telltale illuminates, immediately reduce your speed, avoid hard cornering and anticipate increased stopping distances. You should stop and check your tires as soon as possible.

Inflate the tires to the proper pressure as indicated on the vehicle's placard or tire inflation pressure label located on the driver's side center pillar outer panel. If you cannot reach a service station or if the tire cannot hold the newly added air, replace the low pressure tire with the spare tire.

Then the TPMS malfunction indicator and the Low Tire Pressure telltale may turn on and illuminate after restarting and about 20 minutes of continuous driving before you have the low pressure tire repaired and replaced on the vehicle.

In winter or cold weather, the low tire pressure telltale may be illuminated if the tire pressure was adjusted to the recommended tire inflation pressure in warm weather. It does not mean your TPMS is malfunctioning because the decreased temperature leads to a proportional lowering of tire pressure.

When you drive your vehicle from a warm area to a cold area or from a cold area to a warm area, or the outside temperature is greatly higher or lower, you should check the tire inflation pressure and adjust the tires to the recommended tire inflation pressure.

⚠ WARNING - Low pressure damage

Do not drive on low pressure tires. Significantly low tire pressure can cause the tires to overheat and fail making the vehicle unstable resulting in increased braking distances and a loss of vehicle control.

⚠ CAUTION

When filling tires with more air, conditions to turn off the low tire pressure telltale may not be met. This is because a tire inflator has a margin of error in performance. The low tire pressure telltale will be turned off if the tire pressure is above the recommended tire inflation pressure.



TPMS (Tire Pressure Monitoring System) malfunction indicator

The low tire pressure telltale will illuminate after it blinks for approximately one minute when there is a problem with the Tire Pressure Monitoring System. If the system is able to correctly detect an underinflation warning at the same time as system failure then it will illuminate both the TPMS malfunction and low tire pressure position telltales e.g. if Front Left sensor fails, the TPMS malfunction indicator illuminates, but if the Front Right, Rear Left, or Rear Right tire is under-inflated, the low tire pressure position telltales may illuminate together with the TPMS malfunction indicator.

Have the system checked by an authorized Kia dealer as soon as possible to determine the cause of the problem.

- The TPMS malfunction indicator may be illuminated if the vehicle is moving around electric power supply cables or radios transmitters such as at police stations, government and public offices, broadcasting stations, military installations, airports, or transmitting towers, etc. This can interfere with normal operation of the Tire Pressure Monitoring System (TPMS).
- The TPMS malfunction indicator may be illuminated if snow chains are used or some separate electronic devices such as notebook computer, mobile charger, remote starter or navigation etc., are used in the vehicle. This can interfere with normal operation of the Tire Pressure Monitoring System (TPMS).

Changing a tire with TPMS

If you have a flat tire, the Low Tire Pressure telltale will come on. Have the flat tire repaired by an authorized Kia dealer as soon as possible or replace the flat tire with the spare tire.

CAUTION - Repair Agents

Never use a puncture-repairing agent not approved by Kia to repair and/or inflate a low pressure tire. The sealant not approved by Kia may damage the tire pressure sensor.

Each wheel is equipped with a tire pressure sensor mounted inside the tire behind the valve stem. You must use TPMS specific wheels. It is recommended that you always have your tires serviced by an authorized Kia dealer.

Even if you replace the low pressure tire with the spare tire, the Low Tire Pressure telltale will remain on until the low pressure tire is repaired and placed on the vehicle.

After you replace the low pressure tire with the spare tire, the TPMS malfunction indicator may illuminate after a few minutes because the TPMS sensor mounted on the spare wheel is not initiated.

Once the low pressure tire is inflated again to the recommended pressure and installed on the vehicle or the TPMS sensor mounted on the replaced spare wheel is initiated by an authorized Kia dealer, the TPMS malfunction indicator and the low tire pressure telltale will turn off within a few minutes of driving.

If the indicator has not disappeared after a few minutes of driving, please visit an authorized Kia dealer.

If an original mounted tire is replaced with the spare tire, the TPMS sensor on the replaced spare wheel should be initiated and the TPMS sensor on the original mounted wheel should be deactivated. If the TPMS sensor on the original mounted wheel located in the spare tire carrier still activates, the tire pressure monitoring system may not operate properly. Have the tire with TPMS serviced or replaced by an authorized Kia dealer.

You may not be able to identify a low tire by simply looking at it. Always use a good quality tire pressure gauge to measure the tire's inflation pressure. Please note that a tire that is hot (from being driven) will have a higher pressure measurement than a tire that is cold (from sitting stationary for at least 3 hours and driven less than 1 mile (1.6 km) during that 3 hour period).

Allow the tire to cool before measuring the inflation pressure. Always be sure the tire is cold before inflating to the recommended pressure.

A cold tire means the vehicle has been sitting for 3 hours and driven for less than 1 mile (1.6 km) in that 3 hour period.

Never use tire sealant if your vehicle is equipped with a Tire Pressure Monitoring System. The liquid sealant can damage the tire pressure sensors.

- The TPMS cannot alert you to severe and sudden tire damage caused by external factors such as nails or road debris.
- If you feel any vehicle instability, immediately take your foot off the accelerator, apply the brakes gradually and with light force, and slowly move to a safe position off the road.

*** NOTICE - Protecting TPMS**

Tampering with, modifying, or disabling the Tire Pressure Monitoring System (TPMS) components may interfere with the system's ability to warn the driver of low tire pressure conditions and/or TPMS malfunctions. Tampering with, modifying, or disabling the Tire Pressure Monitoring System (TPMS) components may void the warranty for that portion of the vehicle.

This device complies with Part 15 of the FCC rules.

Operation is subject to the following two conditions:

1. This device may not cause harmful interference, and
2. This device must accept any interference received, including interference that may cause undesired operation.

IF YOU HAVE A FLAT TIRE (WITH SPARE TIRE, IF EQUIPPED)

Jack and tools

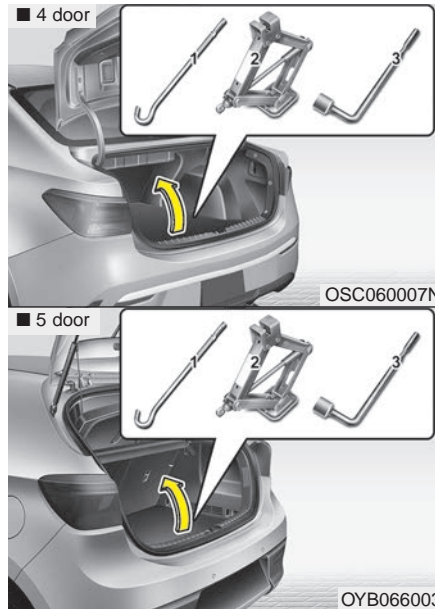

The spare tire, jack, jack handle and wheel lug nut wrench are stored in the luggage compartment.

Remove the luggage under tray out of the way to reach the equipment.

- (1) Jack handle
- (2) Jack
- (3) Wheel lug nut wrench

Jacking instructions

The jack is provided for emergency tire changing only.

To prevent the jack from “rattling” while the vehicle is in motion, store it properly.

Follow jacking instructions to reduce the possibility of personal injury.

⚠ WARNING - Changing tires

Never attempt vehicle repairs in the traffic lanes of a public road or highway.

Always move the vehicle completely off the road and onto the shoulder before trying to change a tire. The jack should be used on firm level ground. If you cannot find a firm level place off the road, call a towing service company for assistance.

Be sure to use the correct front and rear jacking positions on the vehicle; never use the bumpers or any other part of the vehicle for jack support.

⚠️ WARNING - Tire Jack

Do not place any portion of your body under a vehicle that is only supported by a jack since the vehicle can easily roll off the jack. Use vehicle support stands.

Do not allow anyone to remain in the vehicle while it is on the jack.

Make sure any children present are in a secure place away from the road and from the vehicle to be raised with the jack.

⚠️ WARNING -Running vehicle on jack

Do not start or run the engine of the vehicle while the vehicle is on the jack as this may cause the vehicle to fall off the jack.

Removing and storing the spare tire

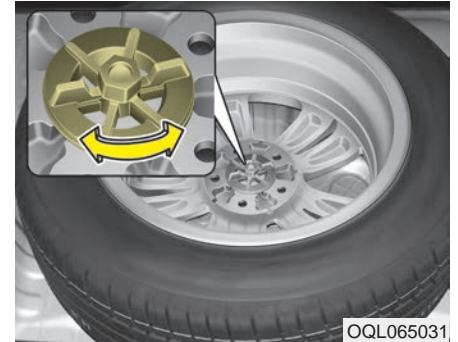

Turn the tire hold-down wing bolt counterclockwise to remove the spare tire.

Store the tire in the reverse order of removal.

To prevent the spare tire and tools from “rattling” while the vehicle is in motion, store them properly.



If it is hard to loosen the tire hold-down wing bolt by hand, you can loosen it easily using the jack handle.

1. Put the jack handle (1) inside of the tire hold-down wing bolt.
2. Turn the tire hold-down wing bolt counterclockwise with the jack handle.

Changing tires



1. Park on a level surface and apply the parking brake firmly.
2. Shift the shift lever into R (Reverse) for Manual Transmission or P (Park) for Intelligent Variable Transmission.
3. Activate the hazard warning flashers.



4. Remove the wheel lug nut wrench, jack, jack handle, and spare tire from the vehicle.
5. Block both the front and rear of the wheel that is diagonally opposite the jack position.

⚠ WARNING - Changing a tire

- To prevent vehicle movement while changing a tire, always set the parking brake fully, and always chock the wheel diagonally opposite the wheel being changed.
- We recommend that the wheels of the vehicle be chocked, and that no person remain in a vehicle that is being jacked.



OYB066004

6. Loosen the wheel lug nuts counterclockwise one turn each, but do not remove any nut until the tire has been raised off the ground.

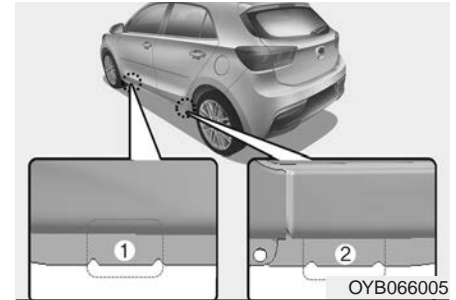

OYB066005

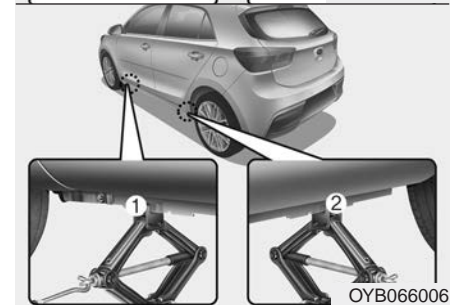

OYB066006

7. Place the jack at the front (1) or rear (2) jacking position closest to the tire you are changing. Place the jack at the designated locations under the frame. The jacking positions are plates welded to the frame with two tabs and a raised dot to index with the jack.

⚠ WARNING - Jack location

To reduce the possibility of injury, be sure to use only the jack provided with the vehicle in the correct jack position; never use any other part of the vehicle for jack support.

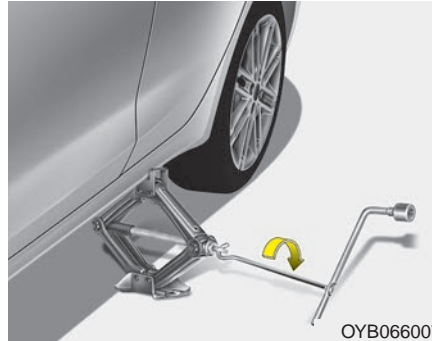

8. Insert the jack handle into the jack and turn it clockwise, raising the vehicle until the tire just clears the ground. This measurement is approximately 1 in (30 mm). Before removing the wheel lug nuts, make sure the vehicle is stable and that there is no chance for movement or slippage.

9. Loosen the wheel nuts and remove them with your fingers. Slide the wheel off the studs and lay it flat so it cannot roll away. To put the wheel on the hub, pick up the spare tire, line up the holes with the studs and slide the wheel onto them. If this is difficult, tip the wheel slightly and get the top hole in the wheel lined up with the top stud. Then jiggle the wheel back and forth until the wheel can be slid over the other studs.

Wheels and wheel covers may have sharp edges. Handle them carefully to avoid possible injury. Before putting the wheel into place, be sure that there is nothing on the hub or wheel (such as mud, tar, gravel, etc.) that prevents the wheel from fitting solidly against the hub.

⚠ WARNING - Installing a wheel

Make sure the wheel makes good contact with the hub when installed. If the contact of the mounting surface between the wheel and hub is not good, the wheel nuts could come loose and cause the loss of a wheel. Loss of a wheel may result in loss of control of the vehicle.

10. To install the wheel, hold it on the studs, put the wheel nuts on the studs and tighten them finger tight. Jiggle the tire to be sure it is completely seated, then tighten the nuts as much as possible with your fingers again.
11. Lower the vehicle to the ground by turning the wheel nut wrench counterclockwise.

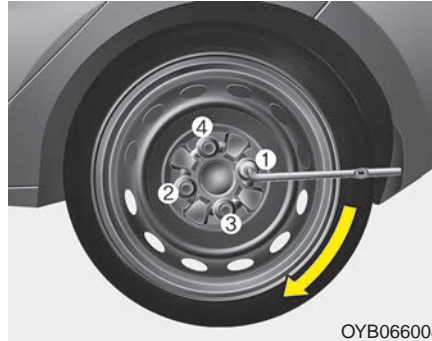

Then position the wrench as shown in the drawing and tighten the wheel nuts. Be sure the socket is seated completely over the nut. Do not stand on the wrench handle or use an extension pipe over the wrench handle.

Go around the wheel tightening every nut following the numerical sequence shown in the image until they are tight. Then double-check each nut for tightness. After changing the wheels, have an authorized Kia dealer tighten the wheel nuts to their proper torque as soon as possible.

Wheel nut tightening torque:

Steel wheel & aluminium alloy wheel:
79 ~ 94 lbf·ft (11 ~ 13 kgf·m)

If you have a tire gauge, remove the valve cap and check the air pressure. If the pressure is lower than recommended, drive slowly to the nearest service station and inflate to the correct pressure. If it is too high, adjust it until it is correct. Always reinstall the valve cap after checking or adjusting the tire pressure. If the cap is not replaced, air may leak from the tire. If you lose a valve cap, buy another and install it as soon as possible.

After you have changed wheels, always secure the flat tire in its place and return the jack and tools to their proper storage locations.

⚠ CAUTION

When replacing the tires, after driving for about 30 miles (50 km), tighten the wheel nuts to check that there is no looseness. Recheck and tighten the wheel nuts again after driving for about 620 miles (1,000 km).

 **CAUTION - Replacing lug nuts**

Make certain during wheel removal that the same nuts that were removed are reinstalled - or, if replaced, that nuts with metric threads and the same chamfer configuration are used. Your vehicle has metric threads on the wheel studs and nuts. Installation of a non-metric thread nut on a metric stud will not secure the wheel to the hub properly and will damage the stud so that it must be replaced.

Note that most lug nuts do not have metric threads. Be sure to use extreme care in checking for thread style before installing aftermarket lug nuts or wheels. If in doubt, consult an authorized Kia dealer.

 **WARNING - Wheel studs**

Do not drive your vehicle with damaged wheel studs. If the studs are damaged, they may lose their ability to retain the wheel. This could lead to the loss of the wheel and a collision.

To prevent the jack, jack handle, wheel lug nut wrench and spare tire from rattling while the vehicle is in motion, store them properly.

Check the inflation pressures as soon as possible after installing the spare tire. Adjust it to the specified pressure, if necessary. Refer to “Tires and wheels” in chapter 7.

Important - use of compact spare tire (if equipped)

Your vehicle is equipped with a compact spare tire. This compact spare tire takes up less space than a regular-size tire. This tire is smaller than a conventional tire and is designed for temporary use only.

You should drive carefully when the compact spare is in use. The compact spare should be replaced by the proper conventional tire and rim at the first opportunity.

The operation of this vehicle is not recommended with more than one compact spare tire in use at the same time.

⚠ WARNING - Spare tire

Do not operate your vehicle on this compact spare at speeds over 50 mph (80 km/h). The compact spare tire is for emergency use only. The original tire should be repaired or replaced as soon as possible to avoid failure of the spare that may possibly lead to bodily injury or death.

The compact spare should be inflated to 60 psi (420 kPa).

*** NOTICE**

Check the inflation pressure after installing the spare tire. Adjust it to the specified pressure, as necessary.

When using a compact spare tire, observe the following precautions:

- Under no circumstances should you exceed 50 mph (80 km/h); a higher speed could damage the tire.
- Ensure that you drive slowly enough for the road conditions to avoid all hazards. Any road hazard, such as a pothole or debris, could seriously damage the compact spare.
- Any continuous road use of this tire could result in tire failure, loss of vehicle control, and possible personal injury.
- Do not exceed the vehicle's maximum load rating or the load-carrying capacity shown on the sidewall of the compact spare tire.
- Avoid driving over obstacles. The compact spare tire diameter is smaller than the diameter of a conventional tire and reduces the ground clearance approximately 1 inch (25 mm), which could result in damage to the vehicle.
- Do not take this vehicle through an automatic car wash while the compact spare tire is installed.
- Do not use tire chains on the compact spare tire. Because of the smaller size, a tire chain will not fit properly. This could damage the vehicle and result in loss of the chain.
- The compact spare tire should not be installed on the front axle if the vehicle must be driven in snow or on ice.

- Do not use the compact spare tire on any other vehicle because this tire has been designed especially for your vehicle.
- The compact spare tire's tread life is shorter than a regular tire. Inspect your compact spare tire regularly and replace worn compact spare tires with the same size and design, mounted on the same wheel.
- The compact spare tire should not be used on any other wheels, nor should standard tires, snow tires, wheel covers or trim rings be used with the compact spare wheel. If such use is attempted, damage to these items or other car components may occur.
- Do not use more than one compact spare tire at a time.
- Do not tow a trailer while the compact spare tire is installed.

Jack label

- Example
- Type A

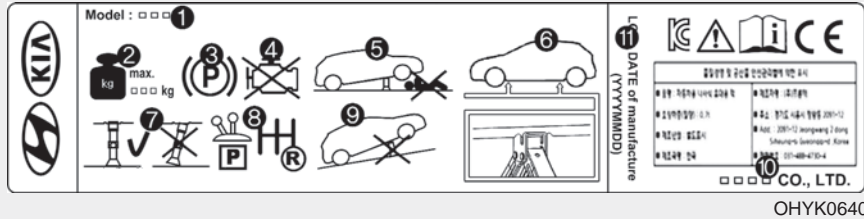

1. Model Name
2. Maximum allowable load
3. When using the jack, set your parking brake.
4. When using the jack, stop the engine.
5. Do not get under a vehicle that is supported by a jack.
6. The designated locations under the frame
7. When supporting the vehicle, the base plate of the jack must be vertical under the lifting point.
8. Shift into Reverse gear on vehicles with Manual Transmission or move the shift lever to the P position on vehicles with Intelligent Variable Transmission.
9. The jack should be used on firm level ground.
10. Jack manufacturer
11. Production date
12. Representative company and address

- Type B

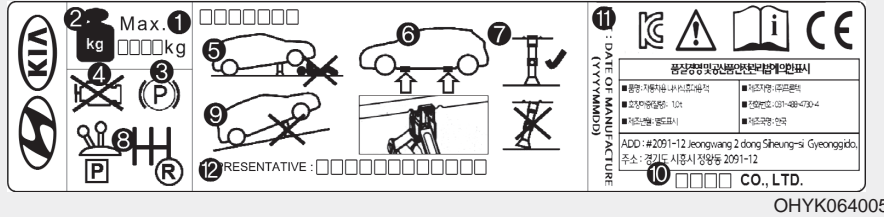

- Type C



* The actual Jack label in the vehicle may differ from the illustration.
For more detailed specifications, refer to the label attached to the jack.

TOWING

Towing service

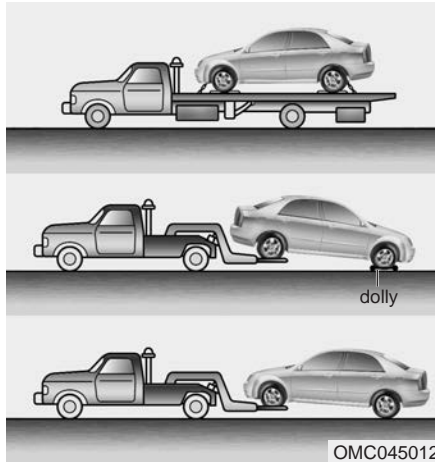

If emergency towing is necessary, we recommend having it done by an authorized Kia dealer or a commercial tow-truck service. Proper lifting and towing procedures are necessary to prevent damage to the vehicle. The use of wheel dollies or flatbed is recommended.

It is acceptable to tow the vehicle with the rear wheels on the ground (without dollies) and the front wheels off the ground.

If any of the loaded wheels or suspension components are damaged or the vehicle is being towed with the front wheels on the ground, use a towing dolly under the front wheels.

When being towed by a commercial tow truck and wheel dollies are not used, the front of the vehicle should always be lifted, not the rear.

⚠ WARNING - Side and curtain air bag

If your vehicle is equipped with side and curtain air bags, set the ignition switch to the LOCK or ACC position when the vehicle is being towed. The side and curtain air bag may deploy when the ignition is in the ON position and the rollover sensor detects a rollover situation.

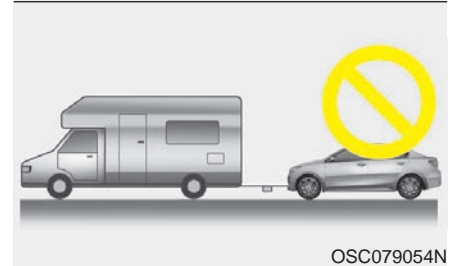
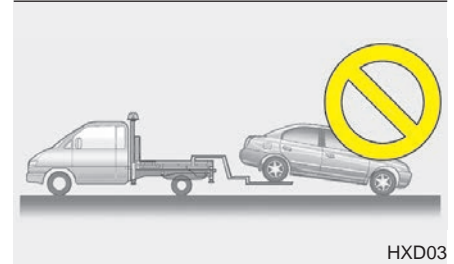
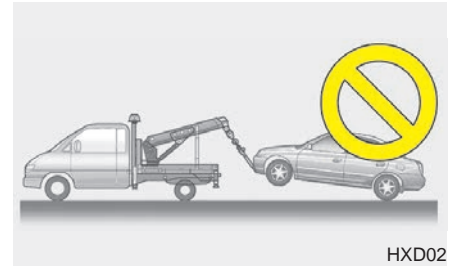

⚠ CAUTION - Towing

- ***Do not tow the vehicle backwards with the front wheels on the ground as this may cause damage to the vehicle.***
- ***Do not tow with sling-type equipment. Use wheel lift or flatbed equipment.***
- ***Do not tow the vehicle with 4 wheels on the ground (such as dinghy towing behind a motorhome or other motor vehicle) as this can seriously damage the Intelligent Variable Transmission.***

When towing your vehicle in an emergency without wheel dollies :

1. Set the ignition switch in the ACC position.
2. Place the transmission shift lever in N (Neutral).
3. Release the parking brake.

⚠ CAUTION - Towing gear position

Always place the transmission shift lever in N (Neutral) when towing your vehicle. Failure to place the transmission shift lever in N (Neutral) may cause internal damage to the transmission.

Removable towing hook (front) (if equipped)

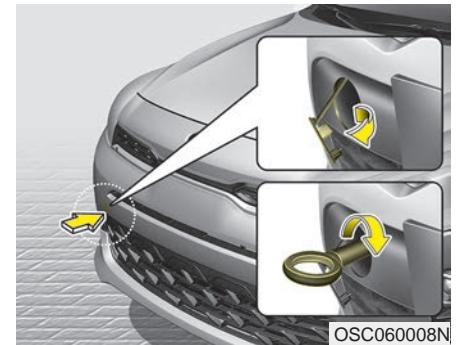

1. Remove the towing hook from the tool case located in the trunk/lift-gate.
2. Remove the hole cover pressing the lower part of the cover on the front bumper.
3. Install the towing hook by turning it clockwise into the hole until it is fully secured.
4. Remove the towing hook and install the cover after use.

Emergency towing

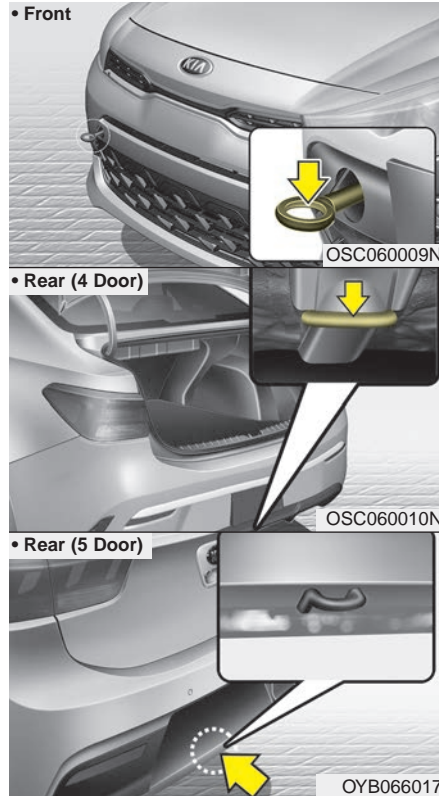

If towing is necessary, we recommend you have it done by an authorized Kia dealer or a commercial tow truck service.

If towing service is not available in an emergency, your vehicle may be temporarily towed using a cable or chain secured to the emergency towing hook under the front (or rear) of the vehicle. Use extreme caution when towing the vehicle. A driver must be in the vehicle to steer it and operate the brakes.

Towing in this manner may be done only on hard-surfaced roads for a short distance and at low speeds. Also, the wheels, axles, power train, steering and brakes must all be in good condition.

- Do not use the towing hooks to pull a vehicle out of mud, sand or other conditions from which the vehicle cannot be driven out under its own power.
- Avoid towing a vehicle heavier than the vehicle doing the towing.

- The drivers of both vehicles should communicate with each other frequently.
- Attach a towing strap to the towing hook.
- Using a portion of the vehicle other than the tow hooks for towing may damage the body of your vehicle.
- Use only a cable or chain specifically intended for use in towing vehicles. Securely fasten the cable or chain to the towing hook provided.
- Accelerate or decelerate the vehicle in a slow and gradual manner while maintaining tension on the tow rope or chain to start or drive the vehicle, otherwise tow hooks and the vehicle may be damaged.
- Before emergency towing, check that the hook is broken or damaged.
- Fasten the towing cable or chain securely to the hook.
- Do not jerk the hook. Apply it steadily with even force.
- To avoid damaging the hook, do not pull from the side or at a vertical angle. Always pull straight ahead.

CAUTION

Using a portion of the vehicle other than the tow hooks for towing may damage the body of your vehicle.

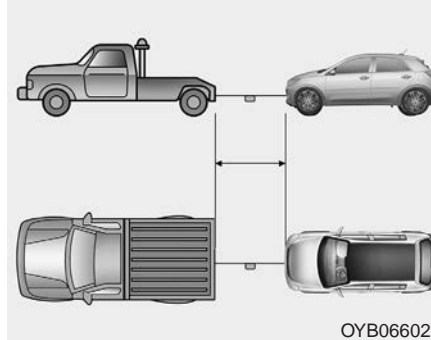

- Use a towing strap less than 16 feet (5 m) long. Attach a white or red cloth (about 12 inches (30 cm) wide) in the middle of the strap for easy visibility.
- Drive carefully so that the towing strap is not loosened during towing.
- The driver must be in the vehicle for steering and braking operations when the vehicle is towed and passengers other than the driver must not be allowed to be on board.

WARNING - Emergency Towing Precautions

Use extreme caution when towing the vehicle.

- Avoid sudden starts or erratic driving maneuvers which would place excessive stress on the emergency towing hook and towing cable or chain. The hook and towing cable or chain may break and cause serious injury or damage.
- If the disabled vehicle is unable to be moved, do not forcibly continue the towing. In this case, contact an authorized Kia dealer or a commercial tow truck service for assistance.
- Tow the vehicle as straight ahead as possible.
- Keep away from the vehicle during towing.

Emergency towing precautions

- Turn the ignition switch to ACC so the steering wheel isn't locked.
- Place the transmission shift lever in N (Neutral).
- Release the parking brake.
- Press the brake pedal with more force than normal since you will have reduced brake performance.
- More steering effort will be required because the power steering system will be disabled.
- If you are driving down a long hill, the brakes may overheat and brake performance will be reduced. Stop often and let the brakes cool off.
- The vehicle should be towed at a speed of 15 mph (25 km/h) or less within the distance of 12 miles (20 km).

If the car is being towed with all four wheels on the ground, it can be towed only from the front. Be sure that the transmission is in neutral. Be sure the steering is unlocked by placing the ignition switch in the ACC position. A driver must be in the towed vehicle to operate the steering and brakes.



CAUTION - Intelligent variable transmission

- ***To avoid serious damage to the intelligent variable transmission, limit the vehicle speed to 10 mph (15 km/h) and drive less than 1 mile (1.5 km/h) when towing.***
- ***Before towing, check for an intelligent variable transmission fluid leak under your vehicle. If the intelligent variable transmission fluid is leaking, a flatbed equipment or towing dolly must be used.***

Maintenance

Engine compartment	7-4	Climate control air filter	7-33
Maintenance services	7-5	• Filter inspection	7-33
• Owner's responsibility	7-5	Wiper blades	7-35
• Owner maintenance precautions	7-6	• Blade inspection	7-35
Owner maintenance	7-7	• Blade replacement	7-35
• Owner maintenance schedule	7-7	Battery	7-39
Scheduled maintenance service	7-9	• For best battery service	7-39
• Scheduled maintenance service precaution	7-9	• Recharging the battery	7-40
Explanation of scheduled maintenance items ...	7-15	• Reset items	7-41
Checking fluid levels	7-20	Tires and wheels	7-42
Engine oil	7-21	• Tire care	7-42
• Checking the engine oil level	7-21	• Recommended cold tire inflation pressures	7-42
• Changing the engine oil and filter	7-22	• Tire pressure	7-43
Engine coolant	7-24	• Checking tire inflation pressure	7-43
• Checking the coolant level	7-24	• Tire rotation	7-44
• Changing the coolant	7-26	• Wheel alignment and tire balance	7-45
Brake/clutch fluid	7-27	• Tire replacement	7-46
• Checking the brake/clutch fluid level	7-27	• Wheel replacement	7-47
Washer fluid	7-29	• Tire traction	7-47
• Checking the washer fluid level	7-29	• Tire maintenance	7-47
Parking brake	7-30	• Tire sidewall labeling	7-47
• Checking the parking brake	7-30	• All season tires	7-54
Air cleaner	7-31	• Summer tires	7-54
• Filter replacement	7-31	• Snow tires	7-54
		• Tire chains	7-55

- Radial-ply tires 7-55
- Low aspect ratio tire 7-56
- Fuses** 7-57
 - Inner panel fuse replacement..... 7-59
 - Memory fuse 7-60
 - Engine compartment fuse replacement..... 7-61
 - Fuse/relay panel description..... 7-63
- Light bulbs** 7-72
 - Bulb replacement precaution 7-72
 - Light bulb position (Front)..... 7-74
 - Light bulb position (Rear)(5 Door)..... 7-75
 - Light bulb position (Rear) (4 Door) 7-76
 - Light bulb position (Side)..... 7-77
 - Headlamp (Low/High beam) (Bulb type)
 - bulb replacement (Headlamp Type A) 7-77
 - Headlamp (Low/High beam) (Bulb type)
 - bulb replacement (Headlamp Type B) 7-78
 - Front turn signal lamp bulb replacement
 - (Headlamp Type A)..... 7-80
 - Front turn signal lamp bulb replacement
 - (Headlamp Type B, C) 7-80
 - Position lamp bulb replacement
 - (Headlamp Type A)..... 7-81
 - Side marker (front) (Bulb type) bulb replacement
 - (Headlamp Type A)..... 7-82
 - Static bending light replacement
 - (Headlamp Type B,C) 7-82
 - Front fog lamp (Bulb type) bulb replacement 7-83
 - Headlamp (Low/High beam) (LED type)
 - bulb replacement (Headlamp Type C) 7-84
 - Position lamp + DRL (LED type) bulb
 - replacement 7-84
 - Side marker (front) (LED type) bulb replacement
 - (Headlamp Type B, C) 7-84
 - Side repeater lamp (LED type) bulb Replacement. 7-85
 - Side repeater lamp (bulb type) bulb Replacement . 7-85
 - Rear turn signal lamp bulb replacement
 - (for 5 door)..... 7-86
 - Back-up lamp bulb replacement (for 5 door)..... 7-87
 - Stop and tail lamp bulb replacement (for 5 door) .. 7-88
 - Tail lamp (inside) bulb replacement (for 5 door) .. 7-89
 - Side marker (rear) (Bulb type) bulb replacement
 - (Rear combination lamp Type A) (for 5 door).... 7-90
 - Stop and tail lamp (LED type) bulb replacement
 - (for 5 door)..... 7-91
 - Side marker (rear) (LED type) bulb replacement
 - (Rear combination lamp Type B) (for 5 door).... 7-91
 - License plate lamp bulb replacement 7-92
 - High mounted stop lamp bulb replacement
 - (for 5 door)..... 7-92
 - Rear turn signal lamp bulb replacement

(for 4 door).....	7-93
• Back-up lamp bulb replacement (for 4 door).....	7-94
• Stop and tail lamp / Side marker (Bulb type) replacement (for 4 door).....	7-94
• Tail lamp (Bulb type) bulb replacement (for 4 door).....	7-95
• Stop and tail lamp (LED type) bulb replacement (for 4 door).....	7-96
• Side marker (rear) (LED type) bulb replacement (Rear combination lamp Type B) (for 4 door)....	7-97
• High mounted stop lamp bulb replacement (for 4 door).....	7-97
• Trunk lamp bulb replacement (for 4 door)	7-98
• Map lamp bulb replacement	7-98
• Vanity mirror lamp bulb replacement	7-99
• Room lamp bulb replacement	7-100
• Glove box lamp bulb replacement	7-100
• Liftgate room lamp bulb replacement (for 5 door).....	7-101
Appearance care.....	7-102
• Exterior care	7-102
• Interior care.....	7-108
Emission control system.....	7-111
• Crankcase emission control system	7-111
• Evaporative emission control (including ORVR:	

Onboard Refueling Vapor Recovery) system	7-111
• Exhaust emission control system	7-112
California perchlorate notice	7-114

ENGINE COMPARTMENT

■ Smartstream G1.6

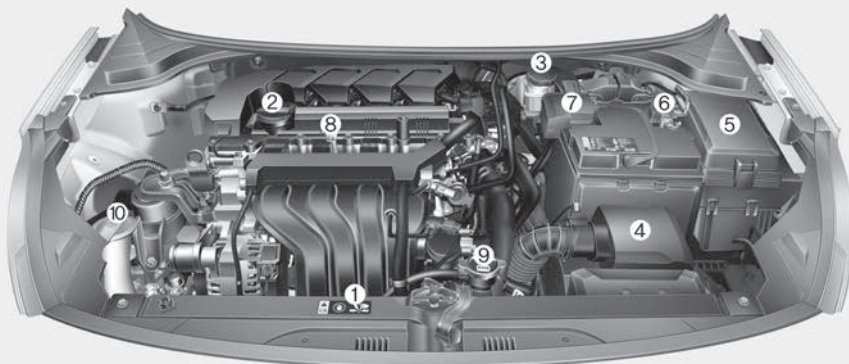

1. Engine coolant reservoir
2. Engine oil filler cap
3. Brake / clutch fluid reservoir
4. Air cleaner
5. Fuse box
6. Negative battery terminal
7. Positive battery terminal
8. Engine oil dipstick
9. Radiator cap
10. Windshield washer fluid reservoir

* The actual engine compartment in the vehicle may differ from the illustration.

OSC078047N

MAINTENANCE SERVICES

You should exercise the utmost care to prevent damage to your vehicle and injury to yourself whenever performing any maintenance or inspection procedures.

Should you have any doubts concerning the inspection or servicing of your vehicle, we strongly recommend that you have an authorized Kia dealer perform this work.

An authorized Kia dealer has factory-trained technicians and genuine Kia parts to service your vehicle properly. For expert advice and quality service, see an authorized Kia dealer.

Inadequate, incomplete or insufficient servicing may result in operational problems with your vehicle that could lead to vehicle damage, an accident, or personal injury.

Owner's responsibility

* NOTICE

Maintenance Service and Record Retention are the owner's responsibility.

You should retain documents that show proper maintenance has been performed on your vehicle in accordance with the scheduled maintenance service charts shown on the following pages. You need this information to establish your compliance with the servicing and maintenance requirements of your vehicle warranties.

Detailed warranty information is provided in your Warranty & Consumer Information manual.

Repairs and adjustments required as a result of improper maintenance or a lack of required maintenance are not covered.

We recommend you have your vehicle maintained and repaired by an authorized Kia dealer. An authorized Kia dealer meets Kia's high service quality standards and receives technical support from Kia in order to provide you with a high level of service satisfaction.

* NOTICE - NHTSA Safety Corrosion Alert

The National Highway Traffic Safety Administration (NHTSA) has issued a general warning to all vehicle owners of all brands regarding the risks associated with vehicle underbody corrosion. From your initial purchase, take the following steps to prevent unsafe corrosion damage to your vehicle:

(Continued)

(Continued)

- Wash the undercarriage of your vehicle regularly during the winter and whenever your vehicle has been exposed to such salts or chemicals.
- Do a thorough washing of the undercarriage at the end of the winter.
- Use professional service technicians or governmental inspection stations to annually inspect for corrosion.
- Immediately seek an inspection of your vehicle if you become visually aware of corrosion flaking or scaling or if you become aware of a change in vehicle performance, such as soft or spongy brakes, fluids leaking, impairment of directional control, suspension noises or rattling metal straps. NHTSA further advises that after a vehicle is 7 years old, it is essential that you take these indicated maintenance steps to ensure that you protect yourself from unsafe corrosion conditions.

Owner maintenance precautions

Improper or incomplete service may result in problems. This section gives instructions only for the maintenance items that are easy to perform.

As explained earlier in this section, several procedures can be done only by an authorized Kia dealer with special tools.

* NOTICE

Improper owner maintenance during the warranty period may affect warranty coverage. For details, read the separate Warranty & Consumer Information manual provided with the vehicle. If you're unsure about any servicing or maintenance procedure, have it done by an authorized Kia dealer.

WARNING - Maintenance work

Do not wear jewelry or loose clothing while working under the hood of your vehicle with the engine running. These can become entangled in moving parts, if you must run the engine while working under the hood, make certain that you remove all jewelry (especially rings, bracelets, watches, and necklaces) and all neckties, scarves, and similar loose clothing before getting near the engine or cooling fans.

WARNING - Touching metal parts

Do not touch metal parts (including strut bars) while the engine is operating or hot. Doing so could result in serious personal injury. Turn the engine off and wait until the metal parts cool down to perform maintenance work on the vehicle.

OWNER MAINTENANCE

The following lists are vehicle checks and inspections that should be performed by the owner or an authorized Kia dealer at the frequencies indicated to help ensure safe, dependable operation of your vehicle.

Any adverse conditions should be brought to the attention of your dealer as soon as possible.

These Owner Maintenance Checks are generally not covered by warranties and you may be charged for labor, parts and lubricants used.

Owner maintenance schedule

When you stop for fuel:

- Check the engine oil level.
- Check the coolant level in coolant reservoir.
- Check the windshield washer fluid level.
- Look for low or under-inflated tires.

⚠ WARNING - Hot coolant
Be careful when checking your engine coolant level when the engine is hot. Scalding hot coolant and steam may blow out under pressure.

While operating your vehicle:

- Note any changes in the sound of the exhaust or any smell of exhaust fumes in the vehicle.
- Check for vibrations in the steering wheel. Notice any increased steering effort or looseness in the steering wheel, or change in its straight-ahead position.
- Notice if your vehicle constantly turns slightly or “pulls” to one side when traveling on smooth, level road.
- When stopping, listen and check for unusual sounds, pulling to one side, increased brake pedal travel or “hard-to-push” brake pedal.
- If any slipping or changes in the operation of your transmission occurs, check the transmission fluid level.
- Check manual transmission operation, including clutch operation.
- Check the intelligent variable transmission P (Park) function.

- Check the parking brake.
- Check for fluid leaks under your vehicle (water dripping from the air conditioning system during or after use is normal).

At least monthly:

- Check the coolant level in the engine coolant reservoir.
- Check the operation of all exterior lights, including the stoplights, turn signals and hazard warning flashers.
- Check the inflation pressures of all tires including the spare for tires that are worn, show uneven wear, or are damaged.
- Check for loose wheel lug nuts.

At least twice a year (i.e., every Spring and Fall) :

- Check the radiator, heater and air conditioning hoses for leaks or damage.
- Check the windshield washer spray and wiper operation. Clean the wiper blades with a clean cloth dampened with washer fluid.
- Check the headlight alignment.
- Check the muffler, exhaust pipes, shields and clamps.
- Check the lap/shoulder belts for wear and function.

At least once a year :

- Clean the body and door drain holes.
- Lubricate the door hinges and check the hood hinges.
- Lubricate the door and hood locks and latches.
- Lubricate the door rubber weatherstrips.
- Check the air conditioning system.
- Inspect and lubricate intelligent variable transmission linkage and controls.
- Clean the battery and terminals.
- Check the brake/clutch fluid level.

SCHEDULED MAINTENANCE SERVICE

Scheduled maintenance service precaution

Follow the Normal Maintenance Schedule if the vehicle is usually operated where none of the following conditions apply. If any of the following conditions apply, follow the Maintenance Under Severe Usage Conditions.

- Repeated driving short distance of less than 5 miles (8 km) in normal temperature or less than 10 miles (16 km) in freezing temperature
- Extensive engine idling or low speed driving for long distances
- Driving on rough, dusty, muddy, unpaved, graveled or salt-spread roads
- Driving in areas using salt or other corrosive materials or in very cold weather
- Driving in heavy dust condition
- Driving in heavy traffic area
- Driving on uphill, downhill, or mountain road repeatedly
- Using for towing or camping, and driving with loading on the roof.
- Driving as a patrol car, taxi, other commercial use of vehicle towing
- Frequently driving under high speed or rapid acceleration.
- Frequently driving in stop-and-go condition
- Engine oil usage which is not recommended (Mineral type, Semi-synthetic, Lower grade etc.)

If your vehicle is operated under the above conditions, you should inspect, replace or refill more frequently than the following Normal Maintenance Schedule. After 120 months or 150,000 miles continue to follow the prescribed maintenance intervals.

Normal Maintenance Schedule - Non Turbo Models

The following maintenance services must be performed to ensure good emission control and performance. Keep receipts for all vehicle emission services to protect your warranty. Where both mileage and time are shown, the frequency of service is determined by whichever occurs first.

MAINTENANCE INTERVALS	Number of months or driving distance, whichever comes first															
	Months	12	24	36	48	60	72	84	96	108	120	132	144	156	168	180
	Miles×1,000	7.5	15	22.5	30	37.5	45	52.5	60	67.5	75	82.5	90	97.5	105	112.5
	Km×1,000	12	24	36	48	60	72	84	96	108	120	132	144	156	168	180
Drive belts *1	At first, inspect at 60,000 miles (96,000 km) or 72 months, after that, inspect every 15,000 miles (24,000 km) or 24 months															
Engine oil and engine oil filter	Smartstream G1.6	R	R	R	R	R	R	R	R	R	R	R	R	R	R	R
Fuel additives *2	Add every 7,500 miles (12,000 km) or 12 months															
Air cleaner filter		I	I	I	R	I	I	I	R	I	I	I	R	I	I	I
Spark plugs	Smartstream G1.6	Replace every 97,500 miles (156,000 km)														
Rotate tires	Rotate every 7,500 miles (12,000 km)															

I : Inspect and if necessary, adjust, correct, clean or replace.

R : Replace or change.

*1 : The drive belt should be replaced when cracks occur or tension is reduced.

*2 : If TOP TIER Detergent Gasoline is not available, one bottle of additive is recommended. Additives are available from your authorized Kia dealer along with information on how to use them. Do not mix other additives.

Normal Maintenance Schedule - Non Turbo Models(CONT.)

MAINTENANCE INTERVALS MAINTENANCE ITEM	Number of months or driving distance, whichever comes first															
	Months	12	24	36	48	60	72	84	96	108	120	132	144	156	168	180
	Miles×1,000	7.5	15	22.5	30	37.5	45	52.5	60	67.5	75	82.5	90	97.5	105	112.5
	Km×1,000	12	24	36	48	60	72	84	96	108	120	132	144	156	168	180
Climate control air filter (for evaporator and blower unit)		-	R	-	R	-	R	-	R	-	R	-	R	-	R	-
Vacuum hose		I	I	I	I	I	I	I	I	I	I	I	I	I	I	I
Coolant (Engine)		At first, replace at 120,000 miles (192,000 km) or 10 years, after that, replace every 30,000 miles (48,000 km) or 24 months														
Battery condition		I	I	I	I	I	I	I	I	I	I	I	I	I	I	I
Brake lines, hoses and connections		I	I	I	I	I	I	I	I	I	I	I	I	I	I	I
Brake discs and pads		I	I	I	I	I	I	I	I	I	I	I	I	I	I	I
Steering gear rack, linkage and boots		I	I	I	I	I	I	I	I	I	I	I	I	I	I	I
Drive shaft and boots		-	I	-	I	-	I	-	I	-	I	-	I	-	I	-
Suspension ball joints and mounting bolts		I	I	I	I	I	I	I	I	I	I	I	I	I	I	I

I : Inspect and if necessary, adjust, correct, clean or replace.

R : Replace or change.

Normal Maintenance Schedule - Non Turbo Models (CONT.)

MAINTENANCE ITEM	MAINTENANCE INTERVALS															
	Number of months or driving distance, whichever comes first															
	Months	12	24	36	48	60	72	84	96	108	120	132	144	156	168	180
	Miles×1,000	7.5	15	22.5	30	37.5	45	52.5	60	67.5	75	82.5	90	97.5	105	112.5
Km×1,000	12	24	36	48	60	72	84	96	108	120	132	144	156	168	180	
Air conditioner compressor/refrigerant																
Exhaust system																
Cooling system	-	-	-		-		-		-		-		-		-	-
Intelligent variable transmission fluid	No check, No service required															
Manual transmission fluid *5	-	-	-		-	-	-		-	-	-		-	-	-	-
Vapor hose and fuel filler cap	-		-		-		-		-		-		-		-	-
Fuel tank air filter *6	-		-		-		-		-		-		-		-	-
Fuel lines, hoses and connections	-	-	-		-	-	-		-	-	-		-	-	-	-
Parking brake	-		-		-		-		-		-		-		-	-
Brake/clutch (if equipped) fluid	Inspect every 7,500 miles (12,000 km) or 12 months, Replace every 60,000 miles (96,000 km) or 48 months															

I : Inspect and if necessary, adjust, correct, clean or replace.

R : Replace or change.

*5 : Manual transmission fluid should be changed anytime it has been submerged in water.

*6 : Fuel tank air filter is considered to be maintenance free but periodic inspection is recommended as the level of maintenance will be dependent upon the quality fuel used in the vehicle.

Maintenance Under Severe Usage Conditions - Non Turbo Models

The following items must be serviced more frequently on cars normally used under severe driving conditions. Refer to the chart below for the appropriate maintenance intervals.

R : Replace I : Inspect and, after inspection, clean, adjust, repair or replace if necessary

MAINTENANCE ITEM		MAINTENANCE OPERATION	MAINTENANCE INTERVALS	DRIVING CONDITION
Engine oil and engine oil filter	Smartstream G1.6	R	Every 3,750 miles (6,000 km) or 6 months	A, B, C, D, E, F, G, H, I, J, K, L
Air cleaner filter		R	More frequently	C, E
Spark plugs		R	More frequently	A, B, F, G, H, I, K
Intelligent variable transmission fluid		R	Every 60,000 miles (96,000 km)	A, C, D, E, F, G, H, I, J
Manual transmission fluid		R	Every 75,000 miles (120,000 km)	C, D, E, F, G, H, I, J
Brake discs and pads, calipers and rotors		I	More frequently	C, D, E, G, H
Parking brake		I	More frequently	C, D, G, H
Steering gear rack, linkage and boots		I	More frequently	C, D, E, F, G
Suspension ball joints and mounting bolts		I	More frequently	C, D, E, F, G

MAINTENANCE ITEM	MAINTENANCE OPERATION	MAINTENANCE INTERVALS	DRIVING CONDITION
Drive shafts and boots	I	More frequently	C, D, E, F, G, H, I, J
Climate control air filter (for evaporator and blower unit)	R	More frequently	C, E, G

Severe driving conditions

- A - Repeatedly driving short distance of less than 5 miles (8 km) in normal temperature or less than 10 miles (16 km) in freezing temperature
- B - Extensive engine idling or low speed driving for long distances
- C - Driving on rough, dusty, muddy, unpaved, graveled or salt-spread roads
- D - Driving in areas using salt or other corrosive materials or in very cold weather
- E - Driving in heavy dust condition

- F - Driving in heavy traffic area
- G - Driving on uphill, downhill, or mountain road repeatedly
- H - Using for towing or camping, and driving with loading on the roof.
- I - Driving as a patrol car, taxi, other commercial use or vehicle towing
- J - Frequently driving under high speed or rapid acceleration.
- K - Frequently driving in stop-and-go conditions
- L - Engine oil usage which is not recommended (Mineral type, Semi-synthetic, Lower grade etc.)

EXPLANATION OF SCHEDULED MAINTENANCE ITEMS

Engine oil and filter

The engine oil and filter should be changed at the intervals specified in the maintenance schedule. If the vehicle is being driven in severe conditions, more frequent oil and filter changes are required.

Drive belts

Inspect all drive belts for evidence of cuts, cracks, excessive wear or oil saturation, and replace if necessary. Drive belts should be checked periodically for proper tension and adjusted as necessary.

Fuel filter (for gasoline)

Kia gasoline vehicle is equipped a lifetime fuel filter that integrated with the fuel tank. Regular maintenance or replacement is not needed but depends on fuel quality. If there are some important safety matters like fuel flow restriction, surging, loss of power, hard starting problem, etc., fuel filter inspection or replace is needed.

The fuel filter be inspected or replaced by an authorized Kia dealer.

Fuel lines, fuel hoses and connections

Check the fuel lines, fuel hoses and connections for leakage and damage. Have an authorized Kia dealer replace any damaged or leaking parts immediately.

Vapor hose and fuel filler cap

The vapor hose and fuel filler cap should be inspected at the intervals specified in the maintenance schedule. Make sure that a new vapor hose or fuel filler cap is installed correctly.

Vacuum crankcase ventilation hoses

Inspect the surface of hoses for evidence of heat and/or mechanical damage. Hard and brittle rubber, cracking, tears, cuts, abrasions, and excessive swelling indicate deterioration. Particular attention should be paid to examine those hose surfaces nearest to high heat sources, such as the exhaust manifold.

Inspect the hose routing to assure that the hoses do not come in contact with any heat source, sharp edges or moving component which might cause heat damage or mechanical wear. Inspect all hose connections, such as clamps and couplings, to make sure they are secure, and that no leaks are present. Hoses should be replaced immediately if there is any evidence of deterioration or damage.

Air cleaner filter

A Genuine Kia air cleaner filter is recommended when the filter is replaced.

Spark plugs

Make sure to install new spark plugs of the correct heat range.

Valve clearance (if equipped)

Inspect excessive valve noise and/or engine vibration and adjust if necessary. An authorized Kia dealer should perform the operation.

Cooling system

Check the cooling system components, such as the radiator, coolant reservoir, hoses and connections for leakage and damage. Replace any damaged parts.

Coolant

The coolant should be changed at the intervals specified in the maintenance schedule.

Manual transmission fluid (if equipped)

Inspect the manual transmission fluid according to the maintenance schedule.

Intelligent Variable Transmission (IVT) fluid (if equipped)

The Intelligent Variable Transmission (IVT) fluid should not be checked under normal usage conditions.

But in severe conditions, the fluid should be changed at an authorized Kia dealer in accordance to the scheduled maintenance at the beginning of this chapter.

(Refer to "Maintenance Under Severe Usage Conditions" this chapter.)

* NOTICE

The Intelligent Variable Transmission (IVT) fluid color is amber. As the vehicle is driven, the Intelligent Variable Transmission (IVT) fluid will begin to look darker. This is normal, and you should not judge the need to replace the fluid based upon the changed color.

⚠ CAUTION

Use only specified Intelligent Variable Transmission (IVT) fluid. The use of non-specified fluid (even marked as compatible with genuine) could result in shift quality deterioration and vibrations, and eventually, transmission failure.

(Refer to “Recommended lubricants and capacities” in chapter 8.)

WARNING

- Do not change oil.

In case of repair, use only Genuine SP-CVT1

- Ne changez pas l'huile.

En cas de réparation, utilisez uniquement SP-CVT1

- 请勿随便更换油。

需要维修的情况下，只能使用正品 SP-CVT1

- Масло не заменять. В случае ремонта следует

использовать только оригинальное SP-CVT1

OBD078066

Brake hoses and lines

Visually check for proper installation, chafing, cracks, deterioration and any leakage. Replace any deteriorated or damaged parts immediately.

*** NOTICE - NHTSA Safety
Corrosion Alert**

NHTSA has warned all vehicle owners of all brands that they must maintain their vehicles in a manner which will prevent brake hose and brake line failures due to corrosion when such vehicles are exposed to winter road salt and related chemicals. While serious corrosion conditions typically only manifest themselves as safety issues after 7 years of vehicle use, the corrosion process starts immediately and thus underbody cleaning maintenance must commence from your vehicle's first exposure to road salts and chemicals. NHTSA urges vehicle owners to take the following steps to prevent corrosion:

(Continued)

(Continued)

1. Wash the undercarriage of your vehicle regularly throughout the winter and do a thorough washing in the spring to remove road salt and other de-icing chemicals.
2. Monitor the brake system for signs of corrosion by having regular professional inspections and watching for signs of problems, including loss of brake fluid, unusual leaks and soft or spongy feel in the brake pedal.
3. Replace the entire brake pipe assembly if you find severe corrosion that causes scaling or flaking of brake components.

Brake/Clutch fluid

Check the brake/clutch fluid level in the brake/clutch fluid reservoir. The level should be between the "MIN" and "MAX" marks on the side of the reservoir. Use only hydraulic brake/clutch fluid conforming to DOT 4 specification.

Parking brake

Inspect the parking brake system including the parking brake lever and cables.

Brake discs, pads, calipers and rotors

Check the pads for excessive wear, discs for run out and wear, and calipers for fluid leakage.

Exhaust pipe and muffler

Visually inspect the exhaust pipes, muffler and hangers for cracks, deterioration, or damage. Start the engine and listen carefully for any exhaust gas leakage. Tighten connections or replace parts as necessary.

Suspension mounting bolts

Check the suspension connections for looseness or damage. Retighten to the specified torque.

Steering gear box, linkage & boots/lower arm ball joint

With the vehicle stopped and engine off, check for excessive free-play in the steering wheel.

Check the linkage for bends or damage. Check the dust boots and ball joints for deterioration, cracks, or damage. Replace any damaged parts.

Drive shafts and boots

Check the drive shafts, boots and clamps for cracks, deterioration, or damage. Replace any damaged parts and, if necessary, repack the grease.

Air conditioning refrigerant

Check the air conditioning lines and connections for leakage and damage.

CHECKING FLUID LEVELS

When checking engine oil, engine coolant, brake fluid, and washer fluid, always be sure to clean the area around any filler plug, drain plug, or dipstick before checking or draining any lubricant or fluid. This is especially important in dusty or sandy areas and when the vehicle is used on unpaved roads. Cleaning the plug and dipstick areas will prevent dirt and grit from entering the engine and other mechanisms that could be damaged.

ENGINE OIL

Checking the engine oil level

- Engine oil is used for lubrication and cooling, so it is gradually consumed during driving the vehicle.
- Regularly check and manage the oil level using the following procedure.

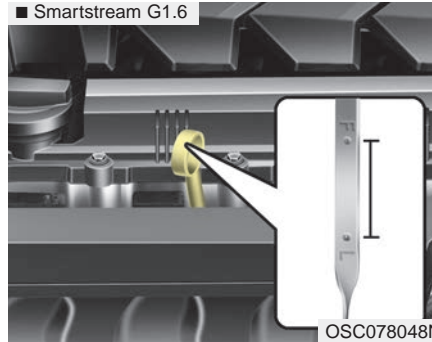

1. Be sure the vehicle is on level ground.
2. Start the engine and allow it to reach normal operating temperature.
3. Turn the engine off and wait for a few minutes (about 15 minutes. (with oil filler cap and dipstick detached)) for the oil to return to the oil pan.
4. Pull the dipstick out, wipe it clean, and reinsert it fully.

⚠ WARNING - Radiator hose
Be very careful not to touch the radiator hose when checking or adding the engine oil as it may be hot enough to burn you.

5. Check if the oil level is between the F-L line and refill it if the oil level is near the L line.

⚠ CAUTION - Replacing engine oil
Do not overfill the engine oil. It may damage the engine.

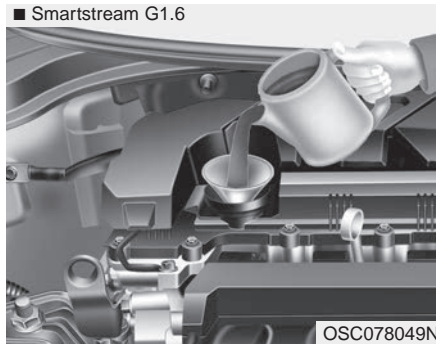

Check if the oil level is between the F-L line and refill it if the oil level is near the L line.

Use a funnel to help prevent oil from being spilled on engine components.

*Use only the specified engine oil.
(Refer to "Recommended lubricants and capacities" in chapter 8.)*

- The engine oil consumption may increase while you break in a new vehicle and it will be stabilized after driving 3,750 miles (6,000 km).
- The engine oil consumption can be affected by driving habits, climate conditions, traffic conditions, oil quality, etc. Therefore, it is recommended that you inspect the engine oil level regularly and refill it if necessary.
- The engine oil change interval is set for the purpose of preventing oil deterioration, and is not related the amount of oil consumption; so, check and refill the amount of the oil regularly.

Changing the engine oil and filter

Have engine oil and filter changed by an authorized Kia dealer according to the Maintenance Schedule at the beginning of this chapter.

- If exceeding the maintenance schedule for replacement of engine oil, the engine oil performance may deteriorate and the engine condition may be affected. Therefore, the replacement cycle should be observed.
- To keep the engine in optimal condition, use recommended engine oil. If not using the recommended oil, replace it according to the severe usage maintenance conditions.

⚠ WARNING - Used engine oil

Used engine oil may cause irritation or cancer of the skin if left in contact with the skin for prolonged periods of time. Always protect your skin by washing your hands thoroughly with soap and warm water as soon as possible after handling used oil.

ENGINE COOLANT

The high-pressure cooling system has a reservoir filled with year round antifreeze coolant. The reservoir is filled at the factory.

Check the antifreeze protection and coolant level at least once a year: at the beginning of the winter season, and before traveling to a colder climate.

Checking the coolant level

WARNING



Removing radiator cap

Never attempt to remove the radiator cap while the engine is operating or hot. Doing so might lead to cooling system and engine damage and could result in serious personal injury from escaping hot coolant or steam.

- Turn the engine off and wait until it cools down. Use extreme care when removing the radiator cap. Wrap a thick towel around it, and turn it counterclockwise slowly to the first stop. Step back while the pressure is released from the cooling system.

When you are sure all the pressure has been released, press down on the cap, using a thick towel, and continue turning counterclockwise to remove it.

- Even if the engine is not operating, do not remove the radiator cap or the drain plug while the engine and radiator are hot. Hot coolant and steam may still blow out under pressure, causing serious injury.

⚠ WARNING - Cooling fan

Use caution when working near the blade of the cooling fan. The electric motor (cooling fan) is controlled by engine coolant temperature, refrigerant pressure and vehicle speed. It may sometimes operate even when the engine is not running.

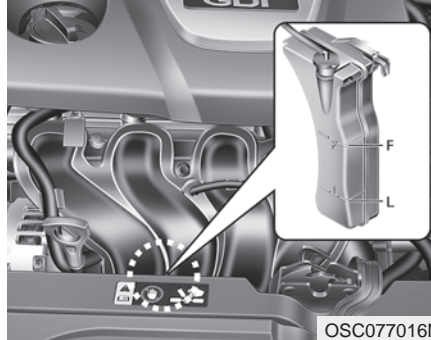

OSC077016N

Check the condition and connections of all cooling system hoses and heater hoses. Replace any swollen or deteriorated hoses.

The coolant level should be filled between F and L marks on the side of the coolant reservoir when the engine is cool.

If the coolant level is low, add enough specified coolant to provide protection against freezing and corrosion. Bring the level to F, but do not overfill. If frequent additions are required, see an authorized Kia dealer for a cooling system inspection.

Recommended engine coolant

- When adding coolant, use only deionized water or soft water for your vehicle and never mix hard water in the coolant filled at the factory. An improper coolant mixture can result in serious malfunction or engine damage.
- The engine in your vehicle has aluminum engine parts and must be protected by an ethylene-glycol with phosphate based coolant to prevent corrosion and freezing.
- DO NOT USE alcohol or methanol coolant or mix them with the specified coolant.
- Do not use a solution that contains more than 60% antifreeze or less than 35% antifreeze. This would reduce the effectiveness of the solution.

*** NOTICE**

Make sure that the coolant cap is properly closed after refilling the coolant. Otherwise the engine could overheat while driving.

For mixture percentage, refer to the following table.

Ambient Temperature	Mixture Percentage (volume)	
	Antifreeze	Water
5°F (-15°C)	35	65
-13°F (-25°C)	40	60
-31°F (-35°C)	50	50
-49°F (-45°C)	60	40

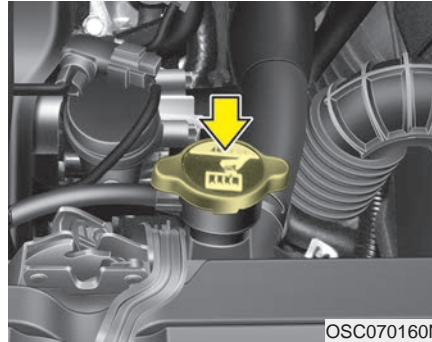

OSC070160N

WARNING



Radiator cap

Do not remove the radiator cap when the engine and radiator are hot. Scalding hot coolant and steam may blow out under pressure which may result in serious injury.

Changing the coolant

Have the coolant changed by an authorized Kia dealer according to the Maintenance Schedule at the beginning of this chapter.

CAUTION

Put a thick cloth or fabric around the radiator cap before refilling the coolant in order to prevent the coolant from overflowing into engine parts such as the alternator.

BRAKE/CLUTCH FLUID (IF EQUIPPED)

Checking the brake/clutch fluid level

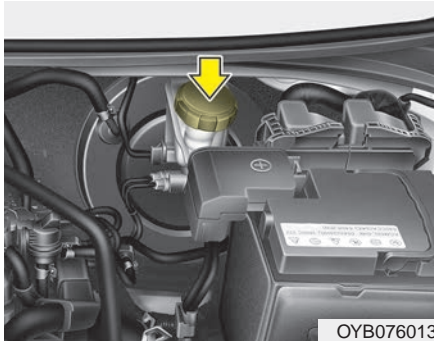

OYB076013

Check the fluid level in the reservoir periodically. The fluid level should be between the MAX (Maximum) and MIN (Minimum) marks on the side of the reservoir.

Before removing the reservoir cap and adding brake/clutch fluid, clean the area around the reservoir cap thoroughly to prevent brake/clutch fluid contamination.



CAUTION - Proper fluid

Only use brake/clutch fluid in brake system. Small amounts of improper fluids (such as engine oil) can cause damage to the brake system.

If the level is low, add fluid until you reach the MAX (Maximum) level. The level will fall with accumulated mileage. This is a normal condition associated with the wear of brake linings. If the fluid level is excessively low, have the brake system checked by an authorized Kia dealer.

Use only the specified brake/clutch fluid. (Refer to "Recommended lubricants and capacities" in chapter 8.)

Never mix different types of fluid.

In the event the brake system requires frequent additions of fluid, the vehicle should be inspected by an authorized Kia dealer.

When changing and adding brake/clutch fluid, handle it carefully. Do not let it come in contact with your eyes. If brake/clutch fluid should come in contact with your eyes, immediately flush them with a large quantity of fresh tap water. Have your eyes examined by a doctor as soon as possible.



CAUTION - Brake/clutch fluid

Do not allow brake/clutch fluid to contact the vehicle's body paint, as paint damage will result.

Brake/clutch fluid which has been exposed to open air for an extended time should never be used as its quality cannot be guaranteed. It should be disposed of properly.

 **CAUTION**

To maintain your vehicle's best brake and ABS/ESC performance, use Kia genuine brake/clutch fluid as in the specification. (Classification : FMVSS116 DOT-4)

WASHER FLUID

Checking the washer fluid level

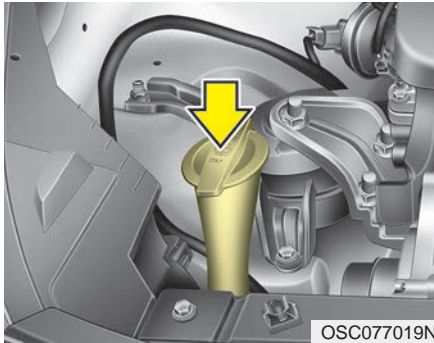

The reservoir is translucent so that you can check the level with a quick visual inspection.

Check the fluid level in the washer fluid reservoir and add fluid if necessary. In warm climates, plain water may be used if washer fluid is not available. However, use washer solvent with antifreeze characteristics in cold climates to prevent freezing.

⚠ WARNING - Flammable fluid

Do not allow the washer fluid to come in contact with open flames or sparks. The windshield washer fluid reservoir is flammable under certain circumstances. This can result in a fire.

⚠ WARNING - Windshield fluid

Do not drink the windshield washer fluid. The windshield washer fluid is poisonous to humans and animals.

⚠ WARNING - Coolant

- Do not use radiator coolant or antifreeze in the washer fluid reservoir.
- Radiator coolant can severely obscure visibility when sprayed on the windshield and may cause loss of vehicle control.

PARKING BRAKE

Checking the parking brake

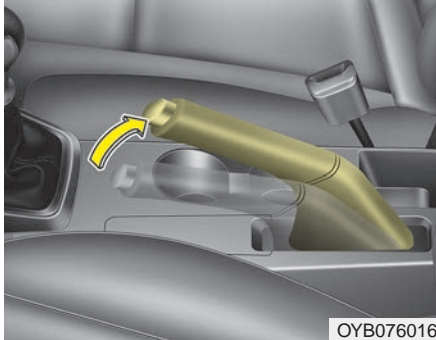

Check the stroke of the parking brake by counting the number of “clicks” heard while fully applying it from the released position. Also, the parking brake alone should securely hold the vehicle on a fairly steep grade. If the stroke is more or less than specified, have the parking brake adjusted by an authorized Kia dealer.

Stroke : 5~7 “clicks” at a force of 44 lbs (20 kg, 196 N).

AIR CLEANER

Filter replacement

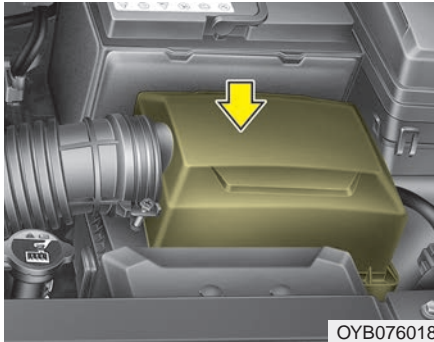

It must be replaced when necessary, and should not be washed.

You can clean the filter when inspecting the air cleaner compartment. Clean the filter by using compressed air.

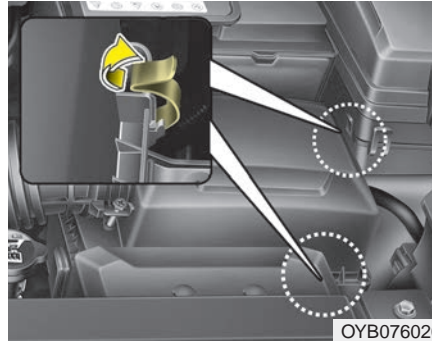

1. Loosen the air cleaner cover attaching clips and open the cover.

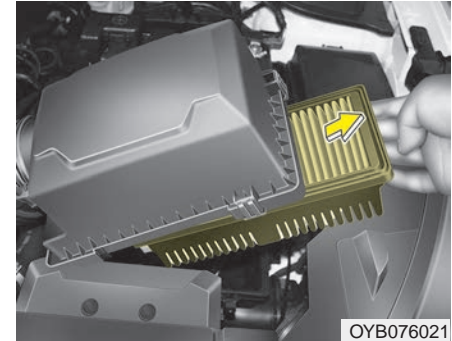

2. Wipe the inside of the air cleaner.
3. Replace the air cleaner filter.
4. Lock the cover with the cover attaching clips.

Replace the filter according to the Maintenance Schedule.

If the vehicle is operated in extremely dusty or sandy areas, replace the element more often than the usual recommended intervals. (Refer to "Maintenance under severe usage conditions" in this chapter.)



CAUTION - Air filter maintenance

- ***Do not drive with the air cleaner removed; this will result in excessive engine wear.***
- ***When removing the air cleaner filter, be careful that dust or dirt does not enter the air intake, or damage may result.***
- ***Use a Kia genuine part. Use of a non-genuine part could damage the air flow sensor.***

CLIMATE CONTROL AIR FILTER

Filter inspection

The climate control air filter should be replaced according to the Maintenance Schedule. If the vehicle is operated in severely air-polluted cities or on dusty rough roads for a long period, it should be inspected more frequently and replaced earlier. When you replace the climate control air filter, replace it performing the following procedure, and be careful to avoid damaging other components.

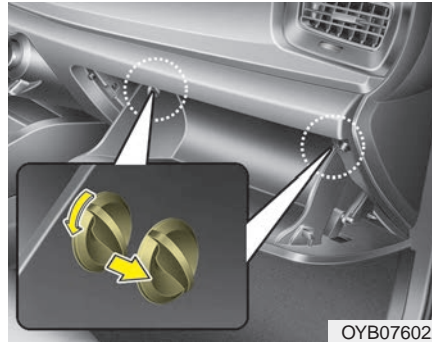

1. Open the glove box and remove the stoppers on both sides.

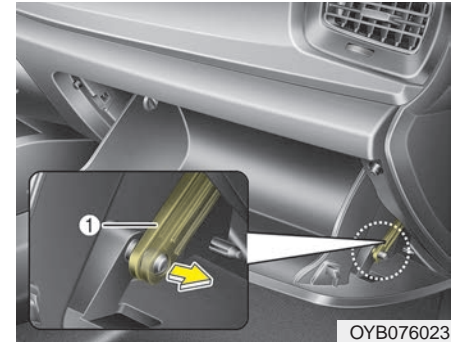

2. With the glove box open, pull the support strap (1).

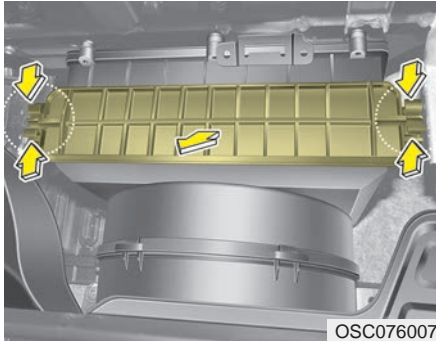

3. Remove the climate control air filter cover while pressing the lock on both sides of the cover.

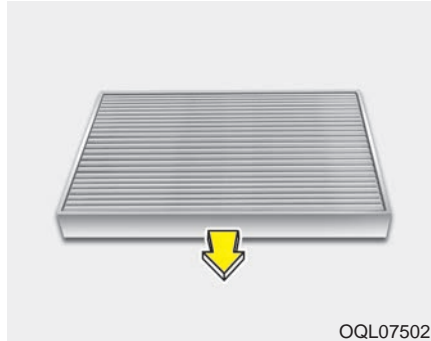

4. Replace the climate control air filter.
5. Reassemble in the reverse order of disassembly.

When replacing the climate control air filter, install it properly. Otherwise, the system may produce noise, and the effectiveness of the filter may be reduced.

WIPER BLADES

Blade inspection

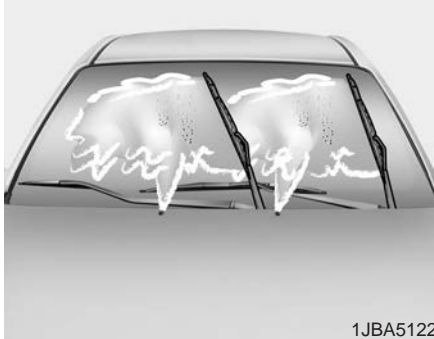

1JBA5122

Commercial hot waxes applied by automatic car washes have been known to make the windshield difficult to clean.

Contamination of either the windshield or the wiper blades with foreign matter can reduce the effectiveness of the windshield wipers. Common sources of contamination are insects, tree sap, and hot wax treatments used by some commercial car washes. If the blades are not wiping properly, clean both the window and the blades with a good cleaner or mild detergent, and rinse thoroughly with clean water.



CAUTION - Wiper blades

To prevent damage to the wiper blades, do not use gasoline, kerosene, paint thinner, or other solvents on or near them.

Blade replacement

When the wipers no longer clean adequately, the blades may be worn or cracked, and require replacement.

To prevent damage to the wiper arms or other components, do not attempt to move the wipers manually.

Aftermarket wiper blades may result in wiper malfunction and/or failure. It is recommended to use certified Kia parts.

Front windshield wiper blade

⚠ CAUTION - Wiper arms
Do not allow the wiper arm to fall against the windshield, since it may chip or crack the windshield.

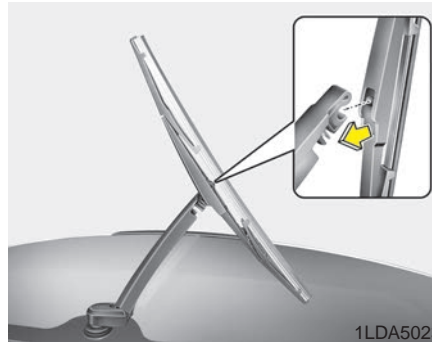

Type A

1. Raise the wiper arm and turn the wiper blade assembly to expose the plastic locking clip.

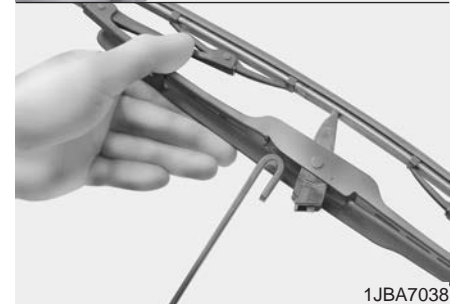
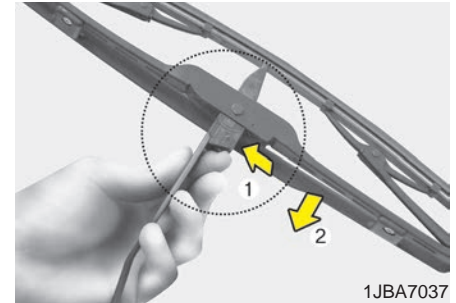

2. Compress the clip (1) and slide the blade assembly downward (2).
3. Lift it off the arm.
4. Install the blade assembly in the reverse order of removal.

**Type B**

1. Raise the wiper arm.

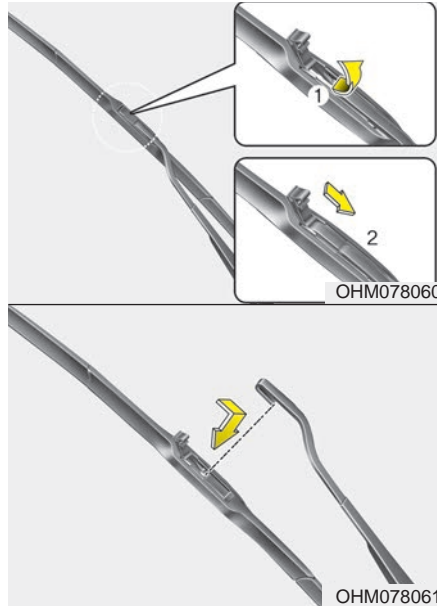

2. Lift up the wiper blade clip. Then pull down the blade assembly and remove it.
3. Install the new blade assembly in the reverse order of removal.

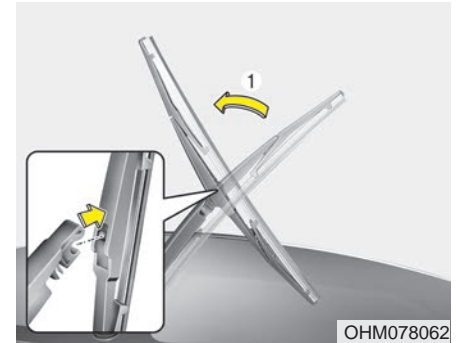
**Rear window wiper blade
(for 5 door)**

1. Raise the wiper arm and pull out the wiper blade assembly.

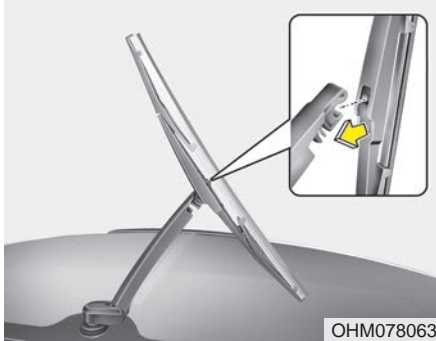

2. Install the new blade assembly by inserting the center part into the slot in the wiper arm until it clicks into place.
3. Make sure the blade assembly is installed firmly by trying to pull it slightly.

To prevent damage to the wiper arms or other components, have an authorized Kia dealer replace the wiper blade.

BATTERY

For best battery service

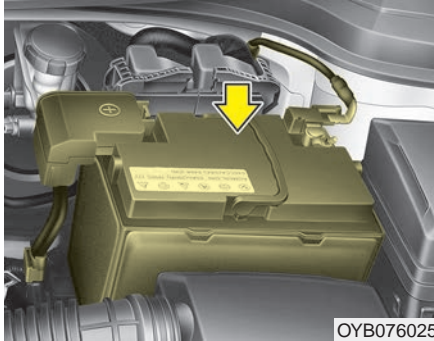

- Keep the battery securely mounted.
- Keep the battery top clean and dry.
- Keep the terminals and connections clean, tight, and coated with petroleum jelly or terminal grease.
- Rinse any spilled electrolyte from the battery immediately with a solution of water and baking soda.
- If the vehicle is not going to be used for an extended time, disconnect the battery cables.

WARNING - Risk of explosion



Keep lit cigarettes and all other flames or sparks away from the battery.



The battery contains hydrogen -- a highly combustible gas which will explode if it comes in contact with a flame or spark.



Keep batteries out of the reach of children because batteries contain highly corrosive **SULFURIC ACID** and electrolytes. Do not allow battery acid to contact your skin, eyes, clothing or paint finish.



Wear eye protection when charging or working near a battery. Always provide ventilation when working in an enclosed space.



Always read the following instructions carefully when handling a battery.



If any electrolyte gets into your eyes, flush your eyes with clean water for at least 15 minutes and get immediate medical attention.

If electrolyte gets on your skin, thoroughly wash the contacted area. If you feel pain or a burning sensation, get medical attention immediately.



An inappropriately disposed battery can be harmful to the environment and human health. Dispose the battery according to your local law(s) or regulation.



The battery contains lead. Do not dispose of it after use. Please return the battery to an authorized Kia dealer to be recycled.

Never attempt to recharge the battery when the battery cables are connected.

⚠ WARNING - Risk of electrocution

Never touch the electrical ignition system while the vehicle is running. This system works with high voltage which can shock you.

⚠ WARNING - Recharging Battery

Never attempt to recharge the battery when the battery cables are connected.

⚠ WARNING - Battery lead compound

Battery posts, terminals, and related accessories contain lead and lead compounds. Wash hands after handling.

*** NOTICE**

If you connect unauthorized electronic devices to the battery, the battery may be discharged. Never use unauthorized devices.

Recharging the battery

Your vehicle has a maintenance-free, calcium-based battery.

- If the battery becomes discharged in a short time (because, for example, the headlamps or interior lamps were left on while the vehicle was not in use), recharge it by slow charging (trickle) for 10 hours.
- If the battery gradually discharges because of high electric load while the vehicle is being used, recharge it at 20-30A for two hours.

When recharging the battery, observe the following precautions:

- The battery must be removed from the vehicle and placed in an area with good ventilation.
- Do not allow cigarettes, sparks, or flame near the battery.
- Watch the battery during charging, and stop or reduce the charging rate if the battery cells begin gassing (boiling) violently or if the temperature of the electrolyte of any cell exceeds 120°F (49°C).
- Wear eye protection when checking the battery during charging.
- Disconnect the battery charger in the following order.
 1. Turn off the battery charger main switch.
 2. Unhook the negative clamp from the negative battery terminal.
 3. Unhook the positive clamp from the positive battery terminal.

- Before performing maintenance or recharging the battery, turn off all accessories and stop the engine.
- The negative battery cable must be removed first and installed last when the battery is disconnected.

Reset items

The following items should be reset after the battery has been discharged or the battery has been disconnected.

- Auto up/down window
- Sunroof
- Trip computer
- Climate control system

TIRES AND WHEELS

Tire care

For proper maintenance, safety, and maximum fuel economy, you must always maintain recommended tire inflation pressures and stay within the load limits and weight distribution recommended for your vehicle.

Recommended cold tire inflation pressures

All tire pressures (including the spare) should be checked when the tires are cold. "Cold Tires" means the vehicle has not been driven for at least three hours or driven less than 1 mile (1.6 km).

Recommended pressures must be maintained for the best ride, top vehicle handling, and minimum tire wear.

For recommended inflation pressure refer to "Tire and wheels" in chapter 8.

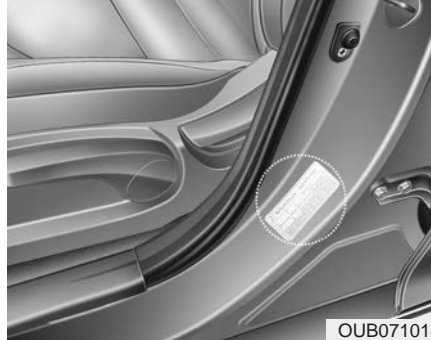

All specifications (sizes and pressures) can be found on a label attached to the driver's side center pillar.

⚠ WARNING

- Checking the tire inflation pressure

Inflate your tires consistent with the instructions provided in this manual.

Regularly check the tire inflation pressure, and correct it as needed: at least twice a month and before a long trip.

If you fail to observe this precaution, you may be driving on tires with incorrect tire pressures, a condition that may not only compromise your vehicle's driving stability, but also lead to tire damage and the risk of an accident.

This risk is much higher on hot days and when driving for long periods at high speeds.

- Underinflation also results in excessive wear, poor handling and reduced fuel economy. Wheel deformation also is possible. Keep your tire pressures at the proper levels. If a tire frequently needs refilling, have it checked by an authorized Kia dealer.
- Overinflation produces a harsh ride, excessive wear at the center of the tire tread, and a greater possibility of damage from road hazards.
- Warm tires normally exceed recommended cold tire pressures by 4 to 6 psi (28 to 41 kPa). Do not release air from warm tires to adjust the pressure or the tires will be underinflated.
- Be sure to reinstall the tire inflation valve caps. Without the valve cap, dirt or moisture could get into the valve core and cause air leakage. If a valve cap is missing, install a new one as soon as possible.

Tire pressure

Always observe the following:

- Check tire pressure when the tires are cold. (After vehicle has been parked for at least three hours or hasn't been driven more than 1 mile (1.6 km) since startup.)
- Check the pressure of your spare tire each time you check the pressure of other tires.
- Never overload your vehicle. Be careful not to overload a vehicle luggage rack if your vehicle is equipped with one.

⚠ WARNING - Tire Inflation
Overinflation or underinflation can reduce tire life, adversely affect vehicle handling, and lead to sudden tire failure. This could result in loss of vehicle control and potential injury.

Checking tire inflation pressure

Check your tires once a month or more.

Also, check the tire pressure of the spare tire.

How to check

Use a good quality gauge to check tire pressure. You cannot tell if your tires are properly inflated simply by looking at them. Radial tires may look properly inflated even when they're underinflated.

Check the tire's inflation pressure when the tires are cold. - "Cold" means your vehicle has been sitting for at least three hours or driven no more than 1 mile (1.6 km).

Remove the valve cap from the tire valve stem. Press the tire gauge firmly onto the valve to get a pressure measurement. If the cold tire inflation pressure matches the recommended pressure on the tire and loading information label, no further adjustment is necessary. If the pressure is low, add air until you reach the recommended amount.

If you overfill the tire, release air by pushing on the metal stem in the center of the tire valve. Recheck the tire pressure with the tire gauge. Be sure to put the valve caps back on the valve stems. They help prevent leaks by keeping out dirt and moisture.

- Inspect your tires frequently for proper inflation as well as wear and damage. Always use a tire pressure gauge.
- Tires with too much or too little pressure can cause tires to wear unevenly, causing poor handling, loss of vehicle control, and sudden tire failure leading to accidents, injuries, and even death. The recommended cold tire pressure for your vehicle can be found in this manual and on the tire label located on the driver's side center pillar.
- Remember to check the pressure of your spare tire. Kia recommends that you check the spare every time you check the pressure of the other tires on your vehicle.

Tire rotation

To equalize tread wear, it is recommended that the tires be rotated every 12,000 km (7,500 miles) or sooner if irregular wear develops.

During rotation, check the tires for correct balance.

When rotating tires, check for uneven wear and damage. Abnormal wear is usually caused by incorrect tire pressure, improper wheel alignment, out-of-balance wheels, severe braking or severe cornering. Look for bumps or bulges in the tread or side of the tire. Replace the tire if you find either of these conditions. Replace the tire if fabric or cord is visible. After rotation, be sure to bring the front and rear tire pressures to specification and check lug nut tightness.

Refer to “Tire and wheels” in chapter 8.

Without a spare tire

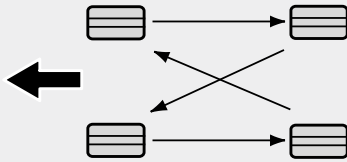

S2BLA790A

Directional tires (if equipped)

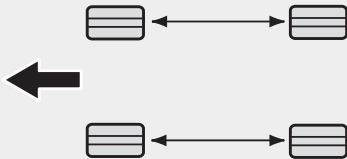

CBGQ0707A

Disc brake pads should be inspected for wear whenever tires are rotated.

Rotate radial tires that have an asymmetric tread pattern only from front to rear and not from right to left.

⚠ WARNING - Mixing tires

- **Do not use the compact spare tire (if equipped) for tire rotation.**
- **Do not mix bias ply and radial ply tires under any circumstances. This may cause unusual handling characteristics.**

Wheel alignment and tire balance

The wheels on your vehicle were aligned and balanced carefully at the factory to give you the longest tire life and best overall performance.

In most cases, you will not need to have your wheels aligned again. However, if you notice unusual tire wear or your vehicle pulling one way or the other, the alignment may need to be reset.

If you notice your vehicle vibrating when driving on a smooth road, your wheels may need to be rebalanced.

⚠ CAUTION - Wheel weight
Improper wheel weights can damage your vehicle's aluminum wheels. Use only approved wheel weights.

Tire replacement



If the tire is worn evenly, a tread wear Indicator (A) will appear as a solid band across the tread. This shows there is less than 1/16 inch (1.6 mm) of tread left on the tire. Replace the tire when this happens.

Do not wait for the band to appear across the entire tread before replacing the tire.

The ABS works by comparing the speed of the wheels. The tire size affects wheel speed. When replacing tires, all 4 tires must use the same size originally supplied with the vehicle. Using tires of a different size can cause the ABS (Anti-lock Brake System) and ESC (Electronic Stability Control) to work irregularly.

* NOTICE

- **We recommend that when replacing tires, use the same which were originally supplied with the vehicle. If not, driving performance could be altered.**
- **It is best to replace all four tires at the same time. If that is not possible, or necessary, then replace the two front or two rear tires as a pair. Replacing just one tire can seriously affect your vehicle's handling.**

Compact spare tire replacement

A compact spare tire has a shorter tread life than a regular size tire. Replace it when you can see the tread wear indicator bars on the tire. The replacement compact spare tire should be the same size and design tire as the one provided with your new vehicle and should be mounted on the same compact spare tire wheel. The compact spare tire is not designed to be mounted on a regular size wheel, and the compact spare tire wheel is not designed for mounting a regular size tire.

Wheel replacement

When replacing the metal wheels for any reason, make sure the new wheels are equivalent to the original factory units in diameter, rim width and offset.

A wheel that is not the correct size may adversely affect wheel and bearing life, braking and stopping abilities, handling characteristics, ground clearance, body-to-tire clearance, snow chain clearance, speedometer and odometer calibration, headlight aim and bumper height.

CAUTION - Wheel

Wheels that do not meet Kia's specifications may fit poorly and result in damage to the vehicle or unusual handling and poor vehicle control.

Tire traction

Tire traction can be reduced if you drive on worn tires, tires that are improperly inflated or on slippery road surfaces. Tires should be replaced when tread wear indicators appear. Slow down whenever there is rain, snow or ice on the road, to reduce the possibility of losing control of the vehicle.

Tire maintenance

In addition to proper inflation, correct wheel alignment helps to decrease tire wear. If you find a tire is worn unevenly, have your dealer check the wheel alignment.

When you have new tires installed, make sure they are balanced. This will increase vehicle ride comfort and tire life. Additionally, a tire should always be rebalanced if it is removed from the wheel.

Tire sidewall labeling

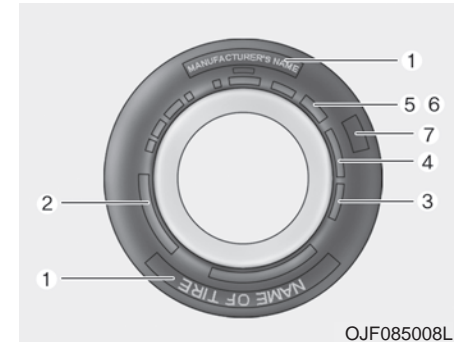

This information identifies and describes the fundamental characteristics of the tire and also provides the tire identification number (TIN) for safety standard certification. The TIN can be used to identify the tire in case of a recall.

1. Manufacturer or brand name

Manufacturer or Brand name is shown.

2. Tire size designation

A tire's sidewall is marked with a tire size designation. You will need this information when selecting replacement tires for your car. The following explains what the letters and numbers in the tire size designation mean.

Example tire size designation:

(These numbers are provided as an example only; your tire size designator could vary depending on your vehicle.)

P205/55R16 89H

P - Applicable vehicle type (tires marked with the prefix "P" are intended for use on passenger vehicles or light trucks; however, not all tires have this marking).

205 - Tire width in millimeters.

55 - Aspect ratio. The tire's section height as a percentage of its width.

R - Tire construction code (Radial).

16 - Rim diameter in inches.

89 - Load Index, a numerical code associated with the maximum load the tire can carry.

H - Speed Rating Symbol. See the speed rating chart in this section for additional information.

Wheel size designation

Wheels are also marked with important information that you need if you ever have to replace one. The following explains what the letters and numbers in the wheel size designation mean.

Example wheel size designation:

6.0JX16

6.0 - Rim width in inches.

J - Rim contour designation.

16 - Rim diameter in inches.

Tire speed ratings

The chart below lists many of the different speed ratings currently being used for passenger vehicles. The speed rating is part of the tire size designation on the sidewall of the tire. This symbol corresponds to that tire's designed maximum safe operating speed.

Speed Rating Symbol	Maximum Speed
S	112 mph (180 km/h)
T	118 mph (190 km/h)
H	130 mph (210 km/h)
V	149 mph (240 km/h)
Z	Above 149 mph (240 km/h)

3. Checking tire life (TIN : Tire Identification Number)

Any tires that are over 6 years old, based on the manufacturing date, (including the spare tire) should be replaced by new ones. You can find the manufacturing date on the tire sidewall (possibly on the inside of the wheel), displaying the DOT Code. The DOT Code is a series of numbers on a tire consisting of numbers and English letters. The manufacturing date is designated by the last four digits (characters) of the DOT code.

DOT : XXXX XXXX OOOO

The front part of the DOT means a plant code number, tire size and tread pattern and the last four numbers indicate week and year manufactured.

For example:

DOT XXXX XXXX 1620 represents that the tire was produced in the 16th week of 2020.



WARNING - Tire age

Replace tires within the recommended time frame. Failure to replace tires as recommended can result in sudden tire failure, which could lead to a loss of control and an accident.

4. Tire ply composition and material

The number of layers or plies of rubber-coated fabric in the tire. Tire manufacturers also must indicate the materials in the tire, which include steel, nylon, polyester, and others. The letter "R" means radial ply construction; the letter "D" means diagonal or bias ply construction; and the letter "B" means belted-bias ply construction.

5. Maximum permissible inflation pressure

This number is the greatest amount of air pressure that should be put in the tire. Do not exceed the maximum permissible inflation pressure. Refer to the Tire and Loading Information label for recommended inflation pressure.

6. Maximum load rating

This number indicates the maximum load in kilograms and pounds that can be carried by the tire. When replacing the tires on the vehicle, always use a tire that has the same load rating as the factory installed tire.

7. Uniform Tire Quality Grading

Quality grades can be found where applicable on the tire sidewall between tread shoulder and maximum section width.

For example:

Treadwear 200

Traction AA

Temperature A

Tread wear

The tread wear grade is a comparative rating based on the wear rate of the tire when tested under controlled conditions on a specified government test course. For example, a tire graded 150 would wear one-and-a-half times (1½) as well on the government course as a tire graded 100. The relative performance of tires depends upon the actual conditions of their use, however, and may depart significantly from the norm due to variations in driving habits, service practices and differences in road characteristics and climate.

Tires degrade over time, even when they are not being used. Regardless of the remaining tread, we recommend that tires be replaced after approximately six (6) years of normal service. Heat caused by hot climates or frequent high loading conditions can accelerate the aging process.

These grades are molded on the side-walls of passenger vehicle tires. The tires available as standard or optional equipment on your vehicles may vary with respect to grade.

Traction - AA, A, B & C

The traction grades, from highest to lowest, are AA, A, B and C. Those grades represent the tires ability to stop on wet pavement as measured under controlled conditions on specified government test surfaces of asphalt and concrete. A tire marked C may have poor traction performance.

The traction grade assigned to this tire is based on straight-ahead braking traction tests, and does not include acceleration, cornering, hydroplaning, or peak traction characteristics.

Temperature -A, B & C

The temperature grades are A (the highest), B and C representing the tire's resistance to the generation of heat and its ability to dissipate heat when tested under controlled conditions on a specified indoor laboratory test wheel.

Sustained high temperature can cause the material of the tire to degenerate and reduce tire life, and excessive temperature can lead to sudden tire failure. The grade C corresponds to a level of performance which all passenger car tires must meet under the Federal Motor Vehicle Safety Standard No. 109. Grades B and A represent higher levels of performance on the laboratory test wheel than the minimum required by law.

Tire terminology and definitions

Air Pressure: The amount of air inside the tire pressing outward on the tire. Air pressure is expressed in kilopascal (kPa) or pounds per square inch (psi).

Accessory Weight: This means the combined weight of optional accessories. Some examples of optional accessories are, intelligent variable transmission, power seats, and air conditioning.

Aspect Ratio: The relationship of a tire's height to its width.

Belt: A rubber coated layer of cords that is located between the plies and the tread. Cords may be made from steel or other reinforcing materials.

Bead: The tire bead contains steel wires wrapped by steel cords that hold the tire onto the rim.

Bias Ply Tire: A pneumatic tire in which the plies are laid at alternate angles less than 90 degrees to the centerline of the tread.

Cold Tire Pressure: The amount of air pressure in a tire, measured in kilopascals (kPa) or pounds per square inch (psi) before a tire has built up heat from driving.

Curb Weight: This means the weight of a motor vehicle with standard and optional equipment including the maximum capacity of fuel, oil and coolant, but without passengers and cargo.

DOT Markings: A code molded into the sidewall of a tire signifying that the tire is in compliance with the U.S. Department of Transportation motor vehicle safety standards. The DOT code includes the Tire Identification Number (TIN), an alphanumeric designator which can also identify the tire manufacturer, production plant, brand and date of production.

GVWR: Gross Vehicle Weight Rating

GAWR FRT: Gross Axle Weight Rating for the Front Axle.

GAWR RR: Gross Axle Weight Rating for the Rear axle.

Intended Outboard Sidewall: The side of an asymmetrical tire, that must always face outward when mounted on a vehicle.

Kilopascal (kPa): The metric unit for air pressure.

Light truck(LT) tire: A tire designated by its manufacturer as primarily intended for use on lightweight trucks or multipurpose passenger vehicles.

Load Index: An assigned number ranging from 1 to 279 that corresponds to the load carrying capacity of a tire.

Load ratings: The maximum load that a tire is rated to carry for a given inflation pressure.

Maximum Inflation Pressure: The maximum air pressure to which a cold tire may be inflated. The maximum air pressure is molded onto the sidewall.

Maximum Load Rating: The load rating for a tire at the maximum permissible inflation pressure for that tire.

Maximum Loaded Vehicle Weight: The sum of curb weight; accessory weight; vehicle capacity weight; and production options weight.

Normal Occupant Weight: The number of occupants a vehicle is designed to seat multiplied by 150 lbs. (68kg).

Occupant Distribution: Designated seating positions.

Outward Facing Sidewall: The side of a asymmetrical tire that has a particular side that faces outward when mounted on a vehicle. The outward facing sidewall bears white lettering or bears manufacturer, brand, and/or model name molding that is higher or deeper than the same moldings on the inner facing sidewall.

Passenger (P-Metric) Tire: A tire used on passenger cars and some light duty trucks and multipurpose vehicles.

Ply: A layer of rubber-coated parallel cords

Pneumatic tire: A mechanical device made of rubber, chemicals, fabric and steel or other materials, that, when mounted on an automotive wheel, provides the traction and contains the gas or fluid that sustains the load.

Production options weight: The combined weight of installed regular production options weighing over 5 lb.(2.3 kg) in excess of the standard items which they replace, not previously considered in curb weight or accessory weight, including heavy duty brakes, ride levelers, roof rack, heavy duty battery, and special trim.

Recommended Inflation Pressure: Vehicle manufacturer's recommended tire inflation pressure and shown on the tire placard.

Radial Ply Tire: A pneumatic tire in which the ply cords that extend to the beads are laid at 90 degrees to the centerline of the tread.

Rim: A metal support for a tire and upon which the tire beads are seated.

Sidewall: The portion of a tire between the tread and the bead.

Speed Rating: An alphanumeric code assigned to a tire indicating the maximum speed at which a tire can operate.

Traction: The friction between the tire and the road surface. The amount of grip provided.

Tread: The portion of a tire that comes into contact with the road.

Treadwear Indicators: Narrow bands, sometimes called "wear bars," that show across the tread of a tire when only 1/16 inch of tread remains.

UTQGS: Uniform Tire Quality Grading Standards, a tire information system that provides consumers with ratings for a tire's traction, temperature and treadwear. Ratings are determined by tire manufacturers using government testing procedures. The ratings are molded into the sidewall of the tire.

Vehicle Capacity Weight: The number of designated seating positions multiplied by 150 lbs. (68kg) plus the rated cargo and luggage load.

Vehicle Maximum Load on the Tire: Load on an individual tire due to curb and accessory weight plus maximum occupant and cargo weight.

Vehicle Normal Load on the Tire: Load on an individual tire that is determined by distributing to each axle its share of the curb weight, accessory weight, and normal occupant weight and driving by 2.

Vehicle Placard: A label permanently attached to a vehicle showing the original equipment tire size and recommended inflation pressure.

All season tires

Kia specifies all season tires on some models to provide good performance for use all year round, including snowy and icy road conditions. All season tires are identified by ALL SEASON and/or M+S (Mud and Snow) on the tire sidewall. Snow tires have better snow traction than all season tires and may be more appropriate in some areas.

Summer tires

Kia specifies summer tires on some models to provide superior performance on dry roads. Summer tire performance is substantially reduced in snow and ice. Summer tires do not have the tire traction rating M+S (Mud and Snow) on the tire side wall. If you plan to operate your vehicle in snowy or icy conditions, Kia recommends the use of snow tires or all season tires on all four wheels.



WARNING

Do not use summer tires at temperatures below 45°F (7°C) or when driving on snow or ice. At temperatures below 45°F (7°C), summer tires can lose elasticity, and therefore traction and braking power as well. Change the tires on your vehicle to winter or all-weather tires of the same size as the standard tires of the vehicle. Both types of tires are identified by the M+S (Mud and Snow) marking. Using summer tires at very cold temperatures could cause cracks to form, thereby damaging the tires permanently.

Snow tires

If you equip your car with snow tires, they should be the same size and have the same load capacity as the original tires. Snow tires should be installed on all four wheels; otherwise, poor handling may result.

Snow tires should carry 4 psi (28 kPa) more air pressure than the pressure recommended for the standard tires on the tire label on the driver's side of the center pillar, or up to the maximum pressure shown on the tire sidewall, whichever is less.

Do not drive faster than 75 mph (120 km/h) when your vehicle is equipped with snow tires.

Tire chains

Tire chains, if necessary, should be installed on the front wheels.

Be sure that the chains are installed in accordance with the manufacturer's instructions.

To minimize tire and chain wear, do not continue to use tire chains when they are no longer needed.

- When driving on roads covered with snow or ice, drive at less than 20 mph (30 km/h).
- Use the SAE "S" class or wire chains.
- If you hear noise caused by chains contacting the body, retighten the chain to avoid contact with the vehicle body.
- To prevent body damage, retighten the chains after driving 0.3–0.6 miles (0.5–1.0 km).
- Do not use tire chains on vehicles equipped with aluminum wheels. In unavoidable circumstances, use a wire type chain.
- Use wire chains less than 0.59 in (15 mm) in width to prevent damage to the chain's connection.

Radial-ply tires

Radial-ply tires provide improved tread life, road hazard resistance and smoother high speed ride. The radial-ply tires used on this vehicle are of belted construction and are selected to complement the ride and handling characteristics of your vehicle.

Radial-ply tires have the same load carrying capacity as bias-ply or bias belted tires of the same size and use the same recommended inflation pressure. Mixing of radial-ply tires with bias-ply or bias belted tires is not recommended. Any combinations of radial-ply and bias-ply or bias belted tires when used on the same vehicle will seriously deteriorate vehicle handling. The best rule to follow is: identical radial-ply tires should always be used as a set of four.

Longer wearing tires can be more susceptible to irregular tread wear. It is very important to follow the tire rotation interval shown in this section to achieve the tread life potential of these tires. Cuts and punctures in radial-ply tires are repairable only in the tread area, because of sidewall flexing. Consult your tire dealer for radial-ply tire repairs.

Low aspect ratio tire (if equipped)

Low aspect ratio tires, whose aspect ratio is lower than 50, are provided for sporty looks.

Because the low aspect ratio tires are optimized for handling and braking, they may be more uncomfortable to ride in and more noisy when compared with normal tires.

CAUTION

Because the sidewall of a low aspect ratio tire is shorter than normal, the wheel and tire of a low aspect ratio tire is more easily damaged. Therefore, follow the instructions below.

- ***When driving on a rough road or off road, drive cautiously because the tires and wheels may become damaged. And after driving, inspect the tires and wheels.***
- ***When passing over a pothole, speed bump, manhole, or curb stone, drive slowly so that the tires and wheels are not damaged.***
- ***If the tire is impacted, we recommend that you inspect the tire condition or contact an authorized Kia dealer.***
- ***To prevent damage to the tire, inspect the tire condition and pressure every 1,900 miles (3,000 km).***

- It is not easy to recognize the tire damage with your own eyes. In the event that the tire is impacted, have the tire checked or replaced because the tire damage may cause air leakage from the tire.
- If the tire is damaged by driving on a rough road, off road, pothole, manhole, or curb stone, the damage will not be covered by the warranty.
- You can find out tire information on the tire sidewall.

FUSES

■ Blade type



■ Cartridge type



■ Multi fuse

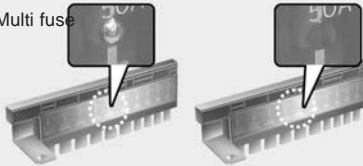

■ BFT



OJF075021

* Left side : Normal , Right side : Blown

A vehicle's electrical system is protected from electrical overload damage by fuses.

This vehicle has 2 (or 3) fuse panels, one located in the driver's side panel bolster, the other in the engine compartment near the battery.

If any of your vehicle's lights, accessories, or controls do not work, check the appropriate circuit fuse. If a fuse has blown, the element inside the fuse will melt.

If the electrical system does not work, first check the driver's side fuse panel.

Always replace a blown fuse with one of the same rating.

If the replacement fuse blows, this indicates an electrical problem. Avoid using the system involved and immediately consult an authorized Kia dealer.

Three kinds of fuses are used: blade type for lower amperage rating, cartridge type, and multi fuse for higher amperage ratings.

⚠ WARNING - Fuse replacement

- **Never replace a fuse with anything but another fuse of the same rating.**
- **A higher capacity fuse could cause damage and possibly a fire.**
- **Never install a wire or aluminum foil instead of the proper fuse - even as a temporary repair. It may cause extensive wiring damage and a possible fire.**
- **Do not modify or add-on electric wiring to the vehicle.**

⚠ CAUTION

Do not use a screwdriver or any other metal object to remove fuses because it may cause a short circuit and damage the system.

*** NOTICE**

- When replacing fuse, turn the ignition “OFF” and turn off switches of all electrical devices then remove battery (-) terminal.
- The actual fuse/relay panel label may differ from equipped items.

⚠ WARNING - Electrical Fire
Always ensure replacements fuses and relays are securely fastened when installed. Failure to do so can result in a vehicle fire.

⚠ CAUTION

- *When replacing a blown fuse or relay, make sure the new fuse or relay fits tightly into the clips. Failure to tightly install the fuse or relay may cause damage to the wiring and electric systems.*
- *Do not remove fuses, relays and terminals fastened with bolts or nuts. The fuses, relays and terminals may not be fastened correctly which may cause vehicle damage.*

⚠ CAUTION

- *Do not input any other objects except fuses or relays into fuse/relay terminals such as a driver or wiring. It may cause contact failure and system malfunction.*
- *Do not plug in screwdrivers or aftermarket wiring into the terminal originally designed for fuse and relays only. The electrical system and wiring of the vehicle interior may be damaged or burned due to contact failure.*
- *If you directly connect the wire on the taillight or replace the bulb which is over the regulated capacity to install trailers etc., the inner junction block can get burned.*

Inner panel fuse replacement



1. Turn the ignition switch and all other switches off.
 2. Open the fuse panel cover.
- If the switch is located in the “OFF” position, a caution indicator will be displayed in the cluster.

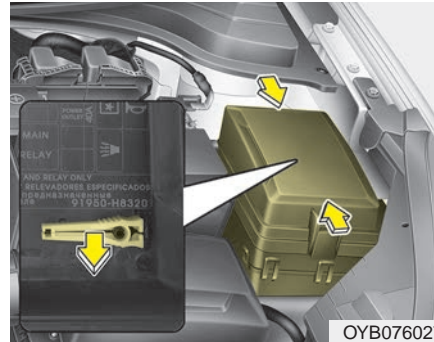

3. Pull the suspected fuse straight out. Use the removal tool provided on the engine compartment fuse panel cover.
4. Check the removed fuse; replace it if it is blown.

Spare fuses are provided in the engine compartment fuse panel.

5. Push in a new fuse of the same rating, and make sure it fits tightly in the clips.

If it fits loosely, consult an authorized Kia dealer.

If you do not have a spare, use a fuse of the same rating from a circuit you may not need for operating the vehicle, such as the power outlet fuse.

If the head lamp, turn signal lamp, stop signal lamp, fog lamp, DRL, tail lamp, HMSL do not work and the fuses are OK, check the fuse panel in the engine compartment. If a fuse is blown, it must be replaced.

* NOTICE

If the headlamp, fog lamp, turn signal lamp, or tail lamp malfunction even without any problem to the lamps, have the vehicle checked by an authorized Kia dealer for assistance.

⚠ CAUTION - Fuse Panel Covers

The contact points of the switches may wear out with excessive use. Please refrain from excessive use of the switches (except for long-term parking for over 1 month).

*** NOTICE**

- Set all switches to ON before driving.
- If the vehicle is going to be unused for over 1 month, set all switches to OFF to prevent the batteries from draining.

Memory fuse



Your vehicle is equipped with the memory fuse to prevent battery discharge if your vehicle is parked without being operated for prolonged periods. Use the following procedures before parking the vehicle for prolonged periods.

1. Turn off the engine.
2. Turn off the headlights and tail lights.
3. Open the driver's side panel cover and pull up the memory fuse.

If the memory fuse is pulled up from the fuse panel, the warning chime, audio, clock and interior lamps, etc., will not operate. Some items must be reset after replacement. Refer to "Battery" in this section.

Even though the memory fuse is pulled up, the battery can still be discharged by operation of the headlights or other electrical devices.

Engine compartment fuse replacement

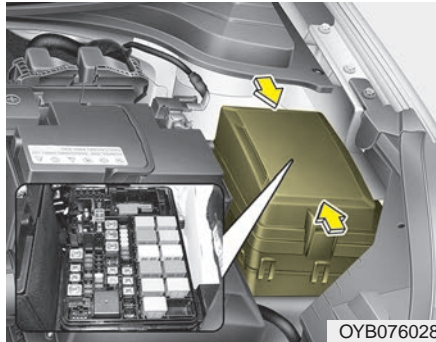

OYB076028

1. Turn the ignition switch and all other switches off.
2. Remove the fuse panel cover by pressing the tab and pulling the cover up. When the blade type fuse is disconnected, remove it by using the clip designed for changing fuses located in the engine compartment fuse box. Upon removal, securely insert reserve fuse of the same rating.

3. Check the removed fuse; replace it if it is blown. To remove or insert the fuse, use the fuse puller in the engine compartment fuse panel.
4. Push in a new fuse of the same rating, and make sure it fits tightly in the clips. If it fits loosely, consult an authorized Kia dealer.

⚠ CAUTION

After checking the fuse panel in the engine compartment, securely install the fuse panel cover through the audible clicking sound.

If not, electrical failures may occur from water contact.

Multi fuse

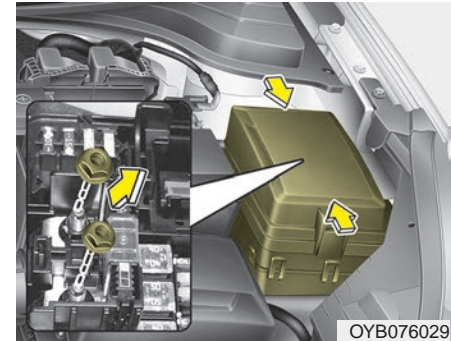

OYB076029

If the multi fuse is blown, it must be removed as follows:

1. Turn off the engine.
2. Disconnect the negative battery cable.
3. Remove the nuts shown in the picture above.
4. Replace the fuse with a new one of the same rating.
5. Reverse these steps to reinstall the multi fuse.

 **CAUTION**

Do not disassemble nor assemble the multi fuse when it is secured with nuts and bolts. Incorrect or partial assembly torque may cause a fire. Have the vehicle checked by an authorized Kia dealer.

 **CAUTION**

Visually inspect the battery cap to ensure it is securely closed. If the battery cap is not securely closed, moisture may enter the system and damage the electrical components.

 **CAUTION - Random wiring prohibited when retrofitting equipment**

Use of random wiring in the vehicle might cause danger due to failure and damage of the vehicle's performance.

Using random wires especially when retrofitting AVN or theft alarm system, remote engine control, car phone or radio might damage the vehicle or cause fire.

 **CAUTION - Remodeling Prohibited**

Do not try remodeling the vehicle in any way. It is illegal, and may affect the vehicle's performance, durability, and safety. The manufacturer's warranty does not cover any problems caused by remodeling. Remodeling the vehicle can cause malfunction of the vehicle, wiring damage, battery discharge, connector damage, or fire.

*** NOTICE - Window tinting precaution**

Window tint(especially metallic film) might cause communication disorder or poor radio reception, and malfunction of the automatic lighting system due to excessive change of illumination inside the vehicle. The solution used might also flow into electric, electronic devices causing disorder and failure.

Fuse/relay panel description

Driver's side fuse panel

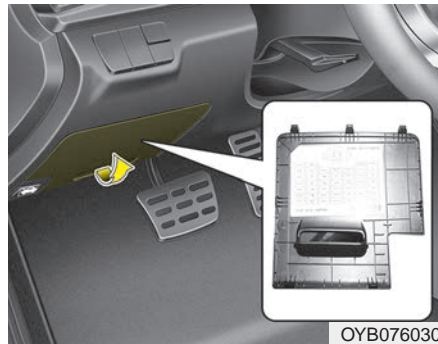

Inside the fuse/relay panel covers, you can find the fuse/relay label describing fuse/relay name and capacity.

* NOTICE

Not all fuse panel descriptions in this manual may be applicable to your vehicle. It is accurate at the time of printing. When you inspect the fuse panel in your vehicle, refer to the fuse panel label.

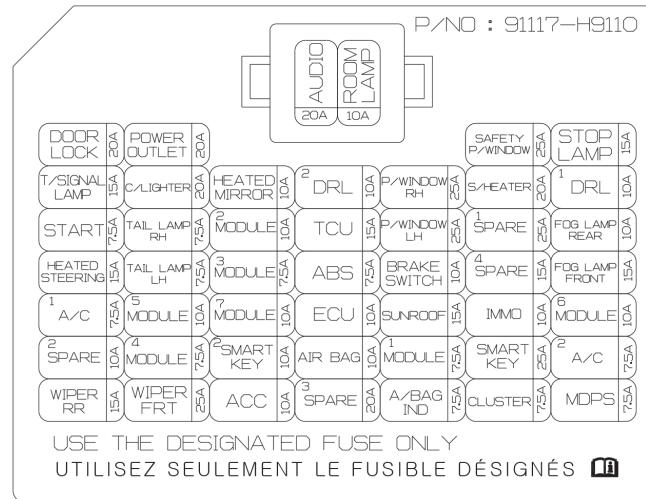

OSC070008N

Instrument panel (Driver's side fuse panel)

Fuse Name	Fuse rating	Circuit Protected
DOOR LOCK	20A	Tail Gate Unlock Relay, Door Lock/Unlock Relay, Two Turn Unlock Relay
POWER OUTLET	20A	Power Outlet
SAFETY P/WINDOW	25A	Driver Safety Power Window Module
STOP LAMP	15A	Stop Signal Electronic Module
T/SIGNAL LAMP	15A	BCM (Body Control Module), SLM (Seat Belt & Lighting Module)
C/LIGHTER	20A	Cigarette Lighter
HEATED MIRROR	10A	Driver Power Outside Mirror, Passenger Power Outside Mirror, Air Conditioner Control Module, ECM (Engine Control Module)/PCM (Power train Control Module)
DRL2	10A	BCM (Body Control Module)
P/WINDOW RH	25A	Power Window Main Switch, Passenger Power Window Switch
S/HEATER	20A	Front Seat Warmer Control Module
DRL1	10A	-
START	7.5A	With Immobilizer : ECM (Engine Control Module)/PCM (Power train Control Module), Engine Room Junction Block(Start Relay), Smart Key Control Module, Ignition Lock Switch, Transaxle Range Switch Without Immobilizer : Burglar Alarm Relay
TAIL LAMP RH	7.5A	Head Lamp Right Handle side, Rear Combination Lamp (OUT) Right Handle side, License Lamp Right Handle side, Rear Combination Lamp (IN) Right Handle side, Illumination (+)
MODULE2	10A	BCM (Body Control Module), Blind-Spot View Monitor Left Handle side/Right Handle side, Crash Pad Switch, Front View Camera

Fuse Name	Fuse rating	Circuit Protected
TCU	15A	Engine Room Junction Block(Back-Up Lamp Switch), Automatic Transmission Shift Lever, Position Switch, Stop Lamp Switch
P/WINDOW LH	25A	Power Window Main Switch
SPARE1	25A	Spare
FOG LAMP REAR	10A	-
HEATED STEERING	15A	Steering Wheel Heated
TAIL LAMP LH	7.5A	Head Lamp Left Handle side, License Lamp Left Handle side, Rear Combination Lamp (OUT) Left Handle side, Rear Combination Lamp (IN) Left Handle side, Glove Box Lamp
MODULE3	7.5A	Front Seat Warmer Control Module, Audio, Electro Chromic Mirror, Air Conditioner Control Module, Audio/Video & Navigation Head Unit, Clock Spring, Automatic Transmission Shift Lever indicator
ABS	7.5A	Data Link Connector, ESC (Electronic Stability Control) Module
BRAKE SWITCH	10A	Stop Lamp Switch, Smart Key Control Module
SPARE4	15A	Spare
FOG LAMP FRONT	15A	Front Fog Lamp Relay
A/C1	7.5A	Engine Room Junction Block(Blower Relay), Air Conditioner Control Module
MODULE5	10A	Engine Room Junction Block(Head Lamp Relay, Head Lamp Hi Relay), Rain Sensor, Sunroof Motor, Front Seat Warmer Control Module, Driver Safety Power Window Module
MODULE7	10A	TPMS (Tire Pressure Monitoring System) Unit
ECU	10A	ECM (Engine Control Module)/PCM (Power train Control Module)

Fuse Name	Fuse rating	Circuit Protected
SUNROOF	15A	Sunroof Motor
IMMO	10A	Immobilizer Module
MODULE6	10A	Key Solenoid
SPARE2	10A	Spare
MODULE4	7.5A	SLM (Seat Belt & Lighting Module), BCM (Body Control Module), Smart Key Control Module
SMART KEY2	10A	Immobilizer Module, Smart Key Control Module
AIR BAG	10A	ACU (Airbag Control Unit), Passenger Occupant Detection Sensor
MODULE1	7.5A	BCM (Body Control Module), SLM (Seat Belt & Lighting Module), Key Interlock
SMART KEY	25A	Smart Key Control Module
A/C2	7.5A	Blower Module
WIPER RR	15A	Multifunction Switch, Rear Wiper Motor, Rear Wiper Relay
WIPER FRT	25A	Multifunction Switch, Front Wiper Motor, Engine Room Junction Block(Wiper Low Relay)
ACC	10A	Power Outlet Relay, BCM (Body Control Module), SLM (Seat Belt & Lighting Module), Audio, Key Interlock, Audio/Video & Navigation Head Unit, USB Charging Connector, Power Outside Mirror Switch, Smart Key Control Module

Fuse Name	Fuse rating	Circuit Protected
SPARE3	20A	Spare
A/BAG IND	7.5A	Instrument Cluster, Center Fascia Switch
CLUSTER	7.5A	Instrument Cluster
MDPS	7.5A	MDPS (Motor Driven Power Steering) Unit
AUDIO	20A	Audio, Audio/Video & Navigation Head Unit
ROOM LAMP	10A	Room Lamp Relay, Glove Box Lamp, Overhead Console Lamp, Air Conditioner Control Module, SLM (Seat Belt & Lighting Module), BCM (Body Control Module), Auto Light & Photo Sensor, TPMS (Tire Pressure Monitoring System) Unit, Front Vanity Lamp Left Handle side/Right Handle side, Instrument Cluster, Data Link Connector, Room Lamp, Trunk Room Lamp

Engine compartment fuse panel

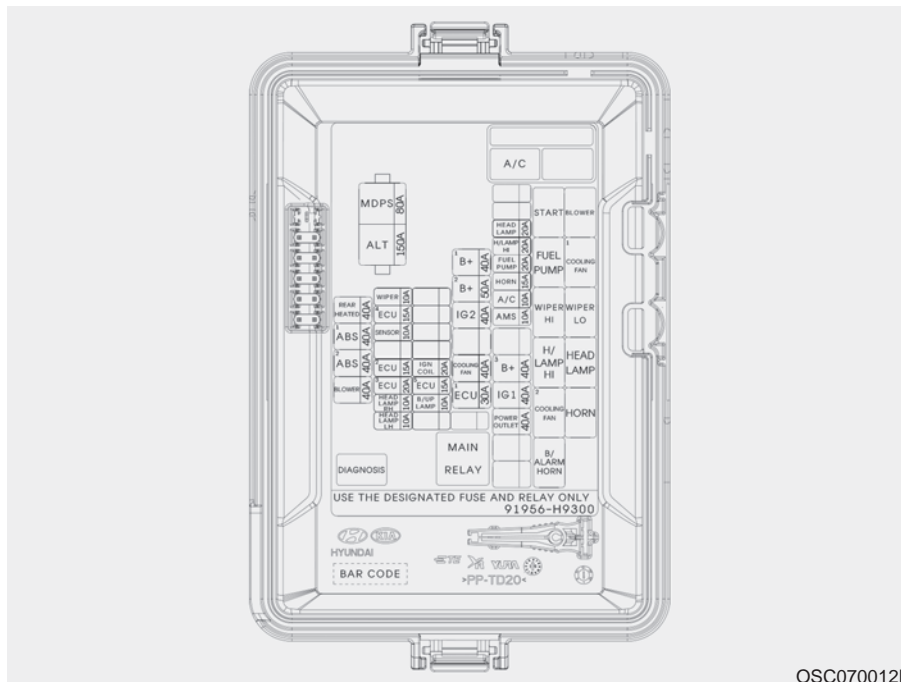
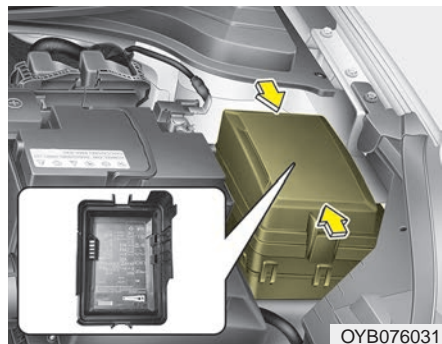

OSC070012N

Engine room compartment fuse panel

Fuse Name	Fuse rating	Circuit Protected
MDPS	80A	MDPS (Motor Driven Power Steering) Unit
ALT	150A	Fuse - ABS1, BAS2, BLOWER, REAR HEATED
REAR HEATED	40A	Instrument Panel Junction Block (Rear Defogger Relay)
ABS1	40A	ESC (Electronic Stability Control) Module
ABS2	40A	ESC (Electronic Stability Control) Module
BLOWER	40A	Blower Relay
WIPER	10A	[With BCM (Body Control Module)] Front Wiper Motor, Multifunction Switch, [With Out BCM (Body Control Module)] Wiper Low Relay
ECU4	15A	ECM (Engine Control Module)/PCM (Power train Control Module)
SENSOR	10A	Oil Control Valve #1/#2, Cooling Fan1/2 Relay, Oxygen Sensor (Up), Oxygen Sensor (Down), Variable Intake Solenoid Valve, Air Conditioner Relay, Purge Control Solenoid Valve, Canister Close Valve
ECU2	15A	ECM (Engine Control Module)/PCM (Power train Control Module)
ECU3	20A	ECM (Engine Control Module)/PCM (Power train Control Module)
HEAD LAMP RH	10A	Head Lamp Right Handle side
HEAD LAMP LH	10A	Head Lamp Left Handle side
IGN COIL	20A	Ignition Coil #1~#4
ECU5	15A	ECM (Engine Control Module)/PCM (Power train Control Module), Fuel Pump Relay, Injector #1~#4

Maintenance

Fuse Name	Fuse rating	Circuit Protected
B/UP LAMP	10A	Back-Up Lamp Switch
B+1	40A	Instrument Panel Junction Block (Fuse - DRL2, FOGLAMP FRONT, STOP LAMP, MODULE6, Power Connector (AUDIO, ROOM LAMP))
B+2	50A	Instrument Panel Junction Block (Fuse - IMMO, SMART KEY, BRAKE SWITCH, SAFETY P/WINDOW, S/HEATER, SUNROOF, Power Window Relay)
IG2	40A	Ignition Switch, IG2 Relay, Start Relay
COOLING FAN	40A	Cooling Fan1/2 Relay
ECU1	30A	Fuse - ECU3, ECU4, Main Relay
HEAD LAMP	20A	Head Lamp Relay
H/LAMP HI	20A	With CANADA DRL : SLM(Seat Belt & Lighting Module) or BCM(Body Control Module) Without CANADA DRL : Head Lamp HI Relay
FUEL PUMP	20A	Fuel Pump Relay
HORN	15A	Horn Relay/ Burglar Alarm Horn Relay
A/C	10A	Air Conditioner Relay
AMS	10A	Battery Sensor
B+3	40A	Instrument Panel Junction Block (Fuse - T/SIGNAL LAMP, DOOR LOCK, Tail Lamp Relay)
IG1	40A	Start Relay, [With Smart Key] IG1 Relay, ACC Relay, [With Out Smart Key] Ignition Switch
POWER OUTLET	40A	Instrument Panel Junction Block (Power Outlet Relay)

Relay

Relay Name	Type
Main Relay	MINI
Start Relay	MICRO
Fuel Pump Relay	MICRO
Wiper HI Relay	MICRO
H/Lamp HI Relay	MICRO
Cooling Fan2 Relay	MICRO
B/Alarm Horn Relay	MICRO
Blower Relay	MICRO
Cooling Fan1 Relay	MICRO
Wiper LO Relay	MICRO
Head Lamp Relay	MICRO
Horn Relay	MICRO
A/C Relay	MICRO

LIGHT BULBS

Bulb replacement precaution

Please keep extra bulbs on hand with appropriate wattage ratings in case of emergencies.

Refer to “Bulb Wattage” in chapter 8.

When changing lamps, first turn off the engine at a safe place, firmly apply the parking brake and detach the battery’s negative (-) terminal.

 **WARNING - Working on the lights**

Prior to working on the light, firmly apply the parking brake, ensure that the ignition switch is turned to the LOCK position and turn off the lights to avoid sudden movement of the vehicle and burning your fingers or receiving an electric shock.

Use only bulbs of the specified wattage.

 **CAUTION - Light replacement**

Be sure to replace the burned-out bulb with one of the same wattage rating. Otherwise, it may cause damage to the fuse or electric wiring system.

 **CAUTION - Headlamp Lens**

To prevent damage, do not clean the headlamp lens with chemical solvents or strong detergents.

• **Lamp part malfunction due to net-work failure**

The headlamp, taillight, and fog light may light up when the head lamp switch is turned ON, and not light up when the taillight or fog light switch is turned ON. This may be caused by network failure or vehicle electrical control system malfunction. If there is a problem, we recommend the system be serviced by an authorized Kia dealer.

• **Lamp part malfunction due to electrical control system stabilization**

A normally functioning lamp may flicker momentarily. This momentary occurrence is due to stabilization function of the vehicle's electrical control system. If the lamp soon returns to normal, the vehicle does not require service.

However, if the lamp goes out after the momentary flickering, or the flickering continues, we recommend the system be serviced by an authorized Kia dealer.

*** NOTICE**

- If the light bulb or lamp connector is removed while the lamp is still on, the fuse box's electronic system may log it as a malfunction. Therefore, a lamp malfunction incident may be recorded as a Diagnostic Trouble Code (DTC) in the fuse box.
- It is normal for an operating lamp to flicker momentarily. This is due to a stabilization function of the vehicle's electronic control device. If the lamp lights up normally after momentarily blinking, then it is functioning as normal. However, if the lamp continues to flicker several times or turns off completely, there may be an error in the vehicle's electronic control device. Please have the vehicle checked by an authorized Kia dealer immediately.

*** NOTICE**

We recommend that the headlight aiming be adjusted after an accident or after the headlight assembly is reinstalled at an authorized Kia dealer.

*** NOTICE**

You can find moisture inside the lens of lamps after a car wash or driving in the rain. It is a natural event caused by the temperature difference between the inside and the outside of the lamp and does not mean a problem with its functions. The moisture inside the lamp would disappear if you drive the vehicle with the headlamp turned on, however, the level at which the moisture is removed may differ depending on the size / location / condition of the lamp. If the moisture continues to stay inside the lamp, we recommend that you have the vehicle checked by an authorized Kia dealer.

If you don't have the necessary tools, the correct bulbs and the expertise, consult an authorized Kia dealer. In many cases, it is difficult to replace vehicle light bulbs because other parts of the vehicle must be removed before you can get to the bulb. This is especially true if you have to remove the headlamp assembly to get to the bulb(s).

Removing/installing the headlamp assembly can result in damage to the vehicle.

If non-genuine parts or substandard bulbs are used, it may lead to blowing a fuse or other wiring damages.

Do not install extra lamps or LEDs to the vehicle. If additional lights are installed, it may lead to lamp malfunctions and flickering. Additionally, the fuse box and other wiring may be damaged.

Light bulb position (Front)

■ Head lamp - Type A

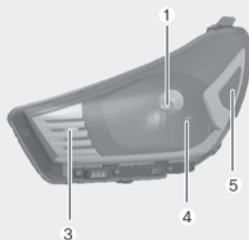

OSC070038N

■ Head lamp - Type B

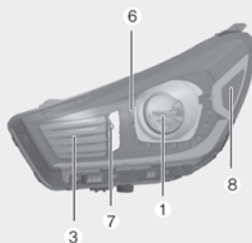

OSC070039N

■ Head lamp - Type C

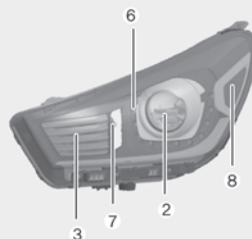

OSC070146N

■ Fog Lamp



OSC070147N

1. Headlamp (Low/High)
2. Headlamp (LED type)
3. Front turn signal lamp
4. Position lamp
5. Side maker (Bulb type)
6. Position lamp / Day time running lamp (LED type)
7. Static bending light
8. Side maker (LED type)
9. Fog lamp (Bulb type)

Light bulb position (Rear) (5 Door)

■ Rear combination lamp (5 Door) - Type A

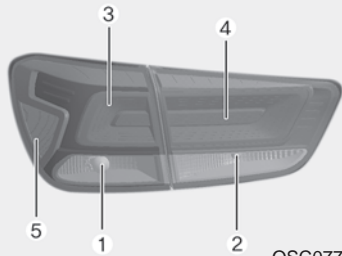

OSC077023N

■ Rear combination lamp (5 Door) - Type B

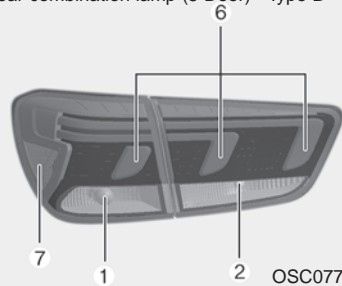

OSC077024N

■ License plate lamp (5 Door)

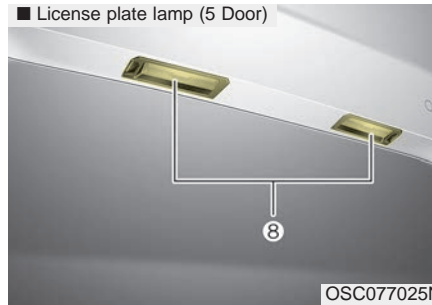

■ High mounted stop lamp (5 Door)

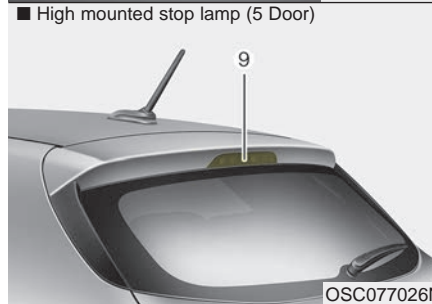

- (1) Rear turn signal lamp (Bulb type)
- (2) Back up lamp (Bulb type)
- (3) Stop and tail lamp (Bulb type)
- (4) Tail lamp (Bulb type)
- (5) Side marker (Bulb type)
- (6) Stop and tail lamp (LED type)
- (7) Side marker (LED type)
- (8) License plate lamp
- (9) High mounted stop lamp

Light bulb position (Rear) (4 Door)

■ Rear combination lamp (4 Door) - Type A

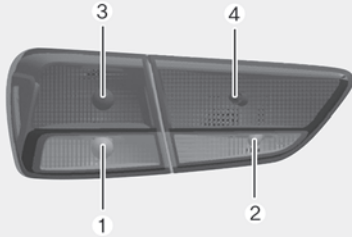

OSC077027N

■ Rear combination lamp (4 Door) - Type B

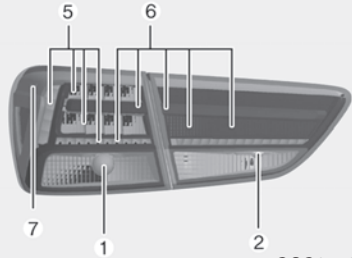

OSC077028N

■ License plate lamp (4 Door)

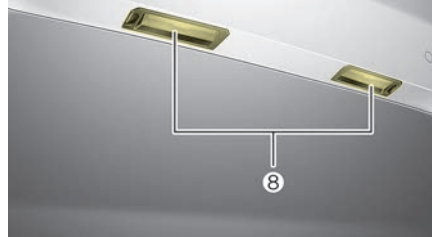

OSC077025N

■ High mounted stop lamp (4 Door)

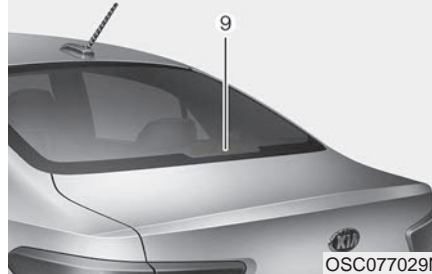

OSC077029N

- (1) Rear turn signal lamp (Bulb type)
- (2) Back up lamp (Bulb type)
- (3) Stop and tail lamp/Side marker (Bulb type)
- (4) Tail lamp (Bulb type)
- (5) Stop lamp (LED type)
- (6) Tail lamp (LED type)
- (7) Side marker (LED type)
- (8) License plate lamp
- (9) High mounted stop lamp

Light bulb position (Side)

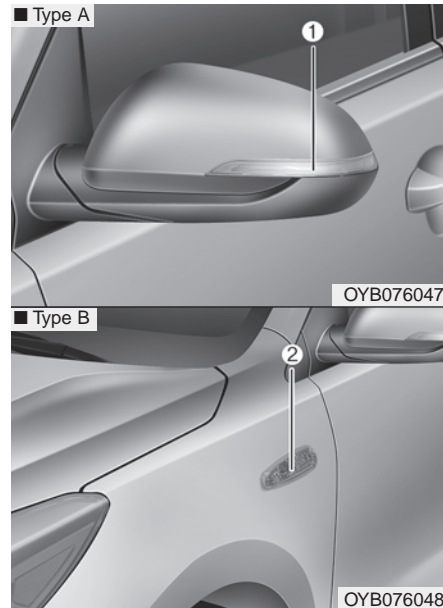

- (1) Side repeater lamp (LED type)
 (2) Side repeater lamp (bulb type)

Headlamp (Low/High beam) (Bulb type) bulb replacement (Headlamp Type A)

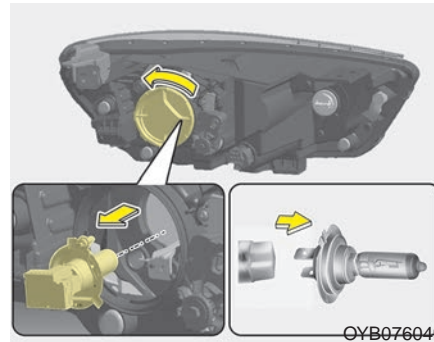

1. Open the hood.
2. Remove the headlamp bulb cover by turning it counterclockwise.
3. Disconnect the headlamp bulb socket-connector.
4. Unsnap the headlamp bulb retaining wire by pressing the end and pushing it upward.
5. Remove the bulb from the head lamp assembly.

6. Install a new headlamp bulb and snap the headlamp bulb retaining wire into position by aligning the wire with the groove on the bulb.
7. Connect the headlamp bulb socket-connector.
8. Install the headlamp bulb cover by turning it clockwise.

Headlamp bulb

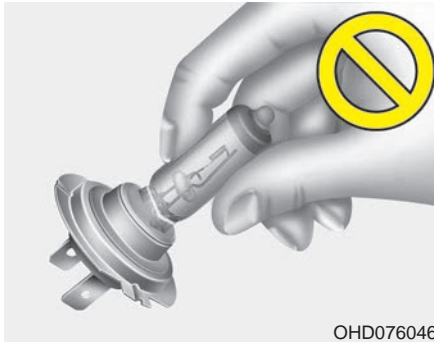

OHD076046

⚠ WARNING - Halogen bulbs

Handle halogen bulbs with care.

- Halogen bulbs contain pressurized gas that will produce flying pieces of glass if broken.

(Continued)

(Continued)

- Always handle them carefully, and avoid scratches and abrasions. If the bulbs are lit, avoid contact with liquids. Never touch the glass with bare hands. Residual oil may cause the bulb to overheat and burst when lit. A bulb should be operated only when installed in a headlamp.
- If a bulb becomes damaged or cracked, replace it immediately and carefully dispose of it.
- Wear eye protection when changing a bulb. Allow the bulb to cool down before handling it.

Headlamp (Low/High beam) (Bulb type) bulb replacement (Headlamp Type B)

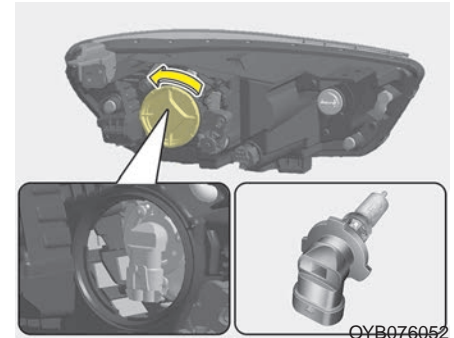

OYB076052

1. Open the hood.
2. Remove the headlamp bulb cover by turning it counterclockwise.
3. Disconnect the headlamp bulb socket-connector.
4. Remove the bulb-socket from the headlamp assembly by turning the bulb-socket counterclockwise until the tabs on the bulb-socket align with the slots on the headlamp assembly.

5. Install a new bulb-socket assembly in the headlamp assembly by aligning the tabs on the bulb-socket with the slots in the headlamp assembly. Push the bulb-socket into the headlamp assembly and turn the bulb-socket clockwise.
6. Install the headlamp bulb cover by turning it clockwise.

Headlamp bulb

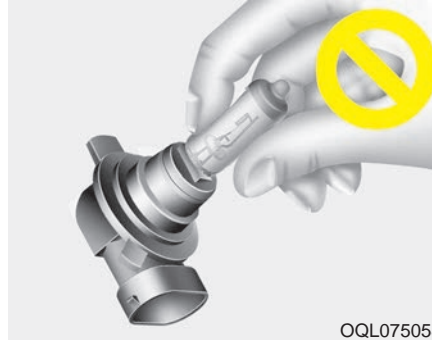

OQL075058

⚠ WARNING - Halogen bulbs

Handle halogen bulbs with care.

- Halogen bulbs contain pressurized gas that will produce flying pieces of glass if broken.

(Continued)

(Continued)

- Always handle them carefully, and avoid scratches and abrasions. If the bulbs are lit, avoid contact with liquids. Never touch the glass with bare hands. Residual oil may cause the bulb to overheat and burst when lit. A bulb should be operated only when installed in a headlamp.
- If a bulb becomes damaged or cracked, replace it immediately and carefully dispose of it.
- Wear eye protection when changing a bulb. Allow the bulb to cool down before handling it.

Front turn signal lamp bulb replacement (Headlamp Type A)

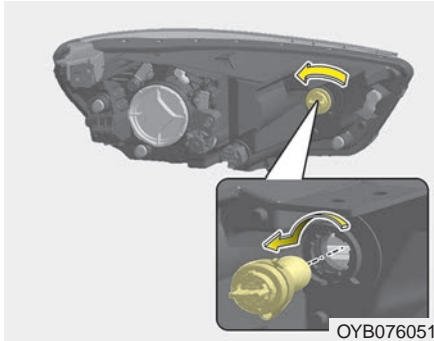

1. Open the hood.
2. Remove the bulb-socket from the headlamp assembly by turning the bulb-socket counterclockwise until the tabs on the bulb-socket align with the slots on the headlamp assembly.
3. Remove the bulb from the bulb-socket by pressing it in and rotating it counterclockwise until the tabs on the bulb align with the slots in the bulb-socket. Pull the bulb out of the bulb-socket

4. Insert a new bulb by inserting it into the bulb-socket and rotating it until it locks into place.
5. Install the socket in the headlamp assembly by aligning the tabs on the bulb-socket with the slots in the assembly. Push the bulb-socket into the headlamp assembly and turn the socket clockwise.

Front turn signal lamp bulb replacement (Headlamp Type B, C)

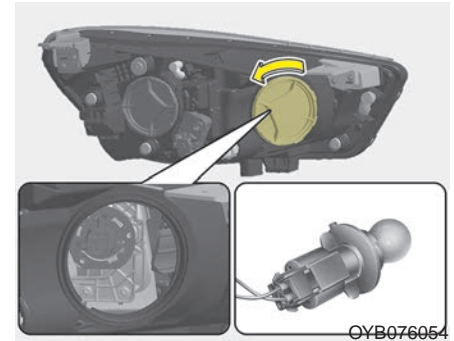

1. Open the hood.
2. Remove the headlamp bulb cover by turning it counterclockwise.
3. Remove the bulb-socket from the headlamp assembly by turning the bulb-socket counterclockwise until the tabs on the bulb-socket align with the slots on the headlamp assembly.

4. Remove the bulb from the bulb socket by pressing it in and rotating it counterclockwise until the tabs on the bulb align with the slots in the bulb-socket. Pull the bulb out of the bulb-socket
5. Insert a new bulb by inserting it into the bulb-socket and rotating it until it locks into place.
6. Install the socket in the headlamp assembly by aligning the tabs on the bulb-socket with the slots in the assembly. Push the bulb-socket into the headlamp assembly and turn the socket clockwise.
7. Install the headlamp bulb cover by turning it clockwise.

Position lamp bulb replacement (Headlamp Type A)

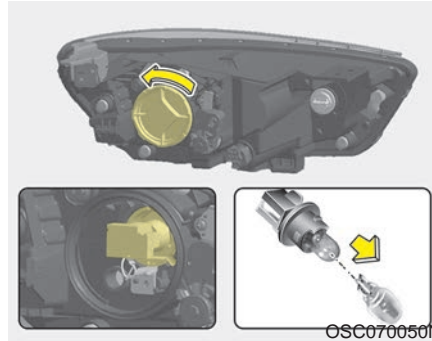

1. Open the hood.
2. Remove the headlamp bulb cover by turning it counterclockwise.
3. Remove the bulb-socket from the headlamp assembly by turning the bulb socket counterclockwise until the tabs on the bulb socket align with the slots on the headlamp assembly.

4. Remove the bulb from bulb socket by pulling it out.
5. Insert a new bulb by inserting it into the bulb socket.
6. Install the bulb socket in the headlamp assembly by aligning the tabs on the bulb socket with the slots in the headlamp assembly. Push the bulb-socket into the headlamp assembly and turn the bulb-socket clockwise.
7. Install the headlamp bulb cover by turning it clockwise.

Side marker (front) (Bulb type) bulb replacement (Headlamp Type A)

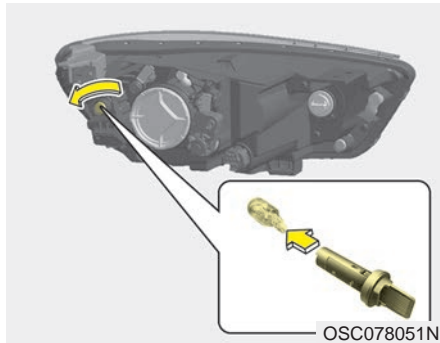

1. Open the hood.
2. Remove the bulb-socket from the headlamp assembly by turning the bulb-socket counterclockwise until the tabs on the bulb-socket align with the slots on the headlamp assembly.
3. Remove the bulb from the bulb-socket by pulling it out.

4. Insert a new bulb by inserting it into the bulb-socket.
5. Install the socket in the headlamp assembly by aligning the tabs on the bulb-socket with the slots in the assembly. Push the bulb-socket into the headlamp assembly and turn the socket clockwise.

Static bending light replacement (Headlamp Type B,C)

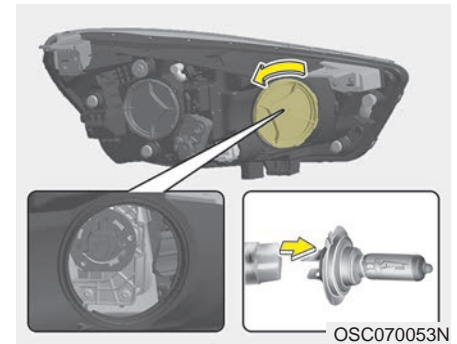

1. Open the hood.
2. Remove the headlamp bulb cover by turning it counterclockwise.
3. Disconnect the static bending light bulb socket-connector.
4. Unsnap the static bending light bulb retaining wire by pressing the end and pushing it upward.

5. Remove the bulb from the head lamp assembly.
6. Install a new static bending light bulb and snap the static bending light bulb retaining wire into position by aligning the wire with the groove on the bulb.
7. Connect the static bending light bulb socket-connector.
8. Install the headlamp bulb cover by turning it clockwise.

Front fog lamp (Bulb type) bulb replacement

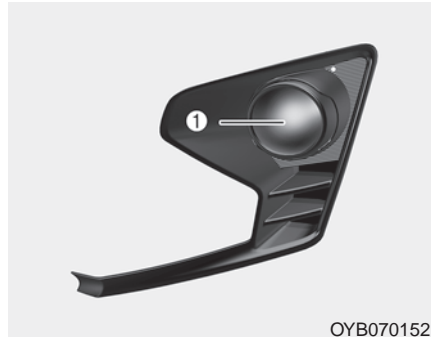

1. Disconnect the negative (-) battery terminal.
2. Disconnect the side after loosening the front bumper sides screws and clips.
3. Disconnect the front fog lamp connector.
4. Remove the socket from the assembly by turning the socket counterclockwise until the tabs on the socket align with the slots on the assembly.

5. Remove the bulb from the socket by pressing it in and rotating it counter-clockwise until the tabs on the bulb align with the slots in the socket. Pull the bulb out of the socket.
6. Insert a new bulb by inserting it into the socket and rotating it until it locks into place.
7. Install the socket in the assembly by aligning the tabs on the socket with the slots in the assembly. Push the socket into the assembly and turn the socket clockwise.
8. Connect the front fog lamp connector.
9. Install the front bumper side assembly to the body of the vehicle.

Headlamp (Low/High beam) (LED type) bulb replacement (Headlamp Type C)



If the headlamp (Low/High beam) (1) does not operate, have the vehicle checked by an authorized Kia dealer.

Position lamp + DRL (LED type) bulb replacement



If the position lamp + DRL (LED) (1) does not operate, have the vehicle checked by an authorized Kia dealer. The LED lamps cannot be replaced as a single component because it is part of an integrated unit. The LED lamps have to be replaced with the unit.

A skilled technician should check or repair the position lamp + DRL (LED), for it may damage related parts of the vehicle.

Side marker (front) (LED type) bulb replacement (Headlamp Type B, C)



If the Side marker (LED) (1) does not operate, have the vehicle checked by an authorized Kia dealer.

The LED lamps cannot be replaced as a single component because it is part of an integrated unit. The LED lamps have to be replaced with the unit.

A skilled technician should check or repair the Side marker (LED), for it may damage related parts of the vehicle.

Side repeater lamp (LED type) bulb Replacement

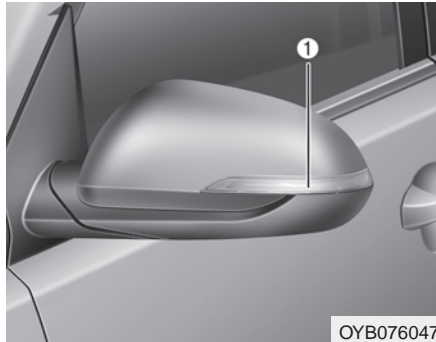

OYB076047

If the side repeater lamp (LED) (1) does not operate, have the vehicle checked by an authorized Kia dealer.

The LED lamps cannot be replaced as a single component because it is part of an integrated unit. The LED lamps have to be replaced with the unit.

A skilled technician should check or repair the side repeater lamp (LED), for it may damage related parts of the vehicle.

Side repeater lamp (bulb type) bulb Replacement

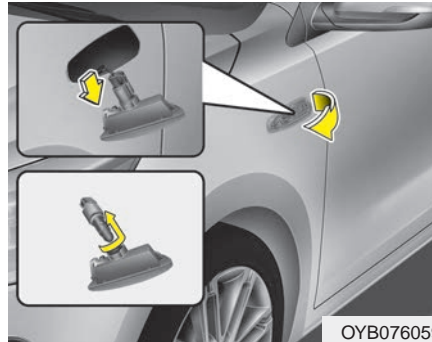

OYB076059

1. Remove the lamp assembly from the vehicle by prying the lens and pulling the assembly out.
2. Disconnect the bulb electrical connector.
3. Separate the socket and the lens parts by turning the socket counterclockwise until the tabs on the socket align with the slots on the lens part.

4. Remove the bulb by pulling it straight out.
5. Insert a new bulb in the socket.
6. Reassemble the socket and the lens part.
7. Connect the bulb electrical connector.
8. Reinstall the lamp assembly to the body of the vehicle.

Rear turn signal lamp bulb replacement (for 5 door)

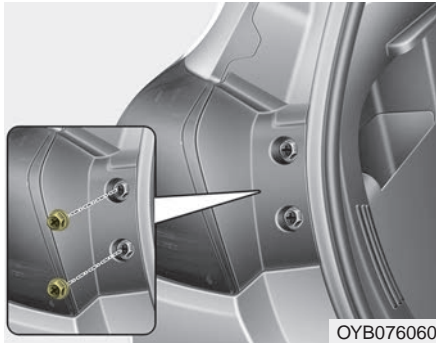

1. Open the trunk lid.
2. Loosen the light assembly retaining screws with a cross-tip screwdriver.

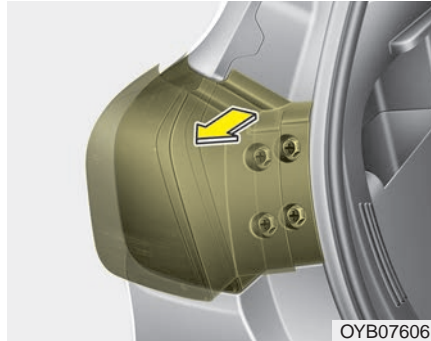

3. Remove the rear combination lamp assembly from the body of the vehicle.
4. Disconnect the rear combination lamp connector.

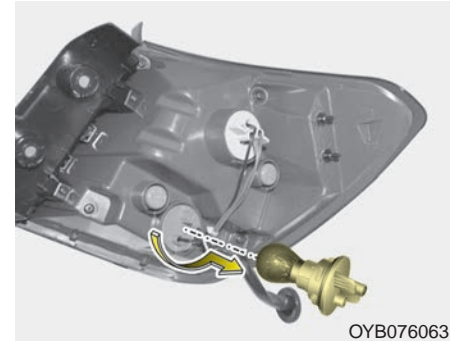

5. Remove the socket from the assembly by turning the socket counterclockwise until the tabs on the socket align with the slots on the assembly.
6. Remove the bulb from the socket by pressing it in and rotating it counterclockwise until the tabs on the bulb align with the slots in the socket. Pull the bulb out of the socket.
7. Insert a new bulb by inserting it into the socket and rotating it until it locks into place.

8. Install the socket in the assembly by aligning the tabs on the socket with the slots in the assembly. Push the socket into the assembly and turn the socket clockwise.
9. Install the rear combination lamp assembly to the body of the vehicle.

Back-up lamp bulb replacement (for 5 door)

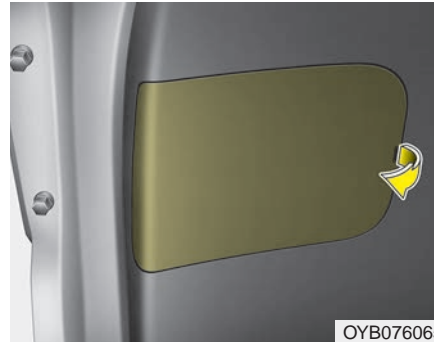

1. Open the liftgate.
2. Remove the service cover.

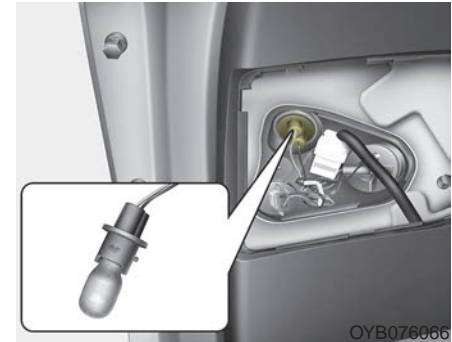

3. Remove the socket from the assembly by turning the socket counterclockwise until the tabs on the socket align with the slots on the assembly.
4. Remove the bulb from bulb-socket by pulling it out.
5. Insert a new bulb by inserting it into the bulb-socket.
6. Install the socket in the assembly by aligning the tabs on the socket with the slots in the assembly. Push the socket into the assembly and turn the socket clockwise.
7. Install the service cover by putting it into the service hole.

Stop and tail lamp bulb replacement (for 5 door)

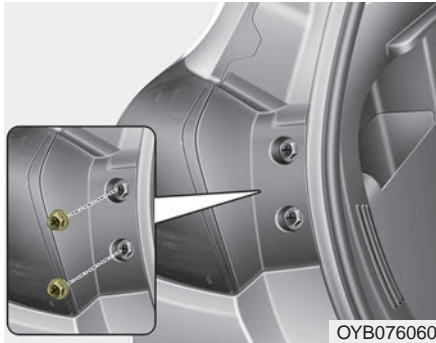

1. Open the trunk lid.
2. Loosen the light assembly retaining screws with a cross-tip screwdriver.

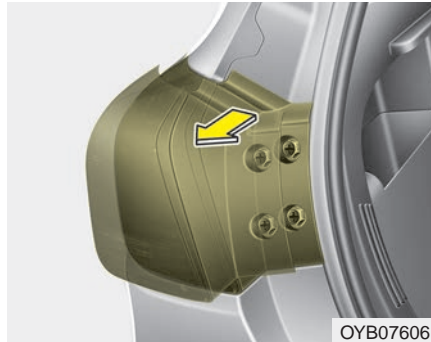

3. Remove the rear combination lamp assembly from the body of the vehicle.
4. Disconnect the rear combination lamp connector.

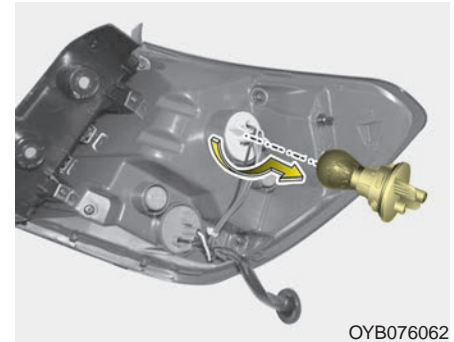

5. Remove the socket from the assembly by turning the socket counterclockwise until the tabs on the socket align with the slots on the assembly.
6. Remove the bulb from the socket by pressing it in and rotating it counterclockwise until the tabs on the bulb align with the slots in the socket. Pull the bulb out of the socket.
7. Insert a new bulb by inserting it into the socket and rotating it until it locks into place.

8. Install the socket in the assembly by aligning the tabs on the socket with the slots in the assembly. Push the socket into the assembly and turn the socket clockwise.
9. Install the rear combination lamp assembly to the body of the vehicle.

Tail lamp (inside) bulb replacement (for 5 door)

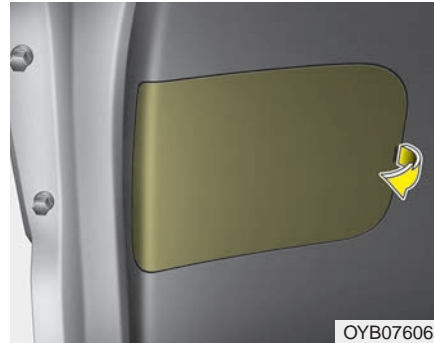

1. Open the liftgate.
2. Remove the service cover.

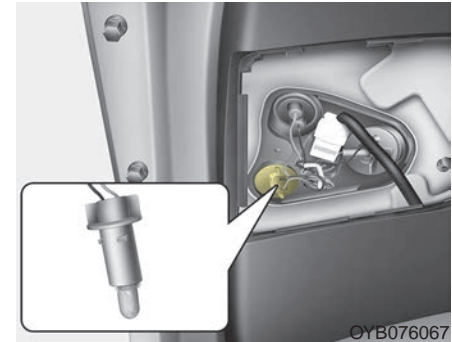

3. Remove the socket from the assembly by turning the socket counterclockwise until the tabs on the socket align with the slots on the assembly.
4. Remove the bulb from bulb-socket by pulling it out.
5. Insert a new bulb by inserting it into the bulb-socket.
6. Install the socket in the assembly by aligning the tabs on the socket with the slots in the assembly. Push the socket into the assembly and turn the socket clockwise.
7. Install the service cover by putting it into the service hole.

**Side marker (rear) (Bulb type)
bulb replacement (Rear combination
lamp Type A) (for 5 door)**

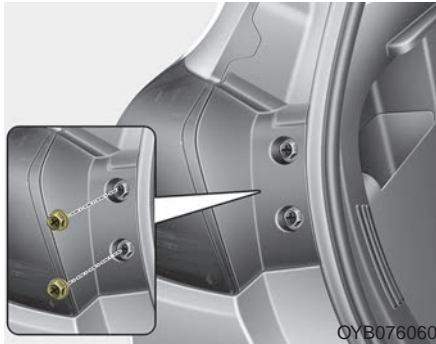

1. Open the liftgate.
2. Remove the service cover.
3. Loosen the light assembly retaining screws with a cross-tip screwdriver.

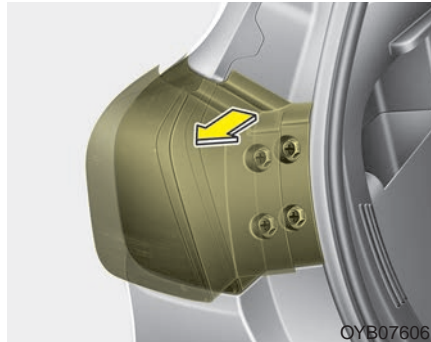

4. Remove the rear combination lamp assembly from the body of the vehicle.
5. Disconnect the rear combination lamp connector.

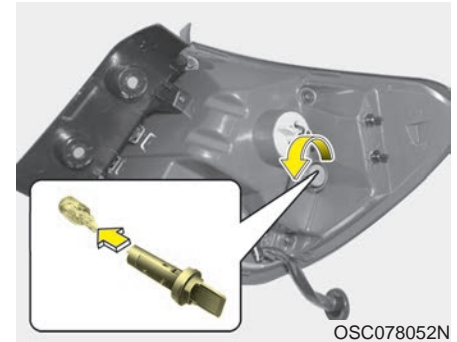

6. Remove the socket from the assembly by turning the socket counterclockwise until the tabs on the socket align with the slots on the assembly.
7. Remove the bulb from bulb-socket by pulling it out.
8. Insert a new bulb by inserting it into the bulb-socket.
9. Install the socket in the assembly by aligning the tabs on the socket with the slots in the assembly. Push the socket into the assembly and turn the socket clockwise.

10. Connect the rear combination lamp connector.
11. Install the rear combination lamp assembly to the body of the vehicle.
12. Install the service cover.

Stop and tail lamp (LED type) bulb replacement (for 5 door)

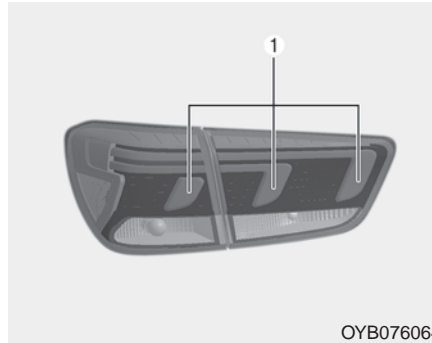

OYB076064

If the stop and tail lamp (LED) (1) does not operate, have the vehicle checked by an authorized Kia dealer. The LED lamps cannot be replaced as a single component because it is part of an integrated unit. The LED lamps have to be replaced with the unit.

A skilled technician should check or repair the stop and tail lamp (LED), for it may damage related parts of the vehicle.

Side marker (rear) (LED type) bulb replacement (Rear combination lamp Type B) (for 5 door)



OSC078024N

If the Side marker (LED) (1) does not operate, have the vehicle checked by an authorized Kia dealer.

The LED lamps cannot be replaced as a single component because it is part of an integrated unit. The LED lamps have to be replaced with the unit.

A skilled technician should check or repair the Side marker (LED), for it may damage related parts of the vehicle.

License plate lamp bulb replacement

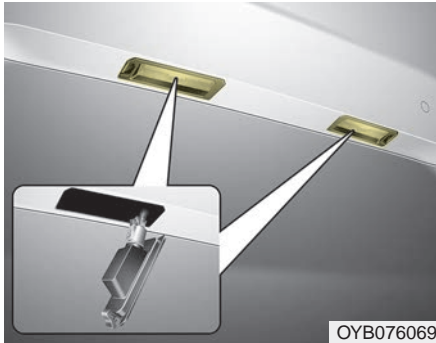

1. Using a flat-blade screwdriver, gently pry the lens cover from lamp housing.
2. Remove the socket from the assembly by turning the socket counterclockwise until the tabs on the socket align with the slots on the assembly.

3. Remove the bulb from bulb-socket by pulling it out.
4. Insert a new bulb by inserting it into the bulb-socket.
5. Install the socket in the assembly by aligning the tabs on the socket with the slots in the assembly. Push the socket into the assembly and turn the socket clockwise.
6. Align the lens cover tabs with the lamp housing notches and snap the lens into place.

High mounted stop lamp bulb replacement (for 5 door)

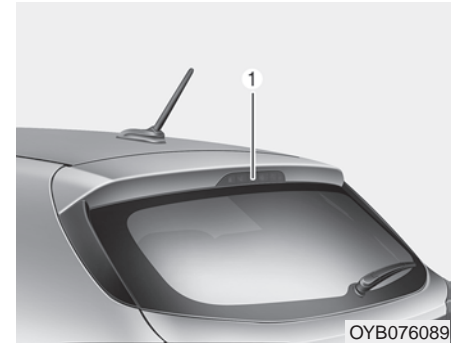

If the high mounted stop lamp (1) does not operate, have the vehicle checked by an authorized Kia dealer. A skilled technician should check or repair the high mounted stop lamp, for it may damage related parts of the vehicle.

Rear turn signal lamp bulb replacement (for 4 door)



1. Open the trunk lid.
2. Remove the service cover by pulling out the service cover.

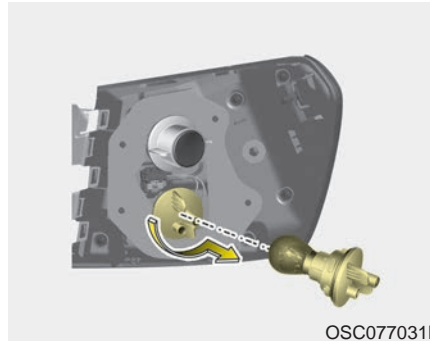

3. Remove the socket from the assembly by turning the socket counterclockwise until the tabs on the socket align with the slots on the assembly.
4. Remove the bulb from the socket by pressing it in and rotating it counterclockwise until the tabs on the bulb align with the slots in the socket. Pull the bulb out of the socket.
5. Insert a new bulb by inserting it into the socket and rotating it until it locks into place.
6. Install the socket in the assembly by aligning the tabs on the socket with the slots in the assembly. Push the socket into the assembly and turn the socket clockwise.
7. Install the service cover.

Back-up lamp bulb replacement (for 4 door)



1. Open the trunk lid.
2. Loosen the retaining screw of the trunk lid cover and then remove the cover.

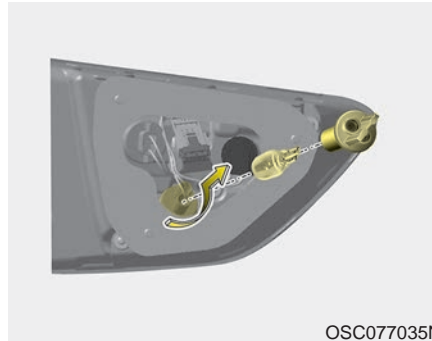

3. Remove the socket from the assembly by turning the socket counterclockwise until the tabs on the socket align with the slots on the assembly.
4. Remove the bulb from bulb-socket by pulling it out.
5. Insert a new bulb by inserting it into the bulb-socket.
6. Install the socket in the assembly by aligning the tabs on the socket with the slots in the assembly. Push the socket into the assembly and turn the socket clockwise.
7. Install the trunk lid cover.

Stop and tail lamp / Side marker (Bulb type) replacement (for 4 door)



1. Open the trunk lid.
2. Remove the service cover by pulling out the service cover.

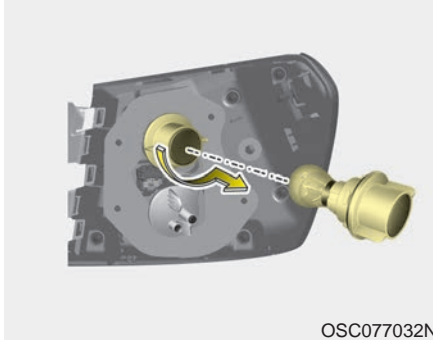

OSC077032N

3. Remove the socket from the assembly by turning the socket counterclockwise until the tabs on the socket align with the slots in the assembly.
4. Remove the bulb from the socket by pressing it in and rotating it counterclockwise until the tabs on the bulb align with the slots in the socket. Pull the bulb out of the socket.
5. Insert a new bulb by inserting it into the socket and rotating it until it locks into place.

6. Install the socket in the assembly by aligning the tabs on the socket with the slots in the assembly. Push the socket into the assembly and turn the socket clockwise.

7. Install the service cover.

Tail lamp (Bulb type) bulb replacement (for 4 door)



OSC077034N

1. Open the trunk lid.
2. Loosen the retaining screw of the trunk lid cover and then remove the cover.

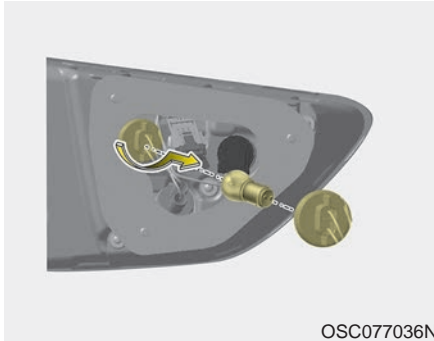

OSC077036N

3. Remove the socket from the assembly by turning the socket counterclockwise until the tabs on the socket align with the slots on the assembly.
4. Remove the bulb from the socket by pressing it in and rotating it counterclockwise until the tabs on the bulb align with the slots in the socket. Pull the bulb out of the socket.
5. Insert a new bulb by inserting it into the socket and rotating it until it locks into place.

6. Install the socket in the assembly by aligning the tabs on the socket with the slots in the assembly. Push the socket into the assembly and turn the socket clockwise.

7. Install the trunk lid cover.

Stop and tail lamp (LED type) bulb replacement (for 4 door)

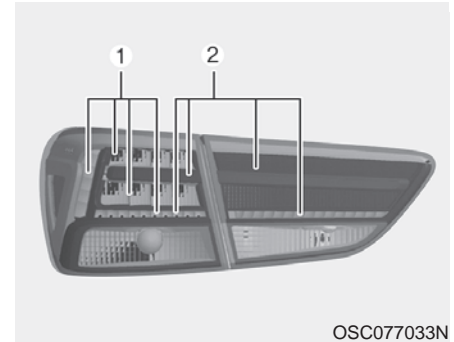

OSC077033N

If the stop and tail lamp (LED) (1,2) does not operate, have the vehicle checked by an authorized Kia dealer.

The LED lamps cannot be replaced as a single component because it is part of an integrated unit. The LED lamps have to be replaced with the unit.

A skilled technician should check or repair the stop and tail lamp (LED), for it may damage related parts of the vehicle.

Side marker (rear) (LED type) bulb replacement (Rear combination lamp Type B) (for 4 door)

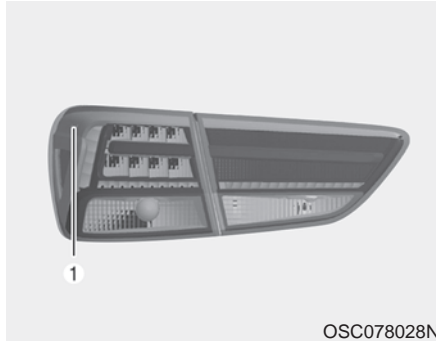

OSC078028N

If the Side marker (LED) (1) does not operate, have the vehicle checked by an authorized Kia dealer.

The LED lamps cannot be replaced as a single component because it is part of an integrated unit. The LED lamps have to be replaced with the unit.

A skilled technician should check or repair the Side marker (LED), for it may damage related parts of the vehicle.

High mounted stop lamp bulb replacement (for 4 door)

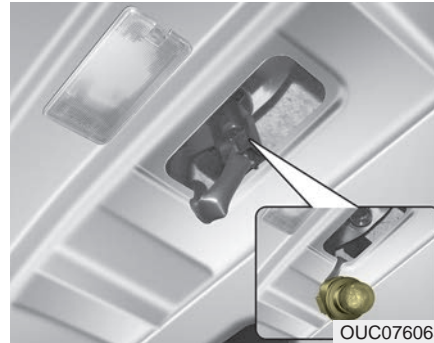

1. Open the trunk lid.
2. Remove the socket from the housing by turning the socket counter-clockwise until the tabs on the socket align with the slots on the housing.
3. Remove the bulb from bulb-socket by pulling it out.

4. Insert a new bulb by inserting it into the bulb-socket.
5. Install the socket in the housing by aligning the tabs on the socket with the slots in the housing. Push the socket into the housing and turn the socket clockwise.

Trunk lamp bulb replacement (for 4 door)

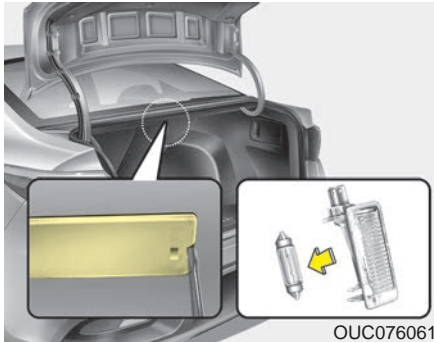



1. Using a flat-blade screwdriver, gently pry the lens cover from lamp housing.
2. Remove the bulb by pulling it straight out.
3. Install a new bulb in the socket.
4. Align the lens cover tabs with the lamp housing notches and snap the lens into place.

CAUTION

Be careful not to dirty or damage the lens, lens tab, and plastic housings.

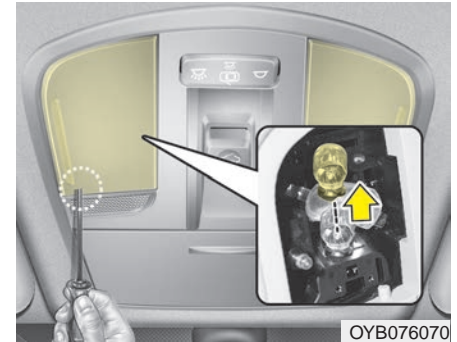
Map lamp bulb replacement



 **WARNING - Interior lamps**
Prior to working on the Interior lamps, ensure that the "OFF" button is depressed to avoid burning your fingers or receiving an electric shock.

1. Using a flat-blade screwdriver, gently pry the lamp assembly from interior.
2. Remove the bulb by pulling it straight out.
3. Install a new bulb in the socket.
4. Install the lamp assembly to interior.

⚠ CAUTION

Be careful not to dirty or damage the lens, lens tab, and plastic housings.

Vanity mirror lamp bulb replacement



⚠ WARNING - Interior lamps
Prior to working on the Interior lamps, ensure that the "OFF" button is depressed to avoid burning your fingers or receiving an electric shock.

1. Using a flat-blade screwdriver, gently pry the lamp assembly from interior.
2. Remove the bulb by pulling it straight out.
3. Install a new bulb in the socket.
4. Install the lamp assembly to interior.

⚠ CAUTION

Be careful not to dirty or damage the lens, lens tab, and plastic housings.

Room lamp bulb replacement

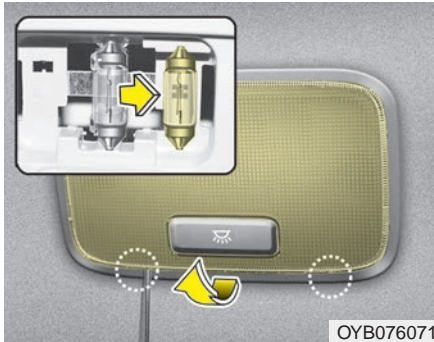

⚠ WARNING - Interior lamps
Prior to working on the Interior lamps, ensure that the “OFF” button is depressed to avoid burning your fingers or receiving an electric shock.

1. Using a flat-blade screwdriver, gently pry the lens cover from lamp housing.
2. Remove the bulb by pulling it straight out.
3. Install a new bulb in the socket.
4. Align the lens cover tabs with the lamp housing notches and snap the lens into place.

⚠ CAUTION

Be careful not to dirty or damage the lens, lens tab, and plastic housings.

Glove box lamp bulb replacement

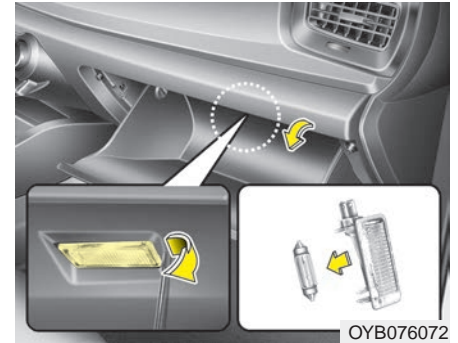

1. Using a flat-blade screwdriver, gently pry the lamp assembly from interior.
2. Remove the bulb by pulling it straight out.
3. Install a new bulb in the socket.
4. Install the lamp assembly to interior.

⚠ CAUTION

Be careful not to dirty or damage the lens, lens tab, and plastic housings.

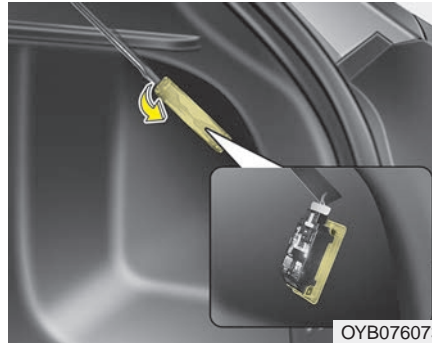
Liftgate room lamp bulb replacement (for 5 door)

1. Using a flat-blade screwdriver, gently pry the lens cover from lamp housing.
2. Remove the bulb by pulling it straight out.
3. Install a new bulb in the socket.
4. Align the lens cover tabs with the lamp housing notches and snap the lens into place.

⚠ CAUTION

Be careful not to dirty or damage the lens, lens tab, and plastic housings.

APPEARANCE CARE

Exterior care

Exterior general caution

It is very important to follow the label directions when using any chemical cleaner or polish. Read all warning and caution statements that appear on the label.

*** NOTICE**

If you park the vehicle around a stainless signboard or windshield building etc., the plastic exterior trim (bumper, spoiler, garnish, lamp, outside mirror etc.) may be damaged by reflected sunlight from the external structure. To avoid damaging the plastic exterior trim, park the vehicle away from the areas where the reflected light may occur or use a vehicle cover (Depending on the vehicle, the type of exterior trim applied such as spoiler may differ).

Finish maintenance

Washing

To help protect your vehicle's finish from rust and deterioration, wash it thoroughly and frequently at least once a month with lukewarm or cold water.

If you use your vehicle for off-road driving, you should wash it after each off-road trip. Pay special attention to the removal of any accumulation of salt, dirt, mud, and other foreign materials. Make sure the drain holes in the lower edges of the doors and rocker panels are kept clear and clean.

Insects, tar, tree sap, bird droppings, industrial pollution and similar deposits can damage your vehicle's finish if not removed immediately.

Even prompt washing with plain water may not completely remove all these deposits. A mild soap, safe for use on painted surfaces, may be used.

After washing, rinse the vehicle thoroughly with lukewarm or cold water. Do not allow soap to dry on the finish.

⚠ WARNING

After washing the vehicle, test the brakes while driving slowly to see if they have been affected by water. If braking performance is impaired, dry the brakes by applying them lightly while maintaining a slow forward speed.

High-pressure washing

- When using high-pressure washers, make sure to maintain sufficient distance from the vehicle. Insufficient clearance or excessive pressure can lead to component damage or water penetration.
- Do not spray the camera, sensors or its surrounding area directly with a high pressure washer. Shock applied from high pressure water may cause the device to not operate normally.
- Do not bring the nozzle tip close to boots (rubber or plastic covers) or connectors as they may be damaged if they come into contact with high pressure water.



CAUTION - Wet engine

- ***Washing the engine compartment with water, including high pressure water, may cause the failure of electrical circuits located in the engine compartment.***
- ***Never allow water or other liquids to come in contact with electrical/electronic components inside the vehicle as this may damage them.***

Waxing

Wax the vehicle when water will no longer bead on the paint.

Always wash and dry the vehicle before waxing. Use a good quality liquid or paste wax, and follow the manufacturer's instructions. Wax all metal trim to protect it and to maintain its luster.

Removing oil, tar, and similar materials with a spot remover will usually strip the wax from the finish. Be sure to re-wax these areas even if the rest of the vehicle does not yet need waxing.

Do not apply wax on an embossed unpainted unit, as it may tarnish the unit.

 **CAUTION - Drying vehicle**

- *Wiping dust or dirt off the body with a dry cloth will scratch the finish.*
- *Do not use steel wool, abrasive cleaners, acid detergents or strong detergents containing high alkaline or caustic agents on chrome-plated or anodized aluminum parts. This may result in damage to the protective coating and cause discoloration or paint deterioration.*

Finish damage repair

Deep scratches or stone chips in the painted surface must be repaired promptly. Exposed metal will quickly rust and may develop into a major repair expense.

If your vehicle is damaged and requires any metal repair or replacement, be sure the body shop applies anti-corrosion materials to the parts repaired or replaced.

Bright-metal maintenance

- To remove road tar and insects, use a tar remover, not a scraper or other sharp object.
- To protect the surfaces of bright-metal parts from corrosion, apply a coating of wax or chrome preservative and rub to a high luster.
- During winter weather or in coastal areas, cover the bright metal parts with a heavier coating of wax or preservative. If necessary, coat the parts with non-corrosive petroleum jelly or other protective compound.

Underbody maintenance

Road salt and other corrosive chemicals are used in cold weather states to melt snow and prevent ice accumulation. If these chemicals are not regularly removed, they will corrode the vehicle underbody and over time damage fuel lines, the fuel tank retention system, the vehicle suspension, the exhaust system, and even the body frame. The National Highway Traffic Safety Administration has warned all vehicle owners of all brands of the need to take the following steps:

- Wash the undercarriage of your vehicle regularly during the winter and whenever your vehicle has been exposed to such salts or chemicals.

- Do a thorough washing of the undercarriage at the end of the winter.
- Use professional service technicians or governmental inspection stations to annually inspect for corrosion.
- Immediately seek an inspection of your vehicle if you become visually aware of corrosion flaking or scaling or if you become aware of a change in vehicle performance, such as soft or spongy brakes, fluids leaking, impairment of directional control, suspension noises or rattling metal straps.

Aluminum wheel maintenance

The aluminum wheels are coated with a clear protective finish.

- Do not use any abrasive cleaner, polishing compound, solvent, or wire brushes on aluminum wheels. They may scratch the finish.
- Clean the wheel when it has cooled.
- Use only a mild soap or neutral detergent, and rinse thoroughly with water. Also, be sure to clean the wheels after driving on salted roads. This helps prevent corrosion.
- Avoid washing the wheels with highspeed vehicle wash brushes.
- Do not use any alkaline or acid detergents as they may damage or corrode aluminum wheels coated with a clear protective finish.

Corrosion protection

Protecting your vehicle from corrosion

By using the most advanced design and construction practices to combat corrosion, we produce vehicles of the highest quality. However, this is only part of the job. To achieve the long-term corrosion resistance your vehicle can deliver, the owner's cooperation and assistance is also required.

Common causes of corrosion

The most common causes of corrosion on your vehicle are:

- Road salt, dirt and moisture that is allowed to accumulate underneath the vehicle.
- Removal of paint or protective coatings by stones, gravel, abrasion or minor scrapes and dents which leave unprotected metal exposed to corrosion.

High-corrosion areas

If you live in an area where your vehicle is regularly exposed to corrosive materials, corrosion protection is particularly important. Some of the common causes of accelerated corrosion are road salts, dust control chemicals, ocean air and industrial pollution.

Moisture breeds corrosion

Moisture creates the conditions in which corrosion is most likely to occur. For example, corrosion is accelerated by high humidity, particularly when temperatures are just above freezing. In such conditions, the corrosive material is kept in contact with the vehicle's surface by moisture that evaporates slowly.

Mud is particularly corrosive because it dries slowly and holds moisture in contact with the vehicle. Although the mud appears to be dry, it can still retain moisture and promote corrosion.

High temperatures can also accelerate corrosion of parts that are not properly ventilated so the moisture can be dispersed. For all these reasons, it is particularly important to keep your vehicle clean and free of mud or accumulations of other materials. This applies not only to the visible surfaces but particularly to the underside of the vehicle.

To help prevent corrosion

You can help prevent corrosion from beginning by observing the following:

Keep your vehicle clean

The best way to prevent corrosion is to keep your vehicle clean and free of corrosive materials. Attention to the underside of the vehicle is particularly important.

- If you live in a high-corrosion area — where road salts are used, near the ocean, areas with industrial pollution, acid rain, etc.—, you should take extra care to prevent corrosion. In winter, hose off the underside of your vehicle at least once a month and be sure to clean the underside thoroughly when winter is over.
- When cleaning underneath the vehicle, give particular attention to the components under the fenders and other areas that are hidden from view. Do a thorough job; just dampening the accumulated mud rather than washing it away will accelerate corrosion rather than prevent it. Water under high pressure and steam are particularly effective in removing accumulated mud and corrosive materials.

- When cleaning lower door panels, rocker panels and frame members, be sure that drain holes are kept open so that moisture can escape and not be trapped inside to accelerate corrosion.

Keep your garage dry

Don't park your vehicle in a damp, poorly ventilated garage. This creates a favorable environment for corrosion. This is particularly true if you wash your vehicle in the garage or drive it into the garage when it is still wet or covered with snow, ice or mud. Even a heated garage can contribute to corrosion unless it is well ventilated so moisture is dispersed.

Keep paint and trim in good condition

Scratches or chips in the finish should be covered with "touch-up" paint as soon as possible to reduce the possibility of corrosion. If bare metal is showing through, the attention of a qualified body and paint shop is recommended.

Bird droppings: Bird droppings are highly corrosive and may damage painted surfaces in just a few hours. Always remove bird droppings as soon as possible.

Don't neglect the interior

Moisture can collect under the floor mats and carpeting and cause corrosion. Check under the mats periodically to be sure the carpeting is dry. Use particular care if you carry fertilizers, cleaning materials or chemicals in the vehicle.

These should be carried only in proper containers and any spills or leaks should be cleaned up, flushed with clean water and thoroughly dried.

Interior care

Interior general precautions

Prevent chemicals such as perfume, cosmetic oil, sun cream, hand cleaner, and air freshener from contacting the interior parts because they may cause damage or discoloration. If they do contact the interior parts, wipe them off immediately. If necessary, use a vinyl cleaner, see product instructions for correct usage.

 **CAUTION - Electrical components**

Never allow water or other liquids to come in contact with electrical/electronic components inside the vehicle as this may damage them.

Cleaning the upholstery and interior trim

Vinyl

Remove dust and loose dirt from vinyl with a whisk broom or vacuum cleaner. Clean vinyl surfaces with a vinyl cleaner.

Fabric

Remove dust and loose dirt from fabric with a whisk broom or vacuum cleaner. Clean with a mild soap solution recommended for upholstery or carpets. Remove fresh spots immediately with a fabric spot cleaner. If fresh spots do not receive immediate attention, the fabric can be stained and its color can be affected. Also, its fire-resistant properties can be reduced if the material is not properly maintained.

Using anything but recommended cleaners and procedures may affect the fabric's appearance and fire-resistant properties.

Cleaning the lap/shoulder belt webbing

Clean the belt webbing with any mild soap solution recommended for cleaning upholstery or carpet. Follow the instructions provided with the soap. Do not bleach or re-dye the webbing because this may weaken it.

Cleaning the interior window glass

If the interior glass surfaces of the vehicle become fogged (that is, covered with an oily, greasy or waxy film), they should be cleaned with a glass cleaner. Follow the directions on the glass cleaner container.

 **CAUTION - Rear window**

Do not scrape or scratch the inside of the rear window. This may result in damage of the rear window defroster grid.

Taking care of leather seats (if equipped)

- Vacuum the seat periodically to remove dust and sand on the seat. It will prevent abrasion or damage of the leather and maintain its quality.
- Wipe the natural leather seat cover often with dry or soft cloth.
- Sufficient use of a leather protective may prevent abrasion of the cover and helps maintain the color. Be sure to read the instructions and consult a specialist when using leather coating or protective agents.
- Leather with bright colors(beige, cream beige) is easily contaminated and clear in appearance. Clean the seats frequently.
- Avoid wiping with wet cloth. It may cause the surface to crack.

Cleaning the leather seats (if equipped)

- Remove all contaminations instantly. Refer to instructions below for removal of each contaminant.
- Cosmetic products(sunscreen, foundation, etc.)
 - Apply cleansing cream on a cloth and wipe the contaminated point. Wipe off the cream with a wet cloth and remove water with a dry cloth.
- Beverages(coffee, soft drink, etc.)
 - Apply a small amount of neutral detergent and wipe until contaminations do not smear.
- Oil
 - Remove oil instantly with absorbable cloth and wipe with stain remover for natural leather only.
- Chewing gum
 - Harden the gum with ice and remove gradually.



CAUTION - Leather

When cleaning leather products (steering wheel, seats etc.), use neutral detergents or low alcohol content solutions. If you use high alcohol content solutions or acid/alkaline detergents, the color of the leather may fade or the surface may get stripped off.

Fabric seat cover using precautions (If equipped)

Please clean the fabric seats regularly with a vacuum cleaner in consideration of fabric material characteristics. If they are heavily soiled with beverage stains, etc., use a suitable interior cleaner. To prevent damage to seat covers, wipe off the seat covers down to the seams with a large wiping motion and moderate pressure using a soft sponge or microfiber cloth.

Velcro closures on clothing or sharp objects may cause snagging or scratches on the surface of the seats. Make sure not to rub such objects against the surface.

EMISSION CONTROL SYSTEM

The emission control system of your vehicle is covered by a written limited warranty. Please see the warranty information contained in the Warranty & Consumer Information manual in your vehicle.

Your vehicle is equipped with an emission control system to meet all applicable emission regulations.

There are three emission control systems, as follows.

- (1) Crankcase emission control system
- (2) Evaporative emission control system
- (3) Exhaust emission control system

In order to assure the proper function of the emission control systems, it is recommended that you have your vehicle inspected and maintained by an authorized Kia dealer in accordance with the maintenance schedule in this manual.

Caution for the Inspection and Maintenance Test (With Electronic Stability Control (ESC) system)

- **To prevent the vehicle from misfiring during dynamometer testing, turn the Electronic Stability Control (ESC) system off by pressing the ESC switch.**
- **After dynamometer testing is completed, turn the ESC system back on by pressing the ESC switch again.**

1. Crankcase emission control system

The positive crankcase ventilation system is employed to prevent air pollution caused by blow-by gases being emitted from the crankcase. This system supplies fresh filtered air to the crankcase through the air intake hose. Inside the crankcase, the fresh air mixes with blow-by gases, which then pass through the PCV valve into the induction system.

2. Evaporative emission control (including ORVR: Onboard Refueling Vapor Recovery) system

The Evaporative Emission Control System is designed to prevent fuel vapors from escaping into the atmosphere.

(The ORVR system is designed to allow the vapors from the fuel tank to be loaded into a canister while refueling at the gas station, preventing the escape of fuel vapors into the atmosphere.)

Canister

Fuel vapors generated inside the fuel tank are absorbed and stored in the onboard canister. When the engine is running, the fuel vapors absorbed in the canister are drawn into the surge tank through the purge control solenoid valve.

Purge Control Solenoid Valve (PCSV)

The purge control solenoid valve is controlled by the Engine Control Module (ECM); when the engine coolant temperature is low during idling, the PCSV closes so that evaporated fuel is not taken into the engine. After the engine warms up during ordinary driving, the PCSV opens to introduce evaporated fuel to the engine.

3. Exhaust emission control system

The Exhaust Emission Control System is a highly effective system which controls exhaust emissions while maintaining good vehicle performance.

Engine exhaust gas precautions (carbon monoxide)

- Carbon monoxide can be present with other exhaust fumes. Therefore, if you smell exhaust fumes of any kind inside your vehicle, have it inspected and repaired immediately. If you ever suspect exhaust fumes are coming into your vehicle, drive it only with all the windows fully open. Have your vehicle checked and repaired immediately.

⚠ WARNING - Exhaust

Engine exhaust gases contain carbon monoxide (CO). Though colorless and odorless, it is dangerous and could be lethal if inhaled. Follow the instructions on this page to avoid CO poisoning.

- Do not operate the engine in confined or closed areas (such as garages) any more than what is necessary to move the vehicle in or out of the area.
- When the vehicle is stopped in an open area for more than a short time with the engine running, adjust the ventilation system (as needed) to draw outside air into the vehicle.
- Never sit in a parked or stopped vehicle for any extended time with the engine running.
- When the engine stalls or fails to start, excessive attempts to restart the engine may cause damage to the emission control system.

Operating precautions for catalytic converters (if equipped)

⚠ WARNING - Catalytic converter

Keep away from the catalytic converter and exhaust system while the vehicle is running or immediately thereafter. The exhaust and catalytic systems are very hot and may burn you.

⚠ WARNING - Fire

- Do not park, idle or drive the vehicle over or near flammable objects, such as grass, vegetation, paper, leaves, etc. A hot exhaust system can ignite flammable items under your vehicle.
- Also, do not remove the heat sink around the exhaust system, do not seal the bottom of the vehicle or do not coat the vehicle for corrosion control. It may present a fire risk under certain conditions.

Your vehicle is equipped with a catalytic converter emission control device.

Therefore, the following precautions must be observed:

- Use only UNLEADED FUEL for gasoline engines.
- Do not operate the vehicle when there are signs of engine malfunction, such as misfire or a noticeable loss of performance.
- Do not misuse or abuse the engine. Examples of misuse are coasting with the ignition off and descending steep grades in gear with the ignition off.
- Do not operate the engine at high idle speed for extended periods (5 minutes or more).
- Do not modify or tamper with any part of the engine or emission control system. All inspections and adjustments must be made by an authorized Kia dealer.
- Avoid driving with an extremely low fuel level. Running out of fuel could cause the engine to misfire, damaging the catalytic converter.

Failure to observe these precautions could result in damage to the catalytic converter and to your vehicle. Additionally, such actions could void your warranties.

CALIFORNIA PERCHLORATE NOTICE

Perchlorate Material-special handling may apply, See www.dtsc.ca.gov/hazardouswaste/perchlorate.

Notice to California Vehicle Dismantlers:
Perchlorate containing materials, such as air bag inflators, seatbelt pretensioners and keyless remote entry batteries, must be disposed of according to Title 22 California Code of Regulations Chapter 67384.10 (a).

Specifications, Consumer information and Reporting safety defects

Engine	8-2
Dimensions	8-2
Bulb wattage	8-3
Tires and wheels	8-5
Weight/volume	8-6
Air conditioning system	8-6
Recommended lubricants and capacities	8-7
• Recommended SAE viscosity number	8-9
Vehicle Identification Number (VIN)	8-10
Vehicle certification label	8-10
Tire specification and pressure label	8-11
Engine number	8-11
Refrigerant label	8-11
Consumer assistance (U.S. only)	8-12
Electrical Equipment (U.S. only)	8-15
Reporting Safety Defects (U.S. only)	8-16
Online factory authorized manuals (U.S. only) ..	8-16

ENGINE

Item	Smartstream G1.6
Displacement [cu.in(cc)]	97.09 (1,591)
Bore x Stroke [in(mm)]	2.97 X 3.50 (75.6 X 89.0)
Firing order	1 → 3 → 4 → 2
No. of cylinders	4, In-line

DIMENSIONS

Item		in (mm)
Overall length	4 Door	172.6 (4,385)
	5 Door	160 (4,065)
Overall width		67.9 (1,725)
Overall height	4 Door	57.1 (1,450)
	5 Door	57.1 (1,450)
Front tread	185/65R15	60.0 (1,524)
	205/45R17	59.5 (1,512)
Rear tread	185/65R15	60.2 (1,529)
	205/45R17	59.7 (1,517)
Wheelbase		101.6 (2,580)

BULB WATTAGE

Light Bulb			Wattage(W)	Bulb type
Front	Head lamp (Low/High)	Bulb type	55/60W	HB2
		LED type	LED	LED
	Front turn signal lamps		21W	PY21W
	Front position lamps	Bulb type	8W	PY28/8W
		LED type	0.5W x 12	LED
	Front fog lamp		51W	HB4
	Side Marker Lamp	Bulb type	5W	W5W
LED type		0.5W x 2	LED	
Rear	Rear Stop/Tail lamps (outside)	Bulb type	21W/5W	P21/5W
	Rear tail lamps (Inside)		5W	W5W
	Rear Stop/Tail lamps (outside)	LED type	1W	LED
	Rear tail lamps (Inside)		0.2W	LED
	Side Marker Lamp	Bulb type	5W	W5W
		LED type	0.2W x 3	LED
	Rear turn signal lamps		21W	PY21W
	Back-up lamps		16W	W16W
	High mounted stop lamp*		5W x 4	W5W
	License plate lamps		5W x 2	W5W

* If equipped

(Continued)

(Continued)

	Light Bulb	Wattage	Bulb type
Interior	Map lamps*	10W x 2	W10W
	Room lamps	8W	FESTOON
	Vanity mirror lamps*	8W	FESTOON
	Glove box lamp*	8W	FESTOON
	Liftgate room lamp	8W	FESTOON

* If equipped

TIRES AND WHEELS

Item	Tire size	Wheel size	Inflation pressure kPa (psi)				Wheel lug nut torque kgf•m (lbf•ft, N•m)
			Normal load *1		Maximum load		
			Front	Rear	Front	Rear	
Full size tire	185/65R15	5.5J X 15	230 (33)	230 (33)	230 (33)	230 (33)	11~13 (79~94, 107~127)
	205/45R17	6.5J X 17					
Compact spare tire *2	T125/80D15	3.5J x 15	420 (60)				

*1 : Normal load : Up to 3 persons

*2 : If your vehicle is not equipped with a compact spare tire, it will be equipped with a Tire Mobility Kit

CAUTION

When replacing tires, use the same size originally supplied with the vehicle.

Using tires of a different size may damage the related parts or cause them to operate improperly.

* NOTICE

- We recommend replacing tires with the same make and model originally supplied with the vehicle; not doing so may affect driving performance.
- When driving in high altitude grades such as mountainous areas, injection of additional air into tires may be required due to lower atmospheric pressure. Therefore, add 1.5 psi for every 1,000m above sea level at the recommended tire pressure when frequently driving in high mountainous areas.

WEIGHT/VOLUME

Item		Smartstream G1.6	
		4 Door	5 Door
Gross vehicle weight	M/T	3,527 (1,600)	3,527 (1,600)
	lbs. (kg)	IVT	3,616 (1,640)
Luggage volume		13.7 (387)	17.4 ^{*1} / 32.8 ^{*2} (493 ^{*1} / 928 ^{*2})
		cu ft (l)	

*1 : Behind rear seat to upper edge of the seat back.

*2 : Behind front seat to roof.

M/T : Manual transmission

IVT : Intelligent variable transmission

AIR CONDITIONING SYSTEM

Item	Weight of volume	Classification
Refrigerant	480 ± 25g 16.9 ± 0.88 oz	R-1234yf
Compressor lubricant	110 ± 10g 3.9 ± 0.35 oz	FD46XG (IDEMITSU)

We recommend that you contact an authorized Kia dealer for more details.

RECOMMENDED LUBRICANTS AND CAPACITIES

To help achieve proper engine and powertrain performance and durability, use only lubricants of the proper quality. The correct lubricants also help promote engine efficiency that results in improved fuel economy. These lubricants and fluids are recommended for use in your vehicle.

Lubricant		Volume	Classification
Engine oil ¹ ² (drain and refill) Recommends 	Smartstream G1.6	4.0 US qt. (3.8 l)	API SN PLUS/SP or ILSAC GF-6
Manual transmission fluid	Smartstream G1.6	1.4 ~ 1.5 US qt. (1.5 ~ 1.6 l)	SAE 70W, API GL-4 - SK HK MTF 70W - SHELL SPIRAX S6 GHME 70W - GS CALTEX GS MTF HD 70W
Intelligent variable transmission	Smartstream G1.6	6.87 US qt. (6.5 l)	SP-CVT1* ³
Coolant	Smartstream G1.6	M/T 5.81 US qt. (5.5 l)	Mixture of antifreeze and water (Ethylene-glycol with phosphate based coolant for cooling device)
		IVT 5.81 US qt. (5.5 l)	
Brake/clutch fluid		0.7~0.8 US qt. (0.7~0.8 l)	FMVSS116 DOT-4
Fuel		11.9 US gal (45 l)	Unleaded gasoline

M/T : Manual transmission

IVT : Intelligent variable transmission

- *1 : Refer to the recommended SAE viscosity numbers on the next page.
- *2 : Requires < API SN PLUS (or above) Full synthetic> grade engine oil. If a lower grade engine oil (mineral oil including Semisynthetic) is used, then the engine oil and engine oil filter must be replaced as indicated severe maintenance condition.
- *3 : Use only specified genuine Intelligent Variable Transmission (IVT) fluid. The use of non-specified fluid (even marked as compatible with genuine) could result in shift quality deterioration and vibrations, eventually, the transmission failure. (Refer to "Explanation of Scheduled Maintenance Items" in chapter 7.)

Recommended SAE viscosity number

Engine oil viscosity (thickness) has an effect on fuel economy and cold weather operation (engine start and engine oil flowability). Lower viscosity engine oils can provide better fuel economy and cold weather performance, however, higher viscosity engine oils are required for satisfactory lubrication in hot weather. Using oils of any viscosity other than those recommended could result in engine damage. When choosing an oil, consider the range of temperature your vehicle will be operated in before the next oil change. Proceed to select the recommended oil viscosity from the chart.

		Temperature Range for SAE Viscosity Numbers									
Temperature		°C	-30	-20	-10	0	10	20	30	40	50
		(°F)	-10	0	20	40	60	80	100	120	
Engine Oil	Smartstream G1.6 ^{*1}	0W-20									

^{*1} : For better fuel economy, it is recommended to use the engine oil of a viscosity grade SAE 0W-20 (API SN PLUS/SP or ILSAC GF-6). However, if the engine oil is not available in your country, select the proper engine oil using the engine oil viscosity chart.



An engine oil displaying this API Certification Mark conforms to the international Lubricant Specification Advisory Committee (ILSAC). It is recommended to only use engine oils that uphold this API Certification Mark.

VEHICLE IDENTIFICATION NUMBER (VIN)

Frame Number

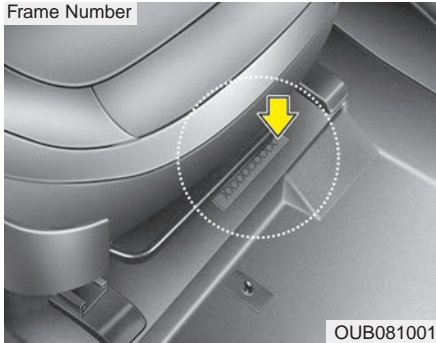

The vehicle identification number (VIN) is the number used in registering your vehicle and in all legal matters pertaining to its ownership, etc. The number is punched under driver or front passenger seat.

VIN Label

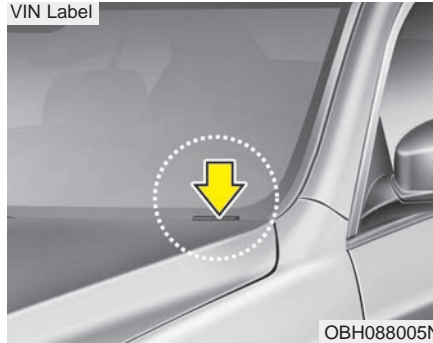

VIN label

The VIN is also on a plate attached to the top of the dashboard. The number on the plate can easily be seen through the windshield from outside.

VEHICLE CERTIFICATION-LABEL

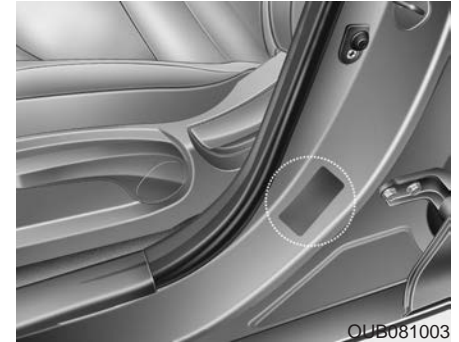

The vehicle certification label attached on the driver's side center pillar gives the vehicle identification number (VIN).

TIRE SPECIFICATION AND PRESSURE LABEL

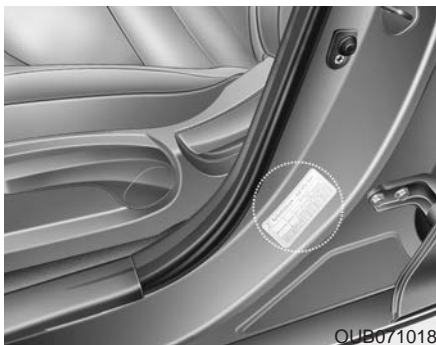

The tires supplied on your new vehicle are chosen to provide the best performance for normal driving.

The tire label located on the driver's side center pillar gives the tire pressures recommended for your vehicle.

ENGINE NUMBER

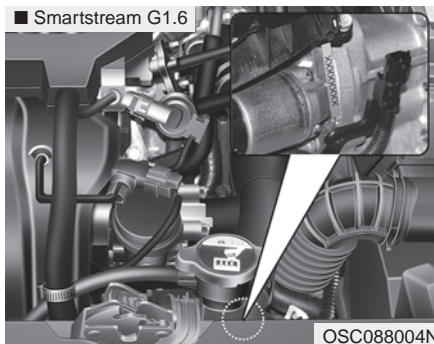

The engine number is stamped on the engine block as shown in the drawing.

REFRIGERANT LABEL

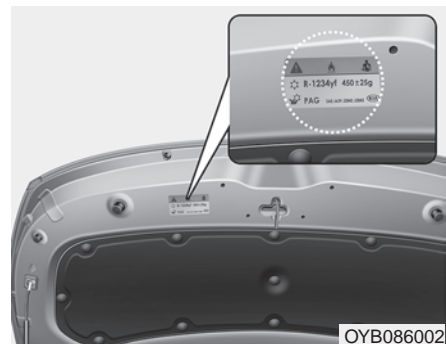

The refrigerant label is located on the underside of the hood.

The label contains the following information :

- Type of refrigerant
 - Amount of refrigerant
- ✱ For more details, refer to “Air Conditioning refrigerant label” in chapter 4.

CONSUMER ASSISTANCE (U.S. ONLY)

Roadside Assistance is provided on all new current model year Kia Vehicles from the date the vehicle is delivered to the first retail buyer or otherwise put into use (in-service date), whichever is earlier, for a period of 60 months or 60,000 miles, whichever is earlier, subject to the terms, conditions and exclusions set forth in the Kia Warranty and Consumer Information Manual applicable to your model year vehicle.

KMA reserves the right to limit or deny services or other benefits to any owner or driver when, in KMA's judgment, the claims and/or service requests are excessive in frequency or type of occurrence.

Toll free consumer assistance

Kia's toll-free Consumer Assistance hot line is staffed from 5:00 AM to 6:00 PM PST, Monday through Friday and is accessible by dialing 1-800-333-4Kia (4542).

For more information regarding assistance available, please refer to your Kia Warranty & Consumer Information Manual.

Emergency roadside assistance

Kia's toll free Roadside Assistance hot line is staffed 24 hours a day, 365 days a year and is accessible by dialing 1-800-333-4Kia (4542).

Please note that you must provide your Vehicle Identification Number (VIN) to verify coverage at the time of your call. The VIN can be found on the dash of your vehicle on the driver's side, on the door jamb of the driver's door, your vehicle's registration or proof of insurance card.

Kia utilizes a network of over 30,000 roadside assistance providers. Should you accidentally run out of fuel, require a battery jump, or need help changing a tire, a Kia Roadside Assistance Representative will dispatch someone to deliver a small quantity of gas, change a flat tire with your inflated spare, or arrange a battery jump to allow you to proceed to your destination. We have access to a network of over 10,000 locksmiths to help you should you become locked out of your Kia.

In the event that mechanical difficulty renders your vehicle undriveable due to a warranty-related concern, Kia's Roadside Assistance Representative will arrange to transport your vehicle to the nearest Kia dealer or to an alternative service location.

Your vehicle must be accessible to our dispatch transport vehicle, as determined by our driver, to receive this service.

*** NOTICE**

Roadside Assistance benefits are not available for any Kia vehicle that has ever been or should be issued a "salvage" title or similar "branded" title under any state's law or has been declared a "total loss" or equivalent by a financial institution or insurance company.

Trip interruption

Trip interruption expense benefits are provided in the event that a warranty-related disablement occurs more than 150 miles from your home, and the repairs require more than 24 hours to complete. Reasonable reimbursement is included for meals, lodging, or rental car expenses. Trip interruption coverage is limited to \$100 per day subject to a three day maximum limit per incident. You must contact the Kia Roadside Assistance Center to obtain pre-authorization of expenses. Once the Kia Roadside Assistance Center gives authorization for trip interruption benefits, they will assist you in making the necessary arrangements. Insurance deductibles, expenses, and claims paid by your insurance company or other providers are not eligible for reimbursement.

Fleet vehicles are excluded from reimbursement under Kia's Trip Interruption Policy.

Registering your vehicle in a foreign country

If you plan to register your vehicle in a foreign country, you should confirm that it conforms to the regulations in that country. Even if you successfully register the vehicle in a foreign country, you may experience the following problems and should therefore consider the possibility of having to deal with them:

1. The fuel specified for your vehicle may be unavailable. If other than the specified fuel is used, it could cause damage to the engine, the fuel injection system, and other fuel-related parts which may not be covered under your New Vehicle Emissions Limited Warranty.
2. We must, therefore, clearly state that when you leave the country in which you purchased your Kia new and register it in another country, problems arising from the use of fuel other than the specified fuel are not subject to manufacturer's warranty. Because vehicles like yours may not be marketed in the new country of registration, parts, servicing techniques and tools necessary to maintain and repair your vehicle may be unavailable.

Even if vehicles like yours are sold there, mechanical specifications required by the government may vary enough from the country of purchase to cause additional problems.
3. There may not be an Authorized Kia Dealer in the area in which you plan to register your vehicle. You may additionally experience difficulty in obtaining services in a foreign country for any number of reasons.

Further, we cannot assume any responsibility for problems that result from unsatisfactory service or lack of service outside of the United States.

ELECTRICAL EQUIPMENT (U.S. ONLY)

The electrical system of your vehicle is designed to perform under all reasonably expected operating conditions. However, before any additional electrical equipment is installed in your vehicle, consult an Authorized Kia Dealer, in order to ensure that you do not void your warranty.

Certain electrical equipment, or the way in which it is installed, may adversely affect the operation of your vehicle, including such systems as the engine control system, the audio system and the electrical charging system and thus potentially void all or part of your warranty.

We assume no responsibility for any expense you may incur or for any malfunction of your vehicle or any of its components or systems that may result from the installation of additional electrical equipment that is not supplied, or recommended for installation by, Kia.

Installation of a mobile two-way radio system

If a mobile two-way radio system is installed improperly, or if an excessively powerful type of system is used, other electronic systems may be adversely affected. To avoid damage to your vehicle, consult an Authorized Kia Dealer concerning the proper equipment and installation.

Kia motor vehicles are designed and manufactured to meet or exceed all applicable safety standards.

For your safety, however, we strongly urge you to read and follow all directions in this Owner's Manual, particularly the information under the headings "NOTICE", "CAUTION" and "WARNING".

If, after reading this manual, you have any questions regarding the operation of your vehicle, safety issues and defects please contact your Kia's toll-free Consumer Assistance hot line as below:

National Consumer Affairs Manager
Kia Motors America, Inc.
P.O. Box 52410
Irvine, CA 92619-2410
1-800-333-4Kia (4542)

REPORTING SAFETY DEFECTS (U.S. ONLY)

Reporting Safety Defects.

If you believe that your vehicle has a defect which could cause a crash or could cause injury or death, you should immediately inform the National Highway Traffic Safety Administration (NHTSA) in addition to notifying [Kia Motors America, Inc.].

If NHTSA receives similar complaints, it may open an investigation, and if it finds that a safety defect exists in a group of vehicles, it may order a recall and remedy campaign. However, NHTSA cannot become involved in individual problems between you, your dealer, or [Kia Motors America, Inc.].

To contact NHTSA, you may call the Vehicle Safety Hotline toll-free at 1-888-327-4236 (TTY: 1-800-424-9153); go to <http://www.safercar.gov>; download the SaferCar mobile application; or write to: Administrator, NHTSA, 1200 New Jersey Ave. SE., Washington, DC 20590. You can also obtain other information about motor vehicle safety from <http://www.safercar.gov>.

ONLINE FACTORY AUTHORIZED MANUALS (U.S. ONLY)

The following publications are available on www.KiaTechinfo.com

Service manual:

This manual covers maintenance and recommended procedures for repair to engine and chassis components. It is written for the Journeyman mechanic, but is simple enough for most mechanically inclined owners to understand.

Electrical troubleshooting manual:

This manual complements the Service Manual by providing indepth troubleshooting information for each electrical circuit in your vehicle.

Owner's manual:

This manual describes the overall features and operating procedures for the vehicle.

Index

A

Air bag - advanced supplemental restraint system.....3-34

 Adding equipment to or modifying your
 air bag-equipped vehicle3-62

 Air bag warning label3-62

 Air bag warning light.....3-38

 Curtain air bag3-54

 Driver's and passenger's front air bag3-49

 How does the air bag system operate3-35

 Occupant detection system3-41

 Side air bag3-52

 SRS Care3-61

 SRS components and functions3-38

 Why didn't my air bag go off in a collision?
 (Inflation and non-inflation conditions of the
 air bag).....3-56

Air cleaner7-31

 Filter replacement7-31

Air conditioning system8-6

Appearance care7-102

 Exterior care.....7-102

 Interior care7-108

Automatic climate control system4-123

 Activate upon washer fluid use4-134

 Air Conditioning refrigerant label4-134

 Automatic heating and air conditioning4-124

 Checking the amount of air conditioner refrigerant
 and compressor lubricant.....4-132

 Climate control air filter4-132

 Manual heating and air conditioning.....4-125

 System operation4-130

B

Battery.....7-39

 For best battery service7-39

 Recharging the battery7-40

 Reset items7-41

Before driving.....5-5

 Before entering vehicle5-5

 Before starting5-5

 Necessary inspections5-5

Blind-Spot Collision Warning (BCW)5-68

 Detecting sensor.....5-69

 Function malfunction and limitations5-73

 Function operation5-72

 Function settings5-70

Brake system.....5-29

 Anti-lock Brake System (ABS).....5-34

 Electronic Stability Control (ESC)5-35

 Good braking practices5-42

 Hill-start Assist Control (HAC).....5-39

 Parking brake5-31

 Power brakes5-29

Vehicle Stability Management (VSM).....	5-40
Brake/clutch fluid	7-27
Checking the brake/clutch fluid level	7-27
Bulb wattage	8-3

C

California perchlorate notice	7-114
Checking fluid levels	7-20
Child Restraint System (CRS)	3-27
Using a child restraint system	3-28
Climate control air filter	7-33
Filter inspection	7-33
Consumer assistance (U.S. only)	8-12
Cruise Control (CC)	5-87
Function operation	5-87
To decrease speed	5-88
To increase set speed	5-88
To resume the function	5-89
To temporarily pause the function	5-89
FCC	4-155
The radio frequency components (Rear Corner Radar) complies	5-104

D

Declaration of conformity	4-155
Defroster	4-110
Rear window defroster	4-110
Dimensions	8-2
Door locks.....	4-18
Auto door lock/unlock feature	4-21
Child-protector rear door lock	4-22
Impact sensing door unlock system.....	4-21
Operating door locks from inside the vehicle	4-19
Operating door locks from outside the vehicle	4-18
Rear Occupant Alert (ROA) system	4-22
Speed sensing door lock system	4-21
Driver Attention Warning (DAW)	5-78
Basic function	5-78
Detecting sensor.....	5-78
Function malfunction and limitations	5-84
Function operation	5-81
Function settings	5-79
Leading Vehicle Departure Alert function.....	5-78

E

Economical operation	5-105
Electrical Equipment (U.S. only)	8-15
Emergency starting	6-5
Jump starting	6-5

Push-starting	6-6
Emission control system	7-111
Crankcase emission control system	7-111
Evaporative emission control (including ORVR): Onboard Refueling Vapor Recovery) system	7-111
Exhaust emission control system	7-112
Engine	8-2
Engine compartment	2-7
Engine compartment	7-4
Engine coolant	7-24
Changing the coolant	7-26
Checking the coolant level	7-24
Engine number	8-11
Engine oil	7-21
Changing the engine oil and filter	7-22
Checking the engine oil level	7-21
ENGINE START/STOP button	5-10
ENGINE START/STOP button position	5-10
Illuminated ENGINE START/STOP button	5-10
Starting the engine	5-13
Stopping the engine (Manual Transmission)	5-16
Explanation of scheduled maintenance items	7-15
Exterior overview	2-2

F

Forward Collision-Avoidance Assist (FCA) (Front view camera only)	5-45
Brake operation	5-50
Detecting sensor	5-45
FCA warning message and function control	5-48
Function malfunction	5-52
Function settings	5-46
Limitations of FCA	5-53
Situation in which the function may not detect pedestrian properly.	5-58
Warning message and warning light	5-51
Fuel filler door	4-42
Closing the fuel filler door	4-43
Opening the fuel filler door	4-42
Fuel requirements	1-3
Do not use methanol	1-4
Fuel Additives	1-5
Gasoline containing alcohol and methanol	1-3
Fuses	7-57
Engine compartment fuse replacement	7-61
Fuse/relay panel description	7-63
Inner panel fuse replacement	7-59
Memory fuse	7-60

H

Hood	4-39
Closing the hood	4-40
Hood open warning	4-40
Opening the hood	4-39
How to use this manual	1-2

I

If the engine overheats	6-7
If the engine will not start	6-4
If engine turns over normally but does not start	6-4
If the engine doesn't turn over or turns over slowly	6-4
If you have a flat tire (with spare tire)	6-19
Changing tires	6-21
Jack and tools	6-19
Jack label	6-28
Removing and storing the spare tire	6-20
Important safety precautions	3-2
Air bag hazards	3-2
Always wear your seat belt	3-2
Control your speed	3-3
Driver distraction	3-2
Keep your vehicle in safe condition	3-3
Restrain all children	3-2
In case of an emergency while driving	6-3
If engine stalls while driving	6-3

If the engine stalls at a crossroad or crossing	6-3
If you have a flat tire while driving	6-3
Infotainment system	4-150
Antenna	4-150
How vehicle audio works	4-151
USB port	4-151
Instrument cluster	4-51
Gauges	4-53
Instrument Cluster Control	4-52
LCD Display Control	4-52
Transmission Shift Indicator	4-57
Instrument panel overview	2-6
Intelligent Variable Transmission (IVT)	5-21
Good driving practices	5-26
Intelligent Variable Transmission (IVT) operation	5-21
Interior features	4-144
Clothes hanger	4-147
Covering shelf (for 5 door)	4-148
Cup holder	4-144
Floor mat anchor(s)	4-147
Power outlet	4-145
Shopping bag holder	4-148
Sunvisor	4-144
USB charger	4-146
Interior light	4-105
Automatic turn off function	4-105
Glove box lamp	4-108
Map lamp	4-105

Room lamp.....	4-106
Trunk/Liftgate room lamp	4-108
Vanity mirror lamp.....	4-109
Interior overview	2-5

K

Key positions	5-7
Ignition switch position	5-7
Starting the engine	5-9
Keys	4-4
Battery replacement.....	4-8
Immobilizer system	4-9
Key operations	4-4
Record your key number	4-4
Remote keyless entry system operations.....	4-5
Transmitter precautions	4-7

L

Lane Following Assist (LFA).....	5-91
Detecting sensor.....	5-91
Function malfunction and limitations	5-95
Function operation	5-92
Function settings	5-92
Lane Keeping Assist (LKA).....	5-61
Detecting sensor.....	5-61
Function malfunction and limitations	5-66

Function operation	5-63
Function settings	5-62
LCD display (for type B cluster)	4-65
Driving Assist mode	4-66
LCD Display Mode	4-65
User Settings Mode (for type B cluster)	4-67
Warning messages (for type B cluster)	4-75
Liftgate (for 5 door)	4-30
Opening the liftgate	4-30
Closing the liftgate.....	4-30
Emergency liftgate safety release	4-31
Light bulbs	7-72
Back-up lamp bulb replacement (for 4 door)	7-94
Back-up lamp bulb replacement (for 5 door)	7-87
Bulb replacement precaution	7-72
Front fog lamp (Bulb type) bulb replacement	7-83
Front turn signal lamp bulb replacement (Headlamp Type A)	7-80
Front turn signal lamp bulb replacement (Headlamp Type B, C).....	7-80
Glove box lamp bulb replacement	7-100
Headlamp (Low/High beam) (Bulb type) bulb replacement (Headlamp Type A).....	7-77
Headlamp (Low/High beam) (Bulb type) bulb replacement (Headlamp Type B).....	7-78
Headlamp (Low/High beam) (LED type) bulb replacement (Headlamp Type C).....	7-84

High mounted stop lamp bulb replacement (for 4 door).....	7-97	Static bending light replacement (Headlamp Type B,C)	7-82
High mounted stop lamp bulb replacement (for 5 door).....	7-92	Stop and tail lamp (LED type) bulb replacement (for 4 door).....	7-96
License plate lamp bulb replacement	7-92	Stop and tail lamp (LED type) bulb replacement (for 5 door).....	7-91
Liftgate room lamp bulb replacement (for 5 door) ..	7-101	Stop and tail lamp / Side marker (Bulb type) replacement (for 4 door)	7-94
Light bulb position (Front)	7-74	Stop and tail lamp bulb replacement (for 5 door)	7-88
Light bulb position (Rear) (4 Door)	7-76	Tail lamp (Bulb type) bulb replacement (for 4 door) ..	7-95
Light bulb position (Rear)(5 Door)	7-75	Tail lamp (inside) bulb replacement (for 5 door)	7-89
Light bulb position (Side)	7-77	Trunk lamp bulb replacement (for 4 door)	7-98
Map lamp bulb replacement	7-98	Vanity mirror lamp bulb replacement	7-99
Position lamp + DRL (LED type) bulb replacement..	7-84	Lighting.....	4-93
Position lamp bulb replacement (Headlamp Type A)..	7-81	Battery saver function	4-93
Rear turn signal lamp bulb replacement (for 4 door) ..	7-93	Front fog light	4-99
Rear turn signal lamp bulb replacement (for 5 door) ..	7-86	Headlight escort function.....	4-93
Room lamp bulb replacement	7-100	Headlight welcome function	4-93
Side marker (front) (Bulb type) bulb replacement (Headlamp Type A)	7-82	High Beam Assist (HBA)	4-97
Side marker (front) (LED type) bulb replacement (Headlamp Type B, C).....	7-84	High beam operation	4-96
Side marker (rear) (Bulb type) bulb replacement (Rear combination lamp Type A) (for 5 door)	7-90	Lighting control	4-94
Side marker (rear) (LED type) bulb replacement (Rear combination lamp Type B) (for 4 door)	7-97	Turn signals and lane change signals	4-98
Side marker (rear) (LED type) bulb replacement (Rear combination lamp Type B) (for 5 door)	7-91		
Side repeater lamp (bulb type) bulb Replacement	7-85		
Side repeater lamp (LED type) bulb Replacement....	7-85		
		M	
		Maintenance services	7-5
		Owner maintenance precautions	7-6
		Owner's responsibility	7-5

Manual climate control system	4-111
Activate upon washer fluid use	4-122
Air Conditioning refrigerant label	4-121
Checking the amount of air conditioner refrigerant and compressor lubricant	4-120
Climate control air filter	4-119
Heating and air conditioning	4-112
System operation	4-117
Manual Transmission	5-17
Good driving practices	5-20
Manual transmission operation	5-17
Mirrors	4-48
Inside rearview mirror	4-48
Outside rearview mirror	4-49

O

Online factory authorized manuals (U.S. only)	8-16
Owner maintenance	7-7
Owner maintenance schedule	7-7

P

Parking brake	7-30
Checking the parking brake	7-30

R

Rear Cross-Traffic Collision Warning (RCCW)	5-96
Detecting sensor	5-97
Function malfunction and limitations	5-99
Function operation	5-98
Functions settings	5-97
Rear View Monitor (RVM)	4-91
Recommended lubricants and capacities	8-7
Recommended SAE viscosity number	8-9
Refrigerant label	8-11
Reporting Safety Defects (U.S. only)	8-16
Road warning	6-2
Hazard warning flasher	6-2

S

Scheduled maintenance service	7-9
Scheduled maintenance service precaution	7-9
Seat	3-4
Driver's seat	3-4
Front passenger's seat	3-4
Front seat adjustment	3-7
Headrest (for front seat)	3-8
Rear seat	3-4
Rear seat adjustment	3-11
Seatback pocket	3-10

Seat belts	3-15	Luggage net holder	4-142
Care of seat belts	3-25	Sunglass holder	4-142
Pre-tensioner seat belt	3-21	T	
Seat belt precautions	3-23	Theft-alarm system	4-15
Seat belt restraint system	3-15	Armed stage	4-15
Smart key	4-11	Disarmed stage.....	4-17
Smart key functions	4-11	Theft-alarm stage.....	4-16
Smart key immobilizer system	4-14	Tire Pressure Monitoring System (TPMS - Type A)	6-8
Smart key precautions	4-13	Changing a tire with TPMS	6-11
Smart trunk release (4 door).....	4-26	Low tire pressure telltale	6-9
Special driving conditions	5-107	TPMS (Tire Pressure Monitoring System) malfunction	
Driving at night	5-108	indicator	6-10
Driving in flooded areas	5-110	Tire Pressure Monitoring System (TPMS - Type B)	6-13
Driving in the rain	5-109	Changing a tire with TPMS	6-17
Driving off-road.....	5-110	Check tire pressure.....	6-13
Hazardous driving conditions	5-107	Low tire pressure position telltale	6-15
Highway driving	5-110	Low tire pressure telltale	6-15
Rocking the vehicle	5-107	Tire specification and pressure label	8-11
Smooth cornering.....	5-108	Tires and wheels	7-42
Sport mode integrated control system	5-44	All season tires	7-54
SPORT mode	5-44	Checking tire inflation pressure.....	7-43
Steering wheel.....	4-45	Low aspect ratio tire	7-56
Electric power steering (EPS)	4-45	Radial-ply tires.....	7-55
Horn	4-47	Recommended cold tire inflation pressures.....	7-42
Tilt steering	4-46	Snow tires	7-54
Storage compartment	4-141	Summer tires	7-54
Center console storage.....	4-141		
Glove box.....	4-141		

Tire care	7-42
Tire chains	7-55
Tire maintenance	7-47
Tire pressure.....	7-43
Tire replacement	7-46
Tire rotation	7-44
Tire sidewall labeling.....	7-47
Tire traction	7-47
Wheel alignment and tire balance	7-45
Wheel replacement	7-47
Tires and wheels	8-5
Towing	6-29
Emergency towing	6-31
Removable towing hook (front).....	6-30
Towing service	6-29
Trailer towing	5-116
Trip computer	4-59
Service Mode (for type A cluster)	4-64
Trip information (Trip computer)	4-59
Trunk (for 4 door).....	4-24
Opening the trunk	4-24
Closing the trunk	4-24
Emergency trunk safety release.....	4-25

V

Vehicle break-in process	1-6
Vehicle certification label	8-10

Vehicle data collection and event data recorders	1-7
Vehicle Identification Number (VIN).....	8-10
Vehicle load limit	5-117
Certification label	5-120
Tire and loading information label	5-117
Vehicle modifications	1-6
Vehicle weight	5-122
Base curb weight	5-122
Cargo weight	5-122
GAW (Gross axle weight)	5-122
GAWR (Gross axle weight rating)	5-122
GVW (Gross vehicle weight)	5-122
GVWR (Gross vehicle weight rating)	5-122
Vehicle curb weight	5-122

W

Warning and indicator lights.....	4-79
Indicator Lights	4-87
Warning lights	4-79
Washer fluid	7-29
Checking the washer fluid level	7-29
Weight/volume	8-6
Windows	4-33
Manual windows	4-38
Power windows	4-34
Windshield defrosting and defogging.....	4-136
Automatic climate control system	4-137

Defogging logic	4-138
Manual climate control system	4-136
Winter driving.....	5-112
Carry emergency equipment	5-116
Change to "winter weight" oil if necessary	5-115
Check battery and cables	5-114
Check spark plugs and ignition system	5-115
Don't let ice and snow accumulate underneath	5-115
Don't let your parking brake freeze	5-115
Snowy or Icy conditions	5-112
To keep locks from freezing	5-115
Use approved window washer anti-freeze in system	5-115
Use high quality ethylene glycol coolant	5-114
Wiper blades	7-35
Blade inspection.....	7-35
Blade replacement	7-35
Wipers and washers	4-100
Rear window wiper and washer switch (for 5 door)	4-104
Windshield washers (front)	4-102
Windshield wipers	4-101

