



owner.ford.com



ford.ca

September 2020  
First Printing  
Litho in U.S.A.



ML3J19F705 AA



The information contained in this publication was correct at the time of going to print. In the interest of continuous development, we reserve the right to change specifications, design or equipment at any time without notice or obligation. No part of this publication may be reproduced, transmitted, stored in a retrieval system or translated into any language in any form by any means without our written permission. Errors and omissions excepted.

© Ford Motor Company 2020

All rights reserved.

Part Number: 202008 20200811223639

## California Proposition 65



**WARNING:** Operating, servicing and maintaining a passenger vehicle or off-highway motor vehicle can expose you to chemicals including engine exhaust, carbon monoxide, phthalates, and lead, which are known to the State of California to cause cancer and birth defects or other reproductive harm. To minimize exposure, avoid breathing exhaust, do not idle the engine except as necessary, service your vehicle in a well-ventilated area and wear gloves or wash your hands frequently when servicing your vehicle. For more information go to [www.P65Warnings.ca.gov/passenger-vehicle](http://www.P65Warnings.ca.gov/passenger-vehicle).



**WARNING:** Battery posts, terminals and related accessories contain lead and lead compounds, chemicals known to the State of California to cause cancer and reproductive harm.  
**Wash your hands after handling.**



# Table of Contents

## Introduction

About This Publication .....	5
------------------------------	---

## Data Privacy

Event Data .....	6
------------------	---

## Child Safety

Child Safety Precautions .....	7
Child Restraint Anchor Points .....	8
Child Restraints .....	10
Installing Child Restraints .....	11
Booster Seats .....	17

## Seatbelts

Seatbelt Precautions .....	20
Fastening and Unfastening the Seatbelts .....	21
Sensitive Locking Mode .....	22
Automatic Locking Mode .....	22
Adjusting the Seatbelts During Pregnancy .....	23
Adjusting the Seatbelt Height .....	23
Adjusting the Seatbelt Length .....	24
Seatbelt Reminder .....	24
Checking the Seatbelts .....	26
Seatbelt Extensions .....	27

## Personal Safety System™

What Is the Personal Safety System .....	28
How Does the Personal Safety System Work .....	28
Personal Safety System Components .....	28

## Airbags

How Do the Front Airbags Work .....	29
How Do the Side Airbags Work .....	29
How Do the Knee Airbags Work .....	30
How Does the Safety Canopy™ Work .....	30

Airbag Precautions .....	31
Properly Adjusting the Driver and Front Passenger Seats .....	32
Children and Airbags .....	32
Front Passenger Sensing System .....	33
Crash Sensors and Airbag Indicator .....	35
Disposing of Airbags .....	36

## Keys and Remote Controls

Removing the Key Blade .....	37
Replacing a Lost Key or Remote Control .....	37

## Security

Passive Anti-Theft System .....	38
---------------------------------	----

## Wipers and Washers

Wipers .....	39
Checking the Wiper Blades .....	39
Replacing the Front Wiper Blades .....	39
Washers .....	40
Wipers and Washers – Troubleshooting .....	40

## Instrument Cluster

Instrument Cluster Warning Lamps .....	41
Instrument Cluster Indicators .....	42

## Climate Control - Vehicles With: Automatic Temperature Control

Identifying the Climate Control Unit .....	44
Switching Climate Control On and Off .....	44
Switching Defrost On and Off .....	44
Switching Maximum Defrost On and Off .....	44
Switching the Heated Wiper Park On and Off .....	44
Switching the Heated Rear Window On and Off .....	44

# Table of Contents

---

Setting the Blower Motor Speed .....	45
Setting the Temperature .....	45
Directing the Flow of Air .....	45
Climate Control Hints .....	45

## **Climate Control - Vehicles With: Manual Temperature Control**

Identifying the Climate Control Unit .....	47
Switching Defrost On and Off .....	47
Switching Maximum Defrost On and Off .....	47
Switching the Heated Rear Window On and Off .....	47
Setting the Blower Motor Speed .....	47
Setting the Temperature .....	48
Directing the Flow of Air .....	48
Climate Control Hints .....	48

## **Front Seats**

Sitting in the Correct Position .....	50
Manual Seats .....	50
Power Seats .....	52
Heated Seats .....	53
Ventilated Seats .....	54

## **Rear Seats**

Manual Seats .....	55
Heated Seats .....	55

## **Memory Function**

Memory Function Precautions .....	57
Locating the Memory Function Buttons .....	57
Saving a Preset Position .....	57
Recalling a Preset Position .....	57

## **Automatic Transmission**

Automatic Transmission Positions .....	58
--	----

## **Brakes**

Brakes – Troubleshooting .....	59
--------------------------------	----

## **Traction Control**

Switching Traction Control On and Off .....	60
---	----

## **Load Carrying**

Load Carrying Precautions .....	61
Locating the Safety Compliance Certification Labels .....	62
What Is the Gross Axle Weight Rating .....	62
What Is the Gross Vehicle Weight Rating .....	62
What Is the Gross Combined Weight Rating .....	62
Calculating Payload .....	64
Calculating the Load Limit .....	64

## **Towing a Trailer**

Towing a Trailer Precautions .....	67
Towing a Trailer Limitations .....	67
Loading Your Trailer .....	67
Towing Weights and Dimensions .....	69

## **Crash and Breakdown Information**

Switching the Hazard Flashers On and Off .....	95
Jump Starting the Vehicle .....	95

## **Maintenance**

Under Hood Overview - 2.7L EcoBoost™ .....	97
Under Hood Overview - 3.0L Diesel .....	98
Under Hood Overview - 3.3L .....	99
Under Hood Overview - 3.5L EcoBoost™ .....	100
Under Hood Overview - 3.5L, Hybrid Electric Vehicle (HEV) .....	101

# Table of Contents

---

Under Hood Overview - 5.0L .....	102	Reporting Safety Defects in Canada .....	129
<b>Vehicle Care</b>		California Proposition 65 - United States of America .....	130
Cleaning the Exterior .....	103	Perchlorate .....	130
<b>Wheel and Tire Information</b>			
Locating the Tire label .....	104		
Department of Transportation Uniform Tire Quality Grades .....	104		
Information on the Tire Sidewall .....	105		
Glossary of Tire Terminology .....	110		
Tire Replacement Requirements .....	111		
Using Snow Chains .....	113		
<b>Tire Care</b>			
Checking the Tire Pressures .....	115		
Inflating the Tires .....	115		
Inspecting the Tire for Wear .....	116		
Inspecting the Tire for Damage .....	116		
Inspecting the Wheel Valve Stems .....	117		
Tire Rotation .....	117		
<b>Tire Pressure Monitoring System</b>			
What Is the Tire Pressure Monitoring System .....	119		
Tire Pressure Monitoring System Precautions .....	119		
Tire Pressure Monitoring System Limitations .....	119		
Viewing the Tire Pressures .....	119		
<b>Changing a Road Wheel</b>			
Changing a Flat Tire .....	120		
<b>Vehicle Identification</b>			
Vehicle Identification Number .....	128		
<b>Customer Information</b>			
Reporting Safety Defects in the United States .....	129		



# Introduction

## ABOUT THIS PUBLICATION



**WARNING:** Driving while distracted can result in loss of vehicle control, crash and injury. We strongly recommend that you use extreme caution when using any device that may take your focus off the road. Your primary responsibility is the safe operation of your vehicle. We recommend against the use of any hand-held device while driving and encourage the use of voice-operated systems when possible. Make sure you are aware of all applicable local laws that may affect the use of electronic devices while driving.

Thank you for choosing Ford. We recommend that you take some time to get to know your vehicle in order to benefit from greater safety and pleasure from driving it. Use this digital manual, that we have also made available for your continued use through the FordPass app and your local Ford website to familiarize yourself with the basics.

**Note:** To download the FordPass app, visit your device's app store.

**Note:** To find the local Ford website, visit <https://corporate.ford.com/global-links.html#sOfO>.

**Note:** Use and operate your vehicle in line with all applicable laws and regulations.

**Note:** Pass on all printed owner's information when selling this vehicle.

Our digital resources include a comprehensive digital Owner's Manual that is dynamically created according to the features on your vehicle by using the vehicle identification number. The digital Owner's Manual includes visual and full

text search functions so that you can quickly locate the information you are looking for. It also includes links to a number of how-to videos created to help you understand some of the advanced technologies on your vehicle.

## Features and Options

**Note:** This publication describes product features and options available throughout the range of available models, sometimes even before they are generally available. It may describe options that are not available on the vehicle you have purchased.

## Illustrations

**Note:** Some of the illustrations in this manual could show features as used in different models, some can appear different to you on your vehicle.

## Location of Components

This manual may qualify the location of a component as left-hand side or right-hand side. The side is determined when facing forward in the seat.

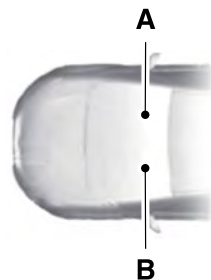

- A Right-hand side.
- B Left-hand side.



# Data Privacy

---

## EVENT DATA

This vehicle is equipped with an event data recorder. The main purpose of an event data recorder is to record, in certain crash or near crash-like situations, such as an airbag deployment or hitting a road obstacle; this data will assist in understanding how a vehicle's systems performed. The event data recorder is designed to record data related to vehicle dynamics and safety systems for a short period of time, typically 30 seconds or less.

The event data recorder in this vehicle is designed to record such data as:

- How various systems in your vehicle were operating.
- Whether or not the driver and passenger seatbelts were buckled/fastened.
- How far (if at all) the driver was depressing the accelerator and/or the brake pedal.
- How fast the vehicle was traveling.
- Where the driver was positioning the steering wheel.

This data can help provide a better understanding of the circumstances in which crashes and injuries occur.

**Note:** *Event data recorder data is recorded by your vehicle only if a non-trivial crash situation occurs; no data is recorded by the event data recorder under normal driving conditions and no personal data or information (for example name, gender, age, and crash location) is recorded. However, parties, such as law enforcement, could combine the event data recorder data with the type of personally identifying data routinely acquired during a crash investigation.*

To read data recorded by an event data recorder, special equipment is required, and access to the vehicle or the event data recorder is needed. In addition to the vehicle manufacturer, other parties, such as law enforcement, that have such special equipment, can read the information if they have access to the vehicle or the event data recorder.

## Active Drive Assist Driver Facing Camera Data (If Equipped)

If active drive assist is active in certain crash or near crash-like situations, such as an airbag deployment or hitting a road obstacle, the system may record driver attentiveness, based on the direction of eyes and duration, and photographs of the driver seat area.

**Note:** *No data is recorded under normal driving conditions.*

# Child Safety

## CHILD SAFETY PRECAUTIONS

 **WARNING:** Always make sure your child is secured properly in a device that is appropriate for their height, age and weight. Child safety restraints must be bought separately from your vehicle. Failure to follow these instructions and guidelines may result in an increased risk of serious injury or death to your child.

 **WARNING:** All children are shaped differently. The National Highway Traffic Safety Administration and other safety organizations, base their recommendations for child restraints on probable child height, age and weight thresholds, or on the minimum requirements of the law. We recommend that you check with a NHTSA Certified Child Passenger Safety Technician (CPST) to make sure that you properly install the child restraint in your vehicle and that you consult your pediatrician to make sure you have a child restraint appropriate for your child. To locate a child restraint fitting station and CPST, contact NHTSA toll free at 1-888-327-4236 or go to [www.nhtsa.dot.gov](http://www.nhtsa.dot.gov). In Canada, contact Transport Canada toll free at 1-800-333-0371 or go to [www.tc.gc.ca](http://www.tc.gc.ca) to find a Child Car Seat Clinic in your area. Failure to properly restrain children in child restraints made especially for their height, age and weight, may result in an increased risk of serious injury or death to your child.

 **WARNING:** On hot days, the temperature inside the vehicle can rise very quickly. Exposure of people or animals to these high temperatures for even a short time can cause death or serious heat related injuries, including brain damage. Small children are particularly at risk.

 **WARNING:** Do not place a rearward facing child restraint in front of an active airbag. Failure to follow this instruction could result in personal injury or death.

 **WARNING:** Properly secure children 12 years old and under in a rear seating position whenever possible. If you are unable to properly secure all children in a rear seating position, properly secure the largest child on the front seat. If you must use a forward facing child restraint on the front seat, move the seat as far back as possible. Failure to follow these instructions could result in personal injury or death.

 **WARNING:** Always carefully follow the instructions and warnings provided by the manufacturer of any child restraint to determine if the restraint device is appropriate for your child's size, height, weight, or age. Follow the child restraint manufacturer's instructions and warnings provided for installation and use in conjunction with the instructions and warnings provided by your vehicle manufacturer. A safety seat that is improperly installed or utilized, is inappropriate for your child's height, age, or weight or does not properly fit the child may increase the risk of serious injury or death.

# Child Safety

**WARNING:** Do not allow a passenger to hold a child on their lap when your vehicle is moving. Failure to follow this instruction could result in personal injury or death in the event of a sudden stop or crash.

**WARNING:** Do not use pillows, books or towels to boost your child's height. Failure to follow this instruction could result in personal injury or death.

**WARNING:** Properly secure child restraints or booster seats when they are not in use. They could become projectiles in a sudden stop or crash. Failure to follow this instruction could result in personal injury or death.

**WARNING:** Do not put the shoulder section of the seatbelt or allow the child to put the shoulder section of the seatbelt under their arm or behind their back. Failure to follow this instruction could reduce the effectiveness of the seatbelt and increase the risk of injury or death in a crash.

**WARNING:** Do not leave children or pets unattended in your vehicle. Failure to follow this instruction could result in personal injury or death.

When installing a child restraint with seatbelts:

- Place the vehicle seat in the upright position before you install the child restraint.
- Use the correct seatbelt buckle for that seating position.
- Insert the belt tongue into the buckle. Make sure the tongue is securely fastened in the buckle.

- Keep the buckle release button pointing up and away from the child restraint, with the tongue between the child restraint and the release button, to prevent accidental unbuckling.
- Put the seatbelt in the automatic locking mode.

## CHILD RESTRAINT ANCHOR POINTS

### What Are the Child Restraint Anchor Points

[\*LATCH \(Lower Anchors and Tethers for Children\)\*](#)

Anchor points allow you to quickly and safely install a child restraint.

### Locating the Child Restraint Lower Anchor Points

Crew Cab

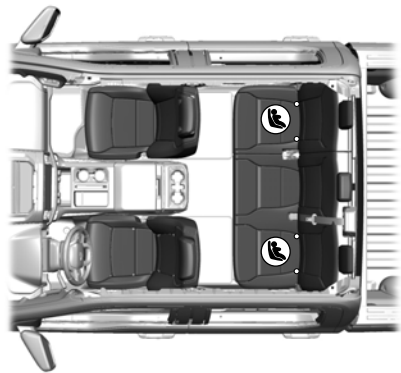

Super Cab

# Child Safety

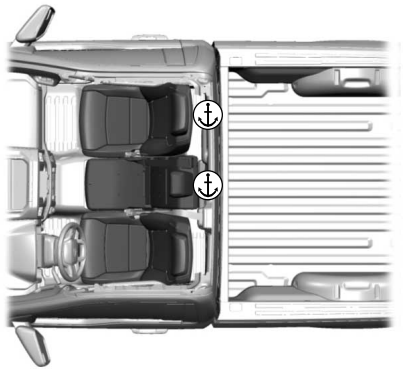
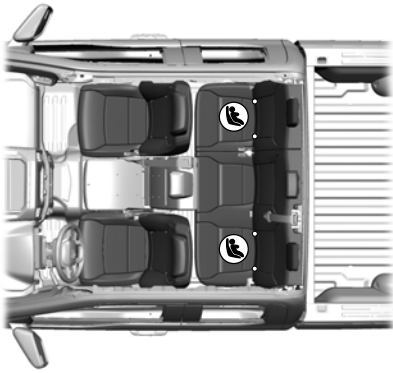

Crew Cab

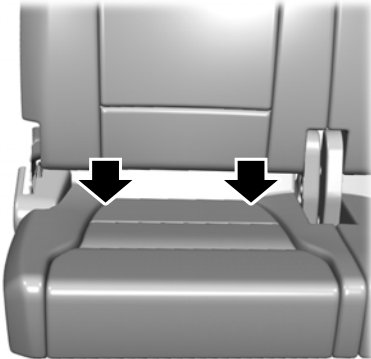

The lower child restraint anchors are at the rear section of the rear seat between the cushion and seat backrest.

**Note:** *Regular Cab vehicles do not have lower anchors.*

## Locating the Child Restraint Top Tether Anchor Points

Regular Cab

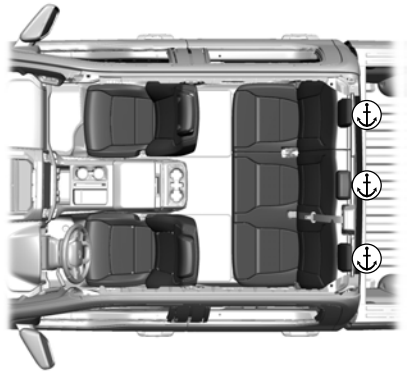

Super Cab

# Child Safety

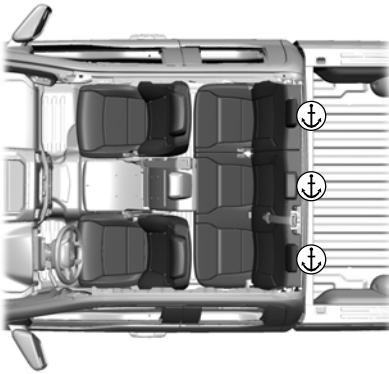

## CHILD RESTRAINTS

### Child Restraint Position Information

Install the child restraint tightly against the vehicle seat. It may be necessary to lift or remove the head restraint.

### Rear Facing Child Restraints

Combined Weight of Child and Child Restraint	LATCH (Lower Anchors Only)	Seatbelt Only
Up to 65 lb (29 kg)	X	X
Over 65 lb (29 kg)		X

### Forward Facing Child Restraints

Combined Weight of Child and Child Restraint	LATCH (Lower Anchors and Top Tether Anchor)	Seatbelt and Top Tether Anchor	Seatbelt and LATCH (Lower Anchors and Top Tether Anchor)
Up to 65 lb (29 kg)	X	X	X
Over 65 lb (29 kg)		X	X

# Child Safety

## Child Restraints Recommendation

Child Size, Height, Weight, or Age	Recommended Restraint Type
Children weighing 40 lb (18 kg) or less (generally age four or younger).	Use a child restraint (sometimes called an infant carrier, convertible seat, or toddler seat).
Children who have outgrown or no longer properly fit in a child restraint (generally children who are less than 57 in (1.45 m) tall, are greater than age four and less than age 12, and between 40 lb (18 kg) and 80 lb (36 kg) and upward to 100 lb (45 kg) if recommended by your child restraint manufacturer).	Use a belt-positioning booster seat.
Children who have outgrown or no longer properly fit in a belt-positioning booster seat (generally children who are at least 57 in (1.45 m) tall or greater than 80 lb (36 kg) or 100 lb (45 kg) if recommended by child restraint manufacturer).	Use a vehicle seatbelt having the lap belt snug and low across the hips, shoulder belt centered across the shoulder and chest, and seat backrest upright.

You are required by law to properly use child restraints for infants and toddlers in the United States, Canada and Mexico.

Many states and provinces require that small children use approved booster seats until they reach age eight, a height of 57 in (1.45 m) tall, or 80 lb (36 kg). Check your local and state or provincial laws for specific requirements about the safety of children in your vehicle.

When possible, properly restrain children 12 years of age and under in a rear seating position of your vehicle. Accident statistics suggest that children are safer when properly restrained in the rear seating positions than in a front seating position.

When installing a rear facing child restraint, adjust the vehicle seats to avoid interference between the child restraint and the vehicle seat in front of the child restraint.

## INSTALLING CHILD RESTRAINTS

### Using Seatbelts



**WARNING:** Depending on where you secure a child restraint, and depending on the child restraint design, you may block access to certain seatbelt buckle assemblies and LATCH lower anchors, rendering those features potentially unusable. To avoid risk of injury, make sure occupants only use seating positions where they are able to be properly restrained.

**Note:** *The following does not apply to the front center position of Super Cab and Crew Cab vehicles.*

**Note:** *Although the child restraint illustrated is a forward facing child restraint, the steps are the same for installing a rear facing child restraint.*

# Child Safety

Perform the following steps when installing a child restraint with seatbelts.

1. Position the child restraint in a seat with a seatbelt.



2. Pull down on the shoulder belt and then grasp the shoulder belt and lap belt together.



3. While holding the shoulder and lap belt portions together, route the tongue through the child restraint according to the child restraint manufacturer's instructions. Make sure you did not twist the belt webbing.

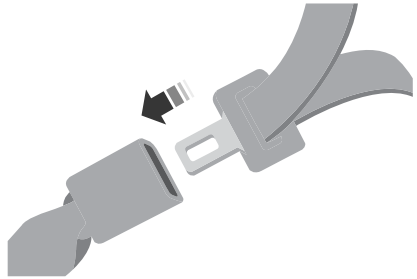

4. Insert the belt tongue into the proper buckle for that seating position until the latch engages. Make sure the tongue is latched securely by pulling on it.



5. To put the retractor in the automatic locking mode, grasp the shoulder portion of the belt and pull downward until you pull all of the seatbelt out.

**Note:** *The automatic locking mode is available on the front passenger and rear seats. This mode is also available on the center seat of a Regular Cab. This vehicle does not require the use of a locking clip.*

6. Allow the belt to retract to remove slack. The seatbelt clicks as it retracts to indicate it is in the automatic locking mode.

# Child Safety

7. Pull the seatbelt out of the retractor to make sure the retractor is in the automatic locking mode. You should not be able to pull more belt out. If the retractor is not locked, unbuckle the belt and repeat Steps 5 and 6.



8. Remove remaining slack from the belt. Force the seat down with extra weight, for example, by pressing down or kneeling on the child restraint while pulling up on the shoulder belt in order to force slack from the belt. This is necessary to remove the remaining slack that exists once you add the extra weight of the child to the child restraint. It also helps to achieve the proper snugness of the child restraint to your vehicle. Sometimes, a slight lean toward the buckle helps to remove remaining slack from the belt.
9. If the child restraint has a tether strap, attach it.

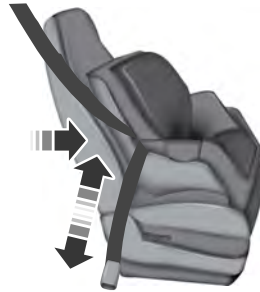

10. Before placing the child in the seat, forcibly move the seat forward and back to make sure the seat is securely held in place.

To check this, grab the seat at the belt path and attempt to move it side to side and forward and back. There should be no more than 1 in (2.5 cm) of movement.

We recommend checking with a NHTSA Certified Child Passenger Safety Technician to make certain the child restraint is properly installed. In Canada, check with Transport Canada for referral to a Child Car Seat Clinic.

## Using Seatbelts

 **WARNING:** Always use both the lap and shoulder portion of the seatbelt in the center seating position.

**Note:** *The following applies to the front center position of Super Cab and Crew Cab vehicles.*

The seatbelt webbing below the tongue is the lap portion of the seatbelt. The webbing above the tongue is the shoulder belt portion of the seatbelt.

1. Position the child restraint in the front center seat.



# Child Safety



2. Slide the tongue up the webbing.



3. While holding both shoulder and lap portions next to the tongue, route the tongue and webbing through the child restraint according to the child restraint manufacturer's instructions. Make sure you did not twist the belt webbing.

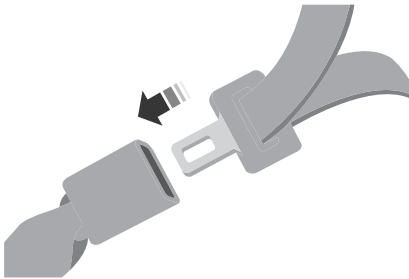

4. Insert the belt tongue into the proper buckle for that seating position until the latch engages. Make sure the tongue is latched securely by pulling on it.



5. When pushing down with your knee on the child restraint, pull up on the shoulder belt portion to tighten the lap belt portion of the seatbelt.
6. Allow the seatbelt to retract and remove any slack in the belt to securely tighten the child restraint in the vehicle.
7. If the child restraint has a tether strap, attach it.



# Child Safety

- Before placing the child in the seat, forcibly move the seat forward and back to make sure the seat is securely held in place. To check this, grab the seat at the belt path and attempt to move it side to side and forward and back. There should be no more than 1 in (2.5 cm) of movement.
- Check from time to time to be sure that there is no slack in the lap and shoulder belt. The shoulder belt must be snug to keep the lap belt tight during a crash.

We recommend checking with a NHTSA Certified Child Passenger Safety Technician to make certain the child restraint is properly installed. In Canada, check with Transport Canada for referral to a Child Car Seat Clinic.

## Using Lower Anchors and Tethers for Children



**WARNING:** Do not attach two child safety restraints to the same anchor. In a crash, one anchor may not be strong enough to hold two child safety restraint attachments and may break, causing serious injury or death.



**WARNING:** Depending on where you secure a child restraint, and depending on the child restraint design, you may block access to certain seatbelt buckle assemblies and LATCH lower anchors, rendering those features potentially unusable. To avoid risk of injury, make sure occupants only use seating positions where they are able to be properly restrained.

The Lower Anchors and Tethers for Children (LATCH) system has three vehicle anchor points:

- Two lower anchors where the vehicle seat backrest and seat cushion meet, called the seat bight.
- One top tether anchor behind that seating position.

LATCH compatible child restraints have two rigid or webbing mounted attachments. These attachments connect to the two lower anchors at the LATCH equipped seating positions in your vehicle. This type of attachment method eliminates the need to use seatbelts to attach the child restraint.

However, you can still use the seatbelt to attach the child restraint if the lower anchors are not used. For forward-facing child restraints, you must also attach the top tether strap to the proper top tether anchor if a top tether strap has been provided with your child restraint.

Follow the instructions later in this chapter on attaching child restraints with tether straps.

## Combining the Seatbelt and Lower Anchors for Attaching Child Restraints

When used in combination, you may attach either the seatbelt or the LATCH lower anchors first, provided a proper installation is achieved. Attach the tether strap afterward, if it is included with the child restraint.

## Using Tether Straps

Many forward-facing child restraints include a tether strap which extends from the back of the child restraint and hooks to an anchoring point called the top tether anchor. Tether straps are available as an accessory for many older child restraints.

# Child Safety

Contact the manufacturer of your child restraint for information about ordering a tether strap, or to obtain a longer tether strap if the tether strap on your child restraint does not reach the appropriate top tether anchor in the vehicle.

Attach the tether strap only to the appropriate tether anchor. The tether strap may not work properly if attached somewhere other than the correct tether anchor.

If you install a child restraint with rigid LATCH attachments, do not tighten the tether strap enough to lift the child restraint off the vehicle seat cushion when the child is seated in it. Keep the tether strap just snug without lifting the front of the child restraint. Keeping the child restraint just touching the vehicle seat gives the best protection in a severe crash.

Once you have installed the child restraint using either the seatbelt, the lower anchors of the LATCH system, or both, you can attach the top tether strap.

## Attaching the Front Seat Tether Strap

Regular Cab



1. Route the child restraint tether strap over the back of the seat and under the head restraint.

**Note:** For vehicles with adjustable head restraints, route the tether strap under the head restraint and between the head restraint posts. Otherwise, route the tether strap over the top of the seat backrest.

2. Locate the correct anchor for the selected seating position. You may need to pull the seat backrest forward to access the tether anchors. Make sure the seat is locked in the upright position before installing the child restraint.
3. Clip the tether strap to the anchor.
4. Tighten the child restraint tether strap according to the manufacturer's instructions.

If you incorrectly clip the tether strap, the child restraint may not be retained properly in the event of a crash.

If you did not properly anchor the child restraint, the risk of a child being injured in a crash greatly increases.

If your child restraint system has a tether strap, and the child restraint manufacturer recommends its use, we also recommend its use.

## Attaching the Rear Seat Tether Strap

Crew Cab and Super Cab

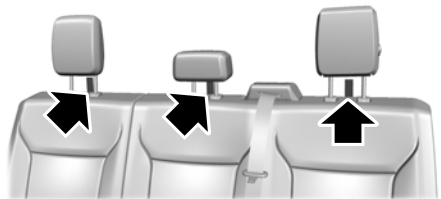

# Child Safety

There are three loops of webbing above the back of the rear seat. Use these loops as routing loops and anchor loops for up to three child restraint tether straps.

For example, you can use the center loop as a routing loop for a child restraint in the center rear seat and as an anchoring loop for child restraints installed in the outermost rear seats.

Many tether straps cannot be tightened if the tether strap is hooked to the loop directly behind the child restraint.

To provide a tight tether strap:

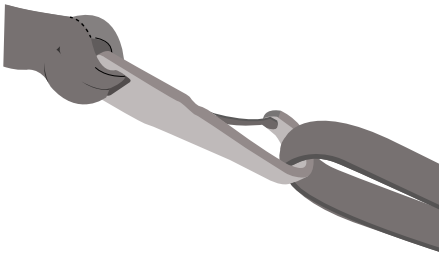

1. Route the vehicle tether loop between the head restraint posts, then route the child restraint tether strap through the loop, forward of the head restraint.
2. Hook the strap to the vehicle tether anchor loop in the adjacent seating position. If using the driver side, pass the strap behind the shoulder belt for the center seat. Put the tether strap through the routing loop. The head restraint support post holds the child restraint tightly, but the head restraint post is not strong enough to hold the child restraint during a crash.
3. Tighten the tether strap according to the child restraint manufacturer's instructions.

If you did not properly anchor the child restraint, the risk of a child being injured in a crash greatly increases.

If your child restraint system has a tether strap, and the child restraint manufacturer recommends its use, we also recommend its use.

## BOOSTER SEATS

Use a belt-positioning booster seat for children who have outgrown or no longer properly fit in a child restraint and meet the following criteria.

- Generally children who are less than 57 in (1.45 m) tall.
- Are greater than age four (4) and less than age twelve (12).
- Are between 40 lb (18 kg) and 80 lb (36 kg) and upward to 100 lb (45 kg).

Many state and provincial laws require that children use approved booster seats until they reach age eight, a height of 57 in (1.45 m) tall, or 80 lb (36 kg).

Booster seats should be used until you can answer yes to all of these questions when seated without a booster seat:

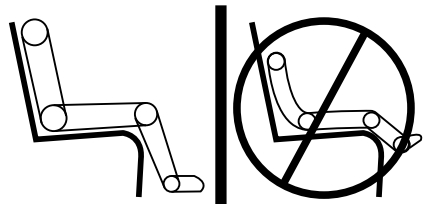

# Child Safety

- Can the child sit all the way back against their vehicle seat backrest with knees bent comfortably at the edge of the seat cushion?
- Can the child sit without slouching?
- Does the lap belt rest low across the hips?
- Is the shoulder belt centered on the shoulder and chest?
- Can the child stay seated like this for the whole trip?

Always use booster seats in conjunction with your vehicle lap and shoulder belt.

## Types of Booster Seats



- Backless booster seats

If your backless booster seat has a removable shield, remove the shield.

If a vehicle seating position has a low seat backrest or no head restraint, a backless booster seat may place your child's head, as measured at the tops of the ears, above the top of the seat. In this case, move the backless booster to another seating position with a higher seat backrest or head restraint and lap and shoulder belts, or consider using a high-back booster seat.



- High-back booster seats

If, with a backless booster seat, you cannot find a seating position that adequately supports your child's head, a high-back booster seat would be a better choice.

Children and booster seats vary in size and shape. Choose a booster that keeps the lap belt low and snug across the hips, never up across the stomach, and lets you adjust the shoulder belt to cross the chest and rest snugly near the center of the shoulder.

The following drawings compare the ideal fit to a shoulder belt uncomfortably close to the neck and a shoulder belt that could slip off the shoulder. The drawings also show how the lap belt should be low and snug across the child's hips.

## Child Safety

---



If the booster seat slides on the vehicle seat upon which it is being used, placing a rubberized mesh sold as shelf or carpet liner under the booster seat may improve this condition. Do not use any item thicker than this under the booster seat. Check with the booster seat manufacturer's instructions.

# Seatbelts

## SEATBELT PRECAUTIONS



**WARNING:** Always drive and ride with your seatbelt upright and the lap belt snug and low across the hips.



**WARNING:** Children must always be properly restrained.



**WARNING:** Do not allow a passenger to hold a child on their lap when your vehicle is moving. Failure to follow this instruction could result in personal injury or death in the event of a sudden stop or crash.



**WARNING:** All occupants of your vehicle, including the driver, should always properly wear their seatbelts, even when an airbag supplemental restraint system is provided. Failure to properly wear your seatbelt could seriously increase the risk of injury or death.



**WARNING:** It is extremely dangerous to ride in a cargo area, inside or outside of a vehicle. In a crash, people riding in these areas are more likely to be seriously injured or killed. Do not allow people to ride in any area of your vehicle that is not equipped with seats and seatbelts. Make sure everyone in your vehicle is in a seat and properly using a seatbelt. Failure to follow this warning could result in serious personal injury or death.



**WARNING:** In a rollover crash, an unbelted person is significantly more likely to die than a person wearing a seatbelt.



**WARNING:** Each seating position in your vehicle has a specific seatbelt assembly made up of one buckle and one tongue designed to be used as a pair. Use the shoulder belt on the outside shoulder only. Never wear the shoulder belt under the arm. Never use a single seatbelt for more than one person.



**WARNING:** Even with advanced restraints systems, properly restrain children 12 and under in a rear seating position. Failure to follow this could seriously increase the risk of injury or death.



**WARNING:** Seatbelts and seats may be hot in a vehicle that is in the sunshine. The hot seatbelts or seats may burn a small child. Check seat covers and buckles before you place a child anywhere near them.



**WARNING:** If your vehicle is involved in a crash, have the seatbelts and associated components inspected as soon as possible. Failure to follow this instruction could result in personal injury or death.

All seating positions in this vehicle have seatbelts. All occupants of the vehicle should properly wear their seatbelts, even when an airbag supplemental restraint system is provided.

The seatbelt system consists of:

- Lap and shoulder seatbelts.
- A shoulder seatbelt with automatic locking mode, except driver seatbelt.
- Height adjusters at the front outermost seating positions.
- Seatbelt pretensioners at the front outermost and rear outermost seating positions.

# Seatbelts



A seatbelt warning light and chime.



Crash sensors and monitoring system with readiness indicator.

The seatbelt pretensioners are designed to tighten the seatbelts when activated. In frontal and near-frontal crashes, the seatbelt pretensioners may be activated alone or, if the crash is of sufficient severity, together with the front airbags. In side crashes and rollovers, the pretensioners will be activated when the Safety Canopy is activated.

## FASTENING AND UNFASTENING THE SEATBELTS

This applies to all seating positions, except for the front center position of Super Cab and Crew Cab.



1. Insert the seatbelt tongue into the buckle until you hear a snap and feel it latch.

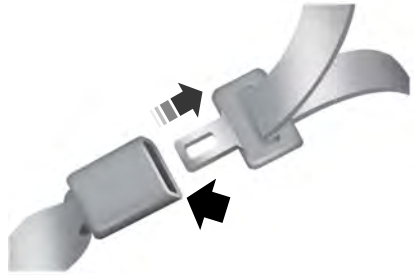

2. Press the button to release the seatbelt.

## Using the Seatbelt With Cinch Tongue

This applies to the front center seating position of Super Cab and Crew Cab.

The cinch tongue slides up and down the seatbelt webbing when you stow the seatbelt or when you put the seatbelts on. When you buckle the seatbelt, the cinch tongue allows you to shorten the lap portion, but pinches the webbing to keep the lap portion from getting longer. The cinch tongue is designed to slip during a crash, so wear the shoulder belt properly and do not allow any slack in either the lap or shoulder portions.

## Fastening the Cinch Tongue



**WARNING:** Always drive and ride with your seatback upright and the lap belt snug and low across the hips.

1. Pull the seatbelt from the retractor so that the shoulder belt portion of the seatbelt crosses your shoulder and chest.
2. Make sure the belt is not twisted. If the belt is twisted, remove the twist.



# Seatbelts

3. Insert the belt tongue into the proper buckle for your seating position until you hear a snap and feel it latch.
4. Make sure you securely fasten the tongue to the buckle by pulling on the tongue.

While you are fastened in the seatbelt, the seatbelt with a cinch tongue adjusts to your movement. However, if you brake hard, turn hard, or if your vehicle receives an impact of 5 mph (8 km/h) or more, the seatbelt locks and helps reduce your forward movement.

## SENSITIVE LOCKING MODE

### What is Sensitive Locking Mode

Sensitive locking mode is a seatbelt retractor feature that allows shoulder belt length adjustment according to your movements and locking in response to vehicle movement.

### How Does Sensitive Locking Mode Work

If the driver suddenly brakes, turns a corner sharply, or the vehicle receives an impact of about 5 mph (8 km/h) or more, the seatbelts lock to help reduce forward movement of the driver and passengers.

In addition, the seatbelt retractor locks if you pull the seatbelt webbing out too quickly. If the retractor locks, slowly lower the height adjuster to allow the seatbelt to retract.

If the retractor does not unlock, pull the seatbelt out slowly then feed a small length of webbing back toward the stowed position.

For rear seatbelts, recline the rear seat backrest or push the seat backrest cushion away from the seatbelt. Feed a small length of webbing back toward the stowed position.

## AUTOMATIC LOCKING MODE

### What Is Automatic Locking Mode

This feature keeps the seatbelts pre-locked. The belt still retracts to remove any slack in the shoulder belt.

### When to Use Automatic Locking Mode

Use this mode any time you install a child restraint in a front seating position in a Regular Cab, Super Cab, Crew Cab or any rear seating position of a Super Cab or Crew Cab. The optional front seat center seatbelt in the Super Cab and Crew Cab has a cinch mechanism. Properly restrain children 12 years old and under in a rear seat whenever possible.

**Note:** *Automatic locking mode is not available on the driver seatbelt.*

### Engaging Automatic Locking Mode



1. Fasten the combination lap and shoulder belt.

# Seatbelts

2. Grasp the shoulder portion and pull downward until you pull the entire belt out.
3. Allow the belt to retract. As the belt retracts, you will hear a clicking sound. This indicates the seatbelt is now in the automatic locking mode.

## Disengaging Automatic Locking Mode

Unbuckle the combination lap and shoulder belt and allow it to retract completely to disengage the automatic locking mode and activate the vehicle sensitive locking mode.

## ADJUSTING THE SEATBELTS DURING PREGNANCY

**WARNING:** Always ride and drive with your seatback upright and properly fasten your seatbelt. Fit the lap portion of the seatbelt snugly and low across the hips. Position the shoulder portion of the seatbelt across your chest. Pregnant women must follow this practice. See the following figure.

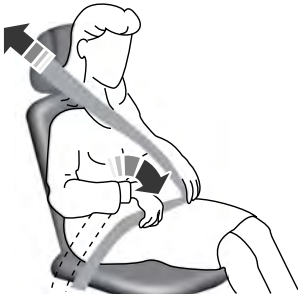

Pregnant women should always wear their seatbelt. Position the lap belt portion of a combination lap and shoulder belt low across the hips below the belly and worn as tight as comfort allows. Position the shoulder belt to cross the middle of the shoulder and the center of the chest.

## ADJUSTING THE SEATBELT HEIGHT

**WARNING:** Position the seatbelt height adjuster so that the seatbelt rests across the middle of your shoulder. Failure to adjust the seatbelt correctly could reduce its effectiveness and increase the risk of injury in a crash.

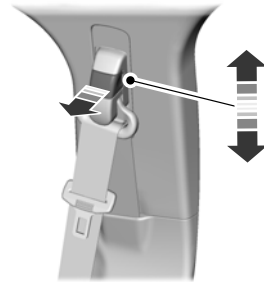

1. Pull the button and slide the height adjuster up or down.
2. Release the button and pull down on the height adjuster to make sure it is locked in place.

# Seatbelts

## ADJUSTING THE SEATBELT LENGTH



1. Pull some seatbelt webbing out of the shoulder belt retractor.
2. While holding the webbing below the tongue, grasp the metal tip of the tongue so that it is parallel to the webbing and slide the tongue up.
3. Provide enough lap belt length so that the tongue can reach the buckle.

## SEATBELT REMINDER

### How Does the Seatbelt Reminder Work

This feature supplements the seatbelt warning function by providing additional reminders that intermittently sound a tone and illuminate the seatbelt warning lamp when you are in the driver seat or you have a front seat passenger and a seatbelt is unbuckled.

The system uses information from the front passenger sensing system to determine if a front seat passenger is present and therefore potentially in need of a warning. To avoid the system switching on the Belt-Minder feature for objects you place on the front passenger seat, only the front seat passengers receive warnings as determined by the front passenger sensing system.

If the Belt-Minder warnings expire (warnings for about five minutes) for one passenger (driver or front passenger), the other passenger can still cause the Belt-Minder feature to switch on.

# Seatbelts

---

<b>If</b>	<b>Then</b>
You and the front seat passenger buckle your seatbelts before you switch the ignition on or less than 1–2 minutes elapse after you switch the ignition on...	The Belt-Minder feature will not activate.
You or the front seat passenger do not buckle your seatbelts before your vehicle reaches at least 6.0 mph (9.7 km/h) and 1–2 minutes elapse after you switch the ignition on...	The Belt-Minder feature activates, the seatbelt warning lamp illuminates and an indicator tone sounds for 6 seconds every 25 seconds, repeating for about 5 minutes or until you and the front seat passenger buckle your seatbelts.
The seatbelt for the driver or front passenger is unbuckled for about 1 minute while the vehicle is traveling at least 6.0 mph (9.7 km/h) and more than 1–2 minutes elapse after you switch the ignition on...	The Belt-Minder feature activates, the seatbelt warning lamp illuminates and an indicator tone sounds for 6 seconds every 25 seconds, repeating for about 5 minutes or until you and the front seat passenger buckle your seatbelts.

# Seatbelts

## Seatbelt Reminder Indicators

A warning lamp illuminates if the ignition is on, a front seat is occupied and the seatbelt has not been fastened.



The warning lamp illuminates until you fasten your seatbelt.

## Seatbelt Reminder Audible Warnings

A warning tone sounds if the warning lamp illuminates and your vehicle exceeds a relatively low speed.

The warning tone sounds for up to five minutes or until you fasten your seatbelt.

## Switching the Seatbelt Reminder On and Off



**WARNING:** While the system allows you to deactivate it, this system is designed to improve your chances of being safely belted and surviving an accident. We recommend you leave the system activated for yourself and others who may use the vehicle.

**Note:** *The driver and front passenger warnings switch off independently. When you perform this procedure for one seating position, do not buckle the other position as this cancels the process.*

**Note:** *If you are using MyKey, you cannot disable the seatbelt reminder. Also, if the seatbelt reminder has been previously disabled, it will be re-enabled during the use of MyKey.*

Read Steps 1 - 4 before proceeding with the programming procedure.

Make sure that:

- The parking brake is set.
  - The transmission is in park (P).
  - The ignition is off.
  - The driver and front passenger seatbelts are unfastened.
1. Switch the ignition on. Do not start the engine.
  2. Wait about one minute until the seatbelt warning light switches off. After Step 2, wait an additional five seconds before proceeding with Step 3. Once you start Step 3, you must complete the procedure within 30 seconds.
  3. For the seating position you are switching off, buckle then unbuckle the seatbelt three times at a moderate speed, ending in the unbuckled state. After Step 3, the seatbelt warning light switches on.
  4. When the seatbelt warning light is on, buckle then unbuckle the seatbelt. After Step 4, the seatbelt warning light flashes for confirmation.

This switches the feature off for that seating position if it is currently on.

This switches the feature on for that seating position if it is currently off.

## CHECKING THE SEATBELTS

Check the seatbelts and child restraints periodically to make sure they work properly and are not damaged. Make sure there are no nicks, tears or cuts. Replace if necessary.

Check all of the following seatbelt assemblies after a crash.

- Retractors.
- Buckles.
- Front seatbelt buckle assemblies.

# Seatbelts

- Shoulder belt height adjusters.
- Shoulder belt guide on seat backrest.
- Child restraint LATCH and tether anchors.
- Attaching hardware.

Read the child restraint manufacturer's instructions for additional inspection and maintenance information specific to the child restraint.

We recommend that all seatbelt assemblies in use in vehicles involved in a crash be replaced. However, if the crash was minor and an authorized dealer finds that the belts do not show damage and continue to operate properly, they do not need to be replaced. Seatbelt assemblies not in use during a crash should also be checked and replaced if either damage or improper operation is noted.

Properly care for seatbelts.



**WARNING:** Do not use extensions to change the way the seatbelt fits across the torso, over the lap or to make the seatbelt buckle easier to reach.

If, because of body size or driving position, it is not possible to properly fasten the seatbelt over your lap and shoulder, an extension that is compatible with the seatbelts is available free of charge from our dealers. Only use our seatbelt extensions made by the original equipment seatbelt manufacturer with our seatbelts. Ask your authorized dealer if your extension is compatible with your vehicle restraint system.

## SEATBELT EXTENSIONS



**WARNING:** Persons who fit into the vehicle's seatbelt should not use an extension. Unnecessary use could result in serious personal injury in the event of a crash.



**WARNING:** Only use extensions provided free of charge by our dealers. The dealer will provide an extension designed specifically for this vehicle, model year and seating position. The use of an extension intended for another vehicle, model year or seating position may not offer you the full protection of your vehicle's seatbelt restraint system.



**WARNING:** Never use seatbelt extensions to install child restraints.

## WHAT IS THE PERSONAL SAFETY SYSTEM

### *Personal Safety System*

An advanced safety system that protects occupants in frontal crashes.

## HOW DOES THE PERSONAL SAFETY SYSTEM WORK

This system provides an improved level of frontal crash protection to front seat occupants and is designed to reduce the risk of airbag-related injuries. The system analyzes occupant conditions and crash severity before activating the appropriate safety devices. During a crash, the restraints control module may deploy the seatbelt pretensioners, and one or both stages of the dual-stage airbags based on crash severity and occupant conditions.

## PERSONAL SAFETY SYSTEM COMPONENTS

- Driver and passenger dual-stage airbag supplemental restraints.
- Front seat outermost seatbelts with pretensioners, energy management retractors and seatbelt usage sensors.
- Front passenger sensing system.
- Passenger airbag off and on indicators.
- Front crash severity sensors.
- Restraints control module with impact and safing sensors.
- Restraint system warning light and tone.
- The electrical wiring for the airbags, crash sensors, seatbelt pretensioners, front seatbelt usage sensors, front passenger sensing system and indicator lights.

# Airbags

## HOW DO THE FRONT AIRBAGS WORK

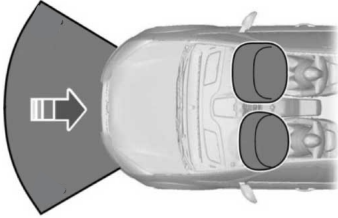

The driver and front passenger airbags deploy during significant frontal and near frontal crashes.

The driver and passenger front airbag system consists of:

- Driver and passenger airbag modules.
- Front passenger sensing system.
- Crash sensors and monitoring system with readiness indicator.

The airbags are a supplemental restraint system and are designed to work with the seatbelts to help protect the driver and right front passenger from certain upper body injuries. Airbags do not inflate slowly; there is a risk of injury from a deploying airbag.

**Note:** *You will hear a loud bang and see a cloud of harmless powdery residue if an airbag deploys. This is normal.*

The airbags inflate and deflate rapidly upon activation. After airbag deployment, it is normal to notice a smoke-like, powdery residue or smell the burnt propellant. This may consist of cornstarch, talcum powder (to lubricate the bag) or sodium

compounds (for example, baking soda) that result from the combustion process that inflates the airbag. Small amounts of sodium hydroxide may be present which may irritate the skin and eyes, but none of the residue is toxic.

Contact with a deploying airbag may cause abrasions or swelling. Temporary hearing loss is also a possibility as a result of the noise associated with a deploying airbag.

Because airbags must inflate rapidly and with considerable force, there is the risk of death or serious injuries such as fractures, facial and eye injuries or internal injuries, particularly to occupants who are not properly restrained or are otherwise out of position at the time of airbag deployment. Thus, it is extremely important that occupants be properly restrained as far away from the airbag module as possible while maintaining vehicle control.

Routine maintenance of the airbags is not required.

## HOW DO THE SIDE AIRBAGS WORK



**WARNING:** Do not place objects or mount equipment on or near the airbag cover, on the side of the front or rear seatbacks, or in areas that may come into contact with a deploying airbag. Failure to follow these instructions may increase the risk of personal injury in the event of a crash.



**WARNING:** Accessory seat covers not released by Ford could prevent the deployment of the airbags and increase the risk of injuries in a crash.



# Airbags



**WARNING:** Do not lean your head on the door. The side airbag could injure you as it deploys from the side of the seatback.

The side airbags are on the outermost side of the seat backrests of the front seats. In certain sideways crashes or rollovers, the airbags will be inflated. The airbag was designed to inflate between the door panel and occupant to further enhance the protection provided to occupants in side impact crashes.



The system consists of the following:

- A label or embossed side panel indicating that side airbags are fitted to your vehicle.
- Side airbags inside the driver and front passenger seat backrests.
- Crash sensors and monitoring system with readiness indicator.

## HOW DO THE KNEE AIRBAGS WORK

Driver and passenger knee airbags are under or within the instrument panel. During a crash, the restraints control module may activate the driver and passenger knee airbags (individually or both) based on crash severity and

respective occupant conditions. Under certain crash and occupant conditions, the driver and passenger knee airbags may deploy (individually or both) but the corresponding front airbag may not activate. It is important to be properly seated and restrained to reduce the risk of death or serious injury.



Make sure the knee airbags are operating properly.

## HOW DOES THE SAFETY CANOPY™ WORK



**WARNING:** Do not place objects or mount equipment on or near the headliner at the siderail that may come into contact with a deploying curtain airbag. Failure to follow these instructions may increase the risk of personal injury in the event of a crash.



**WARNING:** Do not lean your head on the door. The curtain airbag could injure you as it deploys from the headliner.



**WARNING:** To reduce risk of injury, do not obstruct or place objects in the deployment path of the airbag.

The Safety Canopy deploys during significant side crashes or when a certain likelihood of a rollover event is detected by the rollover sensor. The Safety Canopy is mounted to the roof side-rail sheet metal, behind the headliner, above each row of seats. In certain sideways crashes or rollover events, the Safety Canopy will

# Airbags

be activated, regardless of which seats are occupied. The Safety Canopy inflates between the side window area and occupants to further enhance protection provided in side impact crashes and rollover events.

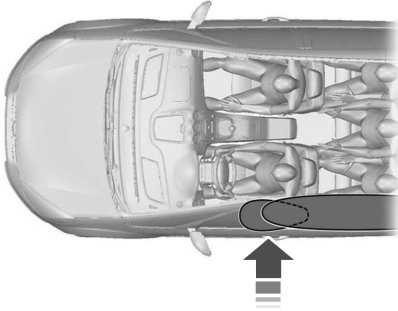

The system consists of the following:

- Safety Canopy curtain airbags above the trim panels over the front and rear side windows identified by a label or wording on the headliner or roof-pillar trim.
- A flexible headliner which opens above the side doors to allow air curtain deployment



• Crash sensors and monitoring system with a readiness indicator.

Properly restrain children 12 years old and under in the rear seats. The Safety Canopy will not interfere with children restrained using a properly installed child or booster seat because it is designed to inflate downward from the headliner above the doors along the side window opening.

## AIRBAG PRECAUTIONS

**WARNING:** Airbags do not inflate slowly or gently, and the risk of injury from a deploying airbag is the greatest close to the trim covering the airbag module.

**WARNING:** All occupants of your vehicle, including the driver, should always properly wear their seatbelts, even when an airbag supplemental restraint system is provided. Failure to properly wear your seatbelt could seriously increase the risk of injury or death.

**WARNING:** Properly secure children 12 years old and under in a rear seating position whenever possible. If you are unable to properly secure all children in a rear seating position, properly secure the largest child on the front seat. If you must use a forward facing child restraint on the front seat, move the seat as far back as possible. Failure to follow these instructions could result in personal injury or death.

**WARNING:** Do not place your arms on the airbag cover or through the steering wheel. Failure to follow this instruction could result in personal injury.

**WARNING:** Keep the areas in front of the airbags free from obstruction. Do not affix anything to or over the airbag covers. Objects could become projectiles during airbag deployment. Failure to follow this instruction could result in personal injury or death.

**WARNING:** To reduce risk of injury, do not obstruct or place objects in the deployment path of the airbag.

# Airbags

 **WARNING:** Do not place a rearward facing child restraint in front of an active airbag. Failure to follow this instruction could result in personal injury or death.

 **WARNING:** Do not attempt to service, repair, or modify the supplementary restraint system or associated components. Failure to follow this instruction could result in personal injury or death.

 **WARNING:** Several airbag system components get hot after inflation. To reduce the risk of injury, do not touch them after inflation.

 **WARNING:** If a supplementary restraint system component has deployed, it will not function again. Have the system and associated components inspected as soon as possible. Failure to follow this instruction could result in personal injury or death.

## PROPERLY ADJUSTING THE DRIVER AND FRONT PASSENGER SEATS

 **WARNING:** National Highway Traffic Safety Administration (NHTSA) recommends a minimum distance of at least 10 in (25 cm) between an occupant's chest and the driver airbag module.

To properly position yourself away from the airbag:

- Move your seat to the rear as far as you can while still reaching the pedals comfortably.
- Recline the seat slightly one or two degrees from the upright position.

After all occupants have adjusted their seats and put on seatbelts, it is very important that they continue to sit properly. Properly seated occupants sit upright, lean against the seat backrest, and center themselves on the seat cushion, with their feet comfortably extended on the floor. Sitting improperly can increase the chance of injury in a crash event. For example, if an occupant slouches, lies down, turns sideways, sits forward, leans forward or sideways, or puts one or both feet up, the chance of injury during a crash greatly increases.

## CHILDREN AND AIRBAGS

 **WARNING:** Do not place a rearward facing child restraint in front of an active airbag. Failure to follow this instruction could result in personal injury or death.



# Airbags

Children must always be properly restrained. Accident statistics suggest that children are safer when properly restrained in the rear seating positions than in the front seating position. Failure to follow these instructions may increase the risk of injury in a crash.

If two adults and a child occupy a vehicle without rear seats, properly restrain the child in the center front seat unless doing so would interfere with driving your vehicle. This provides lap and shoulder belt protection for all occupants, and airbag protection for the adults. A child or infant properly restrained in the center front seat should not incur risk of serious injury from the airbags.

## FRONT PASSENGER SENSING SYSTEM

### What Is the Front Passenger Sensing System

This system detects a properly seated occupant and determines if the front passenger airbag should be enabled.

### How Does the Front Passenger Sensing System Work

The system uses a passenger airbag status indicator which illuminates indicating that the front passenger frontal airbag is either enabled or disabled.

**Note:** When you first switch the ignition on, the passenger airbag status indicator off and on lamps illuminate for a short period to confirm they are functional.



The indicator lamps are in the overhead console.

The front passenger sensing system is designed to disable the front passenger frontal airbag under these conditions:

- The front passenger seat is unoccupied.
- The system determines an infant is present in a child restraint.
- A passenger takes their weight off of the seat for a period of time.
- If there is a problem with the airbag system or the passenger sensing system.

Even with this technology, parents are strongly encouraged to always properly restrain children in the rear seat.

- When the front passenger sensing system disables the front passenger frontal airbag, the passenger airbag status indicator illuminates the off lamp.
- If you have installed the child restraint and the passenger airbag status indicator illuminates the on lamp, switch your vehicle off, remove the child restraint from your vehicle and reinstall the restraint following the child restraint manufacturer's instructions.

The front passenger sensing system works with sensors that are part of the front passenger seat and seatbelt. The sensors are designed to detect the presence of a properly seated occupant and determine if the front passenger frontal airbag should be enabled.

- When the front passenger sensing system enables the front passenger frontal airbag, the passenger airbag status indicator illuminates the on lamp.

# Airbags

If a person of adult size is sitting in the front passenger seat, but the passenger airbag status indicator off lamp is illuminated, it is possible that the person is not sitting properly in the seat. If this happens:

- Switch your vehicle off and ask the person to place the seat backrest in an upright position.
- Have the person sit upright in the seat, centered on the seat cushion, with the person's legs comfortably extended.
- Restart your vehicle and have the person remain in this position for about two minutes. This allows the system to detect that person and enable the passenger frontal airbag.
- If the indicator off lamp remains illuminated even after this, you should advise the person to ride in the rear seat.

After all occupants have adjusted their seats and put on seatbelts, it is very important that they continue to sit upright, leaning against the seat backrest, and centered on the seat cushion, with their feet comfortably extended on the floor.

Sitting improperly can increase the chance of injury in a crash event. For example, if an occupant slouches, lies down, turns sideways, sits forward, leans forward or sideways, or puts one or both feet up, the chance of injury during a crash greatly increases.

If you think that the state of the passenger airbag status indicator lamp is incorrect, check for the following:

- Objects lodged underneath the seat.
- Objects between the seat cushion and the center console.
- Objects hanging off the seat backrest.
- Objects stowed in the seat backrest map pocket.
- Objects placed on the occupant's lap.

- Cargo interference with the seat
- Other passengers pushing or pulling on the seat.
- Rear passenger feet and knees resting or pushing on the seat.

The listed conditions could cause the weight of a properly seated occupant to be incorrectly interpreted by the front passenger sensing system. The person in the front passenger seat could appear heavier or lighter due to the conditions listed.



Make sure the front passenger sensing system is operating properly.

If the airbag readiness light is on, do the following:

- Pull your vehicle over.
- Switch your vehicle off.
- Check for any objects lodged underneath the front passenger seat or cargo interfering with the seat.
- Remove the obstruction if found.
- Restart your vehicle.
- Wait at least two minutes and verify that the airbag readiness light in the instrument cluster is no longer illuminated.
- If the airbag readiness light in the instrument cluster remains illuminated, there may be a problem due to the front passenger sensing system.

Do not attempt to repair or service the system. Take your vehicle in for service immediately.

If it is necessary to modify an advanced front airbag system to accommodate a person with disabilities, contact your Customer Relationship Center.

# Airbags

## Front Passenger Sensing System Precautions



**WARNING:** Sitting improperly, out of position or with the seatback reclined too far can take weight off the seat cushion and affect the decision of the passenger sensing system, resulting in serious injury or death in the event of a

crash. Always sit upright against your seat back, with your feet on the floor.



**WARNING:** Any alteration or modification to the front passenger seat may affect the performance of the front passenger sensing system. This could seriously increase the risk of injury or death.

## Front Passenger Sensing System Indicators

Occupant	Passenger Airbag Status Indicator	Passenger Airbag
Empty	OFF: Illuminated	Disabled
	ON: Not Illuminated	
Child	OFF: Illuminated	Disabled
	ON: Not Illuminated	
Adult	OFF: Not Illuminated	Enabled
	ON: Illuminated	

## CRASH SENSORS AND AIRBAG INDICATOR



**WARNING:** Modifying or adding equipment to the front end of your vehicle (including hood, bumper system, frame, front end body structure, tow hooks and hood pins) may affect the performance of the airbag system, increasing the risk of injury. Do not modify or add equipment to the front end of your vehicle.

Your vehicle has a collection of crash and occupant sensors. These sensors provide information to the restraints control module which activates the following:

- Front seatbelt pretensioners.
- Driver airbag.
- Passenger airbag.
- Knee airbag(s).
- Seat mounted side airbags.
- Safety Canopy.

Based on the type of crash, the restraints control module deploys the appropriate safety devices.

# Airbags

---

The restraints control module also monitors the readiness of the above safety devices plus the crash and occupant sensors. The readiness of the safety system is indicated by a warning indicator light in the instrument cluster or by a backup tone if the warning light is not working. Routine maintenance of the airbag is not required.

A difficulty with the system is indicated by one or more of the following:



The readiness light will not illuminate immediately after you switch the ignition on.

- The readiness light either flashes or stays on.
- You hear a series of five tones. The tone pattern repeats periodically until the problem, the light or both are repaired.

If any of these things happen, even intermittently, have the supplemental restraint system serviced immediately. Unless serviced, the system may not function properly in the event of a crash.

The fact that the seatbelt pretensioners or front airbags did not activate for both front seat occupants in a crash does not mean that something is wrong with the system. Rather, it means the restraints control module determined the accident conditions (crash severity, seatbelt usage) were not appropriate to activate these safety devices.

- The front airbags activate only in frontal and near-frontal crashes. Front airbags may activate in rollovers, side impacts or rear impacts if the crash causes sufficient frontal deceleration.
- The seatbelt pretensioners activate in frontal, near-frontal and side crashes, and in rollovers.
- The knee airbag(s) deploy based on crash severity and occupant conditions.

- The side airbags inflate in certain side impact crashes or rollover events. Side airbags may activate in other types of crashes if the vehicle experiences sufficient sideways motion or deformation.
- The Safety Canopy inflates in certain side impact crashes or rollover events. The Safety Canopy may activate in other types of crashes if the vehicle experiences sufficient sideways motion or deformation, or a certain likelihood of rollover.

## DISPOSING OF AIRBAGS

Contact your authorized dealer as soon as possible. Airbags must be disposed of by qualified personnel.

# Keys and Remote Controls

---

## REMOVING THE KEY BLADE



Push the release button on your passive key and pull the key blade out.

## REPLACING A LOST KEY OR REMOTE CONTROL

You can purchase replacement keys or remote controls from an authorized dealer. Authorized dealers can program remote controls for your vehicle.



**Note:** *Your vehicle keys came with a security label that provides important key cut information. Keep the label in a safe place for future reference.*



## **PASSIVE ANTI-THEFT SYSTEM**

### **What Is the Passive Anti-Theft System**

The passive anti-theft system prevents someone from starting the vehicle with an incorrectly coded key.

### **How Does the Passive Anti-Theft System Work**

The passive anti-theft system arms when you switch the ignition off.

It disarms when the ignition is switched on with a correctly coded key.

**Note:** *The system is not compatible with non-Ford aftermarket remote start systems.*

**Note:** *Do not leave a duplicate coded key in your vehicle. Always take the keys and lock all doors when leaving your vehicle.*

# Wipers and Washers

## WIPERS

### Wiper Precautions

Do not operate the wipers on a dry windshield. This could scratch the glass or damage the wiper blades. Use the windshield washers before wiping a dry windshield.

Fully defrost the windshield before you switch the windshield wipers on.

Switch the windshield wipers off before entering a car wash.

### Switching Windshield Wipers On and Off

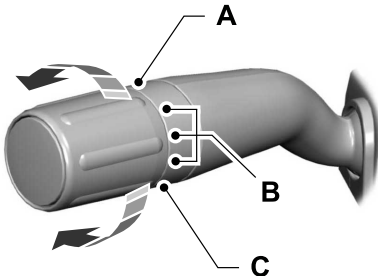

- A High-speed wipe.
- B Intermittent wipe.
- C Off.



Use the rotary control.

### CHECKING THE WIPER BLADES

[\*Improving Your Windshield Wiper Performance\*](#)



E142463

Run the tip of your fingers over the edge of the blade to check for roughness.

### REPLACING THE FRONT WIPER BLADES



E165804

1. Pull the wiper blade and arm away from the glass.

**Note:** Do not hold the wiper blade to lift the wiper arm.

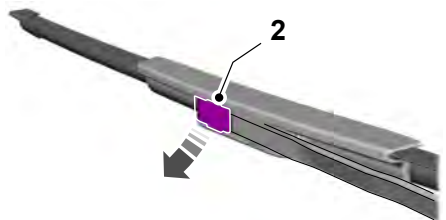

# Wipers and Washers

2. Lift the wiper blade primary locking clip.

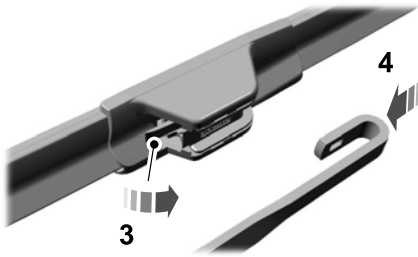

3. Press the wiper blade secondary locking clip.
4. Remove the wiper blade.

**Note:** Make sure that the wiper arm does not spring back against the glass when the wiper blade is not attached.

5. To install, reverse the removal procedure.

**Note:** Make sure that the wiper blade locks into place.

## WASHERS

### Washer Precautions



**WARNING:** If you operate your vehicle in temperatures below 41.0°F (5°C), use washer fluid with antifreeze protection. Failure to use washer fluid with antifreeze protection in cold weather could result in impaired windshield vision and increase the risk of injury or accident.

Do not operate the washers when the washer reservoir is empty. This could cause the washer pump to overheat.

Keep the outside of the windshield clean. The rain sensor is very sensitive and the wipers may operate if dirt, mist or insects hit the windshield.

### Using the Windshield Washer

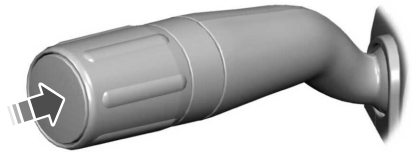

Press and hold the button at the end of the lever to operate the windshield washer.

**Note:** A courtesy wipe occurs a short time after the wipers stop to clear any remaining washer fluid when switched on.

## WIPERS AND WASHERS – TROUBLESHOOTING

### Wipers and Washers – Frequently Asked Questions

#### Why are there streaks and smears on the windshield?

The wiper blades could be dirty, worn or damaged. Check the wiper blades. If the wiper blades are dirty, clean them with washer fluid or water applied with a soft sponge or cloth. If the wiper blades are worn or damaged, install new ones.

# Instrument Cluster

## INSTRUMENT CLUSTER WARNING LAMPS

### Anti-Lock Brake System



If it illuminates when you are driving, this indicates a malfunction. Your vehicle continues to have normal braking without the anti-lock brake system function. Have your vehicle checked as soon as possible.

### Battery



It illuminates when you switch the ignition on.

If it illuminates when the engine is running, this indicates your vehicle requires service. Have your vehicle checked as soon as possible.

### Brake System



It illuminates when you apply the parking brake and the ignition is on. If it illuminates when your



vehicle is moving, make sure the parking brake is released. If the parking brake is released, this indicates low brake fluid level or the brake system requires service. Have your vehicle checked as soon as possible.

**Note:** Indicators may vary depending on region.

### Diesel Exhaust Fluid



It illuminates when the diesel exhaust fluid is low, contaminated or the system requires service.

### Door Ajar



It illuminates when you switch the ignition on and remains on if any door is open.

### Electric Parking Brake



It illuminates or flashes when the electric parking brake requires service.

### Engine Coolant Temperature



If it illuminates, safely stop your vehicle and switch the vehicle off.

### Fasten Seatbelt



It illuminates and a tone sounds until you fasten the seatbelts.

### Hood Ajar



It illuminates when the ignition is on and the hood is not completely closed.

### Low Fuel Level



It illuminates when the fuel level is low.

### Low Tire Pressure



It illuminates when your tire pressure is low. If illuminated, check your tire pressure as soon as possible. If it begins to flash at anytime, have the system checked as soon as possible.

### Low Washer Fluid Level



It illuminates when the washer fluid is low.

### Oil Pressure



It illuminates when the engine oil pressure is low.

# Instrument Cluster

## Powertrain Malfunction, Reduced Power, Electronic Throttle Control, Check 4X4



It illuminates when the powertrain or four-wheel drive require service. Have the system checked as soon as possible.

## Service Engine Soon



It illuminates when the ignition is on and the engine is off, this is normal. If it illuminates when the engine is on this indicates the emission control system requires service. If it flashes, have your vehicle checked immediately.

## Stop Safely



It illuminates if an electrical component requires service or a failure that causes your vehicle to shutdown or enter into a limited operating mode.

## Tailgate Ajar



It illuminates when the ignition is on and the tailgate is not completely closed.

## Water in Fuel



It illuminates when the fuel and water separator has a significant quantity of water in it and requires immediate draining.

## INSTRUMENT CLUSTER INDICATORS

### Active Drive Assist



### Adaptive Cruise Control



### Automatic High Beam



### Automatic Regen Control Off



### Auto Hold Active



### Auto Hold Unavailable



### Auto-Start-Stop



### Blind Spot Monitor



### Cruise Control



### Electronic Locking Differential



# Instrument Cluster

## Four-Wheel Drive



**Note:** Some indicators appear different depending on vehicle options.

## Front Airbag



## Front Fog Lamp



## High Beam



## Hill Descent



## Lamps On



## Ready to Drive



## Reverse Brake Assist



## Stability Control and Traction Control



## Turn Signal Lamps



## Tow Haul



## Wait to Start



# Climate Control - Vehicles With: Automatic Temperature Control

## IDENTIFYING THE CLIMATE CONTROL UNIT



Depending on your vehicle options, the controls could look different than what you see here.

## SWITCHING CLIMATE CONTROL ON AND OFF



Press the button.

## SWITCHING DEFROST ON AND OFF



Press the button to activate the selection screen.



Press the button on the touchscreen to switch the windshield air vents on.



Make sure that the instrument panel air vents are switched off.



Make sure that the footwell air vents are switched off.

## SWITCHING MAXIMUM DEFROST ON AND OFF



Press the button.

Air flows through the windshield air vents, and the blower motor adjusts to the highest speed.

You can also use this setting to defog and clear the windshield of a thin covering of ice.

**Note:** To prevent window fogging, you cannot select recirculated air when maximum defrost is on.

**Note:** The heated rear window also turns on when you select maximum defrost.

## SWITCHING THE HEATED WIPER PARK ON AND OFF



When you switch the heated rear window on, the heated wiper park also turns on.

## SWITCHING THE HEATED REAR WINDOW ON AND OFF



Press the button to clear the rear window of thin ice and fog. The heated rear window turns off after a short period of time.

**Note:** Do not use harsh chemicals, razor blades or other sharp objects to clean or remove decals from the inside of the heated rear window as this could cause damage to the heated rear window grid lines not covered by the vehicle Warranty.

# Climate Control - Vehicles With: Automatic Temperature Control

## SETTING THE BLOWER MOTOR SPEED



Press up or down on the control to select the blower motor speed.

**Note:** For Hybrid Electric Vehicle (HEV) and Plug-In Hybrid Electric Vehicle (PHEV) vehicles, the blower motor may run, and you may feel airflow when the climate control is off to provide cooling to the battery.

## SETTING THE TEMPERATURE

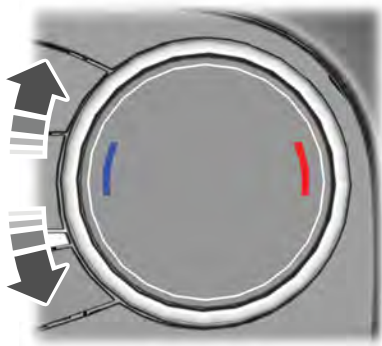

Turn the control on the left-hand side of the climate control to set the left-hand temperature.

**Note:** This control also sets the right-hand side temperature when you switch off dual zone mode.

Turn the control on the right-hand side of the climate control to set the right-hand temperature.

## DIRECTING THE FLOW OF AIR

### Directing Air to the Windshield Air Vents



Press the button to activate the selection screen.



Press the button on the touchscreen.

### Directing Air to the Instrument Panel Air Vents



Press the button to activate the selection screen.



Press the button on the touchscreen.

### Directing Air to the Footwell Air Vents



Press the button to activate the selection screen.



Press the button on the touchscreen.

## CLIMATE CONTROL HINTS

### General Hints

- Prolonged use of recirculated air may cause the windows to fog up.
- You may feel a small amount of air from the footwell air vents regardless of the air distribution setting.
- To reduce humidity build-up inside your vehicle, do not drive with the system switched off or with recirculated air always switched on.
- Do not place objects under the front seats as this may interfere with the airflow to the rear seats.



# Climate Control - Vehicles With: Automatic Temperature Control

---

- Remove any snow, ice or leaves from the air intake area at the base of the windshield.
- To improve the time to reach a comfortable temperature in hot weather, drive with the windows open until you feel cold air through the air vents.

## Automatic Climate Control

- Adjusting the settings when your vehicle interior is extremely hot or cold is not necessary. Automatic mode is best recommended to maintain set temperature.
- The system adjusts to heat or cool the interior to the temperature you select as quickly as possible.
- For the system to function efficiently, the instrument panel and side air vents should be fully open.
- If you press **AUTO** during cold outside temperatures, the system directs air flow to the windshield and side window air vents. In addition, the blower motor may run at a slower speed until the engine warms up.
- If you press **AUTO** during hot temperatures and the inside of the vehicle is hot, the system uses recirculated air to maximize interior cooling. Blower motor speed may also reduce until the air cools.

## Quickly Heating the Interior

1. Press **AUTO**.
2. Adjust the temperature function to the setting you prefer.

## Recommended Settings for Heating

1. Press **AUTO**.

2. Adjust the temperature function to the setting you prefer. Use 72°F (22°C) as a starting point, then adjust the setting as necessary.

## Quickly Cooling the Interior

Press **MAX A/C**.

## Recommended Settings for Cooling

1. Press **AUTO**.
2. Adjust the temperature function to the setting you prefer. Use 72°F (22°C) as a starting point, then adjust the setting as necessary.

## Defogging the Side Windows in Cold Weather

1. Press and release defrost or maximum defrost.
2. Adjust the temperature control to the setting you prefer. Use 72°F (22°C) as a starting point, then adjust the setting as necessary.

# Climate Control - Vehicles With: Manual Temperature Control

## IDENTIFYING THE CLIMATE CONTROL UNIT



Depending on your vehicle options, the controls could look different than what you see here.

## SWITCHING DEFROST ON AND OFF



Press the button to switch the windshield air vents on.



Make sure that the instrument panel air vents are switched off.



Make sure that the footwell air vents are switched off.

## SWITCHING MAXIMUM DEFROST ON AND OFF



Turn the temperature control clockwise past the highest setting to maximize defrosting.

**Note:** *The temperature control springs back to the highest setting.*

Air flows through the windshield air vents, and the blower motor adjusts to the highest speed.

**Note:** *To prevent window fogging, you cannot select recirculated air when maximum defrost is on.*

**Note:** *When you switch maximum defrost on, the heated windshield turns on.*

## SWITCHING THE HEATED REAR WINDOW ON AND OFF



Press the button to clear the rear window of thin ice and fog. The heated rear window turns off after a short period of time.

**Note:** *Do not use harsh chemicals, razor blades or other sharp objects to clean or remove decals from the inside of the heated rear window as this could cause damage to the heated rear window grid lines not covered by the vehicle Warranty.*

## SETTING THE BLOWER MOTOR SPEED



**Note:** *Lights on the control illuminate to indicate the blower motor speed.*

**Note:** *When you switch the blower motor off, air conditioning turns off and the windows could fog up.*

# Climate Control - Vehicles With: Manual Temperature Control

## SETTING THE TEMPERATURE

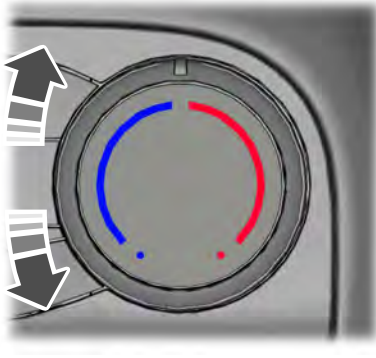

Turn the temperature control counterclockwise for cooler temperature settings.

Turn the temperature control clockwise for warmer temperature settings.

## DIRECTING THE FLOW OF AIR

### Directing Air to the Windshield Air Vents



Press the button.

### Directing Air to the Instrument Panel Air Vents



Press the button.

### Directing Air to the Footwell Air Vents



Press the button.

## CLIMATE CONTROL HINTS

### General Hints

- Prolonged use of recirculated air may cause the windows to fog up.
- You may feel a small amount of air from the footwell air vents regardless of the air distribution setting.
- To reduce humidity build-up inside your vehicle, do not drive with the system switched off or with recirculated air always switched on.
- Do not place objects under the front seats as this may interfere with the airflow to the rear seats.
- Remove any snow, ice or leaves from the air intake area at the base of the windshield.
- To improve the time to reach a comfortable temperature in hot weather, drive with the windows open until you feel cold air through the air vents.

### Quickly Heating the Interior

1. Adjust the blower motor speed to the highest speed setting.
2. Adjust the temperature control to the highest setting.
3. Direct air to the footwell air vents.

### Recommended Settings for Heating

1. Adjust the blower motor speed to the center setting.
2. Adjust the temperature control to the midway point of the hot settings.
3. Direct air to the footwell air vents.

### Quickly Cooling the Interior

1. Press **MAX A/C**.

# Climate Control - Vehicles With: Manual Temperature Control

---

2. Drive with the windows open for a short period of time.

## **Recommended Settings for Cooling**

1. Adjust the blower motor speed to the center setting.
2. Adjust the temperature control to the midway point of the cold settings.
3. Direct air to the instrument panel air vents.

## **Defogging the Side Windows in Cold Weather**

1. Direct air to the instrument panel and windshield air vents.
2. Press and release **A/C**.
3. Adjust the temperature control to the setting you prefer.
4. Adjust the blower motor speed to the highest setting.
5. Direct air toward the side windows.
6. Close the instrument panel air vents.

# Front Seats

## SITTING IN THE CORRECT POSITION

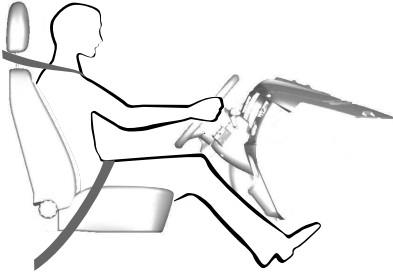

When you use them properly, the seat, head restraint, seatbelt and airbags will provide optimum protection in the event of a crash.

We recommend that you follow these guidelines:

- Sit in an upright position with the base of your spine as far back as possible.
- Do not recline the seat backrest so that your torso is more than 30 degrees from the upright position.
- Adjust the head restraint so that the top of it is level with the top of your head and as far forward as possible. Make sure that you remain comfortable.
- Keep sufficient distance between yourself and the steering wheel. We recommend a minimum of 10 in (25 cm) between your breastbone and the airbag cover.
- Hold the steering wheel with your arms slightly bent.

- Bend your legs slightly so that you can press the pedals fully.
- Position the shoulder strap of the seatbelt over the center of your shoulder and position the lap strap tightly across your hips.

Make sure that your driving position is comfortable and that you can maintain full control of your vehicle.

## MANUAL SEATS

### Head Restraint Components

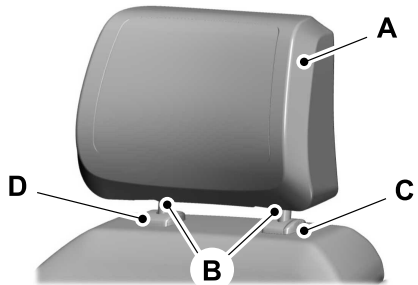

The head restraints consist of:

- A An energy absorbing head restraint.
- B Two steel stems.
- C Guide sleeve adjust and release button.
- D Guide sleeve unlock and remove button (If equipped).

### Adjusting the Head Restraint

#### [4-Way Head Restraints](#)

# Front Seats



**WARNING:** Fully adjust the head restraint before you sit in or operate your vehicle. This will help minimize the risk of neck injury in the event of a crash. Do not adjust the head restraint when your vehicle is moving.



**WARNING:** The head restraint is a safety device. Whenever possible it should be installed and properly adjusted when the seat is occupied. Failure to adjust the head restraint properly could reduce its effectiveness during certain impacts.

**Note:** *Adjust the seat backrest to an upright driving position before adjusting the head restraint. Adjust the head restraint so that the top of it is level with the top of your head and as far forward as possible. Make sure that you remain comfortable. If you are extremely tall, adjust the head restraint to its highest position.*

Pull the head restraint up to raise it.

To lower the head restraint:

1. Press and hold the adjust and release button.
2. Push the head restraint down.

To tilt the head restraint:



1. Adjust the seat backrest to an upright driving or riding position.

2. Pivot the head restraint forward toward your head to the preferred position.

After the head restraint reaches the forward-most tilt position, pivot it forward again to release it to the rearward, untilted position.

**Note:** *Do not attempt to force the head restraint backward after it is tilted. Instead, continue tilting it forward until the head restraint releases to the upright position.*

## Removing the Head Restraint

1. Pull up the head restraint until it reaches the highest adjustment position.
2. Press and hold the adjust and release button and the unlock and remove button.
3. Pull up the head restraint.

**Note:** *You cannot remove head restraints that have audio system speakers.*

## Installing the Head Restraint

Align the steel stems into the guide sleeves and push the head restraint down until it locks.

# Front Seats

## POWER SEATS

### Head Restraint Components

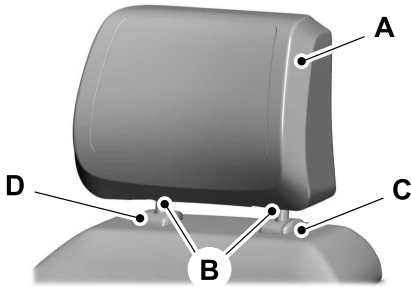

The head restraints consist of:

- A An energy absorbing head restraint.
- B Two steel stems.
- C Guide sleeve adjust and release button.
- D Guide sleeve unlock and remove button (If equipped).

### Adjusting the Head Restraint

#### 4-Way Head Restraints

**WARNING:** Fully adjust the head restraint before you sit in or operate your vehicle. This will help minimize the risk of neck injury in the event of a crash. Do not adjust the head restraint when your vehicle is moving.

**WARNING:** The head restraint is a safety device. Whenever possible it should be installed and properly adjusted when the seat is occupied. Failure to adjust the head restraint properly could reduce its effectiveness during certain impacts.

To raise the head restraint, pull the head restraint up.

To lower the head restraint, do the following:

1. Press and hold the adjust and release button.
2. Push the head restraint down.

To tilt the head restraint, do the following:



1. Adjust the seat backrest to an upright driving or riding position.
2. Pivot the head restraint forward toward your head to the preferred position.

After the head restraint reaches the forward-most tilt position, pivot it forward again to release it to the rearward, untilted position.

**Note:** Do not attempt to force the head restraint backward after it is tilted. Instead, continue tilting it forward until the head restraint releases to the upright position.

# Front Seats

## Removing the Head Restraint

1. Pull up the head restraint until it reaches its highest position.
2. Press and hold the adjust and release button and the unlock and remove button.
3. Pull up the head restraint.

**Note:** *You cannot remove head restraints that have audio system speakers.*

## Installing the Head Restraint

Align the steel stems into the guide sleeves and push the head restraint down until it locks.

## HEATED SEATS

### Heated Seat Precautions



**WARNING:** Use caution when using the heated seat if you are unable to feel pain to your skin because of advanced age, chronic illness, diabetes, spinal cord injury, medication, alcohol use, exhaustion or other physical conditions. The heated seat could cause burns even at low temperatures, especially if used for long periods of time. Failure to follow this instruction could result in personal injury.



**WARNING:** Do not poke sharp objects into the seat cushion or seat backrest. This could damage the heated seat element and cause it to overheat. Failure to follow this instruction could result in personal injury.



**WARNING:** Do not place anything on the seat that blocks the heat, for example a seat cover or a cushion. This could cause the seat to overheat. Failure to follow this instruction could result in personal injury.

Do not:

- Place heavy objects on the seat.
- Operate the heated seat if water or any other liquid spills on the seat. Allow the seat to dry.

### Switching the Heated Seats On and Off

The vehicle must be running to use this feature.



Press the heated seat symbol on the climate controls or touchscreen to cycle through the various heat settings and off. The more indicators that display, the warmer the temperature of the seat.

**Note:** *The heated seats may remain on after you remote start your vehicle, based on your remote start settings. The heated seats may also turn on when you start your vehicle if they were on when you switched your vehicle off.*



# Front Seats

---

## VENTILATED SEATS

### Ventilated Seat Precautions

Do not:

- Spill liquid on the front seats. This may cause the air vent holes to become blocked and not work properly.
- Place cargo or objects under the seats. They may block the air intake causing the air vents to not work properly.

### Switching the Ventilated Seats On and Off

The vehicle must be running to use this feature.



Press this symbol on the climate controls or the touchscreen to cycle through the various ventilation settings and off. More indicator lights indicate higher fan speeds.

**Note:** *When you switch the climate control fan speed and the ventilated seats to their maximum settings, the ventilated seats provide increased cooling.*

If the engine falls below 350 RPM while the ventilated seats are on, the feature turns itself off unless the vehicle is in Auto-Start-Stop mode. You may need to reactivate the ventilated seats.

**Note:** *The ventilated seats may remain on after you remote start your vehicle, based on your remote start settings. The ventilated seats may also turn on when you start your vehicle if they were on when you switched your vehicle off.*

# Rear Seats

## MANUAL SEATS

### Head Restraint Components

#### Rear Seat Outermost Head Restraints

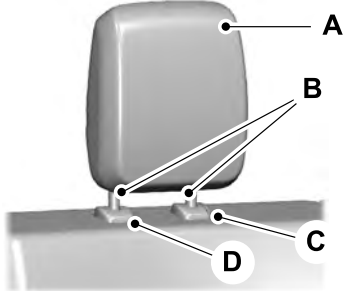

#### Rear Seat Center Head Restraint

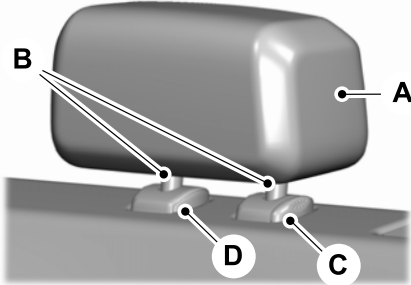

The head restraints consist of:

- A An energy absorbing head restraint.
- B Two steel stems.
- C Guide sleeve adjust and release button.
- D Guide sleeve unlock and remove button (If equipped).

### Adjusting the Head Restraint

Pull the head restraint up to raise it.

To lower the head restraint:

1. Press and hold the adjust and release button.
2. Push the head restraint down.

### Removing the Head Restraint

1. Pull up the head restraint until it reaches its highest position.
2. Press and hold the adjust and release button and the unlock and remove button.
3. Pull up the head restraint.

### Installing the Head Restraint

Align the steel stems into the guide sleeves and push the head restraint down until it locks.

## HEATED SEATS

### Heated Seat Precautions

 **WARNING:** Use caution when using the heated seat if you are unable to feel pain to your skin because of advanced age, chronic illness, diabetes, spinal cord injury, medication, alcohol use, exhaustion or other physical conditions. The heated seat could cause burns even at low temperatures, especially if used for long periods of time. Failure to follow this instruction could result in personal injury.

 **WARNING:** Do not poke sharp objects into the seat cushion or seat backrest. This could damage the heated seat element and cause it to overheat. Failure to follow this instruction could result in personal injury.

## Rear Seats

---



**WARNING:** Do not place anything on the seat that blocks the heat, for example a seat cover or a cushion. This could cause the seat to overheat. Failure to follow this instruction could result in personal injury.

Do not:

- Place heavy objects on the seat.
- Operate the heated seat if water or any other liquid spills on the seat. Allow the seat to dry.

### Switching the Heated Seats On and Off

The vehicle must be running to use this feature.

The rear seat heat controls are on the rear of the center console.



Press the heated seat symbol to cycle through the various heat settings and off. More indicator lights indicate warmer settings.

The heated seats turn off when you switch off the vehicle.

# Memory Function

## MEMORY FUNCTION PRECAUTIONS



**WARNING:** Before activating the memory seat, make sure that the area immediately surrounding the seat is clear of obstructions and that all occupants are clear of moving parts.



**WARNING:** Do not use the memory function when your vehicle is moving.

## LOCATING THE MEMORY FUNCTION BUTTONS



The memory function buttons are on the driver door.

## SAVING A PRESET POSITION

1. Adjust the memory features to your preferred position.
2. Press and hold the preferred preset button until you hear a single tone.

A confirmation message appears in the information display.

You can save up to three preset memory positions at any time.

## RECALLING A PRESET POSITION

Press and release a preset button.

**Note:** You can recall a preset memory position when the ignition is off, or when you place the transmission in park (P) or neutral (N) if the ignition is on and the vehicle is not moving.

**Note:** Pressing any of the preset buttons or any memory feature control during a memory recall cancels the operation.

You can also recall a preset memory position by:

- Pressing the unlock button on your remote control if you linked it to a preset position.
- Unlocking the intelligent driver door handle if a linked remote control is present.

Using a linked remote control to recall your memory position when the ignition is off moves the seat and steering column to the easy entry position.

## Linking a Preset Position to Your Remote Control or Passive Key

# Automatic Transmission

---

## AUTOMATIC TRANSMISSION POSITIONS

### Park (P)

This position locks the driveline and prevents the wheels from turning. Come to a complete stop before putting your vehicle into and out of park (P).

The electric parking brake could apply when you shift to park (P) without the brake pedal fully pressed. The electric parking brake applies when you shift to park (P) on large slopes. The electric parking brake releases with the drive away release function or manually as described in the Releasing the Electric Parking Brake section.

**Note:** *A warning tone sounds if you open the driver door and you have not shifted the transmission selector to park (P).*

### Reverse (R)



**WARNING:** Move the transmission selector lever to reverse (R) only when your vehicle is stationary and the engine is at idle speed.

This position allows your vehicle to move backward. Come to a complete stop before shifting into and out of reverse (R).

### Neutral (N)



**WARNING:** In neutral (N) your vehicle has the ability to roll freely. If you intend to leave your vehicle, make sure you apply the parking brake.

This position allows your vehicle to roll free. Hold the brake pedal down when in this position.

**Note:** *You can start your vehicle in this position.*

### Drive (D)

Drive (D) is the normal driving position, and allows automatic upshifts and downshifts through all available gears.

## **BRAKES – TROUBLESHOOTING**

### **Brakes – Warning Lamps**



If the ABS indicator illuminates when you are driving, this indicates a malfunction. Your vehicle continues to have normal braking without the anti-lock braking system function. See an authorized dealer.

It also momentarily illuminates when you switch the ignition on to confirm the lamp is functional. If it does not illuminate when you switch the ignition on, or begins to flash at any time, have the system checked by an authorized dealer.



The brake indicator momentarily illuminates when you switch the ignition on to confirm the lamp is functional. It may also illuminate when you apply the parking brake and the ignition is on. If it illuminates when your vehicle is moving, make sure the parking brake is disengaged. If the parking brake is disengaged, this indicates low brake fluid level or a brake system fault. See an authorized dealer.

# Traction Control

---

## SWITCHING TRACTION CONTROL ON AND OFF



**WARNING:** The stability and traction control light illuminates steadily if the system detects a failure. Make sure you did not manually disable the traction control system using the information display controls or the switch. If the stability control and traction control light is still illuminating steadily, have the system serviced by an authorized dealer immediately. Operating your vehicle with the traction control disabled could lead to an increased risk of loss of vehicle control, vehicle rollover, personal injury and death.



The traction control system turns on each time you switch the ignition on.

If your vehicle is stuck in mud or snow, switching traction control off may be beneficial as this allows the wheels to spin.

**Note:** *When you switch traction control off, stability control remains fully active.*

The button for the stability and traction control system is on the instrument panel.

When you switch the system off, a message and an illuminated icon appear on the instrument cluster.

Press the switch again to turn the traction control system back on to normal operation.

Your vehicle may have MyKey restrictions regarding this feature.

# Load Carrying

## LOAD CARRYING PRECAUTIONS

Keep your loaded vehicle weight within its design rating capability, with or without a trailer. Properly loading your vehicle provides maximum return of vehicle design performance. Before you load your vehicle, become familiar with the following terms for determining your vehicle's weight rating, with or without a trailer, from the vehicle's Tire and Loading Information label or Safety Compliance Certification label.



**WARNING:** The appropriate loading capacity of your vehicle can be limited either by volume capacity (how much space is available) or by payload capacity (how much weight the vehicle should carry). Once you have reached the maximum payload of your vehicle, do not add more cargo, even if there is space available. Overloading or improperly loading your vehicle can contribute to loss of vehicle control and vehicle rollover.



**WARNING:** Exceeding the Safety Compliance Certification label vehicle weight limits can adversely affect the performance and handling of your vehicle, cause vehicle damage and can result in the loss of control of your vehicle, serious personal injury or death.



**WARNING:** Do not use replacement tires with lower load carrying capacities than the original tires because they may lower your vehicle's GVWR and GAWR limitations. Replacement tires with a higher limit than the original tires do not increase the GVWR and GAWR limitations.



**WARNING:** Do not exceed the GVWR or the GAWR specified on the certification label.



**WARNING:** Exceeding any vehicle weight rating can adversely affect the performance and handling of your vehicle, cause vehicle damage and can result in the loss of control of your vehicle, serious personal injury or death.



**WARNING:** When loading the roof racks, we recommend you evenly distribute the load, as well as maintain a low center of gravity. Loaded vehicles, with higher centers of gravity, may



# Load Carrying

handle differently than unloaded vehicles. Take extra precautions, such as slower speeds and increased stopping distance, when driving a heavily loaded vehicle.

The gross combined weight must never exceed the Gross Combined Weight Rating.

## LOCATING THE SAFETY COMPLIANCE CERTIFICATION LABELS

### Safety Compliance Certification Label Example:

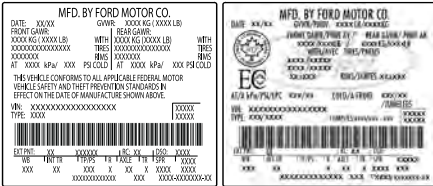

E198828

The Safety Compliance Certification label is located on the door hinge pillar, door-latch post, or the door edge that meets the door-latch post, next to the driver seating position.

## WHAT IS THE GROSS AXLE WEIGHT RATING

### GAWR (Gross Axle Weight Rating)

GAWR is the maximum allowable weight that a single axle (front or rear) can carry. These numbers are on the Safety Compliance Certification label.

## WHAT IS THE GROSS VEHICLE WEIGHT RATING

GVWR is the maximum allowable weight of the fully loaded vehicle. This includes all options, equipment, passengers and cargo. It appears on the Safety Compliance Certification label.

## WHAT IS THE GROSS COMBINED WEIGHT RATING

Gross Combined Weight Rating (GCWR) is the maximum allowable weight of the vehicle and the loaded trailer, including all cargo and passengers, that the vehicle can handle without risking damage. (Important: The towing vehicle's braking system is rated for operation at Gross Vehicle Weight Rating, not at Gross Combined Weight Rating.) Separate functional brakes should

## Load Carrying

---

be used for safe control of towed vehicles and for trailers where the Gross Combined Weight of the towing vehicle plus the trailer exceed the Gross Vehicle Weight Rating of the towing vehicle.

**Note:** For trailer towing information refer to the *RV and Trailer Towing Guide* available at an authorized dealer, or online at the website that follows.

<b>RV &amp; Trailer Towing Guide Online</b>	
Website	<a href="http://www.fleet.ford.com/towing-guides">www.fleet.ford.com/towing-guides</a>

# Load Carrying

## CALCULATING PAYLOAD

### Tire and Loading Label Information

#### Example:



**TIRE AND LOADING INFORMATION**

SEATING CAPACITY TOTAL : 5 FRONT: 2 REAR: 3

The combined weight of occupants and cargo should never exceed **385 kg or 850 lbs.**

TIRE	SIZE	COLD TIRE PRESSURE	SEE OWNERS MANUAL FOR ADDITIONAL INFORMATION
FRONT	235/45R18 94V	235 KPA, 34 PSI	
REAR	235/45R18 94V	235 KPA, 34 PSI	
SPARE	NONE	NONE	



**TIRE AND LOADING INFORMATION**  
**RENSEIGNEMENTS SUR LES PNEUS ET LE CHARGEMENT**

SEATING CAPACITY TOTAL : 5 FRONT : 2 REAR : 3  
NOMBRE DE PLACES AVANT ARRIERE

The combined weight of occupants and cargo should never exceed **396 kg or 875 lbs.**  
Le poids total des occupants et du chargement ne doit jamais dépasser

TIRE PNEU	SIZE DIMENSIONS	COLD TIRE PRESSURE PRESSION DES PNEUS A FROID	SEE OWNER'S MANUAL FOR ADDITIONAL INFORMATION  VOIR LE MANUEL DE L'USAGER POUR PLUS DE RENSEIGNEMENTS
FRONT AVANT	235/40R19 96V	255 KPA, 37 PSI	
REAR ARRIERE	235/40R19 96V	255 KPA, 37 PSI	
SPARE DE SECOURS	T125/80R16 97M	415 KPA, 60 PSI	

E198719

Payload is the combined weight of cargo and passengers that your vehicle is carrying. The maximum payload for your vehicle appears on the Tire and Loading label. The label is either on the B-pillar or the edge of the driver door. Vehicles exported outside the US and Canada may not have a tire and loading label. Look for "The combined weight of occupants and cargo should never exceed XXX kg or XXX lb" for maximum payload. The payload listed on the Tire and Loading Information label

is the maximum payload for your vehicle as built by the assembly plant. If you install any additional equipment on your vehicle, you must determine the new payload. Subtract the weight of the equipment from the payload listed on the Tire and Loading label. When towing, trailer tongue weight or king pin weight is also part of payload.

## CALCULATING THE LOAD LIMIT

Steps for determining the correct load limit:

1. Locate the statement "The combined weight of occupants and cargo should never exceed XXX kg or XXX lb." on your vehicle's placard.
2. Determine the combined weight of the driver and passengers that will be riding in your vehicle.
3. Subtract the combined weight of the driver and passengers from XXX kg or XXX lb.
4. The resulting figure equals the available amount of cargo and luggage load capacity. For example, if the "XXX" amount equals 1,400 lb. and there will be five 150 lb. passengers in your vehicle, the amount of available cargo and luggage load capacity is 650 lb. (1400-750 (5 x 150) = 650 lb.)

# Load Carrying

5. Determine the combined weight of luggage and cargo being loaded on the vehicle. That weight may not safely exceed the available cargo and luggage load capacity calculated in Step 4.
6. If your vehicle will be towing a trailer, load from your trailer will be transferred to your vehicle. Consult this manual to determine how this reduces the available cargo and luggage load capacity of your vehicle.

## Helpful examples for calculating the available amount of cargo and luggage load capacity

Suppose your vehicle has a 1400-pound (635-kilogram) cargo and luggage capacity. You decide to go golfing. Is there enough load capacity to carry you, four of your friends and all the golf bags? You and four friends average 220 pounds (99 kilograms) each and the golf bags weigh approximately 30 pounds (13.5 kilograms) each. The calculation would be:  $1400 - (5 \times 220) - (5 \times 30) = 1400 - 1100 - 150 = 150$  pounds. Yes, you have enough load capacity in your vehicle to transport four friends and your golf bags. In metric units, the calculation would be:  $635 \text{ kilograms} - (5 \times 99 \text{ kilograms}) - (5 \times 13.5 \text{ kilograms}) = 635 - 495 - 67.5 = 72.5$  kilograms.

Suppose your vehicle has a 1400-pound (635-kilogram) cargo and luggage capacity. You and one of your friends decide to pick up cement from the local home improvement store to finish that patio you have been planning for the past two years. Measuring the inside of the vehicle with the rear seat folded down, you have room for twelve 100-pound (45-kilogram) bags of cement. Do you have enough load capacity to transport the cement to your home? If you and your friend each weigh 220 pounds (99 kilograms), the calculation would be:  $1400 - (2 \times 220) - (12 \times 100) = 1400 - 440 - 1200 = -240$  pounds. No, you do not have enough cargo capacity to carry that much weight. In metric units, the calculation would be:  $635 \text{ kilograms} - (2 \times 99 \text{ kilograms}) - (12 \times 45 \text{ kilograms}) = 635 - 198 - 540 = -103$  kilograms. You will need to reduce the load weight by at least 240 pounds (104 kilograms). If you remove three 100-pound (45-kilogram) cement bags, then the load calculation would be:  $1400 - (2 \times 220) - (9 \times 100) = 1400 - 440 - 900 = 60$  pounds. Now you have the load capacity to transport the cement and your friend home. In metric units, the calculation would be:  $635 \text{ kilograms} - (2 \times 99 \text{ kilograms}) - (9 \times 45 \text{ kilograms}) = 635 - 198 - 405 = 32$  kilograms.

## Load Carrying

---

The above calculations also assume that the loads are positioned in your vehicle in a manner that does not overload the front or the rear gross axle weight rating specified for your vehicle on the Safety Compliance Certification label.

# Towing a Trailer

## TOWING A TRAILER PRECAUTIONS



**WARNING:** Do not exceed the GVWR or the GAWR specified on the certification label.



**WARNING:** Towing trailers beyond the maximum recommended gross trailer weight exceeds the limit of your vehicle and could result in engine damage, transmission damage, structural damage, loss of vehicle control, vehicle rollover and personal injury.



**WARNING:** Do not exceed the lowest rating capacity for your vehicle or trailer hitch. Overloading your vehicle or trailer hitch can impair your vehicle stability and handling. Failure to follow this instruction could result in the loss of control of your vehicle, personal injury or death.



**WARNING:** Do not cut, drill, weld or modify the trailer hitch. Modifying the trailer hitch could reduce the hitch rating.



**WARNING:** The anti-lock brake system does not control the trailer brakes.

## TOWING A TRAILER LIMITATIONS

The vehicle's load capacity designation is by weight, not by volume, so you cannot necessarily use all available space when loading a vehicle or trailer.

**Note:** *Your vehicle could have reduced performance when operating at high altitudes and when heavily loaded or towing a trailer. When driving at elevation, to match driving performance as perceived at sea level, reduce gross vehicle weight and gross combination weight by 2% per 1,000 ft (300 m) elevation.*

## LOADING YOUR TRAILER

To help minimize how trailer movement affects your vehicle when driving:

- Load the heaviest items closest to the trailer floor.
- Load the heaviest items centered between the left and right side trailer tires.

## Towing a Trailer

---

- Load the heaviest items above the trailer axles or just slightly forward toward the trailer tongue. Do not allow the final trailer tongue weight to go above or below 10-15% of the loaded trailer weight. The trailer tongue weight should never exceed 10% of the maximum towing capacity.
- Select a ball mount with the correct rise or drop. When both the loaded vehicle and trailer are connected, the trailer frame should be level, or slightly angled down toward your vehicle, when viewed from the side.

# Towing a Trailer

## TOWING WEIGHTS AND DIMENSIONS

### Recommended Towing Weights - 2.7L EcoBoost™

<b>Cab – Wheel-base in (mm)</b>	<b>Driveline</b>	<b>Rear Axle Ratio</b>	<b>Maximum Gross Combined Weight Rating</b>	<b>Maximum Trailer Weight</b>	<b>Maximum Trailer Frontal Area</b>
Regular Cab – 122.4 in (3,110 mm) - L	RWD	3.15	12,200 lb (5,533 kg)	7,600 lb (3,447 kg)	60 ft <sup>2</sup> (5.6 m <sup>2</sup> )
Regular Cab – 122.4 in (3,110 mm) - L	RWD	3.55	12,200 lb (5,533 kg)	7,600 lb (3,447 kg)	60 ft <sup>2</sup> (5.6 m <sup>2</sup> )
Regular Cab – 122.4 in (3,110 mm) - L	4WD	3.55	12,500 lb (5,669 kg)	7,700 lb (3,492 kg)	60 ft <sup>2</sup> (5.6 m <sup>2</sup> )
Regular Cab – 122.4 in (3,110 mm) - L	RWD	3.73	13,200 lb (5,987 kg)	8,600 lb (3,900 kg)	60 ft <sup>2</sup> (5.6 m <sup>2</sup> )
Regular Cab – 122.4 in (3,110 mm) - L	4WD	3.73	13,300 lb (6,032 kg)	8,500 lb (3,855 kg)	60 ft <sup>2</sup> (5.6 m <sup>2</sup> )



## Towing a Trailer

<b>Cab – Wheel-base in (mm)</b>	<b>Driveline</b>	<b>Rear Axle Ratio</b>	<b>Maximum Gross Combined Weight Rating</b>	<b>Maximum Trailer Weight</b>	<b>Maximum Trailer Frontal Area</b>
Regular Cab – 141 in (3,581mm) - L	RWD	3.15	12,300 lb (5,579 kg)	7,600 lb (3,447 kg)	60 ft <sup>2</sup> (5.6 m <sup>2</sup> )
Regular Cab – 141 in (3,581mm) - L	RWD	3.55	12,300 lb (5,579 kg)	7,600 lb (3,447 kg)	60 ft <sup>2</sup> (5.6 m <sup>2</sup> )
Regular Cab – 141 in (3,581mm) - L	4WD	3.55	12,600 lb (5,715 kg)	7,700 lb (3,493 kg)	60 ft <sup>2</sup> (5.6 m <sup>2</sup> )
Regular Cab – 141 in (3,581mm) - L	RWD	3.73	13,300 lb (6,032 kg)	8,600 lb (3,900 kg)	60 ft <sup>2</sup> (5.6 m <sup>2</sup> )
Regular Cab – 141 in (3,581mm) - L	4WD	3.73	13,300 lb (6,032 kg)	8,400 lb (3,810 kg)	60 ft <sup>2</sup> (5.6 m <sup>2</sup> )
Regular Cab – 141 in (3,581mm) - H	RWD	3.73	14,800 lb (6,713 kg)	10,000 lb (4,535 kg)	60 ft <sup>2</sup> (5.6 m <sup>2</sup> )

## Towing a Trailer

<b>Cab – Wheel-base in (mm)</b>	<b>Driveline</b>	<b>Rear Axle Ratio</b>	<b>Maximum Gross Combined Weight Rating</b>	<b>Maximum Trailer Weight</b>	<b>Maximum Trailer Frontal Area</b>
Regular Cab – 141 in (3,581mm) - H	4WD	3.73	15,100 lb (6,849 kg)	10,000 lb (4,535 kg)	60 ft <sup>2</sup> (5.6 m <sup>2</sup> )
Regular Cab – 163 in (4,140mm) - H	RWD	3.73	15,100 lb (6,849 kg)	10,000 lb (4,535 kg)	60 ft <sup>2</sup> (5.6 m <sup>2</sup> )
Super Cab – 145 in (3,675mm) - L	RWD	3.31	12,600 lb (5,715 kg)	7,700 lb (3,492 kg)	60 ft <sup>2</sup> (5.6 m <sup>2</sup> )
Super Cab – 145 in (3,675mm) - L	RWD	3.55	12,600 lb (5,715 kg)	7,700 lb (3,492 kg)	60 ft <sup>2</sup> (5.6 m <sup>2</sup> )
Super Cab – 145 in (3,675mm) - L	4WD	3.55	12,800 lb (5,805 kg)	7,600 lb (3,447 kg)	60 ft <sup>2</sup> (5.6 m <sup>2</sup> )
Super Cab – 145 in (3,675mm) - L	RWD	3.73	13,300 lb (6,032 kg)	8,400 lb (3,810 kg)	60 ft <sup>2</sup> (5.6 m <sup>2</sup> )
Super Cab – 145 in (3,675mm) - H	RWD	3.73	15,000 lb (6,803 kg)	10,000 lb (4,535 kg)	60 ft <sup>2</sup> (5.6 m <sup>2</sup> )

## Towing a Trailer

<b>Cab – Wheel-base in (mm)</b>	<b>Driveline</b>	<b>Rear Axle Ratio</b>	<b>Maximum Gross Combined Weight Rating</b>	<b>Maximum Trailer Weight</b>	<b>Maximum Trailer Frontal Area</b>
Super Cab – 145 in (3,675mm) - L	4WD	3.73	13,300 lb (6,032 kg)	8,100 lb (3,674 kg)	60 ft <sup>2</sup> (5.6 m <sup>2</sup> )
Super Cab – 145 in (3,675mm) - H	4WD	3.73	15,300 lb (6,939 kg)	10,100 lb (4,581 kg)	60 ft <sup>2</sup> (5.6 m <sup>2</sup> )
Super Cab – 163 in (4,140mm) - L	RWD	3.15	12,600 lb (5,715 kg)	7,600 lb (3,447 kg)	60 ft <sup>2</sup> (5.6 m <sup>2</sup> )
Super Cab – 163 in (4,140mm) - L	RWD	3.55	12,600 lb (5,715 kg)	7,600 lb (3,447 kg)	60 ft <sup>2</sup> (5.6 m <sup>2</sup> )
Super Cab – 163 in (4,140mm) - L	RWD	3.73	13,300 lb (6,032 kg)	8,300 lb (3,764 kg)	60 ft <sup>2</sup> (5.6 m <sup>2</sup> )
Crew Cab – 145 in (3,675mm) - L	RWD	3.15	12,700 lb (5,760 kg)	7,700 lb (3,492 kg)	60 ft <sup>2</sup> (5.6 m <sup>2</sup> )
Crew Cab – 145 in (3,675mm) - L	RWD	3.55	12,700 lb (5,760 kg)	7,700 lb (3,492 kg)	60 ft <sup>2</sup> (5.6 m <sup>2</sup> )

## Towing a Trailer

<b>Cab – Wheel-base in (mm)</b>	<b>Driveline</b>	<b>Rear Axle Ratio</b>	<b>Maximum Gross Combined Weight Rating</b>	<b>Maximum Trailer Weight</b>	<b>Maximum Trailer Frontal Area</b>
Crew Cab – 145 in (3,675mm) - L	4WD	3.55	12,900 lb (5,851 kg)	7,700 lb (3,492 kg)	60 ft <sup>2</sup> (5.6 m <sup>2</sup> )
Crew Cab – 145 in (3,675mm) - L	RWD	3.73	13,300 lb (6,032 kg)	8,300 lb (3,764 kg)	60 ft <sup>2</sup> (5.6 m <sup>2</sup> )
Crew Cab – 145 in (3,675mm) - H	RWD	3.73	15,100 lb (6,849 kg)	10,000 lb (4,535 kg)	60 ft <sup>2</sup> (5.6 m <sup>2</sup> )
Crew Cab – 145 in (3,675mm) - L	4WD	3.73	13,300 lb (6,032 kg)	8,100 lb (3,674 kg)	60 ft <sup>2</sup> (5.6 m <sup>2</sup> )
Crew Cab – 145 in (3,675mm) - H	4WD	3.73	15,400 lb (6,985 kg)	10,100 lb (4,581 kg)	60 ft <sup>2</sup> (5.6 m <sup>2</sup> )
Crew Cab – 157 in (3,989mm) - L	RWD	3.15	12,800 lb (5,805 kg)	7,800 lb (3,538 kg)	60 ft <sup>2</sup> (5.6 m <sup>2</sup> )

## Towing a Trailer

<b>Cab – Wheel-base in (mm)</b>	<b>Driveline</b>	<b>Rear Axle Ratio</b>	<b>Maximum Gross Combined Weight Rating</b>	<b>Maximum Trailer Weight</b>	<b>Maximum Trailer Frontal Area</b>
Crew Cab – 157 in (3,989mm) – L	RWD	3.55	12,800 lb (5,805 kg)	7,800 lb (3,538 kg)	60 ft <sup>2</sup> (5.6 m <sup>2</sup> )
Crew Cab – 157 in (3,989mm) – L	RWD	3.73	13,300 lb (6,032 kg)	8,300 lb (3,764 kg)	60 ft <sup>2</sup> (5.6 m <sup>2</sup> )
Crew Cab – 157 in (3,989mm) – H	RWD	3.73	15,100 lb (6,849 kg)	10,000 lb (4,535 kg)	60 ft <sup>2</sup> (5.6 m <sup>2</sup> )

**Note:** All values calculated with SAE J2807 method.

**Note:** Values shown for low, L, or high, H, capacity trailer tow packages.

**Note:** Do not exceed a trailer weight of 5,000 lb (2,268 kg) when towing with, or by, the bumper only.

**Note:** Do not exceed a trailer weight of 6,000 lb (2,721 kg) or 36 ft<sup>2</sup> (3.4 m<sup>2</sup>) trailer frontal area with the medium duty trailer tow package.

**Note:** Exceeding these limitations could significantly reduce the performance of your towing vehicle. Selecting a trailer with a low aerodynamic drag and rounded front design helps optimize performance and fuel economy.

# Towing a Trailer

## Recommended Towing Weights - 3.0L Diesel

<b>Cab – Wheel-base in (mm)</b>	<b>Driveline</b>	<b>Rear Axle Ratio</b>	<b>Maximum Gross Combined Weight Rating</b>	<b>Maximum Trailer Weight</b>	<b>Maximum Trailer Frontal Area</b>
Super Cab – 145 in (3,675mm)	RWD	3.31	16,300 lb (7,393 kg) <sub>1</sub>	10,800 lb (4,898 kg) <sub>1</sub>	60 ft <sup>2</sup> (5.6 m <sup>2</sup> )
Super Cab – 145 in (3,675mm)	RWD	3.55	17,700 lb (8,028 kg) <sub>2</sub>	12,200 lb (5,533 kg) <sub>2</sub>	60 ft <sup>2</sup> (5.6 m <sup>2</sup> )
Super Cab – 145 in (3,675mm)	4WD	3.31	16,300 lb (7,393 kg) <sub>1</sub>	10,500 lb (4,762 kg) <sub>1</sub>	60 ft <sup>2</sup> (5.6 m <sup>2</sup> )
Super Cab – 145 in (3,675mm)	4WD	3.55	16,300 lb (7,393 kg) <sub>1</sub>	10,500 lb (4,762 kg) <sub>1</sub>	60 ft <sup>2</sup> (5.6 m <sup>2</sup> )
Super Cab – 145 in (3,675mm)	4WD	3.55	17,900 lb (8,119 kg) <sub>2</sub>	12,100 lb (5,488 kg) <sub>2</sub>	60 ft <sup>2</sup> (5.6 m <sup>2</sup> )
Crew Cab – 145 in (3,675mm)	RWD	3.31	16,300 lb (7,393 kg) <sub>1</sub>	10,700 lb (4,853 kg) <sub>1</sub>	60 ft <sup>2</sup> (5.6 m <sup>2</sup> )
Crew Cab – 145 in (3,675mm)	RWD	3.55	17,700 lb (8,028 kg) <sub>2</sub>	12,100 lb (5,488 kg) <sub>2</sub>	60 ft <sup>2</sup> (5.6 m <sup>2</sup> )
Crew Cab – 145 in (3,675mm)	4WD	3.31	16,300 lb (7,393 kg) <sub>1</sub>	10,400 lb (4,717 kg) <sub>1</sub>	60 ft <sup>2</sup> (5.6 m <sup>2</sup> )

## Towing a Trailer

<b>Cab – Wheel-base in (mm)</b>	<b>Driveline</b>	<b>Rear Axle Ratio</b>	<b>Maximum Gross Combined Weight Rating</b>	<b>Maximum Trailer Weight</b>	<b>Maximum Trailer Frontal Area</b>
Crew Cab – 145 in (3,675mm)	4WD	3.55	16,300 lb (7,393 kg) <sub>1</sub>	10,400 lb (4,717 kg) <sub>1</sub>	60 ft <sup>2</sup> (5.6 m <sup>2</sup> )
Crew Cab – 145 in (3,675mm)	4WD	3.55	18,000 lb (8,164 kg) <sub>2</sub>	12,100 lb (5,488 kg) <sub>2</sub>	60 ft <sup>2</sup> (5.6 m <sup>2</sup> )
Crew Cab – 157 in (3,989mm)	RWD	3.31	16,300 lb (7,393 kg) <sub>1</sub>	10,600 lb (4,808 kg) <sub>1</sub>	60 ft <sup>2</sup> (5.6 m <sup>2</sup> )
Crew Cab – 157 in (3,989mm)	RWD	3.55	17,800 lb (8,073 kg) <sub>2</sub>	12,100 lb (5,488 kg) <sub>2</sub>	60 ft <sup>2</sup> (5.6 m <sup>2</sup> )
Crew Cab – 157 in (3,989mm)	4WD	3.31	16,300 lb (7,393 kg) <sub>1</sub>	10,400 lb (4,717 kg) <sub>1</sub>	60 ft <sup>2</sup> (5.6 m <sup>2</sup> )
Crew Cab – 157 in (3,989mm)	4WD	3.55	16,300 lb (7,393 kg) <sub>1</sub>	10,400 lb (4,717 kg) <sub>1</sub>	60 ft <sup>2</sup> (5.6 m <sup>2</sup> )
Crew Cab – 157 in (3,989mm)	4WD	3.55	18,000 lb (8,164 kg) <sub>2</sub>	12,100 lb (5,488 kg) <sub>2</sub>	60 ft <sup>2</sup> (5.6 m <sup>2</sup> )

<sup>1</sup> Heavy duty trailer tow package.

<sup>2</sup> Max duty trailer tow package.

**Note:** All values calculated with SAE J2807 method.

**Note:** Do not exceed a trailer weight of 5,000 lb (2,268 kg) when towing with, or by, the bumper only.

## Towing a Trailer

**Note:** Do not exceed a trailer weight of 7,000 lb (3,175 kg) or 36 ft<sup>2</sup> (3.4 m<sup>2</sup>) trailer frontal area with the medium duty trailer tow package.

**Note:** Exceeding these limitations could significantly reduce the performance of your towing vehicle. Selecting a trailer with a low aerodynamic drag and rounded front design helps optimize performance and fuel economy.

### Recommended Towing Weights - 3.3L

Cab – Wheel-base in (mm)	Driveline	Rear Axle Ratio	Maximum Gross Combined Weight Rating	Maximum Trailer Weight	Maximum Trailer Frontal Area
Regular Cab – 122.4 in (3,110mm)	RWD	3.55	9,400 lb (4,263 kg) <sub>1</sub>	5,000 lb (2,267 kg) <sub>1</sub>	36 ft <sup>2</sup> (3.4 m <sup>2</sup> )
Regular Cab – 122.4 in (3,110mm)	4WD	3.55	9,700 lb (4,400 kg) <sub>2</sub>	5,100 lb (2,313 kg) <sub>2</sub>	60 ft <sup>2</sup> (5.6 m <sup>2</sup> )
Regular Cab – 122.4 in (3,110mm)	RWD	3.73	12,600 lb (5,715 kg) <sub>2</sub>	8,200 lb (3,719 kg) <sub>2</sub>	60 ft <sup>2</sup> (5.6 m <sup>2</sup> )
Regular Cab – 122.4 in (3,110mm)	4WD	3.73	12,800 lb (5,805 kg) <sub>2</sub>	8,200 lb (3,719 kg) <sub>2</sub>	60 ft <sup>2</sup> (5.6 m <sup>2</sup> )
Regular Cab – 141 in (3,581mm)	RWD	3.55	9,500 lb (4,309 kg) <sub>1</sub>	5,000 lb (2,267 kg) <sub>1</sub>	36 ft <sup>2</sup> (3.4 m <sup>2</sup> )



## Towing a Trailer

<b>Cab – Wheel-base in (mm)</b>	<b>Driveline</b>	<b>Rear Axle Ratio</b>	<b>Maximum Gross Combined Weight Rating</b>	<b>Maximum Trailer Weight</b>	<b>Maximum Trailer Frontal Area</b>
Regular Cab – 141 in (3,581mm)	RWD	3.73	12,700 lb (5,760 kg) <sub>2</sub>	8,200 lb (3,719 kg) <sub>2</sub>	60 ft <sup>2</sup> (5.6 m <sup>2</sup> )
Regular Cab – 141 in (3,581mm)	4WD	3.73	12,900 lb (5,851 kg) <sub>2</sub>	8,200 lb (3,719 kg) <sub>2</sub>	60 ft <sup>2</sup> (5.6 m <sup>2</sup> )
Super Cab – 145 in (3,675mm)	RWD	3.55	9,700 lb (4,399 kg) <sub>1</sub>	5,000 lb (2,267 kg) <sub>1</sub>	36 ft <sup>2</sup> (3.4 m <sup>2</sup> )
Super Cab – 145 in (3,675mm)	RWD	3.73	12,900 lb (5,851 kg) <sub>2</sub>	8,200 lb (3,719 kg) <sub>2</sub>	60 ft <sup>2</sup> (5.6 m <sup>2</sup> )
Super Cab – 145 in (3,675mm)	4WD	3.73	13,100 lb (5,942 kg) <sub>2</sub>	8,100 lb (3,674 kg) <sub>2</sub>	60 ft <sup>2</sup> (5.6 m <sup>2</sup> )
Crew Cab – 145 in (3,675mm)	RWD	3.55	9,900 lb (4,491 kg) <sub>1</sub>	5,100 lb (2,313 kg) <sub>1</sub>	36 ft <sup>2</sup> (3.4 m <sup>2</sup> )
Crew Cab – 145 in (3,675mm)	RWD	3.73	13,000 lb (5,896 kg) <sub>2</sub>	8,200 lb (3,719 kg) <sub>2</sub>	60 ft <sup>2</sup> (5.6 m <sup>2</sup> )
Crew Cab – 145 in (3,675mm)	4WD	3.73	13,300 lb (6,032 kg) <sub>2</sub>	8,200 lb (3,719 kg) <sub>2</sub>	60 ft <sup>2</sup> (5.6 m <sup>2</sup> )

<sup>1</sup> Medium duty trailer tow package.

<sup>2</sup> Heavy duty trailer tow package.

## Towing a Trailer

**Note:** All values calculated with SAE J2807 method.

**Note:** Do not exceed a trailer weight of 5,000 lb (2,268 kg) when towing with, or by, the bumper only.

**Note:** Do not exceed a trailer weight of 6,000 lb (2,721 kg) or 36 ft<sup>2</sup> (3.4 m<sup>2</sup>) trailer frontal area with the medium duty trailer tow package.

**Note:** Exceeding these limitations could significantly reduce the performance of your towing vehicle. Selecting a trailer with a low aerodynamic drag and rounded front design helps optimize performance and fuel economy.

### Recommended Towing Weights - 3.5L EcoBoost™

Cab – Wheel-base in (mm)	Driveline	Rear Axle Ratio	Maximum Gross Combined Weight Rating	Maximum Trailer Weight	Maximum Trailer Frontal Area
Regular Cab – 141 in (3,581mm)	RWD	3.15	16,100 lb (7,302 kg) <sub>1</sub>	11,200 lb (5,080 kg) <sub>1</sub>	60 ft <sup>2</sup> (5.6 m <sup>2</sup> )
Regular Cab – 141 in (3,581mm)	4WD	3.31	16,400 lb (7,438 kg) <sub>1</sub>	11,200 lb (5,080 kg) <sub>1</sub>	60 ft <sup>2</sup> (5.6 m <sup>2</sup> )
Regular Cab – 141 in (3,581mm)	RWD	3.55	16,100 lb (7,302 kg) <sub>1</sub>	11,200 lb (5,080 kg) <sub>1</sub>	60 ft <sup>2</sup> (5.6 m <sup>2</sup> )
Regular Cab – 141 in (3,581mm)	RWD	3.55	17,900 lb (8,119 kg) <sub>2</sub>	13,000 lb (5,897 kg) <sub>2</sub>	60 ft <sup>2</sup> (5.6 m <sup>2</sup> )

## Towing a Trailer

<b>Cab – Wheel-base in (mm)</b>	<b>Driveline</b>	<b>Rear Axle Ratio</b>	<b>Maximum Gross Combined Weight Rating</b>	<b>Maximum Trailer Weight</b>	<b>Maximum Trailer Frontal Area</b>
Regular Cab – 141 in (3,581mm)	4WD	3.55	16,400 lb (7,438 kg) 1	11,200 lb (5,080 kg) 1	60 ft <sup>2</sup> (5.6 m <sup>2</sup> )
Regular Cab – 141 in (3,581mm)	4WD	3.55	17,900 lb (8,119 kg) 2	12,700 lb (5,761 kg) 2	60 ft <sup>2</sup> (5.6 m <sup>2</sup> )
Regular Cab – 141 in (3,581mm) Heavy Payload Package	RWD	3.73	18,400 lb (8,346 kg) 2	13,300 lb (6,033 kg) 2	60 ft <sup>2</sup> (5.6 m <sup>2</sup> )
Regular Cab – 141 in (3,581mm) Heavy Payload Package	4WD	3.73	18,400 lb (8,346 kg) 2	13,100 lb (5,942 kg) 2	60 ft <sup>2</sup> (5.6 m <sup>2</sup> )
Super Cab – 145 in (3,675mm)	RWD	3.31	16,200 lb (7,348 kg) 1	11,000 lb (4,989 kg) 1	60 ft <sup>2</sup> (5.6 m <sup>2</sup> )
Super Cab – 145 in (3,675mm)	4WD	3.31	16,500 lb (7,484 kg) 1	11,100 lb (5,034 kg) 1	60 ft <sup>2</sup> (5.6 m <sup>2</sup> )
Super Cab – 145 in (3,675mm)	RWD	3.55	16,200 lb (7,348 kg) 1	11,000 lb (4,989 kg) 1	60 ft <sup>2</sup> (5.6 m <sup>2</sup> )

## Towing a Trailer

<b>Cab – Wheel-base in (mm)</b>	<b>Driveline</b>	<b>Rear Axle Ratio</b>	<b>Maximum Gross Combined Weight Rating</b>	<b>Maximum Trailer Weight</b>	<b>Maximum Trailer Frontal Area</b>
Super Cab – 145 in (3,675mm)	RWD	3.55	17,500 lb (7,937 kg) 2	12,300 lb (5,579 kg) 2	60 ft <sup>2</sup> (5.6 m <sup>2</sup> )
Super Cab – 145 in (3,675mm)	4WD	3.55	16,500 lb (7,484 kg) 1	11,100 lb (5,034 kg) 1	60 ft <sup>2</sup> (5.6 m <sup>2</sup> )
Super Cab – 145 in (3,675mm)	4WD	3.55	17,700 lb (8,028 kg) 2	12,300 lb (5,579 kg) 2	60 ft <sup>2</sup> (5.6 m <sup>2</sup> )
Super Cab – 163 in (4,140mm)	RWD	3.15	16,500 lb (7,484 kg) 1	11,200 lb (5,080 kg) 1	60 ft <sup>2</sup> (5.6 m <sup>2</sup> )
Super Cab – 163 in (4,140mm)	4WD	3.31	16,800 lb (7,620 kg) 1	11,200 lb (5,080 kg) 1	60 ft <sup>2</sup> (5.6 m <sup>2</sup> )
Super Cab – 163 in (4,140mm)	RWD	3.55	16,500 lb (7,484 kg) 1	11,200 lb (5,080 kg) 1	60 ft <sup>2</sup> (5.6 m <sup>2</sup> )
Super Cab – 163 in (4,140mm)	RWD	3.55	19,400 lb (8,799 kg) 2	14,000 lb (6,350 kg) 2	60 ft <sup>2</sup> (5.6 m <sup>2</sup> )
Super Cab – 163 in (4,140mm)	4WD	3.55	16,800 lb (7,620 kg) 1	11,200 lb (5,080 kg) 1	60 ft <sup>2</sup> (5.6 m <sup>2</sup> )
Super Cab – 163 in (4,140mm)	4WD	3.55	19,400 lb (8,799 kg) 2	13,800 lb (6,259 kg) 2	60 ft <sup>2</sup> (5.6 m <sup>2</sup> )

## Towing a Trailer

<b>Cab – Wheel-base in (mm)</b>	<b>Driveline</b>	<b>Rear Axle Ratio</b>	<b>Maximum Gross Combined Weight Rating</b>	<b>Maximum Trailer Weight</b>	<b>Maximum Trailer Frontal Area</b>
Super Cab – 163 in (4,140mm) Heavy Payload Package	RWD	3.73	19,400 lb (8,799 kg) <sub>2</sub>	14,000 lb (6,350 kg) <sub>2</sub>	60 ft <sup>2</sup> (5.6 m <sup>2</sup> )
Super Cab – 163 in (4,140mm) Heavy Payload Package	4WD	3.73	19,400 lb (8,799 kg) <sub>2</sub>	13,800 lb (6,259 kg) <sub>2</sub>	60 ft <sup>2</sup> (5.6 m <sup>2</sup> )
Crew Cab – 145 in (3,675mm)	RWD	3.31	16,500 lb (7,484 kg) <sub>1</sub>	11,200 lb (5,080 kg) <sub>1</sub>	60 ft <sup>2</sup> (5.6 m <sup>2</sup> )
Crew Cab – 145 in (3,675mm)	4WD	3.31	16,800 lb (7,620 kg) <sub>1</sub>	11,300 lb (5,125 kg) <sub>1</sub>	60 ft <sup>2</sup> (5.6 m <sup>2</sup> )
Crew Cab – 145 in (3,675mm)	RWD	3.55	16,500 lb (7,484 kg) <sub>1</sub>	11,200 lb (5,080 kg) <sub>1</sub>	60 ft <sup>2</sup> (5.6 m <sup>2</sup> )
Crew Cab – 145 in (3,675mm)	RWD	3.55	19,300 lb (8,754 kg) <sub>2</sub>	14,000 lb (6,350 kg) <sub>2</sub>	60 ft <sup>2</sup> (5.6 m <sup>2</sup> )
Crew Cab – 145 in (3,675mm)	4WD	3.55	16,800 lb (7,620 kg) <sub>1</sub>	11,300 lb (5,125 kg) <sub>1</sub>	60 ft <sup>2</sup> (5.6 m <sup>2</sup> )

## Towing a Trailer

<b>Cab – Wheel-base in (mm)</b>	<b>Driveline</b>	<b>Rear Axle Ratio</b>	<b>Maximum Gross Combined Weight Rating</b>	<b>Maximum Trailer Weight</b>	<b>Maximum Trailer Frontal Area</b>
Crew Cab – 145 in (3,675mm)	4WD	3.55	19,400 lb (8,799 kg) <sub>2</sub>	13,900 lb (6,304 kg) <sub>2</sub>	60 ft <sup>2</sup> (5.6 m <sup>2</sup> )
Crew Cab – 157 in (3,989mm)	RWD	3.31	16,600 lb (7,529 kg) <sub>1</sub>	11,300 lb (5,125 kg) <sub>1</sub>	60 ft <sup>2</sup> (5.6 m <sup>2</sup> )
Crew Cab – 157 in (3,989mm)	4WD	3.31	16,800 lb (7,620 kg) <sub>1</sub>	11,200 lb (5,080 kg) <sub>1</sub>	60 ft <sup>2</sup> (5.6 m <sup>2</sup> )
Crew Cab – 157 in (3,989mm)	RWD	3.55	16,600 lb (7,529 kg) <sub>1</sub>	11,300 lb (5,125 kg) <sub>1</sub>	60 ft <sup>2</sup> (5.6 m <sup>2</sup> )
Crew Cab – 157 in (3,989mm)	RWD	3.55	19,400 lb (8,799 kg) <sub>2</sub>	14,000 lb (6,350 kg) <sub>2</sub>	60 ft <sup>2</sup> (5.6 m <sup>2</sup> )
Crew Cab – 157 in (3,989mm)	4WD	3.55	16,800 lb (7,620 kg) <sub>1</sub>	11,200 lb (5,080 kg) <sub>1</sub>	60 ft <sup>2</sup> (5.6 m <sup>2</sup> )
Crew Cab – 157 in (3,989mm)	4WD	3.55	19,400 lb (8,799 kg) <sub>2</sub>	13,800 lb (6,259 kg) <sub>2</sub>	60 ft <sup>2</sup> (5.6 m <sup>2</sup> )

## Towing a Trailer

<b>Cab – Wheel-base in (mm)</b>	<b>Driveline</b>	<b>Rear Axle Ratio</b>	<b>Maximum Gross Combined Weight Rating</b>	<b>Maximum Trailer Weight</b>	<b>Maximum Trailer Frontal Area</b>
Crew Cab – 157 in (3989mm) Heavy Payload Package	RWD	3.73	19,400 lb (8,799 kg) <sub>2</sub>	14,000 lb (6,350 kg) <sub>2</sub>	60 ft <sup>2</sup> (5.6 m <sup>2</sup> )
Crew Cab – 157 in (3989mm) Heavy Payload Package	4WD	3.73	19,500 lb (8,845 kg) <sub>2</sub>	13,800 lb (6,259 kg) <sub>2</sub>	60 ft <sup>2</sup> (5.6 m <sup>2</sup> )

<sup>1</sup> Heavy duty trailer tow package.

<sup>2</sup> Max duty trailer tow package.

**Note:** All values calculated with SAE J2807 method.

**Note:** Do not exceed a trailer weight of 5,000 lb (2,268 kg) when towing with, or by, the bumper only.

**Note:** Do not exceed a trailer weight of 7,000 lb (3,175 kg) or 36 ft<sup>2</sup> (3.4 m<sup>2</sup>) trailer frontal area with the medium duty trailer tow package.

**Note:** Exceeding these limitations could significantly reduce the performance of your towing vehicle. Selecting a trailer with a low aerodynamic drag and rounded front design helps optimize performance and fuel economy.

# Towing a Trailer

## Recommended Towing Weights - 3.5L, Hybrid Electric Vehicle (HEV)

<b>Cab – Wheel-base in (mm)</b>	<b>Driveline</b>	<b>Rear Axle Ratio</b>	<b>Maximum Gross Combined Weight Rating</b>	<b>Maximum Trailer Weight</b>	<b>Maximum Trailer Frontal Area</b>
Crew Cab – 145 in (3,675mm)	RWD	3.55	16,700 lb (7,574 kg) <sub>1</sub>	11,000 lb (4,989 kg) <sub>1</sub>	60 ft <sup>2</sup> (5.6 m <sup>2</sup> )
Crew Cab – 145 in (3,675mm)	RWD	3.55	18,400 lb (8,346 kg) <sub>2</sub>	12,700 lb (5,760 kg) <sub>2</sub>	60 ft <sup>2</sup> (5.6 m <sup>2</sup> )
Crew Cab – 145 in (3,675mm)	4WD	3.73	17,000 lb (7,711 kg) <sup>1</sup>	11,000 lb (4,989 kg) <sub>1</sub>	60 ft <sup>2</sup> (5.6 m <sup>2</sup> )
Crew Cab – 145 in (3,675mm)	4WD	3.73	18,400 lb (8,346 kg) <sub>2</sub>	12,400 lb (5,624 kg) <sub>2</sub>	60 ft <sup>2</sup> (5.6 m <sup>2</sup> )
Crew Cab – 157 in (3,989mm)	RWD	3.55	16,800 lb (7,620 kg) <sub>1</sub>	11,100 lb (5,035 kg) <sub>1</sub>	60 ft <sup>2</sup> (5.6 m <sup>2</sup> )
Crew Cab – 157 in (3,989mm)	RWD	3.55	18,400 lb (8,346 kg) <sub>2</sub>	12,700 lb (5,761 kg) <sub>2</sub>	60 ft <sup>2</sup> (5.6 m <sup>2</sup> )



## Towing a Trailer

Cab – Wheel-base in (mm)	Driveline	Rear Axle Ratio	Maximum Gross Combined Weight Rating	Maximum Trailer Weight	Maximum Trailer Frontal Area
Crew Cab – 157 in (3,989mm)	4WD	3.73	17,000 lb (7,711 kg) <sup>1</sup>	11,000 lb (4,989 kg) <sub>1</sub>	60 ft <sup>2</sup> (5.6 m <sup>2</sup> )
Crew Cab – 157 in (3,989mm)	4WD	3.73	18,400 lb (8,346 kg) <sub>2</sub>	12,400 lb (5,624 kg) <sub>2</sub>	60 ft <sup>2</sup> (5.6 m <sup>2</sup> )

<sup>1</sup> Heavy duty trailer tow package.

<sup>2</sup> Max duty trailer tow package.

**Note:** All values calculated with SAE J2807 method.

**Note:** Do not exceed a trailer weight of 5,000 lb (2,268 kg) when towing with, or by, the bumper only.

**Note:** Do not exceed a trailer weight of 7,000 lb (3,175 kg) or 36 ft<sup>2</sup> (3.4 m<sup>2</sup>) trailer frontal area with the medium duty trailer tow package.

**Note:** Exceeding these limitations could significantly reduce the performance of your towing vehicle. Selecting a trailer with a low aerodynamic drag and rounded front design helps optimize performance and fuel economy.

# Towing a Trailer

## Recommended Towing Weights - 5.0L

<b>Cab – Wheel-base in (mm)</b>	<b>Driveline</b>	<b>Rear Axle Ratio</b>	<b>Maximum Gross Combined Weight Rating</b>	<b>Maximum Trailer Weight</b>	<b>Maximum Trailer Frontal Area</b>
Regular Cab – 122.4 in (3,110mm)	RWD	3.15	13,000 lb (5,896 kg) 1	8,300 lb (3,764 kg) 1	60 ft <sup>2</sup> (5.6 m <sup>2</sup> )
Regular Cab – 122.4 in (3,110mm)	RWD	3.31	13,000 lb (5,896 kg) 1	8,300 lb (3,764 kg) 1	60 ft <sup>2</sup> (5.6 m <sup>2</sup> )
Regular Cab – 122.4 in (3,110mm)	4WD	3.31	13,200 lb (5,987 kg) 1	8,200 lb (3,719 kg) 1	60 ft <sup>2</sup> (5.6 m <sup>2</sup> )
Regular Cab – 122.4 in (3,110mm)	RWD	3.73	13,800 lb (6,259 kg) 1	9,100 lb (4,127 kg) 1	60 ft <sup>2</sup> (5.6 m <sup>2</sup> )
Regular Cab – 122.4 in (3,110mm)	4WD	3.73	14,600 lb (6,622 kg) 1	9,600 lb (4,354 kg) 1	60 ft <sup>2</sup> (5.6 m <sup>2</sup> )
Regular Cab – 141 in (3,581mm)	RWD	3.15	14,800 lb (6,713 kg) 1	9,900 lb (4,490 kg) 1	60 ft <sup>2</sup> (5.6 m <sup>2</sup> )
Regular Cab – 141 in (3,581mm)	RWD	3.31	14,800 lb (6,713 kg) 1	9,900 lb (4,490 kg) 1	60 ft <sup>2</sup> (5.6 m <sup>2</sup> )

## Towing a Trailer

<b>Cab – Wheel-base in (mm)</b>	<b>Driveline</b>	<b>Rear Axle Ratio</b>	<b>Maximum Gross Combined Weight Rating</b>	<b>Maximum Trailer Weight</b>	<b>Maximum Trailer Frontal Area</b>
Regular Cab – 141 in (3,581mm)	4WD	3.31	14,800 lb (6,713 kg) <sub>1</sub>	9,700 lb (4,399 kg) <sub>1</sub>	60 ft <sup>2</sup> (5.6 m <sup>2</sup> )
Regular Cab – 141 in (3,581mm)	RWD	3.73	15,300 lb (6,940 kg) <sub>1</sub>	10,400 lb (4,717 kg) <sub>1</sub>	60 ft <sup>2</sup> (5.6 m <sup>2</sup> )
Regular Cab – 141 in (3,581mm)	RWD	3.73	17,900 lb (8,119 kg) <sub>2</sub>	13,000 lb (5,896 kg) <sub>2</sub>	60 ft <sup>2</sup> (5.6 m <sup>2</sup> )
Regular Cab – 141 in (3,581mm) Heavy Payload Package	RWD	3.73	18,000 lb (8,164 kg) <sub>2</sub>	13,000 lb (5,896 kg) <sub>2</sub>	60 ft <sup>2</sup> (5.6 m <sup>2</sup> )
Regular Cab – 141 in (3,581mm)	4WD	3.73	15,600 lb (7,076 kg) <sub>1</sub>	10,500 lb (4,762 kg) <sub>1</sub>	60 ft <sup>2</sup> (5.6 m <sup>2</sup> )
Regular Cab – 141 in (3,581mm)	4WD	3.73	17,900 lb (8,119 kg) <sub>2</sub>	12,800 lb (5,806 kg) <sub>2</sub>	60 ft <sup>2</sup> (5.6 m <sup>2</sup> )

## Towing a Trailer

<b>Cab – Wheel-base in (mm)</b>	<b>Driveline</b>	<b>Rear Axle Ratio</b>	<b>Maximum Gross Combined Weight Rating</b>	<b>Maximum Trailer Weight</b>	<b>Maximum Trailer Frontal Area</b>
Regular Cab – 141 in (3,581mm) Heavy Payload Package	4WD	3.73	18,300 lb (8,300 kg) 2	13,000 lb (5,896 kg) 2	60 ft <sup>2</sup> (5.6 m <sup>2</sup> )
Super Cab – 145 in (3,675mm)	RWD	3.15	14,800 lb (6,713 kg) 1	9,800 lb (4,445 kg) 1	60 ft <sup>2</sup> (5.6 m <sup>2</sup> )
Super Cab – 145 in (3,675mm)	RWD	3.31	14,800 lb (6,713 kg) 1	9,800 lb (4,445 kg) 1	60 ft <sup>2</sup> (5.6 m <sup>2</sup> )
Super Cab – 145 in (3,675mm)	4WD	3.31	14,800 lb (6,713 kg) 1	9,500 lb (4,309 kg) 1	60 ft <sup>2</sup> (5.6 m <sup>2</sup> )
Super Cab – 145 in (3,675mm)	RWD	3.73	15,500 lb (7,030 kg) 1	10,500 lb (4,762 kg) 1	60 ft <sup>2</sup> (5.6 m <sup>2</sup> )
Super Cab – 145 in (3,675mm)	RWD	3.73	17,800 lb (8,073 kg) 2	12,800 lb (5,805 kg) 2	60 ft <sup>2</sup> (5.6 m <sup>2</sup> )
Super Cab – 145 in (3,675mm)	4WD	3.73	15,800 lb (7,166 kg) 1	10,500 lb (4,762 kg) 1	60 ft <sup>2</sup> (5.6 m <sup>2</sup> )
Super Cab – 145 in (3,675mm)	4WD	3.73	17,600 lb (7,983 kg) 2	12,300 lb (5,579 kg) 2	60 ft <sup>2</sup> (5.6 m <sup>2</sup> )

## Towing a Trailer

<b>Cab – Wheel-base in (mm)</b>	<b>Driveline</b>	<b>Rear Axle Ratio</b>	<b>Maximum Gross Combined Weight Rating</b>	<b>Maximum Trailer Weight</b>	<b>Maximum Trailer Frontal Area</b>
Super Cab – 163 in (4,140mm)	RWD	3.15	14,800 lb (6,713 kg) <sub>1</sub>	9,600 lb (4,354 kg) <sub>1</sub>	60 ft <sup>2</sup> (5.6 m <sup>2</sup> )
Super Cab – 163 in (4,140mm)	RWD	3.31	14,800 lb (6,713 kg) <sub>1</sub>	9,600 lb (4,354 kg) <sub>1</sub>	60 ft <sup>2</sup> (5.6 m <sup>2</sup> )
Super Cab – 163 in (4,140mm)	4WD	3.31	14,800 lb (6,713 kg) <sub>1</sub>	9,400 lb (4,263 kg) <sub>1</sub>	60 ft <sup>2</sup> (5.6 m <sup>2</sup> )
Super Cab – 163 in (4,140mm)	RWD	3.73	15,600 lb (7,076 kg) <sub>1</sub>	10,400 lb (4,717 kg) <sub>1</sub>	60 ft <sup>2</sup> (5.6 m <sup>2</sup> )
Super Cab – 163 in (4,140mm)	RWD	3.73	18,200 lb (8,255 kg) <sub>2</sub>	13,000 lb (5,896 kg) <sub>2</sub>	60 ft <sup>2</sup> (5.6 m <sup>2</sup> )
Super Cab – 163 in (4,140mm) Heavy Payload Package	RWD	3.73	18,300 lb (8,300 kg) <sub>2</sub>	13,000 lb (5,896 kg) <sub>2</sub>	60 ft <sup>2</sup> (5.6 m <sup>2</sup> )
Super Cab – 163 in (4,140mm)	4WD	3.73	15,800 lb (7,166 kg) <sub>1</sub>	10,400 lb (4,717 kg) <sub>1</sub>	60 ft <sup>2</sup> (5.6 m <sup>2</sup> )
Super Cab – 163 in (4,140mm)	4WD	3.73	18,400 lb (8,346 kg) <sub>2</sub>	13,000 lb (5,896 kg) <sub>2</sub>	60 ft <sup>2</sup> (5.6 m <sup>2</sup> )

## Towing a Trailer

<b>Cab – Wheel-base in (mm)</b>	<b>Driveline</b>	<b>Rear Axle Ratio</b>	<b>Maximum Gross Combined Weight Rating</b>	<b>Maximum Trailer Weight</b>	<b>Maximum Trailer Frontal Area</b>
Super Cab – 163 in (4,140mm) Heavy Payload Package	4WD	3.73	18,500 lb (8,391 kg) <sub>2</sub>	13,000 lb (5,896 kg) <sub>2</sub>	60 ft <sup>2</sup> (5.6 m <sup>2</sup> )
Crew Cab – 145 in (3,675mm)	RWD	3.15	14,800 lb (6,713 kg) <sub>1</sub>	9,700 lb (4,399 kg) <sub>1</sub>	60 ft <sup>2</sup> (5.6 m <sup>2</sup> )
Crew Cab – 145 in (3,675mm)	RWD	3.31	14,800 lb (6,713 kg) <sub>1</sub>	9,700 lb (4,399 kg) <sub>1</sub>	60 ft <sup>2</sup> (5.6 m <sup>2</sup> )
Crew Cab – 145 in (3,675mm)	4WD	3.31	14,800 lb (6,713 kg) <sub>1</sub>	9,400 lb (4,263 kg) <sub>1</sub>	60 ft <sup>2</sup> (5.6 m <sup>2</sup> )
Crew Cab – 145 in (3,675mm)	RWD	3.73	15,600 lb (7,076 kg) <sub>1</sub>	10,500 lb (4,762 kg) <sub>1</sub>	60 ft <sup>2</sup> (5.6 m <sup>2</sup> )
Crew Cab – 145 in (3,675mm)	RWD	3.73	18,100 lb (8,210 kg) <sub>2</sub>	12,900 lb (5,851 kg) <sub>2</sub>	60 ft <sup>2</sup> (5.6 m <sup>2</sup> )
Crew Cab – 145 in (3,675mm)	4WD	3.73	15,800 lb (7,166 kg) <sub>1</sub>	10,400 lb (4,717 kg) <sub>1</sub>	60 ft <sup>2</sup> (5.6 m <sup>2</sup> )
Crew Cab – 145 in (3,675mm)	4WD	3.73	18,400 lb (8,346 kg) <sub>2</sub>	13,000 lb (5,896 kg) <sub>2</sub>	60 ft <sup>2</sup> (5.6 m <sup>2</sup> )

## Towing a Trailer

<b>Cab – Wheel-base in (mm)</b>	<b>Driveline</b>	<b>Rear Axle Ratio</b>	<b>Maximum Gross Combined Weight Rating</b>	<b>Maximum Trailer Weight</b>	<b>Maximum Trailer Frontal Area</b>
Crew Cab – 157 in (3,989mm)	RWD	3.15	14,800 lb (6,713 kg) <sub>1</sub>	9,600 lb (4,354 kg) <sub>1</sub>	60 ft <sup>2</sup> (5.6 m <sup>2</sup> )
Crew Cab – 157 in (3,989mm)	RWD	3.31	14,800 lb (6,713 kg) <sub>1</sub>	9,600 lb (4,354 kg) <sub>1</sub>	60 ft <sup>2</sup> (5.6 m <sup>2</sup> )
Crew Cab – 157 in (3,989mm)	4WD	3.31	14,800 lb (6,713 kg) <sub>1</sub>	9,300 lb (4,218 kg) <sub>1</sub>	60 ft <sup>2</sup> (5.6 m <sup>2</sup> )
Crew Cab – 157 in (3,989mm)	RWD	3.73	15,600 lb (7,076 kg) <sub>1</sub>	10,400 lb (4,717 kg) <sub>1</sub>	60 ft <sup>2</sup> (5.6 m <sup>2</sup> )
Crew Cab – 157 in (3,989mm)	RWD	3.73	18,200 lb (8,255 kg) <sub>2</sub>	13,000 lb (5,896 kg) <sub>2</sub>	60 ft <sup>2</sup> (5.6 m <sup>2</sup> )
Crew Cab – 157 in (3,989mm) Heavy Payload Package	RWD	3.73	18,400 lb (8,346 kg) <sub>2</sub>	13,000 lb (5,896 kg) <sub>2</sub>	60 ft <sup>2</sup> (5.6 m <sup>2</sup> )
Crew Cab – 157 in (3,989mm)	4WD	3.73	15,800 lb (7,166 kg) <sub>1</sub>	10,300 lb (4,672 kg) <sub>1</sub>	60 ft <sup>2</sup> (5.6 m <sup>2</sup> )

## Towing a Trailer

<b>Cab – Wheel-base in (mm)</b>	<b>Driveline</b>	<b>Rear Axle Ratio</b>	<b>Maximum Gross Combined Weight Rating</b>	<b>Maximum Trailer Weight</b>	<b>Maximum Trailer Frontal Area</b>
Crew Cab – 157 in (3,989mm)	4WD	3.73	18,400 lb (8,346 kg) <sub>2</sub>	12,900 lb (5,851 kg) <sub>2</sub>	60 ft <sup>2</sup> (5.6 m <sup>2</sup> )
Crew Cab – 157 in (3,989mm) Heavy Payload Package	4WD	3.73	18,600 lb (8,436 kg) <sub>2</sub>	13,000 lb (5,896 kg) <sub>2</sub>	60 ft <sup>2</sup> (5.6 m <sup>2</sup> )

<sup>1</sup> Heavy duty trailer tow package.

<sup>2</sup> Max duty trailer tow package.

**Note:** All values calculated with SAE J2807 method.

**Note:** Do not exceed a trailer weight of 5,000 lb (2,268 kg) when towing with, or by, the bumper only.

**Note:** Do not exceed a trailer weight of 7,000 lb (3,175 kg) or 36 ft<sup>2</sup> (3.4 m<sup>2</sup>) trailer frontal area with the medium duty trailer tow package.

**Note:** Exceeding these limitations could significantly reduce the performance of your towing vehicle. Selecting a trailer with a low aerodynamic drag and rounded front design helps optimize performance and fuel economy.



# Towing a Trailer

---

## **What Is the Maximum Loaded Trailer Weight**

The maximum loaded trailer weight is the highest possible weight of a fully loaded trailer the vehicle can tow.

For additional information, visit [www.fleet.ford.com/towing-guides](http://www.fleet.ford.com/towing-guides).

# Crash and Breakdown Information

## SWITCHING THE HAZARD FLASHERS ON AND OFF



The hazard flasher button is on the instrument panel. Press the button to switch the hazard flashers on if your vehicle is creating a safety hazard for other road users.

When you switch the hazard flashers on, all front and rear direction indicators flash.

**Note:** *The hazard flashers operate when the ignition is in any position, or if the key is not in the ignition. The battery loses charge and could have insufficient power to restart your vehicle.*

Press the button again to switch them off.

## JUMP STARTING THE VEHICLE

### Jump Starting Precautions



**WARNING:** Batteries normally produce explosive gases which can cause personal injury. Therefore, do not allow flames, sparks or lighted substances to come near the battery. When working near the battery, always shield your face and protect your eyes. Always provide correct ventilation.



**WARNING:** Keep batteries out of reach of children. Batteries contain sulfuric acid. Avoid contact with skin, eyes or clothing. Shield your eyes when working near the battery to protect against possible splashing of acid solution. In case of acid contact with skin or eyes, flush immediately with water for a minimum of 15 minutes and get prompt medical attention. If acid is swallowed, call a physician immediately.



**WARNING:** Use only adequately sized cables with insulated clamps.



**WARNING:** Make sure that the cables are clear of any moving parts and fuel delivery system parts.



**WARNING:** Connect batteries with only the same nominal voltage.

Do not attempt to push-start an automatic transmission vehicle. This could cause transmission damage.

Do not disconnect the battery of the disabled vehicle. This could damage your vehicle's electrical system.

### Preparing the Vehicle

Use only a 12 volt supply to start your vehicle.

Park the booster vehicle close to the hood of the disabled vehicle, making sure the two vehicles do not touch.

### Jump Starting the Vehicle

#### Connecting the Jumper Cables



**WARNING:** Do not connect the negative jumper cable to any other part of your vehicle. Use the ground point.

**Note:** *If you are using a jump pack or booster box, follow the manufacturer's instructions.*

# Crash and Breakdown Information

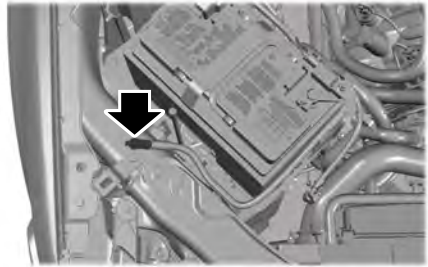
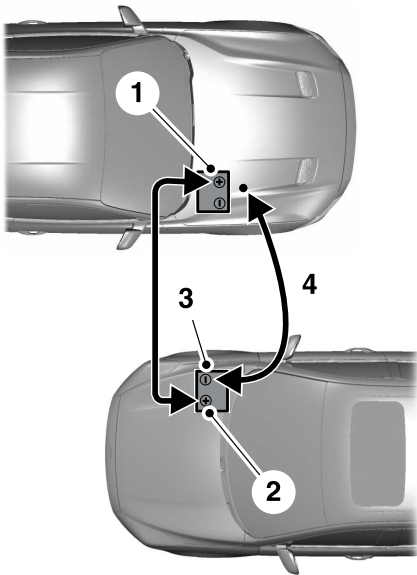

## Starting the Engine

1. Start the engine of the booster vehicle and moderately rev the engine, or gently press the accelerator to keep the engine speed between 2000 and 3000 RPM, as shown in your tachometer.
2. Start the engine of the disabled vehicle.
3. Once you start the disabled vehicle, run both vehicle engines for an additional three minutes before disconnecting the jumper cables.

## Removing the Jumper Cables

Remove the jumper cables in the reverse order that they were connected.

**Note:** Do not switch the headlamps on when disconnecting the cables. The peak voltage could blow the bulbs.

1. Pull the red rubber boot backward. Connect the positive (+) jumper cable to the positive (+) terminal of the discharged battery.
2. Connect the other end of the positive (+) jumper cable to the positive (+) terminal of the booster vehicle battery.
3. Connect the negative (-) jumper cable to the negative (-) terminal of the booster vehicle battery.
4. Make the final connection of the negative (-) jumper cable to an exposed metal part of the disabled vehicle's engine, as shown in the following illustration, away from the battery and fuel injection system, or connect the negative (-) jumper cable to a ground connection point if available.

# Maintenance

## UNDER HOOD OVERVIEW - 2.7L ECOBOOST™

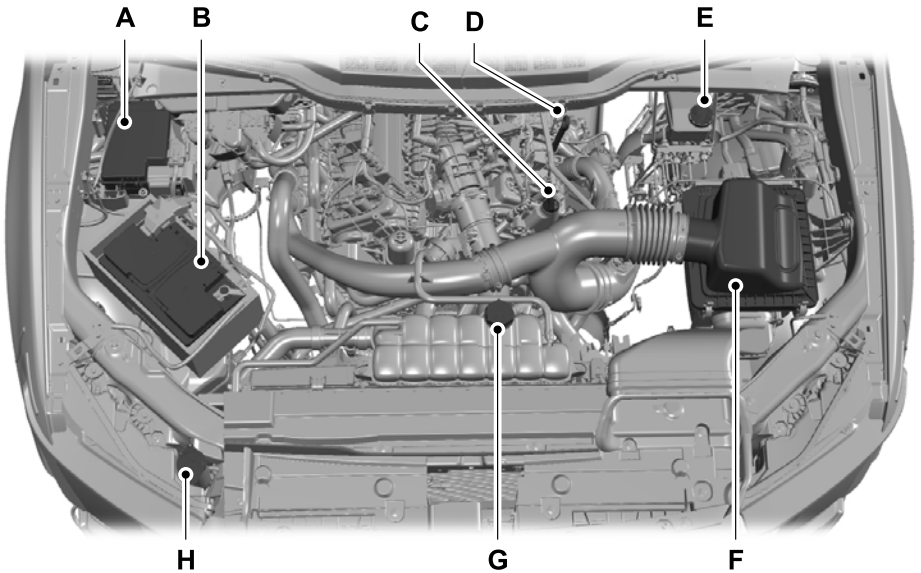

- A. Engine compartment fuse box.
- B. Battery.
- C. Engine oil filler cap.
- D. Engine oil dipstick.
- E. Brake fluid reservoir.
- F. Air filter assembly.
- G. Engine coolant reservoir.
- H. Windshield washer fluid reservoir.

# Maintenance

## UNDER HOOD OVERVIEW - 3.0L DIESEL

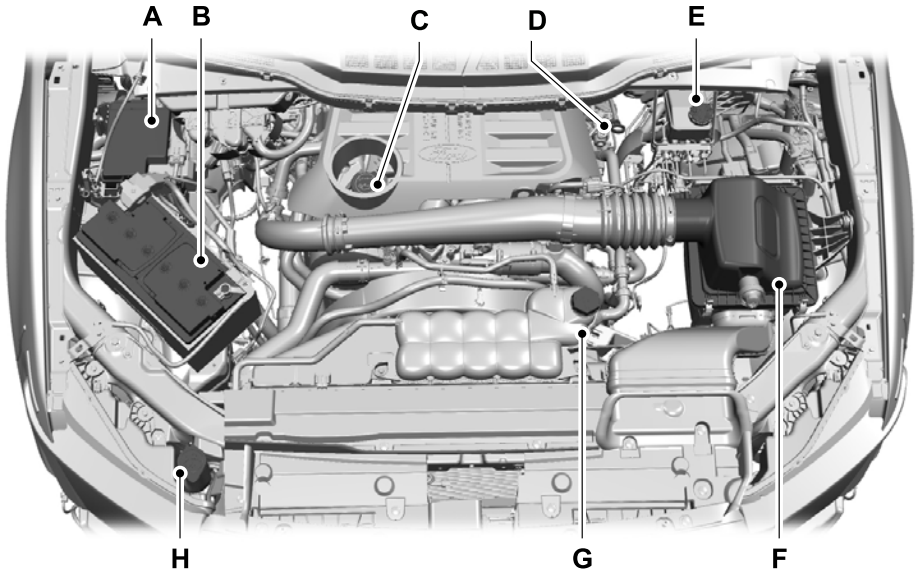

- A. Engine compartment fuse box.
- B. Battery.
- C. Engine oil filler cap.
- D. Engine oil dipstick.
- E. Brake fluid reservoir.
- F. Air filter assembly.
- G. Engine coolant reservoir.
- H. Windshield washer fluid reservoir.

# Maintenance

## UNDER HOOD OVERVIEW - 3.3L

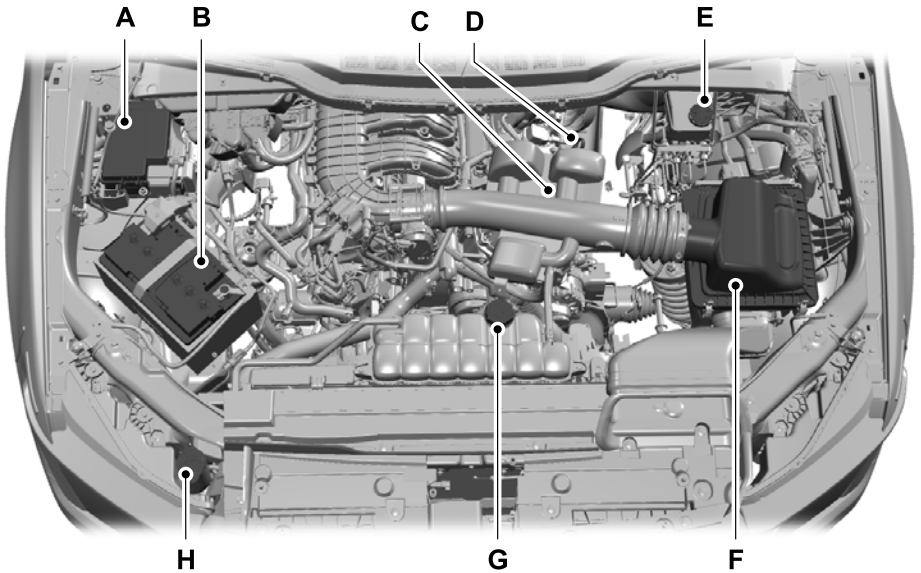

- A. Engine compartment fuse box.
- B. Battery.
- C. Engine oil filler cap.
- D. Engine oil dipstick.
- E. Brake fluid reservoir.
- F. Air filter assembly.
- G. Engine coolant reservoir.
- H. Windshield washer fluid reservoir.

# Maintenance

## UNDER HOOD OVERVIEW - 3.5L ECOBOOST™

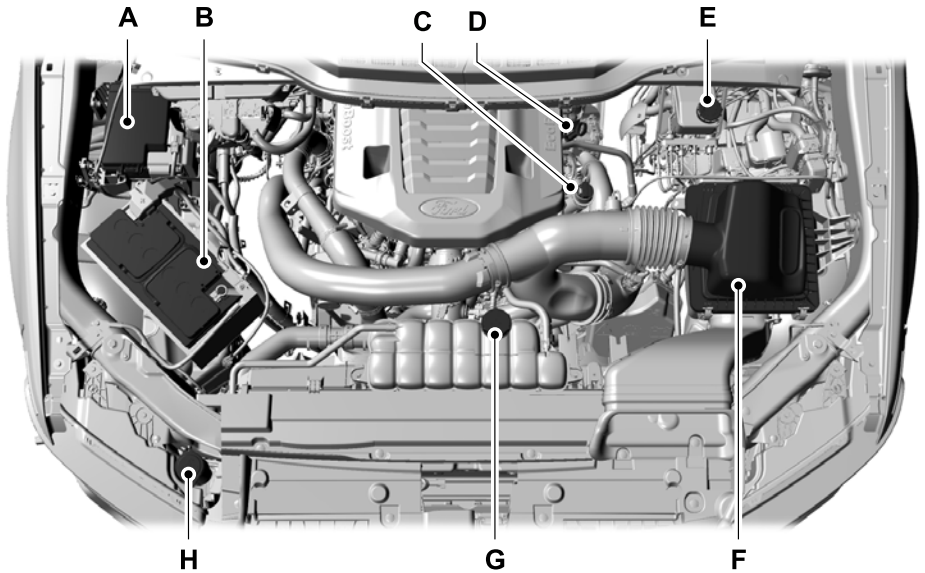

- A. Engine compartment fuse box.
- B. Battery.
- C. Engine oil filler cap.
- D. Engine oil dipstick.
- E. Brake fluid reservoir.
- F. Air filter.
- G. Engine coolant reservoir.
- H. Windshield washer fluid reservoir.

# Maintenance

## UNDER HOOD OVERVIEW - 3.5L, HYBRID ELECTRIC VEHICLE (HEV)

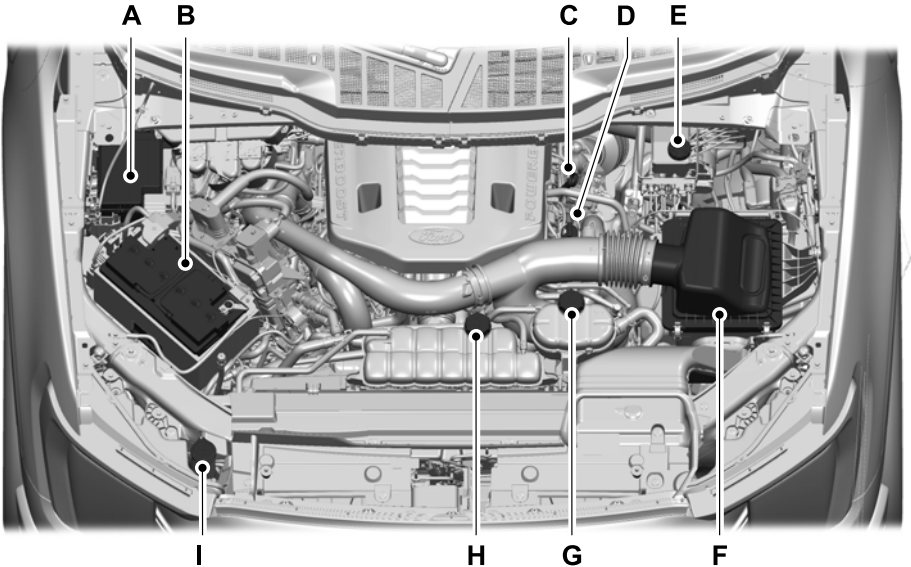

- A. Engine compartment fuse box.
- B. Battery.
- C. Engine oil dipstick.
- D. Engine oil filler cap.
- E. Brake fluid reservoir.
- F. Air filter.
- G. Secondary coolant reservoir.
- H. Engine coolant reservoir.
- I. Windshield washer fluid reservoir.



# Maintenance

## UNDER HOOD OVERVIEW - 5.0L

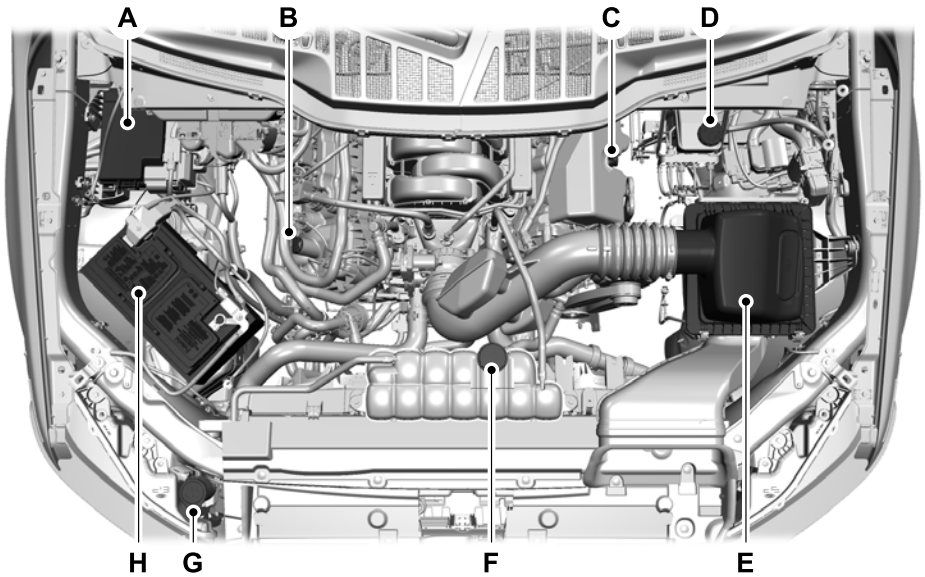

- A. Engine compartment fuse box.
- B. Engine oil filler cap.
- C. Engine oil dipstick.
- D. Brake fluid reservoir.
- E. Air filter assembly.
- F. Engine coolant reservoir.
- G. Windshield washer fluid reservoir.
- H. Battery.

# Vehicle Care

---

## CLEANING THE EXTERIOR

### Cleaning Windows and Wiper Blades

To clean the windshield and wiper blades:

- Clean the windshield with a non-abrasive glass cleaner.

**Note:** *When cleaning the interior of the windshield, avoid getting any glass cleaner on the instrument panel or door panels. Wipe any glass cleaner off these surfaces immediately.*

- Clean the wiper blades with isopropyl rubbing alcohol or windshield washer concentrate.

**Note:** *Do not use razor blades or other sharp objects to clean or remove decals from the inside of the heated rear window. This can cause damage not covered by the vehicle Warranty.*

# Wheel and Tire Information

## LOCATING THE TIRE LABEL

You will find a Tire Label containing tire inflation pressure by tire size and other important information located on the B-Pillar or the edge of the driver's door.

## DEPARTMENT OF TRANSPORTATION UNIFORM TIRE QUALITY GRADES



E142542

Tire Quality Grades apply to new pneumatic passenger car tires. The Quality grades can be found where applicable on the tire sidewall between tread shoulder and maximum section width. For example: **Treadwear 200 Traction AA Temperature A.**

These Tire Quality Grades are determined by standards that the United States Department of Transportation has set.

Tire Quality Grades apply to new pneumatic passenger car tires. They do not apply to deep tread, winter-type snow tires, space-saver or temporary use spare tires, light truck or LT type tires, tires with nominal rim diameters of 10 to 12 inches or limited production tires as defined in Title 49 Code of Federal Regulations Part 575.104 (c)(2).

## U.S. Department of Transportation Tire quality grades:

The U.S. Department of Transportation requires us to give you the following information about tire grades exactly as the government has written it.

### Treadwear

The treadwear grade is a comparative rating based on the wear rate of the tire when tested under controlled conditions on a specified government test course. For example, a tire graded 150 would wear 1½ times as well on the government course as a tire graded 100. The relative performance of tires depends upon the actual conditions of their use, however, and may depart significantly from the norm due to variations in driving habits, service practices, and differences in road characteristics and climate.

# Wheel and Tire Information

## Traction AA A B C



**WARNING:** The traction grade assigned to this tire is based on straight-ahead braking traction tests, and does not include acceleration, cornering, hydroplaning or peak traction characteristics.

The traction grades, from highest to lowest are AA, A, B, and C. The grades represent the tire's ability to stop on wet pavement as measured under controlled conditions on specified government test surfaces of asphalt and concrete. A tire marked C may have poor traction performance.

## Temperature A B C



**WARNING:** The temperature grade for this tire is established for a tire that is properly inflated and not overloaded. Excessive speed, underinflation, or excessive loading, either separately or in combination, can cause heat buildup and possible tire failure.

The temperature grades are A (the highest), B and C, representing the tire's resistance to the generation of heat and its ability to dissipate heat when tested under controlled conditions on a specified indoor laboratory

test wheel. Sustained high temperature can cause the material of the tire to degenerate and reduce tire life, and excessive temperature can lead to sudden tire failure. The grade C corresponds to a level of performance which all passenger car tires must meet under the Federal Motor Vehicle Safety Standard No. 139. Grades B and A represent higher levels of performance on the laboratory test wheel than the minimum required by law.

## INFORMATION ON THE TIRE SIDEWALL

Both United States and Canada Federal regulations require tire manufacturers to place standardized information on the sidewall of all tires. This information identifies and describes the fundamental characteristics of the tire and also provides a U.S. DOT Tire Identification Number for safety standard certification and in case of a recall.

# Wheel and Tire Information

## Information on P Type Tires

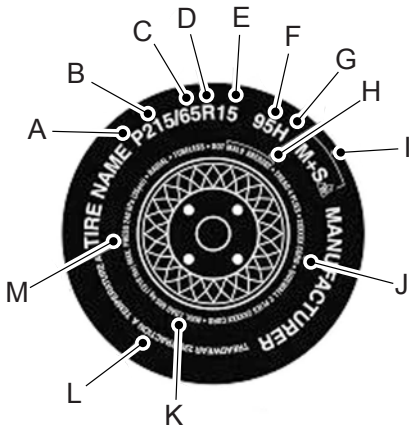

E142543

P215/65R15 95H is an example of a tire size, load index and speed rating. The definitions of these items are listed below. (Note that the tire size, load index and speed rating for your vehicle may be different from this example.)

A. **P:** Indicates a tire, designated by the Tire and Rim Association, that may be used for service on cars, sport utility vehicles, minivans and light trucks. **Note:** If your tire size does not begin with a letter this may mean it is designated by either the European Tire and Rim Technical Organization or the Japan Tire Manufacturing Association.

B. **215:** Indicates the nominal width of the tire in millimeters from sidewall edge to sidewall edge. In general, the larger the number, the wider the tire.

C. **65:** Indicates the aspect ratio which gives the tire's ratio of height to width.

D. **R:** Indicates a radial type tire.

E. **15:** Indicates the wheel or rim diameter in inches. If you change your wheel size, you will have to purchase new tires to match the new wheel diameter.

F. **95:** Indicates the tire's load index. It is an index that relates to how much weight a tire can carry. You may find this information in your owner's manual. If not, contact a local tire dealer.

**Note:** You may not find this information on all tires because it is not required by federal law.

G. **H:** Indicates the tire's speed rating. The speed rating denotes the speed at which a tire is designed to be driven for extended periods of time under a standard condition of load and inflation pressure. The tires on your vehicle may operate at different conditions for load and inflation pressure. These speed ratings may need to be adjusted for the difference in conditions. The ratings range from 81 mph (130 km/h) to 186 mph (299 km/h). These ratings are listed in the following chart.

## Wheel and Tire Information

**Note:** You may not find this information on all tires because it is not required by federal law.

Letter rating	Speed rating
M	81 mph (130 km/h)
N	87 mph (140 km/h)
Q	99 mph (159 km/h)
R	106 mph (171 km/h)
S	112 mph (180 km/h)
T	118 mph (190 km/h)
U	124 mph (200 km/h)
H	130 mph (210 km/h)
V	149 mph (240 km/h)
W	168 mph (270 km/h)
Y	186 mph (299 km/h)

**Note:** For tires with a maximum speed capability over 149 mph (240 km/h), tire manufacturers sometimes use the letters ZR. For those with a maximum speed capability over 186 mph (299 km/h), tire manufacturers always use the letters ZR.

**H. U.S. DOT Tire Identification Number (TIN):** This begins with the letters DOT and indicates that the tire meets all federal standards. The next two numbers or letters are the plant code designating where it was manufactured, the next two are

the tire size code and the last four numbers represent the week and year the tire was built. For example, the numbers 317 mean the 31st week of 1997. After 2000, the numbers go to four digits. For example, 2501 means the 25th week of 2001. The numbers in between are identification codes used for traceability. This information is used to contact customers if a tire defect requires a recall.

**I. M+S or M/S:** Mud and Snow, or

**AT:** All Terrain, or

**AS:** All Season.

**J. Tire Ply Composition and Material Used:** Indicates the number of plies or the number of layers of rubber-coated fabric in the tire tread and sidewall. Tire manufacturers also must indicate the ply materials in the tire and the sidewall, which include steel, nylon, polyester, and others.

**K. Maximum Load:** Indicates the maximum load in kilograms and pounds that can be carried by the tire. See the Safety Compliance Certification Label (affixed to either the door hinge pillar, door-latch post, or the door edge that meets the door-latch post, next to the driver's seating position), for the correct tire pressure for your vehicle.

**L. Treadwear, Traction and Temperature Grades:**

# Wheel and Tire Information

**\*Treadwear:** The treadwear grade is a comparative rating based on the wear rate of the tire when tested under controlled conditions on a specified government test course. For example, a tire graded 150 would wear one and one-half times as well on the government course as a tire graded 100.

**\*Traction:** The traction grades, from highest to lowest are AA, A, B, and C. The grades represent the tire's ability to stop on wet pavement as measured under controlled conditions on specified government test surfaces of asphalt and concrete. A tire marked C may have poor traction performance.

**\*Temperature:** The temperature grades are A (the highest), B and C, representing the tire's resistance to the generation of heat and its ability to dissipate heat when tested under controlled conditions on a specified indoor laboratory test wheel.

## M. Maximum Inflation

**Pressure:** Indicates the tire manufacturers' maximum permissible pressure or the pressure at which the maximum load can be carried by the tire. This pressure is normally higher than the vehicle manufacturer's recommended cold inflation pressure which can be found on the Safety Compliance Certification Label (affixed to either the door hinge pillar,

door-latch post, or the door edge that meets the door-latch post, next to the driver's seating position), or Tire Label which is located on the B-Pillar or the edge of the driver's door. The cold inflation pressure should never be set lower than the recommended pressure on the vehicle label.

The tire suppliers may have additional markings, notes or warnings such as standard load or radial tubeless.

## Additional Information Contained on the Tire Sidewall for LT Type Tires

**Note:** *Tire Quality Grades do not apply to this type of tire.*

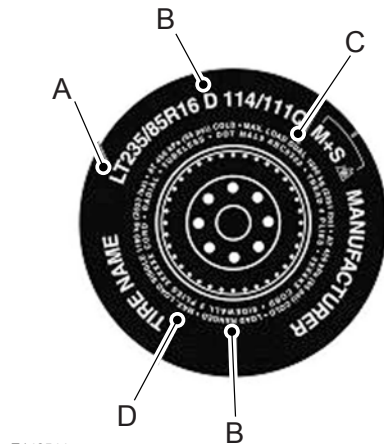

E142544

## Wheel and Tire Information

LT type tires have some additional information beyond those of P type tires; these differences are described below.

**A. LT:** Indicates a tire, designated by the Tire and Rim Association, that is intended for service on light trucks.

**B. Load Range and Load Inflation Limits:** Indicates the tire's load-carrying capabilities and its inflation limits.

**C. Maximum Load Dual lb (kg) at psi (kPa) cold:** Indicates the maximum load and tire pressure when the tire is used as a dual, defined as four tires on the rear axle (a total of six or more tires on the vehicle).

**D. Maximum Load Single lb (kg) at psi (kPa) cold:** Indicates the maximum load and tire pressure when the tire is used as a single, defined as two tires (total) on the rear axle.

### Information on T Type Tires

T145/80D16 is an example of a tire size.

**Note:** *The temporary tire size for your vehicle may be different from this example. Tire Quality Grades do not apply to this type of tire.*



E142545

T type tires have some additional information beyond those of P type tires; these differences are described below:

**A. T:** Indicates a type of tire, designated by the Tire and Rim Association, that is intended for temporary service on cars, sport utility vehicles, minivans and light trucks.

**B. 145:** Indicates the nominal width of the tire in millimeters from sidewall edge to sidewall edge. In general, the larger the number, the wider the tire.



# Wheel and Tire Information

---

C. **80:** Indicates the aspect ratio which gives the tire's ratio of height to width. Numbers of 70 or lower indicate a short sidewall.

D. **D:** Indicates a diagonal type tire.

**R:** Indicates a radial type tire.

E. **16:** Indicates the wheel or rim diameter in inches. If you change your wheel size, you will have to purchase new tires to match the new wheel diameter.

## GLOSSARY OF TIRE TERMINOLOGY

\***Tire label:** A label showing the original equipment tire sizes, recommended inflation pressure and the maximum weight the vehicle can carry.

\***Tire Identification Number (TIN):** A number on the sidewall of each tire providing information about the tire brand and manufacturing plant, tire size and date of manufacture. Also referred to as DOT code.

\***Inflation pressure:** A measure of the amount of air in a tire.

\***Standard load:** A class of P-metric or Metric tires designed to carry a maximum load at set pressure. For example: For P-metric tires 35 psi (2.4 bar) and for Metric tires 36 psi (2.5 bar). Increasing the inflation pressure beyond this pressure will not increase the tire's load carrying capability.

\***Extra load:** A class of P-metric or Metric tires designed to carry a heavier maximum load at 42 psi (2.9 bar). Increasing the inflation pressure beyond this pressure will not increase the tire's load carrying capability.

\***kPa:** Kilopascal, a metric unit of air pressure.

\***PSI:** Pounds per square inch, a standard unit of air pressure.

\***Cold tire pressure:** The tire pressure when the vehicle has been stationary and out of direct sunlight for an hour or more and prior to the vehicle being driven for 1 mi (1.6 km).

\***Recommended inflation pressure:** The cold inflation pressure found on the Safety Compliance Certification Label (affixed to either the door hinge pillar, door-latch post, or the door edge that meets the door-latch post, next to the driver's seating position), or Tire Label located on the B-Pillar or the edge of the driver door.

\***B-pillar:** The structural member at the side of the vehicle behind the front door.

\***Bead area of the tire:** Area of the tire next to the rim.

\***Sidewall of the tire:** Area between the bead area and the tread.

# Wheel and Tire Information

**\*Tread area of the tire:** Area of the perimeter of the tire that contacts the road when mounted on the vehicle.

**\*Rim:** The metal support (wheel) for a tire or a tire and tube assembly upon which the tire beads are seated.

## TIRE REPLACEMENT REQUIREMENTS

### AGE



**WARNING:** Tires degrade over time depending on many factors such as weather, storage conditions, and conditions of use (load, speed, inflation pressure) the tires experience throughout their lives.

In general, tires should be replaced after six years regardless of tread wear. However, heat caused by hot climates or frequent high loading conditions can accelerate the aging process and may require tires to be replaced more frequently.

You should replace your spare tire when you replace the road tires or after six years due to aging even if it has not been used.

## U.S. DOT Tire Identification Number

Both United States and Canada Federal regulations require tire manufacturers to place standardized information on the sidewall of all tires. This information identifies and describes the fundamental characteristics of the tire and also provides a U.S. DOT Tire Identification Number for safety standard certification and in case of a recall.

This begins with the letters DOT and indicates that the tire meets all federal standards. The next two numbers or letters are the plant code designating where it was manufactured, the next two are the tire size code and the last four numbers represent the week and year the tire was built. For example, the numbers 317 mean the 31st week of 1997. After 2000, the numbers go to four digits. For example, 2501 means the 25th week of 2001. The numbers in between are identification codes used for traceability. This information is used to contact customers if a tire defect requires a recall.

## Tire Replacement Requirements

Your vehicle is equipped with tires designed to provide a safe ride and handling capability.

## Wheel and Tire Information



**WARNING:** Only use replacement tires and wheels that are the same size, load index, speed rating and type (such as P-metric versus LT-metric or all-season versus all-terrain) as those originally provided by Ford. The recommended tire and wheel size may be found on either the Safety Compliance Certification Label (affixed to either the door hinge pillar, door-latch post, or the door edge that meets the door-latch post, next to the driver's seating position), or the Tire Label which is located on the B-Pillar or edge of the driver's door. If this information is not found on these labels, then you should contact your authorized dealer as soon as possible. Use of any tire or wheel not recommended by Ford can affect the safety and performance of your vehicle, which could result in an increased risk of loss of vehicle control, vehicle rollover, personal injury and death.



**WARNING:** To reduce the risk of serious injury, when mounting replacement tires and wheels, you should not exceed the maximum pressure indicated on the sidewall of the tire to set the beads without additional precautions listed below. If the beads do not seat at the maximum pressure indicated, re-lubricate and try again.



**WARNING:** For a mounting pressure more than 20 psi (1.38 bar) greater than the maximum pressure, a Ford dealer or other tire service professional should do the mounting.



**WARNING:** Always inflate steel carcass tires with a remote air fill with the person inflating standing at a minimum of 12 ft (3.66 m) away from the wheel and tire assembly.



**WARNING:** When inflating the tire for mounting pressures up to 20 psi (1.38 bar) greater than the maximum pressure on the tire sidewall, the following precautions must be taken to protect the person mounting the tire:

- Make sure that you have the correct tire and wheel size.
- Lubricate the tire bead and wheel bead seat area again.

# Wheel and Tire Information

- Stand at a minimum of 12 ft (3.66 m) away from the wheel and tire assembly.
- Use both eye and ear protection.

**Important:** Remember to replace the wheel valve stems when the road tires are replaced on your vehicle.

It is recommended that the two front tires or two rear tires generally be replaced as a pair if the worn tires still have usable depth.

To avoid potential Four-Wheel Drive (4WD) malfunction or (4WD) system damage, it is recommended to replace all four tires rather than mixing significantly worn tires with new tires.

The tire pressure sensors mounted in the wheels (originally installed on your vehicle) are not designed to be used in aftermarket wheels.

The use of wheels or tires not recommended may affect the operation of your tire pressure monitoring system.

If the tire pressure monitoring system indicator is flashing, your system is malfunctioning. Your replacement tire might be incompatible with your tire pressure monitoring system, or some component of the system may be damaged.

## USING SNOW CHAINS

 **WARNING:** Do not exceed 30 mph (50 km/h). Failure to follow this instruction could result in the loss of control of your vehicle, personal injury or death.

 **WARNING:** Do not use snow chains on snow-free roads.

 **WARNING:** Only fit snow chains to specified tires.

 **WARNING:** If your vehicle is fitted with wheel trims, remove them before fitting snow chains.

 **WARNING:** If you choose to install snow tires on your vehicle, they must be the same size, construction, and load range as the original tires listed on the tire placard, and they must be installed on all four wheels. Mixing tires of different size or construction on your vehicle can adversely affect your vehicle's handling and braking, and may lead to loss of vehicle control.

 **WARNING:** Wheels and tires must be the same size, load index and speed rating as those originally fitted on the vehicle. Use of any other tire or wheel can affect the safety and performance of your vehicle. Additionally, the use of non-recommended tires and wheels can cause steering, suspension, axle, transfer case or power transfer unit failure. Follow the recommended tire inflation pressures found on the Safety Compliance Certification label, or the Tire Label on the B-Pillar or the edge of the driver door. Failure to follow this instruction could result in loss of vehicle control, vehicle rollover, or personal injury or death.

## Wheel and Tire Information

Only use snow chains on rear wheels. Install snow chains in pairs. Do not use self-tensioning snow chains.

Only use snow chains on the following specified tire sizes. Only install chains that are 15mm or less (SAE Class S chains).

- 245/70R17
- 265/70R17
- LT265/70R17
- 265/60R18
- LT265/70R18

We recommend you use steel wheels of the same size and specification if snow chains are required because chains may chip aluminum wheels.

Follow these guidelines when using snow tires and traction devices:

- If possible, avoid fully loading your vehicle.
- Purchase snow chains from a manufacturer that clearly labels body to tire dimension restrictions.
- When driving with snow chains do not exceed 30 mph (50 km/h) or the maximum speed recommended by the chain manufacturer, whichever is less.
- Drive cautiously. If you hear the snow chains rub or bang against the vehicle, stop and tighten them. If this does not work, remove the snow chains to prevent vehicle damage.
- Remove the snow chains when they are no longer needed. Do not use snow chains on dry roads.
- If a temporary spare wheel is mounted on your vehicle, do not use snow chains on the axle with the temporary spare wheel.

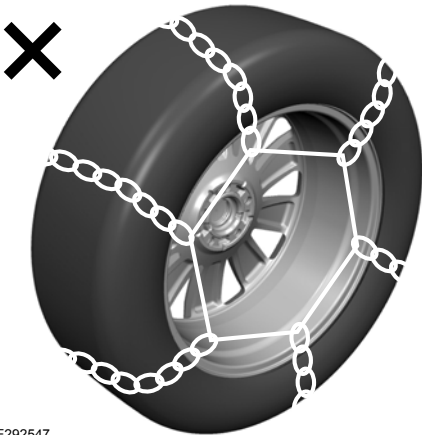

E292547

Use snow chains that fit against the sidewall of the tire to prevent the chains from touching the wheel rims or suspension. Refer to the previous illustration.



If you have any questions regarding snow chains, please contact your authorized dealer.

# Tire Care

## CHECKING THE TIRE PRESSURES

Safe operation of your vehicle requires that your tires are properly inflated. Remember that a tire can lose up to half of its air pressure without appearing flat. Every day before you drive, check your tires. If one looks lower than the others, use a tire gauge to check the pressure of all tires and adjust if required.

At least once a month and before long trips, inspect each tire and check the tire pressure with a tire gauge (including spare, if equipped). Inflate all tires to the inflation pressure recommended by the manufacturer.

## INFLATING THE TIRES



**WARNING:** Under-inflation is the most common cause of tire failures and may result in severe tire cracking, tread separation or blowout, with unexpected loss of vehicle control and increased risk of injury. Under-inflation increases sidewall flexing and rolling resistance, resulting in heat buildup and internal damage to

the tire. It also may result in unnecessary tire stress, irregular wear, loss of vehicle control and accidents. A tire can lose up to half of its air pressure and not appear to be flat!

Use the recommended cold inflation pressure for optimum tire performance and wear. Under-inflation or over-inflation may cause uneven treadwear patterns.

Always inflate your tires to the recommended inflation pressure even if it is less than the maximum inflation pressure information found on the tire. You will find a Tire Label containing the manufacturer's recommended tire inflation pressure by the tire size and other important information located on the B-Pillar or the edge of the driver door.

The recommended tire inflation pressure is also found on the Safety Compliance Certification Label, affixed to either the door hinge pillar, door-latch post, or the door edge that meets the door-latch on the B-pillar, or on the edge of the driver door.

Failure to follow the tire pressure recommendations can cause uneven treadwear patterns and adversely affect the way your vehicle handles.

# Tire Care

## INSPECTING THE TIRE FOR WEAR

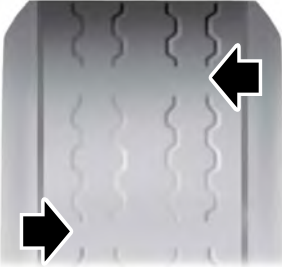

E142546

When the tread is worn down to one sixteenth of an inch (2 mm), tires must be replaced to help prevent your vehicle from skidding and hydroplaning. Built-in treadwear indicators, or wear bars, which look like narrow strips of smooth rubber across the tread will appear on the tire when the tread is worn down to one sixteenth of an inch (2 mm).

When the tire tread wears down to the same height as these wear bars, the tire is worn out and must be replaced.

The tires should also be balanced periodically. An unbalanced tire and wheel assembly may result in irregular tire wear.

Periodically inspect the tire treads for uneven or excessive wear and remove objects such as stones, nails or glass that may be wedged in the tread grooves.

## INSPECTING THE TIRE FOR DAMAGE

Inspect the tire sidewalls for cracking, cuts, bruises and other signs of damage or excessive wear. If internal damage to the tire is suspected, have the tire dismantled and inspected in case it needs to be repaired or replaced. For your safety, tires that are damaged or show signs of excessive wear should not be used because they are more likely to blow out or fail.

Periodically inspect the tire treads and sidewalls for damage, such as bulges in the tread or sidewalls, cracks in the tread groove and separation in the tread or sidewall. If damage is observed or suspected, have the tire inspected by a tire professional.

## Safety Practices



**WARNING:** If your vehicle is stuck in snow, mud or sand, do not rapidly spin the tires; spinning the tires can tear the tire and cause an explosion. A tire can explode in as little as three to five seconds.



**WARNING:** Do not spin the wheels at over 34 mph (55 km/h). The tires may fail and injure a passenger or bystander.

# Tire Care

## Highway Hazards

No matter how carefully you drive, there is always the possibility that you could eventually have a flat tire on the highway. Drive slowly to the closest safe area out of traffic. This could further damage the flat tire, but your safety is more important.

If you feel a sudden vibration or ride disturbance while driving, or you suspect your tire or vehicle has been damaged, immediately reduce your speed. Drive with caution until you can safely pull off the road. Stop and inspect the tires for damage. If a tire is under-inflated or damaged, deflate it, remove the wheel and replace it with your spare tire and wheel. If you cannot detect a cause, have the vehicle towed to the nearest repair facility or tire dealer to have the vehicle inspected.

## Tire and Wheel Alignment

A bad jolt from hitting a curb or pothole can cause the front end of your vehicle to become misaligned or cause damage to your tires. If your vehicle seems to pull to one side when you are driving, the wheels could be out of alignment. Have an authorized dealer check the wheel alignment periodically.

Wheel misalignment in the front or the rear can cause uneven and rapid treadwear of your tires and should be corrected by an authorized dealer.

## INSPECTING THE WHEEL VALVE STEMS

Check the valve stems for holes, cracks, or cuts that could permit air leakage.

## TIRE ROTATION



**WARNING:** If the tire label shows different tire pressures for the front and rear tires and the vehicle has a tire pressure monitoring system, then you need to update the settings for the system sensors. Always perform the system reset procedure after tire rotation. If you do not reset the system, it may not provide a low tire pressure warning when necessary.

Rotating your tires at the recommended interval will help your tires wear more evenly, providing better tire performance and longer tire life.

**Note:** *If your tires show any uneven wear have the alignment checked by an authorized dealer before rotating tires.*



# Tire Care

---

**Note:** *If you have a dissimilar spare wheel and tire assembly, it is intended for temporary use only and should not be used in a tire rotation.*

**Note:** *After having your tires rotated, inflation pressure must be checked and adjusted to the vehicle requirements.*

## Tire Rotation Diagram

Follow the diagram indicating the correct tire locations for rotating the tires.

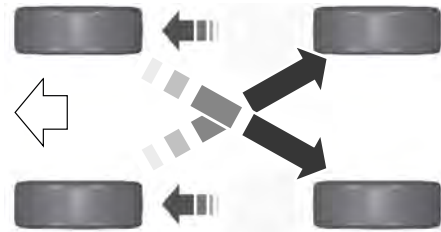

E142548

# Tire Pressure Monitoring System

## WHAT IS THE TIRE PRESSURE MONITORING SYSTEM



The tire pressure monitoring system measures the vehicle's tire pressures. A warning lamp illuminates if one or more tires are significantly underinflated or if there is a system malfunction.

**Note:** Regularly checking the vehicle tire pressures can reduce the possibility for the warning lamp to illuminate due to outside air temperature changes.

**Note:** After you inflate the tires to the recommended pressure it could take up to two minutes of driving over 20 mph (32 km/h) for the warning indicator to turn off.

## TIRE PRESSURE MONITORING SYSTEM PRECAUTIONS



**WARNING:** The tire pressure monitoring system is not a substitute for manually checking tire pressures. You should periodically check tire pressures using a pressure gauge. Failure to correctly maintain tire pressures could increase the risk of tire failure, loss of control, vehicle rollover and personal injury.



**WARNING:** Do not use the tire pressure displayed in the information display as a tire pressure gauge. Failure to follow this instruction could result in personal injury or death.

## VIEWING THE TIRE PRESSURES



Using the information display arrow keys navigate to the truck info section where you can view the tire pressures.

**Note:** The use of tire sealants can damage the tire pressure monitoring system.

## TIRE PRESSURE MONITORING SYSTEM LIMITATIONS

When the outside temperature drops significantly, the tire pressure could decrease and activate the low tire pressure warning lamp.

The warning lamp could also illuminate when you use a spare wheel, or tire sealant from the inflator kit.

# Changing a Road Wheel

## CHANGING A FLAT TIRE



**WARNING:** If the tire pressure monitor sensor becomes damaged it may not function.

**Note:** *The use of tire sealant may damage your tire pressure monitoring system and should only be used in roadside emergencies.*

**Note:** *The tire pressure monitoring system indicator light illuminates when the spare tire is in use. To restore the full function of the monitoring system, all road wheels equipped with tire pressure monitoring sensors must be mounted on this vehicle.*

If you get a flat tire when driving, do not apply the brake heavily. Instead, gradually decrease your speed. Hold the steering wheel firmly and slowly move to a safe place on the side of the road.

Have a flat serviced by an authorized dealer to prevent damage to the system sensors. Replace the spare tire with a road tire as soon as possible. During repairing or replacing the flat tire, have the authorized dealer inspect the system sensor for damage.

### Dissimilar Spare Wheel and Tire Assembly Information



**WARNING:** Failure to follow these guidelines could result in an increased risk of loss of vehicle control, injury or death.

If you have a dissimilar spare wheel and tire, then it is intended for temporary use only. This means that if you need to use it, you should replace it as soon as possible with a road wheel and tire assembly that is the same size and type as the road tires and wheels that were originally provided by Ford.

A dissimilar spare wheel and tire assembly is defined as a spare wheel and tire assembly that is different in brand, size or appearance from the road tires and wheels.

#### Full-size dissimilar spare

When driving with the full-size dissimilar spare wheel and tire assembly, do not:

- Exceed 70 mph (113 km/h).
- Use more than one dissimilar spare wheel and tire assembly at a time.
- Use snow chains on the end of the vehicle with the dissimilar spare wheel and tire assembly.

When driving with the full-size dissimilar spare wheel and tire assembly, four-wheel drive functionality may be limited, especially when driving in a mechanically locked four-wheel drive mode. You may experience the following:

- Additional noise from the transfer case or other drive components.
- Difficulty shifting out of a mechanically locked four-wheel drive mode.

When driving with the full-size dissimilar spare wheel and tire assembly, it is recommended that you do not:

- Exceed 50 mph (80 km/h) in four-wheel drive.
- Engage four-wheel drive unless the vehicle is stationary.
- Use four-wheel drive on dry pavement.

# Changing a Road Wheel

The usage of a full-size dissimilar spare wheel and tire assembly can lead to impairment of the following:

- Handling, stability and braking performance.
- Comfort and noise.
- Ground clearance and parking at curbs.
- Winter weather driving capability.
- Wet weather driving capability.
- Four-wheel drive capability.

When driving with the full-size dissimilar spare wheel and tire assembly additional caution should be given to:

- Towing a trailer.
- Driving vehicles equipped with a camper body.
- Driving vehicles with a load on the cargo rack.

Drive cautiously when using a full-size dissimilar spare wheel and tire assembly and seek service as soon as possible.

## Tire Change Procedure

 **WARNING:** To help prevent your vehicle from moving when changing a wheel, shift the transmission into park (P), set the parking brake and use an appropriate block or wheel chock to secure the wheel diagonally opposite to the wheel being changed. For example, when changing the front left wheel, place an appropriate block or wheel chock on the right rear wheel.

 **WARNING:** Do not work on your vehicle when the jack is the only support as your vehicle could slip off the jack. Failure to follow this instruction could result in personal injury or death.

 **WARNING:** Do not attempt to change a tire on the side of the vehicle close to moving traffic. Pull far enough off the road to avoid the danger of being hit when operating the jack or changing the wheel.

 **WARNING:** Always use the jack provided as original equipment with your vehicle. If using a jack other than the one provided, make sure the jack capacity is adequate for the vehicle weight, including any vehicle cargo or modifications. If you are unsure if the jack capacity is adequate, contact the authorized dealer.

 **WARNING:** Do not get under a vehicle that is only supported by a vehicle jack.

 **WARNING:** The jack supplied with this vehicle is only intended for changing wheels. Do not use the vehicle jack other than when you are changing a wheel in an emergency.

 **WARNING:** The jack should be used on level firm ground wherever possible.

 **WARNING:** Check that the vehicle jack is not damaged or deformed and the thread is lubricated and clean.

 **WARNING:** Never place anything between the vehicle jack and the ground.

 **WARNING:** Never place anything between the vehicle jack and your vehicle.

 **WARNING:** It is recommended that the wheels of the vehicle be chocked, and that no person should remain in a vehicle that is being jacked.

# Changing a Road Wheel



**WARNING:** Switch off the running boards before jacking or placing any object under your vehicle. Never place your hand between the extended running board and your vehicle. A moving running board may cause injury.

**Note:** Only use the spare tire carrier to stow the tire and wheel combination provided with your vehicle. Other tire and wheel combinations can cause the tire carrier to fail.

**Note:** Do not use impact tools or power tools operating at over 200 RPM on the spare tire carrier, this could cause a winch malfunction and prevent a secure fit. Override the winch at least three times, there's an audible click each time, to make sure the wheel and tire have been tightened securely.

**Note:** Passengers should not remain in the vehicle when the vehicle is being jacked.

Park on a level surface, activate the hazard flashers and set the parking brake. Then, place the transmission in park (P) and turn the engine off.

## Removing the Vehicle Jack and Tool Bag

The vehicle jack and tool bag are on the rear passenger side of your vehicle, behind the passenger seat.

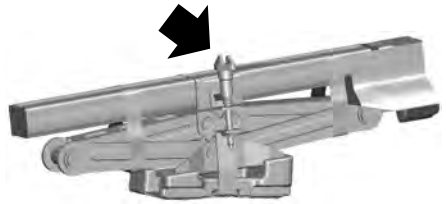

1. Turn the wing bolt on the jack bracket counterclockwise to release the jack and tool bag from the jack bracket.

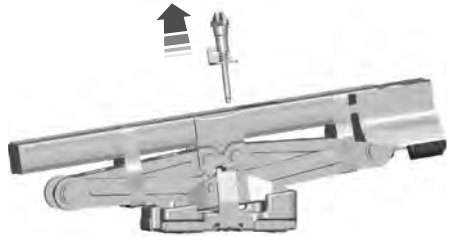

2. Remove the jack and tool bag from the jack bracket.

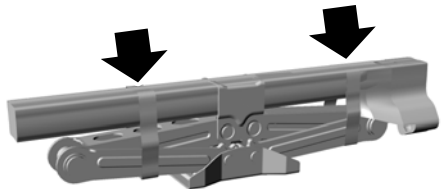

3. Release the jack tool bag straps.

# Changing a Road Wheel

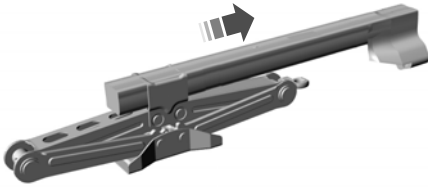

4. Slide the jack tool bag through the jack load rest to remove for access to the jack tools.

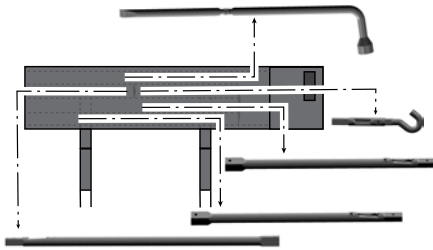

5. Remove the tools from the tool bag.  
**Note:** Your jack does not require maintenance or additional lubrication over the service life of your vehicle.

## Removing the Spare Tire

**Note:** Remove the hook end from the assembled jack handle before continuing.

The spare tire is located under the vehicle, just forward of the rear bumper.

1. Use your key to remove the lock cylinder from the access hole of the bumper to allow access to the guide tube.

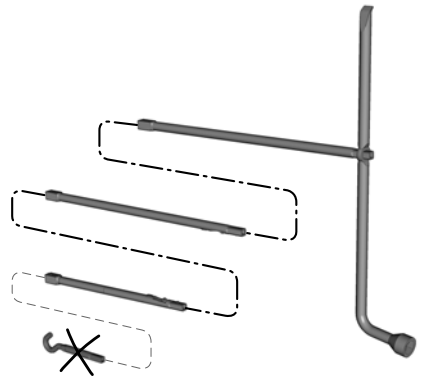

E188735

2. Assemble the jack handle as shown in the illustration.

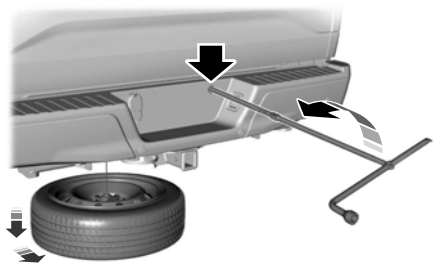

E184020

3. Fully insert the jack handle through the bumper hole and into the guide tube through the access hole in the rear bumper. Turn the handle counterclockwise until the tire is lowered to the ground and the cable is slightly slack to allow the tire to be slid rearward from under the vehicle.
4. Remove the retainer from the center of the wheel.

# Changing a Road Wheel

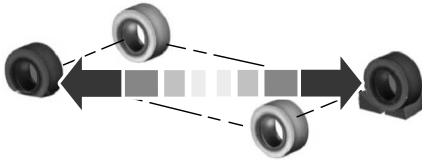

5. Block both the front and rear of the wheel diagonally opposite the flat tire. For example, if the left front tire is flat, block the right rear wheel.
6. Obtain the spare tire and vehicle jack from their storage locations.
7. Loosen each wheel nut on the affected flat tire one-half turn counterclockwise, but do not remove them.

## Jacking the Vehicle

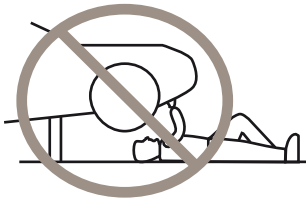

## Front Jacking Points

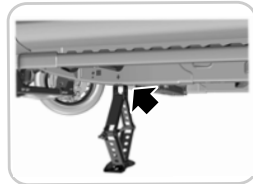
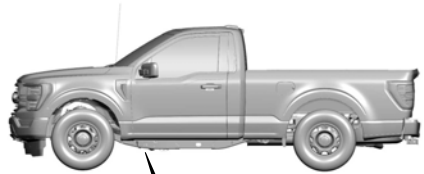

**Note:** Use the frame rail as the front jacking location point, not the control arm. The frame rail is marked with an arrow.

## Rear Jacking Points

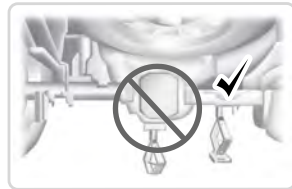

**Note:** Jack at the specified locations to avoid damage to the vehicle.

# Changing a Road Wheel

1. Place the vehicle jack at the jacking point next to the tire you are changing. Turn the jack handle clockwise until the wheel is completely off the ground.
2. Remove the wheel nuts with the lug wrench.
3. Replace the flat tire with the spare tire, making sure the valve stem is facing outward. Reinstall the wheel nuts until the wheel is snug against the hub. Do not fully tighten the wheel nuts until the wheel has been lowered.
4. Lower the wheel by turning the jack handle counterclockwise.
5. Remove the vehicle jack and fully tighten the wheel nuts in the order shown.
6. Stow the flat tire. See the Stowing the Flat or Spare Tire.
7. Stow the vehicle jack and lug wrench. Make sure the jack is securely fastened before you drive. See Stowing the Vehicle Jack and Tool Bag.
8. Unblock the wheels.



E166719

## Stowing the Flat or Spare Tire

**Note:** Failure to follow the spare tire stowage instructions could result in failure of the cable or loss of the spare tire.

1. Lay the tire on the ground with the valve stem facing up.

2. Slide the wheel partially under the vehicle and install the retainer through the wheel center. Pull on the cable to align the components at the end of the cable.
3. Turn the jack handle clockwise until the tire is raised to its stowed position underneath the vehicle. The effort to turn the jack handle increases significantly and the spare tire carrier ratchets or slips when the tire is raised to the maximum tightness. Tighten to the best of your ability, to the point where the ratchet or slip occurs, if possible. The spare tire carrier does not allow you to overtighten. If the spare tire carrier ratchets or slips with little effort, contact your authorized dealer.
4. Check that the tire lies flat against the frame and is properly tightened. Try to push or pull, then turn the tire to be sure it does not move. Loosen and retighten, if necessary. Failure to properly stow the spare tire could result in failure of the winch cable and loss of the tire.
5. Repeat this tightness check procedure when servicing the spare tire pressure, every six months, as per your scheduled maintenance information, or at any time that the spare tire is disturbed through service of other components.
6. If removed, install the spare tire lock into the bumper drive tube with the spare tire lock key and jack handle.



# Changing a Road Wheel

## Stowing the Vehicle Jack and Tool Bag

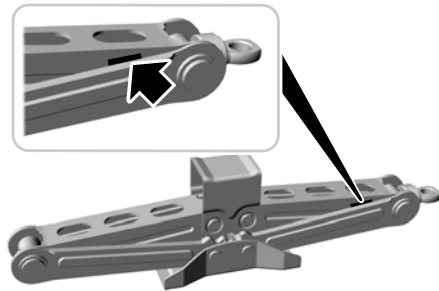

1. Turn the lead screw eyelet to adjust the jack up or down until the stowage markings on the upper channel align with the lower channel.

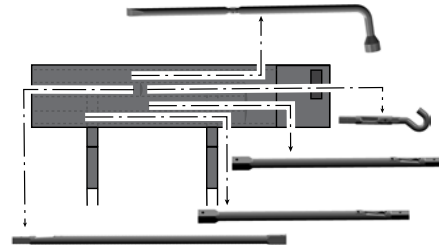

2. Place the tools inside of the tool bag.

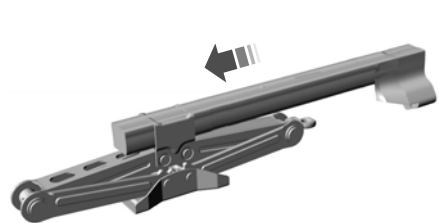

3. Install the tool bag through the vehicle jack load rest.

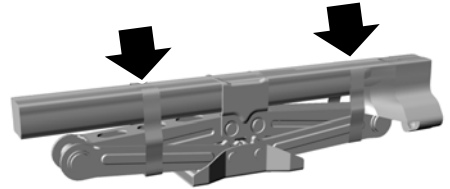

4. Secure the jack tool bag straps around the vehicle jack.

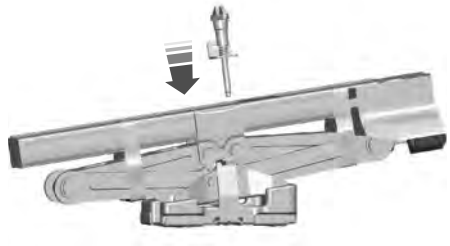

5. Place the jack and tool bag back onto the jack bracket.

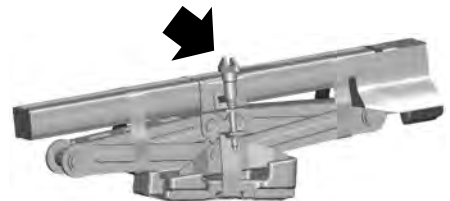

## Changing a Road Wheel

---

6. Turn the wing bolt on the jack bracket clockwise until the jack and tools are secured to the jack bracket.

# Vehicle Identification

## VEHICLE IDENTIFICATION NUMBER

### Locating the Vehicle Identification Number

The vehicle identification number is on the left-hand side of the instrument panel.

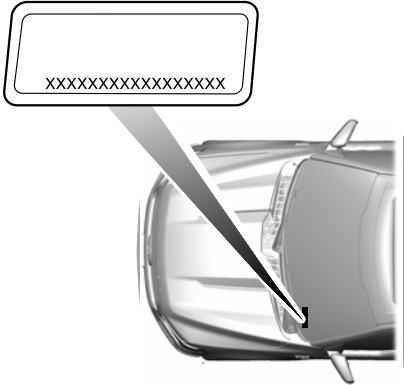

**Note:** In the illustration, XXXX is representative of your vehicle identification number.

### Vehicle Identification Number Overview

The vehicle identification number contains the following information:

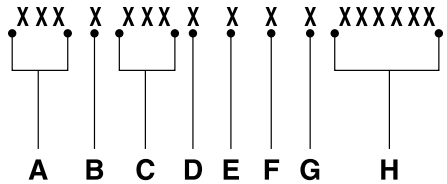

- A World manufacturer identifier.
- B Brake system, gross vehicle weight rating, restraint devices and their locations.
- C Make, vehicle line, series, body type.
- D Engine or motor type.
- E Check digit.
- F Model year.
- G Assembly plant.
- H Production sequence number.

## Customer Information

### REPORTING SAFETY DEFECTS IN THE UNITED STATES

If you believe that your vehicle has a defect which could cause a crash or could cause injury or death, you should immediately inform the National Highway Traffic Safety Administration (NHTSA) in addition to notifying Ford Motor Company.

If NHTSA receives similar complaints, it may open an investigation, and if it finds that a safety defect exists in a group of vehicles, it may order a recall and remedy campaign. However, NHTSA cannot become involved in individual problems between you, your dealer, or Ford Motor Company.

To contact NHTSA, you may call the Vehicle Safety Hotline toll-free at 1-888-327-4236 (TTY: 1-800-424-9153); go to [www.safercar.gov](http://www.safercar.gov); or write to:

Administrator  
1200 New Jersey Avenue,  
Southeast

Washington, D.C. 20590

You can also obtain other information about motor vehicle safety from [www.safercar.gov](http://www.safercar.gov).

### REPORTING SAFETY DEFECTS IN CANADA

If you believe that your vehicle has a defect which could cause a crash or could cause injury or death, you should immediately inform Transport Canada and Ford of Canada.

#### Transport Canada Contact Information

Website	<a href="http://www.tc.gc.ca/eng/motorvehiclesafety/reporting-defects-motor-vehicles.html">http://www.tc.gc.ca/eng/motorvehiclesafety/reporting-defects-motor-vehicles.html</a> (English)
Website	<a href="http://www.tc.gc.ca/fra/securiteautomobile/signaler-defaults-vehicules-automobiles.html">http://www.tc.gc.ca/fra/securiteautomobile/signaler-defaults-vehicules-automobiles.html</a> (French)
Phone	1-800-333-0510

#### Ford of Canada Contact Information

Website	<a href="http://www.ford.ca">www.ford.ca</a>
Phone	1-800-565-3673

## Customer Information

---

### **CALIFORNIA PROPOSITION 65 - UNITED STATES OF AMERICA**



**WARNING:** Operating, servicing and maintaining a passenger vehicle or off-highway motor vehicle can expose you to chemicals including engine exhaust, carbon monoxide, phthalates, and lead, which are known to the State of California to cause cancer and birth defects or other reproductive harm. To minimize exposure, avoid breathing exhaust, do not idle the engine except as necessary, service your vehicle in a well-ventilated area and wear gloves or wash your hands frequently when servicing your vehicle. For more information go to [www.P65Warnings.ca.gov/passenger-vehicle](http://www.P65Warnings.ca.gov/passenger-vehicle).



**WARNING:** Battery posts, terminals and related accessories contain lead and lead compounds, chemicals known to the State of California to cause cancer and reproductive harm. **Wash your hands after handling.**

### **PERCHLORATE**

Certain components in your vehicle such as airbag modules, seatbelt pretensioners and remote control batteries may contain perchlorate material. Special handling may apply for service or vehicle end of life disposal.

For more information visit:  
[www.dtsc.ca.gov/hazardouswaste/perchlorate](http://www.dtsc.ca.gov/hazardouswaste/perchlorate).

# Index

## A

A/C	
See: Climate Control - Vehicles With:	
Automatic Temperature Control.....	44
See: Climate Control - Vehicles With: Manual	
Temperature Control.....	47
About This Publication.....	5
Features and Options.....	5
Illustrations.....	5
Location of Components.....	5
ABS	
See: Brakes.....	59
Adjusting the Seatbelt Height.....	23
Adjusting the Seatbelt Length.....	24
Adjusting the Seatbelts During	
Pregnancy.....	23
Airbag Precautions.....	31
Airbags.....	29
Front Passenger Sensing System.....	33
Air Conditioning	
See: Climate Control - Vehicles With:	
Automatic Temperature Control.....	44
See: Climate Control - Vehicles With: Manual	
Temperature Control.....	47
Automatic Locking Mode.....	22
Disengaging Automatic Locking Mode.....	23
Engaging Automatic Locking Mode.....	22
What Is Automatic Locking Mode.....	22
When to Use Automatic Locking	
Mode.....	22
Automatic Transmission.....	58
Automatic Transmission Positions.....	58
Automatic Transmission Positions.....	58
Drive (D).....	58
Neutral (N).....	58
Park (P).....	58
Reverse (R).....	58

## B

Booster Seats.....	17
Types of Booster Seats.....	18
Brakes.....	59
Brakes – Troubleshooting.....	59
Brakes – Troubleshooting.....	59
Brakes – Warning Lamps.....	59

## C

Calculating Payload.....	64
Calculating the Load Limit.....	64
Helpful examples for calculating the	
available amount of cargo and luggage	
load capacity.....	65
California Proposition 65 - United States	
of America.....	130
Changing a Flat Tire.....	120
Dissimilar Spare Wheel and Tire Assembly	
Information.....	120
Jacking the Vehicle.....	124
Removing the Spare Tire.....	123
Removing the Vehicle Jack and Tool	
Bag.....	122
Stowing the Flat or Spare Tire.....	125
Stowing the Vehicle Jack and Tool	
Bag.....	126
Tire Change Procedure.....	121
Changing a Road Wheel.....	120
Checking the Seatbelts.....	26
Checking the Tire Pressures.....	115
Checking the Wiper Blades.....	39
Children and Airbags.....	32
Child Restraint Anchor Points.....	8
Locating the Child Restraint Lower Anchor	
Points.....	8
Locating the Child Restraint Top Tether	
Anchor Points.....	9
What Are the Child Restraint Anchor	
Points.....	8
Child Restraints.....	10
Child Restraint Position Information.....	10
Child Restraints Recommendation.....	11
Child Safety.....	7
Child Restraint Anchor Points.....	8
Child Restraints.....	10
Installing Child Restraints.....	11
Child Safety Precautions.....	7
Cleaning the Exterior.....	103
Cleaning Windows and Wiper Blades.....	103
Climate Control.....	44
Climate Control Hints.....	45
Defogging the Side Windows in Cold	
Weather.....	46
General Hints.....	45
Quickly Cooling the Interior.....	46

# Index

Quickly Heating the Interior.....	46	Front Seats.....	50
Recommended Settings for Cooling.....	46	Heated Seats.....	53
Recommended Settings for Heating.....	46	Manual Seats.....	50
Crash and Breakdown Information.....	95	Power Seats.....	52
Jump Starting the Vehicle.....	95	Ventilated Seats.....	54
Crash Sensors and Airbag Indicator.....	35		
Customer Information.....	129	<b>G</b>	
<b>D</b>		Glossary of Tire Terminology.....	110
Data Privacy.....	6	<b>H</b>	
Department of Transportation Uniform Tire Quality Grades.....	104	Heated Seats.....	53
Temperature A B C.....	105	Heated Seat Precautions.....	53
Traction AA A B C.....	105	Switching the Heated Seats On and Off.....	53
Treadwear.....	104	Heating	
Directing the Flow of Air.....	45	See: Climate Control - Vehicles With: Automatic Temperature Control.....	44
Directing Air to the Footwell Air Vents.....	45	See: Climate Control - Vehicles With: Manual Temperature Control.....	47
Directing Air to the Instrument Panel Air Vents.....	45	How Does the Personal Safety System Work.....	28
Directing Air to the Windshield Air Vents.....	45	How Does the Safety Canopy™ Work.....	30
Disposing of Airbags.....	36	How Do the Front Airbags Work.....	29
<b>E</b>		How Do the Knee Airbags Work.....	30
Event Data.....	6	How Do the Side Airbags Work.....	29
Active Drive Assist Driver Facing Camera Data.....	6	<b>I</b>	
<b>F</b>		Identifying the Climate Control Unit.....	44
Fastening and Unfastening the Seatbelts.....	21	Inflating the Tires.....	115
Fastening the Cinch Tongue.....	21	Information on the Tire Sidewall.....	105
Using the Seatbelt With Cinch Tongue .....	21	Information on P Type Tires.....	106
Flat Tire		Inspecting the Tire for Damage.....	116
See: Changing a Flat Tire.....	120	Safety Practices.....	116
Front Passenger Sensing System.....	33	Inspecting the Tire for Wear.....	116
Front Passenger Sensing System Indicators.....	35	Inspecting the Wheel Valve Stems.....	117
Front Passenger Sensing System Precautions.....	35	Installing Child Restraints.....	11
How Does the Front Passenger Sensing System Work.....	33	Attaching the Front Seat Tether Strap.....	16
What Is the Front Passenger Sensing System.....	33	Attaching the Rear Seat Tether Strap.....	16
		Combining the Seatbelt and Lower Anchors for Attaching Child Restraints.....	15
		Using Lower Anchors and Tethers for Children.....	15
		Using Seatbelts.....	11
		Using Tether Straps.....	15

# Index

Instrument Cluster Indicators.....	42
Active Drive Assist.....	42
Adaptive Cruise Control.....	42
Auto Hold Active.....	42
Auto Hold Unavailable.....	42
Automatic High Beam.....	42
Automatic Regen Control Off.....	42
Auto-Start-Stop.....	42
Blind Spot Monitor.....	42
Cruise Control.....	42
Electronic Locking Differential.....	42
Four-Wheel Drive.....	43
Front Airbag.....	43
Front Fog Lamp.....	43
High Beam.....	43
Hill Descent.....	43
Lamps On.....	43
Ready to Drive.....	43
Reverse Brake Assist.....	43
Stability Control and Traction Control.....	43
Tow Haul.....	43
Turn Signal Lamps.....	43
Wait to Start.....	43
Instrument Cluster.....	41
Instrument Cluster Warning Lamps.....	41
Anti-Lock Brake System.....	41
Battery.....	41
Brake System.....	41
Diesel Exhaust Fluid.....	41
Door Ajar.....	41
Electric Parking Brake.....	41
Engine Coolant Temperature.....	41
Fasten Seatbelt.....	41
Hood Ajar.....	41
Low Fuel Level.....	41
Low Tire Pressure.....	41
Low Washer Fluid Level.....	41
Oil Pressure.....	41
Powertrain Malfunction, Reduced Power, Electronic Throttle Control, Check 4X4.....	42
Service Engine Soon.....	42
Stop Safely.....	42
Tailgate Ajar.....	42
Water in Fuel.....	42
Introduction.....	5
<b>J</b>	
Jump Starting the Vehicle.....	95
Jump Starting Precautions.....	95
Jump Starting the Vehicle.....	95
Preparing the Vehicle.....	95
<b>K</b>	
Keys and Remote Controls.....	37
<b>L</b>	
Load Carrying.....	61
Load Carrying Precautions.....	61
Loading Your Trailer.....	67
Locating the Memory Function Buttons.....	57
Locating the Safety Compliance Certification Labels.....	62
Locating the Tire label.....	104
<b>M</b>	
Maintenance.....	97
Manual Seats.....	50
Adjusting the Head Restraint.....	50
Head Restraint Components.....	50
Installing the Head Restraint.....	51
Removing the Head Restraint.....	51
Memory Function.....	57
Memory Function Precautions.....	57
<b>P</b>	
Passive Anti-Theft System.....	38
How Does the Passive Anti-Theft System Work.....	38
What Is the Passive Anti-Theft System.....	38
Perchlorate.....	130
Personal Safety System Components.....	28
Personal Safety System™.....	28
Power Seats.....	52
Adjusting the Head Restraint.....	52
Head Restraint Components.....	52
Installing the Head Restraint.....	53



# Index

Removing the Head Restraint.....	53
Properly Adjusting the Driver and Front Passenger Seats.....	32
Puncture	
See: Changing a Flat Tire.....	120

## R

Rear Seats.....	55
Heated Seats.....	55
Manual Seats.....	55
Recalling a Preset Position.....	57
Linking a Preset Position to Your Remote Control or Passive Key.....	57
Removing the Key Blade.....	37
Replacing a Lost Key or Remote Control.....	37
Replacing the Front Wiper Blades.....	39
Reporting Safety Defects in Canada.....	129
Reporting Safety Defects in the United States.....	129

## S

Saving a Preset Position.....	57
Seatbelt Extensions.....	27
Seatbelt Precautions.....	20
Seatbelt Reminder.....	24
How Does the Seatbelt Reminder Work.....	24
Seatbelt Reminder Audible Warnings.....	26
Seatbelt Reminder Indicators.....	26
Switching the Seatbelt Reminder On and Off.....	26
Seatbelts.....	20
Automatic Locking Mode.....	22
Seatbelt Reminder.....	24
Sensitive Locking Mode.....	22
Security.....	38
Passive Anti-Theft System.....	38
Sensitive Locking Mode.....	22
How Does Sensitive Locking Mode Work.....	22
What is Sensitive Locking Mode.....	22
Setting the Blower Motor Speed.....	45
Setting the Temperature.....	45
Sitting in the Correct Position.....	50

Switching Climate Control On and Off.....	44
Switching Defrost On and Off.....	44
Switching Maximum Defrost On and Off.....	44
Switching the Hazard Flashers On and Off.....	95
Switching the Heated Rear Window On and Off.....	44
Switching the Heated Wiper Park On and Off.....	44
Switching Traction Control On and Off.....	60

## T

Tire Care.....	115
Tire Pressure Monitoring System Limitations.....	119
Tire Pressure Monitoring System Precautions.....	119
Tire Pressure Monitoring System.....	119
Tire Replacement Requirements.....	111
AGE.....	111
Tire Rotation.....	117
Tire Rotation Diagram.....	118
Towing a Trailer Limitations.....	67
Towing a Trailer Precautions.....	67
Towing a Trailer.....	67
Towing Weights and Dimensions.....	69
Towing Weights and Dimensions.....	69
Recommended Towing Weights.....	69
What Is the Maximum Loaded Trailer Weight.....	94
Traction Control.....	60

## U

Under Hood Overview - 2.7L EcoBoost™.....	97
Under Hood Overview - 3.0L Diesel.....	98
Under Hood Overview - 3.3L.....	99
Under Hood Overview - 3.5L, Hybrid Electric Vehicle (HEV).....	101
Under Hood Overview - 3.5L EcoBoost™.....	100
Under Hood Overview - 5.0L.....	102
Using Snow Chains.....	113

# Index

## V

Vehicle Care.....	103
Cleaning the Exterior.....	103
Vehicle Identification Number.....	128
Locating the Vehicle Identification Number.....	128
Vehicle Identification Number Overview.....	128
Vehicle Identification.....	128
Vehicle Identification Number.....	128
Ventilated Seats.....	54
Switching the Ventilated Seats On and Off.....	54
Ventilated Seat Precautions.....	54
Ventilation	
See: Climate Control - Vehicles With: Automatic Temperature Control.....	44
See: Climate Control - Vehicles With: Manual Temperature Control.....	47
Viewing the Tire Pressures.....	119

## W

Washers.....	40
Using the Windshield Washer.....	40
Washer Precautions.....	40
Washers	
See: Wipers and Washers.....	39
What Is the Gross Axle Weight Rating.....	62
GAWR (Gross Axle Weight Rating).....	62
What Is the Gross Combined Weight Rating.....	62
What Is the Gross Vehicle Weight Rating.....	62
What Is the Personal Safety System.....	28
What Is the Tire Pressure Monitoring System.....	119
Wheel and Tire Information.....	104
Wipers and Washers – Troubleshooting.....	40
Wipers and Washers – Frequently Asked Questions.....	40
Wipers and Washers.....	39
Washers.....	40
Wipers.....	39

Wipers and Washers – Troubleshooting.....	40
Wipers.....	39
Switching Windshield Wipers On and Off.....	39
Wiper Precautions.....	39