

# FORD **F-150** Owner's Manual



The information contained in this publication was correct at the time of going to print. In the interest of continuous development, we reserve the right to change specifications, design or equipment at any time without notice or obligation. No part of this publication may be reproduced, transmitted, stored in a retrieval system or translated into any language in any form by any means without our written permission. Errors and omissions excepted.

© Ford Motor Company 2020

All rights reserved.

Part Number: 202007 20200831140540

## California Proposition 65



**WARNING:** Operating, servicing and maintaining a passenger vehicle or off-highway motor vehicle can expose you to chemicals including engine exhaust, carbon monoxide, phthalates, and lead, which are known to the State of California to cause cancer and birth defects or other reproductive harm. To minimize exposure, avoid breathing exhaust, do not idle the engine except as necessary, service your vehicle in a well-ventilated area and wear gloves or wash your hands frequently when servicing your vehicle. For more information go to [www.P65Warnings.ca.gov/passenger-vehicle](http://www.P65Warnings.ca.gov/passenger-vehicle).



**WARNING:** Battery posts, terminals and related accessories contain lead and lead compounds, chemicals known to the State of California to cause cancer and reproductive harm.  
**Wash your hands after handling.**



# Table of Contents

---

## Contacting Us

Contacting Us .....	19
---------------------	----

## Introduction

About This Publication .....	21
Using This Publication .....	22

## Symbols Glossary

Symbols Used on Your Vehicle .....	23
------------------------------------	----

## Data Privacy

Data Privacy .....	26
Service Data .....	27
Event Data .....	27
Settings Data .....	28
Connected Vehicle Data .....	28
Mobile Device Data .....	29
Emergency Call System Data .....	29

## Visual Search

Steering Wheel .....	30
Instrument Panel .....	31
Vehicle Interior .....	32
Front Exterior .....	33
Rear Exterior .....	34

## Child Safety

Child Safety Precautions .....	35
Child Restraint Anchor Points .....	36
Child Restraints .....	38
Installing Child Restraints .....	39
Booster Seats .....	46
Child Safety Locks .....	48

## Seatbelts

Seatbelt Precautions .....	49
Fastening and Unfastening the Seatbelts .....	50
Sensitive Locking Mode .....	51

Automatic Locking Mode .....	51
Adjusting the Seatbelts During Pregnancy .....	52
Adjusting the Seatbelt Height .....	52
Adjusting the Seatbelt Length .....	53
Seatbelt Reminder .....	53
Checking the Seatbelts .....	55
Seatbelt Extensions .....	56

## Personal Safety System™

What Is the Personal Safety System .....	57
How Does the Personal Safety System Work .....	57
Personal Safety System Components .....	57

## Airbags

How Do the Front Airbags Work .....	58
How Do the Side Airbags Work .....	58
How Do the Knee Airbags Work .....	59
How Does the Safety Canopy™ Work .....	59
Airbag Precautions .....	60
Properly Adjusting the Driver and Front Passenger Seats .....	61
Children and Airbags .....	61
Front Passenger Sensing System .....	62
Crash Sensors and Airbag Indicator .....	65
Disposing of Airbags .....	66

## Pedestrian Alert System

What Is the Pedestrian Alert System .....	67
---	----

## 911 Assist

What Is 911 Assist .....	68
How Does 911 Assist Work .....	68
Emergency Call Requirements .....	68
Emergency Call Limitations .....	69

# Table of Contents

## Keys and Remote Controls

Remote Control Limitations .....	70
Using the Remote Control .....	70
Opening and Closing the Flip Key .....	70
Removing the Key Blade .....	71
Sounding the Panic Alarm .....	71
Locating Your Vehicle .....	71
Changing the Remote Control Battery - Vehicles With: Push Button Start .....	72
Changing the Remote Control Battery - Vehicles With: Flip Key .....	73
Replacing a Lost Key or Remote Control .....	74
Programming the Remote Control - Vehicles With: Push Button Start .....	75
Programming the Remote Control - Vehicles With: Flip Key .....	76
Keys and Remote Controls – Troubleshooting .....	77

## MyKey™

What Is MyKey .....	78
MyKey Settings .....	78
Creating a MyKey - Vehicles With: Push Button Start .....	79
Creating a MyKey - Vehicles With: Flip Key .....	80
Programming a MyKey .....	80
Clearing All MyKeys .....	80
Checking MyKey System Status .....	80
Using MyKey With Remote Start Systems .....	80
MyKey – Troubleshooting .....	81

## Doors and Locks

Operating the Doors From Outside Your Vehicle .....	84
Operating the Doors From Inside Your Vehicle .....	84
Autounlock .....	85
Autolock .....	85
Mislock .....	85

Doors and Locks Audible Warnings .....	86
Doors and Locks – Troubleshooting .....	86

## Keyless Entry

Locating the Keyless Entry Keypad .....	87
Keyless Entry Limitations .....	87
Master Access Code .....	87
Keyless Entry Settings .....	87
Locking and Unlocking the Doors Using Remote Keyless Entry .....	88
Locking and Unlocking the Doors Using Keyless Entry Keypad .....	89
Keyless Entry – Troubleshooting .....	89

## Easy Entry and Exit

How Does Easy Entry and Exit Work .....	90
Switching Easy Entry and Exit On and Off .....	90

## Tailgate - Vehicles With: Manual Tailgate

Opening the Tailgate .....	91
Locking and Unlocking the Tailgate .....	91
Removing and Installing the Tailgate .....	91
Tailgate Step .....	92
Bed Extender .....	93
Tailgate Work Surface .....	95

## Tailgate - Vehicles With: Power Tailgate

Opening the Tailgate .....	96
Closing the Tailgate .....	96
Removing and Installing the Tailgate .....	97
Tailgate Step .....	98
Bed Extender .....	99
Tailgate Work Surface .....	101
Tailgate – Troubleshooting .....	102

# Table of Contents

## Tailgate - Vehicles With: Remote Release Tailgate

Opening the Tailgate .....	104
Removing and Installing the Tailgate .....	104
Tailgate Step .....	105
Bed Extender .....	106
Tailgate Work Surface .....	108
Tailgate – Troubleshooting .....	109

## Security

Passive Anti-Theft System .....	111
Anti-Theft Alarm System .....	111
Anti-Theft Alarm System Settings .....	112
Security – Troubleshooting .....	113

## Power Running Boards

Power Running Board Precautions .....	115
Power Running Board Settings .....	115
Power Running Board Kick Switch .....	115
Deploying and Stowing the Power Running Boards .....	116
Power Running Boards – Troubleshooting .....	116

## Steering Wheel

Adjusting the Steering Wheel - Vehicles With: Manual Adjustable Steering Column .....	117
Adjusting the Steering Wheel - Vehicles With: Power Adjustable Steering Column .....	117
Resetting the Stopping Position - Vehicles With: Power Adjustable Steering Column .....	118
Horn .....	118
Switching the Heated Steering Wheel On and Off .....	118

## Adjustable Pedals

Adjusting the Pedals .....	119
----------------------------	-----

## Wipers and Washers

Wipers .....	120
Autowipers .....	120
Checking the Wiper Blades .....	121
Replacing the Front Wiper Blades .....	121
Washers .....	122
Wipers and Washers – Troubleshooting .....	122

## Exterior Lighting

Exterior Lighting Control .....	124
Headlamps .....	124
Headlamps – Troubleshooting .....	124
Autolamps .....	125
Exterior Lamps .....	125
Exterior Zone Lighting .....	127
Automatic High Beam Control .....	128
Automatic High Beam Control – Troubleshooting .....	130
Glare Free Lighting .....	131
Glare Free Lighting – Troubleshooting .....	133
Adaptive Front Lighting .....	133

## Interior Lighting

Switching All of the Interior Lamps On and Off .....	135
Switching the Front Interior Lamps On and Off .....	135
Switching the Rear Interior Lamps On and Off .....	135
Interior Lamp Function .....	135
Adjusting the Instrument Panel Lighting Brightness .....	136
Ambient Lighting .....	136

## Windows

Opening and Closing the Windows .....	137
Window Bounce-Back .....	137
Locking the Rear Window Controls .....	138

# Table of Contents

---

Opening and Closing the Sliding Windows .....	138
---	-----

## Interior Mirror

Interior Mirror Precautions .....	139
Manually Dimming the Interior Mirror .....	139
Auto-Dimming Interior Mirror .....	139

## Exterior Mirrors

Adjusting the Exterior Mirrors .....	140
Folding the Exterior Mirrors - Vehicles With: Manual Folding Mirrors .....	140
Folding the Exterior Mirrors - Vehicles With: Power Folding Mirrors .....	140
Extending the Exterior Mirrors .....	141
Auto-Dimming Exterior Mirror .....	141

## Moonroof

Opening and Closing the Sun Shade .....	142
Opening and Closing the Moonroof .....	142
Venting the Moonroof .....	142
Moonroof Bounce-Back .....	143

## Instrument Cluster

Instrument Cluster Overview - Vehicles With: 4.2 Inch Screen .....	144
Instrument Cluster Overview - Vehicles With: 8 Inch Screen .....	145
Instrument Cluster Overview - Vehicles With: 12.3 Inch Screen .....	146
What Is the Tachometer .....	146
What Is the Speedometer .....	146
Fuel Gauge .....	146
What Is the Engine Coolant Temperature Gauge .....	147
What Is the Engine Oil Pressure Gauge .....	147
What Is the Transmission Fluid Temperature Gauge .....	147
What Is the Turbo Boost Gauge .....	147

What Is the Diesel Exhaust Fluid Gauge .....	147
What Are the Instrument Cluster Warning Lamps .....	147
Instrument Cluster Warning Lamps .....	148
What Are the Instrument Cluster Indicators .....	149
Instrument Cluster Indicators .....	149

## Instrument Cluster Display

Using the Instrument Cluster Display Controls .....	151
Instrument Cluster Display Main Menu - Vehicles With: 4.2 Inch Screen .....	151
Instrument Cluster Display Main Menu - Vehicles With: 8 Inch Screen .....	152
Instrument Cluster Display Main Menu - Vehicles With: 12.3 Inch Screen .....	152
Trip Computer - Vehicles With: 4.2 Inch Screen .....	152
Trip Computer - Vehicles With: 8 Inch Screen/12.3 Inch Screen .....	153
Customizing the Instrument Cluster Display .....	153
Personalized Settings .....	153
Hybrid Display Information .....	154
What Is Brake Coach .....	154
What Is the Trip Summary .....	154

## Remote Start

What Is Remote Start .....	155
Remote Start Precautions .....	155
Remote Start Limitations .....	155
Enabling Remote Start .....	155
Remotely Starting and Stopping the Vehicle .....	155
Extending the Remote Start Duration .....	156
Remote Start Remote Control Indicators .....	156
Remote Start Settings .....	156

# Table of Contents

## **Climate Control - Vehicles With: Automatic Temperature Control**

Identifying the Climate Control Unit .....	158
Switching Climate Control On and Off .....	158
Switching Recirculated Air On and Off .....	158
Switching Air Conditioning On and Off .....	158
Switching Defrost On and Off .....	158
Switching Maximum Defrost On and Off .....	158
Switching Maximum Cooling On and Off .....	159
Switching the Heated Wiper Park On and Off .....	159
Switching the Heated Rear Window On and Off .....	159
Switching the Heated Mirrors On and Off .....	159
Setting the Blower Motor Speed .....	159
Setting the Temperature .....	159
Directing the Flow of Air .....	160
Auto Mode .....	160
Climate Control Hints .....	161

## **Climate Control - Vehicles With: Manual Temperature Control**

Identifying the Climate Control Unit .....	163
Switching Climate Control On and Off .....	163
Switching Recirculated Air On and Off .....	163
Switching Air Conditioning On and Off .....	163
Switching Defrost On and Off .....	163
Switching Maximum Defrost On and Off .....	163
Switching Maximum Cooling On and Off .....	164

Switching the Heated Rear Window On and Off .....	164
Switching the Heated Mirrors On and Off .....	164
Setting the Blower Motor Speed .....	164
Setting the Temperature .....	164
Directing the Flow of Air .....	164
Climate Control Hints .....	165

## **Interior Air Quality**

What Is the Cabin Air Filter .....	166
Replacing the Cabin Air Filter .....	166

## **Front Seats**

Front Seat Precautions .....	167
Sitting in the Correct Position .....	167
Manual Seats .....	168
Power Seats .....	170
Massage Seats .....	173
Heated Seats .....	174
Ventilated Seats .....	174

## **Rear Seats**

Manual Seats .....	176
Heated Seats .....	177

## **Rear Occupant Alert System**

What is the Rear Occupant Alert System .....	179
How Does the Rear Occupant Alert System Work .....	179
Rear Occupant Alert System Precautions .....	179
Rear Occupant Alert System Limitations .....	179
Switching Rear Occupant Alert System On and Off .....	179
Rear Occupant Alert System Indicators .....	180
Rear Occupant Alert System Audible Warnings .....	180



# Table of Contents

## Memory Function

What Is the Memory Function .....	181
Memory Function Precautions .....	181
Locating the Memory Function Buttons .....	181
Saving a Preset Position .....	181
Recalling a Preset Position .....	181

## Garage Door Opener

What Is the Garage Door Opener .....	182
How Does the Garage Door Opener Work .....	182
Garage Door Opener Precautions .....	182
Garage Door Opener Limitations .....	183
Programming the Garage Door Opener to Your Hand-Held Transmitter .....	183
Programming the Garage Door Opener to Your Garage Door Opener Motor .....	184
Programming the Garage Door Opener to Your Gate Opener Motor .....	184
Clearing the Garage Door Opener .....	185
Reprogramming the Garage Door Opener .....	185
Garage Door Opener Radio Frequencies .....	185

## USB Ports

Locating the USB Ports .....	186
Playing Media Using the USB Port .....	186
Charging a Device .....	187

## Power Outlet - Vehicles With: Pickup Bed Power Generator Outlet

What Is the Power Outlet .....	188
Power Outlet Precautions - Vehicles With: 2kW .....	188
Power Outlet Precautions - Vehicles With: 2.4kW/7.2kW .....	189
Locating the Power Outlet .....	190

Power Outlet Indicators - Vehicles With: 2kW .....	190
Power Outlet Indicators - Vehicles With: 2.4kW/7.2kW .....	191
What Is Utility Idle Mode - Vehicles With: Flip Key .....	191
Switching Utility Idle On and Off - Vehicles With: Flip Key .....	191
What Is Generator Mode .....	192
Switching Generator Mode On and Off .....	192
Resetting Ground Fault Detection .....	192
Resetting the Circuit Breaker - Vehicles With: 7.2kW .....	193
Power Outlet - Troubleshooting .....	194

## Power Outlet - Vehicles With: 120V Power Outlet

What Is the Power Outlet .....	197
Power Outlet Precautions .....	197
Power Outlet Limitations .....	197
Locating the Power Outlet .....	197
Power Outlet Indicators .....	198

## Power Outlet - Vehicles With: 12V Power Outlet

What Is the Power Outlet .....	199
Power Outlet Precautions .....	199
Locating the Power Outlet .....	199

## Center Console Work Surface

Using the Center Console Work Surface - Vehicles With: Column Shift .....	200
Using the Center Console Work Surface - Vehicles With: Console Shift .....	201
Center Console Work Surface - Troubleshooting .....	202

## Wireless Accessory Charger

What Is the Wireless Accessory Charger .....	203
--	-----

# Table of Contents

Wireless Accessory Charger Precautions .....	203	Auto-Start-Stop Precautions .....	224
Locating the Wireless Accessory Charger .....	203	Switching Auto-Start-Stop On and Off .....	224
Charging a Wireless Device .....	203	Stopping the Engine .....	224
<b>Storage</b>		Restarting the Engine .....	224
Cup Holders .....	205	Auto-Start-Stop Indicators .....	224
Glove Compartment .....	205	Auto-Start-Stop – Troubleshooting .....	225
Under Seat Storage .....	206	<b>Fuel and Refueling</b>	
Glasses Holder .....	208	Fuel and Refueling Precautions .....	227
<b>Starting and Stopping the Engine</b>		Fuel Quality .....	227
Starting and Stopping the Engine – Precautions .....	209	Locating the Fuel Filler Funnel .....	232
Ignition Switch .....	209	Running Out of Fuel .....	232
Push Button Ignition Switch .....	210	Refueling .....	233
Starting the Engine .....	210	Fuel Tank Capacity - Excluding: Hybrid Electric Vehicle (HEV) .....	238
Engine Block Heater .....	213	Fuel Tank Capacity - Hybrid Electric Vehicle (HEV) .....	239
Stopping the Engine .....	214	Fuel and Refueling – Troubleshooting .....	239
Automatic Engine Stop .....	215	<b>Diesel Particulate Filter</b>	
Accessing the Passive Key Backup Position .....	216	What Is the Diesel Particulate Filter .....	240
Starting and Stopping the Engine – Troubleshooting .....	216	How Does the Diesel Particulate Filter Work .....	240
<b>Hybrid Electric Vehicle Information</b>		Diesel Particulate Filter Precautions .....	240
What is a Hybrid Electric Vehicle .....	221	Diesel Particulate Filter Requirements .....	241
How Does a Hybrid Electric Vehicle Work .....	221	Diesel Particulate Filter Manual Regeneration .....	241
Hybrid Electric Vehicle Driving Characteristics .....	221	Diesel Particulate Filter – Troubleshooting .....	243
Low Engine Use Mode .....	221	<b>Selective Catalytic Reduction System - Diesel</b>	
Hybrid Electric Vehicle Information Indicators .....	222	What Is the Selective Catalytic Reduction System .....	245
Hybrid Electric Vehicle Information – Troubleshooting .....	222	How Does the Selective Catalytic Reduction System Work .....	245
<b>Auto-Start-Stop</b>		Selective Catalytic Reduction System Precautions .....	245
What Is Auto-Start-Stop .....	224		

# Table of Contents

Selective Catalytic Reduction System Requirements .....	246	Four-Wheel Drive Modes .....	263
Selective Catalytic Reduction System Guidelines .....	246	Four-Wheel Drive Indicators .....	264
Filling the Selective Catalytic Reduction System Tank .....	247	Four-Wheel Drive Driving Hints .....	264
Checking the Selective Catalytic Reduction System Status .....	249	Four-Wheel Drive – Troubleshooting .....	266
Diesel Exhaust Fluid Capacity and Specification .....	249		
Selective Catalytic Reduction System – Troubleshooting .....	249		
<b>Catalytic Converter</b>		<b>Electronic Locking Differential</b>	
What Is the Catalytic Converter .....	251	What Is the Electronic Locking Differential .....	269
Catalytic Converter Precautions .....	251	Electronic Locking Differential Precautions .....	269
Catalytic Converter – Troubleshooting .....	251	Switching the Electronic Locking Differential On and Off - 4x4 .....	269
		Switching the Electronic Locking Differential On and Off - 4x2 .....	271
		Electronic Locking Differential Indicators .....	272
		Electronic Locking Differential – Troubleshooting .....	272
<b>High Voltage Battery - Hybrid Electric Vehicle (HEV)</b>			
What Is the High Voltage Battery .....	252	<b>Brakes</b>	
High Voltage Battery Precautions .....	252	Brake Precautions .....	273
		Anti-Lock Braking System .....	273
		Brake Over Accelerator .....	273
		Locating the Brake Fluid Reservoir .....	273
		Checking the Brake Fluid .....	273
		Brake Fluid Specification .....	274
		Brakes – Troubleshooting .....	274
<b>Automatic Transmission</b>		<b>Electric Parking Brake</b>	
Automatic Transmission Precautions .....	253	What Is the Electric Parking Brake .....	276
Automatic Transmission Positions .....	253	Applying the Electric Parking Brake .....	276
Shifting Your Vehicle Into Gear .....	254	Applying the Electric Parking Brake in an Emergency .....	276
Manually Shifting Gears .....	254	Manually Releasing the Electric Parking Brake .....	276
Temporary Neutral Mode .....	255	Automatically Releasing the Electric Parking Brake .....	276
Using Progressive Range Selection .....	256	Electric Parking Brake Audible Warning .....	277
Automatic Return to Park (P) .....	256		
Stowing the Selector Lever - Vehicles With: Console Shift .....	256		
Manual Park Release .....	257		
<b>Four-Wheel Drive</b>			
How Does Four-Wheel Drive Work .....	260		
Four-Wheel Drive Precautions .....	260		
Four-Wheel Drive Limitations .....	261		
Selecting a Four-Wheel Drive Mode .....	262		

# Table of Contents

Releasing the Electric Parking Brake if the Vehicle Battery Has Run Out of Charge .....	277
Electric Parking Brake – Troubleshooting .....	277
<b>Reverse Braking Assist</b>	
What Is Reverse Braking Assist .....	279
How Does Reverse Braking Assist Work .....	279
Reverse Braking Assist Precautions .....	279
Switching Reverse Braking Assist On and Off .....	280
Overriding Reverse Braking Assist .....	280
Reverse Braking Assist Indicators .....	280
Reverse Braking Assist – Troubleshooting .....	280
<b>Hill Start Assist</b>	
What Is Hill Start Assist .....	282
How Does Hill Start Assist Work .....	282
Hill Start Assist Precautions .....	282
Hill Start Assist – Troubleshooting .....	282
<b>Auto Hold</b>	
How Does Auto Hold Work .....	283
Switching Auto Hold On and Off .....	283
Using Auto Hold .....	283
Auto Hold Indicators .....	283
<b>Traction Control</b>	
What Is Traction Control .....	284
How Does Traction Control Work .....	284
Switching Traction Control On and Off .....	284
Traction Control Indicator .....	284
Traction Control – Troubleshooting .....	285
<b>Stability Control</b>	
How Does Stability Control Work .....	286
Switching Stability Control On and Off .....	287
Stability Control Indicator .....	288
<b>Hill Descent Control</b>	
What Is Hill Descent Control .....	289
How Does Hill Descent Control Work .....	289
Hill Descent Control Precautions .....	289
Switching Hill Descent Control On and Off .....	289
Setting the Hill Descent Speed .....	289
Hill Descent Control Indicator .....	289
Hill Descent Control – Troubleshooting .....	290
<b>Active Drive Assist</b>	
What Is Active Drive Assist .....	291
How Does Active Drive Assist Work .....	291
Active Drive Assist Precautions .....	291
Active Drive Assist Requirements .....	292
Active Drive Assist Limitations .....	292
Active Drive Assist Settings .....	292
Switching Active Drive Assist On and Off .....	292
Active Drive Assist Alerts .....	292
Active Drive Assist Automatic Cancellation .....	293
Active Drive Assist Indicators .....	293
Active Drive Assist – Troubleshooting .....	294
<b>Steering</b>	
Electric Power Steering .....	295
Steering – Troubleshooting .....	296
<b>Parking Aids</b>	
Parking Aid Precautions .....	297
Rear Parking Aid .....	297
Front Parking Aid .....	298
Side Parking Aid .....	299

# Table of Contents

---

Parking Aid Indicators .....	300
Parking Aids – Troubleshooting .....	301

## Rear View Camera

What Is the Rear View Camera .....	302
Rear View Camera Precautions .....	302
Locating the Rear View Camera .....	302
Rear View Camera Guide Lines .....	302
Rear View Camera Settings .....	303

## 360 Degree Camera

What Is the 360 Degree Camera .....	305
How Does the 360 Degree Camera Work .....	305
360 Degree Camera Precautions .....	305
360 Degree Camera Limitations .....	305
Locating the 360 Degree Cameras .....	305
360 Degree Camera Guide Lines .....	306
360 Degree Camera Settings .....	307

## Active Park Assist

What Is Active Park Assist .....	309
How Does Active Park Assist Work .....	309
Active Park Assist Precautions .....	309
Switching Active Park Assist On and Off .....	309
Entering a Parallel Parking Space .....	309
Entering a Perpendicular Parking Space .....	310
Exiting a Parking Space .....	310
Active Park Assist – Troubleshooting .....	311

## Cruise Control

What Is Cruise Control .....	313
Switching Cruise Control On and Off .....	313
Setting the Cruise Control Speed .....	313
Canceling the Set Speed .....	314
Resuming the Set Speed .....	314

Cruise Control Indicators .....	314
---------------------------------	-----

## Adaptive Cruise Control

How Does Adaptive Cruise Control With Stop and Go Work .....	315
Adaptive Cruise Control Precautions .....	315
Adaptive Cruise Control Limitations .....	316
Switching Adaptive Cruise Control On and Off .....	317
Adaptive Cruise Control Automatic Cancellation .....	318
Setting the Adaptive Cruise Control Speed .....	318
Setting the Adaptive Cruise Control Gap .....	319
Canceling the Set Speed .....	320
Resuming the Set Speed .....	320
Overriding the Set Speed .....	321
Adaptive Cruise Control Indicators .....	321
Switching From Adaptive Cruise Control to Cruise Control .....	321
Lane Centering .....	322
Intelligent Adaptive Cruise Control .....	324
Adaptive Cruise Control – Troubleshooting .....	325

## Drive Mode Control

What Is Drive Mode Control .....	328
How Does Drive Mode Control Work .....	328
Selecting a Drive Mode .....	328
Drive Modes .....	329
Drive Mode Control – Troubleshooting .....	331

## Lane Keeping System

What Is the Lane Keeping System .....	333
How Does the Lane Keeping System Work .....	333
Lane Keeping System Precautions .....	333

# Table of Contents

Lane Keeping System Limitations .....	333	Locating the Cross Traffic Alert Sensors .....	345
Switching the Lane Keeping System On and Off .....	334	Cross Traffic Alert With Trailer Coverage .....	345
Switching the Lane Keeping System Mode .....	334	Cross Traffic Alert Indicators .....	345
Alert Mode .....	334	Cross Traffic Alert – Troubleshooting .....	346
Aid Mode .....	335		
Alert and Aid Mode .....	335		
Lane Keeping System Indicators .....	336		
Lane Keeping System – Troubleshooting .....	337		
<b>Blind Spot Information System</b>		<b>Pre-Collision Assist</b>	
What Is Blind Spot Information System .....	340	What Is Pre-Collision Assist .....	347
How Does Blind Spot Information System Work .....	340	How Does Pre-Collision Assist Work .....	347
Blind Spot Information System Precautions .....	340	Pre-Collision Assist Precautions .....	347
Blind Spot Information System Limitations .....	340	Pre-Collision Assist Limitations .....	348
Blind Spot Information System Requirements .....	340	Switching Pre-Collision Assist On and Off .....	349
Switching Blind Spot Information System On and Off .....	340	Locating the Pre-Collision Assist Sensors .....	349
Locating the Blind Spot Information System Sensors .....	341	Distance Indication .....	350
Blind Spot Information System With Trailer Coverage .....	341	Distance Alert .....	351
Blind Spot Information System Indicators .....	343	Automatic Emergency Braking .....	351
Blind Spot Information System – Troubleshooting .....	343	Evasive Steering Assist .....	352
		Pre-Collision Assist – Troubleshooting .....	353
<b>Cross Traffic Alert</b>		<b>Driver Alert</b>	
What Is Cross Traffic Alert .....	344	What Is Driver Alert .....	355
How Does Cross Traffic Alert Work .....	344	How Does Driver Alert Work .....	355
Cross Traffic Alert Precautions .....	344	Driver Alert Precautions .....	355
Cross Traffic Alert Limitations .....	344	Driver Alert Limitations .....	355
Switching Cross Traffic Alert On and Off .....	344	Switching Driver Alert On and Off .....	355
		Driver Alert – Troubleshooting .....	356
		<b>Speed Sign Recognition</b>	
		What Is Speed Sign Recognition .....	357
		How Does Speed Sign Recognition Work .....	357
		Speed Sign Recognition Precautions .....	357
		Speed Sign Recognition Limitations .....	357
		Speed Sign Recognition Indicators .....	357

# Table of Contents

Setting the Speed Sign Recognition Speed Warning .....	358
Setting the Speed Sign Recognition Speed Tolerance .....	358
Speed Sign Recognition – Troubleshooting .....	358
<b>Load Carrying</b>	
Load Carrying Precautions .....	360
Using a Slide-In Camper .....	361
Locating the Safety Compliance Certification Labels .....	361
What Is the Gross Axle Weight Rating .....	361
What Is the Gross Vehicle Weight Rating .....	361
What Is the Gross Combined Weight Rating .....	361
Calculating Payload .....	363
Calculating the Load Limit .....	363
<b>Pickup Bed</b>	
Pickup Bed Precautions .....	366
Pickup Bed Anchor Points .....	366
Tailgate Anchor Points .....	368
Pickup Bed Ramps .....	368
<b>Connecting a Trailer</b>	
Connecting a Trailer Precautions .....	371
Hitches .....	371
Connecting a Trailer .....	372
Connecting a Trailer – Troubleshooting .....	374
<b>Towing a Trailer</b>	
Towing a Trailer Precautions .....	375
Trailer Brake Precautions .....	375
Towing a Trailer Limitations .....	375
Loading Your Trailer .....	376
Trailer Towing Hints .....	376
Launching or Retrieving a Boat or Personal Watercraft .....	377
Towing Weights and Dimensions .....	378
Towing a Trailer – Troubleshooting .....	404
<b>Integrated Trailer Brake Controller</b>	
What Is the Integrated Trailer Brake Controller .....	405
Integrated Trailer Brake Controller Precautions .....	405
Using the Integrated Trailer Brake Controller .....	405
Adjusting the Integrated Trailer Brake Controller Mode .....	406
Integrated Trailer Brake Controller – Troubleshooting .....	407
<b>Trailer Sway Control</b>	
How Does Trailer Sway Control Work .....	409
Trailer Sway Control Precautions .....	409
Switching Trailer Sway Control On and Off .....	409
<b>Trailer Reversing Aid - Vehicles With: Pro Trailer Backup Assist</b>	
What Is the Trailer Reversing Aid .....	410
How Does the Trailer Reversing Aid Work .....	410
Trailer Reversing Aid Precautions .....	410
Setting Up the Trailer Reversing Aid for a Conventional Trailer .....	410
Switching the Trailer Reversing Aid On and Off .....	413
Using the Trailer Reversing Aid Controller .....	413
Using the Trailer Reverse Guidance Views .....	414
Trailer Reversing Aid - Troubleshooting .....	416

# Table of Contents

## Trailer Reversing Aid - Vehicles With: Trailer Reverse Guidance (TRG)

What Is the Trailer Reversing Aid .....	420
How Does the Trailer Reversing Aid Work .....	420
Trailer Reversing Aid Precautions .....	420
Setting Up the Trailer Reversing Aid for a Conventional Trailer .....	420
Switching the Trailer Reversing Aid On and Off .....	422
Using the Trailer Reverse Guidance Views .....	422
Trailer Reversing Aid - Troubleshooting .....	424

## Driving Hints

Off-Road Driving .....	428
Cold Weather Precautions .....	430
Breaking-In .....	430
Driving Economically .....	430
Floor Mats .....	431

## Snow Plowing - Vehicles Without: Snow Plow Mode

Snow Plowing Precautions .....	432
--------------------------------	-----

## Snow Plowing - Vehicles With: Snow Plow Mode

Snow Plowing Precautions .....	433
Operating Your Vehicle With a Snowplow .....	433
Snowplow Mode .....	434

## Crash and Breakdown Information

Roadside Assistance .....	436
High Voltage Battery Vehicle Precautions - Hybrid Electric Vehicle (HEV) .....	437
Switching the Hazard Flashers On and Off .....	438

Jump Starting the Vehicle .....	438
Post-Crash Alert System .....	440
Automatic Crash Shutoff .....	440
Recovery Towing .....	440
Transporting the Vehicle .....	441

## Towing Your Vehicle

Towing Your Vehicle Precautions .....	443
Recreationally Towing Your Vehicle - 4x4 .....	443
Recreationally Towing Your Vehicle - 4x2 .....	445
Emergency Towing .....	445
Towing Your Vehicle - Troubleshooting .....	445

## Fuses

Fuse Precautions .....	446
Under Hood Fuse Box .....	446
Body Control Module Fuse Box .....	451
Identifying Fuse Types .....	454
Fuses - Troubleshooting .....	454

## Maintenance

Maintenance Precautions .....	455
Opening and Closing the Hood .....	455
Under Hood Overview - 2.7L EcoBoost™ .....	456
Under Hood Overview - 3.0L Diesel .....	457
Under Hood Overview - 3.3L .....	458
Under Hood Overview - 3.5L EcoBoost™ .....	459
Under Hood Overview - 3.5L, Hybrid Electric Vehicle (HEV) .....	460
Under Hood Overview - 5.0L .....	461
Engine Oil .....	462
Checking the Coolant .....	463
Engine Air Filter .....	467
Draining the Fuel Filter Water Trap - Diesel .....	470
Changing the Fuel Filter - Diesel .....	471



# Table of Contents

Changing the Fuel Filter - Gasoline .....	471	Using Snow Chains .....	503
Changing the 12V Battery .....	471	<b>Tire Care</b>	
Adjusting the Headlamps .....	473	Checking the Tire Pressures .....	505
Exterior Bulbs .....	474	Inflating the Tires .....	505
Interior Bulbs .....	483	Inspecting the Tire for Wear .....	506
Drive Belt Routing - 2.7L EcoBoost™, Vehicles With: Dual Generators .....	483	Inspecting the Tire for Damage .....	506
Drive Belt Routing - 2.7L EcoBoost™, Vehicles With: Single Generator .....	483	Inspecting the Wheel Valve Stems .....	507
Drive Belt Routing - 3.0L Diesel .....	483	Tire Rotation .....	507
Drive Belt Routing - 3.3L .....	484	<b>Tire Pressure Monitoring System</b>	
Drive Belt Routing - 3.5L Ecoboost™, Vehicles With: Single Generator .....	484	What Is the Tire Pressure Monitoring System .....	509
Drive Belt Routing - 3.5L Ecoboost™, Vehicles With: Dual Generators .....	484	Tire Pressure Monitoring System Overview .....	509
Drive Belt Routing - 3.5L, Hybrid Electric Vehicle (HEV) .....	484	Tire Pressure Monitoring System Precautions .....	510
Drive Belt Routing - 5.0L, Vehicles With: Single Generator .....	485	Tire Pressure Monitoring System Limitations .....	510
Drive Belt Routing - 5.0L, Vehicles With: Dual Generators .....	485	Viewing the Tire Pressures .....	511
<b>Vehicle Care</b>		Resetting Tire Pressure Monitoring System .....	511
Cleaning Products .....	486	Tire Pressure Monitoring System – Troubleshooting .....	514
Cleaning the Exterior .....	486	<b>Changing a Road Wheel</b>	
Cleaning the Interior .....	488	Changing a Flat Tire .....	516
Repairing Minor Paint Damage .....	490	Wheel Nuts .....	523
Waxing Your Vehicle .....	490	<b>Capacities and Specifications</b>	
<b>Storing Your Vehicle</b>		Engine Specifications - 2.7L EcoBoost™ .....	524
Preparing Your Vehicle for Storage .....	492	Engine Specifications - 3.0L Diesel .....	525
Removing Your Vehicle From Storage .....	493	Engine Specifications - 3.3L .....	526
<b>Wheel and Tire Information</b>		Engine Specifications - 3.5L Ecoboost™ .....	527
Locating the Tire label .....	494	Engine Specifications - 3.5L, Hybrid Electric Vehicle (HEV) .....	528
Department of Transportation Uniform Tire Quality Grades .....	494	Engine Specifications - 5.0L .....	529
Information on the Tire Sidewall .....	495	Motorcraft Parts - 2.7L EcoBoost™ .....	530
Glossary of Tire Terminology .....	500		
Tire Replacement Requirements .....	501		

# Table of Contents

Motorcraft Parts - 3.0L Diesel .....	531	Air Conditioning System Capacity and Specification - 3.5L, Hybrid Electric Vehicle (HEV) .....	558
Motorcraft Parts - 3.3L .....	532	Air Conditioning System Capacity and Specification - 5.0L .....	559
Motorcraft Parts - 3.5L EcoBoost™ .....	533	Washer Fluid Specification .....	559
Motorcraft Parts - 3.5L, Hybrid Electric Vehicle (HEV) .....	534	Diesel Exhaust Fluid Capacity and Specification .....	560
Motorcraft Parts - 5.0L .....	535	Brake Fluid Specification .....	560
Engine Oil Capacity and Specification - 2.7L EcoBoost™ .....	536	Transfer Case Fluid Capacity and Specification .....	561
Engine Oil Capacity and Specification - 3.0L Diesel .....	537	Front Axle Fluid Capacity and Specification .....	562
Engine Oil Capacity and Specification - 3.3L .....	539	Rear Axle Fluid Capacity and Specification .....	562
Engine Oil Capacity and Specification - 3.5L EcoBoost™ .....	541		
Engine Oil Capacity and Specification - 3.5L, Hybrid Electric Vehicle (HEV) .....	543		
Engine Oil Capacity and Specification - 5.0L .....	545	<b>Vehicle Identification</b>	
Cooling System Capacity and Specification - 2.7L EcoBoost™ .....	547	Vehicle Identification Number .....	564
Cooling System Capacity and Specification - 3.0L Diesel .....	548	<b>Connected Vehicle</b>	
Cooling System Capacity and Specification - 3.3L .....	548	What Is a Connected Vehicle .....	565
Cooling System Capacity and Specification - 3.5L EcoBoost™ .....	549	Connected Vehicle Requirements .....	565
Cooling System Capacity and Specification - 3.5L, Hybrid Electric Vehicle (HEV) .....	550	Connected Vehicle Limitations .....	565
Cooling System Capacity and Specification - 5.0L .....	550	Connecting the Vehicle to a Mobile Network .....	565
Fuel Tank Capacity - Gasoline, Excluding: Hybrid Electric Vehicle (HEV) .....	551	Connecting the Vehicle to a Wi-Fi Network .....	565
Fuel Tank Capacity - Diesel .....	552	Connected Vehicle – Troubleshooting .....	566
Fuel Tank Capacity - Gasoline, Hybrid Electric Vehicle (HEV) .....	553		
Air Conditioning System Capacity and Specification - 2.7L EcoBoost™ .....	554	<b>Vehicle Wi-Fi Hotspot</b>	
Air Conditioning System Capacity and Specification - 3.0L Diesel .....	555	Creating a Vehicle Wi-Fi Hotspot .....	569
Air Conditioning System Capacity and Specification - 3.3L .....	556	Changing the Vehicle Wi-Fi Hotspot Name or Password .....	569
Air Conditioning System Capacity and Specification - 3.5L EcoBoost™ .....	557	<b>Audio System</b>	
		Audio System Precautions .....	570
		Switching the Audio Unit On and Off .....	570
		Selecting the Audio Source .....	570
		Playing or Pausing the Audio Source .....	570
		Adjusting the Volume .....	570

# Table of Contents

---

Switching Shuffle Mode On and Off .....	571
Switching Repeat Mode On and Off .....	571
Setting a Memory Preset .....	571
Muting the Audio .....	571
Adjusting the Sound Settings .....	571
Setting the Clock and Date .....	571
AM/FM Radio .....	572
Switching the Display On and Off .....	573
Digital Radio .....	573
Satellite Radio .....	574
Audio System – Troubleshooting .....	577
Identifying the Audio Unit .....	580

## Information and Entertainment Display Overview

Information and Entertainment Display Precautions .....	581
Information and Entertainment Display Limitations .....	581
Status Bar .....	581
Feature Bar .....	582
Information On Demand Screen - Vehicles With: 12.3 Inch Screen .....	582

## Voice Interaction

What is Voice Interaction .....	583
Setting the Wake Word .....	583
Beginning a Voice Interaction .....	583
Voice Interaction Examples .....	583

## Phone

Phone Precautions .....	585
Connecting Your Phone .....	585
Phone Menu .....	585
Making and Receiving a Phone Call .....	586
Sending and Receiving a Text Message .....	587

Switching Text Message Notification On and Off .....	588
--	-----

## Bluetooth®

Connecting a Bluetooth® Device .....	589
Playing Media Using Bluetooth® .....	589

## Apps

App Precautions .....	590
App Requirements .....	590
Accessing Apps .....	590
Enabling Apps on an iOS Device .....	590
Enabling Apps on an Android Device .....	590
Switching Apple CarPlay On and Off .....	591
Switching Android Auto On and Off .....	591

## Personal Profiles

How Do Personal Profiles Work .....	592
Enabling or Disabling Personal Profiles .....	592
Creating a Personal Profile .....	593
Linking or Unlinking a Personal Profile to a Remote Control .....	593

## Navigation

Accessing Navigation .....	594
Navigation Map Updates .....	594
Adjusting the Map .....	594
Live Traffic .....	594
Setting a Destination .....	594
Waypoints .....	595
Route Guidance .....	595
Trailer Towing Navigation .....	596

## Vehicle System Updates

Updating the Vehicle Systems Wirelessly .....	597
Performing a Master Reset .....	598

# Table of Contents

---

## Accessories

Accessories .....	599
-------------------	-----

## Ford Protect

What Is Ford Protect .....	600
----------------------------	-----

## Scheduled Maintenance

General Maintenance Information .....	602
Normal Scheduled Maintenance .....	605
Special Operating Conditions Scheduled Maintenance - Diesel .....	609
Special Operating Conditions Scheduled Maintenance - Gasoline .....	614

## Customer Information

Rollover Warning .....	618
The Better Business Bureau Auto Line Program - United States of America .....	618
The Mediation and Arbitration Program - Canada .....	619
Ordering a Canadian French Owner's Manual .....	619
Reporting Safety Defects in the United States .....	620
Reporting Safety Defects in Canada .....	620
Type Approvals .....	622
California Proposition 65 - United States of America .....	641
Perchlorate .....	642
Replacement Parts Recommendation .....	642
Mobile Communications Equipment .....	642
End User License Agreement .....	643
Emission Law - United States of America .....	668
Export Unique Options .....	669

## Appendices

Electromagnetic Compatibility .....	670
-------------------------------------	-----



# Contacting Us

---

If you require assistance or clarification on policies or procedures, please contact the customer relationship center.

## United States

Ford Motor Company  
Customer Relationship Center  
PO Box 6248  
Dearborn, MI 48126  
1-800-392-3673 (FORD)  
(TDD for the hearing impaired:  
1-888-658-6805  
[www.ford.com/help/contact/](http://www.ford.com/help/contact/)

## Canada

Customer Relationship Center  
Ford Motor Company of Canada Limited  
P.O. Box 2000  
Oakville, Ontario L6J 5E4  
1-800-565-3673 (FORD)  
[www.ford.ca](http://www.ford.ca)  
Facebook: FordServiceCA (English),  
FordServiceQC (Français)

## Europe

Telephone: 02035644444  
E-mail: [UKCRC1@ford.com](mailto:UKCRC1@ford.com)  
Twitter: @forduk

## Australia

Ford Motor Company  
Attention: Customer Relationship Centre  
Private Mail Bag 5  
Fairlane Business Park #3  
Campbellfield, Victoria, 3061  
Telephone: 13 3673 (FORD)  
E-mail: [foacust1@ford.com](mailto:foacust1@ford.com)

## New Zealand

Ford Motor Company  
Attention: Customer Relationship Centre  
Private Bag 76912  
Manukau City 2241  
Telephone: 0800 367 369 (FORDNZ)  
E-mail: [fnzcust@ford.com](mailto:fnzcust@ford.com)

## Asia Pacific

E-mail: [expcac@ford.com](mailto:expcac@ford.com)

## Caribbean, Central America and Israel

Ford Motor Company  
Ford Export Operations  
Attention: Owner Relations  
1555 Fairlane Drive  
Fairlane Business Park #3  
Allen Park, MI 48101  
Fax: (313) 390-0804  
Telephone: (313) 594-4857  
E-mail: [expcac@ford.com](mailto:expcac@ford.com)

## U.S. Virgin Islands and Puerto Rico

Ford Motor Company  
Ford Export Operations  
Attention: Owner Relations  
1555 Fairlane Drive  
Fairlane Business Park #3  
Allen Park, MI 48101  
Telephone: (800) 841-3673  
E-mail: [prcac@ford.com](mailto:prcac@ford.com)

## Argentina

Telephone: 0800-888-3673

## Brazil

[www.ford.com.br](http://www.ford.com.br)

## North Africa

E-mail: [nafcrc@ford.com](mailto:nafcrc@ford.com)

## Sub-Saharan Africa

E-mail: [ssacrc@ford.com](mailto:ssacrc@ford.com)

# Contacting Us

---

## **Puerto Rico**

Ford International Business Development,  
Inc.  
P.O. Box 11957  
Caparra Heights Station  
San Juan, PR 00922-1957  
1-800-392-3673 (FORD)  
Fax: (313) 390-0804  
E-mail: [prcac@ford.com](mailto:prcac@ford.com)  
[www.ford.com.pr](http://www.ford.com.pr)

## **Middle East**

Ford Middle East Customer Relationship  
Center  
P.O. Box 21740  
Dubai, United Arab Emirates  
Telephone: 80004441066  
Toll-free number for the Kingdom of Saudi  
Arabia: 8008443673  
Mobily and Zain cell phone users in Saudi  
Arabia: 800850078  
Kuwait: 22280384  
Local telephone number for Kuwait: +965  
1 898900  
Fax: +971 4 3327266  
E-mail: [menacac@ford.com](mailto:menacac@ford.com)  
[www.me.ford.com](http://www.me.ford.com)

## **South Korea**

Telephone: +82-02-1600-6003  
E-mail: [infokr1@ford.com](mailto:infokr1@ford.com)

## **Ford Credit - US Only**

Ford Credit offers a full range of financing and lease plans to help you acquire your vehicle. If you have financed or leased your vehicle through Ford Credit, thank you for your business.

For assistance call 1-800-727-7000, or for more information about Ford Credit and access to an account manager, visit [www.ford.com/finance](http://www.ford.com/finance).

# Introduction

## ABOUT THIS PUBLICATION



**WARNING:** Driving while distracted can result in loss of vehicle control, crash and injury. We strongly recommend that you use extreme caution when using any device that may take your focus off the road. Your primary responsibility is the safe operation of your vehicle. We recommend against the use of any hand-held device while driving and encourage the use of voice-operated systems when possible. Make sure you are aware of all applicable local laws that may affect the use of electronic devices while driving.

Thank you for choosing Ford. We recommend that you take some time to get to know your vehicle in order to benefit from greater safety and pleasure from driving it. Use this digital manual, that we have also made available for your continued use through the FordPass app and your local Ford website to familiarize yourself with the basics.

**Note:** To download the FordPass app, visit your device's app store.

**Note:** To find the local Ford website, visit <https://corporate.ford.com/operations/locations/global-links.html>.

**Note:** Use and operate your vehicle in line with all applicable laws and regulations.

**Note:** Pass on all printed owner's information when selling this vehicle.

Our digital resources include a comprehensive digital Owner's Manual that is dynamically created according to the features on your vehicle by using the vehicle identification number. See **Locating the Vehicle Identification Number** (page 564). The digital Owner's Manual includes visual and full text search

functions so that you can quickly locate the information you are looking for. It also includes links to a number of how-to videos created to help you understand some of the advanced technologies on your vehicle.

## Features and Options

**Note:** This publication describes product features and options available throughout the range of available models, sometimes even before they are generally available. It may describe options that are not available on the vehicle you have purchased.

## Illustrations

**Note:** Some of the illustrations in this manual could show features as used in different models, some can appear different to you on your vehicle.

## Location of Components

This manual may qualify the location of a component as left-hand side or right-hand side. The side is determined when facing forward in the seat.

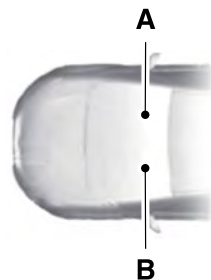

- A Right-hand side.
- B Left-hand side.



# Introduction

---





























## **USING THIS PUBLICATION**

To quickly locate information about your vehicle, use the word search within the Owner's Manual application.

# Symbols Glossary

## SYMBOLS USED ON YOUR VEHICLE

These are some of the symbols you may see on your vehicle.

	Air conditioning system		Child seat tether anchor
	Air conditioning system lubricant type		Cruise control
	Anti-lock braking system		Do not open when hot
	Avoid smoking, flames or sparks		Electric Parking brake
	Battery		Engine air filter
	Battery acid		Engine coolant
	Brake fluid - non petroleum based		Engine coolant temperature
	Brake system		Engine oil
	Brake system		Explosive gas
	Cabin air filter		Fan warning
	Check fuel cap		Fasten seatbelt
	Child safety door lock or unlock		Flammable
	Child seat lower anchor		Front airbag
			Front fog lamps
			Fuel pump reset

# Symbols Glossary



Fuse compartment



Hazard flashers



Heated rear window



Windshield defrosting system



Interior luggage compartment release



Jack



Keep out of reach of children



Lighting control



Low tire pressure warning



Maintain correct fluid level



Note operating instructions



Horn control



Panic alarm



Parking aid



Passenger airbag activated



Passenger airbag deactivated



Power steering fluid



Power windows front/rear



Power window lockout



Requires registered technician



Safety alert



See Owner's Manual



See Service Manual



Malfunction Indicator Lamp (MIL)



Side airbag



Shield the eyes



Stability control



Hill descent control



Trail control



Windshield wiping system

# Symbols Glossary

---



Windshield wash and wipe

# Data Privacy



**WARNING:** Do not connect wireless plug-in devices to the data link connector. Unauthorized third parties could gain access to vehicle data and impair the performance of safety related systems. Only allow repair facilities that follow our service and repair instructions to connect their equipment to the data link connector.

We respect your privacy and are committed to protecting it. The information contained in this manual was correct at the time of publication but as technology rapidly changes, we recommend that you visit the local Ford website for the latest information.

Your vehicle has electronic control units that have data recording functionality and the ability to permanently or temporarily store data. This data could include information on the condition and status of your vehicle, vehicle maintenance requirements, events and malfunctions. The types of data that can be recorded are described in this section. Some of the data recorded is stored in event logs or error logs.

**Note:** *Error logs are reset following a service or repair.*

**Note:** *We may provide information in response to requests from law enforcement, other government authorities and third parties acting with lawful authority or through a legal process. Such information could be used by them in legal proceedings.*

Data recorded includes, for example:

- Operating states of system components, for example fuel level, tire pressure and battery charge level.
- Vehicle and component status, for example wheel speed, deceleration, lateral acceleration and seatbelt status.

- Events or errors in essential systems, for example headlamps and brakes.
- System responses to driving situations, for example airbag deployment and stability control.
- Environmental conditions, for example temperature.

Some of this data, when used in combination with other information, for example an accident report, damage to a vehicle or eyewitness statements, could be associated with a specific person.

## Services That We Provide

If you use our services, we collect and use data, for example account information, vehicle location and driving characteristics, that could identify you. We transmit this data through a dedicated, protected connection. We only collect and use data to enable your use of our services to which you have subscribed, with your consent or where permitted by law. For additional information, see the terms and conditions of the services to which you have subscribed.

For additional information about our privacy policy, refer to the local Ford website.

## Services That Third Parties Provide

We recommend that you review the terms and conditions and data privacy information for any services equipped with your vehicle or to which you subscribe. We take no responsibility for services that third parties provide.

Where equipped, SiriusXM with 360L may use the modem. To disable, turn off the SiriusXM 360L or Vehicle Connectivity setting. See **Enabling and Disabling the Modem** (page 565).

# Data Privacy

---

## SERVICE DATA

Service data recorders in your vehicle are capable of collecting and storing diagnostic information about your vehicle. This potentially includes information about the performance or status of various systems and modules in the vehicle, such as engine, throttle, steering or brake systems. In order to properly diagnose and service your vehicle, Ford Motor Company (Ford of Canada in Canada), and service and repair facilities may access or share among them vehicle diagnostic information received through a direct connection to your vehicle when diagnosing or servicing your vehicle. Additionally, Ford Motor Company (Ford of Canada, in Canada) may, where permitted by law, use vehicle diagnostic information for vehicle improvement or with other information we may have about you, for example, your contact information, to offer you products or services that may interest you. Data may be provided to our service providers such as part suppliers that may help diagnose malfunctions, and who are similarly obligated to protect data. We retain this data only as long as necessary to perform these functions or to comply with law. We may provide information where required in response to official requests to law enforcement or other government authorities or third parties acting with lawful authority or court order, and such information may be used in legal proceedings. For U.S. only (if equipped), if you choose to use connected apps and services, you consent that certain diagnostic information may also be accessed electronically by Ford Motor Company and Ford authorized service facilities, and that the diagnostic information may be used to provide services to you, personalizing your experience, troubleshoot, and to improve products and services and offer you products and services that may interest

you, where permitted by law. For Canada only, for more information, please review the Ford of Canada privacy policy at [www.ford.ca](http://www.ford.ca), including our U.S. data storage and use of service providers in other jurisdictions who may be subject to legal requirements in Canada, the United States and other countries applicable to them, for example, lawful requirements to disclose personal information to governmental authorities in those countries.

## EVENT DATA

This vehicle is equipped with an event data recorder. The main purpose of an event data recorder is to record, in certain crash or near crash-like situations, such as an airbag deployment or hitting a road obstacle; this data will assist in understanding how a vehicle's systems performed. The event data recorder is designed to record data related to vehicle dynamics and safety systems for a short period of time, typically 30 seconds or less.

The event data recorder in this vehicle is designed to record such data as:

- How various systems in your vehicle were operating.
- Whether or not the driver and passenger seatbelts were buckled/fastened.
- How far (if at all) the driver was depressing the accelerator and/or the brake pedal.
- How fast the vehicle was traveling.
- Where the driver was positioning the steering wheel.

This data can help provide a better understanding of the circumstances in which crashes and injuries occur.

# Data Privacy

**Note:** Event data recorder data is recorded by your vehicle only if a non-trivial crash situation occurs; no data is recorded by the event data recorder under normal driving conditions and no personal data or information (for example name, gender, age, and crash location) is recorded.

However, parties, such as law enforcement, could combine the event data recorder data with the type of personally identifying data routinely acquired during a crash investigation.

To read data recorded by an event data recorder, special equipment is required, and access to the vehicle or the event data recorder is needed. In addition to the vehicle manufacturer, other parties, such as law enforcement, that have such special equipment, can read the information if they have access to the vehicle or the event data recorder.

## Active Drive Assist Driver Facing Camera Data (If Equipped)

If active drive assist is active in certain crash or near crash-like situations, such as an airbag deployment or hitting a road obstacle, the system may record driver attentiveness, based on the direction of eyes and duration, and photographs of the driver seat area.

**Note:** No data is recorded under normal driving conditions.

## SETTINGS DATA

Your vehicle has electronic control units that have the ability to store data based on your personalized settings. The data is stored locally in the vehicle or on devices that you connect to it, for example, a USB drive or digital music player. You can delete some of this data and also choose whether to share it through the services to which you subscribe. See **Enabling and Disabling the Modem** (page 565).

## Comfort and Convenience Data

Data recorded includes, for example:

- Seat and steering wheel position.
- Climate control settings.
- Radio presets.

## Entertainment Data

Data recorded includes, for example:

- Music, videos or album art.
- Contacts and corresponding address book entries.
- Navigation destinations.

## CONNECTED VEHICLE DATA



The modem has a SIM. The modem was enabled when your vehicle was built and periodically sends messages to stay connected to the cell phone network, receive automatic software updates and send vehicle-related information to us, for example diagnostic information. These messages could include information that identifies your vehicle, the SIM and the electronic serial number of the modem. Cell phone network service providers could have access to additional information, for example cell phone network tower identification. For additional information about our privacy policy, visit [www.FordConnected.com](http://www.FordConnected.com) or refer to your local Ford website.

**Note:** The modem continues to send this information unless you disable the modem or stop the modem from sharing vehicle data by changing the modem settings. See **Connected Vehicle** (page 565).

**Note:** The service can be unavailable or interrupted for a number of reasons, for example environmental or topographical conditions and data plan coverage.

**Note:** To find out if your vehicle has a modem, visit [www.FordConnected.com](http://www.FordConnected.com).

# Data Privacy

---

## MOBILE DEVICE DATA

If you connect a mobile device to your vehicle, you can display data from your device on the touchscreen for example, music and album art. You can share your vehicle data with mobile apps on your device through the system. See **App Precautions** (page 590).

The mobile apps function operates by your connected device sending data to us in the United States. The data is encrypted and includes, for example, the vehicle identification number of your vehicle, the SYNC module serial number, odometer, enabled apps, usage statistics and debugging information. We retain it only as long as necessary to provide the service, to troubleshoot, for continuous improvement and to offer you products and services that may be of interest to you according to your preferences and where allowed by law.

If you connect a cell phone to the system, the system creates a profile that links to that cell phone. The cell phone profile enables more mobile features and efficient operation. The profile contains, for example data from your phonebook, read and unread text messages and call history, including history of calls when your cell phone was not connected to the system.

If you connect a media device, the system creates and retains a media device index of supported media content. The system also records a short diagnostic log of approximately 10 minutes of all recent system activity.

The cell phone profile, media device index and diagnostic log remain in your vehicle unless you delete them and are generally accessible only in your vehicle when you connect your cell phone or media device. If you no longer plan to use the system or your vehicle, we recommend you use the master reset function to erase the stored information. See **Connecting Your Phone** (page 585).

System data cannot be accessed without special equipment and access to your vehicle's module.

For additional information about our privacy policy, refer to the local Ford website.

**Note:** *To find out if your vehicle has connectivity technology, visit [www.FordConnected.com](http://www.FordConnected.com).*

## EMERGENCY CALL SYSTEM DATA (IF EQUIPPED)

When the emergency call system is active, it may disclose to emergency services that your vehicle has been in a crash involving the deployment of an airbag or activation of the fuel pump shut-off. Certain versions or updates to the emergency call system may also be capable of electronically or verbally disclosing to emergency services operators your vehicle location or other details about your vehicle or crash to assist emergency services operators to provide the most appropriate emergency services. If you do not want to disclose this information, do not activate the emergency call system.

**Note:** *You cannot deactivate emergency call systems that are required by law.*



# Visual Search

## STEERING WHEEL

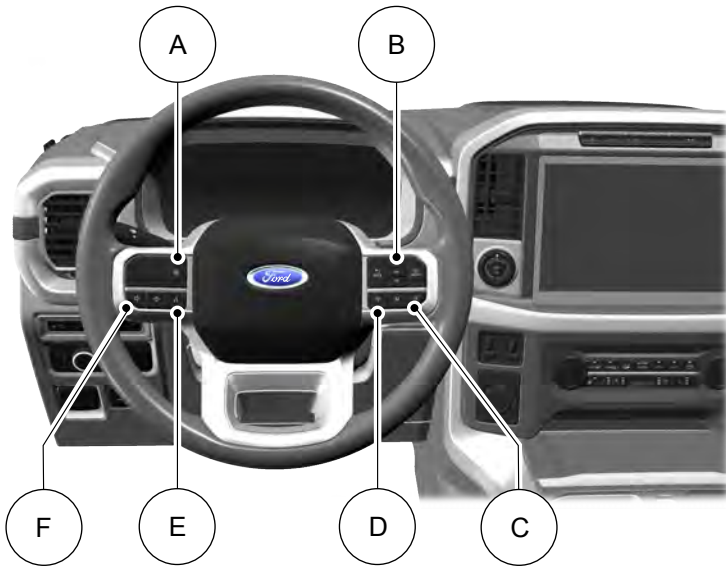

- A See **Switching Lane Centering On and Off** (page 323).
- B See **Using the Instrument Cluster Display Controls** (page 151).
- C See **Selecting a Radio Station** (page 572).
- D See **Making and Receiving a Phone Call** (page 586).
- E See **What is Voice Interaction** (page 583).
- F See **Adjusting the Volume** (page 570).

# Visual Search

## INSTRUMENT PANEL

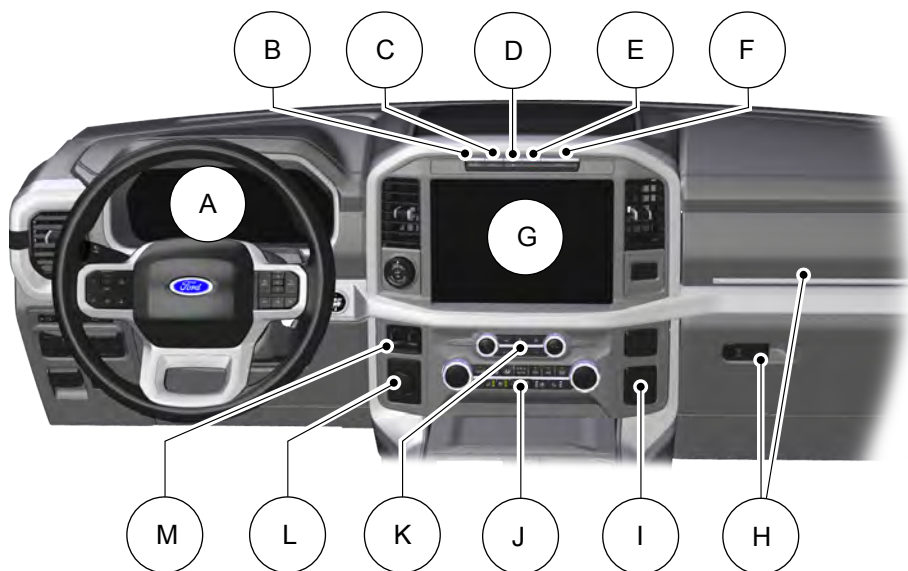

- A See **Instrument Cluster Overview** (page 146). See **Instrument Cluster Overview** (page 145). See **Instrument Cluster Overview** (page 144).
- B See **Switching Traction Control On and Off** (page 284).
- C See **Switching the 360 Degree Camera On and Off** (page 307).
- D See **Switching Active Park Assist On and Off** (page 309).
- E See **Switching the Hazard Flashers On and Off** (page 438).
- F See **Switching Snowplow Mode On and Off** (page 434).
- G See **Feature Bar** (page 582).
- H See **Opening the Glove Compartment** (page 205).
- I See **What Is the Power Outlet** (page 199).
- J See **Identifying the Climate Control Unit** (page 158). See **Identifying the Climate Control Unit** (page 163).
- K See **Identifying the Audio Unit** (page 580).

# Visual Search

- L See **Selecting a Four-Wheel Drive Mode** (page 262).
- M See **Using the Integrated Trailer Brake Controller** (page 405).

## VEHICLE INTERIOR

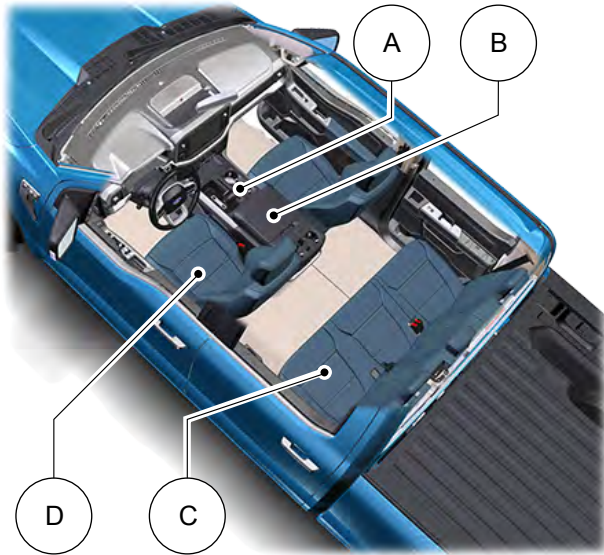

- A See **Shifting Using the Buttons on the Selector Lever** (page 254).
- B See **Using the Center Console Work Surface** (page 200). See **Using the Center Console Work Surface** (page 201).
- C See **Folding the Seats** (page 176).
- D See **Sitting in the Correct Position** (page 167).

# Visual Search

## FRONT EXTERIOR

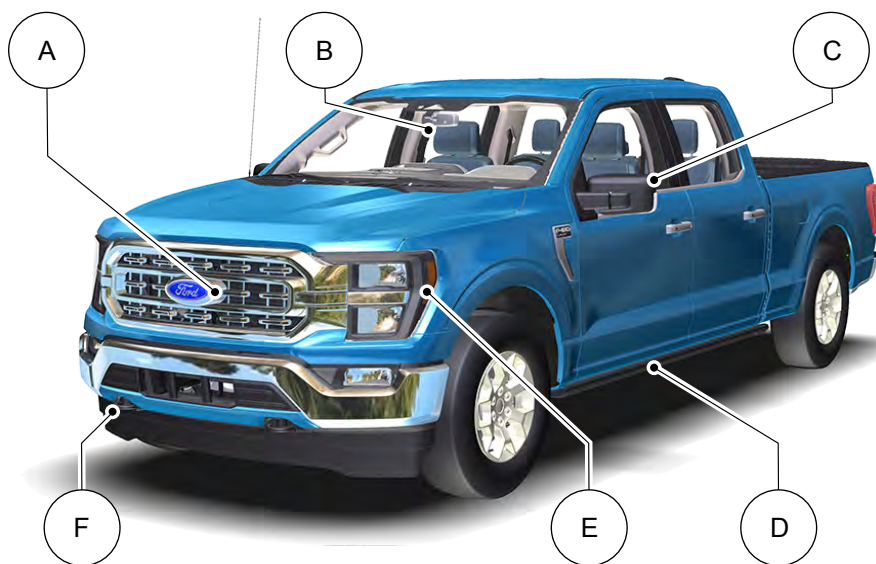

- A See **Locating the 360 Degree Cameras** (page 305).
- B See **What Is the Lane Keeping System** (page 333).
- C See **Folding the Exterior Mirrors** (page 140).
- D See **Deploying and Stowing the Power Running Boards** (page 116).
- E See **Exterior Lighting Control** (page 124).
- F See **Accessing the Front Towing Point** (page 440).

# Visual Search

## REAR EXTERIOR

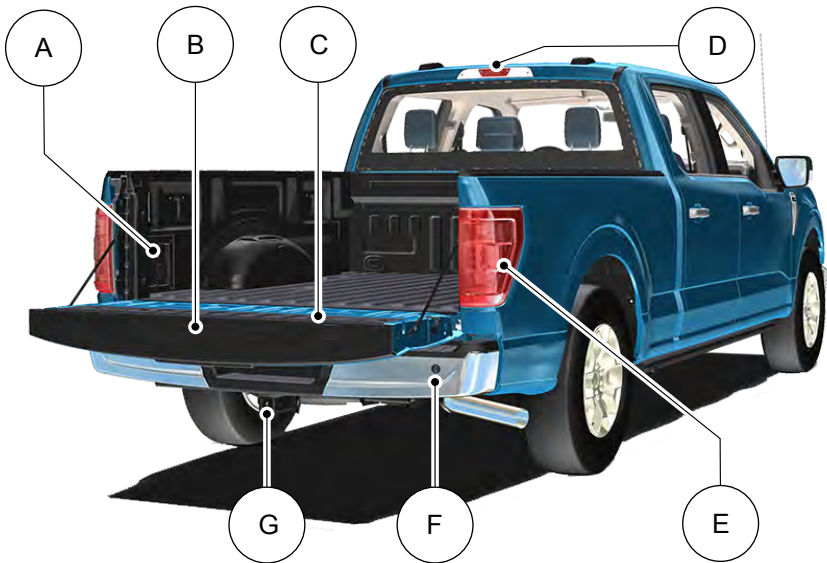

- A See **Locating the Power Outlet** (page 190).
- B See **Tailgate Work Surface** (page 101).
- C See **Accessing the Tailgate Step** (page 98).
- D See **Locating the 360 Degree Cameras** (page 305).
- E See **Locating the Blind Spot Information System Sensors** (page 341).
- F See **Locating the Rear Parking Aid Sensors** (page 298).
- G See **Connecting a Trailer** (page 372).

# Child Safety

## CHILD SAFETY PRECAUTIONS



**WARNING:** Always make sure your child is secured properly in a device that is appropriate for their height, age and weight. Child safety restraints must be bought separately from your vehicle. Failure to follow these instructions and guidelines may result in an increased risk of serious injury or death to your child.



**WARNING:** All children are shaped differently. The National Highway Traffic Safety Administration and other safety organizations, base their recommendations for child restraints on probable child height, age and weight thresholds, or on the minimum requirements of the law. We recommend that you check with a NHTSA Certified Child Passenger Safety Technician (CPST) to make sure that you properly install the child restraint in your vehicle and that you consult your pediatrician to make sure you have a child restraint appropriate for your child. To locate a child restraint fitting station and CPST, contact NHTSA toll free at 1-888-327-4236 or go to [www.nhtsa.dot.gov](http://www.nhtsa.dot.gov). In Canada, contact Transport Canada toll free at 1-800-333-0371 or go to [www.tc.gc.ca](http://www.tc.gc.ca) to find a Child Car Seat Clinic in your area. Failure to properly restrain children in child restraints made especially for their height, age and weight, may result in an increased risk of serious injury or death to your child.



**WARNING:** On hot days, the temperature inside the vehicle can rise very quickly. Exposure of people or animals to these high temperatures for even a short time can cause death or serious heat related injuries, including brain damage. Small children are particularly at risk.



**WARNING:** Do not place a rearward facing child restraint in front of an active airbag. Failure to follow this instruction could result in personal injury or death.



**WARNING:** Properly secure children 12 years old and under in a rear seating position whenever possible. If you are unable to properly secure all children in a rear seating position, properly secure the largest child on the front seat. If you must use a forward facing child restraint on the front seat, move the seat as far back as possible. Failure to follow these instructions could result in personal injury or death.



**WARNING:** Always carefully follow the instructions and warnings provided by the manufacturer of any child restraint to determine if the restraint device is appropriate for your child's size, height, weight, or age. Follow the child restraint manufacturer's instructions and warnings provided for installation and use in conjunction with the instructions and warnings provided by your vehicle manufacturer. A safety seat that is improperly installed or utilized, is inappropriate for your child's height, age, or weight or does not properly fit the child may increase the risk of serious injury or death.

# Child Safety

**WARNING:** Do not allow a passenger to hold a child on their lap when your vehicle is moving. Failure to follow this instruction could result in personal injury or death in the event of a sudden stop or crash.

**WARNING:** Do not use pillows, books or towels to boost your child's height. Failure to follow this instruction could result in personal injury or death.

**WARNING:** Properly secure child restraints or booster seats when they are not in use. They could become projectiles in a sudden stop or crash. Failure to follow this instruction could result in personal injury or death.

**WARNING:** Do not put the shoulder section of the seatbelt or allow the child to put the shoulder section of the seatbelt under their arm or behind their back. Failure to follow this instruction could reduce the effectiveness of the seatbelt and increase the risk of injury or death in a crash.

**WARNING:** Do not leave children or pets unattended in your vehicle. Failure to follow this instruction could result in personal injury or death.

- Keep the buckle release button pointing up and away from the child restraint, with the tongue between the child restraint and the release button, to prevent accidental unbuckling.
- Put the seatbelt in the automatic locking mode.

## CHILD RESTRAINT ANCHOR POINTS

### What Are the Child Restraint Anchor Points

[\*LATCH \(Lower Anchors and Tethers for Children\)\*](#)

Anchor points allow you to quickly and safely install a child restraint.

### Locating the Child Restraint Lower Anchor Points (If Equipped)

Crew Cab

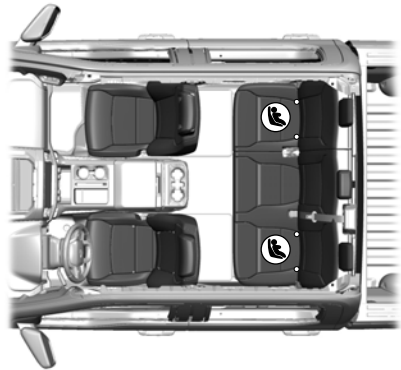

Super Cab

When installing a child restraint with seatbelts:

- Place the vehicle seat in the upright position before you install the child restraint.
- Use the correct seatbelt buckle for that seating position.
- Insert the belt tongue into the buckle. Make sure the tongue is securely fastened in the buckle.

# Child Safety

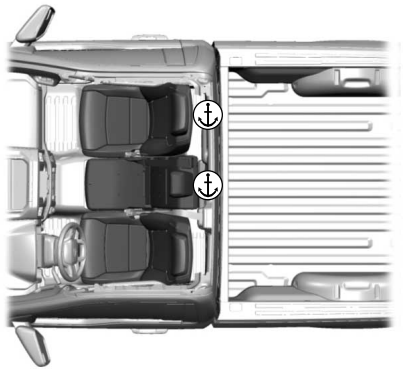
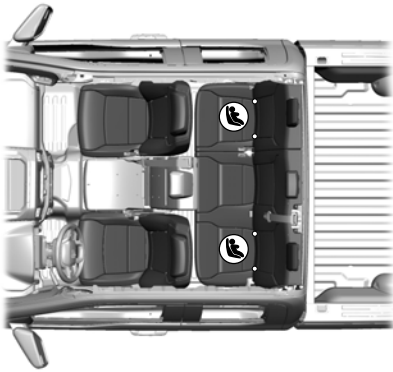

Crew Cab

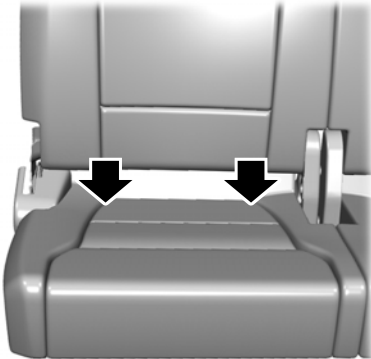

The lower child restraint anchors are at the rear section of the rear seat between the cushion and seat backrest.

**Note:** *Regular Cab vehicles do not have lower anchors.*

## Locating the Child Restraint Top Tether Anchor Points

Regular Cab

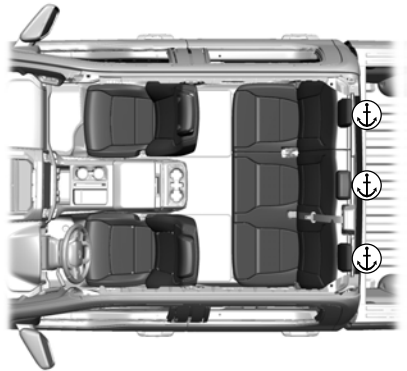

Super Cab



# Child Safety

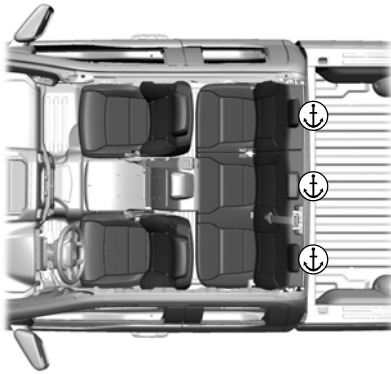

## CHILD RESTRAINTS

### Child Restraint Position Information

Install the child restraint tightly against the vehicle seat. It may be necessary to lift or remove the head restraint.

### Rear Facing Child Restraints

Combined Weight of Child and Child Restraint	LATCH (Lower Anchors Only)	Seatbelt Only
Up to 65 lb (29 kg)	X	X
Over 65 lb (29 kg)		X

### Forward Facing Child Restraints

Combined Weight of Child and Child Restraint	LATCH (Lower Anchors and Top Tether Anchor)	Seatbelt and Top Tether Anchor	Seatbelt and LATCH (Lower Anchors and Top Tether Anchor)
Up to 65 lb (29 kg)	X	X	X
Over 65 lb (29 kg)		X	X

# Child Safety

## Child Restraints Recommendation

Child Size, Height, Weight, or Age	Recommended Restraint Type
Children weighing 40 lb (18 kg) or less (generally age four or younger).	Use a child restraint (sometimes called an infant carrier, convertible seat, or toddler seat).
Children who have outgrown or no longer properly fit in a child restraint (generally children who are less than 57 in (1.45 m) tall, are greater than age four and less than age 12, and between 40 lb (18 kg) and 80 lb (36 kg) and upward to 100 lb (45 kg) if recommended by your child restraint manufacturer).	Use a belt-positioning booster seat.
Children who have outgrown or no longer properly fit in a belt-positioning booster seat (generally children who are at least 57 in (1.45 m) tall or greater than 80 lb (36 kg) or 100 lb (45 kg) if recommended by child restraint manufacturer).	Use a vehicle seatbelt having the lap belt snug and low across the hips, shoulder belt centered across the shoulder and chest, and seat backrest upright.

You are required by law to properly use child restraints for infants and toddlers in the United States, Canada and Mexico.

Many states and provinces require that small children use approved booster seats until they reach age eight, a height of 57 in (1.45 m) tall, or 80 lb (36 kg). Check your local and state or provincial laws for specific requirements about the safety of children in your vehicle.

When possible, properly restrain children 12 years of age and under in a rear seating position of your vehicle. Accident statistics suggest that children are safer when properly restrained in the rear seating positions than in a front seating position.

When installing a rear facing child restraint, adjust the vehicle seats to avoid interference between the child restraint and the vehicle seat in front of the child restraint.

## INSTALLING CHILD RESTRAINTS

### Using Seatbelts



**WARNING:** Depending on where you secure a child restraint, and depending on the child restraint design, you may block access to certain seatbelt buckle assemblies and LATCH lower anchors, rendering those features potentially unusable. To avoid risk of injury, make sure occupants only use seating positions where they are able to be properly restrained.

**Note:** *The following does not apply to the front center position of Super Cab and Crew Cab vehicles.*

**Note:** *Although the child restraint illustrated is a forward facing child restraint, the steps are the same for installing a rear facing child restraint.*

# Child Safety

Perform the following steps when installing a child restraint with seatbelts.

1. Position the child restraint in a seat with a seatbelt.



2. Pull down on the shoulder belt and then grasp the shoulder belt and lap belt together.



3. While holding the shoulder and lap belt portions together, route the tongue through the child restraint according to the child restraint manufacturer's instructions. Make sure you did not twist the belt webbing.

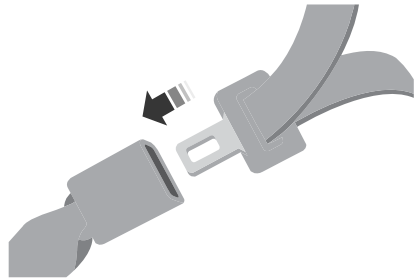

4. Insert the belt tongue into the proper buckle for that seating position until the latch engages. Make sure the tongue is latched securely by pulling on it.



5. To put the retractor in the automatic locking mode, grasp the shoulder portion of the belt and pull downward until you pull all of the seatbelt out.

**Note:** *The automatic locking mode is available on the front passenger and rear seats. This mode is also available on the center seat of a Regular Cab. This vehicle does not require the use of a locking clip.*

6. Allow the belt to retract to remove slack. The seatbelt clicks as it retracts to indicate it is in the automatic locking mode.

# Child Safety

7. Pull the seatbelt out of the retractor to make sure the retractor is in the automatic locking mode. You should not be able to pull more belt out. If the retractor is not locked, unbuckle the belt and repeat Steps 5 and 6.



8. Remove remaining slack from the belt. Force the seat down with extra weight, for example, by pressing down or kneeling on the child restraint while pulling up on the shoulder belt in order to force slack from the belt. This is necessary to remove the remaining slack that exists once you add the extra weight of the child to the child restraint. It also helps to achieve the proper snugness of the child restraint to your vehicle. Sometimes, a slight lean toward the buckle helps to remove remaining slack from the belt.
9. If the child restraint has a tether strap, attach it.



10. Before placing the child in the seat, forcibly move the seat forward and back to make sure the seat is securely held in place.

To check this, grab the seat at the belt path and attempt to move it side to side and forward and back. There should be no more than 1 in (2.5 cm) of movement.

We recommend checking with a NHTSA Certified Child Passenger Safety Technician to make certain the child restraint is properly installed. In Canada, check with Transport Canada for referral to a Child Car Seat Clinic.

## Using Seatbelts

 **WARNING:** Always use both the lap and shoulder portion of the seatbelt in the center seating position.

**Note:** *The following applies to the front center position of Super Cab and Crew Cab vehicles.*

The seatbelt webbing below the tongue is the lap portion of the seatbelt. The webbing above the tongue is the shoulder belt portion of the seatbelt.

1. Position the child restraint in the front center seat.

# Child Safety



2. Slide the tongue up the webbing.



3. While holding both shoulder and lap portions next to the tongue, route the tongue and webbing through the child restraint according to the child restraint manufacturer's instructions. Make sure you did not twist the belt webbing.

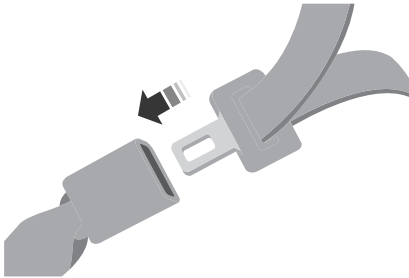

4. Insert the belt tongue into the proper buckle for that seating position until the latch engages. Make sure the tongue is latched securely by pulling on it.



5. When pushing down with your knee on the child restraint, pull up on the shoulder belt portion to tighten the lap belt portion of the seatbelt.
6. Allow the seatbelt to retract and remove any slack in the belt to securely tighten the child restraint in the vehicle.
7. If the child restraint has a tether strap, attach it.



# Child Safety

8. Before placing the child in the seat, forcibly move the seat forward and back to make sure the seat is securely held in place. To check this, grab the seat at the belt path and attempt to move it side to side and forward and back. There should be no more than 1 in (2.5 cm) of movement.
  9. Check from time to time to be sure that there is no slack in the lap and shoulder belt. The shoulder belt must be snug to keep the lap belt tight during a crash.
- Two lower anchors where the vehicle seat backrest and seat cushion meet, called the seat bight.
  - One top tether anchor behind that seating position.

LATCH compatible child restraints have two rigid or webbing mounted attachments. These attachments connect to the two lower anchors at the LATCH equipped seating positions in your vehicle. This type of attachment method eliminates the need to use seatbelts to attach the child restraint.

We recommend checking with a NHTSA Certified Child Passenger Safety Technician to make certain the child restraint is properly installed. In Canada, check with Transport Canada for referral to a Child Car Seat Clinic.

However, you can still use the seatbelt to attach the child restraint if the lower anchors are not used. For forward-facing child restraints, you must also attach the top tether strap to the proper top tether anchor if a top tether strap has been provided with your child restraint.

## Using Lower Anchors and Tethers for Children

Follow the instructions later in this chapter on attaching child restraints with tether straps.



**WARNING:** Do not attach two child safety restraints to the same anchor. In a crash, one anchor may not be strong enough to hold two child safety restraint attachments and may break, causing serious injury or death.



**WARNING:** Depending on where you secure a child restraint, and depending on the child restraint design, you may block access to certain seatbelt buckle assemblies and LATCH lower anchors, rendering those features potentially unusable. To avoid risk of injury, make sure occupants only use seating positions where they are able to be properly restrained.

The Lower Anchors and Tethers for Children (LATCH) system has three vehicle anchor points:

## Installing a Child Restraint in a Center Seat



**WARNING:** The standardized spacing for LATCH lower anchors is 11 in (280 mm) center to center. Do not use LATCH lower anchors for the center seating position unless the child restraint manufacturer's instructions permit and specify using anchors spaced at least as far apart as those in this vehicle.

The lower anchors at the center of the second row rear seat are spaced 25.7 in (652 mm) apart. The standardized spacing for LATCH lower anchors is 11 in (280 mm) center to center.

# Child Safety

You cannot install a child restraint with rigid LATCH attachments at the center seating position. You can only use LATCH compatible child restraints with attachments on belt webbing at this seating position provided that the child restraint manufacturer's instructions permit use with the anchor spacing stated. Do not attach a child restraint to any lower anchor if another child restraint is attached to that anchor.

Each time you use the child restraint, check that the seat is properly attached to the lower anchors and tether anchor, if applicable. Tug the child restraint from side to side and forward and back where it is secured to the vehicle. The seat should move less than 1 in (2.5 cm).

If you did not properly anchor the child restraint, the risk of a child being injured in a crash greatly increases.

## Combining the Seatbelt and Lower Anchors for Attaching Child Restraints

When used in combination, you may attach either the seatbelt or the LATCH lower anchors first, provided a proper installation is achieved. Attach the tether strap afterward, if it is included with the child restraint.

## Using Tether Straps

Many forward-facing child restraints include a tether strap which extends from the back of the child restraint and hooks to an anchoring point called the top tether anchor. Tether straps are available as an accessory for many older child restraints.

Contact the manufacturer of your child restraint for information about ordering a tether strap, or to obtain a longer tether strap if the tether strap on your child restraint does not reach the appropriate top tether anchor in the vehicle.

Attach the tether strap only to the appropriate tether anchor. The tether strap may not work properly if attached somewhere other than the correct tether anchor.

If you install a child restraint with rigid LATCH attachments, do not tighten the tether strap enough to lift the child restraint off the vehicle seat cushion when the child is seated in it. Keep the tether strap just snug without lifting the front of the child restraint. Keeping the child restraint just touching the vehicle seat gives the best protection in a severe crash.

Once you have installed the child restraint using either the seatbelt, the lower anchors of the LATCH system, or both, you can attach the top tether strap.

## Attaching the Front Seat Tether Strap

Regular Cab



1. Route the child restraint tether strap over the back of the seat and under the head restraint.

# Child Safety

**Note:** For vehicles with adjustable head restraints, route the tether strap under the head restraint and between the head restraint posts. Otherwise, route the tether strap over the top of the seat backrest.

2. Locate the correct anchor for the selected seating position. You may need to pull the seat backrest forward to access the tether anchors. Make sure the seat is locked in the upright position before installing the child restraint.
3. Clip the tether strap to the anchor.
4. Tighten the child restraint tether strap according to the manufacturer's instructions.

If you incorrectly clip the tether strap, the child restraint may not be retained properly in the event of a crash.

If you did not properly anchor the child restraint, the risk of a child being injured in a crash greatly increases.

If your child restraint system has a tether strap, and the child restraint manufacturer recommends its use, we also recommend its use.

## Attaching the Rear Seat Tether Strap (If Equipped)

Crew Cab and Super Cab

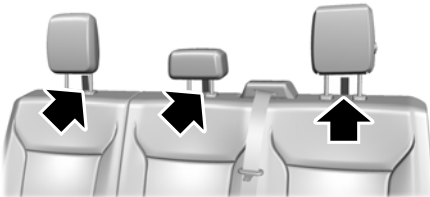

There are three loops of webbing above the back of the rear seat. Use these loops as routing loops and anchor loops for up to three child restraint tether straps.

For example, you can use the center loop as a routing loop for a child restraint in the center rear seat and as an anchoring loop for child restraints installed in the outermost rear seats.

Many tether straps cannot be tightened if the tether strap is hooked to the loop directly behind the child restraint.

To provide a tight tether strap:

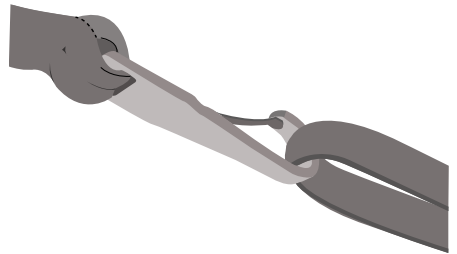

1. Route the vehicle tether loop between the head restraint posts, then route the child restraint tether strap through the loop, forward of the head restraint.
2. Hook the strap to the vehicle tether anchor loop in the adjacent seating position. If using the driver side, pass the strap behind the shoulder belt for the center seat. Put the tether strap through the routing loop. The head restraint support post holds the child restraint tightly, but the head restraint post is not strong enough to hold the child restraint during a crash.
3. Tighten the tether strap according to the child restraint manufacturer's instructions.



# Child Safety

If you did not properly anchor the child restraint, the risk of a child being injured in a crash greatly increases.

If your child restraint system has a tether strap, and the child restraint manufacturer recommends its use, we also recommend its use.

## BOOSTER SEATS

Use a belt-positioning booster seat for children who have outgrown or no longer properly fit in a child restraint and meet the following criteria.

- Generally children who are less than 57 in (1.45 m) tall.
- Are greater than age four (4) and less than age twelve (12).
- Are between 40 lb (18 kg) and 80 lb (36 kg) and upward to 100 lb (45 kg).

Many state and provincial laws require that children use approved booster seats until they reach age eight, a height of 57 in (1.45 m) tall, or 80 lb (36 kg).

Booster seats should be used until you can answer yes to all of these questions when seated without a booster seat:

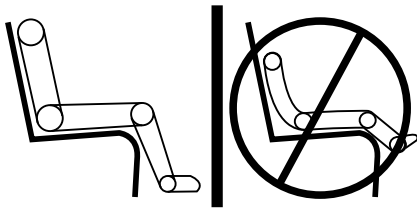

- Can the child sit all the way back against their vehicle seat backrest with knees bent comfortably at the edge of the seat cushion?
- Can the child sit without slouching?
- Does the lap belt rest low across the hips?
- Is the shoulder belt centered on the shoulder and chest?
- Can the child stay seated like this for the whole trip?

Always use booster seats in conjunction with your vehicle lap and shoulder belt.

## Types of Booster Seats



- Backless booster seats

If your backless booster seat has a removable shield, remove the shield.

If a vehicle seating position has a low seat backrest or no head restraint, a backless booster seat may place your child's head, as measured at the tops of the ears, above the top of the seat. In this case, move the backless booster to another seating position with a higher seat backrest or head restraint and lap and shoulder belts, or consider using a high-back booster seat.

# Child Safety



- High-back booster seats

If, with a backless booster seat, you cannot find a seating position that adequately supports your child's head, a high-back booster seat would be a better choice.

Children and booster seats vary in size and shape. Choose a booster that keeps the lap belt low and snug across the hips, never up across the stomach, and lets you adjust the shoulder belt to cross the chest and rest snugly near the center of the shoulder.

The following drawings compare the ideal fit to a shoulder belt uncomfortably close to the neck and a shoulder belt that could slip off the shoulder. The drawings also show how the lap belt should be low and snug across the child's hips.



# Child Safety

---

If the booster seat slides on the vehicle seat upon which it is being used, placing a rubberized mesh sold as shelf or carpet liner under the booster seat may improve this condition. Do not use any item thicker than this under the booster seat. Check with the booster seat manufacturer's instructions.

## Right-Hand Side

Turn the key counterclockwise to switch the child lock on and clockwise to switch it off.

## CHILD SAFETY LOCKS (IF EQUIPPED)



**WARNING:** You cannot open the rear doors from inside if you have put the child safety locks on.



A child safety lock is on the rear edge of each rear door. You must switch the child safety lock separately on each door.

## Left-Hand Side

Turn the key clockwise to switch the child lock on and counterclockwise to switch it off.

# Seatbelts

## SEATBELT PRECAUTIONS



**WARNING:** Always drive and ride with your seatback upright and the lap belt snug and low across the hips.



**WARNING:** Children must always be properly restrained.



**WARNING:** Do not allow a passenger to hold a child on their lap when your vehicle is moving. Failure to follow this instruction could result in personal injury or death in the event of a sudden stop or crash.



**WARNING:** All occupants of your vehicle, including the driver, should always properly wear their seatbelts, even when an airbag supplemental restraint system is provided. Failure to properly wear your seatbelt could seriously increase the risk of injury or death.



**WARNING:** It is extremely dangerous to ride in a cargo area, inside or outside of a vehicle. In a crash, people riding in these areas are more likely to be seriously injured or killed. Do not allow people to ride in any area of your vehicle that is not equipped with seats and seatbelts. Make sure everyone in your vehicle is in a seat and properly using a seatbelt. Failure to follow this warning could result in serious personal injury or death.



**WARNING:** In a rollover crash, an unbelted person is significantly more likely to die than a person wearing a seatbelt.



**WARNING:** Each seating position in your vehicle has a specific seatbelt assembly made up of one buckle and one tongue designed to be used as a pair. Use the shoulder belt on the outside shoulder only. Never wear the shoulder belt under the arm. Never use a single seatbelt for more than one person.



**WARNING:** Even with advanced restraints systems, properly restrain children 12 and under in a rear seating position. Failure to follow this could seriously increase the risk of injury or death.



**WARNING:** Seatbelts and seats may be hot in a vehicle that is in the sunshine. The hot seatbelts or seats may burn a small child. Check seat covers and buckles before you place a child anywhere near them.



**WARNING:** If your vehicle is involved in a crash, have the seatbelts and associated components inspected as soon as possible. Failure to follow this instruction could result in personal injury or death.

All seating positions in this vehicle have seatbelts. All occupants of the vehicle should properly wear their seatbelts, even when an airbag supplemental restraint system is provided.

The seatbelt system consists of:

- Lap and shoulder seatbelts.
- A shoulder seatbelt with automatic locking mode, except driver seatbelt.
- Height adjusters at the front outermost seating positions.
- Seatbelt pretensioners at the front outermost and rear outermost seating positions.

# Seatbelts



A seatbelt warning light and chime.



Crash sensors and monitoring system with readiness indicator.

The seatbelt pretensioners are designed to tighten the seatbelts when activated. In frontal and near-frontal crashes, the seatbelt pretensioners may be activated alone or, if the crash is of sufficient severity, together with the front airbags. In side crashes and rollovers, the pretensioners will be activated when the Safety Canopy is activated.

## FASTENING AND UNFASTENING THE SEATBELTS

This applies to all seating positions, except for the front center position of Super Cab and Crew Cab.

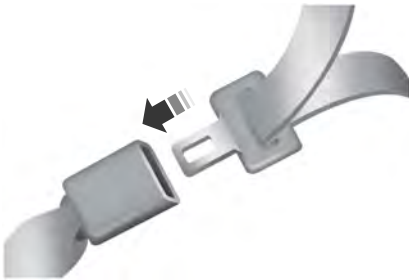

1. Insert the seatbelt tongue into the buckle until you hear a snap and feel it latch.

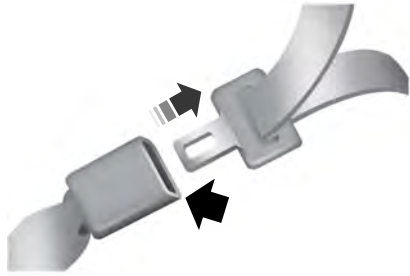

2. Press the button to release the seatbelt.

## Using the Seatbelt With Cinch Tongue

This applies to the front center seating position of Super Cab and Crew Cab.

The cinch tongue slides up and down the seatbelt webbing when you stow the seatbelt or when you put the seatbelts on. When you buckle the seatbelt, the cinch tongue allows you to shorten the lap portion, but pinches the webbing to keep the lap portion from getting longer. The cinch tongue is designed to slip during a crash, so wear the shoulder belt properly and do not allow any slack in either the lap or shoulder portions.

## Fastening the Cinch Tongue



**WARNING:** Always drive and ride with your seatback upright and the lap belt snug and low across the hips.

1. Pull the seatbelt from the retractor so that the shoulder belt portion of the seatbelt crosses your shoulder and chest.
2. Make sure the belt is not twisted. If the belt is twisted, remove the twist.

# Seatbelts

3. Insert the belt tongue into the proper buckle for your seating position until you hear a snap and feel it latch.
4. Make sure you securely fasten the tongue to the buckle by pulling on the tongue.

While you are fastened in the seatbelt, the seatbelt with a cinch tongue adjusts to your movement. However, if you brake hard, turn hard, or if your vehicle receives an impact of 5 mph (8 km/h) or more, the seatbelt locks and helps reduce your forward movement.

## SENSITIVE LOCKING MODE

### What is Sensitive Locking Mode

Sensitive locking mode is a seatbelt retractor feature that allows shoulder belt length adjustment according to your movements and locking in response to vehicle movement.

### How Does Sensitive Locking Mode Work

If the driver suddenly brakes, turns a corner sharply, or the vehicle receives an impact of about 5 mph (8 km/h) or more, the seatbelts lock to help reduce forward movement of the driver and passengers.

In addition, the seatbelt retractor locks if you pull the seatbelt webbing out too quickly. If the retractor locks, slowly lower the height adjuster to allow the seatbelt to retract.

If the retractor does not unlock, pull the seatbelt out slowly then feed a small length of webbing back toward the stowed position.

For rear seatbelts, recline the rear seat backrest or push the seat backrest cushion away from the seatbelt. Feed a small length of webbing back toward the stowed position.

## AUTOMATIC LOCKING MODE

### What Is Automatic Locking Mode

This feature keeps the seatbelts pre-locked. The belt still retracts to remove any slack in the shoulder belt.

### When to Use Automatic Locking Mode

Use this mode any time you install a child restraint in a front seating position in a Regular Cab, Super Cab, Crew Cab or any rear seating position of a Super Cab or Crew Cab. The optional front seat center seatbelt in the Super Cab and Crew Cab has a cinch mechanism. Properly restrain children 12 years old and under in a rear seat whenever possible. See **Child Safety** (page 35).

**Note:** *Automatic locking mode is not available on the driver seatbelt.*

### Engaging Automatic Locking Mode



# Seatbelts

1. Fasten the combination lap and shoulder belt.
2. Grasp the shoulder portion and pull downward until you pull the entire belt out.
3. Allow the belt to retract. As the belt retracts, you will hear a clicking sound. This indicates the seatbelt is now in the automatic locking mode.

## Disengaging Automatic Locking Mode

Unbuckle the combination lap and shoulder belt and allow it to retract completely to disengage the automatic locking mode and activate the vehicle sensitive locking mode.

## ADJUSTING THE SEATBELTS DURING PREGNANCY

**WARNING:** Always ride and drive with your seatback upright and properly fasten your seatbelt. Fit the lap portion of the seatbelt snugly and low across the hips. Position the shoulder portion of the seatbelt across your chest. Pregnant women must follow this practice. See the following figure.

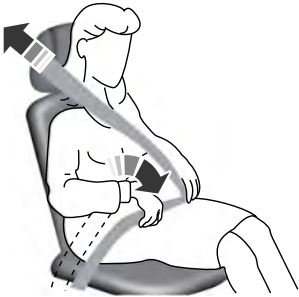

Pregnant women should always wear their seatbelt. Position the lap belt portion of a combination lap and shoulder belt low across the hips below the belly and worn as tight as comfort allows. Position the shoulder belt to cross the middle of the shoulder and the center of the chest.

## ADJUSTING THE SEATBELT HEIGHT

**WARNING:** Position the seatbelt height adjuster so that the seatbelt rests across the middle of your shoulder. Failure to adjust the seatbelt correctly could reduce its effectiveness and increase the risk of injury in a crash.

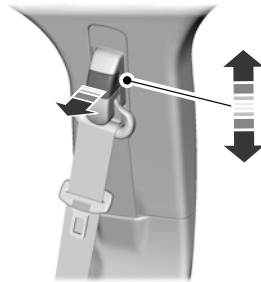

1. Pull the button and slide the height adjuster up or down.
2. Release the button and pull down on the height adjuster to make sure it is locked in place.

# Seatbelts

## ADJUSTING THE SEATBELT LENGTH



1. Pull some seatbelt webbing out of the shoulder belt retractor.
2. While holding the webbing below the tongue, grasp the metal tip of the tongue so that it is parallel to the webbing and slide the tongue up.
3. Provide enough lap belt length so that the tongue can reach the buckle.

## SEATBELT REMINDER

### How Does the Seatbelt Reminder Work

This feature supplements the seatbelt warning function by providing additional reminders that intermittently sound a tone and illuminate the seatbelt warning lamp when you are in the driver seat or you have a front seat passenger and a seatbelt is unbuckled.

The system uses information from the front passenger sensing system to determine if a front seat passenger is present and therefore potentially in need of a warning. To avoid the system switching on the Belt-Minder feature for objects you place on the front passenger seat, only the front seat passengers receive warnings as determined by the front passenger sensing system.

If the Belt-Minder warnings expire (warnings for about five minutes) for one passenger (driver or front passenger), the other passenger can still cause the Belt-Minder feature to switch on.



# Seatbelts

---

<b>If</b>	<b>Then</b>
You and the front seat passenger buckle your seatbelts before you switch the ignition on or less than 1–2 minutes elapse after you switch the ignition on...	The Belt-Minder feature will not activate.
You or the front seat passenger do not buckle your seatbelts before your vehicle reaches at least 6.0 mph (9.7 km/h) and 1–2 minutes elapse after you switch the ignition on...	The Belt-Minder feature activates, the seatbelt warning lamp illuminates and an indicator tone sounds for 6 seconds every 25 seconds, repeating for about 5 minutes or until you and the front seat passenger buckle your seatbelts.
The seatbelt for the driver or front passenger is unbuckled for about 1 minute while the vehicle is traveling at least 6.0 mph (9.7 km/h) and more than 1–2 minutes elapse after you switch the ignition on...	The Belt-Minder feature activates, the seatbelt warning lamp illuminates and an indicator tone sounds for 6 seconds every 25 seconds, repeating for about 5 minutes or until you and the front seat passenger buckle your seatbelts.

# Seatbelts

## Seatbelt Reminder Indicators

A warning lamp illuminates if the ignition is on, a front seat is occupied and the seatbelt has not been fastened.



The warning lamp illuminates until you fasten your seatbelt.

## Seatbelt Reminder Audible Warnings

A warning tone sounds if the warning lamp illuminates and your vehicle exceeds a relatively low speed.

The warning tone sounds for up to five minutes or until you fasten your seatbelt.

## Switching the Seatbelt Reminder On and Off



**WARNING:** While the system allows you to deactivate it, this system is designed to improve your chances of being safely belted and surviving an accident. We recommend you leave the system activated for yourself and others who may use the vehicle.

**Note:** *The driver and front passenger warnings switch off independently. When you perform this procedure for one seating position, do not buckle the other position as this cancels the process.*

**Note:** *If you are using MyKey, you cannot disable the seatbelt reminder. Also, if the seatbelt reminder has been previously disabled, it will be re-enabled during the use of MyKey. See **MyKey™** (page 78).*

Read Steps 1 - 4 before proceeding with the programming procedure.

Make sure that:

- The parking brake is set.
  - The transmission is in park (P).
  - The ignition is off.
  - The driver and front passenger seatbelts are unfastened.
1. Switch the ignition on. Do not start the engine.
  2. Wait about one minute until the seatbelt warning light switches off. After Step 2, wait an additional five seconds before proceeding with Step 3. Once you start Step 3, you must complete the procedure within 30 seconds.
  3. For the seating position you are switching off, buckle then unbuckle the seatbelt three times at a moderate speed, ending in the unbuckled state. After Step 3, the seatbelt warning light switches on.
  4. When the seatbelt warning light is on, buckle then unbuckle the seatbelt. After Step 4, the seatbelt warning light flashes for confirmation.

This switches the feature off for that seating position if it is currently on.

This switches the feature on for that seating position if it is currently off.

## CHECKING THE SEATBELTS

Check the seatbelts and child restraints periodically to make sure they work properly and are not damaged. Make sure there are no nicks, tears or cuts. Replace if necessary.

Check all of the following seatbelt assemblies after a crash.

- Retractors.
- Buckles.
- Front seatbelt buckle assemblies.

# Seatbelts

- Shoulder belt height adjusters.
- Shoulder belt guide on seat backrest.
- Child restraint LATCH and tether anchors.
- Attaching hardware.

Read the child restraint manufacturer's instructions for additional inspection and maintenance information specific to the child restraint.

We recommend that all seatbelt assemblies in use in vehicles involved in a crash be replaced. However, if the crash was minor and an authorized dealer finds that the belts do not show damage and continue to operate properly, they do not need to be replaced. Seatbelt assemblies not in use during a crash should also be checked and replaced if either damage or improper operation is noted.

Properly care for seatbelts. See **Cleaning Seatbelts** (page 490).

## SEATBELT EXTENSIONS



**WARNING:** Persons who fit into the vehicle's seatbelt should not use an extension. Unnecessary use could result in serious personal injury in the event of a crash.



**WARNING:** Only use extensions provided free of charge by our dealers. The dealer will provide an extension designed specifically for this vehicle, model year and seating position. The use of an extension intended for another vehicle, model year or seating position may not offer you the full protection of your vehicle's seatbelt restraint system.



**WARNING:** Never use seatbelt extensions to install child restraints.



**WARNING:** Do not use extensions to change the way the seatbelt fits across the torso, over the lap or to make the seatbelt buckle easier to reach.

If, because of body size or driving position, it is not possible to properly fasten the seatbelt over your lap and shoulder, an extension that is compatible with the seatbelts is available free of charge from our dealers. Only use our seatbelt extensions made by the original equipment seatbelt manufacturer with our seatbelts. Ask your authorized dealer if your extension is compatible with your vehicle restraint system.

## WHAT IS THE PERSONAL SAFETY SYSTEM

### *Personal Safety System*

An advanced safety system that protects occupants in frontal crashes.

## HOW DOES THE PERSONAL SAFETY SYSTEM WORK

This system provides an improved level of frontal crash protection to front seat occupants and is designed to reduce the risk of airbag-related injuries. The system analyzes occupant conditions and crash severity before activating the appropriate safety devices. During a crash, the restraints control module may deploy the seatbelt pretensioners, and one or both stages of the dual-stage airbags based on crash severity and occupant conditions.

## PERSONAL SAFETY SYSTEM COMPONENTS

- Driver and passenger dual-stage airbag supplemental restraints.
- Front seat outermost seatbelts with pretensioners, energy management retractors and seatbelt usage sensors.
- Front passenger sensing system.
- Passenger airbag off and on indicators.
- Front crash severity sensors.
- Restraints control module with impact and safing sensors.
- Restraint system warning light and tone.
- The electrical wiring for the airbags, crash sensors, seatbelt pretensioners, front seatbelt usage sensors, front passenger sensing system and indicator lights.

# Airbags

## HOW DO THE FRONT AIRBAGS WORK

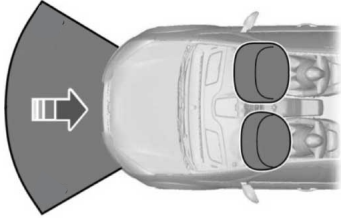

The driver and front passenger airbags deploy during significant frontal and near frontal crashes.

The driver and passenger front airbag system consists of:

- Driver and passenger airbag modules.
- Front passenger sensing system.
- Crash sensors and monitoring system with readiness indicator. See **Crash Sensors and Airbag Indicator** (page 65).

The airbags are a supplemental restraint system and are designed to work with the seatbelts to help protect the driver and right front passenger from certain upper body injuries. Airbags do not inflate slowly; there is a risk of injury from a deploying airbag.

**Note:** *You will hear a loud bang and see a cloud of harmless powdery residue if an airbag deploys. This is normal.*

The airbags inflate and deflate rapidly upon activation. After airbag deployment, it is normal to notice a smoke-like, powdery residue or smell the burnt propellant. This may consist of cornstarch, talcum powder (to lubricate the bag) or sodium

compounds (for example, baking soda) that result from the combustion process that inflates the airbag. Small amounts of sodium hydroxide may be present which may irritate the skin and eyes, but none of the residue is toxic.

Contact with a deploying airbag may cause abrasions or swelling. Temporary hearing loss is also a possibility as a result of the noise associated with a deploying airbag.

Because airbags must inflate rapidly and with considerable force, there is the risk of death or serious injuries such as fractures, facial and eye injuries or internal injuries, particularly to occupants who are not properly restrained or are otherwise out of position at the time of airbag deployment. Thus, it is extremely important that occupants be properly restrained as far away from the airbag module as possible while maintaining vehicle control.

Routine maintenance of the airbags is not required.

## HOW DO THE SIDE AIRBAGS WORK



**WARNING:** Do not place objects or mount equipment on or near the airbag cover, on the side of the front or rear seatbacks, or in areas that may come into contact with a deploying airbag. Failure to follow these instructions may increase the risk of personal injury in the event of a crash.



**WARNING:** Accessory seat covers not released by Ford could prevent the deployment of the airbags and increase the risk of injuries in a crash.

# Airbags



**WARNING:** Do not lean your head on the door. The side airbag could injure you as it deploys from the side of the seatback.

The side airbags are on the outermost side of the seat backrests of the front seats. In certain sideways crashes or rollovers, the airbags will be inflated. The airbag was designed to inflate between the door panel and occupant to further enhance the protection provided to occupants in side impact crashes.



The system consists of the following:

- A label or embossed side panel indicating that side airbags are fitted to your vehicle.
- Side airbags inside the driver and front passenger seat backrests.
- Crash sensors and monitoring system with readiness indicator. See **Crash Sensors and Airbag Indicator** (page 65).

## HOW DO THE KNEE AIRBAGS WORK

Driver and passenger knee airbags are under or within the instrument panel. During a crash, the restraints control module may activate the driver and passenger knee airbags (individually or both) based on crash severity and respective occupant conditions. Under certain crash and occupant conditions, the driver and passenger knee airbags may deploy (individually or both) but the corresponding front airbag may not activate. It is important to be properly seated and restrained to reduce the risk of death or serious injury.



Make sure the knee airbags are operating properly. See **Crash Sensors and Airbag Indicator** (page 65).

## HOW DOES THE SAFETY CANOPY™ WORK



**WARNING:** Do not place objects or mount equipment on or near the headliner at the siderail that may come into contact with a deploying curtain airbag. Failure to follow these instructions may increase the risk of personal injury in the event of a crash.



**WARNING:** Do not lean your head on the door. The curtain airbag could injure you as it deploys from the headliner.



**WARNING:** To reduce risk of injury, do not obstruct or place objects in the deployment path of the airbag.

# Airbags

The Safety Canopy deploys during significant side crashes or when a certain likelihood of a rollover event is detected by the rollover sensor. The Safety Canopy is mounted to the roof side-rail sheet metal, behind the headliner, above each row of seats. In certain sideways crashes or rollover events, the Safety Canopy will be activated, regardless of which seats are occupied. The Safety Canopy inflates between the side window area and occupants to further enhance protection provided in side impact crashes and rollover events.

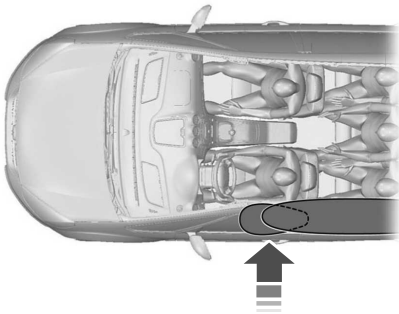

The system consists of the following:

- Safety Canopy curtain airbags above the trim panels over the front and rear side windows identified by a label or wording on the headliner or roof-pillar trim.
- A flexible headliner which opens above the side doors to allow air curtain deployment



• Crash sensors and monitoring system with a readiness indicator. See **Crash Sensors and Airbag Indicator** (page 65).

Properly restrain children 12 years old and under in the rear seats. The Safety Canopy will not interfere with children restrained using a properly installed child or booster seat because it is designed to inflate downward from the headliner above the doors along the side window opening.

## AIRBAG PRECAUTIONS



**WARNING:** Airbags do not inflate slowly or gently, and the risk of injury from a deploying airbag is the greatest close to the trim covering the airbag module.



**WARNING:** All occupants of your vehicle, including the driver, should always properly wear their seatbelts, even when an airbag supplemental restraint system is provided. Failure to properly wear your seatbelt could seriously increase the risk of injury or death.



**WARNING:** Properly secure children 12 years old and under in a rear seating position whenever possible. If you are unable to properly secure all children in a rear seating position, properly secure the largest child on the front seat. If you must use a forward facing child restraint on the front seat, move the seat as far back as possible. Failure to follow these instructions could result in personal injury or death.



**WARNING:** Do not place your arms on the airbag cover or through the steering wheel. Failure to follow this instruction could result in personal injury.

# Airbags



**WARNING:** Keep the areas in front of the airbags free from obstruction. Do not affix anything to or over the airbag covers. Objects could become projectiles during airbag deployment. Failure to follow this instruction could result in personal injury or death.



**WARNING:** To reduce risk of injury, do not obstruct or place objects in the deployment path of the airbag.



**WARNING:** Do not place a rearward facing child restraint in front of an active airbag. Failure to follow this instruction could result in personal injury or death.



**WARNING:** Do not attempt to service, repair, or modify the supplementary restraint system or associated components. Failure to follow this instruction could result in personal injury or death.



**WARNING:** Several airbag system components get hot after inflation. To reduce the risk of injury, do not touch them after inflation.



**WARNING:** If a supplementary restraint system component has deployed, it will not function again. Have the system and associated components inspected as soon as possible. Failure to follow this instruction could result in personal injury or death.

## PROPERLY ADJUSTING THE DRIVER AND FRONT PASSENGER SEATS



**WARNING:** National Highway Traffic Safety Administration (NHTSA) recommends a minimum distance of at least 10 in (25 cm) between an occupant's chest and the driver airbag module.

To properly position yourself away from the airbag:

- Move your seat to the rear as far as you can while still reaching the pedals comfortably.
- Recline the seat slightly one or two degrees from the upright position.

After all occupants have adjusted their seats and put on seatbelts, it is very important that they continue to sit properly. Properly seated occupants sit upright, lean against the seat backrest, and center themselves on the seat cushion, with their feet comfortably extended on the floor. Sitting improperly can increase the chance of injury in a crash event. For example, if an occupant slouches, lies down, turns sideways, sits forward, leans forward or sideways, or puts one or both feet up, the chance of injury during a crash greatly increases.

## CHILDREN AND AIRBAGS



**WARNING:** Do not place a rearward facing child restraint in front of an active airbag. Failure to follow this instruction could result in personal injury or death.



# Airbags



## How Does the Front Passenger Sensing System Work

The system uses a passenger airbag status indicator which illuminates indicating that the front passenger frontal airbag is either enabled or disabled.

**Note:** When you first switch the ignition on, the passenger airbag status indicator off and on lamps illuminate for a short period to confirm they are functional.



Children must always be properly restrained. Accident statistics suggest that children are safer when properly restrained in the rear seating positions than in the front seating position. Failure to follow these instructions may increase the risk of injury in a crash.

If two adults and a child occupy a vehicle without rear seats, properly restrain the child in the center front seat unless doing so would interfere with driving your vehicle. This provides lap and shoulder belt protection for all occupants, and airbag protection for the adults. A child or infant properly restrained in the center front seat should not incur risk of serious injury from the airbags.

## FRONT PASSENGER SENSING SYSTEM

### What Is the Front Passenger Sensing System

This system detects a properly seated occupant and determines if the front passenger airbag should be enabled.

The indicator lamps are in the overhead console.

The front passenger sensing system is designed to disable the front passenger frontal airbag under these conditions:

- The front passenger seat is unoccupied.
- The system determines an infant is present in a child restraint.
- A passenger takes their weight off of the seat for a period of time.
- If there is a problem with the airbag system or the passenger sensing system.

Even with this technology, parents are strongly encouraged to always properly restrain children in the rear seat.

# Airbags

- When the front passenger sensing system disables the front passenger frontal airbag, the passenger airbag status indicator illuminates the off lamp.
- If you have installed the child restraint and the passenger airbag status indicator illuminates the on lamp, switch your vehicle off, remove the child restraint from your vehicle and reinstall the restraint following the child restraint manufacturer's instructions.

The front passenger sensing system works with sensors that are part of the front passenger seat and seatbelt. The sensors are designed to detect the presence of a properly seated occupant and determine if the front passenger frontal airbag should be enabled.

- When the front passenger sensing system enables the front passenger frontal airbag, the passenger airbag status indicator illuminates the on lamp.

If a person of adult size is sitting in the front passenger seat, but the passenger airbag status indicator off lamp is illuminated, it is possible that the person is not sitting properly in the seat. If this happens:

- Switch your vehicle off and ask the person to place the seat backrest in an upright position.
- Have the person sit upright in the seat, centered on the seat cushion, with the person's legs comfortably extended.
- Restart your vehicle and have the person remain in this position for about two minutes. This allows the system to detect that person and enable the passenger frontal airbag.
- If the indicator off lamp remains illuminated even after this, you should advise the person to ride in the rear seat.

After all occupants have adjusted their seats and put on seatbelts, it is very important that they continue to sit upright, leaning against the seat backrest, and centered on the seat cushion, with their feet comfortably extended on the floor.

Sitting improperly can increase the chance of injury in a crash event. For example, if an occupant slouches, lies down, turns sideways, sits forward, leans forward or sideways, or puts one or both feet up, the chance of injury during a crash greatly increases.

If you think that the state of the passenger airbag status indicator lamp is incorrect, check for the following:

- Objects lodged underneath the seat.
- Objects between the seat cushion and the center console.
- Objects hanging off the seat backrest.
- Objects stowed in the seat backrest map pocket.
- Objects placed on the occupant's lap.
- Cargo interference with the seat
- Other passengers pushing or pulling on the seat.
- Rear passenger feet and knees resting or pushing on the seat.

The listed conditions could cause the weight of a properly seated occupant to be incorrectly interpreted by the front passenger sensing system. The person in the front passenger seat could appear heavier or lighter due to the conditions listed.



Make sure the front passenger sensing system is operating properly. See **Crash Sensors and Airbag Indicator** (page 65).

If the airbag readiness light is on, do the following:

# Airbags

- Pull your vehicle over.
- Switch your vehicle off.
- Check for any objects lodged underneath the front passenger seat or cargo interfering with the seat.
- Remove the obstruction if found.
- Restart your vehicle.
- Wait at least two minutes and verify that the airbag readiness light in the instrument cluster is no longer illuminated.
- If the airbag readiness light in the instrument cluster remains illuminated, there may be a problem due to the front passenger sensing system.

Do not attempt to repair or service the system. Take your vehicle in for service immediately.

If it is necessary to modify an advanced front airbag system to accommodate a person with disabilities, contact your Customer Relationship Center. See **Contacting Us** (page 19).

## Front Passenger Sensing System Precautions



**WARNING:** Sitting improperly, out of position or with the seatback reclined too far can take weight off the seat cushion and affect the decision of the passenger sensing system, resulting in serious injury or death in the event of a crash. Always sit upright against your seat back, with your feet on the floor.



**WARNING:** Any alteration or modification to the front passenger seat may affect the performance of the front passenger sensing system. This could seriously increase the risk of injury or death.

## Front Passenger Sensing System Indicators

Occupant	Passenger Airbag Status Indicator	Passenger Airbag
Empty	OFF: Illuminated	Disabled
	ON: Not Illuminated	
Child	OFF: Illuminated	Disabled
	ON: Not Illuminated	
Adult	OFF: Not Illuminated	Enabled
	ON: Illuminated	

# Airbags

## CRASH SENSORS AND AIRBAG INDICATOR



**WARNING:** Modifying or adding equipment to the front end of your vehicle (including hood, bumper system, frame, front end body structure, tow hooks and hood pins) may affect the performance of the airbag system, increasing the risk of injury. Do not modify or add equipment to the front end of your vehicle.

Your vehicle has a collection of crash and occupant sensors. These sensors provide information to the restraints control module which activates the following:

- Front seatbelt pretensioners.
- Driver airbag.
- Passenger airbag.
- Knee airbag(s).
- Seat mounted side airbags.
- Safety Canopy.

Based on the type of crash, the restraints control module deploys the appropriate safety devices.

The restraints control module also monitors the readiness of the above safety devices plus the crash and occupant sensors. The readiness of the safety system is indicated by a warning indicator light in the instrument cluster or by a backup tone if the warning light is not working. Routine maintenance of the airbag is not required.

A difficulty with the system is indicated by one or more of the following:



The readiness light will not illuminate immediately after you switch the ignition on.

- The readiness light either flashes or stays on.
- You hear a series of five tones. The tone pattern repeats periodically until the problem, the light or both are repaired.

If any of these things happen, even intermittently, have the supplemental restraint system serviced immediately. Unless serviced, the system may not function properly in the event of a crash.

The fact that the seatbelt pretensioners or front airbags did not activate for both front seat occupants in a crash does not mean that something is wrong with the system. Rather, it means the restraints control module determined the accident conditions (crash severity, seatbelt usage) were not appropriate to activate these safety devices.

- The front airbags activate only in frontal and near-frontal crashes. Front airbags may activate in rollovers, side impacts or rear impacts if the crash causes sufficient frontal deceleration.
- The seatbelt pretensioners activate in frontal, near-frontal and side crashes, and in rollovers.
- The knee airbag(s) deploy based on crash severity and occupant conditions.
- The side airbags inflate in certain side impact crashes or rollover events. Side airbags may activate in other types of crashes if the vehicle experiences sufficient sideways motion or deformation.
- The Safety Canopy inflates in certain side impact crashes or rollover events. The Safety Canopy may activate in other types of crashes if the vehicle experiences sufficient sideways motion or deformation, or a certain likelihood of rollover.

# Airbags

---

## **DISPOSING OF AIRBAGS**

Contact your authorized dealer as soon as possible. Airbags must be disposed of by qualified personnel.

# **Pedestrian Alert System (If Equipped)**

---

## **WHAT IS THE PEDESTRIAN ALERT SYSTEM**

Due to the quiet operation of hybrid and electric vehicles at low speeds, the system creates a subtle sound to alert pedestrians.

The system is on when your vehicle is running and not in park (P). Some sound may be audible in the passenger compartment.

# 911 Assist (If Equipped)

## WHAT IS 911 ASSIST

911 Assist is a SYNC system feature that can call for help.

For more information, visit [www.owner.ford.com](http://www.owner.ford.com).

## HOW DOES 911 ASSIST WORK

If a crash deploys an airbag, excluding knee airbags and rear inflatable seatbelts, or activates the fuel pump shut-off, your vehicle may be able to contact emergency services by dialing 911 through a paired and connected Bluetooth-enabled phone.

Not all crashes will deploy an airbag or activate the fuel pump shut-off. If a connected cell phone sustains damage or loses its connection to SYNC during a crash, SYNC will search for and try to connect to a previously paired cell phone. SYNC will then attempt to call the emergency services.

Before making the call:

- SYNC provides about 10 seconds to cancel the call. If you fail to cancel the call, SYNC attempts to dial 911.
- SYNC says the following, or a similar message: "SYNC will attempt to call 911, to cancel the call, press Cancel on your screen or press and hold the phone button on your steering wheel."

If you do not cancel the call and SYNC makes a successful call a pre-recorded message plays for the 911 operator. The occupants in your vehicle are able to talk with the operator. Be prepared to provide your name, phone number and location immediately because not all 911 systems are capable of receiving this information electronically.

During an emergency call the system transmits vehicle data to the emergency service.

## EMERGENCY CALL REQUIREMENTS



**WARNING:** Do not wait for 911 Assist to make an emergency call if you can do it yourself. Dial emergency services immediately to avoid delayed response time which could increase the risk of serious injury or death after a crash. If you do not hear 911 Assist within five seconds of the crash, the system or phone may be damaged or non-functional.



**WARNING:** Always place your phone in a secure location in your vehicle so it does not become a projectile or get damaged in a crash. Failure to do so may cause serious injury to someone or damage the phone which could prevent 911 Assist from working properly.



**WARNING:** Unless the 911 Assist setting is set on before a crash, the system will not dial for help which could delay response time, potentially increasing the risk of serious injury or death after a crash.

- SYNC must be powered and working properly at the time of the incident and throughout feature activation and use.
- The 911 Assist feature must be set on before the incident.
- You must pair and connect a Bluetooth-enabled and compatible cell phone to SYNC.
- A connected Bluetooth-enabled phone must have the ability to make and maintain an outgoing call at the time of the incident.

## 911 Assist (If Equipped)

---

- A connected Bluetooth-enabled phone must have adequate network coverage, battery power and signal strength.
- The vehicle must have battery power and be located in the U.S., Canada or in a territory in which 911 is the emergency number.

**Note:** *If any user sets 911 Assist to on or off, that setting applies for all paired phones. If 911 Assist is off and the phone is connected to SYNC, an icon displays on the status bar.*

**Note:** *Every phone operates differently. While SYNC 911 Assist works with most cellular phones, some may have trouble using this feature.*

### EMERGENCY CALL LIMITATIONS

The SYNC 911 Assist feature only operates in the U.S., Canada or in a territory in which 911 is the emergency number. The following are limitations of this feature:

- Your cellular phone or 911 Assist hardware sustains damage in a crash.
- The vehicle's battery or the SYNC system has no power.
- The phone(s) thrown from your vehicle are the ones paired and connected to the system.



# Keys and Remote Controls

## REMOTE CONTROL LIMITATIONS



**WARNING:** Changes or modifications not expressly approved by the party responsible for compliance could void the user's authority to operate the equipment. The term "IC:" before the radio certification number only signifies that Industry Canada technical specifications were met.

This device complies with Part 15 of the FCC Rules and with Industry Canada license-exempt RSS standard(s). Operation is subject to the following two conditions: (1) This device may not cause harmful interference, and (2) This device must accept any interference received, including interference that may cause undesired operation.

Make sure a valid remote control is within 5 ft (1.5 m) from the front door handles and rear of vehicle.

The system may not function if:

- The remote control remains stationary for about a minute.
- The vehicle battery has no charge.
- The remote control battery has no charge.
- There is interference causing issues with the remote control frequencies.
- The remote control is too close to metal objects or electronic devices, for example keys or a cell phone.

## USING THE REMOTE CONTROL

Use your remote control to access various vehicle systems.

**Note:** *The buttons on your remote may vary depending on the vehicle region or options.*

### Unlock



Press the button to unlock all doors. See **Unlocking and Locking the Doors Using the Remote Control** (page 84).

### Lock



Press the button to lock all doors. See **Unlocking and Locking the Doors Using the Remote Control** (page 84).

### Remote Start (If Equipped)



Press the button to remote start. See **Remotely Starting and Stopping the Vehicle** (page 155).

### Tailgate (If Equipped)



Press the button to open the tailgate. See **Opening the Tailgate Using the Remote Control** (page 104).

### Panic Alarm (If Equipped)



Press the button to sound the panic alarm. See **Sounding the Panic Alarm** (page 71).

## OPENING AND CLOSING THE FLIP KEY

### Opening Your Flip Key

Press the round button on the remote control to extend the flip key.

# Keys and Remote Controls

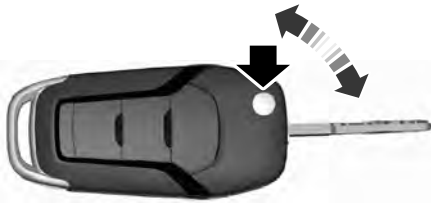

**Note:** *Inspect the key blade for debris. Periodically clean with a brush.*

## Closing Your Flip Key

Press and hold the round button on the remote control to fold the key blade when not in use.

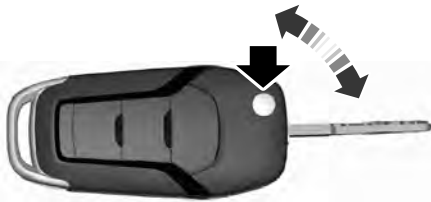

## REMOVING THE KEY BLADE



Push the release button on your passive key and pull the key blade out.

## SOUNDING THE PANIC ALARM



Press the button to sound the panic alarm. Press the button again, or switch the ignition on to turn it off.

**Note:** *The panic alarm only operates when the ignition is off.*

## LOCATING YOUR VEHICLE



Press the lock button twice within three seconds. The turn signal lamps flash.

**Note:** *We recommend you use this method to locate your vehicle.*

# Keys and Remote Controls

## CHANGING THE REMOTE CONTROL BATTERY - VEHICLES WITH: PUSH BUTTON START



**WARNING:** Keep batteries away from children to prevent ingestion. Failure to follow this instruction could result in personal injury or death. If ingested, immediately seek medical attention.



**WARNING:** If the battery compartment does not securely close, stop using the remote control and replace it as soon as possible. In the meantime, keep the remote control away from children. Failure to follow this instruction could result in personal injury or death.

The remote control uses one coin-type 3-volt lithium battery CR2450 or equivalent.



1. Push the release button and pull the key blade out.

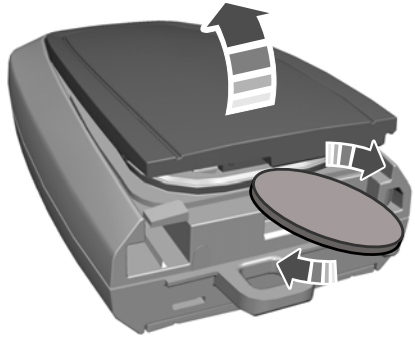
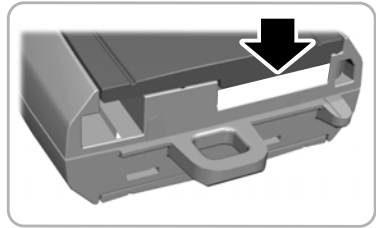

2. Twist a thin coin under the tab hidden behind the key blade head to remove the battery cover.

# Keys and Remote Controls

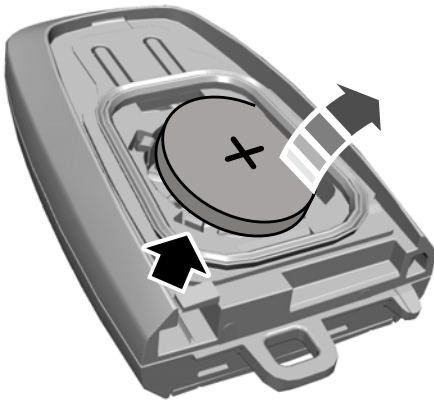

3. Insert a screwdriver, and carefully remove the battery.
4. Install a new battery with the + facing upward.
5. Reinstall the battery housing cover onto the transmitter and install the key blade.



Dispose of old batteries in an environmentally friendly way. Seek advice from your local authority about recycling old batteries.

**Note:** Do not wipe off any grease on the battery terminals or on the back surface of the circuit board.

**Note:** Replacing the battery does not erase the programmed key from your vehicle. The remote control should operate normally.

## CHANGING THE REMOTE CONTROL BATTERY - VEHICLES WITH: FLIP KEY

**WARNING:** Keep batteries away from children to prevent ingestion. Failure to follow this instruction could result in personal injury or death. If ingested, immediately seek medical attention.

**WARNING:** If the battery compartment does not securely close, stop using the remote control and replace it as soon as possible. In the meantime, keep the remote control away from children. Failure to follow this instruction could result in personal injury or death.

### Battery Replacement Procedure

The remote control uses one coin-type 3-volt lithium battery CR2032 or equivalent.

Press the button to release the key blade before beginning the procedure.



1. Insert a screwdriver, in the position shown and gently push the clip.
2. Press the clip down to release the battery cover.

## Keys and Remote Controls

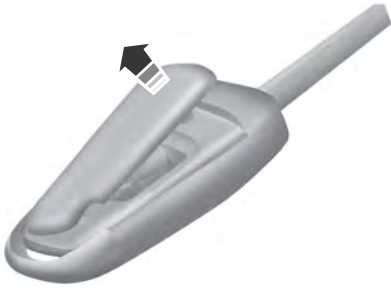

3. Carefully remove the cover.



4. Insert a screwdriver as shown to release the battery.

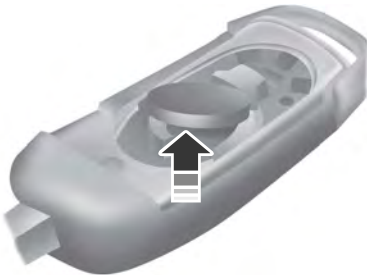

**Note:** Do not touch the battery contacts or the printed circuit board with the screwdriver.

5. Remove the battery.

6. Install a new battery with the + facing up.

7. Replace the battery cover.



Dispose of old batteries in an environmentally friendly way. Seek advice from your local authority about recycling old batteries.

**Note:** Do not wipe off any grease on the battery terminals or on the back surface of the circuit board.

**Note:** Replacing the battery does not erase the programmed key from your vehicle. The remote control should operate normally.

### REPLACING A LOST KEY OR REMOTE CONTROL

You can purchase replacement keys or remote controls from an authorized dealer. Authorized dealers can program remote controls for your vehicle.



**Note:** Your vehicle keys came with a security label that provides important key cut information. Keep the label in a safe place for future reference.

# Keys and Remote Controls

## PROGRAMMING THE REMOTE CONTROL - VEHICLES WITH: PUSH BUTTON START

### General Information

You must have two previously programmed remote controls inside your vehicle and the new unprogrammed remote controls readily accessible. Contact an authorized dealer to have the spare remote control programmed if two previously programmed remotes are not available. Make sure that your vehicle is off before beginning this procedure. Make sure that you close all the doors before beginning and that they remain closed throughout the procedure. Perform all steps within 30 seconds of starting the sequence. Stop and wait for at least one minute before starting again if you perform any steps out of sequence.

Read and understand the entire procedure before you begin.

**Note:** You can program a maximum of four remote controls to your vehicle.

**Note:** If your programmed remote controls are lost or stolen and you do not have an extra coded remote, you need to have your vehicle towed to an authorized dealer. Store an extra programmed remote away from your vehicle in a safe place to help prevent any inconvenience. Contact an authorized dealer to purchase additional spare or replacement remotes.

### Steps for Programming Your Spare Remote Control

**Note:** Your vehicle is equipped with one of the following center consoles.

### Programming Backup Location

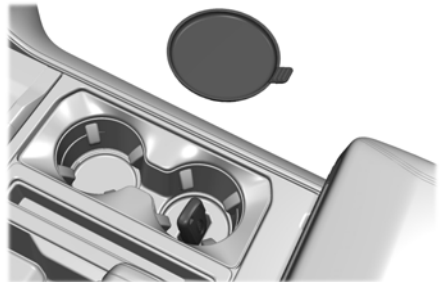

1. Place the first programmed remote in the backup slot inside the center console with your foot off the brake pedal, press and release the push button ignition switch.
2. Wait five seconds and then press and release the push button ignition switch again.
3. Remove the remote control.
4. Within 10 seconds, place a second programmed remote control in the backup slot. Press and release the push button ignition switch.
5. Wait five seconds and then press and release the push button ignition switch again. Keep the ignition on for at least three seconds, but no more than 10 seconds.
6. Remove the remote control.

# Keys and Remote Controls

---

7. Place the unprogrammed remote control in the backup slot and press and release the push button ignition switch.

Programming is now complete. With your foot on the brake pedal, press the push button ignition switch to verify the remote control functions operate and your vehicle starts with the new remote control.

If programming was not successful, wait 10 seconds and repeat Steps 1 through 7. If you are still unsuccessful, take your vehicle to an authorized dealer.

## PROGRAMMING THE REMOTE CONTROL - VEHICLES WITH: FLIP KEY

### General Information

You can program your own remote control to your vehicle. This procedure programs both the engine immobilizer keycode and the remote entry portion of the remote control to your vehicle.

Only use remote controls with an integrated mechanical key.

You must have two previously programmed coded remote controls and the new un-programmed remote readily accessible. Contact an authorized dealer to have the spare remote control programmed if the two previously programmed coded remote controls are not available.

Read and understand the entire procedure before you begin.

### Steps for Programming Your Spare Remote Control

1. Insert the first previously programmed coded key into the ignition.
2. Switch the ignition from off to on. Keep the ignition on for at least three seconds, but no more than 10 seconds.
3. Switch the ignition off and remove the first coded key from the ignition.
4. After three seconds but within 10 seconds of switching the ignition off, insert the second previously coded key into the ignition.
5. Switch the ignition from off to on. Keep the ignition on for at least three seconds, but no more than 10 seconds.
6. Switch the ignition off and remove the second previously programmed coded key from the ignition.
7. After three seconds but within 10 seconds of switching the ignition off and removing the previously programmed coded key, insert the new un-programmed key into the ignition.
8. Switch the ignition from off to on. Keep the ignition on for at least six seconds until you hear the door locks cycle.
9. Remove the newly programmed coded key from the ignition.

The key starts the engine if programming is successful. You can operate the keyless remote entry system with the new remote control with integrated key.

If programming was not successful, wait 20 seconds and repeat Steps 1 through 8. If you are still unsuccessful, take your vehicle to an authorized dealer.

**Note:** *You can program a maximum of six coded remote controls to your vehicle.*

# Keys and Remote Controls

---

## KEYS AND REMOTE CONTROLS – TROUBLESHOOTING

### Keys and Remote Controls – Information Messages

<b>Message</b>	<b>Action</b>
Key Battery Low Replace Soon	Replace remote control battery.



## WHAT IS MYKEY

### [MyKey](#)

MyKey allows you to program keys with restricted driving modes to promote good driving habits.

## MYKEY SETTINGS

### Non-Configurable MyKey Settings

#### Seatbelt Reminder or Belt-Minder™

MyKey mutes the audio system until the front seat passengers buckle the front seat belts.

**Note:** *If your vehicle includes an AM/FM radio or a very basic audio system, then the radio may not mute.*

#### Satellite Radio (If Equipped)

Some Satellite radio channels have restricted access to adult radio content.

#### Early Low Fuel

The low fuel level warning lamp turns on earlier.

#### Driving and Parking Aids

You cannot configure settings for parking aids, blind spot information system, and cross traffic alert. These systems turn on when the vehicle turns on, and you cannot switch them off with a MyKey.

You cannot configure settings for pre-collision assist and lane keeping. These systems turn on when the vehicle turns on, but you can switch them off with a MyKey.

A new destination in the navigation system can only be set using voice commands when using a MyKey, and with your vehicle moving.

**Note:** *MyKey drivers may be able to switch the lane departure warning feature off, but this feature turns back on automatically with every new key cycle.*

## Configurable MyKey Settings

You can configure the following settings after creating a MyKey. See **Creating a MyKey** (page 80).

### Speed Limit



**WARNING:** Do not set MyKey maximum speed limit to a limit that will prevent the driver from maintaining a safe speed considering posted speed limits and prevailing road conditions. The driver is always responsible to drive in accordance with local laws and prevailing conditions. Failure to do so could result in accident or injury.

You can set a speed limit for your vehicle. Warning messages appear in the information display and a tone sounds if your vehicle reaches the set speed. You cannot override the set speed when using a MyKey.

### Speed Minder

You can set a speed reminder for your vehicle. Warning messages appear in the information display and a tone sounds if your vehicle exceeds the set speed.

### Audio System Volume Limit

The audio system maximum volume is reduced. A message appears in the information display if you attempt to exceed the volume limit. Automatic volume control turns off.

# MyKey™ (If Equipped)

## Emergency Assistance

If you set emergency assistance to always on, you cannot switch it off with a MyKey.

## Do Not Disturb

If you set do not disturb to always on, you cannot switch it off with a MyKey.

**Note:** *If a phone is connected using Apple CarPlay or Android Auto while driving with a MyKey, the driver can receive phone calls and text messages even if the do not disturb restriction is on, and if the vehicle is equipped with satellite radio, the adult content is not restricted.*

## Traction Control

If you set traction control to always on, you cannot switch it off with a MyKey.

## CREATING A MYKEY - VEHICLES WITH: PUSH BUTTON START

Vehicles with a center console shifter:

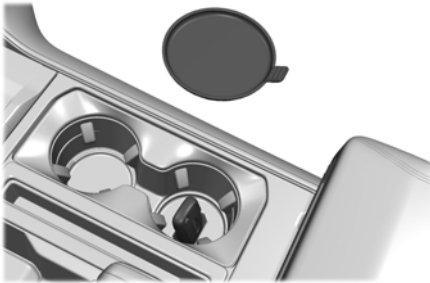

1. Remove the mat from the center console cup holder.
2. Remove the key blade from the transmitter.

3. Place the remote control in the backup slot with the buttons facing toward the front of the vehicle.
4. Switch the ignition on using an admin key.
5. Press **Settings** on the touchscreen.
6. Press **Vehicle Settings**.
7. Press **MyKey**.
8. Press **Create MyKey**.
9. Press **Yes**.

**Note:** *After you confirm the creation of a MyKey, we recommend that you label this key.*

Vehicles with a column shifter.



1. Raise the front center seat storage lid.
2. Place the remote control in the backup slot with the buttons facing toward the front of the vehicle.
3. Switch the ignition on using an admin key.
4. Press **Settings** on the touchscreen.
5. Press **Vehicle Settings**.
6. Press **MyKey**.
7. Press **Create MyKey**.
8. Press **Yes**.

**Note:** *After you confirm the creation of a MyKey, we recommend that you label this key.*

## CREATING A MYKEY - VEHICLES WITH: FLIP KEY

1. Switch the ignition on using an admin key.
2. Press **Settings** on the touchscreen.
3. Press **Vehicle Settings**.
4. Press **MyKey**.
5. Press **Create MyKey**.
6. Press **Yes**.

**Note:** After you confirm the creation of a MyKey, we recommend that you label this key.

## PROGRAMMING A MYKEY

You can program any remote control to become a restricted MyKey, but you must leave one unmodified as an admin key.

1. Switch the ignition on using an admin key.
2. Press **Settings** on the touchscreen.
3. Press **Vehicle Settings**.
4. Press **MyKey**.
5. Select a setting and press the **OK** button.
6. Configure the setting

## CLEARING ALL MYKEYS

When you clear all MyKeys, you remove all restrictions and return all MyKeys to their original admin key status.

1. Switch the ignition on using an admin key.
2. Press **Settings** on the touchscreen.
3. Press **Vehicle Settings**.
4. Press **MyKey**.
5. Press **Clear All MyKeys**.
6. Press **Yes**.

## CHECKING MYKEY SYSTEM STATUS

You can find information about the distance traveled using a MyKey, and the number of admin keys and MyKeys created for your vehicle.

1. Switch the ignition on.
2. Press **Settings** on the touchscreen.
3. Press **Vehicle Settings**.
4. Press **MyKey**.
5. Press **MyKey Information**.

## USING MYKEY WITH REMOTE START SYSTEMS (IF EQUIPPED)

MyKey is not compatible with unapproved, aftermarket remote start systems. If you choose to install a remote start system, see an authorized dealer for an approved remote start system.

## MYKEY – TROUBLESHOOTING

### MyKey – Information Messages - Vehicles With: Push Button Start

Message	Description
Place Key in Backup Location	Displays when trying to create a MyKey and the admin key is not placed in the backup position. See <b>Creating a MyKey</b> (page 79).
Key is Already a MyKey	Displays when trying to create a MyKey with a key already designated as a MyKey.
This Key restricted at Next Key Cycle. Label Key as MyKey	Displays to confirm that the key is restricted after you switch the ignition off.

## MyKey™ (If Equipped)

---

### MyKey – Information Messages - Vehicles With: Flip Key

<b>Message</b>	<b>Description</b>
Key is Already a MyKey	Displays when trying to create a MyKey with a key already designated as a MyKey.
This Key restricted at Next Key Cycle. Label Key as MyKey	Displays to confirm that the key is restricted after you switch the ignition off.

## **MyKey – Frequently Asked Questions - Vehicles With: Push Button Start**

### **What is an admin key?**

An admin key is a key that you have not created as a MyKey. See **Creating a MyKey** (page 79).

### **Why am I not able to create a MyKey?**

You have not placed the admin key in the backup position. See **Creating a MyKey** (page 79). The key used to switch the ignition on is not an admin key. The key used to switch the ignition on is the only admin key. There has to be at least one admin key. You did not switch the ignition off after creating the last MyKey.

### **Why am I not able to program a MyKey?**

The admin key is not inside your vehicle. The key used to switch the ignition on is not an admin key. You have not created any MyKeys. See **Creating a MyKey** (page 79).

### **Why am I not able to clear the MyKeys?**

The admin key is not inside your vehicle. The key used to switch the ignition on is not an admin key. You have not created any MyKeys. See **Creating a MyKey** (page 79).

### **Why is the MyKey distance not accumulating?**

The key used to start the engine is an admin key. An admin key and a MyKey are inside your vehicle. You have not created any MyKeys. See **Creating a MyKey** (page 79). You have cleared the MyKeys. See **Clearing All MyKeys** (page 80).

### **Why am I not able to start the engine with a MyKey?**

An admin key and a MyKey are inside your vehicle. The system recognizes only the admin key when both are present.

## **MyKey – Frequently Asked Questions - Vehicles With: Flip Key**

### **What is an admin key?**

An admin key is a key that you have not created as a MyKey. See **Creating a MyKey** (page 80).

### **Why am I not able to create a MyKey?**

The key used to switch the ignition on is not an admin key. The key used to switch the ignition on is the only admin key. There has to be at least one admin key.

### **Why am I not able to program a MyKey?**

The key used to switch the ignition on is not an admin key. You have not created any MyKeys. See **Creating a MyKey** (page 80).

### **Why am I not able to clear the MyKeys?**

The key used to switch the ignition on is not an admin key. You have not created any MyKeys. See **Creating a MyKey** (page 80).

### **Why is the MyKey distance not accumulating?**

The key used to start the engine is an admin key. You have not created any MyKeys. See **Creating a MyKey** (page 80). You have cleared the MyKeys. See **Clearing All MyKeys** (page 80).

# Doors and Locks

## OPERATING THE DOORS FROM OUTSIDE YOUR VEHICLE

### Unlocking and Locking the Doors Using the Remote Control (if Equipped)

You can only use the remote control when your vehicle is stationary.

### Unlocking the Doors



Press the button to unlock all doors.

### Locking the Doors



Press the button to lock all doors. One short flash of the turn signal lamps confirms that your vehicle has locked.

**Note:** For more information on operating the doors from outside your vehicle

### Unlocking and Locking the Doors Using the Key Blade

If there is a power door lock fault you can use the key blade to lock and unlock the doors.

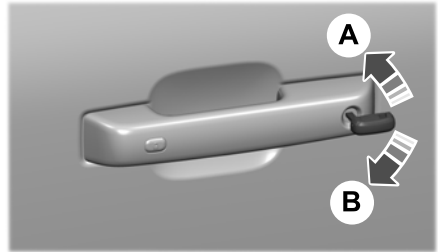

- A Lock.
- B Unlock.

## OPERATING THE DOORS FROM INSIDE YOUR VEHICLE

### Individually Unlocking and Locking the Doors Using the Locking Button

The power door lock control is on the driver and front passenger door panels.

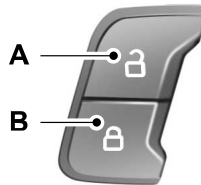

- A Unlock.
- B Lock.

# Doors and Locks

---

## Opening the Doors From Inside Your Vehicle - Crew Cab

Pull the interior door handle twice to unlock and open a rear door. The first pull unlocks the door and the second pull opens the door.

## AUTOUNLOCK (If Equipped)

### What Is Autounlock

Autounlock is an unlocking feature that unlocks the vehicle doors when your vehicle comes to a stop.

### Autounlock Requirements

Autounlock unlocks all the doors when all of the following occur:

- The ignition is on, all the doors are closed and your vehicle is moving at a speed greater than 12 mph (20 km/h).
- Your vehicle comes to a stop.
- You open the driver door within 10 minutes of switching the ignition off or to the accessory position.

### Switching Autounlock On and Off

1. Press **Settings** on the touchscreen.
2. Press **Vehicle Settings**.
3. Switch **Autounlock** on or off.

## AUTOLOCK (If Equipped)

### What Is Autolock

Autolock is a locking feature that locks your vehicle doors when you start driving.

## Autolock Requirements

Autolock locks all the doors when all of the following occur:

- All doors are closed.
- The ignition is on.
- Your vehicle reaches a speed greater than 12 mph (20 km/h).

## Switching Autolock On and Off

1. Press **Settings** on the touchscreen.
2. Press **Vehicle Settings**.
3. Switch **Autolock** on or off.

## MISLOCK (If Equipped)

### What Is Mislock

Mislock is a locking feature that warns you if your vehicle has not locked.

### Mislock Limitations

When you press the lock button once, the direction indicators do not flash if:

- Any door or the tailgate is open.
- The hood is open.

If you switch mislock off, the horn does not sound if you press the lock button on the remote control when a door is open.

## Switching Mislock On and Off

1. Press **Settings** on the touchscreen.
2. Press **Vehicle Settings**.
3. Switch **Mislock Chirp** on or off.



# Doors and Locks

## DOORS AND LOCKS AUDIBLE WARNINGS

### Door Ajar Audible Warning

Sounds when a door is not fully closed and your vehicle is moving.

## DOORS AND LOCKS – TROUBLESHOOTING

### Doors and Locks – Warning Lamps

#### Door Ajar Warning Lamp



It illuminates when you switch the ignition on and remains on if any door or the hood is open.

### Doors and Locks – Information Messages

Message	Action
Driver Door Ajar	Displays if a door is open. Fully close the door.
Passenger Door Ajar	
Rear Left Door Ajar	
Rear Right Door Ajar	

# Keyless Entry (If Equipped)

## LOCATING THE KEYLESS ENTRY KEYPAD (IF EQUIPPED)

The keypad is near the driver window and illuminates when you touch it.



## KEYLESS ENTRY LIMITATIONS

Make sure your remote control is within 3 ft (1 m) from the front door handles and the tailgate.

The system could not function if:

- The remote control remains stationary for about a minute.
- The vehicle battery has no charge.
- The remote control battery has no charge.
- There is interference causing issues with the remote control frequencies.
- The remote control is too close to metal objects or electronic devices, for example keys or a cell phone.

## MASTER ACCESS CODE (If Equipped)

### What Is the Master Access Code

The master access code is a factory-set five-digit entry code. You can operate the keypad with the master access code at any time. The master access code is on the owner's wallet card in the glove box and is available from an authorized dealer.

## KEYLESS ENTRY SETTINGS

### Switching Keyless Entry On and Off

1. Switch the ignition on using an original key that has not been created as a MyKey.
2. Press **Settings** on the touchscreen.
3. Press **Vehicle Settings**.
4. Press **Locks**.

### Reprogramming the Unlocking Function

You can enable two-stage unlocking function allowing you to unlock only the driver door when you touch the unlock sensor.

Press and hold both the lock and unlock buttons on the remote control for four seconds to disable or enable two-stage unlocking.

If you program the unlocking function so that only the driver door unlocks, you can unlock all of the other doors from inside your vehicle using the power door lock control. You can unlock individual doors by pulling the interior door handles on those doors.

# Keyless Entry (If Equipped)

## Creating Personal Access Codes

To create your own personal access code:

1. Enter the factory-set code.
2. Press **1-2** on the keypad within five seconds.
3. Enter your personal five-digit code.
4. Press **1-2** on the keypad to save personal code one.

The doors lock then unlock to confirm that programming was successful.

To program additional personal access codes, repeat Steps 1-3, then for Step 4:

- Press **3-4** to save personal code two.
- Press **5-6** to save personal code three.
- Press **7-8** to save personal code four.
- Press **9-0** to save personal code five.

Hints:

- Do not set a code that uses five of the same number.
- Do not use five numbers in sequential order.
- The factory-set code works even if you have set your own personal code.

## Clearing All Personal Access Codes

1. Enter the factory-set five-digit code.
2. Press and release **1-2** on the keypad within five seconds.
3. Press and hold **1-2** for a few seconds. This must be done within five seconds of completing Step 2.

All personal codes erase and only the factory-set five-digit code works.

## LOCKING AND UNLOCKING THE DOORS USING REMOTE KEYLESS ENTRY

### Unlocking the Doors



With your passive key within 5 ft (1.5 m) of your vehicle, touch the unlock sensor on the back of the door handle for a brief period and then pull on the door handle to unlock, being careful not to touch the lock sensor at the same time or pull on the door handle too quickly. The intelligent access system requires a brief delay to authenticate your intelligent access key.

### Locking the Doors



With your passive key within 3 ft (1 m) of your vehicle, touch the outer door handle lock sensor for approximately one second to lock, being careful to not touch the unlock sensor on the back of the door handle at the same time. After locking, you can immediately pull on the door handle to confirm locking occurred without inadvertently unlocking.

# Keyless Entry (If Equipped)

---

## LOCKING AND UNLOCKING THE DOORS USING KEYLESS ENTRY KEYPAD

### Unlocking the Doors

Enter the factory-set five-digit code or your personal code. You must press each number within five seconds of each other.

- Press 3-4 within five seconds to unlock all doors.
- Press 5-6 within five seconds to release or open the tailgate, if available.

### Locking the Doors

Press and hold 7-8 and 9-0 at the same time with the driver door closed.

**Note:** *You do not need to enter the five digit code first.*

## KEYLESS ENTRY – TROUBLESHOOTING

### Keyless Entry – Frequently Asked Questions

#### Why does the keypad not accept the access code?

If you enter the access code too fast on the keypad, the unlock function may not work. Slowly re-enter the access code.

#### Why does the passive key not work?

The system deactivates passive keys left inside your vehicle when you lock it. You cannot switch the ignition on using a deactivated passive key. Press the unlock button on the remote control to reactivate a passive key.

#### Why does the keypad not function?

The keypad goes into an anti-scan mode if you enter a wrong code seven times. The anti-scan mode disables the keypad for one minute and the red light flashes.

## Easy Entry and Exit (If Equipped)

---

### HOW DOES EASY ENTRY AND EXIT WORK

Easy entry and exit moves the driver seat rearward up to 2 in (5 cm) and the steering column up when you switch the ignition off. The driver seat and steering column return to their previous positions when you switch the ignition on.

**Note:** *Depending on your vehicle, the column may move up and in.*

### SWITCHING EASY ENTRY AND EXIT ON AND OFF

1. Press **Settings** on the touchscreen.
2. Press **Vehicle**.
3. Select **Easy Entry/Exit**.

If you press any adjustment or memory button when in easy exit mode, the system cancels the operation.

# Tailgate - Vehicles With: Manual Tailgate

## OPENING THE TAILGATE

### Opening the Tailgate From Outside Your Vehicle

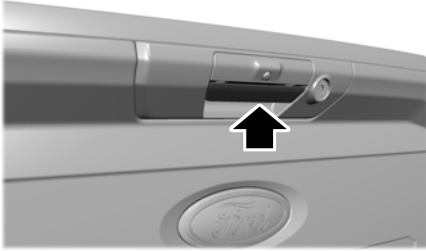

Pull up on the handle to release the tailgate.

**Note:** You may need to unlock the tailgate first.

## LOCKING AND UNLOCKING THE TAILGATE

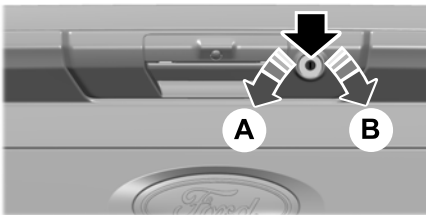

- A Lock.
- B Unlock.

1. Insert the ignition key into the tailgate lock.

2. Turn it to the left to lock the tailgate.
3. Turn it to the right to unlock the tailgate.

## REMOVING AND INSTALLING THE TAILGATE

**WARNING:** Always properly secure cargo to prevent shifting cargo or cargo falling from the vehicle. Failure to do so could result in compromised vehicle stability and serious personal injury to vehicle occupants or others.

**Note:** Skip to Step 4 if your vehicle does not have power door locks.

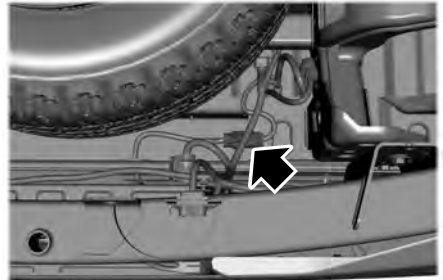

1. Unlatch the tailgate.
2. Disconnect the power door locks in-line connector. It is under the pickup box on the right-hand side of the vehicle near the spare tire.
3. Install a protective cap on the in-line connector portion that remains under the pickup box.

**Note:** A protective cap should be in the glove compartment.

## Tailgate - Vehicles With: Manual Tailgate

- Partially lower the tailgate. Carefully feed the tailgate harness up through the gap between the pickup box and the bumper and place it out of the way under the pickup box.
- Lower the tailgate.

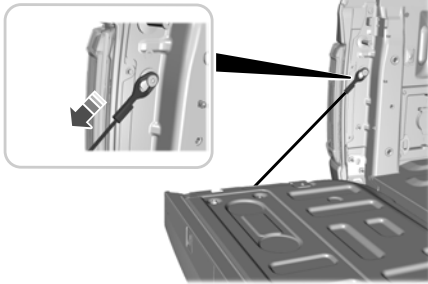

- Use a screwdriver to gently pry the spring clip on each connector past the head of the support screw. Disconnect the cable.
- Disconnect the other cable.

**Note:** To avoid damaging the tailgate, you may need assistance when removing. The tailgate weighs approximately 97lb (44 kg).

- Lift the tailgate to 45 degrees from the horizontal position.
- Lift the right-hand side off its hinge.
- Lift the tailgate to 80 degrees from the horizontal position.
- Remove the tailgate from the left-hand side hinge by sliding it to the right.
- Install the tailgate in reverse order.

### TAILGATE STEP (If Equipped)

#### Accessing the Tailgate Step

##### Integrated Tailgate Step

- Lower the tailgate.

- Push the button in the center of the step molding. The step pops out slightly.

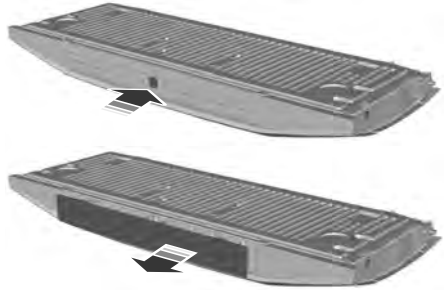

- Pull the step out fully. Lower the step to its lowest position.



- Pull the yellow handle stop backward out of the tailgate until it fully extends.
- To lock the handle in place, rotate the handle up from the horizontal to the vertical position until you hear a click.

**Note:** Do not tow with the step or grab handle.

Replace the slip resistance tape or grab handle molding if it appears as worn or damaged.

## Tailgate - Vehicles With: Manual Tailgate

To reduce the risk of falling:

- Only operate the step when your vehicle is on a level surface.
- Only operate the step in areas with sufficient lighting.
- Make sure you use the grab handle when climbing on the step.
- Do not use the step with bare feet.
- Make sure the step is clean before use.
- Keep the step load below the total maximum load of 350 lb (159 kg).

### Stowing the Tailgate Step

1. Press the yellow button on the handle to lower and then press the yellow lever at the bottom of the handle to unlock. Rotate the handle down from the vertical to the horizontal position and push it into the tailgate.
2. Rotate the step up until it is horizontal, then push it back into the tailgate until the step is secure.

**Note:** Make sure to close and fully latch the step before moving your vehicle. Do not drive with the step or grab handle open.

**Note:** The power tailgate cannot close if the step is opened. A warning message appears and a chime sounds. After stowing the step the power close function is restored.

### BED EXTENDER (If Equipped)

#### Bed Extender Precautions

**Note:** Do not use the bed extender when driving off road.

**Note:** Make sure to engage the locking pins and knobs fully before driving your vehicle.

**Note:** Make sure to secure all cargo.

**Note:** Do not exceed 150 lb (68 kg) on the tailgate when your vehicle is moving.

**Note:** Do not keep the bed extender in the tailgate mode when you are not using it for restraining cargo. Always keep the bed extender in the grocery mode or the stowed position with the tailgate closed.

### Using the Bed Extender

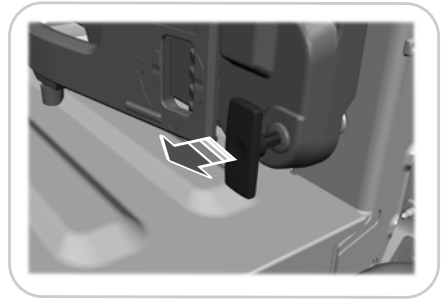
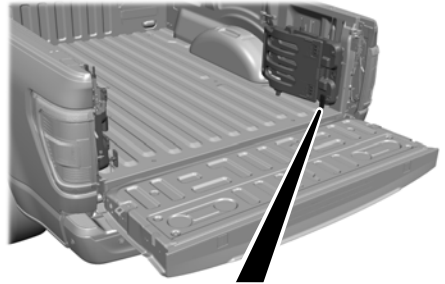

1. Pull the locking pin toward the center of your vehicle.



## Tailgate - Vehicles With: Manual Tailgate

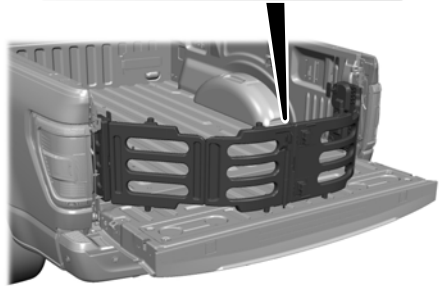
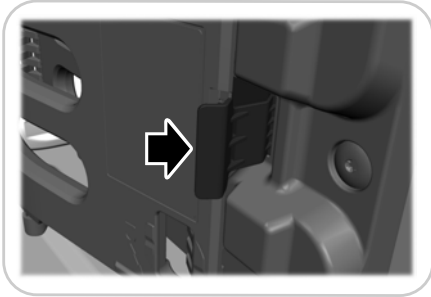
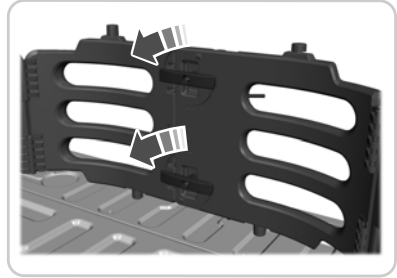
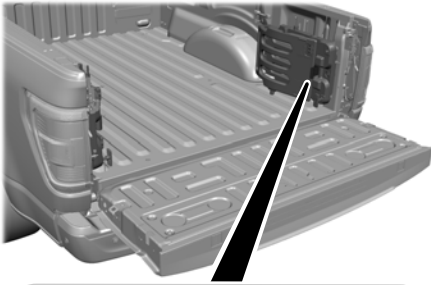

2. Open the latches to release the panels.

4. Connect the two panels. Rotate both knobs one-quarter turn clockwise to secure the panels.

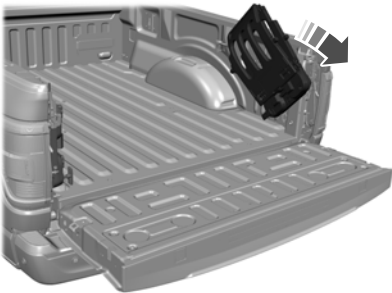

3. Rotate the panels toward the tailgate. Repeat steps 1-3 on the other side of your vehicle.

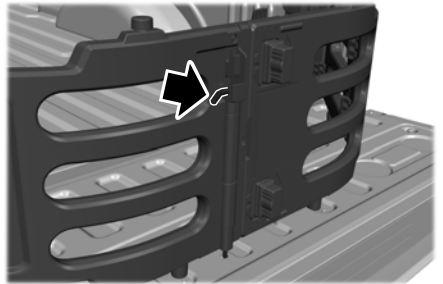

5. Insert the latch rod into the tailgate hole.

6. Engage both sides of the locking pins into their holes in the pick-up box.

# Tailgate - Vehicles With: Manual Tailgate

## Grocery Mode

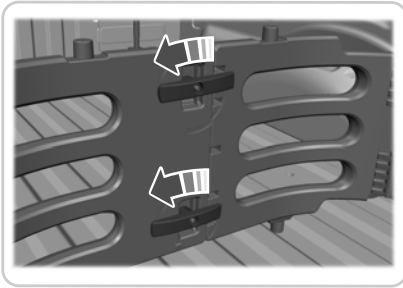
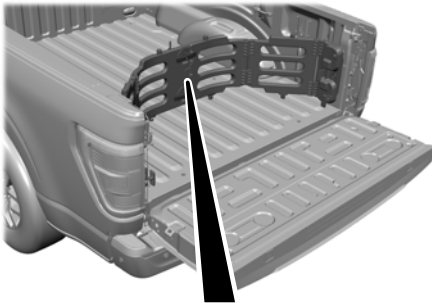

1. Follow steps 1-4.
2. Before engaging the locking pins, rotate the panels away from the tailgate.
3. Engage both sides of the locking pins into their holes in the pick-up box.
4. Close the tailgate.

## **TAILGATE WORK SURFACE (IF EQUIPPED)**

The tailgate work surface is a durable and functional surface on the inside portion of your tailgate you can use to perform various tasks.

To use the tailgate work surface, fold down the tailgate.

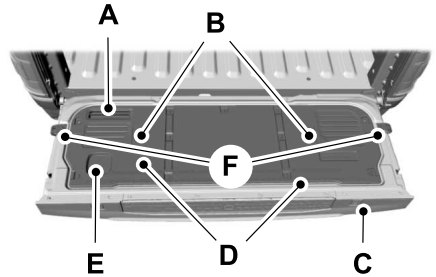

- A Tablet stand.
- B Tool inset.
- C Clamp pocket.
- D Standard and metric ruler.
- E Cup holder.
- F Tailgate anchors.

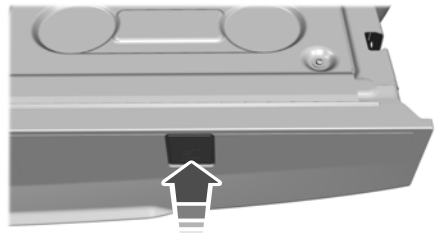

The tailgate work surface contains clamp pockets that allows you to secure work material.

**Note:** *When you have finished using the tailgate work surface, make sure you remove all of your belongings, then close the tailgate.*

# Tailgate - Vehicles With: Power Tailgate

## OPENING THE TAILGATE

### Opening the Tailgate From Inside Your Vehicle

The vehicle must be in park (P) to operate the power tailgate.



Press the button on the instrument panel.

**Note:** A tone sounds while the tailgate opens.

**Note:** The tailgate stops and reverses if it detects an obstruction when opening.

**Note:** An alert sounds if the electronic tailgate is disabled.

### Opening the Tailgate From Outside Your Vehicle

1. Unlock the vehicle with the remote control or power door unlock control.

**Note:** If an intelligent access transmitter is within 3 ft (1 m) of the tailgate, the tailgate unlocks when you press the tailgate release button.



2. Press the button in the top of the tailgate handle.

### Opening the Tailgate Using the Remote Control



Press the remote control button twice within three seconds.

## CLOSING THE TAILGATE

### Closing the Tailgate From Inside Your Vehicle



Press the button on the instrument panel.

**Note:** The tailgate stops and reverses if it detects an obstruction when closing.

### Closing the Tailgate From Outside Your Vehicle

You can close the power tailgate by:

- Pressing the tailgate button on your remote control twice within three seconds.
- Pressing the button on the instrument panel.
- Pressing the button on the tailgate.

**Note:** The tailgate stops and reverses if it detects an obstruction when closing.

### Lift-to-Close

To close the tailgate automatically using lift-to-close, lift the tailgate approximately 4 in (10 cm) and hold it for a few seconds.

**Note:** If the tailgate position is more than halfway between open and close, it may not close automatically.

### Manual Close

You can close the tailgate manually when you lift the tailgate in a continuous motion.

## Tailgate - Vehicles With: Power Tailgate

If you stop the tailgate motion, the lift-to-close feature can engage and power close the tailgate.

### Putting the Tailgate in Manual Mode

You can put the tailgate in manual mode through the vehicle settings in your touchscreen.

**Note:** In manual mode, the tailgate only functions by the tailgate release button and messaging is reduced.

### Closing the Tailgate Using the Remote Control



Press the remote control button twice within three seconds.

## REMOVING AND INSTALLING THE TAILGATE



**WARNING:** Always properly secure cargo to prevent shifting cargo or cargo falling from the vehicle. Failure to do so could result in compromised vehicle stability and serious personal injury to vehicle occupants or others.

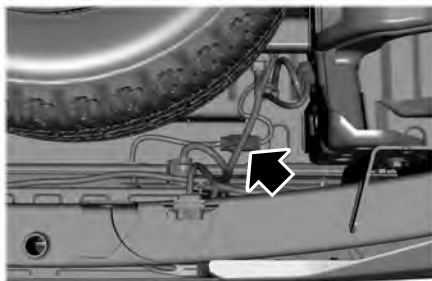

1. Put the tailgate into manual mode by accessing the vehicle settings using the touchscreen.
2. Open the tailgate.
3. Disconnect the power door locks in-line connector. It is under the pickup box on the right-hand side of the vehicle near the spare tire.
4. Install a protective cap on the in-line connector portion that remains under the pickup box.

**Note:** The protective cap is in the glove compartment.

5. Partially raise the tailgate. Carefully feed the tailgate harness up through the gap between the pickup box and the bumper and place it out of the way under the pickup box.
6. Fully lower the tailgate.

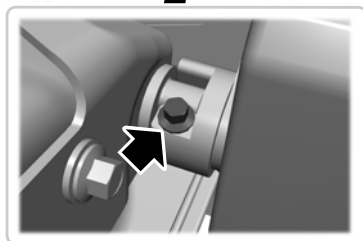
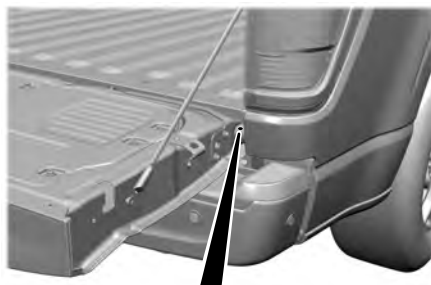

7. Remove the retaining screw.

## Tailgate - Vehicles With: Power Tailgate

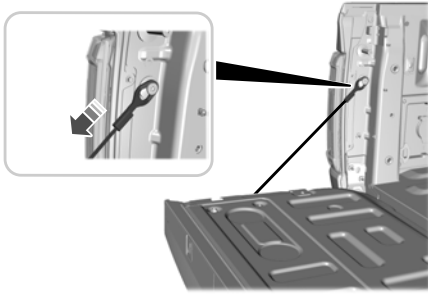

8. Use a screwdriver to gently pry the spring clip on each connector past the head of the support screw. Disconnect the cable.
9. Disconnect the other cable.

**Note:** To avoid damaging the tailgate, you may need assistance when removing. The tailgate weighs approximately 97 lb (44 kg).

10. Lift the tailgate to 45 degrees from the horizontal position.
11. Lift the right-hand side off its hinge.
12. Lift the tailgate to 80 degrees from the horizontal position.
13. Remove the tailgate from the left-hand side hinge by sliding it to the right.
14. Install the tailgate in reverse order.

**Note:** After reinstalling the tailgate it is important to reinstall the retaining screw to the recommended torque, 7 lb.ft (10 Nm). Failure to install the retaining screw can cause the tailgate to detach.

### TAILGATE STEP (If Equipped)

#### Accessing the Tailgate Step

##### Integrated Tailgate Step

1. Lower the tailgate.

2. Push the button in the center of the step molding. The step pops out slightly.

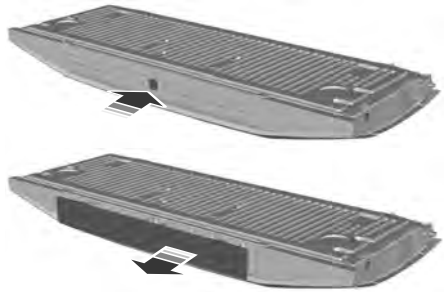

3. Pull the step out fully. Lower the step to its lowest position.



4. Pull the yellow handle stop backward out of the tailgate until it fully extends.
5. To lock the handle in place, rotate the handle up from the horizontal to the vertical position until you hear a click.

**Note:** Do not tow with the step or grab handle.

Replace the slip resistance tape or grab handle molding if it appears as worn or damaged.

# Tailgate - Vehicles With: Power Tailgate

To reduce the risk of falling:

- Only operate the step when your vehicle is on a level surface.
- Only operate the step in areas with sufficient lighting.
- Make sure you use the grab handle when climbing on the step.
- Do not use the step with bare feet.
- Make sure the step is clean before use.
- Keep the step load below the total maximum load of 350 lb (159 kg).

## Stowing the Tailgate Step

1. Press the yellow button on the handle to lower and then press the yellow lever at the bottom of the handle to unlock. Rotate the handle down from the vertical to the horizontal position and push it into the tailgate.
2. Rotate the step up until it is horizontal, then push it back into the tailgate until the step is secure.

**Note:** Make sure to close and fully latch the step before moving your vehicle. Do not drive with the step or grab handle open.

**Note:** The power tailgate cannot close if the step is opened. A warning message appears and a chime sounds. After stowing the step the power close function is restored.

## BED EXTENDER (If Equipped)

### Bed Extender Precautions

**Note:** Do not use the bed extender when driving off road.

**Note:** Make sure to engage the locking pins and knobs fully before driving your vehicle.

**Note:** Make sure to secure all cargo.

**Note:** Do not exceed 150 lb (68 kg) on the tailgate when your vehicle is moving.

**Note:** Do not keep the bed extender in the tailgate mode when you are not using it for restraining cargo. Always keep the bed extender in the grocery mode or the stowed position with the tailgate closed.

## Using the Bed Extender

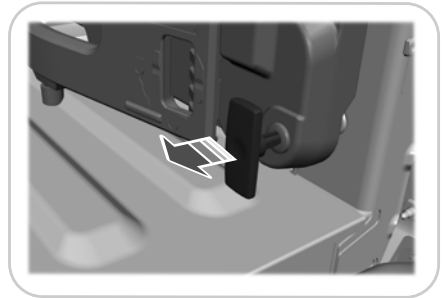
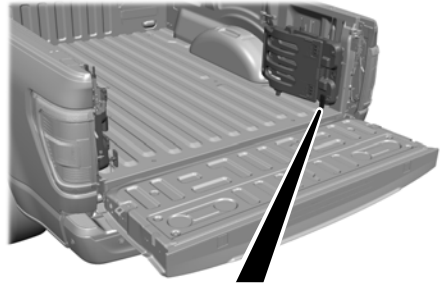

1. Pull the locking pin toward the center of your vehicle.

## Tailgate - Vehicles With: Power Tailgate

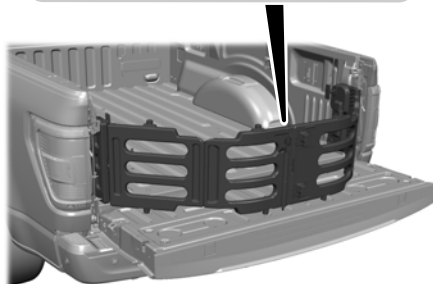
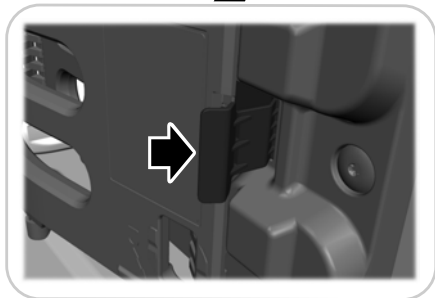
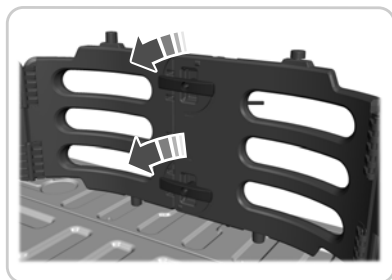
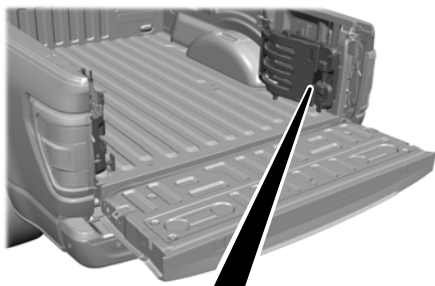

2. Open the latches to release the panels.

4. Connect the two panels. Rotate both knobs one-quarter turn clockwise to secure the panels.

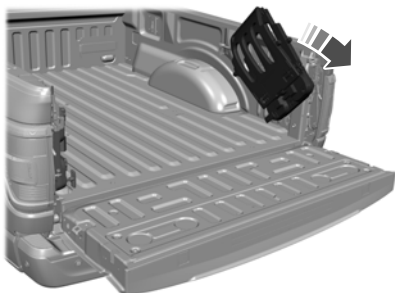

3. Rotate the panels toward the tailgate. Repeat steps 1-3 on the other side of your vehicle.

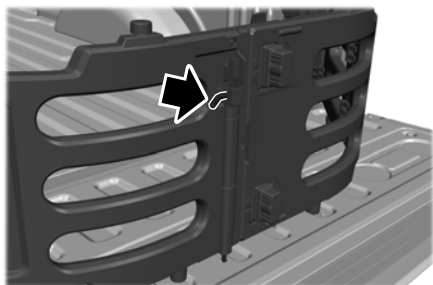

5. Insert the latch rod into the tailgate hole.

6. Engage both sides of the locking pins into their holes in the pick-up box.

# Tailgate - Vehicles With: Power Tailgate

## Grocery Mode

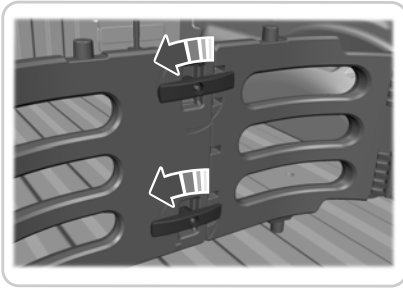
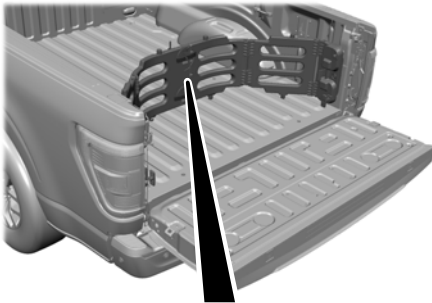

1. Follow steps 1-4.
2. Before engaging the locking pins, rotate the panels away from the tailgate.
3. Engage both sides of the locking pins into their holes in the pick-up box.
4. Close the tailgate.

## **TAILGATE WORK SURFACE (IF EQUIPPED)**

The tailgate work surface is a durable and functional surface on the inside portion of your tailgate you can use to perform various tasks.

To use the tailgate work surface, fold down the tailgate.

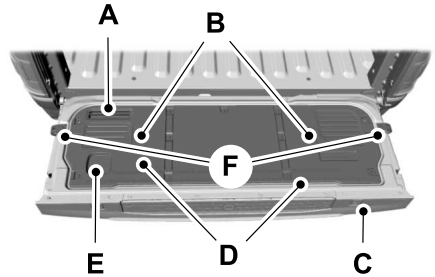

- A Tablet stand.
- B Tool inset.
- C Clamp pocket.
- D Standard and metric ruler.
- E Cup holder.
- F Tailgate anchors.

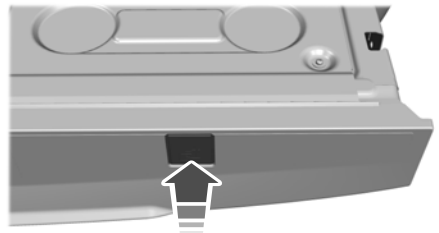

The tailgate work surface contains clamp pockets that allows you to secure work material.

**Note:** *When you have finished using the tailgate work surface, make sure you remove all of your belongings, then close the tailgate.*



# Tailgate - Vehicles With: Power Tailgate

## TAILGATE – TROUBLESHOOTING

### Tailgate – Warning Lamps



Illuminates when the tailgate is not completely closed.

### Tailgate – Information Messages

Message	Action
Tailgate Ajar	The tailgate is not completely closed.
Power Tailgate System Fault Service Now	Reminder to check if tailgate is closed securely. If message persists contact an authorized dealer.
Power Tailgate Stow Step	You need to stow the tailgate step before the power tailgate can close.

# Tailgate - Vehicles With: Power Tailgate

---

## Tailgate – Frequently Asked Questions

### **Why won't my power tailgate open?**

Make sure the transmission is in park (P), ensure nothing is obstructing the tailgate path and or causing resistance (tonneau cover or other aftermarket accessory, freezing conditions or being parked downhill). If you have continued issues, the battery voltage may be low or other system issues. See an authorized dealer.

### **Why won't my power tailgate close?**

Your vehicle speed is at or above 2.5 mph (4 km/h), the tailgate encountered an obstacle or freezing conditions. After removing the obstacles, manually close the tailgate to resume normal operation. If you have continued issues, the battery voltage may be low or other system issues. See an authorized dealer.

# Tailgate - Vehicles With: Remote Release Tailgate

## OPENING THE TAILGATE

### Opening the Tailgate From Inside Your Vehicle

The vehicle must be in park (P) to operate the power tailgate.



Press the button on the instrument panel.

**Note:** A tone sounds while the tailgate opens.

### Opening the Tailgate From Outside Your Vehicle

1. Unlock the vehicle with the remote control or power door unlock control.

**Note:** If an intelligent access transmitter is within 3 ft (1 m) of the tailgate, the tailgate unlocks when you press the tailgate release button.



2. Press the button in the top of the tailgate handle.

### Opening the Tailgate Using the Remote Control



Press the remote control button twice within three seconds.

## REMOVING AND INSTALLING THE TAILGATE



**WARNING:** Always properly secure cargo to prevent shifting cargo or cargo falling from the vehicle. Failure to do so could result in compromised vehicle stability and serious personal injury to vehicle occupants or others.

**Note:** Skip to Step 4 if your vehicle does not have power door locks.

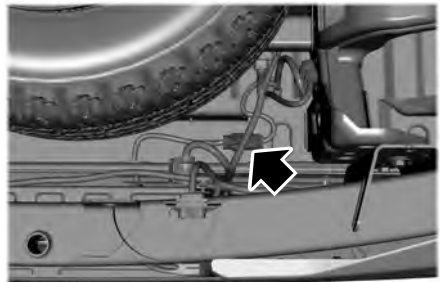

1. Unlatch the tailgate.
2. Disconnect the power door locks in-line connector. It is under the pickup box on the right-hand side of the vehicle near the spare tire.
3. Install a protective cap on the in-line connector portion that remains under the pickup box.

**Note:** A protective cap should be in the glove compartment.

4. Partially lower the tailgate. Carefully feed the tailgate harness up through the gap between the pickup box and the bumper and place it out of the way under the pickup box.
5. Lower the tailgate.

## Tailgate - Vehicles With: Remote Release Tailgate

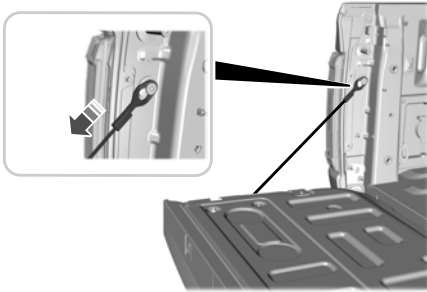

6. Use a screwdriver to gently pry the spring clip on each connector past the head of the support screw. Disconnect the cable.
  7. Disconnect the other cable.
- Note:** To avoid damaging the tailgate, you may need assistance when removing. The tailgate weighs approximately 97 lb (44 kg).
8. Lift the tailgate to 45 degrees from the horizontal position.
  9. Lift the right-hand side off its hinge.
  10. Lift the tailgate to 80 degrees from the horizontal position.
  11. Remove the tailgate from the left-hand side hinge by sliding it to the right.
  12. Install the tailgate in reverse order.

### TAILGATE STEP (If Equipped)

#### Accessing the Tailgate Step

##### Integrated Tailgate Step

1. Lower the tailgate.
2. Push the button in the center of the step molding. The step pops out slightly.

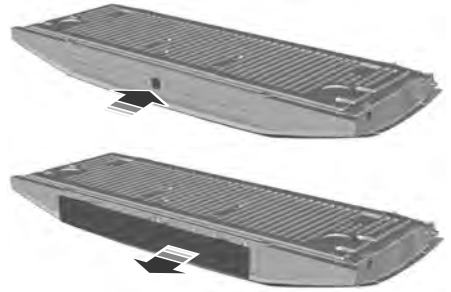

3. Pull the step out fully. Lower the step to its lowest position.



4. Pull the yellow handle stop backward out of the tailgate until it fully extends.
5. To lock the handle in place, rotate the handle up from the horizontal to the vertical position until you hear a click.

**Note:** Do not tow with the step or grab handle.

Replace the slip resistance tape or grab handle molding if it appears as worn or damaged.

To reduce the risk of falling:

- Only operate the step when your vehicle is on a level surface.
- Only operate the step in areas with sufficient lighting.

## Tailgate - Vehicles With: Remote Release Tailgate

- Make sure you use the grab handle when climbing on the step.
- Do not use the step with bare feet.
- Make sure the step is clean before use.
- Keep the step load below the total maximum load of 350 lb (159 kg).

### Stowing the Tailgate Step

1. Press the yellow button on the handle to lower and then press the yellow lever at the bottom of the handle to unlock. Rotate the handle down from the vertical to the horizontal position and push it into the tailgate.
2. Rotate the step up until it is horizontal, then push it back into the tailgate until the step is secure.

**Note:** Make sure to close and fully latch the step before moving your vehicle. Do not drive with the step or grab handle open.

**Note:** The power tailgate cannot close if the step is opened. A warning message appears and a chime sounds. After stowing step the power close function is restored.

### BED EXTENDER (If Equipped)

#### Bed Extender Precautions

**Note:** Do not use the bed extender when driving off road.

**Note:** Make sure to engage the locking pins and knobs fully before driving your vehicle.

**Note:** Make sure to secure all cargo.

**Note:** Do not exceed 150 lb (68 kg) on the tailgate when your vehicle is moving.

**Note:** Do not keep the bed extender in the tailgate mode when you are not using it for restraining cargo. Always keep the bed extender in the grocery mode or the stowed position with the tailgate closed.

### Using the Bed Extender

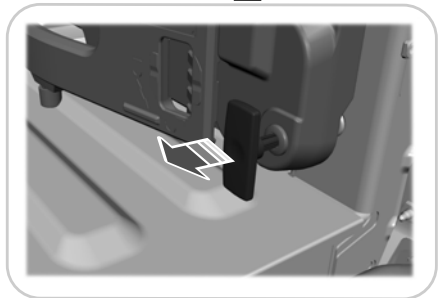
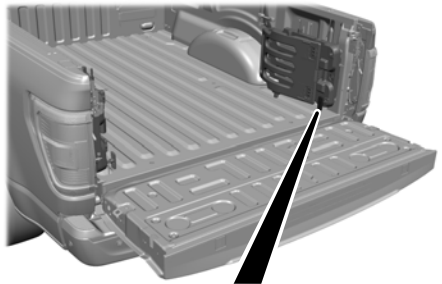

1. Pull the locking pin toward the center of your vehicle.

## Tailgate - Vehicles With: Remote Release Tailgate

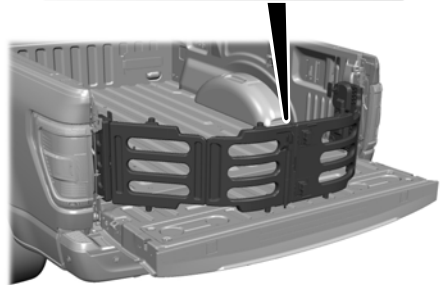
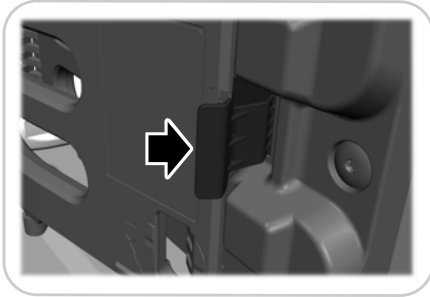
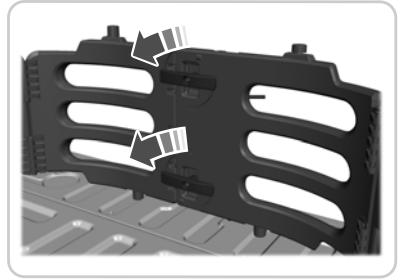
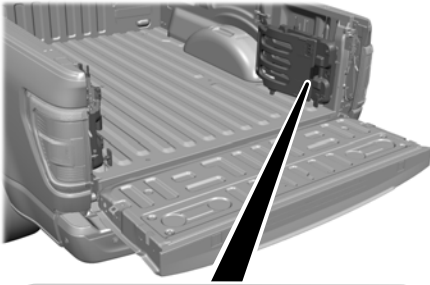

2. Open the latches to release the panels.

4. Connect the two panels. Rotate both knobs one-quarter turn clockwise to secure the panels.

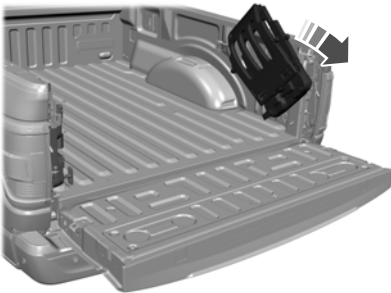

3. Rotate the panels toward the tailgate. Repeat steps 1-3 on the other side of your vehicle.

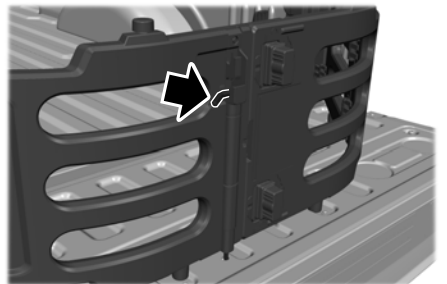

5. Insert the latch rod into the tailgate hole.  
6. Engage both sides of the locking pins into their holes in the pick-up box.

# Tailgate - Vehicles With: Remote Release Tailgate

## Grocery Mode

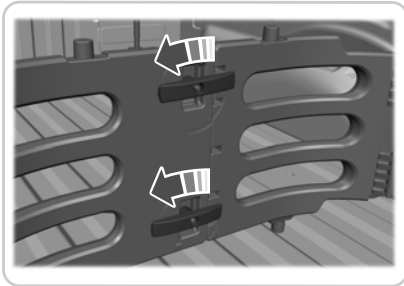
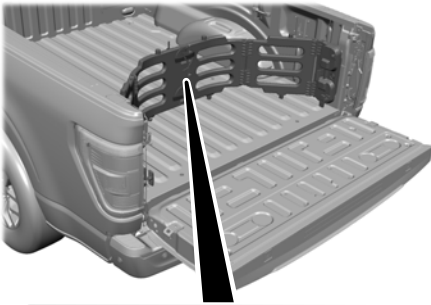

1. Follow steps 1-4.
2. Before engaging the locking pins, rotate the panels away from the tailgate.
3. Engage both sides of the locking pins into their holes in the pick-up box.
4. Close the tailgate.

## TAILGATE WORK SURFACE (IF EQUIPPED)

The tailgate work surface is a durable and functional surface on the inside portion of your tailgate you can use to perform various tasks.

To use the tailgate work surface, fold down the tailgate.

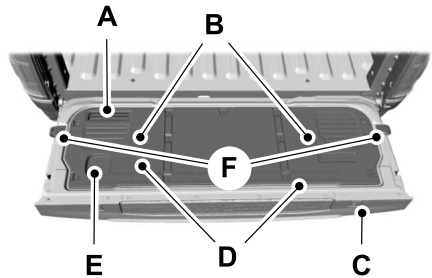

- A Tablet stand.
- B Tool inset.
- C Clamp pocket.
- D Standard and metric ruler.
- E Cup holder.
- F Tailgate anchors.

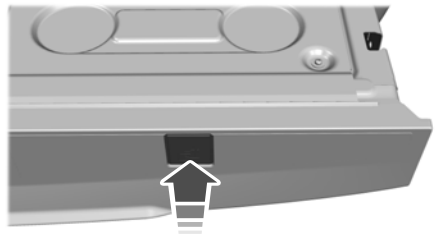

The tailgate work surface contains clamp pockets that allows you to secure work material.

**Note:** When you have finished using the tailgate work surface, make sure you remove all of your belongings, then close the tailgate.

# Tailgate - Vehicles With: Remote Release Tailgate

---

## TAILGATE – TROUBLESHOOTING

### Tailgate – Information Messages

<b>Message</b>	<b>Action</b>
Check Tailgate Ajar	Reminder to check the tailgate due to it recently being opened from the remote control or the button on the instrument panel while the vehicle is On and the transmission is not in park.
Power Tailgate System Fault Service Now	Reminder to check if tailgate is closed securely. If message persists contact an authorized dealer.



# Tailgate - Vehicles With: Remote Release Tailgate

---

## Tailgate – Frequently Asked Questions

### Why won't my tailgate open?

Make sure the transmission is in park (P), ensure nothing is obstructing the tailgate path and or causing resistance (tonneau cover or other aftermarket accessories, freezing conditions or being parked downhill). If you have continued issues, the battery voltage may be low or other system issues. See an authorized dealer.

# Security

## PASSIVE ANTI-THEFT SYSTEM

### What Is the Passive Anti-Theft System

The passive anti-theft system prevents someone from starting the vehicle with an incorrectly coded key.

### How Does the Passive Anti-Theft System Work

The passive anti-theft system arms when you switch the ignition off.

It disarms when the ignition is switched on with a correctly coded key.

**Note:** *The system is not compatible with non-Ford aftermarket remote start systems.*

**Note:** *Do not leave a duplicate coded key in your vehicle. Always take the keys and lock all doors when leaving your vehicle.*

## ANTI-THEFT ALARM SYSTEM (If Equipped)

### What Is the Anti-Theft Alarm System

The Anti-Theft Alarm System warns you of an unauthorized entry to your vehicle.

### How Does the Anti-Theft Alarm System Work

When armed, the anti-theft alarm is triggered in any of the following ways:

- If someone opens a door, the tailgate or the hood without a correctly coded key or remote control.
- If you turn the power on without a correctly coded key.

- If the interior sensors detect movement inside your vehicle.
- If the inclination sensors detect an attempt to raise your vehicle.
- If someone disconnects the vehicle battery or the battery backup alarm.
- If someone disconnects the trailer. See **Connecting a Trailer** (page 371).

Any further attempts to carry out one of the above sounds the alarm again.

If the anti-theft alarm is triggered, the alarm horn sounds for 30 seconds and the direction indicators flash for five minutes.

### What Is the Perimeter Alarm

The perimeter alarm is designed to detect unauthorized access to your vehicle.

### What Are the Interior Sensors (If Equipped)

The interior sensors are designed to detect any movement inside your vehicle.

The interior sensors are in the overhead console.

**Note:** *Do not cover the interior sensors.*

### What Are the Inclination Sensors (If Equipped)

The inclination sensor is designed to detect an attempt to raise your vehicle, for example to remove a wheel or to tow it away.

### What Is the Battery Backup Alarm

The battery backup alarm is an additional alarm system that has its own battery and horn. It is designed to detect if the vehicle battery or the battery backup alarm is disconnected.

# Security

---

## Arming the Anti-Theft Alarm System

The alarm is ready to arm when there is not a key in your vehicle.

Lock your vehicle with your remote control to arm the alarm.

## Disarming the Anti-Theft Alarm System

Disarm the alarm by performing any of the following actions:

- Unlock the doors or luggage compartment with the remote control.
- Switch your vehicle on or start your vehicle.

## ANTI-THEFT ALARM SYSTEM SETTINGS (If Equipped)

### What are the Alarm Security Levels

You can select two levels of alarm security, all sensors and perimeter sensing.

### All Sensors

All sensors is the standard setting.

In all sensors, all equipped sensors are on when you arm the alarm.

**Note:** Do not arm the alarm with all sensors if passengers, animals or other moving objects are inside your vehicle.

### Perimeter Sensing

In perimeter sensing, the interior sensors are off when you arm the alarm.

All the other equipped sensors activate when you arm the alarm in this mode.

### Setting the Alarm Security Level

1. Press **Settings** on the touchscreen.
2. Press **Vehicle Settings**.
3. Press **Alarm System**.
4. Press **Motion Sensors**.
5. Press a setting.

### What Is Ask on Exit

You can choose which level of security you require after you switch the ignition off.

**Note:** If you do not choose a setting, the system defaults to all sensors.

### Switching Ask on Exit On and Off

1. Press **Settings** on the touchscreen.
2. Press **Vehicle Settings**.
3. Press **Alarm System**.
4. Switch **Ask on Exit** on or off.

# Security

---

## SECURITY – TROUBLESHOOTING

### Security – Information Messages

<b>Message</b>	<b>Action</b>
No Key Detected	The system has not detected a correctly coded key.
Starting System Fault	The system has malfunctioned. Have your vehicle checked as soon as possible.
Vehicle Alarm To Stop Alarm, Start Vehicle.	Displays when the alarm has been triggered due to unauthorized entry.
Alarm Announcement	

# Security

---

## **Security – Frequently Asked Questions**

### **What should I do if there is any potential alarm problem with my vehicle?**

Take all remote controls to an authorized dealer if there is any potential alarm problem with your vehicle.

### **What should I do if the vehicle is unable to start with a correctly coded key?**

Have your vehicle checked as soon as possible.

# Power Running Boards (If Equipped)

## POWER RUNNING BOARD PRECAUTIONS



**WARNING:** In extreme climates, excessive ice buildup may occur, causing the running boards not to deploy. Make sure that the running boards have deployed, and have finished moving before attempting to step on them. The running boards will resume normal function once the blockage is cleared.



**WARNING:** Switch off the running boards before jacking or placing any object under your vehicle. Never place your hand between the extended running board and your vehicle. A moving running board may cause injury.

Do not use the running boards, front and rear hinge assemblies, running board motors, or the running board underbody mounts to lift your vehicle when jacking. Use proper jacking points.

The running boards could move slower in cold temperatures.

## POWER RUNNING BOARD SETTINGS

1. Press **Features** on the touchscreen.
2. Press **Running Boards**.
3. Press a setting.

### **Running Boards (Modes)**

#### **Off**

The power running boards remain stowed, regardless of door position.

#### **Auto**

The power running boards deploy when you approach your vehicle with a remote control, unlock the door or open the door.

The power running boards stow:

- After a few seconds when you close the doors.
- If you unlock the door but do not open it.
- If you have switched **Approach detection** on and do not open a door before the **Auto Timer** setting expires.

**Note:** When you select this mode, an option displays that allows you to select how long the running boards stay deployed without opening the door.

#### **Out**

The power running boards remain deployed, regardless of door position.

### **Approach detection**

When you switch **Approach detection** on with **Auto** switched on, the running boards deploy when you approach your vehicle with a remote control.

## POWER RUNNING BOARD KICK SWITCH

You can use the power running board kick switch to deploy and stow the running board without opening or closing the door.

## Power Running Boards (If Equipped)

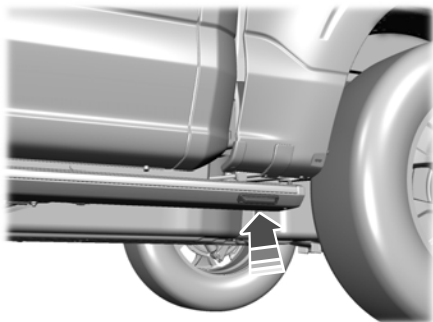

Press the switch with your foot to use the power running board kick switch.

Pressing the kick switch with the power running boards stowed switches the mode to **Out**.

Pressing the kick switch with the power running boards deployed switches the mode to **Auto**.

**Note:** When you use the kick switch, the power running board mode changes until you press the kick switch again.

You can change the kick switch setting on the touchscreen. See **Power Running Board Settings** (page 115).

### **Kick switch**

#### **Always active**

The kick switch is on regardless of whether the doors are locked or unlocked.

#### **Only while unlocked**

The kick switch is on only with the doors unlocked.

## **DEPLOYING AND STOWING THE POWER RUNNING BOARDS**

The power running boards deploy when you approach your vehicle with a remote control, unlock the door or open the door.

The power running boards stow:

- After a few seconds when you close the doors.
- If you unlock the door but do not open it.
- If you have switched **Approach detection** on and do not open a door before the **Auto Timer** setting expires. See **Power Running Board Settings** (page 115).

**Note:** The power running boards reverse direction and move to the end of travel if they encounter an object when moving.

## **POWER RUNNING BOARDS – TROUBLESHOOTING**

### **Power Running Boards – Frequently Asked Questions**

#### **Why is there unwanted noise coming from my power running boards?**

The power running board mechanism could trap debris such as mud, dirt, snow, ice and salt. If this happens, set the running boards to the deployed position. Then, wash the system, in particular the front and rear hinge arms, with a high-pressure car wash wand.

# Steering Wheel

## ADJUSTING THE STEERING WHEEL - VEHICLES WITH: MANUAL ADJUSTABLE STEERING COLUMN

### *Adjusting the Steering Wheel*

 **WARNING:** Do not adjust the steering wheel when your vehicle is moving.

**Note:** Make sure that you are sitting in the correct position. See **Sitting in the Correct Position** (page 167).

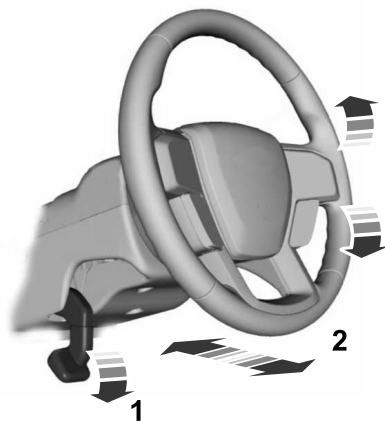

1. Unlock the steering column.
2. Adjust the steering wheel to the position you prefer.
3. Lock the steering column.

## ADJUSTING THE STEERING WHEEL - VEHICLES WITH: POWER ADJUSTABLE STEERING COLUMN

 **WARNING:** Do not adjust the steering wheel when your vehicle is moving.

**Note:** Make sure that you are sitting in the correct position. See **Sitting in the Correct Position** (page 167).



Press the top or bottom of the control to move the steering wheel up or down.

Press the front or rear of the control to move the steering wheel in or out.

You can save and recall the steering wheel position with the memory function. See **Recalling a Preset Position** (page 181).



# Steering Wheel

---

## RESETTING THE STOPPING POSITION - VEHICLES WITH: POWER ADJUSTABLE STEERING COLUMN

**Note:** *The steering wheel stops when it detects an obstruction. This sets a new stopping position.*

To reset the steering column to its normal stopping position:

1. Confirm there is nothing obstructing the motion of the steering column.
2. Press and hold the steering column control until the steering column stops moving.
3. Press the steering column control again.

**Note:** *The steering column may start to move again.*

4. When the steering column stops, continue holding the control for a few seconds.
5. Repeat for each direction, as necessary.

## HORN



Press on the center of the steering wheel near the horn icon to activate the horn.

## SWITCHING THE HEATED STEERING WHEEL ON AND OFF



To activate the heated steering wheel, press the button on the climate control unit.

On some vehicles, an indicator on the button illuminates when the heated steering wheel is on.

**Note:** *A sensor regulates the temperature of the steering wheel.*

## Adjustable Pedals (If Equipped)

### ADJUSTING THE PEDALS



**WARNING:** Do not use the pedal adjustment controls when the vehicle is moving. Failure to follow this instruction could result in personal injury or death.

Your control is on the left-hand side of the steering column or on the instrument panel.

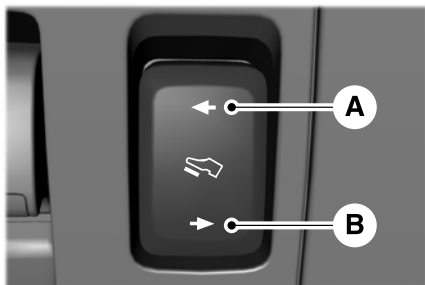

- A. Farther away from you.
- B. Closer to you.

You can save and recall the pedal positions with the memory feature. See **Memory Function** (page 181).

# Wipers and Washers

## WIPERS

### Wiper Precautions

Do not operate the wipers on a dry windshield. This could scratch the glass or damage the wiper blades. Use the windshield washers before wiping a dry windshield.

Fully defrost the windshield before you switch the windshield wipers on.

Switch the windshield wipers off before entering a car wash.

### Switching Windshield Wipers On and Off

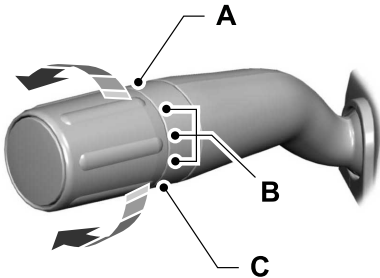

- A High-speed wipe.
- B Intermittent wipe.
- C Off.



Use the rotary control.

## AUTOWIPERS (If Equipped)

### What Are Autowipers

Autowipers turns on and controls the speed and frequency of the windshield wipers.

### Autowipers Settings

1. Press **Settings** on the touchscreen.
2. Press **Vehicle Settings**.
3. Press **Wipers**.
4. Switch **Rain Sensing** on or off.

**Note:** When you switch the feature off, the wipers do not operate based on the rain sensor. When you switch on the windshield wipers to the intermittent wipe position with the feature off, the wipers use the wipe speed set by the rotary control.

### Adjusting the Sensitivity of the Rain Sensor

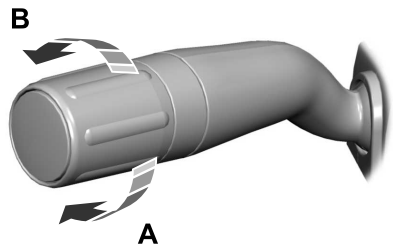

- A Low sensitivity.
- B High sensitivity.

Use the rotary control to set the sensitivity of the rain sensor.

# Wipers and Washers

When you select low sensitivity, the wipers operate when the sensor detects a large amount of water on the windshield.

When you select high sensitivity, the wipers operate when the sensor detects a small amount of water on the windshield.

## CHECKING THE WIPER BLADES

### [Improving Your Windshield Wiper Performance](#)



E142463

Run the tip of your fingers over the edge of the blade to check for roughness.

## REPLACING THE FRONT WIPER BLADES



E165804

1. Pull the wiper blade and arm away from the glass.

**Note:** Do not hold the wiper blade to lift the wiper arm.

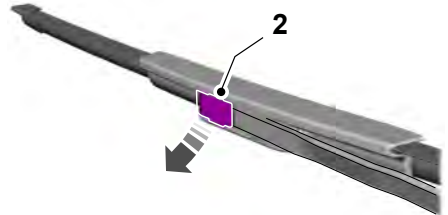

2. Lift the wiper blade primary locking clip.

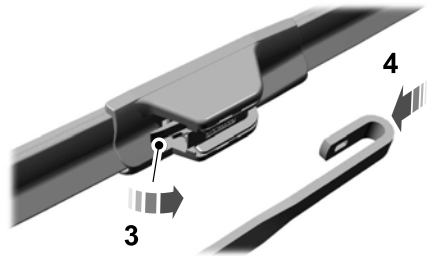

3. Press the wiper blade secondary locking clip.
4. Remove the wiper blade.

**Note:** Make sure that the wiper arm does not spring back against the glass when the wiper blade is not attached.

5. To install, reverse the removal procedure.

**Note:** Make sure that the wiper blade locks into place.

# Wipers and Washers

## WASHERS

### Washer Precautions



**WARNING:** If you operate your vehicle in temperatures below 41.0°F (5°C), use washer fluid with antifreeze protection. Failure to use washer fluid with antifreeze protection in cold weather could result in impaired windshield vision and increase the risk of injury or accident.

Do not operate the washers when the washer reservoir is empty. This could cause the washer pump to overheat.

Keep the outside of the windshield clean. The rain sensor is very sensitive and the wipers may operate if dirt, mist or insects hit the windshield.

### Using the Windshield Washer



Press and hold the button at the end of the lever to operate the windshield washer.

**Note:** A courtesy wipe occurs a short time after the wipers stop to clear any remaining washer fluid when switched on. See **Switching the Courtesy Wipe On and Off** (page 122).

### Switching the Courtesy Wipe On and Off

#### *Courtesy Wipe*

1. Press **Settings** on the touchscreen.
2. Press **Vehicle Settings**.
3. Press **Wipers**.
4. Switch **Courtesy Wipe** on or off.

### Adding Washer Fluid

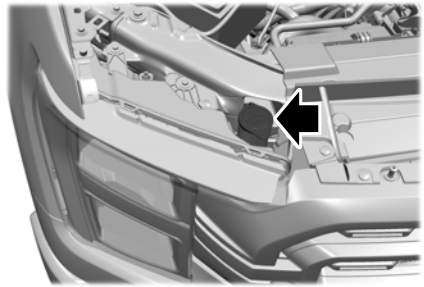

### Washer Fluid Specification

See **Washer Fluid Specification** (page 559).

## WIPERS AND WASHERS – TROUBLESHOOTING

### Wipers and Washers – Warning Lamps



Illuminates when the windshield washer fluid is low.

# Wipers and Washers

---

## Wipers and Washers – Frequently Asked Questions

### Why are there streaks and smears on the windshield?

The wiper blades could be dirty, worn or damaged. Check the wiper blades. See **Checking the Wiper Blades** (page 121). If the wiper blades are dirty, clean them with washer fluid or water applied with a soft sponge or cloth. If the wiper blades are worn or damaged, install new ones. See **Replacing the Front Wiper Blades** (page 121).

# Exterior Lighting

## EXTERIOR LIGHTING CONTROL

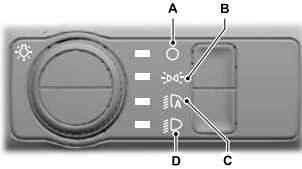

- A Lamps off.
- B Parking lamps on.
- C Autolamps on.
- D Headlamps on.

Rotate the control to make a selection.

**Note:** The lighting control defaults to autolamps every time you switch your vehicle on.

## HEADLAMPS

### Using the High Beam Headlamps

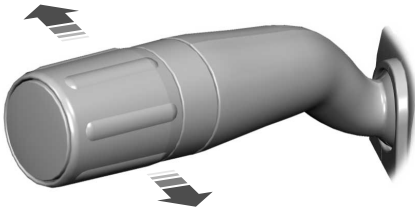

 Push the lever away from you to switch the high beam on.

Push the lever forward again or pull the lever toward you to switch the high beams off.

Slightly pull the lever toward you and release it to flash the headlamps.

## Headlamp Indicators

### Lamps On

 Illuminates when you switch the low beam headlamps or the parking lamps on.

### Headlamp High Beam

 Illuminates when you switch the high beam headlamps on.

## HEADLAMPS – TROUBLESHOOTING

### Headlamps – Frequently Asked Questions

#### Why is there condensation in the headlamps?

Headlamps have vents to accommodate normal changes in air pressure. Condensation can be a natural by-product of this design. When moist air enters the lamp assembly through the vents, there is a possibility that condensation can occur when the temperature is cold. When normal condensation occurs, a fine mist can form on the interior of the lens. The fine mist eventually clears and exits through the vents during normal operation.

#### How much condensation is acceptable?

The presence of a fine mist, for example no streaks, drip marks or large droplets. A fine mist covers less than 50% of the lens.

# Exterior Lighting

## How long may it take for the acceptable condensation to be cleared?

Clearing time may take as long as 48 hours under dry weather conditions.

## How much condensation is unacceptable?

A water puddle inside the lamp. Streaks, drip marks or large droplets present on the interior of the lens.

## What should I do if unacceptable condensation is present?

Have your vehicle checked as soon as possible.

## Why do my headlamps turn off when I have them switched on when I switch my vehicle off?

The battery saver turns the headlamps off after a short period of time after you switch your vehicle off.

## AUTOLAMPS

### What Are Autolamps

#### [Autolamp](#)



**WARNING:** The system does not relieve you of your responsibility to drive with due care and attention. You may need to override the system if it does not turn the headlamps on in low visibility conditions, for example daytime fog.

Autolamps turn the headlamps on in low light situations or when the windshield wipers operate.

### Autolamp Settings

1. Press **Settings** on the touchscreen.
2. Press **Vehicle Settings**.

3. Press **Lighting**.
4. Press **Autolamp Delay**.
5. Press a setting.

## EXTERIOR LAMPS

### Switching the Turn Signal Lamps On and Off

#### [Intelligent Three Blink Turn Signal](#)

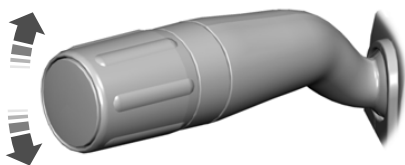

Push the lever up or down to switch the turn signal lamps on.

Set the lever to the middle position to switch the turn signal lamps off.

**Note:** Tap the lever up or down to make the turn signal lamps flash three times.

### How Do Cornering Lamps Work (if Equipped)

The cornering lamps illuminate the inside of a corner when you are turning the steering wheel.



# Exterior Lighting

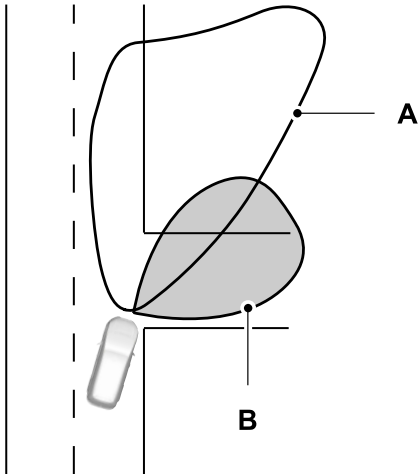

- A Headlamp beam.  
B Cornering lamp beam.

## Switching the Daytime Running Lamps On and Off - Vehicles With Configurable Daytime Running Lamps



**WARNING:** The daytime running lamps system does not activate the rear lamps and may not provide adequate lighting during low visibility driving conditions. Make sure you switch the headlamps on, as appropriate, during all low visibility conditions. Failure to do so may result in a crash.

1. Press **Settings** on the touchscreen.
2. Press **Vehicle Settings**.
3. Press **Lighting**.

4. Switch **Daytime Running Lights** on or off.

The daytime running lamps turn on when all of the following occur:

- You switch the system on.
- You switch your vehicle on.
- The transmission is not in park (P) for vehicles with automatic transmissions or you release the parking brake for vehicles with manual transmissions.
- The lighting control is in the autolamps position.
- The headlamps are off.

**Note:** Other lighting control positions do not turn on the daytime running lamps.

## Switching the Daytime Running Lamps On and Off - Vehicles With Daytime Running Lamps (DRL)



**WARNING:** The daytime running lamps system does not activate the rear lamps and may not provide adequate lighting during low visibility driving conditions. Make sure you switch the headlamps on, as appropriate, during all low visibility conditions. Failure to do so may result in a crash.

Daytime running lamps are always on unless you switch on the headlamps or your vehicle is in park (P).

## Switching the Front Fog Lamps On and Off (if Equipped)

The front fog lamp button is on the lighting control.



Press the button to switch the front fog lamps on or off.

**Note:** Only switch the front fog lamps on during reduced visibility.

# Exterior Lighting

**Note:** The brightness of the daytime running lamps may decrease when the front fog lamps are switched on.

**Note:** When the lighting control is in the autolamps position, you cannot switch the fog lamps on unless the headlamps are on.

## Switching the Cargo Lamps On (if Equipped)



Press the button in the lighting control or in the rear cargo box.

## Switching the Spot Lamps On and Off (if Equipped)

The spot lamp buttons are near the lighting control.



Press the button to switch on the left-hand spot lamp.



Press the button to switch on the right-hand spot lamp.

Move the position of the exterior mirrors to adjust the aim.

**Note:** The lighting control must be set to the parking lamp position.

**Note:** The spot lamps illuminate the area in front of and to the side of your vehicle.

## Exterior Lamp Indicators

### Front Fog Lamp



It illuminates when you switch the front fog lamps on.

### Turn Signal Lamp



It flashes when you switch the turn signal lamps on.

**Note:** An increase in the rate of flashing warns of a failed turn signal lamp bulb.

## Exterior Lamp Audible Warning

### Exterior Lamps On

Sounds when you open the driver door and the exterior lamps are on.

## EXTERIOR ZONE LIGHTING (if Equipped)

### What Is Exterior Zone Lighting

Exterior zone lighting divides the exterior lighting into zones and allows you to switch them on and off to provide lighting around the perimeter of your vehicle.

### Using the Exterior Zone Lighting

1. Press **Features** on the touchscreen.
2. Press **Zone Lighting**.

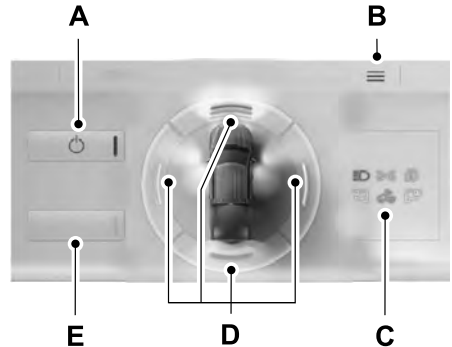

- A On and off button.
- B Settings menu.
- C Exterior lamp indicators.

# Exterior Lighting

---

- D Individual zones on and off.
- E All zones on and off.

You can use zone lighting when your vehicle is on or off. When it is off, the lighting turns off after a certain period of time.

You can also use individual zone controls to switch on each zone.

**Note:** *Make sure to remove exterior lighting covers when using zone lighting.*

**Note:** *When your vehicle is off and the timer has one minute remaining, the direction indicators flash six times.*

**Note:** *Indicators on the touchscreen illuminate when the lights outside of the zone lighting control are on.*

**Note:** *You can remotely control the zone lighting using the FordPass app.*

**Note:** *Vehicles without spot lamps only have two zones.*

## Exterior Zone Lighting Settings

When you access zone lighting for the first time, you can choose to allow zone lighting to override the autolamps when zone lighting is on.

You can change this setting at any time in the zone lighting settings menu.

1. Press **Features** on the touchscreen.
2. Press **Zone Lighting**.
3. Press the settings menu in the upper right-hand corner.
4. Press a setting.

## AUTOMATIC HIGH BEAM CONTROL (If Equipped)

### How Does Automatic High Beam Control Work

Automatic high beam control turns the high beams on if it is dark enough and no other traffic is present. If it detects an approaching vehicle's headlamps or tail lamps, or street lighting ahead, the system turns the high beams off.

A camera sensor, centrally mounted behind the windshield of your vehicle, continuously monitors conditions to turn the high beams on and off.

# Exterior Lighting

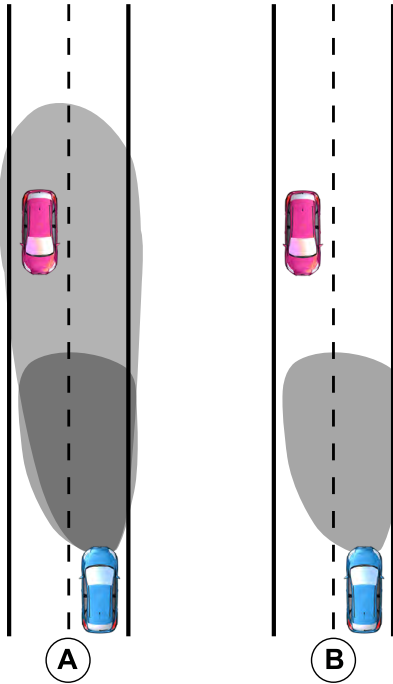

- A Without automatic high beam control.
- B With automatic high beam control.

## Automatic High Beam Control Precautions

**WARNING:** The system does not relieve you of your responsibility to drive with due care and attention. You may need to override the system if it does not turn the high beams on or off.

**WARNING:** Do not use the system in poor visibility, for example fog, heavy rain, spray or snow.

**WARNING:** You may need to override the system when approaching other road users.

**WARNING:** You may need to override the system during inclement weather.

## Automatic High Beam Control Requirements

The system turns the high beams on if all of the following occur:

- You switch the system on.
- You set the lighting control to the autolamps position.
- The ambient light level is low enough that you require high beams.
- There is no traffic in front of your vehicle.
- The vehicle speed is greater than approximately 32 mph (52 km/h).

## Automatic High Beam Control Limitations

The system turns the high beams off if any of the following occur:

- You switch the system off.
- You set the lighting control to any position except autolamps.
- The ambient light level is high enough that you do not require high beams.
- The system detects an approaching vehicle's headlamps or rear lamps.
- The system detects severe rain, snow or fog.
- The system detects street lighting.

# Exterior Lighting

- The camera has reduced visibility.
- The vehicle speed falls below approximately 19 mph (30 km/h).

## Switching Automatic High Beam Control On and Off

1. Press **Settings** on the touchscreen.
2. Press **Vehicle Settings**.
3. Press **Lighting**.
4. Switch **Auto Highbeam** on or off.

## Automatic High Beam Control Indicators



Illuminates to confirm when the system is ready to assist.

## Overriding Automatic High Beam Control

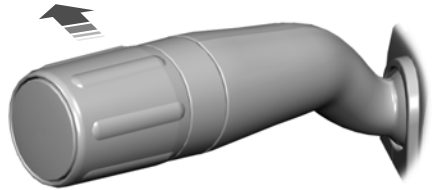

Push the lever away from you to switch the high beams on.

Push the lever away from you again to switch the high beams off.

Push the lever away from you for a third time to switch automatic high beam control back on.

## AUTOMATIC HIGH BEAM CONTROL – TROUBLESHOOTING (If Equipped)

### Automatic High Beam Control – Information Messages

Message	Description
Front Camera Low Visibility Clean Screen	The camera has reduced visibility. Clean the windshield. If the message continues to appear, have your vehicle checked as soon as possible.
Front Camera Temporarily Not Available	The camera has malfunctioned. Wait a short period of time for the camera to cool down. If the message continues to appear, have your vehicle checked as soon as possible.
Front Camera Malfunction Service Required	The camera has malfunctioned. Have your vehicle checked as soon as possible.

# Exterior Lighting

## GLARE FREE LIGHTING (If Equipped)

### How Does Glare Free Lighting Work

Glare free lighting enhances visibility and minimizes glare for other road users.

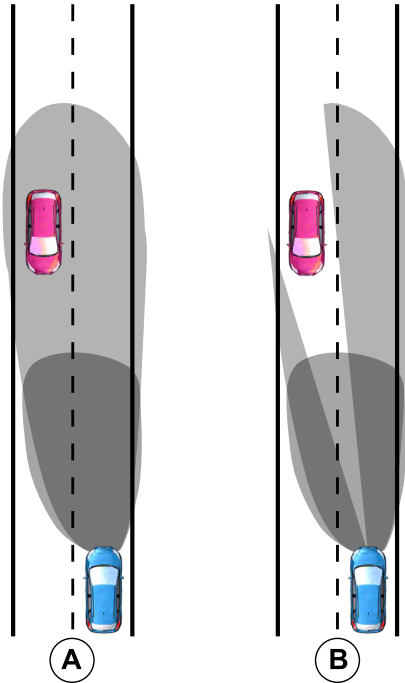

- A Without glare free lighting.  
B With glare free lighting.

## Glare Free Lighting Precautions

**WARNING:** You are responsible for controlling your vehicle at all times. The system is designed to be an aid and does not relieve you of your responsibility to drive with due care and attention. Failure to follow this instruction could result in the loss of control of your vehicle, personal injury or death.

**WARNING:** The system may not adapt the lighting to avoid glare if the lights of oncoming vehicles are hidden by obstacles such as guard rails.

**WARNING:** You may need to override the system when approaching other road users.

**WARNING:** You may need to override the system during inclement weather.

**WARNING:** Do not use the system in poor visibility, for example fog, heavy rain, spray or snow.

## Glare Free Lighting Requirements

The system turns on if all of the following occur:

- You switch the system on.
- You set the lighting control to the autolamps position.
- The ambient light level is low enough.
- Your vehicle speed is greater than approximately 32 mph (52 km/h).

# Exterior Lighting

The system adapts the lighting to avoid glare if all of the following occur:

- You switch the system on.
- You set the lighting control to the autolamps position.
- The system detects an approaching vehicle's headlamps or rear lamps.

## Glare Free Lighting Limitations

The system turns off if any of the following occur:

- You switch the system off.
- You set the lighting control to any position except autolamps.
- The ambient light level is high enough.
- The system detects severe rain, snow or fog.
- The system detects street lighting.
- The camera has reduced visibility.
- The vehicle speed falls below approximately 19 mph (30 km/h).

**Note:** *The deactivation speed is lower on curves.*

## Switching Glare Free Lighting On and Off

1. Press **Settings** on the touchscreen.

2. Press **Vehicle Settings**.
3. Press **Lighting**.
4. Switch **Glarefree Lighting** on or off.

## Glare Free Lighting Indicators



Illuminates to confirm when the system is ready to assist.

## Overriding Glare Free Lighting

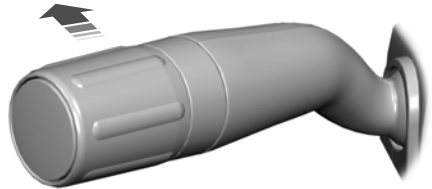

Push the lever away from you to switch the high beams on.

Push the lever away from you again to switch the high beams off.

Push the lever away from you for a third time to switch glare free lighting back on.

# Exterior Lighting

## GLARE FREE LIGHTING – TROUBLESHOOTING (If Equipped)

### Glare Free Lighting – Information Messages

Message	Description
Front Camera Low Visibility Clean Screen	The camera has reduced visibility. Clean the windshield. If the message continues to appear, have your vehicle checked as soon as possible.
Front Camera Temporarily Not Available	The camera has malfunctioned. Wait a short period of time for the camera to cool down. If the message continues to appear, have your vehicle checked as soon as possible.
Front Camera Malfunction Service Required	The camera has malfunctioned. Have your vehicle checked as soon as possible.

## ADAPTIVE FRONT LIGHTING (If Equipped)

### How Does Adaptive Front Lighting Work

Adaptive front lighting adapts when you are steering around a curve or if the camera detects lane markings indicating a curve.

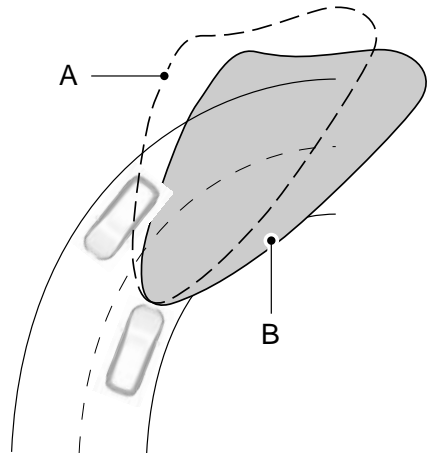

E161714

- A Without adaptive front lighting.
- B With adaptive front lighting.



# Exterior Lighting

---

## Switching Adaptive Front Lighting On and Off

1. Press **Settings** on the touchscreen.
2. Press **Vehicle Settings**.
3. Press **Lighting**.
4. Switch **Adaptive Headlamps** on or off.

Set the lighting control to the autolamps position to use the adaptive front lighting.

# Interior Lighting

## SWITCHING ALL OF THE INTERIOR LAMPS ON AND OFF

The lamps turn on under the following conditions:

- You open any door.
- You press a button on the remote control.
- You press the all lamps on button on the overhead console.



Press to switch all interior lamps on or off.

## SWITCHING THE FRONT INTERIOR LAMPS ON AND OFF



The front interior lamp switches are on the overhead console.

**Note:** The position of each button on the overhead console depends on your vehicle.

### Individual Map Lamps



Press to switch the left-hand individual dome lamp on and off.



Press to switch the right-hand individual dome lamp on and off.

## SWITCHING THE REAR INTERIOR LAMPS ON AND OFF

(IF EQUIPPED)



The rear interior lamps may be above the rear seat or above the rear windows.



Press to switch the lamps on or off.

**Note:** If you switch the rear lamps on through the overhead console, you cannot switch them off with the rear lamp switch.

## INTERIOR LAMP FUNCTION

### What Is the Interior Lamp Function

The interior lamp function switches the courtesy and door lamps on or off.

### Switching the Interior Lamp Function On and Off



Press to switch the interior lamp function on and off.

**Note:** The indicator lamp illuminates amber when the door function is off.

# Interior Lighting

---

## ADJUSTING THE INSTRUMENT PANEL LIGHTING BRIGHTNESS

The instrument lighting dimmer buttons are on the lighting control.



Repeatedly press one of the buttons to adjust the brightness.



## AMBIENT LIGHTING (If Equipped)

### Switching Ambient Lighting On and Off

1. Press **Settings** on the touchscreen.
2. Press **Vehicle Settings**.
3. Press **Ambient Light**.
4. Switch **Ambient Light** on or off.

### Adjusting Ambient Lighting

Drag the slider left or right.

# Windows

## OPENING AND CLOSING THE WINDOWS

### One-Touch Power Windows - Troubleshooting



**WARNING:** Do not leave children unattended in your vehicle and do not let them play with the power windows. Failure to follow this instruction could result in personal injury.



**WARNING:** When closing the power windows, verify they are free of obstruction and make sure that children and pets are not in the proximity of the window openings.



Press the window control switch to open the window. Lift the window control switch to close the window.

**Note:** *The power windows operate with the ignition on, and for several minutes after you switch the ignition off or until you open a front door.*

To reduce wind noise or pulsing noise when one window is open, slightly open the opposite window.

### One-Touch Open

Fully press the window control switch and release it. Press again or lift it to stop the window.

### One-Touch Close

Fully lift the window control switch and release it. Press again or lift it to stop the window.

### Resetting One-Touch Close

Carry out all steps within 30 seconds of starting the sequence.

1. Close the window.
2. Press and hold the window control switch until the window is fully open. Keep the window control switch pressed for a few seconds.
3. Lift and hold the window control switch until the window is fully closed. Keep the window control switch held for a few seconds.
4. Press and hold the window control switch until the window is fully open. Keep the window control switch pressed for a few seconds.
5. Lift and hold the window control switch until the window is fully closed. Keep the window control switch held for a few seconds.

**Note:** *Repeat the procedure if the window does not close when you use one-touch.*

## WINDOW BOUNCE-BACK

### What Is Window Bounce-Back

The window stops and reverses if it detects an obstruction when closing.

### Overriding Window Bounce-Back



**WARNING:** If you override bounce-back, the window does not reverse if it detects an obstacle. Take care when closing the windows to avoid personal injury or damage to your vehicle.

1. Close the window until it reaches the point of resistance and let it reverse.
2. Lift the window control switch within two seconds to override bounce-back and close the window. Bounce-back is now disabled and you can close the window manually.

# Windows

**Note:** *The window goes past the point of resistance and you can fully close it.*

**Note:** *If the window does not close, have your vehicle checked as soon as possible.*

Press and hold the window control switch to open the window. Pull and hold the window control switch to close the window.

## LOCKING THE REAR WINDOW CONTROLS (IF EQUIPPED)



Press the window control switch to lock or unlock the rear window controls. It illuminates when you lock the rear window controls.

## OPENING AND CLOSING THE SLIDING WINDOWS (IF EQUIPPED)



**WARNING:** When closing the power windows, verify they are free of obstruction and make sure that children and pets are not in the proximity of the window openings.



**WARNING:** Do not leave children unattended in your vehicle and do not let them play with the power windows. Failure to follow this instruction could result in personal injury.

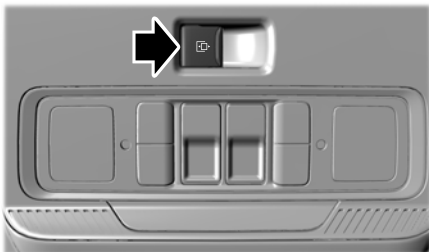

The window control switch is on the overhead console.

# Interior Mirror

---

## INTERIOR MIRROR PRECAUTIONS



**WARNING:** Do not adjust the mirrors when your vehicle is moving. This could result in the loss of control of your vehicle, serious personal injury or death.

**Note:** Do not clean the mirror housing or glass with harsh abrasives, fuel or other petroleum-based cleaning products.

## MANUALLY DIMMING THE INTERIOR MIRROR

Pull the tab below the mirror toward you to reduce glare at night.

## AUTO-DIMMING INTERIOR MIRROR (If Equipped)

### What Is the Auto-Dimming Interior Mirror

The mirror dims to reduce the effect of bright light from behind. It returns to normal when the bright light from behind is no longer present or if you shift into reverse (R).

### Auto-Dimming Interior Mirror Limitations

Do not block the sensors on the front and back of the mirror.

**Note:** A rear center passenger or raised rear center head restraint could prevent light from reaching the sensor.

# Exterior Mirrors

## ADJUSTING THE EXTERIOR MIRRORS



**WARNING:** Do not adjust the mirrors when your vehicle is moving. This could result in the loss of control of your vehicle, serious personal injury or death.

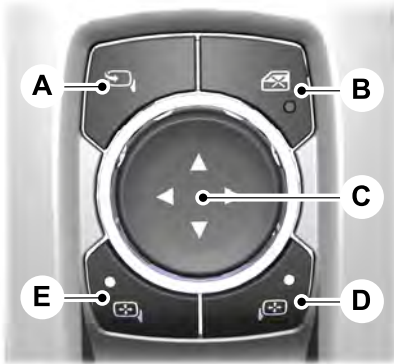

- A Power fold.
- B Window lock.
- C Adjustment control.
- D Right-hand mirror.
- E Left-hand mirror.

To adjust the mirrors, switch your vehicle on, with the ignition in accessory mode or the engine running:

1. Select the mirror you want to adjust. The control light turns on.
2. Use the adjustment control to adjust the position of the mirror.
3. Press the mirror control again. The control light turns off.

## FOLDING THE EXTERIOR MIRRORS - VEHICLES WITH: MANUAL FOLDING MIRRORS

Push the mirror toward the door window glass.

Make sure that you fully engage the mirror in its support when returning it to its original position.

## FOLDING THE EXTERIOR MIRRORS - VEHICLES WITH: POWER FOLDING MIRRORS

The exterior mirrors fold when you lock your vehicle and unfold when you unlock your vehicle.



For tight parking conditions, press the control to fold the mirrors.

Press the control switch again to unfold the mirrors.

**Note:** Do not stop the mirrors midway through their movement. Wait until the mirrors stop moving and press the control again.

The left-hand and right-hand mirrors move at different rates. For example, one mirror may stop while the other one continues to move. This is normal.

If you press the control switch to fold in the mirrors with auto-fold on, the mirrors do not unfold when you unlock your vehicle.

**Note:** The power folding mirrors operate with the ignition on, and for several minutes after you switch the ignition off.

**Note:** If you fold and unfold the mirrors several times within one minute, the power fold function may turn off to protect the motors from overheating.

# Exterior Mirrors

## Switching Auto-fold On and Off

1. Press **Settings** on the touchscreen.
2. Press **Vehicle Settings**.
3. Press **Mirrors**.
4. Switch **Autofold** on or off.

## Loose Mirror

If your power-folding mirrors are manually folded, they may not work properly even after you re-position them. You need to reset them if:

- The mirrors vibrate when you drive.
- The mirrors feel loose.
- The mirrors do not stay in the folded or unfolded position.
- One of the mirrors is not in its normal driving position.

To reset the mirrors perform the following steps:

1. By hand, fold or retract both mirrors.
2. Using the power folding/power telescoping mirror control switch, operate the mirrors until you hear an audible click.
3. Operate the power folding or power telescoping mirrors an additional 3 to 4 times to synchronize the mirrors.

## EXTENDING THE EXTERIOR MIRRORS

This optional feature lets you extend the mirror about 3 in (75 mm). It is useful when towing a trailer. You can manually pull out or push in the mirrors to various positions.

### Power Telescoping Mirrors (if Equipped)

This feature lets you position both mirrors at the same time.

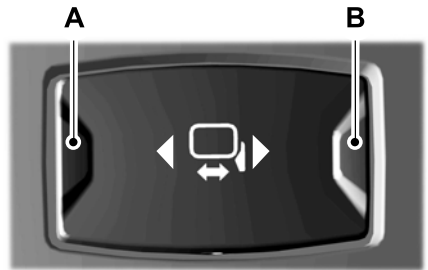

- A. Extend.  
B. Retract.

To adjust your mirrors, make sure you switch your vehicle on, with the ignition in accessory mode or the engine running.

1. Press and release the control switch.
2. Press the adjustment control to position the mirrors.
3. Press the left arrow to extend the mirrors out. Press the right arrow to retract the mirrors in.

**Note:** Moving the mirrors 10 or more times within one minute, or repeated folding and unfolding of the mirrors when holding the control down during full travel, could disable the system to protect the motors from overheating. Wait approximately three minutes with the vehicle running, and up to 10 minutes with the vehicle off, for the system to reset and for function to return to normal.

## AUTO-DIMMING EXTERIOR MIRROR (If Equipped)

### What Is the Auto-Dimming Exterior Mirror

The driver exterior mirror dims when the interior auto-dimming mirror turns on.



# Moonroof (If Equipped)

## OPENING AND CLOSING THE SUN SHADE



**WARNING:** Do not leave children unattended in your vehicle and do not let them play with the sun shades. Failure to follow this instruction could result in personal injury.

The controls are on the overhead console.

### Opening the Sun Shade



Press and release the switch to activate the one-touch open feature. To stop movement, press the switch a second time. The sun shade also opens when you open the moonroof.

**Note:** *The sun shade stops short of its fully opened position for the comfort of rear passengers. To fully open the sun shade, press the switch again.*

### Closing the Sun Shade



Press and release the switch to activate the one-touch close feature. To stop movement, press the switch a second time.

## OPENING AND CLOSING THE MOONROOF



**WARNING:** Do not leave children unattended in your vehicle and do not let them play with the moonroof. Failure to follow this instruction could result in personal injury.



**WARNING:** When closing the moonroof, verify that it is free of obstruction and make sure that children and pets are not in the proximity of the roof opening.

The controls are on the overhead console.

### Opening the Moonroof



Press and release the switch to activate the one-touch open feature. To stop movement, press the switch a second time.

**Note:** *The moonroof stops short of the fully opened position to reduce wind noise or rumbling that may happen with the moonroof fully open.*

*Press and release the switch again to fully open the moonroof.*

### Closing the Moonroof



Press and release the switch to activate the one-touch close feature, from either the open or vent positions. To stop movement, press the switch a second time.

## VENTING THE MOONROOF



**WARNING:** Do not leave children unattended in your vehicle and do not let them play with the moonroof. Failure to follow this instruction could result in personal injury.

The moonroof controls are on the overhead console.

## Moonroof (If Equipped)

---



With the moonroof in the closed position, press and release the switch to vent the moonroof. To close the moonroof from the vent position, press and release the switch again.

### **MOONROOF BOUNCE-BACK**

#### **What Is Moonroof Bounce-Back**

The moonroof stops and reverses some distance if it detects an obstacle when closing.

#### **Overriding Moonroof Bounce-Back**

Press and hold the close button within two seconds after the moonroof comes to a stop.

# Instrument Cluster

## INSTRUMENT CLUSTER OVERVIEW - VEHICLES WITH: 4.2 INCH SCREEN

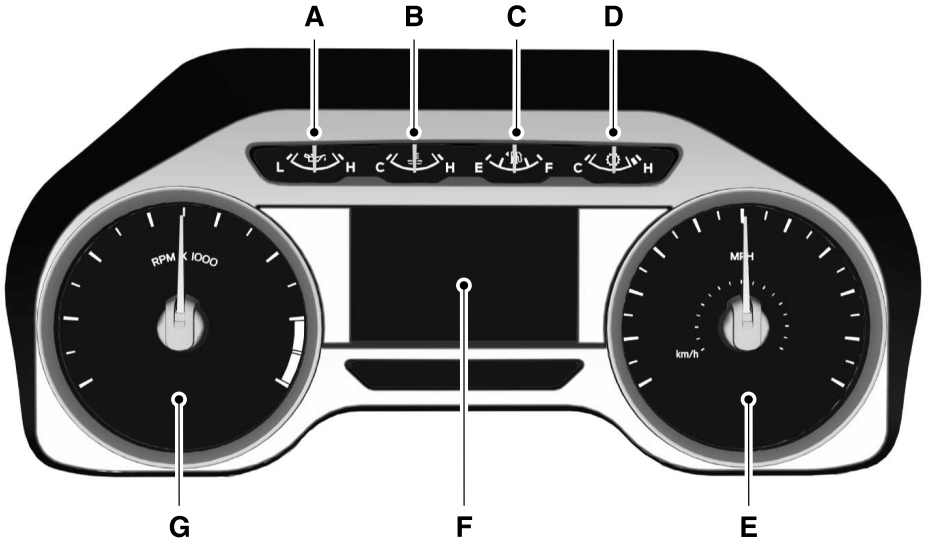

- A Engine oil pressure gauge.
- B Engine coolant temperature gauge.
- C Fuel gauge.
- D Transmission fluid temperature gauge.
- E Speedometer.
- F Information display.
- G Tachometer.

# Instrument Cluster

## INSTRUMENT CLUSTER OVERVIEW - VEHICLES WITH: 8 INCH SCREEN

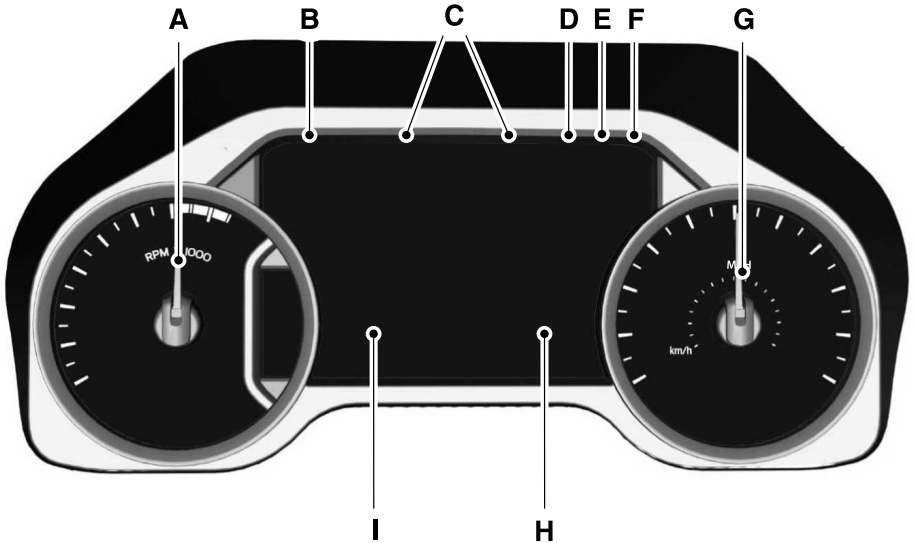

- A Tachometer.
- B Engine coolant temperature gauge.
- C Configurable gauges.
- D Compass.
- E Fuel gauge.
- F Ambient temperature.
- G Speedometer.
- H Distance to empty.
- I Odometer.

# Instrument Cluster

## INSTRUMENT CLUSTER OVERVIEW - VEHICLES WITH: 12.3 INCH SCREEN

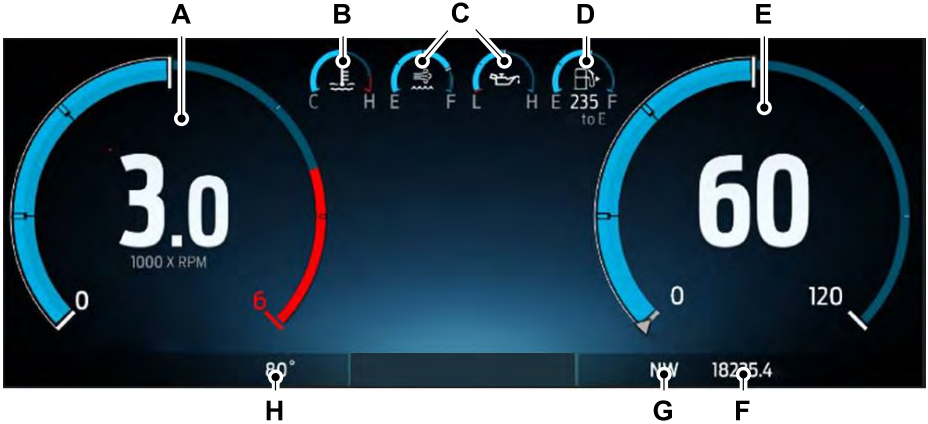

- A Tachometer.
- B Engine coolant temperature gauge.
- C Configurable gauges.
- D Fuel gauge.
- E Speedometer.
- F Odometer.
- G Compass.
- H Ambient temperature.

### WHAT IS THE TACHOMETER

Shows the engine speed. The red line thickens where the engine speed enters the overspeed limiter.

### WHAT IS THE SPEEDOMETER

Displays the vehicle speed.

### FUEL GAUGE

#### What Is the Fuel Gauge

Indicates approximately how much fuel is in the fuel tank.

# Instrument Cluster

---

## Fuel Gauge Limitations

The fuel gauge may not provide an accurate reading when your vehicle is on an incline.

## Locating the Fuel Filler Door

The arrow adjacent to the fuel pump symbol indicates on which side of your vehicle the fuel filler door is located.

## What Is the Low Fuel Reminder

A low fuel level reminder displays and sounds when the distance to empty reaches 75 mi (120 km) to empty for MyKey, and at 50 mi (80 km), 25 mi (40 km), 12 mi (20 km) and 0 mi (0 km) for all vehicle keys.

**Note:** *The low fuel reminder can appear at different fuel gauge positions depending on fuel economy conditions. This variation is normal.*

## What Is Distance to Empty

Indicates the approximate distance your vehicle can travel on the fuel remaining in the tank. Changes in driving pattern can cause the value to not only decrease but also increase or stay constant for periods of time.

## WHAT IS THE ENGINE COOLANT TEMPERATURE GAUGE

Indicates the engine coolant temperature.

## WHAT IS THE ENGINE OIL PRESSURE GAUGE

Indicates the engine oil pressure.

**Note:** *This is a configurable gauge.*

## WHAT IS THE TRANSMISSION FLUID TEMPERATURE GAUGE

Indicates the transmission fluid temperature.

Special operating conditions can cause higher than normal operating temperatures. See **Special Operating Conditions Scheduled Maintenance** (page 614).

**Note:** *This is a configurable gauge.*

## WHAT IS THE TURBO BOOST GAUGE (IF EQUIPPED)

Indicates the amount of manifold air pressure in the engine.

**Note:** *This is a configurable gauge.*

## WHAT IS THE DIESEL EXHAUST FLUID GAUGE (IF EQUIPPED)

Indicates the current diesel exhaust fluid level.

## WHAT ARE THE INSTRUMENT CLUSTER WARNING LAMPS

Warning lamps alert you to a vehicle condition that could become serious. Some lamps illuminate when you start your vehicle to make sure they work. If any lamps remain on after starting your vehicle, refer to the respective system warning lamp for further information.

# Instrument Cluster

## INSTRUMENT CLUSTER WARNING LAMPS

### Anti-Lock Brake System



If it illuminates when you are driving, this indicates a malfunction. Your vehicle continues to have normal braking without the anti-lock brake system function. Have your vehicle checked as soon as possible.

### Battery



It illuminates when you switch the ignition on.

If it illuminates when the engine is running, this indicates your vehicle requires service. Have your vehicle checked as soon as possible.

### Brake System



It illuminates when you apply the parking brake and the ignition is on. If it illuminates when your



vehicle is moving, make sure the parking brake is released. If the parking brake is released, this

indicates low brake fluid level or the brake system requires service. Have your vehicle checked as soon as possible.

**Note:** Indicators may vary depending on region.

### Diesel Exhaust Fluid



It illuminates when the diesel exhaust fluid is low, contaminated or the system requires service. See **What Is the Selective Catalytic Reduction System** (page 245).

### Door Ajar



It illuminates when you switch the ignition on and remains on if any door is open.

### Electric Parking Brake



It illuminates or flashes when the electric parking brake requires service.

### Engine Coolant Temperature



If it illuminates, safely stop your vehicle and switch the vehicle off.

### Fasten Seatbelt



It illuminates and a tone sounds until you fasten the seatbelts.

### Hood Ajar



It illuminates when the ignition is on and the hood is not completely closed.

### Low Fuel Level



It illuminates when the fuel level is low.

### Low Tire Pressure



It illuminates when your tire pressure is low. If illuminated, check your tire pressure as soon as possible. If it begins to flash at anytime, have the system checked as soon as possible.

### Low Washer Fluid Level



It illuminates when the washer fluid is low.

# Instrument Cluster

## Oil Pressure



It illuminates when the engine oil pressure is low.

## Powertrain Malfunction, Reduced Power, Electronic Throttle Control, Check 4X4



It illuminates when the powertrain or four-wheel drive require service. Have the system checked as soon as possible.

## Service Engine Soon



It illuminates when the ignition is on and the engine is off, this is normal. If it illuminates when the engine is on this indicates the emission control system requires service. If it flashes, have your vehicle checked immediately. See **Emission Law** (page 668). See **Starting and Stopping the Engine – Warning Lamps** (page 216).

## Stop Safely



It illuminates if an electrical component requires service or a failure that causes your vehicle to shutdown or enter into a limited operating mode.

## Tailgate Ajar



It illuminates when the ignition is on and the tailgate is not completely closed.

## Water in Fuel



It illuminates when the fuel and water separator has a significant quantity of water in it and requires immediate draining.

## WHAT ARE THE INSTRUMENT CLUSTER INDICATORS

Indicators notify you of various features that are active on your vehicle.

## INSTRUMENT CLUSTER INDICATORS

### Active Drive Assist



See **Active Drive Assist** (page 292).

### Adaptive Cruise Control



See **Adaptive Cruise Control** (page 317).

### Automatic High Beam



See **Automatic High Beam Control Indicators** (page 130).

### Automatic Regen Control Off



See **Diesel Particulate Filter Precautions** (page 240).

### Auto Hold Active



See **Auto Hold** (page 283).

### Auto Hold Unavailable



See **Auto Hold** (page 283).

### Auto-Start-Stop



See **Auto-Start-Stop** (page 224).



# Instrument Cluster

## Blind Spot Monitor



See **Blind Spot Information System** (page 340).

## Cruise Control



See **Cruise Control** (page 313).

## Electronic Locking Differential



See **Electronic Locking Differential** (page 269).

## Four-Wheel Drive



See **Four-Wheel Drive** (page 260).



**Note:** Some indicators appear different depending on vehicle options.

## Front Airbag



See **Airbags** (page 58).

## Front Fog Lamp



See **Switching the Front Fog Lamps On and Off** (page 126).

## High Beam



See **Using the High Beam Headlamps** (page 124).

## Hill Descent



See **Hill Descent Control** (page 289).

## Lamps On



See **Exterior Lighting Control** (page 124).

## Ready to Drive



See **Hybrid Electric Vehicle Information** (page 221).

## Reverse Brake Assist



See **Reverse Braking Assist** (page 279).

## Stability Control and Traction Control



See **Traction Control** (page 284). See **Stability Control** (page 286).



## Turn Signal Lamps



See **Switching the Turn Signal Lamps On and Off** (page 125).

## Tow Haul



See **Towing a Trailer** (page 375).

## Wait to Start



See **Starting a Diesel Engine** (page 211).

# Instrument Cluster Display

## USING THE INSTRUMENT CLUSTER DISPLAY CONTROLS



**WARNING:** Driving while distracted can result in loss of vehicle control, crash and injury. We strongly recommend that you use extreme caution when using any device that may take your focus off the road. Your primary responsibility is the safe operation of your vehicle. We recommend against the use of any hand-held device while driving and encourage the use of voice-operated systems when possible. Make sure you are aware of all applicable local laws that may affect the use of electronic devices while driving.

The controls are on the steering wheel.

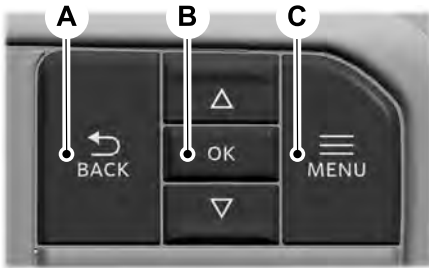

- A Back button.
- B OK button.
- C Menu button.

### Back Button

Press to go back or to exit a menu.

### OK Button

Press to make a selection.

### Menu Button

Press to display the submenu.

### Scroll Buttons

Press the up or down buttons to scroll through the menu items.

### Status Indicator



Menu items with a check box indicates a feature's status. A check in the box indicates the feature is on, and unchecked indicates the feature is off.

## INSTRUMENT CLUSTER DISPLAY MAIN MENU - VEHICLES WITH: 4.2 INCH SCREEN

Depending on your vehicle options, some menu items can appear different or not at all.

**Note:** For your safety, some features are speed-dependent and could be unavailable when your vehicle is above a certain speed.

Menu Item
Select Screens
Truck Info
Towing
Settings

# Instrument Cluster Display

## INSTRUMENT CLUSTER DISPLAY MAIN MENU - VEHICLES WITH: 8 INCH SCREEN

Depending on your vehicle options, some menu items can appear different or not at all.

**Note:** For your safety, some features are speed-dependent and could be unavailable when your vehicle is above a certain speed.

Menu Item
MyView
Trip/Fuel
Truck Info
Towing
Navigation
Phone
Audio
Settings

## INSTRUMENT CLUSTER DISPLAY MAIN MENU - VEHICLES WITH: 12.3 INCH SCREEN

Depending on your vehicle options, some menu items can appear different or not at all.

**Note:** For your safety, some features are speed-dependent and could be unavailable when your vehicle is above a certain speed.

Menu Item
MyView
Trip/Fuel
Truck Info
Towing
Navigation
Phone
Audio
Settings

## TRIP COMPUTER - VEHICLES WITH: 4.2 INCH SCREEN

### Accessing the Trip Computer

#### Using Select Screens

1. Select **Select Screens**.
2. Use the controls on the steering wheel to navigate the menu. See **Customizing the Instrument Cluster Display** (page 153).

#### Using the Home Screen

Once screens have been added, use the controls on the steering wheel to view each trip screen.

#### Resetting the Trip Computer

1. Use the controls on the steering wheel to navigate the home screen.
2. Select **Trip 1** or **Trip 2**.
3. Press and hold the **OK** button for a few seconds.

**Note:** This Trip resets every time you start your vehicle.

# Instrument Cluster Display

---

## TRIP COMPUTER - VEHICLES WITH: 8 INCH SCREEN/12.3 INCH SCREEN

### Accessing the Trip Computer

1. Select **Trip/Fuel**.
2. Select **This Trip, Trip 1** or **Trip 2**.

### Resetting the Trip Computer

1. Select **Trip/Fuel**.
2. Select **Trip 1** or **Trip 2**.
3. Press and hold the **OK** button for a few seconds.

**Note:** *This Trip resets every time you start your vehicle.*

## CUSTOMIZING THE INSTRUMENT CLUSTER DISPLAY

### Adding Screens Using MyView

1. Using the information display controls on the steering wheel, select **MyView**.
2. Select **Configure MyView**.
3. Select a screen.
4. Press the **OK** button.

**Note:** *The number of screens you can add is limited. If the selected screen does not appear you must deselect screens from the MyView menu.*

### Adding Screens Using Select Screens

1. Select **Select Screens**.
2. Use the controls on the steering wheel to highlight a screen to add.
3. Press the **OK** button.

**Note:** *The number of screens you can add is limited. If the selected screen does not appear you must deselect screens from the Select Screens menu.*

### Configuring Gauges

1. Select **Settings**.
2. Select **Configure Gauges**.
3. Select to swap or change left-hand side and right-hand side gauges.

## PERSONALIZED SETTINGS

### Changing the Measure Unit

1. Press **Settings** on the touchscreen.
2. Press **General**.
3. Press **Measure Units**.
4. Select a measurement unit.

### Changing the Temperature Unit

1. Press **Settings** on the touchscreen.
2. Press **General**.
3. Press **Temperature Units**.
4. Select **Fahrenheit** or **Celsius**.

### Changing the Tire Pressure Unit

1. Press **Settings** on the touchscreen.
2. Press **General**.
3. Press **Tire Pressure Units**.
4. Select a pressure unit.

# Instrument Cluster Display

---

## HYBRID DISPLAY INFORMATION

### What Is EV Coach

EV coach helps you get the most of your vehicle's electrical driving and regenerative braking capabilities.

### How Does EV Coach Work

When accelerating or maintaining speed, a blue or white solid bar displays. This indicates vehicle power. A blue rectangular box could also display that shows the power level that the engine turns on at.

When the power level displays in the rectangular box, it is blue which indicates you are in electric only operation.

When the power level displays outside of the rectangular box, it is white which indicates you are in hybrid operation.

When you are decelerating, either releasing the accelerator pedal or applying the brake, you see a green or white solid bar which indicates the power being used to slow your vehicle down. A green rectangular box could also display that shows the amount of power that can be recaptured by the regenerative braking system and returned to the high voltage battery.

When the power level displays in the rectangular box, it is green which indicates that the regenerative braking system is being used to slow down your vehicle and return the maximum amount of energy to the high voltage battery.

When the power level displays outside of the rectangular box, it is white which indicates both regenerative and conventional braking systems are in use.

## WHAT IS BRAKE COACH

The brake coach appears after the vehicle has come to a stop. It coaches you to brake in a manner that maximizes the amount of energy returned through the regenerative braking system.

The percent displayed is an indication of the regenerative braking efficiency with 100% representing the maximum amount of energy recovery. You can switch brake coach on or off in the settings menu on your touchscreen.

## WHAT IS THE TRIP SUMMARY

Displays the trip summary when you switch off your vehicle. The values are cumulative since you last started your vehicle.

# Remote Start (If Equipped)

## WHAT IS REMOTE START

The system allows you to remotely start your vehicle and to adjust the interior temperature according to the settings that you chose.

## REMOTE START PRECAUTIONS



**WARNING:** Do not start the engine in a closed garage or in other enclosed areas. Exhaust fumes are toxic. Always open the garage door before you start the engine. Failure to follow this instruction could result in personal injury or death.

## REMOTE START LIMITATIONS

Remote start does not work under the following conditions:

- The alarm horn is sounding.
- The hood is open.
- The transmission is not in park (P).
- The ignition is on.
- The battery voltage is below the minimum operating voltage.

**Note:** Do not use remote start if your fuel level is low.

**Note:** You can use remote start with FordPass. See **Connecting the Vehicle to a Wi-Fi Network** (page 565).

## ENABLING REMOTE START

1. Press **Settings** on the touchscreen.
2. Press **Vehicle Settings**.
3. Press **Remote Start Setup**.
4. Switch **Remote Start** on or off.

**Note:** To remote start with FordPass, make sure that the modem is enabled. See **Connecting FordPass to the Modem** (page 565).

## REMOTELY STARTING AND STOPPING THE VEHICLE

### Remotely Starting the Vehicle



Press the button on the remote control.



Within three seconds, press the button on the remote control.

Within three seconds, press the button again.

**Note:** You can also use FordPass to start the vehicle.

**Note:** The turn signal lamps flash twice.

**Note:** The parking lamps turn on when the vehicle is running.

**Note:** The horn sounds if the system fails to start.

**Note:** All other vehicle systems remain off when you have remotely started the vehicle.

**Note:** The vehicle remains secured when you have remotely started the vehicle. A valid key must be inside your vehicle to switch the ignition on and drive your vehicle.

### Remotely Stopping the Vehicle



Within three seconds, press the button on the remote control.

Within three seconds, press the button again.

# Remote Start (If Equipped)

## EXTENDING THE REMOTE START DURATION

To extend the remote start duration during remote start, do the following:



Press the button on the remote control.



Within three seconds, press the button on the remote control.

Within three seconds, press the button again.

If the duration is set to 15 minutes, the duration extends by another 15 minutes. This provides a total of 30 minutes.

**Note:** Remote start can only be extended once.

**Note:** A maximum of two remote starts, or one remote start with an extension, are allowed. To reset the restart procedure switch the vehicle to on, then to off.

## REMOTE START REMOTE CONTROL INDICATORS

### Remote Control Feedback

An LED on the remote control provides status feedback of remote start or stop commands.

LED	Status
Solid green.	Remote start successful.
Solid red.	Remote stop successful.
Blinking red.	Request failed or status not received.
Blinking green.	Status incomplete.

## REMOTE START SETTINGS

### Switching Climate Control Auto Mode On and Off

1. Press **Settings** on the touchscreen.
2. Press **Remote Start Setup**.
3. Press **Climate Control**.
4. Select **Vehicle**.
5. Switch **Auto** on or off.

**Note:** If you switch the auto mode on, the system attempts to heat or cool the interior to 72°F (22°C).

**Note:** When you switch the ignition on, the climate control system returns to the last used settings.

### Switching Climate Control Last Settings On and Off

1. Press **Settings** on the touchscreen.
2. Press **Vehicle Settings**.
3. Press **Remote Start Setup**.
4. Switch **Last settings** on or off.

**Note:** If you switch the last settings on, the system remembers the last used settings.

### Switching the Heated Seat Settings On and Off

1. Press **Settings** on the touchscreen.
2. Press **Vehicle Settings**.
3. Press **Remote Start Setup**.
4. Press **Seats**.
5. Switch **Auto** on or off.

**Note:** If you switch the heated seat settings on, the heated seats turn on during cold weather.

## Remote Start (If Equipped)

---

### Switching the Heated Steering Wheel Settings On and Off

1. Press **Settings** on the touchscreen.
2. Press **Vehicle Settings**.
3. Press **Remote Start Setup**.
4. Press **Seats and Steering Wheel**.
5. Switch **Auto** on or off.

**Note:** *If you switch the heated steering wheel settings on, the heated steering wheel turns on during cold weather.*

### Setting the Remote Start Duration

1. Press **Settings** on the touchscreen.
2. Press **Vehicle Settings**.
3. Press **Remote Start Setup**.
4. Press **Duration**.

**Note:** *Wait a few seconds before remotely starting the vehicle after the vehicle stops running.*



# Climate Control - Vehicles With: Automatic Temperature Control

## IDENTIFYING THE CLIMATE CONTROL UNIT



Depending on your vehicle options, the controls could look different than what you see here.

## SWITCHING CLIMATE CONTROL ON AND OFF



Press the button.

## SWITCHING RECIRCULATED AIR ON AND OFF



Press the button to recirculate air currently in the passenger compartment.

**Note:** Recirculated air could turn off or be prevented from turning on in all air flow modes except maximum cooling to reduce the risk of the windows fogging up.

**Note:** Recirculated air could turn on and off when you direct air to the instrument panel or footwell air vents during hot weather to improve cooling efficiency.

## SWITCHING AIR CONDITIONING ON AND OFF



Press the button.

**Note:** Under certain conditions, the air conditioning compressor could continue to operate after you switch air conditioning off.

## SWITCHING DEFROST ON AND OFF



Press the button to activate the selection screen.



Press the button on the touchscreen to switch the windshield air vents on.



Make sure that the instrument panel air vents are switched off.



Make sure that the footwell air vents are switched off.

## SWITCHING MAXIMUM DEFROST ON AND OFF



Press the button.

Air flows through the windshield air vents, and the blower motor adjusts to the highest speed.

You can also use this setting to defog and clear the windshield of a thin covering of ice.

**Note:** To prevent window fogging, you cannot select recirculated air when maximum defrost is on.

**Note:** The heated rear window also turns on when you select maximum defrost.

# Climate Control - Vehicles With: Automatic Temperature Control

## SWITCHING MAXIMUM COOLING ON AND OFF



Press the button.

**Note:** When you switch maximum cooling off, air conditioning remains on.

## SWITCHING THE HEATED WIPER PARK ON AND OFF (IF

EQUIPPED)



When you switch the heated rear window on, the heated wiper park also turns on.

## SWITCHING THE HEATED REAR WINDOW ON AND OFF



Press the button to clear the rear window of thin ice and fog. The heated rear window turns off after a short period of time.

**Note:** Do not use harsh chemicals, razor blades or other sharp objects to clean or remove decals from the inside of the heated rear window as this could cause damage to the heated rear window grid lines not covered by the vehicle Warranty.

## SWITCHING THE HEATED MIRRORS ON AND OFF

### Heated Mirrors



Press the button.

## SETTING THE BLOWER MOTOR SPEED



Press up or down on the control to select the blower motor speed.

**Note:** For Hybrid Electric Vehicle (HEV) and Plug-In Hybrid Electric Vehicle (PHEV) vehicles, the blower motor may run, and you may feel airflow when the climate control is off to provide cooling to the battery.

## SETTING THE TEMPERATURE

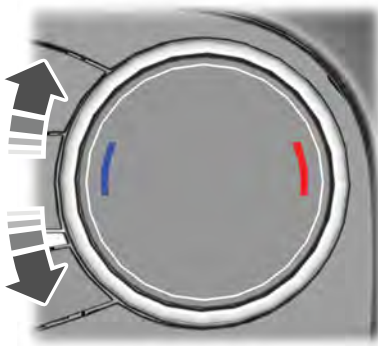

Turn the control on the left-hand side of the climate control to set the left-hand temperature.

**Note:** This control also sets the right-hand side temperature when you switch off dual zone mode.

Turn the control on the right-hand side of the climate control to set the right-hand temperature.

# Climate Control - Vehicles With: Automatic Temperature Control

## DIRECTING THE FLOW OF AIR

### Directing Air to the Windshield Air Vents



Press the button to activate the selection screen.



Press the button on the touchscreen.

### Directing Air to the Instrument Panel Air Vents



Press the button to activate the selection screen.



Press the button on the touchscreen.

### Directing Air to the Footwell Air Vents



Press the button to activate the selection screen.



Press the button on the touchscreen.

## AUTO MODE

### Switching Auto Mode On and Off



Press the button to switch auto mode on. Repeatedly press the button to adjust auto mode.

**Note:** When you switch auto mode on, lights on the blower motor control do not illuminate to indicate the blower motor speed.

Adjust the blower motor control or air distribution control to switch auto mode off.

### Auto Mode Indicators

The indicators are on the Auto Mode button.

Auto Mode Indicator Status	Description
One indicator illuminated.	The blower motor speed is reduced. Use this setting to minimize the amount of noise from the blower motor. This setting increases the time taken to cool the interior.
Two indicators illuminated.	The blower motor speed is moderate.
Three indicators illuminated.	The blower motor speed is increased. Use this setting to reduce the time taken to cool the interior. This setting increases the amount of noise from the blower motor.

# Climate Control - Vehicles With: Automatic Temperature Control

## Switching Dual Mode On and Off



Press the button.

## CLIMATE CONTROL HINTS

### General Hints

- Prolonged use of recirculated air may cause the windows to fog up.
- You may feel a small amount of air from the footwell air vents regardless of the air distribution setting.
- To reduce humidity build-up inside your vehicle, do not drive with the system switched off or with recirculated air always switched on.
- Do not place objects under the front seats as this may interfere with the airflow to the rear seats.
- Remove any snow, ice or leaves from the air intake area at the base of the windshield.
- To improve the time to reach a comfortable temperature in hot weather, drive with the windows open until you feel cold air through the air vents.

### Automatic Climate Control

- Adjusting the settings when your vehicle interior is extremely hot or cold is not necessary. Automatic mode is best recommended to maintain set temperature.
- The system adjusts to heat or cool the interior to the temperature you select as quickly as possible.
- For the system to function efficiently, the instrument panel and side air vents should be fully open.

- If you press **AUTO** during cold outside temperatures, the system directs air flow to the windshield and side window air vents. In addition, the blower motor may run at a slower speed until the engine warms up.
- If you press **AUTO** during hot temperatures and the inside of the vehicle is hot, the system uses recirculated air to maximize interior cooling. Blower motor speed may also reduce until the air cools.

### Quickly Heating the Interior

1. Press **AUTO**.
2. Adjust the temperature function to the setting you prefer.

### Recommended Settings for Heating

1. Press **AUTO**.
2. Adjust the temperature function to the setting you prefer. Use 72°F (22°C) as a starting point, then adjust the setting as necessary.

### Quickly Cooling the Interior

Press **MAX A/C**.

### Recommended Settings for Cooling

1. Press **AUTO**.
2. Adjust the temperature function to the setting you prefer. Use 72°F (22°C) as a starting point, then adjust the setting as necessary.

### Defogging the Side Windows in Cold Weather

1. Press and release defrost or maximum defrost.

## Climate Control - Vehicles With: Automatic Temperature Control

---

2. Adjust the temperature control to the setting you prefer. Use 72°F (22°C) as a starting point, then adjust the setting as necessary.

# Climate Control - Vehicles With: Manual Temperature Control

## IDENTIFYING THE CLIMATE CONTROL UNIT



Depending on your vehicle options, the controls could look different than what you see here.

## SWITCHING CLIMATE CONTROL ON AND OFF



Press the button.

## SWITCHING RECIRCULATED AIR ON AND OFF



Press the button to recirculate air currently in the passenger compartment.

**Note:** Recirculated air could turn off or be prevented from turning on in all air flow modes except maximum cooling to reduce the risk of the windows fogging up.

**Note:** Recirculated air could turn on and off when you direct air to the instrument panel or footwell air vents during hot weather to improve cooling efficiency.

## SWITCHING AIR CONDITIONING ON AND OFF



Press the button.

**Note:** Under certain conditions, the air conditioning compressor could continue to operate after you switch air conditioning off.

## SWITCHING DEFROST ON AND OFF



Press the button to switch the windshield air vents on.



Make sure that the instrument panel air vents are switched off.



Make sure that the footwell air vents are switched off.

## SWITCHING MAXIMUM DEFROST ON AND OFF



Turn the temperature control clockwise past the highest setting to maximize defrosting.

**Note:** The temperature control springs back to the highest setting.

Air flows through the windshield air vents, and the blower motor adjusts to the highest speed.

**Note:** To prevent window fogging, you cannot select recirculated air when maximum defrost is on.

**Note:** When you switch maximum defrost on, the heated windshield turns on.

# Climate Control - Vehicles With: Manual Temperature Control

## SWITCHING MAXIMUM COOLING ON AND OFF

**MAX A/C** Turn the temperature control counterclockwise past the lowest setting to maximize cooling.

**Note:** The temperature control springs back to the lowest setting.

**Note:** When you switch maximum cooling off, air conditioning remains on.

## SWITCHING THE HEATED REAR WINDOW ON AND OFF

**REAR** Press the button to clear the rear window of thin ice and fog. The heated rear window turns off after a short period of time.

**Note:** Do not use harsh chemicals, razor blades or other sharp objects to clean or remove decals from the inside of the heated rear window as this could cause damage to the heated rear window grid lines not covered by the vehicle Warranty.

## SWITCHING THE HEATED MIRRORS ON AND OFF

### Heated Mirrors

 Press the button.

## SETTING THE BLOWER MOTOR SPEED



**Note:** Lights on the control illuminate to indicate the blower motor speed.

**Note:** When you switch the blower motor off, air conditioning turns off and the windows could fog up.

## SETTING THE TEMPERATURE

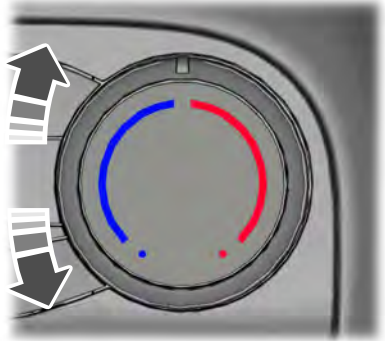

Turn the temperature control counterclockwise for cooler temperature settings.

Turn the temperature control clockwise for warmer temperature settings.

## DIRECTING THE FLOW OF AIR

### Directing Air to the Windshield Air Vents

 Press the button.

### Directing Air to the Instrument Panel Air Vents

 Press the button.

# Climate Control - Vehicles With: Manual Temperature Control

## Directing Air to the Footwell Air Vents



Press the button.

## CLIMATE CONTROL HINTS

### General Hints

- Prolonged use of recirculated air may cause the windows to fog up.
- You may feel a small amount of air from the footwell air vents regardless of the air distribution setting.
- To reduce humidity build-up inside your vehicle, do not drive with the system switched off or with recirculated air always switched on.
- Do not place objects under the front seats as this may interfere with the airflow to the rear seats.
- Remove any snow, ice or leaves from the air intake area at the base of the windshield.
- To improve the time to reach a comfortable temperature in hot weather, drive with the windows open until you feel cold air through the air vents.

### Quickly Heating the Interior

1. Adjust the blower motor speed to the highest speed setting.
2. Adjust the temperature control to the highest setting.
3. Direct air to the footwell air vents.

### Recommended Settings for Heating

1. Adjust the blower motor speed to the center setting.

2. Adjust the temperature control to the midway point of the hot settings.
3. Direct air to the footwell air vents.

### Quickly Cooling the Interior

1. Press **MAX A/C**.
2. Drive with the windows open for a short period of time.

### Recommended Settings for Cooling

1. Adjust the blower motor speed to the center setting.
2. Adjust the temperature control to the midway point of the cold settings.
3. Direct air to the instrument panel air vents.

### Defogging the Side Windows in Cold Weather

1. Direct air to the instrument panel and windshield air vents.
2. Press and release **A/C**.
3. Adjust the temperature control to the setting you prefer.
4. Adjust the blower motor speed to the highest setting.
5. Direct air toward the side windows.
6. Close the instrument panel air vents.



# Interior Air Quality

---

## WHAT IS THE CABIN AIR FILTER

The cabin air filter improves the quality of air in your vehicle by trapping dust, pollen and other particles.

## REPLACING THE CABIN AIR FILTER

Replace the filter at regular intervals. See **Scheduled Maintenance** (page 605).

The cabin air filter is behind the glove compartment.

To remove the lower glove compartment and access the filter:

1. Open the glove compartment.

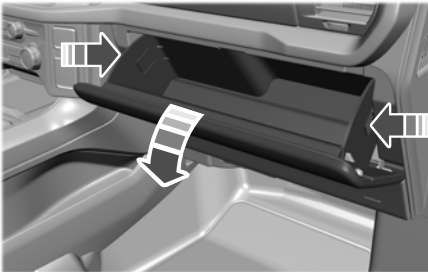

2. Press the tab on each side.
3. Fully lower the glove compartment.
4. Pull the glove compartment toward you.

# Front Seats

## FRONT SEAT PRECAUTIONS



**WARNING:** Sitting improperly, out of position or with the seatback reclined too far can take weight off the seat cushion and affect the decision of the passenger sensing system, resulting in serious injury or death in the event of a crash. Always sit upright against your seat back, with your feet on the floor.



**WARNING:** Do not recline the seat backrest too far as this can cause the occupant to slide under the seatbelt, resulting in personal injury in the event of a crash.



**WARNING:** Do not place objects higher than the top of the seat backrest. Failure to follow this instruction could result in personal injury or death in the event of a sudden stop or crash.



**WARNING:** Do not adjust the driver seat or seat backrest when your vehicle is moving. This may result in sudden seat movement, causing the loss of control of your vehicle.

## SITTING IN THE CORRECT POSITION

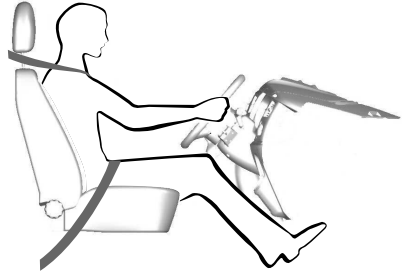

When you use them properly, the seat, head restraint, seatbelt and airbags will provide optimum protection in the event of a crash.

We recommend that you follow these guidelines:

- Sit in an upright position with the base of your spine as far back as possible.
- Do not recline the seat backrest so that your torso is more than 30 degrees from the upright position.
- Adjust the head restraint so that the top of it is level with the top of your head and as far forward as possible. Make sure that you remain comfortable.
- Keep sufficient distance between yourself and the steering wheel. We recommend a minimum of 10 in (25 cm) between your breastbone and the airbag cover.
- Hold the steering wheel with your arms slightly bent.

# Front Seats

- Bend your legs slightly so that you can press the pedals fully.
- Position the shoulder strap of the seatbelt over the center of your shoulder and position the lap strap tightly across your hips.

Make sure that your driving position is comfortable and that you can maintain full control of your vehicle.

## MANUAL SEATS (If Equipped)

### Head Restraint Components

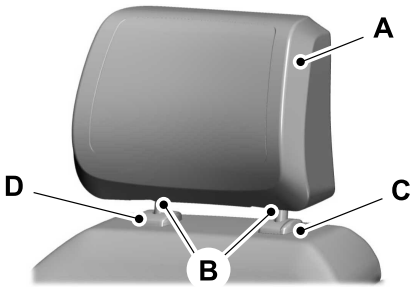



The head restraints consist of:

- A An energy absorbing head restraint.
- B Two steel stems.
- C Guide sleeve adjust and release button.
- D Guide sleeve unlock and remove button (If equipped).

## Adjusting the Head Restraint

### 4-Way Head Restraints

 **WARNING:** Fully adjust the head restraint before you sit in or operate your vehicle. This will help minimize the risk of neck injury in the event of a crash. Do not adjust the head restraint when your vehicle is moving.

 **WARNING:** The head restraint is a safety device. Whenever possible it should be installed and properly adjusted when the seat is occupied. Failure to adjust the head restraint properly could reduce its effectiveness during certain impacts.

**Note:** Adjust the seat backrest to an upright driving position before adjusting the head restraint. Adjust the head restraint so that the top of it is level with the top of your head and as far forward as possible. Make sure that you remain comfortable. If you are extremely tall, adjust the head restraint to its highest position.

Pull the head restraint up to raise it.

To lower the head restraint:

1. Press and hold the adjust and release button.
2. Push the head restraint down.

To tilt the head restraint:



1. Adjust the seat backrest to an upright driving or riding position.

## Front Seats

2. Pivot the head restraint forward toward your head to the preferred position.

After the head restraint reaches the forward-most tilt position, pivot it forward again to release it to the rearward, untilted position.

**Note:** Do not attempt to force the head restraint backward after it is tilted. Instead, continue tilting it forward until the head restraint releases to the upright position.

### Removing the Head Restraint

1. Pull up the head restraint until it reaches the highest adjustment position.
2. Press and hold the adjust and release button and the unlock and remove button.
3. Pull up the head restraint.

**Note:** You cannot remove head restraints that have audio system speakers.

### Installing the Head Restraint

Align the steel stems into the guide sleeves and push the head restraint down until it locks.

### Moving the Seat Backward and Forward

[Manual Seat Adjustment](#)



**WARNING:** Do not adjust the driver seat or seat backrest when your vehicle is moving. This may result in sudden seat movement, causing the loss of control of your vehicle.



**WARNING:** Make sure the seat fully locks into place by rocking it backward and forward. Not securing the seat into the locked position can be dangerous in a crash and could cause serious personal injury or death.



### Adjusting the Seat Backrest

[Manual Seat Adjustment](#)



# Front Seats

## Adjusting the Lumbar Support

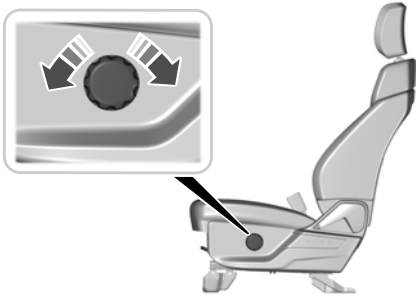

## POWER SEATS (If Equipped)

### Head Restraint Components

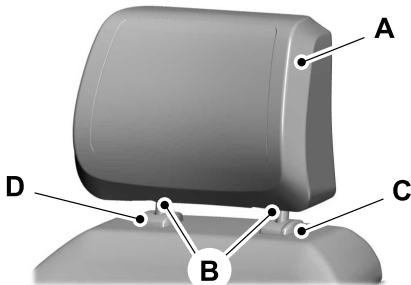

The head restraints consist of:

- A An energy absorbing head restraint.
- B Two steel stems.
- C Guide sleeve adjust and release button.
- D Guide sleeve unlock and remove button (if equipped).

## Adjusting the Head Restraint

### 4-Way Head Restraints

**WARNING:** Fully adjust the head restraint before you sit in or operate your vehicle. This will help minimize the risk of neck injury in the event of a crash. Do not adjust the head restraint when your vehicle is moving.

**WARNING:** The head restraint is a safety device. Whenever possible it should be installed and properly adjusted when the seat is occupied. Failure to adjust the head restraint properly could reduce its effectiveness during certain impacts.

To raise the head restraint, pull the head restraint up.

To lower the head restraint, do the following:

1. Press and hold the adjust and release button.
2. Push the head restraint down.

To tilt the head restraint, do the following:

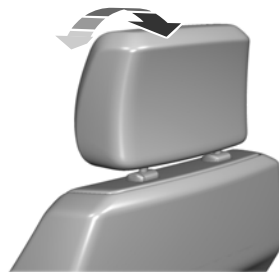

1. Adjust the seat backrest to an upright driving or riding position.
2. Pivot the head restraint forward toward your head to the preferred position.

# Front Seats

After the head restraint reaches the forward-most tilt position, pivot it forward again to release it to the rearward, untilted position.

**Note:** Do not attempt to force the head restraint backward after it is tilted. Instead, continue tilting it forward until the head restraint releases to the upright position.

## Removing the Head Restraint

1. Pull up the head restraint until it reaches its highest position.
2. Press and hold the adjust and release button and the unlock and remove button.
3. Pull up the head restraint.

**Note:** You cannot remove head restraints that have audio system speakers.

## Installing the Head Restraint

Align the steel stems into the guide sleeves and push the head restraint down until it locks.

## Moving the Seat Backward and Forward

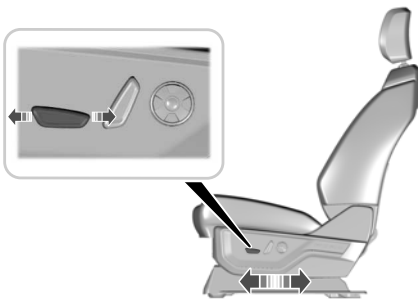

If the seat stops prior to reaching the end of the travel position, or an obstruction occurs, a new stopping position is learned.

To reset the stopping position:

1. Remove any obstruction.
2. Press and hold the control until the seat stops moving.
3. Press and hold the control again until the seat stops.
4. Continue holding the control for a few seconds. The new position is learned.

## Adjusting the Seat Cushion

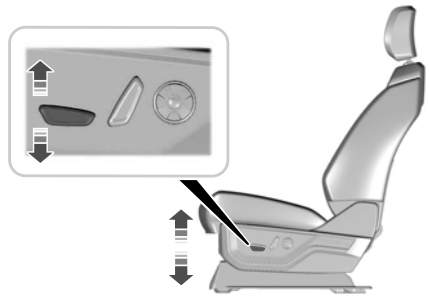

## Adjusting the Seat Backrest

[Max Recline Seat](#)

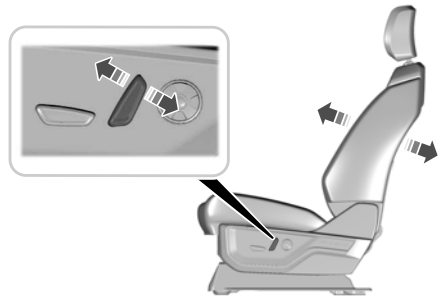

# Front Seats

## Adjusting the Seat Flat (If Equipped)

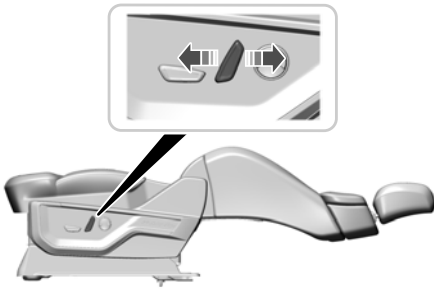

This feature allows the occupant to find a comfortable position to rest when the vehicle is not moving.

**Note:** Before adjusting the seat backrest fully flat, place the rear seat cushion into the upright position and remove any objects that could obstruct the movement of the flat seat. See **Folding the Seats** (page 176).

As the seat folds flat, the cushion adjusts to support the hips and lower back. For additional support, you can also adjust the upper seat backrest.

If you fully recline the passenger seat and the vehicle is moving, a message appears on the instrument cluster and a tone sounds. To switch the warning off, return the seat to an upright position.

## Adjusting the Upper Seat Backrest (If Equipped)

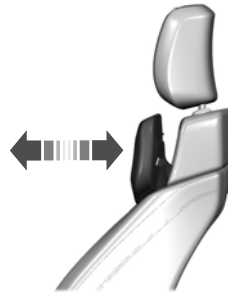

The front upper seat backrest tilts for extra comfort. To tilt the upper seat backrest, pivot the upper seat backrest toward your shoulders.

After the upper seat backrest reaches the forward-most tilt position, pivot it forward again to release it to the rearward, untilted position.

## Adjusting the Seat Height

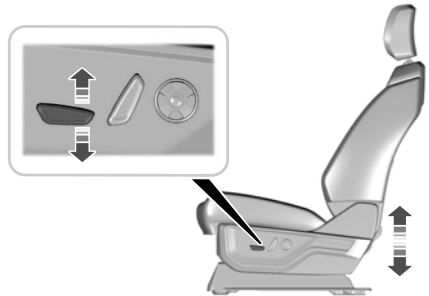

# Front Seats

## Adjusting the Lumbar Support

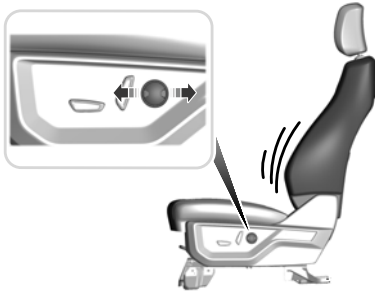

## Adjusting the Massage Seat Settings

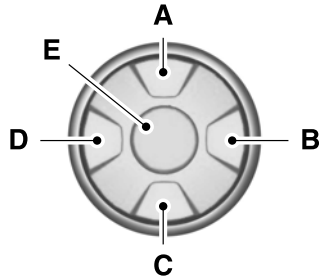

## MASSAGE SEATS (If Equipped)

### Massage Seat Limitations

The engine must be running or the vehicle must be in accessory mode to activate the seats.

The passenger side massage is available if the occupant meets the seat sensor weight requirements.

Allow a few seconds for any selection to activate. Selecting a different adjustment cancels the current one in progress. When the seat backrest and cushion are both active, the massage alternates between zones.

- A Select the previous massage pattern or lumbar area.
- B Decrease the massage or lumbar Intensity.
- C Select the next massage pattern or lumbar area.
- D Increase the massage or lumbar Intensity.
- E Select the massage or lumbar mode.

You can also adjust this feature through the touchscreen.



# Front Seats

## HEATED SEATS (If Equipped)

### Heated Seat Precautions



**WARNING:** Use caution when using the heated seat if you are unable to feel pain to your skin because of advanced age, chronic illness, diabetes, spinal cord injury, medication, alcohol use, exhaustion or other physical conditions. The heated seat could cause burns even at low temperatures, especially if used for long periods of time. Failure to follow this instruction could result in personal injury.



**WARNING:** Do not poke sharp objects into the seat cushion or seat backrest. This could damage the heated seat element and cause it to overheat. Failure to follow this instruction could result in personal injury.



**WARNING:** Do not place anything on the seat that blocks the heat, for example a seat cover or a cushion. This could cause the seat to overheat. Failure to follow this instruction could result in personal injury.

Do not:

- Place heavy objects on the seat.
- Operate the heated seat if water or any other liquid spills on the seat. Allow the seat to dry.

### Switching the Heated Seats On and Off

The vehicle must be running to use this feature.

Press the heated seat symbol on the climate controls or touchscreen to cycle through the various heat settings and off. The more indicators that display, the warmer the temperature of the seat.

**Note:** *The heated seats may remain on after you remote start your vehicle, based on your remote start settings. The heated seats may also turn on when you start your vehicle if they were on when you switched your vehicle off.*

## VENTILATED SEATS (If Equipped)

### Ventilated Seat Precautions

Do not:

- Spill liquid on the front seats. This may cause the air vent holes to become blocked and not work properly.
- Place cargo or objects under the seats. They may block the air intake causing the air vents to not work properly.

### Switching the Ventilated Seats On and Off

The vehicle must be running to use this feature.

## Front Seats

---



Press this symbol on the climate controls or the touchscreen to cycle through the various ventilation settings and off. More indicator lights indicate higher fan speeds.

**Note:** *When you switch the climate control fan speed and the ventilated seats to their maximum settings, the ventilated seats provide increased cooling.*

If the engine falls below 350 RPM while the ventilated seats are on, the feature turns itself off unless the vehicle is in Auto-Start-Stop mode. You may need to reactivate the ventilated seats.

**Note:** *The ventilated seats may remain on after you remote start your vehicle, based on your remote start settings. The ventilated seats may also turn on when you start your vehicle if they were on when you switched your vehicle off.*

## Rear Seats (If Equipped)

### MANUAL SEATS

#### Head Restraint Components

##### Rear Seat Outermost Head Restraints

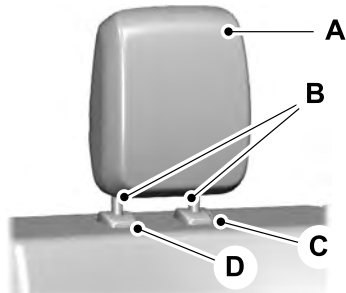

##### Rear Seat Center Head Restraint

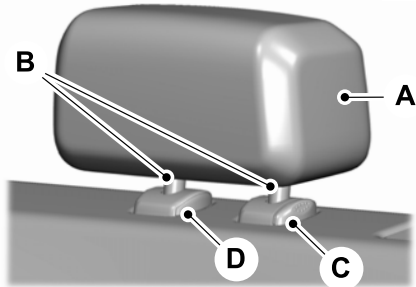

The head restraints consist of:

- A An energy absorbing head restraint.
- B Two steel stems.
- C Guide sleeve adjust and release button.
- D Guide sleeve unlock and remove button (If equipped).

#### Adjusting the Head Restraint

Pull the head restraint up to raise it.

To lower the head restraint:

1. Press and hold the adjust and release button.
2. Push the head restraint down.

#### Removing the Head Restraint

1. Pull up the head restraint until it reaches its highest position.
2. Press and hold the adjust and release button and the unlock and remove button.
3. Pull up the head restraint.

#### Installing the Head Restraint

Align the steel stems into the guide sleeves and push the head restraint down until it locks.

#### Folding the Seats

You can flip each seat cushion up into a vertical storage position.



Rotate the seat up until it locks in place.

## Rear Seats (If Equipped)

### Unfolding the Seats



**WARNING:** Make sure that cargo and other objects are not trapped under the seat cushion and that you return the seat cushion to the full-down position. Failure to do so may prevent the seat from operating properly, which could increase the risk of serious injury in a crash.

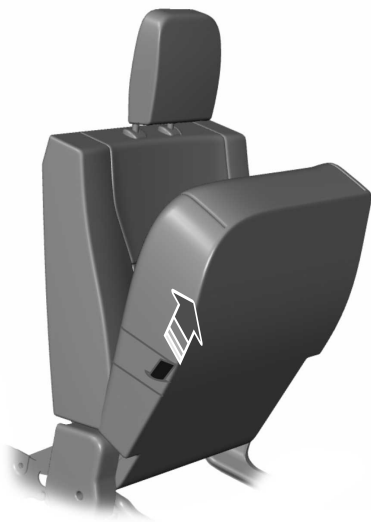

Pull the strap to lower the seat

### HEATED SEATS (If Equipped)

#### Heated Seat Precautions



**WARNING:** Use caution when using the heated seat if you are unable to feel pain to your skin because of advanced age, chronic illness, diabetes, spinal cord injury, medication, alcohol use, exhaustion or other physical conditions. The heated seat could cause burns even at low temperatures, especially if used for long periods of time. Failure to follow this instruction could result in personal injury.



**WARNING:** Do not poke sharp objects into the seat cushion or seat backrest. This could damage the heated seat element and cause it to overheat. Failure to follow this instruction could result in personal injury.



**WARNING:** Do not place anything on the seat that blocks the heat, for example a seat cover or a cushion. This could cause the seat to overheat. Failure to follow this instruction could result in personal injury.

Do not:

- Place heavy objects on the seat.
- Operate the heated seat if water or any other liquid spills on the seat. Allow the seat to dry.

#### Switching the Heated Seats On and Off

The vehicle must be running to use this feature.

The rear seat heat controls are on the rear of the center console.

## Rear Seats (If Equipped)

---



Press the heated seat symbol to cycle through the various heat settings and off. More indicator lights indicate warmer settings.

The heated seats turn off when you switch off the vehicle.

# Rear Occupant Alert System (If Equipped)

## WHAT IS THE REAR OCCUPANT ALERT SYSTEM

The rear occupant alert system monitors vehicle conditions and notifies you to check for rear seat occupants when you switch the ignition off.

## HOW DOES THE REAR OCCUPANT ALERT SYSTEM WORK

The system monitors when rear doors have been opened and closed to indicate the potential presence of an occupant in the rear seat.

A message displays in the information and entertainment display screen and an audible warning sounds when you switch the ignition off after any of the following conditions have been met:

- A rear door is opened or closed while the ignition is on.
- You switch the ignition on within 15 minutes of a rear door opening and closing.
- You switch the ignition on within 15 minutes of the alert having displayed or sounded.

## REAR OCCUPANT ALERT SYSTEM PRECAUTIONS



**WARNING:** On hot days, the temperature inside the vehicle can rise very quickly. Exposure of people or animals to these high temperatures for even a short time can cause death or serious heat related injuries, including brain damage. Small children are particularly at risk.



**WARNING:** Do not leave children or pets unattended in your vehicle. Failure to follow this instruction could result in personal injury or death.

## REAR OCCUPANT ALERT SYSTEM LIMITATIONS

The system does not detect the presence of objects or passengers in the rear seat. It monitors when rear doors are opened and closed.

**Note:** *It is possible to receive an alert when there is no rear seat occupant, but alert conditions are met.*

**Note:** *It is possible to receive no alert when there is an occupant in the rear seat, if alert conditions are not met. For example, if a rear seat occupant does not enter the vehicle through a rear door.*

**Note:** *The audible warning does not sound when the front door is opened before you switch the ignition off.*

## SWITCHING REAR OCCUPANT ALERT SYSTEM ON AND OFF

1. Press **Settings** on the touchscreen.
2. Press **Vehicle**.
3. Switch **Rear Occupant Alert** on or off.

**Note:** *The default setting is on.*

**Note:** *Performing a master reset causes the system to switch on again.*

## Semiannual Reminder (If Equipped)

When you switch the system off, a message appears every six months as a reminder that the system is off. You can switch the system back on or leave it off.

## Rear Occupant Alert System (If Equipped)

---

### REAR OCCUPANT ALERT SYSTEM INDICATORS



Message
Check rear seats for occupants.

Displays when you switch your vehicle off after the alert conditions are met.

The message displays for a short period of time. Press **Close** to acknowledge and remove the message.

### REAR OCCUPANT ALERT SYSTEM AUDIBLE WARNINGS

Sounds when you switch your vehicle off after the alert conditions are met.

The warning sounds for a short period of time.

# Memory Function (If Equipped)

## WHAT IS THE MEMORY FUNCTION

The memory function recalls the position of these features:

- Driver seat.
- Power mirrors.
- Optional power steering column.
- Optional power adjustable pedals.

## MEMORY FUNCTION PRECAUTIONS



**WARNING:** Before activating the memory seat, make sure that the area immediately surrounding the seat is clear of obstructions and that all occupants are clear of moving parts.



**WARNING:** Do not use the memory function when your vehicle is moving.

## LOCATING THE MEMORY FUNCTION BUTTONS



The memory function buttons are on the driver door.

## SAVING A PRESET POSITION

1. Adjust the memory features to your preferred position.
2. Press and hold the preferred preset button until you hear a single tone.

A confirmation message appears in the information display.

You can save up to three preset memory positions at any time.

## RECALLING A PRESET POSITION

Press and release a preset button.

**Note:** You can recall a preset memory position when the ignition is off, or when you place the transmission in park (P) or neutral (N) if the ignition is on and the vehicle is not moving.

**Note:** Pressing any of the preset buttons or any memory feature control during a memory recall cancels the operation.

You can also recall a preset memory position by:

- Pressing the unlock button on your remote control if you linked it to a preset position.
- Unlocking the intelligent driver door handle if a linked remote control is present.

Using a linked remote control to recall your memory position when the ignition is off moves the seat and steering column to the easy entry position.

## Linking a Preset Position to Your Remote Control or Passive Key

See **Linking or Unlinking a Personal Profile to a Remote Control** (page 593).



# Garage Door Opener (If Equipped)

## WHAT IS THE GARAGE DOOR OPENER

[Universal Garage Door Opener: Getting Started](#)

[Universal Garage Door Opener: HomeLink](#)

[Universal Garage Door Opener Homelink for Genie IntelliCode](#)

## HomeLink Wireless Control System



The universal garage door opener replaces the common hand-held garage door opener with a three-button transmitter integrated into the driver's sun visor.

## HOW DOES THE GARAGE DOOR OPENER WORK

The system includes two primary features, a garage door opener and a platform for remote activation of devices within the home. You can program garage doors as well as entry gate operators, security systems, entry door locks and home or office lighting.

Additional system information can be found online at [www.homelink.com](http://www.homelink.com) or by calling the toll-free help line at 1-800-355-3515.

**Note:** You can program a maximum of three devices. To change or replace any of the three devices after it has been initially programmed, you must first erase the current settings. See **Clearing the Garage Door Opener** (page 185).

## GARAGE DOOR OPENER PRECAUTIONS



**WARNING:** Do not use the system with any garage door opener that does not have the safety stop and reverse feature as required by U.S. Federal Safety Standards (this includes any garage door opener manufactured before April 1, 1982). A garage door opener which cannot detect an object, signaling the door to stop and reverse, does not meet current federal safety standards. Using a garage door opener without these features increases the risk of serious injury or death.

**Note:** Make sure that the garage door and security device are free from obstruction when you are programming. Do not program the system with your vehicle in the garage.

**Note:** Make sure you keep the original remote control transmitter for use in other vehicles as well as for future system programming.

**Note:** We recommend that upon the sale or lease termination of your vehicle, you erase the programmed function buttons for security reasons. See **Clearing the Garage Door Opener** (page 185).

## Garage Door Opener (If Equipped)

### GARAGE DOOR OPENER LIMITATIONS

Canadian radio-frequency laws require transmitter signals to time-out (or quit) after several seconds – which may not be long enough for HomeLink to pick up the signal.

U.S. gate operators time-out in the same manner.

**Note:** *If programming a garage door opener or gate operator, it is advised to unplug the device during the “cycling” process to prevent possible overheating.*

### PROGRAMMING THE GARAGE DOOR OPENER TO YOUR HAND-HELD TRANSMITTER

This process is to program your in-vehicle HomeLink function button with your hand-held transmitter.

**Note:** *The programming steps below assume you will be programming HomeLink that was not previously programmed. If your HomeLink was previously programmed, you may need to erase your HomeLink buttons. See **Clearing the Garage Door Opener** (page 185).*

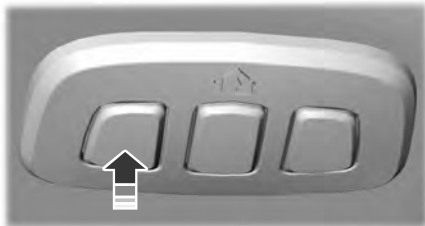

1. With your vehicle parked outside of the garage, switch your ignition to the on position, but do not start your vehicle.
2. Press and release one of the three HomeLink function buttons that you would like to program.
3. Hold your hand-held garage door transmitter 1–3 in (2–8 cm) away from the HomeLink button you want to program.
4. Press and hold the hand-held transmitter button you want to program while watching the indicator light on HomeLink. Continue to hold the hand-held button until the HomeLink indicator light flashes rapidly or is continuously on.

**Note:** *You may need to use a different method if you live in Canada or have difficulties programming your gate operator or garage door opener. See **Programming the Garage Door Opener to Your Gate Opener Motor** (page 184).*

5. Press and hold the HomeLink button you programmed for two seconds, then release. You may need to do this twice to activate the door.

**Note:** *If the indicator light stays on, the programming is complete.*

**Note:** *If the HomeLite indicator flashes rapidly, repeat step 5.*

**Note:** *If your device still does not operate, you must program your garage door. See **Programming the Garage Door Opener to Your Garage Door Opener Motor** (page 184).*

6. To program additional buttons, repeat Steps 1 – 4.

## Garage Door Opener (If Equipped)

### PROGRAMMING THE GARAGE DOOR OPENER TO YOUR GARAGE DOOR OPENER MOTOR



1. Press the learn button on the garage door opener motor, you have 30 seconds to complete the next two steps.
2. Return to your vehicle.



3. Press and hold one of the three HomeLink function buttons you want to program for two seconds, then release. Repeat this step. Depending on your brand of garage door opener, you may need to repeat this sequence a third time.

### PROGRAMMING THE GARAGE DOOR OPENER TO YOUR GATE OPENER MOTOR

#### Gate Operator / Canadian Programming

Canadian radio-frequency laws require transmitter signals to “time-out” (or quit) after several seconds of transmission – which may not be long enough for HomeLink to pick up the signal during programming. Similar to this Canadian law, some U.S. gate operators “time-out” in the same manner.

**Note:** *If programming a garage door opener or gate operator, it is advised to unplug the device during the “cycling” process to prevent possible overheating.*

1. Press and release, every two seconds, your hand-held transmitter until the HomeLink indicator light changes to a rapidly blinking or continuously on light.
2. Release the hand-held transmitter button.
3. Press and hold the HomeLink function button you want to program for two seconds, then release. You may need to do this twice to activate the door.

**Note:** *If the indicator light stays on, the programming is complete.*

**Note:** *If the HomeLink indicator flashes rapidly, repeat Step 3.*

**Note:** *If your device still does not operate, you must program your garage door. See **Programming the Garage Door Opener to Your Garage Door Opener Motor** (page 184).*

4. To program additional buttons, repeat Steps 1 – 4.

## Garage Door Opener (If Equipped)

### CLEARING THE GARAGE DOOR OPENER

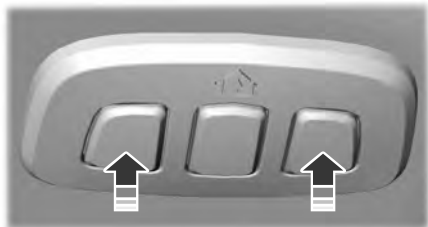

1. Press and hold the outer two function buttons simultaneously for approximately 10 seconds until the indicator light above the buttons flashes rapidly.
2. When the indicator light flashes, release the buttons.

**Note:** You cannot erase individual buttons.

### REPROGRAMMING THE GARAGE DOOR OPENER

To program a device to a previously trained button, follow these steps:

1. Press and hold the desired button. Do NOT release the button.
2. The indicator light begins to flash after 20 seconds. Without releasing the button, follow programming steps.

### GARAGE DOOR OPENER RADIO FREQUENCIES

#### FCC and RSS-210 Industry Canada Compliance

 **WARNING:** Changes or modifications not expressly approved by the party responsible for compliance could void the user's authority to operate the equipment. The term "IC:" before the radio certification number only signifies that Industry Canada technical specifications were met.

This device complies with Part 15 of the FCC Rules and with RSS-210 of Industry Canada. Operation is subject to the following two conditions: (1) this device may not cause harmful interference, and (2) this device must accept any interference received, including interference that could cause undesired operation.

This equipment complies with FCC radiation exposure limits set forth for an uncontrolled environment. End Users must follow the specific operating instructions for satisfying RF exposure compliance. This transmitter must be at least 8 in (20 cm) from the user and must not be co-located or operating in conjunction with any other antenna or transmitter.

# USB Ports

## LOCATING THE USB PORTS

### Data Transfer USB Ports



The USB Ports could be in the following locations:

- On the lower instrument panel.
- Inside the media bin.
- Inside the center console.

**Note:** *These USB ports can also charge devices.*

**Note:** *Not all USB ports in your vehicle have data transfer capabilities.*

**Note:** *We recommend using only USB-IF certified cables and adapters. Non-certified cables and adapters may not work.*

### Charge Only USB Ports



The USB ports could be in the following locations:

- On the lower instrument panel.
- On the upper instrument panel.
- Inside the media bin.
- Inside the center console.
- On the rear of the center console.
- In the cargo area.

## PLAYING MEDIA USING THE USB PORT



**WARNING:** Driving while distracted can result in loss of vehicle control, crash and injury. We strongly recommend that you use extreme caution when using any device that may take your focus off the road. Your primary responsibility is the safe operation of your vehicle. We recommend against the use of any hand-held device while driving and encourage the use of voice-operated systems when possible. Make sure you are aware of all applicable local laws that may affect the use of electronic devices while driving.

Connect your device to the USB port.



Press the audio button on the feature bar.

Select **Sources**.



Select the USB option.



Press the button to play a track. Press the button again to pause the track.



Press the button to skip to the next track.

Press and hold the button to fast forward through the track.



Press the button once to return to the beginning of a track. Repeatedly press the button to return to previous tracks.

Press and hold the button to fast rewind.

# USB Ports

---

## **CHARGING A DEVICE**

Connect your device to the USB port.

You can use the charger when the vehicle is in accessory mode, when the vehicle is running, or when SYNC is on.

# Power Outlet - Vehicles With: Pickup Bed Power Generator Outlet

## WHAT IS THE POWER OUTLET

### *Pro-Power On-Board*

The vehicle functions as a portable generator and can power devices that require up to the rating listed on power outlet label.

## POWER OUTLET PRECAUTIONS - VEHICLES WITH: 2KW



**WARNING:** Do not start the engine in a closed garage or in other enclosed areas. Exhaust fumes are toxic. Always open the garage door before you start the engine. Failure to follow this instruction could result in personal injury or death.



**WARNING:** Exhaust leaks may result in entry of harmful and potentially lethal fumes into the passenger compartment. If you smell exhaust fumes inside your vehicle, have your vehicle inspected immediately. Do not drive if you smell exhaust fumes.



**WARNING:** Do not connect any vehicle power outlets to any premises, including buildings or recreational vehicles. This can create a backfeed to utility lines. Failure to follow this instruction could result in damage to the vehicle, fire, electrical shock or death.



**WARNING:** The vehicle's engine runs while the generator is switched on. Running engines emit carbon monoxide. Only use the generator when the vehicle is outdoors. Failure to follow this instruction could result in personal injury or death.

**Note:** *Automatic engine stop is disabled and the gasoline engine will continue to idle when the outlet is switched on.*

**Note:** *We recommend using UL approved devices for use with the power outlet.*

**Note:** *Unplug electrical devices from the power outlet when they are not switched on.*

**Note:** *Make sure there is no damage to the outlets before driving your vehicle.*

**Note:** *Make sure that objects are not blocking the inverter inlet and exhaust near the rear underseat storage compartment.*

**Note:** *The climate control system may turn on and power may be limited during extreme hot or cold temperatures to optimize the performance of the system.*

**Note:** *When the outlet is switched on and the vehicle is in Park (P) the engine turns off 30 minutes after the low fuel warning is displayed. After the vehicle is turned off, generator mode only operates while driving or until the vehicle is refueled.*

# Power Outlet - Vehicles With: Pickup Bed Power Generator Outlet

## Grounding Types

Vehicle Type	Grounding Type
Gas	Neutral floating: The neutral of the inverter generator is isolated from system ground.
HEV	Neutral bonded: The neutral of the inverter generator is bonded to system ground. Connecting loads that also have neutral bonded to ground will cause the ground fault detection to trip.

**Note:** *If additional grounding measures are required, consult with a qualified electrician.*

## POWER OUTLET PRECAUTIONS - VEHICLES WITH: 2.4KW/7.2KW



**WARNING:** Do not start the engine in a closed garage or in other enclosed areas. Exhaust fumes are toxic. Always open the garage door before you start the engine. Failure to follow this instruction could result in personal injury or death.



**WARNING:** Exhaust leaks may result in entry of harmful and potentially lethal fumes into the passenger compartment. If you smell exhaust fumes inside your vehicle, have your vehicle inspected immediately. Do not drive if you smell exhaust fumes.



**WARNING:** Do not connect any vehicle power outlets to any premises, including buildings or recreational vehicles. This can create a backfeed to utility lines. Failure to follow this instruction could result in damage to the vehicle, fire, electrical shock or death.



**WARNING:** The vehicle's engine runs while the generator is switched on. Running engines emit carbon monoxide. Only use the generator when the vehicle is outdoors. Failure to follow this instruction could result in personal injury or death.

**Note:** *The gasoline engine may start and stop to provide power when the outlet is switched on.*

**Note:** *We recommend using UL approved devices for use with the power outlet.*

**Note:** *Unplug electrical devices from the power outlet when they are not switched on.*

**Note:** *The climate control system may turn on and power may be limited during extreme hot or cold temperatures to optimize the performance of the system.*

**Note:** *When the outlet is switched on and the vehicle is in Park (P) the engine turns off 30 minutes after the low fuel warning is displayed. After the vehicle is turned off, generator mode only operates while driving or until the vehicle is refueled.*



# Power Outlet - Vehicles With: Pickup Bed Power Generator Outlet

## Grounding Types

Vehicle Type	Grounding Type
Gas	Neutral floating: The neutral of the inverter generator is isolated from system ground.
HEV	Neutral bonded: The neutral of the inverter generator is bonded to system ground. Connecting loads that also have neutral bonded to ground will cause the ground fault detection to trip.

**Note:** If additional grounding measures are required, consult with a qualified electrician.

## LOCATING THE POWER OUTLET

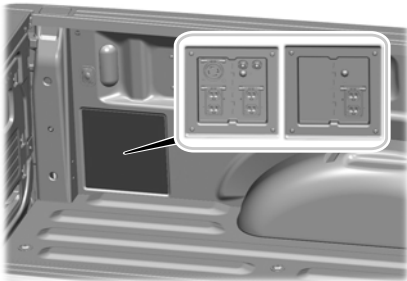

The power outlets are behind covers on the left side of the bed.

## POWER OUTLET INDICATORS - VEHICLES WITH: 2KW

### Power Outlet Status Indicator

The power outlet indicator illuminates to let you know the status of the system.

Indicator Status	Description
On	The power point is working and the vehicle is on.
Off	The power point is off or the vehicle is off.
Flashing	The power point is in fault mode.

### Generator Mode Power Indicator



# Power Outlet - Vehicles With: Pickup Bed Power Generator Outlet

The generator mode power indicator displays the currently used power and total available power level on the touchscreen. When Generator Mode is switched off the indicator displays a reduced available power level. When generator mode is switched on the indicator displays the full available power.

**Note:** *Ensure plugged in devices do not exceed the available power displayed on the generator mode power indicator.*

**Note:** *Maximum power may be reduced when the vehicle is in drive (D).*

## POWER OUTLET INDICATORS - VEHICLES WITH: 2.4KW/ 7.2KW

### Power Outlet Status Indicator

The power outlet indicator illuminates to let you know the status of the system.

Indicator Status	Description
On	The power point is working and the vehicle is on.
Off	The power point is off and the vehicle is off.
Flashing	The power point is in fault mode.

### Generator Mode Power Indicator



The generator mode power indicator displays the currently used power and total available power level on the touchscreen. When Generator Mode is switched off the indicator displays a reduced available power level. When generator mode is switched on the indicator displays the full available power.

**Note:** *Additional indicators may be available based on vehicle configuration.*

**Note:** *Ensure plugged in devices do not exceed the available power displayed on the generator mode power indicator.*

## WHAT IS UTILITY IDLE MODE - VEHICLES WITH: FLIP KEY

Utility Idle mode allows you to remove the key from the ignition and keep the vehicle and bed power point running.

## SWITCHING UTILITY IDLE ON AND OFF - VEHICLES WITH: FLIP KEY

### Switching Utility Idle On

1. Start the vehicle. See **Starting and Stopping the Engine** (page 209).

# Power Outlet - Vehicles With: Pickup Bed Power Generator Outlet

2. Press the Features button on the touchscreen.
3. Press the Pro Power Onboard button.
4. Press the Generator Mode button to switch the power outlet to the rating listed on the power outlet label.
5. Press the Utility Idle button.
6. Turn the key to position **0**.
7. Remove the key from the ignition.

## Switching Utility Idle Off using the Key

1. Insert the key into the ignition.
2. Turn the key to position **III**.

## Switching Utility Idle off using the Information and Entertainment Display Screen

Use the controls on the touchscreen to switch off the vehicle.

## WHAT IS GENERATOR MODE

### Pro-Power On-Board

Generator Mode uses the vehicle engine to increase power to the bed power outlets up to the rating listed on the power outlet label.

## SWITCHING GENERATOR MODE ON AND OFF

### Using the Information and Entertainment Display Screen

1. Switch the vehicle on. See **Starting and Stopping the Engine** (page 209).
2. Press the Features button on the touchscreen.
3. Press the Pro Power Onboard button.

4. Press the Generator Mode button to switch the power outlet to the full rating listed on the power outlet label.

## Using the Instrument Panel



Press the button to switch between off, Convenience Mode, and Generator Mode.

## Using the Bed Control



Press the button to switch Generator Mode on and off.

## RESETTING GROUND FAULT DETECTION

After disconnecting all electrical loads the ground fault can be reset using the switches on the power point, on the instrument panel or on the touchscreen.

Use the controls on the touchscreen to test the ground fault detection circuit.

# Power Outlet - Vehicles With: Pickup Bed Power Generator Outlet

---

## **RESETTING THE CIRCUIT BREAKER - VEHICLES WITH: 7.2KW**



Press the button on the upper right area of the bed outlet when the circuit breaker has opened after a fault has occurred to reset the circuit breaker to the on position. There are two circuit breaker buttons that correspond to the A and B outlets.

# Power Outlet - Vehicles With: Pickup Bed Power Generator Outlet

## POWER OUTLET – TROUBLESHOOTING

### Power Outlet – Information Messages

Message	Description
Item(s) plugged in exceed the system's maximum capacity. Try unplugging one or more items and reset. See Owner's Manual for detail.	Ensure plugged in devices do not exceed the available power displayed. Devices may exceed the power rating shown the device label when plugged in. Unplug the device and switch the ignition on and off to reset the system.
Ground Fault Detected. See Owner's Manual for details.	After disconnecting all electrical loads, the ground fault can be reset using the switches on the power point, on the instrument panel or on the touchscreen. Use the controls on the touchscreen to test the ground fault detection circuit.
Generator System is outside its operating temperature and capacity is reduced. See Owner's Manual for details.	The climate control system may turn on and power may be limited during extreme hot or cold temperatures to optimize the performance of the system.
Another power source is trying to supply power to your vehicle's AC outlets. Disconnect vehicle from that power source. See Owner's Manual for details.	Do not plug in any device that supplies power to the vehicle through the power points. This could result in damage to vehicle systems.
Pro Power OnBoard is currently unavailable. See Owner's Manual for details.	The Pickup Bed Power Generator is in fault mode. Ensure all devices are unplugged from the system. Use the controls on the touchscreen to reset the system. Switch the vehicle on and off if the touchscreen controls are unable to reset the system. See an authorized dealer if these steps do not fix the fault.
This button test outlets for proper operation of ground fault detection. In a successful test, Pro Power OnBoard detects the ground fault and turns off. See Owner's Manual for details.	After disconnecting all electrical loads, the ground fault can be reset using the switches on the power point, on the instrument panel or on the touchscreen. Use the controls on the touchscreen to test the ground fault detection circuit.

# Power Outlet - Vehicles With: Pickup Bed Power Generator Outlet

---

<b>Message</b>	<b>Description</b>
Extended idling in drive (D) is reducing available power to 4300W. See Owner's Manual for details	Extended idling in drive (D) is reducing available power. When safe, shift to park (P) while idling, or reduce power draw to less than 4300W to keep the generator running.

# Power Outlet - Vehicles With: Pickup Bed Power Generator Outlet

---

## Power Outlet – Frequently Asked Questions

### **Why am I not able to put my vehicle in Drive (D) while using the pickup bed power outlet?**

Unplug all devices from the Bed Power Generator Outlets and make sure you have closed the outlet covers. If you are still unable to drive the vehicle, use Manual Park Release to put the transmission into Drive (D). See **Using Manual Park Release** (page 257).

### **What do I do when my touchscreen is malfunctioning and I cannot accept the popup message to put the vehicle in Drive (D)?**

See **Using Manual Park Release** (page 257).

# Power Outlet - Vehicles With: 120V Power Outlet

## WHAT IS THE POWER OUTLET

The power outlet can power devices that require up to the rating on the outlet cover.

**Note:** *The total power delivered is divided if more than one outlet is used.*

## POWER OUTLET PRECAUTIONS



**WARNING:** Do not keep electrical devices plugged in the power point whenever the device is not in use. Do not use any extension cord with the 120 volt AC power point, since it will defeat the safety protection design. Doing so may cause the power point to overload due to powering multiple devices that can reach beyond the 400 watt load limit and could result in fire or serious injury.

## POWER OUTLET LIMITATIONS

Devices may exceed the power rating shown the device label when plugged in. Unplug the device and switch the ignition on and off to reset the system.

You should not use the power outlet for these types of electric devices:

- Cathode ray tube type televisions.
- Motor loads, for example vacuum cleaners, electric saws and other electric power tools, or compressor-driven refrigerators.
- Measuring devices which process precise data, for example medical equipment or measuring equipment.
- Other appliances requiring an extremely stable power supply, for example microcomputer-controlled electric blankets or touch sensor lamps.

## LOCATING THE POWER OUTLET

The power outlet may be located on the instrument panel, the rear of the center console or the in the bed.

### Instrument Panel



### Rear of the Center Console





# Power Outlet - Vehicles With: 120V Power Outlet

## Bed



**Note:** Due to different technologies used on its construction, some devices may exceed the capacity shown on its label when they are initially plugged in.

**Note:** The power outlet temporarily turns off power when in fault mode if the device exceeds the Watt limit. Unplug your device and switch the ignition off. Switch the ignition back on, but do not plug your device back in. Let the system cool off and switch the ignition off to reset the fault mode. Switch the ignition back on and make sure the indicator light remains on.

## POWER OUTLET INDICATORS

The power outlet indicator illuminates to let you know the status of the system.

Indicator Status	Description
On	The power point is working, the ignition is on, or the vehicle is in accessory mode.
Off	The power point is off, the ignition is off, or the vehicle is not in accessory mode.
Flashing	The power point is in fault mode.

# Power Outlet - Vehicles With: 12V Power Outlet

---

## WHAT IS THE POWER OUTLET

The power outlet can power devices using a 12 V outlet adapter.

## POWER OUTLET PRECAUTIONS

When you switch the vehicle on, you can use the socket to power 12 V appliances with a maximum current rating of 20 A. Do not use the power point over the vehicle capacity of 12 V DC 240 W or a fuse could blow. Do not plug in any device that supplies power to the vehicle through the power points. This could result in damage to vehicle systems. Do not hang any accessory from the accessory plug. Always keep the power point caps closed when not in use. Do not insert objects other than an accessory plug into the power point.

To prevent the battery from running out of charge:

- Do not use the power point longer than necessary when the vehicle is off.
- Do not leave devices plugged in overnight or when you park your vehicle for extended periods.

## LOCATING THE POWER OUTLET

Power outlets are in the following locations:

- On the instrument panel.
- Inside the center console.
- On the rear of the center console.

## Center Console Work Surface (If Equipped)

### USING THE CENTER CONSOLE WORK SURFACE - VEHICLES WITH: COLUMN SHIFT

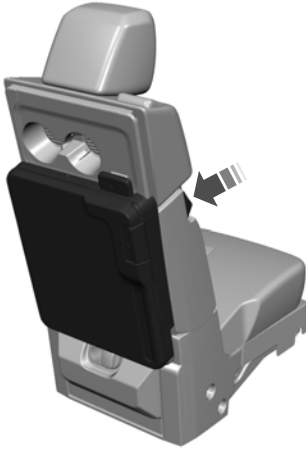

Push the lever on the side of the seat and fold the seat down.

There are three different positions:

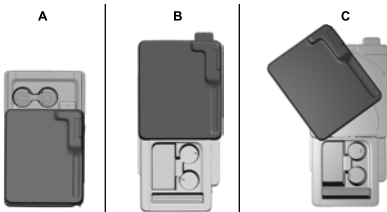

- A. Home position.
- B. Forward position.
- C. Rotated position.



Push the latch down on the top of the work surface to move it to the forward position. There are 11 lockable positions.

## Center Console Work Surface (If Equipped)

**Note:** Do not use the work surface as a handle when entering or exiting the vehicle to avoid damaging it.

### USING THE CENTER CONSOLE WORK SURFACE - VEHICLES WITH: CONSOLE SHIFT

To use the center console work surface, stow the selector lever. See **Stowing the Selector Lever** (page 256).

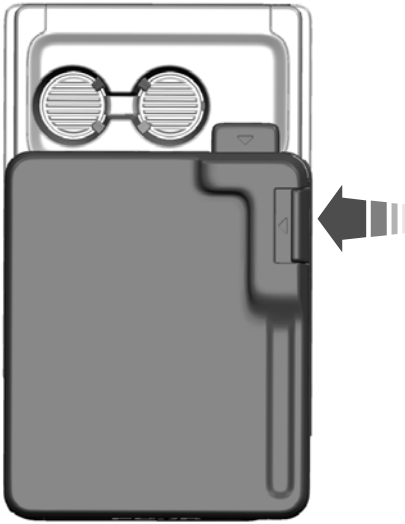

Push the latch on the side of the work surface to rotate it toward the driver. It can be rotated into 11 lockable positions in 5° increments.

**Note:** The work surface must be placed in the home position when driving your vehicle.

**Note:** Do not drive with the center console work surface rotated. This could interfere with steering your vehicle.

**Note:** Do not adjust the steering column when the work surface is rotated.

**Note:** Do not raise the seat when the work surface is in the forward or rotated positions to avoid damaging it.

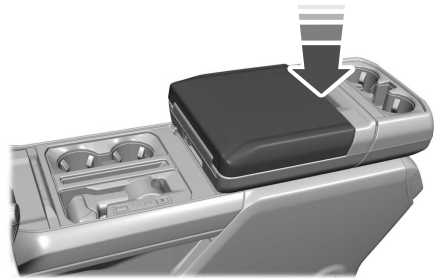

1. Press the button to release the folding surface.

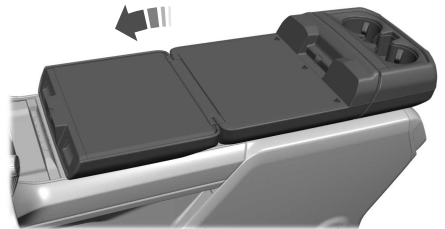

2. Open the work surface. Fold the work surface to close.

# Center Console Work Surface (If Equipped)

---

## CENTER CONSOLE WORK SURFACE – TROUBLESHOOTING

### Center Console Work Surface – Information Messages

<b>Message</b>	<b>Action</b>
Stow work surface before driving.	Return the work surface to the home position to clear the message.

# Wireless Accessory Charger (If Equipped)

## WHAT IS THE WIRELESS ACCESSORY CHARGER

The wireless accessory charger allows you to charge one compatible Qi wireless charging device on the charging area.

## WIRELESS ACCESSORY CHARGER PRECAUTIONS



**WARNING:** Wireless charging devices can affect the operation of implanted medical devices, including cardiac pacemakers. If you have any implanted medical devices, we recommend that you consult with your physician.

Tests on this equipment show that it complies with part 18 of the FCC Rules.

- This equipment generates, uses and can radiate radio frequency energy and may cause harmful interference to radio communications. There is no guarantee that the interference will not occur in a particular installation. If this equipment does cause harmful interference to radio or television reception, please consult the dealer.
- This product is not end-user serviceable.



**WARNING:** Changes or modifications not expressly approved by the party responsible for compliance could void the user's authority to operate the equipment. The term "IC:" before the radio certification number only signifies that Industry Canada technical specifications were met.

This device complies with Industry Canada licence-exempt RSS standard(s).

Operation is subject to:

- This device may not cause interference.
- This device must accept any interference, including interference that may cause undesired operation of the device.

Keep the charging area clean and remove foreign objects prior to charging a device.

Do not place items with a magnetic strip, for example passports, parking tickets or credit cards, near the charging area when charging a device. Damage may occur to the magnetic strip.

Do not place metal objects, for example remote controls, coins and candy wrappers, on or near the charging area when charging a device. Metal objects may heat up and degrade the charging performance, in addition to causing error messages and interruptions in charging.

**Note:** *During charging, the device and the charger could heat up, this is normal. If the battery gets hotter than usual, the device may stop charging.*

## LOCATING THE WIRELESS ACCESSORY CHARGER



The charging area is on the center console or in the media bin below the instrument panel.

## CHARGING A WIRELESS DEVICE

Place the device on the center of the charging surface with the charging side down. The charging stops after your device reaches a full charge.

## **Wireless Accessory Charger (If Equipped)**

---

You can use the charger when the vehicle is in accessory mode, when the vehicle is running, or when SYNC is on.

# Storage

## CUP HOLDERS

### Cup Holder Precautions



**WARNING:** Use caution when stowing items or hot drinks in the cup holders. Items could become loose or spill during hard braking, acceleration or crashes. Failure to follow this instruction could result in personal injury.

## GLOVE COMPARTMENT

### Opening the Glove Compartment

#### Upper Glove Compartment

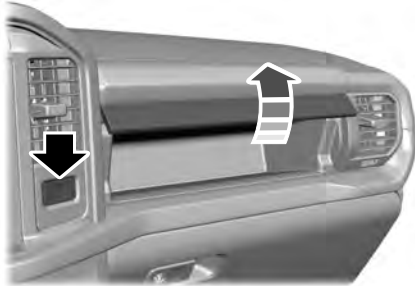

Push the button on the instrument panel to open.

### Lower Glove Compartment



Pull the latch to the left to open.

### Locking the Glove Compartment



The glove compartment may be locked using the key.



# Storage

## UNDER SEAT STORAGE (If Equipped)

### Locating the Under Seat Storage Compartment

#### Front Under Seat Storage



Lift the latch to access the storage compartment under the center seat cushion.

#### Locking the Front Under Seat Storage

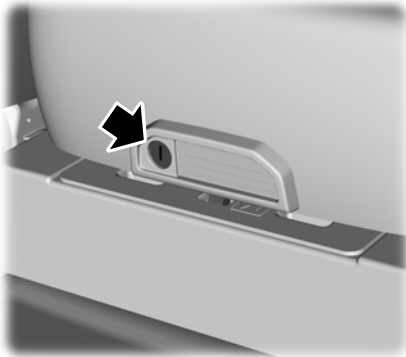

1. Use the key in the remote control to unlock.

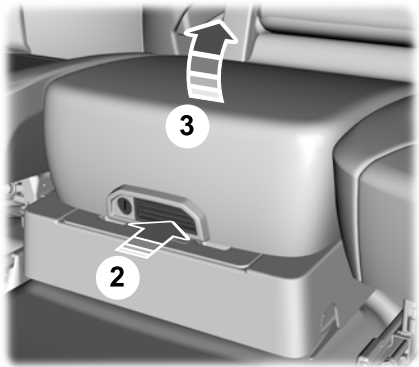

2. Press the latch to release the cushion.
3. Lift the cushion to access the storage compartment.

#### Rear Under Seat Storage



Lift the rear seat to access the under seat storage bin.

# Storage

## Locking the Rear Under Seat Storage



1. Lift the rear seat to access under seat storage bin.

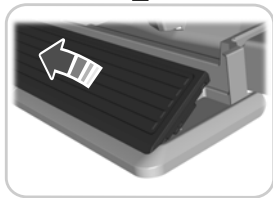
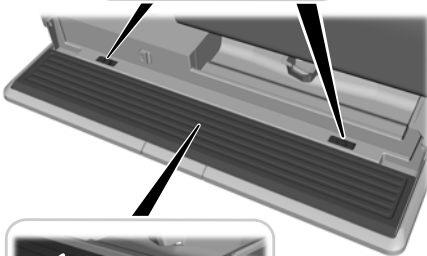
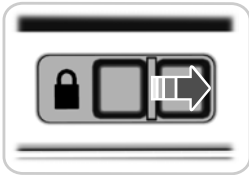

2. Lift the front and side panels to expand and lock them in place.

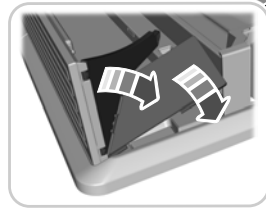
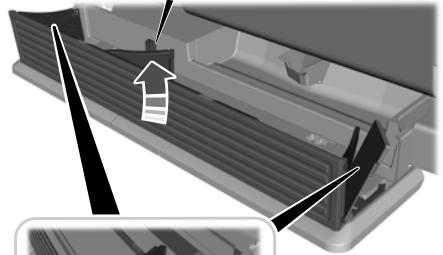
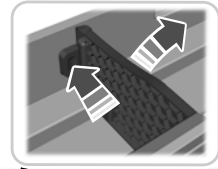

3. Lock the panels in an open position.

# Storage

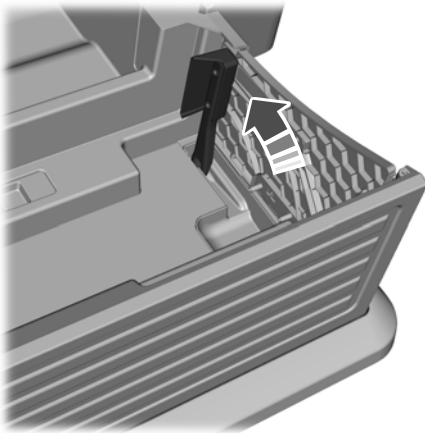

4. To collapse, release the lever, push down to the stowed position and fold in the side and front panels.

**Note:** Make sure the storage divider is not locked into place when collapsing. Push the button to release the divider door and swing to stowed position on front wall.

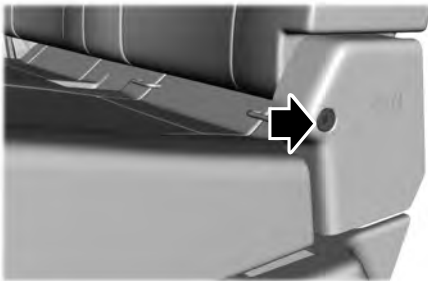

The locking key is in the key fob. Turn the key to lock or unlock the cushion.

## GLASSES HOLDER

### Locating the Glasses Holder

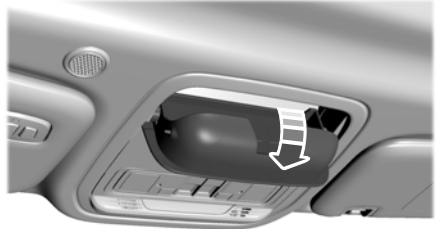

The glasses holder is in the overhead console.

Press near the rear edge of the door to open it.

# Starting and Stopping the Engine

## STARTING AND STOPPING THE ENGINE – PRECAUTIONS

**WARNING:** Extended idling at high engine speeds can produce very high temperatures in the engine and exhaust system, creating the risk of fire or other damage.

**WARNING:** Do not park, idle or drive your vehicle on dry grass or other dry ground cover. The emission system heats up the engine compartment and exhaust system, creating the risk of fire.

**WARNING:** Do not start the engine in a closed garage or in other enclosed areas. Exhaust fumes are toxic. Always open the garage door before you start the engine. Failure to follow this instruction could result in personal injury or death.

**WARNING:** Do not use starting fluid, for example ether, in the air intake system. Such fluid could cause immediate explosive damage to the engine and possible personal injury.

**WARNING:** Exhaust leaks may result in entry of harmful and potentially lethal fumes into the passenger compartment. If you smell exhaust fumes inside your vehicle, have your vehicle inspected immediately. Do not drive if you smell exhaust fumes.

The powertrain control system meets all Canadian interference-causing equipment standard requirements regulating the impulse electrical field or radio noise.

If you stop your vehicle and leave the engine idling for long periods, we recommend that you do one of the following:

- Open the windows at least 1 in (2.5 cm).
- Set your climate control to outside air.

## IGNITION SWITCH

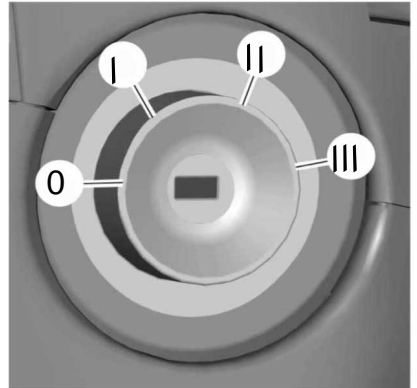

### Switching the Ignition Off

Turn the key to position **0**.

### Switching the Ignition to Accessory Mode

Turn the key to position **I**. Electrical accessories, for example the radio, operate without the engine running.

### Switching the Ignition On

Turn the key to position **II**. All electrical circuits and accessories are operational and the warning lamps and indicators illuminate.

# Starting and Stopping the Engine

## Starting the Engine

Turn the key to position **III**. Release the key when the engine starts.

## PUSH BUTTON IGNITION SWITCH (IF EQUIPPED)



## Switching the Ignition Off

When the ignition is on or in accessory mode, press the push button ignition switch once without your foot on the brake pedal.

## Switching the Ignition to Accessory Mode

When the ignition is off, press the push button ignition switch once without your foot on the brake pedal.

All electrical circuits and accessories are operational and the warning lamps and indicators illuminate.

**Note:** *Your vehicle has a battery saver feature that shuts your vehicle off when it detects a certain amount of battery drain, or after approximately 30 minutes of inactivity in accessory mode.*

## Starting the Engine

With the transmission in park (P), press the brake pedal and press the push button ignition switch. An indicator light on the button illuminates when the ignition is on and when the engine starts.

**Note:** *The system may not function if the passive key is close to metal objects or electronic devices, for example keys or a cell phone.*

**Note:** *A valid key must be inside your vehicle to switch the ignition on and start the engine.*

## STARTING THE ENGINE

### Starting a Gasoline Engine - Vehicles Without: Push Button Start

Before starting your vehicle, check the following:

- Make sure that the headlamps and electrical accessories are off.
  - Make sure that the parking brake is on.
  - Make sure that the transmission is in park (P).
1. Fully press the brake pedal.

**Note:** *Do not touch the accelerator pedal.*



2. Turn the key to position **III**.

**Note:** *The engine may continue cranking for up to 15 seconds or until it starts.*

**Note:** *The engine takes longer to start at lower temperatures. It may crank for several seconds when very cold.*

# Starting and Stopping the Engine

## Starting a Gasoline Engine - Vehicles With: Push Button Start

Before starting your vehicle, check the following:

- Make sure that the headlamps and electrical accessories are off.
- Make sure that the parking brake is on.
- Make sure that the transmission is in park (P).

1. Fully press the brake pedal.

**Note:** Do not touch the accelerator pedal.



2. Press the push button ignition switch.

**Note:** The engine may continue cranking for up to 15 seconds or until it starts.

**Note:** The engine takes longer to start at lower temperatures. It may crank for several seconds when very cold.

## Starting a Diesel Engine - Vehicles Without: Push Button Start

Before starting your vehicle, check the following:

- Make sure that the headlamps and electrical accessories are off.
- Make sure that the parking brake is on.
- Make sure that the transmission is in park (P).



1. Turn the key to position II.

**Note:** Wait until the glow plug indicator turns off.

2. Fully press the brake pedal.

**Note:** Do not touch the accelerator pedal.



3. Turn the key to position III.

**Note:** The engine may continue cranking for up to 15 seconds or until it starts.

**Note:** The engine takes longer to start at lower temperatures. It may crank for several seconds when very cold.

## Glow Plug Indicator



If it illuminates, wait until the glow plug indicator turns off before starting the engine.

## Starting a Diesel Engine - Vehicles With: Push Button Start

Before starting your vehicle, check the following:

- Make sure that the headlamps and electrical accessories are off.
- Make sure that the parking brake is on.
- Make sure that the transmission is in park (P).

1. Fully press the brake pedal.

**Note:** Do not touch the accelerator pedal.



2. Press the push button ignition switch.

# Starting and Stopping the Engine

**Note:** The engine may continue cranking for up to 15 seconds or until it starts.

**Note:** The engine takes longer to start at lower temperatures. It may crank for several seconds when very cold.

## Glow Plug Indicator



The engine does not start until the glow plug indicator turns off. This may take several seconds in extremely cold conditions.

## Starting a Hybrid Electric Vehicle System - Vehicles Without: Push Button Start

Before starting your vehicle, check the following:

- Make sure that the headlamps and electrical accessories are off.
- Make sure that the parking brake is on.
- Make sure that the transmission is in park (P).

1. Fully press the brake pedal.

**Note:** Do not touch the accelerator pedal.



2. Turn the key to position III.

**Note:** The green ready indicator illuminates letting you know that your vehicle is ready for driving. Since your vehicle is equipped with a silent key start, the engine may not start when your vehicle starts.

When the engine starts for the first time on your drive, the idle speed increases, this helps to warm up the engine. If the engine idle speed does not slow down, have your vehicle checked by an authorized dealer.

## Starting a Hybrid Electric Vehicle System - Vehicles With: Push Button Start

Before starting your vehicle, check the following:

- Make sure the headlamps and electrical accessories are off.
- Make sure the parking brake is on.
- Make sure the transmission is in park (P).

**Note:** Do not touch the accelerator pedal.

1. Fully press the brake pedal.



2. Press the push button ignition switch.

**Note:** The green ready indicator illuminates letting you know that your vehicle is ready for driving. Since your vehicle is equipped with a silent key start, the engine may not start when your vehicle starts.

When the engine starts for the first time on your drive, the idle speed increases, this helps to warm up the engine. If the engine idle speed does not slow down, have your vehicle checked by an authorized dealer.

The system does not function if:

- The passive key frequencies are jammed.
- The key battery has no charge.

## Restarting the Engine After Stopping it - Vehicles With: Push Button Start

The system allows you to start the engine within 10 seconds of switching it off, even if it does not detect a valid passive key.

# Starting and Stopping the Engine

Within 10 seconds of switching the engine off, fully press the brake pedal and press the push button ignition switch. After 10 seconds, you can no longer start the engine if the system does not detect a valid passive key.

When you start the engine, it remains running until you press the push button ignition switch, even if your vehicle does not detect a valid passive key. If you open and close a door when the engine is running, the system searches for a valid passive key.

## ENGINE BLOCK HEATER (If Equipped)

### Engine Block Heater Precautions



**WARNING:** Failure to follow engine block heater instructions could result in property damage or serious personal injury.



**WARNING:** Do not use your heater with ungrounded electrical systems or two-pronged adapters. There is a risk of electrical shock.



**WARNING:** Do not fully close the hood, or allow it to drop under its own weight when using the engine block heater. This could damage the power cable and may cause an electrical short resulting in fire, injury and property damage.

We recommend that you do the following for a safe and correct operation:

- Use a 16-gauge outdoor extension cord that is product certified by Underwriter's Laboratory (UL) or Canadian Standards Association (CSA). This extension cord must be suitable for use outdoors, in cold temperatures, and be clearly marked Suitable for Use with Outdoor Appliances. Do not use an indoor extension cord outdoors. This could result in an electric shock or become a fire hazard.
- Use as short an extension cord as possible.
- Do not use multiple extension cords.
- Make sure that when in operation, the extension cord plug and engine block heater cord plug connections are free and clear of water. This could cause an electric shock or fire.
- If the engine block heater cord is under the hood, do not remove the wiring from its original location. Do not close the hood on the extension wiring.
- Park your vehicle in a clean area, clear of combustible materials.
- Firmly connect the engine block heater cord and the extension cord.
- Check the extension cord for heat anywhere when the system has been operating for approximately 30 minutes.
- Unplug and properly stow the system before starting and driving your vehicle. The protective cover seals the terminals of the engine block heater cord plug when not in use.
- Check the engine block heater system for proper operation before winter.



# Starting and Stopping the Engine

## How Does the Engine Block Heater Work

The engine block heater warms the engine coolant. This allows the climate control system to quickly respond. The equipment includes a heater element installed in the engine block and a wire harness. You can connect the system to a grounded 220-240 volt AC electrical source.

**Note:** *The engine block heater is most effective when outdoor temperatures are below 0°F (-18°C).*

## Using the Engine Block Heater

Make sure the receptacle terminals are clean and dry prior to use. Clean them with a dry cloth if necessary.

The heater uses 0.4 to 1.0 kilowatt-hours of energy per hour of use. The system does not have a thermostat. It achieves maximum temperature after approximately three hours of operation. Using the engine block heater longer than three hours does not improve system performance and unnecessarily uses electricity.

## STOPPING THE ENGINE

### Stopping the Engine When Your Vehicle is Stationary - Vehicles Without: Push Button Start

1. Shift into park (P).
2. Apply the parking brake.
3. Wait until the engine reaches idle speed.

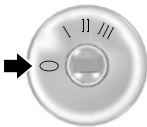

4. Turn the key to position **0**.

### Stopping the Engine When Your Vehicle is Stationary - Vehicles With: Push Button Start

1. Shift into park (P).
2. Apply the parking brake.
3. Wait until the engine reaches idle speed.



4. Press the push button ignition switch.

### Stopping the Engine When Your Vehicle is Moving - Vehicles Without: Push Button Start



**WARNING:** Switching off the engine when your vehicle is still moving results in a significant decrease in braking assistance. Higher effort is required to apply the brakes and to stop your vehicle. A significant decrease in steering assistance could also occur. The steering does not lock, but higher effort could be required to steer your vehicle. When you switch the ignition off, some electrical circuits, for example airbags, also turn off. If you unintentionally switch the ignition off, shift into neutral (N) and restart the engine.

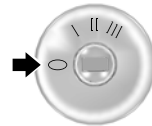

1. Turn the key to position **0**.

# Starting and Stopping the Engine

2. Shift into neutral and use the brakes to bring your vehicle to a safe stop.
3. Shift into park (P).
4. Apply the parking brake.

## Stopping the Engine When Your Vehicle is Moving - Vehicles With: Push Button Start



**WARNING:** Switching off the engine when your vehicle is still moving results in a significant decrease in braking assistance. Higher effort is required to apply the brakes and to stop your vehicle. A significant decrease in steering assistance could also occur. The steering does not lock, but higher effort could be required to steer your vehicle. When you switch the ignition off, some electrical circuits, for example airbags, also turn off. If you unintentionally switch the ignition off, shift into neutral (N) and restart the engine.



1. Press and hold the push button ignition switch until the engine stops, or press it three times within two seconds.
2. Shift into neutral and use the brakes to bring your vehicle to a safe stop.
3. Shift into park (P).
4. Apply the parking brake.

## AUTOMATIC ENGINE STOP

### What Is Automatic Engine Stop

Automatic engine stop is a feature that switches the engine off if it has been idling for an extended period to help you save fuel.

### How Does Automatic Engine Stop Work

Automatic engine stop turns the engine off. The ignition also turns off in order to save battery power. Before the engine shuts down, a message appears in the information display showing a timer counting down. If you do not intervene within 30 seconds, the engine shuts down. Another message appears in the information display to inform you that the engine has shut down in order to save fuel. Start your vehicle as you normally do.

### Switching Automatic Engine Stop On and Off - Vehicles With: 4.2 Inch Screen

1. Using the information display controls on the steering wheel, select **Settings**.
2. Select **Vehicle Settings**.
3. Switch **30min Max Idle** on or off.

**Note:** You cannot permanently switch off the automatic shutdown. If you switch it off, it turns on each time you switch the ignition on.

### Switching Automatic Engine Stop On and Off - Vehicles With: 8 Inch Screen/12.3 Inch Screen

1. Press the menu button on the steering wheel to enter the information display main menu.
2. Select **Settings**.

# Starting and Stopping the Engine

3. Switch **Auto Engine Off** on or off.

**Note:** You cannot permanently switch off the automatic shutdown. If you switch it off, it turns on each time you switch the ignition on.

## Overriding Automatic Engine Stop

**Note:** You cannot permanently switch off the automatic engine shutdown feature. When you switch it off temporarily, it turns on at the next ignition cycle.

You can stop the engine shutdown, or reset the timer, at any point before the 30-second countdown has expired by doing any of the following:

- Pressing the brake pedal or accelerator pedal.
- Pressing the **OK** or **RESET** button during the countdown.

## ACCESSING THE PASSIVE KEY BACKUP POSITION

If you are unable to start your vehicle, locate the backup slot in one of two positions:

### Type One

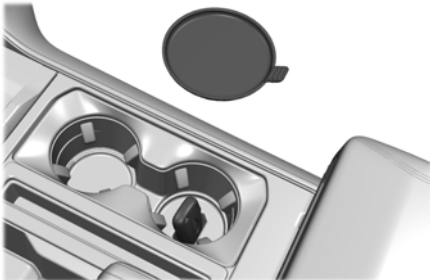

### Type Two



**Note:** If your vehicle is equipped with Type One, make sure to place the key properly into the backup slot.

**Note:** If your vehicle is equipped with Type Two, make sure the buttons are facing the rear of the vehicle and the key ring up. Place the key into the backup slot.

With the key in the backup slot, press the brake pedal, then press the push button ignition switch to start your vehicle.

## STARTING AND STOPPING THE ENGINE – TROUBLESHOOTING

### Starting and Stopping the Engine – Warning Lamps

#### Malfunction Indicator Lamp

 If it illuminates when the engine is running, the on-board diagnostics system is detecting a malfunction of the vehicle emission control system.

# Starting and Stopping the Engine

If it flashes, engine misfire could be occurring. Increased exhaust gas temperatures could damage the catalytic converter or other vehicle components. Avoid heavy acceleration and deceleration, and have your vehicle checked as soon as possible.

## Powertrain Warning Lamp



If it illuminates when the engine is running, this indicates a powertrain or four-wheel drive fault. If it flashes when you are driving, immediately reduce the vehicle speed. Avoid heavy acceleration and deceleration, and have your vehicle checked as soon as possible.

If both lamps illuminate when the engine is running, stop your vehicle as soon as it is safe to do so. Continuing to drive your vehicle could cause reduced power or the engine to stop. Switch the ignition off and attempt to restart the engine. Have your vehicle checked as soon as possible.

## Starting and Stopping the Engine – Information Messages

Message	Action
Cranking Time Exceeded	Displays if you exceed the starting time limit. You cannot attempt to start the engine for 15 minutes. If you cannot start the engine after 15 minutes passes, have your vehicle immediately checked.
Starting System Fault	Displays if you are unable to start your vehicle with a correctly coded key. The system has detected a fault that requires service. Have your vehicle checked as soon as possible.
No Key Detected	Displays if the system does not detect a valid passive key.

# Starting and Stopping the Engine

## Starting and Stopping the Engine – Frequently Asked Questions - Gasoline, Vehicles Without: Push Button Start

### Why is the engine idle speed high when I am starting the engine?

The speed at which the engine idles immediately after starting is optimized to minimize vehicle emissions and maximize cabin comfort and fuel economy.

### Why does the engine not crank?

You can only attempt to start the engine for a limited amount of time before the starting system temporarily disables. If you exceed the starting time limit, a message may appear and you cannot attempt to start the engine for at least 15 minutes.

### Why do I experience different driving characteristics?

If you disconnect the battery, your vehicle may exhibit some unusual driving characteristics for approximately 5 mi (8 km) after you reconnect it. This is because the engine management system must realign itself with the engine. You can disregard any unusual driving characteristics during this period.

### Why can I not start the engine?

If you cannot start the engine after 3 attempts, wait 10 seconds and do the following:

1. Fully press the brake pedal or the clutch pedal.

**Note:** Make sure that the parking brake is applied.

**Note:** Make sure that the transmission is in park (P) or neutral (N).

2. Fully press the accelerator pedal and hold it there.



3. Turn the key to position **III** and wait until the engine stops cranking.
4. Release the accelerator pedal.
5. Turn the key to position **III**.

## Starting and Stopping the Engine – Frequently Asked Questions - Gasoline, Vehicles With: Push Button Start

### Why is the engine idle speed high when I am starting the engine?

The speed at which the engine idles immediately after starting is optimized to minimize vehicle emissions and maximize cabin comfort and fuel economy.

### Why does the engine not crank?

You can only attempt to start the engine for a limited amount of time before the starting system temporarily disables. If you exceed the starting time limit, a message may appear and you cannot attempt to start the engine for at least 15 minutes.

### Why do I experience different driving characteristics?

If you disconnect the battery, your vehicle may exhibit some unusual driving characteristics for approximately 5 mi (8 km) after you reconnect it. This is because the engine management system must realign itself with the engine. You can disregard any unusual driving characteristics during this period.

# Starting and Stopping the Engine

## Why can I not start the engine?

If you cannot start the engine after 3 attempts, wait 10 seconds and do the following:

1. Fully press the brake pedal or the clutch pedal.

**Note:** Make sure that the parking brake is applied.

**Note:** Make sure that the transmission is in park (P) or neutral (N).

2. Fully press the accelerator pedal and hold it there.
3. Press the push button ignition switch.

**Note:** The engine cranks for a short period of time and then it stops.

4. Release the accelerator pedal.



5. Press the push button ignition switch.

## Why does the system not detect a passive key?

If the system does not detect a passive key and you are unable to start the engine, insert the passive key into the backup position and press the push button ignition switch to start the engine. See **Accessing the Passive Key Backup Position** (page 216).

## Starting and Stopping the Engine – Frequently Asked Questions - Diesel, Vehicles Without: Push Button Start

### Why is the engine idle speed high when I am starting the engine?

The speed at which the engine idles immediately after starting is optimized to minimize vehicle emissions and maximize cabin comfort and fuel economy.

### Why does the engine not crank?

You can only attempt to start the engine for a limited amount of time before the starting system temporarily disables. If you exceed the starting time limit, a message may appear and you cannot attempt to start the engine for at least 15 minutes.

### Why do I experience different driving characteristics?

If you disconnect the battery, your vehicle may exhibit some unusual driving characteristics for approximately 5 mi (8 km) after you reconnect it. This is because the engine management system must realign itself with the engine. You can disregard any unusual driving characteristics during this period.

### Why can I not start the engine?

If you cannot start the engine, do the following:

1. Fully press the brake pedal or the clutch pedal.

**Note:** Make sure that the parking brake is applied.

**Note:** Make sure that the transmission is in park (P) or neutral (N).

# Starting and Stopping the Engine



2. Turn the key to position **III** until the engine starts.

## Starting and Stopping the Engine – Frequently Asked Questions - Diesel, Vehicles With: Push Button Start

### Why is the engine idle speed high when I am starting the engine?

The speed at which the engine idles immediately after starting is optimized to minimize vehicle emissions and maximize cabin comfort and fuel economy.

### Why does the engine not crank?

You can only attempt to start the engine for a limited amount of time before the starting system temporarily disables. If you exceed the starting time limit, a message may appear and you cannot attempt to start the engine for at least 15 minutes.

### Why do I experience different driving characteristics?

If you disconnect the battery, your vehicle may exhibit some unusual driving characteristics for approximately 5 mi (8 km) after you reconnect it. This is because the engine management system must realign itself with the engine. You can disregard any unusual driving characteristics during this period.

### Why can I not start the engine?

If you cannot start the engine, do the following:

1. Fully press the brake pedal or the clutch pedal.

**Note:** Make sure that the parking brake is applied.

**Note:** Make sure that the transmission is in park (P) or neutral (N).



2. Press the push button ignition switch until the engine starts.

### Why does the system not detect a passive key?

If the system does not detect a passive key and you are unable to start the engine, insert the passive key into the backup position and press the push button ignition switch to start the engine. See **Accessing the Passive Key Backup Position** (page 216).

# Hybrid Electric Vehicle Information (If Equipped)

---

## WHAT IS A HYBRID ELECTRIC VEHICLE

A hybrid vehicle has an electric motor and a high voltage battery combined with a gasoline engine.

## HOW DOES A HYBRID ELECTRIC VEHICLE WORK

The hybrid vehicle combines electric and gasoline propulsion to provide optimal performance and improved efficiency.

## HYBRID ELECTRIC VEHICLE DRIVING CHARACTERISTICS

The gasoline engine starts and stops to provide power when required and to save fuel when not needed. When coasting at low speeds, coming to a stop or standing, the gas engine normally shuts down and your vehicle operates in electric-only mode.

Conditions that may cause the gasoline engine to start or remain running include:

- Considerable vehicle acceleration.
- Driving uphill.
- The high voltage battery charge level is low.
- Heating or cooling the vehicle interior in high or low outside temperatures.
- The gasoline engine is below normal operating temperature.
- Towing a trailer.
- Certain selectable drive modes could cause the engine to run. See **Selecting a Drive Mode** (page 328). Use of the paddle shifters while in drive (D) could cause the engine to run.

Your hybrid vehicle also comes with standard hydraulic braking and regenerative braking. Regenerative braking is performed by your transmission and captures brake energy and stores it in the high voltage battery.

You could also notice that your engine continues to run instead of shutting off during extended downhill driving. The engine stays on during this engine braking but is not using any fuel.

You could also hear a slight whine or whistle when operating your vehicle. This is the normal operation of the electric motor in the hybrid system.

## LOW ENGINE USE MODE

### What is Low Engine Use Mode

Low engine use mode maintains proper engine lubrication at sufficient temperature and activates when you drive your vehicle with limited engine operation.

### How Does Low Engine Use Mode Work

When in low engine use mode, your vehicle runs the engine as necessary. When low engine use mode begins, a message appears in the information display. If low engine use mode does not complete before you switch your vehicle off, it continues the next time you start your vehicle and the message reappears.

**Note:** Cold temperatures affect the engine warm up time and the low engine use mode may operate more frequently.

**Note:** An oil change is not required but gives you the option of not running a low engine use cycle. Resetting the oil life monitoring system suspends the low engine use mode.



# Hybrid Electric Vehicle Information (If Equipped)

## Low Engine Use Mode Limitations

Cold temperatures affect the engine warm up time and the low engine use mode could operate more frequently.

An oil change is not required but gives you the option of not running a low engine use cycle. Resetting the oil life monitoring system suspends the low engine use mode.

## HYBRID ELECTRIC VEHICLE INFORMATION INDICATORS

**READY** When you start your vehicle, a green READY indicator light appears in the instrument cluster letting you know that your vehicle is ready for driving.

The engine may not start because your vehicle has a silent key start feature. This fuel saving feature allows your vehicle to be ready to drive without requiring the gas engine to be running.

The indicator remains on when your vehicle is on, whether the engine is running or not, to indicate your vehicle is capable of movement using the electric motor, gas engine or both.

Typically, the engine does not start unless the vehicle is cold, a climate control change is requested or you press the accelerator pedal.

## HYBRID ELECTRIC VEHICLE INFORMATION – TROUBLESHOOTING

### Hybrid Electric Vehicle Information – Frequently Asked Questions

#### How long is the high voltage battery system designed to last?

The high voltage battery system is designed to last the life of your vehicle.

#### Does the high voltage battery require maintenance?

The high voltage battery does not require maintenance.

#### What should I do if the vehicle runs out of fuel and the high voltage battery is out of charge?

Refuel and start your vehicle normally. The engine will recharge the high voltage battery.

#### Why does the engine sometimes start at key-on?

The vehicle's computer will determine if an engine start is required at key-on. It starts the engine when necessary for cabin heating, windshield defrost, or if the outside temperature is low.

#### Can I put E15 or E85 in my vehicle, and how will it affect my fuel economy?

Your hybrid vehicle can use E15 (15% ethanol, 85% gasoline) fuel, but you may notice slightly reduced fuel economy because ethanol contains less energy per gallon than gasoline. Your hybrid vehicle is not designed to use E85 (85% ethanol).

## Hybrid Electric Vehicle Information (If Equipped)

---

### **Why does it take a long time before the engine shuts down?**

There are several reasons the engine stays on for an extended amount of time when you first start it. One common reason is to make sure that the emissions components are warm enough to minimize tailpipe emission. As the climate gets cooler, the engine-on time is extended.

### **Why does my engine stay on when it is extremely cold outside?**

In order to make sure that the climate control system can begin heating the cabin or defrosting the windshield as soon as a driver requests it, the engine coolant temperature has to be kept sufficiently hot. Keeping the engine on is required to maintain the correct coolant temperature.

# Auto-Start-Stop (If Equipped)

## WHAT IS AUTO-START-STOP

### *Auto Start-Stop*

The system is designed to help reduce fuel consumption and CO<sub>2</sub> emissions by stopping the engine when it is idling, for example at traffic lights.

## AUTO-START-STOP PRECAUTIONS



**WARNING:** Apply the parking brake, shift into park (P), switch the ignition off and remove the key before you leave your vehicle. Failure to follow this instruction could result in personal injury or death.



**WARNING:** Apply the parking brake, shift into park (P), switch the ignition off and remove the key before you open the hood or have any service or repair work completed. If you do not switch the ignition off, the engine could restart at any time. Failure to follow this instruction could result in personal injury or death.

## SWITCHING AUTO-START-STOP ON AND OFF

The system turns on when you switch the ignition on.



Press the button to switch the system off.

**Note:** *OFF* illuminates in the switch.

**Note:** *Deactivating the system using the button lasts only one key cycle.*

Press the button again to switch the system back on.

**Note:** *The system turns off if it detects a malfunction. If the system malfunctions, have your vehicle checked as soon as possible.*

## STOPPING THE ENGINE

Stop your vehicle, keep your foot on the brake pedal and the transmission in drive (D).

**Note:** *Power assist steering turns off when the engine stops.*

## RESTARTING THE ENGINE

Release the brake pedal or press the accelerator pedal.

A message appears in the information display if the system requires you to take action.

## AUTO-START-STOP INDICATORS



**WARNING:** The system may require the engine to automatically restart when the auto-start-stop indicator illuminates green or flashes amber. Failure to follow this instruction could result in personal injury.



The Auto-Start-Stop indicator illuminates green when the engine stops. It flashes amber and a message appears when you need to take action.



The Auto-Start-Stop indicator illuminates gray with a strikethrough when the system is not available.

## Auto-Start-Stop (If Equipped)

---

**Note:** You can display the reason why the system is not available in the information display.

### **AUTO-START-STOP – TROUBLESHOOTING**

#### **Auto-Start-Stop – Information Messages**

A message appears in the information display if the system requires you to take action.

<b>Message</b>	<b>Condition</b>	<b>Action</b>
Auto StartStop Press Brake to Start Engine	The system needs to restart the engine but requires your confirmation.	Press the brake pedal to restart the engine.
Auto StartStop Press a Pedal to Start Engine	The system needs to restart the engine but requires your confirmation.	Press the brake pedal or the accelerator pedal to restart the engine.

## Auto-Start-Stop (If Equipped)

---

### Auto-Start-Stop – Frequently Asked Questions

#### Why does the engine not always stop when I expect it to?

The system is designed to work in a way that complements other vehicle systems, allowing them to operate at optimum performance.

The system does not stop the engine if:

- The driver door is open.
- Your vehicle is at high altitude.
- The heated windshield is on.
- The engine is warming up.
- The outside temperature is too low or too high.
- The battery charge is low.
- The battery temperature is outside the optimal operating range.
- The engine is required to run to maintain interior climate and reduce fogging.

#### Why does the engine sometimes restart when I do not expect it to?

The system is designed to work in a way that complements other vehicle systems, allowing them to operate at optimum performance.

The system restarts the engine if:

- You switch the heated windshield on.
- You switch maximum defrost on.
- Your vehicle starts to roll downhill in neutral.
- The engine is required to run to maintain adequate brake system assistance.
- The engine is required to run to maintain interior climate and reduce fogging.

#### Can I permanently switch the system off?

No. The system plays an important role in reducing the fuel consumption and the CO<sub>2</sub> emissions.

#### Will the frequent engine starts cause parts to wear out?

Your vehicle has an enhanced battery and starter motor that are designed for the increased number of engine starts.

# Fuel and Refueling

## FUEL AND REFUELING PRECAUTIONS



**WARNING:** Do not overfill the fuel tank. The pressure in an overfilled tank may cause leakage and lead to fuel spray and fire.



**WARNING:** The fuel system may be under pressure. If you hear a hissing sound near the fuel filler inlet, do not refuel until the sound stops. Otherwise, fuel may spray out, which could cause serious personal injury.



**WARNING:** Fuels can cause serious injury or death if misused or mishandled.



**WARNING:** Fuel may contain benzene, which is a cancer-causing agent.



**WARNING:** When refueling always shut the engine off and never allow sparks or open flames near the fuel tank filler valve. Never smoke or use a cell phone while refueling. Fuel vapor is extremely hazardous under certain conditions. Avoid inhaling excess fumes.

Follow these guidelines when refueling:

- Extinguish all smoking materials and any open flames before refueling your vehicle.
- Switch the engine off before refueling.
- Automotive fuels can be harmful or fatal if swallowed. Fuel is highly toxic and if swallowed can cause death or permanent injury. If fuel is swallowed immediately call a physician, even if no symptoms are immediately apparent. The toxic effects of fuel may not be apparent for hours.

- Avoid inhaling fuel vapors. Inhaling fuel vapor can lead to eye and respiratory tract irritation. In severe cases, excessive or prolonged breathing of fuel vapor can cause serious illness and permanent injury.
- Avoid getting fuel in your eyes. If you splash fuel in your eyes, immediately remove contact lenses, if worn, flush with water for 15 minutes and seek medical attention. Failure to seek proper medical attention could lead to permanent injury.
- Fuels can be harmful if absorbed through the skin. If you splash fuel on your skin, clothing or both, promptly remove contaminated clothing and thoroughly wash your skin with soap and water. Repeated or prolonged skin contact causes skin irritation.
- Be particularly careful if you are taking Antabuse or other forms of Disulfiram for the treatment of alcoholism. Breathing fuel vapors could cause an adverse reaction, serious personal injury or sickness. Immediately call a physician if you experience any adverse reactions.

## FUEL QUALITY

### Selecting the Correct Fuel - Flex Fuel – Ethanol

Flex fuel vehicles have one of the following identifiers:

- Yellow fuel filler cap.
- Yellow bezel around the fuel filler inlet.
- Yellow fuel filler housing.
- Yellow E85 label on the fuel tank filler door.

# Fuel and Refueling



Your vehicle operates on regular unleaded gasoline with a minimum pump (R+M)/2 octane rating of 87 or regular unleaded gasoline blended with a maximum of 85% ethanol (E85).

Some fuel stations, particularly those in high altitude areas, offer fuels posted as regular unleaded gasoline with an octane rating below 87. The use of these fuels could result in engine damage that will not be covered by the vehicle Warranty.

For best overall vehicle and engine performance, premium fuel with an octane rating of 91 or higher is recommended. The performance gained by using premium fuel is most noticeable in hot weather as well as other conditions, for example when towing a trailer. See **Towing a Trailer** (page 375).

Do not be concerned if the engine sometimes knocks lightly. However, if the engine knocks heavily while using fuel with the recommended octane rating, contact an authorized dealer to prevent any engine damage.

We recommend Top Tier detergent gasolines, where available to help minimize engine deposits and maintain optimal vehicle and engine performance.

For additional information, visit [www.toptiergas.com](http://www.toptiergas.com).

**Note:** Use of any fuel for which the vehicle was not designed can impair the emission control system, cause loss of vehicle performance, and cause damage to the engine which may not be covered by the vehicle Warranty.

Do not use:

- Diesel fuel.
- Fuels containing kerosene or paraffin.
- Fuels containing more than 85% ethanol or E100 fuel.
- Fuels containing methanol.
- Fuels containing metallic-based additives, including manganese-based compounds.
- Fuels containing the octane booster additive, methylcyclopentadienyl manganese tricarbonyl (MMT).
- Leaded fuel, using leaded fuel is prohibited by law.

The use of fuels with metallic compounds such as methylcyclopentadienyl manganese tricarbonyl, which is a manganese-based fuel additive, will impair engine performance and affect the emission control system.

## Selecting the Correct Fuel - Gasoline

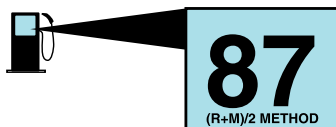

Your vehicle operates on regular unleaded gasoline with a minimum pump (R+M)/2 octane rating of 87.

# Fuel and Refueling

Some fuel stations, particularly those in high altitude areas, offer fuels posted as regular unleaded gasoline with an octane rating below 87. The use of these fuels could result in engine damage that will not be covered by the vehicle Warranty.

For best overall vehicle and engine performance, premium fuel with an octane rating of 91 or higher is recommended. The performance gained by using premium fuel is most noticeable in hot weather as well as other conditions, for example when towing a trailer. See **Towing a Trailer** (page 375).

Do not be concerned if the engine sometimes knocks lightly. However, if the engine knocks heavily while using fuel with the recommended octane rating, contact an authorized dealer to prevent any engine damage.

We recommend Top Tier detergent gasolines, where available to help minimize engine deposits and maintain optimal vehicle and engine performance.

For additional information, visit [www.toptiergas.com](http://www.toptiergas.com).

**Note:** *Use of any fuel for which the vehicle was not designed can impair the emission control system, cause loss of vehicle performance, and cause damage to the engine which may not be covered by the vehicle Warranty.*

Do not use:

- Diesel fuel.
- Fuels containing kerosene or paraffin.
- Fuel containing more than 15% ethanol or E85 fuel.
- Fuels containing methanol.
- Fuels containing metallic-based additives, including manganese-based compounds.

- Fuels containing the octane booster additive, methylcyclopentadienyl manganese tricarbonyl (MMT).
- Leaded fuel, using leaded fuel is prohibited by law.

The use of fuels with metallic compounds such as methylcyclopentadienyl manganese tricarbonyl, which is a manganese-based fuel additive, will impair engine performance and affect the emission control system.

## Selecting the Correct Fuel for Cold Weather - Diesel

### Choosing the Right Fuel: Vehicles Operated Where Ultra Low Sulfur Diesel Fuel Is Required (United States/Canada/Puerto Rico/U.S. Virgin Islands And Other Locales)

**Note:** *Your Warranty will not cover damage caused by using an improper type of fuel or fuel additive.*

**Note:** *Do not blend used engine oil with diesel fuel under any circumstances. Blending used oil with the fuel significantly increases your vehicle's exhaust emissions and reduce engine life due to increased internal wear.*

We recommend Top Tier diesel fuel where available to help minimize engine deposits and maintain optimal vehicle and engine performance.

For additional information, visit [www.toptiergas.com](http://www.toptiergas.com).



# Fuel and Refueling

You should use ultra-low sulfur diesel fuel designated as number 1-D or 2-D with a maximum of 15-ppm sulfur in your diesel vehicle. You can operate your vehicle on diesel fuels containing up to 20% biodiesel, also known as B20. These fuels should meet the ASTM D975 diesel or the ASTM D7467 B6-B20 biodiesel industry specifications. Outside of North America, use fuels meeting EN590 or equivalent local market standard.



Using low-sulfur diesel fuel (16-500 ppm) or high-sulfur diesel fuel (greater than 500 ppm) in your diesel engine will cause certain emission components to malfunction which could also cause the service engine soon light to illuminate indicating an emissions-related concern.

Diesel fuel is adjusted seasonally for cold temperature. For best results at temperatures below 19°F (-7°C), we recommend using a diesel fuel which has been seasonally adjusted for the ambient conditions.

## Choosing the Right Fuel: Vehicles Operated Where Ultra Low Sulfur Diesel Fuel Is Not Required

For the engine to operate reliably on low-sulfur or high-sulfur diesel fuel, the engine must be a factory-built high-sulfur engine (available as a dealer order option for select markets) or an ultra-low sulfur diesel fuel configured engine that has been retrofitted for high-sulfur diesel fuel using authorized dealer service parts. Failure to use retrofit components other than those available through your authorized dealer results in coolant system damage, engine overheating, selective catalyst reduction system or diesel particulate filter damage and possible base engine damage.

Use only a diesel engine configured for use with high-sulfur diesel fuel in markets with diesel fuel that has sulfur content greater than 15 ppm. Using low-sulfur diesel fuel (16–500 ppm) or high-sulfur diesel fuel (greater than 500 ppm) in a diesel engine designed to use only ultra-low sulfur diesel fuel could result in damage to engine emission control devices and the after treatment system, potentially rendering the vehicle inoperable.

Vehicles with engines configured for use with high-sulfur diesel fuel are only available for sale in countries where ultra-low sulfur diesel fuel is generally not available or mandated by the government. Vehicles originally sold in an ultra-low sulfur diesel fuel market that are subsequently exported to non-ultra low sulfur diesel fuel markets will need to be retrofitted at the customer's expense using Ford authorized dealer service parts in order to be reliably operated on non-ultra low sulfur diesel fuel.

## Biodiesel



**WARNING:** Do not mix diesel with gasoline, gasohol or alcohol. This could cause an explosion.

**Note:** *Do not use home heating oil, agricultural fuel, raw fats and oils, waste cooking greases, biodiesel greater than 20% or any diesel not intended for highway use. Damage to the fuel injection system, engine and exhaust catalyst, and diesel particulate filter can occur if you use an improper fuel. Red dye is used to identify fuels intended for agricultural and non-highway use.*

You can operate your vehicle on diesel fuels containing up to 20% biodiesel, also known as B20.

# Fuel and Refueling

Biodiesel fuel is a chemically converted product from renewable fuel sources, such as vegetable oils, animal fats and waste cooking greases.

To help achieve acceptable engine performance and durability when using biodiesel in your vehicle:

- Confirm the biodiesel content of the fuel to be B20 (20% biodiesel) or less.
- Only use biodiesel fuel of good quality that complies with industry standards.
- Follow the recommended service maintenance intervals. See **General Maintenance Information** (page 602).
- Do not store biodiesel fuel in the fuel tank for more than 1 month.
- Consider changing brands or reducing biodiesel content if you have cold temperature fuel gelling issues or a frequently appearing LOW FUEL PRESSURE message.

Use of biodiesel in concentrations greater than 20% can cause damage to your vehicle, including engine and/or exhaust after-treatment hardware (exhaust catalyst and particulate filter) failures. Concentrations greater than 20% can also cause fuel filter restrictions that could result in a lack of power or damage to fuel system components, including fuel pump and fuel injector failures.

We recommend SAE 5W-40 oil for fuels with greater than 5% biodiesel (B5). For more information about oil change intervals and other maintenance when operating on biodiesel. See **Special Operating Conditions Scheduled Maintenance** (page 614).

Look for a label on the fuel pump to confirm the amount of biodiesel contained in diesel fuel. Ask the service station attendant to confirm the biodiesel content of diesel fuel, if you do not see a label on the fuel pump.

If you plan to park or store your vehicle for more than 1 month, then you should empty your vehicle fuel tank of biodiesel fuel. You should fill the tank with a pure petroleum-based diesel fuel and run your vehicle for a minimum of 30 minutes.

**Note:** *Degraded or oxidized biodiesel can damage fuel system seals and plastics and corrode steel parts.*

During cold weather, if you have problems operating on biodiesel, you may need to use diesel fuel with lower biodiesel content, try another brand or discontinue the use of biodiesel.

## Diesel Fuel Additives

It should not be necessary to add any aftermarket additives to your fuel if you use a high-quality diesel fuel that conforms to ASTM industry specifications. Aftermarket additives can damage the fuel injector system or engine.

Use Motorcraft® cetane booster or an equivalent cetane booster additive if you suspect fuel has low cetane. Use Motorcraft® anti-gel and performance improver or an equivalent additive if there is fuel gelling.

Do not use alcohol-based additives to improve cetane quality, to prevent fuel gelling or any other use. The use of alcohol additives could result in damage to the fuel injectors and system.

Your Warranty may not cover repairs needed to correct the effects of using an aftermarket product that does not meet our specifications in your fuel.

# Fuel and Refueling

## Switching Between E85 and Gasoline

We do not recommend repeatedly alternating between E85 and gasoline. If you switch from using E85 to gasoline, or from gasoline to E85, add as much fuel as possible, at least half a tank. Drive your vehicle immediately for a minimum of 5 mi (8 km) to allow it to adapt to the change in ethanol concentration. If you use E85 exclusively, we recommend that you fill the fuel tank with regular unleaded gasoline at each scheduled oil change.

## LOCATING THE FUEL FILLER FUNNEL

### Regular Cab

The fuel filler funnel is behind the right-hand front seat.

### Super Cab/Crew Cab

The fuel filler funnel is under the second row right-hand rear seat.

## RUNNING OUT OF FUEL

### Filling a Portable Fuel Container



**WARNING:** Flow of fuel through a fuel pump nozzle can produce static electricity. This can cause a fire if you are filling an ungrounded fuel container.

Use the following guidelines to avoid electrostatic charge build-up, which can produce a spark, when filling an ungrounded fuel container:

- Only use an approved fuel container to transfer fuel to your vehicle. Place the container on the ground when filling it.
- Do not fill a fuel container when it is inside your vehicle (including the cargo area).
- Keep the fuel pump nozzle in contact with the fuel container when filling it.
- Do not use a device that holds the fuel pump nozzle lever in the fill position.

## Adding Fuel From a Portable Fuel Container



**WARNING:** Do not insert the nozzle of a fuel container or an aftermarket funnel into the fuel filler neck. This may damage the fuel system filler neck or its seal and cause fuel to run onto the ground.



**WARNING:** Do not pry open the fuel tank filler valve. This could damage the fuel system. Failure to follow this instruction could result in fire, personal injury or death.



**WARNING:** Do not dispose of fuel in the household refuse or the public sewage system. Use an authorized waste disposal facility.

When refueling the vehicle fuel tank from a fuel container, use the fuel filler funnel included with your vehicle. See **Locating the Fuel Filler Funnel** (page 232).

**Note:** Do not use aftermarket funnels as they may not work with the capless fuel system and can damage it.

# Fuel and Refueling

When refueling the vehicle fuel tank from a fuel container, do the following:

1. Fully open the fuel filler door.



2. Fully insert the fuel filler funnel into the fuel filler inlet.
3. Add fuel to your vehicle from the fuel container.
4. Remove the fuel filler funnel.
5. Fully close the fuel filler door.
6. Clean the fuel filler funnel and place it back in your vehicle or correctly dispose of it.

**Note:** If your vehicle runs out of fuel add a minimum of 1.3 gal (5 L) of fuel to restart the engine.

**Note:** You may need to switch the ignition from off to on several times after refueling to allow the fuel system to pump the fuel from the tank to the engine. When restarting, cranking time takes a few seconds longer than normal.

**Note:** Extra funnels can be purchased from an authorized dealer if you choose to dispose of the funnel.

## REFUELING

### Refueling System Overview

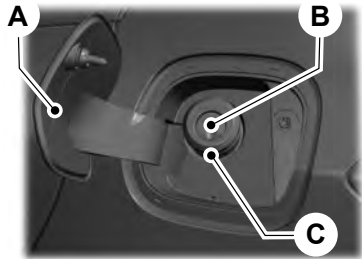

- A Fuel filler door.
- B Fuel tank filler valve.
- C Fuel tank filler pipe.

### Refueling Your Vehicle - Excluding: Hybrid Electric Vehicle (HEV)

**WARNING:** When refueling always shut the engine off and never allow sparks or open flames near the fuel tank filler valve. Never smoke or use a cell phone while refueling. Fuel vapor is extremely hazardous under certain conditions. Avoid inhaling excess fumes.

**WARNING:** The fuel system may be under pressure. If you hear a hissing sound near the fuel filler inlet, do not refuel until the sound stops. Otherwise, fuel may spray out, which could cause serious personal injury.

# Fuel and Refueling

**WARNING:** Do not pry open the fuel tank filler valve. This could damage the fuel system. Failure to follow this instruction could result in fire, personal injury or death.

**WARNING:** Do not remove the fuel pump nozzle from its fully inserted position when refueling.

**WARNING:** Stop refueling when the fuel pump nozzle automatically shuts off for the first time. Failure to follow this will fill the expansion space in the fuel tank and could lead to fuel overflowing.

**WARNING:** Do not overfill the fuel tank. The pressure in an overfilled tank may cause leakage and lead to fuel spray and fire.

**WARNING:** Wait at least five seconds before removing the fuel pump nozzle to allow any residual fuel to drain into the fuel tank.

1. Fully open the fuel filler door.
2. Select the correct fuel pump nozzle for your vehicle.

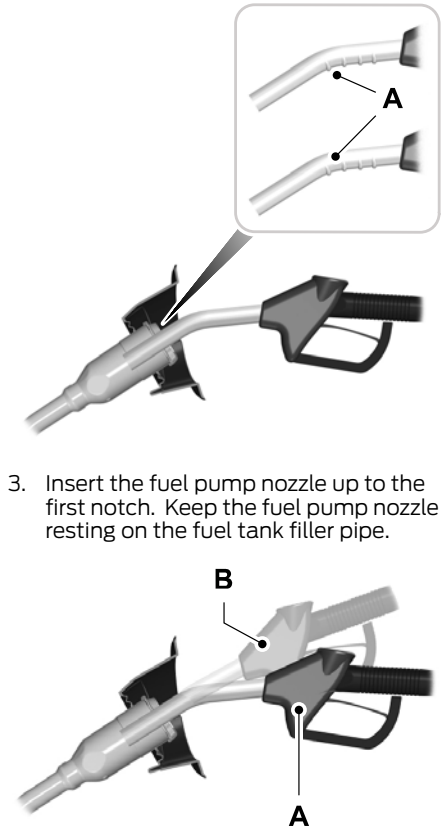

3. Insert the fuel pump nozzle up to the first notch. Keep the fuel pump nozzle resting on the fuel tank filler pipe.

4. Hold the fuel pump nozzle in position A when refueling. Holding the fuel pump nozzle in position B can affect the flow of fuel and shut off the fuel pump nozzle before the fuel tank is full.

# Fuel and Refueling

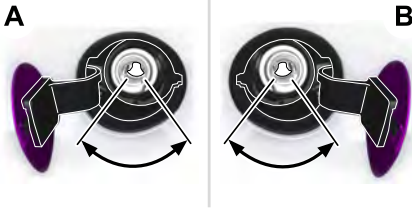

5. Operate the fuel pump nozzle within the area shown. Refer to A for left hand drive or B for right hand drive.

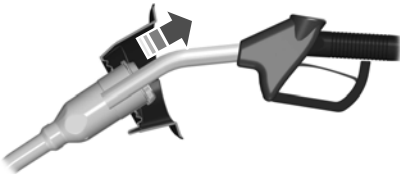

6. When the pump shuts off, wait 5 seconds, then raise the fuel pump nozzle and slowly remove it.
7. Fully close the fuel filler door.

**Note:** Do not attempt to start the engine if you have filled the fuel tank with incorrect fuel. Incorrect fuel use could cause damage not covered by the vehicle Warranty. Have your vehicle immediately checked.

## Refueling Your Vehicle - Hybrid Electric Vehicle (HEV)

**WARNING:** When refueling always shut the engine off and never allow sparks or open flames near the fuel tank filler valve. Never smoke or use a cell phone while refueling. Fuel vapor is extremely hazardous under certain conditions. Avoid inhaling excess fumes.

**WARNING:** The fuel system may be under pressure. If you hear a hissing sound near the fuel filler inlet, do not refuel until the sound stops. Otherwise, fuel may spray out, which could cause serious personal injury.

**WARNING:** Do not pry open the fuel tank filler valve. This could damage the fuel system. Failure to follow this instruction could result in fire, personal injury or death.

**WARNING:** Do not remove the fuel pump nozzle from its fully inserted position when refueling.

**WARNING:** Stop refueling when the fuel pump nozzle automatically shuts off for the first time. Failure to follow this will fill the expansion space in the fuel tank and could lead to fuel overflowing.

**WARNING:** Do not overfill the fuel tank. The pressure in an overfilled tank may cause leakage and lead to fuel spray and fire.

**WARNING:** Wait at least five seconds before removing the fuel pump nozzle to allow any residual fuel to drain into the fuel tank.

1. When you stop your vehicle, shift into park (P) and switch the ignition off.

## Fuel and Refueling

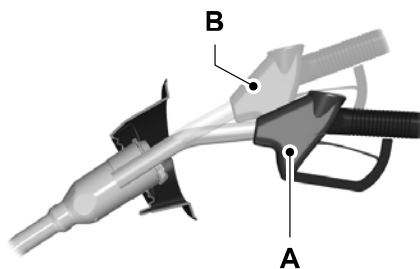
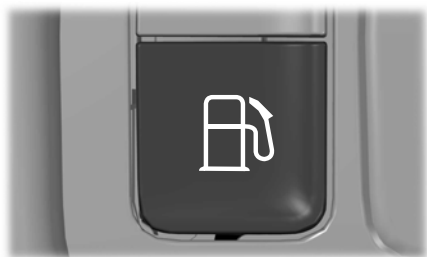

2. Press the button on the left side of the instrument panel next to the headlamp switch to open the fuel filler door. The fuel filler door can take up to 15 seconds to open before you can insert a fuel filler nozzle.
3. Select the correct fuel pump nozzle for your vehicle.

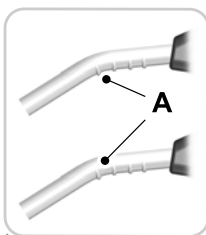

5. Hold the fuel pump nozzle in position A when refueling. Holding the fuel pump nozzle in position B can affect the flow of fuel and shut off the fuel pump nozzle before the fuel tank is full.

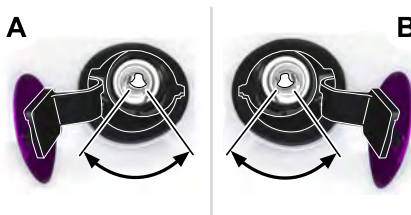

6. Operate the fuel pump nozzle within the area shown. Refer to A for left hand drive or B for right hand drive.

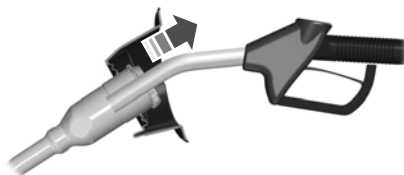
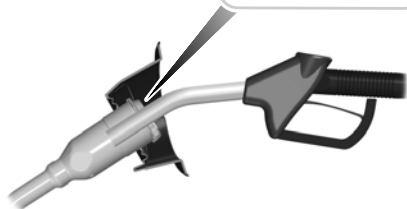

4. Insert the fuel pump nozzle up to the first notch. Keep the fuel pump nozzle resting on the fuel tank filler pipe.

7. When the pump shuts off, wait 5 seconds, then raise the fuel pump nozzle and slowly remove it.
8. Fully close the fuel filler door.

# Fuel and Refueling

**Note:** To close the fuel filler door, press the center rear edge of the fuel filler door and then release.

Complete the refueling process within 20 minutes. If 20 minutes elapses, press the button on the left side of the instrument panel again. Fuel pump nozzle automatic shut off could occur if you do not press the button on the left side instrument panel.

**Note:** Do not attempt to start the engine if you have filled the fuel tank with incorrect fuel. Incorrect fuel use could cause damage not covered by the vehicle Warranty. Have your vehicle immediately checked.

## Manually Opening the Fuel Filler Door - Excluding: Hybrid Electric Vehicle (HEV)

Your vehicle does not have a fuel tank filler cap.

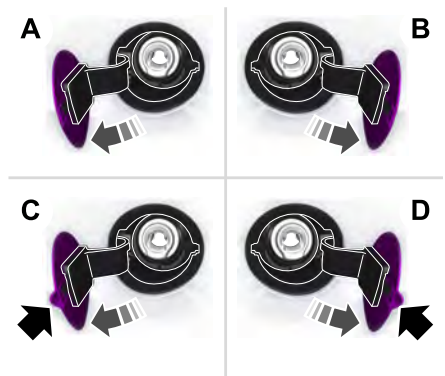

- A Left-hand side. To open the fuel filler door, press the center rear edge of the fuel filler door and then release.
- B Right-hand side. To open the fuel filler door, press the center rear edge of the fuel filler door and then release.
- C Left-hand side. Pull the rear of the fuel filler door to open it.
- D Right-hand side. Pull the rear of the fuel filler door to open it.

## Manually Opening the Fuel Filler Door - Hybrid Electric Vehicle (HEV)

**Note:** The transmission must be in park (P) or neutral (N).

To manually open the fuel door do the following:



## Fuel and Refueling

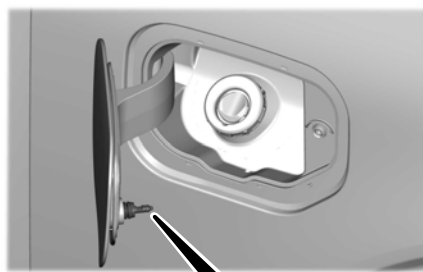
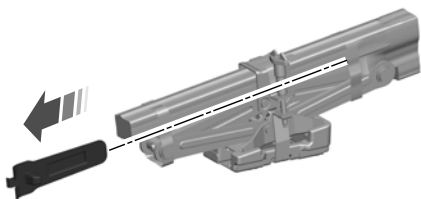

1. Retrieve the emergency opening tool.

**Note:** The emergency opening tool is with the jack and tool bag. See **Changing a Flat Tire** (page 516).

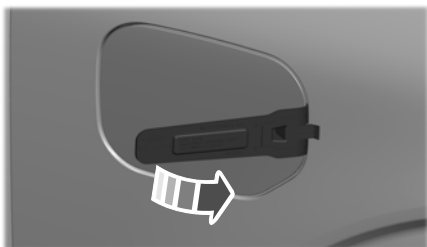

2. Insert the emergency opening tool in the position shown and gently pry the fuel door open.

**Note:** Do not press the fuel filler door release button if the emergency opening tool has been used.

Using the emergency opening tool can cause the tappet to temporarily dislodge from the fuel filler door and remain attached to the fuel filler door opening. If you press the fuel filler door release button after using the emergency opening tool, locate the tappet and reinsert it into the fuel door.

### FUEL TANK CAPACITY - EXCLUDING: HYBRID ELECTRIC VEHICLE (HEV)

#### Advertised Capacity

The advertised capacity is the maximum amount of fuel that you can add to the fuel tank after running out of fuel. Included in the advertised capacity is an empty reserve. The empty reserve is an unspecified amount of fuel that remains in the fuel tank when the fuel gauge indicates empty.

**Note:** The amount of fuel in the empty reserve varies and should not be relied upon to increase driving range.

# Fuel and Refueling

## FUEL TANK CAPACITY - HYBRID ELECTRIC VEHICLE (HEV)

### Advertised Capacity

The advertised capacity is the maximum amount of fuel that you can add to the fuel tank when the fuel gauge indicates empty.

In addition, the fuel tank contains an empty reserve. The empty reserve is an unspecified amount of fuel that remains in the fuel tank when the fuel gauge indicates empty.

**Note:** *The amount of fuel in the empty reserve varies and should not be relied upon to increase driving range.*

## FUEL AND REFUELING – TROUBLESHOOTING

### Fuel and Refueling – Warning Lamps



If it illuminates when you are driving, refuel as soon as possible.

### Fuel and Refueling – Information Messages

#### Refueling System Warning (If Equipped)

If the fuel tank filler valve does not fully close, a message could appear in the information display.

Message
Check Fuel Fill Inlet

If the message appears, do the following:

1. Stop your vehicle as soon as it is safe to do so and switch the engine off.

2. Shift into park (P) or neutral (N).
3. Apply the parking brake.
4. Fully open the fuel filler door.
5. Check the fuel tank filler valve for any debris that may be restricting its movement.
6. Remove any debris from the fuel tank filler valve.
7. Fully insert a fuel pump nozzle or the fuel filler funnel provided with your vehicle into the fuel filler pipe. See **Locating the Fuel Filler Funnel** (page 232). This action should dislodge any debris that may be preventing the fuel tank filler valve from fully closing.
8. Remove the fuel pump nozzle or fuel filler funnel from the fuel filler pipe.
9. Fully close the fuel filler door.

**Note:** *The message may not immediately reset. If the message continues to appear and a warning lamp illuminates, have your vehicle checked as soon as possible.*

# Diesel Particulate Filter (If Equipped)

## WHAT IS THE DIESEL PARTICULATE FILTER

The diesel particulate filter is part of your vehicle's emissions system and filters harmful diesel particulates from the exhaust gas.

## HOW DOES THE DIESEL PARTICULATE FILTER WORK

The diesel particulate filter reduces carbon emissions by trapping exhaust particles before they reach the tailpipe. The system must periodically clean the exhaust particles that gather inside the filter. This is carried out in three ways, passive regeneration, active regeneration and manual regeneration.

### Passive Regeneration

In passive regeneration, the normal exhaust system temperature cleans the filter by oxidizing the soot. Cleaning occurs during normal vehicle operating conditions due to driving patterns.

### Active Regeneration

Once the diesel particulate filter is full, active regeneration raises the exhaust temperature to eliminate the particles. During cleaning, the particles convert to harmless gasses.

When the engine control module detects that the diesel particulate filter is nearly full of particulates, and you are not operating your vehicle in a manner to allow effective regeneration, messages appear in the information display as a reminder for you to drive your vehicle in order to clean the diesel particulate filter. If you drive your vehicle in a manner to allow effective regeneration, the information display shows a cleaning exhaust filter message.

## DIESEL PARTICULATE FILTER PRECAUTIONS



**WARNING:** Do not park or idle your vehicle over dry leaves, dry grass or other combustible materials. The regeneration process creates very high exhaust gas temperatures and the exhaust will radiate a considerable amount of heat during and after regeneration and after you have switched the engine off. This is a potential fire hazard.



**WARNING:** When the **Exhaust Filter Cleaning** message appears in the information display, do not park near flammable materials, vapors or structures until filter cleaning is complete.



**WARNING:** The normal operating temperature of the exhaust system is very high. Never work around or attempt to repair any part of the exhaust system until it has cooled. Use special care when working around the diesel oxidation catalytic converter or the diesel particulate filter. The diesel oxidation catalytic converter and the diesel particulate filter heat up to very high temperatures after only a short period of engine operation and remain hot after you switch the engine off.

**Note:** *Avoid running out of fuel.*

**Note:** *During regeneration at low speed or engine idle, you may smell a hot metallic odor and could notice a clicking metallic sound. This is due to high temperatures reached during regeneration and is normal.*

**Note:** *Changes in the engine or exhaust sound may be heard during the regeneration process.*

## Diesel Particulate Filter (If Equipped)

Failure to perform active or manual regeneration when instructed could result in a clogged diesel particulate filter. If the diesel particulate filter fills beyond the regeneration threshold, your vehicle disables the ability for active and manual regeneration. This could result in irreversible damage your vehicle Warranty may not cover.

### DIESEL PARTICULATE FILTER REQUIREMENTS

The diesel particulate filter on your vehicle requires periodic regeneration to maintain its correct function.

If your journeys meet one of the following conditions:

- You drive only short distances.
- You frequently switch the ignition on and off.
- Your journeys contain a high level of acceleration and deceleration.

You must carry out occasional trips with the following conditions to assist the regeneration process:

- Drive your vehicle in more favorable conditions, which you will find at higher vehicle speeds in normal driving, on a main road or freeway for a minimum of 20 minutes. This drive may include short stops that will not affect the regeneration process.
- Avoid prolonged idling and observe speed limits and road conditions.
- Do not switch the ignition off.
- Select a suitable gear to ideally maintain engine speed between 1500 and 3000 RPM.

### DIESEL PARTICULATE FILTER MANUAL REGENERATION

#### What Is Diesel Particulate Filter Manual Regeneration

Diesel particulate filter manual regeneration allows you to manually start regeneration of the diesel particulate filter at idle to clean the filter.

**Note:** *If you are not sure whether your vehicle has this feature, contact your authorized dealer.*

#### Diesel Particulate Filter Manual Regeneration Precautions



**WARNING:** Stay clear of the exhaust tailpipe during regeneration. Hot exhaust gases can burn you badly.

You may not be able to use manual regeneration if the service engine soon warning lamp appears in the information display.

**Note:** *During the use of manual regeneration, you may observe a light amount of white smoke. This is normal.*

#### Diesel Particulate Filter Manual Regeneration Requirements

You can use the manual regeneration feature when a message appears in the information display and you are not able to drive in a manner that allows effective automatic active regeneration or if you choose to manually start the regeneration of the diesel particulate filter while the vehicle is idle.

## Diesel Particulate Filter (If Equipped)

Before you start manual regeneration, do the following:

- Shift into park (P) and apply the parking brake, on stable, level ground.
- Park your vehicle outside of any structure.
- Park your vehicle 10–15 ft (3–5 m) away from any obstructions and away from materials that can easily combust or melt, for example paper, leaves, petroleum products, fuels, plastics and other dry organic material.
- Make sure there is a minimum of 1/8 tank of fuel.
- Make sure all fluids are at proper levels.

### Diesel Particulate Filter Manual Regeneration Limitations

You cannot use manual regeneration until the diesel particulate filter load percentage has reached 100%. The diesel particulate filter load percentage fluctuates up and down when driving your vehicle due to active and passive regenerations.

If your vehicle is operated with significant stationary operation, low speed drive cycles less than 25 mph (40 km/h), short drive cycles, drive time less than 15 minutes or the vehicle does not fully warm up, passive and active regeneration may not sufficiently clean the diesel particulate filter system.

Aftermarket devices or modifications to the exhaust system may reduce the effectiveness of the exhaust system as well as cause damage to the exhaust system or engine. This may also degrade vehicle performance and could lead to engine damage that may not be covered by the vehicle Warranty.

### Starting Diesel Particulate Filter Manual Regeneration

Start with your vehicle engine and when it has reached the normal operating temperature, press the information display control button on the steering wheel. See **Instrument Cluster Display** (page 151).

If the diesel particulate filter is near or at saturation, a message requesting permission to initiate filter cleaning appears in the information display. See **What Is the Diesel Particulate Filter** (page 240). Answer yes to this prompt and then follow the next prompts regarding exhaust position required to initiate manual regeneration. Be sure to understand each prompt. If you are not sure what is being asked by each prompt, contact an authorized dealer. The display confirms the operation has started and when it has finished. You can also drive to clean the filter.



When the system is at the point of oversaturation, the service engine warning lamp illuminates and a message appears in the information display. You cannot initiate filter cleaning. You must have your vehicle checked as soon as possible.

Once manual regeneration starts, engine speed increases to approximately 1600 rpm and the cooling fan speed increases. You will hear a change in audible sound due to engine speed and cooling fan speed increases.

It is not necessary to open the hood on the engine compartment. Once manual regeneration completes, the engine speed returns to normal idling. The exhaust system remains very hot for several minutes even after regeneration is complete. Do not reposition the vehicle over materials that could burn until the

# Diesel Particulate Filter (If Equipped)

exhaust system has had sufficient time to cool. Depending on the amount of soot collected by the diesel particulate filter, ambient temperature and altitude, manual regeneration lasts approximately 30 minutes.



If there are any issues with the diesel particulate filter system, the engine control system warning lamp and a service engine soon warning lamp illuminate to inform you that your vehicle requires service. Have your vehicle checked as soon as possible.



## DIESEL PARTICULATE FILTER – TROUBLESHOOTING

### Diesel Particulate Filter – Warning Lamps



If filter service is required, the engine control system warning lamp illuminates in the information display.

### Diesel Particulate Filter – Information Messages

Message	Action
Exhaust Filter Cleaning	Your vehicle has entered the cleaning mode. Various engine actions will raise the exhaust temperature in the Diesel Particulate Filter system to burn off the particles (exhaust soot). After the vehicle burns the particles off, the exhaust temperature will return to normal levels. This message is NORMAL.
Exhaust Filter Overloaded Drive to Clean	The diesel particulate filter is full of particles (exhaust soot) and you are not operating the vehicle in a manner that allows normal cleaning. Drive the vehicle above 30 mph (48 km/h) until the message turns off.
Exhaust Filter Overloaded Clean Now	
Exhaust Filter at Limit Clean Now	The diesel particulate filter is full of particles (exhaust soot) and you are not operating the vehicle in a manner that allows normal cleaning. Drive the vehicle above 30 mph (48 km/h) until the message turns off.
Exhaust Filter at Limit Drive to Clean Now	
Exhaust Filter Drive Complete	Your diesel particulate filter is clean.

## Diesel Particulate Filter (If Equipped)

---

<b>Message</b>	<b>Action</b>
Exhaust Filter Cleaned	Your diesel particulate filter is clean (OCR Only).
Exhaust Filter Cleaning Stopped	The manual regeneration process has stopped (OCR Only).
Exhaust Filter Over Limit Service Now	You must have your vehicle serviced by an authorized dealer. Ignoring this warning message could lead to reduced drivability and customer expense, including damage to the diesel particulate filter. Your new vehicle warranty may not cover this damage.

# Selective Catalytic Reduction System - Diesel

## WHAT IS THE SELECTIVE CATALYTIC REDUCTION SYSTEM

The selective catalytic reduction system helps reduce emission levels of oxides of nitrogen from the exhaust system.

## HOW DOES THE SELECTIVE CATALYTIC REDUCTION SYSTEM WORK

The selective catalytic reduction system injects diesel exhaust fluid into the exhaust system to enable correct selective catalytic reduction system function.

## SELECTIVE CATALYTIC REDUCTION SYSTEM PRECAUTIONS



**WARNING:** Keep diesel exhaust fluid out of reach of children. Avoid contact with skin, eyes or clothing. In case of contact with your eyes, flush immediately with water and get prompt medical attention. In case of contact with your skin, clean immediately with soap and water. If you swallow any diesel exhaust fluid, drink plenty of water, call a physician immediately.



**WARNING:** Only refill the diesel exhaust fluid tank in a well ventilated area. When you remove the diesel exhaust fluid tank filler cap or a diesel exhaust fluid container cap, ammonia vapors may escape. Ammonia vapors can be irritating to skin, eyes and mucous membranes. Inhaling ammonia vapors can cause burning to the eyes, throat and nose and cause coughing and watery eyes.



**WARNING:** Diesel exhaust fluid must be refilled when low or replaced when contaminated or your vehicle speed becomes limited to 50 mph (80 km/h). In these conditions, drive with caution and refill diesel exhaust fluid immediately. If the diesel exhaust fluid becomes empty or contaminated and fluid is not replaced, your vehicle becomes limited to engine idle only once stopped. In these conditions, be cautious where you stop your vehicle because you may not be able to drive long distances or maintain highway speeds until you refill or replace the diesel exhaust fluid.



**WARNING:** Tampering with or disabling the selective catalytic reduction system results in severe vehicle performance limitation including eventual speed limiting to 5 mph (8 km/h).

**Note:** Do not put diesel exhaust fluid in the fuel tank. This can cause damage that your vehicle Warranty may not cover.

Selective catalytic reduction systems are sensitive to contamination of the diesel exhaust fluid. Maintaining the purity of the fluid is important to avoid system malfunctions. If you remove or drain the diesel exhaust fluid tank, do not use the same fluid to refill the tank. The system has a sensor to monitor fluid quality.



## Selective Catalytic Reduction System - Diesel

Driving without refilling, replacing contaminated diesel exhaust fluid, or having the selective catalytic reduction system repaired results in the following actions as required by the California Air Resources Board (CARB) and the U.S. Environmental Protection Agency (EPA):

- Within a preset distance to empty, speed is limited upon vehicle restart. Prior to this occurring a message appears in the information display.
- Further vehicle operation without refilling or replacing contaminated diesel exhaust fluid causes the engine to enter an idle-only condition. This only occurs upon vehicle refueling, vehicle idling in park for 1 hour, or engine shutdown for 10 minutes or more and is indicated by a message in the information display indicating required actions to resume normal operation. It is required to add a minimum of 1.0 gal (3.8 L) of diesel exhaust fluid to the tank to exit the idle-only condition, but your vehicle is still in the speed-limiting mode until you refill the tank completely.

**Note:** For vehicle speed limiting or idle-only condition, normal vehicle operation resumes when you refill the diesel exhaust fluid tank or repair the contaminated system. If the system is contaminated or inoperative, have your vehicle checked as soon as possible.

### SELECTIVE CATALYTIC REDUCTION SYSTEM REQUIREMENTS



Only use diesel exhaust fluid that is certified by the American Petroleum Institute (API).

You can purchase diesel exhaust fluid at an authorized dealer, or contact roadside assistance for help in finding a retailer that sells diesel exhaust fluid.

**Note:** *Non-certified diesel exhaust fluid use can cause damage that your Warranty may not cover*

### SELECTIVE CATALYTIC REDUCTION SYSTEM GUIDELINES

- Diesel exhaust fluid is non-flammable, non-toxic, colorless and water-soluble liquid.
- In order for the system to operate correctly you must maintain the diesel exhaust fluid level.
- Do not overfill the diesel exhaust fluid tank.
- Diesel exhaust fluid is corrosive.

# Selective Catalytic Reduction System - Diesel

- Avoid spilling diesel exhaust fluid on painted surfaces, carpeting or plastic components. Immediately wipe away any diesel exhaust fluid that has spilled with a damp cloth and water. If it has already crystallized, use warm water and a sponge.
- Do not store the diesel exhaust fluid bottle in your vehicle. If it leaks it could cause damage to interior components or release an ammonia odor inside your vehicle.
- Do not re-use the diesel exhaust fluid container once it is emptied.
- Store diesel exhaust fluid out of direct sunlight and in temperatures between 23–68°F (-5–20°C).
- The system has a diesel exhaust fluid quality sensor. Dilution of diesel exhaust fluid or use of any other liquid in the selective catalytic reduction system leads to a diesel exhaust fluid system fault, eventually leading to the vehicle only operating in idle-only mode.
- Do not dilute diesel exhaust fluid with water or any other liquid.

## FILLING THE SELECTIVE CATALYTIC REDUCTION SYSTEM TANK

### Filling the Selective Catalytic Reduction System Tank in Cold Weather

Diesel exhaust fluid may freeze if the ambient temperature is below 12°F (-11°C). Your vehicle has a preheating system which allows diesel exhaust fluid to operate below 12°F (-11°C). If you do not use your vehicle for an extended period when the ambient temperature is below 12°F (-11°C), the fluid in the tank may freeze. If the tank is overfilled and the fluid freezes it may cause damage that your Warranty will not cover.

### Filling the Selective Catalytic Reduction System Tank Using a Fuel Station Pump

Filling the diesel exhaust fluid tank using a fuel station pump is similar to refueling your vehicle.

1. Fully open the fuel filler door.

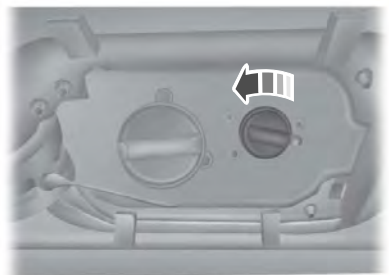

2. Remove the diesel exhaust fluid tank filler cap.

**Note:** *The diesel exhaust fluid tank has a blue filler cap.*

## Selective Catalytic Reduction System - Diesel

3. Fully insert the diesel exhaust fluid pump nozzle.

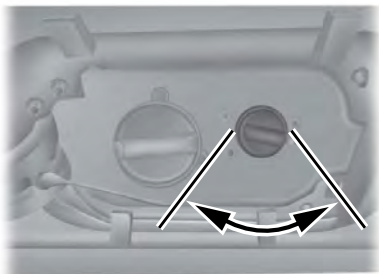

4. Operate the diesel exhaust fluid pump nozzle within the area shown.

**Note:** The pump nozzle shuts off when the tank is full.

5. Slightly raise the diesel exhaust fluid pump nozzle and then slowly remove it.
6. Replace the diesel exhaust fluid tank filler cap. Turn it clockwise until you feel a strong resistance and it clicks.

### Filling the Selective Catalytic Reduction System Tank Using a Portable Container

The following procedure applies to Motorcraft diesel exhaust fluid or similar fluid containers. Follow the manufacturer's instructions.

1. Fully open the fuel filler door.
2. Remove the diesel exhaust fluid container cap.
3. Place the spout on to the container and tighten it until you feel a strong resistance.

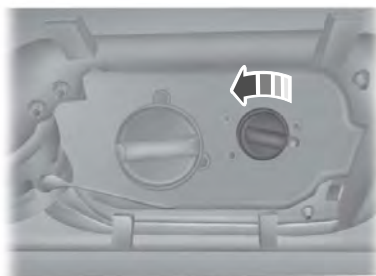

4. Remove the diesel exhaust fluid tank filler cap.

**Note:** The diesel exhaust fluid tank has a blue filler cap.

5. Insert the spout into the filler neck until the seal on the spout fully seats.
6. Pour the fluid into the tank.

**Note:** The fluid stops flowing when the tank is full.

7. Return the container to the vertical position slightly below the diesel exhaust fluid filler neck.
8. Allow any fluid remaining in the spout to drain back into the container.
9. Remove the spout from the diesel exhaust fluid filler neck.
10. Replace the diesel exhaust fluid tank cap. Turn it clockwise until you feel a strong resistance and it clicks.
11. Remove the spout from the diesel exhaust fluid container and replace the cap.

**Note:** If there is diesel exhaust fluid left in the container retain it for later use. The spout is reusable. Wash the spout with clean water prior to storage. Do not use the diesel exhaust fluid spout with any other fluid.

# Selective Catalytic Reduction System - Diesel

## CHECKING THE SELECTIVE CATALYTIC REDUCTION SYSTEM STATUS

The information display shows a series of messages about the amount of diesel exhaust fluid available. A systems check displays messages indicating the amount of diesel exhaust fluid available or displays a warning message indicating the approximate distance remaining as the fluid in the diesel exhaust fluid tank nears empty. See **Selective Catalytic Reduction System – Information Messages** (page 249).

## DIESEL EXHAUST FLUID CAPACITY AND SPECIFICATION

For filling information please refer to the Capacities and Specifications section of the owner's manual. See **Diesel Exhaust Fluid Capacity and Specification** (page 249).

## SELECTIVE CATALYTIC REDUCTION SYSTEM – TROUBLESHOOTING

### Selective Catalytic Reduction System – Warning Lamps



As the diesel exhaust fluid level nears empty, the warning symbol displays and a series of tones and messages starting at 500 mi (800 km) remaining before diesel exhaust fluid is depleted. The warning symbol and messages continue until you refill the diesel exhaust fluid tank.

The warning lamp illuminates and a message appears in the information display if the system becomes contaminated or inoperative.

## Selective Catalytic Reduction System – Information Messages

Message	Action
DEF Level Range: XX mi/ km Refill Now	The distance you can travel before depleting the remaining diesel exhaust fluid. Refill as soon as possible.
DEF Level Empty Speed Limited to XX MPH / km/h in XX mi/km	Your diesel exhaust fluid is nearing empty. Your vehicle's top speed will become limited in the displayed distance. You must replenish the diesel exhaust fluid to resume normal operation of your vehicle. See <b>Diesel Exhaust Fluid Capacity and Specification</b> (page 249).
DEF Level Empty Speed Limited to XX MPH/km/h Upon Restart	Your remaining diesel exhaust fluid has depleted. Your speed will be limited upon restart. You must replenish the diesel exhaust fluid to resume normal operation of your vehicle. See <b>Diesel Exhaust Fluid Capacity and Specification</b> (page 249).

## Selective Catalytic Reduction System - Diesel

Message	Action
DEF Level Low Speed Limited to XX MPH/km/h	The diesel exhaust fluid is empty. You must replenish the diesel exhaust fluid to resume normal operation of your vehicle. See <b>Diesel Exhaust Fluid Capacity and Specification</b> (page 249).
DEF Level Empty Engine Idled Soon	The selective catalytic reduction system detects low exhaust fluid. The engine will eventually enter into an idle only mode. You must replenish the diesel exhaust fluid to resume normal operation of your vehicle. See <b>Diesel Exhaust Fluid Capacity and Specification</b> (page 249).
DEF Level Empty Engine Idled See Manual	The vehicle will enter into an idle only mode. You must replenish the diesel exhaust fluid to resume normal operation of your vehicle. See <b>Diesel Exhaust Fluid Capacity and Specification</b> (page 249).
DEF Fault Speed Limited to XX MPH/km/h in XX mi/km	The selective catalytic reduction system detects a fault. The vehicle's top speed will become limited in the displayed distance and count down from this point. Have your vehicle checked as soon as possible.
DEF Fault Speed Limited to XX MPH/km/h Upon Restart	The selective catalytic reduction system detects a fault. The vehicle's top speed will become limited upon restarting. Have your vehicle checked as soon as possible.
DEF Fault Speed Limited to XX MPH/km/h	The selective catalytic reduction system detects a fault. The vehicle's top speed is limited. Have your vehicle checked as soon as possible.
DEF Fault Engine Idled Soon	The selective catalytic reduction system detects a fault. The engine will eventually enter into an idle only mode. Have your vehicle checked as soon as possible.

# Catalytic Converter

## WHAT IS THE CATALYTIC CONVERTER

The catalytic converter is part of your vehicle's emissions system and filters harmful pollutants from the exhaust gas.

## CATALYTIC CONVERTER PRECAUTIONS



**WARNING:** Do not park, idle or drive your vehicle on dry grass or other dry ground cover. The emission system heats up the engine compartment and exhaust system, creating the risk of fire.



**WARNING:** The normal operating temperature of the exhaust system is very high. Never work around or attempt to repair any part of the exhaust system until it has cooled. Use special care when working around the catalytic converter. The catalytic converter heats up to a very high temperature after only a short period of engine operation and stays hot after the engine is switched off.

To avoid damaging the catalytic converter:

- Do not crank the engine for more than 10 seconds at a time.
- Do not run the engine with a spark plug lead disconnected.
- Do not push-start or tow-start your vehicle. Use booster cables. See **Jump Starting the Vehicle** (page 439).
- Use the correct fuel. See **Fuel and Refueling** (page 227).
- Do not switch the ignition off when your vehicle is moving.
- Avoid running out of fuel.
- Have the items listed in scheduled maintenance information performed according to the specified schedule.

## CATALYTIC CONVERTER – TROUBLESHOOTING

### Catalytic Converter – Warning Lamps

Your vehicle has an on-board diagnostics system that monitors the emission control system. If any of the following warning lamps illuminate, this may indicate that the on-board diagnostics system has detected an emission control system malfunction.



Continuing to drive your vehicle may cause reduced power or the engine to stop. Failure to respond to a warning lamp may cause damage that your vehicle Warranty may not cover. Have your vehicle checked as soon as possible.

# High Voltage Battery - Hybrid Electric Vehicle (HEV)

---

## WHAT IS THE HIGH VOLTAGE BATTERY

The high voltage battery is a highly sophisticated lithium ion battery system, used to store electrified propulsion energy to power the vehicle.

## HIGH VOLTAGE BATTERY PRECAUTIONS



**WARNING:** This battery pack should only be serviced by an authorized electric vehicle technician. Improper handling can result in personal injury or death.



**WARNING:** Apply the parking brake, shift into park (P), switch the ignition off and remove the key before you open the hood or have any service or repair work completed. If you do not switch the ignition off, the engine could restart at any time. Failure to follow this instruction could result in personal injury or death.



**WARNING:** Do not touch the electronic ignition system parts after you have switched the ignition on or when the engine is running. The system operates at high voltage. Failure to adhere to this warning could result in serious personal injury or death.



**WARNING:** Keep your hands and clothing clear of the engine cooling fan.

# Automatic Transmission

## AUTOMATIC TRANSMISSION PRECAUTIONS



**WARNING:** Always fully apply the parking brake and make sure you shift into park (P). Failure to follow this instruction could result in personal injury or death.



**WARNING:** Do not use tow/haul when the road surface is slippery. Failure to follow this instruction could result in the loss of control of your vehicle.



**WARNING:** When your vehicle is stationary, keep the brake pedal fully pressed when shifting gears. Failure to follow this instruction could result in personal injury, death or property damage.



**WARNING:** Do not apply the brake pedal and accelerator pedal simultaneously. Applying both pedals simultaneously for more than a few seconds will limit engine performance, which may result in difficulty maintaining speed in traffic and could lead to serious injury.

## AUTOMATIC TRANSMISSION POSITIONS

### Park (P)

This position locks the driveline and prevents the wheels from turning. Come to a complete stop before putting your vehicle into and out of park (P).

The electric parking brake could apply when you shift to park (P) without the brake pedal fully pressed. The electric parking brake applies when you shift to park (P) on large slopes. The electric parking brake releases with the drive away release function or manually as described in the Releasing the Electric Parking Brake section. See **Electric Parking Brake** (page 276).

**Note:** *A warning tone sounds if you open the driver door and you have not shifted the transmission selector to park (P).*

### Reverse (R)



**WARNING:** Move the transmission selector lever to reverse (R) only when your vehicle is stationary and the engine is at idle speed.

This position allows your vehicle to move backward. Come to a complete stop before shifting into and out of reverse (R).

### Neutral (N)



**WARNING:** In neutral (N) your vehicle has the ability to roll freely. If you intend to leave your vehicle, make sure you apply the parking brake.

This position allows your vehicle to roll free. Hold the brake pedal down when in this position.

**Note:** *You can start your vehicle in this position.*

### Drive (D)

Drive (D) is the normal driving position, and allows automatic upshifts and downshifts through all available gears.



# Automatic Transmission

---

## Manual (M)

To select manual mode press the (M) button on the shifter.

**Note:** *In order to activate manual mode your vehicle must be in drive (D).*

This position allows you to change gears up or down as preferred using + or - buttons on the shifter lever.

To return to the normal drive (D) position, press the (M) button again to exit manual mode.

## SHIFTING YOUR VEHICLE INTO GEAR

### Center Console Shifter

1. Fully press down on the brake pedal.
2. Depress the front button on the shifter and move the gearshift lever into the desired gear.
3. When you are finished driving, come to a complete stop.
4. Depress the front button on the shifter and move the gearshift lever and securely latch it in park (P).

### Column Shifter

1. Fully press down on the brake pedal.
2. Move the gearshift lever into the desired gear.
3. When you are finished driving, come to a complete stop.
4. Pull lever toward the driver and move the gearshift lever and securely latch it in park (P).

## MANUALLY SHIFTING GEARS

### Shifting Using the Buttons on the Selector Lever

Pressing the manual (M) button on the shifter allows you to select the gear you prefer. Only the current gear displays. Press the + button to upshift or the - button to downshift. Return the transmission to a different gearshift position to deactivate manual control or press manual (M).

Your vehicle has a SelectShift Automatic transmission gearshift lever. This gives you the ability to change gears up or down, without a clutch, as preferred.

**Note:** *To prevent the engine from running at too low an RPM, which could cause it to stall, SelectShift still makes some downshifts if it determines that you have not downshifted in time. Although SelectShift makes some downshifts for you, it still allows you to downshift at any time if it determines that damage to the engine from over-revving does not occur.*

**Note:** *SelectShift does not automatically upshift, even if the engine is approaching the RPM limit. Shift manually by pressing the + button.*

**Note:** *Engine damage could occur if you maintain excessive engine revving without shifting.*

# Automatic Transmission

## Center Console Shifter

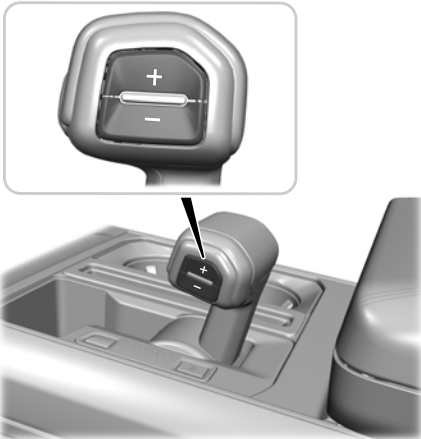

## Column Shifter



## TEMPORARY NEUTRAL MODE

### What Is Temporary Neutral Mode

This mode keeps your vehicle in neutral (N) when you switch your vehicle off. Use this mode if you exit your vehicle or switch your vehicle off at an automatic car wash.

**Note:** Do not tow your vehicle in this mode.

**Note:** Automatic return to park (P) is delayed when your vehicle is in this mode. See **What Is Automatic Return to Park (P)** (page 256).

### Temporary Neutral Mode Limitations

Your vehicle could shift to park (P) after 30 minutes, or when the vehicle battery charge level is low. Prolonged use of this mode can cause the vehicle battery to run out of charge.

Do not tow your vehicle in this mode. Failure to follow these instructions could result in vehicle damage not covered by the vehicle warranty.

### Entering Temporary Neutral Mode

1. Power your vehicle on.
2. Bring your vehicle to a complete stop.
3. Press and hold the brake pedal.
4. Shift into neutral (N).

**Note:** An instructional message appears.

5. Press the manual (M) button.

**Note:** A confirmation message appears when your vehicle enters the mode.

6. Release the brake pedal.

**Note:** Your vehicle is free to roll.

7. Switch your vehicle off.

**Note:** Do not tow your vehicle in this mode.

**Note:** The neutral (N) indicator on the transmission selector may flash in this mode.

### Exiting Temporary Neutral Mode

1. Press the brake pedal.
2. Shift into park (P), or power your vehicle on and shift into drive (D) or reverse (R).

# Automatic Transmission

---

## USING PROGRESSIVE RANGE SELECTION

Progressive range selection gives you the ability to lock out gears from the automatic shifting range. This could provide you with an improved driving experience by reducing transmission shifts, for example, in slippery conditions or steep slopes.

With the transmission in drive (D), press the - button to begin to switch the feature on.

Press the - button again to continue locking out higher gears. Beginning with the highest gear, the instrument cluster will indicate the current gear and highest gear available. For example, press the - button twice to lock out 10th and 9th gears.

**Note:** *The instrument cluster will indicate the current gear and highest gear available.*

Press the + button to unlock gears to allow the transmission to shift to higher gears.

**Note:** *The transmission automatically shifts within the gear range you select.*

## AUTOMATIC RETURN TO PARK (P)

### What Is Automatic Return to Park (P)

Your vehicle shifts into park (P) if you attempt to exit your vehicle without the transmission in park (P).

### How Does Automatic Return to Park (P) Work

Your vehicle shifts into park (P) when your vehicle is stationary and any of the following occur:

- You switch the vehicle off.
- You open the driver door with your seatbelt unlatched.
- You unlatch the driver seatbelt when the driver door is open.

**Note:** *Do not use automatic return to park (P) when your vehicle is moving, except in an emergency. See **Starting and Stopping the Engine** (page 209).*

### Automatic Return to Park (P) Limitations

Automatic return to park may not work if the door ajar switch is malfunctioning.

See an authorized dealer if any of the following occur:

- Door ajar indicator does not illuminate with the driver door open.
- Door ajar indicator illuminates with the driver door closed.
- Transmission not in park message appears with the driver door closed, after you shift out of park (P).

## STOWING THE SELECTOR LEVER - VEHICLES WITH: CONSOLE SHIFT

Press the stow button to fold down the selector lever. Press the button again to release the selector lever from the stow position to use.

The stow function allows the shifter to lay flat in the console, enabling the use of the working surface tray.

# Automatic Transmission

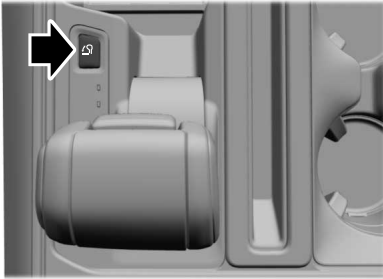

**Note:** Do not store objects in the selector lever stow bin, and be sure that the bottom selector lever tray mat is flat inside the selector lever stow bin.

**Note:** If there are objects in the stow bin while stowing the selector lever, the selector lever could come back to the upright park (P) position.

## MANUAL PARK RELEASE

### What Is Manual Park Release

Manual park release allows you to move your transmission out of the park (P) position in the event of an electrical malfunction or emergency.

## Manual Park Release Precautions

**⚠ WARNING:** When doing this procedure, you need to take the transmission out of park (P) which means your vehicle can roll freely. To avoid unwanted vehicle movement, always fully apply the parking brake prior to doing this procedure. Use wheels chocks if appropriate.

**⚠ WARNING:** If the parking brake is fully released, but the brake warning lamp remains illuminated, the brakes may not be working properly. Have your vehicle checked as soon as possible.

**⚠ WARNING:** Do not drive your vehicle until you verify that the stoplamps are working.

Use the manual park release to move your transmission from the park (P) position in the event of an electrical malfunction or emergency. See **Emergency Towing** (page 445).

**Note:** Do not engage the manual park release with the engine on.

## Using Manual Park Release

### Activating the Manual Park Release Cable

1. Apply the parking brake. See **Electric Parking Brake** (page 276).

**Note:** If vehicle battery is dead, for example, no electrical power available, an external power source may be required to apply the parking brake.

2. Locate the manual park release cable access cover at the bottom of the driver dash lower panel, under the steering wheel.

# Automatic Transmission

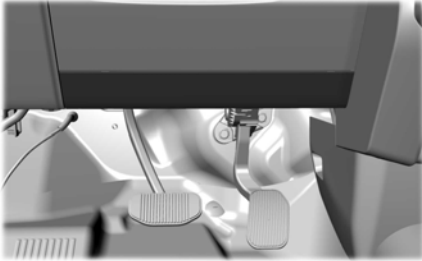

3. Carefully open the hinged access cover using a plastic type wedge or pry tool at the upper edge of the panel. If done correctly the panel will swing downward.

**Note:** Do not activate the override lever until you are in the driver's seat.

4. Switch ignition on, but do not start your vehicle.
5. Once in the driver seat, fully apply the brake pedal and hold. Do not release. Pull the tether straight out toward the driver seat until engaged. If done correctly, a message will appear in the instrument cluster.

**Note:** Do not use excessive force when using the manual park release handle, as it could result in damage to the handle.

**Note:** Your vehicle is now out of the park (P) position and is free to roll.

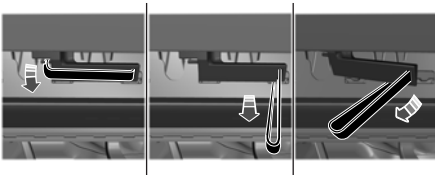

6. With your foot still fully applied on the brake pedal, disengage the parking brake. See **Electric Parking Brake** (page 276).

7. Your vehicle remains in neutral (N) for emergency towing purposes.
8. Switch off the ignition.
9. Once safe to do so, and there is no risk that your vehicle will roll, disconnect the negative (black) battery cable from the battery.

## Returning Your Vehicle to Normal Mode

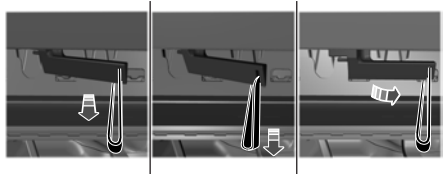

1. Once it is safe to do so, reconnect the negative (black) battery cable to the battery.
2. Apply the parking brake. See **Electric Parking Brake** (page 276).

**Note:** If vehicle battery is dead, for example, no electrical power available, an external power may be required to apply the parking brake.

**Note:** Do not pull the tether until you are in the driver seat.

3. Once in the driver seat, fully apply the brake pedal and hold, do not release. Using the tether, pull the handle towards the driver seat until you hit a hard stop.
4. Pull the lever toward the floor until it hits a hard stop, before returning to the stowed position.

**Note:** Maintain tension on the strap until the lever reaches the stowed position.

5. Return the manual park release cable lever to the stowed position and install the access cover.

## Automatic Transmission

---

6. With your foot fully applied on the brake pedal, start your vehicle. Confirm that your vehicle is in the park (P) position and that the instrument cluster indicates park (P).

**Note:** *If the instrument cluster is not displaying the park (P) position or the instrument cluster displays an error message, apply the parking brake before exiting your vehicle. Contact an authorized dealer for service.*

7. Close the access cover.

## Four-Wheel Drive (If Equipped)

### HOW DOES FOUR-WHEEL DRIVE WORK

#### Using the Electronic Shift On the Fly System (If Equipped)

This four wheel drive system utilizes a 2-speed Electronic Shift On the Fly (ESOF) transfer case which is also known as a part-time system. This system offers the driver two-wheel drive high, four-wheel drive high, and four-wheel drive low as available modes of operation. When either four-wheel drive high or four-wheel drive low are selected, the system provides mechanically locked four-wheel drive power to both the front and rear wheels for use in off-road or slippery conditions such as deep snow, sand or mud. When four-wheel drive low is selected, the system provides additional gearing for increased torque multiplication for conditions like deep sand, steep grades, or pulling heavy objects. Additionally, the system is capable of recreational flat towing by putting the transfer case into a neutral position. See **Recreationally Towing Your Vehicle** (page 443).

#### Using the 2-Speed Automatic Four-Wheel Drive System (If Equipped)

The 2-speed automatic four-wheel drive system utilizes an electronically controlled on-demand 2-speed transfer case. This system monitors various vehicle sensory inputs to provide an increased level of performance. This system offers the driver two-wheel drive high, four-wheel drive auto, four-wheel drive high, and four-wheel drive low as available modes of operation. When four-wheel drive auto is selected, the system continuously varies power to the front wheels for optimum performance for all on-road conditions. When either four-wheel drive high or four-wheel drive low are selected, the system provides electronically locked power to the front

and rear wheels for use in off-road or slippery conditions such as deep snow, sand or mud. When four-wheel drive low is selected, the system provides additional gearing for increased torque multiplication for conditions like deep sand, steep grades, or pulling heavy objects. Additionally, the system is capable of recreational flat towing by putting the transfer case into a neutral position. See **Recreationally Towing Your Vehicle** (page 443).

### FOUR-WHEEL DRIVE PRECAUTIONS



**WARNING:** Vehicles with a higher center of gravity (utility and four-wheel drive vehicles) handle differently than vehicles with a lower center of gravity (passenger cars). Avoid sharp turns, excessive speed and abrupt steering in these vehicles. Failure to drive cautiously increases the risk of losing control of your vehicle, vehicle rollover, personal injury and death.



**WARNING:** If the parking brake is fully released, but the brake warning lamp remains illuminated, the brakes may not be working properly. Have your vehicle checked as soon as possible.



**WARNING:** Do not become overconfident in the ability of four-wheel drive vehicles. Although a four-wheel drive vehicle may accelerate better than a two-wheel drive vehicle in low traction situations, it won't stop any faster than two-wheel drive vehicles. Always drive at a safe speed.

## Four-Wheel Drive (If Equipped)

Truck and utility vehicles can differ from some other vehicles. Your vehicle could be higher to allow it to travel over rough terrain without getting stuck or damaging underbody components. The differences that make your vehicle so versatile also make it handle differently than an ordinary passenger car. Always maintain steering wheel control, especially in rough terrain. Since sudden changes in terrain can result in abrupt steering wheel motion, make sure you grip the steering wheel from the outside. Do not grip the spokes. Drive cautiously to avoid vehicle damage from concealed objects such as rocks and stumps. Drive slower in strong crosswinds which can affect the normal steering characteristics of your vehicle. Be extremely careful when driving on pavement made slippery by loose sand, water, gravel, snow or ice.

**Note:** *Do not use four-wheel drive high or four-wheel drive low mode on dry, hard surfaced roads. Doing so can produce excessive noise, increase tire wear and can damage drive components. Four-wheel drive high or four-wheel drive low mode is only intended for consistently slippery or loose surfaces. Use of four-wheel drive low mode on these surfaces could produce some noise, such as occasional clunks, but should not damage drive components. When transitioning from consistently loose or slippery surfaces, be sure the four-wheel drive system is not mechanically blocked once on dry, hard surfaced roads in two-wheel drive high.*

### FOUR-WHEEL DRIVE LIMITATIONS

Do not use four-wheel drive high or four-wheel drive low mode on dry, hard surfaced roads. Doing so can produce excessive noise, increase tire wear and can damage drive components. four-wheel drive high or four-wheel drive low mode is only intended for consistently slippery or loose surfaces. Use of four low mode on these surfaces could produce some noise ,such as occasional clunks, but should not damage drive components. When transitioning from consistently loose or slippery surfaces, be sure the four-wheel drive system is not mechanically blocked once on dry, hard surfaced roads in two-wheel drive high.

### Operating Four-Wheel Drive with a Spare or Mismatched tires

On four-wheel drive vehicles, the size of the spare tire can affect the four-wheel drive system. If there is a significant difference between the size of the spare tire and the remaining tires, you could have limited four-wheel drive functionality. When driving with the full-size dissimilar spare wheel and tire assembly, it is recommended that you do not:

- Exceed 50 mph (80 km/h) with a four-wheel drive mode turned on.
- Turn on a four-wheel drive mode unless the vehicle is stationary.
- Use a four-wheel drive mode on dry pavement.

When driving with the full-size dissimilar spare wheel and tire assembly, four-wheel drive functionality can be limited, especially when driving in a mechanically locked four-wheel drive mode. You can experience the following:



## Four-Wheel Drive (If Equipped)

- Additional noise from the transfer case or other drive components.
- Difficulty shifting out of a mechanically locked four-wheel drive mode.

Use of a dissimilar spare wheel and tire assembly can lead to impairment of the following:

- Comfort and noise.
- Winter weather driving capability.
- Wet driving capability.
- Four-wheel drive capability.

### Mechanical Shift Blocking

On four-wheel drive vehicles without a four-wheel drive auto selection (ESOF), the transfer case distributes torque to the front wheels by mechanically interlocking the front and rear driveshafts together. Shifting performance of this type of system can be affected by various external factors including, but not limited to:

- Vehicle acceleration.
- Dissimilar tire sizes.
- Steering input.

If the system detects a mechanical shift block at speed after two-wheel drive high has been selected, a message can appear momentarily that four-wheel drive is unable to disengage one or more of following actions can relieve the mechanical shift block:

- Momentary acceleration.
- Momentary braking.
- Bringing the vehicle to a stop.
- Shifting the transmission to neutral and back to drive.
- Shifting the transmission to reverse and back to drive.
- Driving the vehicle around a tight turn at slow speed.

### SELECTING A FOUR-WHEEL DRIVE MODE

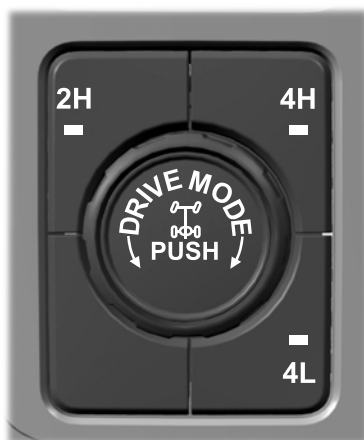

The four-wheel drive mode control is on the instrument panel.

## Four-Wheel Drive (If Equipped)

To select a four-wheel drive mode, press the four-wheel drive mode control button of the desired mode. You can select two-wheel drive high (2H), four-wheel drive high (4H), or if your vehicle has four-wheel drive auto (4A) at a stop or while driving. Once the shift is complete, the information display will then display the selected four-wheel drive mode. While shifts are in progress, the lights on the four-wheel drive control switch can flash and you could see messages in the information display indicating that a shift is in progress or to release the accelerator pedal to improve shift performance.

**Note:** Do not perform this operation if the rear wheels are slipping or while applying the accelerator pedal.

**Note:** You could hear some noise as the system shifts or engages which is normal.

If the system detects a fault, a warning message appears in the information display. See **Four-Wheel Drive – Information Messages** (page 267).

### Shifting to or from Four-Wheel Drive Low (4L)

To select or exit four-wheel drive low (4L):

1. Bring your vehicle to a speed of 3 mph (5 km/h) or less.
2. Place the transmission in neutral (N)
3. Press the desired four-wheel drive button on the four-wheel drive mode control switch.

The information display will display a message indicating a four-wheel drive shift is in progress. If any of the above shift conditions are not present, the shift will not occur and the information display will display information guiding the driver through the proper shifting procedures. If there is a transfer case tooth blockage a message will display in the information

display. To alleviate this condition, place the transmission in a forward gear, move your vehicle forward approximately 5 ft (1.5 m), and shift the transmission back to neutral (N) to allow the transfer case to complete the range shift.

**Note:** You could hear some noise as the system shifts or engages which is normal.

If the system detects a fault, a warning message appears in the information display. See **Four-Wheel Drive – Information Messages** (page 267).

## FOUR-WHEEL DRIVE MODES

### Two-Wheel Drive High

Two-wheel drive high is for general on-road driving. Power is sent to the rear wheels only.

Two-wheel drive high can turn on or off based on Drive Mode selection See **Drive Mode Control** (page 328).

### Four-Wheel Drive Auto (If Equipped)

Four-Wheel Drive Auto provides electronic controlled four-wheel drive with power delivered to the front and rear wheels, as required, for increased traction on varying road conditions. The four-wheel drive auto function varies based on selected Drive Mode. See **Selecting a Drive Mode** (page 328).

**Note:** Four-wheel drive auto can turn on or off automatically based on Drive Mode selection. See **Selecting a Drive Mode** (page 328).

# Four-Wheel Drive (If Equipped)

## Four-Wheel Drive High

Four-Wheel Drive High provides electronically or mechanically locked four-wheel drive power to both the front and rear wheels for use in off-road or winter conditions such as deep snow, sand or mud. This mode is not for use on dry pavement.

**Note:** *Four-wheel drive high can turn on or off automatically based on Drive Mode selection. See **Selecting a Drive Mode** (page 328).*

## Four-Wheel Drive Low

Four-Wheel Drive Low provides electronically or mechanically locked four-wheel drive power to both the front and rear wheels for use on low traction surfaces, but does so with additional gearing for increased torque multiplication. This mode is intended only for off-road applications such as deep sand, steep grades, or pulling heavy objects.

**Note:** *Four-wheel drive low can turn on or off automatically based on Drive Mode selection. See **Selecting a Drive Mode** (page 328).*

## FOUR-WHEEL DRIVE INDICATORS

### Two-wheel Drive High



Momentarily illuminates when two-wheel drive high is selected.

### Four-wheel Drive Auto (If Equipped)



Continuously illuminates when four-wheel drive auto is selected.

## Four-wheel Drive High



Continuously illuminates when four-wheel drive high is selected.

## Four-wheel Drive Low



Continuously illuminates when four-wheel drive low is selected.

## FOUR-WHEEL DRIVE DRIVING HINTS

### Emergency Maneuvers

In an unavoidable emergency situation where a sudden sharp turn must be made, remember to avoid over-driving your vehicle (i.e. turn the steering wheel only as rapidly and as far as required to avoid the emergency). Excessive steering can result in loss of vehicle control. Apply smooth pressure to the accelerator pedal or brake pedal when changes in vehicle speed are required. Avoid abrupt steering, acceleration and braking. This could result in an increased risk of vehicle roll over, loss of vehicle control and personal injury. Use all available road surface to bring your vehicle to a safe direction of travel.

In the event of an emergency stop, avoid skidding the tires and do not attempt any sharp steering wheel movements.

If your vehicle goes from one type of surface to another (i.e. from concrete to gravel) there can be a change in the way your vehicle responds to a maneuver, i.e. steering, acceleration or braking.

## Four-Wheel Drive (If Equipped)

### Driving In Sand

When driving over sand, try to keep all four wheels on the most solid area of the trail. Avoid reducing the tire pressures but shift to a lower gear and drive steadily through the terrain. Apply the accelerator slowly and avoid excessive wheel slip.

When driving at slow speeds in deep sand under high outside temperatures, use a low gear when possible. Low gear operation can maximize the engine and transmission cooling capability.

Avoid driving at excessive speed. This causes vehicle momentum to work against you and your vehicle could become stuck to the point that assistance may be required from another vehicle. Remember, you may be able to back out the way you came if you proceed with caution.

### Driving Through Mud and Water



**WARNING:** Do not spin the wheels at over 34 mph (55 km/h). The tires may fail and injure a passenger or bystander.

### Mud

Be cautious of sudden changes in vehicle speed or direction when you are driving in mud. Even four-wheel drive vehicles can lose traction in slick mud. If your vehicle does slide, steer in the direction of the slide until you regain control of your vehicle. After driving through mud, clean off residue stuck to rotating driveshafts and tires. Excess mud stuck on tires and rotating driveshafts can cause an imbalance that could damage drive components.

### Water

If you must drive through high water, drive slowly. Traction or brake capability may be limited. When driving through water, determine the depth and avoid water higher than the bottom of the hubs. If the ignition system gets wet, your vehicle may stall. Once through water, test the brakes. Wet brakes do not stop your vehicle as effectively as dry brakes. Drying improves by applying light pressure to the brake pedal while moving slowly.

**Note:** *Driving through deep water may damage the transmission. If the front or rear axle is submerged in water, the axle lubricant and power transfer unit lubricant should be checked and changed if necessary.*

### Driving on Hilly or Sloping Terrain

Although natural obstacles may make it necessary to travel diagonally up or down a hill or steep incline, you should try to drive straight up or straight down.

**Note:** *Avoid turning on steep slopes or hills. A danger lies in losing traction, slipping sideways and possible vehicle roll over. Whenever driving on a hill, determine beforehand the route you can use. Do not drive over the crest of a hill without seeing what conditions are on the other side. Do not drive in reverse over a hill without the aid of an observer.*

When climbing a steep slope or hill, start in a lower gear rather than downshifting to a lower gear from a higher gear once the ascent has started. This reduces strain on the engine and the possibility of stalling.

If your vehicle stalls, do not try to turnaround because this could cause vehicle roll over. It is better to reverse back to a safe location.

## Four-Wheel Drive (If Equipped)

Apply just enough power to the wheels to climb the hill. Too much power can cause the tires to slip, spin or lose traction, resulting in loss of vehicle control.

Descend a hill in the same gear you would use to climb up the hill to avoid excessive brake application and brake overheating. Do not descend in neutral. Disengage overdrive or move the transmission selector lever to a lower gear. When descending a steep hill, avoid sudden hard braking as you could lose control. The front wheels have to be turning in order to steer your vehicle.

**Note:** *If your vehicle has anti-lock brakes, apply the brakes steadily. Do not pump the brakes.*

### Driving on Snow and Ice



**WARNING:** If you are driving in slippery conditions that require tire chains or cables, then it is critical that you drive cautiously. Keep speeds down, allow for longer stopping distances and avoid aggressive steering to reduce the chances of a loss of vehicle control which can lead to serious injury or death. If the rear end of your vehicle slides while cornering, steer in the direction of the slide until you regain control of your vehicle.

Four-wheel drive vehicles have advantages over two-wheel drive vehicles in snow and ice but can skid like any other vehicle. Should you start to slide while driving on snowy or icy roads, turn the steering wheel in the direction of the slide until you regain control.

Avoid sudden applications of power and quick changes of direction on snow and ice. Apply the accelerator slowly and steadily when starting from a full stop. Avoid sudden braking. Although a four-wheel drive vehicle may accelerate better than a two-wheel drive vehicle in snow and ice, it cannot stop any faster as braking occurs at all four wheels. Do not become overconfident as to road conditions.

Make sure you allow sufficient distance between you and other vehicles for stopping. Drive slower than usual and consider using one of the lower gears. In emergency stopping situations, apply the brake steadily. Do not pump the brake pedal. See **Anti-Lock Braking System Limitations** (page 273).

**Note:** *Excessive tire slippage can cause transmission damage.*

## FOUR-WHEEL DRIVE – TROUBLESHOOTING

### Four-Wheel Drive – Warning Lamps



Illuminates when a four-wheel drive or power train fault is present.

**Note:** *When a system fault is present, the system can typically remain in whichever mode was selected prior to the fault condition occurring. It does not default to two-wheel drive in all circumstances. When this warning is displayed, have your vehicle serviced by an authorized dealer.*

## Four-Wheel Drive (If Equipped)

### Four-Wheel Drive – Information Messages

Message	Action
Check 4x4	A four-wheel drive system fault is present. Have your vehicle checked as soon as possible.
4x4 Shift in Progress	The four-wheel drive system is making a shift.
For 4x4 LOW Shift to N	Displays when you attempt to switch to four-wheel drive low mode and you do not shift the transmission to neutral (N).
For 4x4 LOW Slow to 3 MPH	Displays when you attempt to switch to four-wheel drive low mode and your vehicle's speed is greater than 3 mph (5 km/h).
To Exit 4x4 LOW Shift to N	Displays when you attempt to switch from four-wheel drive low mode and you do not shift the transmission to neutral (N).
To Exit 4x4 LOW Slow to 3 MPH	Displays when you attempt to switch from four-wheel drive low mode and your vehicle's speed is greater than 3 mph (5 km/h).
Shift Delayed Drive Forward	Displays when there is a transfer case gear tooth blockage while shifting to or from four-wheel drive low mode or to the neutral state. Place the transmission in a forward gear, move your vehicle forward approximately 5 ft (1.5 m), and shift the transmission back to neutral (N) to allow the transfer case to complete the range shift.
4x4 Temporarily Disabled	Displays when the system turns off the clutch due to excessive stress. The system automatically turns on the clutch after it cools.
4x4 Unable to Disengage. See Manual	Displays when the four-wheel drive system detects a mechanical shift block when shifting out of four-wheel drive high. See <b>Four-Wheel Drive Limitations</b> (page 261).

## Four-Wheel Drive (If Equipped)

Message	Action
4x4 Restored	Displays when the four-wheel drive system restores to the four-wheel drive auto setting.
4X4 Temporarily Locked	Displays when the four-wheel drive system temporarily turns on four-wheel drive high mode from four-wheel drive auto mode after detecting driving conditions that require greater four-wheel drive performance. The system automatically returns to four-wheel drive auto mode after the system no longer detects these driving conditions.
Shift to Neutral	Displays when the system requires an additional transmission shift to neutral (N) to complete a transfer case shift.
To Engage 4x4 Slow to 3 MPH	Displays when you command a four-wheel drive shift during conditions which are potentially harmful to the driveline components
To Engage 4x4 Slow to 5 km/h	
To Engage 4x4 Release Accelerator Pedal	Displays when the four-wheel drive system requests that you release the accelerator pedal to complete a four-wheel drive shift. See <b>Selecting a Four-Wheel Drive Mode</b> (page 262).

## Electronic Locking Differential (If Equipped)

### WHAT IS THE ELECTRONIC LOCKING DIFFERENTIAL

The electronic locking differential is a device housed in the rear axle, and when activated, allows both wheels on a specific axle to turn at the same speed. The electronic locking differential can provide additional traction should your vehicle become stuck. You can activate the differential electronically and shift it on the fly within the operating speed range. The electronic differential will disengage when the vehicle speed exceeds a set value and it will reengage when the vehicle speed goes below a set value. See **Switching the Electronic Locking Differential On and Off** (page 269). It will also engage based on certain selected drive modes. See **Selecting a Drive Mode** (page 328). The electronic locking differential is for use in mud, rocks, sand, or any off-road condition where you need maximum traction.

**Note:** *The electronic locking differential is for off-road use only and is not for use on dry pavement. Using the electronic locking differential on dry pavement will result in increased tire wear, noise and vibration.*

### ELECTRONIC LOCKING DIFFERENTIAL PRECAUTIONS

#### Operating the Electronic Locking Differential with a Spare or Mismatched Tires

On vehicles with an electronic locking differential, the size of the spare tire can affect performance of the system. If there is a significant difference between the two rear tires, you may have limited electronic locking differential functionality. If the system has difficulty disengaging, release

the accelerator pedal and turn the steering wheel in the opposite direction when rolling. We recommend engaging and disengaging the electronic locking differential at a stop when you mount a spare on the rear axle.

### SWITCHING THE ELECTRONIC LOCKING DIFFERENTIAL ON AND OFF - 4X4

The button to activate and deactivate the electronic locking differential is in the center of the drive mode rotary switch.

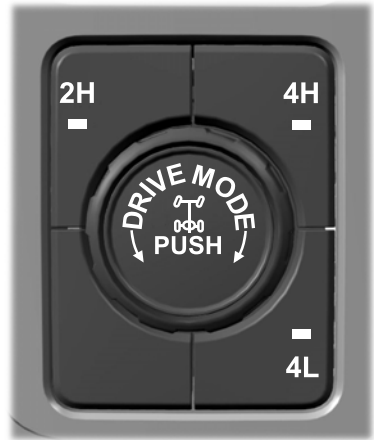



## Electronic Locking Differential (If Equipped)



To manually activate or deactivate the electronic locking differential, press the electronic locking differential button.

**Note:** The electronic locking differential can activate or deactivate automatically based on speed, four-wheel drive mode, and drive mode selection. See **Selecting a Drive Mode** (page 328).

### 4X4 Rear Electronic Locking Differential Engagement Speed and Availability

Drive Modes	Maximum Engagement Speed	Automatic Disengagement Speed	Automatic Re-Engagement Speed
Normal (2H, 4A <sup>2</sup> , 4H)	20 mph (30 km/h)	25 mph (41 km/h)	20 mph (30 km/h)
Eco (2H, 4A <sup>2</sup> , 4H)	20 mph (30 km/h)	25 mph (41 km/h)	20 mph (30 km/h)
Sport (2H, 4A <sup>2</sup> , 4H)	20 mph (30 km/h)	25 mph (41 km/h)	20 mph (30 km/h)
Slippery (2H, 4A <sup>2</sup> , 4H)	20 mph (30 km/h)	25 mph (41 km/h)	20 mph (30 km/h)
Deep Snow/Sand (4H, 4L) <sup>1</sup>	No Speed Limit	No Speed Limit	No Speed Limit
Mud/Ruts (4H, 4L) <sup>1</sup>			
Rock Crawl (4L) <sup>1</sup>			

<sup>1</sup>Automatically engages when these drive modes are selected. You have the ability to manually override the automatic engagement by pressing the electronic locking differential button.

<sup>2</sup>If available for 4A drive modes.

## Electronic Locking Differential (If Equipped)

4WD Mode	Maximum Engagement Speed	Automatic Disengagement Speed	Automatic Re-Engagement Speed
Four-Wheel Drive Low (4L)	No speed Limit	No speed Limit	No speed Limit

**Note:** The electronic locking differential may not engage if you press your accelerator pedal during an engagement attempt. A message could display in the instrument display guiding you to release the accelerator pedal.

**Note:** If the electronic locking differential has difficulty disengaging, release the accelerator pedal and turn the steering wheel in the opposite direction while rolling.

**Note:** The electronic locking differential is for off-road use only and is not for use on dry pavement. Using the electronic locking differential on dry pavement results in increased tire wear, noise and vibration.

### SWITCHING THE ELECTRONIC LOCKING DIFFERENTIAL ON AND OFF - 4X2

The button to activate and deactivate the electronic locking differential is located in the center of the Drive mode rotary switch.



To manually activate or deactivate the electronic locking differential, press the electronic locking differential button.

### 4X2 Rear Electronic Locking Differential Engagement Speed and Availability

Maximum Engagement Speed	Automatic Disengagement Speed	Automatic Re-Engagement Speed
20 mph (30 km/h)	25 mph (41 km/h)	20 mph (30 km/h)

**Note:** The electronic locking differential may not engage if you press your accelerator pedal during an engagement attempt. A message could display in the instrument display guiding you to release the accelerator pedal.

**Note:** If the electronic locking differential has difficulty disengaging, release the accelerator pedal and turn the steering wheel in the opposite direction while rolling.

# Electronic Locking Differential (If Equipped)

**Note:** The electronic locking differential is for off-road use only and is not for use on dry pavement. Using the electronic locking differential on dry pavement results in increased tire wear, noise and vibration.

## ELECTRONIC LOCKING DIFFERENTIAL INDICATORS



**Amber Color:** This indicator illuminates in amber when the electronic locking differential is on, indicating that both rear wheel axle shafts are locked together providing added traction.

**Gray Color:** This indicator illuminates in gray when the electronic locking differential has been requested to activate but the vehicle speed is too high, or the left and right wheel speed difference is too high during an engagement attempt.

If the electronic locking differential has been selected, but has malfunctioned, a message appears in the information display. See your authorized dealer for assistance.

**Note:** If the vehicle is experiencing an anti-lock braking event, the electronic locking differential may momentarily disengage.

## ELECTRONIC LOCKING DIFFERENTIAL – TROUBLESHOOTING

### Electronic Locking Differential – Information Messages

Message	Description and Action
To Engage Locking Differential Slow to XX mph/km/h	The electronic locking differential has been requested and will engage when the speed condition is met.
To Engage Locking Differential Release Accelerator Pedal	Release the accelerator pedal in order to engage.
Check Locking Differential	An electronic locking differential system fault is present. Contact an authorized dealer as soon as possible.

# Brakes

## BRAKE PRECAUTIONS



**WARNING:** Driving your vehicle with the warning lamp on is dangerous. A significant decrease in braking performance may occur. It may take you longer to stop your vehicle. Have your vehicle checked as soon as possible. Driving extended distances with the parking brake engaged can cause brake failure and the risk of personal injury.

Wet brakes result in reduced braking efficiency. Gently press the brake pedal a few times when driving from a car wash or standing water to dry the brakes.

## ANTI-LOCK BRAKING SYSTEM

### Anti-Lock Braking System Limitations

The anti-lock braking system does not eliminate the risk of crash when:

- You drive too closely to the vehicle in front of you.
- Your vehicle is hydroplaning.
- You take corners too fast.
- The road surface is poor.

**Note:** *If the system activates, the brake pedal could pulse and could travel further. Maintain pressure on the brake pedal.*

## BRAKE OVER ACCELERATOR

Brake over accelerator allows you to slow your vehicle if the accelerator pedal becomes stuck or entrapped. If you experience this condition, apply the brakes and bring your vehicle to a safe stop. Shift the transmission into park (P), switch the power off and apply the parking brake. Inspect the accelerator pedal for any interference. If nothing is found, have your vehicle towed to the nearest authorized dealer.

## LOCATING THE BRAKE FLUID RESERVOIR

See **Under Hood Overview** (page 456).

## CHECKING THE BRAKE FLUID



**WARNING:** Do not use any fluid other than the recommended brake fluid as this will reduce brake efficiency. Use of incorrect fluid could result in the loss of vehicle control, serious personal injury or death.



**WARNING:** Only use brake fluid from a sealed container. Contamination with dirt, water, petroleum products or other materials may result in brake system damage or failure. Failure to adhere to this warning could result in the loss of vehicle control, serious personal injury or death.



**WARNING:** Do not allow the fluid to touch your skin or eyes. If this happens, rinse the affected areas immediately with plenty of water and contact your physician.

# Brakes



**WARNING:** The brake system could be affected if the brake fluid level is below the **MIN** mark or above the **MAX** mark on the brake fluid reservoir.



1. Park your vehicle on a level surface.
2. Look at the brake fluid reservoir to see where the brake fluid level is relative to the **MIN** and the **MAX** marks on the reservoir.

**Note:** To avoid fluid contamination, the reservoir cap must remain in place and fully tight, unless you are adding fluid.

Only use fluid that meets our specifications. See **Capacities and Specifications** (page 560).

## BRAKE FLUID SPECIFICATION

See **Brake Fluid Specification** (page 560).

## BRAKES – TROUBLESHOOTING

### Brakes – Warning Lamps



If the ABS indicator illuminates when you are driving, this indicates a malfunction. Your vehicle continues to have normal braking without the anti-lock braking system function. See an authorized dealer.

It also momentarily illuminates when you switch the ignition on to confirm the lamp is functional. If it does not illuminate when you switch the ignition on, or begins to flash at any time, have the system checked by an authorized dealer.



The brake indicator momentarily illuminates when you switch the ignition on to confirm the lamp is functional. It may also illuminate when you apply the parking brake and the ignition is on. If it illuminates when your vehicle is moving, make sure the parking brake is disengaged. If the parking brake is disengaged, this indicates low brake fluid level or a brake system fault. See an authorized dealer.

### Brakes – Frequently Asked Questions

#### Is it normal for my brakes to make noise?

Occasional brake noise is normal. If a metal-to-metal, continuous grinding, or continuous squeal sound is present, the brake lining could be worn-out. Have the system checked by an authorized dealer.

# Brakes

---

## **There is an electrical motor sound when I hit the brakes. Is this normal?**

Yes, that sound is the electric brake booster operating. This sound is normal when operating your vehicle's brakes.

**Note:** *Brake dust could accumulate on the wheels, even under normal driving conditions. Some dust is inevitable as the brakes wear and does not contribute to brake noise. See **Cleaning Wheels** (page 487).*

# Electric Parking Brake

## WHAT IS THE ELECTRIC PARKING BRAKE

The electric parking brake is used to hold your vehicle on slopes and flat roads.

## APPLYING THE ELECTRIC PARKING BRAKE



**WARNING:** Always fully apply the parking brake and make sure you shift into park (P). Failure to follow this instruction could result in personal injury or death.



**WARNING:** If you drive extended distances with the parking brake applied, you could cause damage to the brake system.



The switch is on the lower part of the instrument panel.

1. Pull the switch up.

The red warning lamp flashes during operation and illuminates when the parking brake is applied.

**Note:** You can apply the electric parking brake when the ignition is off.

**Note:** The electric parking brake could apply when you shift into park (P). See **Park (P)** (page 253).

## APPLYING THE ELECTRIC PARKING BRAKE IN AN EMERGENCY

You can use the electric parking brake to slow or stop your vehicle in an emergency.

1. Pull the switch up and hold it.

The electric parking brake continues to slow your vehicle down unless you release the switch.

The red warning lamp illuminates, a tone sounds and the stoplamps turn on when you use the electric parking brake in an emergency.

**Note:** Do not apply the electric parking brake when your vehicle is moving, except in an emergency.

## MANUALLY RELEASING THE ELECTRIC PARKING BRAKE

1. Switch the ignition on.
2. Press and hold the brake pedal.
3. Push the switch down.

The red warning lamp turns off.

## Pulling Away on a Hill When Towing a Trailer

1. Press and hold the brake pedal.
2. Pull the switch upward and hold it.
3. Shift into gear.
4. Press the accelerator pedal until engine has developed sufficient torque to prevent your vehicle from rolling down the hill.
5. Release the switch and pull away in a normal manner.

## AUTOMATICALLY RELEASING THE ELECTRIC PARKING BRAKE

1. Close the driver door.
2. Shift into gear.
3. Press the accelerator pedal and pull away in a normal manner.

# Electric Parking Brake

## ELECTRIC PARKING BRAKE AUDIBLE WARNING

Sounds when the parking brake is on and your vehicle is moving. If the warning tone continues after you have released the parking brake, this indicates a malfunction. Have your vehicle checked as soon as possible.

## RELEASING THE ELECTRIC PARKING BRAKE IF THE VEHICLE BATTERY HAS RUN OUT OF CHARGE



**WARNING:** The electric parking brake does not operate if the vehicle battery has run out of charge.

Connect a booster battery to the vehicle battery to release the electric parking brake if the vehicle battery has run out of charge. See **Jump Starting the Vehicle** (page 439).

## ELECTRIC PARKING BRAKE – TROUBLESHOOTING

### Electric Parking Brake – Warning Lamps

#### Brake System



It illuminates red when you apply the parking brake and your vehicle is on. If the lamp flashes when the parking brake has been released, this indicates the parking brake system requires service. Have your vehicle checked as soon as possible.



**Note:** *Lamps may vary depending on region.*

#### Electric Parking Brake



When the lamp illuminates yellow, it indicates a malfunction in the electric parking brake. Have your vehicle checked as soon as possible.



# Electric Parking Brake

## Electric Parking Brake – Information Messages

<b>Message</b>	<b>Action</b>
To Release: Press Brake and Switch	The electric parking brake is set and a manual release is attempted without the brake pedal being pressed.
Park Brake Use Switch to Release	The electric parking brake is set and an automatic release is attempted but cannot be performed. Perform a manual release.
Release Park Brake	The electric parking brake is set and your vehicle speed exceeds 3 mph (5 km/h). Release the parking brake before continuing driving.
Park Brake Not Applied	The electric parking brake is not fully applied.
Park Brake Not Released	The electric parking brake is not fully released.
Park Brake Maintenance Mode	The electric parking brake system has been put into a special mode that is used to allow service of the rear brakes. Contact an authorized dealer.
Park Brake Limited Function Service Required	The electric parking brake system has detected a condition that requires service. Some functionality may still be available. Contact an authorized dealer.
Park Brake Malfunction Service Now	The electric parking brake system has detected a condition that requires service. Contact an authorized dealer.

# Reverse Braking Assist (If Equipped)

## WHAT IS REVERSE BRAKING ASSIST

Reverse Braking Assist reduces impact damage or avoids a collision completely by using the sensors on the rear of your vehicle.

## HOW DOES REVERSE BRAKING ASSIST WORK

Reverse Braking Assist functions when in reverse (R) and traveling at a speed of 1–7 mph (2–12 km/h).

If the system detects an obstacle behind your vehicle, it provides a warning through the rear parking aid or cross traffic alert system.

## REVERSE BRAKING ASSIST PRECAUTIONS



**WARNING:** You are responsible for controlling your vehicle at all times. The system is designed to be an aid and does not relieve you of your responsibility to drive with due care and attention. Failure to follow this instruction could result in the loss of control of your vehicle, personal injury or death.



**WARNING:** To help avoid personal injury, always use caution when in reverse (R) and when using the sensing system.



**WARNING:** The system may not operate properly during severe weather conditions, for example snow, ice, heavy rain and spray. Always drive with due care and attention. Failure to take care may result in a crash.



**WARNING:** Traffic control systems, inclement weather, air brakes, external motors and fans may affect the correct operation of the sensing system. This may cause reduced performance or false alerts.



**WARNING:** Some situations and objects prevent hazard detection. For example low or direct sunlight, inclement weather, unconventional vehicle types, and pedestrians. Apply the brakes when necessary. Failure to follow this instruction could result in the loss of control of your vehicle, personal injury or death.



**WARNING:** Do not use the system with accessories that extend beyond the front or rear of your vehicle, for example a trailer hitch or bike rack. The system is not able to make corrections for the additional length of the accessories.

The system only applies the brakes for a short period of time when an event occurs. Act as soon as you notice the brakes apply in order to remain in control of the vehicle.

**Note:** *Certain add-on devices around the bumper or fascia may create false alerts. For example, large trailer hitches, bicycle or surfboard racks, license plate brackets, bumper covers or any other device that may block the normal detection zone of the system. Remove the add-on device to prevent false alerts.*

**Note:** *The system does not react to small or moving objects, particularly those close to the ground.*

**Note:** *The system does not operate during hard acceleration or steering.*

## Reverse Braking Assist (If Equipped)

**Note:** If your vehicle sustains damage to the bumper or fascia leaving it misaligned or bent, it could alter the sensing zone causing inaccurate measurement of obstacles or false alerts.

**Note:** Vehicle loading and suspension changes can impact the angle of the sensors and may change the normal detection zone of the system resulting in inaccurate measurement of obstacles or false alerts.

**Note:** When you connect a trailer, the system may detect the trailer and provide an alert, or the system turns off. If the system does not turn off, switch the system off manually after you connect the trailer.

**Note:** You may experience reduced system performance on road surfaces that limit deceleration. For example, roads with ice, loose gravel, mud or sand.

### SWITCHING REVERSE BRAKING ASSIST ON AND OFF

1. Press **Features** on the touchscreen.

2. Press **Driver Assistance**.
3. Switch **Reverse Brake Assist** on or off.

**Note:** The system is unavailable when rear parking aid or cross traffic alert is off.

### OVERRIDING REVERSE BRAKING ASSIST

There could be instances when unexpected or unwanted braking occurs. Firmly pressing the accelerator pedal or switching the feature off overrides the system.

### REVERSE BRAKING ASSIST INDICATORS

If the system determines that a collision with an obstacle may occur, full braking may apply. Bring your vehicle to a stop a safe distance away from the obstacle.



A message and warning indicator appear when the system applies the brakes.

## REVERSE BRAKING ASSIST – TROUBLESHOOTING

### Reverse Braking Assist – Information Messages

Message	Action
Reverse Brake Assist Not Available See Manual	Make sure that all doors, liftgate and hood are closed. Drive the vehicle on a straight road for a short period. If message remains, contact an authorized dealer.
Reverse Brake Assist Fault	Displays when a system error has occurred. Have your vehicle checked by an authorized dealer as soon as possible.
Reverse Brake Assist Off	Displays when reverse brake assist is off. Make sure the parking aids and cross traffic systems are on.

## Reverse Braking Assist (If Equipped)

---

### Reverse Braking Assist – Frequently Asked Questions

Why is reverse braking assist unavailable?

- Make sure that all doors, liftgate and hood are closed. Drive the vehicle on a straight road for a short period. If the message remains, contact an authorized dealer.
- Make sure the cross traffic alert system is on. See **How Does Cross Traffic Alert Work** (page 344).
- Make sure the rear parking aid system is on. See **What is the Rear Parking Aid** (page 297).
- Make sure traction control is on. See **Traction Control** (page 284).
- The vehicle has sustained a rear end impact. Contact an authorized dealer to have the sensors checked for proper coverage and operation.
- An ABS, traction control or stability control event may have occurred. Reverse braking assist resumes operation when the event is complete.
- Make sure the rear view camera and 360 degree camera are not dirty or obstructed. If dirty, clean the camera. If the message still appears after cleaning the camera, wait a short time and the message should clear. If the message does not clear, contact an authorized dealer.
- Make sure there are no blocked or faulted sensors. See **How Does Cross Traffic Alert Work** (page 344).
- You recently had your vehicle serviced, or the battery disconnected. Drive your vehicle a short distance to resume system operation.
- Reverse braking assist does not function when you connect a trailer. Operation resumes when you disconnect the trailer.

**Note:** *If the answers to why the system is unavailable do not assist in returning reverse braking assist to available, have the system checked as soon as possible.*

# Hill Start Assist

## WHAT IS HILL START ASSIST

### *Hill Start Assist*

Hill Start Assist makes it easier for you to pull away when your vehicle is on a slope without using the parking brake.

## HOW DOES HILL START ASSIST WORK

When the system activates, your vehicle remains stationary for a few seconds after you release the brake pedal. This gives you time to move your foot from the brake pedal to the accelerator pedal. The brakes release when the engine has developed sufficient torque to prevent your vehicle from rolling down the slope.

## HILL START ASSIST PRECAUTIONS



**WARNING:** The system does not replace the parking brake. When you leave your vehicle, always apply the parking brake.



**WARNING:** You must remain in your vehicle when the system turns on. At all times, you are responsible for controlling your vehicle, supervising the system and intervening, if required. Failure to take care may result in the loss of control of your vehicle, serious personal injury or death.



**WARNING:** The system turns off if there is a malfunction or if you excessively rev the engine.

## HILL START ASSIST – TROUBLESHOOTING

### Hill Start Assist – Information Messages

Message	Action
Hill Start Assist Not Available	Displays when system is not available. Have your vehicle checked as soon as possible.

# Auto Hold

## HOW DOES AUTO HOLD WORK

Auto Hold applies the brakes to hold your vehicle after you stop it and release the brake pedal. This can help when waiting on a hill or in traffic.

## SWITCHING AUTO HOLD ON AND OFF



**WARNING:** The system does not replace the parking brake. When you leave your vehicle, always apply the parking brake.



**WARNING:** You must remain in your vehicle when the system turns on. At all times, you are responsible for controlling your vehicle, supervising the system and intervening, if required. Failure to take care may result in the loss of control of your vehicle, serious personal injury or death.

You can switch the system on or off by accessing the menu in the SYNC display screen.

1. Press **Features** on the touchscreen.
2. Press **Driver Assistance**.

**Note:** You can only switch the system on after you close the driver door, and fasten your seatbelt.

**Note:** The system remembers the last setting when you start your vehicle.

**Note:** Make sure you switch the system off before using an automatic car wash.

## USING AUTO HOLD

1. Bring your vehicle to a complete stop. The auto hold active indicator illuminates in the information display.

2. Release the brake pedal. The system holds your vehicle at a standstill. The auto hold active indicator remains illuminated in the information display.
3. Pull away in the normal manner. The system releases the brakes and the auto hold active indicator switches off.

**Note:** The system only activates if you apply enough brake pressure on the brake pedal.

**Note:** Under certain conditions, the system could apply the electric parking brake. The brake system warning lamp illuminates. The electric parking brake releases when you press the accelerator pedal. See **Automatically Releasing the Electric Parking Brake** (page 276).

**Note:** The system switches off if you shift into reverse (R) and press the brake pedal.

There could be actions that can cause the auto hold system not to work when the following occur:

- When you use active park assist.
- Your vehicle is in stay in neutral mode.
- The driver door is open.
- You have not fastened your seatbelt.
- You shift into reverse (R) before the system is active.

## AUTO HOLD INDICATORS



Illuminates when the system is active.



Illuminates when the system is on but cannot hold your vehicle at a standstill at this particular time.

# Traction Control

## WHAT IS TRACTION CONTROL

The traction control system helps to avoid drive wheel spin and loss of traction.

## HOW DOES TRACTION CONTROL WORK

If your vehicle begins to slide, the system applies the brakes to individual wheels and, when needed, reduces engine power at the same time. If the wheels spin when accelerating on slippery or loose surfaces, the system reduces engine power in order to increase traction.

## SWITCHING TRACTION CONTROL ON AND OFF



**WARNING:** The stability and traction control light illuminates steadily if the system detects a failure. Make sure you did not manually disable the traction control system using the information display controls or the switch. If the stability control and traction control light is still illuminating steadily, have the system serviced by an authorized dealer immediately. Operating your vehicle with the traction control disabled could lead to an increased risk of loss of vehicle control, vehicle rollover, personal injury and death.



The traction control system turns on each time you switch the ignition on.

If your vehicle is stuck in mud or snow, switching traction control off may be beneficial as this allows the wheels to spin.

**Note:** When you switch traction control off, stability control remains fully active.

The button for the stability and traction control system is on the instrument panel.

When you switch the system off, a message and an illuminated icon appear on the instrument cluster.

Press the switch again to turn the traction control system back on to normal operation.

Your vehicle may have MyKey restrictions regarding this feature. See **What Is MyKey** (page 78).

## TRACTION CONTROL INDICATOR



If the indicator does not illuminate when you switch the ignition on, or remains on when the engine is running, this indicates a malfunction. Have your vehicle checked by an authorized dealer as soon as possible.



The traction control off indicator illuminates when you switch the traction control system off, or when an alternative stability control mode is selected that requires the traction control off.

# Traction Control

---

## TRACTION CONTROL – TROUBLESHOOTING

### Traction Control – Information Messages

<b>Message</b>	<b>Action</b>
Service AdvanceTrac	The system detects a condition that requires service. Contact an authorized dealer as soon as possible.
AdvanceTrac Off	The status of the AdvanceTrac system after you switched it off.
AdvanceTrac On	The status of the AdvanceTrac system after you switched it on.
Traction Control Off	The status of the traction control system after you switched it off.
Traction Control On	The status of the traction control system after you switched it on.



# Stability Control

## HOW DOES STABILITY CONTROL WORK



**WARNING:** Vehicle modifications involving braking system, aftermarket roof racks, suspension, steering system, tire construction and wheel and tire size may change the handling characteristics of your vehicle and may adversely affect the performance of the electronic stability control system. In addition, installing any stereo loudspeakers may interfere with and adversely affect the electronic stability control system. Install any aftermarket stereo loudspeaker as far as possible from the front center console, the tunnel, and the front seats in order to minimize the risk of interfering with the electronic stability control sensors. Reducing the effectiveness of the electronic stability control system could lead to an increased risk of loss of vehicle control, vehicle rollover, personal injury and death.



**WARNING:** Remember that even advanced technology cannot defy the laws of physics. It's always possible to lose control of a vehicle due to inappropriate driver input for the conditions. Aggressive driving on any road condition can cause you to lose control of your vehicle increasing the risk of personal injury or property damage. Activation of the electronic stability control system is an indication that at least some of the tires have exceeded their ability to grip the road; this could reduce the operator's ability to control the vehicle potentially resulting in a loss of vehicle control, vehicle rollover, personal injury and death. If your electronic stability control system activates, SLOW DOWN.

If a driving condition activates either the stability control or traction control you may experience the following conditions:

- The stability and traction control light flashes.
- Your vehicle slows down.
- Reduced engine power.

The stability control system has several features built into it to help you maintain control of your vehicle:

### Electronic Stability Control

Electronic stability control enhances your vehicle's ability to prevent skids or lateral slides by applying brakes to one or more of the wheels individually and, if necessary, reducing engine power.

### Roll Stability Control

Roll stability control enhances your vehicle's ability to prevent rollovers by detecting your vehicle's roll motion and the rate at which it changes by applying the brakes to one or more wheels individually.

### Curve Control

Curve control enhances your vehicle's ability to follow the road when cornering severely or avoiding objects in the roadway. Curve control operates by reducing engine power and, if necessary, applying brakes to one or more of the wheels individually.

### Side Wind Stabilization

Side wind stabilization is an advanced feature that works by carefully applying the brakes on one side of the vehicle to reduce the effect of a side wind gust on the vehicle's path.

# Stability Control

## Torque Vectoring by Brakes

Torque vectoring control applies brake torque on the inner driven wheel in a curve for better traction to avoid an understeer, or oversteer situation. Unlike electronic stability control, enhanced torque vectoring control does not slow the vehicle. It helps control excessive wheel slip and gives the vehicle improved cornering agility.

## Traction Control

Traction control enhances your vehicle's ability to maintain traction of the wheels by detecting and controlling wheel spin. See **What Is Traction Control** (page 284).

## SWITCHING STABILITY CONTROL ON AND OFF

The system turns on each time you switch the ignition on.

You can switch the electronic stability control system off by pressing and holding the ESC off button for over 5 seconds, or you can press the button again to switch the system on.

Shifting the transmission into reverse (R) will disable the system.

You can switch the traction control system off or on independently. See **Switching Traction Control On and Off** (page 284).

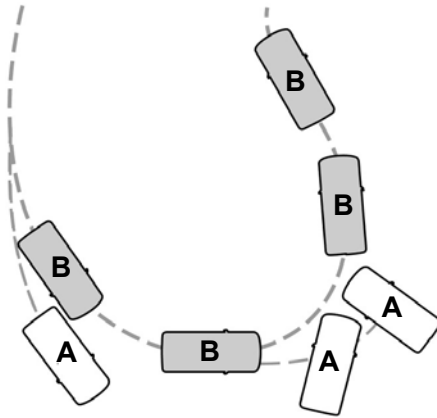

E72903

- A Vehicle without stability control skidding off its intended route.
- B Vehicle with stability control maintaining control on a slippery surface.

# Stability Control

## Stability Control and Traction Control with Roll Stability Control

	<b>Stability Control OFF Light</b>	<b>Roll Stability Control<sup>3</sup></b>	<b>Electronic Stability Control<sup>3</sup></b>	<b>Traction Control System<sup>3</sup></b>
Default at start-up	Illuminated during bulb check	Enabled	Enabled <sup>3</sup>	Enabled
Button pressed momentarily	illuminated	Enabled	Enabled <sup>3</sup>	Disabled <sup>1</sup>
Button Pressed and held for 5 - 15 seconds	illuminated	Enabled	Disabled <sup>2</sup>	Disabled <sup>1</sup>
Button not pressed and transfer case is switched to 4x4 Low or put into Rock Crawl Mode	illuminated	Enabled	Disabled	Disabled <sup>1</sup>

<sup>1</sup> The Traction Control system can still be enabled but with tighter or looser thresholds.

<sup>2</sup> When you press and hold the button, a progress bar will display to show the button hold time progress.

<sup>3</sup> Functions can vary depending on what selectable drive mode the vehicle is currently in.

## STABILITY CONTROL INDICATOR



If it does not illuminate when you switch the power on, or remains on, this indicates a malfunction.

Have your vehicle checked by an authorized dealer as soon as possible.

# Hill Descent Control (If Equipped)

## WHAT IS HILL DESCENT CONTROL

Hill descent control allows the driver to set and maintain vehicle speed while descending steep slopes in various surface conditions.

## HOW DOES HILL DESCENT CONTROL WORK

Hill descent control can maintain vehicle speeds on downhill slopes between 2–20 mph (3–32 km/h). Above 20 mph (32 km/h), the system remains on but the descent speed cannot be set or maintained.

**Note:** *The system does not function below 2 mph (3 km/h).*

The system requires a cool down interval after a period of sustained use. Hill descent control provides a warning in the message center and a tone sounds when the system is about to disengage for cooling. At this time, manually apply the brakes as needed to maintain descent speed.

**Note:** *The amount of time that the system can remain active before cooling varies with conditions.*

## HILL DESCENT CONTROL PRECAUTIONS



**WARNING:** The system does not control speed in low traction conditions or extremely steep slopes. The system is designed to be an aid and does not relieve you of your responsibility to drive with due care and attention. Failure to follow this instruction could result in personal injury.



**WARNING:** Hill descent control cannot control descent in all surface conditions and circumstances, such as ice or extremely steep grades. Hill descent control is a driver assist system and cannot substitute for good judgment by the driver. Failure to do so may result in loss of vehicle control, crash or serious injury.



**WARNING:** The system does not replace the parking brake. When you leave your vehicle, always apply the parking brake and shift the transmission into park (P) for automatic transmission or first gear for manual transmission.

## SWITCHING HILL DESCENT CONTROL ON AND OFF



Press the button on the instrument panel. A light illuminates and a tone sounds when the system is active.

## SETTING THE HILL DESCENT SPEED

To increase or decrease the descent speed, press the accelerator or brake pedal, or use the SET + and SET - buttons on the steering wheel. Once you reach the preferred speed remove your feet from the pedals.

## HILL DESCENT CONTROL INDICATOR



Illuminates when you switch hill descent control on.

# Hill Descent Control (If Equipped)

## HILL DESCENT CONTROL – TROUBLESHOOTING

### Hill Descent Control – Information Messages

<b>Message</b>	<b>Action</b>
For Hill Descent Reduce Speed XX MPH/km/h or Less	Your vehicle speed requirement for off-road mode entry has not been met.
For Hill Descent Select Gear	You need to select a transmission gear for hill descent mode.
Hill Descent Driver Resume Control	Hill descent control mode is deactivated and you must resume control.
Hill Descent Control Fault	A hill descent system fault is present.
Hill Descent Control Off System Cooling	The hill descent system is cooling due to overuse.
Hill Descent Control not available with Cruise Control Active	The hill descent system cannot activate while Cruise Control is actively controlling speed.

# Active Drive Assist (If Equipped)

## WHAT IS ACTIVE DRIVE ASSIST

Active drive assist keeps your vehicle centered in the lane when using adaptive cruise control.

## HOW DOES ACTIVE DRIVE ASSIST WORK

Active drive assist uses cameras to monitor your vehicle position within a lane and applies steering support to keep your vehicle centered in the lane.

When active, active drive assist uses a driver facing camera and infrared lighting to monitor your eyes and head position to detect if you are distracted. If the system determines you are distracted, it alerts you to return your eyes to the road.

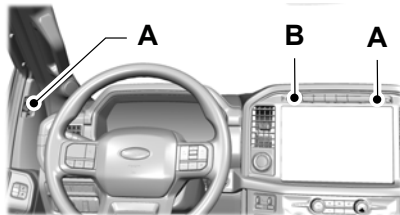

- A Lighting area.
- B Camera.

**Note:** When active drive assist is active, in certain crash or near crash-like situations, such as an air bag deployment or hitting a road obstacle, camera data may be recorded through the vehicle event data recorder. See **Event Data** (page 27).

**Note:** No data is recorded under normal driving conditions.

## ACTIVE DRIVE ASSIST PRECAUTIONS

**WARNING:** You are responsible for controlling your vehicle at all times. The system is designed to be an aid and does not relieve you of your responsibility to drive with due care and attention. Failure to follow this instruction could result in the loss of control of your vehicle, personal injury or death.

**WARNING:** Do not use the system when towing a trailer. Failure to follow this instruction could result in the loss of control of your vehicle, personal injury or death.

**WARNING:** Obstructions to the driver facing camera or infrared lighting could prevent the system from properly operating. Keep the camera and lighting areas free from obstruction. Failure to follow this instruction could result in the loss of control of your vehicle, personal injury or death.

**WARNING:** Do not use the system if any changes or modifications to the steering wheel have been made. Any changes or modifications to the steering wheel could affect the functionality or performance of the system. Failure to follow this instruction could result in the loss of control of your vehicle, personal injury or death.

# Active Drive Assist (If Equipped)

## ACTIVE DRIVE ASSIST REQUIREMENTS

Active drive assist only activates when all of the following occur:

- Active drive assist is enabled in your information and entertainment screen. See **Active Drive Assist Settings** (page 292).
- Adaptive cruise control is on.
- The system detects both lane markings.
- Your hands are on the steering wheel.
- Your eyes are on the road.

## ACTIVE DRIVE ASSIST LIMITATIONS

Any of the following conditions could result in active drive assist not operating correctly:

- Your vehicle is not centered in the lane.
- The lane is too narrow or too wide.
- The system does not detect at least one lane marking or when lanes merge or split.
- Limited steering torque input is applied.
- Using the system in areas under construction.
- When modifications to the steering system have been made.
- When using a spare tire.
- If you have a pre-existing eye condition, such as an eye misalignment, or have had eye surgery.

**Note:** *The steering assistance is limited and may not be sufficient for all driving situations.*

**Note:** *In exceptional conditions, the system could deviate from the center line.*

**Note:** *The information provided by the navigation map data could be inaccurate or out of date.*

## ACTIVE DRIVE ASSIST SETTINGS

### Enabling Active Drive Assist

1. Press **Features** on the touchscreen.
2. Press **Driver Assistance**.
3. Press **Cruise Control**.
4. Press **Lane Centering Assist**.

## SWITCHING ACTIVE DRIVE ASSIST ON AND OFF

### Switching Active Drive Assist On

The controls are on the steering wheel.



Using the adaptive cruise control and lateral support buttons, ensure both systems are active. Active drive assist activates.



### Switching Active Drive Assist Off



Press either the lateral support or adaptive cruise control button when system is active or in standby mode.



Active drive assist turns off through each ignition cycle.

## ACTIVE DRIVE ASSIST ALERTS

When active drive assist is providing hands-on driving and detects no steering activity for a certain period of time, the system alerts you to put your hands on the steering wheel.

## Active Drive Assist (If Equipped)

When active drive assist is providing hands-on driving and detects you are not looking at the road for a certain period of time, the system alerts you to return your eyes to the road.

If you do not react to the warnings, active drive assist cancels, quickly activates and releases the brakes, and slows your vehicle down to low speeds while maintaining steering control.

If your vehicle slows down and you resume control, a message appears to prompt you to press the accelerator pedal to allow the system to resume.

**Note:** *The system disables until the next key cycle if repeated inactivity is detected.*

### ACTIVE DRIVE ASSIST AUTOMATIC CANCELLATION

When an external condition cancels active drive assist, for example, no lane markings available, a tone sounds and a message appears in the instrument cluster.

 If your vehicle starts to slow down, you must take control of steering and press and release the button to reactivate active drive assist.

System cancellation can also occur if:

- The lane becomes too narrow.
- The system cannot detect valid lane markings.
- Lane markings are crossed.
- Your eyes are not on the road or your hands are not on the steering wheel.

If you have your hands on the steering wheel and your eyes are on the road when the feature is active and a cancellation occurs, the system sounds a tone and displays a cancelled graphic in the instrument cluster.

If you are not paying attention to the road or your hands are not on the steering wheel and a cancellation occurs, the system will display a message and a tone sounds until you resume control. If you do not resume control in time, active drive assist quickly activates and releases the brakes, and slows your vehicle down to low speeds while maintaining steering control. If your vehicle slows down and you resume control, a message appears to prompt you to press the accelerator pedal to allow the system to resume.

**Note:** *The system disables until the next key cycle if repeated inactivity is detected.*

### ACTIVE DRIVE ASSIST INDICATORS



When on, the color of the indicator changes to indicate the status.

Gray indicates active drive assist is on but inactive.

Green indicates active drive assist is active and applying continuous steering support.

### Hands-On Driving Support Available



When this indicator is present, you must keep your hands on the steering wheel.



## Active Drive Assist (If Equipped)

### ACTIVE DRIVE ASSIST – TROUBLESHOOTING

### Active Drive Assist – Information Messages

Depending on your vehicle options and instrument cluster type, not all messages display or are available.

Message	Action
Keep Hands on Steering Wheel	Make sure you return your hands to the steering wheel and provide steering input.
Resume Control	The system is going to cancel and you must take control.
Watch the Road	Return your attention to the road.
Active Drive Assist Not Available	Conditions exist preventing the system from being available. If the message continues to display, have the system checked as soon as possible.
Press Accelerator Pedal to Resume	Press the accelerator pedal and follow the prompts.

**Note:** *Certain messages could be abbreviated or shortened depending on which cluster type you have.*

# Steering

## ELECTRIC POWER STEERING

### Electric Power Steering Precautions



**WARNING:** The electric power steering system has diagnostic checks that continuously monitor the system. If a fault is detected, a message displays in the information display. Stop your vehicle as soon as it is safe to do so. Switch the vehicle off. After at least 10 seconds, switch the vehicle on and watch the information display for a steering system warning message. If a steering system warning message returns, have the system checked as soon as possible.



**WARNING:** If the system detects an error, you may not feel a difference in the steering, however a serious condition may exist. Have your vehicle checked as soon as possible. Failure to do so may result in loss of steering control.

Adapt your speed and driving behavior according to reduced steering assist.

Extreme continuous steering may increase the effort to steer. This occurs to prevent internal overheating and damage to the steering system. If this occurs, you will not lose the ability to steer your vehicle manually nor will it cause damage to the system. Normal steering and driving allows the system to cool down and steering assist returns to normal.

**Note:** There is no fluid reservoir to check or fill.

### Electric Power Steering Adaptive Steering (If Equipped)

[Electric Power-Assisted Steering \(EPAS\)](#)

The adaptive steering system changes the steering ratio with changes to vehicle speed, optimizing the steering response in all conditions. The system also changes when you switch on the transmission tow/haul feature. When you select the tow/haul button, the adaptive steering system reduces vehicle sensitivity to steering inputs at higher vehicle speeds, while maintaining the ease of parking and maneuverability at low speeds.

**Note:** *The adaptive steering system continuously monitors for faults. If the system detects a fault, a message appears in the information display. If a red warning message displays, stop your vehicle as soon as it is safe to do so. The message could clear if the fault is no longer present. If an adaptive steering system warning message appears each time you start your vehicle, have the system checked as soon as possible.*

**Note:** *The system is designed with a locking device. It remains mechanically locked at a fixed steering ratio with the lock engaged. You may notice a click when you turn your vehicle on or off.*

**Note:** *If your vehicle loses electrical power or detects a fault when you are driving, the system shuts down and you retain a normal steering function with a fixed steering ratio. During this time it is possible that the steering wheel could not be straight when the vehicle is driving straight ahead. In addition, you could notice that the steering wheel angle required to steer your vehicle could be different.*

# Steering

**Note:** During parking maneuvers, the adaptive steering system balances the driver work load for various steering wheel inputs and vehicle loading conditions. Under extreme operating conditions the system locking device could engage. This strategy prevents overheating and permanent damage to the adaptive steering system. Typical steering and driving maneuvers allow the system to cool and return to normal operation.

## Adaptive Learning (If Equipped)

Adaptive learning helps correct road irregularities and improves overall handling and steering. It communicates with the brake system to help operate advanced stability control and crash avoidance systems. Additionally, whenever the battery is disconnected or a new battery is installed, you must drive your vehicle a short distance before the system relearns the strategy and reactivates all systems.

## Steering – Information Messages

Message	Action
Steering Fault Service Now	The power steering system has detected a condition that requires service. Have your vehicle checked as soon as possible.
Steering Loss Stop Safely	The power steering system is not working. Stop your vehicle in a safe place. Have your vehicle checked as soon as possible.
Steering Assist Fault Service Required	The power steering system has detected a condition that requires service. Have your vehicle checked as soon as possible.
Steering Lock Malfunction Service Now	The steering system has detected a condition that requires service. Have your vehicle checked as soon as possible.

## STEERING – TROUBLESHOOTING

### Steering – Warning Indicators



The adaptive steering system indicator illuminates if the system detects a fault during the continuous diagnostic checks.

**Note:** If a red warning message displays, stop your vehicle as soon as it is safe to do so.

## Parking Aids (If Equipped)

### PARKING AID PRECAUTIONS



**WARNING:** To help avoid personal injury, always use caution when in reverse (R) and when using the sensing system.



**WARNING:** The system may not detect objects with surfaces that absorb reflection. Always drive with due care and attention. Failure to take care may result in a crash.



**WARNING:** Traffic control systems, inclement weather, air brakes, external motors and fans may affect the correct operation of the sensing system. This may cause reduced performance or false alerts.



**WARNING:** The system may not detect small or moving objects, particularly those close to the ground.



**WARNING:** The parking aid system can only assist you to detect objects when your vehicle is moving at parking speeds. To help avoid personal injury you must take care when using the parking aid system.



**WARNING:** The system may not function if the sensor is blocked.



**WARNING:** In cold and severe weather conditions the system may not function. Rain, snow and spray can all limit sensor performance.



**WARNING:** If damage occurs in the immediate area surrounding the sensor, have your vehicle checked as soon as possible.

When you connect a trailer to your vehicle, the rear parking aid detects the trailer and provides an alert. Disable the parking aid when you connect a trailer to prevent the alert.

**Note:** *Certain add-on devices installed around the bumper or fascia may create false alerts, for example, large trailer hitches, bike or surfboard racks, license plate brackets, bumper covers or any other device that could block the normal detection zone of the parking aid system. Aftermarket spare tires or spare tire covers mounted to the rear tailgate could cause false alerts from the park aid system. Remove the add-on device to prevent false alerts.*

**Note:** *Keep the sensors free from snow, ice and large accumulations of dirt. If the sensors are covered, the system's accuracy can be affected.*

Do not clean the sensors with sharp objects.

**Note:** *When using a programmed MyKey you cannot switch this off. See MyKey™ (page 78).*

### REAR PARKING AID (If Equipped)

#### What is the Rear Parking Aid

##### Reverse Sensing System

Rear parking sensors detect objects behind your vehicle when in reverse (R).

#### Rear Parking Aid Limitations

There is a decreased coverage area at the outer corners.

When using a programmed MyKey, you cannot switch the rear parking aid off.

## Parking Aids (If Equipped)

The rear parking aid sensors are active when your vehicle is in reverse (R) and the vehicle speed is less than 3 mph (5 km/h).

The sensor coverage area is up to 71 in (180 cm) from the rear bumper.

The rear parking aid detects large objects when you shift into reverse (R) and any of the following occur:

- Your vehicle is moving backward at a low speed.
- Your vehicle is stationary but an object is approaching the rear of your vehicle at a low speed.
- Your vehicle is moving backward at a low speed and an object is moving towards your vehicle, for example another vehicle at a low speed.

### Locating the Rear Parking Aid Sensors



The rear parking aid sensors are in the rear bumper.

### Rear Parking Aid Audible Warnings

A warning tone sounds when your vehicle approaches an object. As your vehicle moves closer to an object, the rate of the tone increases. The warning tone continuously sounds when an object is 12 in (30 cm) or less from the rear bumper.

If your vehicle remains stationary for a few seconds, the audible warning turns off. If your vehicle moves backward the tone sounds again.

**Note:** When the parking aid system sounds a tone, the audio system could reduce the set volume.

## FRONT PARKING AID (If Equipped)

### What is the Front Parking Aid

Front parking sensors detect objects in front of your vehicle.

### Front Parking Aid Limitations

The front parking aid sensors are active when your vehicle is in any position other than park (P) and the vehicle speed is less than 5 mph (8 km/h).

The sensor coverage area is up to 27.6 in (70 cm) from the bumper.

If your vehicle is in reverse (R), the front parking aid detects objects when your vehicle is moving at a low speed or an object is moving toward your vehicle and provides an audio warning, for example another vehicle at a low speed. Once your vehicle reaches a stop, the audio warning stops after a few seconds. Visual indication is always active in reverse (R).

If your vehicle is in any forward gear, the front parking aid provides audible warnings and visual indication when your vehicle is moving at a speed of 5 mph (8 km/h) or below and the system detects an object within the detection zone. Once your vehicle reaches a stop, the visual indication and audio warning stops after a few seconds.

## Parking Aids (If Equipped)

If your vehicle is in neutral (N), the front and rear sensors provide visual indication only when your vehicle is moving below a speed of 5 mph (8 km/h) and obstacles are detected inside the detection areas. Once your vehicle reaches a stop, the visual indication and audio warning stops after a few seconds.

### Locating the Front Parking Aid Sensors



The front parking aid sensors are in the front bumper.

### Front Parking Aid Audible Warnings

A warning tone sounds when there is an object within 27.6 in (70 cm) from the front bumper. As your vehicle moves closer to an object, the rate of the tone increases.

The warning tone continuously sounds when an object is 12 in (30 cm) or less from the front bumper.

**Note:** *If the detected object is 12 in (30 cm) or less from your vehicle, visual indication remains on.*

### SIDE PARKING AID (If Equipped)

#### What is the Side Parking Aid

The front and rear outermost parking aid sensors map objects that are near to the sides of your vehicle.

#### Side Parking Aid Limitations

The sensor coverage is up to 24 in (60 cm) from the sides of your vehicle.

The side parking aid may not function if:

- You switch your vehicle on, off and back on within a few seconds.
- Your vehicle remains stationary for over two minutes.
- The anti-lock brake system activates.
- The traction control system activates.

**Note:** *If you switch traction control off, the side sensing system also turns off.*

To reinitialize the system, drive the length of your vehicle.

The side parking aid does not detect an object that is moving toward the side of your vehicle, for example another vehicle moving at a low speed, if it does not pass a front or rear parking aid sensor.

If your vehicle is in neutral (N), the side sensing system provides visual indication only when your vehicle is moving below 7 mph (12 km/h) and there is a front or rear park aid obstacle detected, and the side obstacle is within 24 in (60 cm) from the side of your vehicle. Once your vehicle reaches a stop, the visual indication stops after a few seconds.

# Parking Aids (If Equipped)

## Locating the Side Parking Aid Sensors



The side parking sensors are in the front and rear bumpers.

## Side Parking Aid Audible Warnings

When the side parking aid detects an object within the coverage area and the driving path of your vehicle, an audible warning sounds. As your vehicle moves closer to the object, the rate of the tone increases.

## PARKING AID INDICATORS



The system provides object distance indication through the information display.

- As the distance to the object decreases, the indicator blocks illuminate and move toward the vehicle icon.
- If there is no object detected, the distance indicator blocks are grey.

Visual indication remains on when the transmission is in reverse (R). When you stop your vehicle, visual indication turns off after four seconds.

If the parking aids are not available, the side distance indicator blocks do not display.

# Parking Aids (If Equipped)

## PARKING AIDS – TROUBLESHOOTING

If a fault is present in the parking aids, a warning message appears in the instrument cluster or the information and entertainment display.

### Parking Aids – Information Messages

Message	Action
Check Front Park Aid	The system detects a condition that requires service. Have your vehicle checked as soon as possible.
Check Rear Park Aid	The system detects a condition that requires service. Have your vehicle checked as soon as possible.
Front Park Aid On Off	Displays the park aid status.
Rear Park Aid On Off	Displays the park aid status.



# Rear View Camera

## WHAT IS THE REAR VIEW CAMERA

The rear view camera provides a video image of the area behind your vehicle when the transmission is in reverse (R).



The rear view camera button is on the instrument panel.

## REAR VIEW CAMERA PRECAUTIONS



**WARNING:** The rear view camera system is a reverse aid supplement device that still requires the driver to use it in conjunction with the interior and exterior mirrors for maximum coverage.



**WARNING:** Objects that are close to either corner of the bumper or under the bumper, might not be seen on the screen due to the limited coverage of the camera system.



**WARNING:** Reverse your vehicle slowly. Failure to follow this instruction could result in the loss of control of your vehicle, personal injury or death.



**WARNING:** Use caution when the rear cargo door is ajar. If the rear cargo door is ajar, the camera will be out of position and the video image could be incorrect. All guide lines disappear when the rear cargo door is ajar. Failure to follow this instruction could result in personal injury.



**WARNING:** Use caution when turning camera features on or off when the transmission is not in park (P). Make sure your vehicle is not moving.

**Note:** When towing, the camera only sees what you are towing. This might not provide adequate coverage and you might not see some objects. In some vehicles, the guide lines may disappear when you connect the trailer tow connector.

## LOCATING THE REAR VIEW CAMERA

The rear view camera is on the tailgate. It provides a video image of the area behind your vehicle.

## REAR VIEW CAMERA GUIDE LINES

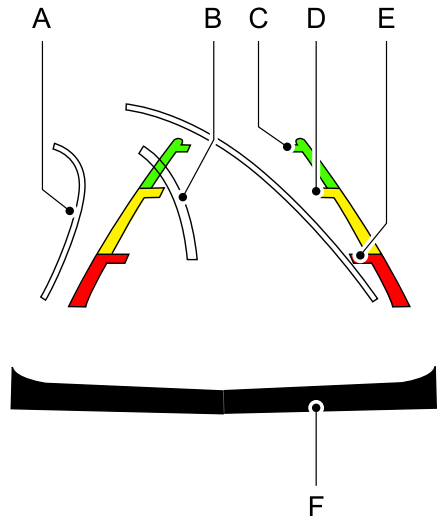

- A. Active guide lines.
- B. Centerline.

# Rear View Camera

- C. Fixed guide line: Green zone.
- D. Fixed guide line: Yellow zone.
- E. Fixed guide line: Red zone.
- F. Rear bumper.

Active guide lines only show with fixed guide lines. To use active guide lines, turn the steering wheel to point the guide lines toward an intended path. If the steering wheel position changes while reversing, your vehicle might deviate from the intended path.

The fixed and active guide lines fade in and out depending on the steering wheel position. The active guide lines do not display when the steering wheel position is straight.

Use caution while reversing. Objects in the red zone are closest to your vehicle and objects in the green zone are farther away. Objects get closer to your vehicle as they move from the green zone to the yellow or red zones. Use the side view mirrors and rear view mirror to get better coverage on both sides and rear of your vehicle.

**Note:** Active guide lines and fixed guide lines are only available when the transmission is in reverse (R).

**Note:** The centerline is only available if the active or fixed guide lines are on.

**Note:** Not all camera modes work properly without an auxiliary camera.

## REAR VIEW CAMERA SETTINGS

### Zooming the Rear View Camera In and Out



**WARNING:** When manual zoom is on, the full area behind your vehicle may not show. Be aware of your surroundings when using the manual zoom feature.

Selectable settings for this feature are zoom in (+) and zoom out (-). Press the symbol on the camera screen to change the view. The default setting is zoom off.

This allows you to get a closer view of an object behind your vehicle. The zoomed image keeps the bumper in the image to provide a reference. The zoom is only active while the transmission is in reverse (R).

**Note:** Zooming in also engages park hold which applies the electric park brake when you shift to park (P). When you press the zoom button, the electronic park hold button illuminates on the touchscreen. See **Connecting a Trailer** (page 371).

**Note:** Manual zoom is only available when the transmission is in reverse (R).

**Note:** Only the centerline shows when you enable manual zoom.

### Switching Rear View Camera Delay On and Off

1. Press **Features** on the touchscreen.
2. Press **Driver Assistance**.
3. Press **Rear View Camera**.
4. Switch **Rear View Camera Delay** on or off.

## Rear View Camera

---

When shifting the transmission out of reverse (R) and into any gear other than park (P), the camera image remains in the display until:

- Your vehicle speed reaches approximately 5 mph (8 km/h).
- You shift your vehicle into park (P).

# 360 Degree Camera (If Equipped)

## WHAT IS THE 360 DEGREE CAMERA

The 360 degree camera system consists of front, side and rear cameras which provide visibility around your vehicle.

## HOW DOES THE 360 DEGREE CAMERA WORK

The 360 Degree Camera system:

- Allows you to see what is directly in front of or behind your vehicle.
- Helps you when parallel parking and centering in a parking space.
- Provides a cross traffic view in front of and behind your vehicle.
- Allows you to see a top-down view of the area outside your vehicle, including the blind spots and obstacles near your vehicle.

## 360 DEGREE CAMERA PRECAUTIONS



**WARNING:** The 360 degree camera system still requires the driver to use it in conjunction with looking out of the windows, and checking the interior and exterior mirrors for maximum coverage.



**WARNING:** Objects that are close to either corner of the bumper or under the bumper, might not be seen on the screen due to the limited coverage of the camera system.



**WARNING:** Use caution when turning camera features on or off when the transmission is not in park (P). Make sure your vehicle is not moving.



**WARNING:** You are responsible for controlling your vehicle at all times. The system is designed to be an aid and does not relieve you of your responsibility to drive with due care and attention. Failure to follow this instruction could result in the loss of control of your vehicle, personal injury or death.

## 360 DEGREE CAMERA LIMITATIONS

**Note:** Use caution if a door is ajar. The 360 degree camera could be out of position and the image could be incorrect.

## LOCATING THE 360 DEGREE CAMERAS

[Cargo Bed Camera](#)

### Rear View Camera

The rear view camera is on the tailgate. It provides a video image of the area behind your vehicle.

### Front View Camera

The front view camera is in the grille. It provides a video image of the area in front of your vehicle.

### Side View Camera

The side view camera is on the outside mirror. It provides a video image of the area on the sides of your vehicle to aid you when parking or when backing up a trailer.

# 360 Degree Camera (If Equipped)

## Bed Camera

The bed camera is mounted within the high-mount stop lamp. It displays the contents of your truck bed. The camera contains a dynamic guideline to help locate the center of your vehicle. This view can be accessed while in drive (D) or reverse (R).

## Auxiliary Camera

The auxiliary camera is a variant of the rear view camera and is accessed by pressing the AUX button on the display screen when moving in reverse (R) or in drive (D). It displays a rear view image from the back of a trailer while in reverse.

## 360 DEGREE CAMERA GUIDE LINES

**Note:** Active guide lines are only available when the transmission is in reverse (R).

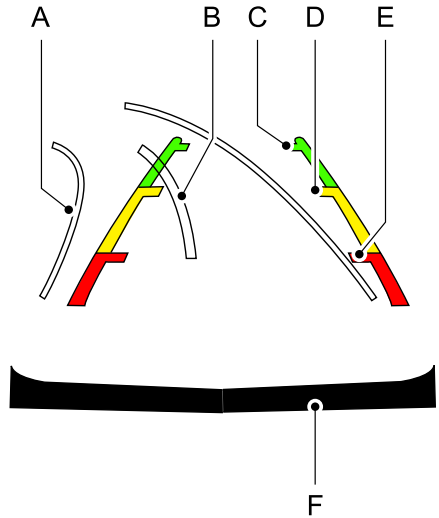

- A. Active guide lines.
- B. Centerline.
- C. Fixed guide line: Green zone.
- D. Fixed guide line: Yellow zone.
- E. Fixed guide line: Red zone.
- F. Rear bumper.

Active guide lines only show with fixed guide lines. Turn the steering wheel to point the guide lines toward an intended path. If the steering wheel position changes when reversing, your vehicle could deviate from the intended path.

The fixed and active guide lines fade in and out depending on the steering wheel position. The active guide lines do not display when the steering wheel position is straight.

## 360 Degree Camera (If Equipped)

Objects in the red zone are closest to your vehicle and objects in the green zone are farther away. Objects get closer to your vehicle as they move from the green zone to the yellow or red zones. Use the side view mirrors and rear view mirror to get better coverage on both sides and rear of your vehicle.

### Keep Out Zone

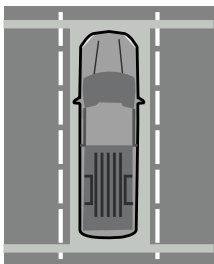

The Keep Out Zone is represented by the yellow dotted lines running parallel to your vehicle.

## 360 DEGREE CAMERA SETTINGS

### Switching the 360 Degree Camera On and Off

 The 360 degree camera system button is on the instrument panel. The front and rear cameras have multiple screens which consist of:

- Normal view.
- Normal view with 360.
- Split view.
- Bed camera.
- Auxiliary camera.









**Note:** *The rear view camera activates when you switch into reverse (R). Additional views are then accessible on the touchscreen.*

When in park (P), neutral (N) or drive (D), the front images display when the button is pressed. When in reverse (R), only the rear images display when the button is pressed.

**Note:** *Not all cameras are available.*

**Note:** *The 360 degree camera system turns off when your vehicle is in motion at low speed, except when in reverse (R).*

### Switching the 360 Degree Camera View

-  Press to access the different camera views.
-  Front normal view provides an image of what is directly in front of your vehicle.
-  Front split view provides an extended view of what is in front of your vehicle.
-  Normal + 360 view contains the normal camera view next to a 360 degree camera view.
-  Rear normal view provides an image of what is directly behind your vehicle.
-  Rear split view provides an extended view of what is behind your vehicle.
-  Bed camera shows the truck bed.
-  Trailer AUX camera shows a rear view camera image of what is behind your trailer. This camera needs to be purchased and installed separately.

## 360 Degree Camera (If Equipped)

---



Trailer reverse guidance shows the sides of your truck and trailer.

See **Trailer Reversing Aid**

(page 410).



Zooms in on the image and park hold is activated. See

**Connecting a Trailer** (page 371).



Zooms in on the 360 degree image.

# Active Park Assist (If Equipped)

## WHAT IS ACTIVE PARK ASSIST

Assists you with parking in and out of parking spaces.

## HOW DOES ACTIVE PARK ASSIST WORK

Active park assist uses sensors to detect parking spaces. Active park assist controls steering, acceleration, braking and shifting as required to maneuver into or out of a parking space when activate.

## ACTIVE PARK ASSIST PRECAUTIONS



**WARNING:** You must remain in your vehicle when the system turns on. At all times, you are responsible for controlling your vehicle, supervising the system and intervening, if required. Failure to take care may result in the loss of control of your vehicle, serious personal injury or death.



**WARNING:** The sensors may not detect objects in heavy rain or other conditions that cause interference.



**WARNING:** You are responsible for controlling your vehicle at all times. The system is designed to be an aid and does not relieve you of your responsibility to drive with due care and attention. Failure to follow this instruction could result in the loss of control of your vehicle, personal injury or death.



**WARNING:** Do not use the system with accessories that extend beyond the front or rear of your vehicle, for example a trailer hitch or bike rack. The system is not able to make corrections for the additional length of the accessories.

## SWITCHING ACTIVE PARK ASSIST ON AND OFF



Press the active park assist button, then press the active park assist icon on the touchscreen to bring up full screen notifications.

Press the soft keys on the touchscreen to switch between the parallel park in, perpendicular park in, or parallel park out parking modes.

## Cancelling Active Park Assist

To cancel parking assistance at any time, shift out of neutral (N).

## Pausing Active Park Assist

To pause parking assistance at any time, release the active park assist button.

If you open the passenger or rear doors, active park assist pauses.

To resume parking, press and hold the button again.

## ENTERING A PARALLEL PARKING SPACE

1. Press the active park assist button.

**Note:** *The system detects other vehicles and curbs to find a parking space.*



## Active Park Assist (If Equipped)

2. Use the turn signal lever to search for a parking space on the driver or passenger side of your vehicle.

**Note:** *If you do not use the turn signal lever, the system searches for a parking space on the passenger side of your vehicle.*

3. Drive your vehicle approximately 3 ft (1 m) away from and parallel to the other parked vehicles when searching for a parking space.

**Note:** *A tone sounds and a message appears in the information and entertainment display when active park assist finds a suitable parking space.*

4. Press and hold the brake pedal.
5. Release the steering wheel and shift into neutral (N).
6. Press and hold the active park assist button.
7. Release the brake pedal to allow your vehicle to park.

**Note:** *You can slow down your vehicle at any time by pressing the brake pedal.*

**Note:** *When parallel parking between objects, the system parks closer to the object in front of your vehicle to allow easier access to the luggage compartment.*

**Note:** *When parking is complete, your vehicle shifts into park (P).*

### ENTERING A PERPENDICULAR PARKING SPACE

1. Press the active park assist button.

**Note:** *Active park assist does not recognize parking space lines and centers your vehicle between objects.*

2. Press the active park assist icon on the touchscreen.
3. Select perpendicular parking.

4. Use the turn signal lever to search for a parking space on the driver or passenger side of your vehicle.

**Note:** *If you do not use the turn signal lever, the system searches for a parking space on the passenger side of your vehicle.*

5. Drive your vehicle approximately 3 ft (1 m) away from and perpendicular to the other parked vehicles when searching for a parking space.

**Note:** *A tone sounds and a message appears in the information and entertainment display when active park assist finds a parking space.*

6. Press and hold the brake pedal.
7. Release the steering wheel and shift into neutral (N).
8. Press and hold the active park assist button.
9. Release the brake pedal to allow the vehicle to park.

**Note:** *Active park assist backs your vehicle into parking spaces.*

**Note:** *Active park assist aligns the front end of your vehicle with the lane side of the object next to it.*

**Note:** *When the system detects only one object, it allows enough distance to open the door on either side.*

**Note:** *You can slow down your vehicle at any time by pressing the brake pedal.*

**Note:** *When parking is complete, your vehicle shifts into park (P).*

### EXITING A PARKING SPACE

Active park assist only assists leaving parallel parking spaces.

1. Press the active park assist button.
2. Press the active park assist icon on the touchscreen.

## Active Park Assist (If Equipped)

3. Select parallel park exit.
4. Use the turn signal to choose the direction to exit the parking space.
5. Press and hold the brake pedal.
6. Release the steering wheel and shift into neutral (N).
7. Release the parking brake.
8. Press and hold the active park assist button.
9. Release the brake pedal to allow your vehicle to move.

**Note:** After active park assist drives your vehicle to a position where you can exit the parking space in a forward movement, a message appears instructing you to take full control of your vehicle.

10. Take control of your vehicle.

**Note:** You can slow down your vehicle at any time by pressing the brake pedal.

### ACTIVE PARK ASSIST – TROUBLESHOOTING

#### Active Park Assist – Information Messages

Message	Action
Active Park Fault	The system requires service. Have your vehicle checked as soon as possible.

#### Active Park Assist – Frequently Asked Questions

##### Why does active park assist not operate correctly?

The system is unable to detect a vehicle, curb or object to park next to or in between. The system needs boundary objects to operate correctly.

##### Why does active park assist not search for a parking space?

You have switched traction control off.

##### Why does active park assist not search for a parking space?

The transmission is in reverse (R). Your vehicle must be moving forward to be able to detect a parking space.

##### Why does active park assist not offer a parking space?

The sensors could be blocked. For example, snow, ice or large accumulations of dirt. Blocked sensors can affect how the system functions.

##### Why does active park assist not offer a parking space?

The sensors in the front or rear bumper could be damaged.

## Active Park Assist (If Equipped)

---

### **Why does active park assist not offer a parking space?**

There is not enough room in the parking space for your vehicle to safely park.

### **Why does active park assist not offer a parking space?**

There is not enough space for the parking maneuver on the opposite side of the parking space.

### **Why does active park assist not offer a parking space?**

The parking space is more than 5 ft (1.5 m) or less than 2 ft (0.5 m) away from your vehicle.

### **Why does active park assist not offer a parking space?**

Your vehicle's speed is greater than 22 mph (35 km/h) for parallel parking or greater than 19 mph (30 km/h) for perpendicular parking.

### **Why does active park assist not offer a parking space?**

You recently disconnected or replaced the battery. After you reconnect the battery you must drive your vehicle on a straight road for a short period of time.

### **Why does active park assist not correctly position the vehicle into a parking space?**

An irregular curb along the parking space prevents the system from correctly aligning your vehicle.

### **Why does active park assist not correctly position the vehicle into a parking space?**

Vehicles or objects bordering the space could not be correctly parked.

### **Why does active park assist not correctly position the vehicle into a parking space?**

Your vehicle stopped too far past the parking space.

### **Why does active park assist not correctly position the vehicle into a parking space?**

The tires are not correctly installed or maintained. For example, using a spare tire, not inflated correctly, improper size, or of different sizes.

### **Why does active park assist not correctly position the vehicle into a parking space?**

A repair or alteration changed the detection capabilities.

### **Why does active park assist not correctly position the vehicle into a parking space?**

A parked vehicle has a high attachment. For example, a salt sprayer, snowplow or moving truck bed.

### **Why does active park assist not correctly position the vehicle into a parking space?**

The parking space length, or position of parked objects, changes after your vehicle passes the space.

### **Why does active park assist not correctly position the vehicle into a parking space?**

The temperature around your vehicle quickly changes. For example, driving from a heated garage into a cold outside temperature, or after leaving a car wash.

# Cruise Control (If Equipped)

## WHAT IS CRUISE CONTROL

Cruise control lets you maintain a set speed without keeping your foot on the accelerator pedal.

### Requirements

Use cruise control when the vehicle speed is greater than 15 mph in imperial units and 20 km/h in metric units.

## SWITCHING CRUISE CONTROL ON AND OFF



**WARNING:** Do not use cruise control on winding roads, in heavy traffic or when the road surface is slippery. This could result in loss of vehicle control, serious injury or death.

The cruise controls are on the steering wheel.

### Switching Cruise Control On



Press the button to activate the system. When the system activates, the set speed is equal to whichever is greater, the current vehicle speed, or 15 mph when in imperial units or 20 km/h when in metric units. If the speed is too low, or other conditions are not correct for cruise control activation, the system will instead enter standby mode.

### Switching Cruise Control Off



Press the button when the system is active or switch the ignition off.

**Note:** When you switch cruise control off, the set speed clears.

## SETTING THE CRUISE CONTROL SPEED



**WARNING:** When you are going downhill, your vehicle speed could increase above the set speed. The system does not apply the brakes.

Drive to the speed you prefer.

**SET+**

Press either the Set+ or Set- buttons to set the current speed.

**SET-**

Take your foot off the accelerator pedal.

**Note:** The indicator changes color in the information display.

### Changing the Set Speed

**SET+**

Press the Set+ button to increase the set speed in small increments. Press and hold the Set+ button to accelerate. Release the button when you have reached your preferred speed.

**SET-**

Press the Set- button to decrease the set speed in small increments. Press and hold the Set- button to decelerate. Release the button when you have reached your preferred speed.

**Note:** If you accelerate by pressing the accelerator pedal, the set speed does not change. When you release the accelerator pedal, your vehicle returns to the speed that you previously set.

# Cruise Control (If Equipped)

---

## CANCELING THE SET SPEED



Press the button, or tap the brake pedal to cancel the set speed.

**Note:** *The system remembers the set speed.*

**Note:** *The system cancels if the vehicle speed drops below 10 mph (16 km/h) under the set speed when driving uphill.*

## RESUMING THE SET SPEED



Press the button.

## CRUISE CONTROL INDICATORS



Illuminates when you switch the system on.

# Adaptive Cruise Control (If Equipped)

## HOW DOES ADAPTIVE CRUISE CONTROL WITH STOP AND GO WORK

Adaptive cruise control with stop and go uses radar and camera sensors to maintain a set gap between your vehicle and the vehicle in front of you while following it to a complete stop. Stop and go can also be set to follow a vehicle directly in front of you and adjust the set speed, while you are at a complete stop.

## ADAPTIVE CRUISE CONTROL PRECAUTIONS



**WARNING:** You are responsible for controlling your vehicle at all times. The system is designed to be an aid and does not relieve you of your responsibility to drive with due care and attention. Failure to follow this instruction could result in the loss of control of your vehicle, personal injury or death.



**WARNING:** Do not use adaptive cruise control on winding roads, in heavy traffic or when the road surface is slippery. This could result in loss of vehicle control, serious injury or death.



**WARNING:** Pay close attention to changing road conditions such as entering or leaving a highway, on roads with intersections or roundabouts, roads without visible lanes of travel, roads that are winding, slippery, unpaved, or steep slopes.



**WARNING:** The system is not a crash warning or avoidance system.



**WARNING:** Do not use the system when towing a trailer that has aftermarket electronic trailer brake controls. Failure to follow this instruction could result in the loss of control of your vehicle, personal injury or death.



**WARNING:** Do not use tire sizes other than those recommended because this can affect the normal operation of the system. Failure to do so may result in a loss of vehicle control, which could result in serious injury.



**WARNING:** Do not use the system with a snow plow blade installed.



**WARNING:** Do not use the system in poor visibility, for example fog, heavy rain, spray or snow.

## When Following a Vehicle



**WARNING:** When following a vehicle that is braking, your vehicle does not always decelerate quickly enough to avoid a crash without driver intervention. Apply the brakes when necessary. Failure to follow this instruction could result in personal injury or death.

## Hilly Condition Usage

You should select a lower gear when the system is active in situations such as prolonged downhill driving on steep slopes, for example in mountainous areas.

# Adaptive Cruise Control (If Equipped)

## ADAPTIVE CRUISE CONTROL LIMITATIONS

### Sensor Limitations

**WARNING:** On rare occasions, detection issues can occur due to the road infrastructures, for example bridges, tunnels and safety barriers. In these cases, the system may brake late or unexpectedly. At all times, you are responsible for controlling your vehicle, supervising the system and intervening, if required.

**WARNING:** If the system malfunctions, have your vehicle checked as soon as possible.

**WARNING:** Large contrasts in outside lighting can limit sensor performance.

**WARNING:** The system only warns of vehicles detected by the radar sensor. In some cases there may be no warning or a delayed warning. Apply the brakes when necessary. Failure to follow this instruction could result in personal injury or death.

**WARNING:** The system may not detect stationary or slow moving vehicles below 6 mph (10 km/h).

**WARNING:** The system does not detect pedestrians or objects in the road.

**WARNING:** The system does not detect oncoming vehicles in the same lane.

**WARNING:** The system may not operate properly if the sensor is blocked. Keep the windshield free from obstruction.

**WARNING:** The sensor may incorrectly track lane markings as other structures or objects. This can result in a false or missed warning.

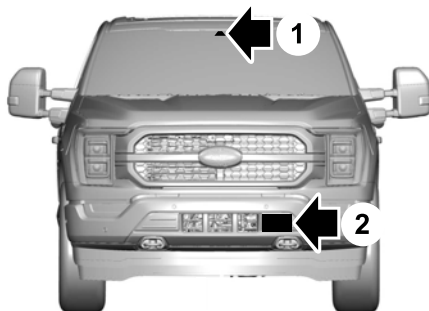

- 1 Camera.
- 2 Radar sensor.

The camera is on the windshield behind the interior mirror.

The radar sensor is in the lower grille.

**Note:** You cannot see the sensor. It is behind a fascia panel.

**Note:** Keep the front of your vehicle free of dirt, metal badges or objects. Vehicle front protectors, aftermarket lights, additional paint or plastic coatings could also degrade sensor performance.

A message displays if something obstructs the camera or the sensor. When something blocks the sensor, the system cannot detect a vehicle ahead and does not function. See **Adaptive Cruise Control – Information Messages** (page 325).

# Adaptive Cruise Control (If Equipped)

The radar sensor has a limited field of view. It may not detect vehicles at all or detect a vehicle later than expected in some situations. The lead vehicle image does not illuminate if the system does not detect a vehicle in front of you.

## Detection Issues Can Occur:

A

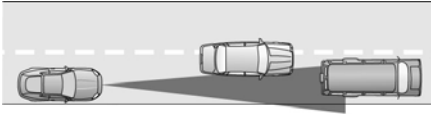

B

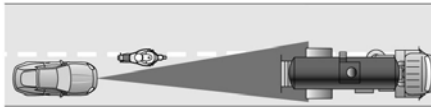

C

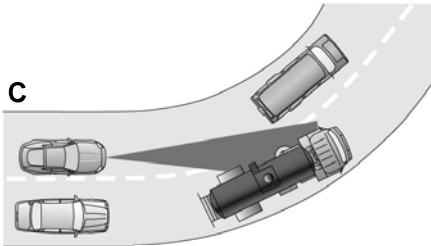

- A When driving on a different line than the vehicle in front.
- B With vehicles that edge into your lane. The system can only detect these vehicles once they move fully into your lane.
- C There may be issues with the detection of vehicles in front when driving into and coming out of a bend or curve in the road.

In these cases, the system may brake late or unexpectedly.

If something hits the front end of your vehicle or damage occurs, the radar-sensing zone may change. This could cause missed or false vehicle detection.

Optimal system performance requires a clear view of the road by the windshield camera.

Optimal performance may not occur if:

- The camera is blocked.
- There is poor visibility or lighting conditions.
- There are bad weather conditions.

## SWITCHING ADAPTIVE CRUISE CONTROL ON AND OFF

The cruise controls are on the steering wheel. See **Visual Search** (page 30).

### Switching Adaptive Cruise Control On



Press the button to activate the system. When the system activates, the set speed is equal to whichever is greater, the current vehicle speed, or 15 mph when in imperial units or 20 km/h when in metric units. If the speed is too low, or other conditions are not correct for adaptive cruise control activation, the system enters standby mode. When you are below 15 mph when in imperial units, adaptive cruise control does not activate unless you are following another vehicle.

The indicator, current gap setting and set speed appear in the instrument cluster display.



# Adaptive Cruise Control (If Equipped)

## Switching Adaptive Cruise Control Off



Press the button when the system is in standby mode or switch the ignition off.

**Note:** When you switch the system off, the set speed clears.

## ADAPTIVE CRUISE CONTROL AUTOMATIC CANCELLATION

The system may cancel if:

- The tires lose traction.
- You apply the parking brake.

The system may cancel and set the parking brake if:

- You unbuckle the seatbelt and open the driver door after you stop your vehicle.
- Your vehicle is at a stop continuously for more than three minutes.

The system may deactivate or prevent activating when requested if:

- The vehicle has a blocked sensor.
- The brake temperature is too high.
- There is a failure in the system or a related system.

## SETTING THE ADAPTIVE CRUISE CONTROL SPEED

Drive to the speed you prefer.



Press the Set+ or Set- buttons to set the current speed.



Take your foot off the accelerator pedal.

The indicator, current gap setting and set speed appear in the information display.



A vehicle image illuminates if there is a vehicle detected in front of you.

**Note:** When adaptive cruise control is active, the speedometer may vary slightly from the set speed displayed in the information display.

## Setting the Adaptive Cruise Speed from a Complete Stop



Press the Set+ or Set- buttons while keeping the brake pedal fully depressed.



The set speed adjusts to 20 km/h when in metric units or 15 mph when in imperial units.

The indicator, current gap setting and set speed appear in the information display.

**Note:** The system will activate from a complete stop only when it detects a lead vehicle in close proximity.

# Adaptive Cruise Control (If Equipped)

## Manually Changing the Set Speed

**SET+** Press the Set+ button to increase the set speed in small increments. Press and hold the Set+ button to accelerate. Release the button when you have reached your preferred speed.

**SET-** Press the Set- button to decrease the set speed in small increments. Press and hold the Set- button to decelerate. Release the button when you have reached your preferred speed.

You can also press the accelerator or brake pedal until you reach the speed you prefer. Press the Set+ or Set- button to select the current speed as the set speed.

The system may apply the brakes to slow the vehicle to the new set speed. The set speed continuously displays in the information display when the system is active.

## SETTING THE ADAPTIVE CRUISE CONTROL GAP

 Press the button to cycle through the four gap settings.



The selected gap appears in the information display as shown by the bars in the image.

**Note:** *The gap setting is time dependent and therefore, the distance adjusts with your vehicle speed.*

**Note:** *It is your responsibility to select a gap appropriate to the driving conditions.*

## Adaptive Cruise Control Gap Settings

Graphic Display, Bars Indicated Between Vehicles	Gap Distance	Dynamic Behavior
1	Closest.	Sport.
2	Close.	Normal.
3	Medium.	Normal.
4	Far.	Comfort.

Each time you switch the system on, it selects the last chosen gap setting.

# Adaptive Cruise Control (If Equipped)

## Following a Vehicle

When a vehicle ahead of you enters the same lane or a slower vehicle is ahead in the same lane, the vehicle speed adjusts to maintain the gap setting.

**Note:** *When you are following a vehicle and you switch on a turn signal lamp, adaptive cruise control may provide a small, temporary acceleration to help you pass.*

Your vehicle maintains a consistent gap from the vehicle ahead until:

- The vehicle in front of you accelerates to a speed above the set speed.
- The vehicle in front of you moves out of the lane you are in.
- You set a new gap distance.

The system applies the brakes to slow down your vehicle to maintain a safe gap distance from the vehicle in front of you. The system only applies limited braking. You can override the system by applying the brakes.

**Note:** *The brakes may emit noise when applied by the system.*

If the system determines that its maximum braking level is not sufficient, an audible warning sounds, a message appears in the information display and an indicator flashes when the system continues to brake. Take immediate action.

## CANCELING THE SET SPEED



Press the button or tap the brake pedal.

The set speed does not erase.

## RESUMING THE SET SPEED



Press the button.

Your vehicle speed returns to the previously set speed and gap setting. The set speed displays continuously in the information display when the system is active.

**Note:** *Only use resume if you are aware of the set speed and intend to return to it.*

## Resuming the Set Speed from a Complete Stop

If your vehicle follows a vehicle to a complete stop and remains stationary for less than a few seconds, your vehicle accelerates from a stationary position to follow the vehicle ahead.

If your vehicle follows a vehicle to a complete stop and remains stationary for more than a few seconds, an indicator and message displays.



# Adaptive Cruise Control (If Equipped)

Message	Action
Stopped	Cruise control does not resume automatically when this display is active.
Press button to resume	If the lead vehicle begins to move, you are prompted to press the resume button. Press and release the button or use the accelerator pedal to resume following the lead vehicle.
Auto-Resume	Displays when on a limited access highway after following a vehicle to a complete stop. In this situation, the vehicle resumes following the lead vehicle without a button press or pressing the accelerator pedal. The system can remain in auto-resume state for approximately 30 seconds, after which it no longer automatically resumes.

## OVERRIDING THE SET SPEED



**WARNING:** If you override the system by pressing the accelerator pedal, it does not automatically apply the brakes to maintain a gap from any vehicle ahead.

When you press the accelerator pedal, you override the set speed and gap distance.

Use the accelerator pedal to intentionally exceed the set speed limit.

When you override the system, the green indicator illuminates and the vehicle icon does not appear in the instrument cluster display.

The system resumes operation when you release the accelerator pedal. The vehicle speed decreases to the set speed, or a lower speed if following a slower vehicle.

## ADAPTIVE CRUISE CONTROL INDICATORS



Illuminates when you switch adaptive cruise control on. The color of the indicator changes to indicate the system status.

White indicates the system is on but inactive.

Green indicates that you set the speed and the system is active.

## SWITCHING FROM ADAPTIVE CRUISE CONTROL TO CRUISE CONTROL



**WARNING:** Normal cruise control will not brake when your vehicle is approaching slower vehicles. Always be aware of which mode you have selected and apply the brakes when necessary.

# Adaptive Cruise Control (If Equipped)

1. Press **Features** on the touchscreen.
2. Press **Driver Assistance**.
3. Press **Cruise Control**.
4. Press **Normal Cruise Control**.



The cruise control indicator replaces the adaptive cruise control indicator if you select normal cruise control. The gap setting does not display, and the system does not respond to lead vehicles. Automatic braking remains active to maintain set speed. The system remembers the last setting when you start your vehicle.

## LANE CENTERING

### How Does Lane Centering Work

Adaptive cruise control with lane centering uses radar and camera sensors to help keep your vehicle in the lane by applying continuous assistance steering torque input toward the lane center on highways.

**Note:** *The adaptive cruise control gap setting operates normally.*

### Lane Centering Precautions



**WARNING:** Do not use the system when towing a trailer. Failure to follow this instruction could result in the loss of control of your vehicle, personal injury or death.



**WARNING:** Do not use the system if any changes or modifications to the steering wheel have been made. Any changes or modifications to the steering wheel could affect the functionality or performance of the system. Failure to follow this instruction could result in the loss of control of your vehicle, personal injury or death.

Adaptive cruise control precautions apply to lane centering unless stated otherwise or contradicted by a lane centering precaution. See **Adaptive Cruise Control Precautions** (page 315).

### Lane Centering Requirements

You must keep your hands on the steering wheel at all times.

The system only activates when all of the following occur:

- You have adaptive cruise control with stop and go on.
- Lane centering assist is enabled in your information and entertainment screen. See **Switching Lane Centering On and Off** (page 323).
- You have your hands on the steering wheel.
- The system detects both lane markings.

**Note:** *If it does not detect valid lane markings, the system stays inactive until valid markings are available.*

### Lane Centering Limitations

Adaptive cruise control limitations apply to lane centering unless stated otherwise or contradicted by a lane centering limitation. See **Adaptive Cruise Control Limitations** (page 316).

# Adaptive Cruise Control (If Equipped)

Lane Centering may not correctly operate in any of the following conditions:

- Your vehicle is not centered in the lane.
- The lane is too narrow or wide.
- The system does not detect at least one lane marking or when lanes merge or split.
- Limited steering torque input is applied.
- Areas under construction or new infrastructure.
- When modifications to the steering system have been made.
- When using a spare tire.
- In high wind conditions.

**Note:** *The driving assistance torque is limited and may not be sufficient for all driving situations such as driving through tight curves or driving through curves at high speeds.*

**Note:** *In exceptional conditions, the system may deviate from the center line.*

## Switching Lane Centering On and Off

You must keep your hands on the steering wheel at all times.

The controls are on the steering wheel.



Press the button.

The indicator appears in the information display. When the system is on, the color of the indicator changes to indicate the system status.

You can override the system at any time by steering your vehicle.

**Note:** *The correct requirements must be met before you can switch the system on. See **Lane Centering Requirements** (page 322).*

## Enabling and Disabling Lane Centering

1. Press **Features** on the touchscreen.
2. Press **Driver Assistance**.
3. Press **Cruise Control**.
4. Press **Lane Centering Assist**.

## Lane Centering Alerts

You must keep your hands on the steering wheel at all times.

When the system is active and detects no steering activity for a period of time, the system alerts you to put your hands on the steering wheel. If you do not react to the warnings the system cancels and slows your vehicle down to idle speeds while maintaining steering control.

The system also alerts you if your vehicle crosses lane markings without detected steering activity.

**Note:** *The system may detect a light grip or touch on the steering wheel as hands-off driving.*

When an external condition cancels the system, for example, no lane markings available, a tone sounds and a message appears in the instrument cluster display.



If your vehicle starts to slow down, provide steering input to the wheel and press and release the button to regain full system performance.

**Note:** *The system disables until the next key cycle if your vehicle slows down due to driver inactivity twice within a key cycle.*

# Adaptive Cruise Control (If Equipped)

## Lane Centering Automatic Cancellation

When an external condition cancels the system, for example, no lane markings available, a tone sounds and a message appears in the instrument cluster display.



If your vehicle starts to slow down, you must provide steering input to the wheel and press and release the button to regain full system performance.

Automatic cancellation can also occur if:

- The lane becomes too wide or too narrow.
- The system cannot detect valid lane markings.
- Lane markings cross over one another.

**Note:** *The system disables until the next key cycle if your vehicle slows down due to driver inactivity twice within a key cycle.*

## Lane Centering Indicators



Illuminates when you switch lane centering on. The color of the indicator changes to indicate the system status.

Gray indicates the system is on but inactive.

Green indicates the system is active and applying steering torque assistance input to keep your vehicle in the center of the lane.

Amber with an audible tone and then gray indicates a system automatic cancellation.

## INTELLIGENT ADAPTIVE CRUISE CONTROL (If Equipped)

### How Does Intelligent Adaptive Cruise Control Work

Intelligent adaptive cruise control combines speed sign recognition with adaptive cruise control to adjust the cruise set speed to the speed limit detected by the speed sign recognition system. As the system detects new speed signs, the set speed updates.

**Note:** *The adaptive cruise control gap setting operates normally.*

### Intelligent Adaptive Cruise Control Precautions



**WARNING:** You are responsible for controlling your vehicle at all times. The system is designed to be an aid and does not relieve you of your responsibility to drive with due care and attention. Failure to follow this instruction could result in the loss of control of your vehicle, personal injury or death.

### Intelligent Adaptive Cruise Control Requirements

Traffic sign recognition must be enabled for intelligent adaptive cruise control to be active.

### Intelligent Adaptive Cruise Control Limitations

The speed limit information provided by the navigation map data could be inaccurate or out of date.

## Adaptive Cruise Control (If Equipped)

The system may not detect and read speed limit signs with conditional information, for example, when a sign is flashing, during specific time ranges, or when children are present.

**Note:** *The system does not set the vehicle speed to speed limits shown with a supplementary traffic sign.*

Under certain conditions, the system may not adjust the vehicle speed until after your vehicle passes the speed limit.

### Switching Intelligent Mode On and Off

1. Press **Features** on the touchscreen.
2. Press **Driver Assistance**.
3. Press **Cruise Control**.
4. Press **Intelligent**.

### Adjusting the Set Speed Tolerance

1. Press **Features** on the touchscreen.
2. Press **Driver Assistance**.
3. Press **Cruise Control**.
4. Press **Adaptive Cruise Control**.
5. Press **Speed Sign Recognition**.
6. Press **Tolerance**.
7. Use **+** and **-** to set the tolerance.

**Note:** *You cannot set the tolerance more than 19 mph (30 km/h) above or below the recognized speed.*

### Intelligent Adaptive Cruise Control Alerts

If you increase the set speed beyond the speed limit or speed limit plus a positive tolerance value, the set speed indicator flashes.

The warning does not occur if:

- You override the set speed using the accelerator pedal.
- The vehicle speed exceeds the set speed due to being on a downhill slope.

### Intelligent Adaptive Cruise Control Indicators



The set speed limit displays next to the detected speed limit in the instrument cluster.

### ADAPTIVE CRUISE CONTROL – TROUBLESHOOTING

#### Adaptive Cruise Control – Information Messages - Vehicles With: Lane Centering

**Note:** *Depending on your vehicle options and instrument cluster type, not all messages display or are available.*

**Note:** *The system could abbreviate or shorten certain messages depending upon which cluster type you have.*



## Adaptive Cruise Control (If Equipped)

---

<b>Message</b>	<b>Action</b>
Keep Hands on Steering Wheel	Make sure you return your hands to the steering wheel and provide steering input.
Lane Centering Assist Not Available	Lane centering assist conditions exist preventing the system from being available.
Resume Control	The system is going to cancel and you must take control.
Press Accelerator Pedal to Resume	Press the accelerator and follow the prompts.

## Adaptive Cruise Control (If Equipped)

### Adaptive Cruise Control – Information Messages - Vehicles With: Stop and Go

**Note:** Depending on your vehicle options and instrument cluster type, not all messages display or are available.

**Note:** The system could abbreviate or shorten certain messages depending upon which cluster type you have.

Message	Action
Adaptive Cruise Malfunction	A malfunction is preventing the adaptive cruise from engaging.
Front Sensor Not Aligned	Contact an authorized dealer to have the radar checked for proper coverage and operation.
Adaptive Cruise Not Available	Conditions exist preventing the system from being available.
Adaptive Cruise Not Available Sensor Blocked See Manual	You have a blocked radar because of poor radar visibility due to inclement weather or ice, mud, or water in front of the radar. You can typically clean the sensor to resolve this. Due to the nature of radar technology, it is possible to get a blockage warning with no actual block. This happens, for example, when driving in sparse rural or desert environments. A false blocked condition either self clears, or clears after you restart your vehicle.
Normal Cruise Active Adaptive Braking Off	You have selected normal cruise control. The system does not brake or react to traffic.
Adaptive Cruise - Driver Resume Control	Displays when the adaptive cruise control is going to cancel and you must take control.
Adaptive Cruise Speed Too Low to Activate	Displays when the vehicle speed is too slow to activate the adaptive cruise control and there is no lead vehicle in range.

# Drive Mode Control

## WHAT IS DRIVE MODE CONTROL

Your vehicle has various drive modes that you can select for different driving conditions. Depending on the drive mode that you select, the system adjusts various vehicle settings.

## HOW DOES DRIVE MODE CONTROL WORK

Drive mode control adjusts your vehicle configuration for each mode you select.

Changing the drive mode changes the functionality of the steering system to adjust the steering effort and feel.

The stability and traction control assist your vehicle control in adverse conditions or high-performance driving.

Throttle control enhances the powertrain response, transmission controls become optimized with shift schedules, and four-wheel drive settings are optimized and tuned to each mode.

Changing the drive mode engages or disengages the electronic locking differential.

Changing the drive mode changes the four-wheel drive modes to be the default, available or not available.

**Note:** The system has diagnostic checks that continuously monitor the system for proper operation. If a mode is unavailable due to a system fault, the mode defaults to normal.

**Note:** The system reverts to the normal mode each time you start your vehicle. At startup the system also displays a prompt on the instrument cluster display that gives you the option to return to the previously selected drive mode during the last ignition cycle. If you select yes, the system returns to the last selected drive mode and the driveline setting associated with that mode. If you select no, the system remains in normal mode and the driveline setting associated with that mode. If you do not select yes or no, the system stays in normal mode and the driveline stays in the last used setting.

## SELECTING A DRIVE MODE



Rotate the drive mode control on the center console to select or change a drive mode.

**Note:** Button icons vary depending on the vehicle.

# Drive Mode Control

## DRIVE MODES

### Deep Snow/Sand - 4x4



For off-road driving on soft, dry sand or deep snow. This mode optimizes accelerator pedal response, traction and stability controls to help maintain forward momentum. If your vehicle becomes stuck in deep conditions, use this mode to help get unstuck.

Four-wheel drive high is the default four-wheel drive mode. Four-wheel drive low is selectable in deep snow/sand mode.

**Note:** Do not use this mode when driving on pavement or packed snow. This could cause driveline bind up and damage the system depending on the four-wheel drive mode selection. See **Four-Wheel Drive** (page 260).

### Eco - 4x4



For efficient driving. This mode helps deliver maximum fuel efficiency and helps to increase driving range.

Two-wheel drive high is the default four-wheel drive mode. Four-wheel drive low is not available in eco mode.

### Eco - 4x2



For efficient driving. This mode helps deliver maximum fuel efficiency and helps to increase driving range.

### Mud/Ruts - 4x4



For off-road driving. This mode enhances vehicle performance to traverse muddy, rutted or uneven terrains.

Four-wheel drive high is the default four-wheel drive mode. Four-wheel drive low is selectable in mud/rut mode.

**Note:** Do not use this mode when driving on pavement or packed snow. This could cause driveline bind up and damage the system depending on the four-wheel drive mode selection. See **Four-Wheel Drive** (page 260).

### Normal - 4x4



For everyday driving. This mode is the perfect balance of excitement, comfort and convenience. This is the default mode after each ignition cycle.

Two-wheel drive high is the default four-wheel drive mode. All four-wheel drive modes are selectable when in normal mode.

### Normal - 4x2



For everyday driving. This mode is the perfect balance of excitement, comfort and convenience. This is the default mode after each ignition cycle.

### Rock Crawl - 4x4



For off-road driving and optimum rock-climbing. Rock crawl mode engages the electronic locking differential. Rock crawl mode optimizes the throttle and transmission response to provide you additional control of your vehicle.

Four-wheel drive low is the only four-wheel drive mode available in rock crawl mode.

# Drive Mode Control

## Slippery - 4x2



For less than ideal road conditions such as snow or ice covered roads. This mode can be used for crossing terrain where a firm surface is covered with loose, wet or slippery material. Slippery mode lowers throttle response and optimizes shifting for slippery surfaces.

**Note:** Do not use this mode when driving on dry pavement. This could cause driveline bind up and damage the system depending on the four-wheel drive mode selection. See **Four-Wheel Drive** (page 260).

## Slippery - 4x4, Vehicles With: 2-Speed Torque On Demand



For less than ideal road conditions such as snow or ice covered roads. This mode can be used for crossing terrain where a firm surface is covered with loose, wet or slippery material. Slippery mode lowers throttle response and optimizes shifting for slippery surfaces.

Four-wheel drive auto is the default four-wheel drive mode. Two-wheel drive high is not available in slippery mode.

**Note:** Do not use this mode when driving on dry pavement. This could cause driveline bind up and damage the system depending on the four-wheel drive mode selection. See **Four-Wheel Drive** (page 260).

## Slippery - 4x4, Vehicles With: Electronic Shift-On-The-Fly



For less than ideal road conditions such as snow or ice covered roads. This mode can be used for crossing terrain where a firm surface is covered with loose, wet or slippery material. Slippery mode lowers throttle response and optimizes shifting for slippery surfaces.

Four-wheel drive high is the default four-wheel drive mode. All four-wheel drive modes are selectable in slippery mode.

**Note:** Do not use this mode when driving on dry pavement. This could cause driveline bind up and damage the system depending on the four-wheel drive mode selection. See **Four-Wheel Drive** (page 260).

## Sport - 4x2



For sporty driving with improved performance handling and response. This mode increases accelerator pedal response and provides a sportier steering feel. The powertrain system holds onto lower gears longer, helping your vehicle accelerate faster.

## Sport - 4x4, Vehicles With: 2-Speed Torque On Demand



For sporty driving with improved performance handling and response. This mode increases accelerator pedal response and provides a sportier steering feel. The powertrain system holds onto lower gears longer, helping your vehicle accelerate faster.

Four-wheel drive auto is the default four-wheel drive mode. Four-wheel drive low is not available in sport mode.

# Drive Mode Control

## Sport - 4x4, Vehicles With: Electronic Shift-On-The-Fly



For sporty driving with improved performance handling and response. This mode increases accelerator pedal response and provides a sportier steering feel. The powertrain system holds onto lower gears longer, helping your vehicle accelerate faster.

Two-wheel drive high is the default four-wheel drive mode. Four-wheel drive low is not available in sport mode.

## Tow/Haul - 4x4



For improved transmission operation when towing a trailer or a heavy load. This mode moves upshifts to higher engine speeds to reduce the frequency of transmission shifting. This mode also provides engine braking in all forward gears, which slows your vehicle and assists you in controlling your vehicle when descending a grade. The amount of downshift braking provided varies based on the amount you press the brake pedal.

All four-wheel drive modes are selectable in tow/haul mode. This mode does not default to a certain four-wheel drive mode.

## Tow/Haul - 4x2



For improved transmission operation when towing a trailer or a heavy load. This mode moves upshifts to higher engine speeds to reduce the frequency of transmission shifting. This mode also provides engine braking in all forward gears, which slows your vehicle and assists you in controlling your vehicle when descending a grade. The amount of downshift braking provided varies based on the amount you press the brake pedal.

## Trail - 4x2



Trail mode is for off-road driving on muddy, rutted, soft or uneven terrain. This mode lowers throttle response to increase wheel spin to keep the tires clear and to prevent getting stuck.

## DRIVE MODE CONTROL – TROUBLESHOOTING

### Drive Mode Control – Warning Lamps



Some drive modes reduce traction and stability control performance and the indicator illuminates in the instrument cluster.

## Drive Mode Control – Information Messages

Message	Action
Selected 4x4 Mode Not Available in Current Drive Mode	You have selected a four-wheel drive mode that is not available in the current drive mode. Select an available four-wheel drive mode.

# Drive Mode Control

---

## **Drive Mode Control – Frequently Asked Questions**

### **Why did the system default to normal mode?**

If a mode is unavailable due to a system fault, it defaults to normal mode.

# Lane Keeping System (If Equipped)

## WHAT IS THE LANE KEEPING SYSTEM

The lane keeping system alerts you by providing temporary steering assistance or steering wheel vibration when it detects an unintended lane departure.

## HOW DOES THE LANE KEEPING SYSTEM WORK

The lane keeping system uses a forward looking camera mounted on the windshield to monitor vehicle movement within the travel lane.

When the camera detects a drift out of the travel lane, the lane keeping system alerts the driver by vibrating the steering wheel, or aids the driver by providing a small steering input to move the vehicle back into the travel lane.

The driver can select one of three modes:

- Alert (If Equipped)
- Aid
- Alert + Aid

## LANE KEEPING SYSTEM PRECAUTIONS



**WARNING:** You are responsible for controlling your vehicle at all times. The system is designed to be an aid and does not relieve you of your responsibility to drive with due care and attention. Failure to follow this instruction could result in the loss of control of your vehicle, personal injury or death.



**WARNING:** The system will not operate if the sensor cannot track the road lane markings.



**WARNING:** The sensor may incorrectly track lane markings as other structures or objects. This can result in a false or missed warning.



**WARNING:** In cold and severe weather conditions the system may not function. Rain, snow and spray can all limit sensor performance.



**WARNING:** The system may not operate properly if the sensor is blocked. Keep the windshield free from obstruction.



**WARNING:** If damage occurs in the immediate area surrounding the sensor, have your vehicle checked as soon as possible.



**WARNING:** The system may not correctly operate if your vehicle is fitted with a suspension kit not approved by US.

## LANE KEEPING SYSTEM LIMITATIONS

The lane keeping system only operates when the vehicle speed is greater than 40 mph (64 km/h).

The system works when the camera can detect at least one lane marking.

The lane keeping system may not correctly operate in any of the following conditions:

- The lane keeping system does not detect at least one lane marking.
- You switch the turn signal on.
- You apply direct steering, accelerate fast or brake hard.
- The vehicle speed is less than 40 mph (64 km/h).



# Lane Keeping System (If Equipped)

- The anti-lock brake, stability control or traction control system activates.
- The lane is too narrow.
- Something is obscuring the camera or it is unable to detect the lane markings due to environment, traffic or vehicle conditions.
- Entering or exiting a tight curve when driving at high speeds.

The lane keeping system may not correct lane positioning in any of the following conditions:

- High winds.
- Uneven road surfaces.
- Heavy or uneven loads.
- Incorrect tire pressure.

## SWITCHING THE LANE KEEPING SYSTEM ON AND OFF



To activate the lane keeping system, press the button on the steering wheel.

To deactivate the lane keeping system, press the button again.

**Note:** When switching the system on or off a message appears in the information and entertainment display to show the status.

**Note:** The system stores the on or off setting until manually changed, unless it detects a MyKey™. If the system detects a MyKey™, it defaults to the last setting for that MyKey™.

**Note:** If the system detects a MyKey™, pressing the button does not affect the on or off status of the system. You can only change the mode and intensity settings.

## SWITCHING THE LANE KEEPING SYSTEM MODE

The lane keeping system has different settings that you can view or adjust using the information display.

The system stores the last known selection for each of these settings. You do not need to readjust your settings each time you switch on the system.

To change the lane keeping system mode, use the touchscreen:

1. Press **Features** on the touchscreen.
2. Press **Driver Assistance**.
3. Press **Lane-Keeping System**.
4. Press **Lane-Keeping Mode**.
5. Select a mode.

**Note:** The system remembers the last setting when you start your vehicle. If the system detects a MyKey™, it defaults to the last setting for that MyKey™.

## ALERT MODE

### What Is Alert Mode

Alert mode vibrates the steering wheel when it detects an unintended lane departure.

# Lane Keeping System (If Equipped)

## How Does Alert Mode Work

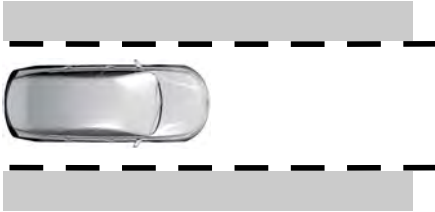

When in alert mode, the lane keeping system alerts you by vibrating the steering wheel. The intensity of the vibration is set through the lane keeping system menu.

### Adjusting the Steering Wheel Vibration Intensity

To change the steering wheel vibration intensity, use the touchscreen:

1. Press **Features** on the touchscreen.
2. Press **Driver Assistance**.
3. Press **Lane-Keeping System**.
4. Press **Lane-Keeping Intensity**.
5. Select an intensity setting.

## AID MODE

### What Is Aid Mode

Aid mode provides temporary steering assistance toward the center of the lane.

## How Does Aid Mode Work

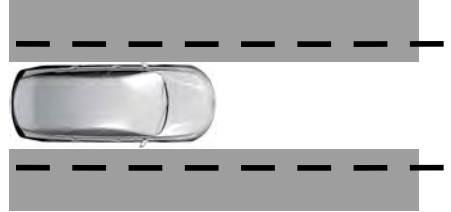

The lane keeping system aids you when an unintentional lane departure occurs. The system provides a small steering input to move the vehicle towards the center of the lane.

## ALERT AND AID MODE

### What Is Alert and Aid Mode

Alert and aid mode uses multiple features to keep you in your lane. The system first provides a small steering input to bring your vehicle back towards the center of the lane. If your vehicle moves too far out of the center of the lane the system alerts you with vibration in the steering wheel.

# Lane Keeping System (If Equipped)

## How Does Alert and Aid Mode Work

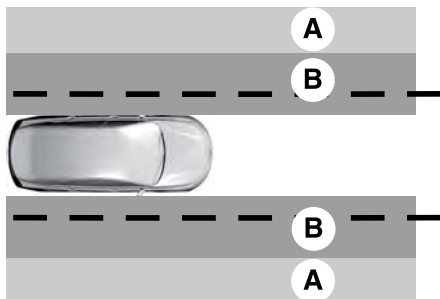

A Alert.

B Aid.

The lane keeping system detects a lane departure and provides aid when the vehicle enters **B** and applies the additional alert warning if **A** is entered.

## LANE KEEPING SYSTEM INDICATORS

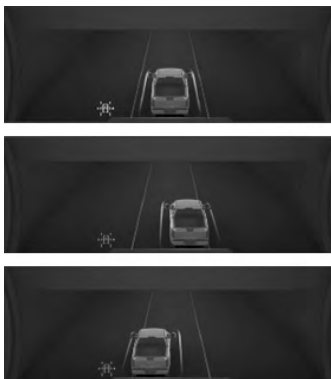

If you switch the lane keeping system on, a graphic with lane markings appears in the information display.

When you switch the system off, the lane marking graphics do not display.

**Note:** *The overhead vehicle graphic may still display if adaptive cruise control is enabled.*

While the lane keeping system is on, the color of the lane markings change to indicate the system status.

Gray	Green	Yellow	Red
Indicates that the system is temporarily unavailable to provide a warning or intervention on the indicated side.	Indicates that the system is available or ready to provide a warning or intervention on the indicated side.	Indicates that the system is providing or has just provided a lane keeping aid intervention.	Indicates that the system is providing or has just provided a lane keeping alert warning.

# Lane Keeping System (If Equipped)

---

## LANE KEEPING SYSTEM – TROUBLESHOOTING

### Lane Keeping System – Information Messages

<b>Message</b>	<b>Action</b>
Lane Keeping Sys. Malfunction Service Required	The system has malfunctioned. Have your vehicle checked as soon as possible.
Front Camera Temporarily Not Available	The system has detected a condition that has caused the system to be temporarily unavailable.
Front Camera Low Visibility Clean Screen	The system has detected a condition that requires you to clean the windshield in order for it to operate properly.
Front Camera Malfunction Service Required	The system has malfunctioned. Have your vehicle checked as soon as possible.
Keep Hands on Steering Wheel	The system requests that you keep your hands on the steering wheel.

# Lane Keeping System (If Equipped)

## Lane Keeping System – Frequently Asked Questions

<b>Why is the feature not available (lane markings are gray) when I can see the lane markings on the road?</b>
Your vehicle speed is less than 40 mph (65 km/h).
The sun is shining directly into the camera lens.
A quick intentional lane change has occurred.
Your vehicle stays too close to the lane markings for an extended interval of time.
Driving at high speeds in curves.
The last alert warning or aid intervention occurred a short time ago.
Ambiguous lane markings, for example, in construction zones.
Rapid transition from light to dark, or from dark to light.
Sudden offset in lane markings.
ABS or AdvanceTrac™ is active.
There is a camera blockage due to dirt, grime, fog, frost or water on the windshield.
You are driving too close to the vehicle in front of you.
Transitioning between no lane markings to lane markings, or vice versa.
There is standing water on the road.
Faint lane markings, for example, partial yellow lane markings on concrete roads.
Lane width is too narrow or too wide.
You have not calibrated the camera after a windshield replacement.
Driving on tight or on uneven roads.

## Lane Keeping System (If Equipped)

---

**Why does the vehicle not come back toward the middle of the lane, as expected, in the Aid, or Aid + Alert mode?**

High cross winds are present.

There is a large road crown.

Rough roads, grooves or shoulder drop-offs.

Heavy, uneven loading of the vehicle or improper tire inflation pressure.

You changed the tires or modified the suspension.

# Blind Spot Information System (If Equipped)

## WHAT IS BLIND SPOT INFORMATION SYSTEM

Blind spot information system detects vehicles that may have entered the blind spot zone.

## HOW DOES BLIND SPOT INFORMATION SYSTEM WORK

Blind spot information system uses sensors on both sides of your vehicle, detecting rearward from the exterior mirrors to approximately 13 ft (4 m) beyond the rear bumper. The detection area extends to approximately 59 ft (18 m) beyond the rear bumper when the vehicle speed is greater than 30 mph (48 km/h) to alert you of faster approaching vehicles.



E255695

## BLIND SPOT INFORMATION SYSTEM PRECAUTIONS



**WARNING:** Do not use the blind spot information system as a replacement for using the interior and exterior mirrors or looking over your shoulder before changing lanes. The blind spot information system is not a replacement for careful driving.



**WARNING:** The system may not operate properly during severe weather conditions, for example snow, ice, heavy rain and spray. Always drive with due care and attention. Failure to take care may result in a crash.

**Note:** *Blind spot information system does not prevent contact with other vehicles. It does not detect parked vehicles, pedestrians, animals or other infrastructure.*

## BLIND SPOT INFORMATION SYSTEM LIMITATIONS

Blind spot information system does not operate in park (P) or reverse (R).

The system may not alert you if a vehicle quickly passes through the detection zone.

## BLIND SPOT INFORMATION SYSTEM REQUIREMENTS

Blind spot information system turns on when all the following occur:

- You start your vehicle.
- You shift into drive (D).
- The vehicle speed is greater than 6 mph (10 km/h).

## SWITCHING BLIND SPOT INFORMATION SYSTEM ON AND OFF

To switch blind spot information system on or off, use the touchscreen:

1. Press **Features** on the touchscreen.
2. Press **Driver Assistance**.
3. Press **Blind Spot Information System**.
4. Switch the feature on or off.

## Blind Spot Information System (If Equipped)

When you switch blind spot information system off, a warning lamp illuminates and a message displays. When you switch the system on or off, the alert indicators flash twice.

**Note:** *The system remembers the last setting when you start your vehicle.*

To permanently switch the system off, contact an authorized dealer.

### LOCATING THE BLIND SPOT INFORMATION SYSTEM SENSORS

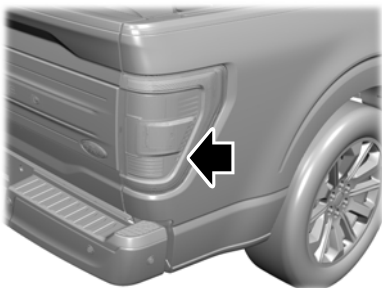

The sensors are inside the brake lamp on both sides of your vehicle.

**Note:** *Keep the sensors free from snow, ice and large accumulations of dirt.*

**Note:** *Do not cover the sensors with bumper stickers, repair compound or other objects.*

**Note:** *Blocked sensors may affect system accuracy.*

If the sensors become blocked, a message appears in the instrument cluster display. See **Blind Spot Information System – Information Messages** (page 343). The alert indicators illuminate but the system does not alert you.

### BLIND SPOT INFORMATION SYSTEM WITH TRAILER COVERAGE (If Equipped)

#### What Is Blind Spot Information System with Trailer Coverage

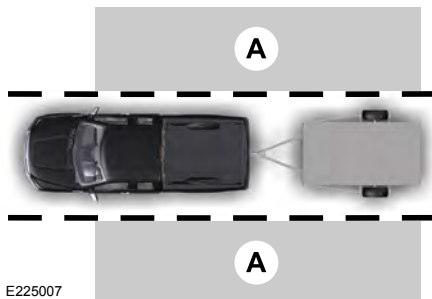

E225007

Blind spot information system detects vehicles that may have entered the blind spot zone.

#### Blind Spot Information System With Trailer Coverage Limitations

Trailer coverage only supports conventional trailers. The system turns off if you select a fifth wheel trailer type.

Make sure the trailer width is less than 8.5 ft (2.6 m) and the length is less than 33 ft (10.1 m). If you input values higher, the system turns off.



# Blind Spot Information System (If Equipped)

Some trailers could cause a slight change in system performance:

- Large box trailers could cause false alerts to occur when driving next to infrastructures or near parked cars. A false alert could also occur while making a 90-degree turn.
- Trailers that have a width greater than 8.5 ft (2.6 m) at the front and have a total length greater than 20 ft (6 m) could cause delayed alerts when a vehicle is passing at high speeds.
- Box trailers that have a width greater than 8.5 ft (2.6 m) at the front could cause early alerts when you pass a vehicle.
- Clam shell or v-nose box trailers with a width greater than 8.5 ft (2.6 m) at the front could cause delayed alerts when a vehicle traveling the same speed as your vehicle merges lanes.

## Setting a Trailer Length

You can set-up a trailer to work with the blind spot information system through the touchscreen. When setting up a trailer, a sequence of screens appear asking for trailer information.

1. Select type of trailer screen - conventional, fifth wheel or gooseneck.

**Note:** The system only supports conventional trailers.

2. Do you want to set up blind spot with trailer screen? If no, the system turns off. If yes, the menu goes to the next screen.
3. Is the width less than 9 ft (2.6 m) and length less than 33 ft (10.1 m)? If no, the system turns off. If yes, the menu goes to the next screen.

4. Trailer width measurement. Measure the width at the front of the trailer. It is not measured at the widest point of the trailer. The maximum width at the front of the trailer the system can support is 9 ft (2.6 m).

**Note:** You do not need to enter an exact trailer width measurement. You only need to confirm that the width of the trailer is 9 ft (2.6 m) or less.

5. Trailer length measurement. The trailer length is the distance between the trailer hitch ball and the rear of the trailer. The maximum length that the system can support is 33 ft (10.1 m).
6. Enter the length of trailer. The default setting is 18 ft (5.5 m). Toggling up or down using the menu buttons increases or decreases the measurement by 3 ft (1 m). Select a length that is equal to or within 3 ft (1 m) of the actual measured length. For example, if the actual measure length is 25 ft (7.5 m), toggle the length in the menu to 27 ft (8.2 m). The system setup saves when you enter the length of the trailer.

**Note:** If the trailer is a bike rack or cargo rack with electrical lighting, enter a length of 3 ft (1 m). Cross traffic alert remains on for trailers with a length of 3 ft (1 m) or less.

**Note:** The system requires proper measurement and measure entry to function properly.

## Selecting a Trailer

When you connect a trailer to your vehicle, the trailer set up menu appears in the touchscreen. This menu allows you to set up a new trailer or choose from a previously set up trailer. A warning message appears and the system turns off if you do not choose or add a new trailer.

# Blind Spot Information System (If Equipped)

**Note:** The warning message may not appear until your vehicle reaches 22 mph (35 km/h).

## BLIND SPOT INFORMATION SYSTEM INDICATORS



When blind spot information system detects a vehicle, an alert indicator illuminates in the exterior mirror on the side the approaching vehicle is coming from. If you turn the turn signal on for that side of your vehicle, the alert indicator flashes.

## BLIND SPOT INFORMATION SYSTEM – TROUBLESHOOTING

### Blind Spot Information System – Information Messages

Message	Action
Blind Spot System Fault	A fault with the system has occurred. Have your vehicle checked as soon as possible.
Blind Spot Not Available Sensor Blocked See Manual	Something is blocking the sensors. Clean the sensors.
Blind Spot Alert Deactivated Trailer Attached	The system automatically turns off and displays this message when you connect a trailer to the vehicle that does not have a trailer blind spot system or when you switch the trailer blind spot system off through the touchscreen.

# Cross Traffic Alert (If Equipped)

## WHAT IS CROSS TRAFFIC ALERT

The system alerts you of vehicles approaching from the sides behind your vehicle when you shift into reverse (R).

## HOW DOES CROSS TRAFFIC ALERT WORK

Cross Traffic Alert detects vehicles that approach at a speed between 4–37 mph (6–60 km/h). Coverage decreases when the sensors are partially, mostly or fully obstructed.

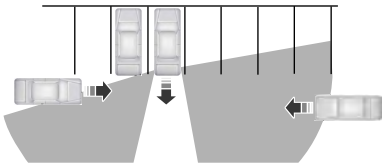

E142440

The sensor on the left-hand side is only partially obstructed and zone coverage on the right-hand side is maximized.

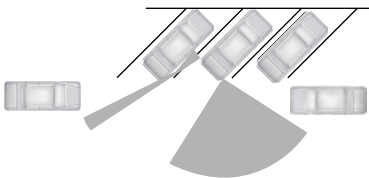

E142441

Zone coverage also decreases when parking at narrow angles. The sensor on the left-hand side is mostly obstructed and zone coverage on that side is severely reduced.

**Note:** *Slowly reversing helps increase the coverage area and effectiveness.*

## CROSS TRAFFIC ALERT PRECAUTIONS

**WARNING:** Do not use the cross traffic alert system as a replacement for using the interior and exterior mirrors or looking over your shoulder before reversing out of a parking space. The cross traffic alert system is not a replacement for careful driving.

**WARNING:** The system may not operate properly during severe weather conditions, for example snow, ice, heavy rain and spray. Always drive with due care and attention. Failure to take care may result in a crash.

## CROSS TRAFFIC ALERT LIMITATIONS

Cross Traffic Alert may not correctly operate when any of the following occur:

- Something is blocking the sensors.
- Adjacently parked vehicles or objects are obstructing the sensors.
- Vehicles approach at speeds less than 4 mph (6 km/h) or greater than 37 mph (60 km/h).
- Your vehicle speed is greater than 7 mph (12 km/h).
- You reverse out of an angled parking space.

## SWITCHING CROSS TRAFFIC ALERT ON AND OFF

To switch cross traffic alert on or off use the touchscreen.

1. Press **Features** on the touchscreen.
2. Press **Driver Assistance**.

## Cross Traffic Alert (If Equipped)

3. Switch **Cross Traffic Alert** on or off.

**Note:** The system switches on every time you switch the ignition on. To permanently switch the system off, contact an authorized dealer.

### LOCATING THE CROSS TRAFFIC ALERT SENSORS

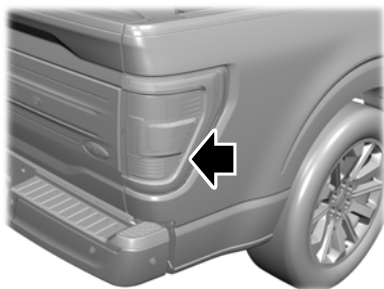

The sensors are inside the brake lamp on both sides of your vehicle.

**Note:** Keep the sensors free from snow, ice and large accumulations of dirt.

**Note:** Do not cover the sensors with bumper stickers, repair compound or other objects.

**Note:** Blocked sensors may affect system accuracy.

If something is blocking the sensors, a message may appear in the information display when you shift into reverse (R).

### CROSS TRAFFIC ALERT WITH TRAILER COVERAGE (If Equipped)

#### What Is Cross Traffic Alert With Trailer Coverage

Cross traffic alert with trailer coverage allows the system to continue operating with a trailer or trailer hitch attachment.

#### Cross Traffic Alert With Trailer Coverage Limitations

Cross traffic alert remains on when you attach a trailer in vehicles that come with blind spot information system with trailer tow under the following conditions:

- You connect a trailer.
- The trailer is a bike rack or cargo rack with a maximum length of 3 ft (1 m).
- You set the trailer length to 3 ft (1 m) in the information display.

**Note:** The system may not correctly operate when towing a trailer. For vehicles with an approved trailer tow module and tow bar, the system turns off when you attach a trailer. For vehicles with an aftermarket trailer tow module or tow bar, we recommend that you switch the system off when you attach a trailer.

### CROSS TRAFFIC ALERT INDICATORS



When the cross traffic alert detects an approaching vehicle, a tone sounds, a warning lamp illuminates in the relevant exterior mirror and arrows appear in the information display to show which side the vehicle is approaching from.

## Cross Traffic Alert (If Equipped)

If the system malfunctions, a warning lamp illuminates in the instrument cluster and a message appears in the information display. Have your vehicle checked as soon as possible.

**Note:** *If arrows do not display, a message appears in the information display.*

**Note:** *In some conditions, the system could alert you, even when there is nothing in the detection zone, for example a vehicle passing further away from your vehicle.*

## CROSS TRAFFIC ALERT – TROUBLESHOOTING

### Cross Traffic Alert – Information Messages

Message	Action
Cross Traffic Alert	Displays instead of indication arrows when the system detects a vehicle. Check for approaching traffic.
Cross Traffic Not Available Sensor Blocked See Manual	Indicates blocked cross traffic alert system sensors. Clean the sensors. If the message continues to appear, have your vehicle checked as soon as possible.
Cross Traffic System Fault	The system has malfunctioned. Have your vehicle checked as soon as possible.
Cross Traffic Alert Deactivated Trailer Attached	Displays if you attach a trailer to your vehicle.

# Pre-Collision Assist

## WHAT IS PRE-COLLISION ASSIST

### [Pre-Collision Assist with Pedestrian Detection](#)

Pre-collision assist detects and warns of approaching hazards in the roadway. If your vehicle is rapidly approaching another stationary vehicle, a vehicle traveling in the same direction as yours, or a pedestrian within your driving path, the system provides multiple levels of assistance to help avoid a collision.

## HOW DOES PRE-COLLISION ASSIST WORK

The system warns the driver of potential hazards by providing three levels of assistance.

If your vehicle is rapidly approaching potential hazards the system provides the following levels of functionality:

1. Alert.
2. Brake Support.
3. Automatic Emergency Braking.



**Alert:** When active, a flashing visual warning appears and an audible warning tone sounds.

**Brake Support:** The system is designed to help reduce the impact speed by preparing the brakes for rapid braking. The system does not automatically apply the brakes. If you press the brake pedal, the system could apply additional braking up to maximum braking force, even if you lightly press the brake pedal.

**Automatic Emergency Braking:** Automatic emergency braking may activate if the system determines that a collision is imminent.

**Note:** If you perceive pre-collision assist alerts as being too frequent or disturbing, then you can reduce the alert sensitivity, although the manufacturer recommends using the highest sensitivity setting where possible. Setting lower sensitivity would lead to fewer and later system warnings.

Each system has various levels of detection capabilities. See **Pre-Collision Assist Limitations** (page 348).

## PRE-COLLISION ASSIST PRECAUTIONS



**WARNING:** You are responsible for controlling your vehicle at all times. The system is designed to be an aid and does not relieve you of your responsibility to drive with due care and attention. Failure to follow this instruction could result in the loss of control of your vehicle, personal injury or death.



**WARNING:** The system does not detect vehicles that are driving in a different direction, cyclists or animals. Apply the brakes when necessary. Failure to follow this instruction could result in the loss of control of your vehicle, personal injury or death.



**WARNING:** The system does not operate during hard acceleration or steering. Failure to take care may lead to a crash or personal injury.



**WARNING:** The system may fail or operate with reduced function during cold and severe weather conditions. Snow, ice, rain, spray and fog can adversely affect the system. Keep the front camera and radar free of snow and ice. Failure to take care may result in the loss of control of your vehicle, serious personal injury or death.

# Pre-Collision Assist



**WARNING:** Take additional care if your vehicle is heavily loaded or you are towing a trailer. These conditions could result in reduced performance of this system. Failure to follow this instruction could result in the loss of control of your vehicle, personal injury or death.



**WARNING:** The system cannot help prevent all crashes. Do not rely on this system to replace driver judgment and the need to maintain a safe distance and speed.



**WARNING:** In situations where the vehicle camera has limited detection capability, this may reduce system performance. These situations include but are not limited to direct or low sunlight, vehicles at night without tail lights, unconventional vehicle types, pedestrians with complex backgrounds, running pedestrians, partly obscured pedestrians, or pedestrians that the system cannot distinguish from a group. Failure to take care may result in the loss of control of your vehicle, serious personal injury or death.

**Note:** *Brake support and automatic emergency braking are active at speeds up to 75 mph (120 km/h). If the vehicle has a radar sensor included with adaptive cruise control, then brake support and automatic emergency braking are active up to the maximum speed of the vehicle.*

## Pedestrian Detection Limitations

Pedestrian detection is active at speeds up to 50 mph (80 km/h).

Pedestrian detection operates optimally when detected hazards are clearly identifiable. System performance may reduce in situations where pedestrians are running, partly obscured, have a complex background, or cannot be distinguished from a group.

## Intersection Assist (If Equipped)

If your vehicle comes with a radar sensor included in adaptive cruise control, the pre-collision assist system may operate in a scenario where you are turning across an oncoming vehicle's path. Detection of vehicles driving in an oncoming direction is active if your vehicle is driving at speeds up to 19 mph (30 km/h).

## PRE-COLLISION ASSIST LIMITATIONS

Pre-collision assist depends on the detection ability of its camera and sensors. Any obstructions or damage to these areas can limit detection or prevent the system from functioning. See **Locating the Pre-Collision Assist Sensors** (page 349).

The system is active at speeds above 3 mph (5 km/h)

**Note:** *The pre-collision assist system automatically disables when you select four-wheel drive low, manually disable AdvanceTrac™, or select rock crawl mode.*

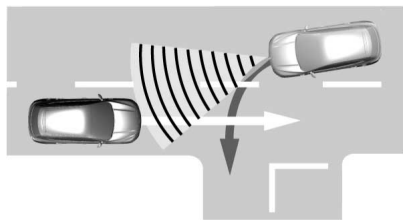

# Pre-Collision Assist

## SWITCHING PRE-COLLISION ASSIST ON AND OFF

To switch the system on or off, use the touchscreen:

1. Press **Features** on the touchscreen.
2. Press **Driver Assistance**.
3. Press **Pre-Collision Assist**.
4. Switch the feature on or off.

## Adjusting the Pre-Collision Assist Settings

You can adjust the following settings by using the touchscreen controls in the pre-collision assist menu:

- Change alert and distance alert sensitivity to one of three possible settings.
- Switch distance indication and alert on or off.
- If required, switch automatic emergency braking on or off.
- If required, switch the entire pre-collision assist feature on or off.
- If required, switch evasive steering assist on or off.

**Note:** *Automatic emergency braking and evasive steering turn on every time you switch the ignition on.*

**Note:** *If your vehicle has a radar sensor, we recommend that you switch the system off if you install a snow plow or similar object in such a way that it may block the radar sensor. Your vehicle remembers the selected setting across key cycles.*

**Note:** *If you switch automatic emergency braking off, evasive steering assist switches off.*

## LOCATING THE PRE-COLLISION ASSIST SENSORS

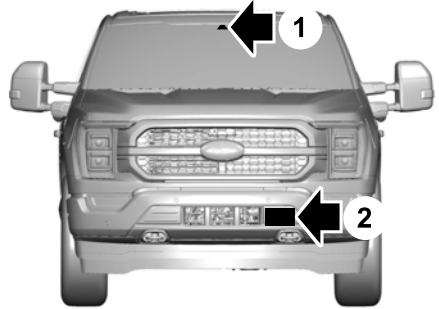

- 1 Camera.
- 2 Radar sensor (if equipped).

If a message regarding a blocked sensor or camera appears in the information display, something is obstructing the radar signals or camera images. The radar sensor is behind the fascia cover in the center of the lower grille. With a blocked sensor or camera, the system may not function, or performance may reduce. See **Pre-Collision Assist – Information Messages** (page 353).

**Note:** *Proper system operation requires a clear view of the road by the camera. Have any windshield damage in the area of the camera's field of view repaired.*

**Note:** *If something hits the front end of your vehicle or damage occurs and your vehicle has a radar sensor, the radar sensing zone could change. This could cause missed or false vehicle detections. Have your vehicle serviced to have the radar checked for proper coverage and operation.*



# Pre-Collision Assist

**Note:** If your vehicle detects excessive heat at the camera or a potential misalignment condition, a message could display in the information display indicating temporary sensor unavailability. When operational conditions are correct, the message deactivates. For example, when the ambient temperature around the sensor decreases or the sensor recalibrates successfully.

## DISTANCE INDICATION (If Equipped)

### What Is Distance Indication

Distance indication displays the gap between your vehicle and the vehicle ahead of you.

**Note:** The graphic does not display if you switch on cruise control or adaptive cruise control.

Vehicle Speed	System Sensitivity	Distance Indicator Color	Distance Gap	Time Gap
62 mph (100 km/h).	Normal.	Gray.	Greater than 82 ft (25 m).	Greater than 0.9 seconds.
		Yellow.	56–82 ft (17–25 m).	0.6–0.9 seconds.
		Red.	Less than 56 ft (17 m).	Less than 0.6 seconds.

# Pre-Collision Assist

## Switching Distance Indication On and Off

To switch the system on or off, use the touchscreen:

1. Press **Features** on the touchscreen.
2. Press **Driver Assistance**.
3. Press **Pre-Collision Assist**.
4. Switch **Distance Indication** on or off.

## Distance Indication Indicator

The indicator displays the time gap between your vehicle and vehicles traveling in the same direction ahead of you.



## DISTANCE ALERT (If Equipped)

### What Is Distance Alert

The system alerts you with a warning lamp if the distance to the vehicle ahead is small.

**Note:** *The warning lamp does not illuminate if cruise control or adaptive cruise control is active.*

### Adjusting the Sensitivity of Distance Alert

To adjust the sensitivity of the system, use the touchscreen:

1. Press **Features** on the touchscreen.
2. Press **Driver Assistance**.
3. Press **Pre-Collision Assist**.
4. Press **Alert Sensitivity**.
5. Select a setting.

## AUTOMATIC EMERGENCY BRAKING

### What Is Automatic Emergency Braking

Automatic emergency braking may activate if the system determines that a collision is imminent. The system may help reduce impact damage to avoid the crash completely.

Automatic emergency braking is only available up to certain speeds. See **Pre-Collision Assist Limitations** (page 348).

# Pre-Collision Assist

---

## Switching Automatic Emergency Braking On and Off

To switch the system on or off, use the touchscreen:

1. Press **Features** on the touchscreen.
2. Press **Driver Assistance**.
3. Press **Pre-Collision Assist**.
4. Press **Auto Emergency Braking**.
5. Switch the feature on or off.

## EVASIVE STEERING ASSIST (If Equipped)

### What Is Evasive Steering Assist

If your vehicle is rapidly approaching a road user, evasive steering assist helps you steer around the road user.

After you turn the steering wheel in an attempt to avoid a crash with the road user, the system applies additional steering torque to help you steer around the road user. After you pass the road user, the system applies steering torque when you turn the steering wheel to steer back into the lane. The system deactivates after you fully pass the road user.

**Note:** Road users are defined as obstacles encountered on the road that the system is able to detect. See **Pre-Collision Assist Precautions** (page 347).

## Evasive Steering Assist Limitations

Evasive steering assist only activates when all the following occur:

- Automatic emergency braking and evasive steering assist are on.
- The system detects a road user ahead and starts to apply the brakes.
- You significantly turn the steering wheel to steer around a road user.

**Note:** The system does not automatically steer around a road user. If you do not turn the steering wheel, the system does not activate.

**Note:** The system does not activate if the distance to the road user ahead is too small and the system cannot avoid a crash.

## Switching Evasive Steering Assist On and Off

To switch the system on or off, use the touchscreen:

1. Press **Features** on the touchscreen.
2. Press **Driver Assistance**.
3. Press **Pre-Collision Assist**.
4. Switch **Evasive Steering** on or off.

**Note:** If you switch automatic emergency braking off, evasive steering assist turns off.

**Note:** Automatic emergency braking and evasive steering assist turn on every time you switch the ignition on.

# Pre-Collision Assist

---

## PRE-COLLISION ASSIST – TROUBLESHOOTING

## Pre-Collision Assist – Warning Lamps



A telltale illuminates in the cluster to indicate if the system is disabled or unavailable.

## Pre-Collision Assist – Information Messages

Message	Action
Pre-Collision Assist Not Available Sensor Blocked	You have a blocked sensor due to bad weather, ice, mud or water in front of the radar sensor. You can typically clean the sensor to resolve.
Pre-Collision Assist Not Available	A fault with the system has occurred. Have your vehicle checked as soon as possible.

# Pre-Collision Assist

---

## **Pre-Collision Assist – Frequently Asked Questions**

### **Camera Troubleshooting**

#### **The windshield in front of the camera is dirty or obstructed.**

Clean the outside of the windshield in front of the camera.

#### **The windshield in front of the camera is clean, but the message remains in the instrument cluster display.**

Wait a short time. It could take several minutes for the camera to detect that there is no obstruction.

## **Pre-Collision Assist – Frequently Asked Questions - Vehicles With: Intersection Assist**

### **Camera Troubleshooting**

#### **The windshield in front of the camera is dirty or obstructed.**

Clean the outside of the windshield in front of the camera.

#### **The windshield in front of the camera is clean, but the message remains in the instrument cluster display.**

Wait a short time. It could take several minutes for the camera to detect that there is no obstruction.

### **Radar Troubleshooting (If Equipped)**

#### **The surface of the radar in the grille is dirty or obstructed.**

Clean the grille surface in front of the radar or remove the object causing the obstruction.

#### **The surface of the radar in the grille is clean, but the message remains in the instrument cluster display.**

Wait a short time. It could take several minutes for the radar to detect that there is no obstruction.

#### **Heavy rain, spray or fog is interfering with the radar signals.**

The pre-collision assist system is temporarily disabled. Pre-collision assist reactivates a short time after the weather conditions improve.

#### **Swirling water or snow or ice on the surface of the road could interfere with the radar signals.**

The pre-collision assist system is temporarily disabled. Pre-collision assist reactivates a short time after the weather conditions improve.

#### **Radar is out of alignment due to a front end impact.**

Have your vehicle serviced to have the radar checked for proper coverage and operation.

# Driver Alert (If Equipped)

## WHAT IS DRIVER ALERT

Driver alert alerts you if it determines that you are becoming drowsy or if your driving deteriorates.

## HOW DOES DRIVER ALERT WORK

Driver Alert calculates your alertness level based on your driving behavior in relation to the lane markings and other factors through use of the front camera sensor behind the interior mirror.

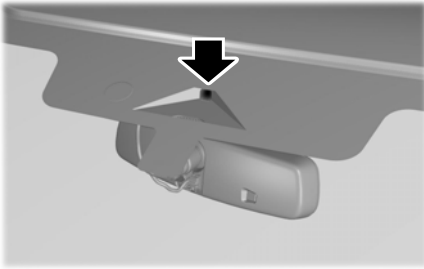

## DRIVER ALERT PRECAUTIONS

**WARNING:** You are responsible for controlling your vehicle at all times. The system is designed to be an aid and does not relieve you of your responsibility to drive with due care and attention. Failure to follow this instruction could result in the loss of control of your vehicle, personal injury or death.

**WARNING:** Take regular rest breaks if you feel tired. Do not wait for the system to warn you.

**WARNING:** Certain driving styles may result in the system warning you even if you are not feeling tired.

**WARNING:** In cold and severe weather conditions the system may not function. Rain, snow and spray can all limit sensor performance.

**WARNING:** The system will not operate if the sensor cannot track the road lane markings.

**WARNING:** If damage occurs in the immediate area surrounding the sensor, have your vehicle checked as soon as possible.

**WARNING:** The system may not correctly operate if your vehicle is fitted with a suspension kit not approved by us.

**WARNING:** The system may not operate properly if the sensor is blocked. Keep the windshield free from obstruction.

**Note:** If something is blocking the camera or damaged the windshield, Driver Alert may not function.

## DRIVER ALERT LIMITATIONS

Driver alert may not function correctly if:

- The sensor cannot track the road lane markings.
- Your vehicle's speed is less than approximately 40 mph (65 km/h).

## SWITCHING DRIVER ALERT ON AND OFF

1. Press **Features** on the touchscreen.

## Driver Alert (If Equipped)

---

2. Press **Driver Assistance**.
3. Switch **Driver Alert** on or off.

**Note:** *The system remains on or off depending on how it was last set.*

### Resetting Driver Alert

You can reset the system by either:

- Switching the ignition off and on.
- Stopping the vehicle and then opening and closing the driver door.

## DRIVER ALERT – TROUBLESHOOTING

### Driver Alert – Information Messages

Message	Action
Driver Alert Warning Rest Now	Stop and rest as soon as it is safe to do so.
Driver Alert Warning Rest Suggested	Take a rest soon.

# Speed Sign Recognition (If Equipped)

## WHAT IS SPEED SIGN RECOGNITION

Speed sign recognition detects speed limit signs to inform you of the current speed limit. Detected speed signs appear in the information display.

## HOW DOES SPEED SIGN RECOGNITION WORK

Speed sign recognition uses a sensor behind the interior mirror to detect speed signs.

If your vehicle has speed sign recognition with navigation, stored speed sign data may influence the indicated speed limit value.

## SPEED SIGN RECOGNITION PRECAUTIONS



**WARNING:** You are responsible for controlling your vehicle at all times. The system is designed to be an aid and does not relieve you of your responsibility to drive with due care and attention. Failure to follow this instruction could result in the loss of control of your vehicle, personal injury or death.



**WARNING:** In cold and severe weather conditions the system may not function. Rain, snow and spray can all limit sensor performance.



**WARNING:** The system may not operate properly if the sensor is blocked. Keep the windshield free from obstruction.

**Note:** Do not carry out windshield repairs in the immediate area surrounding the sensor.

**Note:** If your vehicle has a suspension kit not approved by us, the system may not correctly function.

**Note:** The system may not detect all speed signs and may incorrectly read signs.

**Note:** Always fit our original parts when replacing headlamp bulbs. Other bulbs may reduce system performance.

## SPEED SIGN RECOGNITION LIMITATIONS

Speed sign recognition may not operate correctly due to:

- Outdated map data.
- Incorrect recognition of speed limits by the sensor of signs on parallel roads or exit ramps.
- Missed recognition of faded, dirty, or distorted signs.

## SPEED SIGN RECOGNITION INDICATORS



When the system detects a speed limit sign, it appears in the information display.



## Speed Sign Recognition (If Equipped)

### SETTING THE SPEED SIGN RECOGNITION SPEED WARNING

To set the speed warning, use the touchscreen.

1. Press **Features** on the touchscreen.
2. Press **Driver Assistance**.
3. Press **Speed Sign Recognition**.
4. Switch the feature on or off.

### SETTING THE SPEED SIGN RECOGNITION SPEED TOLERANCE

To set the tolerance of the speed warning, use the touchscreen.

1. Press **Features** on the touchscreen.
2. Press **Driver Assistance**.
3. Press **Speed Sign Recognition**.
4. Press **Tolerance**.
5. Use the + and - buttons to select the required level.

## SPEED SIGN RECOGNITION – TROUBLESHOOTING

### Speed Sign Recognition – Information Messages

Message	Action
Traffic Sign Reduced Performance See Manual	The traffic sign data provided by the navigation system is unavailable due to weak or no signal. Wait for a short period of time for the signal to improve. If the message continues to appear, have the system checked as soon as possible.

# Speed Sign Recognition (If Equipped)

---

## **Speed Sign Recognition – Frequently Asked Questions**

### **Why does the speed limit change without any sign on the road?**

The speed limit changes due to the speed limit data stored in the map data.

### **Why does speed sign recognition show a wrong speed limit?**

The system shows a wrong speed limit due to incorrect and outdated map data or due to incorrect recognition of the speed limits by the camera.

# Load Carrying

## LOAD CARRYING PRECAUTIONS

Keep your loaded vehicle weight within its design rating capability, with or without a trailer. Properly loading your vehicle provides maximum return of vehicle design performance. Before you load your vehicle, become familiar with the following terms for determining your vehicle's weight rating, with or without a trailer, from the vehicle's Tire and Loading Information label or Safety Compliance Certification label.



**WARNING:** The appropriate loading capacity of your vehicle can be limited either by volume capacity (how much space is available) or by payload capacity (how much weight the vehicle should carry). Once you have reached the maximum payload of your vehicle, do not add more cargo, even if there is space available. Overloading or improperly loading your vehicle can contribute to loss of vehicle control and vehicle rollover.



**WARNING:** Exceeding the Safety Compliance Certification label vehicle weight limits can adversely affect the performance and handling of your vehicle, cause vehicle damage and can result in the loss of control of your vehicle, serious personal injury or death.



**WARNING:** Do not use replacement tires with lower load carrying capacities than the original tires because they may lower your vehicle's GVWR and GAWR limitations. Replacement tires with a higher limit than the original tires do not increase the GVWR and GAWR limitations.



**WARNING:** Do not exceed the GVWR or the GAWR specified on the certification label.



**WARNING:** Exceeding any vehicle weight rating can adversely affect the performance and handling of your vehicle, cause vehicle damage and can result in the loss of control of your vehicle, serious personal injury or death.



**WARNING:** When loading the roof racks, we recommend you evenly distribute the load, as well as maintain a low center of gravity. Loaded vehicles, with higher centers of gravity, may

# Load Carrying

handle differently than unloaded vehicles. Take extra precautions, such as slower speeds and increased stopping distance, when driving a heavily loaded vehicle.

The gross combined weight must never exceed the Gross Combined Weight Rating.

## USING A SLIDE-IN CAMPER

For information regarding the use of slide-in campers, consult the Truck Camper Loading document supplied with your vehicle.

**Note:** *We do not recommend using a slide-in camper on an F-150 SuperCrew cab.*

## LOCATING THE SAFETY COMPLIANCE CERTIFICATION LABELS

### Safety Compliance Certification Label Example:

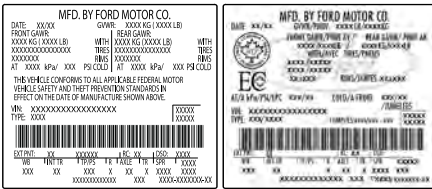

E198628

The Safety Compliance Certification label is located on the door hinge pillar, door-latch post, or the door edge that meets the door-latch post, next to the driver seating position.

## WHAT IS THE GROSS AXLE WEIGHT RATING

### GAWR (Gross Axle Weight Rating)

GAWR is the maximum allowable weight that a single axle (front or rear) can carry. These numbers are on the Safety Compliance Certification label.

## WHAT IS THE GROSS VEHICLE WEIGHT RATING

GVWR is the maximum allowable weight of the fully loaded vehicle. This includes all options, equipment, passengers and cargo. It appears on the Safety Compliance Certification label.

## WHAT IS THE GROSS COMBINED WEIGHT RATING

Gross Combined Weight Rating (GCWR) is the maximum allowable weight of the vehicle and the loaded trailer, including all cargo and passengers, that the vehicle can handle without risking damage. (Important: The towing vehicle's braking system is rated for operation at Gross Vehicle Weight Rating, not at Gross Combined Weight Rating.) Separate functional brakes should

## Load Carrying

---

be used for safe control of towed vehicles and for trailers where the Gross Combined Weight of the towing vehicle plus the trailer exceed the Gross Vehicle Weight Rating of the towing vehicle.

**Note:** For trailer towing information refer to the *RV and Trailer Towing Guide* available at an authorized dealer, or online at the website that follows.

<b>RV &amp; Trailer Towing Guide Online</b>	
Website	<a href="http://www.fleet.ford.com/towing-guides">www.fleet.ford.com/towing-guides</a>

# Load Carrying

## CALCULATING PAYLOAD

### Tire and Loading Label Information

#### Example:



**TIRE AND LOADING INFORMATION**

SEATING CAPACITY TOTAL : 5 FRONT: 2 REAR: 3

The combined weight of occupants, and cargo should never exceed: **385 kg or 850 lbs.**

TIRE	SIZE	COLD TIRE PRESSURE	SEE OWNERS MANUAL FOR ADDITIONAL INFORMATION
FRONT	235/45R18 94V	235 KPA, 34 PSI	
REAR	235/45R18 94V	235 KPA, 34 PSI	
SPARE	NONE	NONE	



**TIRE AND LOADING INFORMATION**  
**RENSEIGNEMENTS SUR LES PNEUS ET LE CHARGEMENT**

SEATING CAPACITY TOTAL 5 FRONT 2 REAR 3  
NOMBRE DE PLACES

The combined weight of occupants and cargo should never exceed 396 kg or 875 lbs.  
Le poids total des occupants et du chargement ne doit jamais dépasser

TIRE PNEU	SIZE DIMENSIONS	COLD TIRE PRESSURE PRESSION DES PNEUS A FROID	SEE OWNER'S MANUAL FOR ADDITIONAL INFORMATION  VOIR LE MANUEL DE L'USAGER POUR PLUS DE RENSEIGNEMENTS
FRONT AVANT	235/40R19 96V	255 KPA, 37 PSI	
REAR ARRIERE	235/40R19 96V	255 KPA, 37 PSI	
SPARE DE SECOURS	T125/80R16 97M	415 KPA, 60 PSI	

E198719

Payload is the combined weight of cargo and passengers that your vehicle is carrying. The maximum payload for your vehicle appears on the Tire and Loading label. The label is either on the B-pillar or the edge of the driver door. Vehicles exported outside the US and Canada may not have a tire and loading label. Look for "The combined weight of occupants and cargo should never exceed XXX kg or XXX lb" for maximum payload. The payload listed on the Tire and Loading Information label

is the maximum payload for your vehicle as built by the assembly plant. If you install any additional equipment on your vehicle, you must determine the new payload. Subtract the weight of the equipment from the payload listed on the Tire and Loading label. When towing, trailer tongue weight or king pin weight is also part of payload.

## CALCULATING THE LOAD LIMIT

Steps for determining the correct load limit:

1. Locate the statement "The combined weight of occupants and cargo should never exceed XXX kg or XXX lb." on your vehicle's placard.
2. Determine the combined weight of the driver and passengers that will be riding in your vehicle.
3. Subtract the combined weight of the driver and passengers from XXX kg or XXX lb.
4. The resulting figure equals the available amount of cargo and luggage load capacity. For example, if the "XXX" amount equals 1,400 lb. and there will be five 150 lb. passengers in your vehicle, the amount of available cargo and luggage load capacity is 650 lb. (1400-750 (5 x 150) = 650 lb.)

## Load Carrying

---

- Determine the combined weight of luggage and cargo being loaded on the vehicle. That weight may not safely exceed the available cargo and luggage load capacity calculated in Step 4.
- If your vehicle will be towing a trailer, load from your trailer will be transferred to your vehicle. Consult this manual to determine how this reduces the available cargo and luggage load capacity of your vehicle.

### Helpful examples for calculating the available amount of cargo and luggage load capacity

Suppose your vehicle has a 1400-pound (635-kilogram) cargo and luggage capacity. You decide to go golfing. Is there enough load capacity to carry you, four of your friends and all the golf bags? You and four friends average 220 pounds (99 kilograms) each and the golf bags weigh approximately 30 pounds (13.5 kilograms) each. The calculation would be:  $1400 - (5 \times 220) - (5 \times 30) = 1400 - 1100 - 150 = 150$  pounds. Yes, you have enough load capacity in your vehicle to transport four friends and your golf bags. In metric units, the calculation would be:  $635 \text{ kilograms} - (5 \times 99 \text{ kilograms}) - (5 \times 13.5 \text{ kilograms}) = 635 - 495 - 67.5 = 72.5$  kilograms.

Suppose your vehicle has a 1400-pound (635-kilogram) cargo and luggage capacity. You and one of your friends decide to pick up cement from the local home improvement store to finish that patio you have been planning for the past two years. Measuring the inside of the vehicle with the rear seat folded down, you have room for twelve 100-pound (45-kilogram) bags of cement. Do you have enough load capacity to transport the cement to your home? If you and your friend each weigh 220 pounds (99 kilograms), the calculation would be:  $1400 - (2 \times 220) - (12 \times 100) = 1400 - 440 - 1200 = -240$  pounds. No, you do not have enough cargo capacity to carry that much weight. In metric units, the calculation would be:  $635 \text{ kilograms} - (2 \times 99 \text{ kilograms}) - (12 \times 45 \text{ kilograms}) = 635 - 198 - 540 = -103$  kilograms. You will need to reduce the load weight by at least 240 pounds (104 kilograms). If you remove three 100-pound (45-kilogram) cement bags, then the load calculation would be:  $1400 - (2 \times 220) - (9 \times 100) = 1400 - 440 - 900 = 60$  pounds. Now you have the load capacity to transport the cement and your friend home. In metric units, the calculation would be:  $635 \text{ kilograms} - (2 \times 99 \text{ kilograms}) - (9 \times 45 \text{ kilograms}) = 635 - 198 - 405 = 32$  kilograms.

## Load Carrying

---

The above calculations also assume that the loads are positioned in your vehicle in a manner that does not overload the front or the rear gross axle weight rating specified for your vehicle on the Safety Compliance Certification label.



# Pickup Bed

## PICKUP BED PRECAUTIONS



**WARNING:** Do not allow people or animals in truck beds that have modifications, such as bed covers or slide-in campers, when the engine is running. Exhaust fumes are toxic. Failure to follow this instruction could result in personal injury or death.



**WARNING:** It is extremely dangerous to ride in a cargo area, inside or outside of a vehicle. In a crash, people riding in these areas are more likely to be seriously injured or killed. Do not allow people to ride in any area of your vehicle that is not equipped with seats and seatbelts. Make sure everyone in your vehicle is in a seat and properly using a seatbelt. Failure to follow this warning could result in serious personal injury or death.

the maximum payload of your vehicle, do not add more cargo, even if there is space available. Overloading or improperly loading your vehicle can contribute to loss of vehicle control and vehicle rollover.



**WARNING:** It is extremely dangerous to ride in a cargo area, inside or outside of a vehicle. In a crash, people riding in these areas are more likely to be seriously injured or killed. Do not allow people to ride in any area of your vehicle that is not equipped with seats and seatbelts. Make sure everyone in your vehicle is in a seat and properly using a seatbelt. Failure to follow this warning could result in serious personal injury or death.

## Locating the Pickup Bed Anchor Points

The pickup bed anchor points are located at each corner of the pickup bed.

## PICKUP BED ANCHOR POINTS

### Pickup Bed Anchor Point Precautions



**WARNING:** Always properly secure cargo to prevent shifting cargo or cargo falling from the vehicle. Failure to do so could result in compromised vehicle stability and serious personal injury to vehicle occupants or others.



**WARNING:** The appropriate loading capacity of your vehicle can be limited either by volume capacity (how much space is available) or by payload capacity (how much weight the vehicle should carry). Once you have reached

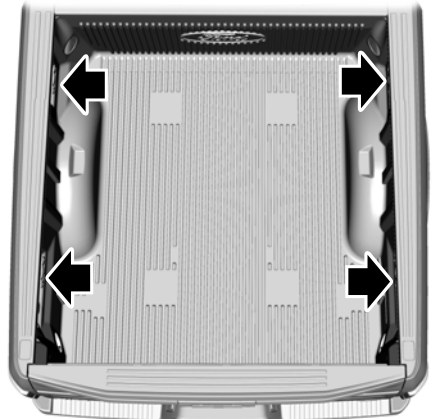

# Pickup Bed

## Installing and Removing the Pickup Bed Tie-Down Cleats (if

Equipped)

### Installing the Cleats

1. Insert the key into the lock and turn clockwise to unlock.
2. Insert the cleat into the pickup bed anchor point and slide upward.
3. Turn the key counterclockwise to lock.

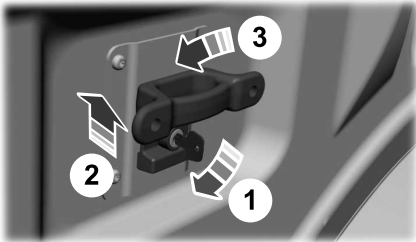
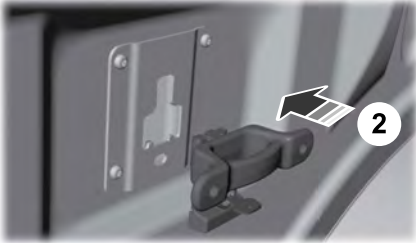

**Note:** Leave the key in the lock when removing or installing the cleats. The key cannot be removed unless it is in the locked position.

### Removing the Cleats

To remove, reverse the installation procedure.

## Pickup Bed Anchor Point Load Capacities

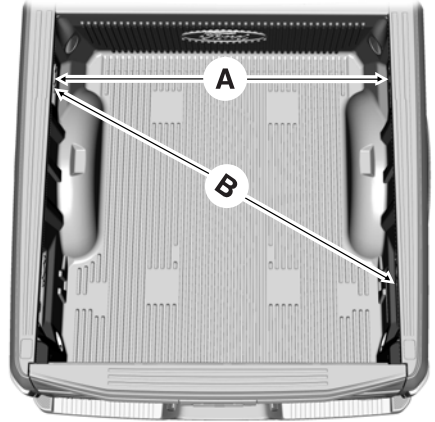

A	B
Maximum force between directly opposed cleats 276 lb (125 kg).	Maximum force between diagonally opposed cleats 600 lb (272 kg).

**Note:** You could damage the pickup bed walls if you overload the tie downs.

**Note:** Make sure that you properly balance and secure the cargo load. Failure to do this can cause cargo instability and damage to the box.

**Note:** Do not secure cargo with tie downs connected from the tie down brackets to the cargo box tie downs. This could cause the tailgate to detach.

# Pickup Bed

## TAILGATE ANCHOR POINTS

### Locating the Tailgate Anchor Points

The tailgate anchor points are located at each side of the tailgate.

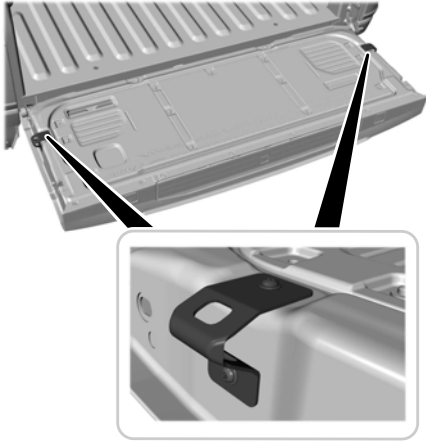

**Note:** You could damage the tailgate if you overload the tie downs.

### Tailgate Anchor Point Load Capacities

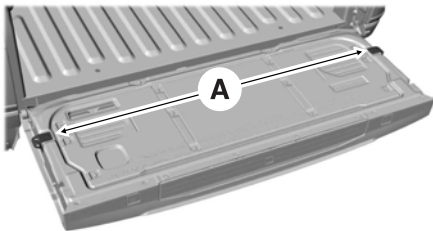

**A**

The maximum force between the tailgate anchor points 400 lb (181 kg).

**Note:** Do not secure cargo from a pickup bed anchor point to a tailgate anchor point. This could cause the tailgate to detach.

## PICKUP BED RAMPS

### Pickup Bed Ramp Precautions

**WARNING:** When sliding the ramp up or down, take care not to get your fingers or hands caught in the mechanism. Failure to follow this instruction could result in personal injury.

**WARNING:** Make sure that you correctly install the ramp to the tailgate plate. Failure to follow this instruction could result in personal injury.

**WARNING:** Do not step or sit on the ramp when it is in the stowed position. Failure to follow this instruction could result in personal injury.

**WARNING:** Only install the ramp within the prescribed ramp angles. Failure to follow this instruction could result in personal injury.

**Note:** Each pickup bed ramp has a maximum capacity of 400 lb (181.4 kg).

**Note:** Verify the ramp is on stable ground before usage.

**Note:** For loading and unloading equipment, your ramp should be set between 10 degrees upward and 26 degrees downward to avoid damage to the ramp claw and tailgate plate.

# Pickup Bed

**Note:** When using your vehicle for off-road operation, remove the bed ramps from the vehicle and store them in a safe location away from your vehicle.

## Installing and Removing the Pickup Bed Ramp Holder

### Installing the Ramp Holder

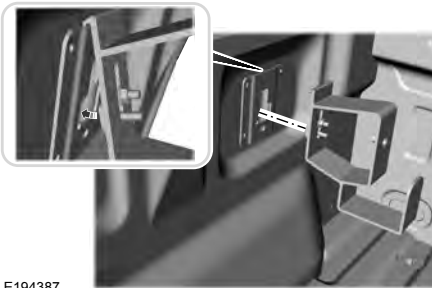

E194387

1. Hook the top of the ramp holder over the mounting plate and rotate the ramp holder into position.

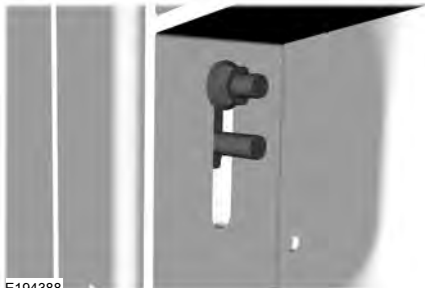

E194388

2. Slide the ramp holder studs upwards into the installed position.
3. Tighten the ramp holder nut.

**Note:** The nut should be on the upper stud.

### Removing the Ramp Holder

Remove in the reverse order.

## Installing and Removing the Pickup Bed Ramps

**Note:** You cannot use the pickup bed ramps with the tailgate work surface or tailgate step.

### Installing the Bed Ramp

1. Remove the front and rear cables.

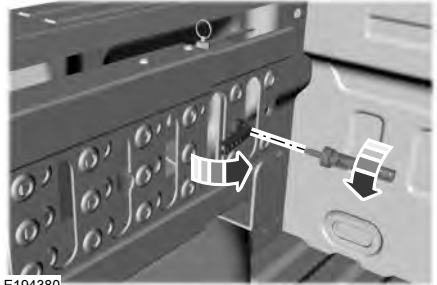

E194380

2. Open the cam lever arms and unscrew the cam bolts.
3. Remove the ramp from the ramp holder.



E211150

4. Rotate the stops at the underside of the ramp to the open position.

**Note:** You can use a smooth surface tool to rotate the stops.

# Pickup Bed

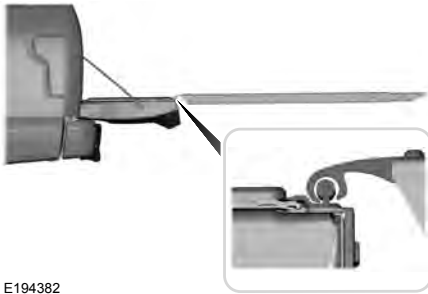

5. Slide the ramp claw onto the tailgate plate.

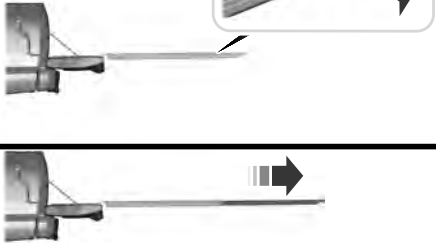
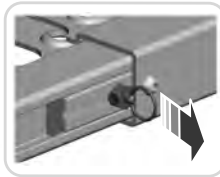

6. Pull the location pin outward and extend the ramp until the pin is seated in the usage position, then set the ramp on even ground.

## Removing the Ramp

Remove in the reverse order.

## Storing the Pickup Bed Ramps

### Storing the Bed Ramp

1. Pick up the ramp. Pull the location pin outward.
2. Slide the ramp into the storage position until the location pin locks.

**Note:** Make sure the proper pin location has been applied for your bed size.

3. Slide the ramp claw off of the tailgate plate.
4. Rotate the stops at the underside of the ramp to the closed position.

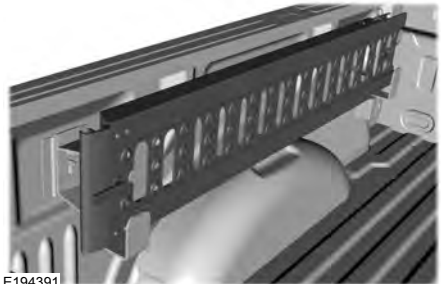

5. Place the ramp into the ramp holder.
6. Install the cam bolts and close the cam lever arms.
7. Attach the front and rear cables.

**Note:** Make sure you properly secure the locking cable. If the locking cable is unsecured, you may hear a rattling noise.

# Connecting a Trailer

## CONNECTING A TRAILER PRECAUTIONS



**WARNING:** Do not adjust the spring bars so that your vehicle's rear bumper is higher than before attaching the trailer. Doing so will defeat the function of the weight-distributing hitch, which may cause unpredictable handling, and could result in serious personal injury.

Do not tow a trailer until you drive your vehicle at least 1,000 mi (1,600 km).

Do not use a hitch that either clamps onto the bumper or attaches to the axle. You must distribute the load in your trailer so that 10-15% of the total weight of the trailer is on the trailer coupler.

Consult your local motor vehicle laws for towing a trailer.

See the instructions included with towing accessories for the proper installation and adjustment specifications.

Service your vehicle more frequently if you tow a trailer. See **Normal Scheduled Maintenance** (page 605).

If you use a rental trailer, follow the instructions the rental agency gives you.

When attaching the trailer wiring connector to your vehicle, only use a proper fitting connector that works with the vehicle and trailer functions.

Account for the trailer coupler weight as part of your vehicle load when calculating the total vehicle weight.

Do not exceed the load limits. See **Calculating the Load Limit** (page 363).

## HITCHES

### Hooking Up a Trailer Using a Weight-Distributing Hitch



**WARNING:** Do not adjust the spring bars so that your vehicle's rear bumper is higher than before attaching the trailer. Doing so will defeat the function of the weight-distributing hitch, which may cause unpredictable handling, and could result in serious personal injury.

When hooking-up a trailer using a weight-distributing hitch

1. Park the loaded vehicle, without the trailer, on a level surface.

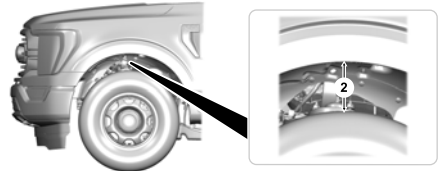

2. Measure the height of your vehicle's front wheel opening from the wheel to the fender.
3. Attach the loaded trailer to your vehicle without the weight-distributing bars connected.

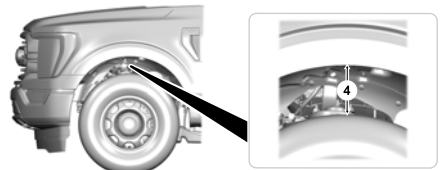

4. Measure the height of your vehicle's front wheel opening from the wheel to the fender a second time.

**Note:** *The second measurement should be greater than the first.*

# Connecting a Trailer

5. Install and adjust the tension in the weight-distributing bars so that the height of your vehicle's front wheel opening is between the first and second measurements.
6. Check that the trailer is level or slightly nose down toward your vehicle. If not, adjust the ball height accordingly and repeat steps 2-6.

Once the trailer is level or slightly nose down toward the vehicle:

- Lock the bar tension adjuster in place.
- Check that the trailer coupler securely attaches and locks onto the hitch.
- Install safety chains, lighting, and trailer brake controls as required by law or the trailer manufacturer.

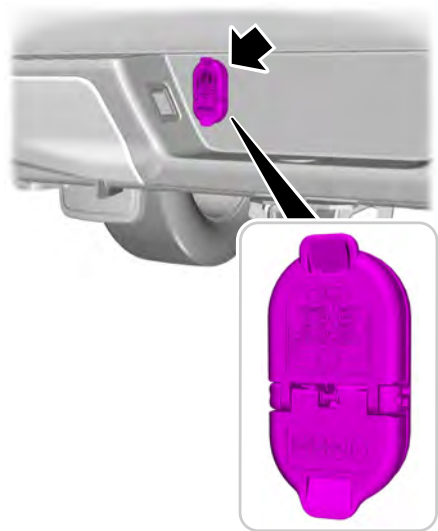

## CONNECTING A TRAILER

### [Smart Trailer Tow Connector](#)

#### Recognizing a Trailer

1. Attach the trailer and wiring connector to your vehicle.
2. Switch on your vehicle.
3. Set up a profile for the trailer using the touchscreen.

**Note:** *If your vehicle does not recognize the trailer, press and hold the brake pedal for a few seconds.*

**Note:** *Trailer profiles store trailer types, dimensions, preferences, trailer specific mileage and fuel economy.*

**Note:** *Disabling the trailer detection notification makes the default trailer profile active when a connection is detected.*

When attaching the trailer wiring connector to your vehicle, only use a proper fitting connector that works with the vehicle and trailer functions.

#### Safety Chains

Install trailer safety chains to the trailer hitch as recommended by the manufacturer. Cross the chains under the trailer coupler and allow enough slack for turning tight corners. Do not allow the chains to drag on the ground.

**Note:** *Do not attach safety chains to the bumper. Always connect the safety chains to the frame or hook retainers of your trailer hitch.*

# Connecting a Trailer

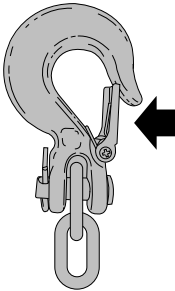

If the trailer safety chain hook has a latch, make sure the latch is fully closed.

## Trailer Brakes

Electric brakes and manual, automatic or surge-type trailer brakes are safe if you install them properly and adjust them to the manufacturer's specifications. The trailer brakes must meet local and federal regulations.

Separate functioning brake systems are required for safe control of towed vehicles and trailers weighing more than 1500 lb (680 kg) when loaded.

## Trailer Connection Checklist

1. Press **Features** on the touchscreen.
2. Press **Towing**.
3. Press **Connection Checklist**.

## Trailer Light Check



**WARNING:** Never connect any trailer lamp wiring to the vehicle's tail lamp wiring; this may damage the electrical system resulting in fire. Contact your authorized dealer as soon as possible for assistance in proper trailer tow wiring installation. Additional electrical equipment may be required.

Perform a trailer light illumination sequence to confirm that all lights are functioning by using the FordPass app.

**Note:** *The FordPass app allows one person to confirm that all lights are functioning.*

## Electronic Park Hold



Applies the electronic parking brake when you shift to park (P).

The electronic park hold button illuminates when activated.

The feature prevents your vehicle from moving in any direction when you are aligned with your trailer coupler and shift to park (P).

**Note:** *The feature is active for the current key cycle.*

You can also press a zoom button when using the camera views to switch the feature on.

## Trailer Connection Alarm

The alarm is set when the following occur:

- Your vehicle detects the trailer.
- Your vehicle is locked.
- The alarm is armed.

When the trailer is disconnected in this state, the vehicle alarm sounds and an alert is sent to your FordPass app.

**Note:** *For reliable trailer detection, the trailer's lamps must be SAE certified for each intended purpose.*

**Note:** *If the trailer is not compatible with the feature, the turn signals flash twice.*



# Connecting a Trailer

## CONNECTING A TRAILER – TROUBLESHOOTING

### Connecting a Trailer – Information Messages

<b>Message</b>	<b>Description</b>
Trailer Disconnected	The system senses a trailer connection becomes disconnected, either intentionally or unintentionally, during a given ignition cycle.
Trailer Wiring Fault	There are certain faults in your vehicle wiring and trailer wiring or brake system.
Trailer Battery Not Charging See Manual	There is a fault with your trailer battery, or your trailer battery voltage is very low.
Trailer Tire Low Specified:	One or more tires on your trailer is below the specified tire pressure.
Trailer Tire Over Temperature	Displays when one or more tires on the trailer is above the recommended temperature.
Trailer Tire Pressure Sensor Fault	A trailer tire pressure sensor is malfunctioning. If the warning stays on or continues to come on, have the system checked as soon as possible.
Trailer Tire Pressure Monitor Fault	The trailer tire pressure monitoring system is malfunctioning. If the warning stays on or continues to come on, have the system checked.
Trailer Tire Pressure Monitor Capability Not Detected	The system cannot detect the trailer tire pressure monitoring system.
Trailer Tire Pressure Indication Not Setup See Manual	The trailer tire pressure monitoring system is not setup.

# Towing a Trailer

## TOWING A TRAILER PRECAUTIONS



**WARNING:** Do not exceed the GVWR or the GAWR specified on the certification label.



**WARNING:** Towing trailers beyond the maximum recommended gross trailer weight exceeds the limit of your vehicle and could result in engine damage, transmission damage, structural damage, loss of vehicle control, vehicle rollover and personal injury.



**WARNING:** Do not exceed the lowest rating capacity for your vehicle or trailer hitch. Overloading your vehicle or trailer hitch can impair your vehicle stability and handling. Failure to follow this instruction could result in the loss of control of your vehicle, personal injury or death.



**WARNING:** Do not cut, drill, weld or modify the trailer hitch. Modifying the trailer hitch could reduce the hitch rating.



**WARNING:** The anti-lock brake system does not control the trailer brakes.

## TRAILER BRAKE PRECAUTIONS



**WARNING:** Do not connect a trailer's hydraulic brake system directly to your vehicle's brake system. Your vehicle may not have enough braking power and your chances of having a collision greatly increase.

The rating for the tow vehicle's braking system operation is at the gross vehicle weight rating, not the gross combined weight rating.

Trailers weighing more than 1,500 lb (680 kg) when loaded require separate functioning brake systems.

## TOWING A TRAILER LIMITATIONS

The vehicle's load capacity designation is by weight, not by volume, so you cannot necessarily use all available space when loading a vehicle or trailer.

**Note:** *Your vehicle could have reduced performance when operating at high altitudes and when heavily loaded or towing a trailer. When driving at elevation, to match driving performance as perceived at sea level, reduce gross vehicle weight and gross combination weight by 2% per 1,000 ft (300 m) elevation.*

# Towing a Trailer

---

## LOADING YOUR TRAILER

To help minimize how trailer movement affects your vehicle when driving:

- Load the heaviest items closest to the trailer floor.
- Load the heaviest items centered between the left and right side trailer tires.
- Load the heaviest items above the trailer axles or just slightly forward toward the trailer tongue. Do not allow the final trailer tongue weight to go above or below 10–15% of the loaded trailer weight. The trailer tongue weight should never exceed 10% of the maximum towing capacity.
- Select a ball mount with the correct rise or drop. When both the loaded vehicle and trailer are connected, the trailer frame should be level, or slightly angled down toward your vehicle, when viewed from the side.

## TRAILER TOWING HINTS

Towing a trailer places an extra load on your vehicle's engine, transmission, axle, brakes, tires and suspension. Periodically inspect these components during and after any towing operation.

When driving with a trailer or payload, a slight takeoff vibration or shudder may be present due to the increased payload weight.

Your vehicle may have a temporary or conventional spare tire. A temporary spare tire is different in diameter or width, tread-type, or is from a different manufacturer than the road tires on your vehicle. Consult information on the tire label or Safety Compliance label for limitations when using.

When towing a trailer:

- Obey country specific regulations for towing a trailer.
- Do not drive faster than 70 mph (113 km/h) during the first 500 mi (800 km).
- Do not make full-throttle starts.
- Check your hitch, electrical connections and trailer wheel lug nuts thoroughly after you have traveled 50 mi (80 km).
- When stopped in congested or heavy traffic during hot weather, place the transmission in park (P) to aid engine and transmission cooling and to help A/C performance.
- Turn off the speed control with heavy loads or in hilly terrain. The speed control may turn off when you are towing on long, steep slopes.
- Shift to a lower gear when driving down a long or steep hill. Do not continuously apply the brakes, as they may overheat and become less effective.
- If your transmission has Grade Assist or Tow/Haul, use this feature when towing. This provides engine braking and helps eliminate excessive transmission shifting for optimum fuel economy and transmission cooling.
- If your vehicle has AdvanceTrac with roll stability control, this system may turn on during typical cornering maneuvers with a heavily loaded trailer. This is normal. Turning the corner at a slower speed when towing may reduce this tendency.

# Towing a Trailer

---

- If you are frequently towing a trailer in hot weather, hilly conditions, at the gross combined weight rating or any combination of these factors, consider refilling your rear axle with synthetic gear lubricant if the axle is not already filled with it.
- Allow more distance for stopping with a trailer attached. Anticipate stops and gradually brake.
- Avoid parking on a slope. However, if you must park on a slope, turn the steering wheel to point your vehicle tires away from traffic flow, set the parking brake, place the transmission in park (P) and place wheel chocks in front and back of the trailer wheels.

**Note:** *Chocks are not included with your vehicle.*

**Note:** *Certain states require electric trailer brakes for trailers over a specified weight. Be sure to check state regulations for this specified weight. The maximum trailer weights listed may be limited to this specified weight, as your vehicle's electrical system may not include the wiring connector needed to use electric trailer brakes.*

## LAUNCHING OR RETRIEVING A BOAT OR PERSONAL WATERCRAFT

When backing down a ramp during boat launching or retrieval:

- Do not allow the static water level to rise above the bottom edge of the rear bumper.
- Do not allow waves to break higher than 6 in (15 cm) above the bottom edge of the rear bumper.

Exceeding 6 in (15 cm) could allow water to enter vehicle components, causing internal damage to the components and affecting driveability, emissions and reliability.

**Note:** *Replace the rear axle lubricant anytime the rear axle has been submerged in water.*

**Note:** *Disconnect the trailer wiring connector before backing the trailer into the water.*

**Note:** *Reconnect the trailer wiring connector after removing the trailer from the water.*

# Towing a Trailer

## TOWING WEIGHTS AND DIMENSIONS

### Recommended Towing Weights - 2.7L EcoBoost™

<b>Cab – Wheel-base in (mm)</b>	<b>Driveline</b>	<b>Rear Axle Ratio</b>	<b>Maximum Gross Combined Weight Rating</b>	<b>Maximum Trailer Weight</b>	<b>Maximum Trailer Frontal Area</b>
Regular Cab – 122.4 in (3,110 mm) - L	RWD	3.15	12,200 lb (5,533 kg)	7,600 lb (3,447 kg)	60 ft <sup>2</sup> (5.6 m <sup>2</sup> )
Regular Cab – 122.4 in (3,110 mm) - L	RWD	3.55	12,200 lb (5,533 kg)	7,600 lb (3,447 kg)	60 ft <sup>2</sup> (5.6 m <sup>2</sup> )
Regular Cab – 122.4 in (3,110 mm) - L	4WD	3.55	12,500 lb (5,669 kg)	7,700 lb (3,492 kg)	60 ft <sup>2</sup> (5.6 m <sup>2</sup> )
Regular Cab – 122.4 in (3,110 mm) - L	RWD	3.73	13,200 lb (5,987 kg)	8,600 lb (3,900 kg)	60 ft <sup>2</sup> (5.6 m <sup>2</sup> )
Regular Cab – 122.4 in (3,110 mm) - L	4WD	3.73	13,300 lb (6,032 kg)	8,500 lb (3,855 kg)	60 ft <sup>2</sup> (5.6 m <sup>2</sup> )

## Towing a Trailer

<b>Cab – Wheel-base in (mm)</b>	<b>Driveline</b>	<b>Rear Axle Ratio</b>	<b>Maximum Gross Combined Weight Rating</b>	<b>Maximum Trailer Weight</b>	<b>Maximum Trailer Frontal Area</b>
Regular Cab – 141 in (3,581mm) - L	RWD	3.15	12,300 lb (5,579 kg)	7,600 lb (3,447 kg)	60 ft <sup>2</sup> (5.6 m <sup>2</sup> )
Regular Cab – 141 in (3,581mm) - L	RWD	3.55	12,300 lb (5,579 kg)	7,600 lb (3,447 kg)	60 ft <sup>2</sup> (5.6 m <sup>2</sup> )
Regular Cab – 141 in (3,581mm) - L	4WD	3.55	12,600 lb (5,715 kg)	7,700 lb (3,493 kg)	60 ft <sup>2</sup> (5.6 m <sup>2</sup> )
Regular Cab – 141 in (3,581mm) - L	RWD	3.73	13,300 lb (6,032 kg)	8,600 lb (3,900 kg)	60 ft <sup>2</sup> (5.6 m <sup>2</sup> )
Regular Cab – 141 in (3,581mm) - L	4WD	3.73	13,300 lb (6,032 kg)	8,400 lb (3,810 kg)	60 ft <sup>2</sup> (5.6 m <sup>2</sup> )
Regular Cab – 141 in (3,581mm) - H	RWD	3.73	14,800 lb (6,713 kg)	10,000 lb (4,535 kg)	60 ft <sup>2</sup> (5.6 m <sup>2</sup> )

## Towing a Trailer

<b>Cab – Wheel-base in (mm)</b>	<b>Driveline</b>	<b>Rear Axle Ratio</b>	<b>Maximum Gross Combined Weight Rating</b>	<b>Maximum Trailer Weight</b>	<b>Maximum Trailer Frontal Area</b>
Regular Cab – 141 in (3,581mm) - H	4WD	3.73	15,100 lb (6,849 kg)	10,000 lb (4,535 kg)	60 ft <sup>2</sup> (5.6 m <sup>2</sup> )
Regular Cab – 163 in (4,140mm) - H	RWD	3.73	15,100 lb (6,849 kg)	10,000 lb (4,535 kg)	60 ft <sup>2</sup> (5.6 m <sup>2</sup> )
Super Cab – 145 in (3,675mm) - L	RWD	3.31	12,600 lb (5,715 kg)	7,700 lb (3,492 kg)	60 ft <sup>2</sup> (5.6 m <sup>2</sup> )
Super Cab – 145 in (3,675mm) - L	RWD	3.55	12,600 lb (5,715 kg)	7,700 lb (3,492 kg)	60 ft <sup>2</sup> (5.6 m <sup>2</sup> )
Super Cab – 145 in (3,675mm) - L	4WD	3.55	12,800 lb (5,805 kg)	7,600 lb (3,447 kg)	60 ft <sup>2</sup> (5.6 m <sup>2</sup> )
Super Cab – 145 in (3,675mm) - L	RWD	3.73	13,300 lb (6,032 kg)	8,400 lb (3,810 kg)	60 ft <sup>2</sup> (5.6 m <sup>2</sup> )
Super Cab – 145 in (3,675mm) - H	RWD	3.73	15,000 lb (6,803 kg)	10,000 lb (4,535 kg)	60 ft <sup>2</sup> (5.6 m <sup>2</sup> )

## Towing a Trailer

<b>Cab – Wheel-base in (mm)</b>	<b>Driveline</b>	<b>Rear Axle Ratio</b>	<b>Maximum Gross Combined Weight Rating</b>	<b>Maximum Trailer Weight</b>	<b>Maximum Trailer Frontal Area</b>
Super Cab – 145 in (3,675mm) - L	4WD	3.73	13,300 lb (6,032 kg)	8,100 lb (3,674 kg)	60 ft <sup>2</sup> (5.6 m <sup>2</sup> )
Super Cab – 145 in (3,675mm) - H	4WD	3.73	15,300 lb (6,939 kg)	10,100 lb (4,581 kg)	60 ft <sup>2</sup> (5.6 m <sup>2</sup> )
Super Cab – 163 in (4,140mm) - L	RWD	3.15	12,600 lb (5,715 kg)	7,600 lb (3,447 kg)	60 ft <sup>2</sup> (5.6 m <sup>2</sup> )
Super Cab – 163 in (4,140mm) - L	RWD	3.55	12,600 lb (5,715 kg)	7,600 lb (3,447 kg)	60 ft <sup>2</sup> (5.6 m <sup>2</sup> )
Super Cab – 163 in (4,140mm) - L	RWD	3.73	13,300 lb (6,032 kg)	8,300 lb (3,764 kg)	60 ft <sup>2</sup> (5.6 m <sup>2</sup> )
Crew Cab – 145 in (3,675mm) - L	RWD	3.15	12,700 lb (5,760 kg)	7,700 lb (3,492 kg)	60 ft <sup>2</sup> (5.6 m <sup>2</sup> )
Crew Cab – 145 in (3,675mm) - L	RWD	3.55	12,700 lb (5,760 kg)	7,700 lb (3,492 kg)	60 ft <sup>2</sup> (5.6 m <sup>2</sup> )



## Towing a Trailer

<b>Cab – Wheel-base (mm)</b>	<b>Driveline</b>	<b>Rear Axle Ratio</b>	<b>Maximum Gross Combined Weight Rating</b>	<b>Maximum Trailer Weight</b>	<b>Maximum Trailer Frontal Area</b>
Crew Cab – 145 in (3,675mm) - L	4WD	3.55	12,900 lb (5,851 kg)	7,700 lb (3,492 kg)	60 ft <sup>2</sup> (5.6 m <sup>2</sup> )
Crew Cab – 145 in (3,675mm) - L	RWD	3.73	13,300 lb (6,032 kg)	8,300 lb (3,764 kg)	60 ft <sup>2</sup> (5.6 m <sup>2</sup> )
Crew Cab – 145 in (3,675mm) - H	RWD	3.73	15,100 lb (6,849 kg)	10,000 lb (4,535 kg)	60 ft <sup>2</sup> (5.6 m <sup>2</sup> )
Crew Cab – 145 in (3,675mm) - L	4WD	3.73	13,300 lb (6,032 kg)	8,100 lb (3,674 kg)	60 ft <sup>2</sup> (5.6 m <sup>2</sup> )
Crew Cab – 145 in (3,675mm) - H	4WD	3.73	15,400 lb (6,985 kg)	10,100 lb (4,581 kg)	60 ft <sup>2</sup> (5.6 m <sup>2</sup> )
Crew Cab – 157 in (3,989mm) - L	RWD	3.15	12,800 lb (5,805 kg)	7,800 lb (3,538 kg)	60 ft <sup>2</sup> (5.6 m <sup>2</sup> )

## Towing a Trailer

<b>Cab – Wheel-base in (mm)</b>	<b>Driveline</b>	<b>Rear Axle Ratio</b>	<b>Maximum Gross Combined Weight Rating</b>	<b>Maximum Trailer Weight</b>	<b>Maximum Trailer Frontal Area</b>
Crew Cab – 157 in (3,989mm) – L	RWD	3.55	12,800 lb (5,805 kg)	7,800 lb (3,538 kg)	60 ft <sup>2</sup> (5.6 m <sup>2</sup> )
Crew Cab – 157 in (3,989mm) – L	RWD	3.73	13,300 lb (6,032 kg)	8,300 lb (3,764 kg)	60 ft <sup>2</sup> (5.6 m <sup>2</sup> )
Crew Cab – 157 in (3,989mm) – H	RWD	3.73	15,100 lb (6,849 kg)	10,000 lb (4,535 kg)	60 ft <sup>2</sup> (5.6 m <sup>2</sup> )

**Note:** All values calculated with SAE J2807 method.

**Note:** Values shown for low, L, or high, H, capacity trailer tow packages.

**Note:** Do not exceed a trailer weight of 5,000 lb (2,268 kg) when towing with, or by, the bumper only.

**Note:** Do not exceed a trailer weight of 6,000 lb (2,721 kg) or 36 ft<sup>2</sup> (3.4 m<sup>2</sup>) trailer frontal area with the medium duty trailer tow package.

**Note:** Exceeding these limitations could significantly reduce the performance of your towing vehicle. Selecting a trailer with a low aerodynamic drag and rounded front design helps optimize performance and fuel economy.

## Towing a Trailer

### Recommended Towing Weights - 3.0L Diesel

<b>Cab – Wheel-base in (mm)</b>	<b>Driveline</b>	<b>Rear Axle Ratio</b>	<b>Maximum Gross Combined Weight Rating</b>	<b>Maximum Trailer Weight</b>	<b>Maximum Trailer Frontal Area</b>
Super Cab – 145 in (3,675mm)	RWD	3.31	16,300 lb (7,393 kg) <sub>1</sub>	10,800 lb (4,898 kg) <sub>1</sub>	60 ft <sup>2</sup> (5.6 m <sup>2</sup> )
Super Cab – 145 in (3,675mm)	RWD	3.55	17,700 lb (8,028 kg) <sub>2</sub>	12,200 lb (5,533 kg) <sub>2</sub>	60 ft <sup>2</sup> (5.6 m <sup>2</sup> )
Super Cab – 145 in (3,675mm)	4WD	3.31	16,300 lb (7,393 kg) <sub>1</sub>	10,500 lb (4,762 kg) <sub>1</sub>	60 ft <sup>2</sup> (5.6 m <sup>2</sup> )
Super Cab – 145 in (3,675mm)	4WD	3.55	16,300 lb (7,393 kg) <sub>1</sub>	10,500 lb (4,762 kg) <sub>1</sub>	60 ft <sup>2</sup> (5.6 m <sup>2</sup> )
Super Cab – 145 in (3,675mm)	4WD	3.55	17,900 lb (8,119 kg) <sub>2</sub>	12,100 lb (5,488 kg) <sub>2</sub>	60 ft <sup>2</sup> (5.6 m <sup>2</sup> )
Crew Cab – 145 in (3,675mm)	RWD	3.31	16,300 lb (7,393 kg) <sub>1</sub>	10,700 lb (4,853 kg) <sub>1</sub>	60 ft <sup>2</sup> (5.6 m <sup>2</sup> )
Crew Cab – 145 in (3,675mm)	RWD	3.55	17,700 lb (8,028 kg) <sub>2</sub>	12,100 lb (5,488 kg) <sub>2</sub>	60 ft <sup>2</sup> (5.6 m <sup>2</sup> )
Crew Cab – 145 in (3,675mm)	4WD	3.31	16,300 lb (7,393 kg) <sub>1</sub>	10,400 lb (4,717 kg) <sub>1</sub>	60 ft <sup>2</sup> (5.6 m <sup>2</sup> )

## Towing a Trailer

<b>Cab – Wheel-base in (mm)</b>	<b>Driveline</b>	<b>Rear Axle Ratio</b>	<b>Maximum Gross Combined Weight Rating</b>	<b>Maximum Trailer Weight</b>	<b>Maximum Trailer Frontal Area</b>
Crew Cab – 145 in (3,675mm)	4WD	3.55	16,300 lb (7,393 kg) <sub>1</sub>	10,400 lb (4,717 kg) <sub>1</sub>	60 ft <sup>2</sup> (5.6 m <sup>2</sup> )
Crew Cab – 145 in (3,675mm)	4WD	3.55	18,000 lb (8,164 kg) <sub>2</sub>	12,100 lb (5,488 kg) <sub>2</sub>	60 ft <sup>2</sup> (5.6 m <sup>2</sup> )
Crew Cab – 157 in (3,989mm)	RWD	3.31	16,300 lb (7,393 kg) <sub>1</sub>	10,600 lb (4,808 kg) <sub>1</sub>	60 ft <sup>2</sup> (5.6 m <sup>2</sup> )
Crew Cab – 157 in (3,989mm)	RWD	3.55	17,800 lb (8,073 kg) <sub>2</sub>	12,100 lb (5,488 kg) <sub>2</sub>	60 ft <sup>2</sup> (5.6 m <sup>2</sup> )
Crew Cab – 157 in (3,989mm)	4WD	3.31	16,300 lb (7,393 kg) <sub>1</sub>	10,400 lb (4,717 kg) <sub>1</sub>	60 ft <sup>2</sup> (5.6 m <sup>2</sup> )
Crew Cab – 157 in (3,989mm)	4WD	3.55	16,300 lb (7,393 kg) <sub>1</sub>	10,400 lb (4,717 kg) <sub>1</sub>	60 ft <sup>2</sup> (5.6 m <sup>2</sup> )
Crew Cab – 157 in (3,989mm)	4WD	3.55	18,000 lb (8,164 kg) <sub>2</sub>	12,100 lb (5,488 kg) <sub>2</sub>	60 ft <sup>2</sup> (5.6 m <sup>2</sup> )

<sup>1</sup> Heavy duty trailer tow package.

<sup>2</sup> Max duty trailer tow package.

**Note:** All values calculated with SAE J2807 method.

**Note:** Do not exceed a trailer weight of 5,000 lb (2,268 kg) when towing with, or by, the bumper only.

## Towing a Trailer

**Note:** Do not exceed a trailer weight of 7,000 lb (3,175 kg) or 36 ft<sup>2</sup> (3.4 m<sup>2</sup>) trailer frontal area with the medium duty trailer tow package.

**Note:** Exceeding these limitations could significantly reduce the performance of your towing vehicle. Selecting a trailer with a low aerodynamic drag and rounded front design helps optimize performance and fuel economy.

### Recommended Towing Weights - 3.3L

Cab – Wheel-base in (mm)	Driveline	Rear Axle Ratio	Maximum Gross Combined Weight Rating	Maximum Trailer Weight	Maximum Trailer Frontal Area
Regular Cab – 122.4 in (3,110 mm)	RWD	3.55	9,400 lb (4,263 kg) <sub>1</sub>	5,000 lb (2,267 kg) <sub>1</sub>	36 ft <sup>2</sup> (3.4 m <sup>2</sup> )
Regular Cab – 122.4 in (3,110 mm)	4WD	3.55	9,700 lb (4,400 kg) <sub>2</sub>	5,100 lb (2,313 kg) <sub>2</sub>	60 ft <sup>2</sup> (5.6 m <sup>2</sup> )
Regular Cab – 122.4 in (3,110 mm)	RWD	3.73	12,600 lb (5,715 kg) <sub>2</sub>	8,200 lb (3,719 kg) <sub>2</sub>	60 ft <sup>2</sup> (5.6 m <sup>2</sup> )
Regular Cab – 122.4 in (3,110 mm)	4WD	3.73	12,800 lb (5,805 kg) <sub>2</sub>	8,200 lb (3,719 kg) <sub>2</sub>	60 ft <sup>2</sup> (5.6 m <sup>2</sup> )
Regular Cab – 141 in (3,581 mm)	RWD	3.55	9,500 lb (4,309 kg) <sub>1</sub>	5,000 lb (2,267 kg) <sub>1</sub>	36 ft <sup>2</sup> (3.4 m <sup>2</sup> )

## Towing a Trailer

<b>Cab – Wheel-base in (mm)</b>	<b>Driveline</b>	<b>Rear Axle Ratio</b>	<b>Maximum Gross Combined Weight Rating</b>	<b>Maximum Trailer Weight</b>	<b>Maximum Trailer Frontal Area</b>
Regular Cab – 141 in (3,581mm)	RWD	3.73	12,700 lb (5,760 kg) <sub>2</sub>	8,200 lb (3,719 kg) <sub>2</sub>	60 ft <sup>2</sup> (5.6 m <sup>2</sup> )
Regular Cab – 141 in (3,581mm)	4WD	3.73	12,900 lb (5,851 kg) <sub>2</sub>	8,200 lb (3,719 kg) <sub>2</sub>	60 ft <sup>2</sup> (5.6 m <sup>2</sup> )
Super Cab – 145 in (3,675mm)	RWD	3.55	9,700 lb (4,399 kg) <sub>1</sub>	5,000 lb (2,267 kg) <sub>1</sub>	36 ft <sup>2</sup> (3.4 m <sup>2</sup> )
Super Cab – 145 in (3,675mm)	RWD	3.73	12,900 lb (5,851 kg) <sub>2</sub>	8,200 lb (3,719 kg) <sub>2</sub>	60 ft <sup>2</sup> (5.6 m <sup>2</sup> )
Super Cab – 145 in (3,675mm)	4WD	3.73	13,100 lb (5,942 kg) <sub>2</sub>	8,100 lb (3,674 kg) <sub>2</sub>	60 ft <sup>2</sup> (5.6 m <sup>2</sup> )
Crew Cab – 145 in (3,675mm)	RWD	3.55	9,900 lb (4,491 kg) <sub>1</sub>	5,100 lb (2,313 kg) <sub>1</sub>	36 ft <sup>2</sup> (3.4 m <sup>2</sup> )
Crew Cab – 145 in (3,675mm)	RWD	3.73	13,000 lb (5,896 kg) <sub>2</sub>	8,200 lb (3,719 kg) <sub>2</sub>	60 ft <sup>2</sup> (5.6 m <sup>2</sup> )
Crew Cab – 145 in (3,675mm)	4WD	3.73	13,300 lb (6,032 kg) <sub>2</sub>	8,200 lb (3,719 kg) <sub>2</sub>	60 ft <sup>2</sup> (5.6 m <sup>2</sup> )

<sup>1</sup> Medium duty trailer tow package.

<sup>2</sup> Heavy duty trailer tow package.

## Towing a Trailer

**Note:** All values calculated with SAE J2807 method.

**Note:** Do not exceed a trailer weight of 5,000 lb (2,268 kg) when towing with, or by, the bumper only.

**Note:** Do not exceed a trailer weight of 6,000 lb (2,721 kg) or 36 ft<sup>2</sup> (3.4 m<sup>2</sup>) trailer frontal area with the medium duty trailer tow package.

**Note:** Exceeding these limitations could significantly reduce the performance of your towing vehicle. Selecting a trailer with a low aerodynamic drag and rounded front design helps optimize performance and fuel economy.

### Recommended Towing Weights - 3.5L EcoBoost™

Cab – Wheel-base in (mm)	Driveline	Rear Axle Ratio	Maximum Gross Combined Weight Rating	Maximum Trailer Weight	Maximum Trailer Frontal Area
Regular Cab – 141 in (3,581mm)	RWD	3.15	16,100 lb (7,302 kg) 1	11,200 lb (5,080 kg) 1	60 ft <sup>2</sup> (5.6 m <sup>2</sup> )
Regular Cab – 141 in (3,581mm)	4WD	3.31	16,400 lb (7,438 kg) 1	11,200 lb (5,080 kg) 1	60 ft <sup>2</sup> (5.6 m <sup>2</sup> )
Regular Cab – 141 in (3,581mm)	RWD	3.55	16,100 lb (7,302 kg) 1	11,200 lb (5,080 kg) 1	60 ft <sup>2</sup> (5.6 m <sup>2</sup> )
Regular Cab – 141 in (3,581mm)	RWD	3.55	17,900 lb (8,119 kg) 2	13,000 lb (5,897 kg) 2	60 ft <sup>2</sup> (5.6 m <sup>2</sup> )

## Towing a Trailer

<b>Cab – Wheel-base in (mm)</b>	<b>Driveline</b>	<b>Rear Axle Ratio</b>	<b>Maximum Gross Combined Weight Rating</b>	<b>Maximum Trailer Weight</b>	<b>Maximum Trailer Frontal Area</b>
Regular Cab – 141 in (3,581mm)	4WD	3.55	16,400 lb (7,438 kg) 1	11,200 lb (5,080 kg) 1	60 ft <sup>2</sup> (5.6 m <sup>2</sup> )
Regular Cab – 141 in (3,581mm)	4WD	3.55	17,900 lb (8,119 kg) 2	12,700 lb (5,761 kg) 2	60 ft <sup>2</sup> (5.6 m <sup>2</sup> )
Regular Cab – 141 in (3,581mm) Heavy Payload Package	RWD	3.73	18,400 lb (8,346 kg) 2	13,300 lb (6,033 kg) 2	60 ft <sup>2</sup> (5.6 m <sup>2</sup> )
Regular Cab – 141 in (3,581mm) Heavy Payload Package	4WD	3.73	18,400 lb (8,346 kg) 2	13,100 lb (5,942 kg) 2	60 ft <sup>2</sup> (5.6 m <sup>2</sup> )
Super Cab – 145 in (3,675mm)	RWD	3.31	16,200 lb (7,348 kg) 1	11,000 lb (4,989 kg) 1	60 ft <sup>2</sup> (5.6 m <sup>2</sup> )
Super Cab – 145 in (3,675mm)	4WD	3.31	16,500 lb (7,484 kg) 1	11,100 lb (5,034 kg) 1	60 ft <sup>2</sup> (5.6 m <sup>2</sup> )
Super Cab – 145 in (3,675mm)	RWD	3.55	16,200 lb (7,348 kg) 1	11,000 lb (4,989 kg) 1	60 ft <sup>2</sup> (5.6 m <sup>2</sup> )



## Towing a Trailer

<b>Cab – Wheel-base in (mm)</b>	<b>Driveline</b>	<b>Rear Axle Ratio</b>	<b>Maximum Gross Combined Weight Rating</b>	<b>Maximum Trailer Weight</b>	<b>Maximum Trailer Frontal Area</b>
Super Cab – 145 in (3,675mm)	RWD	3.55	17,500 lb (7,937 kg) 2	12,300 lb (5,579 kg) 2	60 ft <sup>2</sup> (5.6 m <sup>2</sup> )
Super Cab – 145 in (3,675mm)	4WD	3.55	16,500 lb (7,484 kg) 1	11,100 lb (5,034 kg) 1	60 ft <sup>2</sup> (5.6 m <sup>2</sup> )
Super Cab – 145 in (3,675mm)	4WD	3.55	17,700 lb (8,028 kg) 2	12,300 lb (5,579 kg) 2	60 ft <sup>2</sup> (5.6 m <sup>2</sup> )
Super Cab – 163 in (4,140mm)	RWD	3.15	16,500 lb (7,484 kg) 1	11,200 lb (5,080 kg) 1	60 ft <sup>2</sup> (5.6 m <sup>2</sup> )
Super Cab – 163 in (4,140mm)	4WD	3.31	16,800 lb (7,620 kg) 1	11,200 lb (5,080 kg) 1	60 ft <sup>2</sup> (5.6 m <sup>2</sup> )
Super Cab – 163 in (4,140mm)	RWD	3.55	16,500 lb (7,484 kg) 1	11,200 lb (5,080 kg) 1	60 ft <sup>2</sup> (5.6 m <sup>2</sup> )
Super Cab – 163 in (4,140mm)	RWD	3.55	19,400 lb (8,799 kg) 2	14,000 lb (6,350 kg) 2	60 ft <sup>2</sup> (5.6 m <sup>2</sup> )
Super Cab – 163 in (4,140mm)	4WD	3.55	16,800 lb (7,620 kg) 1	11,200 lb (5,080 kg) 1	60 ft <sup>2</sup> (5.6 m <sup>2</sup> )
Super Cab – 163 in (4,140mm)	4WD	3.55	19,400 lb (8,799 kg) 2	13,800 lb (6,259 kg) 2	60 ft <sup>2</sup> (5.6 m <sup>2</sup> )

## Towing a Trailer

<b>Cab – Wheel-base in (mm)</b>	<b>Driveline</b>	<b>Rear Axle Ratio</b>	<b>Maximum Gross Combined Weight Rating</b>	<b>Maximum Trailer Weight</b>	<b>Maximum Trailer Frontal Area</b>
Super Cab – 163 in (4,140mm) Heavy Payload Package	RWD	3.73	19,400 lb (8,799 kg) <sub>2</sub>	14,000 lb (6,350 kg) <sub>2</sub>	60 ft <sup>2</sup> (5.6 m <sup>2</sup> )
Super Cab – 163 in (4,140mm) Heavy Payload Package	4WD	3.73	19,400 lb (8,799 kg) <sub>2</sub>	13,800 lb (6,259 kg) <sub>2</sub>	60 ft <sup>2</sup> (5.6 m <sup>2</sup> )
Crew Cab – 145 in (3,675mm)	RWD	3.31	16,500 lb (7,484 kg) <sub>1</sub>	11,200 lb (5,080 kg) <sub>1</sub>	60 ft <sup>2</sup> (5.6 m <sup>2</sup> )
Crew Cab – 145 in (3,675mm)	4WD	3.31	16,800 lb (7,620 kg) <sub>1</sub>	11,300 lb (5,125 kg) <sub>1</sub>	60 ft <sup>2</sup> (5.6 m <sup>2</sup> )
Crew Cab – 145 in (3,675mm)	RWD	3.55	16,500 lb (7,484 kg) <sub>1</sub>	11,200 lb (5,080 kg) <sub>1</sub>	60 ft <sup>2</sup> (5.6 m <sup>2</sup> )
Crew Cab – 145 in (3,675mm)	RWD	3.55	19,300 lb (8,754 kg) <sub>2</sub>	14,000 lb (6,350 kg) <sub>2</sub>	60 ft <sup>2</sup> (5.6 m <sup>2</sup> )
Crew Cab – 145 in (3,675mm)	4WD	3.55	16,800 lb (7,620 kg) <sub>1</sub>	11,300 lb (5,125 kg) <sub>1</sub>	60 ft <sup>2</sup> (5.6 m <sup>2</sup> )

## Towing a Trailer

<b>Cab – Wheel-base in (mm)</b>	<b>Driveline</b>	<b>Rear Axle Ratio</b>	<b>Maximum Gross Combined Weight Rating</b>	<b>Maximum Trailer Weight</b>	<b>Maximum Trailer Frontal Area</b>
Crew Cab – 145 in (3,675mm)	4WD	3.55	19,400 lb (8,799 kg) <sub>2</sub>	13,900 lb (6,304 kg) <sub>2</sub>	60 ft <sup>2</sup> (5.6 m <sup>2</sup> )
Crew Cab – 157 in (3,989mm)	RWD	3.31	16,600 lb (7,529 kg) <sub>1</sub>	11,300 lb (5,125 kg) <sub>1</sub>	60 ft <sup>2</sup> (5.6 m <sup>2</sup> )
Crew Cab – 157 in (3,989mm)	4WD	3.31	16,800 lb (7,620 kg) <sub>1</sub>	11,200 lb (5,080 kg) <sub>1</sub>	60 ft <sup>2</sup> (5.6 m <sup>2</sup> )
Crew Cab – 157 in (3,989mm)	RWD	3.55	16,600 lb (7,529 kg) <sub>1</sub>	11,300 lb (5,125 kg) <sub>1</sub>	60 ft <sup>2</sup> (5.6 m <sup>2</sup> )
Crew Cab – 157 in (3,989mm)	RWD	3.55	19,400 lb (8,799 kg) <sub>2</sub>	14,000 lb (6,350 kg) <sub>2</sub>	60 ft <sup>2</sup> (5.6 m <sup>2</sup> )
Crew Cab – 157 in (3,989mm)	4WD	3.55	16,800 lb (7,620 kg) <sub>1</sub>	11,200 lb (5,080 kg) <sub>1</sub>	60 ft <sup>2</sup> (5.6 m <sup>2</sup> )
Crew Cab – 157 in (3,989mm)	4WD	3.55	19,400 lb (8,799 kg) <sub>2</sub>	13,800 lb (6,259 kg) <sub>2</sub>	60 ft <sup>2</sup> (5.6 m <sup>2</sup> )

## Towing a Trailer

<b>Cab – Wheel-base in (mm)</b>	<b>Driveline</b>	<b>Rear Axle Ratio</b>	<b>Maximum Gross Combined Weight Rating</b>	<b>Maximum Trailer Weight</b>	<b>Maximum Trailer Frontal Area</b>
Crew Cab – 157 in (3989mm) Heavy Payload Package	RWD	3.73	19,400 lb (8,799 kg) <sub>2</sub>	14,000 lb (6,350 kg) <sub>2</sub>	60 ft <sup>2</sup> (5.6 m <sup>2</sup> )
Crew Cab – 157 in (3989mm) Heavy Payload Package	4WD	3.73	19,500 lb (8,845 kg) <sub>2</sub>	13,800 lb (6,259 kg) <sub>2</sub>	60 ft <sup>2</sup> (5.6 m <sup>2</sup> )

<sup>1</sup> Heavy duty trailer tow package.

<sup>2</sup> Max duty trailer tow package.

**Note:** All values calculated with SAE J2807 method.

**Note:** Do not exceed a trailer weight of 5,000 lb (2,268 kg) when towing with, or by, the bumper only.

**Note:** Do not exceed a trailer weight of 7,000 lb (3,175 kg) or 36 ft<sup>2</sup> (3.4 m<sup>2</sup>) trailer frontal area with the medium duty trailer tow package.

**Note:** Exceeding these limitations could significantly reduce the performance of your towing vehicle. Selecting a trailer with a low aerodynamic drag and rounded front design helps optimize performance and fuel economy.

## Towing a Trailer

### Recommended Towing Weights - 3.5L, Hybrid Electric Vehicle (HEV)

<b>Cab – Wheel-base in (mm)</b>	<b>Driveline</b>	<b>Rear Axle Ratio</b>	<b>Maximum Gross Combined Weight Rating</b>	<b>Maximum Trailer Weight</b>	<b>Maximum Trailer Frontal Area</b>
Crew Cab – 145 in (3,675mm)	RWD	3.55	16,700 lb (7,574 kg) <sub>1</sub>	11,000 lb (4,989 kg) <sub>1</sub>	60 ft <sup>2</sup> (5.6 m <sup>2</sup> )
Crew Cab – 145 in (3,675mm)	RWD	3.55	18,400 lb (8,346 kg) <sub>2</sub>	12,700 lb (5,760 kg) <sub>2</sub>	60 ft <sup>2</sup> (5.6 m <sup>2</sup> )
Crew Cab – 145 in (3,675mm)	4WD	3.73	17,000 lb (7,711 kg) <sup>1</sup>	11,000 lb (4,989 kg) <sub>1</sub>	60 ft <sup>2</sup> (5.6 m <sup>2</sup> )
Crew Cab – 145 in (3,675mm)	4WD	3.73	18,400 lb (8,346 kg) <sub>2</sub>	12,400 lb (5,624 kg) <sub>2</sub>	60 ft <sup>2</sup> (5.6 m <sup>2</sup> )
Crew Cab – 157 in (3,989mm)	RWD	3.55	16,800 lb (7,620 kg) <sub>1</sub>	11,100 lb (5,035 kg) <sub>1</sub>	60 ft <sup>2</sup> (5.6 m <sup>2</sup> )
Crew Cab – 157 in (3,989mm)	RWD	3.55	18,400 lb (8,346 kg) <sub>2</sub>	12,700 lb (5,761 kg) <sub>2</sub>	60 ft <sup>2</sup> (5.6 m <sup>2</sup> )

## Towing a Trailer

Cab – Wheel-base in (mm)	Driveline	Rear Axle Ratio	Maximum Gross Combined Weight Rating	Maximum Trailer Weight	Maximum Trailer Frontal Area
Crew Cab – 157 in (3,989mm)	4WD	3.73	17,000 lb (7,711 kg) <sup>1</sup>	11,000 lb (4,989 kg) <sub>1</sub>	60 ft <sup>2</sup> (5.6 m <sup>2</sup> )
Crew Cab – 157 in (3,989mm)	4WD	3.73	18,400 lb (8,346 kg) <sub>2</sub>	12,400 lb (5,624 kg) <sub>2</sub>	60 ft <sup>2</sup> (5.6 m <sup>2</sup> )

<sup>1</sup> Heavy duty trailer tow package.

<sup>2</sup> Max duty trailer tow package.

**Note:** All values calculated with SAE J2807 method.

**Note:** Do not exceed a trailer weight of 5,000 lb (2,268 kg) when towing with, or by, the bumper only.

**Note:** Do not exceed a trailer weight of 7,000 lb (3,175 kg) or 36 ft<sup>2</sup> (3.4 m<sup>2</sup>) trailer frontal area with the medium duty trailer tow package.

**Note:** Exceeding these limitations could significantly reduce the performance of your towing vehicle. Selecting a trailer with a low aerodynamic drag and rounded front design helps optimize performance and fuel economy.

# Towing a Trailer

## Recommended Towing Weights - 5.0L

<b>Cab – Wheel-base in (mm)</b>	<b>Driveline</b>	<b>Rear Axle Ratio</b>	<b>Maximum Gross Combined Weight Rating</b>	<b>Maximum Trailer Weight</b>	<b>Maximum Trailer Frontal Area</b>
Regular Cab – 122.4 in (3,110 mm)	RWD	3.15	13,000 lb (5,896 kg) 1	8,300 lb (3,764 kg) 1	60 ft <sup>2</sup> (5.6 m <sup>2</sup> )
Regular Cab – 122.4 in (3,110 mm)	RWD	3.31	13,000 lb (5,896 kg) 1	8,300 lb (3,764 kg) 1	60 ft <sup>2</sup> (5.6 m <sup>2</sup> )
Regular Cab – 122.4 in (3,110 mm)	4WD	3.31	13,200 lb (5,987 kg) 1	8,200 lb (3,719 kg) 1	60 ft <sup>2</sup> (5.6 m <sup>2</sup> )
Regular Cab – 122.4 in (3,110 mm)	RWD	3.73	13,800 lb (6,259 kg) 1	9,100 lb (4,127 kg) 1	60 ft <sup>2</sup> (5.6 m <sup>2</sup> )
Regular Cab – 122.4 in (3,110 mm)	4WD	3.73	14,600 lb (6,622 kg) 1	9,600 lb (4,354 kg) 1	60 ft <sup>2</sup> (5.6 m <sup>2</sup> )
Regular Cab – 141 in (3,581 mm)	RWD	3.15	14,800 lb (6,713 kg) 1	9,900 lb (4,490 kg) 1	60 ft <sup>2</sup> (5.6 m <sup>2</sup> )
Regular Cab – 141 in (3,581 mm)	RWD	3.31	14,800 lb (6,713 kg) 1	9,900 lb (4,490 kg) 1	60 ft <sup>2</sup> (5.6 m <sup>2</sup> )

## Towing a Trailer

<b>Cab – Wheel-base in (mm)</b>	<b>Driveline</b>	<b>Rear Axle Ratio</b>	<b>Maximum Gross Combined Weight Rating</b>	<b>Maximum Trailer Weight</b>	<b>Maximum Trailer Frontal Area</b>
Regular Cab – 141 in (3,581mm)	4WD	3.31	14,800 lb (6,713 kg) <sub>1</sub>	9,700 lb (4,399 kg) <sub>1</sub>	60 ft <sup>2</sup> (5.6 m <sup>2</sup> )
Regular Cab – 141 in (3,581mm)	RWD	3.73	15,300 lb (6,940 kg) <sub>1</sub>	10,400 lb (4,717 kg) <sub>1</sub>	60 ft <sup>2</sup> (5.6 m <sup>2</sup> )
Regular Cab – 141 in (3,581mm)	RWD	3.73	17,900 lb (8,119 kg) <sub>2</sub>	13,000 lb (5,896 kg) <sub>2</sub>	60 ft <sup>2</sup> (5.6 m <sup>2</sup> )
Regular Cab – 141 in (3,581mm) Heavy Payload Package	RWD	3.73	18,000 lb (8,164 kg) <sub>2</sub>	13,000 lb (5,896 kg) <sub>2</sub>	60 ft <sup>2</sup> (5.6 m <sup>2</sup> )
Regular Cab – 141 in (3,581mm)	4WD	3.73	15,600 lb (7,076 kg) <sub>1</sub>	10,500 lb (4,762 kg) <sub>1</sub>	60 ft <sup>2</sup> (5.6 m <sup>2</sup> )
Regular Cab – 141 in (3,581mm)	4WD	3.73	17,900 lb (8,119 kg) <sub>2</sub>	12,800 lb (5,806 kg) <sub>2</sub>	60 ft <sup>2</sup> (5.6 m <sup>2</sup> )



## Towing a Trailer

<b>Cab – Wheel-base in (mm)</b>	<b>Driveline</b>	<b>Rear Axle Ratio</b>	<b>Maximum Gross Combined Weight Rating</b>	<b>Maximum Trailer Weight</b>	<b>Maximum Trailer Frontal Area</b>
Regular Cab – 141 in (3,581mm) Heavy Payload Package	4WD	3.73	18,300 lb (8,300 kg) 2	13,000 lb (5,896 kg) 2	60 ft <sup>2</sup> (5.6 m <sup>2</sup> )
Super Cab – 145 in (3,675mm)	RWD	3.15	14,800 lb (6,713 kg) 1	9,800 lb (4,445 kg) 1	60 ft <sup>2</sup> (5.6 m <sup>2</sup> )
Super Cab – 145 in (3,675mm)	RWD	3.31	14,800 lb (6,713 kg) 1	9,800 lb (4,445 kg) 1	60 ft <sup>2</sup> (5.6 m <sup>2</sup> )
Super Cab – 145 in (3,675mm)	4WD	3.31	14,800 lb (6,713 kg) 1	9,500 lb (4,309 kg) 1	60 ft <sup>2</sup> (5.6 m <sup>2</sup> )
Super Cab – 145 in (3,675mm)	RWD	3.73	15,500 lb (7,030 kg) 1	10,500 lb (4,762 kg) 1	60 ft <sup>2</sup> (5.6 m <sup>2</sup> )
Super Cab – 145 in (3,675mm)	RWD	3.73	17,800 lb (8,073 kg) 2	12,800 lb (5,805 kg) 2	60 ft <sup>2</sup> (5.6 m <sup>2</sup> )
Super Cab – 145 in (3,675mm)	4WD	3.73	15,800 lb (7,166 kg) 1	10,500 lb (4,762 kg) 1	60 ft <sup>2</sup> (5.6 m <sup>2</sup> )
Super Cab – 145 in (3,675mm)	4WD	3.73	17,600 lb (7,983 kg) 2	12,300 lb (5,579 kg) 2	60 ft <sup>2</sup> (5.6 m <sup>2</sup> )

## Towing a Trailer

<b>Cab – Wheel-base in (mm)</b>	<b>Driveline</b>	<b>Rear Axle Ratio</b>	<b>Maximum Gross Combined Weight Rating</b>	<b>Maximum Trailer Weight</b>	<b>Maximum Trailer Frontal Area</b>
Super Cab – 163 in (4,140mm)	RWD	3.15	14,800 lb (6,713 kg) <sub>1</sub>	9,600 lb (4,354 kg) <sub>1</sub>	60 ft <sup>2</sup> (5.6 m <sup>2</sup> )
Super Cab – 163 in (4,140mm)	RWD	3.31	14,800 lb (6,713 kg) <sub>1</sub>	9,600 lb (4,354 kg) <sub>1</sub>	60 ft <sup>2</sup> (5.6 m <sup>2</sup> )
Super Cab – 163 in (4,140mm)	4WD	3.31	14,800 lb (6,713 kg) <sub>1</sub>	9,400 lb (4,263 kg) <sub>1</sub>	60 ft <sup>2</sup> (5.6 m <sup>2</sup> )
Super Cab – 163 in (4,140mm)	RWD	3.73	15,600 lb (7,076 kg) <sub>1</sub>	10,400 lb (4,717 kg) <sub>1</sub>	60 ft <sup>2</sup> (5.6 m <sup>2</sup> )
Super Cab – 163 in (4,140mm)	RWD	3.73	18,200 lb (8,255 kg) <sub>2</sub>	13,000 lb (5,896 kg) <sub>2</sub>	60 ft <sup>2</sup> (5.6 m <sup>2</sup> )
Super Cab – 163 in (4,140mm) Heavy Payload Package	RWD	3.73	18,300 lb (8,300 kg) <sub>2</sub>	13,000 lb (5,896 kg) <sub>2</sub>	60 ft <sup>2</sup> (5.6 m <sup>2</sup> )
Super Cab – 163 in (4,140mm)	4WD	3.73	15,800 lb (7,166 kg) <sub>1</sub>	10,400 lb (4,717 kg) <sub>1</sub>	60 ft <sup>2</sup> (5.6 m <sup>2</sup> )
Super Cab – 163 in (4,140mm)	4WD	3.73	18,400 lb (8,346 kg) <sub>2</sub>	13,000 lb (5,896 kg) <sub>2</sub>	60 ft <sup>2</sup> (5.6 m <sup>2</sup> )

## Towing a Trailer

<b>Cab – Wheel-base in (mm)</b>	<b>Driveline</b>	<b>Rear Axle Ratio</b>	<b>Maximum Gross Combined Weight Rating</b>	<b>Maximum Trailer Weight</b>	<b>Maximum Trailer Frontal Area</b>
Super Cab – 163 in (4,140mm) Heavy Payload Package	4WD	3.73	18,500 lb (8,391 kg) <sub>2</sub>	13,000 lb (5,896 kg) <sub>2</sub>	60 ft <sup>2</sup> (5.6 m <sup>2</sup> )
Crew Cab – 145 in (3,675mm)	RWD	3.15	14,800 lb (6,713 kg) <sub>1</sub>	9,700 lb (4,399 kg) <sub>1</sub>	60 ft <sup>2</sup> (5.6 m <sup>2</sup> )
Crew Cab – 145 in (3,675mm)	RWD	3.31	14,800 lb (6,713 kg) <sub>1</sub>	9,700 lb (4,399 kg) <sub>1</sub>	60 ft <sup>2</sup> (5.6 m <sup>2</sup> )
Crew Cab – 145 in (3,675mm)	4WD	3.31	14,800 lb (6,713 kg) <sub>1</sub>	9,400 lb (4,263 kg) <sub>1</sub>	60 ft <sup>2</sup> (5.6 m <sup>2</sup> )
Crew Cab – 145 in (3,675mm)	RWD	3.73	15,600 lb (7,076 kg) <sub>1</sub>	10,500 lb (4,762 kg) <sub>1</sub>	60 ft <sup>2</sup> (5.6 m <sup>2</sup> )
Crew Cab – 145 in (3,675mm)	RWD	3.73	18,100 lb (8,210 kg) <sub>2</sub>	12,900 lb (5,851 kg) <sub>2</sub>	60 ft <sup>2</sup> (5.6 m <sup>2</sup> )
Crew Cab – 145 in (3,675mm)	4WD	3.73	15,800 lb (7,166 kg) <sub>1</sub>	10,400 lb (4,717 kg) <sub>1</sub>	60 ft <sup>2</sup> (5.6 m <sup>2</sup> )
Crew Cab – 145 in (3,675mm)	4WD	3.73	18,400 lb (8,346 kg) <sub>2</sub>	13,000 lb (5,896 kg) <sub>2</sub>	60 ft <sup>2</sup> (5.6 m <sup>2</sup> )

## Towing a Trailer

<b>Cab – Wheel-base in (mm)</b>	<b>Driveline</b>	<b>Rear Axle Ratio</b>	<b>Maximum Gross Combined Weight Rating</b>	<b>Maximum Trailer Weight</b>	<b>Maximum Trailer Frontal Area</b>
Crew Cab – 157 in (3,989mm)	RWD	3.15	14,800 lb (6,713 kg) <sub>1</sub>	9,600 lb (4,354 kg) <sub>1</sub>	60 ft <sup>2</sup> (5.6 m <sup>2</sup> )
Crew Cab – 157 in (3,989mm)	RWD	3.31	14,800 lb (6,713 kg) <sub>1</sub>	9,600 lb (4,354 kg) <sub>1</sub>	60 ft <sup>2</sup> (5.6 m <sup>2</sup> )
Crew Cab – 157 in (3,989mm)	4WD	3.31	14,800 lb (6,713 kg) <sub>1</sub>	9,300 lb (4,218 kg) <sub>1</sub>	60 ft <sup>2</sup> (5.6 m <sup>2</sup> )
Crew Cab – 157 in (3,989mm)	RWD	3.73	15,600 lb (7,076 kg) <sub>1</sub>	10,400 lb (4,717 kg) <sub>1</sub>	60 ft <sup>2</sup> (5.6 m <sup>2</sup> )
Crew Cab – 157 in (3,989mm)	RWD	3.73	18,200 lb (8,255 kg) <sub>2</sub>	13,000 lb (5,896 kg) <sub>2</sub>	60 ft <sup>2</sup> (5.6 m <sup>2</sup> )
Crew Cab – 157 in (3,989mm) Heavy Payload Package	RWD	3.73	18,400 lb (8,346 kg) <sub>2</sub>	13,000 lb (5,896 kg) <sub>2</sub>	60 ft <sup>2</sup> (5.6 m <sup>2</sup> )
Crew Cab – 157 in (3,989mm)	4WD	3.73	15,800 lb (7,166 kg) <sub>1</sub>	10,300 lb (4,672 kg) <sub>1</sub>	60 ft <sup>2</sup> (5.6 m <sup>2</sup> )

## Towing a Trailer

Cab – Wheel-base in (mm)	Driveline	Rear Axle Ratio	Maximum Gross Combined Weight Rating	Maximum Trailer Weight	Maximum Trailer Frontal Area
Crew Cab – 157 in (3,989mm)	4WD	3.73	18,400 lb (8,346 kg) <sub>2</sub>	12,900 lb (5,851 kg) <sub>2</sub>	60 ft <sup>2</sup> (5.6 m <sup>2</sup> )
Crew Cab – 157 in (3,989mm) Heavy Payload Package	4WD	3.73	18,600 lb (8,436 kg) <sub>2</sub>	13,000 lb (5,896 kg) <sub>2</sub>	60 ft <sup>2</sup> (5.6 m <sup>2</sup> )

<sup>1</sup> Heavy duty trailer tow package.

<sup>2</sup> Max duty trailer tow package.

**Note:** All values calculated with SAE J2807 method.

**Note:** Do not exceed a trailer weight of 5,000 lb (2,268 kg) when towing with, or by, the bumper only.

**Note:** Do not exceed a trailer weight of 7,000 lb (3,175 kg) or 36 ft<sup>2</sup> (3.4 m<sup>2</sup>) trailer frontal area with the medium duty trailer tow package.

**Note:** Exceeding these limitations could significantly reduce the performance of your towing vehicle. Selecting a trailer with a low aerodynamic drag and rounded front design helps optimize performance and fuel economy.

# Towing a Trailer

---

## What Is the Maximum Loaded Trailer Weight

The maximum loaded trailer weight is the highest possible weight of a fully loaded trailer the vehicle can tow.

For additional information, visit [www.fleet.ford.com/towing-guides](http://www.fleet.ford.com/towing-guides).

## Calculating the Maximum Loaded Trailer Weight for Your Vehicle

1. Start with the gross combined weight rating for your vehicle model and axle ratio.
2. Subtract all of the following that apply to your vehicle:

- Vehicle curb weight.
- Hitch hardware weight, for example a draw bar, ball, locks or weight distributing hardware.
- Driver weight.
- Passenger weight.
- Payload, cargo and luggage weight.
- Aftermarket equipment weight.

This equals the maximum loaded trailer weight for this combination.

**Note:** *The trailer tongue load is considered part of the payload for your vehicle. Reduce the total payload by the final trailer tongue weight.*

**Note:** *Consult an authorized dealer to determine the maximum trailer weight allowed for your vehicle if you are not sure.*

# Towing a Trailer

## TOWING A TRAILER – TROUBLESHOOTING

### Towing a Trailer – Information Messages

<b>Message</b>	<b>Description</b>
Trailer Left Turn Lamps Fault Check Lamps	The left-hand trailer turn lamp requires service.
Trailer Right Turn Lamps Fault Check Lamps	The right-hand trailer turn lamp requires service.
Trailer Battery Not Charging See Manual	The trailer battery requires service.
Trailer Lighting Module Fault See Manual	The trailer lighting module requires service.
Trailer Stop Lamps Fault Check Lamps	The trailer stoplamps require service.
Trailer Sway Reduce Speed	The trailer sway control detects trailer sway. Reduce the vehicle's speed.
Trailer Tire Over Temperature	Displays when one or more tires on the trailer is above the recommended temperature.
Trailer Tire Low Specified:	One or more tires on your trailer is below the specified tire pressure.
Trailer Tire Pressure Sensor Fault	A trailer tire pressure sensor requires service. If the warning stays on or continues to come on, have the system checked as soon as possible.
Trailer Tire Pressure Monitor Fault	The trailer tire pressure monitoring system requires service. If the warning stays on or continues to come on, have the system checked as soon as possible.
Trailer Tire Pressure Monitor Capability Not Detected	The system cannot detect the trailer tire pressure monitoring system.
Trailer Tire Pressure Indication Not Setup See Manual	The trailer tire pressure monitoring system is not setup.

# Integrated Trailer Brake Controller (If Equipped)

## WHAT IS THE INTEGRATED TRAILER BRAKE CONTROLLER

The trailer brake controller assists in smooth and effective trailer braking based on the towing vehicle's brake pressure.

## INTEGRATED TRAILER BRAKE CONTROLLER PRECAUTIONS



**WARNING:** Use the integrated trailer brake controller to properly adjust the trailer brakes and check all connections before towing a trailer. Failure to follow this instruction could result in the loss of control of your vehicle, personal injury or death.

- Only use the manual control lever for proper adjustment of the gain during trailer setup. Misuse, such as application during trailer sway, could cause instability of trailer or tow vehicle.
- Avoid towing in adverse weather conditions. The trailer brake controller does not provide anti-lock control of the trailer wheels. Trailer wheels can lock up on slippery surfaces, resulting in reduced stability of trailer and tow vehicle.
- The trailer brake controller is only a factory-installed or dealer-installed item. Ford is not responsible for warranty or performance of the controller due to misuse or customer installation.

**Note:** Do not attempt removal of the trailer brake controller without consulting the Workshop Manual. Damage to the unit may result.

## USING THE INTEGRATED TRAILER BRAKE CONTROLLER

1. Make sure the trailer brakes are in good working condition, functioning normally and properly adjusted. See your trailer dealer if necessary.

**Note:** An authorized dealer can diagnose the trailer brake controller to determine exactly which trailer fault has occurred. Your vehicle warranty does not cover issues with your trailer.

2. Hook up the trailer and make the electrical connections according to the trailer manufacturer's instructions.

**Note:** Select default mode if the trailer has surge brakes, or no brakes at all. The system has no effect on the braking performance of the trailer in either of these cases.

**Note:** If a trailer is connected by a four-pin connector, the trailer braking function will not be supported.

3. When you plug in a trailer with electric or electric-over-hydraulic brakes, a message confirming connection appears in the information display.
4. Use the gain adjustment to find the desired starting point. A gain setting of 6.0 is a good starting point for heavier loads.

**Note:** Use the following steps to adjust the gain setting whenever road, weather and trailer, or vehicle loading conditions, change from when you initially set the gain.

5. In a traffic-free environment, tow the trailer on a dry, level surface and squeeze the manual control lever completely.



## Integrated Trailer Brake Controller (If Equipped)

- If the trailer wheels lock up, indicated by squealing tires, reduce the gain setting. If the trailer wheels turn freely, increase the gain setting. Repeat Steps 5 and 6 until the gain setting is at a point just below trailer wheel lock-up. If towing a heavier trailer, trailer wheel lock-up may not be attainable even with the maximum gain setting of 10.

**Note:** Only perform this procedure at speeds of approximately 20–25 mph (30–40 km/h).

**Note:** The trailer brake controller reduces output at vehicle speeds below 11 mph (18 km/h) so that trailer and vehicle braking is not jerky or harsh. This feature is only available when applying the brakes using your vehicle's brake pedal, not the controller.

**Note:** Your vehicle's brake system and the trailer brake system work independently of each other. Changing the gain setting on the controller does not affect the operation of your vehicle's brakes whether you attach a trailer or not.

**Note:** With the proper electrical connection, pressing your vehicle brake pedal or using the manual control lever illuminates both trailer and vehicle brake lamps.

**Note:** When you switch the engine off, the controller output is disabled and the display and module shut down. The controller module and display turn on when you switch the ignition on.

### Adjusting the Trailer Brake Gain

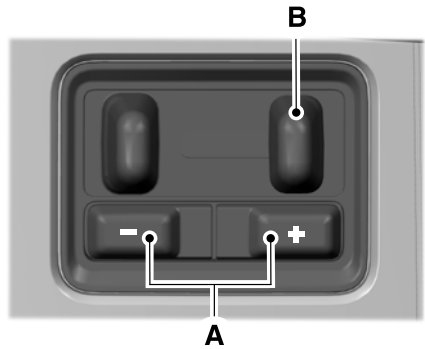

- A Increase or decrease the amount of gain in set increments.
- B Slide the control to engage the trailer brakes.

**Note:** Adjust gain setting before using the trailer brake controller for the first time.

**Note:** The gain should be set to provide the maximum trailer braking assistance while making sure the trailer wheels do not lock when using the brakes. Locked trailer wheels may lead to trailer instability.

**Note:** Setting adjustments are saved when a trailer profile is selected.

### ADJUSTING THE INTEGRATED TRAILER BRAKE CONTROLLER MODE

Select the correct integrated trailer brake controller mode option using the touchscreen.

**Note:** Trailer brake gain settings are saved to the active trailer profile.

# Integrated Trailer Brake Controller (If Equipped)

## Selecting the Trailer Brake Type

1. Press **Default** for trailers with electromagnetic drum brake systems or press **Electric over Hydraulic** for trailers with electrically actuated hydraulic brake systems.
2. Press **Save**.

## Selecting the Trailer Brake Effort

1. Select a setting for your trailer.

**Note:** *The default value is **Low** and is the recommended setting for most trailers. Select a different setting if your trailer's brakes require more initial voltage, or you prefer more aggressive trailer braking.*

2. Press **Save**.

## INTEGRATED TRAILER BRAKE CONTROLLER – TROUBLESHOOTING

### Integrated Trailer Brake Controller – Information Messages

Message	Action
Trailer Connected	The system detects a correct trailer connection during a given ignition cycle.
Trailer Disconnected	The system detects the trailer wiring connection is disconnected, during a given ignition cycle.
Trailer Wiring Fault	The system detects an electrical fault in the trailer brake circuit. If this message appears without a trailer attached, see your authorized dealer. If a trailer is attached, inspect and repair the trailer wiring.
Trailer Brake Gain: {trailer gain value:#0.0}	Displays the current gain setting for the trailer brake.
Trailer Brake Gain: {trailer gain value:#0.0} No Trailer	Displays the current gain setting for the trailer brake when you do not have a trailer connected.

# Integrated Trailer Brake Controller (If Equipped)

---

## Integrated Trailer Brake Controller – Frequently Asked Questions

### **How do I determine if there is an issue with the wiring on my vehicle?**

A message displays accompanied by a single tone, when no trailer is connected. This indicates that the issue is between the trailer brake controller and the 7-pin connector at the bumper.

### **How do I determine if there is an issue with the wiring on my trailer?**

A message only displays with a trailer connected. Consult your trailer dealer for assistance.

# Trailer Sway Control

## HOW DOES TRAILER SWAY CONTROL WORK

### Trailer Sway Control

The system applies the brakes to the individual wheels and reduces engine torque to aid vehicle stability.

If the trailer begins to sway, the stability control lamp flashes and the message **Trailer Sway Reduce Speed** appears in the information display.

Stop your vehicle as soon as it is safe to do so. Check the vertical weight on the tow ball and trailer load distribution.

3. Switch **Trailer Sway Control** on or off. The system turns on each time you start your vehicle.

## TRAILER SWAY CONTROL PRECAUTIONS



**WARNING:** Turning off trailer sway control increases the risk of loss of vehicle control, serious injury or death. Ford does not recommend disabling this feature except in situations where speed reduction may be detrimental (such as hill climbing), the driver has significant trailer towing experience, and can control trailer sway and maintain safe operation.

**Note:** *This feature does not prevent trailer sway, but reduces it once it begins.*

**Note:** *This feature cannot stop all trailers from swaying.*

**Note:** *In some cases, if vehicle speed is too high, the system may activate multiple times, gradually reducing vehicle speed.*

## SWITCHING TRAILER SWAY CONTROL ON AND OFF

1. Press **Features** on the touchscreen.
2. Press **Towing**.

# Trailer Reversing Aid - Vehicles With: Pro Trailer Backup Assist

## WHAT IS THE TRAILER REVERSING AID

The Pro Trailer Backup Assist utilizes the control knob on the instrument panel to help you steer a trailer. Turn the control knob in the direction you want the trailer to go and the system steers the vehicle.

## HOW DOES THE TRAILER REVERSING AID WORK

The trailer reversing aid uses a sensor attached to the trailer to detect the trailer angle relative to the towing vehicle and provides instructions, graphics and camera views on the touchscreen.

## TRAILER REVERSING AID PRECAUTIONS



**WARNING:** Driving while distracted can result in loss of vehicle control, crash and injury. We strongly recommend that you use extreme caution when using any device that may take your focus off the road. Your primary responsibility is the safe operation of your vehicle. We recommend against the use of any hand-held device while driving and encourage the use of voice-operated systems when possible. Make sure you are aware of all applicable local laws that may affect the use of electronic devices while driving.



**WARNING:** This system is an extra driving aid. It does not replace your attention and judgment, or the need to apply the brakes. This system does NOT automatically brake your vehicle. If you fail to press the brake pedal when necessary, you may collide with another vehicle.

**Note:** *The system is not a substitute for safe driving practices. Always be aware of your vehicle and trailer combination, and the surrounding environment.*

**Note:** *The system does not detect or prevent your vehicle or trailer from making contact with obstacles in the surrounding environment.*

**Note:** *The front end of your vehicle swings out when changing the direction of the trailer.*

**Note:** *In certain conditions, the trailer could turn faster or the trailer angle could increase more than anticipated. Always monitor the clearance between the trailer and vehicle and the surroundings.*

## SETTING UP THE TRAILER REVERSING AID FOR A CONVENTIONAL TRAILER

### Configuring the Trailer

You must configure a trailer in the system to use the trailer reversing aids. This is a one-time setup process and the trailer information is saved in the system for the next time you use that trailer.

The system only works with conventional trailers. It does not work with other types including goose neck and fifth wheel. The following illustration shows examples of conventional trailers on the left-hand side.

# Trailer Reversing Aid - Vehicles With: Pro Trailer Backup Assist

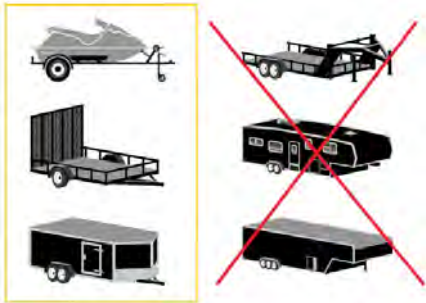

E209766

## Positioning the Trailer

Hitch your trailer to the truck and connect the electrical wiring harness. Check to make sure that the wiring is working. See **Connecting a Trailer** (page 371).



E209759

Park your vehicle and hitched trailer on a level surface.

For best results, make sure that your trailer rides level with the ground when you hitch your vehicle. See **Connecting a Trailer** (page 371).



E209760

Make sure that the trailer and your vehicle are in line with each other. You can do this by putting the transmission in drive (D) and pulling straight forward.

## Configuring the Trailer in the Touchscreen



1. Press the button to switch the system on.
2. Press **Add Trailer** on the touchscreen.
3. Follow the directions on the touchscreen to enter the trailer name and trailer type, then proceed to the sensor setup.

# Trailer Reversing Aid - Vehicles With: Pro Trailer Backup Assist

## Trailer Sensor Installation



Refer to the instructions included with your trailer sensor for detailed information regarding installation.

**Note:** Make sure the arrows on the sensor housing are facing up. Mount the sensor to a vertical part of the trailer that pivots when you turn your vehicle. Do not mount to a stationary surface such as the truck side of the trailer hitch.

## Calibrating the System

Calibrating the system requires driving forward and turning left or right. Follow the instructions on the touchscreen to complete the calibration process.

**Note:** To calibrate the system, you need an area where you can safely drive forward and turn left or right. An open parking lot is an ideal place to perform the calibration.

**Note:** Keep the steering wheel straight when instructed to by the touchscreen. If the steering wheel is in a turned position during this instruction, the calibration pauses.

**Note:** During calibration, the system determines the trailer length. The system supports trailer lengths of 6–33 ft (1.85–10.05 m) distance from the hitch point to the center of the axle or axles. The system is designed to work with drawbars that have a license plate to hitch ball center measurement of 9–18 in (23–46 cm) when installed. Do not attempt to use drawbars or trailers that have a length outside of this range as the system performance degrades and could cause improper system function.

**Note:** The touchscreen shows if you are going too slow or fast. Calibration pauses if the speed is outside the required range of 2–16 mph (4–25 km/h).

**Note:** You need to turn approximately 90° to calibrate the system. Some trailers could require you to drive straight then turn multiple times before calibration is complete. The touchscreen provides instructions and notifies you when calibration is complete.

# Trailer Reversing Aid - Vehicles With: Pro Trailer Backup Assist

## SWITCHING THE TRAILER REVERSING AID ON AND OFF

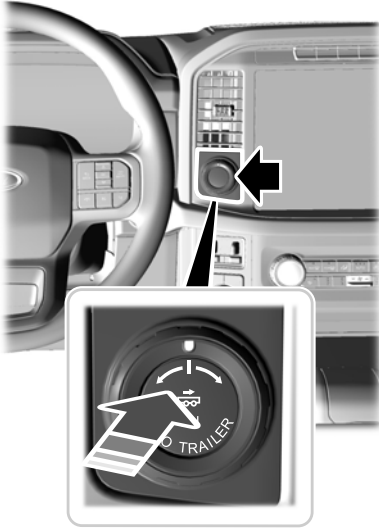

Press the button and use the touchscreen to select the connected trailer.

**Note:** A trailer must be configured to use Pro Trailer Backup Assist. See **Configuring the Trailer** (page 410).

**Note:** If you use the steering wheel when using Pro Trailer Backup Assist, the system turns off and a message displays in the touchscreen.

**Note:** If the trailer was connected just prior to turning the system on, you may need to drive forward to initialize the system. Follow the instructions on the touchscreen to activate the system.

## USING THE TRAILER REVERSING AID CONTROLLER

Use the control knob to steer the trailer. Take your hands off the steering wheel and turn the control knob instead. The control knob acts as the steering control for the trailer.



Turn and hold counterclockwise to make the trailer go left.



Turn and hold clockwise to make the trailer go right.



# Trailer Reversing Aid - Vehicles With: Pro Trailer Backup Assist

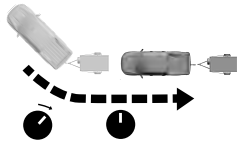

Release the knob when the trailer is moving in the direction you want.

**Note:** The more you turn the knob, the sharper the trailer turns.

**Note:** Quickly turning and releasing the knob results in a jerky movement of the vehicle.

**Note:** You may have to use the knob to correct the trailer direction when attempting to move the trailer straight back under some conditions.

## USING THE TRAILER REVERSE GUIDANCE VIEWS

Up to seven camera views could be available when using the trailer reversing aid. Use the view that helps you the most when reversing your vehicle and trailer.



360° camera view. Shows a 360° view on the right-hand side of the touchscreen with a rear camera view on the left-hand side of the touchscreen.



Rear view camera view. Shows your trailer hitch or what is directly behind your vehicle.



Rear split view camera view. Shows a 180° degree view of what is behind your vehicle.



Bed camera view. Shows the truck bed.

**Note:** If you have a 12 in (30 cm) touchscreen, this view provides a picture-in-picture view.



Trailer AUX camera view. Shows a rear view camera image of what is behind your trailer. You need to separately purchase this camera and have it installed.

**Note:** If you have a 12 in (30 cm) touchscreen, this view provides a picture-in-picture view.



Trailer reverse guidance view. Shows you a view of the sides of your truck and the trailer. In auto mode, this view moves as the trailer moves so that you do not have to adjust the camera as you turn. Left and right arrows let you see other camera views.



Auto. Press to return to auto view.

**Note:** Auto mode is the default setting.

## Hitch Angle Graphic

The hitch angle graphic shows a small representation of your truck and trailer with visual feedback to help you monitor the trailer. The graphic shows two different colored lines for the trailer hitch angle. A black line shows you where your trailer is in relation to your vehicle. The white line represents the amount the trailer can turn based on knob input.

The graphic shows a yellow and red zone for the hitch angle to warn you of a high angle condition that could require you to pull forward to reduce the hitch angle. The angle limits for each zone vary based on the trailer length.

# Trailer Reversing Aid - Vehicles With: Pro Trailer Backup Assist

---

The yellow zone indicates you are approaching the maximum controllable trailer angle for the system. When the trailer enters this zone, it is more difficult to reduce the trailer turn when backing up. It may be necessary to put your vehicle back into drive (D) and pull forward to get the truck and trailer back to an in-line position.

The red zone indicates you have exceeded the maximum controllable trailer angle for the system. Immediately stop reversing. Put your vehicle into drive (D) and pull forward until the trailer is no longer in the red zone.

## Setting the Trailer Angle Limit

1. Press **Features** on the touchscreen.
2. Press **Towing**.

3. Press **Manage trailers**.
4. Press **Pro Trailer Backup Assist**.
5. Press **Trailer Angle Limit**.
6. Press a setting.

## Normal Control Angle

Default setting. This provides a balanced limit that returns from a turn to straight backing with minimal change to the trailer direction.

## Max Control Angle

Increases the trailer angle limit close to the maximum controllable angle to allow sharper turns but also causes more change in the trailer direction when straightening out from a turn.

# Trailer Reversing Aid - Vehicles With: Pro Trailer Backup Assist

## TRAILER REVERSING AID - TROUBLESHOOTING

### Trailer Reversing Aid – Information Messages

Message	Description
Detecting Trailer Please Wait...	Displays when the system turns on and is initializing.
Pro Trailer Backup Assist™ System is Not Available	A condition exists that prevents the system from turning on. If the message continues to display, visit your authorized dealer to have your vehicle checked.
Trailer Reverse Guidance System is Not Available	
Pro Trailer Backup Assist™ Driving Required to Initialize Steering Press Knob to Exit	The steering system needs to learn internal parameters to fully enable the feature. Drive your vehicle straight forward above 25 mph (40 km/h) for approximately 5 minutes.
Trailer Reverse Guidance Driving Required to Initialize Steering Press OK to Exit	
Pro Trailer Backup Assist™ Stop now Maximum trailer angle Press Knob to Exit	Displays when you reach the maximum controllable trailer angle for the system. Place your vehicle in drive (D) and pull forward to get the truck and trailer back to an in-line position. If this message consistently displays, you may need to repeat the trailer calibration. Delete the trailer from the system and repeat the setup and calibration process.
Stop now. Deactivated by trailer angle.	Displays when you exceed the maximum controllable trailer angle for the system. Place your vehicle in drive (D) and pull forward to get your vehicle and trailer back to an in-line position, then activate the system by selecting the connected trailer and following the instructions on the touchscreen. If this message consistently displays, you may need to repeat the trailer setup and calibration. Delete the trailer from the system and repeat the setup and calibration process.
Pro Trailer Backup Assist™ Stop Now Take Control of Steering Wheel	Displays when the system can no longer steer the vehicle and you must take over steering.

## Trailer Reversing Aid - Vehicles With: Pro Trailer Backup Assist

<b>Message</b>	<b>Description</b>
Pro Trailer Backup Assist™ Sensor Not Detected Refer to Owner's Manual Press Knob to Exit	Displays when the system does not detect the sensor. Check the sensor connection, that there is no damaged wiring between the connector and sensor and that there is only one sensor connected.
Trailer Reverse Guidance Sensor Not Detected Refer to Owner's Manual Press OK to Exit	
Pro Trailer Backup Assist™ Trailer Not Detected. Shift to Park Press Knob to Exit	These messages display when the system does not detect the trailer. Check that the sensor is correctly installed and the trailer length is within the allowed range. If these messages continue to display, visit your authorized dealer to have your vehicle checked.
Pro Trailer Backup Assist™ Trailer Not Detected. Refer to Owner's Manual. Press Knob to Exit	
Trailer Reverse Guidance Trailer Not Detected. Refer to Owner's Manual. Press OK to Exit	
Pro Trailer Backup Assist™ Trailer Not Detected Pull Forward to Initialize Press Knob to Exit	These messages display when your vehicle has not moved after the trailer sensor is connected or extended operation below 1 mph (1 km/h). Drive forward above 2 mph (3 km/h) to initialize the system.
Trailer Reverse Guidance Trailer Not Detected Pull Forward to Initialize Press OK to Exit	
Pro Trailer Backup Assist™ Stop Now System Not Active Press Knob to Exit	Displays when your vehicle is backing up but the system is not activated. Select the connected trailer on the touchscreen and follow the instructions to activate the system. This message also displays when you back up during the calibration process.
Pro Trailer Backup Assist™ Backup Slowly Turn Knob to Steer Press Knob to Exit	Displays when the system turns on and is available to use.

# Trailer Reversing Aid - Vehicles With: Pro Trailer Backup Assist

---

## Trailer Reversing Aid – Frequently Asked Questions

### Why does the trailer not reverse straight?

Verify the sensor is correctly installed. Other factors such as the hitch connection, road camber, road slope and trailer suspension could influence how straight the system can reverse the trailer when the control knob is not turned. You can compensate for the trailer drifting to the right or left by slowly turning the knob until the trailer is following your desired path and then holding the knob in that position.

### Why does the system not detect a sensor?

There could be an issue with the connection, the wiring harness could be damaged, you could have multiple sensors connected or the sensor could be incorrectly installed. Check that the 12-way connector is fully inserted into the 12-way socket. The red rubber seal is not visible when the connector is fully inserted. Also check that the wiring harness sensor connection is fully inserted at the trailer sensor, and check for damaged wiring between the 12-way connector and the trailer sensor. Also, check that the sensor is installed on a vertical surface with the arrows pointing straight up.

### What does it mean if the system pauses during calibration?

There could be steering input or trailer movement during the straight drive portion of the calibration process.

### What does it mean if the system remains on one message for an extended time during calibration?

The sensor could be incorrectly installed, the trailer length could be outside the allowed range or the road surface could be too rough or bumpy.

### What does it mean if the system displays that it is not available?

There could be a sub-system that the system uses that is not correctly operating or there could be a battery voltage issue. If the system continues to display it is not available, visit your authorized dealer to have your vehicle checked.

### What does it mean if the system displays that driving is required to initialize steering?

The steering system needs to learn internal parameters to fully turn on the feature. Drive your vehicle straight forward above 25 mph (40 km/h) for approximately 5 minutes. This could also occur when your vehicle is new, there is a battery voltage issue or if the steering system has been serviced.

### What does it mean if the system does not detect a trailer when configured with a sensor?

Verify that the sensor is properly connected. See **Trailer Sensor Installation** (page 412). Repeat calibration on a different route if you have verified sensor installation.

# Trailer Reversing Aid - Vehicles With: Pro Trailer Backup Assist

---

## What does it mean if the system requires you to pull forward to initialize?

This occurs when the vehicle has not moved during the current key cycle after you connect and select the trailer in the touchscreen or you operate the system at speeds below 1 mph (1 km/h) for an extended period of time. Drive forward above 2 mph (3 km/h) and the system indicates when it initializes.

## What does it mean if the trailer is at its maximum angle or the system deactivated by trailer angle?

You are at the maximum controllable trailer angle for the system. Place your vehicle in drive (D) and pull forward to get the truck and trailer back to an in-line position. If this message consistently displays, this could indicate the sensor is incorrectly installed, the trailer needs to be recalibrated or the drawbar or the trailer dimensions are outside of the supported range. The system is designed to work with drawbars that have a license plate to hitch ball center measurement of 9–18 in (23–46 cm) when installed. The system is designed to work with trailers that have a hitch point to center of the axle or axles measurement of 6–33 ft (1.85–10.05 m). Do not attempt to use drawbars or trailers that have a length outside of this range as the system performance degrades and could cause improper system function. Check that the correct trailer is selected in the touchscreen. Verify the sensor is installed according to the instructions included in the sensor kit and check that the drawbar and the trailer dimensions are within the allowed range. Then, delete the trailer from the system and repeat the setup process to calibrate the trailer.

## What does it mean when the system tells you to take control of the steering wheel?

The system is no longer steering the vehicle and you must take over steering. There are four reasons the system could display this message. The first reason the system could display this message is that you have touched the steering wheel when the system is steering. The second reason the system could display this message is that you have exceeded the maximum speed for the feature. The third reason the system could display this message is that the trailer is not detected. The final reason the system could display this message is that an internal condition for system operation is not met that requires your vehicle to return to manual control of the steering.

**Note:** *The system is designed to be used with the same trailer connection every time you choose the trailer from the touchscreen. When using a different drawbar or a different pin hole on drawbars with more than one, connecting the drawbar to your vehicle affects the trailer position and you may need to repeat the trailer setup and calibration process.*

# Trailer Reversing Aid - Vehicles With: Trailer Reverse Guidance (TRG)

## WHAT IS THE TRAILER REVERSING AID

[ProTrailer Back-Up Assist with Trailer Reverse Guidance](#)

Trailer Reverse Guidance provides views and graphics on the touchscreen to help you steer your vehicle when you backup a trailer.

## HOW DOES THE TRAILER REVERSING AID WORK

The trailer reversing aid uses a sensor attached to the trailer to detect the trailer angle relative to the towing vehicle and provides instructions, graphics and camera views on the touchscreen.

## TRAILER REVERSING AID PRECAUTIONS



**WARNING:** Driving while distracted can result in loss of vehicle control, crash and injury. We strongly recommend that you use extreme caution when using any device that may take your focus off the road. Your primary responsibility is the safe operation of your vehicle. We recommend against the use of any hand-held device while driving and encourage the use of voice-operated systems when possible. Make sure you are aware of all applicable local laws that may affect the use of electronic devices while driving.



**WARNING:** This system is an extra driving aid. It does not replace your attention and judgment, or the need to apply the brakes. This system does NOT automatically brake your vehicle. If you fail to press the brake pedal when necessary, you may collide with another vehicle.

**Note:** *The system is not a substitute for safe driving practices. Always be aware of your vehicle and trailer combination, and the surrounding environment.*

**Note:** *The system does not detect or prevent your vehicle or trailer from making contact with obstacles in the surrounding environment.*

**Note:** *The front end of your vehicle swings out when changing the direction of the trailer.*

**Note:** *In certain conditions, the trailer could turn faster or the trailer angle could increase more than anticipated. Always monitor the clearance between the trailer and vehicle and the surroundings.*

## SETTING UP THE TRAILER REVERSING AID FOR A CONVENTIONAL TRAILER

### Configuring the Trailer

You must configure a trailer in the system to use the trailer reversing aids. This is a one-time setup process and the trailer information is saved in the system for the next time you use that trailer.

The system only works with conventional trailers. It does not work with other types including goose neck and fifth wheel. The following illustration shows examples of conventional trailers on the left-hand side.

# Trailer Reversing Aid - Vehicles With: Trailer Reverse Guidance (TRG)

**Note:** Trailer Reverse Guidance camera views are available with no trailer setup. However, complete functionality including graphics and automatic view switching is enabled by setup. Setup is required to enable the Trailer Backup Assist feature.

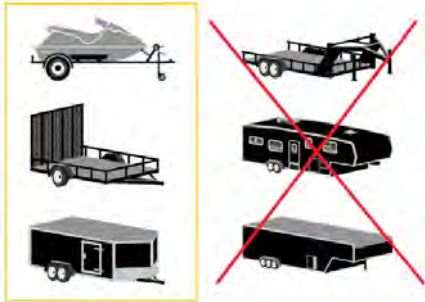

E209766

## Positioning the Trailer

Hitch your trailer to the truck and connect the electrical wiring harness. Check to make sure that the wiring is working. See **Connecting a Trailer** (page 371).



E209759

Park your vehicle and hitched trailer on a level surface.

For best results, make sure that your trailer rides level with the ground when you hitch your vehicle. See **Connecting a Trailer** (page 371).



E209760

Make sure that the trailer and your vehicle are in line with each other. You can do this by putting the transmission in drive (D) and pulling straight forward.

## Configuring the Trailer in the Touchscreen

1. Shift to reverse (R).
2. Press the camera view button.
3. Press the trailer view icon.
4. Press **Add Trailer**.
5. Follow the directions on the touchscreen to enter the trailer name and trailer type, then proceed to the sensor setup.

## Trailer Sensor Installation





# Trailer Reversing Aid - Vehicles With: Trailer Reverse Guidance (TRG)



Refer to the instructions included with your trailer sensor for detailed information regarding installation.

**Note:** Make sure the arrows on the sensor housing are facing up. Mount the sensor to a vertical part of the trailer that pivots when you turn your vehicle. Do not mount to a stationary surface such as the truck side of the trailer hitch.

## Calibrating the System

Calibrating the system requires driving forward and turning left or right. Follow the instructions on the touchscreen to complete the calibration process.

**Note:** To calibrate the system, you need an area where you can safely drive forward and turn left or right. An open parking lot is an ideal place to perform the calibration.

**Note:** Keep the steering wheel straight when instructed to by the touchscreen. If the steering wheel is in a turned position during this instruction, the calibration pauses.

**Note:** During calibration, the system determines the trailer length. The system supports trailer lengths of 6–33 ft (1.85–10.05 m) distance from the hitch point to the center of the axle or axles. The system is designed to work with drawbars that have a license plate to hitch ball center measurement of 9–18 in (23–46 cm) when installed. Do not attempt to use drawbars or trailers that have a length outside of this range as the system performance degrades and could cause improper system function.

**Note:** The touchscreen shows if you are going too slow or fast. Calibration pauses if the speed is outside the required range of 2–16 mph (4–25 km/h).

**Note:** You need to turn approximately 90° to calibrate the system. Some trailers could require you to drive straight then turn multiple times before calibration is complete. The touchscreen provides instructions and notifies you when calibration is complete.

## SWITCHING THE TRAILER REVERSING AID ON AND OFF

Shift into reverse (R), press the rear camera button to expand the menu, press the trailer icon and use the touchscreen to select the connected trailer.

**Note:** If the trailer was connected just prior to turning the system on, you may need to drive forward to initialize the system. Follow the instructions on the touchscreen to activate the system.

## USING THE TRAILER REVERSE GUIDANCE VIEWS

Up to seven camera views could be available when using the trailer reversing aid. Use the view that helps you the most when reversing your vehicle and trailer.

# Trailer Reversing Aid - Vehicles With: Trailer Reverse Guidance (TRG)



360° camera view. Shows a 360° view on the right-hand side of the touchscreen with a rear camera view on the left-hand side of the touchscreen.



Rear view camera view. Shows your trailer hitch or what is directly behind your vehicle.



Rear split view camera view. Shows a 180° degree view of what is behind your vehicle.



Bed camera view. Shows the truck bed.

**Note:** *If you have a 12 in (30 cm) touchscreen, this view provides a picture-in-picture view.*



Trailer AUX camera view. Shows a rear view camera image of what is behind your trailer. You need to separately purchase this camera and have it installed.

**Note:** *If you have a 12 in (30 cm) touchscreen, this view provides a picture-in-picture view.*



Trailer reverse guidance view. Shows you a view of the sides of your truck and the trailer. In auto mode, this view moves as the trailer moves so that you do not have to adjust the camera as you turn. Left and right arrows let you see other camera views.



Straight backup mode. Shows which way to turn your steering wheel to keep the trailer straight. Use this view when you want to keep your trailer completely in line with your truck.

**Note:** *It may be helpful to shift your vehicle into drive (D), pull forward and straighten out the vehicle and trailer before engaging straight backup mode.*



This takes you back to the 360° camera system and out of the trailer reverse guidance feature.



Auto. Press to return to auto view.

**Note:** *Auto mode is the default setting.*

## Hitch Angle Graphic

The hitch angle graphic shows a small representation of your truck and trailer with visual feedback to help you monitor the trailer. The graphic shows two different colored lines for the trailer hitch angle. A black line shows you where your trailer is in relation to your vehicle. The white line represents the amount the trailer can turn based on steering wheel position.

The graphic shows a yellow and red zone for the hitch angle to warn you of a high angle condition that could require you to pull forward to reduce the hitch angle. The angle limits for each zone vary based on the trailer length.

The yellow zone indicates you are approaching the maximum controllable trailer angle for the system. When the trailer enters this zone, it is more difficult to reduce the trailer turn when backing up. It may be necessary to put your vehicle back into drive (D) and pull forward to get the truck and trailer back to an in-line position.

The red zone indicates you have exceeded the maximum controllable trailer angle for the system. Immediately stop reversing. Put your vehicle into drive (D) and pull forward until the trailer is no longer in the red zone.

# Trailer Reversing Aid - Vehicles With: Trailer Reverse Guidance (TRG)

## TRAILER REVERSING AID - TROUBLESHOOTING

### Trailer Reversing Aid – Information Messages

Message	Description
Detecting Trailer Please Wait...	Displays when the system turns on and is initializing.
Pro Trailer Backup Assist™ System is Not Available	A condition exists that prevents the system from turning on. If the message continues to display, visit your authorized dealer to have your vehicle checked.
Trailer Reverse Guidance System is Not Available	
Pro Trailer Backup Assist™ Driving Required to Initialize Steering Press Knob to Exit	The steering system needs to learn internal parameters to fully enable the feature. Drive your vehicle straight forward above 25 mph (40 km/h) for approximately 5 minutes.
Trailer Reverse Guidance Driving Required to Initialize Steering Press OK to Exit	
Pro Trailer Backup Assist™ Stop now Maximum trailer angle Press Knob to Exit	Displays when you reach the maximum controllable trailer angle for the system. Place your vehicle in drive (D) and pull forward to get the truck and trailer back to an in-line position. If this message consistently displays, you may need to repeat the trailer calibration. Delete the trailer from the system and repeat the setup and calibration process.
Stop now. Deactivated by trailer angle.	Displays when you exceed the maximum controllable trailer angle for the system. Place your vehicle in drive (D) and pull forward to get your vehicle and trailer back to an in-line position, then activate the system by selecting the connected trailer and following the instructions on the touchscreen. If this message consistently displays, you may need to repeat the trailer setup and calibration. Delete the trailer from the system and repeat the setup and calibration process.
Pro Trailer Backup Assist™ Stop Now Take Control of Steering Wheel	Displays when the system can no longer steer the vehicle and you must take over steering.

## Trailer Reversing Aid - Vehicles With: Trailer Reverse Guidance (TRG)

<b>Message</b>	<b>Description</b>
Pro Trailer Backup Assist™ Sensor Not Detected Refer to Owner's Manual Press Knob to Exit	Displays when the system does not detect the sensor. Check the sensor connection, that there is no damaged wiring between the connector and sensor and that there is only one sensor connected.
Trailer Reverse Guidance Sensor Not Detected Refer to Owner's Manual Press OK to Exit	
Pro Trailer Backup Assist™ Trailer Not Detected. Shift to Park Press Knob to Exit	These messages display when the system does not detect the trailer. Check that the sensor is correctly installed and the trailer length is within the allowed range. If these messages continue to display, visit your authorized dealer to have your vehicle checked.
Pro Trailer Backup Assist™ Trailer Not Detected. Refer to Owner's Manual. Press Knob to Exit	
Trailer Reverse Guidance Trailer Not Detected. Refer to Owner's Manual. Press OK to Exit	
Pro Trailer Backup Assist™ Trailer Not Detected Pull Forward to Initialize Press Knob to Exit	These messages display when your vehicle has not moved after the trailer sensor is connected or extended operation below 1 mph (1 km/h). Drive forward above 2 mph (3 km/h) to initialize the system.
Trailer Reverse Guidance Trailer Not Detected Pull Forward to Initialize Press OK to Exit	
Pro Trailer Backup Assist™ Stop Now System Not Active Press Knob to Exit	Displays when your vehicle is backing up but the system is not activated. Select the connected trailer on the touchscreen and follow the instructions to activate the system. This message also displays when you back up during the calibration process.
Pro Trailer Backup Assist™ Backup Slowly Turn Knob to Steer Press Knob to Exit	Displays when the system turns on and is available to use.

# Trailer Reversing Aid - Vehicles With: Trailer Reverse Guidance (TRG)

---

## Trailer Reversing Aid – Frequently Asked Questions

### Why does the trailer not reverse straight?

Verify the sensor is correctly installed. Other factors such as the hitch connection, road camber, road slope and trailer suspension could influence how straight the system can reverse the trailer when the control knob is not turned. You can compensate for the trailer drifting to the right or left by slowly turning the knob until the trailer is following your desired path and then holding the knob in that position.

### Why does the system not detect a sensor?

There could be an issue with the connection, the wiring harness could be damaged, you could have multiple sensors connected or the sensor could be incorrectly installed. Check that the 12-way connector is fully inserted into the 12-way socket. The red rubber seal is not visible when the connector is fully inserted. Also check that the wiring harness sensor connection is fully inserted at the trailer sensor, and check for damaged wiring between the 12-way connector and the trailer sensor. Also, check that the sensor is installed on a vertical surface with the arrows pointing straight up.

### What does it mean if the system pauses during calibration?

There could be steering input or trailer movement during the straight drive portion of the calibration process.

### What does it mean if the system remains on one message for an extended time during calibration?

The sensor could be incorrectly installed, the trailer length could be outside the allowed range or the road surface could be too rough or bumpy.

### What does it mean if the system displays that it is not available?

There could be a sub-system that the system uses that is not correctly operating or there could be a battery voltage issue. If the system continues to display it is not available, visit your authorized dealer to have your vehicle checked.

### What does it mean if the system displays that driving is required to initialize steering?

The steering system needs to learn internal parameters to fully turn on the feature. Drive your vehicle straight forward above 25 mph (40 km/h) for approximately 5 minutes. This could also occur when your vehicle is new, there is a battery voltage issue or if the steering system has been serviced.

### What does it mean if the system does not detect a trailer when configured with a sensor?

Verify that the sensor is properly connected. See **Trailer Sensor Installation** (page 412). Repeat calibration on a different route if you have verified sensor installation.

# Trailer Reversing Aid - Vehicles With: Trailer Reverse Guidance (TRG)

---

## What does it mean if the system requires you to pull forward to initialize?

This occurs when the vehicle has not moved during the current key cycle after you connect and select the trailer in the touchscreen or you operate the system at speeds below 1 mph (1 km/h) for an extended period of time. Drive forward above 2 mph (3 km/h) and the system indicates when it initializes.

## What does it mean if the trailer is at its maximum angle or the system deactivated by trailer angle?

You are at the maximum controllable trailer angle for the system. Place your vehicle in drive (D) and pull forward to get the truck and trailer back to an in-line position. If this message consistently displays, this could indicate the sensor is incorrectly installed, the trailer needs to be recalibrated or the drawbar or the trailer dimensions are outside of the supported range. The system is designed to work with drawbars that have a license plate to hitch ball center measurement of 9–18 in (23–46 cm) when installed. The system is designed to work with trailers that have a hitch point to center of the axle or axles measurement of 6–33 ft (1.85–10.05 m). Do not attempt to use drawbars or trailers that have a length outside of this range as the system performance degrades and could cause improper system function. Check that the correct trailer is selected in the touchscreen. Verify the sensor is installed according to the instructions included in the sensor kit and check that the drawbar and the trailer dimensions are within the allowed range. Then, delete the trailer from the system and repeat the setup process to calibrate the trailer.

## What does it mean when the system tells you to take control of the steering wheel?

The system is no longer steering the vehicle and you must take over steering. There are four reasons the system could display this message. The first reason the system could display this message is that you have touched the steering wheel when the system is steering. The second reason the system could display this message is that you have exceeded the maximum speed for the feature. The third reason the system could display this message is that the trailer is not detected. The final reason the system could display this message is that an internal condition for system operation is not met that requires your vehicle to return to manual control of the steering.

**Note:** *The system is designed to be used with the same trailer connection every time you choose the trailer from the touchscreen. When using a different drawbar or a different pin hole on drawbars with more than one, connecting the drawbar to your vehicle affects the trailer position and you may need to repeat the trailer setup and calibration process.*

# Driving Hints

---

## OFF-ROAD DRIVING

### What Is Off-Road Driving

Off-road driving is driving your vehicle on unsurfaced roads or trails, made from dirt, rocks, sand and mud.

### Basic Off-Road Driving Techniques

#### Off-road Driving Hints

Before taking your vehicle off-roading, a basic vehicle inspection should be done to make sure that the vehicle is in top working condition. It is always recommended that at least two vehicles are used while off-roading. The buddy system helps make sure that help is close at hand should a vehicle become stuck or damaged. It is also wise to take supplies such as a first aid kit, supply of water, tow strap, cell or satellite phone with you any time an off-road excursion is planned.

1. Grip the steering wheel with thumbs on the outside of the rim. This will reduce the risk of injury due to abrupt steering wheel motions that occur when negotiating rough terrain.
2. Throttle, brake and steering inputs should be made in a smooth and controlled manner. Sudden inputs to the controls can cause loss of traction or upset the vehicle, especially while on loose terrain or while crossing obstacles such as rocks or logs.
3. Look ahead on your route noting upcoming obstacles, or any other factors which may indicate a change in available traction, and adjust the vehicle speed and route accordingly.

4. When driving off-road, if the front or rear suspension is bottoming out and/or excessive contact with the skid-plates is encountered, reduce vehicle speed to avoid potential damage to the vehicle.
5. When with other vehicles, it is recommended that communication is used, and the lead vehicle notify other vehicles of obstacles that could cause potential vehicle damage.
6. Always keep available ground clearance in mind and pick a route that minimizes the risk of catching the underside of the vehicle on an obstacle.
7. When negotiating low speed obstacles, applying light brake pressure in conjunction with the throttle will help prevent the vehicle from jerking and will allow you to negotiate the obstacle in a more controlled manner. Using 4L will also help with this.
8. Off-roading requires a high degree of concentration. Even if your local law does not prohibit alcohol use while driving off-road, Ford strongly recommends against drinking if you plan to off-road.

#### Crossing Obstacles

- Review the path ahead before attempting to cross any obstacle. It is best if the obstacle is reviewed from outside the vehicle so that there is a good understanding of terrain condition both in front of and behind the obstacle.
- Approach obstacles slowly.

# Driving Hints

- If a large obstacle such as a rock cannot be avoided, choose a path that places the rock directly under the tire rather than the undercarriage of the vehicle. This will help prevent damage to the vehicle.
- Ditches and washouts should be crossed at a 45° angle, allowing each wheel to independently cross the obstacle.

## Hill Climbing



**WARNING:** Extreme care should be used when steering the vehicle in reverse down a slope so as not to cause the vehicle to swerve out of control.

- Always attempt to climb a steep hill along the fall line of the slope and not diagonally.
- If the vehicle is unable to make it up the hill, DO NOT attempt to turn back down the slope. Place the vehicle in low range and slowly back down in reverse.
- When descending a steep slope, select low gear and engage hill descent control. Use the throttle and brake pedals to control your descent speed.

**Note:** *Hill descent control is functional in reverse and should be used in this situation.*

## Water Wading



**WARNING:** Do not attempt to cross a deep, fast flowing body of water. Failure to follow this instruction could result in the loss of control of your vehicle, personal injury or death.

As the water depth increases, you must reduce your vehicle speed to avoid potential vehicle damage.



- Always determine the depth before attempting a water crossing. Never drive through water that is higher than the bottom of the wheel hubs.
- Slowly proceed and avoid splashing water any more than is necessary.
- Be aware that obstacles and debris may be beneath the water's surface.
- Keep the doors fully closed during the water crossing.
- After driving through water and as soon as it is safe to do so check the brakes, horn, lights, and steering wheel to confirm those systems are functioning properly.

**Note:** *Engine damage can occur if water enters the air filter.*

## After Driving Your Vehicle Off-Road



**WARNING:** After off-road use, before returning to the road, check the wheels and tires for damage. Off-road use may cause damage to your wheels and tires that can lead to tire failure, loss of vehicle control, serious injury or death.



# Driving Hints

---

Driving off-road places more stress on your vehicle than most on-road driving. After driving off-road check for damage to your vehicle and, if necessary, have your vehicle fixed as soon as possible.

Inspect the underbody of your vehicle by checking tires, body structure, steering, suspension, and exhaust system for damage.

Check the radiator for mud and debris and clean as needed.

Remove accumulations of plants or brush. These things could be a fire hazard or hide damage to the fuel lines, brake hoses, and propeller shafts.

After extended operation in mud, sand, water, or similar dirty conditions, inspect the underbody and clean your vehicle as soon as possible.

If you experience unusual vibration after driving in mud, slush or similar conditions, check the wheels for impacted material. Impacted material can cause vibrations while driving and wheel imbalance. Remove the material to resolve the problem.

## COLD WEATHER PRECAUTIONS

The functional operation of some components and systems can be affected at temperatures below approximately -13°F (-25°C).

## BREAKING-IN

### Tires

You need to break in new tires for approximately 300 mi (480 km). During this time, your vehicle may exhibit some unusual driving characteristics.

## Brakes and Clutch

Avoid heavy use of the brakes and clutch if possible for the first 100 mi (150 km) in town and for the first 1,000 mi (1,500 km) on freeways.

## DRIVING ECONOMICALLY

The following helps to improve fuel consumption:

- There is no need to wait for your engine to warm up. The vehicle is ready to drive immediately after starting.
- Your fuel consumption should improve throughout your hybrid's break-in period.
- Accelerate and slow down in a smooth, moderate fashion.
- Moderate braking is particularly important since it allows you to maximize the energy captured by the regenerative braking system.
- Drive at steady speeds without stopping.
- Anticipate stops; slowing down may eliminate the need to stop.
- Driving on flat terrain.
- Drive at reasonable speeds and observe posted speed limits.
- Shut all windows when driving at high speeds.
- Combine errands and minimize stop-and-go driving.
- Drive with the tonneau cover installed if your vehicle comes with one.
- Keep the tires properly inflated and use only the recommended size.
- Use the recommended engine oil.
- Follow the recommended maintenance schedule and carry out the recommended checks.
- Perform all scheduled maintenance.

# Driving Hints

**Note:** *Having your engine running is not always an indication of inefficiency. In some cases, it is actually more efficient than driving in electric mode.*

Avoid these actions; they reduce your fuel consumption:

- Revving the engine.
- Aggressive driving increases the amount of energy required to move your vehicle.
- Driving in lower temperatures during the first 5–10 mi (12–16 km) of driving.
- Idle for periods longer than one minute.
- Use the air conditioner or front defroster.
- Adding certain accessories to your vehicle like bug deflectors, rollbars, light bars, running boards, ski racks or luggage racks.
- Use the speed control in hilly terrain.
- Using fuel blended with alcohol.
- Drive a heavily loaded vehicle or tow a trailer.
- Driving with the wheels out of alignment.

## FLOOR MATS

**WARNING:** Use a floor mat designed to fit the footwell of your vehicle that does not obstruct the pedal area. Failure to follow this instruction could result in the loss of control of your vehicle, personal injury or death.

**WARNING:** Pedals that cannot move freely can cause loss of vehicle control and increase the risk of serious personal injury.

**WARNING:** Secure the floor mat to both retention devices so that it cannot slip out of position and interfere with the pedals. Failure to follow this instruction could result in the loss of control of your vehicle, personal injury or death.

**WARNING:** Do not place additional floor mats or any other covering on top of the original floor mats. This could result in the floor mat interfering with the operation of the pedals. Failure to follow this instruction could result in the loss of control of your vehicle, personal injury or death.

**WARNING:** Always make sure that objects cannot fall into the driver foot well while your vehicle is moving. Objects that are loose can become trapped under the pedals causing a loss of vehicle control.



To install the floor mats, position the floor mat eyelet over the retention post and press down to lock in position.

To remove the floor mat, reverse the installation procedure.

**Note:** *Regularly check the floor mats to make sure they are secure.*

# **Snow Plowing - Vehicles Without: Snow Plow Mode**

---

## **SNOW PLOWING PRECAUTIONS**

Your vehicle is not approved for snow plowing. Never snow plow with your vehicle.

# Snow Plowing - Vehicles With: Snow Plow Mode

## SNOW PLOWING PRECAUTIONS



**WARNING:** Modifying or adding equipment to the front end of your vehicle (including hood, bumper system, frame, front end body structure, tow hooks and hood pins) may affect the performance of the airbag system, increasing the risk of injury. Do not modify or add equipment to the front end of your vehicle.



**WARNING:** Do not attempt to service, repair, or modify the supplementary restraint system or associated components. Failure to follow this instruction could result in personal injury or death.



**WARNING:** All occupants of your vehicle, including the driver, should always properly wear their seatbelts, even when an airbag supplemental restraint system is provided. Failure to properly wear your seatbelt could seriously increase the risk of injury or death.



**WARNING:** Do not spin the wheels at over 34 mph (55 km/h). The tires may fail and injure a passenger or bystander.

**Note:** Look for an alterer's label on your vehicle from the snowplow installer certifying that the installation meets all applicable Federal Motor Vehicle Safety Standards (FMVSS).

**Note:** Federal and some local regulations require additional exterior lamps for snowplow-equipped vehicles. Contact an authorized dealer for additional information.

**Note:** Do not remove or defeat the tripping mechanisms designed into the snow removal equipment by its manufacturer. Doing so could cause damage to your vehicle and the snow removal equipment as well as possible airbag deployment.

## OPERATING YOUR VEHICLE WITH A SNOWPLOW

Weight limits and guidelines for selecting and installing the snowplow are in the Ford Truck Body Builders Layout Book. For additional information, visit [www.fordbbas.com](http://www.fordbbas.com).

A typical snowplow installation affects the following:

- Front gross axle weight rating. See **What Is the Gross Axle Weight Rating** (page 361).
- Gross vehicle weight rating. See **What Is the Gross Vehicle Weight Rating** (page 361).
- Braking and steering.
- Front wheel toe. See the **Ford Workshop Manual**.
- Headlight aim. See **Adjusting the Headlamps** (page 473).
- Tire air pressure. See **Information on the Tire Sidewall** (page 495).

**Note:** Do not exceed the front gross axle weight rating or gross vehicle weight rating.

**Note:** Your vehicle may require rear ballast weight for proper braking and steering.

Your vehicle has a driver and passenger airbag supplemental restraint system. The supplemental restraint system activates in certain frontal and offset frontal collisions when the vehicle sustains sufficient longitudinal deceleration.

# Snow Plowing - Vehicles With: Snow Plow Mode

When operating your vehicle with a snowplow:

- Do not exceed 45 mph (72 km/h).
- Your engine could run at a higher temperature than normal.
  - If you are driving more than 15 mi (24 km) at temperatures above freezing, angle the plow blade either full left or full right to provide maximum airflow to the radiator.
  - If you are driving less than 15 mi (24 km) at speeds up to 45 mph (72 km/h) in cold weather, you do not need to worry about blade position to provide maximum airflow.
- Shift to **4L** when plowing in small areas at speeds below 5 mph (8 km/h).
- Shift to **4H** when plowing larger areas or light snow at higher speeds above 5 mph (8 km/h). Do not exceed 15 mph (24 km/h).
- Do not shift the transmission from a forward gear to reverse (R) until the engine is at idle and the wheels have stopped.

**Note:** Careless or high-speed driving when snowplowing, which results in significant vehicle decelerations, can deploy the airbag. Such driving also increases the risk of accidents.

**Note:** Drive your vehicle at least 500 mi (800 km) before using your vehicle for snowplowing.

**Note:** Follow the severe duty schedule for engine oil and transmission fluid change intervals. See **Special Operating Conditions Scheduled Maintenance** (page 614).

## SNOWPLOW MODE

### What Is Snowplow Mode

Snowplow mode reduces vehicle electrical load to allow the electrical system to have sufficient power to support residential snowplow use.

### Switching Snowplow Mode On and Off

Vehicles receive a physical button in the instrument panel or an option in the SYNC menu to enable snowplow mode.

Snowplow mode does not remember the setting when you switch your vehicle off. You must re-enable the mode every time you wish to use it.

The following features turn off and are disabled in snowplow mode and cannot be turned back on until snowplow mode is switched off:

- 120 V inverter.
- Fog lamps.
- Heated and cooled front seats.

The body module also activates the snowplow relay that provides power to aftermarket snowplow controls.

**Note:** The electrical system supports the addition of a residential snowplow of up to 60 A continuous, and snowplow lights of up to 20 A continuous using snowplow mode. The system does not support snowplow usage with additional electrical aftermarket accessories.

### Push Button (If Equipped)

Press the snowplow button on the instrument panel to switch on snowplow mode. The snowplow button illuminates and a message displays.

## Snow Plowing - Vehicles With: Snow Plow Mode

---

Press the snowplow button or switch off the vehicle to switch off snowplow mode.

### Using SYNC (If Equipped)

1. Press **Features** on the touchscreen.
2. Press **Snow Plow Mode**.
3. Switch **Snow Plow Mode** on or off.

# Crash and Breakdown Information

---

## ROADSIDE ASSISTANCE

### Vehicles Sold in the United States: Getting Roadside Assistance

To fully assist you should you have a vehicle concern, Ford Motor Company offers a complimentary roadside assistance program. This program is separate from the New Vehicle Limited Warranty.

The service is available:

- 24 hours a day, seven days a week.
- For the coverage period supplied with your vehicle.

Roadside Assistance covers:

- A flat tire change with a good spare (except vehicles supplied with a tire inflation kit).
- Battery jump start.
- Lock-out assistance (key replacement cost is the customer's responsibility).
- Fuel delivery — independent service contractors, if not prohibited by state, local or municipal law, shall deliver up to 2 gal (8 L) of gasoline or 5 gal (20 L) of diesel fuel to a disabled vehicle. Roadside assistance limits fuel delivery service to two no-charge occurrences within a 12-month period.
- Winch out — available within 100 ft (30 m) of a paved or county maintained road, no recoveries.

- Towing — independent service contractors, if not prohibited by state, local or municipal law, shall tow Ford eligible vehicles to an authorized dealer within 35 mi (56 km) of the disablement location or to the nearest authorized dealer. If a member requests a tow to an authorized dealer that is more than 35 mi (56 km) from the disablement location, the member shall be responsible for any mileage costs in excess of 35 mi (56 km).
- Roadside Assistance includes up to \$200 for a towed trailer if the disabled eligible vehicle requires service at the nearest authorized dealer. If the towing vehicle is operational but the trailer is not, then the trailer does not qualify for any roadside services.

### Vehicles Sold in the United States: Using Roadside Assistance

Complete the roadside assistance identification card and place it in your wallet for quick reference. This card is in the Owner's Manual kit.

United States vehicle customers who require Roadside Assistance, call 1-800-241-3673.

If you need to arrange roadside assistance for yourself, Ford Motor Company reimburses a reasonable amount for towing to the nearest dealership within 35 mi (56 km). To obtain reimbursement information, United States vehicle customers call 1-800-241-3673. Customers need to submit their original receipts.

# Crash and Breakdown Information

---

## Vehicles Sold in Canada: Getting Roadside Assistance

To fully assist you should you have a vehicle concern, Ford Motor Company of Canada, Limited offers a complimentary roadside assistance program. This program is eligible within Canada or the continental United States.

The service is available 24 hours a day, seven days a week.

This program is separate from the New Vehicle Limited Warranty, but the coverage is concurrent with the powertrain coverage period of your vehicle. Canadian roadside coverage and benefits may differ from the U.S. coverage.

If you require more information, please call us in Canada at 1-800-665-2006, or visit our website at [www.ford.ca](http://www.ford.ca).

## HIGH VOLTAGE BATTERY VEHICLE PRECAUTIONS - HYBRID ELECTRIC VEHICLE (HEV)

In the event of damage or fire involving an electric vehicle or hybrid-electric vehicle:

- Assume the high-voltage battery and associated components are energized and fully charged.
- Physical damage to the vehicle or high-voltage battery could result in immediate or delayed release of toxic, flammable gases and fire.

## Crashes

A crash or impact significant enough to require an emergency response for conventional vehicles would also require the same response for an electric or hybrid-electric vehicle.

If possible:

1. Move your vehicle to a safe, nearby location and remain on the scene.
2. Roll down the windows before you switch your vehicle off.
3. Place your vehicle in park (P), apply the parking brake, switch off the vehicle, turn on the hazard flashers and move the key at least 16 ft (5 m) away from the vehicle.

Always:

- Call emergency assistance if needed and advise that an electric or hybrid-electric vehicle is involved.
- Avoid contact with leaking fluids and gases, and remain out of the way of oncoming traffic until emergency responders arrive.
- When emergency responders arrive, tell them that the vehicle involved is an electric vehicle or hybrid-electric vehicle.

## Fires

As with any vehicle, call emergency assistance immediately if you see sparks, smoke or flames coming from the vehicle. Remain a safe distance from the vehicle and try to stay clear of the smoke.

1. Exit the vehicle immediately.
2. Advise emergency assistance that an electric or hybrid-electric vehicle is involved.
3. As with any vehicle fire, do not inhale smoke, vapors or gas from the vehicle, as they may be hazardous.



# Crash and Breakdown Information

## Post-Incident

1. Do not store a severely damaged vehicle with a lithium-ion battery inside a structure or within 49 ft (15 m) of any structure or vehicle.
2. Make sure that passenger and luggage compartments remain ventilated.
3. As with any vehicle, call emergency assistance immediately if you see sparks, smoke or flames coming from the vehicle.

## SWITCHING THE HAZARD FLASHERS ON AND OFF



The hazard flasher button is on the instrument panel. Press the button to switch the hazard flashers on if your vehicle is creating a safety hazard for other road users.

When you switch the hazard flashers on, all front and rear direction indicators flash.

**Note:** *The hazard flashers operate when the ignition is in any position, or if the key is not in the ignition. The battery loses charge and could have insufficient power to restart your vehicle.*

Press the button again to switch them off.

## JUMP STARTING THE VEHICLE

### Jump Starting Precautions



**WARNING:** Batteries normally produce explosive gases which can cause personal injury. Therefore, do not allow flames, sparks or lighted substances to come near the battery. When working near the battery, always shield your face and protect your eyes. Always provide correct ventilation.



**WARNING:** Keep batteries out of reach of children. Batteries contain sulfuric acid. Avoid contact with skin, eyes or clothing. Shield your eyes when working near the battery to protect against possible splashing of acid solution. In case of acid contact with skin or eyes, flush immediately with water for a minimum of 15 minutes and get prompt medical attention. If acid is swallowed, call a physician immediately.



**WARNING:** Use only adequately sized cables with insulated clamps.



**WARNING:** Make sure that the cables are clear of any moving parts and fuel delivery system parts.



**WARNING:** Connect batteries with only the same nominal voltage.

Do not attempt to push-start an automatic transmission vehicle. This could cause transmission damage.

Do not disconnect the battery of the disabled vehicle. This could damage your vehicle's electrical system.

## Preparing the Vehicle

Use only a 12 volt supply to start your vehicle.

Park the booster vehicle close to the hood of the disabled vehicle, making sure the two vehicles do not touch.

# Crash and Breakdown Information

## Jump Starting the Vehicle

### Connecting the Jumper Cables



**WARNING:** Do not connect the negative jumper cable to any other part of your vehicle. Use the ground point.

**Note:** If you are using a jump pack or booster box, follow the manufacturer's instructions.

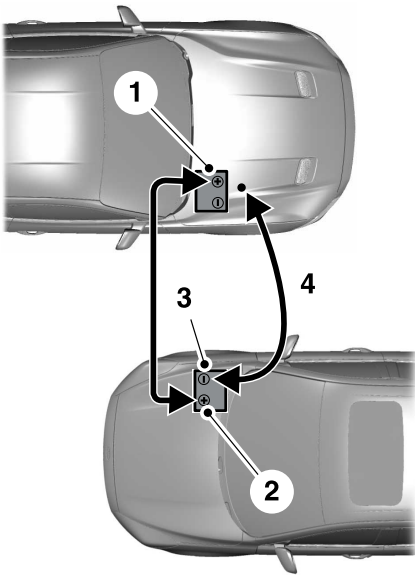

1. Pull the red rubber boot backward. Connect the positive (+) jumper cable to the positive (+) terminal of the discharged battery.
2. Connect the other end of the positive (+) jumper cable to the positive (+) terminal of the booster vehicle battery.

3. Connect the negative (-) jumper cable to the negative (-) terminal of the booster vehicle battery.
4. Make the final connection of the negative (-) jumper cable to an exposed metal part of the disabled vehicle's engine, as shown in the following illustration, away from the battery and fuel injection system, or connect the negative (-) jumper cable to a ground connection point if available.

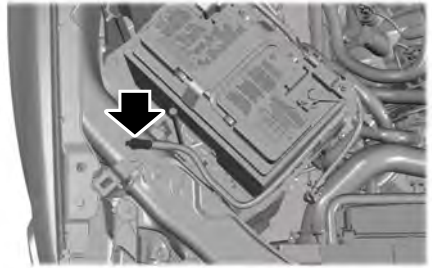

### Starting the Engine

1. Start the engine of the booster vehicle and moderately rev the engine, or gently press the accelerator to keep the engine speed between 2000 and 3000 RPM, as shown in your tachometer.
2. Start the engine of the disabled vehicle.
3. Once you start the disabled vehicle, run both vehicle engines for an additional three minutes before disconnecting the jumper cables.

### Removing the Jumper Cables

Remove the jumper cables in the reverse order that they were connected.

**Note:** Do not switch the headlamps on when disconnecting the cables. The peak voltage could blow the bulbs.

# Crash and Breakdown Information

## POST-CRASH ALERT SYSTEM

### What Is the Post-Crash Alert System

The system helps draw attention to your vehicle in the event of a serious impact.

### How Does the Post-Crash Alert System Work

The system is designed to turn the hazard flashers on and to intermittently sound the horn in the event of a serious impact that deploys an airbag or the seatbelt pretensioners.

### Post-Crash Alert System Limitations

Depending on applicable laws in the country your vehicle was built for, the horn does not sound in the event of a serious impact.

### Switching the Post-Crash Alert System Off

Press the hazard flasher switch or the unlock button on the remote control to switch the system off.

**Note:** *The alert turns off when the vehicle battery runs out of charge.*

## AUTOMATIC CRASH SHUTOFF

### What Is Automatic Crash Shutoff

The automatic crash shutoff is designed to stop the fuel going to the engine in the event of a moderate or severe crash.

**Note:** *Not every impact causes a shutoff.*

## Automatic Crash Shutoff Precautions



**WARNING:** If your vehicle has been involved in a crash, have the fuel system checked. Failure to follow this instruction could result in fire, personal injury or death.

## Re-Enabling Your Vehicle

1. Switch the ignition off.
2. Attempt to start your vehicle.
3. Switch the ignition off.
4. Attempt to start your vehicle.

**Note:** *If your vehicle does not start after the third attempt, have your vehicle checked as soon as possible.*

## RECOVERY TOWING

### Accessing the Front Towing Point



**WARNING:** Using recovery hooks is dangerous and should only be done by a person familiar with proper vehicle recovery safety practices. Improper use of recovery hooks may cause hook failure or separation from the vehicle and could result in serious injury or death.



**WARNING:** Slowly remove the slack from the recovery strap prior to pulling. Failure to do so can introduce significantly higher loads which can cause the recovery hooks to break off, or the recovery strap to fail which can cause serious injury or death.

# Crash and Breakdown Information



**WARNING:** Never link two straps together with a clevis pin. These heavy metal objects could become projectiles if the strap breaks and can cause serious injury or death.

Your vehicle has frame-mounted front recovery hooks.

**Note:** Do not apply a load to the recovery hooks that is greater than the gross vehicle weight rating of your vehicle.

Before using recovery hooks:

- Make sure all attaching points are secure and capable of withstanding the applied load.
- Do not use chains, cables or tow straps with metal hook ends.
- Only use recovery straps that have a minimum breaking strength two to three times the gross vehicle weight of the stuck vehicle.
- Make sure the recovery strap is in good condition and free of visible cuts, tears or damage.
- Use a damper device such as a tarp, heavy blanket or piece of carpet, and place it over the recovery strap to help absorb the energy in the event the strap breaks.
- Make sure the stuck vehicle is not loaded heavier than its gross vehicle weight rating specified on the certification label.
- Align the tow vehicle and stuck vehicle in a straight line, within 10 degrees.
- Keep bystanders to the sides of the vehicle, at a distance of at least twice the length of the recovery strap. This helps avoid injury from the hazard of a recovery hook or strap breaking, or a vehicle lurching into their path.

## TRANSPORTING THE VEHICLE

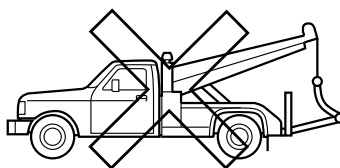
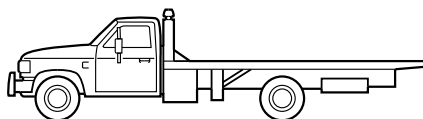
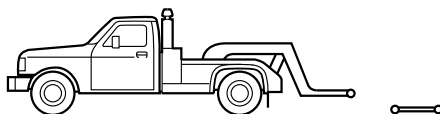

If you need to tow your vehicle, contact a professional towing service or your roadside assistance service provider.

Your manufacturer produces a towing manual for all authorized tow truck operators. Have your tow truck operator refer to this manual for proper hook-up and towing procedures.

We recommend the use of a wheel lift and dollies or flatbed equipment to tow your vehicle. Vehicle damage could occur if towed incorrectly, or by any other means.

Front-wheel and rear-wheel drive vehicles must have their designated drive wheels off the ground regardless of towing direction. Use tow dollies to prevent damage to the transmission.

## Crash and Breakdown Information

---

All-wheel or four-wheel drive vehicles require that all wheels be off the ground using a wheel lift and dollies or flatbed equipment. This prevents damage to the transmission and drive system.

# Towing Your Vehicle

## TOWING YOUR VEHICLE PRECAUTIONS

Use the following guidelines when towing your vehicle. Failure to follow this instruction could result in vehicle damage not covered by the vehicle warranty.

**Note:** Make sure you properly secure your vehicle to the tow vehicle.

**Note:** If you are unsure of the vehicle's configuration, contact an authorized dealer.

## RECREATIONALLY TOWING YOUR VEHICLE - 4X4



**WARNING:** Do not disconnect the battery during recreational towing. It prevents the transfer case from shifting properly and may cause the vehicle to roll, even if the transmission is in park (P).



**WARNING:** Shifting the transfer case to its neutral position for recreational towing may cause the vehicle to roll, even if the transmission is in park (P). It may injure the driver and others. Make sure you press the foot brake and the vehicle is in a secure, safe position when you shift to neutral (N).

Follow these guidelines if you have a need for recreational towing. An example of recreational towing would be towing your vehicle behind a motorhome. These guidelines are to make sure that you do not damage the transmission.

You can only tow your vehicle with all wheels on the ground by placing the transfer case in its neutral position and engaging the recreational tow feature. Perform the following steps after positioning your vehicle behind the tow vehicle and properly securing them together.

**Note:** Put your climate control system in recirculated air mode to prevent exhaust fumes from entering your vehicle.

**Note:** Failure to put the transfer case in its neutral position can damage vehicle components.

**Note:** You can check the towing status at any time by opening the driver door or turning the ignition to the accessory or on position. A message appears in the instrument cluster display confirming **Neutral Tow** is on.

**Note:** If your vehicle has an anti-theft alarm, make sure you switch perimeter sensing on when towing. See **Setting the Alarm Security Level** (page 112).

### Switching Neutral Tow On

1. Start your vehicle.
2. Press the **2H** button on the four-wheel drive mode control.
3. Place your vehicle in temporary neutral mode. See **Entering Temporary Neutral Mode** (page 255).
4. Switch your vehicle off by pressing the push button ignition switch once or turning the key as far toward the off position as possible. A message appears in the instrument cluster display.
5. Switch your vehicle to accessory mode by pressing the push button ignition switch once without pressing the brake pedal or by turning the key to the on position.
6. Press and hold the brake pedal.

# Towing Your Vehicle

---

- Using the instrument cluster controls on the steering wheel, select **Settings**.
- Select **Neutral Tow**.
- Press and hold the **OK** button until a confirmation message appears in the information display.

**Note:** If completed successfully, the information display shows **Neutral Tow Enabled Leave Transmission in Neutral**. This indicates that your vehicle is safe to tow with all wheels on the ground.

**Note:** If you do not see a confirmation message in the instrument cluster display, you must perform the procedure again from the beginning.

**Note:** You may hear noise as the transfer case shifts into its neutral position. This is normal.

- Release the brake pedal.
- Leave the transmission in neutral (N) and switch your vehicle off by pressing the push button ignition switch once without pressing the brake pedal or turning the key as far toward the off position.

**Note:** Vehicles with keys do not turn to the off position when the transmission is in neutral (N). You must leave the key in the ignition when towing. Use the keyless entry keypad or an extra set of keys to lock and unlock your vehicle.

## Switching Neutral Tow Off

- With your vehicle properly secured to the tow vehicle, press the brake pedal and start the engine.
- Switch your vehicle off by pressing the push button ignition switch once or turning the key as far towards the off position.

- Place your vehicle in accessory mode by pressing the push button ignition switch once without pressing the brake pedal or by turning the ignition key to the on position.
- Press and hold the brake pedal.
- Shift into park (P).
- Release the brake pedal.

**Note:** If completed successfully, the instrument cluster displays **2H** and **Neutral Tow Disabled**.

**Note:** You must perform the switching neutral tow on and switching neutral tow off procedures again from the beginning if the indicator light and message do not display.

**Note:** You may hear a noise as the transfer case shifts out of its neutral position. This is normal.

- Apply the parking brake, then disconnect your vehicle from the tow vehicle.
- Release the parking brake, start the engine, and shift into drive (D) to make sure the transfer case is out of the neutral tow position.
- If the transfer case does not successfully shift out of its neutral position, set the parking brake. Have your vehicle checked as soon as possible.

## Resolving the Shift Delayed Drive Forward Message

- Press and hold the brake pedal.
- Start your vehicle.
- Shift into neutral (N).
- With the vehicle running, shift into drive (D) and let the vehicle roll forward up to 3 ft (1 m).

# Towing Your Vehicle

**Note:** You may hear a noise as the transfer case shifts out of its neutral position. This is normal.

5. Make sure the instrument cluster displays **Neutral Tow Disabled**.

## RECREATIONALLY TOWING YOUR VEHICLE - 4X2

You cannot recreational tow your vehicle with all wheels on the ground because vehicle or transmission damage could occur. You must recreational tow your vehicle with all four wheels off the ground, such as when using a car-hauling trailer. Otherwise, you cannot recreational tow your vehicle.

## EMERGENCY TOWING

If your vehicle becomes inoperable without access to wheel dollies or a vehicle transport trailer, it can be flat-towed with all wheels on the ground, regardless of the powertrain and transmission configuration, under the following conditions:

- Your vehicle is facing forward for towing in a forward direction.
- Use the manual park release procedure. See **Using Manual Park Release** (page 257). Failure to do so may result in damage to the transmission.
- Maximum speed is 35 mph (56 km/h).
- Maximum distance is 50 mi (80 km).

## TOWING YOUR VEHICLE – TROUBLESHOOTING

### Towing Your Vehicle – Information Messages

Message	Description
Neutral Tow Enabled Leave Transmission in Neutral	The transfer case is in the neutral position and your vehicle is safe to tow with all four wheels on the ground.
Shift Delayed Drive Forward	There is a transfer case gear tooth blockage present. With your vehicle on, shift the transmission into drive (D) and let the vehicle roll forward, up to 3 ft (1 m).
Neutral Tow Disabled	The transfer case is not in the neutral position and your vehicle is not safe to tow with all four wheels on the ground.



# Fuses

## FUSE PRECAUTIONS



**WARNING:** Always disconnect the battery before servicing high current fuses.



**WARNING:** To reduce risk of electrical shock, always replace the cover to the power distribution box before reconnecting the battery or refilling fluid reservoirs.



**WARNING:** Always replace a fuse with one that has the specified amperage rating. Using a fuse with a higher amperage rating can cause severe wire damage and could start a fire.

## UNDER HOOD FUSE BOX

### Locating the Under Hood Fuse Box

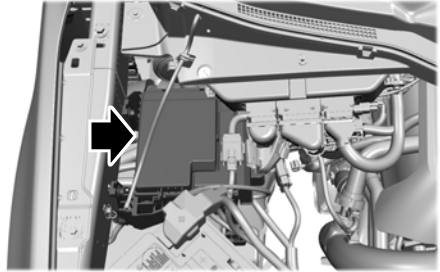

### Accessing the Under Hood Fuse Box

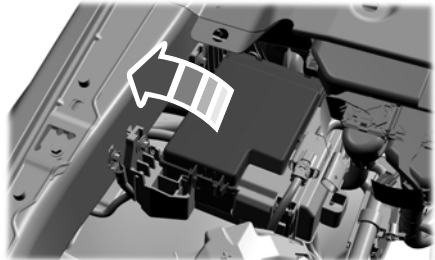

# Fuses

## Identifying the Fuses in the Under Hood Fuse Box

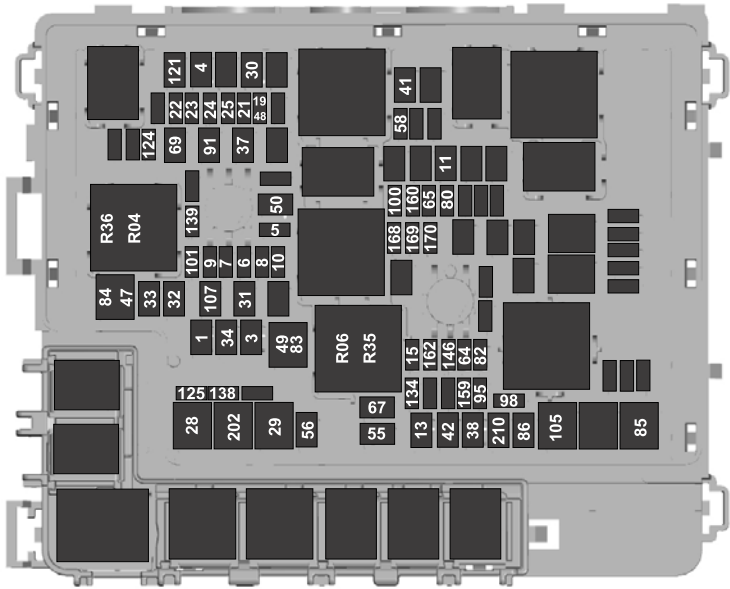

Fuse Location	Fuse Rating	Protected Component
1	40 A	Body control module - battery power in feed 1.
3	40 A	Body control module - battery power in feed 2.
4	30 A	Fuel pump.
5	5 A	Keep-alive power. Powertrain control module (hybrid).
6	25 A	Powertrain control module power.
7	20 A	Powertrain control module power.
8	20 A	Powertrain control module power (hybrid).
	10 A	Powertrain control module power (gas, diesel).

# Fuses

<b>Fuse Location</b>	<b>Fuse Rating</b>	<b>Protected Component</b>
9	20 A	Powertrain control module power.
10	20 A	Powertrain control module power (diesel).
11	30 A	Starter motor.
13	40 A	Blower motor.
15	25 A	Horn.
19	20 A	Snow plow switch. Rear heated seats (gas).
21	10 A	Headlamp run/start feed.
22	10 A	Electronic power assist steering.
23	10 A	Electric brake boost.
24	10 A	Powertrain control module (gas, hybrid). Transmission control module (diesel). Glow plug control module (diesel).
25	10 A	Center high-mounted stop lamp camera. Trailer camera. 2 kW inverter. 24 V alternator - run/start feed. Analog rear video camera.
28	50 A	Electric brake boost.
29	50 A	Electric brake boost.
30	40 A	Driver power seat.
31	30 A	Passenger power seat.
32	20 A	Auxiliary power point.
33	20 A	Auxiliary power point. USB smart charger.
34	20 A	Auxiliary power point.
37	30 A	Tailgate module.
38	40 A	Climate controlled seat module. Power running boards.

# Fuses

<b>Fuse Location</b>	<b>Fuse Rating</b>	<b>Protected Component</b>
41	25 A	Power sliding back window.
42	30 A	Trailer brake control module.
47	50 A	Cooling fan.
48	20 A	Rear heated seats (diesel, hybrid)
49	50 A	Cooling fan.
50	40 A	Heated backlight (gas, hybrid).
55	30 A	Trailer tow park lamps.
56	20 A	Trailer tow stop and turn lamps.
58	10 A	Trailer tow backup lamps.
64	25 A	Four-wheel drive.
65	15 A	Transmission control module (diesel).
67	20 A	Transmission run/start.
69	30 A	Left-hand windshield wiper.
80	15 A	Not used (spare).
82	25 A	Four-wheel drive.
83	50 A	Supplemental heater (diesel).
84	50 A	Supplemental heater (diesel).
85	50 A	Supplemental heater (diesel).
86	25 A	Selective catalytic reduction system.
91	20 A	Trailer tow light module.
95	15 A	Powertrain control module power (hybrid).
98	10 A	Powertrain control module power (hybrid). Coolant pumps (hybrid).
100	15 A	Left-hand headlamps.
101	15 A	Right-hand headlamps.
105	50 A	Active front steering.

## Fuses

<b>Fuse Location</b>	<b>Fuse Rating</b>	<b>Protected Component</b>
107	30 A	Trailer tow battery charge.
121	30 A	Fuel filter heater (diesel).
124	5 A	Rain sensor module.
125	10 A	USB smart charger.
134	25 A	Multi-contour seats relay.
138	10 A	Tailgate release.
139	5 A	USB smart charger.
146	15 A	Traction battery control module.
159	5 A	DC/DC power (hybrid).
160	10 A	Smart data link control.
162	7.5 A	Not used (spare).
168	20 A	Traction battery control module (hybrid).
169	10 A	Motor electric cool pump (hybrid).
170	10 A	Pedestrian alert control module (hybrid). Traction battery control module (hybrid). Electric motor cool pump (hybrid).
202	60 A	Body control module B+.
210	30 A	Body control module start stop.

<b>Relay Number</b>	<b>Protected Component</b>
R04	Electronic fan relay 1.
R06	Electronic fan relay 3.
R35	Supplemental heater.
R36	Supplemental heater.

# Fuses

## BODY CONTROL MODULE FUSE BOX

## Accessing the Body Control Module Fuse Box

### Locating the Body Control Module Fuse Box

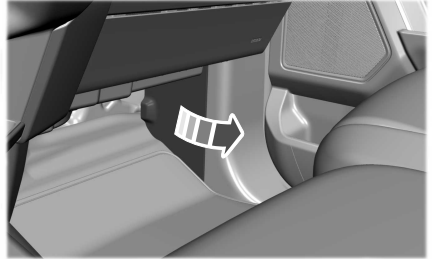
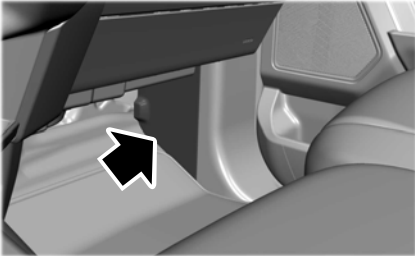

### Identifying the Fuses in the Body Control Module Fuse Box

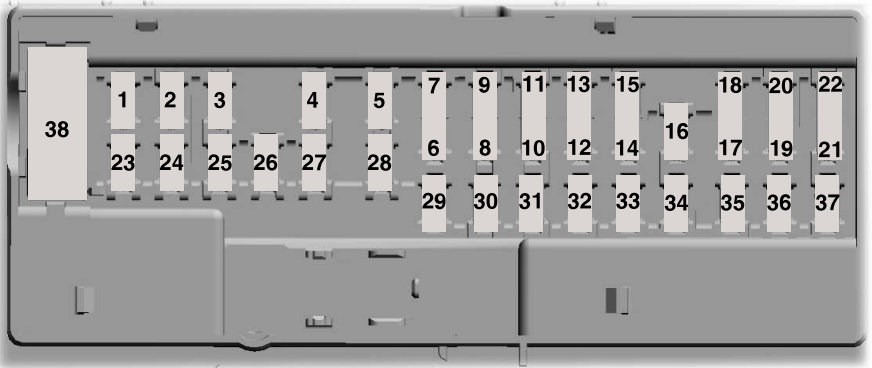

# Fuses

<b>Fuse Location</b>	<b>Fuse Rating</b>	<b>Protected Component</b>
1	—	Not used.
2	10 A	Delayed accessory feed.
3	7.5 A	Wireless charger.
4	20 A	Not used.
5	—	Not used.
6	10 A	Driver power window switch.
7	10 A	Gear shift module.
8	5 A	Cell phone passport module.
9	5 A	Combined sensor module.
10	—	Not used.
11	—	Not used.
12	7.5 A	Enhanced central gateway. Climate control.
13	7.5 A	Instrument cluster. Steering column control module.
14	15 A	Not used (spare).
15	15 A	Integrated control panel. SYNC.
16	—	Not used.
17	7.5 A	Headlamp control module.
18	7.5 A	Not used.
19	5 A	Headlamp switch.
20	5 A	Passive start. Ignition switch. Key inhibit solenoid.
21	5 A	Trailer brake switch.
22	5 A	Not used.

# Fuses

<b>Fuse Location</b>	<b>Fuse Rating</b>	<b>Protected Component</b>
23	30 A	Driver door control module.
24	30 A	Moonroof.
25	20 A	Not used.
26	30 A	Passenger door control module.
27	30 A	Not used.
28	30 A	Amplifier.
29	15 A	12 inch display. Adjustable pedals.
30	5 A	Not used.
31	10 A	RF receiver. Driver monitor. Terrain management switch.
32	20 A	Audio control module.
33	—	Not used.
34	30 A	Run/start relay.
35	5 A	400 watt inverter run/start.
36	15 A	Auto-dimming interior mirror. Rear heat seat run/start. Adaptive front steering run/start. Heated wheel (vehicles without adaptive front steering).
37	20 A	Advanced driver-assistance systems.
38	30 A circuit breaker.	Rear power windows.



# Fuses

## IDENTIFYING FUSE TYPES

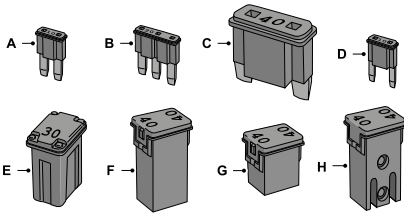

- A Micro 2.
- B Micro 3.
- C Maxi.
- D Mini.
- E M Case.
- F J Case.
- G J Case Low Profile.
- H Slotted M Case.

## FUSES – TROUBLESHOOTING

### Fuses – Frequently Asked Questions

#### When do I need to check a fuse?

If electrical components in the vehicle are not working.

#### When do I need to replace a fuse?

If a fuse has blown.

#### How do I identify a blown fuse?

You can identify a blown fuse by a broken wire within the fuse.

# Maintenance

## MAINTENANCE PRECAUTIONS

Service your vehicle regularly to help maintain its roadworthiness and resale value. There is a large network of authorized dealers that are there to help you with their professional servicing expertise. We believe that their specially trained technicians are best qualified to service your vehicle properly and expertly. They are supported by a wide range of highly specialized tools developed specifically for servicing your vehicle.

If your vehicle requires professional service, an authorized dealer can provide the necessary parts and service. Check your warranty information to find out which parts and services are covered.

Use only recommended fuels, lubricants, fluids and service parts conforming to specifications. See **Capacities and Specifications** (page 529).

- Do not work on a hot engine.
- Make sure that nothing gets caught in moving parts.
- Do not work on a vehicle with the engine running in an enclosed space, unless you are sure you have enough ventilation.
- Keep all open flames and other burning material, such as cigarettes, away from the battery and all fuel related parts.
- Set the parking brake, shift the transmission to park (P) and block the wheels.

## OPENING AND CLOSING THE HOOD

 **WARNING:** Make sure that you fully latch the hood before driving. Failure to follow this instruction could result in personal injury or death.



1. Pull the hood release handle under the left hand side of the instrument panel.

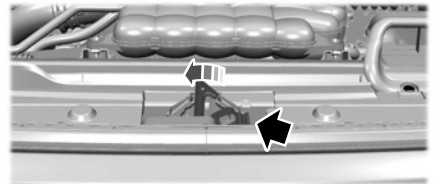

2. Pull the secondary release lever under the front of the hood near the center of your vehicle.

# Maintenance

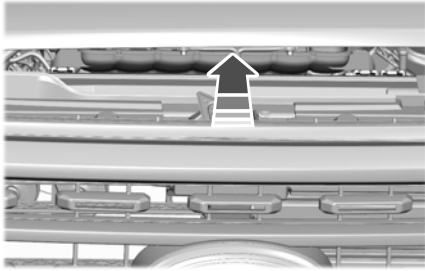

3. Raise the hood until the lift cylinders hold it open.
4. To close, lower the hood and make sure that it fully latches.

## UNDER HOOD OVERVIEW - 2.7L ECOBOOST™

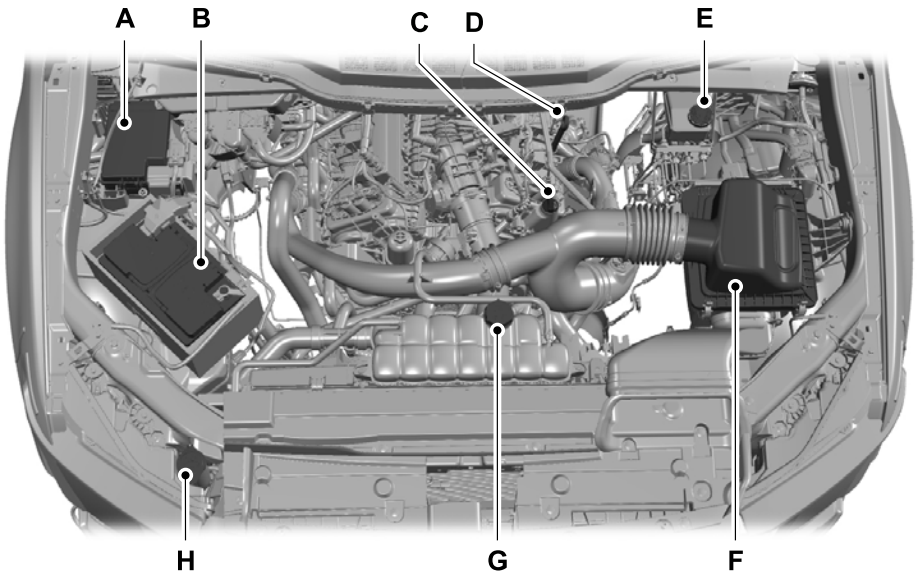

- A. Engine compartment fuse box. See **Fuses** (page 446).
- B. Battery. See **Changing the 12V Battery** (page 471).
- C. Engine oil filler cap. See **Checking the Engine Oil Level** (page 462).

# Maintenance

- D. Engine oil dipstick. See **Engine Oil Dipstick Overview** (page 462).
- E. Brake fluid reservoir. See **Checking the Brake Fluid** (page 273).
- F. Air filter assembly. See **Changing the Engine Air Filter** (page 468).
- G. Engine coolant reservoir. See **Checking the Coolant** (page 463).
- H. Windshield washer fluid reservoir.

## UNDER HOOD OVERVIEW - 3.0L DIESEL

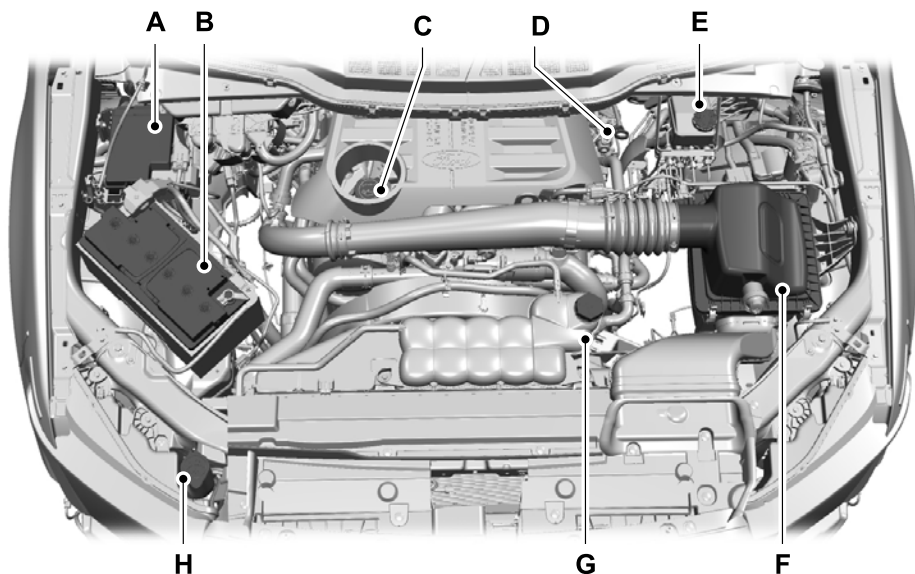

- A. Engine compartment fuse box. See **Fuses** (page 446).
- B. Battery. See **Changing the 12V Battery** (page 471).
- C. Engine oil filler cap. See **Checking the Engine Oil Level** (page 462).
- D. Engine oil dipstick. See **Engine Oil Dipstick Overview** (page 462).
- E. Brake fluid reservoir. See **Checking the Brake Fluid** (page 273).
- F. Air filter assembly. See **Changing the Engine Air Filter** (page 468).

# Maintenance

- G. Engine coolant reservoir. See **Checking the Coolant** (page 463).
- H. Windshield washer fluid reservoir.

## UNDER HOOD OVERVIEW - 3.3L

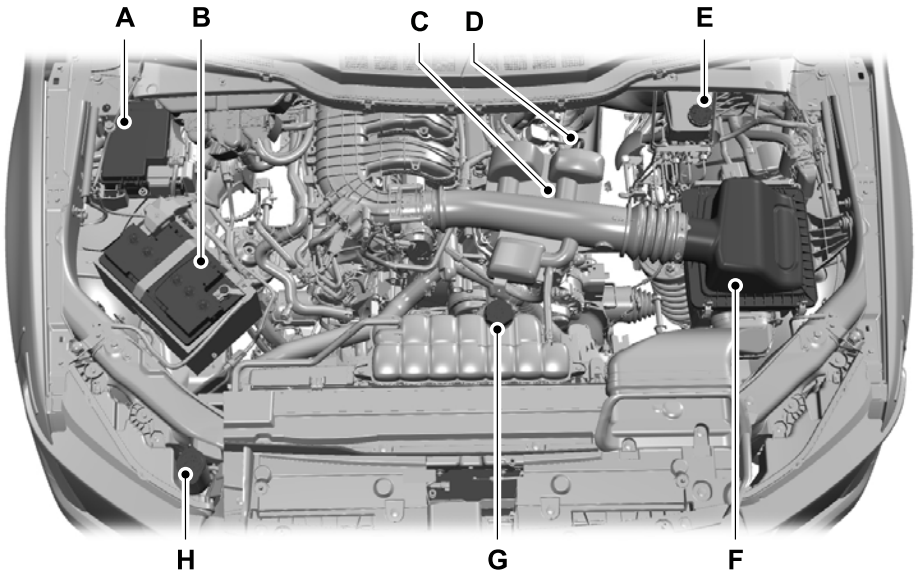

- A. Engine compartment fuse box. See **Fuses** (page 446).
- B. Battery. See **Changing the 12V Battery** (page 471).
- C. Engine oil filler cap. See **Checking the Engine Oil Level** (page 462).
- D. Engine oil dipstick. See **Engine Oil Dipstick Overview** (page 462).
- E. Brake fluid reservoir. See **Checking the Brake Fluid** (page 273).
- F. Air filter assembly. See **Changing the Engine Air Filter** (page 468).
- G. Engine coolant reservoir. See **Checking the Coolant** (page 463).
- H. Windshield washer fluid reservoir.

# Maintenance

## UNDER HOOD OVERVIEW - 3.5L ECOBOOST™

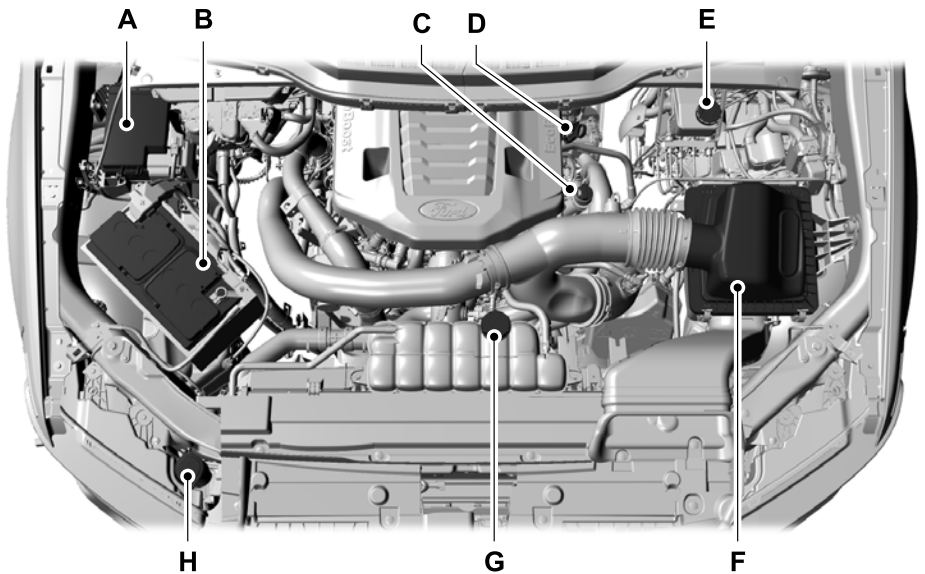

- A. Engine compartment fuse box. See **Fuses** (page 446).
- B. Battery. See **Changing the 12V Battery** (page 471).
- C. Engine oil filler cap. See **Checking the Engine Oil Level** (page 462).
- D. Engine oil dipstick. See **Engine Oil Dipstick Overview** (page 462).
- E. Brake fluid reservoir. See **Brakes** (page 273).
- F. Air filter. See **Changing the Engine Air Filter** (page 469).
- G. Engine coolant reservoir. See **Checking the Coolant** (page 463).
- H. Windshield washer fluid reservoir.

# Maintenance

## UNDER HOOD OVERVIEW - 3.5L, HYBRID ELECTRIC VEHICLE (HEV)

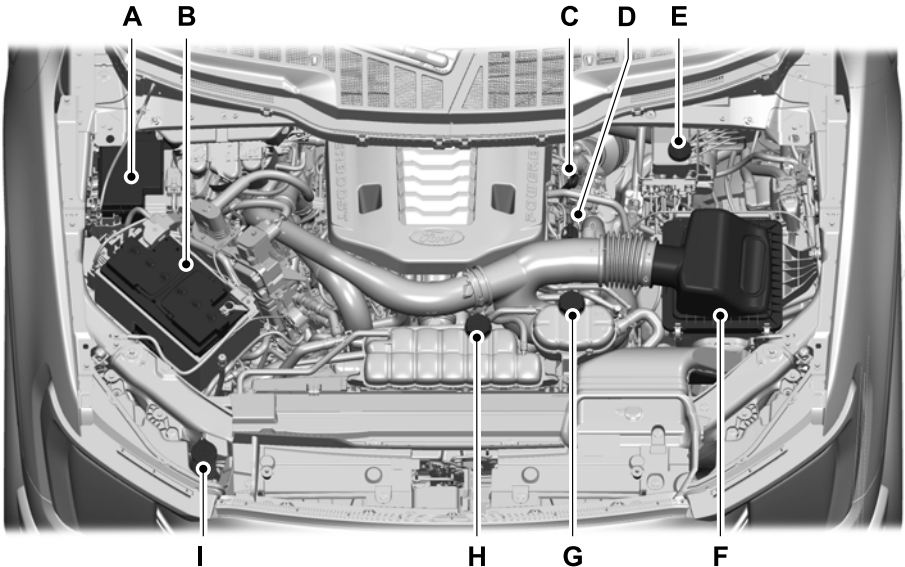

- A. Engine compartment fuse box. See **Fuses** (page 446).
- B. Battery. See **Changing the 12V Battery** (page 471).
- C. Engine oil dipstick. See **Engine Oil Dipstick Overview** (page 462).
- D. Engine oil filler cap. See **Adding Engine Oil** (page 462).
- E. Brake fluid reservoir. See **Checking the Brake Fluid** (page 273).
- F. Air filter. See **Changing the Engine Air Filter** (page 469).
- G. Secondary coolant reservoir. See **Checking the Coolant** (page 463).
- H. Engine coolant reservoir. See **Checking the Coolant** (page 463).
- I. Windshield washer fluid reservoir.

# Maintenance

## UNDER HOOD OVERVIEW - 5.0L

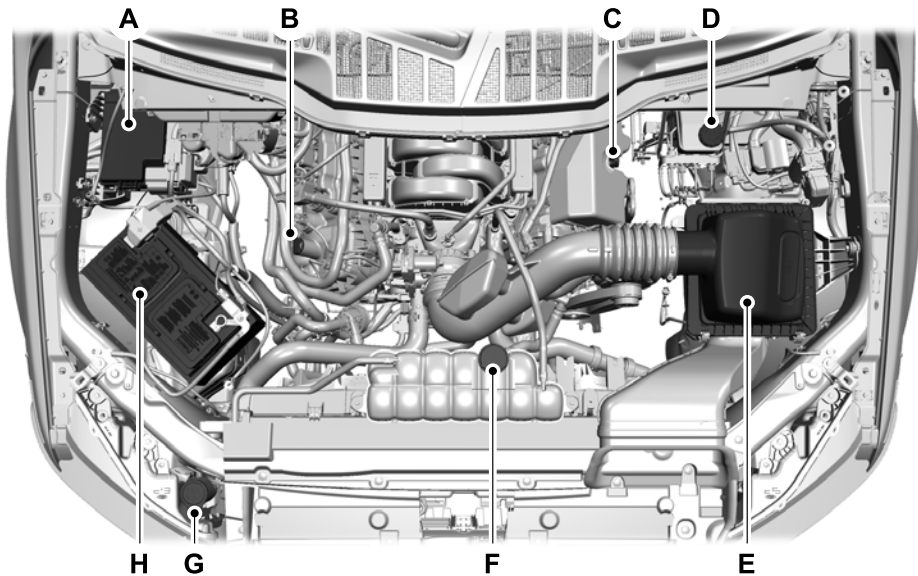

- A. Engine compartment fuse box. See **Fuses** (page 446).
- B. Engine oil filler cap. See **Engine Oil Dipstick Overview** (page 462).
- C. Engine oil dipstick. See **Engine Oil Dipstick Overview** (page 462).
- D. Brake fluid reservoir. See **Checking the Brake Fluid** (page 273).
- E. Air filter assembly. See **Changing the Engine Air Filter** (page 469).
- F. Engine coolant reservoir. See **Checking the Coolant** (page 463).
- G. Windshield washer fluid reservoir.
- H. Battery. See **Changing the 12V Battery** (page 471).



# Maintenance

## ENGINE OIL

### Engine Oil Dipstick Overview - Diesel

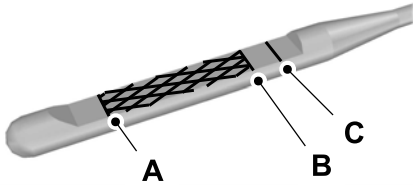

- A Minimum.
- B Nominal.
- C Maximum.

### Engine Oil Dipstick Overview - Gasoline

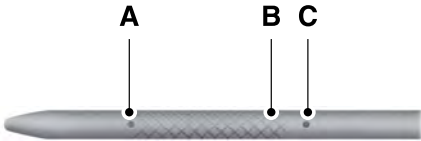

- A Minimum.
- B Nominal.
- C Maximum.

## Checking the Engine Oil Level

1. Make sure that your vehicle is on level ground.
2. Check the oil level before starting the engine, or switch the engine off after warming up and wait 10 minutes for the oil to drain into the oil pan.
3. Remove the dipstick and wipe it with a clean, lint-free cloth.
4. Reinstall the dipstick and make sure it is fully seated.
5. Remove the dipstick again to check the oil level.

**Note:** If the oil level is between the maximum and minimum marks, the oil level is acceptable. Do not add oil.

6. If the oil level is at the minimum mark, immediately add oil.
7. Reinstall the dipstick. Make sure it is fully seated.

**Note:** The oil consumption of new engines reaches its normal level after approximately 3,000 mi (5,000 km).

## Adding Engine Oil



**WARNING:** Do not remove the filler cap when the engine is running.



**WARNING:** Do not add engine oil when the engine is hot. Failure to follow this instruction could result in personal injury.

Do not use supplemental engine oil additives because they are unnecessary and could lead to engine damage that the vehicle warranty may not cover.

1. Clean the area surrounding the engine oil filler cap before you remove it.
2. Remove the engine oil filler cap.

# Maintenance

3. Add engine oil that meets our specifications. See **Capacities and Specifications** (page 524).
4. Reinstall the engine oil filler cap. Turn it clockwise until you feel a strong resistance.

**Note:** Do not add oil further than the maximum mark. Oil levels above the maximum mark may cause engine damage.

**Note:** Immediately soak up any oil spillage with an absorbent cloth.

## Resetting the Engine Oil Change Reminder - Vehicles With: 4.2 Inch Screen

1. Press the Menu button on the steering wheel to enter the information display main menu.
2. Select **Truck Info**.
3. Select **Oil Life**.
4. Select **Reset Oil Life**.
5. Press and hold the **OK** button until the system reset confirmation appears.

## Resetting the Engine Oil Change Reminder - Vehicles With: 8 Inch Screen/12.3 Inch Screen

Depending on your cluster, there are two paths to reset the engine oil change reminder.

### Path 1

1. Press the Menu button on the steering wheel to enter the information display main menu.
2. Select **Settings**.
3. Select **Vehicle Maintenance**.
4. Select **Oil Life**.
5. Press and hold the **OK** button until the system reset confirmation appears.

### Path 2

1. Press the Menu button on the steering wheel to enter the information display main menu.
2. Select **Truck Info**.
3. Select **Engine Information**.
4. Press and hold the **OK** button until the system reset confirmation appears.

## Engine Oil Capacity and Specification

For filling information, please refer to the Capacities and Specifications section of your owner's manual. See **Engine Oil Capacity and Specification** (page 463).

## CHECKING THE COOLANT

When the engine is cold, check the concentration and level of the coolant at the intervals listed in the scheduled maintenance information. See **Scheduled Maintenance** (page 602).

**Note:** Make sure that the coolant level is between the minimum and maximum marks on the coolant reservoir.

**Note:** Coolant expands when it is hot. The level may extend beyond the **MAX** mark.

If the coolant level is at or below the minimum mark, add prediluted coolant immediately.

Maintain coolant concentration within 48% to 50%, which equates to a freeze point between -29°F (-34°C) and -35°F (-37°C). Coolant concentration should be checked using a refractometer. We do not recommend the use of hydrometers or coolant test strips for measuring coolant concentration.

# Maintenance

## Adding Coolant



**WARNING:** Do not remove the coolant reservoir cap when the engine is on or the cooling system is hot. Wait 10 minutes for the cooling system to cool down. Cover the coolant reservoir cap with a thick cloth to prevent the possibility of scalding and slowly remove the cap. Failure to follow this instruction could result in personal injury.



**WARNING:** Do not add engine coolant when the engine is on or the cooling system is hot. Failure to follow this instruction could result in personal injury.



**WARNING:** Do not add coolant further than the **MAX** mark.



**WARNING:** Do not put coolant in the windshield washer reservoir. If sprayed on the windshield, coolant could make it difficult to see through the windshield.

**Note:** Do not use stop leak pellets, cooling system sealants, or non-specified additives as they can cause damage to the engine cooling or heating systems. Resulting component damage may not be covered by the vehicle Warranty.

**Note:** Automotive fluids are not interchangeable.

It is very important to use prediluted coolant approved to the correct specification in order to avoid plugging the small passageways in the engine cooling system. See **Capacities and Specifications** (page 524). Do not mix different colors or types of coolant in your vehicle. Mixing of engine coolants or using an incorrect coolant may harm the engine or cooling system components and could void the vehicle Warranty.

**Note:** If prediluted coolant is not available, use the approved concentrated coolant diluting it to 50/50 with distilled water. See **Capacities and Specifications** (page 524). Using water that has not been deionized may contribute to deposit formation, corrosion and plugging of the small cooling system passageways.

To top up the coolant level do the following:

1. Unscrew the cap slowly. Any pressure escapes as you unscrew the cap.
2. Add enough prediluted coolant to reach the correct level.

**Note:** We do not recommend the use of recycled coolant.

3. Replace the coolant reservoir cap. Turn the cap clockwise until it contacts the hard stop.
4. Check the coolant level in the coolant reservoir the next few times you drive your vehicle. If necessary, repeat step 2.

If you have to add more than 1.1 qt (1 L) of engine coolant per month, have your vehicle checked as soon as possible. Operating an engine with a low level of coolant can result in engine overheating and possible engine damage.

In case of emergency, you can add a large amount of water without engine coolant in order to reach a vehicle service location. Service your vehicle as soon as possible.

Water alone, without engine coolant, can cause engine damage from corrosion, overheating or freezing.

Do not use the following as a coolant substitute, as they can cause engine damage from overheating or freezing:

- Alcohol.
- Methanol.

# Maintenance

- Brine.
- Any coolant mixed with alcohol or methanol antifreeze.

Do not add extra inhibitors or additives to the coolant. These can be harmful and compromise the corrosion protection of the coolant.

## Severe Climates

If you drive in extremely cold climates, you may need to increase the coolant concentration above 50%.

**Note:** *A coolant concentration of 60% provides improved freeze point protection. Coolant concentrations above 60% decrease the overheat protection characteristics of the coolant and could cause engine damage.*

If you drive in extremely hot climates, you may need to decrease the coolant concentration to 40%.

**Note:** *Coolant concentrations below 40% decrease the freeze and corrosion protection characteristics of the coolant and could cause engine damage.*

## Coolant Change

Change the coolant at specific mileage intervals. Refer to the scheduled maintenance information. See **Normal Scheduled Maintenance** (page 605).

**Note:** *Dispose of used coolant in the appropriate manner.*

Follow your community's regulations and standards for recycling and disposing of automotive fluids.

## Fail-Safe Cooling

Fail-safe cooling allows you to temporarily drive your vehicle before any incremental component damage occurs. The fail-safe distance depends on ambient temperature, vehicle load and terrain.

## How Fail-Safe Cooling Works



If the engine begins to overheat, the coolant temperature gauge moves toward the red zone:



A warning lamp illuminates and a message may appear in the information display.

If the engine reaches a preset over-temperature condition, the engine automatically switches to alternating cylinder operation. Each disabled cylinder acts as an air pump and cools the engine.

When this occurs, your vehicle still operates, however:

- Engine power is limited.
- The air conditioning system turns off.

Continued operation increases the engine temperature, causing the engine to completely shut down. Your steering and braking effort increases in this situation.

When the engine temperature cools, you can re-start the engine. Have your vehicle checked as soon as possible to minimize engine damage.

## When Fail-Safe Mode Is Activated

 **WARNING:** Fail-safe mode is for use during emergencies only. Operate your vehicle in fail-safe mode only as long as necessary to bring your vehicle to rest in a safe location and seek immediate repairs. When in fail-safe mode, your vehicle will have limited power, will not be able to maintain high-speed operation, and may completely shut down without warning, potentially losing engine power, power steering assist, and power brake assist, which may increase the possibility of a crash resulting in serious injury.

# Maintenance



**WARNING:** Do not remove the coolant reservoir cap when the engine is on or the cooling system is hot. Wait 10 minutes for the cooling system to cool down. Cover the coolant reservoir cap with a thick cloth to prevent the possibility of scalding and slowly remove the cap. Failure to follow this instruction could result in personal injury.

Your vehicle has limited engine power when in the fail-safe mode, drive your vehicle with caution. Your vehicle does not maintain high-speed operation and the engine could operate poorly.

Remember that the engine is capable of automatically shutting down to prevent engine damage. In this situation:

1. Pull off the road as soon as safely possible and switch the engine off.
2. If you are a member of a roadside assistance program, we recommend that you contact your roadside assistance service provider.
3. If this is not possible, wait for a short period of time for the engine to cool.
4. Check the coolant level. If the coolant level is at or below the minimum mark, add prediluted coolant immediately.
5. When the engine temperature cools, you can re-start the engine. Have your vehicle checked as soon as possible to minimize engine damage.

**Note:** *Driving your vehicle without repair increases the chance of engine damage.*

## Engine Coolant Temperature Management (If Equipped)



**WARNING:** To reduce the risk of crash and injury, be prepared that the vehicle speed may reduce and the vehicle may not be able to accelerate with full power until the coolant temperature reduces.

If you tow a trailer with your vehicle, the engine may temporarily reach a higher temperature during severe operating conditions, for example ascending a long or steep grade in high ambient temperatures.

At this time, you may notice the coolant temperature gauge moves toward the red zone and a message may appear in the information display.

You may notice a reduction in vehicle speed caused by reduced engine power in order to manage the engine coolant temperature. Your vehicle may enter this mode if certain high-temperature and high-load conditions take place. The amount of speed reduction depends on vehicle loading, grade and ambient temperature. If this occurs, there is no need to stop your vehicle. You can continue to drive.

The air conditioning may automatically turn on and off during severe operating conditions to protect the engine from overheating. When the coolant temperature decreases to the normal operating temperature, the air conditioning turns on.

If the coolant temperature gauge moves fully into the red zone, or if the coolant temperature warning or service engine soon messages appear in your information display, do the following:

# Maintenance

1. Stop your vehicle as soon as it is safe to do so. Fully apply the parking brake, shift into park (P) or neutral (N).
2. Leave the engine running until the coolant temperature gauge needle returns to the normal position. If the temperature does not drop after several minutes, follow the remaining steps.
3. Switch the engine off and wait for it to cool. Check the coolant level.
4. If the coolant level is at or below the minimum mark, add prediluted coolant immediately.
5. If the coolant level is normal, restart the engine and continue.

## ENGINE AIR FILTER

### Checking the Engine Air Filter Restriction Gauge - Diesel

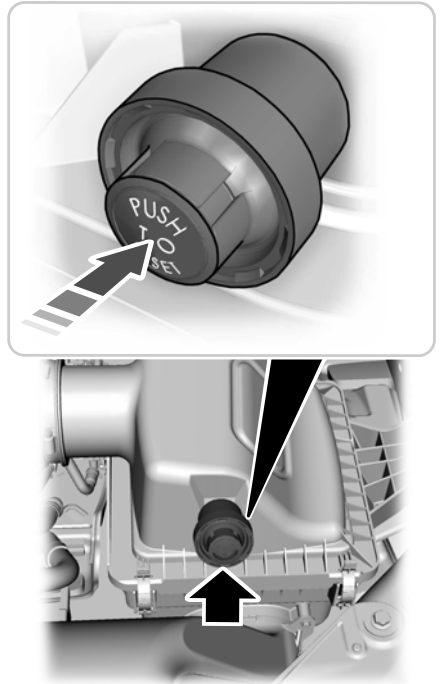

The air filter restriction gauge is in the upper housing of the air filter assembly.

Check the air filter restriction gauge whenever you open the hood to carry out general engine maintenance. Change the air filter element when the restriction gauge reads near the change filter line and the gauge is yellow. Allowing the restriction gauge to reach maximum affects engine performance and fuel economy.

# Maintenance

After operating your vehicle during heavy snowfall or extreme rain, do the following:

- Snow: At the earliest opportunity, open the hood and clear any snow and ice from the air filter housing inlet and reset the air filter restriction gauge.
- Extreme rain: The air filter element dries out after approximately 15–30 minutes of driving at highway speeds. At the earliest opportunity, open the hood and reset the air filter restriction gauge.

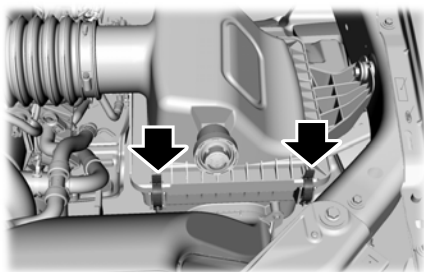

## Changing the Engine Air Filter - Diesel



**WARNING:** To reduce the risk of vehicle damage and personal burn injuries, do not start your engine with the air cleaner removed and do not remove it while the engine is running.

Change the air filter element at the correct service interval. See **Scheduled Maintenance** (page 602).

Use the correct specification air filter element. See **Motorcraft Parts** (page 531).

**Note:** Failure to use the correct air filter element may result in severe engine damage. Resulting component damage may not be covered by the vehicle Warranty.

1. Release the clips that secure the air filter housing cover. Lift and rotate the air filter housing cover.

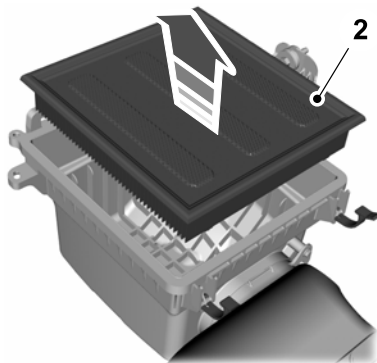

2. Remove the air filter element from the air filter housing.
3. To install, reverse the removal procedure.
4. After installing a new air filter element, reset the air filter restriction gauge by pressing the reset button. See **Checking the Engine Air Filter Restriction Gauge** (page 467).

# Maintenance

## Changing the Engine Air Filter - Gasoline



**WARNING:** To reduce the risk of vehicle damage and personal burn injuries, do not start your engine with the air cleaner removed and do not remove it while the engine is running.

Change the air filter element at the proper intervals. See **Scheduled Maintenance** (page 602).

When changing the air filter element, use only the air filter element listed. See **Capacities and Specifications** (page 524).

**Note:** Failure to use the correct air filter element could result in severe engine damage that the vehicle Warranty may not cover.

**Note:** When servicing the air cleaner, do not allow foreign material to enter the air induction system. The engine is susceptible to damage from even small particles.

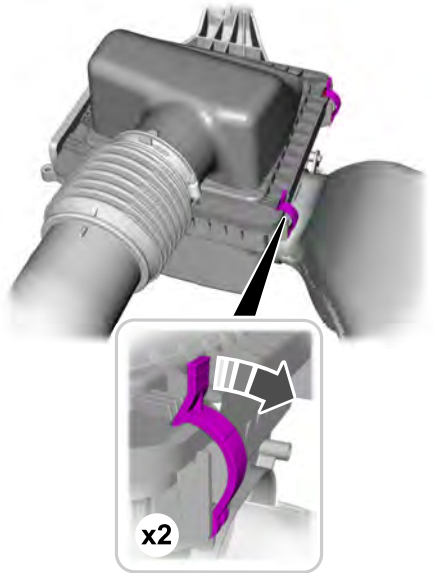

1. Release the clips that secure the air filter cover to the housing.
2. Carefully lift the air filter housing cover.
3. Remove the air filter element from the air filter housing.
4. To install, reverse the removal procedure.



# Maintenance

## Engine Air Filter - Information Messages - Diesel

Message	Action
Filter OK	Indicates the engine air filter is performing as expected.
Check Filter See Manual	Indicates that there is a higher than expected restriction across the engine air filter, which could represent an air filter at full useful life or a filter with an obstruction. When this displays, inspect the engine air filter and replace if necessary. After the inspection or engine air filter replacement, you must reset the system in order to change the status from Check Filter to Filter OK.
System Fault See Manual	Indicates that there is an error within the electronic air filter maintenance minder system requiring service.

## DRAINING THE FUEL FILTER WATER TRAP - DIESEL



**WARNING:** Do not drain the water-in-fuel separator while the engine is running. Failure to follow this warning may result in fire, serious injury, death or property damage.



**WARNING:** Do not dispose of fuel in the household refuse or the public sewage system. Use an authorized waste disposal facility.

Your vehicle's fuel system has a fuel filter and water separator to remove water from the fuel.

If the water in fuel indicator illuminates when the engine is running, stop your vehicle as soon as safely possible, shut off the engine, then drain the fuel and water separator.

**Note:** *Allowing water to stay in the fuel system after the water in fuel indicator illuminates could result in extensive damage or failure of the fuel injection system.*

The fuel water trap is above the frame rail under the driver side of the vehicle.

Make sure the ignition is off before performing the following steps.

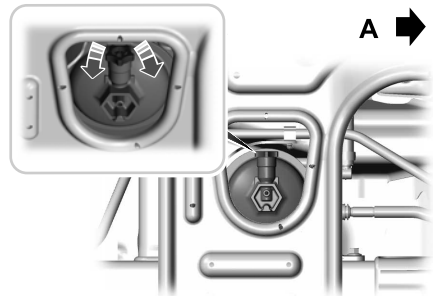

A Front of Vehicle.

1. Loosen the drain plug approximately one and a half turns.
2. Allow the water to drain.
3. Tighten the drain plug until you feel a strong resistance.
4. Switch the ignition on for 30 seconds, then switch the ignition off. Repeat twice.

# Maintenance

5. Start the engine.
6. Check for leaks.

**Note:** *The water in fuel warning lamp turns off after approximately two seconds with the engine running.*

**Note:** *The in-tank pump will turn off automatically after approximately 30 seconds.*

## CHANGING THE FUEL FILTER - DIESEL

Your fuel filters must be changed at the correct service interval or when you see the low fuel pressure message appear. Refer to scheduled maintenance for the correct service interval.

## CHANGING THE FUEL FILTER - GASOLINE

Your vehicle has a lifetime fuel filter that integrates with the fuel tank. It does not need regular maintenance or replacement.

## CHANGING THE 12V BATTERY



**WARNING:** Batteries normally produce explosive gases which can cause personal injury. Therefore, do not allow flames, sparks or lighted substances to come near the battery. When working near the battery, always shield your face and protect your eyes. Always provide correct ventilation.



**WARNING:** When lifting a plastic-cased battery, excessive pressure on the end walls could cause acid to flow through the vent caps, resulting in personal injury and damage to the vehicle or battery. Lift the battery with a battery carrier or with your hands on opposite corners.



**WARNING:** Keep batteries out of reach of children. Batteries contain sulfuric acid. Avoid contact with skin, eyes or clothing. Shield your eyes when working near the battery to protect against possible splashing of acid solution. In case of acid contact with skin or eyes, flush immediately with water for a minimum of 15 minutes and get prompt medical attention. If acid is swallowed, call a physician immediately.



**WARNING:** Battery posts, terminals and related accessories contain lead and lead compounds, chemicals known to the State of California to cause cancer and reproductive harm. **Wash your hands after handling.**



**WARNING:** This vehicle may have more than one battery. Removing the battery cables from only one battery does not disconnect your vehicle electrical system. Make sure you disconnect the battery cables from all batteries when disconnecting power. Failure to do so may cause serious personal injury or property damage.

The battery is in the engine compartment. See **Under Hood Overview** (page 456).

Your vehicle has a maintenance-free battery. It does not require additional water during service.

# Maintenance

For longer, trouble-free operation, keep the top of the battery clean and dry and the battery cables tightly fastened to the battery terminals. If any corrosion is present on the battery or terminals, remove the cables from the terminals and clean with a wire brush. You can neutralize the acid with a solution of baking soda and water.

We recommend that you disconnect the negative battery cable terminal from the battery if you plan to store your vehicle for an extended period.

**Note:** *If you only disconnect the negative battery cable terminal, make sure it is isolated or placed away from the battery terminal to avoid unintended connection or arcing.*

To maintain correct operation of the battery management system, if you add any electrical devices to your vehicle, do not connect the ground connection directly to the negative battery terminal. A connection at the negative battery terminal can cause inaccurate measurements of the battery condition and potential incorrect system operation.

**Note:** *If you add electrical accessories or components to your vehicle this may adversely affect battery performance, durability and the performance of other electrical systems on your vehicle.*

If you replace the battery make sure it matches the electrical requirements of your vehicle.

If you disconnect or replace the battery and your vehicle has an automatic transmission, it must relearn its adaptive strategy. Because of this, the transmission may shift firmly when first driven. This is normal operation while the transmission fully updates its operation to optimum shift feel.

## Remove and Reinstall the Battery

To disconnect or remove the battery, do the following:

1. Apply the parking brake and switch the ignition off.
2. Switch all electrical equipment off, for example lights and radio.
3. Wait a minimum of two minutes before disconnecting the battery.

**Note:** *The engine management system has a power hold function and remains powered for a period of time after you switch the ignition off. This is to allow diagnostic and adaptive tables to be stored. Disconnecting the battery without waiting can cause damage not covered by the vehicle Warranty.*

4. Disconnect the negative battery cable terminal.
5. Disconnect the positive battery cable terminal.
6. Remove the battery securing clamp.
7. Remove the battery.
8. To install, reverse the removal procedure.

**Note:** *Before reconnecting the battery, make sure the ignition remains switched off.*

**Note:** *Make sure the battery cable terminals are fully tightened.*

**Note:** *After cleaning or replacing the battery, make sure you reinstall the battery cover or shield.*

If you disconnect or replace the vehicle battery, you must reset the following features:

- Window bounce-back. See **Windows** (page 137).
- Clock Settings.
- Pre-set radio stations.
- Steering Angle Sensor.

# Maintenance

**Note:** To calibrate the steering angle sensor, drive the vehicle above 30 mph (50 km/h) for a minimum of 1.2 mi (2 km). Make sure to drive straight ahead for a minimum of 30 seconds. Several vehicle functions are disabled and a warning light could appear until the sensor is calibrated.

## Battery Management System

The battery management system monitors battery conditions and takes actions to extend battery life. If excessive battery drain is detected, the system temporarily disables some of the following features:

- Heated rear window.
- Heated seats.
- Climate control.
- Heated steering wheel.
- Audio unit.
- Navigation system.

A message may appear in the information display to alert you that battery protection actions are active.

After battery replacement, or in some cases after charging the battery with an external charger, the battery management system requires eight hours of vehicle sleep time to relearn the battery state of charge. During this time your vehicle must remain fully locked with the ignition off.

**Note:** If you add electrical accessories or components to the vehicle, it may adversely affect battery performance and durability. This may also affect the performance of other electrical systems in the vehicle.

## Battery Disposal



Make sure that you dispose of old batteries in an environmentally friendly way. Seek advice from your local authority about recycling old batteries.

## ADJUSTING THE HEADLAMPS

### Vertical Aim Adjustment

The headlamps on your vehicle are properly aimed at the assembly plant. If your vehicle has been in an accident, contact an authorized dealer to check and realign your headlamps.

### Headlamp Aiming Target

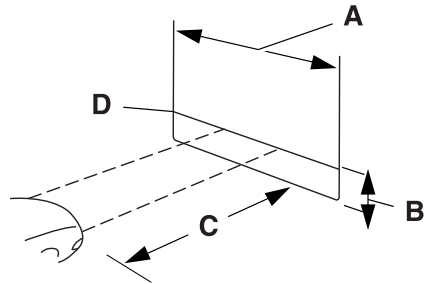

- A 8 feet (2.4 m).
- B Center height of lamp to ground.
- C 25 feet (7.6 m).
- D Horizontal reference line.

1. Park your vehicle directly in front of a wall or screen on a level surface, approximately 25 ft (7.6 m) away.
2. Measure the height from the center of your headlamp, indicated by a 3 millimeter circle on the lens, to the ground and mark an 8 ft (2.4 m) horizontal reference line on the vertical wall or screen at this height, a piece of masking tape works well.
3. Switch on the low beam headlamps to illuminate the wall or screen and open the hood. Cover one of the headlamps so no light hits the wall.

# Maintenance



4. On the wall or screen, observe a light pattern with a distinct horizontal edge toward the right. If this edge is not at the horizontal reference line, adjust the beam so the edge is at the same height as the horizontal reference line.



5. Locate the vertical adjuster on each headlamp. Use a #2 Phillips screwdriver to turn the adjuster either counterclockwise or clockwise in order to adjust the vertical aim of the headlamp.
6. Repeat Steps 3 through 7 to adjust the other headlamp.
7. Close the hood and turn off the lamps.

## Horizontal Aim Adjustment

Horizontal aim is not required for this vehicle and is not adjustable.

## EXTERIOR BULBS

### Exterior Bulb Specification Chart

Replacement bulbs are specified in the chart below. Headlamp bulbs must be marked with an authorized D.O.T. marking for North America to make sure they have the proper lamp performance, light brightness, light pattern and safe visibility. The correct bulbs will not damage the lamp assembly or void the lamp assembly warranty and will provide quality bulb illumination time.

Lamp	Specification	Power (Watt)
Central high mounted stop lamp.	912	16
Central high mounted cargo lamp. Vehicles with cargo box.	LED	LED
Daytime running lamp (XLT optional, Lariat, Platinum, King Ranch, Limited).	LED	LED
Daytime running lamp (XLT optional, XL).	H11	55

# Maintenance

Lamp	Specification	Power (Watt)
Front turn signal and parking lamp (XLT optional, Lariat, Platinum, King Ranch, Limited).	LED	LED
Front turn signal and parking lamp (XLT optional, XL).	4257NA	21/5
Front fog lamp (XLT optional, Lariat, Platinum, King Ranch, Limited).	LED	LED
Front fog lamp (XL and XLT optional).	9140	55
Front side marker lamp (Lariat optional, Platinum, King Ranch, Limited).	LED	LED
Front side marker lamp (Lariat optional, XL, XLT).	W5W	5
Headlamp (XLT optional, Lariat, Platinum, King Ranch, Limited).	LED	LED
Headlamp low beam (XLT optional, XL).	H11	55
Headlamp high beam (XLT optional, XL).	9005	65
License plate lamp.	W5W	5
Puddle lamp.	LED	LED
Rear cargo box lamp.	LED	LED
Rear turn signal (XL optional).	WTY21W	21
Rear lamp, stop lamp (XL optional).	WT21W/7W	21/7
Rear lamp, stop lamp, rear turn signal and rear side marker lamp (XL optional, XLT).	WT21W/7W	21/7
Reversing lamp (XL optional).	WT21W	21
Reversing lamp (XL optional, XLT).	LED	LED
Side turn signal lamp.	LED	LED
Taillamp-all functions (Lariat, Platinum, King Ranch, Limited).	LED	LED

**Note:** LED lamps are not serviceable. See an authorized dealer if they fail.

# Maintenance

## Removing a Rear Lamp Assembly

1. Make sure the headlamps are off.
2. Open the tailgate to access the rear lamp assemblies.

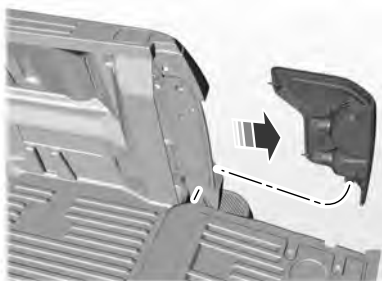

3. Remove the two bolts from the tail lamp assembly. Then, carefully pull the lamp assembly from the tailgate pillar by releasing the two retaining tabs.
4. Disconnect the electrical connector from the bulb.
5. To install, reverse the removal procedure.

## Changing a Headlamp Bulb



**WARNING:** Make sure the bulbs have cooled down before removing them. Failure to follow this warning could result in serious personal injury.

## Accessing the Halogen High Beam and Low Beam Bulbs

1. Rotate the steering wheel to the opposite side of the bulb needing replacement.

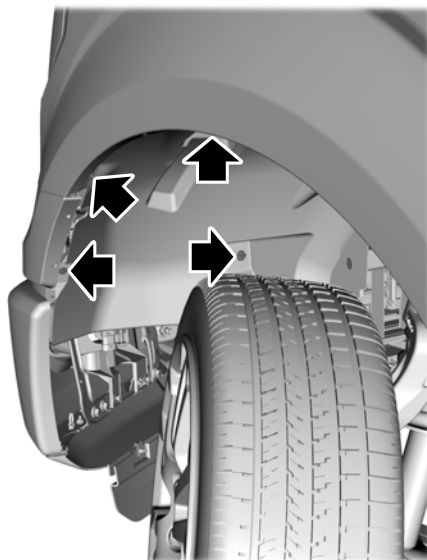

2. Remove the screws and push pins from the front of the wheel liner.
3. Pull the wheel liner back towards the tire to gain access to the bulbs.

# Maintenance

## Replacing the Halogen High Beam and Low Beam Bulbs and Low Beam Bulbs

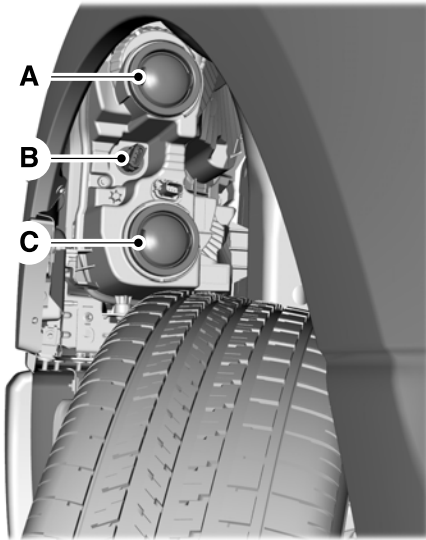

- A. Low beam headlamp bulb.
- B. Turn signal lamp bulb.
- C. High beam headlamp bulb.



1. Make sure the headlamps are off.
2. For the high beam and low beam bulbs, remove the rubber cap to access the bulbs.
3. Remove the bulb holder from the lamp assembly by turning it counterclockwise and pulling it straight out.
4. Disconnect the bulb from the electrical connector.
5. To install, reverse the removal procedure.

**Note:** Handle a halogen headlamp bulb carefully and keep out of children's reach. Grasp the bulb only by its plastic base and do not touch the glass. The oil from your hand could cause the bulb to break the next time the headlamps are operated.



# Maintenance

**Note:** If the bulb is accidentally touched, clean it with rubbing alcohol before installing it.

## Changing a Front Turn Signal Lamp Bulb



**WARNING:** Make sure the bulbs have cooled down before removing them. Failure to follow this warning could result in serious personal injury.

1. Rotate the steering wheel to the opposite side of the bulb needing replacement.

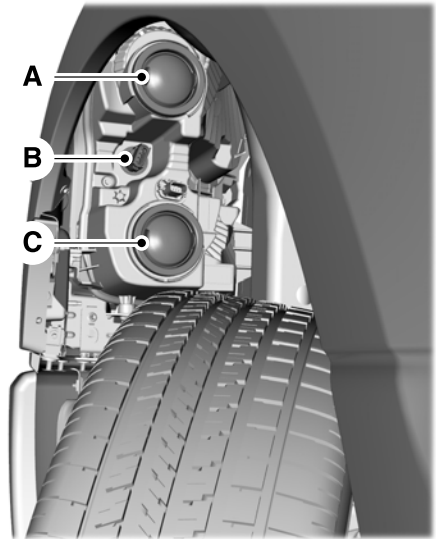
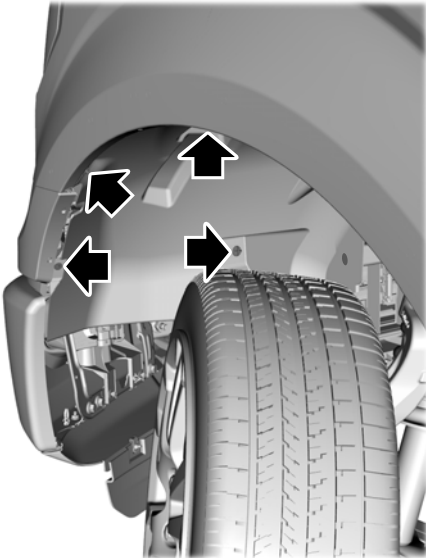

- A. Low beam headlamp bulb.
- B. Turn signal lamp bulb.
- C. High beam headlamp bulb.

2. Remove the screws and push pins from the front of the wheel liner.
3. Pull the wheel liner back toward the tire to gain access to the bulb.

# Maintenance

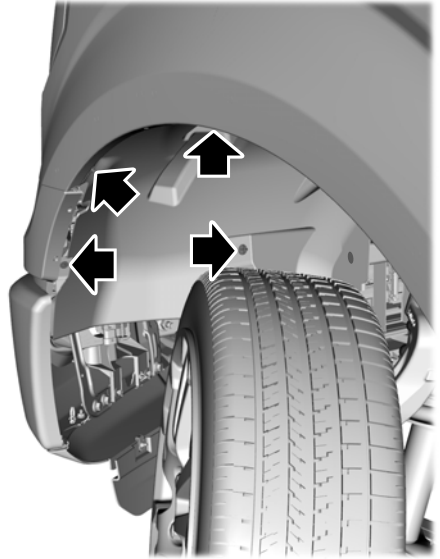

1. Make sure the headlamps are off.
2. Remove the screws and push pins from the front of the wheel liner.
3. Pull the wheel liner back toward the tire to gain access to the bulb.
1. Make sure the headlamps are off.
2. Remove the bulb holder from the lamp assembly by turning it counterclockwise and pulling it straight out.
3. Disconnect the bulb from the electrical connector.
4. To install, reverse the removal procedure.

## Changing a Front Side Marker Lamp Bulb

1. Rotate the steering wheel to the opposite side of the bulb needing replacement.

# Maintenance

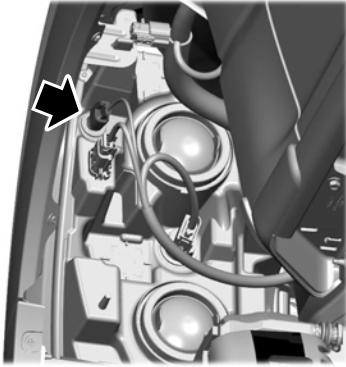

4. Remove the bulb holder from the lamp assembly by turning it counterclockwise and pulling it straight out.
5. Disconnect the bulb from the electrical connector.
6. To install, reverse the removal procedure.

## Changing a Front Fog Lamp Bulb

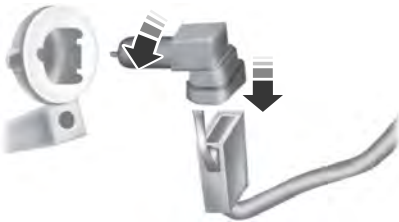

1. Make sure the fog lamps are off.

2. Disconnect the electrical connector from the fog lamp bulb.
3. Turn the bulb counterclockwise and remove it from the fog lamp.
4. To install, reverse the removal procedure.

## Changing a Rear Lamp Bulb

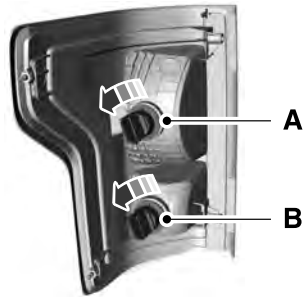

- A. Stoplamp, rear and turn signal bulb.  
B. Reversing lamp bulb.

1. Remove the rear lamp assembly.
2. Rotate the bulb socket counterclockwise and remove it from the rear lamp assembly.
3. To install, reverse the removal procedure.

# Maintenance

## Changing a Stoplamp Bulb

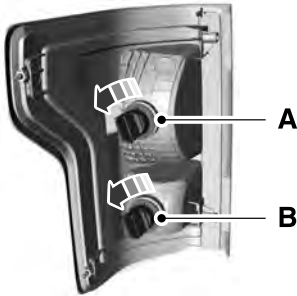

- A. Stoplamp, rear and turn signal bulb.
- B. Reversing lamp bulb.

1. Remove the rear lamp assembly. See **Removing a Rear Lamp Assembly** (page 476).
2. Rotate the bulb socket counterclockwise and remove it from the rear lamp assembly.
3. To install, reverse the removal procedure.

## Changing a Rear Turn Signal Lamp Bulb

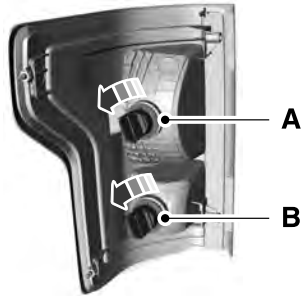

- A. Stoplamp, rear and turn signal bulb.
- B. Reversing lamp bulb.

1. Remove the rear lamp assembly. See **Removing a Rear Lamp Assembly** (page 476).
2. Rotate the bulb socket counterclockwise and remove it from the rear lamp assembly.
3. To install, reverse the removal procedure.

# Maintenance

## Changing a Reversing Lamp Bulb

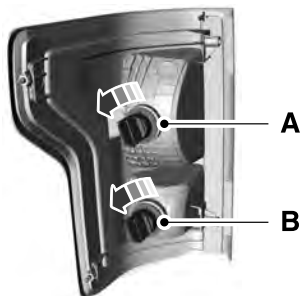

- A. Stoplamp, rear and turn signal bulb.
- B. Reversing lamp bulb.

1. Remove the rear lamp assembly. See **Removing a Rear Lamp Assembly** (page 476).
2. Rotate the bulb socket counterclockwise and remove it from the rear lamp assembly.
3. To install, reverse the removal procedure.

## Changing a High Mounted Stoplamp Bulb

1. Make sure the lamps are off.
2. Remove the four screws and move the lamp assembly away from the vehicle to expose the bulb sockets.



3. Remove the bulb socket by rotating it counterclockwise and pulling it out of the lamp assembly.
4. Pull the bulb straight out of the socket.
5. To install, reverse the removal procedure.

## Changing a License Plate Lamp Bulb

The license plate bulbs are behind the rear bumper.



1. Reach behind the rear bumper to locate the bulb.
2. Twist the bulb socket counterclockwise and carefully pull to remove it from the lamp assembly.
3. Pull the bulb straight out of the socket.

# Maintenance

- To install, reverse the removal procedure.

## INTERIOR BULBS

### Interior Bulb Specification Chart

Your vehicle has LED lamps. These are not serviceable items. See an authorized dealer if they fail.

## DRIVE BELT ROUTING - 2.7L ECOBOOST™, VEHICLES WITH: DUAL GENERATORS

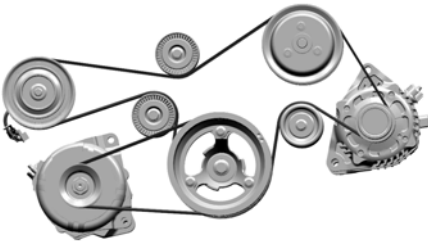

## DRIVE BELT ROUTING - 2.7L ECOBOOST™, VEHICLES WITH: SINGLE GENERATOR



## DRIVE BELT ROUTING - 3.0L DIESEL



# Maintenance

## DRIVE BELT ROUTING - 3.3L

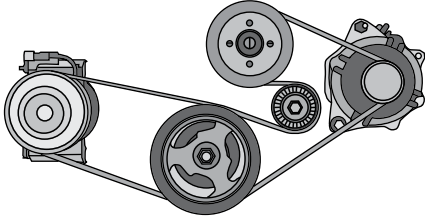

**Note:** The short drive belt is on the inner groove closest to the engine. The long drive belt is on the outer groove farthest from the engine.

## DRIVE BELT ROUTING - 3.5L ECOBOOST™, VEHICLES WITH: SINGLE GENERATOR



**Note:** The long drive belt is on the inner groove closest to the engine. The short drive belt is on the outer groove farthest from the engine.

## DRIVE BELT ROUTING - 3.5L ECOBOOST™, VEHICLES WITH: DUAL GENERATORS

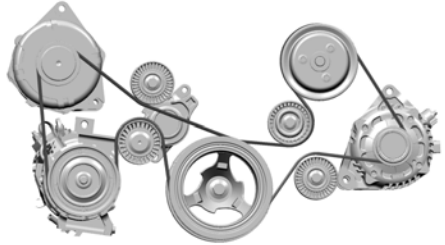

**Note:** The short drive belt is on the inner groove closest to the engine. The long drive belt is on the outer groove farthest from the engine.

## DRIVE BELT ROUTING - 3.5L, HYBRID ELECTRIC VEHICLE (HEV)

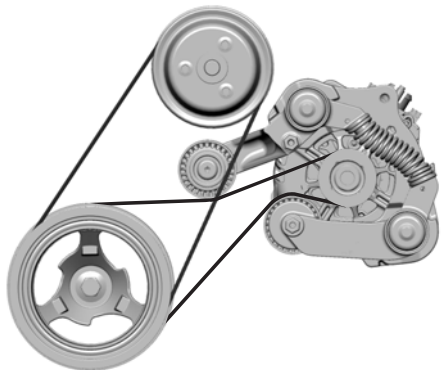

# Maintenance

---

**Note:** *The generator drive belt is on the inner groove closest to the engine. The water pump belt is on the outer groove farthest from the engine.*

## **DRIVE BELT ROUTING - 5.0L, VEHICLES WITH: SINGLE GENERATOR**

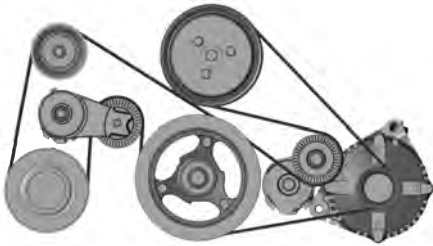

## **DRIVE BELT ROUTING - 5.0L, VEHICLES WITH: DUAL GENERATORS**

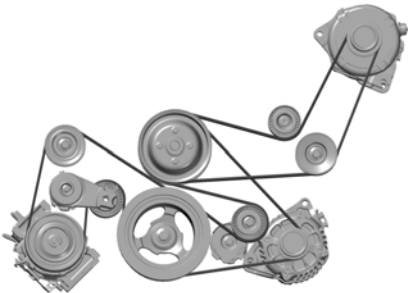



# Vehicle Care

## CLEANING PRODUCTS

### Materials

For best results, use the following products

or products of equivalent quality:

For additional information and assistance, we recommend that you contact an authorized dealer.

Name	Specification
Motorcraft® Bug and Tar Remover, ZC-42 (U.S. & Canada)	
Motorcraft® Custom Bright Metal Cleaner, ZC-15 (U.S. & Canada)	ESR-M5B194-B
Motorcraft® Detail Wash, ZC-3-A (U.S. & Canada)	ESR-M14P4-A
Motorcraft® Engine Shampoo and Degreaser, ZC-20 (U.S.)	ESR-M14P3-A
Motorcraft® Engine Shampoo, CXC-66-A (Canada)	
Motorcraft® Premium Leather and Vinyl Cleaner, ZC-56 (U.S. & Canada)	
Motorcraft® Multi-Purpose Cleaner, CXC-101 (Canada)	
Motorcraft® Premium Windshield Wash Concentrate with Bitterant, ZC-32-B2 (U.S.)	WSS-M14P19-A
Motorcraft® Premium Quality Windshield Washer Fluid, CXC-37-A/B/D/F (Canada)	WSS-M14P19-A
Motorcraft® Professional Strength Carpet & Upholstery Cleaner, ZC-54 (U.S. & Canada)	
Motorcraft® Premium Glass Cleaner, CXC-100 (Canada)	ESR-M14P5-A
Motorcraft® Spot and Stain Remover, ZC-14 (U.S.)	
Motorcraft® Ultra-Clear Spray Glass Cleaner, ZC-23 (U.S.)	ESR-M14P5-A
Motorcraft® Wheel and Tire Cleaner, ZC-37-A (U.S. & Canada)	

## CLEANING THE EXTERIOR

### Cleaning the Exterior Precautions

Immediately remove fuel spillages, AdBlue residuals, bird droppings, insect deposits and road tar. These may cause damage to your vehicle's paintwork or trim over time.

Remove any exterior accessories, for example antennas, before entering a car wash.

### Cleaning Headlamps and Rear Lamps

We recommend that you only use cold or lukewarm water containing car shampoo to clean the headlamps and the rear lamps.

# Vehicle Care

---

Do not scrape the lamps.

Do not wipe lamps when they are dry.

## Cleaning Windows and Wiper Blades

To clean the windshield and wiper blades:

- Clean the windshield with a non-abrasive glass cleaner.

**Note:** *When cleaning the interior of the windshield, avoid getting any glass cleaner on the instrument panel or door panels. Wipe any glass cleaner off these surfaces immediately.*

- Clean the wiper blades with isopropyl rubbing alcohol or windshield washer concentrate.

**Note:** *Do not use razor blades or other sharp objects to clean or remove decals from the inside of the heated rear window. This can cause damage not covered by the vehicle Warranty.*

## Cleaning Chrome, Aluminium or Stainless Steel

We recommend that you only use a car shampoo, a soft cloth and water on bumpers and other chrome, aluminium or stainless steel parts.

**Note:** *For additional information and assistance, we recommend that you contact an authorized dealer.*

**Note:** *Rinse the area well after cleaning.*

**Note:** *Do not use abrasive materials, for example steel wool or plastic pads, as they can scratch these surfaces.*

**Note:** *Do not use chrome cleaner, metal cleaner or polish on wheels or wheel covers.*

## Cleaning Wheels

Only use a recommended wheel and tire cleaner to clean the wheels weekly. For additional information and assistance, we recommend that you contact an authorized dealer.

1. Use a sponge to remove heavy deposits of dirt and brake dust.
2. Rinse well after cleaning.

**Note:** *Do not apply a cleaning chemical to warm or hot wheel rims and covers.*

If you intend on parking your vehicle for an extended period after cleaning the wheels with a wheel cleaner, drive your vehicle for a few minutes before parking your vehicle. This reduces the risk of corrosion of the brake discs, brake pads and linings.

Do not clean the wheels when they are hot.

**Note:** *Some car washes could damage wheel rims and covers.*

**Note:** *Using non-recommended cleaners, harsh cleaning products, chrome wheel cleaners or abrasive materials could damage wheel rims and covers.*

## Cleaning the Engine Compartment

Use a vacuum cleaner to remove debris from the screen area below windshield.

**Note:** *If you are not familiar with the parts around the engine do not wash the engine compartment. Avoid frequent engine washes.*

When washing the engine compartment:

- Never wash or rinse the engine while it is hot or running.
- Never wash or rinse any ignition coil, spark plug wire or spark plug well.
- Cover the battery, power distribution box, and air filter assembly to prevent water damage.

# Vehicle Care

**Note:** *If your vehicle has an engine cover remove the cover before application of shampoo and degreaser.*

- Spray an approved engine shampoo and degreaser on all parts that require cleaning and rinse with water.

## Cleaning Stripes or Graphics

It is recommended to wash your vehicle by hand however, pressure washing may be used under the following conditions:

- Use a spray with a 40° wide spray angle pattern.
- Keep the nozzle at a 12 in (305 mm) distance and 90° angle to your vehicle's surface.
- Do not use water pressure higher than 2,000 psi (14,000 kPa).
- Do not use water hotter than 179°F (82°C).

**Note:** *Holding the pressure washer nozzle at an angle to the vehicle's surface may damage graphics and cause the edges to peel away from the vehicle's surface.*

## Cleaning Camera Lenses and Sensors

We recommend that you only use lukewarm or cold water and a soft cloth to clean the camera lens and sensors.

**Note:** *Do not pressure wash camera lens and sensors.*

## Cleaning the Underbody

Flush the complete underside of your vehicle frequently. Keep body and door drain holes free from packed dirt.

Rear suspension components may require regular cleaning with a power washer or a thorough rinse with a strong stream of water if the vehicle is operated in dusty or muddy environments. Rear leaf springs or other suspension components may emit squeaking or popping noises while operating the vehicle if particles, such as dirt, rocks, or other debris, are present in the components.

## CLEANING THE INTERIOR

### Cleaning the Instrument Panel



**WARNING:** Do not use chemical solvents or strong detergents when cleaning the steering wheel or instrument panel to avoid contamination of the airbag system.

We recommend that you only clean the instrument panel and cluster lens with a damp soft cloth. Dry the area with a clean, soft cloth.

For additional information and assistance, we recommend that you contact an authorized dealer.

**Note:** *Avoid cleaners or polishes that increase the gloss of the upper portion of the instrument panel. The dull finish in this area helps protect you from undesirable windshield reflection.*

### Cleaning Plastic

We recommend that you only use a mild soap and water solution on a soft cloth. Dry the area with a clean, soft cloth.

# Vehicle Care

---

## Cleaning Displays and Screens

We recommend that you only use a microfiber cloth in a circular motion to clean off the fingerprint or dust.

If dirt or fingerprints are still on the screen, apply a small amount of alcohol to the cloth and try to clean it again.

**Note:** *Do not pour or spray alcohol onto the touchscreen.*

**Note:** *Do not use detergent or any type of solvent to clean the touchscreen.*

## Cleaning Seats and the Headliner



**WARNING:** On vehicles equipped with seat-mounted airbags, do not use chemical solvents or strong detergents. Such products could contaminate the side airbag system and affect performance of the side airbag in a crash.

## Cleaning Fabric Seats and the Headliner

We recommend that you only clean the fabric seats and headliners in the following way:

1. Remove dust and loose dirt with a vacuum cleaner.
2. Wipe the surface with a soft, damp cloth and a mild soap and water solution. Dry the area with a clean, soft cloth.
3. For additional information and assistance, we recommend that you contact an authorized dealer.

For heavy stains, spot clean the area. If a ring forms on the fabric, immediately clean the entire area, but do not oversaturate or the ring could set.

## Cleaning Vinyl and Leather

We recommend that you only clean the leather and vinyl surfaces in the following way:

1. Remove dust and loose dirt with a vacuum cleaner.
2. Wipe the surface with a soft, damp cloth and a mild soap and water solution. Dry the area with a clean, soft cloth.
3. For additional information and assistance, we recommend that you contact an authorized dealer.

## With King Ranch Edition

Your vehicle has seating covered in premium, top-grain leather that is extremely durable, but still requires special care and maintenance in order to preserve longevity and comfort.

Regular cleaning and conditioning maintains the appearance of the leather.

## Scratches

Because the leather in the seat comes from genuine steer hides, there may be evidence of naturally occurring markings, such as small scars. These markings give character to the seating covers and are considered to be proof of a genuine leather product.

To lessen the appearance of certain scratches and other wear marks, apply conditioner on the affected area.

# Vehicle Care

## Conditioning

- Clean the surfaces using the steps outlined in the cleaning leather and vinyl section.
- Make sure the leather is dry then apply a nickel-sized amount of conditioner to a clean, dry cloth.
- Rub the conditioner into the leather until it disappears. Allow the conditioner to dry, then repeat the process for the entire interior. If a film appears, wipe it off with a dry, clean cloth.

For additional information, visit:

[www.krsaddleshop.com](http://www.krsaddleshop.com)

## Cleaning Carpets and Floor Mats

We recommend that you only clean your carpets in the following way:

1. Remove dust and loose dirt with a vacuum cleaner.
2. Wipe the surface with a soft, damp cloth and a mild soap and water solution. Dry the area with a clean, soft cloth.
3. For additional information and assistance, we recommend that you contact an authorized dealer.

For heavy stains, spot clean the area. If a ring forms on the fabric, clean the entire area immediately, but do not oversaturate or the ring could set.

We recommend that you only clean your floor mats in the following way:

1. Remove dust and loose dirt with a vacuum cleaner.
2. Wash rubber floor mats using mild soap and lukewarm or cold water.
3. Completely dry the floor mat before placing them back in your vehicle.

## Cleaning Seatbelts



**WARNING:** Do not use cleaning solvents, bleach or dye on the vehicle's seatbelts, as these actions may weaken the belt webbing.

1. Wipe the surface with a soft, damp cloth and a mild soap and water solution. Dry the area with a clean, soft cloth.

## Cleaning Moonroof Tracks

1. Remove debris from the tracks with a vacuum cleaner.
2. Wipe the bulb seal and mating painted roof metal surface with a soft, damp cloth and a mild soap and water solution.

## REPAIRING MINOR PAINT DAMAGE

Authorized dealers have touch-up paint to match your vehicle's color. Your vehicle color code is printed on a sticker on the front, left-hand side door jamb. Take your color code to your authorized dealer to make sure you get the correct color.

Before repairing minor paint damage, use a cleaner to remove particles such as bird droppings, tree sap, insect deposits, tar spots, road salt and industrial fallout.

Read the instructions before using cleaning products.

## WAXING YOUR VEHICLE

Wax the high-gloss painted surface of your prewashed vehicle once or twice a year.

# Vehicle Care

---

We recommend that you only use an approved quality wax that does not contain abrasives. Follow the manufacturer's instructions to apply and remove the wax. For additional information and assistance, we recommend that you contact an authorized dealer.

When washing and waxing, park your vehicle in a shaded area out of direct sunlight.

**Note:** *Avoid waxing unpainted or low-gloss black colored parts, they discolor over time.*

# Storing Your Vehicle

---

## PREPARING YOUR VEHICLE FOR STORAGE

If you plan on storing your vehicle for 30 days or more, the following maintenance recommendations ensures your vehicle stays in good operating condition.

Under various conditions, long-term storage may lead to degraded engine performance or failure unless you use specific precautions to preserve your vehicle.

### General

- Store all vehicles in a dry, ventilated place.
- If vehicles are stored outside, they require regular maintenance to protect against rust and weather damage.
- Make sure all linkages, cables, levers and pins under your vehicle are covered with grease to prevent rust.
- Move vehicles at least 25 ft (7.5 m) every 15 days to lubricate working parts and prevent corrosion.
- Fill the fuel tank with high-quality fuel until the first automatic shutoff of the fuel pump nozzle.

### Engine

- Change the engine oil and filter prior to storage because used engine oil contains contaminants which may cause engine damage.
- Start the engine every 15 days for a minimum of 15 minutes. Run at fast idle with the climate controls set to defrost until the engine reaches normal operating temperature.
- With your foot on the brake, shift through all the gears while the engine is running.

### Body

- Wash your vehicle thoroughly to remove dirt, grease, oil, tar or mud from exterior surfaces, rear-wheel housings and the underside of front fenders.
- Periodically wash your vehicle if it is stored in exposed locations.
- Touch-up exposed or primed metal to prevent rust.
- Cover chrome and stainless steel parts with a thick coat of auto wax to prevent discoloration. Re-wax as necessary when you wash your vehicle.
- Lubricate all hood, door and luggage compartment hinges and latches with a light grade oil.
- Cover interior trim to prevent fading.
- Keep all rubber parts free from oil and solvents.

### Hybrid Battery Systems

We recommend the following actions for your vehicle:

- When storing your vehicle for greater than 30 days the state of charge should be approximately 50%. Additionally we recommend disconnecting the 12V battery which will reduce system loads on the HV battery.

### 12 Volt Battery

- Check and recharge as necessary. Keep connections clean.

**Note:** *It is necessary to reset memory features if you disconnect the battery cables.*

### Brakes

Make sure the brakes and parking brake release fully.

# Storing Your Vehicle

---

**Note:** *If you intend on parking your vehicle for an extended period after cleaning the wheels with a wheel cleaner, drive your vehicle for a few minutes before doing so to reduce the risk of increased corrosion of the brake discs, brake pads and linings.*

## Tires

- Maintain recommended air pressure.

**Note:** *If you intend on parking your vehicle for an extended period after cleaning the wheels with a wheel cleaner, drive your vehicle for a few minutes before doing so. This reduces the risk of corrosion of the brake discs, brake pads and linings.*

- Check fluid levels (including coolant, oil and gas) to make sure there are no leaks, and fluids are at recommended levels.
- If you remove the battery, clean the battery cable ends and check for damage.

Contact an authorized dealer if you have any concerns or issues.

## REMOVING YOUR VEHICLE FROM STORAGE

When your vehicle is ready to come out of storage, do the following:

- We recommend that you change the engine oil before you use your vehicle again.
- Wash your vehicle to remove any dirt or grease film build-up on window surfaces.
- Check windshield wipers for any deterioration.
- Check under the hood for any foreign material that may have collected during storage such as mice or squirrel nests.
- Check the exhaust for any foreign material that may have collected during storage.
- Check tire pressures and set tire inflation per the Tire Label.
- Check brake pedal operation. Drive your vehicle 15 ft (4.5 m) back and forth to remove rust build-up.



# Wheel and Tire Information

## LOCATING THE TIRE LABEL

You will find a Tire Label containing tire inflation pressure by tire size and other important information located on the B-Pillar or the edge of the driver's door. See **Locating the Safety Compliance Certification Labels** (page 361).

## DEPARTMENT OF TRANSPORTATION UNIFORM TIRE QUALITY GRADES



E142542

Tire Quality Grades apply to new pneumatic passenger car tires. The Quality grades can be found where applicable on the tire sidewall between tread shoulder and maximum section width. For example: **Treadwear 200 Traction AA Temperature A.**

These Tire Quality Grades are determined by standards that the United States Department of Transportation has set.

Tire Quality Grades apply to new pneumatic passenger car tires. They do not apply to deep tread, winter-type snow tires, space-saver or temporary use spare tires, light truck or LT type tires, tires with nominal rim diameters of 10 to 12 inches or limited production tires as defined in Title 49 Code of Federal Regulations Part 575.104 (c)(2).

**U.S. Department of Transportation Tire quality grades:** The U.S. Department of Transportation requires us to give you the following information about tire grades exactly as the government has written it.

### Treadwear

The treadwear grade is a comparative rating based on the wear rate of the tire when tested under controlled conditions on a specified government test course. For example, a tire graded 150 would wear 1½ times as well on the government course as a tire graded 100. The relative performance of tires depends upon the actual conditions of their use, however, and may depart significantly from the norm due to variations in driving habits, service practices, and differences in road characteristics and climate.

# Wheel and Tire Information

## Traction AA A B C



**WARNING:** The traction grade assigned to this tire is based on straight-ahead braking traction tests, and does not include acceleration, cornering, hydroplaning or peak traction characteristics.

The traction grades, from highest to lowest are AA, A, B, and C. The grades represent the tire's ability to stop on wet pavement as measured under controlled conditions on specified government test surfaces of asphalt and concrete. A tire marked C may have poor traction performance.

## Temperature A B C



**WARNING:** The temperature grade for this tire is established for a tire that is properly inflated and not overloaded. Excessive speed, underinflation, or excessive loading, either separately or in combination, can cause heat buildup and possible tire failure.

The temperature grades are A (the highest), B and C, representing the tire's resistance to the generation of heat and its ability to dissipate heat when tested under controlled conditions on a specified indoor laboratory

test wheel. Sustained high temperature can cause the material of the tire to degenerate and reduce tire life, and excessive temperature can lead to sudden tire failure. The grade C corresponds to a level of performance which all passenger car tires must meet under the Federal Motor Vehicle Safety Standard No. 139. Grades B and A represent higher levels of performance on the laboratory test wheel than the minimum required by law.

## INFORMATION ON THE TIRE SIDEWALL

Both United States and Canada Federal regulations require tire manufacturers to place standardized information on the sidewall of all tires. This information identifies and describes the fundamental characteristics of the tire and also provides a U.S. DOT Tire Identification Number for safety standard certification and in case of a recall.

## Wheel and Tire Information

### Information on P Type Tires

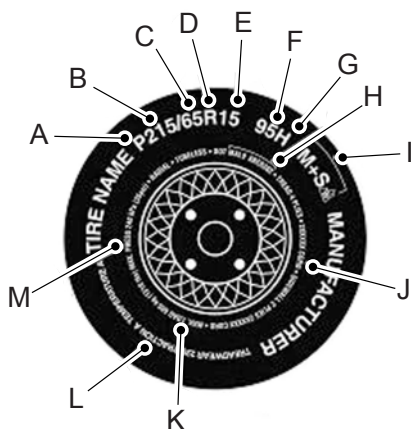

E142543

P215/65R15 95H is an example of a tire size, load index and speed rating. The definitions of these items are listed below. (Note that the tire size, load index and speed rating for your vehicle may be different from this example.)

**A. P:** Indicates a tire, designated by the Tire and Rim Association, that may be used for service on cars, sport utility vehicles, minivans and light trucks. **Note:** If your tire size does not begin with a letter this may mean it is designated by either the European Tire and Rim Technical Organization or the Japan Tire Manufacturing Association.

**B. 215:** Indicates the nominal width of the tire in millimeters from sidewall edge to sidewall edge. In general, the larger the number, the wider the tire.

**C. 65:** Indicates the aspect ratio which gives the tire's ratio of height to width.

**D. R:** Indicates a radial type tire.

**E. 15:** Indicates the wheel or rim diameter in inches. If you change your wheel size, you will have to purchase new tires to match the new wheel diameter.

**F. 95:** Indicates the tire's load index. It is an index that relates to how much weight a tire can carry. You may find this information in your owner's manual. If not, contact a local tire dealer.

**Note:** *You may not find this information on all tires because it is not required by federal law.*

**G. H:** Indicates the tire's speed rating. The speed rating denotes the speed at which a tire is designed to be driven for extended periods of time under a standard condition of load and inflation pressure. The tires on your vehicle may operate at different conditions for load and inflation pressure. These speed ratings may need to be adjusted for the difference in conditions. The ratings range from 81 mph (130 km/h) to 186 mph (299 km/h). These ratings are listed in the following chart.

## Wheel and Tire Information

**Note:** You may not find this information on all tires because it is not required by federal law.

Letter rating	Speed rating
M	81 mph (130 km/h)
N	87 mph (140 km/h)
Q	99 mph (159 km/h)
R	106 mph (171 km/h)
S	112 mph (180 km/h)
T	118 mph (190 km/h)
U	124 mph (200 km/h)
H	130 mph (210 km/h)
V	149 mph (240 km/h)
W	168 mph (270 km/h)
Y	186 mph (299 km/h)

**Note:** For tires with a maximum speed capability over 149 mph (240 km/h), tire manufacturers sometimes use the letters ZR. For those with a maximum speed capability over 186 mph (299 km/h), tire manufacturers always use the letters ZR.

**H. U.S. DOT Tire Identification Number (TIN):** This begins with the letters DOT and indicates that the tire meets all federal standards. The next two numbers or letters are the plant code designating where it was manufactured, the next two are

the tire size code and the last four numbers represent the week and year the tire was built. For example, the numbers 317 mean the 31st week of 1997. After 2000, the numbers go to four digits. For example, 2501 means the 25th week of 2001. The numbers in between are identification codes used for traceability. This information is used to contact customers if a tire defect requires a recall.

**I. M+S or M/S:** Mud and Snow, or

**AT:** All Terrain, or

**AS:** All Season.

**J. Tire Ply Composition and Material Used:** Indicates the number of plies or the number of layers of rubber-coated fabric in the tire tread and sidewall. Tire manufacturers also must indicate the ply materials in the tire and the sidewall, which include steel, nylon, polyester, and others.

**K. Maximum Load:** Indicates the maximum load in kilograms and pounds that can be carried by the tire. See the Safety Compliance Certification Label (affixed to either the door hinge pillar, door-latch post, or the door edge that meets the door-latch post, next to the driver's seating position), for the correct tire pressure for your vehicle.

**L. Treadwear, Traction and Temperature Grades:**

# Wheel and Tire Information

**\*Treadwear:** The treadwear grade is a comparative rating based on the wear rate of the tire when tested under controlled conditions on a specified government test course. For example, a tire graded 150 would wear one and one-half times as well on the government course as a tire graded 100.

**\*Traction:** The traction grades, from highest to lowest are AA, A, B, and C. The grades represent the tire's ability to stop on wet pavement as measured under controlled conditions on specified government test surfaces of asphalt and concrete. A tire marked C may have poor traction performance.

**\*Temperature:** The temperature grades are A (the highest), B and C, representing the tire's resistance to the generation of heat and its ability to dissipate heat when tested under controlled conditions on a specified indoor laboratory test wheel.

## M. Maximum Inflation

**Pressure:** Indicates the tire manufacturers' maximum permissible pressure or the pressure at which the maximum load can be carried by the tire. This pressure is normally higher than the vehicle manufacturer's recommended cold inflation pressure which can be found on the Safety Compliance Certification Label (affixed to either the door hinge pillar,

door-latch post, or the door edge that meets the door-latch post, next to the driver's seating position), or Tire Label which is located on the B-Pillar or the edge of the driver's door. The cold inflation pressure should never be set lower than the recommended pressure on the vehicle label.

The tire suppliers may have additional markings, notes or warnings such as standard load or radial tubeless.

## Additional Information Contained on the Tire Sidewall for LT Type Tires

**Note:** *Tire Quality Grades do not apply to this type of tire.*

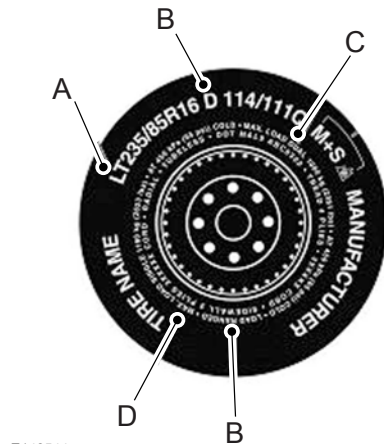

## Wheel and Tire Information

LT type tires have some additional information beyond those of P type tires; these differences are described below.

A. **LT:** Indicates a tire, designated by the Tire and Rim Association, that is intended for service on light trucks.

B. **Load Range and Load Inflation Limits:** Indicates the tire's load-carrying capabilities and its inflation limits.

C. **Maximum Load Dual lb (kg) at psi (kPa) cold:** Indicates the maximum load and tire pressure when the tire is used as a dual, defined as four tires on the rear axle (a total of six or more tires on the vehicle).

D. **Maximum Load Single lb (kg) at psi (kPa) cold:** Indicates the maximum load and tire pressure when the tire is used as a single, defined as two tires (total) on the rear axle.

### Information on T Type Tires

T145/80D16 is an example of a tire size.

**Note:** *The temporary tire size for your vehicle may be different from this example. Tire Quality Grades do not apply to this type of tire.*



E142545

T type tires have some additional information beyond those of P type tires; these differences are described below:

A. **T:** Indicates a type of tire, designated by the Tire and Rim Association, that is intended for temporary service on cars, sport utility vehicles, minivans and light trucks.

B. **145:** Indicates the nominal width of the tire in millimeters from sidewall edge to sidewall edge. In general, the larger the number, the wider the tire.

# Wheel and Tire Information

---

C. **80:** Indicates the aspect ratio which gives the tire's ratio of height to width. Numbers of 70 or lower indicate a short sidewall.

D. **D:** Indicates a diagonal type tire.

**R:** Indicates a radial type tire.

E. **16:** Indicates the wheel or rim diameter in inches. If you change your wheel size, you will have to purchase new tires to match the new wheel diameter.

## GLOSSARY OF TIRE TERMINOLOGY

\***Tire label:** A label showing the original equipment tire sizes, recommended inflation pressure and the maximum weight the vehicle can carry.

\***Tire Identification Number (TIN):** A number on the sidewall of each tire providing information about the tire brand and manufacturing plant, tire size and date of manufacture. Also referred to as DOT code.

\***Inflation pressure:** A measure of the amount of air in a tire.

\***Standard load:** A class of P-metric or Metric tires designed to carry a maximum load at set pressure. For example: For P-metric tires 35 psi (2.4 bar) and for Metric tires 36 psi (2.5 bar). Increasing the inflation pressure beyond this pressure will not increase the tire's load carrying capability.

\***Extra load:** A class of P-metric or Metric tires designed to carry a heavier maximum load at 42 psi (2.9 bar). Increasing the inflation pressure beyond this pressure will not increase the tire's load carrying capability.

\***kPa:** Kilopascal, a metric unit of air pressure.

\***PSI:** Pounds per square inch, a standard unit of air pressure.

\***Cold tire pressure:** The tire pressure when the vehicle has been stationary and out of direct sunlight for an hour or more and prior to the vehicle being driven for 1 mi (1.6 km).

\***Recommended inflation pressure:** The cold inflation pressure found on the Safety Compliance Certification Label (affixed to either the door hinge pillar, door-latch post, or the door edge that meets the door-latch post, next to the driver's seating position), or Tire Label located on the B-Pillar or the edge of the driver door.

\***B-pillar:** The structural member at the side of the vehicle behind the front door.

\***Bead area of the tire:** Area of the tire next to the rim.

\***Sidewall of the tire:** Area between the bead area and the tread.

# Wheel and Tire Information

**\*Tread area of the tire:** Area of the perimeter of the tire that contacts the road when mounted on the vehicle.

**\*Rim:** The metal support (wheel) for a tire or a tire and tube assembly upon which the tire beads are seated.

## TIRE REPLACEMENT REQUIREMENTS

### AGE



**WARNING:** Tires degrade over time depending on many factors such as weather, storage conditions, and conditions of use (load, speed, inflation pressure) the tires experience throughout their lives.

In general, tires should be replaced after six years regardless of tread wear. However, heat caused by hot climates or frequent high loading conditions can accelerate the aging process and may require tires to be replaced more frequently.

You should replace your spare tire when you replace the road tires or after six years due to aging even if it has not been used.

## U.S. DOT Tire Identification Number

Both United States and Canada Federal regulations require tire manufacturers to place standardized information on the sidewall of all tires. This information identifies and describes the fundamental characteristics of the tire and also provides a U.S. DOT Tire Identification Number for safety standard certification and in case of a recall.

This begins with the letters DOT and indicates that the tire meets all federal standards. The next two numbers or letters are the plant code designating where it was manufactured, the next two are the tire size code and the last four numbers represent the week and year the tire was built. For example, the numbers 317 mean the 31st week of 1997. After 2000, the numbers go to four digits. For example, 2501 means the 25th week of 2001. The numbers in between are identification codes used for traceability. This information is used to contact customers if a tire defect requires a recall.

## Tire Replacement Requirements

Your vehicle is equipped with tires designed to provide a safe ride and handling capability.



## Wheel and Tire Information



**WARNING:** Only use replacement tires and wheels that are the same size, load index, speed rating and type (such as P-metric versus LT-metric or all-season versus all-terrain) as those originally provided by Ford. The recommended tire and wheel size may be found on either the Safety Compliance Certification Label (affixed to either the door hinge pillar, door-latch post, or the door edge that meets the door-latch post, next to the driver's seating position), or the Tire Label which is located on the B-Pillar or edge of the driver's door. If this information is not found on these labels, then you should contact your authorized dealer as soon as possible. Use of any tire or wheel not recommended by Ford can affect the safety and performance of your vehicle, which could result in an increased risk of loss of vehicle control, vehicle rollover, personal injury and death.



**WARNING:** To reduce the risk of serious injury, when mounting replacement tires and wheels, you should not exceed the maximum pressure indicated on the sidewall of the tire to set the beads without additional precautions listed below. If the beads do not seat at the maximum pressure indicated, re-lubricate and try again.



**WARNING:** For a mounting pressure more than 20 psi (1.38 bar) greater than the maximum pressure, a Ford dealer or other tire service professional should do the mounting.



**WARNING:** Always inflate steel carcass tires with a remote air fill with the person inflating standing at a minimum of 12 ft (3.66 m) away from the wheel and tire assembly.



**WARNING:** When inflating the tire for mounting pressures up to 20 psi (1.38 bar) greater than the maximum pressure on the tire sidewall, the following precautions must be taken to protect the person mounting the tire:

- Make sure that you have the correct tire and wheel size.
- Lubricate the tire bead and wheel bead seat area again.

# Wheel and Tire Information

- Stand at a minimum of 12 ft (3.66 m) away from the wheel and tire assembly.
- Use both eye and ear protection.

**Important:** Remember to replace the wheel valve stems when the road tires are replaced on your vehicle.

It is recommended that the two front tires or two rear tires generally be replaced as a pair if the worn tires still have usable depth.

To avoid potential Four-Wheel Drive (4WD) malfunction or (4WD) system damage, it is recommended to replace all four tires rather than mixing significantly worn tires with new tires.

The tire pressure sensors mounted in the wheels (originally installed on your vehicle) are not designed to be used in aftermarket wheels.

The use of wheels or tires not recommended may affect the operation of your tire pressure monitoring system.

If the tire pressure monitoring system indicator is flashing, your system is malfunctioning. Your replacement tire might be incompatible with your tire pressure monitoring system, or some component of the system may be damaged.

## USING SNOW CHAINS



**WARNING:** Do not exceed 30 mph (50 km/h). Failure to follow this instruction could result in the loss of control of your vehicle, personal injury or death.



**WARNING:** Do not use snow chains on snow-free roads.



**WARNING:** Only fit snow chains to specified tires.



**WARNING:** If your vehicle is fitted with wheel trims, remove them before fitting snow chains.



**WARNING:** If you choose to install snow tires on your vehicle, they must be the same size, construction, and load range as the original tires listed on the tire placard, and they must be installed on all four wheels. Mixing tires of different size or construction on your vehicle can adversely affect your vehicle's handling and braking, and may lead to loss of vehicle control.



**WARNING:** Wheels and tires must be the same size, load index and speed rating as those originally fitted on the vehicle. Use of any other tire or wheel can affect the safety and performance of your vehicle. Additionally, the use of non-recommended tires and wheels can cause steering, suspension, axle, transfer case or power transfer unit failure. Follow the recommended tire inflation pressures found on the Safety Compliance Certification label, or the Tire Label on the B-Pillar or the edge of the driver door. Failure to follow this instruction could result in loss of vehicle control, vehicle rollover, or personal injury or death.

## Wheel and Tire Information

Only use snow chains on rear wheels. Install snow chains in pairs. Do not use self-tensioning snow chains.

Only use snow chains on the following specified tire sizes. Only install chains that are 15mm or less (SAE Class S chains).

- 245/70R17
- 265/70R17
- LT265/70R17
- 265/60R18
- LT265/70R18

We recommend you use steel wheels of the same size and specification if snow chains are required because chains may chip aluminum wheels.

Follow these guidelines when using snow tires and traction devices:

- If possible, avoid fully loading your vehicle.
- Purchase snow chains from a manufacturer that clearly labels body to tire dimension restrictions.
- When driving with snow chains do not exceed 30 mph (50 km/h) or the maximum speed recommended by the chain manufacturer, whichever is less.
- Drive cautiously. If you hear the snow chains rub or bang against the vehicle, stop and tighten them. If this does not work, remove the snow chains to prevent vehicle damage.
- Remove the snow chains when they are no longer needed. Do not use snow chains on dry roads.
- If a temporary spare wheel is mounted on your vehicle, do not use snow chains on the axle with the temporary spare wheel.

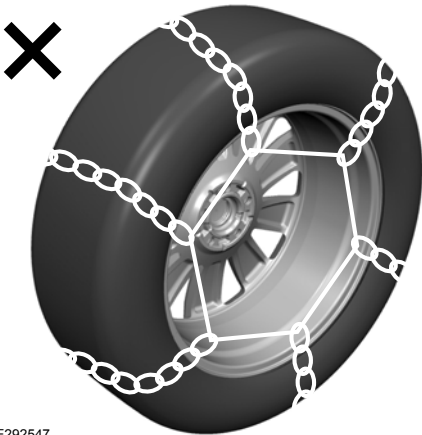

E292547

Use snow chains that fit against the sidewall of the tire to prevent the chains from touching the wheel rims or suspension. Refer to the previous illustration.

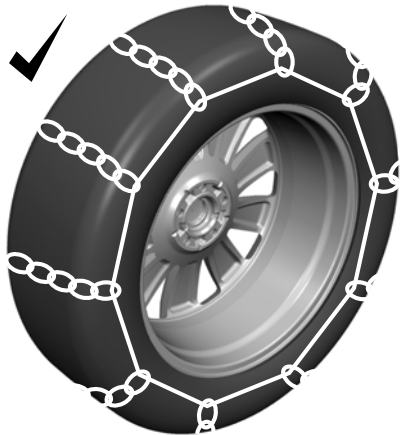

If you have any questions regarding snow chains, please contact your authorized dealer.

# Tire Care

## CHECKING THE TIRE PRESSURES

Safe operation of your vehicle requires that your tires are properly inflated. Remember that a tire can lose up to half of its air pressure without appearing flat. Every day before you drive, check your tires. If one looks lower than the others, use a tire gauge to check the pressure of all tires and adjust if required.

At least once a month and before long trips, inspect each tire and check the tire pressure with a tire gauge (including spare, if equipped). Inflate all tires to the inflation pressure recommended by the manufacturer.

## INFLATING THE TIRES



**WARNING:** Under-inflation is the most common cause of tire failures and may result in severe tire cracking, tread separation or blowout, with unexpected loss of vehicle control and increased risk of injury. Under-inflation increases sidewall flexing and rolling resistance, resulting in heat buildup and internal damage to

the tire. It also may result in unnecessary tire stress, irregular wear, loss of vehicle control and accidents. A tire can lose up to half of its air pressure and not appear to be flat!

Use the recommended cold inflation pressure for optimum tire performance and wear. Under-inflation or over-inflation may cause uneven treadwear patterns.

Always inflate your tires to the recommended inflation pressure even if it is less than the maximum inflation pressure information found on the tire. You will find a Tire Label containing the manufacturer's recommended tire inflation pressure by the tire size and other important information located on the B-Pillar or the edge of the driver door.

The recommended tire inflation pressure is also found on the Safety Compliance Certification Label, affixed to either the door hinge pillar, door-latch post, or the door edge that meets the door-latch on the B-pillar, or on the edge of the driver door.

Failure to follow the tire pressure recommendations can cause uneven treadwear patterns and adversely affect the way your vehicle handles.

# Tire Care

## INSPECTING THE TIRE FOR WEAR



E142546

When the tread is worn down to one sixteenth of an inch (2 mm), tires must be replaced to help prevent your vehicle from skidding and hydroplaning. Built-in treadwear indicators, or wear bars, which look like narrow strips of smooth rubber across the tread will appear on the tire when the tread is worn down to one sixteenth of an inch (2 mm).

When the tire tread wears down to the same height as these wear bars, the tire is worn out and must be replaced.

The tires should also be balanced periodically. An unbalanced tire and wheel assembly may result in irregular tire wear.

Periodically inspect the tire treads for uneven or excessive wear and remove objects such as stones, nails or glass that may be wedged in the tread grooves.

## INSPECTING THE TIRE FOR DAMAGE

Inspect the tire sidewalls for cracking, cuts, bruises and other signs of damage or excessive wear. If internal damage to the tire is suspected, have the tire dismantled and inspected in case it needs to be repaired or replaced. For your safety, tires that are damaged or show signs of excessive wear should not be used because they are more likely to blow out or fail.

Periodically inspect the tire treads and sidewalls for damage, such as bulges in the tread or sidewalls, cracks in the tread groove and separation in the tread or sidewall. If damage is observed or suspected, have the tire inspected by a tire professional.

### Safety Practices



**WARNING:** If your vehicle is stuck in snow, mud or sand, do not rapidly spin the tires; spinning the tires can tear the tire and cause an explosion. A tire can explode in as little as three to five seconds.



**WARNING:** Do not spin the wheels at over 34 mph (55 km/h). The tires may fail and injure a passenger or bystander.

# Tire Care

## Highway Hazards

No matter how carefully you drive, there is always the possibility that you could eventually have a flat tire on the highway. Drive slowly to the closest safe area out of traffic. This could further damage the flat tire, but your safety is more important.

If you feel a sudden vibration or ride disturbance while driving, or you suspect your tire or vehicle has been damaged, immediately reduce your speed. Drive with caution until you can safely pull off the road. Stop and inspect the tires for damage. If a tire is under-inflated or damaged, deflate it, remove the wheel and replace it with your spare tire and wheel. If you cannot detect a cause, have the vehicle towed to the nearest repair facility or tire dealer to have the vehicle inspected.

## Tire and Wheel Alignment

A bad jolt from hitting a curb or pothole can cause the front end of your vehicle to become misaligned or cause damage to your tires. If your vehicle seems to pull to one side when you are driving, the wheels could be out of alignment. Have an authorized dealer check the wheel alignment periodically.

Wheel misalignment in the front or the rear can cause uneven and rapid treadwear of your tires and should be corrected by an authorized dealer.

## INSPECTING THE WHEEL VALVE STEMS

Check the valve stems for holes, cracks, or cuts that could permit air leakage.

## TIRE ROTATION



**WARNING:** If the tire label shows different tire pressures for the front and rear tires and the vehicle has a tire pressure monitoring system, then you need to update the settings for the system sensors. Always perform the system reset procedure after tire rotation. If you do not reset the system, it may not provide a low tire pressure warning when necessary.

Rotating your tires at the recommended interval will help your tires wear more evenly, providing better tire performance and longer tire life.

**Note:** *If your tires show any uneven wear have the alignment checked by an authorized dealer before rotating tires.*

# Tire Care

---

**Note:** *If you have a dissimilar spare wheel and tire assembly, it is intended for temporary use only and should not be used in a tire rotation.*

**Note:** *After having your tires rotated, inflation pressure must be checked and adjusted to the vehicle requirements.*

## Tire Rotation Diagram

Follow the diagram indicating the correct tire locations for rotating the tires.

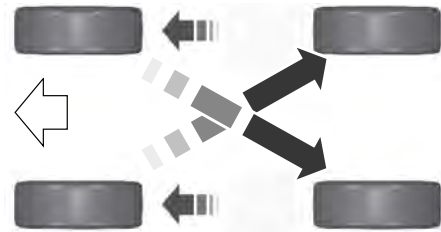

E142548

# Tire Pressure Monitoring System

## WHAT IS THE TIRE PRESSURE MONITORING SYSTEM



The tire pressure monitoring system measures the vehicle's tire pressures. A warning lamp illuminates if one or more tires are significantly underinflated or if there is a system malfunction.

## TIRE PRESSURE MONITORING SYSTEM OVERVIEW



**WARNING:** If the tire pressure monitor sensor becomes damaged it may not function.



**WARNING:** Under-inflation is the most common cause of tire failures and may result in severe tire cracking, tread separation or blowout, with unexpected loss of vehicle control and increased risk of injury. Under-inflation increases sidewall flexing and rolling resistance, resulting in heat buildup and internal damage to the tire. It also may result in unnecessary tire stress, irregular wear, loss of vehicle control and accidents. A tire can lose up to half of its air pressure and not appear to be flat!



**WARNING:** Do not use the tire pressure displayed in the information display as a tire pressure gauge. Failure to follow this instruction could result in personal injury or death.

Each tire, including the spare (if provided), should be checked monthly when cold and inflated to the inflation pressure recommended by the vehicle manufacturer on the vehicle placard or tire inflation pressure label. (If your vehicle has tires of a different size than the size indicated on the vehicle placard or tire inflation pressure label, you should determine the proper tire inflation pressure for those tires).

As an added safety feature, your vehicle has been equipped with a Tire Pressure Monitoring System (TPMS) that illuminates a low tire pressure telltale when one or more of your tires is significantly under-inflated. Accordingly, when the low tire pressure telltale illuminates, you should stop and check your tires as soon as possible, and inflate them to the proper pressure. Driving on a significantly under-inflated tire causes the tire to overheat and can lead to tire failure. Under-inflation also reduces fuel efficiency and tire tread life, and may affect the vehicle's handling and stopping ability.

Please note that the TPMS is not a substitute for proper tire maintenance, and it is the driver's responsibility to maintain correct tire pressure, even if under-inflation has not reached the level to trigger illumination of the TPMS low tire pressure telltale.

Your vehicle has also been equipped with a TPMS malfunction indicator to indicate when the system is not operating properly. The TPMS malfunction indicator is combined with the low tire pressure telltale. When the system detects a malfunction, the telltale will flash for approximately one minute and then remain continuously illuminated. This sequence will continue upon subsequent vehicle start-ups as long as the malfunction exists.



# Tire Pressure Monitoring System

When the malfunction indicator is illuminated, the system may not be able to detect or signal low tire pressure as intended. TPMS malfunctions may occur for a variety of reasons, including the installation of replacement or alternate tires or wheels on the vehicle that prevent the TPMS from functioning properly. Always check the TPMS malfunction telltale after replacing one or more tires or wheels on your vehicle to ensure that the replacement or alternate tires and wheels allow the TPMS to continue to function properly.



**WARNING:** Changes or modifications not expressly approved by the party responsible for compliance could void the user's authority to operate the equipment. The term "IC:" before the radio certification number only signifies that Industry Canada technical specifications were met.

This device complies with Part 15 of the FCC Rules and with License exempt RSS Standards of Industry Canada. Operation is subject to the following two conditions:

1. This device may not cause harmful interference, and
2. This device must accept any interference received, including interference that may cause undesired operation.

## TIRE PRESSURE MONITORING SYSTEM PRECAUTIONS



**WARNING:** The tire pressure monitoring system is not a substitute for manually checking tire pressures. You should periodically check tire pressures using a pressure gauge. Failure to correctly maintain tire pressures could increase the risk of tire failure, loss of control, vehicle rollover and personal injury.



**WARNING:** Do not use the tire pressure displayed in the information display as a tire pressure gauge. Failure to follow this instruction could result in personal injury or death.

**Note:** *The use of tire sealants can damage the tire pressure monitoring system.*

## TIRE PRESSURE MONITORING SYSTEM LIMITATIONS

When the outside temperature drops significantly, the tire pressure could decrease and activate the low tire pressure warning lamp.

The warning lamp could also illuminate when you use a spare wheel, or tire sealant from the inflator kit.

**Note:** *Regularly checking the vehicle tire pressures can reduce the possibility for the warning lamp to illuminate due to outside air temperature changes.*

**Note:** *After you inflate the tires to the recommended pressure it could take up to two minutes of driving over 20 mph (32 km/h) for the warning indicator to turn off.*

# Tire Pressure Monitoring System

## VIEWING THE TIRE PRESSURES

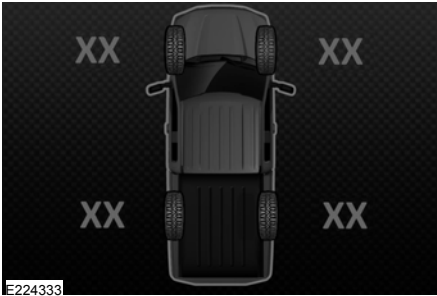

Using the information display arrow keys navigate to the truck info section where you can view the tire pressures.

## RESETTING TIRE PRESSURE MONITORING SYSTEM

### Tire Pressure Monitoring System Reset Procedure



**WARNING:** To determine the required pressure(s) for your vehicle, see the Safety Compliance Certification Label (on the door hinge pillar, door-latch post or the door edge that meets the door-latch post, next to the driver seat) or the Tire Label on the B-Pillar or the edge of the driver door.

You must reset the tire pressure monitoring system after each tire rotation on vehicles that require different recommended tire pressures in the front tires as compared to the rear tires.

**Note:** To reduce the chances of interference from another vehicle, perform the system reset procedure at least three feet, one meter, away from another vehicle undergoing the system reset procedure at the same time.

**Note:** Do not wait more than two minutes between resetting each tire sensor or the system can time-out and you need to repeat the entire procedure on all four wheels.

1. Drive the vehicle above 20 mph (32 km/h) for at least two minutes, then park in a safe location where you can easily get to all four tires and have access to an air pump.
2. Switch the ignition off.
3. Switch the ignition on but do not start the engine.
4. Switch the hazard flashers on then off three times.

**Note:** You must accomplish this within 10 seconds. If you successfully enter the reset mode, the horn sounds once, the system indicator flashes and a message shows in the information display.

# Tire Pressure Monitoring System

**Note:** *If the system does not enter reset mode, try again starting at Step 2. If after repeated attempts to enter the reset mode, the horn does not sound, the system indicator does not flash and no message shows in the information display, contact your authorized dealer.*

5. Remove the valve cap from the valve stem on the left front tire. Decrease the air pressure until the horn sounds.

**Note:** *The single horn tone confirms that the sensor identification code has been learned by the module for this position. If the horn sounds twice, the reset procedure was unsuccessful, and you must repeat it.*

6. Remove the valve cap from the valve stem on the right front tire. Decrease the air pressure until the horn sounds.
7. Repeat the previous step on the right rear tire and then on the left rear tire.
8. Switch the ignition off.

**Note:** *If the horn sounds twice again after switching the ignition off, and repeating the procedure, contact your authorized dealer and have your vehicle checked as soon as possible.*

9. Set all four tires to the recommended air pressure as indicated on the Safety Compliance Certification Label.

## Trailer Tire Pressure Monitoring System (If Equipped)

**Note:** *Additional equipment may be required for your vehicle to support trailer tire pressure and temperature monitoring. See your authorized dealer for more information.*

**Note:** *The trailer tire pressure monitoring system is not a substitute for proper tire maintenance. It is your responsibility to maintain correct tire pressures at all times.*

**Note:** *If a trailer tire is repaired, replaced or broken down for service, the screw and valve on the trailer tire pressure sensor should be replaced. See your authorized dealer for details.*

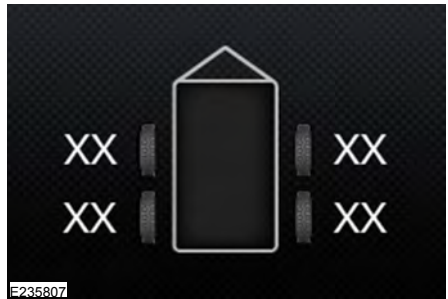

The trailer tire pressure monitoring system is an added safety feature that allows you to view your trailer tire pressures and temperatures through the information display. See **Tire Pressure Monitoring System – Information Messages** (page 515). Tire

# Tire Pressure Monitoring System

---

pressure sensors are mounted into each tire on your trailer. The sensors send a message to your vehicle indicating the current trailer tire pressure and temperature.

If the trailer tire pressure monitoring system detects that a tire is low, a warning message appears in the information display. The trailer tire information screen in the information display highlights the tire with a low pressure.

If the trailer tire pressure monitoring system detects that a tire temperature is over temp, a warning message appears in the Information display. The trailer tire information screen in the information display highlights the tire with a high temperature.

The main function of the trailer tire pressure monitoring system is to warn you when your trailer tires need air or if the tires are experiencing high temperatures. It can also warn you in the event the system is no longer capable of functioning as intended. See

**Tire Pressure Monitoring System – Information Messages** (page 515).

## **When a Temporary Spare or New Tire is Installed**

If you have replaced a trailer tire with a new or spare tire, a warning message appears and pressure readings are no longer displayed for that tire.

To restore the full function of the trailer tire pressure monitoring system:

- Have the damaged wheel and tire assembly repaired and remounted to your trailer.
- Install the trailer tire pressure monitoring sensor into the new wheel and tire assembly.
- Perform the trailer tire pressure monitoring system reset procedure.

## **Trailer Tire Pressure Monitoring System Reset Procedure**

**Note:** *You need to perform the tire pressure monitoring system reset procedure after each tire rotation, or when a new trailer tire pressure sensor is installed into a trailer tire.*

The trailer tire pressure monitoring system can be reset through the menu in the information display. See **Tire Pressure Monitoring System – Information Messages** (page 515). Performing the trailer setup process also resets the trailer tire pressure monitoring system.

# Tire Pressure Monitoring System

## TIRE PRESSURE MONITORING SYSTEM – TROUBLESHOOTING



The low tire pressure warning lamp has combined functions, as it warns you when your tires need air, and when the system is no longer capable of functioning as intended.

### Tire Pressure Monitoring System – Warning Lamps

Warning Lamp	Possible Cause	Action Required
Solid warning lamp	One or more tires are significantly under inflated	After inflating your tires to the manufacturer's recommended pressure as shown on the Tire Label, on the edge of driver door or the B-Pillar, drive your vehicle for at least two minutes over 20 mph (32 km/h) before the light turns off.
	Tire rotation without sensor training	On vehicles with different front and rear tire pressures, the system must be retrained following every tire rotation.
Solid warning lamp or flashing warning lamp	Temporary spare wheel in use	Repair the damaged road wheel and tire and refit it to your vehicle to restore operation of the system.
	Tire pressure monitoring system malfunction	If the tires are inflated to the recommended tire pressures and the temporary spare wheel is not in use, the system detected a fault that requires service. Have your vehicle checked as soon as possible.

# Tire Pressure Monitoring System

## Tire Pressure Monitoring System – Information Messages

Message	Action
Tire Pressure Low	After inflating your tires to the manufacturer's recommended pressure as shown on the Tire Label, on the edge of the driver door or the B-Pillar, drive your vehicle for at least two minutes over 20 mph (32 km/h) before the light turns off.
Tire Pressure Monitor Fault	The system has detected a fault that requires service. Have your vehicle checked as soon as possible.
Tire Pressure Sensor Fault	The system has detected a fault that requires service or a spare tire is in use. Have your vehicle checked as soon as possible.

## Trailer Tire Pressure Monitoring System

Message	Action
Trailer Tire Low Specified:	One or more tires on your trailer is below the specified tire pressure.
Trailer Tire Over Temperature	Displays when one or more tires on your trailer is above the recommended temperature.
Trailer Tire Pressure Sensor Fault	A trailer tire pressure sensor is malfunctioning. If the warning stays on or continues to come on, contact an authorized dealer as soon as possible.
Trailer Tire Pressure Monitor Fault	The trailer tire pressure monitoring system is malfunctioning. If the warning stays on or continues to come on, contact an authorized dealer.
Trailer Tire Pressure Monitor Capability Not Detected	The system cannot detect the trailer tire pressure monitoring system.
Trailer Tire Pressure Indication Not Setup See Manual	The trailer tire pressure monitoring system is not setup. See <b>Tire Pressure Monitoring System</b> (page 509).

# Changing a Road Wheel

## CHANGING A FLAT TIRE



**WARNING:** If the tire pressure monitor sensor becomes damaged it may not function.

**Note:** *The use of tire sealant may damage your tire pressure monitoring system and should only be used in roadside emergencies.*

**Note:** *The tire pressure monitoring system indicator light illuminates when the spare tire is in use. To restore the full function of the monitoring system, all road wheels equipped with tire pressure monitoring sensors must be mounted on this vehicle.*

If you get a flat tire when driving, do not apply the brake heavily. Instead, gradually decrease your speed. Hold the steering wheel firmly and slowly move to a safe place on the side of the road.

Have a flat serviced by an authorized dealer to prevent damage to the system sensors. See **Tire Pressure Monitoring System Precautions** (page 510). Replace the spare tire with a road tire as soon as possible. During repairing or replacing the flat tire, have the authorized dealer inspect the system sensor for damage.

## Dissimilar Spare Wheel and Tire Assembly Information



**WARNING:** Failure to follow these guidelines could result in an increased risk of loss of vehicle control, injury or death.

If you have a dissimilar spare wheel and tire, then it is intended for temporary use only. This means that if you need to use it, you should replace it as soon as possible with a road wheel and tire assembly that is the same size and type as the road tires and wheels that were originally provided by Ford.

A dissimilar spare wheel and tire assembly is defined as a spare wheel and tire assembly that is different in brand, size or appearance from the road tires and wheels.

### Full-size dissimilar spare

When driving with the full-size dissimilar spare wheel and tire assembly, do not:

- Exceed 70 mph (113 km/h).
- Use more than one dissimilar spare wheel and tire assembly at a time.
- Use snow chains on the end of the vehicle with the dissimilar spare wheel and tire assembly.

When driving with the full-size dissimilar spare wheel and tire assembly, four-wheel drive functionality may be limited, especially when driving in a mechanically locked four-wheel drive mode. You may experience the following:

- Additional noise from the transfer case or other drive components.
- Difficulty shifting out of a mechanically locked four-wheel drive mode.

When driving with the full-size dissimilar spare wheel and tire assembly, it is recommended that you do not:

- Exceed 50 mph (80 km/h) in four-wheel drive.
- Engage four-wheel drive unless the vehicle is stationary.
- Use four-wheel drive on dry pavement.

# Changing a Road Wheel

The usage of a full-size dissimilar spare wheel and tire assembly can lead to impairment of the following:

- Handling, stability and braking performance.
- Comfort and noise.
- Ground clearance and parking at curbs.
- Winter weather driving capability.
- Wet weather driving capability.
- Four-wheel drive capability.

When driving with the full-size dissimilar spare wheel and tire assembly additional caution should be given to:

- Towing a trailer.
- Driving vehicles equipped with a camper body.
- Driving vehicles with a load on the cargo rack.

Drive cautiously when using a full-size dissimilar spare wheel and tire assembly and seek service as soon as possible.

## Tire Change Procedure

 **WARNING:** To help prevent your vehicle from moving when changing a wheel, shift the transmission into park (P), set the parking brake and use an appropriate block or wheel chock to secure the wheel diagonally opposite to the wheel being changed. For example, when changing the front left wheel, place an appropriate block or wheel chock on the right rear wheel.

 **WARNING:** Do not work on your vehicle when the jack is the only support as your vehicle could slip off the jack. Failure to follow this instruction could result in personal injury or death.

 **WARNING:** Do not attempt to change a tire on the side of the vehicle close to moving traffic. Pull far enough off the road to avoid the danger of being hit when operating the jack or changing the wheel.

 **WARNING:** Always use the jack provided as original equipment with your vehicle. If using a jack other than the one provided, make sure the jack capacity is adequate for the vehicle weight, including any vehicle cargo or modifications. If you are unsure if the jack capacity is adequate, contact the authorized dealer.

 **WARNING:** Do not get under a vehicle that is only supported by a vehicle jack.

 **WARNING:** The jack supplied with this vehicle is only intended for changing wheels. Do not use the vehicle jack other than when you are changing a wheel in an emergency.

 **WARNING:** The jack should be used on level firm ground wherever possible.

 **WARNING:** Check that the vehicle jack is not damaged or deformed and the thread is lubricated and clean.

 **WARNING:** Never place anything between the vehicle jack and the ground.

 **WARNING:** Never place anything between the vehicle jack and your vehicle.

 **WARNING:** It is recommended that the wheels of the vehicle be chocked, and that no person should remain in a vehicle that is being jacked.



# Changing a Road Wheel



**WARNING:** Switch off the running boards before jacking or placing any object under your vehicle. Never place your hand between the extended running board and your vehicle. A moving running board may cause injury.

**Note:** Only use the spare tire carrier to stow the tire and wheel combination provided with your vehicle. Other tire and wheel combinations can cause the tire carrier to fail.

**Note:** Do not use impact tools or power tools operating at over 200 RPM on the spare tire carrier, this could cause a winch malfunction and prevent a secure fit. Override the winch at least three times, there's an audible click each time, to make sure the wheel and tire have been tightened securely.

**Note:** Passengers should not remain in the vehicle when the vehicle is being jacked.

Park on a level surface, activate the hazard flashers and set the parking brake. Then, place the transmission in park (P) and turn the engine off.

## Removing the Vehicle Jack and Tool Bag

The vehicle jack and tool bag are on the rear passenger side of your vehicle, behind the passenger seat.

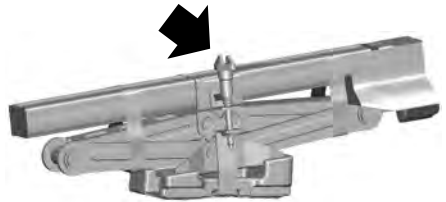

1. Turn the wing bolt on the jack bracket counterclockwise to release the jack and tool bag from the jack bracket.

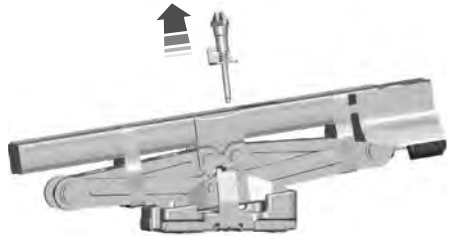

2. Remove the jack and tool bag from the jack bracket.

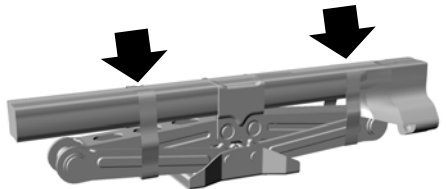

3. Release the jack tool bag straps.

# Changing a Road Wheel

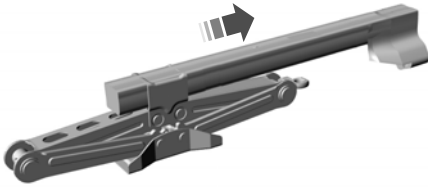

4. Slide the jack tool bag through the jack load rest to remove for access to the jack tools.

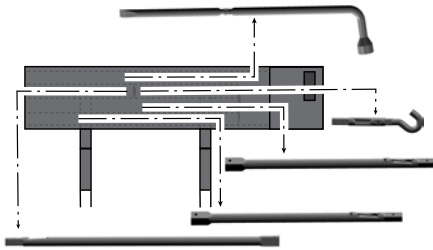

5. Remove the tools from the tool bag.  
**Note:** Your jack does not require maintenance or additional lubrication over the service life of your vehicle.

## Removing the Spare Tire

**Note:** Remove the hook end from the assembled jack handle before continuing.

The spare tire is located under the vehicle, just forward of the rear bumper.

1. Use your key to remove the lock cylinder from the access hole of the bumper to allow access to the guide tube.

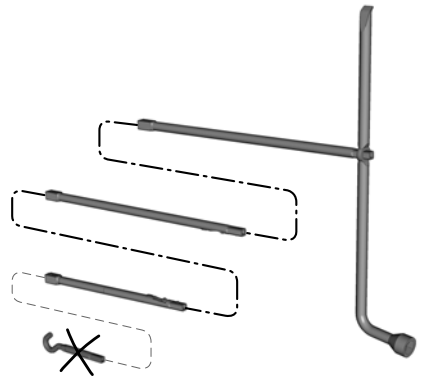

E188735

2. Assemble the jack handle as shown in the illustration.

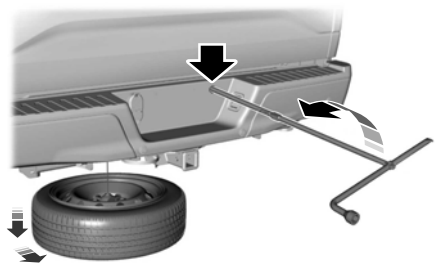

E184020

3. Fully insert the jack handle through the bumper hole and into the guide tube through the access hole in the rear bumper. Turn the handle counterclockwise until the tire is lowered to the ground and the cable is slightly slack to allow the tire to be slid rearward from under the vehicle.
4. Remove the retainer from the center of the wheel.

# Changing a Road Wheel

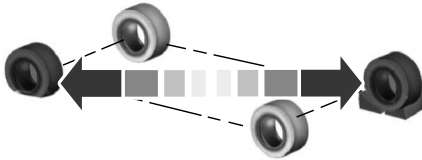

5. Block both the front and rear of the wheel diagonally opposite the flat tire. For example, if the left front tire is flat, block the right rear wheel.
6. Obtain the spare tire and vehicle jack from their storage locations.
7. Loosen each wheel nut on the affected flat tire one-half turn counterclockwise, but do not remove them.

## Jacking the Vehicle

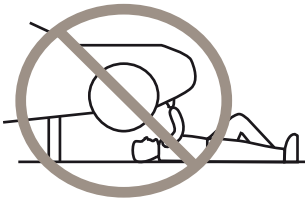

## Front Jacking Points

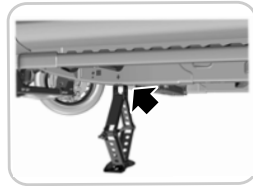
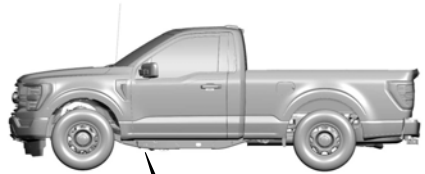

**Note:** Use the frame rail as the front jacking location point, not the control arm. The frame rail is marked with an arrow.

## Rear Jacking Points



**Note:** Jack at the specified locations to avoid damage to the vehicle.

# Changing a Road Wheel

1. Place the vehicle jack at the jacking point next to the tire you are changing. Turn the jack handle clockwise until the wheel is completely off the ground.
2. Remove the wheel nuts with the lug wrench.
3. Replace the flat tire with the spare tire, making sure the valve stem is facing outward. Reinstall the wheel nuts until the wheel is snug against the hub. Do not fully tighten the wheel nuts until the wheel has been lowered.
4. Lower the wheel by turning the jack handle counterclockwise.
5. Remove the vehicle jack and fully tighten the wheel nuts in the order shown.
6. Stow the flat tire. See the Stowing the Flat or Spare Tire.
7. Stow the vehicle jack and lug wrench. Make sure the jack is securely fastened before you drive. See Stowing the Vehicle Jack and Tool Bag.
8. Unblock the wheels.



E166719

## Stowing the Flat or Spare Tire

**Note:** Failure to follow the spare tire stowage instructions could result in failure of the cable or loss of the spare tire.

1. Lay the tire on the ground with the valve stem facing up.

2. Slide the wheel partially under the vehicle and install the retainer through the wheel center. Pull on the cable to align the components at the end of the cable.
3. Turn the jack handle clockwise until the tire is raised to its stowed position underneath the vehicle. The effort to turn the jack handle increases significantly and the spare tire carrier ratchets or slips when the tire is raised to the maximum tightness. Tighten to the best of your ability, to the point where the ratchet or slip occurs, if possible. The spare tire carrier does not allow you to overtighten. If the spare tire carrier ratchets or slips with little effort, contact your authorized dealer.
4. Check that the tire lies flat against the frame and is properly tightened. Try to push or pull, then turn the tire to be sure it does not move. Loosen and retighten, if necessary. Failure to properly stow the spare tire could result in failure of the winch cable and loss of the tire.
5. Repeat this tightness check procedure when servicing the spare tire pressure, every six months, as per your scheduled maintenance information, or at any time that the spare tire is disturbed through service of other components.
6. If removed, install the spare tire lock into the bumper drive tube with the spare tire lock key and jack handle.

# Changing a Road Wheel

## Stowing the Vehicle Jack and Tool Bag

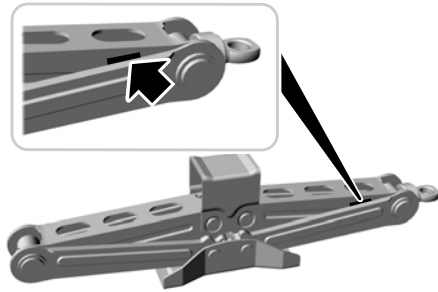

1. Turn the lead screw eyelet to adjust the jack up or down until the stowage markings on the upper channel align with the lower channel.

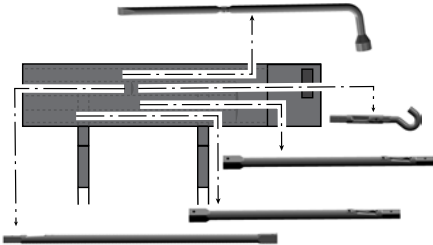

2. Place the tools inside of the tool bag.

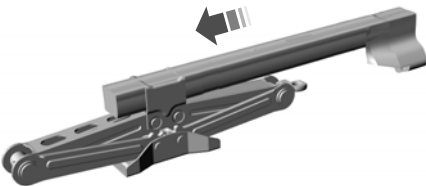

3. Install the tool bag through the vehicle jack load rest.

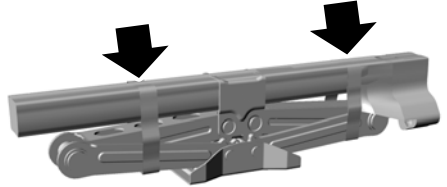

4. Secure the jack tool bag straps around the vehicle jack.

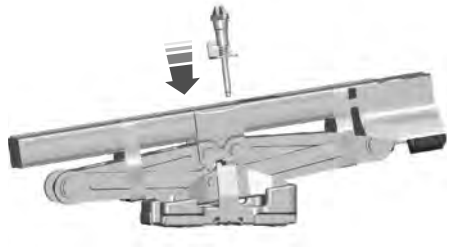

5. Place the jack and tool bag back onto the jack bracket.

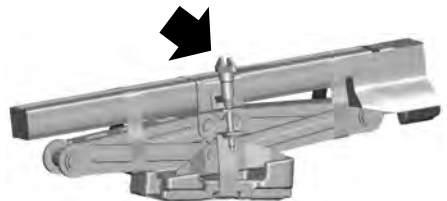

# Changing a Road Wheel

- Turn the wing bolt on the jack bracket clockwise until the jack and tools are secured to the jack bracket.

## WHEEL NUTS



**WARNING:** When you install a wheel, always remove any corrosion, dirt or foreign materials present on the mounting surfaces of the wheel or the surface of the wheel hub, brake drum or brake disc that contacts the wheel. Make sure to secure any fasteners that attach the rotor to the hub so they do not interfere with the mounting surfaces of the wheel. Installing wheels without correct metal-to-metal contact at the wheel mounting surfaces can cause the wheel nuts to loosen and the wheel to come off while your vehicle is in motion, resulting in loss of vehicle control, personal injury or death.

Bolt Size	lb.ft (Nm) <sup>1</sup>
M14 x 1.5	150 lb.ft (204 Nm)

<sup>1</sup> Torque specifications are for nut and bolt threads free of dirt and rust. Use only our recommended replacement wheel nuts and or wheel bolts.

Retighten the wheel nuts to the specified torque within 100 mi (160 km) after any wheel disturbance, such as tire rotation, changing a flat tire or wheel removal.



A Hub pilot bore.

Inspect the wheel pilot hole and mounting surface prior to installation. Remove any visible corrosion or loose particles.

# Capacities and Specifications

---

## ENGINE SPECIFICATIONS - 2.7L ECOBOOST™

<b>Engine</b>	<b>Specification</b>
Compression ratio.	10.0:1
Displacement.	165 in <sup>3</sup> (2,700 cm <sup>3</sup> )
Firing order.	1-4-2-5-3-6
Ignition system.	Coil on plug
Required fuel.	Minimum 87 octane
Spark plug gap.	0.028 in (0.7 mm) - 0.031 in (0.8 mm)

# Capacities and Specifications

---

## ENGINE SPECIFICATIONS - 3.0L DIESEL

<b>Engine</b>	<b>Specification</b>
Compression ratio.	16:1
Displacement.	183 in <sup>3</sup> (3,000 cm <sup>3</sup> )
Firing order.	1-4-2-5-3-6
Required fuel.	Ultra Low Sulfur Diesel



# Capacities and Specifications

---

## ENGINE SPECIFICATIONS - 3.3L

<b>Engine</b>	<b>Specification</b>
Compression ratio.	12:1
Displacement.	203.8 in <sup>3</sup> (3,340 cm <sup>3</sup> )
Firing order.	1-4-2-5-3-6
Ignition system.	Coil on plug
Required fuel.	Minimum 87 octane
Spark plug gap.	0.049 in (1.25 mm) - 0.053 in (1.35 mm)

# Capacities and Specifications

---

## ENGINE SPECIFICATIONS - 3.5L ECOBOOST™

<b>Engine</b>	<b>Specification</b>
Compression ratio.	10.5:1
Displacement.	213.4 in <sup>3</sup> (3,497 cm <sup>3</sup> )
Firing order.	1-4-2-5-3-6
Ignition system.	Coil on plug
Required fuel.	Minimum 87 octane
Spark plug gap.	0.028 in (0.7 mm) - 0.031 in (0.8 mm)

# Capacities and Specifications

---

## ENGINE SPECIFICATIONS - 3.5L, HYBRID ELECTRIC VEHICLE (HEV)

<b>Engine</b>	<b>Specification</b>
Compression ratio.	10.5:1
Displacement.	213.4 in <sup>3</sup> (3,497 cm <sup>3</sup> )
Firing order.	1-4-2-5-3-6
Ignition system.	Coil on plug
Required fuel.	Minimum 87 octane
Spark plug gap.	0.028 in (0.7 mm) - 0.031 in (0.8 mm)

# Capacities and Specifications

---

## ENGINE SPECIFICATIONS - 5.0L

<b>Engine</b>	<b>Specification</b>
Compression ratio.	12:1
Displacement.	307 in <sup>3</sup> (5,038 cm <sup>3</sup> )
Firing order.	1-3-7-2-6-5-4-8
Ignition system.	Coil on plug, coil near plug
Required fuel.	Minimum 87 octane
Spark plug gap.	0.039 in (1 mm) - 0.043 in (1.1 mm)

## Capacities and Specifications

---

### MOTORCRAFT PARTS - 2.7L ECOBOOST™

Component	Motorcraft Part Number
Air filter element.	FA-1883
Battery.	BAGM-48H6-760
Cabin air filter.	FP-79
Engine oil filter. <sup>1</sup>	FL-2062
Spark plug.	SP-578
Windshield wiper blade.	WW-2248

<sup>1</sup> If a Motorcraft oil filter is not available, use an oil filter that meets industry performance specification SAE/USCAR-36.

We recommend Motorcraft parts that are available at your authorized dealer or at [www.fordparts.com](http://www.fordparts.com). We engineer these parts for your vehicle to meet or exceed our specifications. Use of other parts could impact vehicle performance, emissions and durability. Your warranty could be void for any damage related to use of other parts.

# Capacities and Specifications

---

## MOTORCRAFT PARTS - 3.0L DIESEL

<b>Component</b>	<b>Motorcraft Part Number</b>
Air filter element.	FA-1883
Battery.	BAGM-49H8
Cabin air filter.	FP-79
Engine oil filter. <sup>1</sup>	FL-2081
Fuel filter.	FD-4627
Glow plug.	ZD-22
Windshield wiper blade.	WW-2248

<sup>1</sup> If a Motorcraft oil filter is not available, use an oil filter that meets industry performance specification SAE/USCAR-36.

We recommend Motorcraft parts that are available at your authorized dealer or at [www.fordparts.com](http://www.fordparts.com). We engineer these parts for your vehicle to meet or exceed our specifications. Use of other parts could impact vehicle performance, emissions and durability. Your warranty could be void for any damage related to use of other parts.

# Capacities and Specifications

---

## MOTORCRAFT PARTS - 3.3L

<b>Component</b>	<b>Motorcraft Part Number</b>
Air filter element.	FA-1883
Battery.	BAGM-48H6-760
Cabin air filter.	FP-79
Engine oil filter. <sup>1</sup>	FL-500-S
Spark plug.	SP-520
Windshield wiper blade.	WW-2248

<sup>1</sup> If a Motorcraft oil filter is not available, use an oil filter that meets industry performance specification SAE/USCAR-36.

We recommend Motorcraft parts that are available at your authorized dealer or at [www.fordparts.com](http://www.fordparts.com). We engineer these parts for your vehicle to meet or exceed our specifications. Use of other parts could impact vehicle performance, emissions and durability. Your warranty could be void for any damage related to use of other parts.

# Capacities and Specifications

---

## MOTORCRAFT PARTS - 3.5L ECOBOOST™

<b>Component</b>	<b>Motorcraft Part Number</b>
Air filter element.	FA-1883
Battery-standard.	BAGM-48H6-760
Battery-optional.	BAGM-94RH7-800
Cabin air filter.	FP-79
Engine oil filter. <sup>1</sup>	FL-500-S
Spark plug.	SP-578
Windshield wiper blade.	WW-2248

<sup>1</sup>If a Motorcraft oil filter is not available, use an oil filter that meets industry performance specification SAE/USCAR-36.

We recommend Motorcraft parts that are available at your authorized dealer or at [www.fordparts.com](http://www.fordparts.com). We engineer these parts for your vehicle to meet or exceed our specifications. Use of other parts could impact vehicle performance, emissions and durability. Your warranty could be void for any damage related to use of other parts.



## Capacities and Specifications

---

### MOTORCRAFT PARTS - 3.5L, HYBRID ELECTRIC VEHICLE (HEV)

<b>Component</b>	<b>Motorcraft Part Number</b>
Air filter element.	FA-1883
Battery-standard.	BAGM-94RH7-800
Cabin air filter.	FP-79
Engine oil filter. <sup>1</sup>	FL-500-S
Spark plug.	SP-578
Windshield wiper blade.	WW-2248

<sup>1</sup> If a Motorcraft oil filter is not available, use an oil filter that meets industry performance specification SAE/USCAR-36.

We recommend Motorcraft parts that are available at your authorized dealer or at [www.fordparts.com](http://www.fordparts.com). We engineer these parts for your vehicle to meet or exceed our specifications. Use of other parts could impact vehicle performance, emissions and durability. Your warranty could be void for any damage related to use of other parts.

# Capacities and Specifications

---

## MOTORCRAFT PARTS - 5.0L

<b>Component</b>	<b>Motorcraft Part Number</b>
Air filter element.	FA-1883
Battery-standard.	BAGM-48H6-760
Battery-optional.	BAGM-94RH7-800
Cabin air filter.	FP-79
Engine oil filter. <sup>1</sup>	FL-500-S
Spark plug.	SP-588
Windshield wiper blade.	WW-2248

<sup>1</sup>If a Motorcraft oil filter is not available, use an oil filter that meets industry performance specification SAE/USCAR-36.

We recommend Motorcraft parts that are available at your authorized dealer or at [www.fordparts.com](http://www.fordparts.com). We engineer these parts for your vehicle to meet or exceed our specifications. Use of other parts could impact vehicle performance, emissions and durability. Your warranty could be void for any damage related to use of other parts.

# Capacities and Specifications

## ENGINE OIL CAPACITY AND SPECIFICATION - 2.7L ECOBOOST™

Use oil that meets the defined specification and viscosity grade.

If you do not use oil that meets the defined specification and viscosity grade, it could result in:

- Component damage that your vehicle warranty does not cover.
- Longer engine cranking periods.
- Increased emission levels.
- Reduced vehicle performance.
- Reduced fuel economy.



E142732

An oil that displays this symbol conforms to current engine, emission system and fuel economy performance standards of ILSAC.

We recommend Motorcraft motor oil for your vehicle. If Motorcraft oil is not available, use motor oils of the recommended viscosity grade that meet API SP requirements and display the API Certification Mark for gasoline engines.

Do not use supplemental engine oil additives because they are unnecessary and could lead to engine damage that your vehicle warranty does not cover.

### Capacities

Variant	Including the Oil Filter
All.	6.0 qt (5.7 L)

### Materials

Name	Specification
Motorcraft® SAE 5W-30 Synthetic Blend Motor Oil(U.S.) Motorcraft® SAE 5W-30 Super Premium Motor Oil / Huile moteur de très haute qualité SAE 5W-30 Motorcraft®(Canada) XO-5W30-Q1SP(U.S.) CXO-5W30-LSP6(Canada)	WSS-M2C961-A1

# Capacities and Specifications

## Alternative Engine Oil for Extremely Cold Climates

use the following engine oil in climates where the ambient temperature reaches  $-22.0^{\circ}\text{F}$  ( $-30^{\circ}\text{C}$ ) or below.

To improve engine cold start performance,

### Materials

Name	Specification
Engine Oil - SAE 0W-30 - Synthetic Blend	WSS-M2C963-A1

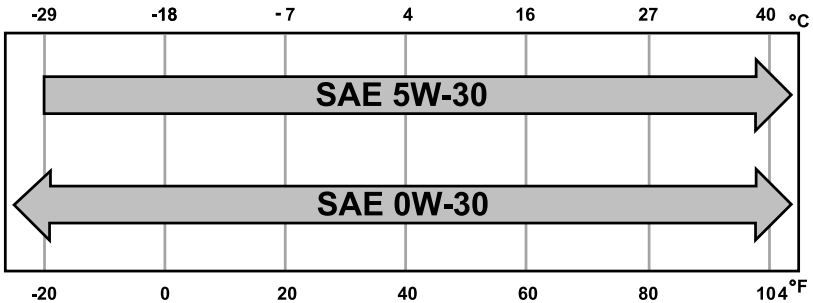

## ENGINE OIL CAPACITY AND SPECIFICATION - 3.0L DIESEL

Use oil that meets the defined specification and viscosity grade.

If you do not use oil that meets the defined specification and viscosity grade, it could result in:

- Component damage that your vehicle warranty does not cover.
- Longer engine cranking periods.
- Increased emission levels.
- Reduced vehicle performance.
- Reduced fuel economy.

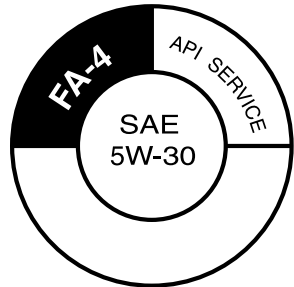

E258300

The American Petroleum Institute (API) service symbol is used to identify the proper engine oil for your engine. The API service symbol will be displayed on the oil container you purchase. The API symbol displays the oil performance category in the top half of symbol and the viscosity grade in the center of the symbol.

# Capacities and Specifications

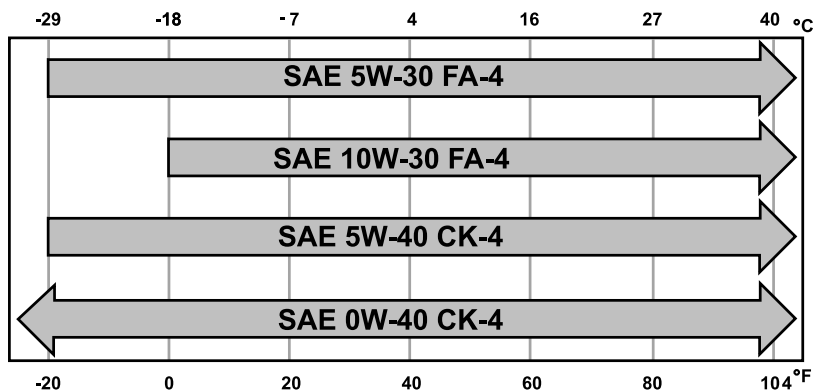

The use of correct oil viscosities for diesel engines is important for satisfactory operation. Determine which oil viscosity best suits the temperature range you expect to encounter for the next service interval from the following SAE viscosity grade chart.

Do not use supplemental engine oil additives because they are unnecessary and could lead to engine damage that your vehicle warranty does not cover.

**Note:** We recommend an engine block heater at temperatures below  $-9^{\circ}\text{F}$  ( $-23^{\circ}\text{C}$ ).

## Capacities

Variant	Including the Oil Filter
All.	6.5 qt (6.15 L)

## Materials

Name	Specification
Motorcraft® SAE 5W-30 F-150 Diesel Motor Oil(U.S.) Motorcraft® SAE 5W-30 F-150 Diesel Motor Oil / Huile moteur diesel F-150 SAE 5W-30 Motorcraft®(Canada) XO-5W30-QFA(U.S. & Canada)	WSS-M2C214-B1

# Capacities and Specifications

## Alternative Engine Oil for Extremely Cold Climates

use the following engine oil in climates where the ambient temperature reaches -22.0°F (-30°C) or below.

To improve engine cold start performance,

### Materials

Name	Specification
Engine Oil - SAE 0W-40	WSS-M2C171-F1

## Alternative Engine Oil for Biodiesel Fuel Blends (B20 Max)

### Materials

Name	Specification
Motorcraft® SAE 5W-40 Full Synthetic Diesel Motor Oil (U.S.) (Canada) XO-5W40-5Q3SD (U.S.)	WSS-M2C171-F1

## Alternative Engine Oil for Severe Duty Service

### Materials

Name	Specification
Motorcraft® SAE 5W-40 Full Synthetic Diesel Motor Oil (U.S.) (Canada) XO-5W40-5Q3SD (U.S.)	WSS-M2C171-F1

## ENGINE OIL CAPACITY AND SPECIFICATION - 3.3L

Use oil that meets the defined specification and viscosity grade.

If you do not use oil that meets the defined specification and viscosity grade, it could result in:

- Component damage that your vehicle warranty does not cover.
- Longer engine cranking periods.
- Increased emission levels.
- Reduced vehicle performance.
- Reduced fuel economy.

# Capacities and Specifications



E142732

An oil that displays this symbol conforms to current engine, emission system and fuel economy performance standards of ILSAC.

We recommend Motorcraft motor oil for your vehicle. If Motorcraft oil is not available, use motor oils of the recommended viscosity grade that meet API SP requirements and display the API Certification Mark for gasoline engines.

Do not use supplemental engine oil additives because they are unnecessary and could lead to engine damage that your vehicle warranty does not cover.

## Capacities

Variant	Including the Oil Filter
All.	6.0 qt (5.7 L)

## Materials

Name	Specification
Motorcraft® SAE 5W-20 Synthetic Blend Motor Oil(U.S.) Motorcraft® SAE 5W-20 Super Premium Motor Oil / Huile moteur de très haute qualité SAE 5W-20 Motorcraft®(Canada) XO-5W20-Q1SP(U.S.) CXO-5W20-LSP6(Canada)	WSS-M2C960-A1

## Alternative Engine Oil for Extremely Cold Climates

To improve engine cold start performance, use the following engine oil in climates where the ambient temperature reaches -22.0°F (-30°C) or below.

# Capacities and Specifications

## Materials

Name	Specification
Motorcraft® SAE 0W-20 Synthetic Blend Motor Oil (U.S.) (Canada) XO-0W20-Q1SP (U.S.)	WSS-M2C962-A1

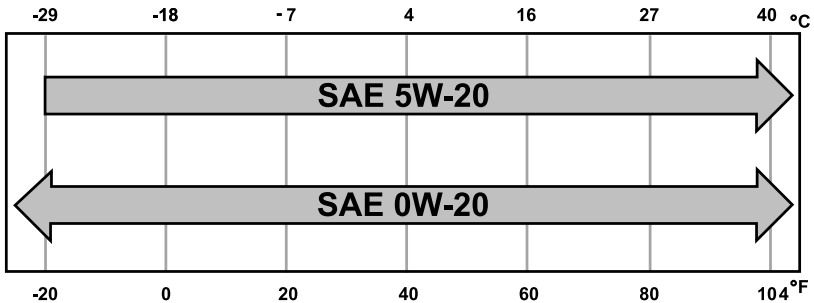

## ENGINE OIL CAPACITY AND SPECIFICATION - 3.5L ECOBOOST™

Use oil that meets the defined specification and viscosity grade.

If you do not use oil that meets the defined specification and viscosity grade, it could result in:

- Component damage that your vehicle warranty does not cover.
- Longer engine cranking periods.
- Increased emission levels.
- Reduced vehicle performance.
- Reduced fuel economy.



E142732

An oil that displays this symbol conforms to current engine, emission system and fuel economy performance standards of ILSAC.



# Capacities and Specifications

We recommend Motorcraft motor oil for your vehicle. If Motorcraft oil is not available, use motor oils of the recommended viscosity grade that meet API SP requirements and display the API

Certification Mark for gasoline engines.

Do not use supplemental engine oil additives because they are unnecessary and could lead to engine damage that your vehicle warranty does not cover.

## Capacities

Variant	Including the Oil Filter
All.	6.0 qt (5.7 L)

## Materials

Name	Specification
Motorcraft® SAE 5W-30 Synthetic Blend Motor Oil(U.S.) Motorcraft® SAE 5W-30 Super Premium Motor Oil / Huile moteur de très haute qualité SAE 5W-30 Motorcraft®(Canada) XO-5W30-Q1SP(U.S.) CXO-5W30-LSP6(Canada)	WSS-M2C961-A1

## Alternative Engine Oil for Extremely Cold Climates

To improve engine cold start performance, use the following engine oil in climates where the ambient temperature reaches -22.0°F (-30°C) or below.

## Materials

Name	Specification
Engine Oil - SAE 0W-30 - Synthetic Blend	WSS-M2C963-A1

# Capacities and Specifications

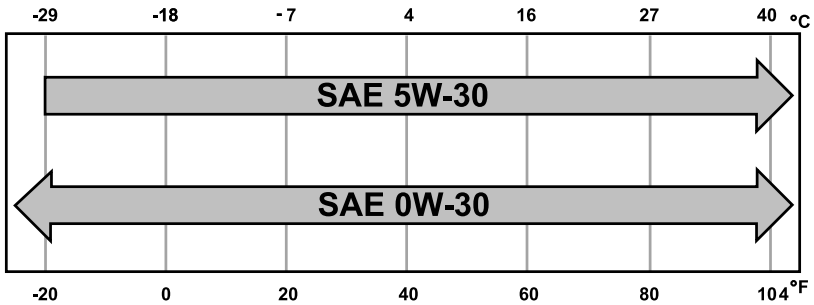

## ENGINE OIL CAPACITY AND SPECIFICATION - 3.5L, HYBRID ELECTRIC VEHICLE (HEV)

Use oil that meets the defined specification and viscosity grade.

If you do not use oil that meets the defined specification and viscosity grade, it could result in:

- Component damage that your vehicle warranty does not cover.
- Longer engine cranking periods.
- Increased emission levels.
- Reduced vehicle performance.
- Reduced fuel economy.



E142732

An oil that displays this symbol conforms to current engine, emission system and fuel economy performance standards of ILSAC.

We recommend Motorcraft motor oil for your vehicle. If Motorcraft oil is not available, use motor oils of the recommended viscosity grade that meet API SP requirements and display the API Certification Mark for gasoline engines.

Do not use supplemental engine oil additives because they are unnecessary and could lead to engine damage that your vehicle warranty does not cover.

# Capacities and Specifications

## Capacities

Variant	Including the Oil Filter
All.	6.0 qt (5.7 L)

## Materials

Name	Specification
Motorcraft® SAE 5W-30 Synthetic Blend Motor Oil(U.S.) Motorcraft® SAE 5W-30 Super Premium Motor Oil / Huile moteur de très haute qualité SAE 5W-30 Motorcraft®(Canada) XO-5W30-Q1SP(U.S.) CXO-5W30-LSP6(Canada)	WSS-M2C961-A1

## Alternative Engine Oil for Extremely Cold Climates

To improve engine cold start performance, use the following engine oil in climates where the ambient temperature reaches -22.0°F (-30°C) or below.

## Materials

Name	Specification
Engine Oil - SAE 0W-30 - Synthetic Blend	WSS-M2C963-A1

# Capacities and Specifications

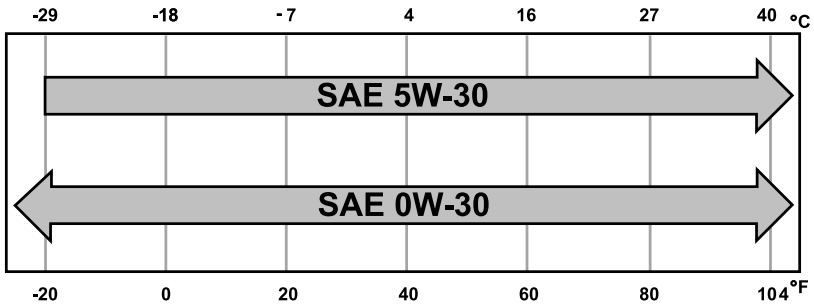

## ENGINE OIL CAPACITY AND SPECIFICATION - 5.0L

Use oil that meets the defined specification and viscosity grade.

If you do not use oil that meets the defined specification and viscosity grade, it could result in:

- Component damage that your vehicle warranty does not cover.
- Longer engine cranking periods.
- Increased emission levels.
- Reduced vehicle performance.
- Reduced fuel economy.



E142732

An oil that displays this symbol conforms to current engine, emission system and fuel economy performance standards of ILSAC.

We recommend Motorcraft motor oil for your vehicle. If Motorcraft oil is not available, use motor oils of the recommended viscosity grade that meet API SP requirements and display the API Certification Mark for gasoline engines.

Do not use supplemental engine oil additives because they are unnecessary and could lead to engine damage that your vehicle warranty does not cover.

# Capacities and Specifications

## Capacities

Variant	Including the Oil Filter
All.	7.75 qt (7.33 L)

## Materials

Name	Specification
Motorcraft® SAE 5W-30 Synthetic Blend Motor Oil(U.S.) Motorcraft® SAE 5W-30 Super Premium Motor Oil / Huile moteur de très haute qualité SAE 5W-30 Motorcraft®(Canada) XO-5W30-Q1SP(U.S.) CXO-5W30-LSP6(Canada)	WSS-M2C961-A1

## Alternative Engine Oil for Extremely Cold Climates

To improve engine cold start performance, use the following engine oil in climates where the ambient temperature reaches -22.0°F (-30°C) or below.

## Materials

Name	Specification
Engine Oil - SAE 0W-30 - Synthetic Blend	WSS-M2C963-A1

# Capacities and Specifications

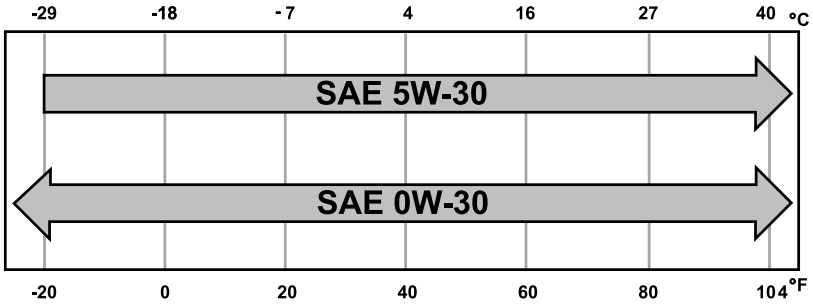

## COOLING SYSTEM CAPACITY AND SPECIFICATION - 2.7L ECOBOOST™

Use coolant that meets the defined specification.

If you do not use coolant that meets the defined specification, it could result in:

- Component damage that your vehicle warranty does not cover.
- Reduced vehicle performance.

### Capacities

Variant	Quantity
All.	15.1 qt (14.3 L)

### Materials

Name	Specification
Motorcraft® Yellow Prediluted Antifreeze/Coolant(U.S.) Motorcraft® Yellow Prediluted Antifreeze/Coolant / Antigel/liquide de refroidissement prédilué jaune Motorcraft®(Canada) VC-13DL-G(U.S.) CVC-13DL-G(Canada)	WSS-M97B57-A2

# Capacities and Specifications

## COOLING SYSTEM CAPACITY AND SPECIFICATION - 3.0L DIESEL

Use coolant that meets the defined specification.

### Capacities

Variant	Quantity
All.	13.7 qt (13 L)

If you do not use coolant that meets the defined specification, it could result in:

- Component damage that your vehicle warranty does not cover.
- Reduced vehicle performance.

### Materials

Name	Specification
Motorcraft® Yellow Prediluted Antifreeze/Coolant(U.S.) Motorcraft® Yellow Prediluted Antifreeze/Coolant / Antigel/liquide de refroidissement prédilué jaune Motorcraft®(Canada) VC-13DL-G(U.S.) CVC-13DL-G(Canada)	WSS-M97B57-A2

## COOLING SYSTEM CAPACITY AND SPECIFICATION - 3.3L

Use coolant that meets the defined specification.

### Capacities

Variant	Quantity
All.	12.7 qt (12 L)

If you do not use coolant that meets the defined specification, it could result in:

- Component damage that your vehicle warranty does not cover.
- Reduced vehicle performance.

# Capacities and Specifications

## Materials

Name	Specification
Motorcraft® Yellow Prediluted Antifreeze/ Coolant (U.S.) Motorcraft® Yellow Prediluted Antifreeze/Coolant / Antigel/liquide de refroidissement prédilué jaune Motorcraft® (Canada) VC-13DL-G (U.S.) CVC-13DL-G (Canada)	WSS-M97B57-A2

## COOLING SYSTEM CAPACITY AND SPECIFICATION - 3.5L ECOBOOST™

Use coolant that meets the defined specification.

If you do not use coolant that meets the defined specification, it could result in:

- Component damage that your vehicle warranty does not cover.
- Reduced vehicle performance.

## Capacities

Variant	Quantity
All.	14.3 qt (13.5 L)

## Materials

Name	Specification
Motorcraft® Yellow Prediluted Antifreeze/ Coolant (U.S.) Motorcraft® Yellow Prediluted Antifreeze/Coolant / Antigel/liquide de refroidissement prédilué jaune Motorcraft® (Canada) VC-13DL-G (U.S.) CVC-13DL-G (Canada)	WSS-M97B57-A2



# Capacities and Specifications

## COOLING SYSTEM CAPACITY AND SPECIFICATION - 3.5L, HYBRID ELECTRIC VEHICLE (HEV)

Use coolant that meets the defined

### Capacities

Variant	Quantity
Low temperature cooling circuit.	7.2 qt (6.8 L)
High temperature cooling circuit.	15.3 qt (14.5 L)

### Materials

Name	Specification
Motorcraft® Yellow Prediluted Antifreeze/Coolant (U.S.) Motorcraft® Yellow Prediluted Antifreeze/Coolant / Antigel/liquide de refroidissement prédilué jaune Motorcraft® (Canada) VC-13DL-G (U.S.) CVC-13DL-G (Canada)	WSS-M97B57-A2

## COOLING SYSTEM CAPACITY AND SPECIFICATION - 5.0L

Use coolant that meets the defined specification.

### Capacities

Variant	Quantity
All.	13.2 qt (12.5 L)

specification.

If you do not use coolant that meets the defined specification, it could result in:

- Component damage that your vehicle warranty does not cover.
- Reduced vehicle performance.

If you do not use coolant that meets the defined specification, it could result in:

- Component damage that your vehicle warranty does not cover.
- Reduced vehicle performance.

# Capacities and Specifications

---

## Materials

Name	Specification
Motorcraft® Yellow Prediluted Antifreeze/ Coolant (U.S.) Motorcraft® Yellow Prediluted Antifreeze/Coolant / Antigel/liquide de refroidissement prédilué jaune Motorcraft® (Canada) VC-13DL-G (U.S.) CVC-13DL-G (Canada)	WSS-M97B57-A2

## FUEL TANK CAPACITY - GASOLINE, EXCLUDING: HYBRID ELECTRIC VEHICLE (HEV)

### Capacities

Variant	Quantity
Regular cab.	23.0 gal (87.1 L)
Super cab.	23.0 gal (87.1 L)
Crew cab.	26.0 gal (98.4 L)
Optional.	36.0 gal (136.3 L)

# Capacities and Specifications

---

## FUEL TANK CAPACITY - DIESEL

### Capacities

Variant	Quantity
All.	26.0 gal (98.4 L)

## Capacities and Specifications

---

### FUEL TANK CAPACITY - GASOLINE, HYBRID ELECTRIC VEHICLE (HEV)

#### Capacities

Variant	Quantity
All.	30.6 gal (115.8 L)

# Capacities and Specifications

## AIR CONDITIONING SYSTEM CAPACITY AND SPECIFICATION - 2.7L ECOBOOST™

the air conditioning refrigerant system can cause personal injury.

Use refrigerant and oil that meets the defined specifications.

If you do not use refrigerant and oil that meets the defined specifications, it could result in:

- Component damage that your vehicle warranty does not cover.
- Reduced vehicle performance.



**WARNING:** The air conditioning refrigerant system contains refrigerant under high pressure. Only qualified personnel should service the air conditioning refrigerant system. Opening

### Capacities

Variant	Refrigerant	Refrigerant Oil
All.	29 oz (0.82 kg)	2.71 fl oz (80 ml)

### Materials

Name	Specification
R-1234yf Refrigerant(U.S.) R-1234yf Refrigerant / Frigorigène R-1234yf(Canada) YN-33-A(U.S.) HS7Z-19B519-BA(Canada)	WSS-M17B21-A
Motorcraft® R-1234yf Refrigerant PAG Oil(U.S.) Motorcraft® R-1234yf Refrigerant PAG Oil / Huile PAG pour frigorigène R-1234yf Motorcraft®(Canada) YN-35(U.S. & Canada)	WSS-M2C300-A2

# Capacities and Specifications

## AIR CONDITIONING SYSTEM CAPACITY AND SPECIFICATION - 3.0L DIESEL



**WARNING:** The air conditioning refrigerant system contains refrigerant under high pressure. Only qualified personnel should service the air conditioning refrigerant system. Opening

the air conditioning refrigerant system can cause personal injury.

Use refrigerant and oil that meets the defined specifications.

If you do not use refrigerant and oil that meets the defined specifications, it could result in:

- Component damage that your vehicle warranty does not cover.
- Reduced vehicle performance.

### Capacities

Variant	Refrigerant	Refrigerant Oil
All.	29 oz (0.82 kg)	2.71 fl oz (80 ml)

### Materials

Name	Specification
R-1234yf Refrigerant(U.S.) R-1234yf Refrigerant / Frigorigène R-1234yf(Canada) YN-33-A(U.S.) HS7Z-19B519-BA(Canada)	WSS-M17B21-A
Motorcraft® R-1234yf Refrigerant PAG Oil(U.S.) Motorcraft® R-1234yf Refrigerant PAG Oil / Huile PAG pour frigorigène R-1234yf Motorcraft®(Canada) YN-35(U.S. & Canada)	WSS-M2C300-A2

# Capacities and Specifications

## AIR CONDITIONING SYSTEM CAPACITY AND SPECIFICATION - 3.3L



**WARNING:** The air conditioning refrigerant system contains refrigerant under high pressure. Only qualified personnel should service the air conditioning refrigerant system. Opening

the air conditioning refrigerant system can cause personal injury.

Use refrigerant and oil that meets the defined specifications.

If you do not use refrigerant and oil that meets the defined specifications, it could result in:

- Component damage that your vehicle warranty does not cover.
- Reduced vehicle performance.

### Capacities

Variant	Refrigerant	Refrigerant Oil
All.	29 oz (0.82 kg)	2.71 fl oz (80 ml)

### Materials

Name	Specification
R-1234yf Refrigerant(U.S.) R-1234yf Refrigerant / Frigorigène R-1234yf(Canada) YN-33-A(U.S.) HS7Z-19B519-BA(Canada)	WSS-M17B21-A
Motorcraft® R-1234yf Refrigerant PAG Oil(U.S.) Motorcraft® R-1234yf Refrigerant PAG Oil / Huile PAG pour frigorigène R-1234yf Motorcraft®(Canada) YN-35(U.S. & Canada)	WSS-M2C300-A2

# Capacities and Specifications

## AIR CONDITIONING SYSTEM CAPACITY AND SPECIFICATION - 3.5L ECOBOOST™



**WARNING:** The air conditioning refrigerant system contains refrigerant under high pressure. Only qualified personnel should service the air conditioning refrigerant system. Opening

the air conditioning refrigerant system can cause personal injury.

Use refrigerant and oil that meets the defined specifications.

If you do not use refrigerant and oil that meets the defined specifications, it could result in:

- Component damage that your vehicle warranty does not cover.
- Reduced vehicle performance.

### Capacities

Variant	Refrigerant	Refrigerant Oil
All.	29 oz (0.82 kg)	2.71 fl oz (80 ml)

### Materials

Name	Specification
R-1234yf Refrigerant(U.S.) R-1234yf Refrigerant / Frigorigène R-1234yf(Canada) YN-33-A(U.S.) HS7Z-19B519-BA(Canada)	WSS-M17B21-A
Motorcraft® R-1234yf Refrigerant PAG Oil(U.S.) Motorcraft® R-1234yf Refrigerant PAG Oil / Huile PAG pour frigorigène R-1234yf Motorcraft®(Canada) YN-35(U.S. & Canada)	WSS-M2C300-A2



# Capacities and Specifications

## AIR CONDITIONING SYSTEM CAPACITY AND SPECIFICATION - 3.5L HYBRID ELECTRIC VEHICLE (HEV)

the air conditioning refrigerant system can cause personal injury.

Use refrigerant and oil that meets the defined specifications.

If you do not use refrigerant and oil that meets the defined specifications, it could result in:

- Component damage that your vehicle warranty does not cover.
- Reduced vehicle performance.



**WARNING:** The air conditioning refrigerant system contains refrigerant under high pressure. Only qualified personnel should service the air conditioning refrigerant system. Opening

### Capacities

Variant	Refrigerant	Refrigerant Oil
All.	23 oz (0.65 kg)	5.41 fl oz (160 ml)

### Materials

Name	Specification
R-1234yf Refrigerant(U.S.) R-1234yf Refrigerant / Frigorigène R-1234yf(Canada) YN-33-A(U.S.) HS7Z-19B519-BA(Canada)	WSS-M17B21-A
Motorcraft® R-1234yf Refrigerant POE Oil(U.S.) Motorcraft® R-1234yf Refrigerant POE Oil / Huile POE pour frigorigène R-1234yf Motorcraft®(Canada) YN-34(U.S. & Canada)	WSS-M2C31-B2

# Capacities and Specifications

## AIR CONDITIONING SYSTEM CAPACITY AND SPECIFICATION - 5.0L



**WARNING:** The air conditioning refrigerant system contains refrigerant under high pressure. Only qualified personnel should service the air conditioning refrigerant system. Opening

the air conditioning refrigerant system can cause personal injury.

Use refrigerant and oil that meets the defined specifications.

If you do not use refrigerant and oil that meets the defined specifications, it could result in:

- Component damage that your vehicle warranty does not cover.
- Reduced vehicle performance.

### Capacities

Variant	Refrigerant	Refrigerant Oil
All.	29 oz (0.82 kg)	2.71 fl oz (80 ml)

### Materials

Name	Specification
R-1234yf Refrigerant(U.S.) R-1234yf Refrigerant / Frigorigène R-1234yf(Canada) YN-33-A(U.S.) HS7Z-19B519-BA(Canada)	WSS-M17B21-A
Motorcraft® R-1234yf Refrigerant PAG Oil(U.S.) Motorcraft® R-1234yf Refrigerant PAG Oil / Huile PAG pour frigorigène R-1234yf Motorcraft®(Canada) YN-35(U.S. & Canada)	WSS-M2C300-A2

## WASHER FLUID SPECIFICATION

### Capacities

Variant	Quantity
All.	Fill as required.

# Capacities and Specifications

## Materials

Name	Specification
Motorcraft® Premium Windshield Wash Concentrate with Bitterant(U.S.) Motorcraft® Premium Quality Windshield Washer Fluid / Liquide lave-glace de haute qualité Motorcraft®(Canada) ZC-32-B2(U.S.) CXC-37-A/B/D/F(Canada)	WSS-M14P19-A

## DIESEL EXHAUST FLUID CAPACITY AND SPECIFICATION

### Capacities

Variant	Quantity
All.	5.6 gal (21.3 L)

## Materials

Name	Specification
Motorcraft® Diesel Exhaust Fluid(U.S.) Motorcraft® Diesel Exhaust Fluid / Fluide pour échappement diesel Motorcraft®(Canada) PM-27-GAL,PM-27-JUG(U.S.) CPM-27-J(Canada)	WSS-M99C130-A

## BRAKE FLUID SPECIFICATION

Use fluid that meets the defined specification and viscosity grade.

If you do not use fluid that meets the defined specification and viscosity grade, it could result in:

- Component damage that your vehicle warranty does not cover.
- Reduced brake performance.

**Note:** We recommend you use DOT 4 Low Viscosity (LV) High Performance Brake Fluid or equivalent meeting WSS-M6C65-A2. If you use any fluid other than the recommended fluid, it could cause reduced brake performance and not meet our performance standards. Keep brake fluid clean and dry. Contamination with dirt, water, petroleum products or other materials could result in brake system damage and possible failure.

# Capacities and Specifications

## Capacities

Variant	Quantity
All.	Fill as required.

## Materials

Name	Specification
Motorcraft® DOT 4 LV High Performance Motor Vehicle Brake Fluid(U.S.) Motorcraft® DOT 4 LV High Performance Motor Vehicle Brake Fluid / Liquide de frein automobile haute performance DOT 4 LV Motorcraft®(Canada) PM-20(U.S. & Canada)	WSS-M6C65-A2

## TRANSFER CASE FLUID CAPACITY AND SPECIFICATION

Use fluid that meets the defined specification and viscosity grade.

If you do not use fluid that meets the defined specification and viscosity grade, it could result in:

- Component damage that your vehicle warranty does not cover.
- Reduced vehicle performance.

## Capacities

Variant	Quantity
Four-wheel drive (Electronic shift on the Fly).	1.5 qt (1.4 L)
Automatic four-wheel drive (Torque on demand).	1.5 qt (1.4 L)
Two-speed automatic four-wheel drive (Mechanical lock).	1.9 qt (1.8 L)

# Capacities and Specifications

## Materials

Name	Specification
Motorcraft® MERCON® LV Automatic Transmission Fluid(U.S.) Motorcraft® MERCON® LV Automatic Transmission Fluid / Huile pour boîte automatique MERCON® LV Motorcraft®(Canada) XT-10-QLVC(U.S.) CXT-10-LV6(Canada)	WSS-M2C938-AMERCON® LV,

## FRONT AXLE FLUID CAPACITY AND SPECIFICATION

Use fluid that meets the defined specification and viscosity grade.

If you do not use fluid that meets the defined specification and viscosity grade, it could result in:

- Component damage that your vehicle warranty does not cover.
- Reduced vehicle performance.

## Capacities

Variant	Quantity
Four-wheel drive.	1.8 qt (1.7 L)

## Materials

Name	Specification
Motorcraft® SAE 75W-85 Premium Synthetic Hypoid Gear Lubricant(U.S.) Motorcraft® SAE 75W-85 Premium Synthetic Hypoid Gear Lubricant / Huile synthétique de haute qualité pour engrenages hypoides SAE 75W-85 Motorcraft®(Canada) XY-75W85-QL(U.S. & Canada)	WSS-M2C942-A

## REAR AXLE FLUID CAPACITY AND SPECIFICATION

Use fluid that meets the defined specification and viscosity grade.

If you do not use fluid that meets the defined specification and viscosity grade, it could result in:

- Component damage that your vehicle warranty does not cover.
- Reduced vehicle performance.

# Capacities and Specifications

---

## Capacities

Variant	Quantity
8.8 inch.	2.0–2.1 qt (1.9–2 L)
9.75 inch.	2.2–2.3 qt (2.1–2.2 L)

## Materials

Name	Specification
Motorcraft® SAE 75W-85 Premium Synthetic Hypoid Gear Lubricant (U.S.) Motorcraft® SAE 75W-85 Premium Synthetic Hypoid Gear Lubricant / Huile synthétique de haute qualité pour engrenages hypoides SAE 75W-85 Motorcraft® (Canada) XY-75W85-QL (U.S. & Canada)	WSS-M2C942-A

# Vehicle Identification

## VEHICLE IDENTIFICATION NUMBER

### Locating the Vehicle Identification Number

The vehicle identification number is on the left-hand side of the instrument panel.

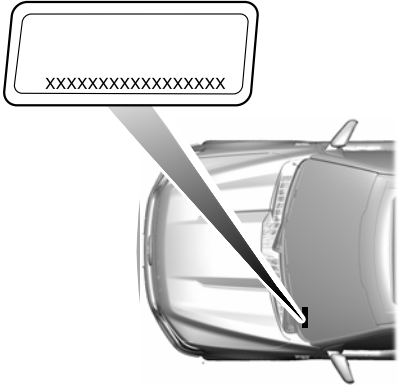

**Note:** In the illustration, XXXX is representative of your vehicle identification number.

### Vehicle Identification Number Overview

The vehicle identification number contains the following information:

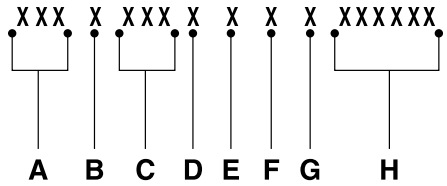

- A World manufacturer identifier.
- B Brake system, gross vehicle weight rating, restraint devices and their locations.
- C Make, vehicle line, series, body type.
- D Engine or motor type.
- E Check digit.
- F Model year.
- G Assembly plant.
- H Production sequence number.

# Connected Vehicle

## WHAT IS A CONNECTED VEHICLE

A connected vehicle has technology that allows your vehicle to connect to a mobile network and for you to access a range of features. When used in conjunction with the FordPass app, it could allow you to monitor and control your vehicle further, for example checking the tire pressures, the fuel level and the vehicle location. For additional information, refer to the local Ford website.

## CONNECTED VEHICLE REQUIREMENTS

Connected service and related feature functionality requires a compatible vehicle network.

Some remote features require additional service activation. Log in to your Ford account for details. Some restrictions, third party terms and message or data rates may apply.

## CONNECTED VEHICLE LIMITATIONS

Evolving technology, cellular networks, or regulations could affect functionality and availability, or continued provision of some features. These changes could even stop some features from functioning.

## CONNECTING THE VEHICLE TO A MOBILE NETWORK

### What Is the Modem



The modem allows access to a range of features built into your vehicle.

## Enabling and Disabling the Modem

1. Press **Settings**.
2. Press **Connectivity**.
3. Press **Connected Vehicle Features**.
4. Switch vehicle connectivity on or off.

## Connecting FordPass to the Modem

1. Make sure that the modem is enabled using the vehicle settings menu.
2. Open the FordPass app on your device and log in.
3. Add your vehicle or select your vehicle if already added.
4. Select the option for vehicle details.
5. Select the option to activate your vehicle.
6. Make sure that the name on the screen matches the name shown in your FordPass account.
7. Confirm that FordPass account is connected to the modem.

## CONNECTING THE VEHICLE TO A WI-FI NETWORK



Select the settings option on the feature bar.

1. Press **Connectivity**.
2. Press **Manage Wi-Fi Networks**.
3. Switch **System Wi-Fi** on.
4. Press **View Available Networks**.
5. Select an available Wi-Fi network.

**Note:** Enter the network password to connect to a secure network.



# Connected Vehicle

---

## CONNECTED VEHICLE – TROUBLESHOOTING

### Connected Vehicle – Frequently Asked Questions - Vehicles With: Modem

Symptom	Possible Cause and Resolution
I cannot confirm the connection of my FordPass account to the modem.	<ul style="list-style-type: none"><li>- Modem is not enabled.<ul style="list-style-type: none"><li>• Switch vehicle connectivity on.</li></ul></li><li>- Weak network signal.<ul style="list-style-type: none"><li>• Move your vehicle closer to a place where the network signal is not obstructed.</li></ul></li></ul>

# Connected Vehicle

## Connected Vehicle – Frequently Asked Questions - Vehicles With: SYNC 4

Symptom	Possible Cause and Resolution
I cannot connect to a Wi-Fi network.	<ul style="list-style-type: none"> <li>– Password error.               <ul style="list-style-type: none"> <li>• Enter the correct network password.</li> </ul> </li> <li>– Weak network signal.               <ul style="list-style-type: none"> <li>• Move your vehicle closer to the Wi-Fi hotspot or to a place where the network signal is not obstructed.</li> </ul> </li> <li>– Multiple access points in range with the same network name.               <ul style="list-style-type: none"> <li>• Use a unique name for your network name. Do not use the default name unless it contains a unique identifier, for example as part of the MAC address.</li> </ul> </li> </ul>
The Wi-Fi connection disconnects after successful connection.	<ul style="list-style-type: none"> <li>– Weak network signal.               <ul style="list-style-type: none"> <li>• Move your vehicle closer to the Wi-Fi hotspot or to a place where the network signal is not obstructed.</li> </ul> </li> </ul>
I am close to a Wi-Fi hotspot but the network signal strength is weak.	<ul style="list-style-type: none"> <li>– Obstructed network signal.               <ul style="list-style-type: none"> <li>• If your vehicle has a heated windshield, position your vehicle so that the windshield is not facing the Wi-Fi hotspot.</li> <li>• If your vehicle has metallic tinting on the windows but not on the windshield, position your vehicle so that the windshield is facing the Wi-Fi hotspot or open the windows that are facing the hotspot.</li> <li>• If your vehicle has metallic tinting on the windows and the windshield, open the windows that are facing the hotspot.</li> <li>• If your vehicle is in a garage and you have the garage door closed, open the garage door as it may block the signal.</li> </ul> </li> </ul>
I cannot see a network in the list of available networks that I expect to see.	<ul style="list-style-type: none"> <li>– Hidden network.               <ul style="list-style-type: none"> <li>• Make the network visible and try again, or use the Add Network Manually option in Wi-Fi settings menu.</li> </ul> </li> <li>– Unsupported security type.               <ul style="list-style-type: none"> <li>• Some network security types are not supported, for example WEP.</li> </ul> </li> </ul>

# Connected Vehicle

<b>Symptom</b>	<b>Possible Cause and Resolution</b>
I cannot see the Wi-Fi hotspot name when I search for Wi-Fi networks on my cell phone or other device.	<ul style="list-style-type: none"><li>- System limitation.<ul style="list-style-type: none"><li>• Make sure Wi-Fi hotspot visibility is on.</li><li>• The system does not provide a Wi-Fi hotspot at this time.</li></ul></li></ul>
Software downloads take too long.	<ul style="list-style-type: none"><li>- Weak network signal<ul style="list-style-type: none"><li>• Move your vehicle closer to the Wi-Fi hotspot or to a place where the network signal is not obstructed.</li></ul></li><li>- Wi-Fi hotspot in high demand or has a slow Internet connection.<ul style="list-style-type: none"><li>• Use a more reliable Wi-Fi hotspot.</li></ul></li></ul>
The system seems to connect to a Wi-Fi network and the signal strength is excellent but the software does not update.	<ul style="list-style-type: none"><li>- No software update available.</li><li>- Wi-Fi network requires a subscription or acceptance of terms and conditions.<ul style="list-style-type: none"><li>• Test the connection using another device. If the network requires a subscription or acceptance of terms and conditions, contact the network service provider.</li></ul></li></ul>

# Vehicle Wi-Fi Hotspot

## CREATING A VEHICLE WI-FI HOTSPOT

You can create a Wi-Fi hotspot in your vehicle and allow devices to connect to it for access to the Internet.



Select the settings option on the feature bar.

1. Press **Vehicle Hotspot**.

**Note:** The vehicle hotspot default setting is on.

2. Press **Settings**.
3. Press **Wi-Fi visibility**.

**Note:** The Wi-Fi Visibility default setting is on.

## Finding the Wi-Fi Hotspot Name and Password



Select the settings option on the feature bar.

1. Press **Vehicle Hotspot**.
2. Press **Settings**.

**Note:** The network name is the hotspot name.

3. Press **View Password**.

## Connecting a Device to the Wi-Fi Hotspot

1. On your device, switch Wi-Fi on and select the hotspot from the list of available Wi-Fi networks.
2. When prompted, enter the password.

## Purchasing a Data Plan

1. Connect a device to the hotspot.

**Note:** The vehicle network carrier's portal opens on your device.

2. If the portal does not open on your device, open a website and it redirects to the vehicle network carrier's portal.

**Note:** Secure websites do not redirect.

3. Follow the instructions on the carrier portal to purchase a plan.

**Note:** If you have an active plan, the system does not redirect to the vehicle network carrier's portal when you connect a device. Visit the vehicle network carrier's website to purchase more data.

**Note:** If data usage information is available in the vehicle hotspot menu, it is approximate.

**Note:** If you carry out a master reset, the system does not remove your vehicle from your vehicle network carrier's account. To remove your vehicle from the account, contact your vehicle network carrier.

**Note:** The vehicle network carrier provides Vehicle Hotspot services, subject to your vehicle network carrier agreement, coverage and availability.

## CHANGING THE VEHICLE WI-FI HOTSPOT NAME OR PASSWORD



Select the settings option on the feature bar.

1. Press **Vehicle Hotspot**.
2. Press **Settings**.
3. Press **Edit**.
4. Press **Change Network Name**.
5. Enter your required network name.
6. Press **Done**.
7. Press **Change Password**.
8. Enter your required password.
9. Press **Done**.

# Audio System

## AUDIO SYSTEM PRECAUTIONS



**WARNING:** Driving while distracted can result in loss of vehicle control, crash and injury. We strongly recommend that you use extreme caution when using any device that may take your focus off the road. Your primary responsibility is the safe operation of your vehicle. We recommend against the use of any hand-held device while driving and encourage the use of voice-operated systems when possible. Make sure you are aware of all applicable local laws that may affect the use of electronic devices while driving.

Listening to loud audio for long periods of time could damage your hearing.

## SWITCHING THE AUDIO UNIT ON AND OFF



Press the button on the volume control.

## SELECTING THE AUDIO SOURCE

### Audio Unit



Press to open the media source menu.

You can press this multiple times to change the audio source or scroll through the media sources.

### Touchscreen

Press **Sources** on the touchscreen to open the media source menu.

## PLAYING OR PAUSING THE AUDIO SOURCE

### Audio Unit



Press the button to pause playback. Press again to resume playback.

### Touchscreen



Press the button to pause playback. Press again to resume playback.

**Note:** *Not all sources can be paused.*

## ADJUSTING THE VOLUME

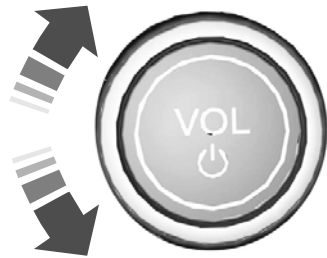

Turn to adjust the volume.

Some vehicles may be able to adjust the volume using buttons on the steering wheel.

# Audio System

## SWITCHING SHUFFLE MODE ON AND OFF



Press the button on the touchscreen to switch shuffle mode on or off.

**Note:** *Not all sources have shuffle mode.*

## SWITCHING REPEAT MODE ON AND OFF



Press the button on the touchscreen to switch repeat mode on or off.

**Note:** *Not all sources have repeat mode.*

## SETTING A MEMORY PRESET

1. Select a station or channel.
2. Press and hold a memory preset button on the touchscreen.

**Note:** *The audio mutes briefly while the system saves the preset and returns once it is stored.*

**Note:** *You can save presets from multiple sources to the memory preset bar.*

## MUTING THE AUDIO



Press to mute the signal. Press again to restore the signal.

## ADJUSTING THE SOUND SETTINGS

### Balance and Fade (If Equipped)

1. Press **Settings** on the touchscreen.
2. Press **Sound Settings**.
3. Press **Balance / Fade**.

4. Press the arrows to adjust the settings.

### Tone Settings

1. Press **Settings** on the touchscreen.
2. Press **Sound Settings**.
3. Press **Tone Settings**.
4. Press the arrows or slider bar to adjust the settings.

### Speed Compensated Volume

1. Press **Settings** on the touchscreen.
2. Press **Sound Settings**.
3. Press **Speed Compensated Volume**.
4. Press a setting.

### Occupancy Mode (If Equipped)

1. Press **Settings** on the touchscreen.
2. Press **Sound Settings**.
3. Press **Occupancy Mode**.
4. Press a setting.

### Sound Mode (If Equipped)

1. Press **Settings** on the touchscreen.
2. Press **Sound Settings**.
3. Press **Sound Mode**.
4. Press a setting.

## SETTING THE CLOCK AND DATE

1. Press **Settings** on the touchscreen.
2. Press **Clock Settings**.
3. Set the time.

**Note:** *The AM and PM options are not available if 24-hour mode is on.*

# Audio System

## Switching Automatic Time Updates On and Off

1. Press **Settings** on the touchscreen.
2. Press **Clock Settings**.
3. Switch **Automatic time zone update** on or off.

## AM/FM RADIO

### AM/FM Radio Limitations

The further you travel from an AM or FM station, the weaker the signal and the weaker the reception.

Hills, mountains, tall buildings, bridges, tunnels, freeway overpasses, parking garages, dense tree foliage and thunderstorms can interfere with the reception.

When you pass a ground-based broadcast repeating tower, a stronger signal may overtake a weaker one and result in the audio system muting.

## Selecting a Radio Station

### Manually Selecting a Radio Station

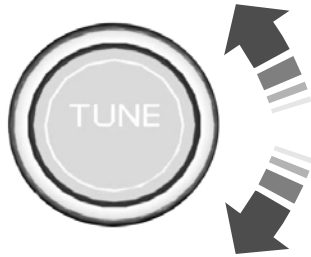

Turn to search through the radio frequency band.

### Using Direct Tune

1. Press **Direct Tune** to open the number pad.
2. Enter the station you prefer.

**Note:** *You can only enter a valid station for the audio source you are currently listening to.*

### Using Seek



Press either button. The system stops at the first station it finds in that direction.



### Using the Station List

1. Press **Browse**.

**Note:** *Available on FM radio only.*

2. Press a station.

# Audio System

## SWITCHING THE DISPLAY ON AND OFF

### Audio Unit



Press the button.

### Touchscreen

To switch the display off:

1. Press **Settings** on the touchscreen.
2. Press **Display Settings**.
3. Press **Display Off**.

**Note:** The display defaults to on each time you switch your vehicle on.

To switch the display on, press anywhere on the touchscreen.

## DIGITAL RADIO (If Equipped)

### What Is Digital Radio

HD Radio™ technology is the digital evolution of analog AM/FM radio.

For additional information, visit [www.HDRadio.com](http://www.HDRadio.com).

HD Radio Technology is manufactured under license from iBiquity Digital Corporation and foreign patents. HD Radio and the HD and HD Radio logos are proprietary trademarks of DTS. The vehicle manufacturer and DTS are not responsible for the content sent using HD Radio technology. Content may be changed, added or deleted at any time at the station owner's discretion.

### How Does Digital Radio Work

Your system has a special receiver that allows it to receive digital broadcasts in addition to analog broadcasts.

HD1 signifies the main programming status and is available in both analog and digital broadcasts. Other multicast stations are only available digitally and could contain new or different content.

**Note:** When the system first receives an HD1 station, it plays the station in the analog version until it verifies the station is an HD Radio station. Then it shifts to the digital version.

**Note:** There is an audio mute delay when switching to an HD2 or HD3 station because the system has to reacquire and decode the digital signal.

### Digital Radio Limitations

If you are outside the reception area, the system could not work.

If you are on the fringe of the reception area, the station could mute due to weak signal strength.

**Note:** If you are listening to HD1, the system changes back to the analog broadcast until the digital broadcast is available again. If you are listening to any other multicast channels, the station mutes and stays muted unless it is able to connect to the digital signal again.

Depending on the station quality, you could hear a slight sound change when the station changes between analog and digital audio.

You cannot access a saved HD station if your vehicle is outside the station's reception area.

### Switching Digital Radio Reception On and Off

1. Press **Settings** on the touchscreen.
2. Press **Radio Settings**.
3. Switch **AM HD Radio** or **FM HD Radio** on or off.



# Audio System

## Digital Radio Indicators

### HD Radio Indicator

The indicator appears when HD Radio is on and you tune to a station broadcasting HD Radio technology.



The color of the indicator changes to indicate the system status.

Gray indicates the system is acquiring a digital station.

Orange indicates digital audio is playing.

### Multicast Indicator

The multicast indicator appears if the current station is broadcasting multiple digital broadcasts. The highlighted numbers indicate additional digital channels available.

**Note:** For stations that have more than one HD multicast, the HD indicator and radio text appears as a button. Press the button to cycle through all of the HD stations on that specific frequency.

## SATELLITE RADIO (If Equipped)

### What Is Satellite Radio

Your factory-installed SiriusXM radio system includes a limited subscription term, which begins on the date of sale or lease of your vehicle. See an authorized dealer for availability.

For additional information about extended subscription terms, visit [www.SiriusXM.com](http://www.SiriusXM.com) in the United States, [www.SiriusXM.ca](http://www.SiriusXM.ca) in Canada, or call SiriusXM at 1-888-539-7474.

**Note:** SiriusXM reserves the unrestricted right to change, rearrange, add or delete programming including canceling, moving or adding particular channels, and its prices, at any time, with or without notice to you. Neither SiriusXM and its affiliates nor Ford Motor Company and its affiliates will be liable to you or any third party for any such modification, suspension or termination.

### Satellite Radio Limitations

For optimal reception performance, keep the antenna clear of snow and ice build-up and keep luggage and other material as far away from the antenna as possible.

Hills, mountains, tall buildings, bridges, tunnels, freeway overpasses, parking garages, dense tree foliage and thunderstorms can interfere with your reception.

When you pass a ground-based broadcast-repeating tower, a stronger signal may overtake a weaker one and could result in the audio system muting. Your display could show an error message to indicate the interference.

### Locating the Satellite Radio Identification Number

1. Select SiriusXM as the audio source.
2. Tune to channel 0.

# Audio System

## Selecting a Channel

### Manually Selecting a Channel



Press the button to find the previous or next available radio channel.



### Linear Tuner

The linear tuner is displayed when manually selecting a channel. You can swipe left or right on the linear tuner carousel to navigate through the channel list. Tap on a channel title to listen to it.

### Using Direct Tune

1. Press the channel up or down button to open the linear tuner screen.
2. Press **Direct Tune** to open the number pad.
3. Enter the channel you prefer.

### Using Browse

1. Press **Browse**.
2. Select a channel.

## Satellite Radio Settings

### Subscription

Your subscription status is displayed. You can subscribe or manage your subscription directly from the touchscreen.

### Listener Add/Switch

You can create up to five listener profiles per SiriusXM account. Each listener profile can be personalized with a name and profile image.

**Note:** Requires a trial or active subscription to use.

**Note:** A default profile is available when no listener profiles are created.

### SiriusXM Favorites

SiriusXM Favorites are shown for the active listener profile. While you are listening to SiriusXM, you can save favorites by:

- Tapping the currently tuned channel or show logo on the SiriusXM audio screen. A favorite icon appears next to the logo when it is saved as a favorite.
- Tuning to a channel or show you want to save as a favorite. Navigate to the SiriusXM Favorites screen and press the Add Current button. The currently tuned channel or show is saved as a favorite.
- Saving a radio preset. This saves the currently tuned SiriusXM channel or show as a favorite.

**Note:** Requires a trial or active subscription to use.

### Listening History

Listening history is a list of recently listened to SiriusXM content and is shown for the active listener profile. You can view, manage and reset the listening history using the controls on the touchscreen.

**Note:** Requires a trial or active subscription to use.

### Listener Settings

Listener settings apply to the active listener profile.

**Note:** Requires a trial or active subscription to use.

**Note:** A default profile is available when no listener profiles are created.

# Audio System

---

## Help and Support

You can contact SiriusXM Customer Care

directly from SYNC and view information required to manage your SiriusXM account.

# Audio System

## AUDIO SYSTEM – TROUBLESHOOTING

### Audio System – Information Messages

#### Satellite Radio Troubleshooting

Error Message	Potential Effects	Recommended Action
Connectivity Disabled	Internet streaming and On Demand shows are unavailable and some SiriusXM features are disabled.	Internet connectivity is turned off. See <b>Connected Vehicle</b> (page 565).
No Internet	Audio system may mute. "Switch to Satellite" button may be displayed on the SiriusXM audio screen if the channel is also available via satellite.	SYNC will attempt to connect. See <b>Satellite Radio Limitations</b> (page 574). Switch to a satellite connection for the current channel if the option is available.
No Satellite Signal	Audio system may mute. "Switch to Internet" button may be displayed on the SiriusXM audio screen if the channel is also available via streaming.	Antenna may be obstructed or satellite reception is weak in your location. See <b>Satellite Radio Limitations</b> (page 574). Switch to an internet connection for the current channel if the option is available.
Slow Network Connection	Audio system may mute while audio attempts to load.	Allow some time for audio to load or tune to a different channel.
Channel Unavailable	Audio system may mute. Radio may tune to a different channel.	A temporary update may be in progress. Allow some time before retrying to tune to the channel. If issue persists, the channel may no longer be available.
Episode Unavailable	Audio system may mute. Radio may tune to a different channel.	A temporary update may be in progress. Allow some time before retrying to play the episode. If issue persists, the episode may no longer be available.

# Audio System

Something went wrong	Audio system may mute. Radio may tune to a different channel.	Retry action after some time or tune to a different channel.
Subscribe to Listen	Cannot listen to selected content. Content may appear grayed out and some features may be disabled.	<p>Your subscription has expired or you have not yet subscribed for access to the listed content. Navigate to Subscription under the Satellite Radio Settings menu. If you have an active subscription which includes the listed channel or content and you see this error, you may need to refresh your radio. To refresh your SiriusXM radio, visit <a href="http://www.siriusxm.com/refresh">www.siriusxm.com/refresh</a> in the US, or <a href="http://www.siriusxm.ca/refresh">www.siriusxm.ca/refresh</a> in Canada.</p> <p>You may need to provide your SiriusXM Radio identification number. See <b>Locating the Satellite Radio Identification Number</b> (page 574).</p>

# Audio System

Upgrade to Listen	Cannot listen to selected content. Content may appear grayed out and some features may be disabled.	Your subscription does not include access to the listed content. You may need to upgrade your subscription. Navigate to Subscription under the Satellite Radio Settings menu. If you have an active subscription which includes the listed channel or content and you see this error, you may need to refresh your radio. To refresh your SiriusXM radio, visit <a href="http://www.siriusxm.com/refresh">www.siriusxm.com/refresh</a> in the US, or <a href="http://www.siriusxm.ca/refresh">www.siriusxm.ca/refresh</a> in Canada. You may need to provide your SiriusXM Radio identification number. See <b>Locating the Satellite Radio Identification Number</b> (page 574).
Location Restricted Content	Audio may mute. "Not available in your location" or "Unable to determine your location" may be displayed.	Content is not available in your location or SiriusXM is unable to determine your location. Tuning to a different channel may resolve the issue.
Channel Blocked	Audio may mute. Radio may tune to a different channel.	The Block Explicit Content filter is turned on. Navigate to Listener Settings under the Satellite Radio Settings menu to access the Block Explicit Content filter. Navigate to Listener Settings. See <b>Satellite Radio Settings</b> (page 575).
Antenna Problem or Hardware Problem	Audio may mute. Access to SiriusXM features may be unavailable.	If issue persists, you may need to visit an authorized dealer for service.

# Audio System

SiriusXM Updating...	Audio may mute.	Allow SiriusXM some time to complete updating.
Loading...	Audio may mute. Content may be temporarily unavailable while loading.	No action necessary. If loading time is longer than usual, See <b>Satellite Radio Limitations</b> (page 574).
SiriusXM Loading...	Audio may mute. Content and controls may be temporarily unavailable.	No action necessary. Allow SiriusXM some time to finish loading.

## IDENTIFYING THE AUDIO UNIT



Depending on your vehicle options, the controls may look different from what you see here.

# Information and Entertainment Display Overview

## INFORMATION AND ENTERTAINMENT DISPLAY PRECAUTIONS



**WARNING:** Driving while distracted can result in loss of vehicle control, crash and injury. We strongly recommend that you use extreme caution when using any device that may take your focus off the road. Your primary responsibility is the safe operation of your vehicle. We recommend against the use of any hand-held device while driving and encourage the use of voice-operated systems when possible. Make sure you are aware of all applicable local laws that may affect the use of electronic devices while driving.

## INFORMATION AND ENTERTAINMENT DISPLAY LIMITATIONS

### Speed-restricted Features

For your safety, some functions of the system are speed-dependent. Their use is limited to when your vehicle is traveling at speeds under 3 mph (5 km/h). Make sure that you review your device's manual before using it with the system.

Some features of this system may be too difficult to use when your vehicle is moving so they are restricted from use unless your vehicle is stationary.

See the following chart for more specific examples.

Restricted Features	
System Functionality	Editing settings while the rear view camera or active park assist are active.
Wi-Fi	Editing Wi-Fi settings.
	Editing the list of wireless networks.
	Connecting to a new Wi-Fi network.

## STATUS BAR

The bar is on top of the display and indicates the status of your vehicle's features.



Cell phone microphone muted.



Audio system muted.



System update installed.



Wi-Fi connected.



Cell phone roaming.



Text message received.















Automatic crash notification system on.



Automatic crash notification system off.













# Information and Entertainment Display Overview

-  Cell phone battery status.
-  Wireless charger is active.
-  Cell phone network signal strength.
-  Vehicle data sharing on.
-  Vehicle data sharing off.
-  Vehicle location sharing on.
-  Vehicle data and vehicle location sharing on.
-  Vehicle system update activating.
-  Additional consent needed.
-  Vehicle system activation reminder.
-  Vehicle system update not successful.
-  Vehicle system update reminder.

## FEATURE BAR

The bar is on the bottom of the display and allows you to access vehicle features.



-  Select to use the radio, a USB, a media player or a Bluetooth device.

-  Select to adjust climate settings.
-  Select to make calls and access the phonebook on your cell phone.
-  Select to use the navigation system.
-  Select to view favorites.
-  Select to search for and use compatible apps on your iOS or Android device.
-  Select to adjust system settings.
-  Select to view features.
- 
- 
- 

**Note:** The icon may be different depending on your vehicle.

## INFORMATION ON DEMAND SCREEN - VEHICLES WITH: 12.3 INCH SCREEN

### [SYNC4 Basic Interactions](#)

-  Press the button to view the next Information on Demand screen.
-  Press the button to view the previous Information on Demand screen.
-  Press the button to view available cards.

# Voice Interaction

## WHAT IS VOICE INTERACTION

Voice Interaction allows you to control vehicle features using conversational requests.

## SETTING THE WAKE WORD

1. Press the Settings option on the feature bar.
2. Press the Voice Control button.
3. Switch on Listen for Wake Word.
4. Press Preferred Wake Word
5. Select a wake word.

## BEGINNING A VOICE INTERACTION

Say the selected wake word.



Press the voice interaction button on the steering wheel.

## VOICE INTERACTION EXAMPLES

### General Examples

Command	Result
Start Over.	The system resets the current voice interaction.
Cancel.	The system ends the current voice interaction.
Next Page.	The system goes to the next page.
Previous Page.	The system goes to the previous page.
Help.	The system displays a list of available commands you can use on the current screen.

### Entertainment Examples

Command	Result
Play The Beatles.	The system plays music by the selected artist.
Show music by The Beatles.	The system shows music by the selected artist.
Set the station to 101.9 FM.	The system tunes the radio to 101.9 FM.
Set the station to Sirius Channel 2.	The system tunes the radio to Sirius Channel 2.

# Voice Interaction

## Climate Examples

Command	Result
I am cold.	The system prompts you to change the temperature.
Set the temperature to 72°F (22°C).	The system sets the temperature to 72°F (22°C).

## Phone Examples

Command	Result
Call Henry.	The system calls Henry using your connected device.
Dial (phone number).	The system dials the selected phone number.
Send a text message to Henry.	The system begins a dictated text message.
Read my message from Henry.	The system reads you the most recent message from Henry.

## Apps Examples

Command	Result
Mobile Apps.	The system prompts you to say the name of an app to start it on the system.
List Mobile Apps.	The system will list all of the currently available Mobile Apps.
Find Mobile Apps	The system will search and connect to compatible app running on your mobile device.

## Navigation Examples

Command	Result
Drive to 1 American Road in Dearborn Michigan.	The system begins guided navigation to the address.
Show me directions to the Golden Gate Bridge.	The system shows directions to the selected POI.
Show me directions to Oakwood Boulevard and Pelham Road.	The system shows directions to the selected intersection.
Cancel route.	The system ends guided navigation to the destination.

# Phone

## PHONE PRECAUTIONS



**WARNING:** Driving while distracted can result in loss of vehicle control, crash and injury. We strongly recommend that you use extreme caution when using any device that may take your focus off the road. Your primary responsibility is the safe operation of your vehicle. We recommend against the use of any hand-held device while driving and encourage the use of voice-operated systems when possible. Make sure you are aware of all applicable local laws that may affect the use of electronic devices while driving.

## CONNECTING YOUR PHONE

Go to the settings menu on your cell phone and switch Bluetooth on.



Select the phone option on the feature bar.

1. Select **Add Phone**.

**Note:** A prompt alerts you to search for your vehicle on your cell phone.

2. Select your vehicle on your cell phone.

**Note:** A number appears on your cell phone and on the touchscreen.

3. Confirm that the PIN (personal identification number) on your cell phone matches the number on the touchscreen.

**Note:** The touchscreen indicates that you have successfully paired your cell phone.

4. Download the phonebook from your cell phone when you are prompted.

**Note:** If you pair more than one cell phone, use the phone settings to specify the primary phone. You can change this setting at any time.

## PHONE MENU

This menu becomes available after pairing a phone.

### **Recent Call List**

Display and select an entry from a list of previous calls.

### **Contacts**

Display a smart search form to look up your contacts. Use the List button to alphabetically sort your contacts.

### **Favorites**

Display the list of favorite contacts that are set up on your phone.

### **Phone List**

Display the list of paired or connected devices that you can select.

**Note:** Up to 12 devices can be stored.

### **Do Not Disturb**

Reject incoming calls and switch ring tones and alerts off.

### **Phone Keypad**

Directly dial a number.

# Phone

## MAKING AND RECEIVING A PHONE CALL

### Making Calls

#### To call a number in your contacts, select:

Menu Item	Action and Description
Contacts	You can then select the name of the contact you want to call. Any numbers stored for that contact display along with any stored contact photos. You can then select the number that you want to call. The system begins the call.

#### To call a number from your recent calls, select:

Menu Item	Action and Description
Recent Call List	You can then select an entry that you want to call. The system begins the call.

#### To call a number from your favorites, select:

Menu Item	Action and Description
Favorites	You can then select an entry that you want to call. The system begins the call.

#### To call a number that is not stored in your phone, select:

Menu Item	Action and Description
Phone Keypad	Select the digits of the number you wish to call.
Call	The system begins the call.

Pressing the backspace button deletes the last digit you typed.

### Receiving Calls

During an incoming call, an audible tone sounds. Caller information appears in the display if it is available.

#### To accept the call, select:

Menu Item
Accept

**Note:** You can also accept the call by pressing the phone button on the steering wheel.

#### To reject the call, select:

Menu Item
Reject

Ignore the call by doing nothing. The system logs it as a missed call.

### During a Phone Call

During a phone call, the contacts name and number display on the screen along with the call duration.

The phone status items are also visible:

- Signal Strength.
- Battery.

You can select any of the following during an active phone call:

# Phone

Item	
End Call	Immediately end a phone call. You can also press the button on the steering wheel.
Keypad	Press this to access the phone keypad.

Item	
Mute	You can switch the microphone off so the caller does not hear you.
Privacy	Transfer the call to the cell phone or back to the touch-screen.

## SENDING AND RECEIVING A TEXT MESSAGE

Menu Item	Description
Hear It	Hear the text message.
View	View the text message.
Call	Call the sender.
Reply	Reply to the text message with a standard text message.

## **SWITCHING TEXT MESSAGE NOTIFICATION ON AND OFF**

### **IOS**

1. Go to the settings menu on your cell phone.
2. Select Bluetooth.
3. Select the information icon to the right of your vehicle.
4. Switch text message notification on or off.

### **Android**

1. Go to the settings menu on your cell phone.
2. Select Bluetooth.
3. Select the profiles option.
4. Select the phone profile.
5. Switch text message notification on or off.

# Bluetooth®

## CONNECTING A BLUETOOTH® DEVICE

1. Make sure Bluetooth is enabled on your device.
2. Press **Settings** on the touchscreen.
3. Press **Connectivity**.
4. Press **Bluetooth**.
5. Press **Add a Bluetooth Device**.

**Note:** A prompt alerts you to search for your vehicle on your device.

6. Select your vehicle on your device.

**Note:** A number appears on your device and on the touchscreen.

7. Confirm that the number on your device matches the number on the touchscreen.

**Note:** The touchscreen indicates that you have successfully paired your device.

## PLAYING MEDIA USING BLUETOOTH®



**WARNING:** Driving while distracted can result in loss of vehicle control, crash and injury. We strongly recommend that you use extreme caution when using any device that may take your focus off the road. Your primary responsibility is the safe operation of your vehicle. We recommend against the use of any hand-held device while driving and encourage the use of voice-operated systems when possible. Make sure you are aware of all applicable local laws that may affect the use of electronic devices while driving.

Connect your device.



Press the audio button on the feature bar.

Press **Sources**.



Press the Bluetooth option.



Press to play a track. Press again to pause the track.



Press to skip to the next track.

Press and hold to fast forward through the track.



Press once to return to the beginning of a track. Repeatedly press to return to previous

tracks.

Press and hold to fast rewind through the track.



# Apps

## APP PRECAUTIONS



**WARNING:** Driving while distracted can result in loss of vehicle control, crash and injury. We strongly recommend that you use extreme caution when using any device that may take your focus off the road. Your primary responsibility is the safe operation of your vehicle. We recommend against the use of any hand-held device while driving and encourage the use of voice-operated systems when possible. Make sure you are aware of all applicable local laws that may affect the use of electronic devices while driving.

## APP REQUIREMENTS

When you start an app through the system for the first time, you could be asked to grant certain permissions. You can review and change the permissions that you have granted at any time when your vehicle is not moving. We recommend that you check your data plan before using your apps through the system. Using them could result in additional charges. We also recommend that you check the app provider's terms and conditions and privacy policy before using their app. Make sure that you have an active account for apps that you want to use through the system. Some apps will work with no setup. Others require you to configure some personal settings before you can use them.

## ACCESSING APPS



Select the apps option on the feature bar.

## ENABLING APPS ON AN IOS DEVICE



Select the apps option on the feature bar.

1. Select Mobile Apps Help.
2. Follow the instructions to pair and connect your device via Bluetooth or with a USB cable.
3. Start the apps on your device that you want to use.
4. Select the app that you want to use on the touchscreen.

**Note:** Some apps may run through Apple CarPlay if it is enabled.

**Note:** Closing an app on your device will close it on the touchscreen.

**Note:** For troubleshooting assistance select Mobile Apps List under Mobile Apps Help.

## ENABLING APPS ON AN ANDROID DEVICE



Select the apps option on the feature bar.

1. Select Mobile Apps Help.
2. Follow the instructions to pair and connect your device via Bluetooth or with a USB cable.
3. Start the apps on your device that you want to use.
4. Select **Find Mobile Apps**.
5. Select the app that you want to use on the touchscreen.

**Note:** Some devices may lose the ability to play music over USB when Mobile Apps are enabled.

**Note:** Some apps may run through Android Auto if it is enabled.

# Apps

**Note:** Closing an app on your device will close it on the touchscreen.

**Note:** For troubleshooting assistance select Mobile Apps List under Mobile Apps Help.

## SWITCHING APPLE CARPLAY ON AND OFF

### Enabling Apple CarPlay with USB

1. Connect your device to a USB port.
2. Follow the instructions on your device and the touchscreen.

**Note:** Selecting "Enable Wireless CarPlay" on your device will prepare the device for wireless carplay when you re-enter the vehicle.

### Enabling Apple CarPlay with Wireless

1. Pair your device to Bluetooth.
2. Follow the instructions on your device and the touchscreen.

### Disabling Apple CarPlay



Select the settings option on the feature bar.

1. Press Phone List.
2. Select your device from the list.
3. Press Disable.

### Re-Enabling Apple CarPlay



Select the settings option on the feature bar.

1. Press Phone List.
2. Select your device from the list.
3. Press Connect to Apple CarPlay.

## SWITCHING ANDROID AUTO ON AND OFF

### Enabling Android Auto with USB

(If Equipped)

1. Connect your device to a USB port.
2. Follow the instructions on the touchscreen.

**Note:** Certain features of the system are not available when you are using Android Auto.

### Enabling Android Auto with Wireless

1. Pair your device to Bluetooth.
2. Follow the instructions on your device and the touchscreen.

**Note:** Certain Android Devices do not support Android Auto Wireless. Please check your Android OS version for compatibility.

### Disabling Android Auto



Select the settings option on the feature bar.

1. Press Phone List.
2. Select your device from the list.
3. Press Disable.

### Re-Enabling Android Auto



Select the settings option on the feature bar.

1. Press Phone List.
2. Select your device from the list.
3. Press Connect to Android Auto.

# Personal Profiles (If Equipped)

---

## HOW DO PERSONAL PROFILES WORK

This feature allows you to create multiple personal profiles enabling users to personalize vehicle's settings such as seats and mirrors, as well as non-positional settings like radio, navigation, driver assist system settings. Positional settings are saved by holding a memory seat button. Non-positional settings are saved you change a setting while a profile is active. You can create one profile for each preset memory seat button along with a guest profile.

### Recalling and Changing a Profile

You can recall a profile using the touchscreen or the preset button you selected when you created your profile. You can also link a remote control and a mobile device to your profile, which are used to recall it.

## ENABLING OR DISABLING PERSONAL PROFILES

When you switch on the Personal Profiles feature:

- Unlocking a door with a remote control or mobile device that is not linked to a driver profile does not change the active profile, but remains in the last known profile. It does not change the positional settings.
- Pressing a memory seat button that is not linked to a driver profile or saved to a preset setting does not change the active profile, but remains in the last known profile. It does not change the positional settings.
- Pressing a memory seat button that is not linked to a driver profile but is saved to a preset setting does not change the active profile, but remains in the last known profile. It recalls the positional settings that you saved to that memory seat button.

When you switch off a Personal Profiles feature:

- Unlocking a door with a remote control or mobile device does not recall any non-positional settings but still recalls positional settings from the driver profile which the remote control or mobile device is linked to.
- Pressing a memory seat button that is not linked to a driver profile or saved to a preset setting recalls non-positional settings from the guest profile. It does not change the positional settings.
- Pressing a memory seat button that is linked to a driver profile or has saved to a preset setting recalls non-positional settings from the guest profile. It recalls the positional settings that you saved to that memory seat button.

## CREATING A PERSONAL PROFILE

Use the touchscreen to create a personal profile.

1. Switch the vehicle on and leave the vehicle in park (P).
2. Select the Personal Profiles button under Settings.
3. Follow the instructions on the display.

## LINKING OR UNLINKING A PERSONAL PROFILE TO A REMOTE CONTROL

You can save preset memory positions for up to three remote controls by assigning a remote control to a personal profile using the touchscreen.

Use the touchscreen to link a remote control to a personal profile.

1. Switch the vehicle on and leave the vehicle in park (P).
2. Select the Personal Profiles button under Settings.
3. Touch the arrow for the profile you wish to link to a remote control.
4. Select remote control.
5. Follow the instructions on the display.

**Note:** *If more than one linked remote control is in range, the memory function moves to the settings of the first key to initiate a memory recall.*

**Note:** *The guest profile consists of existing settings when there is no driver profile created. After you create a driver profile, the guest profile serves as an additional driver profile.*

**Note:** *You cannot link a remote control to a guest profile.*

# Navigation (If Equipped)

## ACCESSING NAVIGATION



Press the button to access Navigation.

**Note:** *As the driver, be aware of all local traffic regulations and road attributes, and operate your vehicle in a safe and legal manner.*

## NAVIGATION MAP UPDATES

To update your Map data over Wi-Fi, your vehicle must be connected to a Wi-Fi access point. For USB updates and other details, contact dealers at 1-866-462-8837 in the United States and Canada, or 01-800-557-5539 in Mexico.

**Note:** *If you find map data errors, you may report them by going to [www.here.com/mapcreator](http://www.here.com/mapcreator).*

## ADJUSTING THE MAP

### Zooming the Map In and Out

You can use pinch gestures to zoom in and out. Place two fingers on the screen and move them apart to zoom in. Place two fingers on the screen and bring them together to zoom out.

### Changing the Format of the Map



Press the Menu button.

1. Press the Map Orientation tile.
2. Select a map orientation.

## LIVE TRAFFIC

### What Is Live Traffic

You can observe real-time road congestion when live traffic is on.

### Switching Live Traffic On and Off



Press the Menu button.

1. Press the Traffic on Map tile.
2. Press Traffic on or Traffic Off.

## SETTING A DESTINATION

### Setting a Destination Using the Text Entry Screen

1. Press the search bar at the top of the screen.
2. Enter your destination using the keyboard.
3. Press Search.
4. Select a destination from the list.
5. Press Start to begin navigation.

### Setting a Destination Using the Map Screen

Press and hold on the map to place a pin at that location. Information about the location of the pin appears on the screen.



Press the button to begin navigation to the pin.

# Navigation (If Equipped)

## Setting a Destination Using a Predictive Destination

Press the predicted destination card on the screen to navigate to it. These appear when the navigation system has learned your driving habits.

## Setting a Destination Using a Recent Destination



Press the Menu button.

1. Press the Recents tile.
2. Select a destination from the list.

## Setting a Destination Using a Saved Destination



Press the Menu button.

1. Press Saved Places.
2. Select a saved destination.

**Note:** Press the star icon next when viewing location details to save the location.

## Setting a Destination Using a Point of Interest

Press and hold on a point of interest icon on the map. Information about the location of the point of interest appears on the screen.



Press the button to begin navigation to the point of interest.

## WAYPOINTS

### Adding a Waypoint



Press the Add Waypoint button when in an active navigation session.

1. Enter your waypoint on the keyboard.
2. Press Search.
3. Select a waypoint from the list.
4. Press Add to Trip.

### Editing Waypoints

1. Press the waypoint you would like to edit.
2. Select an option to reorder or delete the waypoint.

## ROUTE GUIDANCE

### Adjusting the Guidance Prompt Volume

Turn the volume control when a guidance prompt plays to adjust the volume.

### Repeating an Instruction

Press the turn indicator to hear the last voice instruction.

### Canceling Route Guidance



Press the button to cancel route guidance to the selected location.

## TRAILER TOWING NAVIGATION

When you have an active subscription and Trailer Towing Navigation is switched on, the system will calculate the best route for trailer towing by avoiding dangerous road conditions based on the dimensions of your trailer.

### Switching Trailer Towing Navigation On and Off

1. Press the **Navigation** button on the feature bar.
2. Press the **Menu** button.
3. Press **Trailer Routing**.
4. Switch **Trailer-optimized Routing** on or off.

### Entering Trailer Dimensions

1. Press the **Navigation** button on the feature bar.
2. Press the **Menu** button.
3. Press **Trailer Routing**.
4. Press **Towing Menu**.
5. Press **Add Trailer**.
6. Follow the instructions on the screen to enter the type and dimensions of the trailer into the system.

### Navigation Alerts

Alerts will appear on the navigation map while driving. An orange alert triangle indicates you should proceed with caution. When not following active guidance to a destination, a red alert triangle may appear and indicates you should avoid the road and find a detour.

# Vehicle System Updates

## UPDATING THE VEHICLE SYSTEMS WIRELESSLY

### [Over the Air Updates](#)



System software updates allow you to update your vehicle system software wirelessly. To make sure you receive all updates, set a recurring schedule and connect to Wi-Fi. Updates may take longer if not connected to Wi-Fi, or may not download at all.

### System Update Requirements

Before updating, reference this list to make sure your vehicle is ready to be updated. If these requirements are not met during a scheduled update, the update will be canceled and you can reschedule.

- Your vehicle is not running.
- Your vehicle is stopped.
- Your vehicle is parked.
- The hazard indicators are switched off.
- The alarm is not sounding.
- The doors are closed.
- The parking lights are switched off.
- You are not pressing the brake pedal.
- An emergency call is not in progress.
- Your vehicle is not in limp mode.

### Scheduling an Update

Make sure Vehicle Connectivity and Automatic Updates are switched on.

### Using the Settings Menu



Press the settings option on the feature bar.

1. Press the **System Update** tile.
2. Press **Schedule Update**.
3. Use the controls to set the time and day of the update.

4. Save the schedule.

**Note:** You can set the updates to occur every seven days.

### Using the Status Bar Icon



When an update is available, tap the notification icon and follow the prompts on the screen.

### Applying a Vehicle System Software Update

You can schedule a convenient time for the update to complete. During scheduled updates you may not be able to use your vehicle.

**Note:** Updates may take up to 30 minutes to complete.

You can see the progress of the update on the touchscreen. An update cannot be canceled once it has been started.

During an update you will not be able to drive your vehicle, start the vehicle, use remote controls to lock and unlock the vehicle. The alarm, central locks, and door tones are disabled. The electronic door lock will not function during an update. You can open the doors using the mechanical latch if child locks are not on. Pull the handle until it stops to use the mechanical latch.

**Note:** Double locking is switched off and central locking is switched on during and after an update.

**Note:** If your vehicle is plugged in, charging will stop during an update and resume when the update is complete.

### Viewing Update Details

If an update is successful, the touchscreen will provide additional details about the update. You can also access this information under the System Update tile.



# Vehicle System Updates

---

If an update is not successful, follow the prompt that appears on the touchscreen.

## PERFORMING A MASTER RESET



Press the settings option on the feature bar.

1. Press the **Reset** tile.
2. Press **Master Reset**.
3. Follow the prompts on the screen to complete the reset.

# Accessories

For a complete listing of the accessories that are available for your vehicle, please contact your authorized dealer or visit the online store web site:

<b>Web Address (United States)</b>
<a href="http://www.Accessories.Ford.com">www.Accessories.Ford.com</a>

<b>Web Address (Canada)</b>
<a href="http://www.Accessories.Ford.ca">www.Accessories.Ford.ca</a>

We will repair or replace any properly authorized dealer-installed Ford Original Accessory found to be defective in factory-supplied materials or workmanship during the warranty period, as well as any component damaged by the defective accessories.

We will warrant your Ford Original Accessory through the warranty that provides the greatest benefit:

- 24 months, unlimited mileage.
- The remainder of your new vehicle limited warranty.

Contact an authorized dealer for details and a copy of the warranty.

Ford Licensed Accessories are the accessory manufacturer's designs. The manufacturer develops and therefore warrants Ford Licensed Accessories, and does not design or test these accessories to Ford Motor Company engineering requirements. Contact an authorized Ford dealer for the manufacturer's limited warranty details, and request a copy of the Ford Licensed Accessories product limited warranty from the accessory manufacturer.

For maximum vehicle performance, keep the following information in mind when adding accessories or equipment to your vehicle:

- When adding accessories, equipment, passengers and luggage to your vehicle, do not exceed the total weight capacity of the vehicle or of the front or rear axle (GVWR or GAWR as indicated on the Safety Compliance Certification label). Ask an authorized dealer for specific weight information.
- The Federal Communications Commission (FCC) and Canadian Radio Telecommunications Commission (CRTC) regulate the use of mobile communications systems that are equipped with radio transmitters, for example two-way radios, telephones and theft alarms. Any such equipment installed in your vehicle should comply with Federal Communications Commission (FCC) and Canadian Radio Telecommunications Commission (CRTC) regulations and should be installed only by an authorized dealer.
- An authorized dealer needs to install mobile communications systems. Improper installation may harm the operation of your vehicle, particularly if the manufacturer did not design the mobile communication system specifically for automotive use.
- If you or an authorized Ford dealer add any non-Ford electrical or electronic accessories or components to your vehicle, you may adversely affect battery performance and durability. In addition, you may also adversely affect the performance of other electrical systems in the vehicle.

# Ford Protect

---

## WHAT IS FORD PROTECT

Protect yourself from the rising cost of vehicle repairs with a Ford Protect extended service plan.

### **Ford Protect Extended Service Plans - United States Only**

Ford Protect extended service plans mean peace of mind. Extended service plans are backed by Ford Motor Company, and provide more protection beyond the New Vehicle Limited Warranty coverage. When you visit your Ford Dealer, insist on the Ford Protect extended service plan.

### **Ford Protect Can Quickly Pay for Itself**

One trip to the service center could easily exceed the price of your Ford Protect extended service plan. With the Ford Protect extended service plan, you minimize your risk for unexpected repair bills and rising repair costs.

### **Up to 1,000+ Covered Vehicle Components**

There are four mechanical Ford Protect extended service plans with different levels of coverage. Ask your authorized dealer for details.

1. PremiumCARE - Our most comprehensive coverage. With over 1,000 covered components, this plan is so complete it is probably easier to list what is not covered.
2. ExtraCARE - Covers 113 components, and includes many high-tech items.
3. BaseCARE - Covers 84 components.
4. PowertrainCARE - Covers 29 critical components.

Ford Protect extended service plans are honored by all authorized Ford dealers in the United States, Canada and Mexico.

That means you get:

- Reliable, quality service at any Ford or Lincoln dealership.
- Repairs performed by factory trained technicians, using genuine parts.

### **Rental Car Reimbursement**

#### ***First Day Rental Benefit***

If you bring your car into your dealer for service, we will give you a rental vehicle to use for the day.

#### ***Extended Rental Benefits***

If your vehicle is kept overnight for covered repairs, you are eligible for rental car coverage, warranty repairs, and field service actions.

### **Roadside Assistance**

Exclusive 24/7 roadside assistance, including:

- Towing, flat-tire change and battery jump starts.
- Out of fuel and lock-out assistance.
- Travel expense reimbursement for lodging, meals and rental car.
- Assistance for taxi, shuttle, rental car coverage or other transportation.

### **Transferable Coverage**

If you sell your vehicle before your Ford Protect extended service plan coverage expires, you can transfer any remaining coverage to the new owner. This should give you and your potential buyer peace of mind.

# Ford Protect

---

## Less Cost to Properly Maintain Your Vehicle

The Ford Protect extended service plan also offers a Premium Maintenance Plan that covers all scheduled maintenance, and selected wear items. The coverage is prepaid, so you never have to worry about the cost of your vehicle's maintenance.

Covered maintenance includes:

- Windshield wiper blades.
- Spark plugs.
- The clutch disc (if equipped).
- Brake pads and linings.
- Shock absorbers.
- Struts.
- Engine belts.
- Engine coolant hoses, clamps and o-rings.
- Diesel exhaust fluid replenishment (if equipped).
- Cabin air filter replacement every 20,000 mi (32,000 km) for electric vehicles only.

## Interest Free Finance Options

Just a 5% down payment provides you with an affordable, no interest, no fee payment program allowing you all the security and benefits Ford Protect extended service plan has to offer while paying over time. You are pre-approved with no credit check or hassles. To learn more, call our Ford Protect extended service plan specialists at 800-367-3377.

Ford Protect Extended Service Plan  
P.O. Box 321067  
Detroit, MI 48232

## Ford Protect Extended Service Plan (Canada Only)

You can get more protection for your vehicle by purchasing a Ford Protect extended service plan. Ford Protect extended service plan is the only service contract backed by Ford Motor Company of Canada, Limited. Depending on the plan you purchase, Ford Protect extended service plan provides benefits such as:

- Rental reimbursement.
- Coverage for certain maintenance and wear items.
- Protection against repair costs after your New Vehicle Limited Warranty Coverage expires.
- Roadside Assistance benefits.

There are several Ford Protect extended service plans available in various time, distance and deductible combinations. Each plan is tailored to fit your own driving needs, including reimbursement for towing and rental. When you purchase Ford Protect extended service plan, you receive added peace-of-mind protection throughout Canada, the United States and Mexico, provided by a network of participating authorized Ford Motor Company dealers.

**Note:** *Repairs performed outside of Canada and the United States are not eligible for Ford Protect extended service plan coverage.*

This information is subject to change. Visit your local Ford of Canada dealer or [www.ford.ca](http://www.ford.ca) to find the Ford Protect extended service plan that is right for you.

# Scheduled Maintenance

---

## GENERAL MAINTENANCE INFORMATION

### Why Maintain Your Vehicle?

Carefully following the maintenance schedule helps protect against major repair expenses resulting from neglect or inadequate maintenance and may help to increase the value of your vehicle when you sell or trade it. Keep all receipts for completed maintenance with your vehicle.

It is important that you have your vehicle serviced at the proper times. These intervals serve two purposes: first is to maintain the reliability of your vehicle and the second is to keep the cost of owning your vehicle down.

It is your responsibility to have all scheduled maintenance performed and to make sure that the materials used meet the specifications identified in this owner's manual. See **Capacities and Specifications** (page 528).

Failure to perform scheduled maintenance and regularly inspect your vehicle may result in vehicle damage not covered by the vehicle Warranty.

### Why Maintain Your Vehicle at Your Dealership?

#### Our Genuine Replacement Parts

Dealerships stock our parts and our authorized branded re-manufactured replacement parts. These parts meet or exceed our specifications. Parts installed at your dealership carry a nationwide 24-month or unlimited mile (kilometer) parts and labor limited warranty.

If you do not use our authorized parts they may not meet our specifications and could affect emissions compliance.

### Protecting Your Investment

Maintenance is an investment that pays dividends in the form of improved reliability, durability and resale value. To maintain the proper performance of your vehicle and its emission control systems, make sure you have scheduled maintenance performed at the designated intervals.

Your vehicle comes with the Intelligent Oil-Life Monitor system, a message appears in the information display at the proper oil change interval. This interval may be up to one year or 10,000 mi (16,000 km), hybrid vehicles could exceed 10,000 mi (16,000 km).

When the oil change message appears in the information display, it is time for an oil change. Make sure you perform the oil change within two weeks or 500 mi (800 km) of the message appearing. Make sure to reset the Intelligent Oil-Life Monitor after each oil change. See **Resetting the Engine Oil Change Reminder** (page 463).

If your information display resets prematurely or becomes inoperative, you should perform the oil change interval at six months or 5,000 mi (8,000 km) from your last oil change. Never exceed one year or 10,000 mi (16,000 km) between oil change intervals.

You can drive high performance vehicles in such a way that may lead to higher oil consumption including extended time at high engine speeds, high loads, engine braking, hard cornering maneuvers, track and off-road usage. Under these conditions, oil consumption of approximately 1 quart per 500 miles (1 liter per 800 km) is possible. Check the engine oil level at every refueling and adjust to maintain proper levels to avoid engine damage.

# Scheduled Maintenance

It is important to rely upon your dealership to properly diagnose and repair your vehicle.

We strongly recommend only using our genuine or our authorized re-manufactured replacement parts engineered for your vehicle.

## Additives and Chemicals

We do not recommend using chemicals or additives not approved by us as part of your vehicle's normal maintenance. Please consult your warranty information.

## Oils, Fluids and Flushing

In many cases, fluid discoloration is a normal operating characteristic and, by itself, does not necessarily indicate a concern or that the fluid needs to be changed. Have discolored fluids that also show signs of overheating or foreign material contamination checked immediately.

Make sure to change the vehicle's oils and fluids at the specified intervals or in conjunction with a repair. Flushing is a viable way to change fluid for many vehicle sub-systems during scheduled maintenance. It is critical that systems are flushed only with new fluid that is the same as that required to fill and operate the system or using our approved flushing chemical.

## Owner Checks and Services

Make sure you perform the following basic maintenance checks and inspections.

<b>Check Every Month</b>
The air filter restriction gauge. <sup>1</sup>
The engine oil level.
Function of all interior and the exterior lights.
The tires including the spare for wear and proper pressure.
The windshield washer fluid level.
The fuel and water separator. Drain if necessary or if indicated by the information display. <sup>1</sup>
The holes and slots in the tail pipe to make sure they are functional and clear of debris. <sup>1</sup>

<sup>1</sup> Diesel vehicles only.

# Scheduled Maintenance

<b>Check Every Six Months</b>
The battery connections. Clean if necessary.
The body and door drain holes for obstructions. Clean if necessary.
The cooling system fluid level and the coolant system strength.
The door weatherstrips for wear. Lubricate if necessary.
The hinges, latches and outside locks for proper operation. Lubricate if necessary.
The parking brake for proper operation.
The seatbelts and seat latches for wear and function.
Safety warning lamps, brake, ABS, airbag and seatbelt for operation.
The washer spray and wiper operation. Clean or replace blades as necessary.

## Multi-Point Inspection

It is important to have the systems on your vehicle regularly checked. This can help identify potential issues and prevent major problems. We recommend having the following multi-point inspection performed at every scheduled maintenance interval to help make sure your vehicle keeps running great.

<b>Multi-Point Inspection</b>	
Accessory drive belt or belts	Hazard warning system operation
Battery performance	Horn operation
Engine air filter	Radiator, cooler, heater and air conditioning hoses
Exhaust system	Suspension components for leaks or damage
Exterior lamps operation	Steering and linkage
Fluid levels <sup>1</sup> ; fill if necessary	Tires including the spare for wear and proper pressure <sup>2</sup>

# Scheduled Maintenance

Multi-Point Inspection	
For oil and fluid leaks	Windshield for cracks, chips or pits
Half-shaft dust boots	Washer spray and wiper operation

<sup>1</sup> Brake, coolant recovery reservoir, automatic transmission and window washer.

<sup>2</sup> If your vehicle has a temporary mobility kit, check the tire sealant expiration Use By date on the canister. Replace as needed.

Be sure to ask your dealership service advisor or technician about the multi-point vehicle inspection. It is a comprehensive way to perform a thorough inspection of your vehicle. Your checklist gives you immediate feedback on the overall condition of your vehicle.

Your vehicle lets you know when an oil change is due by displaying a message in the information display.

The following table provides examples of vehicle use and its impact on oil change intervals. It is a guideline only. Actual oil change intervals depend on several factors and generally decrease with severity of use.

## NORMAL SCHEDULED MAINTENANCE

### Oil Change Reminder

Your vehicle comes with an oil change reminder that determines when you should change the engine oil based on how you use your vehicle.

When to Expect the OIL CHANGE REQUIRED Message	
Interval <sup>1</sup>	Vehicle Use and Example
7,500–10,000 mi (12,000–16,000 km)	<b>Normal</b>
	Normal commuting with highway driving. No, or moderate, load or towing. Flat to moderately hilly roads. No extended idling.
5,000–7,500 mi (8,000–12,000 km)	<b>Severe</b>
	Moderate to heavy load or towing. Mountainous or off-road conditions. Extended idling. Extended hot or cold operation.



# Scheduled Maintenance

<b>When to Expect the OIL CHANGE REQUIRED Message</b>	
<b>Interval<sup>1</sup></b>	<b>Vehicle Use and Example</b>
3,000–5,000 mi (5,000–8,000 km)	<b>Extreme</b>
	Maximum load or towing. Extreme hot or cold operation.

<sup>1</sup>Hybrid vehicles may achieve longer distances between oil changes, but do not exceed the 1 year max oil change interval. Remaining oil life can be accessed through the information display.

# Scheduled Maintenance

## Normal Maintenance Intervals

<b>At Every Oil Change Interval as Indicated by the Information Display <sup>1</sup></b>
Change the engine oil and filter. <sup>2</sup>
Rotate the tires, inspect tire wear and measure the tread depth.
Perform a multi-point inspection, recommended.
Inspect the automatic transmission fluid level, if applicable with dipstick. Consult your dealer for requirements.
Inspect the brake pads, shoes, rotors, drums, brake linings, hoses and the parking brake.
Inspect the engine coolant system strength and hoses.
Inspect the exhaust system and heat shields.
Inspect the front axle and U-joints. Lubricate grease fittings if applicable. <sup>3</sup>
Inspect the half-shaft boots.
Inspect the steering linkage, ball joints, suspension, tire-rod ends, driveshaft and the U-joints. Lubricate any areas with grease fittings.
Inspect the wheels and related components for abnormal noise, wear, looseness or drag.
Fuel and water separator. Drain if necessary or if indicated by the information display. <sup>4</sup>
Refill the diesel exhaust fluid tank. <sup>4</sup>
Inspect the air filter restriction gauge. Replace the filter if necessary. <sup>4</sup>

<sup>1</sup> Do not exceed one year or 10,000 mi (16,000 km) between service intervals.

<sup>2</sup> Reset the oil change reminder after engine oil and filter changes. See **Resetting the Engine Oil Change Reminder** (page 463).

<sup>3</sup> Four-wheel drive vehicles only.

<sup>4</sup> Diesel vehicles only.

# Scheduled Maintenance

<b>Brake Fluid Maintenance<sup>1</sup></b>	
Every 3 Years	Change the brake fluid. <sup>2</sup>

<sup>1</sup> Perform this maintenance item every 3 years. Do not exceed the designated time for the interval.

<sup>2</sup> Brake fluid servicing requires special equipment available at your authorized dealer.

<b>Other Maintenance Items<sup>1</sup></b>	
Every 20,000 mi (32,000 km)	Replace the cabin air filter.
Every 30,000 mi (48,000 km)	Replace the engine air filter.
	Replace the engine-mounted and frame-mounted fuel filters. <sup>2</sup>
Every 55,000 mi (88,500 km)	Replace the spark plugs. <sup>3</sup>
Every 60,000 mi (96,600 km)	Inspect the accessory drive belt(s). <sup>3</sup>
Every 100,000 mi (160,000 km)	Replace the accessory drive belt(s). <sup>3</sup>
Every 100,000 mi (160,000 km)	Replace the spark plugs.
	Inspect the accessory drive belt(s). <sup>4</sup>
Every 150,000 mi (240,000 km)	Change the automatic transmission fluid and filter. <sup>5</sup>
	Change the front axle fluid. <sup>6</sup>
	Change the rear axle fluid.
	Change the transfer case fluid. <sup>6</sup>
	Replace the accessory drive belt(s).
	Replace the fuel pump drive belt. <sup>2</sup>

# Scheduled Maintenance

Other Maintenance Items <sup>1</sup>	
	Replace the timing belt. <sup>2</sup>
At 200,000 mi (322,000 km)	Change the engine coolant. <sup>7</sup>

<sup>1</sup> Perform these maintenance items within 3,000 mi (4,800 km) of the last engine oil and filter change. Do not exceed the designated distance for the interval.

<sup>2</sup> Diesel vehicles only.

<sup>3</sup> Only for vehicles with pickup bed power outlet.

<sup>4</sup> After initial inspection, inspect every other oil change until replaced.

<sup>5</sup> Non-hybrid vehicles only.

<sup>6</sup> Four-wheel drive vehicles only.

<sup>7</sup> Initial replacement at 10 years or 200,000 mi (322,000 km), then every five years or 100,000 mi (160,000 km).

## SPECIAL OPERATING CONDITIONS SCHEDULED MAINTENANCE - DIESEL

If you operate your vehicle primarily in any of the following conditions, you need to perform extra maintenance, as indicated. If you operate your vehicle occasionally under any of these conditions, it is not necessary to perform the extra maintenance. For specific recommendations, see your dealership service advisor or technician.

Perform the services shown in the following tables when specified or within 3,000 mi (4,800 km) of the oil change required message appearing in the information display.

- Example 1: The message comes on at 28,751 mi (46,270 km). Perform the 30,000 mi (48,000 km) automatic transmission fluid replacement.
- Example 2: The message has not come on, but the odometer reads 30,000 mi (48,000 km), for example, the oil change reminder was reset at 25,000 mi (40,000 km). Perform the engine air filter replacement.

Towing a Trailer or Using a Car-Top Carrier	
As required	Change the engine oil and filter as indicated by the information display, and perform the services listed in the scheduled maintenance chart.
	See the axle maintenance items under Exceptions.
Inspect frequently, service as required	Inspect and lubricate the U-joints.
See the axle maintenance items under Exceptions.	Replace the engine-mounted and frame-mounted fuel filters.

## Scheduled Maintenance

<b>Towing a Trailer or Using a Car-Top Carrier</b>	
Every 30,000 mi (48,000 km) or 1200 engine hours	Inspect the engine and cooling system coolant concentration and freeze-point protection.
Every 60,000 mi (96,000 km) or 2400 engine hours	Flush and refill the coolant. Do not add coolant additive.

**Note:** After the initial coolant flush and fill at 60,000 mi (96,000 km) or 2400 engine hours, flush and fill every 45,000 mi (72,000 km) or 1800 engine hours thereafter.

<b>Frequent or Extended Idling - Over 10 Minutes Per Hour of Normal Driving or Frequent Low-Speed Operation if you use your Vehicle for Stationary Operation</b>	
As required	Change the engine oil and filter as indicated by the information display, and perform the services listed in the scheduled maintenance chart.
Inspect frequently, service as required	Inspect the air filter restriction gauge. Replace the filter if necessary
Every 30,000 mi (48,000 km), six months or 600 engine hours	Replace the engine-mounted and frame-mounted fuel filters.
Every 30,000 mi (48,000 km) or 1200 engine hours	Inspect the engine and cooling system coolant concentration and freeze-point protection.
Every 60,000 mi (96,000 km) or 2400 engine hours	Flush and refill the coolant. Do not add coolant additive.

**Note:** After the initial coolant flush and fill at 60,000 mi (96,000 km) or 2400 engine hours, flush and fill every 45,000 mi (72,000 km) or 1800 engine hours thereafter.

## Scheduled Maintenance

<b>Frequent Low-Speed Operation, Consistent Heavy Traffic Under 25 mph (40 km/h) or Long Rush-Hour Traffic</b>	
As required	Change the engine oil and filter as indicated by the information display, and perform the services listed in the scheduled maintenance chart.
Inspect frequently, service as required	Inspect the air filter restriction gauge. Replace the filter if necessary
Every 30,000 mi (48,000 km), six months or 600 engine hours	Replace the engine-mounted and frame-mounted fuel filters.
Every 30,000 mi (48,000 km) or 1200 engine hours	Inspect the engine and cooling system coolant concentration and freeze-point protection.
Every 60,000 mi (96,000 km) or 2400 engine hours	Flush and refill the coolant. Do not add coolant additive.

**Note:** After the initial coolant flush and fill at 60,000 mi (96,000 km) or 2400 engine hours, flush and fill every 45,000 mi (72,000 km) or 1800 engine hours thereafter.

<b>Sustained High-Speed Driving at Gross Vehicle Weight Rating - Maximum Loaded Weight for Vehicle Operation</b>	
As required	Change the engine oil and filter as indicated by the information display, and perform the services listed in the scheduled maintenance chart.
Every 30,000 mi (48,000 km), six months or 600 engine hours	Replace the engine-mounted and frame-mounted fuel filters.
Every 30,000 mi (48,000 km) or 1200 engine hours	Inspect the engine and cooling system coolant concentration and freeze-point protection.
Every 60,000 mi (96,000 km) or 2400 engine hours	Flush and refill the coolant. Do not add coolant additive.

**Note:** After the initial coolant flush and fill at 60,000 mi (96,000 km) or 2400 engine hours, flush and fill every 45,000 mi (72,000 km) or 1800 engine hours thereafter.

## Scheduled Maintenance

<b>Operating in Sustained Ambient Temperatures Below -9°F (-23°C) or Above 100°F (38°C)</b>	
As required	Change the engine oil and filter as indicated by the information display, and perform the services listed in the scheduled maintenance chart.
Every 30,000 mi (48,000 km), six months or 600 engine hours	Replace the engine-mounted and frame-mounted fuel filters.

<b>Operating in Dusty or Sandy Conditions - Such as Unpaved or Dusty Roads</b>	
Every 5,000 mi (8,000 km)	Inspect the wheels and related components for abnormal noise, wear, looseness or drag.
Every 7,500 mi (12,000 km)	Rotate the tires, inspect the tires for wear and measure the tread depth.
	Inspect the brake system pads and rotors.
	Inspect the air filter restriction gauge. Replace the filter if necessary.
Every 7,500 mi (12,000 km), six months or 300 engine hours	Inspect the steering and suspension ball joints and tie rods. Lubricate any grease fittings.
	Change the engine oil and filter. <sup>1</sup>
	Inspect and lubricate the U-joints.
Every 30,000 mi (48,000 km), 6 months or 600 engine hours	Replace the engine-mounted and frame-mounted fuel filters.
Every 30,000 mi (48,000 km)	Replace the air inlet foam filter.

<sup>1</sup> Reset the oil change reminder after engine oil and filter changes. See **Resetting the Engine Oil Change Reminder** (page 463).

# Scheduled Maintenance

Off-Road Operation	
Every 5,000 mi (8,000 km)	Inspect the wheels and related components for abnormal noise, wear, looseness or drag.
As required	Inspect functional holes in exhaust tip to make sure they are clean and clear of debris or foreign materials. See <b>Vehicle Care</b> (page 486).
	Inspect the steering and suspension ball joints and tie rods. Lubricate any grease fittings.
Every 7,000 mi (12,000 km), six months or 300 engine hours	Rotate the tires, inspect the tires for wear and measure tread depth.
	Inspect the brake system pads and rotors.
	Inspect the air filter restriction gauge. Replace the filter if necessary.
Every 7,000 mi (12,000 km) or 300 engine hours	Change the engine oil and filter. <sup>1</sup>
Every 30,000 mi (48,000 km), six months or 600 engine hours	Replace the engine-mounted and frame-mounted fuel filters.
Every 30,000 mi (48,000 km)	Replace the air inlet foam filter.

<sup>1</sup> Reset the oil change reminder after engine oil and filter changes. See **Resetting the Engine Oil Change Reminder** (page 463).

Using Biodiesel, Up to and Including 20% Biodiesel (B20)	
As required	Change the engine oil and filter as indicated by the information display, and perform the services listed in the scheduled maintenance chart.
Every 30,000 mi (48,000 km), six months or 300 engine hours	Replace the engine-mounted and frame-mounted fuel filters.

## Exceptions

There are several exceptions to the Normal Schedule.



# Scheduled Maintenance

---

## Axle and Transfer Case Maintenance

Axle(s) and transfer case, four-wheel drive vehicles, fluid changes or level checks are not required unless a leak is suspected, or the assembly has been submerged in water. Contact an authorized dealer for service.

## California Fuel Filter Replacement

If you register your vehicle in California, the California Air Resources Board has determined that the failure to perform this maintenance item does not nullify the emission warranty or limit recall liability before the completion of your vehicle's useful life. Ford Motor Company, however, urges you to have all recommended maintenance services performed at the specified intervals and to record all vehicle service.

## Hot Climate Oil Change Intervals

For vehicles operating in the Middle East, North Africa, Sub-Saharan Africa or locations with similar climates using an oil that meets our specification or has an American Petroleum Institute (API) Certified for Gasoline Engines (Certification mark) oil, the normal oil change interval is 3,000 mi (4,800 km).

## Engine Air Filter Replacement

The life of the engine air filter is dependent on exposure to dusty and dirty conditions. Vehicles operated in these conditions require frequent inspection and replacement of the engine air filter.

## Diesel Particulate Filter

Over time, a slight amount of ash builds up in the diesel particulate filter, which is not removed during the regeneration process. The filter may need to be replaced with a new or remanufactured part at approximately 250,000 mi (400,000 km). Actual mileage varies depending on engine and vehicle operating conditions.

In this case, the engine control system sets a service light, a wrench icon, to inform you to bring your vehicle to the dealer for service. If there are any issues with the oxidation catalyst or particulate filter system, the engine control system sets a service light, a wrench or engine icon, to inform you to bring your vehicle to the dealer for service.

## SPECIAL OPERATING CONDITIONS SCHEDULED MAINTENANCE - GASOLINE

If you operate your vehicle primarily in any of the following conditions, you need to perform extra maintenance, as indicated. If you operate your vehicle occasionally under any of these conditions, it is not necessary to perform the extra maintenance. For specific recommendations, see your dealership service advisor or technician.

Perform the services shown in the following tables when specified or within 3,000 mi (4,800 km) of the oil change required message appearing in the information display.

## Scheduled Maintenance

- Example 1: The message comes on at 28,751 mi (46,270 km). Perform the 30,000 mi (48,000 km) automatic transmission fluid replacement.
- Example 2: The message has not come on, but the odometer reads 30,000 mi (48,000 km), for example, the oil change reminder was reset at 25,000 mi (40,000 km). Perform the engine air filter replacement.

<b>Towing a Trailer or Using a Car-top Carrier</b>	
As required	Change the engine oil and filter as indicated by the information display and perform services listed in the Normal Scheduled Maintenance chart.
Inspect frequently, service as required	Inspect and lubricate the U-joints.
	See the axle maintenance items under Exceptions.
Every 60,000 mi (96,000 km)	Replace the spark plugs.

<b>Extensive Idling or Low-speed Driving for Long Distances, as in Heavy Commercial Use, such as Delivery, Taxi, Patrol Car or Livery</b>	
As required	Change the engine oil and filter as indicated by the information display and perform services listed in the Normal Scheduled Maintenance chart.
Inspect frequently, service as required	Replace the engine air filter.
Every 60,000 mi (96,000 km)	Replace the spark plugs.

## Scheduled Maintenance

<b>Operating in Dusty or Sandy Conditions, such as Unpaved or Dusty Roads</b>	
Inspect frequently, service as required	Replace the engine air filter.
Every 5,000 mi (8,000 km)	Inspect the wheels and related components for abnormal noise, wear, looseness or drag.
	Rotate the tires, inspect tires for wear and measure the tread depth.
Every 5,000 mi (8,000 km) or six months	Change the engine oil and filter. <sup>1</sup>

<sup>1</sup>Reset your oil change reminder after each engine oil and filter change. See **Resetting the Engine Oil Change Reminder** (page 463).

<b>Off-road Operation</b>	
Inspect frequently, service as required	Inspect the steering linkage, ball joints and the U-joints. Lubricate grease fittings, if applicable.
	Replace the engine air filter.
Every 5,000 mi (8,000 km) or six months	Change the engine oil and filter. <sup>1</sup>
	Inspect the wheels and related components for abnormal noise, wear, looseness or drag.
	Rotate the tires, inspect tires for wear and the measure the tread depth.

<sup>1</sup>Reset your oil change reminder after each engine oil and filter change. See **Resetting the Engine Oil Change Reminder** (page 463).

<b>Exclusive Use of E85 - Flex Fuel Vehicles Only</b>	
Every oil change interval	If ran exclusively on E85, fill the fuel tank full with regular unleaded fuel.

### Exceptions

There are several exceptions to the Normal Schedule.

# Scheduled Maintenance

---

## **Axle and Transfer Case Maintenance**

Axle(s) and transfer case, four-wheel drive vehicles, fluid changes or level checks are not required unless a leak is suspected or the assembly has been submerged in water. Contact an authorized dealer for service.

## **California Fuel Filter Replacement**

If you register your vehicle in California, the California Air Resources Board has determined that the failure to perform this maintenance item does not nullify the emission warranty or limit recall liability before the completion of your vehicle's useful life. Ford Motor Company, however, urges you to have all recommended maintenance services performed at the specified intervals and to record all vehicle service.

## **Hot Climate Oil Change Intervals**

Vehicles operating in the Middle East, North Africa, Sub-Saharan Africa or locations with similar climates using an oil that meets our specification or has an American Petroleum Institute (API) Certified for Gasoline Engines (Certification mark) oil, the normal oil change interval is 3,000 mi (4,800 km).

## **Engine Air Filter Replacement**

The life of the engine air filter is dependent on exposure to dusty and dirty conditions. Vehicles operated in these conditions require frequent inspection and replacement of the engine air filter.

# Customer Information

## ROLLOVER WARNING



**WARNING:** Utility vehicles have a significantly higher rollover rate than other types of vehicles.



**WARNING:** Vehicles with a higher center of gravity (utility and four-wheel drive vehicles) handle differently than vehicles with a lower center of gravity (passenger cars). Avoid sharp turns, excessive speed and abrupt steering in these vehicles. Failure to drive cautiously increases the risk of losing control of your vehicle, vehicle rollover, personal injury and death.



**WARNING:** In a rollover crash, an unbelted person is significantly more likely to die than a person wearing a seatbelt.



**WARNING:** Do not become overconfident in the ability of four-wheel drive vehicles. Although a four-wheel drive vehicle may accelerate better than a two-wheel drive vehicle in low traction situations, it won't stop any faster than two-wheel drive vehicles. Always drive at a safe speed.

Utility vehicles and trucks handle differently than passenger cars in the various driving conditions that are encountered on streets, highways and off-road. Utility vehicles and trucks are not designed for cornering at speeds as high as passenger cars any more than low-slung sports cars are designed to perform satisfactorily under off-road conditions.

## THE BETTER BUSINESS BUREAU AUTO LINE PROGRAM - UNITED STATES OF AMERICA

Your satisfaction is important to Ford Motor Company and to your dealer. If a warranty concern has not been resolved using the three-step procedure outlined earlier in this chapter in the Getting the Services you need section, you may be eligible to participate in the BBB AUTO LINE program.

The BBB AUTO LINE program consists of two parts – mediation and arbitration. During mediation, a representative of the BBB will contact both you and Ford Motor Company to explore options for settlement of the claim. If an agreement is not reached during mediation or you do not want to participate in mediation, and if your claim is eligible, you may participate in the arbitration process. An arbitration hearing will be scheduled so that you can present your case in an informal setting before an impartial person. The arbitrator will consider the testimony provided and make a decision after the hearing.

Disputes submitted to the BBB AUTO LINE program are usually decided within forty days after you file your claim with the BBB. You are not bound by the decision, and may reject the decision and proceed to court where all findings of the BBB Auto Line dispute, and decision, are admissible in the court action. Should you choose to accept the BBB AUTO LINE decision, Ford is then bound by the decision, and must comply with the decision within 30 days of receipt of your acceptance letter.

## Customer Information

---

BBB AUTO LINE Application: Using the information provided below, please call or write to request a program application. You will be asked for your name and address, general information about your new vehicle, information about your warranty concerns, and any steps you have already taken to try to resolve them. A Customer Claim Form will be mailed that will need to be completed, signed and returned to the BBB along with proof of ownership. Upon receipt, the BBB will review the claim for eligibility under the Program Summary Guidelines.

**You can get more information by calling BBB AUTO LINE at 1-800-955-5100, or writing to:**

**BBB AUTO LINE  
3033 Wilson Boulevard, Suite 600  
Arlington, Virginia 22201**

BBB AUTO LINE applications can also be requested by calling the Ford Motor Company Customer Relationship Center at 1-800-392-3673.

For additional information refer to the Better Business Bureau website.

**Note:** *Ford Motor Company reserves the right to change eligibility limitations, modify procedures, or to discontinue this process at any time without notice and without obligation.*

### **THE MEDIATION AND ARBITRATION PROGRAM - CANADA**

For vehicles delivered to authorized Canadian dealers. In those cases where you continue to feel that the efforts by Ford of Canada and the authorized dealer to resolve a factory-related vehicle service concern have been unsatisfactory, Ford of Canada participates in an impartial third party mediation/arbitration program administered by the Canadian Motor Vehicle Arbitration Plan (CAMVAP).

The CAMVAP program is a straightforward and relatively speedy alternative to resolve a disagreement when all other efforts to produce a settlement have failed. This procedure is without cost to you and is designed to eliminate the need for lengthy and expensive legal proceedings.

In the CAMVAP program, impartial third-party arbitrators conduct hearings at mutually convenient times and places in an informal environment. These impartial arbitrators review the positions of the parties, make decisions and, when appropriate, render awards to resolve disputes. CAMVAP decisions are fast, fair, and final as the arbitrator's award is binding on both you and Ford of Canada.

CAMVAP services are available in all Canadian territories and provinces. For more information, without charge or obligation, call your CAMVAP Provincial Administrator directly at 1-800-207-0685 or visit [www.camvap.ca](http://www.camvap.ca).

### **ORDERING A CANADIAN FRENCH OWNER'S MANUAL**

You can obtain a French owner's manual from an authorized dealer or by contacting Helm, LLC at:

## Customer Information

---

HELM, LLC  
47911 Halyard Drive, Suite 200  
Plymouth, Michigan 48170  
Attention: Customer Service

Call toll free: 1-800-782-4356

Monday-Friday 8:00 a.m. - 6:00 p.m. EST

For additional information, visit  
[www.helminc.com](http://www.helminc.com).

### **REPORTING SAFETY DEFECTS IN THE UNITED STATES**

If you believe that your vehicle has a defect which could cause a crash or could cause injury or death, you should immediately inform the National Highway Traffic Safety Administration (NHTSA) in addition to notifying Ford Motor Company.

If NHTSA receives similar complaints, it may open an investigation, and if it finds that a safety defect exists in a group of vehicles, it may order a recall and remedy campaign. However, NHTSA cannot become involved in individual problems between you, your dealer, or Ford Motor Company.

To contact NHTSA, you may call the Vehicle Safety Hotline toll-free at 1-888-327-4236 (TTY: 1-800-424-9153); go to [www.safercar.gov](http://www.safercar.gov); or write to:

Administrator

1200 New Jersey Avenue,  
Southeast

Washington, D.C. 20590

You can also obtain other information about motor vehicle safety from [www.safercar.gov](http://www.safercar.gov).

### **REPORTING SAFETY DEFECTS IN CANADA**

If you believe that your vehicle has a defect which could cause a crash or could cause injury or death, you should immediately inform Transport Canada and Ford of Canada.

<b>Transport Canada Contact Information</b>	
Website	<a href="http://www.tc.gc.ca/eng/motorvehiclesafety/reporting-defects-motor-vehicles.html">http://www.tc.gc.ca/eng/motorvehiclesafety/reporting-defects-motor-vehicles.html</a> (English)
Website	<a href="http://www.tc.gc.ca/fra/securiteautomobile/signaler-defauts-vehicules-automobiles.html">http://www.tc.gc.ca/fra/securiteautomobile/signaler-defauts-vehicules-automobiles.html</a> (French)
Phone	1-800-333-0510

# Customer Information

---

<b>Ford of Canada Contact Information</b>	
Website	<a href="http://www.ford.ca">www.ford.ca</a>
Phone	1-800-565-3673



# Customer Information

## TYPE APPROVALS

### Radio Frequency Certifications for Blind Spot Information System

#### Argentina



#### South Korea



#### Ukraine



#### United States and Canada



**WARNING:** Changes or modifications not expressly approved by the party responsible for compliance could void the user's authority to operate the equipment. The term "IC:" before the radio certification number only signifies that Industry Canada technical specifications were met.

FCC ID: L2CF5TR

IC: 3432A-F5TR

This device complies with Part 15 of the FCC Rules and with Innovation, Science and Economic Development Canada's licence-exempt RSS(s). Operation is subject to the following two conditions:

1. This device may not cause harmful interference, and
2. This device must accept any interference received, including interference that may cause undesired operation.

### Radio Frequency Certifications for Body Control Module

#### Argentina



# Customer Information

## European Union EU



## Taiwan



## South Korea



## United States and Canada

**WARNING:** Changes or modifications not expressly approved by the party responsible for compliance could void the user's authority to operate the equipment. The term "IC:" before the radio certification number only signifies that Industry Canada technical specifications were met.

FCC ID: M3NA2C766336

IC: 7812A-A2C766336

This device complies with Part 15 of the FCC Rules and with Innovation, Science and Economic Development Canada's licence-exempt RSS(s). Operation is subject to the following two conditions:

1. This device may not cause harmful interference, and
2. This device must accept any interference received, including interference that may cause undesired operation.

## Radio Frequency Certifications for Cruise Control Module

### Argentina



# Customer Information

## United States and Canada



**WARNING:** Changes or modifications not expressly approved by the party responsible for compliance could void the user's authority to operate the equipment. The term "IC:" before the radio certification number only signifies that Industry Canada technical specifications were met.

FCC ID: L2CF3TR

IC: 3432A-F3TR

This device complies with Part 15 of the FCC Rules and with Innovation, Science and Economic Development Canada's licence-exempt RSS(s). Operation is subject to the following two conditions:

1. This device may not cause harmful interference, and
2. This device must accept any interference received, including interference that may cause undesired operation.

## Radio Frequency Certifications for Integrated Keyhead Transmitter

### Paraguay



NR: 2017-10-I-0000334

NR: 2018-07-I-000317

## Pakistan



## United Arab Emirates (U.A.E.)

TRA

REGISTERED No. ER37535/15

DEALER No.: DA37380/15

TRA

REGISTERED No. ER49357/16

DEALER No.: DA37380/15

## United States and Canada



**WARNING:** Changes or modifications not expressly approved by the party responsible for compliance could void the user's authority to operate the equipment. The term "IC:" before the radio certification number only signifies that Industry Canada technical specifications were met.

FCC ID: N5F-A08TAA

FCC ID: N5F-A08TDA

IC: 3248A-A08TAA

# Customer Information

This device complies with Part 15 of the FCC Rules and with Innovation, Science and Economic Development Canada's licence-exempt RSS(s). Operation is subject to the following two conditions:

1. This device may not cause harmful interference, and
2. This device must accept any interference received, including interference that may cause undesired operation.

## Radio Frequency Certifications for Passive Anti-Theft System

### Argentina



### Brazil



0106-14-03199

Este equipamento opera em caráter secundário, isto é, não tem direito a proteção contra interferência prejudicial, mesmo de estações do mesmo tipo, e não pode causar interferência a sistemas operando em caráter primário.

### Djibouti

AGREE PAR LE MCPT (REPUBLIQUE DE DJIBOUTI)  
Numéro d'agrément: 243/MCPT/SC/16  
Date d'agrément: 23/05/16

### Ghana

NCA APPROVED: NCA/TA/16/22

### Indonesia

SERTIFIKAT NOMOR : 44714/SDPPI/2016  
PLG ID: 4941

### Jamaica

This product has been Type Approved by Jamaica: SMA – OUC11545917

### Jordan

Type Approval No.: TRC/LPD/2013/235  
Equipment Type: Low Power Device (LPD)

# Customer Information

---

## Malaysia



CIDF18000209

## Mauritania

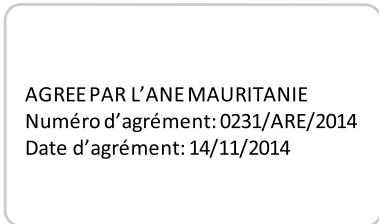

## Moldova



## Morocco



## Pakistan



## Paraguay



# Customer Information

---

## Serbia



## South Korea



MSIP-RRM-OAC-OUC11541917

## Singapore

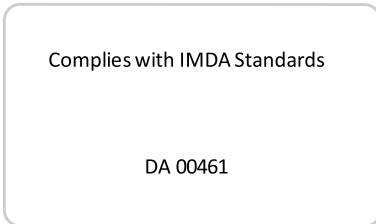

## Syria

SyTRA

REGISTERED No:

1510/4NK

## Taiwan

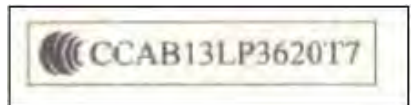

## South Africa



# Customer Information

## Ukraine



## Vietnam



## United Arab Emirates (U.A.E.)

TRA

REGISTERED No: ER49115/16

DEALER No: DA37380/15

## United States and Canada



**WARNING:** Changes or modifications not expressly approved by the party responsible for compliance could void the user's authority to operate the equipment. The term "IC:" before the radio certification number only signifies that Industry Canada technical specifications were met.

FCC ID: OUC11545917

IC: 850K-11545917

This device complies with Part 15 of the FCC Rules and with Innovation, Science and Economic Development Canada's licence-exempt RSS(s). Operation is subject to the following two conditions:

1. This device may not cause harmful interference, and
2. This device must accept any interference received, including interference that may cause undesired operation.

## Radio Frequency Certifications for Passive Entry/Passive Start Remote Control

## European Union EU

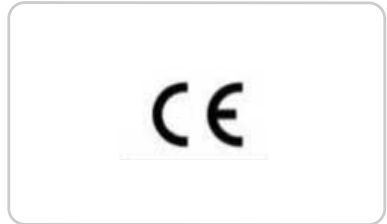

## United States and Canada



**WARNING:** Changes or modifications not expressly approved by the party responsible for compliance could void the user's authority to operate the equipment. The term "IC:" before the radio certification number only signifies that Industry Canada technical specifications were met.

FCC ID: M3N-A3C054338

# Customer Information

---

FCC ID: M3N-A3C054339

IC: 7812A-A3C054338

IC: 7812A-A3C054339

This device complies with Part 15 of the FCC Rules and with Innovation, Science and Economic Development Canada's licence-exempt RSS(s). Operation is subject to the following two conditions:

1. This device may not cause harmful interference, and
2. This device must accept any interference received, including interference that may cause undesired operation.

## Radio Frequency Certifications for Passive Key

### Argentina



### Brazil



02444-16-01821

**Este equipamento não tem direito à proteção contra interferência prejudicial e não pode causar interferência em sistemas devidamente autorizados.**

### Jamaica

This product has been Type Approved by Jamaica: SMA – M3N-A2C931423



# Customer Information

## Pakistan

Pakistan Telecommunication Authority



Approved by PTA 2016

 CCAB16LP384DT9

## Paraguay



NR: 2016-9-I-000220

NR: 2016-9-I-000223

## Taiwan

 CCAB16LP284CT7

## United Arab Emirates (U.A.E.)

TRA

REGISTERED No. ER47690/16

DEALER No.: DA37380/15

TRA

REGISTERED No. ER46754/16

DEALER No.: DA37380/15

## United States and Canada



**WARNING:** Changes or modifications not expressly approved by the party responsible for compliance could void the user's authority to operate the equipment. The term "IC:" before the radio certification number only signifies that Industry Canada technical specifications were met.

FCC ID: M3N-A2C931423

FCC ID: M3N-A2C931426

IC: 7812A-A2C931423

IC: 7812A-A2C931426

# Customer Information

---

This device complies with Part 15 of the FCC Rules and with Innovation, Science and Economic Development Canada's licence-exempt RSS(s). Operation is subject to the following two conditions:

1. This device may not cause harmful interference, and
2. This device must accept any interference received, including interference that may cause undesired operation.

## Radio Frequency Certifications for Radio Transceiver Module

### Argentina



### Ghana

NCA APPROVED: SRO-1M-7E4-108

NCA APPROVED: SRO-1M-7E4-114

### Morocco

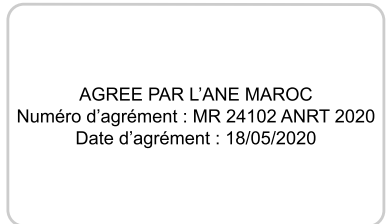

### South Africa

### Djibouti

AGREE PAR LE MCPT (REPUBLIQUE DE DJIBOUTI)  
Numéros d'agrément : 033/DDTIC/2020  
Date d'agrément : 07/06/2020

AGREE PAR LE MCPT (REPUBLIQUE DE DJIBOUTI)  
Numéros d'agrément : 034/DDTIC/2020  
Date d'agrément : 07/06/2020



# Customer Information

## United Arab Emirates (U.A.E.)

TRA  
REGISTERED No:  
ER81341/20

DEALER No:  
DA88113/20

This device complies with Part 15 of the FCC Rules and with Innovation, Science and Economic Development Canada's licence-exempt RSS(s). Operation is subject to the following two conditions:

1. This device may not cause harmful interference, and
2. This device must accept any interference received, including interference that may cause undesired operation.

## Zambia

TRA  
REGISTERED No:  
ER81342/20

DEALER No:  
DA88113/20



## United States and Canada



**WARNING:** Changes or modifications not expressly approved by the party responsible for compliance could void the user's authority to operate the equipment. The term "IC:" before the radio certification number only signifies that Industry Canada technical specifications were met.

FCC ID: L2C0082R

FCC ID: L2C0083TR

IC: 342A-0083TR

## Radio Frequency Certifications for SYNC4

### Argentina



CNC COMISIÓN NACIONAL  
DE COMUNICACIONES

CNC ID: C-24008

# Customer Information

---

## European Union EU

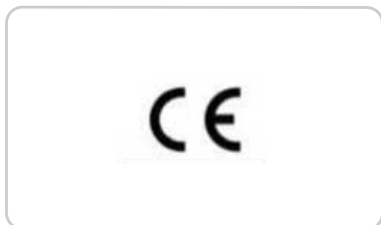

## Morocco



## Ghana

NCA APPROVED: ZRO-1H-7E3-182

## Oman

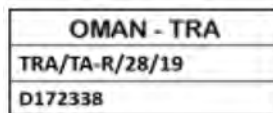

## India



## South Korea



MSIP-R-C-FDM-SYNCG4

## United Arab Emirates (U.A.E.)

## Jordan

JORDAN: T/4/11/11/7214



# Customer Information

## United States and Canada



**WARNING:** Changes or modifications not expressly approved by the party responsible for compliance could void the user's authority to operate the equipment. The term "IC:" before the radio certification number only signifies that Industry Canada technical specifications were met.

FCC ID: KMH-SYNCG4

IC: 1422A-SYNCG4

This device complies with Part 15 of the FCC Rules and with Innovation, Science and Economic Development Canada's licence-exempt RSS(s). Operation is subject to the following two conditions:

1. This device may not cause harmful interference, and
2. This device must accept any interference received, including interference that may cause undesired operation.

## Radio Frequency Certifications for SYNC4 Low

### Argentina

**CNC** COMISIÓN NACIONAL  
DE COMUNICACIONES

CNC ID: C-24009

## European Union EU

## Ghana

NCA APPROVED: ZRO-1H-7E3-180

## India



## Jordan

JORDAN: T/4/11/11/7160

# Customer Information

## Morocco

AGREE PAR L'ANRT MAROC  
N° D'AGRÉMENT: MR 20606 ANRT 2019  
07 AOUT 2019

## Oman

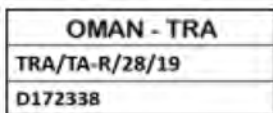

## South Korea



MSIP-R-C-FDM-SYNCG4L

## United Arab Emirates (U.A.E.)



## United States and Canada

 **WARNING:** Changes or modifications not expressly approved by the party responsible for compliance could void the user's authority to operate the equipment. The term "IC:" before the radio certification number only signifies that Industry Canada technical specifications were met.

FCC ID: KMH-SYNCG4L

IC: 1422A-SYNCG4L

This device complies with Part 15 of the FCC Rules and with Innovation, Science and Economic Development Canada's licence-exempt RSS(s). Operation is subject to the following two conditions:

1. This device may not cause harmful interference, and
2. This device must accept any interference received, including interference that may cause undesired operation.

## Radio Frequency Certifications for Telematics Control Unit

### European Union EU

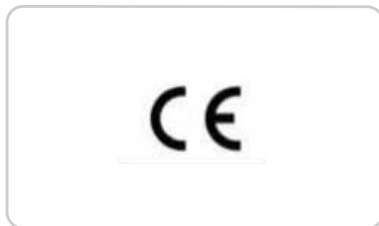

# Customer Information

## United States and Canada



**WARNING:** Changes or modifications not expressly approved by the party responsible for compliance could void the user's authority to operate the equipment. The term "IC:" before the radio certification number only signifies that Industry Canada technical specifications were met.

FCC ID: KMH-14H074-NA1

IC: 1422A-14H074NA1

This device complies with Part 15 of the FCC Rules and with Innovation, Science and Economic Development Canada's licence-exempt RSS(s). Operation is subject to the following two conditions:

1. This device may not cause harmful interference, and
2. This device must accept any interference received, including interference that may cause undesired operation.

## Radio Frequency Certifications for Tire Pressure Monitoring Sensor(s) - FP3

### Argentina



CNC ID: H-24068

## Brazil



05160-16-08001

Este equipamento opera em caráter secundário, isto é, não tem direito a proteção contra interferência prejudicial, mesmo de estações do mesmo tipo, e não pode causar interferência a sistemas operando em caráter primário.

## Jamaica

This product has been Type Approved by Jamaica: SMA – FP3

## Mexico

IFT: RLVSCFP16-1400  
"La operación de este equipo está sujeta a las siguientes dos condiciones:  
(1) es posible que este equipo o dispositivo no cause interferencia perjudicial y  
(2) este equipo o dispositivo debe aceptar cualquier interferencia, incluyendo la que pueda causar su operación no deseada."

# Customer Information

## Paraguay



## Radio Frequency Certifications for Tire Pressure Monitoring Sensor(s) - FP4

### Argentina



## United States and Canada

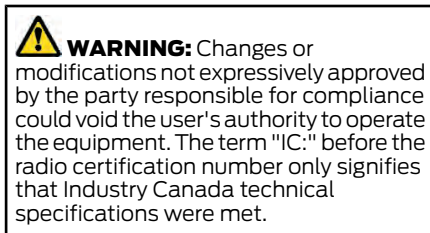

FCC ID: MRXFP3

IC: 2546A-FP3

This device complies with Part 15 of the FCC Rules and with Innovation, Science and Economic Development Canada's licence-exempt RSS(s). Operation is subject to the following two conditions:

1. This device may not cause harmful interference, and
2. This device must accept any interference received, including interference that may cause undesired operation.

### China

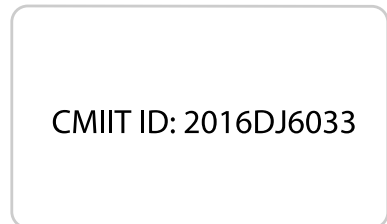



# Customer Information

---

## Djibouti

AGREE PAR LE MCPT  
(REPUBLIQUE DE DJIBOUTI)  
Numéro d'agrément : 547/MCPT/DPT/16  
Date d'agrément : 27/09/16

## Mauritania

AGREE PAR L'ANE MAURITANIE  
Numéro d'agrément : 0358/ARE/2016  
Date d'agrément : 04/10/2016

## Ghana

NCA APPROVED: 2R9-8M-7E0-0BE

## Jordan

Model: FP4  
Manufacturer: Schrader Electronics Ltd  
Type Approval No: TRC/LPD/2017/360  
Equipment Type: Low Power Device (LPD)

## Moldova



## Nigeria

Connection and use of this  
communications  
equipment is permitted by the Nigerian  
Communications Commission

# Customer Information

---

## Oman

OMAN TRA  
TA-R/3591/16  
D080134

## Pakistan

Pakistan Telecommunication Authority



Approved by PTA 2016

## Paraguay



NR: 2018-07-I-000318

## Serbia



M005 18

## South Korea



MSIP-CRM-SRD-FP4

## Ukraine



UA.TR.109

# Customer Information

## United Arab Emirates

TRA  
REGISTERED No:  
ER48598/16

DEALER No.  
DA0047074

## Radio Frequency Certifications for Wireless Accessory Charging Module

### European Union EU



## Radio Frequency Certifications for Garage Door Opener

### United States and Canada



**WARNING:** Changes or modifications not expressly approved by the party responsible for compliance could void the user's authority to operate the equipment. The term "IC:" before the radio certification number only signifies that Industry Canada technical specifications were met.

FCC ID: NZLSAHL5D

IC: 4112A-SAHL5D

This device complies with Part 15 of the FCC Rules and with Innovation, Science and Economic Development Canada's licence-exempt RSS(s). Operation is subject to the following two conditions:

1. This device may not cause harmful interference, and
2. This device must accept any interference received, including interference that may cause undesired operation.

### South Korea



R-RMM-DLH-WACM

# Customer Information

## Taiwan

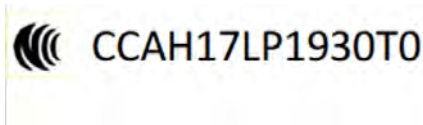

## United States

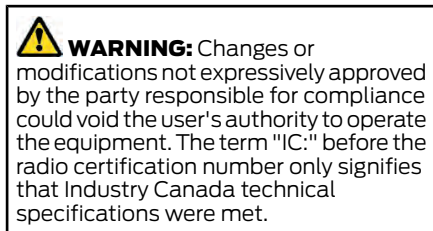

FCC ID: L2C0066T

This device complies with Part 15 of the FCC Rules and with Innovation, Science and Economic Development Canada's licence-exempt RSS(s). Operation is subject to the following two conditions:

1. This device may not cause harmful interference, and
2. This device must accept any interference received, including interference that may cause undesired operation.

## CALIFORNIA PROPOSITION 65 - UNITED STATES OF AMERICA

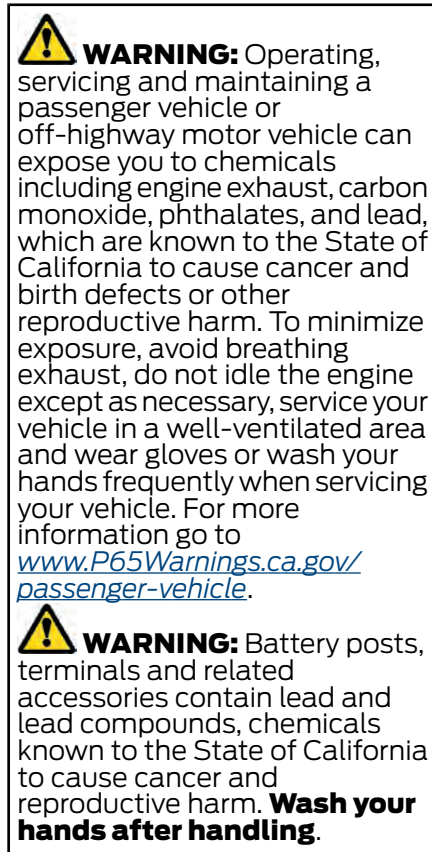

# Customer Information

---

## PERCHLORATE

Certain components in your vehicle such as airbag modules, seatbelt pretensioners and remote control batteries may contain perchlorate material. Special handling may apply for service or vehicle end of life disposal.

For more information visit:  
[www.dtsc.ca.gov/hazardouswaste/perchlorate](http://www.dtsc.ca.gov/hazardouswaste/perchlorate).

## REPLACEMENT PARTS RECOMMENDATION

We have built your vehicle to the highest standards using quality parts. We recommend that you demand the use of genuine Ford and Motorcraft parts whenever your vehicle requires scheduled maintenance or repair. You can clearly identify genuine Ford and Motorcraft parts by looking for the Ford, FoMoCo or Motorcraft branding on the parts or their packaging.

### Scheduled Maintenance and Mechanical Repairs

One of the best ways for you to make sure that your vehicle provides years of service is to have it maintained in line with our recommendations using parts that conform to the specifications detailed in this Owner's Manual.

Genuine Ford and Motorcraft parts meet or exceed these specifications.

### Collision Repairs

We hope that you never experience a collision, but accidents happen sometimes.

Genuine Ford replacement collision parts meet our stringent requirements for fit, finish, structural integrity, corrosion protection and dent resistance. During vehicle development we validate that these parts deliver the intended level of protection as a whole system. A great way to know for sure you are getting this level of protection is to use genuine Ford replacement collision parts.

### Warranty on Replacement Parts

Genuine Ford and Motorcraft replacement parts are the only replacement parts that benefit from a Ford Warranty.

The Ford Warranty may not cover damage caused to your vehicle as a result of failed non-Ford parts.

For additional information, refer to the terms and conditions of the Ford Warranty.

## MOBILE COMMUNICATIONS EQUIPMENT



**WARNING:** Driving while distracted can result in loss of vehicle control, crash and injury. We strongly recommend that you use extreme caution when using any device that may take your focus off the road. Your primary responsibility is the safe operation of your vehicle. We recommend against the use of any hand-held device while driving and encourage the use of voice-operated systems when possible. Make sure you are aware of all applicable local laws that may affect the use of electronic devices while driving.

# Customer Information

---

Using mobile communications equipment is becoming increasingly important in the conduct of business and personal affairs. However, you must not compromise your own or others' safety when using such equipment. Mobile communications can enhance personal safety and security when appropriately used, particularly in emergency situations. Safety must be paramount when using mobile communications equipment to avoid negating these benefits. Mobile communication equipment includes, but is not limited to, cellular phones, pagers, portable email devices, text messaging devices and portable two-way radios.

## END USER LICENSE AGREEMENT

### VEHICLE SOFTWARE END USER LICENSE AGREEMENT (EULA)

- You ("You" or "Your" as applicable) have acquired a vehicle having several devices, including SYNC ® and various control modules, ("DEVICES") that include software licensed or owned by Ford Motor Company and its affiliates ("FORD MOTOR COMPANY"). Those software products of FORD MOTOR COMPANY origin, as well as associated media, printed materials, and "online" or electronic documentation ("SOFTWARE") are protected by international intellectual property laws and treaties. The SOFTWARE is licensed, not sold. All rights reserved.
- The SOFTWARE may interface with and/or communicate with, or may be later upgraded to interface with and/or communicate with additional software and/or systems provided by FORD MOTOR COMPANY.

**IF YOU DO NOT AGREE TO THIS END USER LICENSE AGREEMENT ("EULA") DO NOT USE THE DEVICES OR COPY THE SOFTWARE. ANY USE OF THE SOFTWARE, INCLUDING BUT NOT LIMITED TO USE ON THE DEVICES, WILL CONSTITUTE YOUR AGREEMENT TO THIS EULA (OR RATIFICATION OF ANY PREVIOUS CONSENT).**

**GRANT OF SOFTWARE LICENSE:** This EULA grants you the following license:

- You may use the SOFTWARE as installed on the DEVICES and as otherwise interfacing with systems and/or services provide by or through FORD MOTOR COMPANY or its third party software and service providers.

### Description of Other Rights and Limitations

- **Speech Recognition:** If the SOFTWARE includes speech recognition component(s), you should understand that speech recognition is an inherently statistical process and that recognition errors are inherent in the process. Neither FORD MOTOR

## Customer Information

---

COMPANY nor its suppliers shall be liable for any damages arising out of errors in the speech recognition process. It is your responsibility to monitor any speech recognition functions included in the system.

- **Limitations on Reverse Engineering, Decompilation and Disassembly:**

You may not reverse engineer, decompile, translate, disassemble or attempt to discover any source code or underlying ideas or algorithms of the SOFTWARE nor permit others to reverse engineer, decompile or disassemble the SOFTWARE, except and only to the extent that such activity is expressly permitted by applicable law notwithstanding this limitation or to the extent as may be permitted by the licensing terms governing use of any open source components included with the SOFTWARE.

- **Limitations on Distributing, Copying, Modifying and Creating Derivative Works:**

You may not distribute, copy, make modifications to or create derivative works based on the SOFTWARE, except and only to the extent that such activity is expressly permitted by applicable law notwithstanding this limitation or to the extent as may be permitted by the licensing terms governing use of any open source components included with the SOFTWARE.

- **Single EULA:** The end user documentation for the DEVICES and related systems and services may contain multiple EULAs, such as multiple translations and/or multiple media versions (e.g., in the user documentation and in the software). Even if you receive multiple EULAs, you are licensed to use only one (1) copy of the SOFTWARE.

- **SOFTWARE Transfer:** You may permanently transfer your rights under this EULA only as part of a sale or transfer of the DEVICES, provided you retain no copies, you transfer all of the SOFTWARE (including all component parts, the media and printed materials, any upgrades, and, if applicable, the Certificate(s) of Authenticity), and the recipient agrees to the terms of this EULA. If the SOFTWARE is an upgrade, any transfer must include all prior versions of the SOFTWARE.

- **Termination:** Without prejudice to any other rights, FORD MOTOR COMPANY may terminate this EULA if you fail to comply with the terms and conditions of this EULA.

- **Internet-Based Services**

**Components:** The SOFTWARE may contain components that enable and facilitate the use of certain Internet-based services. You acknowledge and agree that FORD MOTOR COMPANY, third party software and service suppliers, its affiliates and/or its designated agent may automatically check the version of the SOFTWARE and/or its components that you are utilizing and may provide upgrades or supplements to the SOFTWARE that may be automatically downloaded to your DEVICES.

- **Additional Software/Services:** The SOFTWARE may permit FORD MOTOR COMPANY, third party software and service suppliers, its affiliates and/or its designated agent to provide or make available to you SOFTWARE updates, supplements, add-on components, or Internet-based services components of the SOFTWARE after the date you obtain your initial copy of the SOFTWARE ("Supplemental Components".) SOFTWARE updates may cause you to incur additional

## Customer Information

---

charges from your wireless service provider. If FORD MOTOR COMPANY or third party software and services suppliers provide or make available to you Supplemental Components and no other EULA terms are provided along with the Supplemental Components, then the terms of this EULA shall apply. FORD MOTOR COMPANY, its affiliates and/or its designated agent reserve the right to discontinue without liability any Internet-based services provided to you or made available to you through the use of the SOFTWARE.

- **Links to Third Party Sites:** The SOFTWARE may provide you with the ability to link to third party sites. The third party sites are not under the control of FORD MOTOR COMPANY, its affiliates and/or its designated agent. Neither FORD MOTOR COMPANY nor its affiliates nor its designated agent are responsible for (i) the contents of any third party sites, any links contained in third party sites, or any changes or updates to third party sites, or (ii) webcasting or any other form of transmission received from any third party sites. If the SOFTWARE provides links to third party sites, those links are provided to you only as a convenience, and the inclusion of any link does not imply an endorsement of the third party site by FORD MOTOR COMPANY, its affiliates and/or its designated agent.

- **Obligation to Drive Responsibly:** You recognize your obligation to drive responsibly and keep attention on the road. You will read and abide with the DEVICES operating instructions particularly as they pertain to safety and you agree to assume any risk associated with the use of the DEVICES.

**UPGRADES AND RECOVERY MEDIA:** If the SOFTWARE is provided by FORD MOTOR COMPANY separate from the DEVICES on media such as a ROM chip, CD ROM disk(s) or via web download or other means, and is labeled "For Upgrade Purposes Only" or "For Recovery Purposes Only" you may install one (1) copy of such SOFTWARE onto the DEVICES as a replacement copy for the existing SOFTWARE, and use it in accordance with this EULA, including any additional EULA terms accompanying the upgrade SOFTWARE.

**INTELLECTUAL PROPERTY RIGHTS:** All title and intellectual property rights in and to the SOFTWARE (including but not limited to any images, photographs, animations, video, audio, music, text and "applets" incorporated into the SOFTWARE), the accompanying printed materials, and any copies of the SOFTWARE, are owned by FORD MOTOR COMPANY, or its affiliates or suppliers. The SOFTWARE is licensed, not sold. You may not copy the printed materials accompanying the SOFTWARE. All title and intellectual property rights in and to the content which may be accessed through use of the SOFTWARE is the property of the respective content owner and may be protected by applicable copyright or other intellectual property laws and treaties. This EULA grants you no rights to use such content outside its intended use. All rights not specifically granted under this EULA are reserved by FORD MOTOR COMPANY, its affiliates, and third party software and service providers and suppliers. Use of any on-line services which may be accessed through the SOFTWARE may be governed by the respective terms of use relating to such services. If this SOFTWARE contains documentation that is provided only in electronic form, you may print one copy of such electronic documentation.



# Customer Information

---

**EXPORT RESTRICTIONS:** You acknowledge that the SOFTWARE is subject to U.S. and European Union export jurisdiction. You agree to comply with all applicable international and national laws that apply to the SOFTWARE, including the U.S. Export Administration Regulations, as well as end-user, end-use and destination restrictions issued by U.S. and other governments.

**TRADEMARKS:** This EULA does not grant you any rights in connection with any trademarks or service marks of FORD MOTOR COMPANY, its affiliates, and third party software and service providers.

**PRODUCT SUPPORT:** Please refer to FORD MOTOR COMPANY instructions provided in the documentation for the DEVICES product support, such as the vehicle owner guide.

Should you have any questions concerning this EULA, or if you desire to contact FORD MOTOR COMPANY for any other reason, please refer to the address provided in the documentation for the DEVICES.

**No Liability for Certain Damages:** EXCEPT AS PROHIBITED BY LAW, FORD MOTOR COMPANY, ANY THIRD PARTY SOFTWARE OR SERVICES SUPPLIERS, AND THEIR AFFILIATES SHALL HAVE NO LIABILITY FOR ANY INDIRECT, SPECIAL, CONSEQUENTIAL OR INCIDENTAL DAMAGES ARISING FROM OR IN CONNECTION WITH THE USE OR PERFORMANCE OF THE SOFTWARE. THIS LIMITATION SHALL APPLY EVEN IF ANY REMEDY FAILS OF ITS ESSENTIAL PURPOSE. THERE ARE NO WARRANTIES OTHER THAN THOSE THAT MAY BE EXPRESSLY PROVIDED FOR YOUR NEW VEHICLE.

## **SYNC® Automotive Important Safety Information Read and follow instructions:**

- Before using your SYNC® system, read and follow all instructions and safety information provided in this end user manual ("Owner Guide".) Not following precautions found in the Owner Guide can lead to an accident or other serious injuries.

### General Operation

- **Voice Command Control:** Certain functions within the SYNC® system may be accomplished using voice commands. Using voice commands while driving helps you to operate the system without removing your hands from the wheel or eyes from the road.
- **Prolonged Views of Screen:** Do not access any function requiring a prolonged view of the screen while you are driving. Pull over in a safe and legal manner before attempting to access a function of the system requiring prolonged attention.
- **Volume Setting:** Do not raise the volume excessively. Keep the volume at a level where you can still hear outside traffic and emergency signals while driving. Driving while unable to hear these sounds could cause an accident.
- **Navigation Features:** Any navigation features included in the system are intended to provide turn by turn instructions to get you to a desired destination. Please make certain all persons using this system carefully read and follow instructions and safety information fully.

## Customer Information

---

- **Distraction Hazard:** Any navigation features may require manual (non-verbal) setup. Attempting to perform such set-up or insert data while driving can distract your attention and could cause an accident or other serious injury. Stop the vehicle in a safe and legal manner before attempting these operations.
  - **Let Your Judgment Prevail:** Any navigation features are provided only as an aid. Make your driving decisions based on your observations of local conditions and existing traffic regulations. Any such feature is not a substitute for your personal judgment. Any route suggestions made by this system should never replace any local traffic regulations or your personal judgment or knowledge of safe driving practices.
  - **Route Safety:** Do not follow the route suggestions if doing so would result in an unsafe or illegal maneuver, if you would be placed in an unsafe situation, or if you would be directed into an area that you consider unsafe. The driver is ultimately responsible for the safe operation of the vehicle and therefore, must evaluate whether it is safe to follow the suggested directions.
  - **Potential Map Inaccuracy:** Maps used by this system may be inaccurate because of changes in roads, traffic controls or driving conditions. Always use good judgment and common sense when following the suggested routes.
  - **Emergency Services:** Do not rely on any navigation features included in the system to route you to emergency services. Ask local authorities or an emergency services operator for these locations. Not all emergency services such as police, fire stations, hospitals and clinics are likely to be contained in the map database for such navigation features.
- Your Responsibilities and Assumptions of Risk
- You agree to each of the following:(a) Any use of the SOFTWARE while driving an automobile or other vehicle in violation of applicable law or otherwise driving in an unsafe manner presents a significant risk of distracted driving and should not be attempted under any circumstances;(b) Use of the SOFTWARE at excessive volume poses a significant risk of hearing damage and should not be attempted under any circumstances;(c) The SOFTWARE may not be compatible with new or different versions of an operating system, third party software, or third party services, and the SOFTWARE may potentially cause a critical failure of an operating system, third party software, or third party service.(d) Any third party service accessed by or third party software used with the SOFTWARE (i) may charge an additional fee for access, (ii) may not work correctly, on an uninterrupted basis, or error free, (iii) may change streaming formats or discontinue operation, (iv) may contain adult, profane or offensive content; and (v) may contain inaccurate, false or misleading traffic, weather, financial or safety information or other content; and (e) Use of the SOFTWARE may cause you to incur additional charges from your wireless service provider (WSP) and any data or minute calculators that may be included in the software program are for reference only, are not warranted in any way and should not be relied upon in anyway.
  - When using the SOFTWARE, you agree to be responsible for and assume the entire risk to the items set forth in Section (a) – (e) above.

# Customer Information

---

## Disclaimer of Warranty

YOU EXPRESSLY ACKNOWLEDGE AND AGREE THAT USE OF THE DEVICES AND SOFTWARE IS AT YOUR SOLE RISK AND THAT THE ENTIRE RISK AS TO SATISFACTORY QUALITY, PERFORMANCE, COMPATIBILITY, ACCURACY AND EFFORT IS WITH YOU. TO THE MAXIMUM EXTENT PERMITTED BY APPLICABLE LAW, THE SOFTWARE AND ANY THIRD PARTY SOFTWARE OR THIRD-PARTY SERVICES ARE PROVIDED "AS IS" AND "AS AVAILABLE", WITH ALL FAULTS AND WITHOUT WARRANTY OF ANY KIND, AND FORD MOTOR COMPANY HEREBY DISCLAIMS ALL WARRANTIES AND CONDITIONS WITH RESPECT TO THE SOFTWARE, THIRD PARTY SOFTWARE, AND THIRD-PARTY SERVICES, EITHER EXPRESS, IMPLIED OR STATUTORY, INCLUDING, BUT NOT LIMITED TO, THE IMPLIED WARRANTIES AND/OR CONDITIONS OF MERCHANTABILITY, OF SATISFACTORY QUALITY, OF FITNESS FOR AN PARTICULAR PURPOSE, OF ACCURACY, OF QUIET ENJOYMENT, AND NON-INFRINGEMENT OF THIRD-PARTY RIGHTS. FORD MOTOR COMPANY DOES NOT WARRANT (a) AGAINST INTERFERENCE WITH YOUR ENJOYMENT OF THE SOFTWARE, THIRD PARTY SOFTWARE, OR THIRD-PARTY SERVICES, (b) THAT THE SOFTWARE, THIRD PARTY SOFTWARE, OR THIRD-PARTY SERVICES WILL MEET YOUR REQUIREMENTS, (c) THAT THE OPERATION OF THE SOFTWARE, THIRD PARTY SOFTWARE, OR THIRD-PARTY SERVICES WILL BE UNINTERRUPTED OR ERROR-FREE, (d) OR THAT DEFECTS IN THE SOFTWARE, THIRD PARTY SOFTWARE, OR THIRD-PARTY SERVICES WILL BE CORRECTED. NO ORAL OR WRITTEN INFORMATION OR ADVICE GIVEN BY FORD MOTOR COMPANY OR ITS AUTHORIZED REPRESENTATIVE SHALL

CREATE A WARRANTY. SHOULD THE SOFTWARE, THIRD PARTY SOFTWARE, OR THIRD-PARTY SERVICES PROVE DEFECTIVE, YOU ASSUME THE ENTIRE COST OF ALL NECESSARY SERVICING, REPAIR OR CORRECTION. SOME JURISDICTIONS DO NOT ALLOW THE DISCLAIMER OF IMPLIED WARRANTIES OR LIMITATIONS ON APPLICABLE STATUTORY RIGHTS OF A CONSUMER, SO THE ABOVE DISCLAIMER MAY NOT FULLY APPLY TO YOU. THE SOLE WARRANTY PROVIDED BY FORD MOTOR COMPANY SHALL BE FOUND IN THE WARRANTY INFORMATION INCLUDING WITH YOUR OWNER GUIDE. TO THE EXTENT THAT THERE IS ANY CONFLICT BETWEEN THE TERMS OF THIS SECTION AND THE WARRANTY BOOKLET, THE WARRANTY BOOKLET SHALL CONTROL.

## Applicable Law, Venue, Jurisdiction

- The laws of the State of Michigan govern this EULA and Your use of the SOFTWARE. Your use of the SOFTWARE may also be subject to other local, state, national, or international laws. Any litigation arising out of or related to this EULA shall be brought and maintained exclusively in a court of the State of Michigan located in Wayne County or in the United States District Court for the Eastern District of Michigan. You hereby consent to submit to the personal jurisdiction of a court in the State of Michigan located in Wayne County and the United States District Court for the Eastern District of Michigan for any dispute arising out of or relating to this EULA.

## Customer Information

---

### **Binding Arbitration and Class Action Waiver**

**(a) Application.** This Section applies to any dispute EXCEPT IT DOES NOT INCLUDE A DISPUTE RELATING TO COPYRIGHT INFRINGEMENT, OR TO THE ENFORCEMENT OR VALIDITY OF YOUR, FORD MOTOR COMPANY, OR ANY OF FORD MOTOR COMPANY'S LICENSORS' INTELLECTUAL PROPERTY RIGHTS.

Dispute means any dispute, action, or other controversy between You and FORD MOTOR COMPANY, other than the exceptions listed above, concerning the SOFTWARE (including its price) or this EULA, whether in contract, warranty, tort, statute, regulation, ordinance, or any other legal or equitable basis.

**(b) Notice of Dispute.** In the event of a Dispute, You or FORD MOTOR COMPANY must give the other a "Notice of Dispute", which is a written statement of the name, address, and contact information of the party giving it, the facts giving rise to the dispute, and the relief requested. You and FORD MOTOR COMPANY will attempt to resolve any dispute through informal negotiation within 60 days from the date the Notice of Dispute is sent. After 60 days, You or FORD MOTOR COMPANY may commence arbitration.

**(c) Small claims court.** You may also litigate any dispute in small claims court in your county of residence or FORD MOTOR COMPANY'S principal place of business, if the dispute meets all requirements to be heard in the small claims court. You may litigate in small claims court whether or not You negotiated informally first.

**(d) Binding arbitration.** If You and FORD MOTOR COMPANY, do not resolve any dispute by informal negotiation or in small claims court, any other effort to resolve the dispute will be conducted exclusively by binding arbitration. You are giving up

the right to litigate (or participate in as a party or class member) all disputes in court before a judge or jury. Instead, all disputes will be resolved before a neutral arbitrator, whose decision will be final except for a limited right of appeal under the Federal Arbitration Act. Any court with jurisdiction over the parties may enforce the arbitrator's award.

**(e) Class action waiver.** Any proceedings to resolve or litigate any dispute in any forum will be conducted solely on an individual basis. Neither you nor FORD MOTOR COMPANY, will seek to have any dispute heard as a class action, as a private attorney general action, or in any other proceeding in which any party acts or proposes to act in a representative capacity. No arbitration or proceeding will be combined with another without the prior written consent of all parties to all affected arbitrations or proceedings.

**(f) Arbitration procedure.** Any arbitration will be conducted by the American Arbitration Association (the "AAA"), under its Commercial Arbitration Rules. If You are an individual and use the SOFTWARE for personal or vehicle use, or if the value of the dispute is \$75,000 or less whether or not You are an individual or how You use the SOFTWARE, the AAA Supplementary Procedures for Consumer-Related Disputes will also apply. To commence arbitration, submit a Commercial Arbitration Rules Demand for Arbitration form to the AAA. You may request a telephonic or in-person hearing by following the AAA rules. In a dispute involving \$10,000 or less, any hearing will be telephonic unless the arbitrator finds good cause to hold an in-person hearing instead. For more information, see [adr.org](http://adr.org) or call 1-800-778-7879. You agree to commence arbitration only in your county of residence or FORD MOTOR COMPANY'S principal place of business. The arbitrator

## Customer Information

---

may award the same damages to You individually as a court could. The arbitrator may award declaratory or injunctive relief only to You individually, and only to the extent required to satisfy Your individual claim.

### **(g) Arbitration fees and incentives.**

- i. Disputes involving \$75,000 or less. FORD MOTOR COMPANY will promptly reimburse your filing fees and pay the AAA's and arbitrator's fees and expenses. If you reject FORD MOTOR COMPANY'S last written settlement offer made before the arbitrator was appointed ("last written offer"), your dispute goes all the way to an arbitrator's decision (called an "award"), and the arbitrator awards you more than the last written offer, FORD MOTOR COMPANY will give you three incentives: (1) pay the greater of the award or \$1,000; (2) pay twice your reasonable attorney's fees, if any; and (3) reimburse any expenses (including expert witness fees and costs) that your attorney reasonably accrues for investigating, preparing, and pursuing your claim in arbitration. The arbitrator will determine the amounts.
- ii. Disputes involving more than \$75,000. The AAA rules will govern payment of filing fees and the AAA's and arbitrator's fees and expenses.
- iii. Disputes involving any amount. In any arbitration you commence, FORD MOTOR COMPANY will seek its AAA or arbitrator's fees and expenses, or Your filing fees it reimbursed, only if the arbitrator finds the arbitration frivolous or brought for an improper purpose. In any arbitration FORD MOTOR COMPANY commences, it will pay all

filing, AAA, and arbitrator's fees and expenses. It will not seek its attorney's fees or expenses from you in any arbitration. Fees and expenses are not counted in determining how much a dispute involves.

**(h) Claims or disputes must be filed within one year.** To the extent permitted by law, any claim or dispute under this EULA to which this Section applies must be filed within one year in small claims court (Section c) or in arbitration (Section d). The one-year period begins when the claim or dispute first could be filed. If such a claim or dispute is not filed within one year, it is permanently barred.

**(i) Severability.** If the class action waiver (Section e) is found to be illegal or unenforceable as to all or some parts of a dispute, then that portion of Section e will not apply to those parts. Instead, those parts will be severed and proceed in a court of law, with the remaining parts proceeding in arbitration. If any other provision of that portion Section e is found to be illegal or unenforceable, that provision will be severed with the remainder of Section e remaining in full force and effect.

### **Telenav Software End User License Agreement**

Please read these terms and conditions carefully before you use the TeleNav Software. Your use of the TeleNav Software indicates that you accept these terms and conditions. If you do not accept these terms and conditions, do not break the seal of the package, launch, or otherwise use the TeleNav Software. TeleNav may revise this Agreement and the privacy policy at any time, with or without notice to you. You agree to visit <http://www.telenav.com> from time to time to review the then current version of this Agreement and of the privacy policy.

# Customer Information

---

## 1. Safe and Lawful Use

You acknowledge that devoting attention to the TeleNav Software may pose a risk of injury or death to you and others in situations that otherwise require your undivided attention, and you therefore agree to comply with the following when using the TeleNav Software:

- (a) observe all traffic laws and otherwise drive safely;
- (b) use your own personal judgment while driving. If you feel that a route suggested by the TeleNav Software instructs you to perform an unsafe or illegal maneuver, places you in an unsafe situation, or directs you into an area that you consider to be unsafe, do not follow such instructions;
- (c) do not input destinations, or otherwise manipulate the TeleNav Software, unless your vehicle is stationary and parked;
- (d) do not use the TeleNav Software for any illegal, unauthorized, unintended, unsafe, hazardous, or unlawful purposes, or in any manner inconsistent with this Agreement;
- (e) arrange all GPS and wireless devices and cables necessary for use of the TeleNav Software in a secure manner in your vehicle so that they will not interfere with your driving and will not prevent the operation of any safety device (such as an airbag).

You agree to indemnify and hold TeleNav harmless against all claims resulting from any dangerous or otherwise inappropriate use of the TeleNav Software in any moving vehicle, including as a result of your failure to comply with the directions above.

## 2. Account Information

You agree: (a) when registering the TeleNav Software, to provide TeleNav with true, accurate, current, and complete information about yourself, and (b) to inform TeleNav promptly of any changes to such information, and to keep it true, accurate, current and complete.

## 3. Software License

- Subject to your compliance with the terms of this Agreement, TeleNav hereby grants to you a personal, non-exclusive, non-transferable license (except as expressly permitted below in connection with your permanent transfer of the TeleNav Software license), without the right to sublicense, to use the TeleNav Software (in object code form only) in order to access and use the TeleNav Software. This license shall terminate upon any termination or expiration of this Agreement. You agree that you will use the TeleNav Software only for your personal business or leisure purposes, and not to provide commercial navigation services to other parties.

### 3.1 License Limitations

- **(a)** reverse engineer, decompile, disassemble, translate, modify, alter or otherwise change the TeleNav Software or any part thereof; **(b)** attempt to derive the source code, audio library or structure of the TeleNav Software without the prior express written consent of TeleNav; **(c)** remove from the TeleNav Software, or alter, any of TeleNav's or its suppliers' trademarks, trade names, logos, patent or copyright notices, or other notices or markings; **(d)**

# Customer Information

---

distribute, sublicense or otherwise transfer the TeleNav Software to others, except as part of your permanent transfer of the TeleNav Software; or **(e)** use the TeleNav Software in any manner that

- i. infringes the intellectual property or proprietary rights, rights of publicity or privacy or other rights of any party,
- ii. violates any law, statute, ordinance or regulation, including but not limited to laws and regulations related to spamming, privacy, consumer and child protection, obscenity or defamation, or
- iii. is harmful, threatening, abusive, harassing, tortuous, defamatory, vulgar, obscene, libelous, or otherwise objectionable; and (f) lease, rent out, or otherwise permit unauthorized access by third parties to the TeleNav Software without advanced written permission of TeleNav.

## 4. Disclaimers

- To the fullest extent permissible pursuant to applicable law, in no event will TeleNav, its licensors and suppliers, or agents or employees of any of the foregoing, be liable for any decision made or action taken by you or anyone else in reliance on the information provided by the TeleNav Software. TeleNav also does not warrant the accuracy of the map or other data used for the TeleNav Software. Such data may not always reflect reality due to, among other things, road closures, construction, weather, new roads and other changing conditions. You are responsible for the entire risk arising out of your use of the TeleNav Software. For example but without limitation, you agree not to rely on the TeleNav Software for critical navigation in areas where the well-being or survival of you or others

is dependent on the accuracy of navigation, as the maps or functionality of the TeleNav Software are not intended to support such high risk applications, especially in more remote geographical areas.

- TELENAV EXPRESSLY DISCLAIMS AND EXCLUDES ALL WARRANTIES IN CONNECTION WITH THE TELENAV SOFTWARE, WHETHER STATUTORY, EXPRESS OR IMPLIED, INCLUDING ALL WARRANTIES WHICH MAY ARISE FROM COURSE OF DEALING, CUSTOM OR TRADE AND INCLUDING, BUT NOT LIMITED TO, THE IMPLIED WARRANTIES OF MERCHANTABILITY, FITNESS FOR A PARTICULAR PURPOSE AND NON-INFRINGEMENT OF THIRD PARTY RIGHTS WITH RESPECT TO THE TELENAV SOFTWARE.
- Certain jurisdictions do not permit the disclaimer of certain warranties, so this limitation may not apply to you.

## 5. Limitation of Liability

- TO THE EXTENT PERMITTED UNDER APPLICABLE LAW, UNDER NO CIRCUMSTANCES SHALL TELENAV OR ITS LICENSORS AND SUPPLIERS BE LIABLE TO YOU OR TO ANY THIRD PARTY FOR ANY INDIRECT, INCIDENTAL, CONSEQUENTIAL, SPECIAL OR EXEMPLARY DAMAGES (INCLUDING IN EACH CASE, BUT NOT LIMITED TO, DAMAGES FOR THE INABILITY TO USE THE EQUIPMENT OR ACCESS DATA, LOSS OF DATA, LOSS OF BUSINESS, LOSS OF PROFITS, BUSINESS INTERRUPTION OR THE LIKE) ARISING OUT OF THE USE OF OR INABILITY TO USE THE TELENAV SOFTWARE, EVEN IF TELENAV HAS BEEN ADVISED OF THE POSSIBILITY OF SUCH DAMAGES. NOTWITHSTANDING ANY DAMAGES THAT YOU MIGHT INCUR FOR ANY

# Customer Information

---

REASON WHATSOEVER (INCLUDING, WITHOUT LIMITATION, ALL DAMAGES REFERENCED HEREIN AND ALL DIRECT OR GENERAL DAMAGES IN CONTRACT, TORT (INCLUDING NEGLIGENCE) OR OTHERWISE), THE ENTIRE LIABILITY OF TELENAV AND OF ALL OF TELENAV'S SUPPLIERS SHALL BE LIMITED TO THE AMOUNT ACTUALLY PAID BY YOU FOR THE TELENAV SOFTWARE. SOME STATES AND/OR JURISDICTIONS DO NOT ALLOW THE EXCLUSION OR LIMITATION OF INCIDENTAL OR CONSEQUENTIAL DAMAGES, SO THE ABOVE LIMITATIONS OR EXCLUSIONS MAY NOT APPLY TO YOU.

## **6. Arbitration and Governing Law**

- You agree that any dispute, claim or controversy arising out of or relating to this Agreement or the TeleNav Software shall be settled by independent arbitration involving a neutral arbitrator and administered by the American Arbitration Association in the County of Santa Clara, California. The arbitrator shall apply the Commercial Arbitration Rules of the American Arbitration Association, and the judgment upon the award rendered by the arbitrator may be entered by any court having jurisdiction. Note that there is no judge or jury in an arbitration proceeding and the decision of the arbitrator shall be binding upon both parties. You expressly agree to waive your right to a jury trial. This Agreement and performance hereunder will be governed by and construed in accordance with the laws of the State of California, without giving effect to its conflict of law provisions. To the extent judicial action is necessary in connection with the binding arbitration, both TeleNav and you agree to submit

to the exclusive jurisdiction of the courts of the County of Santa Clara, California. The United Nations Convention on Contracts for the International Sale of Goods shall not apply.

## **7. Assignment**

- You may not resell, assign, or transfer this Agreement or any of your rights or obligations, except in totality, in connection with your permanent transfer of the TeleNav Software, and expressly conditioned upon the new user of the TeleNav Software agreeing to be bound by the terms and conditions of this Agreement. Any such sale, assignment or transfer that is not expressly permitted under this paragraph will result in immediate termination of this Agreement, without liability to TeleNav, in which case you and all other parties shall immediately cease all use of the TeleNav Software. Notwithstanding the foregoing, TeleNav may assign this Agreement to any other party at any time without notice, provided the assignee remains bound by this Agreement.

## **8. Miscellaneous**

### **8.1**

This Agreement constitutes the entire agreement between TeleNav and you with respect to the subject matter hereof.

### **8.2**

Except for the limited licenses expressly granted in this Agreement, TeleNav retains all right, title and interest in and to the TeleNav Software, including without limitation all related intellectual property rights. No licenses or other rights which are not expressly granted in this Agreement are intended to, or shall be, granted or



# Customer Information

---

conferred by implication, statute, inducement, estoppel or otherwise, and TeleNav and its suppliers and licensors hereby reserve all of their respective rights other than the licenses explicitly granted in this Agreement.

## 8.3

By using the TeleNav Software, you consent to receive from TeleNav all communications, including notices, agreements, legally required disclosures or other information in connection with the TeleNav Software (collectively, "Notices") electronically. TeleNav may provide such Notices by posting them on TeleNav's Website or by downloading such Notices to your wireless device. If you desire to withdraw your consent to receive Notices electronically, you must discontinue your use of the TeleNav Software.

## 8.4

TeleNav's or your failure to require performance of any provision shall not affect that party's right to require performance at any time thereafter, nor shall a waiver of any breach or default of this Agreement constitute a waiver of any subsequent breach or default or a waiver of the provision itself.

## 8.5

If any provision herein is held unenforceable, then such provision will be modified to reflect the intention of the parties, and the remaining provisions of this Agreement will remain in full force and effect.

## 8.6

The headings in this Agreement are for convenience of reference only, will not be deemed to be a part of this Agreement, and will not be referred to in connection with the construction or interpretation of this Agreement. As used in this Agreement, the words "include" and "including" and variations thereof, will not be deemed to be terms of limitation, but rather will be deemed to be followed by the words "without limitation".

## 9. Other Vendors Terms and Conditions

- The Telenav Software utilizes map and other data licensed to Telenav by third party vendors for the benefit of you and other end users. This Agreement includes end-user terms applicable to these companies (included at the end of this Agreement), and thus your use of the Telenav Software is also subject to such terms. You agree to comply with the following additional terms and conditions, which are applicable to Telenav's third party vendor licensors::

## 9.1 End User Terms Required by HERE North America, LLC

The data ("Data") is provided for your personal, internal use only and not for resale. It is protected by copyright, and is subject to the following terms and conditions which are agreed to by you, on the one hand, and Telenav ("Telenav") and its licensors (including their licensors and suppliers) on the other hand.

© 2013 HERE. All rights reserved.

The Data for areas of Canada includes information taken with permission from Canadian authorities, including: © Her Majesty the Queen in Right of Canada, © Queen's Printer for Ontario, © Canada Post Corporation, GeoBase®, © Department of Natural Resources Canada.

# Customer Information

---

HERE holds a non-exclusive license from the United States Postal Service® to publish and sell ZIP+4® information.

©United States Postal Service® 2014. Prices are not established, controlled or approved by the United States Postal Service®. The following trademarks and registrations are owned by the USPS: United States Postal Service, USPS, and ZIP+4

The Data for Mexico includes certain data from Instituto Nacional de Estadística y Geografía.

## **9.2 End User Terms Required by NAV2 (Shanghai) Co., Ltd**

The data (“Data”) is provided for your personal, internal use only and not for resale. It is protected by copyright, and is subject to the following terms and conditions which are agreed to by you, on the one hand, and NAV2 (Shanghai) Co., Ltd (“NAV2”) and its licensors (including their licensors and suppliers) on the other hand. 20xx. All rights reserved

### **Terms and Conditions**

**Permitted Use.** You agree to use this Data together with the Telenav Software solely for the internal business and personal purposes for which you were licensed, and not for service bureau, time-sharing or other similar purposes. Accordingly, but subject to the restrictions set forth in the following paragraphs, you agree not to otherwise reproduce, copy, modify, decompile, disassemble, create any derivative works of, or reverse engineer any portion of this Data, and may not transfer or distribute it in any form, for any purpose, except to the extent permitted by mandatory laws.

**Restrictions.** Except where you have been specifically licensed to do so by Telenav, and without limiting the preceding paragraph, you may not use this Data (a) with any products, systems, or applications installed or otherwise connected to or in communication with vehicles, capable of vehicle navigation, positioning, dispatch, real time route guidance, fleet management or similar applications; or (b) with or in communication with any positioning devices or any mobile or wireless-connected electronic or computer devices, including without limitation cellular phones, palmtop and handheld computers, pagers, and personal digital assistants or PDAs.

**Warning.** The Data may contain inaccurate or incomplete information due to the passage of time, changing circumstances, sources used and the nature of collecting comprehensive geographic data, any of which may lead to incorrect results.

**No Warranty.** This Data is provided to you “as is,” and you agree to use it at your own risk. Telenav and its licensors (and their licensors and suppliers) make no guarantees, representations or warranties of any kind, express or implied, arising by law or otherwise, including but not limited to, content, quality, accuracy, completeness, effectiveness, reliability, fitness for a particular purpose, usefulness, use or results to be obtained from this Data, or that the Data or server will be uninterrupted or error-free.

**Disclaimer of Warranty:** TELENAV AND ITS LICENSORS (INCLUDING THEIR LICENSORS AND SUPPLIERS) DISCLAIM ANY WARRANTIES, EXPRESS OR IMPLIED, OF QUALITY, PERFORMANCE, MERCHANTABILITY, FITNESS FOR A

## Customer Information

---

PARTICULAR PURPOSE OR NON-INFRINGEMENT. Some States, Territories and Countries do not allow certain warranty exclusions, so to that extent the above exclusion may not apply to you.

**Disclaimer of Liability:** TELENAV AND ITS LICENSORS (INCLUDING THEIR LICENSORS AND SUPPLIERS) SHALL NOT BE LIABLE TO YOU: IN RESPECT OF ANY CLAIM, DEMAND OR ACTION, IRRESPECTIVE OF THE NATURE OF THE CAUSE OF THE CLAIM, DEMAND OR ACTION ALLEGING ANY LOSS, INJURY OR DAMAGES, DIRECT OR INDIRECT, WHICH MAY RESULT FROM THE USE OR POSSESSION OF THE INFORMATION; OR FOR ANY LOSS OF PROFIT, REVENUE, CONTRACTS OR SAVINGS, OR ANY OTHER DIRECT, INDIRECT, INCIDENTAL, SPECIAL OR CONSEQUENTIAL DAMAGES ARISING OUT OF YOUR USE OF OR INABILITY TO USE THIS INFORMATION, ANY DEFECT IN THE INFORMATION, OR THE BREACH OF THESE TERMS OR CONDITIONS, WHETHER IN AN ACTION IN CONTRACT OR TORT OR BASED ON A WARRANTY, EVEN IF TELENAV OR ITS LICENSORS HAVE BEEN ADVISED OF THE POSSIBILITY OF SUCH DAMAGES. Some States, Territories and Countries do not allow certain liability exclusions or damages limitations, so to that extent the above may not apply to you.

**Export Control.** You shall not export from anywhere any part of the Data or any direct product thereof except in compliance with, and with all licenses and approvals required under, applicable export laws, rules and regulations, including but not limited to the laws, rules and regulations administered by the Office of Foreign Assets Control of the U.S. Department of Commerce and the Bureau of Industry and Security of the U.S. Department of Commerce. To the extent that any such

export laws, rules or regulations prohibit HERE from complying with any of its obligations hereunder to deliver or distribute Data, such failure shall be excused and shall not constitute a breach of this Agreement.

**Entire Agreement.** These terms and conditions constitute the entire agreement between Telenav (and its licensors, including their licensors and suppliers) and you pertaining to the subject matter hereof, and supersedes in their entirety any and all written or oral agreements previously existing between us with respect to such subject matter.

**Governing Law.** The above terms and conditions shall be governed by the laws of the State of Illinois [insert "Netherlands" where European HERE Data is used], without giving effect to (i) its conflict of laws provisions, or (ii) the United Nations Convention for Contracts for the International Sale of Goods, which is explicitly excluded. You agree to submit to the jurisdiction of the State of Illinois [insert "The Netherlands" where European HERE Data is used] for any and all disputes, claims and actions arising from or in connection with the Data provided to you hereunder.

**Government End Users.** If the Data is being acquired by or on behalf of the United States government or any other entity seeking or applying rights similar to those customarily claimed by the United States government, this Data is a "commercial item" as that term is defined at 48 C.F.R. ("FAR") 2.101, is licensed in accordance with these End-User Terms, and each copy of Data delivered or otherwise furnished shall be marked and embedded as appropriate with the following "Notice of Use," and shall be treated in accordance with such Notice:

# Customer Information

## NOTICE OF USE

CONTRACTOR (MANUFACTURER/  
SUPPLIER) NAME: HERE

CONTRACTOR (MANUFACTURER/  
SUPPLIER) ADDRESS: c/o Nokia, 425  
West Randolph Street, Chicago, Illinois  
60606

This Data is a commercial item as  
defined in FAR 2.101 and is subject to  
these End-User Terms under which this  
Data was provided.

© 1987 – 2014 HERE – All rights reserved.

If the Contracting Officer, federal government agency, or any federal official refuses to use the legend provided herein, the Contracting Officer, federal government agency, or any federal official must notify HERE prior to seeking additional or alternative rights in the Data.

### I. US/Canada Territory

A. United States Data. The End-User Terms for any Application containing Data for the United States shall contain the following notices:

“HERE holds a non-exclusive license from the United States Postal Service® to publish and sell ZIP+4® information.”

“©United States Postal Service® 20XX. Prices are not established, controlled or approved by the United States Postal Service®. The following trademarks and registrations are owned by the USPS: United States Postal Service, USPS, and ZIP+4.”

B. Canada Data. The following provisions apply to the Data for Canada, which may include or reflect data from third party licensors (“Third Party Data”), including Her Majesty the Queen in Right of Canada (“Her Majesty”), Canada Post Corporation (“Canada Post”) and the Department of Natural Resources of Canada (“NRCan”):

1. Disclaimer and Limitation: Client agrees that its use of the Third Party Data is subject to the following provisions:

a. Disclaimer: The Third Party Data is licensed on an “as is” basis. The licensors of such data, including Her Majesty, Canada Post and NRCan, make no guarantees, representations or warranties respecting such data, either express or implied, arising by law or otherwise, including but not limited to, effectiveness, completeness, accuracy or fitness for a particular purpose.

b. Limitation on Liability: The Third Party Data licensors, including Her Majesty, Canada Post and NRCan, shall not be liable: (i) in respect of any claim, demand or action, irrespective of the nature of the cause of the claim, demand or action alleging any loss, injury or damages, direct or indirect, which may result from the use or possession of such Data; or (ii) in any way for loss of revenues or contracts, or any other consequential loss of any kind resulting from any defect in the Data.

# Customer Information

---

2. Copyright Notice: In connection with each copy of all or any portion of the Data for the Territory of Canada, Client shall affix in a conspicuous manner the following copyright notice on at least one of: (i) the label for the storage media of the copy; (ii) the packaging for the copy; or (iii) other materials packaged with the copy, such as user manuals or end user license agreements: "This data includes information taken with permission from Canadian authorities, including © Her Majesty the Queen in Right of Canada, © Queen's Printer for Ontario, © Canada Post Corporation, GeoBase®, © The Department of Natural Resources Canada. All rights reserved."

3. End-User Terms: Except as otherwise agreed by the parties, in connection with the provision of any portion of the Data for the Territory of Canada to End-Users as may be authorized under the Agreement, Client shall provide such End-Users, in a reasonably conspicuous manner, with terms (set forth with other end user terms required to be provided under the Agreement, or as otherwise may be provided, by Client) which shall include the following provisions on behalf of the Third Party Data licensors, including Her Majesty, Canada Post and NRCan:

The Data may include or reflect data of licensors, including Her Majesty the Queen in the Right of Canada ("Her Majesty"), Canada Post Corporation ("Canada Post") and the Department of Natural Resources Canada ("NRCan"). Such data is licensed on an "as is" basis. The licensors, including Her Majesty, Canada Post and NRCan, make no guarantees, representations or warranties respecting such data,

either express or implied, arising by law or otherwise, including but not limited to, effectiveness, completeness, accuracy or fitness for a particular purpose. The licensors, including Her Majesty, Canada Post and NRCan, shall not be liable in respect of any claim, demand or action, irrespective of the nature of the cause of the claim, demand or action alleging any loss, injury or damages, direct or indirect, which may result from the use or possession of the data or the Data. The licensors, including Her Majesty, Canada Post and NRCan, shall not be liable in any way for loss of revenues or contracts, or any other consequential loss of any kind resulting from any defect in the data or the Data.

End User shall indemnify and save harmless the licensors, including Her Majesty, Canada Post and NRCan, and their officers, employees and agents from and against any claim, demand or action, irrespective of the nature of the cause of the claim, demand or action, alleging loss, costs, expenses, damages or injuries (including injuries resulting in death) arising out of the use or possession of the data or the Data.

4. Additional Provisions: The terms contained in this Section are in addition to all of the rights and obligations of the parties under the Agreement. To the extent that any of the provisions of this Section are inconsistent with, or conflict with, any other provisions of the Agreement, the provisions of this Section shall prevail.

# Customer Information

II. Mexico. The following provision applies to the Data for Mexico, which includes certain data from the Instituto Nacional de Estadística y Geografía (“INEGI”):

A. Any and all copies of the Data and/or packaging containing Data for Mexico shall contain the following notice: “Fuente: INEGI (Instituto Nacional de Estadística y Geografía)”

## III. Latin America Territory

A. Third Party Notices. Any and all copies of the Data and/or packaging relating thereto shall include the respective Third Party Notices set forth below and used as described below corresponding to the Territory (or portion thereof) included in such copy:

Territory Notice

Argentina	IGN “INSTITUTO GEOGRAFICO NACIONAL ARGENTINO”
Ecuador	“INSTITUTO GEOGRAFICO MILITAR DEL ECUADOR AUTORIZACION N° IGM-2011-01- PCO-01 DEL 25 DE ENERO DE 2011” “source: © IGN 2009 - BD TOPO ®”
Guadeloupe, French Guiana and Martinique Mexico	“Fuente: INEGI (Instituto Nacional de Estadística y Geografía)”

## IV. Middle East Territory

A. Third Party Notices. Any and all copies of the Data and/or packaging relating thereto shall include the respective Third Party Notices set forth below and used as described below corresponding to the Territory (or portion thereof) included in such copy:

Country Notice

Jordan “© Royal Jordanian Geographic Centre”. The foregoing notice requirement for Jordan Data is a material term of the Agreement. If Client or any of its permitted sublicensees (if any) fail to meet such requirement, HERE shall have the right to terminate Client’s license with respect to the Jordan Data.

B. Jordan Data. Client and its permitted sublicensees (if any) are restricted from licensing and/or otherwise distributing HERE’s database for the country of Jordan (“Jordan Data”) for use in Enterprise Applications to (i) non-Jordanian entities for use of the Jordan Data solely in Jordan or (ii) Jordan-based customers. In addition, Client, its permitted sublicensees (if any) and End-Users are restricted from using the Jordan Data in Enterprise Applications if such party is (i) a non-Jordanian entity using the Jordan Data solely in Jordan or (ii) a Jordan-based customer. For purposes of the foregoing, “Enterprise Applications” shall mean Geomarketing applications, GIS applications, mobile business asset management applications, call center applications, telematics applications, public organization Internet applications or for providing geocoding services.

# Customer Information

---

## V. Europe Territory

### A. Use of Certain Traffic Codes in Europe

1. General Restrictions Applicable to Traffic Codes. Client acknowledges and agrees that in certain countries of the Europe Territory, Client will need to obtain rights directly from third party RDS-TMC code providers to receive and use the Traffic Codes in the Data and to deliver to End-Users Transactions in any way derived from or based on such Traffic Codes. For such countries, HERE shall deliver the Data incorporating Traffic Codes to Client only after receiving certification from Client of its having obtained such rights.

2. Display of Third Party Rights Legends for Belgium. Client shall, for each Transaction that uses Traffic Codes for Belgium, provide the following notice to the End-User: "Traffic Codes for Belgium are provided by the Ministerie van de Vlaamse Gemeenschap and the Ministère de l'Équipement et des Transports."

B. Paper Maps. With respect to any license granted to Client relating to making, selling or distributing paper maps (i.e., a map fixed on a paper or paper-like medium): (a) such license with respect to Data for the Territory of Great Britain is conditioned on Client's entering into and complying with a separate written agreement with the Ordnance Survey ("OS") to create and sell paper maps, Client's paying to the OS any and all applicable paper map royalties, and Client's complying with the OS copyright notice requirements; (b) such license for selling or otherwise distributing for charge with respect to Data for the Territory of Czech Republic

is conditioned on Client's obtaining prior written consent from Kartografie a.s.; (c) such license for selling or distributing with respect to Data for the Territory of Switzerland is conditioned on Client's obtaining a permit from Bundesamt für Landestopografie of Switzerland; (d) Client is restricted from using Data for the Territory of France to create paper maps with a scale between 1:5,000 and 1:250,000; and (e) Client is restricted from using any Data to create, sell or distribute paper maps that are the same or substantially similar, in terms of data content and specific use of color, symbols and scale, to paper maps published by the European national mapping agencies, including without limitation, Landvermessungämter of Germany, Topografische Dienst of the Netherlands, Nationaal Geografisch Instituut of Belgium, Bundesamt für Landestopografie of Switzerland, Bundesamt für Eich-und Vermessungswesen of Austria, and the National Land Survey of Sweden.

C. OS Enforcement. Without limiting Section IV(B) above, with respect to Data for the Territory of Great Britain, Client acknowledges and agrees that the Ordnance Survey ("OS") may bring a direct action against Client to enforce compliance with the OS copyright notice (see Section IV(D) below) and paper map requirements (see Section IV(B) above) contained in this Agreement.

D. Third Party Notices. Any and all copies of the Data and/or packaging relating thereto shall include the respective Third Party Notices set forth below and used as described below corresponding to the Territory (or portion thereof) included in such copy:

Country(ies) Notice

## Customer Information

Austria	“© Bundesamt für Eich- und Vermessungswesen”	Spain	“Información geográfica propiedad del CNIG”
Croatia Cyprus, Estonia, Latvia, Lithuania, Moldova, Poland, Slovenia and/or Ukraine	“© EuroGeographics”	Sweden	“Based upon electronic data © National Land Survey Sweden.”
France	“source: © IGN 2009 – BD TOPO ®”	Switzerland	“Topografische Grundlage: © Bundesamt für Landestopographie.
Germany	“Die Grundlagendaten wurden mit Genehmigung der zuständigen Behörden entnommen”	E. Respective Country Distribution. Client acknowledges that HERE has not received approvals to distribute map data for the following countries in such respective countries: Albania, Belarus, Kyrgyzstan, Moldova and Uzbekistan. HERE may update such list from time to time. The license rights granted to Client under this TL with respect to the Data for such countries are contingent upon Client’s compliance with all applicable laws and regulations, including, without limitation, any required licenses or approvals to distribute the Application incorporating such Data in such respective countries.	
Great Britain	“Contains Ordnance Survey data © Crown copyright and database right 2010 Contains Royal Mail data © Royal Mail copyright and database right 2010”	VI. Australia Territory	A. Third Party Notices. Any and all copies of the Data and/or packaging relating thereto shall include the respective Third Party Notices set forth below and used as described below corresponding to the Territory (or portion thereof) included in such copy:  Copyright. Based on data provided under license from PSMA Australia Limited (www.pasma.com.au).
Greece	“Copyright Geomatics Ltd.”		
Hungary	“Copyright © 2003; Top-Map Ltd.”		
Italy	“La Banca Dati Italiana è stata prodotta usando quale riferimento anche cartografia numerica ed al tratto prodotta e fornita dalla Regione Toscana.”		
Norway	“Copyright © 2000; Norwegian Mapping Authority”		
Portugal	“Source: IgeoE – Portugal”		



# Customer Information

---

Product incorporates data which is © 20XX Telstra Corporation Limited, GM Holden Limited, Intelomatics Australia Pty Ltd and Continental Pty Ltd.

B. Third Party Notices for Australia. In addition to the foregoing, the End-User Terms for any Application containing RDS-TMC Traffic Codes for Australia shall contain the following notice: "Product incorporates traffic location codes which is © 20XX Telstra Corporation Limited and its licensors."

## **AT&T Vehicle Network Carrier Telematics Disclosure**

END USER FOR PURPOSES OF THIS SECTION MEANS YOU AND YOUR HEIRS, EXECUTORS, LEGAL PERSONAL REPRESENTATIVES AND PERMITTED ASSIGNS. FOR PURPOSES OF THIS SECTION "UNDERLYING WIRELESS SERVICE CARRIER" INCLUDES ITS AFFILIATES AND CONTRACTORS AND THEIR RESPECTIVE OFFICERS, DIRECTORS, EMPLOYEES, SUCCESSORS AND ASSIGNS. END USER HAS NO CONTRACTUAL RELATIONSHIP WITH THE UNDERLYING WIRELESS SERVICE CARRIER AND END USER IS NOT A THIRD PARTY BENEFICIARY OF ANY AGREEMENT BETWEEN FORD AND UNDERLYING CARRIER. END USER UNDERSTANDS AND AGREES THAT THE UNDERLYING CARRIER HAS NO LEGAL, EQUITABLE, OR OTHER LIABILITY OF ANY KIND TO END USER. IN ANY EVENT, REGARDLESS OF THE FORM OF THE ACTION, WHETHER FOR BREACH OF CONTRACT, WARRANTY, NEGLIGENCE, STRICT LIABILITY IN TORT OR OTHERWISE, END USER'S EXCLUSIVE REMEDY FOR CLAIMS ARISING IN ANY WAY IN CONNECTION WITH THIS AGREEMENT, FOR ANY CAUSE WHATSOEVER, INCLUDING BUT NOT LIMITED TO ANY FAILURE OR

DISRUPTION OF SERVICE PROVIDED HEREUNDER, IS LIMITED TO PAYMENT OF DAMAGES IN AN AMOUNT NOT TO EXCEED THE AMOUNT PAID BY END USER FOR THE SERVICES DURING THE TWO-MONTH PERIOD PRECEDING THE DATE THE CLAIM AROSE.

(ii) END USER AGREES TO INDEMNIFY AND HOLD HARMLESS THE UNDERLYING WIRELESS SERVICE CARRIER AND ITS OFFICERS, EMPLOYEES, AND AGENTS AGAINST ANY AND ALL CLAIMS, INCLUDING WITHOUT LIMITATION CLAIMS FOR LIBEL, SLANDER, OR ANY PROPERTY DAMAGE, PERSONAL INJURY OR DEATH, ARISING IN ANY WAY, DIRECTLY OR INDIRECTLY, IN CONNECTION WITH THIS AGREEMENT OR THE USE, FAILURE TO USE, OR INABILITY TO USE THE DEVICE EXCEPT WHERE THE CLAIMS RESULT FROM THE UNDERLYING CARRIER'S GROSS NEGLIGENCE OR WILLFUL MISCONDUCT. THIS INDEMNITY WILL SURVIVE THE TERMINATION OF THE AGREEMENT.

(iii) END USER HAS NO PROPERTY RIGHT IN ANY NUMBER ASSIGNED TO THE DEVICE.

(iv) END USER UNDERSTANDS THAT FORD AND THE UNDERLYING CARRIER CANNOT GUARANTY THE SECURITY OF WIRELESS TRANSMISSIONS, AND WILL NOT BE LIABLE FOR ANY LACK OF SECURITY RELATING TO THE USE OF THE SERVICES

THE SERVICE IS FOR [END USER'S] USE ONLY AND END USER MAY NOT RESELL THE SERVICE TO ANY OTHER PARTY END USER UNDERSTANDS THAT THE UNDERLYING CARRIER DOES NOT GUARANTEE ANY END USER UNINTERRUPTED SERVICE OR COVERAGE. THE UNDERLYING CARRIER DOES NOT WARRANT THAT END USERS CAN OR WILL BE LOCATED USING THE SERVICE. THE UNDERLYING CARRIER

# Customer Information

---

MAKES NO WARRANTY, EXPRESS OR IMPLIED, OF MERCHANTABILITY OR FITNESS FOR A PARTICULAR PURPOSE, SUITABILITY, OR PERFORMANCE REGARDING ANY SERVICES OR GOODS, AND IN NO EVENT SHALL AT&T BE LIABLE, WHETHER OR NOT DUE TO ITS OWN NEGLIGENCE, FOR ANY: (A) ACT OR OMISSION OF A THIRD PARTY; (B) MISTAKES, OMISSIONS, INTERRUPTIONS, ERRORS, FAILURES TO TRANSMIT, DELAYS, OR DEFECTS IN THE SERVICE PROVIDED BY OR THROUGH THE UNDERLYING CARRIER; (C) DAMAGE OR INJURY CAUSED BY SUSPENSION OR TERMINATION BY THE UNDERLYING CARRIER; OR (D) DAMAGE OR INJURY CAUSED BY A FAILURE OR DELAY IN CONNECTING A CALL TO ANY ENTITY, INCLUDING 911 OR ANY OTHER EMERGENCY SERVICE. TO THE FULL EXTENT ALLOWED BY LAW, THE END USER RELEASES, INDEMNIFIES AND HOLDS THE UNDERLYING CARRIER HARMLESS FROM AND AGAINST ANY AND ALL CLAIMS OF ANY PERSON OR ENTITY FOR DAMAGES OF ANY NATURE ARISING IN ANY WAY FROM OR RELATING TO, DIRECTLY OR INDIRECTLY, SERVICES PROVIDED BY THE UNDERLYING CARRIER OR ANY PERSON'S USE THEREOF, INCLUDING CLAIMS ARISING IN WHOLE OR IN PART FROM THE ALLEGED NEGLIGENCE OF THE UNDERLYING CARRIER.

## **VII. China Territory**

### ***Personal Use Only***

You agree to use this Data together with [insert name of Client Application] for the solely personal, non-commercial purposes for which you were licensed, and not for service bureau, time-sharing or other similar purposes. Accordingly, but subject to the restrictions set forth in the following paragraphs, you may copy this Data only as necessary for your personal use to (i)

view it, and (ii) save it, provided that you do not remove any copyright notices that appear and do not modify the Data in any way. You agree not to otherwise reproduce, copy, modify, decompile, disassemble or reverse engineer any portion of this Data, and may not transfer or distribute it in any form, for any purpose, except to the extent permitted by mandatory laws.

### ***Restrictions***

Except where you have been specifically licensed to do so by NAV2, and without limiting the preceding paragraph, you may not (a) use this Data with any products, systems, or applications installed or otherwise connected to or in communication with vehicles, capable of vehicle navigation, positioning, dispatch, real time route guidance, fleet management or similar applications; or (b) with or in communication with any positioning devices or any mobile or wireless-connected electronic or computer devices, including without limitation cellular phones, palmtop and handheld computers, pagers, and personal digital assistants or PDAs. You agree to cease using this Data if you fail to comply with these terms and conditions.

### ***Limited Warranty***

NAV2 warrants that (a) the Data will perform substantially in accordance with the accompanying written materials for a period of ninety (90) days from the date of receipt, and (b) any support services provided by NAV2 shall be substantially as described in applicable written materials provided to you by NAV2, and NAV2's support engineers will make commercially reasonable efforts to solve any problem issues.

# Customer Information

---

## **Customer Remedies**

NAV2 and its suppliers' entire liability and your exclusive remedy shall be, at NAV2's sole discretion, either (a) return of the price paid, if any, or (b) repair or replacement of the Data that do not meet NAV2's Limited Warranty and that are returned to NAV2 with a copy of your receipt. This Limited Warranty is void if failure of the Data has resulted from accident, abuse, or misapplication. Any replacement Data will be warranted for the remainder of the original warranty period or thirty (30) days, whichever is longer. Neither these remedies nor any product support services offered by NAV2 are available without proof of purchase from an authorized international source.

## **No Other Warranty:**

EXCEPT FOR THE LIMITED WARRANTY SET FORTH ABOVE AND TO THE EXTENT PERMITTED BY APPLICABLE LAW, NAV2 AND ITS LICENSORS (INCLUDING THEIR LICENSORS AND SUPPLIERS) DISCLAIM ANY WARRANTIES, EXPRESS OR IMPLIED, OF QUALITY, PERFORMANCE, MERCHANTABILITY, FITNESS FOR A PARTICULAR PURPOSE, OWNERSHIP OR NON-INFRINGEMENT. Certain warranty exclusions may not be permitted under applicable law, so to that extent the above exclusion may not apply to you.

## **Limited Liability:**

TO THE EXTENT PERMITTED BY APPLICABLE LAW, NAV2 AND ITS LICENSORS (INCLUDING THEIR LICENSORS AND SUPPLIERS) SHALL NOT BE LIABLE TO YOU: IN RESPECT OF ANY CLAIM, DEMAND OR ACTION, IRRESPECTIVE OF THE NATURE OF THE CAUSE OF THE CLAIM, DEMAND OR ACTION ALLEGING ANY LOSS, INJURY OR DAMAGES, DIRECT OR INDIRECT, WHICH MAY RESULT FROM THE USE OR POSSESSION OF THE INFORMATION; OR

FOR ANY LOSS OF PROFIT, REVENUE, CONTRACTS OR SAVINGS, OR ANY OTHER DIRECT, INDIRECT, INCIDENTAL, SPECIAL OR CONSEQUENTIAL DAMAGES ARISING OUT OF YOUR USE OF OR INABILITY TO USE THIS INFORMATION, ANY DEFECT IN THE INFORMATION, OR THE BREACH OF THESE TERMS OR CONDITIONS, WHETHER IN AN ACTION IN CONTRACT OR TORT OR BASED ON A WARRANTY, EVEN IF NAV2 OR ITS LICENSORS HAVE BEEN ADVISED OF THE POSSIBILITY OF SUCH DAMAGES. UNDER NO CIRCUMSTANCES SHALL NAV2'S OR ITS SUPPLIERS' LIABILITY HEREUNDER EXCEED THE PRICE PAID. Certain liability exclusions may not be permitted under applicable law, so to that extent the above exclusion may not apply to you.

## **Export Control**

You agree not to export to anywhere any part of the Data provided to you or any direct product thereof except in compliance with, and with all licenses and approvals required under, applicable export laws, rules and regulations.

## **IP Protection**

The Data are owned by NAV2 or its suppliers and are protected by applicable copyright and other intellectual property law and treaties. The Data are provided solely on the basis of a license to use, not sale.

## **Entire Agreement**

These terms and conditions constitute the entire agreement between NAV2 (and its licensors, including their licensors and suppliers) and you pertaining to the subject matter hereof, and supersedes in their entirety any and all written or oral agreements previously existing between us with respect to such subject matter.

# Customer Information

---

## **Governing Law.**

The above terms and conditions shall be governed by the laws of the People's Republic of China, without giving effect to (i) its conflict of laws provisions, or (ii) the United Nations Convention for Contracts for the International Sale of Goods, which is explicitly excluded. Any dispute arising from or in connection with the Data provided to you hereunder shall be submitted to the Shanghai International Economic and Trade Arbitration Commission for arbitration.

## **Gracenote® Copyright**

CD and music-related data from Gracenote, Inc., copyright©

2000-2007 Gracenote. Gracenote Software, copyright © 2000-2007 Gracenote. This product and service may practice one or more of the following U.S. Patents 5,987,525; 6,061,680; 6,154,773; 6,161,132; 6,230,192; 6,230,207; 6,240,459; 6,330,593 and other patents issued or pending. Some services supplied under license from Open Globe, Inc. for U.S. Patent 6,304,523.

Gracenote and CDDDB are registered trademarks of Gracenote. The Gracenote logo and logotype, and the "Powered by Gracenote™" logo are trademarks of Gracenote.

## **Gracenote® End User License Agreement (EULA)**

This device contains software from Gracenote, Inc. of 2000 Powell Street Emeryville, California 94608 ("Gracenote").

The software from Gracenote (the "Gracenote Software") enables this device to do disc and music file identification and obtain music-related information, including name, artist, track, and title information ("Gracenote Data") from online servers

("Gracenote Servers"), and to perform other functions. You may use Gracenote Data only by means of the intended End User functions of this device. This device may contain content belonging to Gracenote's providers. If so, all of the restrictions set forth herein with respect to Gracenote Data shall also apply to such content and such content providers shall be entitled to all of the benefits and protections set forth herein that are available to Gracenote. You agree that you will use the content from Gracenote ("Gracenote Content"), Gracenote Data, the Gracenote Software, and Gracenote Servers for your own personal, non-commercial use only. You agree not to assign, copy, transfer or transmit the Gracenote Content, Gracenote Software or any Gracenote Data (except in a Tag associated with a music file) to any third party. YOU AGREE NOT TO USE OR EXPLOIT GRACENOTE CONTENT, GRACENOTE DATA, THE GRACENOTE SOFTWARE, OR GRACENOTE SERVERS, EXCEPT AS EXPRESSLY PERMITTED HEREIN.

You agree that your non-exclusive licenses to use the Gracenote Content, Gracenote Data, the Gracenote Software, and Gracenote Servers will terminate if you violate these restrictions. If your licenses terminate, you agree to cease any and all use of the Gracenote Content, Gracenote Data, the Gracenote Software, and Gracenote Servers.

Gracenote, respectively, reserve all rights in Gracenote Data, the Gracenote Software, and the Gracenote Servers and Gracenote Content, including all ownership rights. Under no circumstances will either Gracenote become liable for any payment to you for any information that you provide,

## Customer Information

---

including any copyrighted material or music file information. You agree that Gracenote may enforce its respective rights, collectively or separately, under this agreement against you, directly in each company's own name.

Gracenote uses a unique identifier to track queries for statistical purposes. The purpose of a randomly assigned numeric identifier is to allow Gracenote to count queries without knowing anything about who you are. For more information, see the web page at [www.gracenote.com](http://www.gracenote.com) for the Gracenote Privacy Policy.

THE GRACENOTE SOFTWARE, EACH ITEM OF GRACENOTE DATA AND THE GRACENOTE CONTENT ARE LICENSED TO YOU "AS IS". NEITHER GRACENOTE MAKES ANY REPRESENTATIONS OR WARRANTIES, EXPRESS OR IMPLIED, REGARDING THE ACCURACY OF ANY GRACENOTE DATA FROM THE GRACENOTE SERVERS OR GRACENOTE CONTENT. GRACENOTE COLLECTIVELY AND SEPARATELY RESERVE THE RIGHT TO DELETE DATA AND/OR CONTENT FROM THE COMPANIES' RESPECTIVE SERVERS OR, IN THE CASE OF GRACENOTE, CHANGE DATA CATEGORIES FOR ANY CAUSE THAT GRACENOTE DEEMS SUFFICIENT. NO WARRANTY IS MADE THAT EITHER GRACENOTE CONTENT OR THE GRACENOTE SOFTWARE OR GRACENOTE SERVERS ARE ERROR-FREE OR THAT THE FUNCTIONING OF THE GRACENOTE SOFTWARE OR GRACENOTE SERVERS WILL BE UNINTERRUPTED. GRACENOTE IS NOT OBLIGATED TO PROVIDE YOU WITH ANY ENHANCED OR ADDITIONAL DATA TYPES THAT GRACENOTE MAY CHOOSE TO PROVIDE IN THE FUTURE AND IS FREE TO DISCONTINUE ITS ONLINE SERVICES AT ANY TIME. GRACENOTE DISCLAIMS ALL WARRANTIES EXPRESS OR IMPLIED, INCLUDING, BUT NOT LIMITED TO,

IMPLIED WARRANTIES OF MERCHANTABILITY, FITNESS FOR A PARTICULAR PURPOSE, TITLE, AND NON-INFRINGEMENT. NEITHER GRACENOTE WARRANTS THE RESULTS THAT WILL BE OBTAINED BY YOUR USE OF THE GRACENOTE SOFTWARE OR ANY GRACENOTE SERVER. IN NO CASE WILL GRACENOTE BE LIABLE FOR ANY CONSEQUENTIAL OR INCIDENTAL DAMAGES OR FOR ANY LOST PROFITS OR LOST REVENUES FOR ANY REASON WHATSOEVER. © Gracenote 2007.

### ***Taiwan Territory***

Note: In accordance with the management approach of low-power radio wave radiation motors:

Article 12: For approved and certified low-power radiation motor models, companies, firms or users must not alter the frequency, increase the power or change the characteristics and functions of the original design without authorization.

Article 14: The usage of low-power radio-frequency motors must not affect aviation safety and interfere with legal telecommunications. Should interference be detected, immediately stop using the device and only resume usage after ensuring that there is no longer any interference. For the legal telecommunication and wireless telecommunication of the telco, the low-power radio frequency motor must be able to tolerate legal limits of interference from telecommunication, industrial, scientific and radio wave equipment.

# Customer Information

## SUNA TRAFFIC CHANNEL – TERMS AND CONDITIONS

By activating, using and/or accessing the SUNA Traffic Channel, SUNA Predictive or other content or material provided by Intelematics (together, **SUNA Products and/or Services**), you must accept certain terms and conditions. The following is a brief summary of the terms and conditions that apply to you. To view the full terms and conditions relevant to your use of the SUNA Products and/or Services, please consult:

Website
<a href="http://www.sunatrafic.com.au/termsandconditions/">www.sunatrafic.com.au/termsandconditions/</a>

### 1. Acceptance

By using SUNA Products and/or Services, you will be deemed to have accepted and agreed to be bound by the terms and conditions fully detailed at:

Website
<a href="http://www.sunatrafic.com.au/termsandconditions/">www.sunatrafic.com.au/termsandconditions/</a>

### 2. Intellectual Property

SUNA Products and/or Services are for your personal use. You may not record, or retransmit the content, nor use the content in association with any other traffic information or route guidance service or device not approved by Intelematics. You obtain no right of ownership in any Intellectual Property Rights (including copyright) in the data that is used to provide SUNA Products and/or Services.

### 3. Appropriate Use

SUNA Products and/or Services are intended as an aid to personal motoring and travel planning, and do not provide comprehensive or accurate information on all occasions. On occasions, you may experience additional delay as a result of using SUNA Products and/or Services. You acknowledge that it is not intended, or suitable, for use in applications where time of arrival or driving directions may impact the safety of the public or yourself.

### 4. Use of SUNA Products and Services while driving

You, and other authorised drivers of the vehicle in which SUNA Products and/or Services are available or installed and active, remain at all times responsible for observing all relevant laws and codes of safe driving. In particular, you agree to only actively operate SUNA Products and/or Services when the Vehicle is at a complete stop and it is safe to do so.

### 5. Service Continuity and Reception of the SUNA Traffic Channel

We will use reasonable endeavours to provide the SUNA Traffic Channel 24 hours a day, 365 days a year. The SUNA Traffic Channel may occasionally be unavailable for technical reasons or for planned maintenance. We will try to perform maintenance at times when congestion is light. We reserve the right to withdraw SUNA Products and/or Services at any time.

Also, we cannot assure the uninterrupted reception of the SUNA Traffic Channel RDS-TMC signal at any particular location.

### 6. Limitation of Liability

Neither Intelematics (nor its suppliers or the manufacturer of your device (the **"Suppliers"**)) shall be liable to you or to any third party for any damages either direct, indirect, incidental, consequential or otherwise arising out of the use of or inability to use SUNA Products and/or

# Customer Information

Services even if Intelematics or a Supplier has been advised of the possibility of such damages. You also acknowledge that the neither Intelematics nor any Supplier guarantees nor make any warranties that relate to the availability, accuracy or completeness of SUNA Products and/or Services, and to the extent which it is lawful to do so, both Intelematics and each Supplier excludes any warranties which might otherwise be implied by any State or Federal legislation in relation to SUNA Products and/or Services.

## 7. Please Note

Great care has been taken in preparing this manual. Constant product development may mean that some information is not entirely up-to-date. The information in this document is subject to change without notice.

## EMISSION LAW - UNITED STATES OF AMERICA



**WARNING:** Do not remove or alter the original equipment floor covering or insulation between it and the metal floor of the vehicle. The floor covering and insulation protect occupants of the vehicle from the engine and exhaust system heat and noise. On vehicles with no original equipment floor covering insulation, do not carry passengers in a manner that permits prolonged skin contact with the metal floor. Failure to follow these instructions may result in fire or personal injury.

U.S. federal laws and certain state laws prohibit removing or rendering inoperative emission control system components. Similar federal or provincial laws may apply in Canada. We do not approve of any vehicle modification without first determining applicable laws.



Tampering with emissions control systems including related sensors or the Diesel Exhaust Fluid system can result in reduced engine power and the illumination of the service engine soon light.

## Tampering With a Noise Control System

Federal laws prohibit the following acts:

- Removal or rendering inoperative by any person other than for purposes of maintenance.
- Repair or replacement of any device or element of the design incorporated into a new vehicle for the purpose of noise control prior to its sale or delivery to the ultimate purchaser or while it is in use.
- The use of the vehicle after any person removes or renders inoperative any device or element of the design.

The U.S. Environmental Protection Agency may presume to constitute tampering as follows:

- Removal of hood blanket, fender apron absorbers, fender apron barriers, underbody noise shields or acoustically absorptive material.
- Tampering or rendering inoperative the engine speed governor, to allow engine speed to exceed manufacturer specifications.

If the engine does not start, runs rough, experiences a decrease in engine performance, experiences excess fuel consumption or produces excessive exhaust smoke, check for the following:

- A plugged or disconnected air inlet system hose.
- A plugged engine air filter element.
- Water in the fuel filter and water separator.

## Customer Information

---

- A clogged fuel filter.
- Contaminated fuel.
- Air in the fuel system, due to loose connections.
- An open or pinched sensor hose.
- Incorrect engine oil level.
- Incorrect fuel for climatic conditions.
- Incorrect engine oil viscosity for climactic conditions.

**Note:** *Some vehicles have a lifetime fuel filter that is integrated with the fuel tank. Regular maintenance or replacement is not needed.*

**Note:** *If these checks do not help you correct the concern, have your vehicle checked as soon as possible.*

### **Noise Emissions Warranty, Prohibited Tampering Acts and Maintenance**

On January 1, 1978, Federal regulation became effective governing the noise emission on trucks over 10,000 lb (4,536 kg) Gross Vehicle Weight Rating (GVWR). The preceding statements concerning prohibited tampering acts and maintenance, and the noise warranty found in the Warranty Guide, are applicable to complete chassis cabs over 10,000 lb (4,536 kg) GVWR.

### **EXPORT UNIQUE OPTIONS**

For your particular global region, your vehicle may be equipped with features and options that are different from the features and options that are described in this Owner's Manual. A market unique supplement may be supplied that complements this book. By referring to the market unique supplement, if provided, you can properly identify those features, recommendations and specifications that are unique to your vehicle. This Owner's

Manual is written primarily for the U.S. and Canadian markets. Features or equipment listed as standard may be different on units built for export. **Refer to this Owner's Manual for all other required information and warnings.**



# Appendices

## ELECTROMAGNETIC COMPATIBILITY



**WARNING:** Do not place objects or mount equipment on or near the airbag cover, on the side of the front or rear seatbacks, or in areas that may come into contact with a deploying airbag. Failure to follow these instructions may increase the risk of personal injury in the event of a crash.



**WARNING:** Do not fasten antenna cables to vehicle wiring, fuel pipes and brake pipes.



**WARNING:** Keep antenna and power cables at least 4 in (10 cm) from any electronic modules and airbags.

**Note:** We test and certify your vehicle to meet electromagnetic compatibility legislation. It is your responsibility to make sure that any equipment an authorized dealer installs on your vehicle complies with applicable local legislation and other requirements. Installation of some aftermarket electronic devices could degrade the performance of vehicle functions, which use radio frequency signals such as broadcast radio receiver, tire pressure monitoring system, push button start, Bluetooth connectivity or satellite navigation.

**Note:** Any radio frequency transmitter equipment in your vehicle (such as cellular telephones and amateur radio transmitters) must keep to the parameters in the following illustrations and table. We do not provide any other special provisions or conditions for installations or use.

### Car/SUV

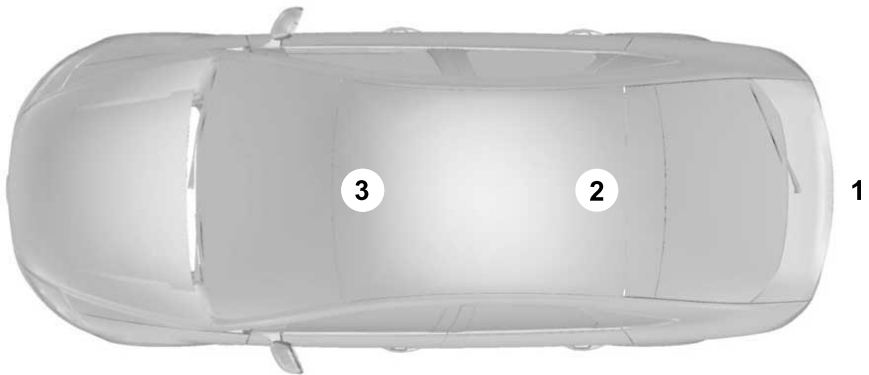

# Appendices

---

## Van

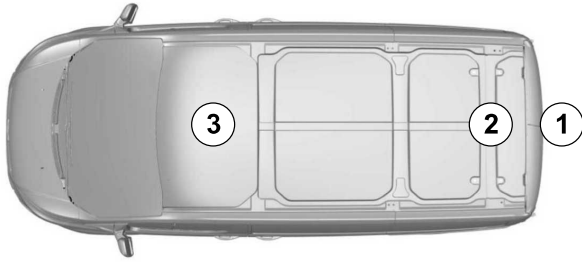

## Truck

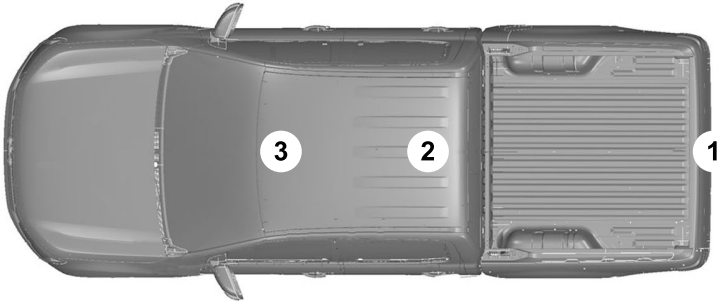

# Appendices

---

<b>Frequency Band MHz</b>	<b>Maximum output power Watt (Peak RMS)</b>	<b>Antenna Positions</b>
1-30	50	1
50-54	50	2, 3
68-88	50	2, 3
142-176	50	2, 3
380-512	50	2, 3
806-870	10	2, 3

# Index

## 3

360 Degree Camera.....	305
360 Degree Camera Settings.....	307
360 Degree Camera Guide Lines.....	306
Keep Out Zone.....	307
360 Degree Camera Limitations.....	305
360 Degree Camera Precautions.....	305
360 Degree Camera Settings.....	307
Switching the 360 Degree Camera On and Off.....	307
Switching the 360 Degree Camera View.....	307

## 4

4WD	
See: Four-Wheel Drive.....	260

## 9

911 Assist.....	68
-----------------	----

## A

### A/C

See: Climate Control - Vehicles With: Automatic Temperature Control.....	158
See: Climate Control - Vehicles With: Manual Temperature Control.....	163
About This Publication.....	21
Features and Options.....	21
Illustrations.....	21
Location of Components.....	21

### ABS

See: Brakes.....	273
Accessing Apps.....	590
Accessing Navigation.....	594
Accessing the Passive Key Backup Position.....	216
Accessories.....	599
Active Drive Assist.....	291
Active Drive Assist – Troubleshooting.....	294
Active Drive Assist Alerts.....	292
Active Drive Assist Automatic Cancellation.....	293

Active Drive Assist Indicators.....	293
Hands-On Driving Support Available.....	293
Active Drive Assist Limitations.....	292
Active Drive Assist Precautions.....	291
Active Drive Assist Requirements.....	292
Active Drive Assist Settings.....	292
Enabling Active Drive Assist.....	292
Active Drive Assist – Troubleshooting.....	294
Active Drive Assist – Information Messages.....	294
Active Park Assist.....	309
Active Park Assist – Troubleshooting.....	311
Active Park Assist Precautions.....	309
Active Park Assist – Troubleshooting.....	311
Active Park Assist – Frequently Asked Questions.....	311
Active Park Assist – Information Messages.....	311
Adaptive Cruise Control.....	315
Adaptive Cruise Control – Troubleshooting.....	325
Intelligent Adaptive Cruise Control.....	324
Lane Centering.....	322
Adaptive Cruise Control Automatic Cancellation.....	318
Adaptive Cruise Control Indicators.....	321
Adaptive Cruise Control Limitations.....	316
Sensor Limitations.....	316
Adaptive Cruise Control Precautions.....	315
Hilly Condition Usage.....	315
When Following a Vehicle.....	315
Adaptive Cruise Control – Troubleshooting.....	325
Adaptive Cruise Control – Information Messages.....	325
Adaptive Front Lighting.....	133
How Does Adaptive Front Lighting Work.....	133
Switching Adaptive Front Lighting On and Off.....	134
Adjustable Pedals.....	119
Adjusting the Exterior Mirrors.....	140
Adjusting the Headlamps.....	473
Horizontal Aim Adjustment.....	474

# Index

Vertical Aim Adjustment.....	473
Adjusting the Instrument Panel Lighting Brightness.....	136
Adjusting the Integrated Trailer Brake Controller Mode.....	406
Selecting the Trailer Brake Effort.....	407
Selecting the Trailer Brake Type.....	407
Adjusting the Map.....	594
Changing the Format of the Map.....	594
Zooming the Map In and Out.....	594
Adjusting the Pedals.....	119
Adjusting the Seatbelt Height.....	52
Adjusting the Seatbelt Length.....	53
Adjusting the Seatbelts During Pregnancy.....	52
Adjusting the Sound Settings.....	571
Balance and Fade.....	571
Occupancy Mode.....	571
Sound Mode.....	571
Speed Compensated Volume.....	571
Tone Settings.....	571
Adjusting the Steering Wheel - Vehicles With: Manual Adjustable Steering Column.....	117
Adjusting the Steering Wheel - Vehicles With: Power Adjustable Steering Column.....	117
Adjusting the Volume.....	570
Aid Mode.....	335
How Does Aid Mode Work.....	335
What Is Aid Mode.....	335
Airbag Precautions.....	60
Airbags.....	58
Front Passenger Sensing System.....	62
Air Conditioning See: Climate Control - Vehicles With: Automatic Temperature Control.....	158
See: Climate Control - Vehicles With: Manual Temperature Control.....	163
Air Conditioning System Capacity and Specification - 2.7L EcoBoost™.....	554
Air Conditioning System Capacity and Specification - 3.0L Diesel.....	555
Air Conditioning System Capacity and Specification - 3.3L.....	556
Air Conditioning System Capacity and Specification - 3.5L, Hybrid Electric Vehicle (HEV).....	558
Air Conditioning System Capacity and Specification - 3.5L EcoBoost™.....	557
Air Conditioning System Capacity and Specification - 5.0L.....	559
Alert and Aid Mode.....	335
How Does Alert and Aid Mode Work.....	336
What Is Alert and Aid Mode.....	335
Alert Mode.....	334
Adjusting the Steering Wheel Vibration Intensity.....	335
How Does Alert Mode Work.....	335
What Is Alert Mode.....	334
AM/FM Radio.....	572
AM/FM Radio Limitations.....	572
Selecting a Radio Station.....	572
Ambient Lighting.....	136
Adjusting Ambient Lighting.....	136
Switching Ambient Lighting On and Off.....	136
Anti-Lock Braking System.....	273
Anti-Lock Braking System Limitations.....	273
Anti-Theft Alarm System.....	111
Arming the Anti-Theft Alarm System.....	112
Disarming the Anti-Theft Alarm System.....	112
How Does the Anti-Theft Alarm System Work.....	111
What Are the Inclination Sensors.....	111
What Are the Interior Sensors.....	111
What Is the Anti-Theft Alarm System.....	111
What Is the Battery Backup Alarm.....	111
What Is the Perimeter Alarm.....	111
Anti-Theft Alarm System Settings.....	112
Setting the Alarm Security Level.....	112
Switching Ask on Exit On and Off.....	112
What are the Alarm Security Levels.....	112
What Is Ask on Exit.....	112
Appendices.....	670
Applying the Electric Parking Brake.....	276
Applying the Electric Parking Brake in an Emergency.....	276
App Precautions.....	590
App Requirements.....	590
Apps.....	590
Audio System.....	570
AM/FM Radio.....	572

# Index

Audio System – Troubleshooting.....	577
Digital Radio.....	573
Satellite Radio.....	574
Audio System Precautions.....	570
Audio System – Troubleshooting.....	577
Audio System – Information	
Messages.....	577
Auto-Dimming Exterior Mirror.....	141
What Is the Auto-Dimming Exterior	
Mirror.....	141
Auto-Dimming Interior Mirror.....	139
Auto-Dimming Interior Mirror	
Limitations.....	139
What Is the Auto-Dimming Interior	
Mirror.....	139
Auto Hold.....	283
Auto Hold Indicators.....	283
Autolamps.....	125
Autolamp Settings.....	125
What Are Autolamps.....	125
Autolock.....	85
Autolock Requirements.....	85
Switching Autolock On and Off.....	85
What Is Autolock.....	85
Automatically Releasing the Electric	
Parking Brake.....	276
Automatic Crash Shutoff.....	440
Automatic Crash Shutoff	
Precautions.....	440
Re-Enabling Your Vehicle.....	440
What Is Automatic Crash Shutoff.....	440
Automatic Emergency Braking.....	351
Switching Automatic Emergency Braking	
On and Off.....	352
What Is Automatic Emergency	
Braking.....	351
Automatic Engine Stop.....	215
How Does Automatic Engine Stop	
Work.....	215
Overriding Automatic Engine Stop.....	216
Switching Automatic Engine Stop On and	
Off.....	215
What Is Automatic Engine Stop.....	215
Automatic High Beam Control.....	128
Automatic High Beam Control	
Indicators.....	130
Automatic High Beam Control	
Limitations.....	129
Automatic High Beam Control	
Precautions.....	129
Automatic High Beam Control	
Requirements.....	129
How Does Automatic High Beam Control	
Work.....	128
Overriding Automatic High Beam	
Control.....	130
Switching Automatic High Beam Control	
On and Off.....	130
Automatic High Beam Control –	
Troubleshooting.....	130
Automatic High Beam Control –	
Information Messages.....	130
Automatic Locking Mode.....	51
Disengaging Automatic Locking Mode.....	52
Engaging Automatic Locking Mode.....	51
What Is Automatic Locking Mode.....	51
When to Use Automatic Locking Mode.....	51
Automatic Return to Park (P).....	256
Automatic Return to Park (P)	
Limitations.....	256
How Does Automatic Return to Park (P)	
Work.....	256
What Is Automatic Return to Park	
(P).....	256
Automatic Transmission.....	253
Automatic Return to Park (P).....	256
Automatic Transmission Positions.....	253
Manually Shifting Gears.....	254
Manual Park Release.....	257
Temporary Neutral Mode.....	255
Automatic Transmission Positions.....	253
Drive (D).....	253
Manual (M).....	254
Neutral (N).....	253
Park (P).....	253
Reverse (R).....	253
Automatic Transmission	
Precautions.....	253
Auto Mode.....	160
Auto Mode Indicators.....	160
Switching Auto Mode On and Off.....	160
Switching Dual Mode On and Off.....	161
Auto-Start-Stop.....	224
Auto-Start-Stop – Troubleshooting.....	225
Auto-Start-Stop Indicators.....	224
Auto-Start-Stop Precautions.....	224

# Index

Auto-Start-Stop – Troubleshooting.....	225
Auto-Start-Stop – Frequently Asked Questions.....	226
Auto-Start-Stop – Information Messages.....	225
Autounlock.....	85
Autounlock Requirements.....	85
Switching Autounlock On and Off.....	85
What Is Autounlock.....	85
Autowipers.....	120
Adjusting the Sensitivity of the Rain Sensor.....	120
Autowipers Settings.....	120
What Are Autowipers.....	120

## B

Battery	
See: Changing the 12V Battery.....	471
Bed Extender.....	93
Bed Extender Precautions.....	93
Using the Bed Extender.....	93
Beginning a Voice Interaction.....	583
Blind Spot Information System.....	340
Blind Spot Information System – Troubleshooting.....	343
Blind Spot Information System With Trailer Coverage.....	341
Blind Spot Information System Indicators.....	343
Blind Spot Information System Limitations.....	340
Blind Spot Information System Precautions.....	340
Blind Spot Information System Requirements.....	340
Blind Spot Information System – Troubleshooting.....	343
Blind Spot Information System – Information Messages.....	343
Blind Spot Information System With Trailer Coverage.....	341
Blind Spot Information System With Trailer Coverage Limitations.....	341
Selecting a Trailer.....	342
Setting a Trailer Length.....	342

What Is Blind Spot Information System with Trailer Coverage.....	341
Bluetooth®.....	589
Body Control Module Fuse Box.....	451
Accessing the Body Control Module Fuse Box.....	451
Identifying the Fuses in the Body Control Module Fuse Box.....	451
Locating the Body Control Module Fuse Box.....	451
Bonnet Lock	
See: Opening and Closing the Hood.....	455
Booster Seats.....	46
Types of Booster Seats.....	46
Brake Fluid Specification.....	274
Brake Over Accelerator.....	273
Brake Precautions.....	273
Brakes.....	273
Anti-Lock Braking System.....	273
Brakes – Troubleshooting.....	274
Brakes – Troubleshooting Frequently Asked Questions.....	274
Brakes – Warning Lamps.....	274
Breaking-In.....	430
Brakes and Clutch.....	430
Tires.....	430

## C

Calculating Payload.....	363
Calculating the Load Limit.....	363
Helpful examples for calculating the available amount of cargo and luggage load capacity.....	364
California Proposition 65 - United States of America.....	641
Canceling the Set Speed.....	314
Capacities and Specifications.....	524
Catalytic Converter.....	251
Catalytic Converter – Troubleshooting.....	251
Catalytic Converter Precautions.....	251
Catalytic Converter – Troubleshooting.....	251
Catalytic Converter – Warning Lamps.....	251

# Index

Center Console Work Surface.....	200	Child Restraint Anchor Points.....	36
Center Console Work Surface –		Locating the Child Restraint Lower Anchor	
Troubleshooting.....	202	Points.....	36
Center Console Work Surface –		Locating the Child Restraint Top Tether	
Troubleshooting.....	202	Anchor Points.....	37
Center Console Work Surface – Information		What Are the Child Restraint Anchor	
Messages.....	202	Points.....	36
Changing a Flat Tire.....	516	Child Restraints.....	38
Dissimilar Spare Wheel and Tire Assembly		Child Restraint Position Information.....	38
Information.....	516	Child Restraints Recommendation.....	39
Jacking the Vehicle.....	520	Child Safety.....	35
Removing the Spare Tire.....	519	Child Restraint Anchor Points.....	36
Removing the Vehicle Jack and Tool		Child Restraints.....	38
Bag.....	518	Installing Child Restraints.....	39
Stowing the Flat or Spare Tire.....	521	Child Safety Locks.....	48
Stowing the Vehicle Jack and Tool		Left-Hand Side.....	48
Bag.....	522	Right-Hand Side.....	48
Tire Change Procedure.....	517	Child Safety Precautions.....	35
Changing a Road Wheel.....	516	Cleaning Products.....	486
Changing the 12V Battery.....	471	Materials.....	486
Remove and Reinstall the Battery.....	472	Cleaning the Exterior.....	486
Changing the Fuel Filter - Diesel.....	471	Cleaning Camera Lenses and	
Changing the Fuel Filter - Gasoline.....	471	Sensors.....	488
Changing the Remote Control Battery -		Cleaning Chrome, Aluminium or Stainless	
Vehicles With: Flip Key.....	73	Steel.....	487
Battery Replacement Procedure.....	73	Cleaning Headlamps and Rear	
Changing the Remote Control Battery -		Lamps.....	486
Vehicles With: Push Button Start.....	72	Cleaning Stripes or Graphics.....	488
Changing the Vehicle Wi-Fi Hotspot		Cleaning the Engine Compartment.....	487
Name or Password.....	569	Cleaning the Exterior Precautions.....	486
Charging a Device.....	187	Cleaning the Underbody.....	488
Charging a Wireless Device.....	203	Cleaning Wheels.....	487
Checking MyKey System Status.....	80	Cleaning Windows and Wiper	
Checking the Brake Fluid.....	273	Blades.....	487
Checking the Coolant.....	463	Cleaning the Interior.....	488
Adding Coolant.....	464	Cleaning Carpets and Floor Mats.....	490
Coolant Change.....	465	Cleaning Displays and Screens.....	489
Engine Coolant Temperature		Cleaning Moonroof Tracks.....	490
Management.....	466	Cleaning Plastic.....	488
Fail-Safe Cooling.....	465	Cleaning Seatbelts.....	490
Severe Climates.....	465	Cleaning Seats and the Headliner.....	489
Checking the Seatbelts.....	55	Cleaning the Instrument Panel.....	488
Checking the Selective Catalytic		Clearing All MyKeys.....	80
Reduction System Status.....	249	Clearing the Garage Door Opener.....	185
Checking the Tire Pressures.....	505	Climate Control.....	158
Checking the Wiper Blades.....	121	Auto Mode.....	160
Children and Airbags.....	61		



# Index

Climate Control Hints.....	161	Enabling and Disabling the Modem.....	565
Defogging the Side Windows in Cold Weather.....	161	What Is the Modem.....	565
General Hints.....	161	Connecting the Vehicle to a Wi-Fi Network.....	565
Quickly Cooling the Interior.....	161	Connecting Your Phone.....	585
Quickly Heating the Interior.....	161	Contacting Us.....	19
Recommended Settings for Cooling.....	161	Argentina.....	19
Recommended Settings for Heating.....	161	Asia Pacific.....	19
Closing the Tailgate.....	96	Australia.....	19
Closing the Tailgate From Inside Your Vehicle.....	96	Brazil.....	19
Closing the Tailgate From Outside Your Vehicle.....	96	Canada.....	19
Closing the Tailgate Using the Remote Control.....	97	Caribbean, Central America and Israel.....	19
Cold Weather Precautions.....	430	Europe.....	19
Connected Vehicle.....	565	Ford Credit - US Only.....	20
Connected Vehicle – Troubleshooting.....	566	Middle East.....	20
Connecting the Vehicle to a Mobile Network.....	565	New Zealand.....	19
Connected Vehicle Data.....	28	North Africa.....	19
Connected Vehicle Limitations.....	565	Puerto Rico.....	20
Connected Vehicle Requirements.....	565	South Korea.....	20
Connected Vehicle – Troubleshooting.....	566	Sub-Saharan Africa.....	19
Connected Vehicle – Frequently Asked Questions.....	566	U.S. Virgin Islands and Puerto Rico.....	19
Connecting a Bluetooth® Device.....	589	United States.....	19
Connecting a Trailer.....	372	Cooling System Capacity and Specification - 2.7L EcoBoost™.....	547
Connecting a Trailer – Troubleshooting.....	374	Cooling System Capacity and Specification - 3.0L Diesel.....	548
Electronic Park Hold.....	373	Cooling System Capacity and Specification - 3.3L.....	548
Hitches.....	371	Cooling System Capacity and Specification - 3.5L, Hybrid Electric Vehicle (HEV).....	550
Recognizing a Trailer.....	372	Cooling System Capacity and Specification - 3.5L EcoBoost™.....	549
Safety Chains.....	372	Cooling System Capacity and Specification - 5.0L.....	550
Trailer Brakes.....	373	Crash and Breakdown Information.....	436
Trailer Connection Alarm.....	373	Automatic Crash Shutoff.....	440
Trailer Connection Checklist.....	373	Jump Starting the Vehicle.....	438
Trailer Light Check.....	373	Post-Crash Alert System.....	440
Connecting a Trailer Precautions.....	371	Recovery Towing.....	440
Connecting a Trailer – Troubleshooting.....	374	Crash Sensors and Airbag Indicator.....	65
Connecting a Trailer – Information Messages.....	374	Creating a MyKey - Vehicles With: Flip Key.....	80
Connecting the Vehicle to a Mobile Network.....	565	Creating a MyKey - Vehicles With: Push Button Start.....	79
Connecting FordPass to the Modem.....	565	Creating a Personal Profile.....	593

# Index

Creating a Vehicle Wi-Fi Hotspot.....	569	Diesel Exhaust Fluid Capacity and Specification.....	249
Connecting a Device to the Wi-Fi Hotspot.....	569	Diesel Particulate Filter.....	240
Finding the Wi-Fi Hotspot Name and Password.....	569	Diesel Particulate Filter Manual Regeneration.....	241
Cross Traffic Alert.....	344	Diesel Particulate Filter – Troubleshooting.....	243
Cross Traffic Alert – Troubleshooting.....	346	Diesel Particulate Filter Manual Regeneration.....	241
Cross Traffic Alert With Trailer Coverage.....	345	Diesel Particulate Filter Manual Regeneration Limitations.....	242
Cross Traffic Alert Indicators.....	345	Diesel Particulate Filter Manual Regeneration Precautions.....	241
Cross Traffic Alert Limitations.....	344	Diesel Particulate Filter Manual Regeneration Requirements.....	241
Cross Traffic Alert Precautions.....	344	Starting Diesel Particulate Filter Manual Regeneration.....	242
Cross Traffic Alert – Troubleshooting.....	346	What Is Diesel Particulate Filter Manual Regeneration.....	241
Cross Traffic Alert – Information Messages.....	346	Diesel Particulate Filter Precautions.....	240
Cross Traffic Alert With Trailer Coverage.....	345	Diesel Particulate Filter Requirements.....	241
Cross Traffic Alert With Trailer Coverage Limitations.....	345	Diesel Particulate Filter – Troubleshooting.....	243
What Is Cross Traffic Alert With Trailer Coverage.....	345	Diesel Particulate Filter – Information Messages.....	243
Cruise Control.....	313	Diesel Particulate Filter – Warning Lamps.....	243
Cruise Control Indicators.....	314	Digital Radio.....	573
Cup Holders.....	205	Digital Radio Indicators.....	574
Cup Holder Precautions.....	205	Digital Radio Limitations.....	573
Customer Information.....	618	How Does Digital Radio Work.....	573
Customizing the Instrument Cluster Display.....	153	Switching Digital Radio Reception On and Off.....	573
Adding Screens Using MyView.....	153	What Is Digital Radio.....	573
Adding Screens Using Select Screens.....	153	Directing the Flow of Air.....	160
Configuring Gauges.....	153	Directing Air to the Footwell Air Vents.....	160
<b>D</b>		Directing Air to the Instrument Panel Air Vents.....	160
Data Privacy.....	26	Directing Air to the Windshield Air Vents.....	160
Services That Third Parties Provide.....	26	Disposing of Airbags.....	66
Services That We Provide.....	26	Distance Alert.....	351
Department of Transportation Uniform Tire Quality Grades.....	494	Adjusting the Sensitivity of Distance Alert.....	351
Temperature A B C.....	495	What Is Distance Alert.....	351
Traction AA A B C.....	495		
Treadwear.....	494		
Deploying and Stowing the Power Running Boards.....	116		

# Index

Distance Indication.....	350
Distance Indication Indicator.....	351
Switching Distance Indication On and Off.....	351
What Is Distance Indication.....	350
Doors and Locks Audible Warnings.....	86
Door Ajar Audible Warning.....	86
Doors and Locks.....	84
Autolock.....	85
Autounlock.....	85
Doors and Locks – Troubleshooting.....	86
Mislock.....	85
Operating the Doors From Inside Your Vehicle.....	84
Operating the Doors From Outside Your Vehicle.....	84
Doors and Locks – Troubleshooting.....	86
Doors and Locks – Information Messages.....	86
Doors and Locks – Warning Lamps.....	86
Draining the Fuel Filter Water Trap - Diesel.....	470
Drive Belt Routing - 2.7L EcoBoost™, Vehicles With: Dual Generators.....	483
Drive Belt Routing - 2.7L EcoBoost™, Vehicles With: Single Generator.....	483
Drive Belt Routing - 3.0L Diesel.....	483
Drive Belt Routing - 3.3L.....	484
Drive Belt Routing - 3.5L, Hybrid Electric Vehicle (HEV).....	484
Drive Belt Routing - 3.5L EcoBoost™, Vehicles With: Dual Generators.....	484
Drive Belt Routing - 3.5L EcoBoost™, Vehicles With: Single Generator.....	484
Drive Belt Routing - 5.0L, Vehicles With: Dual Generators.....	485
Drive Belt Routing - 5.0L, Vehicles With: Single Generator.....	485
Drive Mode Control.....	328
Drive Mode Control – Troubleshooting.....	331
Drive Modes.....	329
Drive Mode Control – Troubleshooting.....	331
Drive Mode Control – Frequently Asked Questions.....	332
Drive Mode Control – Information Messages.....	331
Drive Mode Control – Warning Lamps.....	331
Drive Modes.....	329
Deep Snow/Sand.....	329
Eco.....	329
Mud/Ruts.....	329
Normal.....	329
Rock Crawl.....	329
Slippery.....	330
Sport.....	330
Tow/Haul.....	331
Trail.....	331
Driver Alert.....	355
Driver Alert – Troubleshooting.....	356
Driver Alert Limitations.....	355
Driver Alert Precautions.....	355
Driver Alert – Troubleshooting.....	356
Driver Alert – Information Messages.....	356
Driving Economically.....	430
Driving Hints.....	428
Off-Road Driving.....	428

## E

Easy Entry and Exit.....	90
Electric Parking Brake Audible Warning.....	277
Electric Parking Brake.....	276
Electric Parking Brake – Troubleshooting.....	277
Electric Parking Brake – Troubleshooting.....	277
Electric Parking Brake – Information Messages.....	278
Electric Parking Brake – Warning Lamps.....	277
Electric Power Steering.....	295
Electric Power Steering Adaptive Steering.....	295
Electric Power Steering Precautions.....	295
Electromagnetic Compatibility.....	670
Electronic Locking Differential.....	269
Electronic Locking Differential – Troubleshooting.....	272
Electronic Locking Differential Indicators.....	272

# Index

Electronic Locking Differential Precautions.....	269
Operating the Electronic Locking Differential with a Spare or Mismatched Tires.....	269
Electronic Locking Differential – Troubleshooting.....	272
Electronic Locking Differential – Information Messages.....	272
Emergency Call Limitations.....	69
Emergency Call Requirements.....	68
Emergency Call System Data.....	29
Emergency Towing.....	445
Emission Law - United States of America.....	668
Noise Emissions Warranty, Prohibited Tampering Acts and Maintenance.....	669
Tampering With a Noise Control System.....	668
Enabling Apps on an Android Device.....	590
Enabling Apps on an iOS Device.....	590
Enabling or Disabling Personal Profiles.....	592
Enabling Remote Start.....	155
End User License Agreement.....	643
VEHICLE SOFTWARE END USER LICENSE AGREEMENT (EULA) .....	643
Engine Air Filter.....	467
Changing the Engine Air Filter.....	468
Checking the Engine Air Filter Restriction Gauge.....	467
Engine Air Filter - Information Messages.....	470
Engine Block Heater.....	213
Engine Block Heater Precautions.....	213
How Does the Engine Block Heater Work.....	214
Using the Engine Block Heater.....	214
Engine Oil Capacity and Specification - 2.7L EcoBoost™.....	536
Alternative Engine Oil for Extremely Cold Climates.....	537
Engine Oil Capacity and Specification - 3.0L Diesel.....	537
Alternative Engine Oil for Biodiesel Fuel Blends (B20 Max).....	539
Alternative Engine Oil for Extremely Cold Climates.....	539
Alternative Engine Oil for Severe Duty Service.....	539
Engine Oil Capacity and Specification - 3.3L.....	539
Alternative Engine Oil for Extremely Cold Climates.....	540
Engine Oil Capacity and Specification - 3.5L, Hybrid Electric Vehicle (HEV).....	543
Alternative Engine Oil for Extremely Cold Climates.....	544
Engine Oil Capacity and Specification - 3.5L EcoBoost™.....	541
Alternative Engine Oil for Extremely Cold Climates.....	542
Engine Oil Capacity and Specification - 5.0L.....	545
Alternative Engine Oil for Extremely Cold Climates.....	546
Engine Oil.....	462
Adding Engine Oil.....	462
Checking the Engine Oil Level.....	462
Engine Oil Capacity and Specification.....	463
Engine Oil Dipstick Overview.....	462
Resetting the Engine Oil Change Reminder.....	463
Engine Specifications - 2.7L EcoBoost™.....	524
Engine Specifications - 3.0L Diesel.....	525
Engine Specifications - 3.3L.....	526
Engine Specifications - 3.5L, Hybrid Electric Vehicle (HEV).....	528
Engine Specifications - 3.5L EcoBoost™.....	527
Engine Specifications - 5.0L.....	529
Entering a Parallel Parking Space.....	309
Entering a Perpendicular Parking Space.....	310
Evasive Steering Assist.....	352
Evasive Steering Assist Limitations.....	352
Switching Evasive Steering Assist On and Off.....	352
What Is Evasive Steering Assist.....	352

# Index

Event Data.....	27
Active Drive Assist Driver Facing Camera Data.....	28
Exiting a Parking Space.....	310
Export Unique Options.....	669
Extending the Exterior Mirrors.....	141
Power Telescoping Mirrors.....	141
Extending the Remote Start Duration.....	156
Exterior Bulbs.....	474
Changing a Front Fog Lamp Bulb.....	480
Changing a Front Side Marker Lamp Bulb.....	479
Changing a Front Turn Signal Lamp Bulb.....	478
Changing a Headlamp Bulb.....	476
Changing a High Mounted Stoplamp Bulb.....	482
Changing a License Plate Lamp Bulb.....	482
Changing a Rear Lamp Bulb.....	480
Changing a Rear Turn Signal Lamp Bulb.....	481
Changing a Reversing Lamp Bulb.....	482
Changing a Stoplamp Bulb.....	481
Exterior Bulb Specification Chart.....	474
Removing a Rear Lamp Assembly.....	476
Exterior Lamps.....	125
Exterior Lamp Audible Warning.....	127
Exterior Lamp Indicators.....	127
How Do Cornering Lamps Work.....	125
Switching the Cargo Lamps On.....	127
Switching the Daytime Running Lamps On and Off.....	126
Switching the Front Fog Lamps On and Off.....	126
Switching the Spot Lamps On and Off.....	127
Switching the Turn Signal Lamps On and Off.....	125
Exterior Lighting Control.....	124
Exterior Lighting.....	124
Adaptive Front Lighting.....	133
Autolamps.....	125
Automatic High Beam Control.....	128
Automatic High Beam Control – Troubleshooting.....	130
Exterior Lamps.....	125
Exterior Zone Lighting.....	127
Glare Free Lighting.....	131
Glare Free Lighting – Troubleshooting.....	133
Headlamps.....	124
Headlamps – Troubleshooting.....	124
Exterior Mirrors.....	140
Auto-Dimming Exterior Mirror.....	141
Exterior Zone Lighting.....	127
Exterior Zone Lighting Settings.....	128
Using the Exterior Zone Lighting.....	127
What is Exterior Zone Lighting.....	127
<b>F</b>	
Fastening and Unfastening the Seatbelts.....	50
Fastening the Cinch Tongue.....	50
Using the Seatbelt With Cinch Tongue .....	50
Feature Bar.....	582
Filling the Selective Catalytic Reduction System Tank.....	247
Filling the Selective Catalytic Reduction System Tank in Cold Weather.....	247
Filling the Selective Catalytic Reduction System Tank Using a Fuel Station Pump.....	247
Filling the Selective Catalytic Reduction System Tank Using a Portable Container.....	248
Flat Tire See: Changing a Flat Tire.....	516
Floor Mats.....	431
Folding the Exterior Mirrors - Vehicles With: Manual Folding Mirrors.....	140
Folding the Exterior Mirrors - Vehicles With: Power Folding Mirrors.....	140
Switching Auto-fold On and Off.....	141
Foot Pedals See: Adjusting the Pedals.....	119
Ford Protect.....	600
Four-Wheel Drive Driving Hints.....	264
Driving In Sand.....	265
Driving on Hilly or Sloping Terrain.....	265
Driving on Snow and Ice.....	266
Driving Through Mud and Water.....	265
Emergency Maneuvers.....	264

# Index

Four-Wheel Drive.....	260	Ventilated Seats.....	174
Four-Wheel Drive Driving Hints.....	264	Fuel and Refueling.....	227
Four-Wheel Drive Modes.....	263	Fuel and Refueling –	
Four-Wheel Drive – Troubleshooting.....	266	Troubleshooting.....	239
Four-Wheel Drive Indicators.....	264	Fuel Quality.....	227
Four-wheel Drive Auto.....	264	Refueling.....	233
Four-wheel Drive High.....	264	Running Out of Fuel.....	232
Four-wheel Drive Low.....	264	Fuel and Refueling Precautions.....	227
Two-wheel Drive High.....	264	Fuel and Refueling –	
Four-Wheel Drive Limitations.....	261	Troubleshooting.....	239
Mechanical Shift Blocking.....	262	Fuel and Refueling – Information	
Operating Four-Wheel Drive with a Spare		Messages.....	239
or Mismatched tires.....	261	Fuel and Refueling – Warning	
Four-Wheel Drive Modes.....	263	Lamps.....	239
Four-Wheel Drive Auto.....	263	Fuel Gauge.....	146
Four-Wheel Drive High.....	264	Fuel Gauge Limitations.....	147
Four-Wheel Drive Low.....	264	Locating the Fuel Filler Door.....	147
Two-Wheel Drive High.....	263	What Is Distance to Empty.....	147
Four-Wheel Drive Precautions.....	260	What Is the Fuel Gauge.....	146
Four-Wheel Drive –		What Is the Low Fuel Reminder.....	147
Troubleshooting.....	266	Fuel Quality.....	227
Four-Wheel Drive – Information		Selecting the Correct Fuel.....	227
Messages.....	267	Selecting the Correct Fuel for Cold	
Four-Wheel Drive – Warning Lamps.....	266	Weather.....	229
Front Axle Fluid Capacity and		Switching Between E85 and	
Specification.....	562	Gasoline.....	232
Front Exterior.....	33	Fuel Tank Capacity - Diesel.....	552
Front Parking Aid.....	298	Fuel Tank Capacity - Excluding: Hybrid	
Front Parking Aid Audible Warnings.....	299	Electric Vehicle (HEV).....	238
Front Parking Aid Limitations.....	298	Advertised Capacity.....	238
Locating the Front Parking Aid		Fuel Tank Capacity - Gasoline, Excluding:	
Sensors.....	299	Hybrid Electric Vehicle (HEV).....	551
What is the Front Parking Aid.....	298	Fuel Tank Capacity - Gasoline, Hybrid	
Front Passenger Sensing System.....	62	Electric Vehicle (HEV).....	553
Front Passenger Sensing System		Fuel Tank Capacity - Hybrid Electric	
Indicators.....	64	Vehicle (HEV).....	239
Front Passenger Sensing System		Advertised Capacity.....	239
Precautions.....	64	Fuse Precautions.....	446
How Does the Front Passenger Sensing		Fuses.....	446
System Work.....	62	Body Control Module Fuse Box.....	451
What Is the Front Passenger Sensing		Fuses – Troubleshooting.....	454
System.....	62	Under Hood Fuse Box.....	446
Front Seat Precautions.....	167	Fuses – Troubleshooting.....	454
Front Seats.....	167	Fuses – Frequently Asked Questions.....	454
Heated Seats.....	174		
Manual Seats.....	168	<b>G</b>	
Massage Seats.....	173	Garage Door Opener.....	182
Power Seats.....	170		

# Index

Garage Door Opener Limitations.....	183
Garage Door Opener Precautions.....	182
Garage Door Opener Radio	
Frequencies.....	185
FCC and RSS-210 Industry Canada	
Compliance.....	185
General Maintenance Information.....	602
Multi-Point Inspection.....	604
Owner Checks and Services.....	603
Protecting Your Investment.....	602
Why Maintain Your Vehicle?.....	602
Why Maintain Your Vehicle at Your	
Dealership?.....	602
Glare Free Lighting.....	131
Glare Free Lighting Indicators.....	132
Glare Free Lighting Limitations.....	132
Glare Free Lighting Precautions.....	131
Glare Free Lighting Requirements.....	131
How Does Glare Free Lighting Work.....	131
Overriding Glare Free Lighting.....	132
Switching Glare Free Lighting On and	
Off.....	132
Glare Free Lighting –	
Troubleshooting.....	133
Glare Free Lighting – Information	
Messages.....	133
Glasses Holder.....	208
Locating the Glasses Holder.....	208
Glossary of Tire Terminology.....	500
Glove Compartment.....	205
Locking the Glove Compartment.....	205
Opening the Glove Compartment.....	205
<b>H</b>	
Headlamp Adjusting	
See: Adjusting the Headlamps.....	473
Headlamps.....	124
Headlamp Indicators.....	124
Using the High Beam Headlamps.....	124
Headlamps – Troubleshooting.....	124
Headlamps – Frequently Asked	
Questions.....	124
Heated Seats.....	174
Heated Seat Precautions.....	174
Switching the Heated Seats On and	
Off.....	174
Heating	
See: Climate Control - Vehicles With:	
Automatic Temperature Control.....	158
See: Climate Control - Vehicles With: Manual	
Temperature Control.....	163
High Voltage Battery.....	252
High Voltage Battery Precautions.....	252
High Voltage Battery Vehicle	
Precautions - Hybrid Electric Vehicle	
(HEV).....	437
Crashes.....	437
Fires.....	437
Post-Incident.....	438
Hill Descent Control.....	289
Hill Descent Control –	
Troubleshooting.....	290
Hill Descent Control Indicator.....	289
Hill Descent Control Precautions.....	289
Hill Descent Control –	
Troubleshooting.....	290
Hill Descent Control – Information	
Messages.....	290
Hill Start Assist.....	282
Hill Start Assist – Troubleshooting.....	282
Hill Start Assist Precautions.....	282
Hill Start Assist – Troubleshooting.....	282
Hill Start Assist – Information	
Messages.....	282
Hitches.....	371
Hooking Up a Trailer Using a	
Weight-Distributing Hitch.....	371
Hood Lock	
See: Opening and Closing the Hood.....	455
Horn.....	118
How Does 911 Assist Work.....	68
How Does Active Drive Assist	
Work.....	291
How Does Active Park Assist	
Work.....	309
How Does Adaptive Cruise Control With	
Stop and Go Work.....	315
How Does a Hybrid Electric Vehicle	
Work.....	221
.....	221
How Does Auto Hold Work.....	283
How Does Blind Spot Information	
System Work.....	340

# Index

How Does Cross Traffic Alert Work.....	344	How Do Personal Profiles Work.....	592
How Does Drive Mode Control Work.....	328	Recalling and Changing a Profile.....	592
How Does Driver Alert Work.....	355	How Do the Front Airbags Work.....	58
How Does Easy Entry and Exit Work.....	90	How Do the Knee Airbags Work.....	59
How Does Four-Wheel Drive Work.....	260	How Do the Side Airbags Work.....	58
Using the 2-Speed Automatic Four-Wheel Drive System.....	260	Hybrid Display Information.....	154
Using the Electronic Shift On the Fly System.....	260	How Does EV Coach Work.....	154
How Does Hill Descent Control Work.....	289	What Is EV Coach.....	154
How Does Hill Start Assist Work.....	282	Hybrid Electric Vehicle Driving Characteristics.....	221
How Does Pre-Collision Assist Work.....	347	Hybrid Electric Vehicle Information.....	221
How Does Reverse Braking Assist Work.....	279	Hybrid Electric Vehicle Information – Troubleshooting.....	222
How Does Speed Sign Recognition Work.....	357	Low Engine Use Mode.....	221
How Does Stability Control Work.....	286	Hybrid Electric Vehicle Information Indicators.....	222
Electronic Stability Control.....	286	Hybrid Electric Vehicle Information – Troubleshooting.....	222
How Does the 360 Degree Camera Work.....	305	Hybrid Electric Vehicle Information – Frequently Asked Questions.....	222
How Does the Diesel Particulate Filter Work.....	240		
Active Regeneration.....	240	Identifying Fuse Types.....	454
Passive Regeneration.....	240	Identifying the Audio Unit.....	580
How Does the Garage Door Opener Work.....	182	Identifying the Climate Control Unit.....	158
How Does the Lane Keeping System Work.....	333	Ignition Switch.....	209
How Does the Personal Safety System Work.....	57	Starting the Engine.....	210
How Does the Rear Occupant Alert System Work.....	179	Switching the Ignition Off.....	209
How Does the Safety Canopy™ Work.....	59	Switching the Ignition On.....	209
How Does the Selective Catalytic Reduction System Work.....	245	Switching the Ignition to Accessory Mode.....	209
How Does the Trailer Reversing Aid Work.....	410	Inflating the Tires.....	505
How Does Traction Control Work.....	284	Information and Entertainment Display Limitations.....	581
How Does Trailer Sway Control Work.....	409	Speed-restricted Features.....	581
		Information and Entertainment Display Overview.....	581
		Information and Entertainment Display Precautions.....	581
		Information On Demand Screen - Vehicles With: 12.3 Inch Screen.....	582
		Information on the Tire Sidewall.....	495
		Information on P Type Tires.....	496
		Inspecting the Tire for Damage.....	506
		Safety Practices.....	506
		Inspecting the Tire for Wear.....	506



# Index

Inspecting the Wheel Valve	
Stems.....	507
Installing Child Restraints.....	39
Attaching the Front Seat Tether	
Strap.....	44
Attaching the Rear Seat Tether Strap.....	45
Combining the Seatbelt and Lower Anchors	
for Attaching Child Restraints.....	44
Installing a Child Restraint in a Center	
Seat.....	43
Using Lower Anchors and Tethers for	
Children.....	43
Using Seatbelts.....	39
Using Tether Straps.....	44
Instrument Cluster Display.....	151
Hybrid Display Information.....	154
Personalized Settings.....	153
Trip Computer - Vehicles With: 4.2 Inch	
Screen.....	152
Trip Computer - Vehicles With: 8 Inch	
Screen/12.3 Inch Screen.....	153
Instrument Cluster Display Main Menu -	
Vehicles With: 12.3 Inch Screen.....	152
Instrument Cluster Display Main Menu -	
Vehicles With: 4.2 Inch Screen.....	151
Instrument Cluster Display Main Menu -	
Vehicles With: 8 Inch Screen.....	152
Instrument Cluster Indicators.....	149
Active Drive Assist.....	149
Adaptive Cruise Control.....	149
Auto Hold Active.....	149
Auto Hold Unavailable.....	149
Automatic High Beam.....	149
Automatic Regen Control Off.....	149
Auto-Start-Stop.....	149
Blind Spot Monitor.....	150
Cruise Control.....	150
Electronic Locking Differential.....	150
Four-Wheel Drive.....	150
Front Airbag.....	150
Front Fog Lamp.....	150
High Beam.....	150
Hill Descent.....	150
Lamps On.....	150
Ready to Drive.....	150
Reverse Brake Assist.....	150
Stability Control and Traction	
Control.....	150
Tow Haul.....	150
Turn Signal Lamps.....	150
Wait to Start.....	150
Instrument Cluster.....	144
Fuel Gauge.....	146
Instrument Cluster Overview - Vehicles	
With: 12.3 Inch Screen.....	146
Instrument Cluster Overview - Vehicles	
With: 4.2 Inch Screen.....	144
Instrument Cluster Overview - Vehicles	
With: 8 Inch Screen.....	145
Instrument Cluster Warning	
Lamps.....	148
Anti-Lock Brake System.....	148
Battery.....	148
Brake System.....	148
Diesel Exhaust Fluid.....	148
Door Ajar.....	148
Electric Parking Brake.....	148
Engine Coolant Temperature.....	148
Fasten Seatbelt.....	148
Hood Ajar.....	148
Low Fuel Level.....	148
Low Tire Pressure.....	148
Low Washer Fluid Level.....	148
Oil Pressure.....	149
Powertrain Malfunction, Reduced Power,	
Electronic Throttle Control, Check	
4X4.....	149
Service Engine Soon.....	149
Stop Safely.....	149
Tailgate Ajar.....	149
Water in Fuel.....	149
Instrument Panel.....	31
Integrated Trailer Brake	
Controller.....	405
Integrated Trailer Brake Controller -	
Troubleshooting.....	407
Integrated Trailer Brake Controller	
Precautions.....	405
Integrated Trailer Brake Controller -	
Troubleshooting.....	407
Integrated Trailer Brake Controller -	
Frequently Asked Questions.....	408
Integrated Trailer Brake Controller -	
Information Messages.....	407
Intelligent Adaptive Cruise Control.....	324
Adjusting the Set Speed Tolerance.....	325

# Index

How Does Intelligent Adaptive Cruise Control Work.....	324
Intelligent Adaptive Cruise Control Alerts.....	325
Intelligent Adaptive Cruise Control Indicators.....	325
Intelligent Adaptive Cruise Control Limitations.....	324
Intelligent Adaptive Cruise Control Precautions.....	324
Intelligent Adaptive Cruise Control Requirements.....	324
Switching Intelligent Mode On and Off.....	325
Interior Air Quality.....	166
Interior Bulbs.....	483
Interior Bulb Specification Chart.....	483
Interior Lamp Function.....	135
Switching the Interior Lamp Function On and Off.....	135
What Is the Interior Lamp Function.....	135
Interior Lighting.....	135
Ambient Lighting.....	136
Interior Lamp Function.....	135
Interior Mirror.....	139
Auto-Dimming Interior Mirror.....	139
Interior Mirror Precautions.....	139
Introduction.....	21
<b>J</b>	
Jump Starting the Vehicle.....	438
Jump Starting Precautions.....	438
Jump Starting the Vehicle.....	439
Preparing the Vehicle.....	438
<b>K</b>	
Keyless Entry.....	87
Keyless Entry Settings.....	87
Keyless Entry – Troubleshooting.....	89
Locking and Unlocking the Doors Using Keyless Entry Keypad.....	89
Locking and Unlocking the Doors Using Remote Keyless Entry.....	88
Master Access Code.....	87
Keyless Entry Limitations.....	87
Keyless Entry Settings.....	87
Clearing All Personal Access Codes.....	88
Creating Personal Access Codes.....	88
Reprogramming the Unlocking Function.....	87
Switching Keyless Entry On and Off.....	87
Keyless Entry – Troubleshooting.....	89
Keyless Entry – Frequently Asked Questions.....	89
Keys and Remote Controls.....	70
Keys and Remote Controls – Troubleshooting.....	77
Keys and Remote Controls – Troubleshooting.....	77
Keys and Remote Controls – Information Messages.....	77
<b>L</b>	
Lane Centering.....	322
How Does Lane Centering Work.....	322
Lane Centering Alerts.....	323
Lane Centering Automatic Cancellation.....	324
Lane Centering Indicators.....	324
Lane Centering Limitations.....	322
Lane Centering Precautions.....	322
Lane Centering Requirements.....	322
Switching Lane Centering On and Off.....	323
Lane Keeping System Indicators.....	336
Lane Keeping System.....	333
Aid Mode.....	335
Alert and Aid Mode.....	335
Alert Mode.....	334
Lane Keeping System – Troubleshooting.....	337
Lane Keeping System Limitations.....	333
Lane Keeping System Precautions.....	333
Lane Keeping System – Troubleshooting.....	337
Lane Keeping System – Frequently Asked Questions.....	338
Lane Keeping System – Information Messages.....	337
Launching or Retrieving a Boat or Personal Watercraft.....	377

# Index

Linking or Unlinking a Personal Profile to a Remote Control.....	593
Live Traffic.....	594
Switching Live Traffic On and Off.....	594
What Is Live Traffic.....	594
Load Carrying.....	360
Load Carrying Precautions.....	360
Loading Your Trailer.....	376
Locating the 360 Degree	
Cameras.....	305
Auxiliary Camera.....	306
Bed Camera.....	306
Front View Camera.....	305
Rear View Camera.....	305
Side View Camera.....	305
Locating the Blind Spot Information	
System Sensors.....	341
Locating the Brake Fluid Reservoir.....	273
Locating the Cross Traffic Alert	
Sensors.....	345
Locating the Fuel Filler Funnel.....	232
Regular Cab.....	232
Super Cab/Crew Cab.....	232
Locating the Keyless Entry Keypad.....	87
Locating the Memory Function	
Buttons.....	181
Locating the Power Outlet.....	190
Bed.....	198
Instrument Panel.....	197
Rear of the Center Console.....	197
Locating the Pre-Collision Assist	
Sensors.....	349
Locating the Rear View Camera.....	302
Locating the Safety Compliance	
Certification Labels.....	361
Locating the Tire label.....	494
Locating the USB Ports.....	186
Charge Only USB Ports.....	186
Data Transfer USB Ports.....	186
Locating the Wireless Accessory	
Charger.....	203
Locating Your Vehicle.....	71
Locking and Unlocking the Doors Using Keyless Entry Keypad.....	89
Locking the Doors.....	89
Unlocking the Doors.....	89
Locking and Unlocking the Doors Using Remote Keyless Entry.....	88
Locking the Doors.....	88
Unlocking the Doors.....	88
Locking and Unlocking the Tailgate.....	91
Locking the Rear Window Controls.....	138
Low Engine Use Mode.....	221
How Does Low Engine Use Mode Work.....	221
Low Engine Use Mode Limitations.....	222
What is Low Engine Use Mode.....	221

## M

Maintenance.....	455
Engine Air Filter.....	467
Engine Oil.....	462
Exterior Bulbs.....	474
Interior Bulbs.....	483
Maintenance Precautions.....	455
Making and Receiving a Phone Call.....	586
During a Phone Call.....	586
Making Calls.....	586
Receiving Calls.....	586
Manually Dimming the Interior Mirror.....	139
Manually Releasing the Electric Parking Brake.....	276
.....	276
Manually Shifting Gears.....	254
Shifting Using the Buttons on the Selector Lever.....	254
Manual Park Release.....	257
Manual Park Release Precautions.....	257
Using Manual Park Release.....	257
What Is Manual Park Release.....	257
Manual Seats.....	168
Adjusting the Head Restraint.....	168
Adjusting the Lumbar Support.....	170
Adjusting the Seat Backrest.....	169
Folding the Seats.....	176
Head Restraint Components.....	168
Installing the Head Restraint.....	169
Moving the Seat Backward and Forward.....	169
Removing the Head Restraint.....	169
Unfolding the Seats.....	177

# Index

Massage Seats.....	173	Normal Scheduled Maintenance.....	605
Adjusting the Massage Seat Settings.....	173	Normal Maintenance Intervals.....	607
Massage Seat Limitations.....	173	Oil Change Reminder.....	605
Master Access Code.....	87	<b>O</b>	
What Is the Master Access Code.....	87	Off-Road Driving.....	428
Memory Function.....	181	After Driving Your Vehicle Off-Road.....	429
Memory Function Precautions.....	181	Basic Off-Road Driving Techniques.....	428
Mislock.....	85	Water Wading.....	429
Mislock Limitations.....	85	What Is Off-Road Driving.....	428
Switching Mislock On and Off.....	85	Opening and Closing the Flip Key.....	70
What Is Mislock.....	85	Closing Your Flip Key.....	71
Mobile Communications		Opening Your Flip Key.....	70
Equipment.....	642	Opening and Closing the Hood.....	455
Mobile Device Data.....	29	Opening and Closing the Moonroof.....	142
Moonroof Bounce-Back.....	143	Closing the Moonroof.....	142
Overriding Moonroof Bounce-Back.....	143	Opening the Moonroof.....	142
What Is Moonroof Bounce-Back.....	143	Opening and Closing the Sliding	
Moonroof.....	142	Windows.....	138
Moonroof Bounce-Back.....	143	Opening and Closing the Sun	
Motorcraft Parts - 2.7L		Shade.....	142
EcoBoost™.....	530	Closing the Sun Shade.....	142
Motorcraft Parts - 3.0L Diesel.....	531	Opening the Sun Shade.....	142
Motorcraft Parts - 3.3L.....	532	Opening and Closing the Windows.....	137
Motorcraft Parts - 3.5L, Hybrid Electric		One-Touch Close.....	137
Vehicle (HEV).....	534	One-Touch Open.....	137
Motorcraft Parts - 3.5L		Opening the Tailgate.....	91
EcoBoost™.....	533	Opening the Tailgate From Inside Your	
Motorcraft Parts - 5.0L.....	535	Vehicle.....	96
Muting the Audio.....	571	Opening the Tailgate From Outside Your	
MyKey Settings.....	78	Vehicle.....	91
Configurable MyKey Settings.....	78	Opening the Tailgate Using the Remote	
Non-Configurable MyKey Settings.....	78	Control.....	96
MyKey - Troubleshooting.....	81	Operating the Doors From Inside Your	
MyKey - Frequently Asked Questions.....	83	Vehicle.....	84
MyKey - Information Messages.....	81	Individually Unlocking and Locking the	
MyKey™.....	78	Doors Using the Locking Button.....	84
MyKey Settings.....	78	Opening the Doors From Inside Your Vehicle	
MyKey - Troubleshooting.....	81	.....	85
<b>N</b>		Operating the Doors From Outside Your	
Navigation Map Updates.....	594	Vehicle.....	84
Navigation.....	594	Unlocking and Locking the Doors Using the	
Adjusting the Map.....	594	Key Blade.....	84
Live Traffic.....	594	Unlocking and Locking the Doors Using the	
Route Guidance.....	595	Remote Control.....	84
Setting a Destination.....	594	Operating Your Vehicle With a	
Waypoints.....	595	Snowplow.....	433

# Index

Ordering a Canadian French Owner's Manual.....	619
Overriding Reverse Braking Assist.....	280
Overriding the Set Speed.....	321
<b>P</b>	
Parking Aid Indicators.....	300
Parking Aid Precautions.....	297
Parking Aids.....	297
Front Parking Aid.....	298
Parking Aids – Troubleshooting.....	301
Rear Parking Aid.....	297
Side Parking Aid.....	299
Parking Aids – Troubleshooting.....	301
Parking Aids – Information Messages.....	301
Passive Anti-Theft System.....	111
How Does the Passive Anti-Theft System Work.....	111
What Is the Passive Anti-Theft System.....	111
Pedestrian Alert System.....	67
Perchlorate.....	642
Performing a Master Reset.....	598
Personalized Settings.....	153
Changing the Measure Unit.....	153
Changing the Temperature Unit.....	153
Changing the Tire Pressure Unit.....	153
Personal Profiles.....	592
Personal Safety System	
Components.....	57
Personal Safety System™.....	57
Phone Menu.....	585
.....	585
Favorites.....	585
Phone List.....	585
Phone.....	585
Phone Precautions.....	585
Pickup Bed Anchor Points.....	366
Installing and Removing the Pickup Bed Tie-Down Cleats.....	367
Locating the Pickup Bed Anchor Points.....	366
Pickup Bed Anchor Point Load Capacities.....	367
Pickup Bed Anchor Point Precautions.....	366
Pickup Bed.....	366
Pickup Bed Anchor Points.....	366
Pickup Bed Ramps.....	368
Tailgate Anchor Points.....	368
Pickup Bed Precautions.....	366
Pickup Bed Ramps.....	368
Installing and Removing the Pickup Bed Ramp Holder.....	369
Installing and Removing the Pickup Bed Ramps.....	369
Pickup Bed Ramp Precautions.....	368
Storing the Pickup Bed Ramps.....	370
Playing Media Using Bluetooth®.....	589
Playing Media Using the USB Port.....	186
Playing or Pausing the Audio Source.....	570
Audio Unit.....	570
Touchscreen.....	570
Post-Crash Alert System.....	440
How Does the Post-Crash Alert System Work.....	440
Post-Crash Alert System Limitations.....	440
Switching the Post-Crash Alert System Off.....	440
What Is the Post-Crash Alert System.....	440
Power Outlet Indicators.....	198
Power Outlet Indicators - Vehicles With: 2.4kW/7.2kW.....	191
Generator Mode Power Indicator.....	191
Power Outlet Status Indicator.....	191
Power Outlet Indicators - Vehicles With: 2kW.....	190
Generator Mode Power Indicator.....	190
Power Outlet Status Indicator.....	190
Power Outlet Limitations.....	197
Power Outlet.....	188
Power Outlet – Troubleshooting.....	194
Power Outlet Precautions.....	197
Power Outlet Precautions - Vehicles With: 2.4kW/7.2kW.....	189
Power Outlet Precautions - Vehicles With: 2kW.....	188
Power Outlet – Troubleshooting.....	194
Power Outlet – Frequently Asked Questions.....	196

# Index

Power Outlet – Information	
Messages.....	194
Power Running Board Kick Switch.....	115
.....	116
Power Running Board Precautions.....	115
Power Running Board Settings.....	115
.....	115
Power Running Boards.....	115
Power Running Boards –	
Troubleshooting.....	116
Power Running Boards –	
Troubleshooting.....	116
Power Running Boards – Frequently Asked	
Questions.....	116
Power Seats.....	170
Adjusting the Head Restraint.....	170
Adjusting the Lumbar Support.....	173
Adjusting the Seat Backrest.....	171
Adjusting the Seat Cushion.....	171
Adjusting the Seat Height.....	172
Head Restraint Components.....	170
Installing the Head Restraint.....	171
Moving the Seat Backward and	
Forward.....	171
Removing the Head Restraint.....	171
Pre-Collision Assist Limitations.....	348
Intersection Assist.....	348
Pedestrian Detection Limitations.....	348
Pre-Collision Assist Precautions.....	347
Pre-Collision Assist.....	347
Automatic Emergency Braking.....	351
Distance Alert.....	351
Distance Indication.....	350
Evasive Steering Assist.....	352
Pre-Collision Assist –	
Troubleshooting.....	353
Pre-Collision Assist –	
Troubleshooting.....	353
Pre-Collision Assist – Frequently Asked	
Questions.....	354
Pre-Collision Assist – Information	
Messages.....	353
Pre-Collision Assist – Warning	
Lamps.....	353
Preparing Your Vehicle for	
Storage.....	492
12 Volt Battery.....	492
Body.....	492
Brakes.....	492
Engine.....	492
General.....	492
Hybrid Battery Systems .....	492
Tires.....	493
Programming a MyKey.....	80
Programming the Garage Door Opener	
to Your Garage Door Opener	
Motor.....	184
Programming the Garage Door Opener	
to Your Gate Opener Motor.....	184
Gate Operator / Canadian	
Programming.....	184
Programming the Garage Door Opener	
to Your Hand-Held Transmitter.....	183
Programming the Remote Control -	
Vehicles With: Flip Key.....	76
General Information .....	76
Steps for Programming Your Spare Remote	
Control .....	76
Programming the Remote Control -	
Vehicles With: Push Button Start.....	75
General Information.....	75
Steps for Programming Your Spare Remote	
Control .....	75
Properly Adjusting the Driver and Front	
Passenger Seats.....	61
Puncture	
See: Changing a Flat Tire.....	516
Push Button Ignition Switch.....	210
Starting the Engine.....	210
Switching the Ignition Off.....	210
Switching the Ignition to Accessory	
Mode.....	210
<b>R</b>	
Rear Axle Fluid Capacity and	
Specification.....	562
Rear Exterior.....	34
Rear Occupant Alert System Audible	
Warnings.....	180
Rear Occupant Alert System	
Indicators.....	180
Rear Occupant Alert System	
Limitations.....	179
Rear Occupant Alert System	
Precautions.....	179

# Index

Rear Occupant Alert System.....	179	Remote Start.....	155
Rear Parking Aid.....	297	Remote Start Settings.....	156
Locating the Rear Parking Aid		Remote Start Settings.....	156
Sensors.....	298	Setting the Remote Start Duration.....	157
Rear Parking Aid Audible Warnings.....	298	Switching Climate Control Auto Mode On	
Rear Parking Aid Limitations.....	297	and Off.....	156
What is the Rear Parking Aid.....	297	Switching Climate Control Last Settings	
Rear Seats.....	176	On and Off.....	156
Heated Seats.....	177	Switching the Heated Seat Settings On and	
Manual Seats.....	176	Off.....	156
Rear View Camera Guide Lines.....	302	Switching the Heated Steering Wheel	
Rear View Camera Precautions.....	302	Settings On and Off.....	157
Rear View Camera.....	302	Removing and Installing the	
Rear View Camera Settings.....	303	Tailgate.....	91
Rear View Camera Settings.....	303	Removing the Key Blade.....	71
Switching Rear View Camera Delay On and		Removing Your Vehicle From	
Off.....	303	Storage.....	493
Zooming the Rear View Camera In and		Repairing Minor Paint Damage.....	490
Out.....	303	Replacement Parts	
Recalling a Preset Position.....	181	Recommendation.....	642
Linking a Preset Position to Your Remote		Collision Repairs.....	642
Control or Passive Key.....	181	Scheduled Maintenance and Mechanical	
Recovery Towing.....	440	Repairs.....	642
Accessing the Front Towing Point.....	440	Warranty on Replacement Parts.....	642
Recreationally Towing Your Vehicle -		Replacing a Lost Key or Remote	
4x2.....	445	Control.....	74
Recreationally Towing Your Vehicle -		Replacing the Cabin Air Filter.....	166
4x4.....	443	Replacing the Front Wiper Blades.....	121
Switching Off.....	444	Reporting Safety Defects in	
Switching On.....	443	Canada.....	620
Refueling.....	233	Reporting Safety Defects in the United	
Manually Opening the Fuel Filler		States.....	620
Door.....	237	Reprogramming the Garage Door	
Refueling System Overview.....	233	Opener.....	185
Refueling Your Vehicle.....	233	Resetting Ground Fault Detection.....	192
Releasing the Electric Parking Brake if		Resetting the Circuit Breaker - Vehicles	
the Vehicle Battery Has Run Out of		With: 7.2kW.....	193
Charge.....	277	Resetting the Stopping Position -	
Remote Control Limitations.....	70	Vehicles With: Power Adjustable	
Remotely Starting and Stopping the		Steering Column.....	118
Vehicle.....	155	Resetting Tire Pressure Monitoring	
Remotely Starting the Vehicle.....	155	System.....	511
Remotely Stopping the Vehicle.....	155	Tire Pressure Monitoring System Reset	
Remote Start Limitations.....	155	Procedure.....	511
Remote Start Precautions.....	155	Trailer Tire Pressure Monitoring	
Remote Start Remote Control		System.....	512
Indicators.....	156	Restarting the Engine.....	224
Remote Control Feedback.....	156		

# Index

Resuming the Set Speed.....	314	Seatbelt Reminder.....	53
Resuming the Set Speed from a Complete Stop.....	320	How Does the Seatbelt Reminder Work.....	53
Reverse Braking Assist Indicators.....	280	Seatbelt Reminder Audible Warnings.....	55
Reverse Braking Assist		Seatbelt Reminder Indicators.....	55
Precautions.....	279	Switching the Seatbelt Reminder On and Off.....	55
Reverse Braking Assist.....	279	Seatbelts.....	49
Reverse Braking Assist – Troubleshooting.....	280	Automatic Locking Mode.....	51
Reverse Braking Assist – Troubleshooting.....	280	Seatbelt Reminder.....	53
Reverse Braking Assist – Frequently Asked Questions.....	281	Sensitive Locking Mode.....	51
Reverse Braking Assist – Information Messages.....	280	Security.....	111
Roadside Assistance.....	436	Anti-Theft Alarm System.....	111
Vehicles Sold in Canada: Getting Roadside Assistance.....	437	Anti-Theft Alarm System Settings.....	112
Vehicles Sold in the United States: Getting Roadside Assistance.....	436	Passive Anti-Theft System.....	111
Vehicles Sold in the United States: Using Roadside Assistance.....	436	Security – Troubleshooting.....	113
Rollover Warning.....	618	Security – Troubleshooting.....	113
Route Guidance.....	595	Security – Frequently Asked Questions.....	114
Adjusting the Guidance Prompt		Security – Information Messages.....	113
Volume.....	595	Selecting a Drive Mode.....	328
Canceling Route Guidance.....	595	Selecting a Four-Wheel Drive Mode.....	262
Repeating an Instruction.....	595	Shifting to or from Four-Wheel Drive Low (4L).....	263
Running-In		Selecting the Audio Source.....	570
See: Breaking-In.....	430	Audio Unit.....	570
Running Out of Fuel.....	232	Touchscreen.....	570
Adding Fuel From a Portable Fuel Container.....	232	Selective Catalytic Reduction System Guidelines.....	246
Filling a Portable Fuel Container.....	232	Selective Catalytic Reduction System Precautions.....	245
<b>S</b>		Selective Catalytic Reduction System Requirements.....	246
Satellite Radio.....	574	Selective Catalytic Reduction System.....	245
Locating the Satellite Radio Identification Number.....	574	Filling the Selective Catalytic Reduction System Tank.....	247
Satellite Radio Limitations.....	574	Selective Catalytic Reduction System – Troubleshooting.....	249
Satellite Radio Settings.....	575	Selective Catalytic Reduction System – Troubleshooting.....	249
Selecting a Channel.....	575	Selective Catalytic Reduction System – Information Messages.....	249
What Is Satellite Radio.....	574	Selective Catalytic Reduction System – Warning Lamps.....	249
Saving a Preset Position.....	181	Sending and Receiving a Text Message.....	587
Scheduled Maintenance.....	602		
Seatbelt Extensions.....	56		
Seatbelt Precautions.....	49		



# Index

Sensitive Locking Mode.....	51	Shifting Your Vehicle Into Gear.....	254
How Does Sensitive Locking Mode		Center Console Shifter.....	254
Work.....	51	Column Shifter.....	254
What is Sensitive Locking Mode.....	51	Side Parking Aid.....	299
Service Data.....	27	Locating the Side Parking Aid	
Setting a Destination.....	594	Sensors.....	300
Setting a Destination Using a Point of		Side Parking Aid Audible Warnings.....	300
Interest.....	595	Side Parking Aid Limitations.....	299
Setting a Destination Using a Predictive		What is the Side Parking Aid.....	299
Destination.....	595	Sitting in the Correct Position.....	167
Setting a Destination Using a Recent		Snow Plowing Precautions.....	432
Destination.....	595	Snow Plowing.....	432
Setting a Destination Using a Saved		Snowplow Mode.....	434
Destination.....	595	Snowplow Mode.....	434
Setting a Destination Using the Map		Switching Snowplow Mode On and	
Screen.....	594	Off.....	434
Setting a Destination Using the Text Entry		What Is Snowplow Mode.....	434
Screen.....	594	Sounding the Panic Alarm.....	71
Setting a Memory Preset.....	571	Special Operating Conditions Scheduled	
Settings Data.....	28	Maintenance - Diesel.....	609
Comfort and Convenience Data.....	28	Exceptions.....	613
Entertainment Data.....	28	Special Operating Conditions Scheduled	
Setting the Adaptive Cruise Control		Maintenance - Gasoline.....	614
Gap.....	319	Exceptions.....	616
Following a Vehicle.....	320	Speed Control	
Setting the Adaptive Cruise Control		See: Cruise Control.....	313
Speed.....	318	Speed Sign Recognition Indicators.....	357
Manually Changing the Set Speed.....	319	Speed Sign Recognition	
Setting the Adaptive Cruise Speed from a		Limitations.....	357
Complete Stop.....	318	Speed Sign Recognition	
Setting the Blower Motor Speed.....	159	Precautions.....	357
Setting the Clock and Date.....	571	Speed Sign Recognition.....	357
Switching Automatic Time Updates On and		Speed Sign Recognition –	
Off.....	572	Troubleshooting.....	358
Setting the Cruise Control Speed.....	313	Speed Sign Recognition –	
Changing the Set Speed.....	313	Troubleshooting.....	358
Setting the Hill Descent Speed.....	289	Speed Sign Recognition – Frequently Asked	
Setting the Speed Sign Recognition		Questions.....	359
Speed Tolerance.....	358	Speed Sign Recognition – Information	
Setting the Speed Sign Recognition		Messages.....	358
Speed Warning.....	358	Stability Control Indicator.....	288
Setting the Temperature.....	159	Stability Control.....	286
Setting the Wake Word.....	583	Starter Switch	
Setting Up the Trailer Reversing Aid for		See: Ignition Switch.....	209
a Conventional Trailer.....	410	Starting and Stopping the Engine –	
Calibrating the System.....	412	Precautions.....	209
Configuring the Trailer.....	410	Starting and Stopping the Engine.....	209
Trailer Sensor Installation.....	412	Automatic Engine Stop.....	215

# Index

Engine Block Heater.....	213	Switching Active Park Assist On and Off.....	309
Starting and Stopping the Engine – Troubleshooting.....	216	Cancelling Active Park Assist.....	309
Starting the Engine.....	210	Switching Adaptive Cruise Control On and Off.....	317
Stopping the Engine.....	214	Switching Adaptive Cruise Control Off.....	318
Starting and Stopping the Engine – Troubleshooting.....	216	Switching Adaptive Cruise Control On.....	317
Starting and Stopping the Engine – Frequently Asked Questions.....	218	Switching Air Conditioning On and Off.....	158
Starting and Stopping the Engine – Information Messages.....	217	Switching All of the Interior Lamps On and Off.....	135
Starting and Stopping the Engine – Warning Lamps.....	216	Switching Android Auto On and Off.....	591
Starting the Engine.....	210	Disabling Android Auto.....	591
Restarting the Engine After Stopping it.....	212	Enabling Android Auto with USB.....	591
Starting a Diesel Engine.....	211	Enabling Android Auto with Wireless.....	591
Starting a Gasoline Engine.....	210	Re-Enabling Android Auto.....	591
Starting a Hybrid Electric Vehicle System.....	212	Switching Apple CarPlay On and Off.....	591
Status Bar.....	581	Disabling Apple CarPlay.....	591
Steering.....	295	Enabling Apple CarPlay with USB.....	591
Electric Power Steering.....	295	Enabling Apple CarPlay with Wireless.....	591
Steering – Troubleshooting.....	296	Re-Enabling Apple CarPlay.....	591
Steering – Troubleshooting.....	296	Switching Auto Hold On and Off.....	283
Steering – Information Messages.....	296	Switching Auto-Start-Stop On and Off.....	224
Steering – Warning Indicators.....	296	Switching Blind Spot Information System On and Off.....	340
Steering Wheel.....	30	Switching Climate Control On and Off.....	158
Stopping the Engine.....	224	Switching Cross Traffic Alert On and Off.....	344
Stopping the Engine When Your Vehicle is Moving.....	214	Switching Cruise Control On and Off.....	313
Stopping the Engine When Your Vehicle is Stationary.....	214	Switching Cruise Control Off.....	313
Storage.....	205	Switching Cruise Control On.....	313
Cup Holders.....	205	Switching Defrost On and Off.....	158
Glasses Holder.....	208	Switching Driver Alert On and Off.....	355
Glove Compartment.....	205	Resetting Driver Alert.....	356
Under Seat Storage.....	206	Switching Easy Entry and Exit On and Off.....	90
Storing Your Vehicle.....	492	Switching From Adaptive Cruise Control to Cruise Control.....	321
Stowing the Selector Lever - Vehicles With: Console Shift.....	256		
Sunroof			
See: Moonroof.....	142		
Switching Active Drive Assist On and Off.....	292		
Switching Active Drive Assist Off.....	292		
Switching Active Drive Assist On.....	292		

# Index

Switching Generator Mode On and Off.....	192
Using the Bed Control.....	192
Using the Information and Entertainment Display Screen.....	192
Using the Instrument Panel.....	192
Switching Hill Descent Control On and Off.....	289
Switching Maximum Cooling On and Off.....	159
Switching Maximum Defrost On and Off.....	158
Switching Pre-Collision Assist On and Off.....	349
Adjusting the Pre-Collision Assist Settings.....	349
Switching Rear Occupant Alert System On and Off.....	179
Semiannual Reminder.....	179
Switching Recirculated Air On and Off.....	158
Switching Repeat Mode On and Off.....	571
Switching Reverse Braking Assist On and Off.....	280
Switching Shuffle Mode On and Off.....	571
Switching Stability Control On and Off.....	287
Stability Control and Traction Control with Roll Stability Control.....	288
Switching Text Message Notification On and Off.....	588
Android.....	588
iOS.....	588
Switching the Audio Unit On and Off.....	570
Switching the Display On and Off.....	573
Audio Unit.....	573
Touchscreen.....	573
Switching the Electronic Locking Differential On and Off - 4x2.....	271
Switching the Electronic Locking Differential On and Off - 4x4.....	269
Switching the Front Interior Lamps On and Off.....	135
Individual Map Lamps.....	135
Switching the Hazard Flashers On and Off.....	438
Switching the Heated Mirrors On and Off.....	159
Switching the Heated Rear Window On and Off.....	159
Switching the Heated Steering Wheel On and Off.....	118
Switching the Heated Wiper Park On and Off.....	159
Switching the Lane Keeping System Mode.....	334
Switching the Lane Keeping System On and Off.....	334
Switching the Rear Interior Lamps On and Off.....	135
Switching the Trailer Reversing Aid On and Off.....	413
Switching Traction Control On and Off.....	284
Switching Trailer Sway Control On and Off.....	409
Switching Utility Idle On and Off - Vehicles With: Flip Key.....	191
Switching Utility Idle off using the Information and Entertainment Display Screen.....	192
Switching Utility Idle Off using the Key.....	192
Switching Utility Idle On.....	191
Symbols Glossary.....	23
Symbols Used on Your Vehicle.....	23
<b>T</b>	
Tailgate Anchor Points.....	368
Locating the Tailgate Anchor Points.....	368
Tailgate Anchor Point Load Capacities.....	368
Tailgate Step.....	92
Accessing the Tailgate Step.....	92
Stowing the Tailgate Step.....	93
Tailgate.....	91
Bed Extender.....	93
Closing the Tailgate.....	96
Opening the Tailgate.....	91
Tailgate Step.....	92
Tailgate – Troubleshooting.....	102

# Index

Tailgate – Troubleshooting.....	102
Tailgate – Frequently Asked Questions.....	103
Tailgate – Information Messages.....	102
Tailgate – Warning Lamps.....	102
Tailgate Work Surface.....	95
Technical Specifications	
See: Capacities and Specifications.....	524
Temporary Neutral Mode.....	255
Entering Temporary Neutral Mode.....	255
Exiting Temporary Neutral Mode.....	255
Temporary Neutral Mode Limitations.....	255
What Is Temporary Neutral Mode.....	255
The Better Business Bureau Auto Line Program - United States of America.....	618
- Canada.....	619
Tire Care.....	505
Tire Pressure Monitoring System	
Limitations.....	510
Tire Pressure Monitoring System Overview.....	509
Tire Pressure Monitoring System Precautions.....	510
Tire Pressure Monitoring System.....	509
Tire Pressure Monitoring System – Troubleshooting.....	514
Tire Pressure Monitoring System – Troubleshooting.....	514
Tire Pressure Monitoring System – Information Messages.....	515
Tire Pressure Monitoring System – Warning Lamps.....	514
Tire Replacement Requirements.....	501
AGE.....	501
Tire Rotation.....	507
Tire Rotation Diagram.....	508
Towing a Trailer Limitations.....	375
Towing a Trailer Precautions.....	375
Towing a Trailer.....	375
Towing a Trailer – Troubleshooting.....	404
Towing Weights and Dimensions.....	378
Towing a Trailer – Troubleshooting.....	404
Towing a Trailer – Information Messages.....	404
Towing Weights and Dimensions.....	378
Calculating the Maximum Loaded Trailer Weight for Your Vehicle.....	403
Recommended Towing Weights.....	378
What Is the Maximum Loaded Trailer Weight .....	403
Towing Your Vehicle Precautions.....	443
Towing Your Vehicle.....	443
Towing Your Vehicle – Troubleshooting.....	445
Towing Your Vehicle – Troubleshooting.....	445
Towing Your Vehicle – Information Messages.....	445
Traction Control Indicator.....	284
Traction Control.....	284
Traction Control – Troubleshooting.....	285
Traction Control – Troubleshooting.....	285
Traction Control – Information Messages.....	285
Trailer Brake Precautions.....	375
Trailer Reversing Aid Precautions.....	410
Trailer Reversing Aid.....	410
Setting Up the Trailer Reversing Aid for a Conventional Trailer.....	410
Trailer Reversing Aid - Troubleshooting.....	416
Trailer Reversing Aid - Troubleshooting.....	416
Trailer Reversing Aid – Frequently Asked Questions.....	418
Trailer Reversing Aid – Information Messages.....	416
Trailer Sway Control Precautions.....	409
Trailer Sway Control.....	409
Trailer Towing Hints.....	376
Trailer Towing Navigation.....	596
Entering Trailer Dimensions.....	596
Navigation Alerts.....	596
Switching Trailer Towing Navigation On and Off.....	596
Transfer Case Fluid Capacity and Specification.....	561
Transporting the Vehicle.....	441
Trip Computer - Vehicles With: 4.2 Inch Screen.....	152
Accessing the Trip Computer.....	152

# Index

Resetting the Trip Computer.....	152
Trip Computer - Vehicles With: 8 Inch Screen/12.3 Inch Screen.....	153
Accessing the Trip Computer.....	153
Resetting the Trip Computer.....	153
Type Approvals.....	622
Radio Frequency Certifications for Blind Spot Information System.....	622
Radio Frequency Certifications for Body Control Module.....	622
Radio Frequency Certifications for Cruise Control Module.....	623
Radio Frequency Certifications for Garage Door Opener.....	640
Radio Frequency Certifications for Integrated Keyhead Transmitter.....	624
Radio Frequency Certifications for Passive Anti-Theft System.....	625
Radio Frequency Certifications for Passive Entry/Passive Start Remote Control.....	628
Radio Frequency Certifications for Passive Key.....	629
Radio Frequency Certifications for Radio Transceiver Module.....	631
Radio Frequency Certifications for SYNC4.....	632
Radio Frequency Certifications for SYNC4 Low.....	634
Radio Frequency Certifications for Telematics Control Unit.....	635
Radio Frequency Certifications for Tire Pressure Monitoring Sensor(s) - FP3.....	636
Radio Frequency Certifications for Tire Pressure Monitoring Sensor(s) - FP4.....	637
Radio Frequency Certifications for Wireless Accessory Charging Module.....	640
<b>U</b>	
Under Hood Fuse Box.....	446
Accessing the Under Hood Fuse Box.....	446
Identifying the Fuses in the Under Hood Fuse Box.....	447
Locating the Under Hood Fuse Box.....	446
Under Hood Overview - 2.7L EcoBoost™.....	456
Under Hood Overview - 3.0L Diesel.....	457
Under Hood Overview - 3.3L.....	458
Under Hood Overview - 3.5L, Hybrid Electric Vehicle (HEV).....	460
Under Hood Overview - 3.5L EcoBoost™.....	459
Under Hood Overview - 5.0L.....	461
Under Seat Storage.....	206
Locating the Under Seat Storage Compartment.....	206
Updating the Vehicle Systems Wirelessly.....	597
Applying a Vehicle System Software Update.....	597
Scheduling an Update.....	597
System Update Requirements.....	597
Viewing Update Details.....	597
USB Ports.....	186
Using a Slide-In Camper.....	361
Using Auto Hold.....	283
Using MyKey With Remote Start Systems.....	80
Using Progressive Range Selection.....	256
Using Snow Chains.....	503
Using the Center Console Work Surface - Vehicles With: Column Shift.....	200
Using the Center Console Work Surface - Vehicles With: Console Shift.....	201
Using the Instrument Cluster Display Controls.....	151
Back Button.....	151
Button.....	151
Menu Button.....	151
Scroll Buttons.....	151
Status Indicator.....	151
Using the Integrated Trailer Brake Controller.....	405
Adjusting the Trailer Brake Gain.....	406
Using the Remote Control.....	70
Lock.....	70
Panic Alarm.....	70
Remote Start.....	70
Tailgate.....	70
Unlock.....	70

# Index

Using the Trailer Reverse Guidance	
Views.....	414
Hitch Angle Graphic.....	414
Using the Trailer Reversing Aid	
Controller.....	413
Using This Publication.....	22

## V

Vehicle Care.....	486
Cleaning the Exterior.....	486
Cleaning the Interior.....	488
Vehicle Identification Number.....	564
Locating the Vehicle Identification	
Number.....	564
Vehicle Identification Number	
Overview.....	564
Vehicle Identification.....	564
Vehicle Identification Number.....	564
Vehicle Interior.....	32
Vehicle System Updates.....	597
Vehicle Wi-Fi Hotspot.....	569
Ventilated Seats.....	174
Switching the Ventilated Seats On and	
Off.....	174
Ventilated Seat Precautions.....	174
Ventilation	
See: Climate Control - Vehicles With:	
Automatic Temperature Control.....	158
See: Climate Control - Vehicles With: Manual	
Temperature Control.....	163
Venting the Moonroof.....	142
Viewing the Tire Pressures.....	511
Visual Search.....	30
Voice Interaction Examples.....	583
Voice Interaction.....	583

## W

Washer Fluid Specification.....	559
Washers.....	122
Adding Washer Fluid.....	122
Switching the Courtesy Wipe On and	
Off.....	122
Using the Windshield Washer.....	122
Washer Fluid Specification.....	122
Washer Precautions.....	122

Washers	
See: Wipers and Washers.....	120
Waxing Your Vehicle.....	490
Waypoints.....	595
Adding a Waypoint.....	595
Editing Waypoints.....	595
What Are the Instrument Cluster	
Indicators.....	149
What Are the Instrument Cluster	
Warning Lamps.....	147
What Is 911 Assist.....	68
What Is a Connected Vehicle.....	565
What Is Active Drive Assist.....	291
What Is Active Park Assist.....	309
What Is a Hybrid Electric Vehicle.....	221
What Is Auto-Start-Stop.....	224
What Is Blind Spot Information	
System.....	340
What Is Brake Coach.....	154
What Is Cross Traffic Alert.....	344
What Is Cruise Control.....	313
Requirements.....	313
What Is Drive Mode Control.....	328
What Is Driver Alert.....	355
What Is Ford Protect.....	600
Ford Protect Extended Service Plan	
(Canada Only).....	601
Ford Protect Extended Service Plans -	
United States Only.....	600
What Is Generator Mode.....	192
What Is Hill Descent Control.....	289
What Is Hill Start Assist.....	282
What Is MyKey.....	78
What Is Pre-Collision Assist.....	347
What Is Remote Start.....	155
What Is Reverse Braking Assist.....	279
What Is Speed Sign Recognition.....	357
What Is the 360 Degree Camera.....	305
What Is the Cabin Air Filter.....	166
What Is the Catalytic Converter.....	251
What Is the Diesel Exhaust Fluid	
Gauge.....	147
What Is the Diesel Particulate	
Filter.....	240
What Is the Electric Parking Brake.....	276
What Is the Electronic Locking	
Differential.....	269

# Index

What Is the Engine Coolant Temperature Gauge.....	147
What Is the Engine Oil Pressure Gauge.....	147
What Is the Garage Door Opener.....	182
HomeLink Wireless Control System.....	182
What Is the Gross Axle Weight Rating.....	361
GAWR (Gross Axle Weight Rating).....	361
What Is the Gross Combined Weight Rating.....	361
What Is the Gross Vehicle Weight Rating.....	361
What Is the High Voltage Battery.....	252
What Is the Integrated Trailer Brake Controller.....	405
What Is the Lane Keeping System.....	333
What Is the Memory Function.....	181
What Is the Pedestrian Alert System.....	67
What Is the Personal Safety System.....	57
What Is the Power Outlet.....	188
What is the Rear Occupant Alert System.....	179
What Is the Rear View Camera.....	302
What Is the Selective Catalytic Reduction System.....	245
What Is the Speedometer.....	146
What Is the Tachometer.....	146
What Is the Tire Pressure Monitoring System.....	509
What Is the Trailer Reversing Aid.....	410
What Is the Transmission Fluid Temperature Gauge.....	147
What Is the Trip Summary.....	154
What Is the Turbo Boost Gauge.....	147
What Is the Wireless Accessory Charger.....	203
What Is Traction Control.....	284
What Is Utility Idle Mode - Vehicles With: Flip Key.....	191
What is Voice Interaction.....	583
Wheel and Tire Information.....	494
Wheel Nuts.....	523
Window Bounce-Back.....	137
Overriding Window Bounce-Back.....	137
What Is Window Bounce-Back.....	137
Windows.....	137
Window Bounce-Back.....	137
Wipers and Washers – Troubleshooting.....	122
Wipers and Washers – Frequently Asked Questions.....	123
Wipers and Washers – Warning Lamps.....	122
Wipers and Washers.....	120
Autowipers.....	120
Washers.....	122
Wipers.....	120
Wipers and Washers – Troubleshooting.....	122
Wipers.....	120
Switching Windshield Wipers On and Off.....	120
Wiper Precautions.....	120
Wireless Accessory Charger Precautions.....	203
Wireless Accessory Charger.....	203