



STELVIO

2021 OWNER'S MANUAL

This Owner's Manual illustrates and describes the operation of features and equipment that are either standard or optional on this vehicle. This manual may also include a description of features and equipment that are no longer available or were not ordered on this vehicle. Please disregard any features and equipment described in this manual that are not on this vehicle. FCA US LLC reserves the right to make changes in design and specifications, and/or make additions to or improvements to its products without imposing any obligation upon itself to install them on products previously manufactured.

With respect to any vehicles sold in Canada, the name FCA US LLC shall be deemed to be deleted and the name FCA Canada Inc. used in substitution therefore.

If you are the first registered retail owner of your vehicle, you may obtain a complimentary printed copy of the Warranty Booklet by calling **1-844-253-2872** (U.S.) or **1-800-387-1143** (Canada) or by contacting your dealer.

This Owner's Manual is intended to familiarize you with the important features of your vehicle. Your most up-to-date Owner's Manual, Navigation/Uconnect manuals and Warranty Booklet can be found by visiting the website on the back cover. U.S. residents can purchase replacement kits by visiting www.techauthority.com and Canadian residents can purchase replacement kits by calling **1-800-387-1143**.

 **WARNING:** Operating, servicing and maintaining a passenger vehicle or off-highway motor vehicle can expose you to chemicals including engine exhaust, carbon monoxide, phthalates, and lead, which are known to the State of California to cause cancer and birth defects or other reproductive harm. To minimize exposure, avoid breathing exhaust, do not idle the engine except as necessary, service your vehicle in a well-ventilated area and wear gloves or wash your hands frequently when servicing your vehicle. For more information go to www.P65Warnings.ca.gov/passenger-vehicle.

Dear Customer,

We would like to congratulate and thank you for the purchase of your Alfa Romeo.

We have written this Owner's Manual to help you get to know all of the features of your vehicle and use it in the best possible way. Please take the necessary time to familiarize yourself with all the dynamic features of your vehicle.

Here you will find important information and warnings regarding the use of your vehicle, and how to achieve the best performance from the technical features of your Alfa Romeo.

You are advised to read through the Owner's Manual before taking it on the road for the first time. It is important to become familiar with the controls of your vehicle, especially with sections concerning the brakes, handling, transmission, and vehicle behavior on different road surfaces.

This Owner's Manual also provides a description of special features and tips, as well as essential information for the safe driving, care, and maintenance of your Alfa Romeo over time.

It is supplemented by Warranty Information, and customer-oriented documents. Within this information, you will find a description of the services that Alfa Romeo offers to its customers, the vehicle's warranty coverage, and the details of the terms and conditions for maintaining its validity.

We are sure that these will help you to get in touch with and appreciate both your new vehicle and the service provided by the people at Alfa Romeo.

For questions or comments pertaining to your vehicle, please contact:

Alfa Romeo Customer Care Center:

P.O. Box 21-8004 Auburn Hills, MI

48321-8004

Phone: 1-844-Alfa-USA

(1-844-253-2872)

Alfa Romeo Customer Care (Canada):

P.O. Box 1621

Windsor, Ontario N9A 4H6

Phone: 1-877-230-0563 (English)

Phone: 1-877-515-9112 (French)

Refueling



Gas engines: Do not use fuel containing methanol or ethanol E85. Using these mixtures may cause misfiring and driving issues, as well as damage vital components of the supply system. ⇨ page 269

Diesel engines: Do not use other products or mixtures as they may cause damage to the engine beyond repair and consequently invalidate the warranty. For further details on the use of the correct fuel, see ⇨ page 269.

Starting The Engine



Make sure that the electric park brake is engaged and that the transmission is in PARK (P) or NEUTRAL (N). Next, press the brake pedal, and then push the engine START/STOP button.

Parking On Flammable Material



The catalytic converter develops high temperatures during operation. Do not park the vehicle on potential fire hazards such as: grass, dry leaves, pine needles or other flammable material.

Respecting The Environment



The vehicle is fitted with a system that carries out a continuous diagnosis of the emission-related components in order to help protect the environment (if equipped).

Electrical Accessories



If you decide to add electrical accessories after purchasing the vehicle, with the risk of gradually draining the battery, contact an authorized dealer. They can calculate the overall electrical requirement and check that the vehicle's electric system can support the required load.

Scheduled Servicing



Correctly performed maintenance procedures are essential for ensuring that your vehicle continuously maintains its quality in performance and safety features, environmental friendliness, and low running costs.

Rollover Warning

Utility vehicles have a significantly higher rollover rate than other types of vehicles. This vehicle has a higher ground clearance and a higher center of gravity than many passenger vehicles. It is capable of performing better in a wide variety of off-road applications. Driven in an unsafe manner, all vehicles can go out of control. Because of the higher center of gravity, if this vehicle is out of control it may roll over while some other vehicles may not.

Do not attempt sharp turns, abrupt maneuvers, or other unsafe driving actions that can cause loss of vehicle control. Failure to operate this vehicle safely may result in a collision, rollover of the vehicle, and severe or fatal injury. Drive carefully.



80bfe0f0

Rollover Warning Label

Failure to use the driver and passenger seat belts provided is a major cause of severe or fatal injury. In fact, the US government notes that the universal use of existing seat belts could cut the highway death toll by 10,000 or more each year and could reduce disabling injuries by two million annually. In a rollover crash, an unbelted person is significantly more likely to die than a person wearing a seat belt. Always buckle up.

Accessories Purchased By The Owner



WARNING!

Any change or alteration of the vehicle might seriously affect its safety and road handling, thus causing accidents, in which the occupants could even be fatally injured.

If you decide to install electrical accessories that require a permanent electrical supply (e.g. radio, satellite anti-theft system, etc.) or accessories that in any case drain the electrical supply after purchasing the vehicle, contact an authorized dealer. Dealer personnel will check whether the vehicle's electrical system is able to withstand the load required or whether it needs to be integrated with a more powerful battery.

NOTE:

Use caution when adding additional spoilers, alloy wheel rims, or non-standard wheel hubs: they could reduce the ventilation of the brakes and affect efficiency under sharp and repeated braking, or on long descents. Make sure that nothing obstructs the pedal (mats, etc.).

FCA US LLC shall not be liable for damage caused by the installation of accessories either not supplied or recommended by FCA US LLC and/or not installed in compliance with the provided instructions.

Installing Electrical/Electronic Devices

FCA US LLC authorizes the installation of transceivers provided that installation is carried out at a specialized center, in compliance with manufacturer's specifications.

NOTE:

Local authorities may not allow the vehicle on the road if devices that modify the features of the vehicle have been installed. This also may void the warranty in relation to faults caused by the change either directly or indirectly related to it.

FCA US LLC shall not be liable for damage caused by the installation of accessories either not supplied or recommended by FCA US LLC and/or not installed in compliance with the provided instructions.

Radio Transmitters And Mobile Phones

Radio transmitter equipment (vehicle mobile phones, CB radios, amateur radio etc.) cannot be used inside the vehicle unless a separate antenna is mounted externally.



Transmission and reception of these devices may be affected by the shielding effect of the vehicle body. As far as the use of approved mobile phones is concerned, follow the usage instructions provided by the mobile phone manufacturer.



CAUTION!

- The use of these devices inside the passenger compartment (without an external antenna) may cause the electrical systems to malfunction. This could compromise the safety of the vehicle in addition to constituting a potential hazard for passengers' health.
- If mobile phones/laptops/smartphones/tablets are inside the vehicle and/or close to the electronic key, a reduced performance of the Passive Entry/Keyless Start system may occur.

Symbols Key

WARNING!	These statements are against operating procedures that could result in a collision, bodily injury and/or death.
CAUTION!	These statements are against procedures that could result in damage to your vehicle.
NOTE:	A suggestion which will improve installation, operation, and reliability. If not followed, may result in damage.
TIP:	General ideas/solutions/suggestions on easier use of the product or functionality.
PAGE REFERENCE ARROW 	Follow this reference for additional information on a particular feature.
FOOTNOTE 	Supplementary and relevant information pertaining to the topic.

If you do not read this entire Owner's Manual, you may miss important information. Observe all Cautions and Warnings.

Some vehicle components have colored labels with symbols indicating precautions to be observed when using this component. It is important to follow all warnings when operating your vehicle. See below for a brief description of each symbol.

	READ THE OWNER'S MANUAL		DO NOT TOUCH WITH HANDS		COMPONENT CAN START AUTOMATICALLY ALSO WHEN ENGINE IS OFF
	PROTECT YOUR EYES		DO NOT OPEN THE CAP WHEN THE ENGINE IS HOT		DO NOT OPEN: HIGH PRESSURE GAS
	KEEP CHILDREN AT A DISTANCE		BURSTING		MOVING PARTS KEEP PARTS OF YOUR BODY AND CLOTHES AWAY
	DO NOT APPROACH FLAMES		CORROSIVE LIQUID		HIGH VOLTAGE

GETTING TO KNOW YOUR VEHICLE

GETTING TO KNOW YOUR INSTRUMENT PANEL

STARTING AND OPERATING

SAFETY

IN CASE OF EMERGENCY

SERVICING AND MAINTENANCE

TECHNICAL SPECIFICATIONS

CUSTOMER ASSISTANCE

INDEX



READ THIS CAREFULLY

Refueling.....	2
Starting The Engine.....	2
Parking On Flammable Material	2
Respecting The Environment	2
Electrical Accessories	2
Scheduled Servicing	2
Rollover Warning	3

VEHICLE CHANGES / ALTERATIONS

Accessories Purchased By The Owner	4
Installing Electrical/Electronic Devices	4
Radio Transmitters And Mobile Phones ...	4
Symbols Key	5

SYMBOL GLOSSARY

GETTING TO KNOW YOUR VEHICLE

KEYS.....	17
Key Fob.....	17
ENGINE IMMOBILIZER SYSTEM	19
IGNITION SWITCH	20
Keyless Push Button Ignition	20

REMOTE START —

IF EQUIPPED.....	21
How To Use Remote Start.....	21
To Exit Remote Start Mode.....	22
Remote Start Comfort Systems —	
If Equipped.....	22

VEHICLE SECURITY SYSTEM —

IF EQUIPPED.....	22
To Arm The System.....	22
To Disarm The System	22
Volumetric/Anti-Lift Protection —	
If Equipped.....	23

DOORS.....

Power Door Locks.....	23
Locking The Doors With A Depleted	
Battery	24
Passive Entry System	24
Power Lock Safety Device.....	26
Automatic Door Locks —	
If Equipped	27
Child-Protection Door Lock System —	
Rear Doors.....	27

STEERING WHEEL.....

Manual Tilt/Telescoping Steering	
Column.....	28
Heated Steering Wheel —	
If Equipped	29

DRIVER MEMORY SETTINGS —

IF EQUIPPED	29
Programming The Memory Feature	30
Memory Position Recall	30

SEATS30

Sparco Racing Seats	
(Quadrifoglio Vehicles) — If Equipped ...	30
Split Folding Rear Seat	31
Power Adjustment (Front Seats)	33
Heated Seats — If Equipped	34
Head Restraints	35

MIRRORS37

Automatic Dimming Mirror	37
Vanity Mirror	38
Outside Power Mirrors	38
Power Folding Outside Mirrors.....	39
Outside Automatic Dimming Mirrors —	
If Equipped	39
Heated Mirrors	39

UNIVERSAL GARAGE DOOR OPENER

(HOMELINK®)39

Before You Begin Programming	
HomeLink®	40
Erasing All The HomeLink®	
Channels.....	40
Identifying Whether You Have A Rolling	
Code Or Non-Rolling Code Device.....	40
Programming HomeLink® To A Garage	
Door Opener	40
Programming HomeLink® To A	
Miscellaneous Device	41
Reprogramming A Single HomeLink®	
Button	41
Canadian/Gate Operator	
Programming.....	42

EXTERIOR LIGHTS	42
Headlight Switch	42
Daytime Running Lights (DRLs)	43
High Beam Headlights	43
Automatic Headlights	43
Flash-To-Pass	43
Automatic High Beam Headlights – If Equipped	43
Parking Lights	44
Headlight Off Delay	44
Rear Fog Lights	44
Adaptive Headlight System (AFS) – If Equipped	44
Turn Signals	45
Lane Change Assist	45
INTERIOR LIGHTS	45
Front Map Reading Lights	45
Interior Ambient Lighting	46
Rear Overhead Light	46
Instrument Panel Dimmer Control	46
WINDSHIELD WIPERS AND WASHERS...47	
Windshield Wiper Operation	47
Rain Sensing Wipers.....	48
Rear Window Wiper/Washer	49
Headlamp Washers – If Equipped	49
CLIMATE CONTROLS	49
Automatic Dual-Zone Climate Control System	50

INTERIOR STORAGE AND EQUIPMENT... 56	
Glove Compartment.....	56
Center Console.....	57
Rear Armrest	57
Power Outlets	57
Cigar Lighter And Ash Tray – If Equipped	58
Wireless Charging Pad – If Equipped	58
POWER WINDOWS..... 59	
Power Window Controls.....	59
Auto-Up Feature With Anti-Pinch Protection	60
Power Window System Initialization	60
Wind Buffeting	60
POWER SUNROOF – IF EQUIPPED	60
Power Sunroof.....	60
Opening And Closing The Sunroof	61
Venting Sunroof.....	61
Sunshade Operation	61
Pinch Protect Feature	61
Re-Initialization Procedure	61
Sunroof Maintenance	62
HOOD	62
Opening The Hood	62
Closing The Hood	63
POWER LIFTGATE	63
Opening.....	63
Closing	64
Liftgate Initialization	65
Cargo Area Features	66

GETTING TO KNOW YOUR INSTRUMENT PANEL

INSTRUMENT PANEL FEATURES	68
Instrument Cluster	68
Instrument Cluster Descriptions	69
INSTRUMENT CLUSTER DISPLAY	70
Instrument Cluster Display Description	70
Reconfigurable Instrument Cluster Display.....	70
Reconfigurable Display Items.....	70
Customer Programmable Settings.....	74
WARNING LIGHTS AND MESSAGES ON THE INSTRUMENT PANEL	75
Red Warning Lights	75
Amber Warning Lights.....	77
Green Indicator Lights.....	79
Blue Indicator Lights	79
Red Symbols	80
Amber Symbols.....	81
Green Symbols	85
Blue Symbols	85
ONBOARD DIAGNOSTIC SYSTEM..... 86	
Onboard Diagnostic System (OBD II) Cybersecurity	86
EMISSIONS INSPECTION AND MAINTENANCE PROGRAMS	87

STARTING AND OPERATING

STARTING THE ENGINE.....	88
Starting Procedure.....	88
Remote Starting System	88
Cold Weather Operation.....	89
Extended Park Starting.....	89
If Engine Fails To Start	90
After Starting – Warming Up	
The Engine.....	90
Stopping The Engine.....	90
Turbocharger Cool Down.....	90
ENGINE BLOCK HEATER –	
IF EQUIPPED	91
ENGINE BREAK-IN	
RECOMMENDATIONS.....	91
Engine Break-In.....	91
ELECTRIC PARK BRAKE (EPB)	92
Electric Park Brake (EPB) Operating	
Modes.....	93
Safe Hold.....	94
AUTOMATIC TRANSMISSION.....	94
Display	95
Gear Selector	95
Transmission Operating Modes.....	96
Automatic Transmission Limp	
Home Mode.....	98
Brake Transmission Shift	
Interlock (BTSI) System	99
Important Notes	99
ALFA DNA SELECTOR	100
Alfa DNA System	100
Driving Modes	101

ALFA ACTIVE SUSPENSION (AAS) –	
IF EQUIPPED.....	103
STOP/START SYSTEM.....	104
Operating Mode.....	104
System Manual Activation/	
Deactivation.....	104
Possible Reasons The Engine Does	
Not Autostop	105
Engine Restarting Conditions	105
Safety Functions.....	105
Energy Saving Function.....	105
Irregular Operation	105
Vehicle Inactivity.....	105
SPEED LIMITER.....	106
Description.....	106
Activation	106
Speed Limit Programming	106
Exceeding The Programmed Speed ...	106
Programmed Speed Icon Flashing.....	107
Deactivation.....	107
CRUISE CONTROL SYSTEMS –	
IF EQUIPPED	107
Cruise Control	107
Adaptive Cruise Control (ACC)	109
HIGHWAY ASSIST SYSTEM (HAS) –	
IF EQUIPPED.....	117
To Activate/Deactivate.....	117
Operation	118
Indications On The Display	118
System Status.....	119
Limited System Availability/	
Operation	120

TRAFFIC JAM ASSIST (TJA) SYSTEM –	
IF EQUIPPED	120
To Activate/Deactivate	121
Operation.....	121
Indications On The Display	122
System Status	122
Limited System Availability/	
Operation	123
TRAFFIC SIGN RECOGNITION (TSR)	
SYSTEM – IF EQUIPPED.....	124
To Activate/Deactivate	124
Indications On The Display	124
INTELLIGENT SPEED CONTROL (ISC)	
SYSTEM – IF EQUIPPED.....	125
To Activate/Deactivate	125
Indications On The Display	126
Acceptance/Rejection Of	
The Suggested Speed.....	126
PARKSENSE FRONT/REAR PARK ASSIST	
SYSTEM – IF EQUIPPED	126
ParkSense Sensors.....	127
ParkSense Display	128
Enabling And Disabling ParkSense....	128
ParkSense Warning Display	129
Operation With A Trailer.....	129
ParkSense System Usage	
Precautions	129

LANE DEPARTURE WARNING (LDW) SYSTEM	130
Lane Departure Warning Operation	130
Turning Lane Departure Warning On Or Off	131
Lane Departure Warning Message.....	131
Changing Lane Departure Warning Status	132
LANE KEEPING ASSIST (LKA) SYSTEM – IF EQUIPPED	132
Turning Lane Keeping Assist On Or Off	132
Lane Keeping Assist Warning Message	133
REAR BACK UP CAMERA / DYNAMIC GRIDLINES	136
REFUELING THE VEHICLE	137
Refueling The Vehicle	137
Refueling Capacity.....	137
Refueling Procedure	137
VEHICLE LOADING	139
Certification Label.....	139
TRAILER TOWING.....	140
Common Towing Definitions	141
Trailer Hitch Classification	142
Trailer Towing Weights (Maximum Trailer Weight Ratings)	142
Trailer And Tongue Weight	143
Towing Requirements.....	143
Towing Tips	145
Installing The Receiver	145
Connecting The Electrical System	146
Removing The Receiver.....	146

SUGGESTIONS FOR DRIVING.....	146
Saving Fuel	146
Driving Style.....	146
Conditions Of Use.....	147
Performance – Quadrifoglio.....	147

SAFETY

ACTIVE SAFETY SYSTEMS	149
Anti-Lock Brake System (ABS)	149
Active Torque Vectoring (ATV) System – If Equipped	149
Dynamic Steering Torque (DST) System	150
Drive Train Control (DTC) System.....	150
Electronic Stability Control (ESC) System	150
Hill Descent Control (HDC) System – If Equipped	151
Hill Start Assist (HSA) System	152
Panic Brake Assist (PBA) System	153
Traction Control System (TCS).....	153
AUXILIARY DRIVING SYSTEMS.....	153
Blind Spot Monitoring (BSM) System – If Equipped	154
Active Blind Spot Assist (ABSA) System – If Equipped	156
Driver Attention Assist (DAA) System – If Equipped	159
Forward Collision Warning Plus (FCW+) System – If Equipped	160
Tire Pressure Monitoring System (TPMS)	165

OCCUPANT RESTRAINT SYSTEMS	167
Occupant Restraint Systems Features	167
Important Safety Precautions.....	167
Seat Belt Systems	168
Supplemental Restraint Systems (SRS)	173
Child Restraints	182
SAFETY TIPS	192
Transporting Passengers	192
Transporting Pets	193
Safety Checks You Should Make Inside The Vehicle	193
Periodic Safety Checks You Should Make Outside The Vehicle	194
Exhaust Gas.....	195
Carbon Monoxide Warnings.....	195

IN CASE OF EMERGENCY

HAZARD WARNING FLASHERS	196
SOS – EMERGENCY CALL	196
JACKING AND TIRE CHANGING.....	199
General Instructions.....	199
Jack Information And Usage Precautions.....	199
Changing Procedure.....	200
TIRE SERVICE KIT – IF EQUIPPED	202
Description.....	202
Inflation Procedure.....	203
Checking And Restoring Tire Pressure	205

JUMP STARTING	205
Remote Battery Connection Posts.....	206
Jump Starting Procedure.....	207
Bump Starting.....	208
ENGINE OVERHEATING	208
MANUAL PARK RELEASE	209
TOWING A DISABLED VEHICLE	209
Four-Wheel Drive (AWD) Models.....	210
TOW EYES	210
ENHANCED ACCIDENT RESPONSE	
SYSTEM (EARS)	211
EVENT DATA RECORDER (EDR).....	211

SERVICING AND MAINTENANCE

SCHEDULED SERVICING	212
Periodic Checks	212
Heavy Usage Of The Vehicle	212
Maintenance Plan – 2.0L Engine.....	213
Maintenance Plan – 2.9L Engine.....	216
ENGINE COMPARTMENT.....	218
Checking Levels – 2.0L Engine	218
Checking Levels – 2.9L Engine	219
Engine Oil	219
Engine Coolant Fluid.....	220
Washer Fluid For Windshield/	
Headlights	220
Brake Fluid	221

Automatic Transmission Activation	
System Oil	221
Useful Advice For Extending The Life	
Of Your Battery	221
Battery.....	221
Pressure Washing	222
BATTERY RECHARGING	222
Important Notes	222
VEHICLE MAINTENANCE.....	223
Engine Oil	223
Engine Oil Filter	224
Engine Air Cleaner Filter	224
Air Conditioning System	
Maintenance.....	224
Lubricating Moving Parts Of	
The Bodywork	224
Windshield Wiper.....	225
Exhaust System	226
Cooling System	227
Braking System.....	228
Automatic Transmission	229
Replacing The Battery.....	229
Fuses.....	230
Bulb Replacement.....	234

TIRES	240
Tire Safety Information	240
Tires – General Information	248
Spare Tires – If Equipped	253
Wheel And Wheel Trim Care	254
Tire Types.....	255
Tire Chains and Traction Devices	255
Tire Rotation Recommendations	256
DEPARTMENT OF TRANSPORTATION	
UNIFORM TIRE QUALITY GRADES	257
Treadwear.....	257
Traction Grades.....	257
Temperature Grades.....	257
STORING THE VEHICLE	257
BODYWORK	258
Protection Against Atmospheric	
Agents	258
Corrosion Warranty.....	258
Preserving The Bodywork	258
INTERIORS	259
Seats And Fabric Parts	259
Leather Seats.....	260
Plastic And Coated Parts	260
Alcantara Parts – If Equipped.....	260
Genuine Leather Parts.....	260
Carbon Fiber Parts	260

TECHNICAL SPECIFICATIONS

VEHICLE IDENTIFICATION

NUMBER (VIN) 261

Vehicle Identification

Number (VIN) Plate261

ENGINE 261

POWER SUPPLY 263

TRANSMISSION 263

BRAKES..... 264

SUSPENSION 264

STEERING 265

DIMENSIONS 266

Luggage Compartment Volume268

WEIGHTS..... 268

FUEL REQUIREMENTS..... 269

Reformulated Gasoline 269

Gasoline/Oxygenate Blends..... 269

CNG And LP Fuel System

Modifications..... 270

MMT In Gasoline 270

Materials Added To Fuel..... 270

Fuel System Cautions 270

FLUID CAPACITIES 271

ENGINE FLUIDS AND LUBRICANTS 272

CHASSIS FLUIDS AND LUBRICANTS..... 273

CUSTOMER ASSISTANCE

SUGGESTIONS FOR OBTAINING SERVICE

FOR YOUR VEHICLE 275

Prepare For The Appointment..... 275

Prepare A List 275

Be Reasonable With Requests..... 275

IF YOU NEED ASSISTANCE 275

Alfa Romeo Customer Center 275

Alfa Romeo Customer

Care (Canada)..... 275

Customer Assistance For

The Hearing Or Speech Impaired

(TDD/TTY)..... 275

Service Contract 276

WARRANTY INFORMATION 276

REPORTING SAFETY DEFECTS..... 276

In The 50 United States And

Washington, D.C. 276





In Canada..... 277

PUBLICATION ORDER FORMS 277



GENERAL INFORMATION..... 278

Some car components have colored labels with symbols indicating precautions to be observed when using this component. It is important to follow all warnings when operating your vehicle. See below for the definition of each symbol ⇨ page 75.







Red Warning Lights

	Air Bag Warning Light ⇨ page 75
	Brake Warning Light ⇨ page 75
	Electronic Braking Force Distribution (EBD) Failure ⇨ page 76
	Oil Temperature Warning Light ⇨ page 76
	Seat Belt Reminder Warning Light ⇨ page 77



Amber Warning Lights

	Anti-Lock Brake System (ABS) Warning Light ⇨ page 77
	Electronic Stability Control (ESC) Indicator Light – If Equipped ⇨ page 77



Amber Warning Lights

	Electronic Stability Control (ESC) OFF Indicator Light – If Equipped ⇨ page 77
	Engine Check/Malfunction Indicator Light (MIL) ⇨ page 77
	Forward Collision Warning (FCW) System ⇨ page 78
	Fuel Reserve/Limited Range ⇨ page 78
	Rear Fog Lights ⇨ page 78
	Tire Pressure Low Warning Light ⇨ page 78
	Tire Pressure Monitoring System (TPMS) Warning Light ⇨ page 78

Green Warning Lights

	Automatic High Beam Indicator Light – If Equipped ⇨ page 79
	Left Turn Signal Indicator Light ⇨ page 79





Green Warning Lights







	Park/Headlight On Indicator Light ⇨ page 79
	Right Turn Signal Indicator Light ⇨ page 79



Blue Warning Lights









	High Beam Indicator Light – If Equipped ⇨ page 79
---	--









Red Symbols

	Alfa Steering Torque (AST) Failure ⇨ page 80
	Alternator Failure ⇨ page 80
	Automatic Transmission Failure ⇨ page 80
	Driver Attention Assist (DAA) System Activation ⇨ page 80
	Door Open ⇨ page 80









Red Symbols	
	Electronic Throttle Control (ETC) Warning Light ⇨ page 80
	Engine Coolant Temperature Too High ⇨ page 80
	Hood Cap Not Properly Shut ⇨ page 81
	Insufficient Engine Oil Level ⇨ page 81
	Low Engine Oil Pressure ⇨ page 81
	Power Steering Failure ⇨ page 80
	Trunk Lid Not Properly Shut ⇨ page 81









Amber Symbols	
	ABS Activation ⇨ page 81
	Adaptive Front Lighting System Failure ⇨ page 81







Amber Symbols	
	Automatic High Beam Headlights Failure – If Equipped ⇨ page 82
	Automatic Transmission Fluid Overheating ⇨ page 85
	Audio System Failure ⇨ page 82
	All Wheel Drive Failure ⇨ page 81
	Blind Spot Monitoring System Failure – If Equipped ⇨ page 82
	Dusk Sensor Failure ⇨ page 82
	Dynamic Drive Control System Failure ⇨ page 82
	Driver Attention Assist (DAA) System Failure ⇨ page 82
	Electric Park Brake Failure ⇨ page 82

Amber Symbols	
	Engine Immobilizer Failure/ Break-In Attempt ⇨ page 82
	Engine Oil Change Required– If Equipped ⇨ page 83
	Engine Oil Pressure Sensor Failure ⇨ page 83
	Engine Oil Level Sensor Failure ⇨ page 83
	Exterior Lights Failure ⇨ page 82
	Forward Collision Warning (FCW) System Failure – If Equipped ⇨ page 84
	Fuel Cut-Off Indicator Light ⇨ page 83
	Fuel Level Sensor Failure ⇨ page 83
	Fuel Cut-Off System Failure ⇨ page 83



Amber Symbols	
	Generic Indication ⇨ page 83
	Highway Assist System (HAS)/ Traffic Jam Assist (TJA) System Failure ⇨ page 83
	Keyless System Failure ⇨ page 83
	Lane Departure Warning (LDW) System Failure – If Equipped ⇨ page 84
	Loose Fuel Filler Cap ⇨ page 84
	Low Coolant Level – If Equipped ⇨ page 84
	Park Sensors System Failure ⇨ page 84
	Rain Sensor Failure ⇨ page 84
	Stop/Start System Failure ⇨ page 84

Amber Symbols	
	Speed Limiter System Failure ⇨ page 84
	Service Adaptive Cruise Control (ACC) System ⇨ page 84
	Soft Suspension Calibration Insertion – If Equipped ⇨ page 84
	Shock Absorbers Failure ⇨ page 84
	Temporary All Wheel Drive Failure – If Equipped ⇨ page 84
	Wear On Brake Pads ⇨ page 85
	Windshield Wiper Failure ⇨ page 85
	Windshield Washer Liquid Level ⇨ page 84
	Wear ON Carbon Ceramic Material (CCM) Brake Discs – If Equipped ⇨ page 85

Green Symbols	
	Adaptive Cruise Control (ACC) System – If Equipped ⇨ page 85
	Automatic Headlights ⇨ page 85
	Cruise Control Activated ⇨ page 85
	Headlights ⇨ page 85
	Stop/Start Operation ⇨ page 85
Blue Indicator Lights	
	Automatic High Beam Headlights – If Equipped ⇨ page 85
	High Beam Headlights ⇨ page 85

In this section, you will find important information to help you become familiar with the features needed to operate your vehicle, and how they function.

KEYS

KEY FOB

Your vehicle is equipped with a key fob which supports Passive Entry, Remote Keyless Entry (RKE), Remote Start (if equipped), and remote liftgate operation. The key fob allows you to lock or unlock the doors and liftgate. The key fob does not need to be pointed at the vehicle to activate the system. The key fob also contains an emergency key, which is stored inside the key fob.

NOTE:

- ❑ The key fob's wireless signal may be blocked if the key fob is located next to a mobile phone, laptop, or other electronic device. This may result in poor performance.
- ❑ With ignition in the ON position and the vehicle moving at 2 mph (4 km/h), all RKE commands are disabled.



Key Fob

In case the ignition switch does not change with the push of a button, the key fob may have a low or fully depleted battery. A low key fob battery can be verified by referring to the instrument cluster, which will display directions to follow → page 278.

To Lock/Unlock The Doors And Liftgate

Push and release the unlock button on the key fob once to unlock the driver's door or twice within one second to unlock all doors and the liftgate. To lock all the doors and the liftgate, push the lock button once.

The current unlock setting can be changed through the radio system menu, so that the system unlocks:

- ❑ All doors on the first push of the key fob unlock button.
- ❑ The driver door on the first push of the key fob unlock button.
- ❑ The liftgate "independently" or "with doors".

When the doors are locked/unlocked, the turn signals will flash and the illuminated entry system will be activated.

NOTE:

If one or more doors are open when the lock button is pushed, or the liftgate is open, the doors will lock. The doors will unlock again automatically if the key is left inside the passenger compartment, otherwise the doors will stay locked.

Flashing of the turn signals upon locking/unlocking the doors, and activation of the courtesy light upon unlocking the doors, can be activated or deactivated through the radio system. For further information, refer to the Information and Entertainment System Owner's Manual Supplement.

Opening The Liftgate

Rapidly push the button on the key fob twice to open the liftgate. The turn signals will flash to indicate that the liftgate has been opened.



Replacing The Battery In The Key Fob

The recommended replacement battery is one CR2032 battery.

NOTE:

- ❑ Customers are recommended to use a battery obtained from Mopar®. Aftermarket coin battery dimensions may not meet the original OEM coin battery dimensions.
- ❑ Perchlorate Material — special handling may apply. See www.dtsc.ca.gov/hazardouswaste/perchlorate for further information.
- ❑ Do not touch the battery terminals that are on the back housing or the printed circuit board.

To replace the battery, proceed as follows:

1. Push the sides of the key fob inward and extract the cover pulling downwards.



Key Fob Cover Removal

2. Remove the emergency key from its housing.

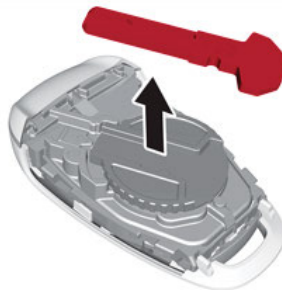

Removing Emergency Key

3. Remove the battery plug by rotating it counter clockwise.

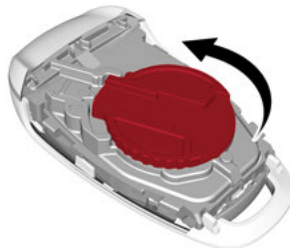

Removing Battery Plug

4. Remove the battery from its slot and replace it with a new one. When replacing the battery, match the (+) sign on the battery to the (+) sign on the inside of the

battery clip, located on the back cover. Avoid touching the new battery with your fingers. Skin oils may cause battery deterioration. If you touch a battery, clean it with rubbing alcohol.



Battery Location

Proceed in reverse order to reassemble the key.



WARNING!

- ❑ The integrated key fob contains a coin cell battery. Do not ingest the battery; there is a chemical burn hazard. If the coin cell battery is swallowed, it can cause severe internal burns in just two hours and can lead to death.
- ❑ If you think a battery may have been swallowed or placed inside any part of the body, seek immediate medical attention.

(Continued)



WARNING! (Continued)

- ❑ Keep new and used batteries away from children. If the battery compartment does not close securely, stop using the product and keep it away from children.



CAUTION!

The battery replacement operation must be done with care, in order not to damage the electronic key.

Programming And Requesting Additional Key Fobs

Programming the key fob may be performed by an authorized dealer.

NOTE:

- ❑ Once a key fob is programmed to a vehicle, it cannot be repurposed and reprogrammed to another vehicle.
- ❑ Only key fobs that are programmed to the vehicle electronics can be used to start and operate the vehicle. Once a key fob is programmed to a vehicle, it cannot be programmed to any other vehicle.



WARNING!

- ❑ Always remove the key fobs from the vehicle and lock all doors when leaving the vehicle unattended.

(Continued)



WARNING! (Continued)

- ❑ Always remember to place the ignition in the OFF position.

Duplication of key fobs may be performed at an authorized dealer. This procedure consists of programming a blank key fob to the vehicle electronics. A blank key fob is one that has never been programmed.

NOTE:

- ❑ When having the Engine Immobilizer system serviced, bring all vehicle keys with you to an authorized dealer.
- ❑ For Quadrifoglio models, if you need a replacement key fob, contact an authorized dealer.

ENGINE IMMOBILIZER SYSTEM

The Engine Immobilizer system prevents unauthorized use of the vehicle by disabling engine starting. The system does not need to be enabled or activated. Operation is automatic, regardless of whether the vehicle is locked or unlocked.

The system uses a key fob, keyless push button ignition and a Radio Frequency (RF) receiver to prevent unauthorized vehicle operation. Therefore, only key fobs that are programmed to the vehicle can be used to start and operate the vehicle. The system will

shut the engine off in two seconds if an invalid key fob is used to start the engine.

After placing the ignition switch in the ON/RUN position, the Vehicle Security Light will turn on for three seconds for a bulb check. If the light remains on after the bulb check, it indicates that there is a problem with the electronics. In addition, if the light begins to flash after the bulb check, it indicates that someone used an invalid key fob to start the engine. Either of these conditions will result in the engine being shut off after two seconds.

If the Vehicle Security Light turns on during normal vehicle operation (vehicle running for longer than 10 seconds), it indicates that there is a fault in the electronics. Should this occur, have the vehicle serviced as soon as possible by an authorized dealer.



CAUTION!

The Engine Immobilizer system is not compatible with some aftermarket remote starting systems. Use of these systems may result in vehicle starting problems and loss of security protection.

All of the key fobs provided with your new vehicle have been programmed to the vehicle electronics.

NOTE:

A key fob that has not been programmed is also considered an invalid key ↪ page 278.



IGNITION SWITCH

KEYLESS PUSH BUTTON IGNITION

This feature allows the driver to operate the ignition switch with the push of a button as long as the key fob is in the passenger compartment.

The START/STOP ignition button has several operating modes. These modes are OFF, ACC, and ON/RUN.



Keyless Ignition START/STOP Button

The push button ignition can be placed in the following modes:

OFF

- The engine is stopped
- Steering is locked
- Some electrical devices (e.g. central locking, alarm, etc.) are still available

ACC

- Engine is not started
- Some electrical devices are available (e.g. power windows)

ON/RUN

- The engine will start (when foot is on the brake pedal)
- All electrical devices are available (e.g. climate controls, etc.)

If the ignition switch does not change the mode by pushing the button, the key fob may have a low or depleted battery. In this situation, a back up method can be used to operate the ignition switch. Proceed as follows:

1. Lift the front armrest.
2. Lay the key fob on the indicated spot in the bottom of the center console, positioning the key fob as shown in the following image, while pushing the START/STOP ignition button to start the ignition.



Key Fob Placement Location

NOTE:

- For more information on proper engine starting procedures, see [page 88](#).
- With the keyless ignition in the ACC position, if 30 minutes pass with the gear selector in PARK and the engine stopped, the keyless ignition will automatically reset to the OFF position.
- When opening the driver's door with the ignition in the ACC position (engine not running), a chime will sound to remind you to place the ignition in the OFF position. In addition to the chime, the message will display "Ignition Or Accessory On" in the cluster [page 278](#).



WARNING!

- When exiting the vehicle, always make sure the ignition is in the OFF position, remove the key fob from the vehicle, and lock your vehicle.
- Never leave children alone in a vehicle, or with access to an unlocked vehicle.
- Allowing children to be in a vehicle unattended is dangerous for a number of reasons. A child or others could be seriously or fatally injured. Children should be warned not to touch the parking brake, brake pedal or the gear selector.

(Continued)



WARNING! (Continued)

- ❑ Do not leave the key fob in or near the vehicle, or in a location accessible to children, and do not leave the Keyless Push Button Ignition in the ON/RUN position. A child could operate power windows, other controls, or move the vehicle.
- ❑ Do not leave children or animals inside parked vehicles in hot weather. Interior heat build-up may cause serious injury or death.



CAUTION!

An unlocked vehicle is an invitation for thieves. Always remove key fob from the vehicle and lock all doors when leaving the vehicle unattended.

REMOTE START — IF EQUIPPED



This system uses the key fob to start the engine conveniently from outside the vehicle while still maintaining security.

NOTE:

Obstructions between the vehicle and key fob may reduce this range → page 278.



WARNING!

- ❑ Do not start or run an engine in a closed garage or confined area. Exhaust gas contains Carbon Monoxide (CO) which is odorless and colorless. Carbon Monoxide is poisonous and can cause serious injury or death when inhaled.
- ❑ Keep key fobs away from children. Operation of the Remote Start system, windows, door locks or other controls could cause serious injury or death.

How To Use REMOTE START

Push the Remote Start button on the key fob twice within five seconds. The vehicle doors will lock, the turn signals will flash twice, and the horn will chirp twice. Pushing the Remote Start button a third time shuts the engine off.

NOTE:

- ❑ With Remote Start, the engine will only run for 15 minutes.
- ❑ Remote Start can only be used twice.
- ❑ If an engine fault is present or fuel level is low, the vehicle will start and then shut down in 10 seconds.
- ❑ The park lamps will turn on and remain on during Remote Start mode.

- ❑ For security, power window operation is disabled when the vehicle is in the Remote Start mode.
- ❑ The ignition must be placed in the ACC position before the Remote Start sequence can be repeated for a third cycle.

All of the following conditions must be met before the engine will Remote Start:

- ❑ Gear selector in PARK
- ❑ Doors closed
- ❑ Hood closed
- ❑ Liftgate closed
- ❑ Hazard switch off
- ❑ Brake switch inactive (brake pedal not pressed)
- ❑ Battery at an acceptable charge level
- ❑ PANIC button not pushed
- ❑ System not disabled from previous Remote Start event
- ❑ Vehicle Security system indicator flashing
- ❑ Ignition in OFF position
- ❑ Fuel level meets minimum requirement
- ❑ Vehicle Security system is not signaling an intrusion
- ❑ Malfunction Indicator Light (MIL) is not illuminated



TO EXIT REMOTE START MODE

To drive the vehicle after starting the Remote Start system, either push and release the unlock button on the key fob to unlock the doors, or unlock the vehicle using Passive Entry via the door handles, and disarm the Vehicle Security system (if equipped). Then, prior to the end of the 15 minute cycle, push and release the START/STOP ignition button while pressing the brake pedal.

The Remote Start system will turn the engine off if the Remote Start button is pushed again, or if the engine is allowed to run for the entire 15 minute cycle.

REMOTE START COMFORT SYSTEMS — IF EQUIPPED

When Remote Start is activated, the heated steering wheel and front heated seat features will automatically activate when ambient temperature is less than 39° F (4°C). These features will stay on through the duration of Remote Start.

NOTE:

This feature can be activated through the radio system. Refer to the Information and Entertainment System Owner's Manual Supplement for further information

VEHICLE SECURITY SYSTEM — IF EQUIPPED

The Vehicle Security system monitors the vehicle doors, hood, liftgate, and the keyless push button ignition for unauthorized operation. It also monitors movement inside the passenger compartment (volumetric protection — if equipped), cutting of battery cables, and unexpected lifting/tilting of the vehicle (anti-lift protection — if equipped).

While the Vehicle Security system is armed, interior switches for door locks are disabled.

If something triggers the alarm, the Vehicle Security system will provide the following audible and visible signals:

- The horn will pulse
- The turn signals will flash
- The Vehicle Security Light in the instrument cluster will flash

NOTE:

The Vehicle Security system is activated by the Engine Immobilizer system, which is automatically activated when you get out of the vehicle with the key fob and lock the doors.

TO ARM THE SYSTEM

Follow these steps to arm the Vehicle Security system:

1. Make sure the vehicle's ignition is placed in the OFF position.

2. Perform one of the following methods to lock the vehicle:
 - Push the lock button on the interior power door lock switch with the driver and/or passenger door open.
 - Push the lock button on the exterior Passive Entry door handle with a valid key fob available in the same exterior zone ↪ page 24.
 - Push the lock button on the key fob.
3. If any doors (or liftgate) are open, close them.

TO DISARM THE SYSTEM

The Vehicle Security system can be disarmed using any of the following methods:

- Push the unlock button on the key fob.
- Grab the Passive Entry door handle to unlock the door ↪ page 24.
- Cycle the ignition out of the OFF position to disarm the system.

NOTE:

- The driver's door key cylinder and liftgate button on the key fob cannot arm or disarm the Vehicle Security system. Use of the door key cylinder when the system is armed will sound the alarm when the door is opened.
- When the Vehicle Security system is armed, the interior power door lock switches will not unlock the doors.

The Vehicle Security system is designed to protect your vehicle. However, you can create conditions where the system will give you a false alarm. If one of the previously described arming sequences has occurred, the Vehicle Security system will arm, regardless of whether you are in the vehicle or not. If you remain in the vehicle and open a door, the alarm will sound. If this occurs, disarm the Vehicle Security system.

If the Vehicle Security system is armed and the battery becomes disconnected, the Vehicle Security system will remain armed when the battery is reconnected; the exterior lights will flash, and the horn will sound. If this occurs, disarm the Vehicle Security system.

NOTE:

The alarm does not disarm when the doors are unlocked by inserting the blade of the emergency key (found inside the key fob) into the door handle lock cylinder.

VOLUMETRIC/ANTI-LIFT PROTECTION — IF EQUIPPED

To ensure the correct operation of the Volumetric/Anti-Lift Protection system, completely close the side windows.

To disable the function, push the Volumetric/Anti-Lift Protection button before activating the alarm.

When the function is disabled, the light on the Volumetric/Anti-Lift Protection button flashes for several seconds.



Volumetric/Anti-Lift Protection Button

Any disabling of the Volumetric/Anti-Lift Protection must be repeated each time the ignition is placed in the OFF position.

DOORS POWER DOOR LOCKS

The power door lock switches are located on each front door panel. Push the switch to lock or unlock the doors.

Push the interior lock button on the rear door panel trim to lock the rear doors only.

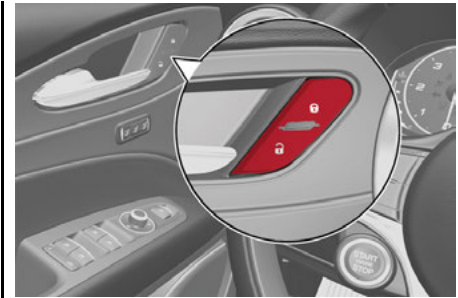

Door Lock And Unlock Switch Panel



WARNING!

- Do not leave children or animals inside parked vehicles in hot weather. Interior heat build-up may cause serious injury or death.
- For personal security and safety in the event of a collision, lock the vehicle doors as you drive as well as when you park and leave the vehicle.
- Before exiting a vehicle, always shift the automatic transmission into PARK, apply the parking brake, turn the engine OFF, remove the key fob from the vehicle and lock your vehicle.
- Never leave children alone in a vehicle, or with access to an unlocked vehicle.

(Continued)



**WARNING!** *(Continued)*

- ❑ Allowing children to be in a vehicle unattended is dangerous for a number of reasons. A child or others could be seriously or fatally injured. Children should be warned not to touch the parking brake, brake pedal or the gear selector.
- ❑ Do not leave the key fob in or near the vehicle, or in a location accessible to children. A child could operate power windows, other controls, or move the vehicle.

**CAUTION!**

An unlocked vehicle is an invitation. Always remove the key from the ignition and lock all of the doors when leaving the vehicle unattended.

LOCKING THE DOORS WITH A DEPLETED BATTERY

Proceed as follows to lock the doors if the vehicle battery is depleted:

1. With the doors unlocked insert the emergency key from the key fob or a screwdriver into the door lock manual release lock cylinder.

**Door Lock Manual Release Lock Cylinder**

2. Turn the manual release lock cylinder clockwise for the right door locks or counterclockwise for the left door locks.
3. Remove the key/screwdriver from the manual release lock.

Proceed in one of the following ways to realign the door lock device (only when the battery charge has been restored):

- ❑ Push the lock button on the key fob
- ❑ Push the unlock button on the door panel
- ❑ Unlock the driver's door lock with the emergency key
- ❑ Operate the internal door handle

NOTE:

For the rear doors, if the Child Safety Locks are engaged, and the previously described locking procedure is carried out, operating the internal handle will not open the door. Instead, it will only realign the lock release device. To open

the door, the outside handle must be used. The door central locking/unlocking buttons are not deactivated when the emergency lock is engaged.

PASSIVE ENTRY SYSTEM

The Passive Entry system is an enhancement to the vehicle's key fob. This feature allows you to lock and unlock the vehicle's door(s) and liftgate without having to push the key fob lock or unlock buttons.

NOTE:

- ❑ Passive Entry may be programmed on/off through the radio screen. Refer to the Information and Entertainment System Owner's Manual Supplement for Passive Entry settings.
- ❑ The key fob may not be able to be detected by the vehicle Passive Entry system if it is located next to a mobile phone, laptop, or other electronic device; these devices may block the key fob's wireless signal and prevent the Passive Entry system from locking/unlocking the vehicle.
- ❑ If wearing gloves, or if it has been raining/snowing on the Passive Entry door handle, the unlock sensitivity can be affected, resulting in a slower response time.
- ❑ If the vehicle is unlocked by Passive Entry and no door is opened within 60 seconds, the vehicle will relock and (if equipped) will arm the Vehicle Security system.

To Unlock From The Driver Or Passenger Side

With a valid Passive Entry key fob close to the door handle, grab the handle to unlock the vehicle. Grabbing the driver's door handle will unlock the driver door automatically. Grabbing the passenger door handle will unlock all doors and the liftgate automatically.

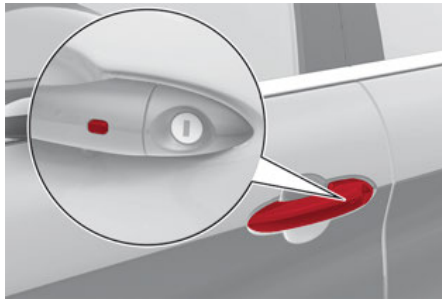

Passive Entry Door Handle Button

NOTE:

- Either the driver door only or all doors will unlock when you grab hold of the front driver's door handle, depending on the selected setting in the radio. Refer to the Information and Entertainment System Owner's Manual Supplement for Passive Entry settings.
- All doors will unlock when the front passenger door handle is grabbed regardless of the driver's door unlock preference setting.



External Liftgate Release Button
(Vehicles With Passive Entry)

Frequency Operated Button Integrated Key (FOBIK-Safe)

To minimize the possibility of unintentionally locking a Passive Entry key fob inside your vehicle, the Passive Entry system is equipped with an automatic door unlock feature which will function if the ignition switch is in the OFF position.

The vehicle will **not unlock** the doors if an unauthorized key fob has been detected close to the outside of the vehicle.

If the Passive Entry function is disabled through the radio screen, the protections to avoid accidentally leaving the key fob inside the vehicle are deactivated.

To Lock The Vehicle's Doors And Liftgate

With one of the vehicle's Passive Entry key fobs close to either front door handle,

pushing the Passive Entry lock button will lock the vehicle.

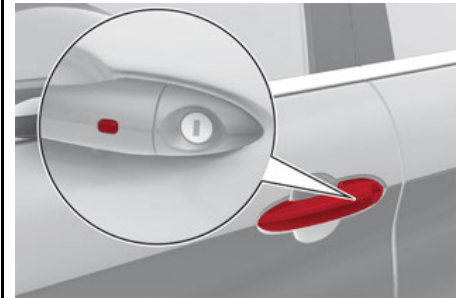

Passive Entry Door Handle Button

NOTE:

DO NOT grab the door handle when pushing the door handle lock button. This could unlock the door(s).



Do NOT Grab The Door Handle When Locking



NOTE:

- ❑ After pushing the Passive Entry lock button, you must wait two seconds before you can lock or unlock the doors, using either Passive Entry door handle. This is done to allow you to check if the vehicle is locked by pulling the door handle without the vehicle unlocking.
- ❑ The Passive Entry system will not operate if the key fob battery is depleted.
- ❑ The vehicle doors and liftgate can also be locked by pushing the lock button on the key fob or on the interior door lock.

To Unlock/Enter The Liftgate

With one of the vehicle's Passive Entry key fobs close to the liftgate, push the liftgate release button.



External Liftgate Release Button

NOTE:

- ❑ If the key fob is inadvertently forgotten inside of the cargo area, and an attempt is made to close it from outside, the liftgate will not lock. With the doors locked, the liftgate unlocked, and the key fob detected inside the vehicle, the liftgate will unlock again and the lights flash twice.
- ❑ Before driving, make sure the liftgate is closed correctly.

To Lock The Liftgate

With a valid Passive Entry key fob close to the vehicle, push the Passive Entry button located as part of the liftgate release button switch. All doors and the liftgate will lock. Door locking will activate the alarm as well.



**External Liftgate Release Switch
(Vehicles With Passive Entry)**

NOTE:

The liftgate may still be locked by pushing the lock button on the key fob, pushing the door lock button on the door handles, or pushing the lock button on the interior door panel of the vehicle → page 278.

POWER LOCK SAFETY DEVICE

The Power Lock Safety Device prevents the operation of the interior door handles and the door lock and unlock buttons. The power lock also prevents opening of the doors from inside the passenger compartment.

It is recommended to lock the vehicle doors each time the vehicle is parked.

Activating The Power Lock

The Power Lock Safety Device is enabled on all the doors by quickly pushing the lock button on the key fob twice.

The turn signals will flash to let you know that the power lock is active.

If one or more of the doors are not closed correctly, the Power Lock Safety Device will not activate, preventing a person from getting stuck inside the passenger compartment by entering the vehicle, and then closing the open door.

Deactivating The Power Lock

The Power Lock Safety Device disengages automatically:

- When the doors are unlocked by pushing the unlock button on the key fob.
- When the keyless ignition is placed in the ON position.

AUTOMATIC DOOR LOCKS — IF EQUIPPED

The auto door lock feature default condition is enabled. When enabled, the door locks will lock automatically when the vehicle's speed exceeds 12 mph (20 km/h). The auto door lock feature is enabled/disabled through the radio screen. Refer to the Information and Entertainment System Owner's Manual Supplement for further information.

CHILD-PROTECTION DOOR LOCK SYSTEM — REAR DOORS

To provide a safer environment for small children riding in the rear seats, the rear doors are equipped with a Child-Protection Door Lock system.

To use the system, open each rear door, use a flat blade screwdriver (or emergency key) and rotate the dial to the lock or unlock position.



Child Safety Lock Positions

NOTE:

- When the Child-Protection Door Lock system is engaged, the door can be opened only by using the outside door handle even though the inside door lock is in the unlocked position.
- After disengaging the Child-Protection Door Lock system, always test the door from the inside to make certain it is in the unlocked position.

- After engaging the Child-Protection Door Lock system, always test the door from the inside to make certain it is in the locked position.
- For emergency exit with the system engaged, pull up on the door lock knob (unlocked position), roll down the window, and open the door with the outside door handle.



WARNING!

Avoid trapping anyone in a vehicle in a collision. Remember that the rear doors can only be opened from the outside when the Child-Protection locks are engaged (locked).

NOTE:

Always use this device when carrying children. After engaging the child lock on both rear doors, check for effective engagement by trying to open a door with the internal handle. Once the Child-Protection Door Lock system is engaged, it is impossible to open the doors from inside the vehicle. Before getting out of the vehicle, be sure to check that there is no one left inside.



STEERING WHEEL

MANUAL TILT/TELESCOPING STEERING COLUMN

This feature allows you to tilt the steering column upward or downward. It also allows you to lengthen or shorten the steering column. The tilt/telescoping lever is located below the steering wheel at the end of the steering column.

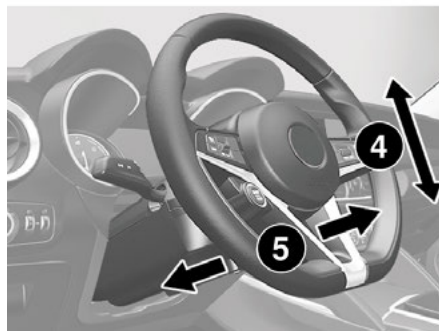
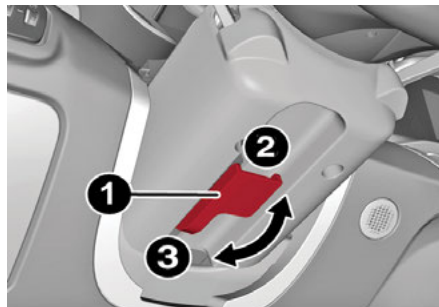

Steering Wheel Adjustment

- 1 – Tilt/Telescoping Control Handle
- 2 – Closed
- 3 – Open
- 4 – Tilt Movement
- 5 – Telescoping Movement



WARNING!

- ❑ Do not adjust the steering column while driving. Adjusting the steering column while driving or driving with the steering column unlocked, could cause the driver to lose control of the vehicle. Failure to follow this warning may result in serious injury or death.
- ❑ Do not place any objects on the steering wheel (e.g. permanently fixed covers) which could interfere with the hand detection sensor on the steering wheel of the Active Blind Spot Assist (ABSA), Lane Keeping Assist (LKA), Traffic Jam Assist (TJA), or Highway Assist systems (HAS) (if equipped).

To unlock the steering column, push the tilt/telescoping control handle down to the open position. To tilt the steering column, move the steering wheel upward or downward as desired. To lengthen or shorten the steering column, pull the steering wheel outward or push it inward as desired. To lock the steering column in position, push the tilt/telescoping control handle to the closed position.





WARNING!

It is absolutely forbidden to carry out any after-market operation involving steering system or steering column modifications (e.g. installation of anti-theft device) that could adversely affect performance. Doing so could void the New Vehicle Limited Warranty, cause **SERIOUS SAFETY PROBLEMS INCLUDING INJURY**, and also result in the vehicle not meeting type-approval requirements.

HEATED STEERING WHEEL — IF EQUIPPED

The steering wheel contains a heating element that helps warm your hands in cold weather. The heated steering wheel has only one temperature setting. The heated steering wheel may not turn on when it is already warm.

The heated steering wheel button is located on the instrument panel.

- Push the heated steering wheel  button once to turn the heating element on.
- Push the heated steering wheel  button a second time to turn the heating element off.

When the function is enabled, the indicator on the button will illuminate.



M0313000034US

Heated Steering Wheel Button

NOTE:

The engine must be running for the heated steering wheel to operate.

For information on use with the Remote Start system, see  page 22.



WARNING!

- Persons who are unable to feel pain to the skin because of advanced age, chronic illness, diabetes, spinal cord injury, medication, alcohol use, exhaustion, or other physical conditions must exercise care when using the steering wheel heater. It may cause burns even at low temperatures, especially if used for long periods.

(Continued)



WARNING! (Continued)

- Do not place anything on the steering wheel that insulates against heat, such as a blanket or steering wheel covers of any type and material. This may cause the steering wheel heater to overheat.

DRIVER MEMORY SETTINGS — IF EQUIPPED

This feature allows the driver to store up to three different memory profiles for easy recall through a memory switch. Each memory profile saves desired position settings for the following features:

- Driver seat
- Side mirrors

The memory setting switch is located on the driver's side door trim panel, near the door handle. The switch consists of three buttons, one for each memory profile.



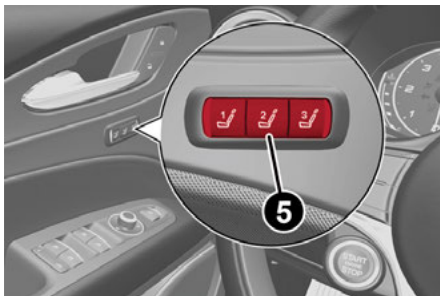

Memory Setting Switch Location

5 – Driver Memory Settings Buttons

PROGRAMMING THE MEMORY FEATURE

To create a new memory profile, perform the following:

1. Place the vehicle's ignition in the ACC position (do not start the engine), and make sure the driver's door is closed.

NOTE:

A memory profile can also be set for three minutes after the driver's door has been opened.

2. Adjust all memory profile settings to desired preferences, driver's seat and mirror positions.
3. Push and hold the memory button you want to program for 1.5 seconds. A chime will sound to indicate that the memory profile has been saved successfully.

NOTE:

When a new profile has been set, the previously set profile for that button will be overwritten.

MEMORY POSITION RECALL

To recall a previously set position, push and release the memory profile button, assigned to the desired positions.

NOTE:

Memory position recall can be done for approximately three minutes after the doors have been opened, and for approximately one minute after the ignition is placed in the OFF position.

SEATS

Seats are a part of the Occupant Restraint system of the vehicle.



WARNING!

- It is dangerous to ride in a cargo area, inside or outside of a vehicle. In a collision, people riding in these areas are more likely to be seriously injured or killed.
- Do not allow people to ride in any area of your vehicle that is not equipped with seats and seat belts. In a collision, people riding in these areas are more likely to be seriously injured or killed.
- Be sure everyone in your vehicle is in a seat and using a seat belt properly.

SPARCO RACING SEATS (QUADRIFOGLIO VEHICLES) — IF EQUIPPED

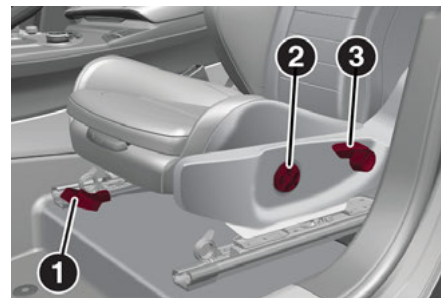

Manual Seat Adjustment

- 1 – Adjustment Lever
- 2 – Height Adjustment Button
- 3 – Recline Lever

Adjusting The Seat Forward Or Rearward

The adjustment lever is at the front of the seat, near the floor. Pull the bar upward to move the seat forward or rearward. Release the bar once the seat is in the desired position. Using body pressure, move forward and rearward on the seat to be sure that the seat adjusters have latched.

Adjusting The Seat Up Or Down

Push the height adjustment button upward or downward to obtain your desired height.

Reclining The Seatback

To adjust the seatback, lift the recline lever located on the outboard side of the seat, lean back to the desired position and release the lever. To return the seatback, lift the lever, lean forward and release the lever.



WARNING!

- Adjusting a seat while driving may be dangerous. Moving a seat while driving could result in loss of control which could cause a collision and serious injury or death.
- Seats should be adjusted before fastening the seat belts and while the vehicle is parked. Serious injury or death could result from a poorly adjusted seat belt.
- Do not ride with the seatback reclined so that the shoulder belt is no longer resting against your chest. In a collision you could slide under the seat belt, which could result in serious injury or death.



CAUTION!

Do not place any article under a power seat or impede its ability to move as it may cause damage to the seat controls. Seat travel may become limited if movement is stopped by an obstruction in the seat's path.

SPLIT FOLDING REAR SEAT

The rear seat is a 40/20/40 seat that allows the luggage compartment to be partially or totally extended.



Split Folding Rear Seat

Central Backrest Section Tilting

Before tilting the backrest, make sure that the rear center seat belt is not fastened and that there aren't any objects on the seat itself (if there are any, remove them).

Pull the release strap upward to release the central part of the backrest from its housing and tilt it forward using the head restraint.

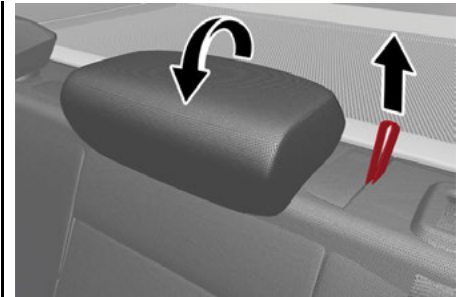

Center Backrest Section Tilting

Central Backrest Section Repositioning

Using the head restraint, lift the central portion upwards, manually guiding it back into place. Lightly push to make sure that it is properly latched. Make sure that the armrest is properly latched by gently trying to move it. If it is not latched, repeat the operation.

Repositioning The Backrests

Move the seat belts to the side, making sure that they are correctly extended and not twisted. Also make sure that they are not caught on anything behind the backrests of the seats. Then, lift the backrests by pushing them rearward until you hear the lock click into place on both attachment mechanisms.



**WARNING!**

Be certain that the seatback is securely locked into position. If the seatback is not securely locked into position the seat will not provide the proper stability for child seats and/or passengers. An improperly latched seat could cause serious injury.

Extending The Luggage Compartment

The rear seatbacks can be folded forward to provide an additional storage area.

Extending the right side of the luggage compartment allows you to carry two passengers on the left part of the rear seat, while extending the left side allows you to carry one passenger.

Proceed as follows:

1. Completely lower the rear seat head restraints → page 35.
2. Place the seat belt so that it doesn't impede the movement of the backrest while tilting it.

3. Pull the left-hand seat back release lever (inside the luggage compartment or the release at the base of the rear seat accessible from the rear doors) to fold down the left side, or the right-hand seat back release lever to fold down the right side of the backrest. It will fold forwards automatically. If necessary, assist the backrest during the initial stage of tilting.

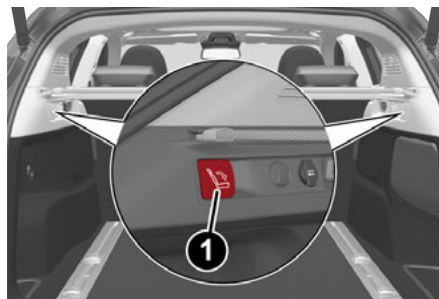

Seat Back Release Lever In Luggage Compartment

1 — Seat Back Release Lever

NOTE:

- Pull both seat back release levers to fold down both backrests. Tilting the rear seat completely forward allows for maximum loading volume.
- You may need to move the front seats forward in order for the rear seats to fold forward completely.



Seat Back Release Lever Below Rear Seat

It is also possible to disengage the sections of the rear seat from inside the luggage compartment or by using one of the two levers located below the rear seat. Each lever folds down the section of the backrest on the same side.

POWER ADJUSTMENT (FRONT SEATS)

NOTE:

The seat layout may vary according to the vehicle options.

The power seat switches are located on the outboard side of the seat near the floor. Use these switches to move the driver's seat up, down, forward, and rearward, or to recline the seatback.

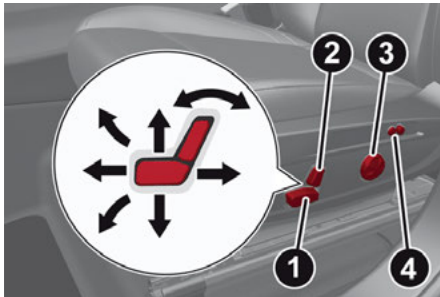

Power Seat Adjustment

- 1 – Seat Adjustment
- 2 – Recline Adjustment
- 3 – Lumbar Adjustment
- 4 – Power Adjustable Bolster Buttons
(If Equipped)

Adjusting The Seat Forward Or Rearward

The seat can be adjusted both forward and rearward by using the seat adjustment switch. The seat will move in the direction of the switch. Release the switch when the desired position has been reached.

Adjusting The Seat Up Or Down

The height of the seats can be adjusted up or down. Pull upward or push downward on the seat switch, and the seat will move in the direction of the switch. Release the switch when the desired position is reached.

Tilting The Seat Up Or Down – If Equipped

The seat angle can be adjusted in four directions. Lift or push the front part of seat switch to move the front part of the seat in the corresponding direction. Release the seat switch when the seat has reached the desired position.

Reclining The Seatback

The angle of the seatback can be adjusted forward or rearward by using the recline switch. The seat will move in the direction of the switch. Release the switch when the desired position is reached.



WARNING!

- Adjusting a seat while driving may be dangerous. Moving a seat while driving could result in loss of control which could cause a collision and serious injury or death.
- Seats should be adjusted before fastening the seat belts and while the vehicle is parked. Serious injury or death could result from a poorly adjusted seat belt.
- Do not ride with the seatback reclined so that the shoulder belt is no longer resting against your chest. In a collision you could slide under the seat belt, which could result in serious injury or death.



CAUTION!

Do not place any article under a power seat or impede its ability to move as it may cause damage to the seat controls. Seat travel may become limited if movement is stopped by an obstruction in the seat's path.



Power Lumbar

The power lumbar switch is located on the outboard side of the power seat. Push the switch forward or rearward to increase or decrease the lumbar support. Push the switch upward or downward to raise or lower the lumbar support.

Seat Cushion Extension — If Equipped

Lift the adjustment lever and push the front of the cushion forward or rearward to extend the cushion by a few inches (centimeters).

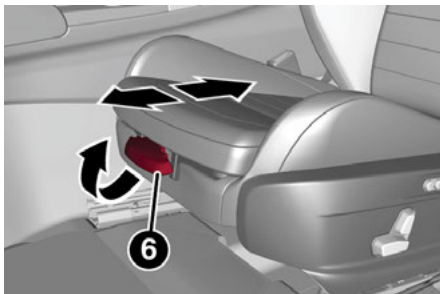

Seat Cushion Extension

6 — Adjustment Lever

Power Bolster Adjustment — If Equipped

Push the power bolster adjustment buttons to regulate the width of the backrest through the lateral padding.

Easy Entry Function

The Easy Entry function is designed to move the driver side seat forward automatically by 2.36 inches (60 mm) to make it easier for the driver to get in and out of the car.

The movement is activated only if the seat is set to a driving position which is in front of the B-pillar of the vehicle.

The function is associated with power driver seats for each of the three stored positions.

The Easy Entry function can be activated/deactivated through the radio system. Refer to the Information and Entertainment System Owner's Manual Supplement for further information.

HEATED SEATS — IF EQUIPPED



WARNING!

- Persons who are unable to feel pain to the skin because of advanced age, chronic illness, diabetes, spinal cord injury, medication, alcohol use, exhaustion or other physical condition must exercise care when using the seat heater. It may cause burns even at low temperatures, especially if used for long periods of time.

(Continued)



WARNING! *(Continued)*

- Do not place anything on the seat or seatback that insulates against heat, such as a blanket or cushion. This may cause the seat heater to overheat. Sitting in a seat that has been overheated could cause serious burns due to the increased surface temperature of the seat.

For information on use with the Remote Start system, see [page 22](#).

Front Heated Seats — If Equipped

NOTE:

Quadrifoglio vehicles equipped with Sparco Racing Seats will not be equipped with the heated seat feature.

A push of the heated seat buttons located on the instrument panel, near the climate controls, will select the heat levels in order of highest to lowest. A fourth push of the button will turn the heated seat off.

NOTE:

The heated seat function can also be activated through the radio system. Refer to the Information and Entertainment System Owner's Manual Supplement for further information.

You can select three heating levels:

- Maximum — three LED indicators illuminated on the buttons
- Average — two LED indicators illuminated on the buttons
- Minimum — one LED indicator illuminated on the buttons



M0311000272US

Heated Seat Buttons

NOTE:

- After selecting a heating level, heat will be felt within a few minutes.
- The engine must be running for the heated seats to operate.

- The “minimum” setting is automatically deactivated once a certain period of time has elapsed.

Rear Heated Seats — If Equipped

If equipped with rear heated seats, the controls can be found on the rear of the center console and will function the same as the front heated seat controls.



Rear Heated Seat Buttons

NOTE:

To preserve the battery charge, this function cannot be activated when the engine is off.

HEAD RESTRAINTS

Head restraints are designed to reduce the risk of injury by restricting head movement in the event of a rear impact. Head restraints should be adjusted so that the top of the head restraint is located above the top of your ear.



WARNING!

- A loose head restraint thrown forward in a collision or hard stop could cause serious injury or death to occupants of the vehicle. Always securely stow removed head restraints in a location outside the occupant compartment.
- ALL the head restraints MUST be reinstalled in the vehicle to properly protect the occupants. Follow the reinstallation instructions above prior to operating the vehicle or occupying a seat.
- Do not place items over the top of the Reactive Head Restraint, such as coats, seat covers or portable DVD players. These items may interfere with the operation of the Reactive Head Restraint in the event of a collision and could result in serious injury or death.



Front Head Restraints



WARNING!

- All occupants, including the driver, should not operate a vehicle or sit in a vehicle's seat until the head restraints are placed in their proper positions in order to minimize the risk of neck injury in the event of a crash.
- Head restraints should never be adjusted while the vehicle is in motion. Driving a vehicle with the head restraints improperly adjusted or removed could cause serious injury or death in the event of a collision.

NOTE:

For Quadrifoglio vehicles equipped with Sparco Racing Seats, the head restraints are not adjustable or removable.

The front head restraints may be height-adjustable.

To raise the head restraint, pull up on the head restraint until it clicks into place.

To lower the head restraint, push in the adjustment button and lower the head restraint to the desired height while holding the button. Then, release the adjustment button.

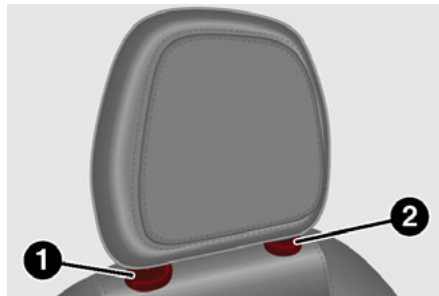

Front Head Restraint

- 1 – Release Button
- 2 – Adjustment Button

NOTE:

To allow for maximum visibility for the driver, if a seat is not occupied by a passenger, the head restraint can be lowered to the fully lowered position.

Rear Head Restraint Adjustments



WARNING!

- All occupants, including the driver, should not operate a vehicle or sit in a vehicle's seat until the head restraints are placed in their proper positions in order to minimize the risk of neck injury in the event of a crash.
- Head restraints should never be adjusted while the vehicle is in motion. Driving a vehicle with the head restraints improperly adjusted or removed could cause serious injury or death in the event of a collision.

The height of the outboard head restraints can be adjusted. The head restraint of the center seat, if equipped, cannot be adjusted, only removed.

For upward adjustment, pull upward on the head restraint until it clicks into place.

For downward adjustment, push in the adjustment button and lower the head restraint at the same time to the desired height.

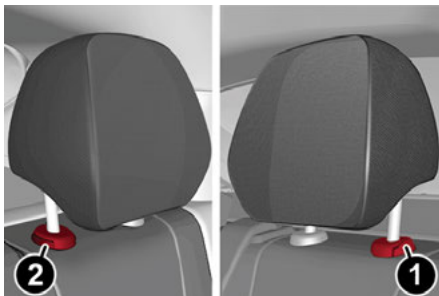

Rear Head Restraint

- 1 – Adjustment Button
- 2 – Release Button

NOTE:

To allow for maximum visibility for the driver, if a seat is not occupied by a passenger, the head restraint should be lowered to the fully lowered position.

Head Restraint Removal

To remove the head restraints, proceed as follows:

1. Recline the seat back to allow clearance of the head restraint from the vehicle's roof.
2. Raise the head restraints to their maximum height.

3. Push the adjustment button and the release button at the side of the two supports at the same time.
4. Pull upward on the head restraint to fully remove it.

To reinstall the head restraints, proceed as follows:

1. Hold down both the adjustment button and release button while placing the head restraint posts into the holes.
2. Then, reposition the head restraint to the appropriate height for the passengers.
3. Replace the seat back to the appropriate position for passengers.



WARNING!

- A loose head restraint thrown forward in a collision or hard stop could cause serious injury or death to occupants of the vehicle. Always securely stow removed head restraints in a location outside the occupant compartment.
- ALL the head restraints MUST be reinstalled in the vehicle to properly protect the occupants. Follow the re-installation instructions above prior to operating the vehicle or occupying a seat.

MIRRORS

AUTOMATIC DIMMING MIRROR

The rearview mirror can be adjusted up, down, left, and right. The mirror should be adjusted to center on the view through the rear window.

This mirror automatically adjusts for headlight glare from vehicles behind you.

You can turn the feature on or off by pushing the button at the base of the mirror.



Electrochromic Mirror Power Button



CAUTION!

To avoid damage to the mirror during cleaning, never spray any cleaning solution directly onto the mirror. Apply the solution onto a clean cloth and wipe the mirror clean.



VANITY MIRROR

On the driver and passenger sun visor, there is a light which illuminates the sun visor mirror when folded down.



Lift For Vanity Mirror

The courtesy light turns on automatically by lifting the cover.

Sun Visors

The sun visors are located at the sides of the interior rearview mirror. They can be adjusted forward and toward the side window.

To direct the visor toward the passenger side window, detach the visor from the interior rearview mirror side hook and turn it towards the side window.

From this position, the sun visor can also be extended toward the rear of the vehicle for additional blockage of sunlight.

There are courtesy mirrors with lights on the back of the sun visors.



Rotate Sun Visor Toward Passenger Window

NOTE:

A rear facing child restraint system should never be fitted in the front passenger seat. Always comply with the instructions on the sun visor ↪ page 182.

OUTSIDE POWER MIRRORS

The power mirror switch is located on the driver's side door trim panel.

To adjust the power mirrors, first select the desired mirror using the power mirror control.

To adjust the selected mirror, push the knob in the direction desired.

NOTE:

- Once adjustment is complete, rotate the knob to the neutral position to prevent accidental movements.

- The power mirrors can be adjusted with the ignition in the ACC or ON/RUN position.

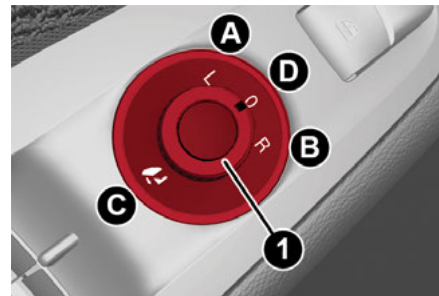

Power Mirror Control

- 1 — Power Mirror Control Knob
- A — Left
- B — Right
- C — Power Folding Position
- D — Neutral

**WARNING!**

Vehicles and other objects seen in an outside convex mirror will look smaller and farther away than they really are. Relying too much on side convex mirrors could cause you to collide with another vehicle or other object. Use your inside mirror when judging the size or distance of a vehicle seen in a side convex mirror.

POWER FOLDING OUTSIDE MIRRORS

To fold the door mirrors in using the Power Folding Mirror function, make sure the power mirror control knob is in the neutral position, and move the knob to the power folding position. Move the knob again to return the mirrors to the driving position.

If the power mirror control knob is moved again during door mirror folding (from closed to open position and vice versa), the movement direction is reversed.



Folding Mirror

Automatic Power Folding Mirrors

The exterior mirrors will fold in when exiting the vehicle (the ignition is OFF, all doors are closed, and the doors are locked). The mirrors return to the driving position when the vehicle is then unlocked.

If the door mirrors were folded using the power mirror control knob, they can only be returned to the driving position by moving the knob to the power folding position again.

NOTE:

The power folding operation can be enabled only when the vehicle speed is lower than 31 mph (50 km/h).

OUTSIDE AUTOMATIC DIMMING MIRRORS — IF EQUIPPED

The outside mirrors will automatically dim for glare from vehicles behind you. This feature is controlled by the inside automatic dimming mirror. The mirrors will automatically adjust for headlight glare when the inside mirror adjusts.

HEATED MIRRORS

Push the rear defrost  button, located within the climate controls, to activate the heated mirrors.

UNIVERSAL GARAGE DOOR OPENER (HOMELINK®)

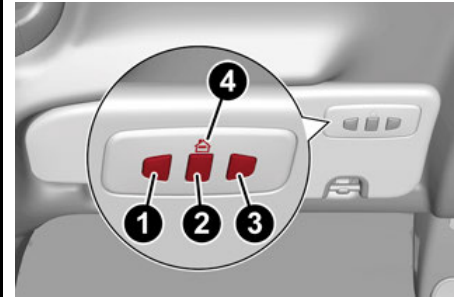

HomeLink® Buttons

- 1 — Homelink® Button 1
- 2 — Homelink® Button 2
- 3 — Homelink® Button 3
- 4 — Homelink® Indicator

- HomeLink® replaces up to three hand-held transmitters that operate devices such as garage door openers, motorized gates, lighting, or home security systems. The HomeLink® unit is powered by your vehicle's 12 Volt battery.
- The HomeLink® buttons that are located in the overhead console or sun visor designate the three different HomeLink® channels.



- To operate HomeLink®, push and release any of the programmed HomeLink® buttons. These buttons will activate the devices they are programmed with each press of the corresponding HomeLink® button.
- The HomeLink® indicator light is located above the center button → page 278.

BEFORE YOU BEGIN PROGRAMMING HOME LINK®

For efficient programming and accurate transmission of the radio-frequency signal, it is recommended that a new battery be placed in the hand-held transmitter of the device that is being programmed to the HomeLink® system. Make sure your hand-held transmitter is programmed to activate the device you are trying to program your HomeLink® button to.

Ensure that your vehicle is parked outside of the garage before you begin programming.

It is recommended that you erase all the channels of your HomeLink® before you use it for the first time.

If you require assistance, please call toll-free 1-800-355-3515 or visit HomeLink.com

ERASING ALL THE HOME LINK® CHANNELS

To erase the channels, follow this procedure:

1. Place the ignition switch into the ON/RUN position.
2. Push and hold the two outside HomeLink® buttons (I and III) for up to 20 seconds, or until the HomeLink® indicator light flashes.

NOTE:

Erasing all channels should only be performed when programming HomeLink® for the first time. Do not erase channels when programming additional buttons.

IDENTIFYING WHETHER YOU HAVE A ROLLING CODE OR NON-ROLLING CODE DEVICE

Before programming a device to one of your HomeLink® buttons, you must determine whether the device has a rolling code or non-rolling code.

Rolling Code Devices

To determine if your device has a rolling code, a good indicator is its manufacturing date. Typically, devices manufactured after 1995 have rolling codes. A device with a rolling code will also have a “LEARN” or “TRAIN” button located where the antenna is attached to the device. The button may not be immediately visible when looking at the device. The name

and color of the button may vary slightly by manufacturer.

NOTE:

The “LEARN” or “TRAIN” button is not the button you normally use to operate the device.

Non-rolling Code Devices

Most devices manufactured before 1995 will not have a rolling code. These devices will also not have a “LEARN” or “TRAIN” button.

PROGRAMMING HOME LINK® TO A GARAGE DOOR OPENER

To program any of the HomeLink® buttons to activate your garage door opener motor, follow the steps below:

NOTE:

All HomeLink® buttons are programmed using this procedure. You do not need to erase all channels when programming additional buttons.

1. Place the ignition switch into the ON/RUN position.
2. Place the garage door opener transmitter 1 to 3 inches (3 to 8 cm) away from the HomeLink® button you wish to program, while keeping the HomeLink® indicator light in view.
3. Push and hold the HomeLink® button you want to program while you push and hold the garage door opener transmitter button you are trying to replicate.

- Continue to hold both buttons and observe the HomeLink® indicator light. The HomeLink® indicator light will flash slowly and then rapidly. Once this happens, release both buttons.

NOTE:

Make sure the garage door opener motor is plugged in before moving on to the rolling code/non-rolling code final steps.

Rolling Code Garage Door Opener Final Steps

NOTE:

You have 30 seconds in which to initiate rolling code final step 2, after completing rolling code final step 1.

- At the garage door opener motor (in the garage), locate the “LEARN” or “TRAIN” button. This can usually be found where the hanging antenna wire is attached to the garage door opener motor. Firmly push and release the “LEARN” or “TRAIN” button.
- Return to the vehicle and push the programmed HomeLink® button three times (holding the button for two seconds each time). If the garage door opener motor operates, programming is complete.
- Push the programmed HomeLink® button to confirm that the garage door opener motor operates. If the garage door opener motor does not operate, repeat the final steps for the rolling code procedure.

Non-Rolling Code Garage Door Opener Final Steps

- Push and hold the programmed HomeLink® button and observe the HomeLink® indicator light. If the HomeLink® indicator light stays on constantly, programming is complete.
- Push the programmed HomeLink® button to confirm that the garage door opener motor operates. If the garage door opener motor does not operate, repeat the steps from the beginning.



WARNING!

- Your motorized door or gate will open and close while you are programming the universal transceiver. Do not program the transceiver if people or pets are in the path of the door or gate.
- Do not run your vehicle in a closed garage or confined area while programming the transceiver. Exhaust gas from your vehicle contains Carbon Monoxide (CO) which is odorless and colorless. Carbon Monoxide is poisonous when inhaled and can cause you and others to be severely injured or killed.

PROGRAMMING HOMELINK® TO A MISCELLANEOUS DEVICE

Follow the procedure on programming HomeLink® to a garage door opener  page 40. Be sure to determine if the device

has a rolling code, or non-rolling code before beginning the programming process.

NOTE:

Canadian radio frequency laws require transmitter signals to time-out (or quit) after several seconds of transmission, which may not be long enough for HomeLink® to pick up the signal during programming. Similar to this Canadian law, some U.S. gate operators are designed to time-out in the same manner. The procedure may need to be performed multiple times to successfully pair the device to your HomeLink® buttons.

REPROGRAMMING A SINGLE HOMELINK® BUTTON

To reprogram a single HomeLink® button that has been previously trained, without erasing all the channels, follow the procedure below. Be sure to determine whether the new device you want to program the HomeLink® button to has a Rolling Code, or Non-rolling Code.

- Place the ignition in the ON/RUN position, without starting the engine.
- Push and hold the desired HomeLink® button until the HomeLink® indicator light begins to flash after 20 seconds. **Do not release the button.**
- Without releasing the button**, proceed with Step 2 in “Programming HomeLink® To A Garage Door Opener” and follow all remaining steps.



CANADIAN/GATE OPERATOR PROGRAMMING

The programming of transmitters in Canada/ United States require the transmitter signals to “time-out” after several seconds of transmission.

Canadian radio frequency laws require transmitter signals to time-out (or quit) after several seconds of transmission – which may not be long enough for HomeLink® to pick up the signal during programming. Similar to this Canadian law, some U.S. gate operators are designed to time-out in the same manner.

It may be helpful to unplug the device during the cycling process to prevent possible overheating of the garage door or gate motor.

1. Place the ignition in the ON/RUN position.
2. Place the hand-held transmitter 1 to 3 inches (3 to 8 cm) away from the HomeLink® button you wish to program while keeping the HomeLink® indicator light in view.
3. Continue to press and hold the Home-Link® button, while you press and release (cycle) your hand-held transmitter every two seconds until HomeLink® has successfully accepted the frequency signal. The indicator light will flash slowly and then rapidly when fully trained.
4. Watch for the HomeLink® indicator to change flash rates. When it changes, it is programmed. It may take up to

30 seconds or longer in rare cases. The garage door may open and close while you are programming.

5. Press and hold the programmed Home-Link® button and observe the indicator light.

NOTE:

- If the indicator light stays on constantly, programming is complete and the garage door/device should activate when the HomeLink® button is pressed.
- To program the two remaining HomeLink® buttons, repeat each step for each remaining button. DO NOT erase the channels.

If you unplugged the garage door opener/device for programming, plug it back in at this time.

Reprogramming A Single HomeLink® Button (Canadian/Gate Operator)

To reprogram a channel that has been previously trained, follow these steps:

1. Place the ignition to the ON/RUN position.
2. Press and hold the desired HomeLink® button until the indicator light begins to flash after 20 seconds. Do not release the button.
3. Without releasing the button, proceed with “Canadian/Gate Operator Programming” step 2 and follow all remaining steps.

EXTERIOR LIGHTS

HEADLIGHT SWITCH

The headlight switch is located on the left side of the instrument panel, next to the steering wheel. The headlight switch controls the operation of the headlights, parking lights, instrument panel lights, instrument panel light dimming, interior lights and rear fog lights.

In addition, there are buttons for the ParkSense system and Engine Stop/Start
 ⇨ page 88.

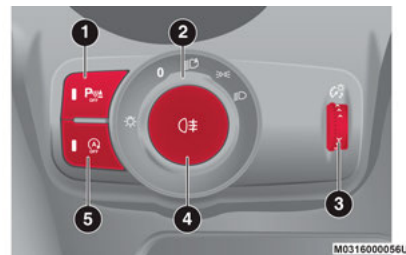

Headlight Switch

- 1 — ParkSense Button
- 2 — Headlight Control Switch
- 3 — Instrument Panel Dimmer
- 4 — Rear Fog Light Button
- 5 — Engine Stop/Start Button

The instrument panel and the various controls on the dashboard will be illuminated when the exterior lights are turned on.

To turn on the headlights, rotate the headlight switch clockwise. When the headlight switch is on, the parking lights, taillights, license plate light and instrument panel lights are also turned on. To turn off the headlights, rotate the headlight switch back to the O (off) position.

DAYTIME RUNNING LIGHTS (DRLs)

The Daytime Running Lights (DRLs) (low intensity) come on automatically whenever the ignition is placed in the ON/RUN position, and the headlight switch is turned to the  position, and the dusk sensor detects sufficient external light.

On some vehicles, the Daytime Running Lights may deactivate, or reduce intensity, on one side of the vehicle (when a turn signal is activated on that side), or on both sides of the vehicle (when the hazard warning lights are activated).



If equipped, the DRLs can be activated/deactivated from the radio system, by selecting the following functions in sequence on the main MENU:

1. “Settings”
2. “Lights”
3. “Daytime Running Lights”

NOTE:

The Daytime Running Lights **cannot** be deactivated in Canadian markets.

HIGH BEAM HEADLIGHTS

Push the multifunction lever towards the instrument panel to switch the headlights to high beams. The headlight switch must first be turned to the  (auto) or  (on) position.

With high beam headlights on, the  High Beam Indicator on the instrument panel will illuminate.

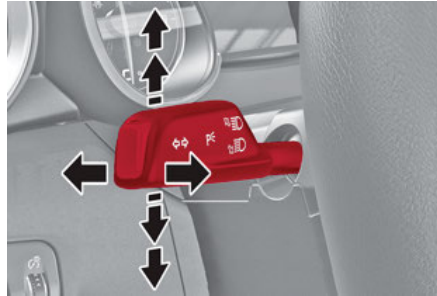

Multifunction Lever

Pulling the multifunction lever back will turn the low beams on.

AUTOMATIC HEADLIGHTS

This system automatically turns the headlights on or off according to ambient light levels. To turn the system on, rotate the headlight switch to the  (AUTO) position.

NOTE:

The function can only operate with the ignition position cycled to ON/RUN.

To turn the automatic headlights off, turn the headlight switch out of the  (AUTO) position.

FLASH-TO-PASS

You can signal another vehicle with your headlights by lightly pulling the multifunction lever toward you. This will cause the high beam headlights to turn on, and remain on, until the lever is released.

AUTOMATIC HIGH BEAM HEADLIGHTS — IF EQUIPPED

The Automatic High Beam Headlights system provides increased forward lighting at night by automating high beam control through the use of a camera mounted on the windshield. This camera detects vehicle specific light and automatically switches from high beams to low beams until the approaching vehicle is out of view.

This function is enabled with the radio system, and can only be activated with the light switch turned to  (auto).

If the high beam headlights are on, the blue icon/warning light  will illuminate in the instrument panel.

When the speed is higher than 25 mph (40 km/h) and the function is active, the lights will turn off if the multifunction lever is pushed again.

When the speed is lower than 15 mph (25 km/h) and the function is active, the function switches the high beam headlights off.



If the high beam headlights are operated quickly again (pushing the multifunction lever towards the instrument panel), the warning light/icon  will illuminate in the instrument panel, and the high beam headlights will turn on constantly until the speed exceeds 25 mph (40 km/h).

When the speed of 25 mph (40 km/h) is exceeded again, the automatic functioning is reactivated.

If the multifunction lever is pushed again with the Automatic High Beam Headlights activated, the Automatic High Beam Headlights function deactivates.

To deactivate the automatic headlight function, rotate the headlight switch to the  position.

NOTE:

- If the system recognizes heavy traffic areas, the automatic functions remain disabled independently of the vehicle's speed.
- The Automatic High Beam functionality may also be influenced by:
 - Reflections on road signs
 - Dim headlights from oncoming traffic
 - Poor weather conditions
 - Presence of dirt or other obstructions on the sensor
 - Damage to the windshield

PARKING LIGHTS

To turn on the parking lights and instrument panel lights, rotate the headlight switch clockwise to the  position. All of the parking lights will turn on for eight minutes, and opening the door activates an audible warning.

To leave only the lights on one side (right/left) illuminated, move the multifunction lever (located on the left side of the steering wheel) to the side that you want to remain on. With the parking lights on, the  indicator light on the instrument panel will illuminate.

To turn off the parking lights, rotate the headlight switch back to the O (off) position.

HEADLIGHT OFF DELAY

To assist when exiting the vehicle, the “Headlight Off Delay” feature will leave the headlights on for up to 90 seconds. This delay is initiated when the ignition is placed in the OFF position while the headlight switch is on, and then the headlight switch is cycled off. Headlight delay can be canceled by either turning on the headlights or side lights, or by placing the ignition in the ON position.

The function can be activated from the radio system by selecting the following functions in sequence on the main menu:

1. “Settings.”
2. “Lights.”
3. “Headlight Off Delay.”

REAR FOG LIGHTS

The rear fog light switch is located within the headlight switch.

Push the  button, located in the center of the headlight switch, to turn the rear fog lights on/off.

The rear fog lights turn on only when the headlights or parking lights are also turned on. The lights can be turned off by pushing the  button again or by turning the headlight switch to the O (off) position.

When the engine is stopped with the rear fog lights on, they will be off the next time the engine is started.

ADAPTIVE HEADLIGHT SYSTEM (AFS) — IF EQUIPPED

This is a system combined with Xenon headlights (Bi-Xenon 35 W headlamp, if equipped) which directs the headlights horizontally, and continuously and automatically adapts them to the driving conditions around bends or when cornering.

The system directs the headlights to light up the road in the best way, taking into account the speed of the vehicle and the bend or corner angle, as well as the speed at which the steering wheel is turned.

The adaptive lights are automatically activated when the vehicle is started.

TURN SIGNALS

Move the multifunction lever up or down to activate the turn signals. The arrows on each side of the instrument cluster flash to show proper operation.

The ⇨ or ⇩ turn signal will blink on the instrument panel.

LANE CHANGE ASSIST

Lightly push the lever up or down once, without moving beyond the detent, and the turn signal will flash five times then automatically turn off.

To turn off the flashing before the end of the cycle, move the lever in the opposite direction until the first click (about half way).

INTERIOR LIGHTS

Courtesy lights are turned on when the front doors are opened or when the dimmer control is rotated to its farthest upward position. The glove compartment light turns on automatically when the glove compartment is opened and turn off when it is closed. The door courtesy lights illuminate when one of the front doors is opened, and turn off when it is closed. The liftgate courtesy lights turn on automatically when the liftgate is opened and turn off when it is closed. All of these lights turn on and off regardless of the ignition status.

FRONT MAP READING LIGHTS

The front map/reading and overhead lights are mounted in the overhead console. Each light

can be turned on by pushing the corresponding switch on the console. These switches are backlit for night time visibility. To turn the lights off, push the switch a second time.

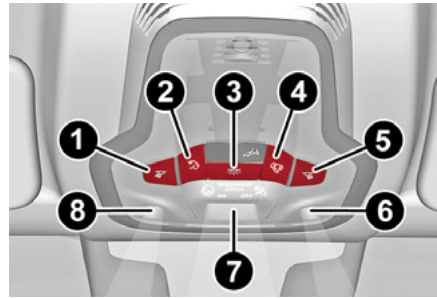

Overhead Console

- 1 – Driver's Reading/Map Light Switch
- 2 – Rear Overhead Lights Switch
- 3 – Overhead Lights Switch
- 4 – Overhead Lights On/Off When Doors Open
- 5 – Passenger's Reading/Map Light Switch
- 6 – Passenger's Reading/Map Light
- 7 – Center Reading/Map Light
- 8 – Driver's Reading/Map Light

NOTE:

Before exiting the vehicle, ensure that the overhead lights are off. This will prevent the battery from discharging once the doors are closed. If a light is left on accidentally, the overhead lights will turn off automatically approxi-

mately 15 minutes after the ignition has been placed in the OFF position.

Overhead Light Timing

On certain models, to assist getting in and out of the vehicle at night or in poorly-lit areas, two timed modes have been provided.

Timing While Getting Into The Vehicle — The overhead lights turn on according to the following modes:

- Will illuminate for a few seconds when the doors are unlocked.
- Will illuminate for approximately three minutes when one of the doors is opened.
- Will illuminate for a few seconds when the doors are locked.

Timing is interrupted when the ignition is placed in the ON/RUN position.

Three Modes Are Available For Turning Off Overhead Lighting:

- When all doors are closed after entering the vehicle, the three-minute timer will stop and a seconds timer will start for the interior lights. This timing will stop when the ignition is placed in the ON/RUN position.
- When doors are locked (either with key fob or with key inserted on driver side door), the overhead light turns off.
- The interior lights will turn off after 15 minutes to preserve the battery.



Timing While Getting Out Of The Vehicle —

After placing the ignition in the OFF position, the overhead lights will turn on as follows:

- For a few seconds after the engine stops.
- For approximately three minutes when one of the doors is opened.
- For a few seconds when the last door is closed.

The timing stops automatically when the doors are locked.

INTERIOR AMBIENT LIGHTING

The brightness of the interior passenger compartment lights can be adjusted through the radio system.

To access the adjustment function, on the main menu select the following items in sequence:

1. "Settings"
2. "Lights"
3. "Interior Ambient Lighting"

The lights can be adjusted to seven different levels of brightness.

REAR OVERHEAD LIGHT

The rear overhead lights are activated or deactivated by on/off switches located on the front overhead console or within the rear overhead lights themselves.

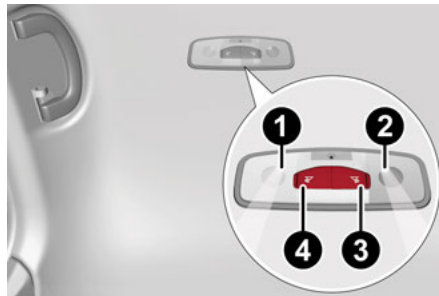

Rear Overhead Light

- 1 — Passenger Rear Overhead Light
- 2 — Driver Side Rear Overhead Light
- 3 — Driver Side Rear Overhead Light Switch
- 4 — Passenger Side Rear Overhead Light Switch

The light turns on when a door is opened.

NOTE:

The light will turn off automatically after a few minutes if a door is left open. To turn it on again, open another door or close and reopen the same door.

INSTRUMENT PANEL DIMMER CONTROL

With the daytime running lights or headlights on, push the dimmer control upward and hold to increase the instrument panel brightness and the control button icons. Push the dimmer control downward and hold to decrease brightness. Release the control when the desired brightness level has been reached.



Dimmer Control

WINDSHIELD WIPERS AND WASHERS

The windshield wiper stalk is located on the right side of the steering wheel.

The windshield wipers will only operate with the ignition is placed in the ACC or ON/RUN position.



CAUTION!

- Turn the windshield wipers off when driving through an automatic car wash. Damage to the windshield wipers may result if the wiper control is left in any position other than off.
- In cold weather, always turn off the wiper switch and allow the wipers to return to the “Park” position before turning off the engine. If the wiper switch is left on and the wipers freeze to the windshield, damage to the wiper motor may occur when the vehicle is restarted.
- Always remove any buildup of snow that prevents the windshield wiper blades from returning to the off position. If the windshield wiper control is turned off and the blades cannot return to the off position, damage to the wiper motor may occur.

WINDSHIELD WIPER OPERATION

Rotating the switch to the Low Continuous Wiper Speed position (2) activates the first (low) level continuous speed of the windshield wipers in manual mode.

Rotating the switch to the High Continuous Wiper Speed position (1) activates the second (high) level continuous speed of the windshield wipers in manual mode.

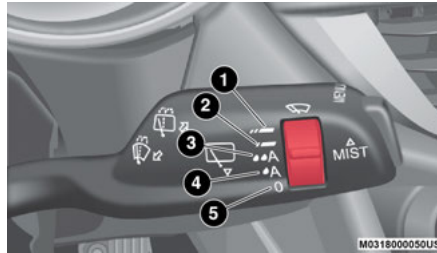

Windshield Wiper Stalk

- 1 – High Continuous Wiper Speed
- 2 – Low Continuous Wiper Speed
- 3 – High Sensitivity Rain Sensing
- 4 – Low Sensitivity Rain Sensing
- 5 – Windshield Wiper Off

Rain Sensors

Rotating the switch to the Low Sensitivity Rain Sensing position (4), activates the first, less sensitive level of the Rain Sensing function.

Rotating the switch to the High Sensitivity Rain Sensing position (3), activates the second, more sensitive level of the Rain Sensing function ↪ page 48.

Windshield Washer

To use the washer, pull the windshield wiper lever toward the steering wheel and hold.

Both the windshield washer jet and the windshield wiper will be activated. The wipers and washers will continue to operate until you let go of the lever.

The windshield wiper stops working three strokes after the stalk is released, followed by a final stroke six seconds later to complete the cycle.



Mist

Push the lever upward to the MIST position and release for a single wiping cycle.

NOTE:

The Mist feature does not activate the washer pump; therefore, no washer fluid will be sprayed on the windshield. The wash function must be used in order to spray the windshield with washer fluid.

For information on wiper care and replacement, see ⇨ page 225.

**WARNING!**

Sudden loss of visibility through the windshield could lead to a collision. You might not see other vehicles or other obstacles. To avoid sudden icing of the windshield during freezing weather, warm the windshield with the defroster before and during windshield washer use.

RAIN SENSING WIPERS

This feature senses rain or snowfall on the windshield and automatically activates the wipers. The Rain Sensor is located behind the interior rearview mirror.



Rain Sensor

Rotate the end of the multifunction lever to one of four settings to activate this feature.

The sensor has an adjustment range that varies progressively from wiper still (no stroke) when the windshield is dry, to wiper at continuous speed (fast operation) with intense rain.

Activation

Rotating the wiper switch to the Low Sensitivity Rain Sensing position (4) or High Sensitivity Rain Sensing position (3) activates the rain sensor.

The activation of the rain sensor system is done by tapping the wiper stalk upwards while the switch is in the Low Sensitivity Rain Sensing position (4) or High Sensitivity Rain Sensing position (3).

The variation in sensitivity during rain sensor operation is also signaled by a stroke of the wiper.

If the windshield washer is used with the rain sensor activated, the normal washing cycle is performed, and then the rain sensor resumes its normal automatic operation.

NOTE:

Keep the glass in the sensor area clean.

Deactivation

To turn off the Rain Sensing Wipers, use the wiper switch or place the ignition in the OFF position.

In the event of malfunction of the rain sensor while it is active, the windshield wiper operates intermittently at a speed consistent with the sensitivity setting of the rain sensor, whether or not there is rain on the glass for as long as the sensor failure is indicated on the display.

The sensor continues to operate and it is possible to set the windshield wiper to continuous mode (1 or 2). The failure indication remains on for as long as the sensor is active.

The rain sensor is able to recognize and automatically adjust itself in the presence of the following conditions:

- Presence of dirt on the controlled surface (e.g. salt, dirt, etc.).
- Presence of streaks of water caused by the worn window wiper blades.
- Difference between day and night.

REAR WINDOW WIPER/WASHER

Push the windshield wiper lever downward to activate/deactivate continuous rear wiper operation.

Push the windshield wiper lever towards the instrument panel to activate the rear window washer (a brief push activates one washing cycle, keeping the stalk pushed washes continuously until the stalk is released).

Shifting the vehicle into REVERSE with the windshield wiper operating activates a single cycle of the rear window wiper.

HEADLAMP WASHERS — IF EQUIPPED

The windshield wiper lever operates the headlight washers when the ignition is in the ON position and the headlights are turned on. To use the headlight washers, pull the lever toward you and release it. The headlight washers will spray a timed high-pressure spray of washer fluid onto each headlight lens. In addition, the windshield washers will spray the windshield and the windshield wipers will cycle.

NOTE:

The headlight washers work on every tenth wash cycle request.

CLIMATE CONTROLS

The Climate Control system allows you to regulate the temperature, air flow, and direction of air circulating throughout the vehicle. The controls are located on the touchscreen and on the instrument panel below the radio.



AUTOMATIC DUAL-ZONE CLIMATE CONTROL SYSTEM

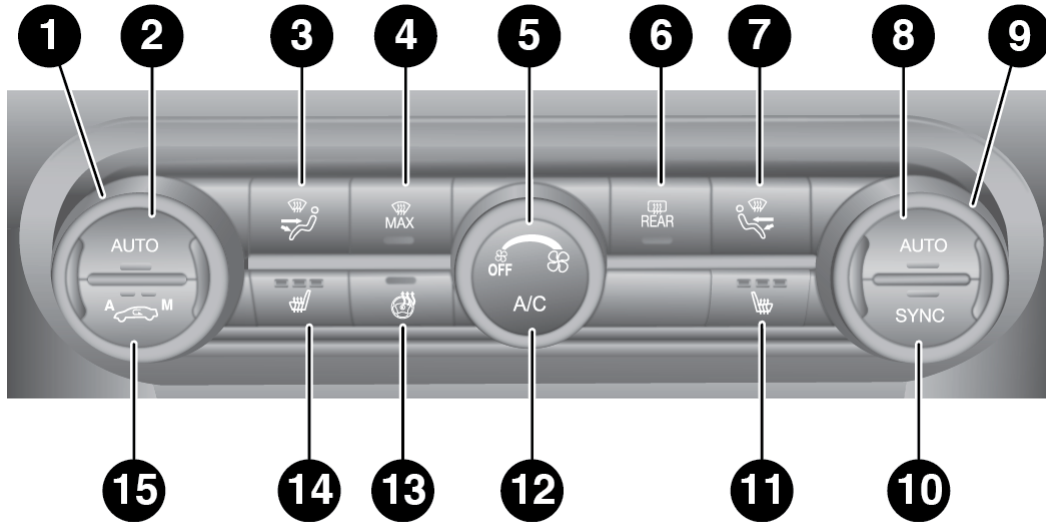

M0320000289US

Automatic Climate Control System

- | | |
|--|--|
| 1 – Driver Temperature Adjustment Knob | 9 – Passenger Temperature Adjustment Knob |
| 2 – Driver Side AUTO Button (Automatic Operation) | 10 – SYNC Button (Set Temperature Alignment) Driver/Passenger Side |
| 3 – Driver Side Air Distribution Selection Button | 11 – Passenger Heated Seat Button – If Equipped |
| 4 – Max Defrost Button | 12 – Air Conditioning Button |
| 5 – Blower Speed Adjustment Knob | 13 – Steering Wheel Heater Button – If Equipped |
| 6 – Rear Defrost Button | 14 – Driver Heated Seat Button – If Equipped |
| 7 – Passenger Side Air Distribution Selection Button | 15 – Air Recirculation Button |
| 8 – Passenger Side AUTO Button (Automatic Operation) | |

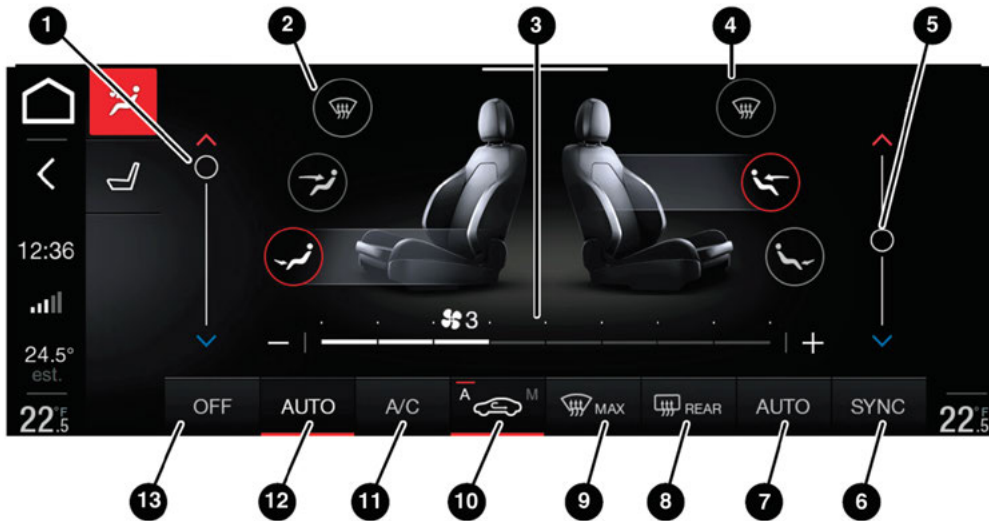

Automatic Climate Control System (Touchscreen Controls)

- | | |
|--|---|
| 1 – Driver Side Temperature Adjustment Bar | 8 – Heated Rear Window On/Off Button |
| 2 – Driver Side Air Distribution Buttons | 9 – MAX-DEF Activation/Deactivation Button (Rapid Defrosting/Demisting) |
| 3 – Fan Speed Adjustment Button | 10 – Air Recirculation On/Off Button |
| 4 – Passenger Side Air Distribution Buttons | 11 – Climate Control System Compressor On/Off Button |
| 5 – Passenger Side Temperature Adjustment Bar | 12 – Driver Side AUTO Button (Automatic Operation) |
| 6 – SYNC Button | 13 – Climate Control System On/Off Button |
| 7 – Passenger Side AUTO Button (Automatic Operation) | |



CAUTION!

The system uses R1234yf refrigerant, which does not pollute the environment in the event of accidental leakage. Under no circumstances, use R134a and R12 fluids, which are incompatible with the components of this system.

Description

The Automatic Dual Zone Climate Control System adjusts the temperature and air distribution independently between the driver and passenger.

The system maintains the set temperature inside the passenger compartment and compensates for outside temperature change.

NOTE:

The reference temperature is 72 °F (22 °C) for optimal comfort management.

The automatic setting will adjust the following to maintain comfort within the passenger compartment:

- Air temperature from the driver/front passenger side vents
- Air distribution from the driver/front passenger side vents
- Fan speed (continuous variation of the air flow)
- Compressor variations (for cooling/dehumidifying the air)
- Air recirculation

The Climate Control System can also be operated manually by using the buttons and knobs on the faceplate.

Manual selections will override the automatic settings, which are stored until the AUTO button is pushed. If the system intervenes for safety reasons, the automatic setting will take control of the system.

The below operations will not deactivate the automatic (AUTO) function:

- Air Recirculation activation/deactivation
- A/C activation/deactivation
- SYNC function activation
- Rear Window Defrost activation/deactivation

When in AUTO mode, the vehicle's internal temperature is controlled according to the set temperature.

The following can be manually set or adjusted:

- Driver/passenger air temperature
- Blower speed (continuous variation)
- Air distribution (seven positions for driver and passenger)
- A/C activation
- Front Defroster
- Air recirculation
- Rear Defroster
- System deactivation

A/C Compressor

Push the A/C button or the icon to activate or deactivate the A/C compressor (indicator illuminated when activated). The A/C compressor will remain off even after the engine has stopped.

When the A/C compressor is turned off, the system deactivates air recirculation to prevent the windows from fogging up. If the climate control system can maintain the temperature, with the A/C turned off, the AUTO feature will remain on and the AUTO button indicator light will not switch off.

To restore automatic control of the A/C compressor, push the A/C button or the icon or the AUTO button. With the A/C compressor off, the air speed can be set manually using the Air Speed Adjustment Knob.

When the A/C compressor is on, and the engine is running, air speed cannot be lower than the minimum speed (only one indicator light is lit).

NOTE:

When the A/C is off, the Climate Control system can not produce air that is colder than the current outside temperature. Under certain environmental conditions, windows could fog up rapidly since the air is not dehumidified.

Air Recirculation And Air Quality System (AQS)



Air Recirculation is managed according to the following operating mode:

- Automatic engagement: indicator is illuminated above the “A” on the Air Recirculation Button
- Forced activation (air circulation always activated): indicator illuminated above the  icon on the Air Recirculation Button
- Forced deactivation (air recirculation always off with intake of outside air): both indicators not illuminated on the Air Recirculation Button

The three operating conditions are obtained by pushing the Air Recirculation Button  in sequence.

Enabling The Air Quality System (AQS) Function – If Equipped

When the automatic recirculation function is selected, the AQS function automatically activates internal air recirculation when the outside air is polluted (e.g. in heavy traffic and tunnels).

At low external temperatures or in high humidity, the automatic function turns off to avoid fogging up the windows. The user can select the function again by pushing the Air Recirculation Button.

In automatic operation, air recirculation will be controlled by the system according to outside environmental conditions.

NOTE:

- With the AQS function active and after the internal air recirculation system has been functioning for a set amount of time, the Climate Control System enables air intake to cycle the air in the passenger compartment for a set time. The AQS function is disabled during the air changes.
- The engagement of the recirculation system makes it possible to reach the required heating or cooling conditions faster. It is, however, inadvisable to use it on rainy/cold days as it can increase the possibility of the windows fogging. When the outside temperature is low, recirculation is forced off to prevent the windows from fogging up.

Front Defrost



Air comes from the windshield and side window demist outlets. Use Defrost mode with maximum temperature settings for best windshield and side window defrosting and defogging.

Rear Defrost



Push the Rear Defrost button to activate (indicators illuminated) the Rear Defroster.

The Rear Defrost will turn off after 20 minutes or once the engine is turned off.

NOTE:

To avoid damage, do not apply stickers over the interior heating filaments of the Rear Defroster.

Front Defrost And MAX-DEF Function



Push the MAX-DEF button (indicator illuminated) to defrost the windshield and side windows.

While in MAX-DEF function, the air conditioner will:

- Activate the air conditioner compressor when the weather allows
- Turn air recirculation off
- Set the maximum air temperature (HI) on both the driver and passenger side
- Activate a blower speed based on the temperature of the engine coolant
- Adjust the air flow towards the windshield and front side windows
- Activate the Rear Window Defrost
- Display the fan speed (indicators illuminated) and current air distribution setting

NOTE:

The MAX-DEF function remains active for approximately three minutes once the engine coolant reaches the proper temperature.



When the function is on, AUTO mode will deactivate. The only manual operations possible are adjusting blower speed and turning off the Rear Window Defrost.

Pushing the  button switches off the MAX-DEF function.

Air Temperature Adjustment

Rotate the driver or passenger Temperature Adjustment Knob clockwise for warmer temperatures or counterclockwise for cooler temperatures. The set temperatures are shown on the radio system.

Push the SYNC button to sync the driver and passenger air temperatures.

Rotate the passenger Temperature Adjustment Knob to cancel the SYNC function. This will set a new passenger side temperature.

Rotate the Temperature Adjustment Knob fully clockwise to engage the HI (maximum heating) setting or fully counterclockwise to engage the LO (maximum cooling) setting. To deactivate these functions, rotate the Temperature Adjustment Knob to the desired temperature.

Rear passengers' temperature is linked to driver side selection.

AUTO Button

When the AUTO button is pushed (indicator illuminated), the Climate Control system automatically adjusts the following settings:

- Quantity and distribution of air flow in the passenger compartment
- The air conditioner
- Air recirculation
- Cancels any manual settings

Selecting the AUTO function illuminates the indicator on the A/C button.

If air distribution or the fan speed is manually adjusted, the AUTO button indicator will turn off to indicate that the Climate Control system is no longer in AUTO mode.

After a manual adjustment, push the AUTO button to resume the automatic system.

SYNC Button

Push the SYNC button (indicator illuminated) to sync the passenger side air temperature with the driver side air temperature.

This function makes temperature regulation easier when the driver is traveling alone.

Turn the passenger Temperature Adjustment Knob or push the passenger side Air Distribution Selection Button to change the passenger side air temperature and return to separate air temperature management.

Blower Speed

Turn the Blower Speed Knob to increase or decrease the blower speed. The speed is displayed with lighted indicators in the radio system display.

- Maximum fan speed = all indicators illuminated on the radio system display
- Minimum fan speed = one indicator illuminated on the radio system display

The fan can be turned off by rotating the Blower Speed Knob counterclockwise to the off position (all segments on the radio system display are turned off).

NOTE:

To restore automatic control of the fan speed, push the AUTO button.

Air Distribution Selection

Push the Air Distribution Selection button on the faceplate to change the mode of air distribution.

NOTE:

In AUTO mode, the Climate Controls automatically manage the air distribution. When set manually, the respective symbols on the radio system indicate the air distribution setting.

Panel Mode



Air comes from the outlets in the instrument panel to ventilate the chest and face. Each of these outlets can be individually adjusted to direct the flow of air. The air vanes of the center outlets and outboard outlets can be moved up and down or side to side to regulate airflow direction. There is a shut off wheel located below the air vanes to shut off or adjust the amount of airflow from these outlets.

Bi-Level Mode



Air comes from the instrument panel outlets and floor outlets. A slight amount of air is directed through the defrost and side window demister outlets.

NOTE:

Bi-Level mode is designed under comfort conditions to provide cooler air out of the panel outlets and warmer air from the floor outlets.

Floor Mode



Air comes from the floor outlets. A slight amount of air is directed through the defrost and side window demister outlets. This setting heats the passenger compartment the quickest.

Mix Mode



Air is directed through the floor, defrost, and side window demister outlets. This setting works best in cold or snowy conditions that require extra heat to the windshield. This setting is good for maintaining comfort while reducing moisture on the windshield.

Front Defrost And Panel Mode



Air flow is distributed between the windshield demisting/defrosting vents and side/central dashboard vents. This setting allows air to flow to the windshield on sunny days.

Front Defrost And Bi-Level Mode



Air flow is distributed to all vents.

Switching The Climate Control System On/Off To Turn Off The Climate Control System

Rotate the Air Speed Adjustment Knob completely counterclockwise to turn off the Climate Control system.

With the air conditioner is off:

- Air recirculation is on
- The A/C compressor is off
- The fan is off
- The heated rear window can be activated/deactivated

NOTE:

The Climate Control system stores the previously set temperatures and resumes operation when any button on the system is pushed.

To Turn On The Climate Control System

To switch the Climate Control system on in automatic mode, push the AUTO button.

Operating Mode

The Climate Control system can be activated in different ways. It is recommended to use the automatic function. Push the AUTO button and set the desired temperatures.

The automatic system adjusts the temperature, quantity, and distribution of air introduced into the passenger compartment. It also controls air recirculation and the activation of the air conditioner.

At any time during automatic operation, you can change the temperature, activate or deactivate the Rear Defrost, activate SYNC, activate or deactivate the air conditioner, and activate or deactivate air recirculation. The system will automatically adjust to the new settings.

Climate Control Display Settings

The Climate Control settings are visible on the radio screen.

The display on the radio system is a pop up window, which is activated by pushing the buttons or turning the knobs on the Climate Control system. The indicator lights located on the buttons and knobs indicate that the selected feature is on/off. If no operation is performed for a predetermined time, the pop-up will close on the display.

Humidity Sensor

The Humidity Sensor helps prevent the windows from fogging up. The AUTO function (indicator illuminated) must be on for the Humidity Sensor to function.

When outside temperature is low, the system may turn the compressor on and turn air recirculation off for safer driving.



Stop/Start

The Stop/Start system shuts off the engine when the vehicle speed is 0 mph (0 km/h), as a fuel conservation measure.

In order to maintain comfort in the cabin, the Stop/Start feature will not activate if any of the following conditions exist:

- ❑ The Climate Control system is in AUTO mode (indicator illuminated), and the vehicle has yet to reach the set temperature
- ❑ The Climate Control system is in LO maximum cooling
- ❑ The Climate Control system is in HI maximum heating
- ❑ The Climate Control system is in the MAX-DEF status

When the Stop/Start system is active, the engine will restart if the inside temperature changes significantly, or if the LO setting, or MAX-DEF setting, is activated.

With Stop/Start system on (engine is OFF), air flow is reduced to keep the compartment comfort conditions for longer.

Until the temperature drastically changes within the cabin, the climate control system will continue to maintain the temperature while the engine is off. By deactivating the Stop/Start system with the (A) button (located by the headlight switch), the climate control system operates normally according to the settings.

NOTE:

- ❑ In harsh climate conditions, limit the use of the Stop/Start system to prevent the compressor from continuously switching on and off. This will cause rapid misting of the windows and the accumulation of humidity in the passenger compartment.
- ❑ When the Stop/Start system is on, the climate control system will always take air in from outside, reducing the probability of the windows fogging up.

System Maintenance

In winter months, the Climate Control system must be turned on at least once a month for approximately 10 minutes.

Have the system inspected at an authorized dealer before the summer.

INTERIOR STORAGE AND EQUIPMENT**GLOVE COMPARTMENT**

The glove compartment is located on the passenger side of the instrument panel.

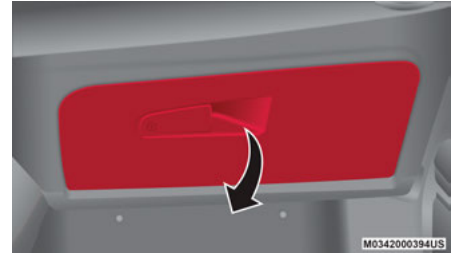
**Opening The Glove Compartment**

Pull the release handle to open the glove compartment.

When the glove compartment is opened, a light turns on to illuminate the inside of the compartment.

NOTE:

- ❑ If equipped with a lock, unlock the glove compartment by placing the emergency key in the lock on the handle.
- ❑ Do not insert large objects that will prevent the glove compartment from closing completely.



WARNING!

Do not operate this vehicle with a glove compartment in the open position. Driving with the glove compartment open may result in injury in a collision.

CENTER CONSOLE

The center console storage compartment is located between the front seats.

To access the center console storage, lift the upper part of the center console as shown below.



Center Console



WARNING!

Do not operate this vehicle with a console compartment lid in the open position. Driving with the console compartment lid open may result in injury in a collision.

REAR ARMREST

The rear armrest is foldable and can be stored in the backrest.

- To lower the armrest, pull on the tab located at the top of the seatback and fold it downward.
- To close the armrest, lift it until it is inserted into the backrest.

There are two cupholders and a phone compartment inside the armrest.



Rear Cupholder

NOTE:

The armrest was not designed to support the weight of an adult passenger or a child. Only use it to hold drinks or small objects.

POWER OUTLETS

The Instrument Panel Power Outlet is located on the center stack under the climate controls. It will only operate when the ignition is in the ON/RUN position.



Instrument Panel Power Outlet

NOTE:

Do not connect devices, with a power rating higher than 180 W, to the outlet. Do not use power adapters that do not fit the outlet as this may damage it.



Luggage Compartment Power Outlet

There is an additional power outlet located on the left side of the luggage compartment. It will only operate when the ignition is in the ON/RUN position.



Luggage Compartment Power Outlet

NOTE:

Do not connect devices with powers higher than 150 W to the socket. Do not damage the outlet by using unsuitable adapters.

115 Volt Power Inverter — If Equipped

The power inverter is located inside of the center console. It can be used for small battery-powered electrical appliances with powers up to 150 W (e.g. cameras, video camera, tablets, razors, etc.)

NOTE:

Do not connect devices with powers higher than 150 W to the socket. Do not damage the socket by using unsuitable adapters.



Power Inverter

CIGAR LIGHTER AND ASH TRAY — IF EQUIPPED

If equipped, the cigar lighter is located on the bottom of the center stack, in front of the cupholders.

To activate the cigar lighter, push in and wait a few seconds. Once the cigar lighter has returned to its original position, it is ready for use.

NOTE:

Always ensure the cigar lighter is turned off when not in use.



1 — Cigar Lighter

If equipped, the ash tray is a removable plastic container located inside the cupholder.

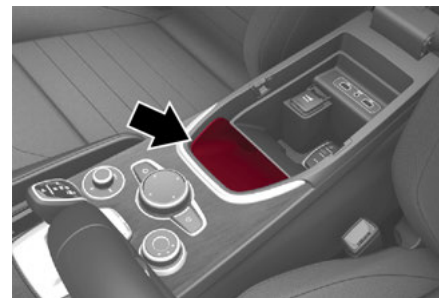
WIRELESS CHARGING PAD — IF EQUIPPED

Wireless Charging Pad

Your vehicle may be equipped with a 15 W (3 A) Qi wireless charging pad located inside of the center console. This charging pad is designed to wirelessly charge your

Qi enabled mobile phone. Qi is a standard that uses magnetic induction to transfer power to your mobile device.

Your mobile phone must be designed for Qi wireless charging.

NOTE:

- Do not place the key fob or any other type of metal/magnetized object inside the mobile phone housing or near the wireless charging pad.
- Be sure to place the mobile device correctly (display facing upward) on the wireless charging pad.
- The ignition must be in the ON/RUN position in order for the phone to charge.
- To avoid interference with the key fob search, the wireless charging pad will stop charging when any door is opened.



CAUTION!

The key fob should not be placed on the charging pad or within 15 cm (150 mm) of it. Doing so can cause excessive heat buildup and damage to the fob. Placing the fob in close proximity of the charging pad blocks the fob from being detected by the vehicle and prevents the vehicle from starting.

The following messages will display in the radio system:

- “Your phone is being charged” — The phone has begun to charge.
 - “Phone Fully Charged” — The phone has completed charging its battery.
 - “Foreign Object Detected” — The phone is not enabled for wireless charging or an object that is not permitted has been placed on the wireless charging pad.
 - “Unavailable System” — There is a malfunction with the wireless charging pad.
- The driver can deactivate these messages through the radio system. Refer to the Information and Entertainment System Owner’s Manual Supplement for further information.

POWER WINDOWS

POWER WINDOW CONTROLS

The power window switches work with the ignition in the ACC or ON/RUN position and for three minutes after the ignition has been placed in the OFF position. When one of the front doors is opened, this operation is disabled.

The window controls on the driver’s door control all the door windows.

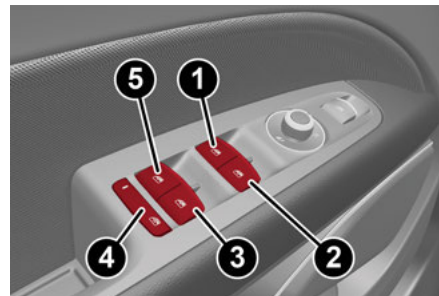

Power Window Switches

- 1 — Front Left Window Switch
- 2 — Front Right Window Switch
- 3 — Rear Right Window Switch
- 4 — Window Lockout Switch
- 5 — Rear Left Window Switch

The passenger door windows can also be operated by using the single window controls on the passenger door trim panel.

To open the window part way (manually), push the window switch down briefly and release. Push past the detent to activate “continuous automatic” operation.

If the button is pushed again, the window will stop in the desired position.

Pull the window switch to the first detent to move the window upward. Pull the window switch to the second detent, and the window will go up automatically.



To close the window, pull the window switch up. To stop the window during Auto-Up operation, push or pull the window switch again.



WARNING!

Never leave children unattended in a vehicle, and do not let children play with power windows. Do not leave the key fob in or near the vehicle, or in a location accessible to children. Occupants, particularly unattended children, can become entrapped by the windows while operating the power window switches. Such entrapment may result in serious injury or death.

AUTO-UP FEATURE WITH ANTI-PINCH PROTECTION

The vehicle is equipped with an anti-pinch safety device for closing the windows.

If the safety system senses any obstacle while the window is closing, it will stop the window's movement and reverse it, depending on its position.

This device is also useful if the windows are activated accidentally by children inside the vehicle.

The anti-pinch safety function is activated both during the manual and the automatic operation of the window.

When the anti-pinch system is activated, the window closing is immediately interrupted. Then the window closing is automatically reversed and the window lowers by about 8 inches (20 cm) in relation to the first stop position. The window cannot be operated during this time.

NOTE:

In the event of an error, or if the anti-pinch protection is activated three consecutive times, the automatic closing operation of the window will be deactivated. In order to restore the correct operation of the system, the window must be lowered.

POWER WINDOW SYSTEM INITIALIZATION

If power supply is interrupted, the electric window automatic operation must be reinitialized.

To perform the initialization procedure, which must be done on each door with the doors closed, manually fully close the window to be initialized.

WIND BUFFETING

Wind buffeting can be described as the perception of pressure on the ears or a helicopter-type sound in the ears. Your vehicle may exhibit wind buffeting with the windows down, or the sunroof (if equipped) in certain open or partially open positions. This is a normal occurrence and can be minimized. If the buffeting occurs with the rear windows

open, open the front and rear windows together to minimize the buffeting. If the buffeting occurs with the sunroof open, adjust the sunroof opening to minimize the buffeting or open any window.

POWER SUNROOF — IF EQUIPPED

POWER SUNROOF

The power sunroof consists of a single glass panel and is fitted with a power sunshade the full length of the panel.

Operation of the sunroof is only possible with the ignition in the ACC or ON/RUN position
 ⇨ page 20.

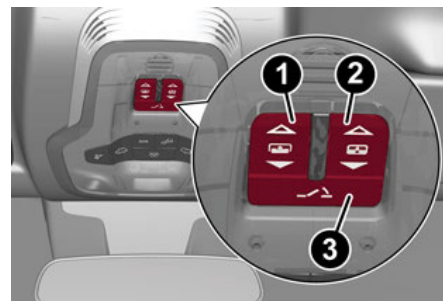

Sunroof And Power Shade Buttons

- 1 — Power Shade Open/Close
- 2 — Sunroof Open/Close Button
- 3 — Vent Open/Close

The sunroof has three preset positions:

- Fully closed
- Comfort (intermediate opening)
- Fully open

NOTE:

You cannot have the sunshade closed when the sunroof is open.



WARNING!

- Never leave children unattended in a vehicle, or with access to an unlocked vehicle. Never leave the key fob in or near the vehicle, or in a location accessible to children. Do not leave the Keyless Push Button Ignition in the ON/RUN position. Occupants, particularly unattended children, can become entrapped by the power sunroof while operating the power sunroof switch. Such entrapment may result in serious injury or death.
- In a collision, there is a greater risk of being thrown from a vehicle with an open sunroof. You could also be seriously injured or killed. Always fasten your seat belt properly and make sure all passengers are also properly secured.
- Do not allow small children to operate the sunroof. Never allow your fingers, other body parts, or any object, to project through the sunroof opening. Injury may result.

OPENING AND CLOSING THE SUNROOF

To open the sunroof's front panel, push the open/close button toward the rear of the vehicle to open to the comfort position (half way). Pushing the button a second time will open to the fully open position.

To close the sunroof, push the open/close button toward the front of the vehicle. The roof will close completely.

The automatic motion can be interrupted in any position by pushing the open/close button again.



CAUTION!

Do not open the sun roof if a roof rack or crossbars are fitted. Do not open the sun roof if there is snow or ice on it: you may damage it.

VENTING SUNROOF

To bring the roof into vent position, push and release the vent button.

This type of vent opening can be activated regardless of the position of the sunroof. When starting with the roof in the closed position, pushing the vent button automatically causes the sunroof to open to the vent position. If the roof is already open, the button must be held until the roof reaches the vent-opening position.

Pushing the vent button again during automatic movement of the roof will stop it.

SUNSHADE OPERATION

The sunshade is power operated.

Push the Power Shade open/close button toward the rear of the vehicle to open the sun shade.

Push the Power Shade open/close button toward the front of the vehicle to close the sun shade.

The automatic motion can be interrupted in any position by pushing the Power Shade open/close button again.

PINCH PROTECT FEATURE

The sunroof has an anti-pinch safety system capable of detecting the presence of an obstacle during the closing movement. If an obstacle is detected, the system intervenes and the movement of the sunroof is immediately reversed.

RE-INITIALIZATION PROCEDURE

Automatic operation of the sunroof must be re-initialized in case of faulty sunroof operation. It may also be necessary to initialize the sunroof after the vehicle's battery has been disconnected and then reconnected.



NOTE:

The anti-pinch safety device is deactivated during the re-initialization procedure.

Proceed as follows:

1. With the ignition in the ON/RUN position, make sure the sunroof glass is fully closed (sunshade open).
2. Open the driver's side door, and place the ignition in the OFF position.
3. Within five seconds, place the ignition in the ACC or ON/RUN position.
4. Within 10 seconds, push and hold the sunroof close switch (forward). After 8 - 10 seconds of holding the switch, the re-initialization process will begin. Continue to hold the switch while the sunroof motor cycles, and the sunshade will fully close.
5. Once the sunroof glass and the power sunshade have stopped motion, release the sunroof close switch, then push and hold it again within five seconds. Continue to hold the switch while the sunshade fully opens, the sunroof glass fully opens, followed by the glass fully closing then the sunshade fully closing.
6. Release the switch once all of the operations stop. Re-initialization of the sunroof motors is now complete.

NOTE:

If the switch is released prior to full completion of the operations described, the entire

re-initialization procedure must be repeated from step 1.

7. Confirm express operations for the sunroof glass and sunshade are functional for opening and closing operations.

SUNROOF MAINTENANCE

Use only a non-abrasive cleaner and a soft cloth to clean the glass panel. Periodically check for and clear out any debris that may have collected in the tracks.

HOOD**OPENING THE HOOD**

To open the hood, two latches must be released.

1. Pull the release lever located underneath the driver's side of the instrument panel.

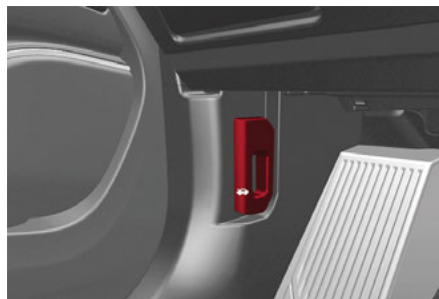

Hood Release Lever

2. Lift the hood slightly. Move the underhood latch from right to left to release the hood.

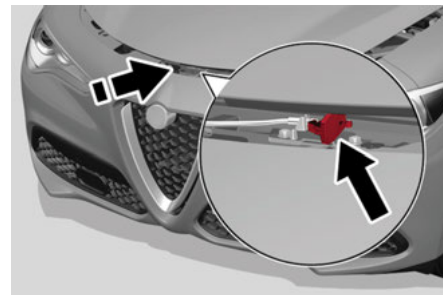

Hood Latch Location

3. Raise the hood completely. The operation is assisted by the addition of two gas props which hold it in the open position.

NOTE:

- Do not tamper with the props and assist the hood while lifting it.
- Use both hands to lift the hood. Before lifting, check that the windshield wiper arms are not raised from the windshield or in operation. Also, ensure that the vehicle is stationary and that the Electric Park Brake is engaged.

CLOSING THE HOOD

To close, lower the hood to approximately 16 inches (40 cm) from the engine compartment then let it drop. Make sure that the hood is completely closed and fully latched.

NOTE:

Since the hood is equipped with a double locking system, one for each side, you must check that it is closed on each side.



WARNING!

Be sure the hood is fully latched before driving your vehicle. If the hood is not fully latched, it could open when the vehicle is in motion and block your vision. Failure to follow this warning could result in serious injury or death.

POWER LIFTGATE

Unlocking of the liftgate is electrically operated and is deactivated when the vehicle is in motion.

If anything obstructs the power liftgate while it is closing or opening, the liftgate will automatically reverse to the closed or open position, provided it meets sufficient resistance.

OPENING

The liftgate may be released in several ways:

- Pressing the liftgate release button on the key fob twice within five seconds
- Pushing the external liftgate release switch (when the liftgate is unlocked)
- Lifting the interior liftgate release button on the driver's door panel trim.



External Liftgate Release Switch



Interior Liftgate Release

1 – Interior Liftgate Release Switch

The turn signal indicators will blink and the interior lights will turn on when the liftgate is opened. They turn off automatically when the liftgate is closed.

The lights turn off automatically after a few minutes if the liftgate is left open.

A signal will chime while the liftgate is opening or closing.

NOTE:

You can stop the liftgate from moving by pushing the interior liftgate release button again.



Liftgate Emergency Opening

There is a panel on the luggage compartment interior trim, next to the liftgate lock, accessible by folding down the rear seat backrest, which allows access to the manual lock release.

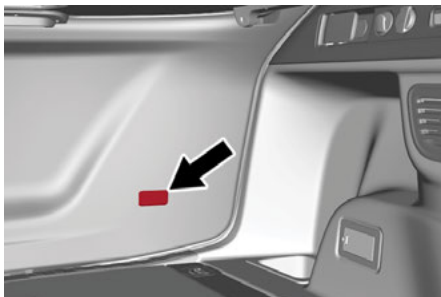

Manual Lock Release Location

Pull to release the lock.



Manual Lock Release Cord

The liftgate can now be opened manually.

CLOSING

It is possible to close the liftgate by pushing:

- The power liftgate switch.
- The power lock switch located on the liftgate (all the doors, including the liftgate, will be locked).
- The liftgate button on the key fob twice.
- The power liftgate switch on the liftgate.
- The power liftgate switch on the driver's door panel trim and hold until the operation is complete.



Power Liftgate/Lock Switches

- 1 — Power Liftgate Switch
- 2 — Power Door Lock Switch

NOTE:

It is possible to stop the liftgate from moving with any of the Power Liftgate switches.

Customizing The Liftgate Opening Height

To avoid difficulties in tight spaces, you can set the height at which the liftgate opens to.

To customize the liftgate opening position, follow the steps below:

1. Open the liftgate manually and move it to the position that you want the liftgate to open to.
2. Press and hold one of the closing buttons for at least five seconds (successful programming is indicated by the turn signals flashing three times).

The liftgate is now programmed to open to the set position.

This function can be selected on the radio system.

To set the liftgate opening height, refer to the Information and Entertainment System Owner's Manual Supplement for further information.

Hands-Free Liftgate — If Equipped

To operate the Hands-Free Liftgate system:

1. If the doors are locked, the system must detect the electronic key near the liftgate.
2. If the doors are unlocked, the system does not have to detect the electronic key near the liftgate.

- Go to the rear of the vehicle, in the center and about 3 feet (1 m) from the liftgate.
- Move your foot under the bumper, simulating a kick. When you have completed this movement, withdraw your leg. To activate the liftgate, both sensors must detect your leg.



Hands Free Liftgate Activation Zone

If it is closed, the Hands-Free Liftgate unlocks and opens completely, and with another movement of the foot, it stops. A further movement of the foot reverses the direction and closes the liftgate completely, if you do not stop it again.

If it is open, with a movement of the foot, the Hands-Free Liftgate closes completely, and with another movement of the foot, it stops. If the liftgate is stopped, another movement of the foot will reverse the direction and open it completely.

NOTE:

To conserve the battery charge, avoid performing this operation repeatedly with the engine off.

You can activate/deactivate the Hands-Free Liftgate on the radio system by pushing the MENU button to select the Main menu, and selecting the following items:

- “Settings.”
- “Doors And Locks.”
- “Automatic Liftgate Opening.”



WARNING!

- Driving with the liftgate open can allow poisonous exhaust gases into your vehicle. You and your passengers could be injured by these fumes. Keep the liftgate closed when you are operating the vehicle.
- If you are required to drive with the liftgate open, make sure that all windows are closed, and the climate control blower switch is set at high speed. Do not use the recirculation mode.

(Continued)



WARNING! (Continued)

- During power operation, personal injury or cargo damage may occur. Ensure the liftgate travel path is clear. Make sure the liftgate is closed and latched before driving away.



CAUTION!

The Hands-Free Liftgate can be turned off manually in the radio system to avoid unintentional activation. For further information refer to the Information and Entertainment System Owner’s Manual Supplement.

LIFTGATE INITIALIZATION

NOTE:

Automatic operation of the liftgate must be initialized again in case of faulty liftgate operation. Proceed as follows:

- Close all the doors and the liftgate.
- Push the lock button on the key fob.
- Push the unlock button on the key fob.



CARGO AREA FEATURES**Retractable Cargo Area Cover**

The Retractable Cargo Area Cover can be rolled up and removed.

To Use The Cargo Area Cover:

1. From the rolled up (retracted) position, hold the handle and pull the cover outward toward the rear of the vehicle.
2. Then assist the cover pins into the slots located just inside the liftgate opening.

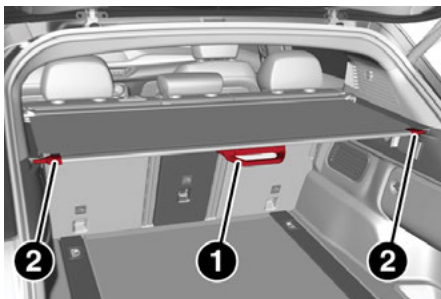

Retractable Cargo Area Cover

- 1 – Handle
2 – Cover Pins

Removing The Cover:

1. Retract the cover by pulling the handle slightly rearward to release the cover pins.
2. Guide the cover forward until it is fully retracted.
3. Pull the two cover hooks (one on each side) towards the inside of the cargo area. Then lift the cover up and remove it.

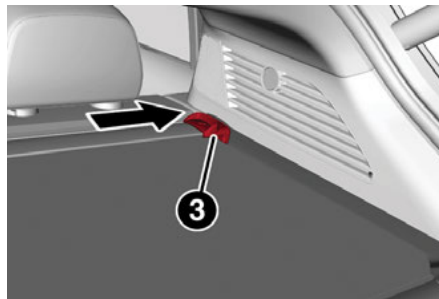

Cover Attached

- 3 – Cover Hook

**WARNING!**

In a collision, a loose cargo cover in the vehicle could cause injury. It could fly around in a sudden stop and strike someone in the vehicle. Do not store the cargo cover on the cargo floor or in the passenger compartment. Remove the cover from the vehicle when taken from its mounting. Do not store it in the vehicle.

Rear Cargo Anchors

The cargo area floor may be equipped with fixed or mobile anchoring loops that allows you to anchor and secure luggage safely.

The fixed anchor loops are located in the four corners of the cargo floor.

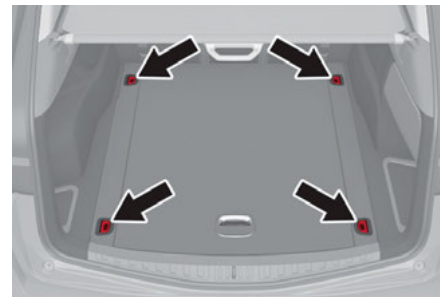

Anchor Loops

Cargo Area Adjustable Rail — If Equipped

The mobile loops (if equipped), slide on two guides secured to the cargo area floor.

To position a loop, push down the center button while sliding the loop along the guide to the desired position. Release the button and move the loop slightly to the next fixed position in the notches on the guide.

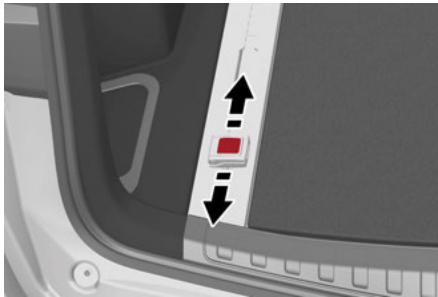

Adjustable Anchor Loop — If Equipped

Lift the loop to fasten the load.

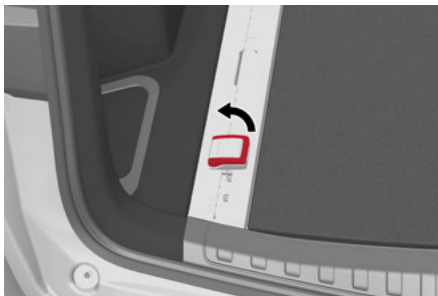

Lift Adjustable Anchor Loop To Use

Cargo Net — If Equipped

Cargo nets can be used to contain lightweight materials during transport.

The cargo net is included in the optional “Convenience Package” and is available from an authorized dealer.

Grocery Hooks

Two hooks (one on the left side and one on the right side) are also available on the side panels to fix loads that are not excessively heavy (e.g. bags).



Grocery Hook

NOTE:

Do not apply a load greater than 22 lb (10 kg) on a single hook.

Accessing The Tire Service Kit — If Equipped

To access the Tire Service Kit → page 202, lift up the load floor by the handle.



Load Floor



This section gives you all the information you need to understand and use the instrument panel correctly.

INSTRUMENT PANEL FEATURES

INSTRUMENT CLUSTER

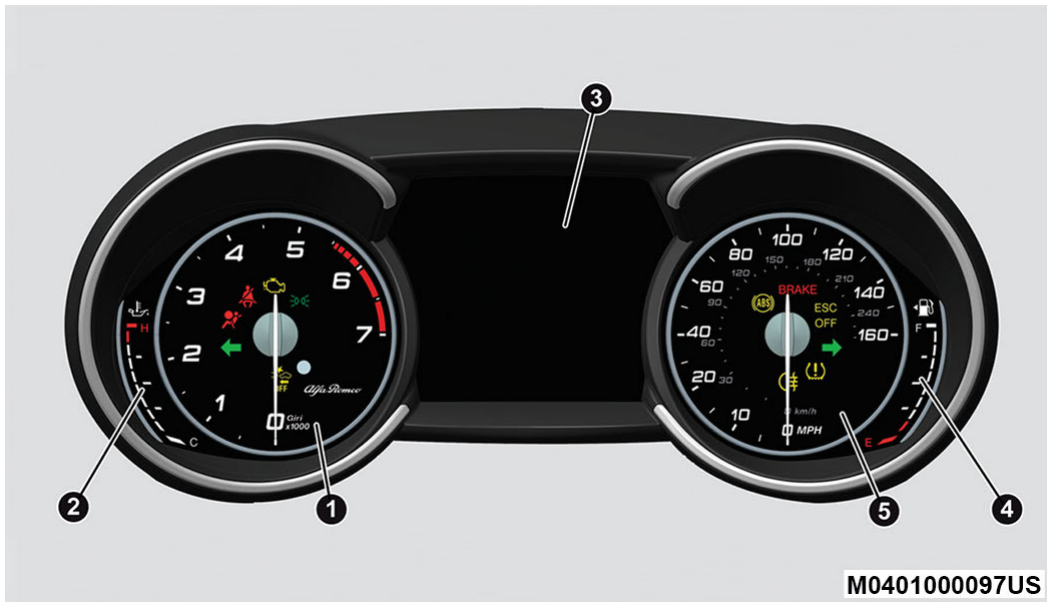

Instrument Cluster

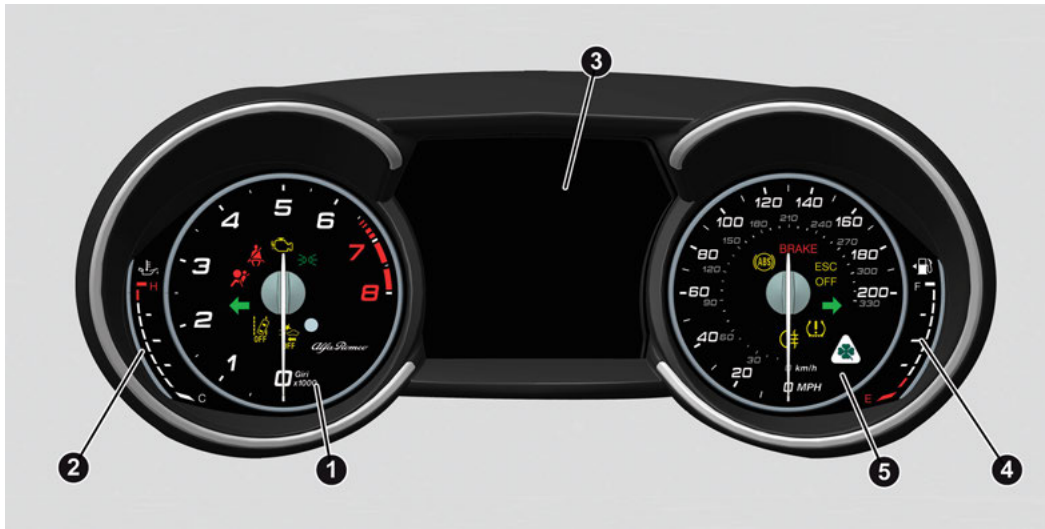

Quadrifoglio Instrument Cluster

INSTRUMENT CLUSTER DESCRIPTIONS

1. Tachometer

- Indicates the engine speed in revolutions per minute (RPM x 1000).
- Inside the tachometer there is a light sensor capable of detecting ambient light conditions and adjusting the operating mode (night/day) and the brightness of the instrument panel and the Information and Entertainment System display.

2. Engine Oil Temperature Gauge

- The digital bar indicator monitors the temperature of the engine oil and starts supplying indications when the fluid temperature reaches approximately 122 °F (50 °C).
- Under normal usage, the digital scale should hover around the middle of the scale according to the working conditions.



WARNING!

A hot engine cooling system is dangerous. You or others could be badly burned by steam or boiling coolant. It is recommended to call an authorized dealer for service if your vehicle overheats → page 227.





**CAUTION!**

Driving with a hot engine cooling system could damage your vehicle. If the temperature gauge reads "H" pull over and stop the vehicle. Idle the vehicle with the air conditioner turned off until the pointer drops back into the normal range. If the pointer remains on the "H", turn the engine off immediately and call an authorized dealer for service.

3. Instrument Cluster Display

- The instrument cluster display features a driver interactive display ↗ page 70.

4. Fuel Gauge

- The digital bar gauge shows the amount of fuel in the tank.
- The  fuel reserve/limited range warning light turns on, a message is displayed and there is an acoustic signal when about 2.4 gallons (9 liters) of fuel are left in the tank.
- The  fuel pump symbol points to the side of the vehicle where the fuel door is located.
- Proceeding further, the second white notch will go off and the last one will become red, together with the indication "E" present at the bottom of the tank.

**Fuel Level Gauge****NOTE:**

If the low fuel warning light switches on, refuel at the earliest opportunity.

5. Speedometer

- Indicates vehicle speed.

NOTE:

The hard telltales will illuminate for a bulb check when the ignition is first cycled.

INSTRUMENT CLUSTER DISPLAY

INSTRUMENT CLUSTER DISPLAY DESCRIPTION

This vehicle is equipped with a driver interactive display that is located in the instrument cluster.

When one or more of the doors have been opened or closed and the ignition is in the OFF position, the instrument cluster will display the vehicle mileage for a few seconds.

RECONFIGURABLE INSTRUMENT CLUSTER DISPLAY

During operation, the instrument cluster display is divided into multiple sections which show driving data, warnings, and failure indications.

**Instrument Cluster Display**

RECONFIGURABLE DISPLAY ITEMS

1. External Lights (Low Beam/High Beam) Display
2. Front, Side Anti-Collision Systems, Cruise Control Change Information
3. Speed Limiter Display
4. Driving Assistance Systems (FCW, LDW, HAS) Information Display
5. Active Cruise Control (ACC) / Cruise Control (CC) Information Display
6. Traffic Sign Recognition (TSR) / Speed Limiter Information Display

7. Traffic Sign Recognition (TSR) Information Display

8. Time

9. External Temperature

10. Main Display: Vehicle Speed Display, Trip Computer Information, etc...

The screens can be selected, on rotation, by pushing the MENU selection button on the windshield wiper stalk.



MENU Selection Button

Depending on the driving mode chosen using the Alfa DNA (Dynamic, Natural, and Advanced Efficiency) the screens can be graphically different. Navigation instructions and call information can be set and displayed in the Information and Entertainment System.

Home

The parameters shown on the display, for the modes: Dynamic, Normal and Advanced Efficiency are:

- Time
- Outside Temperature
- Current speed (shown only if the repeat mode of the “Navigation” and “Phone” functions have not been previously activated).

• Range

In RACE mode (if equipped) the consumption indication index is not active and a sports gearshift indicator is displayed.



Instrument Cluster Display

- 1 – Time
- 2 – Temperature
- 3 – Distance To Empty
- 4 – Speed

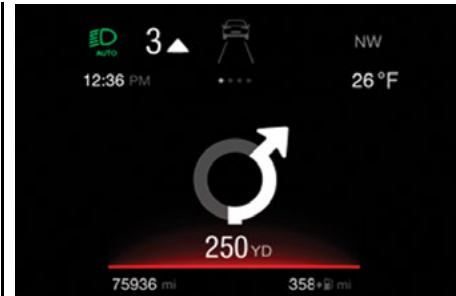

Instrument Cluster Display

Trip A And B

For all driving modes (Dynamic, Natural, and Advanced Efficiency) and with the ignition device ON, the “Trip computer” can be used to display the measurements regarding the operating state of the vehicle. This function is characterized by two separate records, called “Trip A” and “Trip B” (the latter can be deactivated by Information and Entertainment System), where the “complete missions” (journeys) are recorded in a reciprocally independent manner.

“Trip A” and “Trip B” are used to display the values relating to:

- Distance traveled
- Average fuel consumption
- Average speed
- Active trip
- Fuel consumption indicator



Instrument Cluster Display

To reset the values, press and hold down the button on the windshield wiper stalk.



Reset Button

Performance

The displayed parameters differ according to the active mode. The modes which can be selected using the Alfa DNA system are:

Natural



Efficiency Consumption Graph

The screen graphically reproduces some parameters closely linked to the efficiency of the driving style, with a view to limiting consumption.

Advanced Efficiency



Dynamic Driving Style

- 1 – Acceleration
- 2 – Deceleration
- 3 – Gear Shifts

The three central icons on the screen indicate the effectiveness of the driving style linked to the parameters of: acceleration, deceleration and gearshift with a view to reducing fuel consumption.

The graphic bar below the icons shows current consumption and the green line represents the optimal area. The globe lights up gradually according to lower consumption.

Alternative Performance

The displayed parameters vary depending on the active mode. The modes can be selected through the Alfa DNA system and are as follows:

Normal and Advanced Efficiency

The display graphically shows the values of:

- instantaneous consumption
- average fuel consumption (based on "Trip A");

Below a certain speed value, when the accelerator pedal is not pressed or in the event of failure, dashes are displayed in place of the consumption value (" - - -").



Normal and Advanced Efficiency

Dynamic

The display graphically shows the values of:

- accelerator pedal position (expressed in percentage);
- brake pedal position (expressed in percentage);
- engine coolant temperature (H = hot C = cold).



Dynamic

Race (If Equipped)

The display graphically shows the values of:

- engine torque;
- turbocharger pressure;
- engine oil pressure (L = low pressure/H= high pressure).

NOTE:

The engine torque and turbocharger pressure values vary according to the engine type.



Race

Dynamic

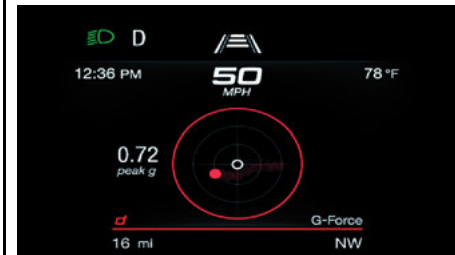

Acceleration Gauge

The displayed parameters are related to vehicle stability, the graphs illustrate the trend of the longitudinal/lateral accelerations (G-meter information), considering gravity acceleration as a reference unit.

Lateral acceleration peaks are also indicated.

11. Driving Mode Display (Alfa DNA System)
12. Distance Traveled (miles/km) display
13. Fuel Consumption
14. Warning Indications Display (e.g. danger of ice, open doors, ABS operation, etc.)
15. Range

CUSTOMER PROGRAMMABLE SETTINGS

Multiple settings can be programmed by the user using the radio. This section describes only the basic settings:

- Units & Language
- Clock & Date
- Cluster

To access the settings list in the radio, proceed as follows:

- Press the Home button to access the main menu.
- Select Settings from the main menu using the Rotary Knob or by pressing Settings on the touchscreen.



Rotary Knob

- 1 – ON/OFF Control And Volume Knob
- 2 – OPTION Button
- 3 – Rotary Pad
- 4 – MENU Button

Units & Language

The following settings can be modified under the “Units & Language” menu:

- Units: select US, Metric, or Custom.
The custom option allows for individual selection of the unit measures
- Language: change the language of the system
- Restore Unit & Language Settings: restores the factory settings

To access and the change the setting, turn and push the Rotary Pad or press the desired setting on the touchscreen.

Clock & Date

The following settings can be modified under the “Clock & Date” menu:

- Sync With GPS Time: activates or deactivates the clock synchronization through the GPS. If the function is deactivated, the options Set Time and Set Date are enabled.
- Set Time: set the time manually.
- Time Format: set the time format to either a 12-hour or a 24-hour clock.
- Set Date: set the date manually.
- Restore Clock & Date Settings: restores the factory settings.

To access and change the setting, turn and push the Rotary Pad or press the desired setting on the touchscreen.

Cluster

The following settings can be modified under the “Cluster” menu:

- Warning Buzzer Volume: allows you to set the volume of the warning buzzer on seven levels.
- Trip B: activate or deactivate the Trip function.
- Show Phone Info: allows you to activate/deactivate repetition of the phone function screens also on the instrument cluster display.

- ❑ Show Audio Info: allows you to activate/deactivate repetition of the audio function screens (Radio and Media) also on the instrument cluster display.
- ❑ Show Nav Info: allows you to activate/deactivate repetition of the navigator function screens also on the instrument cluster display.
- ❑ Digital Speed on all screens: this allows you to activate/deactivating of digital speed on the instrument cluster display screens other than the main screen.
- ❑ Consumption Bar: allows you to activate/deactivate the consumption bar on the display screens of the instrument panel where it is available.
- ❑ Performance Pages: allows you to choose, for each driving mode, one of the two alternative contents displayed in the screen.
- ❑ Custom Areas: allows you to select which content to display in each of the three customizable areas on the display of the instrument panel: time, date, outside temperature, radio information, compass.
- ❑ Restore Cluster Settings: deletes the current settings and restores the factory settings.

To access and the change the setting, turn and push the Rotary Pad or press the desired setting on the touchscreen.

WARNING LIGHTS AND MESSAGES ON THE INSTRUMENT PANEL

The following pages consist of warning lights and messages.

NOTE:

- ❑ The warning light turns on together with a dedicated message and/or chime when applicable. These indications are precautionary and as such must not be considered as exhaustive and/or alternative to the information contained in the Owner's Manual, which you are advised to read carefully in all cases. Always refer to the information in this section in the event of a failure indication.
- ❑ The failure indicators appearing on the display are divided into two categories: very serious and less serious faults. Serious faults are indicated by a repeated and prolonged warning cycle. Less serious faults are indicated by a warning cycle with a shorter duration. You can stop the warning cycle in both cases by pushing the button located on the windshield wiper stalk. The instrument panel warning light will stay on until the cause of the failure is eliminated.

RED WARNING LIGHTS

Air Bag Warning Light



This warning light will illuminate to indicate a fault with the air bag, and will turn on for four to eight seconds as a bulb check when the ignition is placed in the ON/RUN or ACC/ON/RUN position. This light will illuminate with a single chime when a fault with the air bag has been detected, it will stay on until the fault is cleared. If the light is either not on during startup, stays on, or turns on while driving, have the system inspected at an authorized dealer as soon as possible.

Brake Warning Light



This warning light monitors various brake functions, including brake fluid level and parking brake application. If the brake light turns on it may indicate that the parking brake is applied, that the brake fluid level is low, or that there is a problem with the Anti-Lock Brake System reservoir.

If the light remains on when the parking brake has been disengaged, and the fluid level is at the full mark on the master cylinder reservoir, it indicates a possible brake hydraulic system malfunction or that a problem with the Brake Booster has been detected by the Anti-Lock Brake System (ABS) / Electronic Stability Control (ESC) system. In this case, the light will remain on until the condition has been



corrected. If the problem is related to the brake booster, the ABS pump will run when applying the brake, and a brake pedal pulsation may be felt during each stop.

The dual brake system provides a reserve braking capacity in the event of a failure to a portion of the hydraulic system. A leak in either half of the dual brake system is indicated by the Brake Warning Light, which will turn on when the brake fluid level in the master cylinder has dropped below a specified level.

The light will remain on until the cause is corrected.

NOTE:

The light may flash momentarily during sharp cornering maneuvers, which change fluid level conditions. The vehicle should have service performed, and the brake fluid level checked. If brake failure is indicated, immediate repair is necessary.



WARNING!

- The fault of the warning light is signaled by the turning on of the icon on the instrument panel. In this case, the warning light may not indicate any faults with the restraint systems. Before proceeding, contact an authorized dealer to have the system checked immediately.

(Continued)



WARNING! *(Continued)*

- If the warning light does not turn on when the ignition device is moved to ON or if it stays on when driving (together with the message on the display), there might be a fault in the restraint systems; in this case, the air bags or pretensioners may not deploy in the event of an accident or, in a lower number of cases, they could deploy erroneously. Before proceeding, contact an authorized dealer to have the system checked immediately.

Vehicles equipped with the Anti-Lock Brake System (ABS) are also equipped with Electronic Brake Force Distribution (EBD). In the event of an EBD failure, the Brake Warning Light will turn on along with the ABS Light. Immediate repair to the ABS system is required.

Operation of the Brake Warning Light can be checked by turning the ignition switch from the OFF position to the ON/RUN position. The light should illuminate for approximately two seconds. The light should then turn off unless the parking brake is applied or a brake fault is detected. If the light does not illuminate, have the light inspected by an authorized dealer.

The light also will turn on when the parking brake is applied with the ignition switch in the ON/RUN position.

NOTE:

This light shows only that the parking brake is applied. It does not show the degree of brake application.

Electronic Brake Force Distribution (EBD) Failure



The simultaneous turning on of the BRAKE (red) and ABS (amber) warning lights with the engine on indicates either a failure of the EBD system or that the system is not available. In this case, the rear wheels may suddenly lock and the vehicle may swerve when braking abruptly.

Drive very carefully to the nearest authorized dealer to have the system inspected immediately.

Oil Temperature Warning Light



This telltale indicates engine oil temperature is high.

Stop the vehicle and shut off the engine as soon as possible. If the problem persists, contact an authorized dealer.

Seat Belt Reminder Warning Light



When the ignition is first placed in the ON/RUN position, if the driver's seat belt is unbuckled, a chime will sound and the light will turn on. When driving, if the driver or front passenger seat belt remains unbuckled, the Seat Belt Reminder Light will flash or remain on continuously and a chime will sound → page 167.



WARNING!

- The fault of the warning light is signaled by the turning on of the icon on the instrument panel. In this case, the warning light may not indicate any faults with the restraint systems. Before proceeding, contact an authorized dealer to have the system checked immediately.
- If the warning light does not turn on when the ignition device is moved to ON or if it stays on when driving (together with the message on the display), there might be a fault in the restraint systems; in this case, the air bags or pretensioners may not deploy in the event of an accident or, in a lower number of cases, they could deploy erroneously. Before proceeding, contact an authorized dealer to have the system checked immediately.

AMBER WARNING LIGHTS

Anti-Lock Brake System (ABS) Warning Light



This light monitors the ABS. The light will turn on when the ignition is placed in the ON/RUN position and may stay on for as long as four seconds.

If the ABS light remains on or turns on while driving, then the Anti-Lock portion of the brake system is not functioning and service is required. However, the conventional brake system will continue to operate normally if the brake indicator light is not on.

If the ABS light is on, the brake system should be serviced as soon as possible to restore the benefits of Anti-Lock Brakes. If the ABS light does not turn on when the ignition is placed in the ON/RUN position, have the light inspected by an authorized dealer.

Electronic Stability Control (ESC) Indicator Light — If Equipped



When the ignition is cycled to ON, the indicator light illuminates, but should turn off as soon as the engine is started.

ESC System Intervention: Intervention by the system is indicated by the flashing of the indicator light: it indicates that the vehicle is in critical stability and grip conditions.

ESC System Failure: If the indicator light does not turn off, or if it stays on with the engine running, a failure was found in the ESC system.

Hill Start Assist System Failure: The illumination of the indicator light indicates a Hill Start Assist system failure.

In these cases, contact an authorized dealer as soon as possible.

Electronic Stability Control (ESC) OFF Indicator Light — If Equipped



When the ignition is cycled to ON, the indicator light illuminates, but should turn off as soon as the engine is started.

The indicator light illuminates to indicate that some active safety systems have been partially or totally deactivated → page 149.

When the active safety systems are reactivated, the indicator light turns off.

Engine Check/Malfunction Indicator Light (MIL)



In normal conditions, when the ignition is cycled to ON, the indicator light illuminates, but it should turn off as soon as the engine is started.

The operation of the indicator light may be checked by the traffic police using specific devices. Comply with the laws and regulations of the country where you are driving.



Under these conditions, the vehicle can continue traveling at moderate speed but without demanding excessive effort from the engine or high speed. Prolonged use of the vehicle with the indicator light on constantly may cause damage. Contact an authorized dealer as soon as possible.



CAUTION!

If, turning the ignition device to ON, the warning light  does not turn on or if it turns on steadily or flashing when traveling (on some versions together with the message on the display), contact an authorized dealer as soon as possible.

Forward Collision Warning (FCW) System



This indicator light informs the driver that the frontal collision alarm function is not enabled.

Drive carefully and contact an authorized dealer as soon as possible.

Fuel Reserve/Limited Range



The indicator light (or the symbol in the display) illuminates when about 2.4 gallons (9 liters) of fuel is left in the tank.



WARNING!

If the warning light (or the icon on the display) flashes while driving, contact an authorized dealer.

Rear Fog Lights



The indicator illuminates when the rear fog light is activated.

Tire Pressure Low Warning Light



The indicator light will illuminate to indicate that the tire pressure is lower than the recommended value and/or that slow pressure loss is occurring. In these cases, optimal tire duration and fuel consumption may not be guaranteed.

In any situation in which the message on the display is “See Manual” → page 165.

Tire Pressure Monitoring System (TPMS) Warning Light



The warning light switches on and a message is displayed to indicate that the tire pressure is lower than the recommended value and/or that slow pressure loss is occurring. In these cases, optimal tire duration and fuel consumption may not be guaranteed.

Should one or more tires be in the condition mentioned above, the display will show the indications corresponding to each tire.



CAUTION!

Do not continue driving with one or more flat tires as handling may be compromised. Stop the vehicle, avoiding sharp braking and steering. If a tire puncture occurs, repair immediately using the dedicated tire repair kit and contact an authorized dealer as soon as possible.

Each tire, including the spare (if provided), should be checked monthly when cold and inflated to the inflation pressure recommended by the vehicle manufacturer on the vehicle placard or tire inflation pressure label. If your vehicle has tires of a different size than the size indicated on the vehicle placard or tire inflation pressure label, you should determine the proper tire inflation pressure for those tires.

As an added safety feature, your vehicle has been equipped with a TPMS that illuminates a low tire pressure telltale when one or more of your tires is significantly underinflated. Accordingly, when the low tire pressure telltale illuminates, you should stop and check your tires as soon as possible, and inflate them to the proper pressure. Driving on a significantly underinflated tire causes the tire to overheat

and can lead to tire failure. Under inflation also reduces fuel efficiency and tire tread life, and may affect the vehicle's handling and stopping ability.

Please note that the TPMS is not a substitute for proper tire maintenance, and it is the driver's responsibility to maintain correct tire pressure, even if under inflation has not reached the level to trigger illumination of the TPMS low tire pressure telltale.

Your vehicle has also been equipped with a TPMS malfunction indicator to indicate when the system is not operating properly. The TPMS malfunction indicator is combined with the low tire pressure telltale. When the system detects a malfunction, the telltale will flash for approximately one minute and then remain continuously illuminated. This sequence will continue upon subsequent vehicle start-ups as long as the malfunction exists. When the malfunction indicator is illuminated, the system may not be able to detect or signal low tire pressure as intended. TPMS malfunctions may occur for a variety of reasons, including the installation of replacement or alternate tires or wheels on the vehicle that prevent the TPMS from functioning properly. Always check the TPMS malfunction telltale after replacing one or more tires or wheels on your vehicle to ensure that the replacement or alternate tires and wheels allow the TPMS to continue to function properly.



WARNING!

The TPMS has been optimized for the original equipment tires and wheels. TPMS pressures and warning have been established for the tire size equipped on your vehicle. Undesirable system operation or sensor damage may result when using replacement equipment that is not of the same size, type, and/or style. Aftermarket wheels can cause sensor damage. Using aftermarket tire sealants may cause the Tire Pressure Monitoring System (TPMS) sensor to become inoperable. After using an aftermarket tire sealant it is recommended that you take your vehicle to an authorized dealership to have your sensor function checked.

GREEN INDICATOR LIGHTS

Automatic High Beam Indicator Light – If Equipped



This indicator light will illuminate when the automatic high beam headlights are activated.

Left Turn Signal Indicator Light



The instrument cluster directional arrow will flash independently for the left turn signal as selected, as well as the exterior turn signal lamp(s) (front and rear) as selected when the multifunction lever is moved down (left). This directional arrow will

flash in conjunction with the right directional arrow when the hazard warning light button is pushed.

Park/Headlight On Indicator Light



This indicator will illuminate when the park lights or headlights are turned on.

Headlight Off Delay

This function allows the headlights to remain on for 30, 60 or 90 seconds after the ignition was placed in the OFF position.

Right Turn Signal Indicator Light



The instrument cluster directional arrow will flash independently for the right turn signal as selected, as well as the exterior turn signal lamp(s) (front and rear) as selected when the multifunction lever is moved up (right). This directional arrow will flash in conjunction with the left directional arrow when the hazard warning light button is pushed.

BLUE INDICATOR LIGHTS

High Beam Indicator Light – If Equipped



This indicator shows that the high beam headlights are on. Push the multifunction control lever away from you to switch the headlights to high beam. Push the lever a second time to switch the headlights back to low beam. Pull the lever toward you for a temporary high beam on, “flash to pass” scenario.



RED SYMBOLS**Alfa Steering Torque (AST) Failure**

The switching on of the telltale signals a failure in the automatic steering correction system.

Contact an authorized dealer to have the system checked.

Alternator Failure

The switching on of the telltale with engine on corresponds to an alternator failure.

Contact an authorized dealer as soon as possible.

Automatic Transmission Failure

The telltale turns on, together with a buzzer warning, to indicate that the automatic transmission is faulty.

Contact an authorized dealer as soon as possible.

**CAUTION!**

Driving the vehicle with this symbol on may severely damage the gearbox, with resulting breakage. The oil may also overheat: contact with hot engine or with exhaust components at high temperature could cause fires.

Driver Attention Assist (DAA) System Activation

The symbol appears, together with a message on the display, in case of activation of the DAA system.

Stop to pause while driving, pulling the car over in safe conditions.

Door Open

The telltale turns on when one or more doors are not completely shut. An acoustic signal is activated with the doors open and the car moving.

Close the doors properly.

Power Steering Failure

If the telltale remains on, you may not have steering assistance and the effort required to operate the steering wheel may be increased; steering is, however, possible.

NOTE:

After the battery is disconnected, the steering wheel must be initialized. The Power Steering Failure light on the instrument panel will illuminate to indicate this. To carry out this procedure, simply turn the steering wheel all the way from one end to the other, and then turn it back to the central position.

Contact an authorized dealer as soon as possible.

Electronic Throttle Control (ETC) Warning Light

This warning light, along with the related message, signals a failure in the ETC.

If a failure is detected, the warning light turns on while the engine is running.

Place the gear selector in the Park (P) position and the ignition in the off position: the warning light should switch off. If the warning light stays on with engine running, the vehicle can still be driven.

If the warning light flashes with the engine running, immediate intervention is required. A loss of performance, irregular/high idling speed or engine stopping might take place and the vehicle may need to be towed.

Contact an authorized dealer as soon as possible to have the failure eliminated.

Engine Coolant Temperature Too High

The telltale lights up when the engine has overheated.

In normal driving conditions: stop the car, turn off the engine and check that the coolant level in the reservoir is not below the MIN mark. In this case, wait for the engine to cool down, then slowly and carefully open the cap, fill with coolant and check that the level is between

the MIN and MAX marks on the reservoir itself. Also check visually for any fluid leaks. Contact an authorized dealer if the telltale comes on when the engine is started again.

If the vehicle is used under demanding conditions (e.g. in high-performance driving): slow down and, if the warning light stays on, stop the vehicle. Stop for two or three minutes with the engine running and slightly accelerated to facilitate better coolant circulation, then turn the engine off. Check that the coolant level is correct as described above.

Hood Cap Not Properly Shut



The telltale turns on when the hood cap is not properly closed, along with the icon, an image of the vehicle with an open hood cap appears on the display.

A buzzer is heard when the hood cap is open and the vehicle is moving.

Close the hood properly.

Insufficient Engine Oil Level



The telltale turns on, along with the related message on the display, to indicate low engine oil level.

Contact an authorized dealer to have the system checked.

Low Engine Oil Pressure



This telltale indicates low engine oil pressure. If the telltale turns on while driving, stop the vehicle and shut off the engine as soon as possible. A chime will sound when this telltale turns on. Do not operate the vehicle until the cause is corrected. This telltale does not indicate how much oil is in the engine.

NOTE:

Do not use the vehicle until the failure has been solved. The turning on of the telltale does not indicate the amount of oil in the engine: the oil level can be checked on the display upon entering the vehicle and also by activating the "Oil level" function on the Information and Entertainment System.

Contact an authorized dealer as soon as possible.



CAUTION!

If the LOW ENGINE OIL PRESSURE symbol switches on when driving, stop the engine immediately and contact an authorized dealer.

Trunk Lid Not Properly Shut



The telltale turns on when the trunk lid is not properly closed, along with the icon, an image of the vehicle with an open trunk lid appears on the display.

A buzzer is heard when the trunk lid is open and the vehicle is moving.

Close the trunk lid properly.

AMBER SYMBOLS

ABS Activation



This telltale will illuminate to indicate that the ABS system has activated.

Adaptive Front Lighting System Failure



The telltale will illuminate to indicate the automatic directional light system failure.

Go to an authorized dealer to have the system checked.

All Wheel Drive Failure



This telltale will illuminate along with an accompanying message when the AWD dynamic control system is temporarily deactivated to prevent damage.

The traction system will work in RWD mode in this instance.

Contact an authorized dealer as soon as possible to have the failure eliminated.

Audio System Failure



The telltale will illuminate to report a failure of the audio system.

Contact an authorized dealer as soon as possible to have the failure eliminated.

Automatic High Beam Headlights Failure — If Equipped



The telltale will illuminate to report a failure of the automatic high beam headlights.

Contact an authorized dealer as soon as possible to have the failure eliminated.

Blind Spot Monitoring System Failure — If Equipped



The telltale will illuminate in the event of a Blind Spot Monitoring system failure.

Contact an authorized dealer as soon as possible.

Driver Attention Assist (DAA) System Failure



The symbol comes on in the event of a DAA system failure.

Contact an Alfa Romeo Dealership as soon as possible to have the failure eliminated.

Dusk Sensor Failure



The telltale will illuminate in the case of failure of the automatic low beam alignment.

Contact an authorized dealer as soon as possible.

Dynamic Drive Control System Failure



The telltale will illuminate to signal a failure in the dynamic drive control system.

Electric Park Brake Failure



The telltale will illuminate and a message will display to signal a failure in the electric park brake system.

This failure may partially or completely block the vehicle because the park brake could remain activated even if automatically or manually disengaged using the relevant controls. In these circumstances, you can disengage the park brake following the emergency disengagement procedure ↪ page 92.

If you are still able to drive the vehicle (park brake is not engaged), drive to the nearest authorized dealer and remember, when executing any maneuvers/commands, that the electric park brake is not operational.



WARNING!

If a failure is present with sharp braking, the rear wheels may lock and the vehicle may swerve.

Engine Immobilizer Failure/Break-In Attempt



Engine Immobilizer System Failure The telltale will illuminate to report a failure of the Engine Immobilizer system.

Break-In Attempt The telltale will illuminate when the ignition is cycled to ON position, to indicate a possible break-in attempt detected by the alarm system.

Electronic Key Not Recognized The telltale will illuminate when the engine is started and the electronic key is not recognized by the system.

Alarm System Failure The telltale will illuminate to report an alarm system failure.

Contact an authorized dealer as soon as possible.

Exterior Lights Failure



The telltale will illuminate to indicate a failure on the following lights: Daytime Running Lights (DRLs) / parking lights / trailer turn signal indicators (if present) / trailer lights (if present) / side lights / turn signal indicators / rear fog light / reversing light / brake lights / license plate lights.

The failure may be caused by a blown bulb, a blown protection fuse, or an interruption of the electrical connection.

Replace the bulb or the relevant fuse. Contact an authorized dealer.

Engine Oil Change Required — If Equipped



The telltale is illuminated only for a limited time.

NOTE:

After the first indication, each time the engine is started the symbol will continue to illuminate as described above until the oil is changed.

If the telltale flashes, this does not mean that there is a fault on the vehicle, rather it simply reports that it is now necessary to change the oil as a result of regular use of the vehicle. The deterioration of engine oil is accelerated by using the vehicle for short drives, preventing the engine from reaching operating temperature.

Contact an authorized dealer as soon as possible.



CAUTION!

Deteriorated engine oil should be replaced as soon as possible after the symbol is switched on, and never more than 500 miles (805 km) after it first switches on. Failure to observe the above may result in severe damage to the engine and invalidate the New Vehicle Limited Warranty. When this symbol comes on, it does not mean that the level of engine oil is low, so if it flashes you do not need to top up the engine oil.

Engine Oil Level Sensor Failure



The telltale will illuminate in the event of engine oil level sensor failure.

Contact an authorized dealer as soon as possible.

Engine Oil Pressure Sensor Failure



The telltale will illuminate in the event of engine oil pressure sensor failure.

Contact an authorized dealer as soon as possible.

Fuel Cut-Off System Failure



The telltale will illuminate in the event of fuel cut-off system failure.

Contact an authorized dealer as soon as possible.

Fuel Cut-Off Indicator Light



The telltale will illuminate after an accident has occurred and the system has shut the fuel off.

For reactivating the fuel cut-off system → page 167. If it is not possible to restore the fuel supply, contact an authorized dealer.

Fuel Level Sensor Failure



The telltale will illuminate in the event of fuel level sensor failure.

Contact an authorized dealer as soon as possible.

Generic Indication



Signals information and failures.

The accompanying messages describe the failure.

Highway Assist System (HAS)/Traffic Jam Assist (TJA) System Failure



The symbol lights up in case of HAS or TJA system failure.

Contact an Alfa Romeo Dealership as soon as possible to have the failure eliminated.

Keyless System Failure



The telltale will illuminate in the event of keyless system failure.

Contact an authorized dealer as soon as possible.



Lane Departure Warning (LDW) System Failure — If Equipped



The telltale will illuminate in the event of a fault in the Lane Departure Warning system.

Contact an authorized dealer as soon as possible.

Loose Fuel Filler Cap



Lights up if the fuel tank cap is open or not properly closed.

Tighten the cap properly.

Low Coolant Level — If Equipped



This telltale will illuminate to indicate that the vehicle coolant level is low.

Windshield Washer Liquid Level



The telltale will illuminate to indicate that the level of the windshield and headlight washing fluid (if any) is low.

Always use liquid with the features indicated in the “Fluids And Lubricants” ⇨ page 220.

Park Sensors System Failure



The telltale will illuminate when the system has failed or is not available.

Contact an authorized dealer to have the system checked.

Rain Sensor Failure



The telltale will illuminate in the case of failure of the automatic windshield wiper.

Contact an authorized dealer as soon as possible.

Service Adaptive Cruise Control (ACC) System



This light will illuminate when the ACC is not operating and needs service.

Contact an authorized dealer to have the system checked.

Shock Absorbers Failure



While driving, if the telltale illuminates, it signals a failure in the suspension system.

Contact an authorized dealer to have the system checked.

Forward Collision Warning (FCW) System Failure — If Equipped



The telltale will illuminate in the case of failure of the Forward Collision Warning system.

Contact an authorized dealer as soon as possible.

Stop/Start System Failure



This telltale will illuminate to report a Stop/Start system failure.

Contact an authorized dealer as soon as possible to have the failure eliminated.

Soft Suspension Calibration Insertion — If Equipped



The telltale will illuminate when the most comfortable suspension setting is activated.

Speed Limiter System Failure



While driving, the telltale will illuminate to signal a Speed Limiter system failure.

Contact an authorized dealer as soon as possible to have the failure eliminated.

Temporary All Wheel Drive Failure — If Equipped



This telltale will illuminate to indicate that the AWD dynamic control system is temporarily deactivated to prevent damage. The traction system will work in RWD mode in this instance.

In the event that this telltale illuminates, reduce the load to allow the system to cool down. The AWD system will resume normal operation when the symbol disappears from the display.

Automatic Transmission Fluid Overheating



The telltale will illuminate in the case of transmission overheating, after a particularly demanding use. In this case an engine performance limitation is carried out.

Wait for the telltale to turn off with the engine off or idling.

Wear On Brake Pads



This light will illuminate when the brake pads have reached their wear limit.

Contact an authorized dealer as soon as possible.

NOTE:

Always use genuine parts or similar because the Integrated Brake System (IBS) system could detect anomalies.

WEAR ON Carbon Ceramic Material (CCM) Brake Discs — If Equipped



This light will illuminate when the carbon ceramic material brake discs have reached their wear limit.

Contact an authorized dealer as soon as possible.



WARNING!

It is recommended to use only OEM brake pads to ensure the original performance of the braking system.

Windshield Wiper Failure



Signals a windshield wiper failure.
Contact an authorized dealer.

GREEN SYMBOLS

Adaptive Cruise Control System — If Equipped



The symbol comes on when the Adaptive Cruise Control system is activated.

Automatic Headlights



The symbol lights up when the automatic headlights are on.

Headlights



The telltale will illuminate when the headlights are turned on.

Cruise Control Activated



The telltale will illuminate when the Cruise Control system is activated.

Stop/Start Operation



The telltale will illuminate in the case of Stop/Start system intervention (stopping the engine).

When the engine is restarted, the telltale will shut off → page 104.

BLUE SYMBOLS

Automatic High Beam Headlights — If Equipped



The telltale will illuminate when the automatic high beam headlights are activated.

High Beam Headlights



The telltale will illuminate when the high beam headlights are activated.



ONBOARD DIAGNOSTIC SYSTEM

Operation

The Onboard Diagnostic system (OBD) carries out a continuous diagnosis of the components of the vehicle related to emissions.

It also alerts the driver of when these components are no longer in peak condition by switching on the  Engine Check/Malfunction Indicator warning light on the instrument panel.

The aim of the OBD system (Onboard Diagnostic) is to:

- Monitor the efficiency of the system
- Indicate an increase in emissions
- Indicate the need to replace damaged components

The vehicle also has a connector, which can interface with appropriate tools, that makes it possible to read the error codes stored in the electronic control units together with a series of specific parameters for engine operation and diagnosis. This check can be carried out by an authorized dealer.

NOTE:

After eliminating a fault, to check the system completely, an authorized dealer is obliged to run tests and, if necessary certain road tests.

ONBOARD DIAGNOSTIC SYSTEM (OBD II) CYBERSECURITY

Your vehicle is required to have OBD II and a connection port to allow access to information related to the performance of your emissions controls. Authorized service technicians may need to access this information to assist with the diagnosis and service of your vehicle and emissions system.



WARNING!

- ONLY an authorized service technician should connect equipment to the OBD II connection port in order to read the VIN, diagnose, or service your vehicle.
- If unauthorized equipment is connected to the OBD II connection port, such as a driver-behavior tracking device, it may:
 - Be possible that vehicle systems, including safety related systems, could be impaired or a loss of vehicle control could occur that may result in an accident involving serious injury or death.
 - Access, or allow others to access, information stored in your vehicle systems, including personal information.

EMISSIONS INSPECTION AND MAINTENANCE PROGRAMS

In some localities, it may be a legal requirement to pass an inspection of your vehicle's emissions control system. Failure to pass could prevent vehicle registration.



For states that require an Inspection and Maintenance (I/M), this check verifies the Malfunction Indicator Light (MIL) is functioning and is not on when the engine is running, and that the OBD II system is ready for testing.

Normally, the OBD II system will be ready. The OBD II system may **not** be ready if your vehicle was recently serviced, recently had a depleted battery or a battery replacement. If the OBD II system should be determined not ready for the I/M test, your vehicle may fail the test.

Your vehicle has a simple ignition actuated test, which you can use prior to going to the test station. To check if your vehicle's OBD II system is ready, you must do the following:

1. Cycle the ignition switch to the ACC position, but do not crank or start the engine.

NOTE:

If you crank or start the engine, you will have to start this test over.

2. As soon as you cycle the ignition switch to the ACC position, you will see the Malfunction Indicator Light (MIL) symbol come on as part of a normal bulb check.
3. Approximately 15 seconds later, one of two things will happen:

- The MIL will flash for about 10 seconds and then return to being fully illuminated until you turn OFF the ignition or start the engine. This means that your vehicle's OBD II system is **not ready** and you should **not** proceed to the I/M station.

- The MIL will not flash at all and will remain fully illuminated until you place the ignition in the off position or start the engine. This means that your vehicle's OBD II system is **ready** and you can proceed to the I/M station.

If your OBD II system is **not ready**, you should see an authorized dealer or repair facility. If your vehicle was recently serviced or had a battery failure or replacement, you may need to do nothing more than drive your vehicle as you normally would in order for your OBD II system to update. A recheck with the above test routine may then indicate that the system is **now ready**.

Regardless of whether your vehicle's OBD II system is ready or not, if the MIL is illuminated during normal vehicle operation you should have your vehicle serviced before going to the I/M station. The I/M station can fail your vehicle because the MIL is on with the engine running.



STARTING THE ENGINE

Before starting the engine, be sure to adjust the seat, the interior rearview mirror, door mirrors, and fasten the seat belt correctly.

Never press the accelerator pedal before starting the engine.

If necessary, messages indicating the starting procedure will be shown in the display.



WARNING!

- When leaving the vehicle, always remove the key fob from the vehicle and lock your vehicle.
- Never leave children alone in a vehicle, or with access to an unlocked vehicle.
- Allowing children to be in a vehicle unattended is dangerous for a number of reasons. A child or others could be seriously or fatally injured. Children should be warned not to touch the parking brake, brake pedal or the transmission gear selector.
- Do not leave the key fob in or near the vehicle, or in a location accessible to children. A child could operate power windows, other controls, or move the vehicle.
- Do not leave children or animals inside parked vehicles in hot weather. Interior heat build-up may cause serious injury or death.

STARTING PROCEDURE

Proceed as follows:

1. Apply the Electric Park Brake (EPB) and place the gear selector in PARK (P) or NEUTRAL (N).
2. Fully press the brake pedal without touching the accelerator.
3. Briefly push the ignition button.
4. If the engine doesn't start within a few seconds, you need to repeat the procedure.

If the problem persists, contact an authorized dealer.



WARNING!

- Never pour fuel or other flammable liquid into the throttle body air inlet opening in an attempt to start the vehicle. This could result in flash fire causing serious personal injury.
- Do not attempt to push or tow your vehicle to get it started. Vehicles equipped with an automatic transmission cannot be started this way. Unburned fuel could enter the catalytic converter and once the engine has started, ignite and damage the converter and vehicle.

(Continued)



WARNING! *(Continued)*

- If the vehicle has a discharged battery, booster cables may be used to obtain a start from a booster battery or the battery in another vehicle. This type of start can be dangerous if done improperly
 ⇨ page 205.



CAUTION!

To prevent damage to the starter, do not continuously crank the engine for more than 25 seconds at a time. Wait 60 seconds before trying again.

REMOTE STARTING SYSTEM

This system uses the key fob to start the engine conveniently from outside the vehicle while still maintaining security. The system has a range of at least 300 feet (91 meters).

The remote starting system also activates the climate control, the heated seats (if equipped), and the heated steering wheel (if equipped), depending on temperatures outside and inside of the vehicle.

NOTE:

Obstructions between the vehicle and key fob may reduce this range.

How To Use Remote Start

All of the following conditions must be met before the engine will remote start:

- Gear selector in PARK (P).
- Doors closed.
- Hood closed.
- Liftgate closed.
- Hazard switch off.
- Brake switch inactive (brake pedal not pressed).
- Battery at an acceptable charge level.
- PANIC button not pushed.
- System not disabled from previous remote start event.
- Vehicle Security System indicator flashing.
- Ignition in the OFF mode (if equipped with keyless ignition system).
- Fuel level meets minimum requirement.

Remote Start Comfort Systems — If Equipped

When Remote Start is activated, the heated steering wheel and driver heated seat features will automatically turn on in cold weather.

These features will stay on through the duration of remote start until the ignition is placed in the ON/RUN mode.

Remote Start Windshield Wiper De-Icer Activation — If Equipped

When remote start is active and the outside ambient temperature is less than 39° F (4° C), the Windshield Wiper De-Icer will be enabled. Exiting remote start will resume previous operation, except if the Windshield Wiper De-Icer is active.

The Windshield Wiper De-Icer timer and operation will continue.

COLD WEATHER OPERATION

To prevent possible engine damage while starting at low temperatures, this vehicle will inhibit engine cranking when the ambient temperature is less than -22° F (-30° C) and the oil temperature sensor reading indicates an engine block heater has not been used. An externally-powered electric engine block heater is available as optional equipment or from an authorized dealer.

The message “plug in engine heater” will be displayed in the instrument cluster when the ambient temperature is below 5° F (-15° C) at the time the engine is shut off as a reminder to avoid possible crank delays at the next cold start.



CAUTION!

Use of the recommended oil and adhering to the prescribed oil change intervals is important to prevent engine damage and ensure satisfactory starting in cold conditions.

EXTENDED PARK STARTING

If the vehicle has not been started or driven for at least 30 days, it is advisable to follow the indications below.

To start the engine, proceed as follows:

1. Briefly push the ignition button
2. If the engine does not start, wait five seconds and let the starter cool down and then repeat the starting procedure
3. If the engine does not start after eight attempts, let the starter cool down for at least 10 seconds, and then repeat the starting procedure

If the problem persists, contact an authorized dealer.

NOTE:

After prolonged vehicle inactivity, very difficult starting, that can be noticed through rapid fatigue of the starter, might also be due to a partially drained battery → page 205.



IF ENGINE FAILS TO START**Starting the Engine with Key Fob Battery Run Down or Drained**

If the ignition does not respond when the button is pushed, the key fob battery might be run down or drained. Therefore, the system does not detect the presence of the key fob in the vehicle, and will display a dedicated message ⇨ page 20.

**WARNING!**

- ❑ Never pour fuel or other flammable liquid into the throttle body air inlet opening in an attempt to start the vehicle. This could result in flash fire causing serious personal injury.
- ❑ Do not attempt to push or tow your vehicle to get it started. Vehicles equipped with an automatic transmission cannot be started this way. Unburned fuel could enter the catalytic converter and once the engine has started, ignite and damage the converter and vehicle.
- ❑ If the vehicle has a discharged battery, booster cables may be used to obtain a start from a booster battery or the battery in another vehicle. This type of start can be dangerous if done improperly ⇨ page 205.

**CAUTION!**

To prevent damage to the starter, do not continuously crank the engine for more than 25 seconds at a time. Wait 60 seconds before trying again.

AFTER STARTING — WARMING UP THE ENGINE

Proceed as follows:

- ❑ Travel slowly, letting the engine run at a reduced RPM, without accelerating suddenly.
- ❑ It is recommended to wait until the digital engine coolant temperature indicator starts to rise for maximum performance.

STOPPING THE ENGINE

To stop the engine, proceed as follows:

1. Park the vehicle in a position that is not dangerous for oncoming traffic.
2. Engage the PARK (P) mode.
3. With engine idling, push the ENGINE START/STOP button on the steering wheel to STOP the engine.

NOTE:

Do not leave the ignition in ACC mode when the engine is off.

To shut off the engine with vehicle speed greater than 5 mph (8 km/h), you must push and hold the ignition or push the ENGINE START/STOP button three times consecutively within a few seconds. The engine will shut down, and the ignition will be placed in the ACC mode

With the keyless ignition system, it is possible to exit the vehicle taking the key fob with you, without the engine switching off. The vehicle will inform about the absence of the key on board, when the doors are closed.

After the engine has stopped (cycling from the ACC to the OFF position) the accessories are still powered for about three minutes, or until a door is opened.

When the ignition is in the OFF mode, the window switches remain active for three minutes. Opening a front door will cancel this function.

After severe driving, idle the engine to allow the temperature inside the engine compartment to cool before shutting off the engine.

TURBOCHARGER COOL DOWN

It is recommended before switching the vehicle off, to keep the engine idling for a few minutes so that the turbocharger can be suitably lubricated. This procedure is particularly recommended after severe driving.

After a full load operation, keep the engine idling for three to five minutes before switching it off.

This time allows the lubricating oil and the engine coolant to eliminate the excessive heat from combustion chamber, bearings, inner components and turbocharger.

ENGINE BLOCK HEATER — IF EQUIPPED

The engine block heater warms the engine and permits quicker starts in cold weather.

Connect the cord to a 110-115 Volt AC electrical outlet with a grounded, three-wire extension cord.

For ambient temperatures below 0°F (-18°C), the engine block heater is recommended. For ambient temperatures below -20°F (-29°C), the engine block heater is required.

Follow the steps below to properly use the engine block heater:

1. Locate the engine block heater cord (access door on the passenger side wiper cowl).
2. Pull the cord to the front of the vehicle and plug it into a grounded, three-wire extension cord.
3. After the vehicle is running, properly stow the cord away behind the access door on the passenger side wiper cowl.

NOTE:

- The engine block heater cord is a factory installed option. If your vehicle is not equipped, heater cords are available from an authorized dealer.
- The engine block heater will require 110 Volt AC and 6.5 Amps to activate the heater element.
- The engine block heater must be plugged in at least one hour to have a warming effect on the engine and at least four hours to have a warming effect when ambient temperatures are below -20°F (-29°C).



WARNING!

Remember to disconnect the engine block heater cord before driving. Damage to the 110-115 Volt electrical cord could cause electrocution.

ENGINE BREAK-IN RECOMMENDATIONS

ENGINE BREAK-IN

For both engines, use the following engine break-in recommendations:

NOTE:

A new engine may consume some oil during its first few thousand miles (kilometers) of operation. This should be considered a normal part

of the break-in period and not interpreted as an indication of a problem. Please monitor your oil level during the break-in period and add oil as required.

It is recommended for the operator to observe the following driving behaviors during the new vehicle break-in period:

0 to 100 miles (0 to 160 km):

- Do not allow the engine to operate at idle for an extended period of time.
- Press the accelerator pedal slowly and not more than halfway to avoid rapid acceleration.
- Avoid aggressive braking.
- Drive with the engine speed less than 3,500 RPM.

- Maintain vehicle speed below 55 mph (88 km/h) and observe local speed limits.

100 to 300 miles (160 to 483 km):

- Press the accelerator pedal slowly and not more than halfway to avoid rapid acceleration in lower gears (FIRST to THIRD gears).
- Avoid aggressive braking.
- Drive with the engine speed less than 5,000 RPM.
- Maintain vehicle speed below 70 mph (112 km/h) and observe local speed limits.



300 to 500 miles (483 to 805 km):

- ❑ Exercise the full engine RPM range, shifting manually (paddles or gear shift) at higher RPM when possible.
- ❑ Do not perform sustained operation with the accelerator pedal at wide open throttle.
- ❑ Maintain vehicle speed below 85 mph (136 km/h) and observe local speed limits.

For the first 1,500 miles (2,414 km):

- ❑ Do not participate in track events, sport driving schools, or similar activities during the first 1,500 miles (2,414 km).

NOTE:

Monitor engine oil with every refueling and add if necessary. Oil and fuel consumption may be higher through the first oil change interval.

ELECTRIC PARK BRAKE (EPB)

The EPB features a switch located on the center console, a caliper with motor for each rear wheel, and an electronic control module.



Electric Park Brake Switch

The EPB can be engaged in two ways:

- ❑ Manually, by pulling the switch on the center console.
- ❑ Automatically, in “Safe Hold” or “Auto Park Brake” conditions.

NOTE:

Normally, the EPB is engaged automatically when the engine is stopped. This function can be deactivated/activated on the Information and Entertainment system by selecting the following items in sequence on the main menu: “Settings”, “Driver Assistance” and “Automatic Parking Brake”.

In addition to engaging the EPB, along with steering and positioning chocks in front of the wheels (when on a steep slope), you must always place the vehicle in the PARK (P) mode before leaving.

Should the vehicle battery be faulty, the battery must be replaced in order to unlock the EPB.

Engaging The EPB Manually

Briefly pull the switch located on the center console to manually engage the EPB when the vehicle is stationary.

Noise may be heard from the rear of the vehicle when engaging the EPB.

A slight movement of the brake pedal may be detected when engaging the EPB with the brake pedal pressed.

With the EPB engaged, the BRAKE warning light on the instrument cluster display and the switch will illuminate.



CAUTION!

With the Electronic Parking Brake failure warning light on, some functions of the EPB are deactivated. In this case the driver is responsible for brake activation and vehicle parking in complete safety conditions.

If, under exceptional circumstances, the use of the brake is required with the vehicle in motion, keep the switch on the center console pulled as long as the brake action is necessary.

The BRAKE warning light may turn on with the hydraulic system temporarily unavailable; in this case, braking is controlled by the motors.

The brake lights will also automatically turn on in the same way as normal braking with the use of the brake pedal.

Release the switch on the center console to stop the braking action with the vehicle in motion.

If, through this procedure, the vehicle is braked until a speed below 1.9 mph (2.0 km/h) is reached and the switch is kept pulled, the parking brake will definitively engage.

NOTE:

Driving the vehicle with the EPB engaged, or using it several times to slow down the vehicle, may cause severe damage to the braking system.

Disengaging The EPB Manually

In order to manually release the parking brake, the ignition should be in the ACC mode. Press the brake pedal, and then push the switch on the center console briefly.

Noise may be heard from the rear of the vehicle, and a slight movement of the brake pedal may be detected during disengagement.

After disengaging the EPB, the BRAKE warning light on the instrument cluster display and the light on the switch will turn off.

If the BRAKE warning light on the instrument cluster display remains on with the EPB disengaged, this indicates a fault: in this case, contact an authorized dealer.



WARNING!

- Never leave children alone in a vehicle, or with access to an unlocked vehicle.
- Allowing children to be in a vehicle unattended is dangerous for a number of reasons. A child or others could be seriously or fatally injured. Children should be warned not to touch the parking brake, brake pedal or the gear selector.
- Do not leave the key fob in or near the vehicle or in a location accessible to children. A child could operate power windows, other controls, or move the vehicle.
- Be sure the parking brake is fully disengaged before driving; failure to do so can lead to brake failure and a collision.
- Always fully apply the parking brake when leaving your vehicle, or it may roll and cause damage or injury.

NOTE:

- Always engage the EPB when parking the vehicle to prevent injury or damage caused by the unexpected movement of the vehicle.
- Never use gear position PARK (P) instead of the EPB.

ELECTRIC PARK BRAKE (EPB) OPERATING MODES

The EPB may operate as follows:

- “Dynamic Operating Mode”: this mode is activated by pulling the switch repeatedly while driving.
- “Static Engagement and Release Mode”: with the vehicle stationary, the EPB can be activated by pulling the switch on the center console once. Push the switch and the brake pedal at the same time to disengage the brake.
- “Drive Away Release” — if equipped: the EPB will automatically disengage with the driver side seat belt fastened and the detection of an action performed by the driver to move the vehicle (DRIVE [D] or REVERSE [R]). This feature can be turned on or off in the Information and Entertainment System.

NOTE:

If the car is equipped with carbon-ceramic brake discs, it is necessary to fasten the seat belts or turn off the EPB before starting to avoid damages to the ceramic brake discs.

- “Safe Hold”: if the vehicle speed is lower than 1.9 mph (2.0 km/h), the gear selector is not in PARK (P) position and the driver's intention of leaving the vehicle is detected, the EPB will automatically engage to hold the vehicle in safety conditions.



- “Auto Park Brake”: if the vehicle speed is below 1.9 mph (2.0 km/h), the EPB will automatically engage when the gear selector is in PARK (P) position. The light on the switch located on the center console switches on together with the BRAKE warning light on the instrument cluster display when the parking brake is engaged and applied to the wheels. Each automatic parking brake engagement can be canceled by pushing the switch on the center console and at the same time moving the gear selector for the transmission to position PARK (P).

SAFE HOLD

Safe Hold is a safety function that automatically engages the EPB in the event of a dangerous condition for the vehicle.

The EPB engages automatically to prevent vehicle movement if:

- The vehicle speed is below 1.9 mph (2.0 km/h).
- A transmission operating mode different from PARK (P) is activated.
- The driver's seat belt is not fastened.
- The driver side door is open.

- No attempts to apply pressure on the brake pedal have been detected.
- The vehicle is parked on roads with a slope of more than 4%.

The “Safe Hold” function can be temporarily disabled by pushing the EPB switch located on the center console and the brake pedal at the same time, with the vehicle stationary and the driver side door open.

Once disabled, the function will activate again when the vehicle speed reaches 12 mph (20 km/h) or the ignition is cycled to OFF and then to ACC.

AUTOMATIC TRANSMISSION

The vehicle is equipped with an electronically controlled 8-speed automatic transmission where gear shifting automatically takes place, depending on the vehicle usage instantaneous parameters (vehicle speed, grade, and accelerator pedal position).

Manual gear shifting can still occur thanks to the “Sequential” mode position for the gear selector.



WARNING!

- It is dangerous to shift out of PARK or NEUTRAL if the engine speed is higher than idle speed. If your foot is not firmly pressing the brake pedal, the vehicle could accelerate quickly forward or in reverse. You could lose control of the vehicle and hit someone or something. Only shift into gear when the engine is idling normally and your foot is firmly pressing the brake pedal.
- Unintended movement of a vehicle could injure those in or near the vehicle. As with all vehicles, you should never exit a vehicle while the engine is running. Before exiting a vehicle, always apply the parking brake, shift the transmission into PARK, and turn the ignition OFF. When the ignition is in the OFF mode, the transmission is locked in PARK, securing the vehicle against unwanted movement.
- When leaving the vehicle, always make sure the ignition is in the OFF mode, remove the key fob from the vehicle, and lock the vehicle.

(Continued)



WARNING! (Continued)

- ❑ Never leave children alone in a vehicle, or with access to an unlocked vehicle. Allowing children to be in a vehicle unattended is dangerous for a number of reasons. A child or others could be seriously or fatally injured. Children should be warned not to touch the parking brake, brake pedal or the transmission gear selector.
- ❑ Do not leave the key fob in or near the vehicle (or in a location accessible to children), and do not leave the ignition in the ON/RUN or ACC mode. A child could operate power windows, other controls, or move the vehicle.



CAUTION!

Damage to the transmission may occur if the following precautions are not observed:

- ❑ Shift into or out of PARK or REVERSE only after the vehicle has come to a complete stop.
- ❑ Do not shift between PARK, REVERSE, NEUTRAL, or DRIVE when the engine is above idle speed.
- ❑ Before shifting into any gear, make sure your foot is firmly pressing the brake pedal.

DISPLAY

The following information is shown on the dedicated area of the display:

- ❑ **In Automatic Mode:** the active mode (P, R, N, D) and with "D" the current gear number.
- ❑ **In Manual Drive Mode (Sequential):** the mode (M), the current gear and the double or single gear shift request, both up and down (single or double arrow).



Gear Display

GEAR SELECTOR

The gear functioning is controlled by the gear selector, which can assume the following positions:

- ❑ **P** = PARK
- ❑ **R** = REVERSE
- ❑ **N** = NEUTRAL

- ❑ **D** = DRIVE (automatic forward speed)

- ❑ **AutoStick:** + manually shift to higher gear; - manually shift to lower gear

The positions diagram is illustrated on the top of the gear selector.

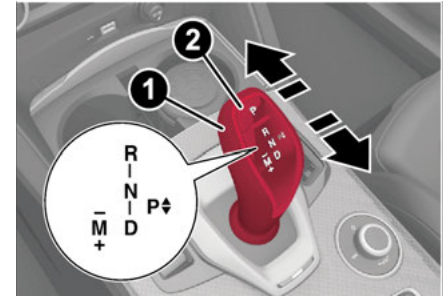

Gear Selector Center Console

- 1 — Gear Selector
- 2 — PARK (P) Button

The letter corresponding to the mode selected on the gear selector lights up and appears on the instrument cluster display.



To select a mode, move the gear selector forward or rearward while pressing the brake pedal. To engage REVERSE (R), press the brake pedal together with the gear selector button.

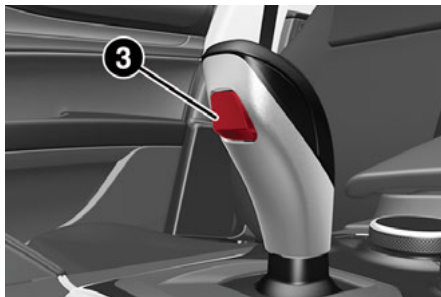

Gear Selector

3 – Gear Selector Button

The gear selector is a joystick style shifting mechanism which returns to the center position automatically. It can be pushed forward twice and rearward twice, based on the starting condition.

The PARK (P) mode can be enabled/disabled by pushing the PARK (P) button. PARK (P) mode is automatically activated if the following conditions are met simultaneously:

- DRIVE (D) mode or REVERSE (R) mode is active
- The vehicle's speed is close to 0 mph (0 km/h)

- The brake pedal is released
- The driver's seat belt is not fastened
- The driver's door is open

To transition the vehicle into REVERSE (R) mode from DRIVE (D) mode, or into DRIVE (D) mode from REVERSE (R) mode, it is necessary to move the gear selector by pushing the gear selector button.

AutoStick can be activated by moving the gear selector from DRIVE (D) to the left and then forward toward the - symbol (or backward toward the + symbol) changing the gear.

To shift out of PARK (P), or to pass from position NEUTRAL (N) to position DRIVE (D) or REVERSE (R), the vehicle must be moving at a low speed or stopped, and the brake pedal must also be pressed.

NOTE:

- DO NOT accelerate while shifting from position PARK (P) or NEUTRAL (N) to another position.
- After selecting a gear, wait a few seconds before accelerating. This precaution is particularly important with engine cold.
- It is not possible to select NEUTRAL (N) mode from PARK (P) mode.

TRANSMISSION OPERATING MODES

PARK (P)

The transmission is locked in this mode. The engine can be started in this mode.

NOTE:

Never try to engage PARK (P) mode when the vehicle is moving. Before leaving the vehicle, make sure this mode is engaged (letter P shown on the display and gear selector) and that the parking brake is engaged.

When parking on a flat surface, first engage the PARK (P) mode and then engage the EPB.

When parking uphill, before activating the PARK (P) mode, engage the EPB. Otherwise, it could be difficult to engage the PARK (P) mode.

To check that the PARK (P) mode is actually engaged, make sure P is illuminated on the display and on the gear selector.



WARNING!

- Never use the PARK position as a substitute for the parking brake. Always apply the parking brake fully when parked to guard against vehicle movement and possible injury or damage.

(Continued)



WARNING! *(Continued)*

- Your vehicle could move and injure you and others if it is not in PARK. Check by trying to move the gear selector out of PARK with the brake pedal released. Make sure the transmission is in PARK before leaving the vehicle.
- It is dangerous to shift out of PARK or NEUTRAL if the engine speed is higher than idle speed. If your foot is not firmly pressing the brake pedal, the vehicle could accelerate quickly forward or in reverse. You could lose control of the vehicle and hit someone or something. Only shift into gear when the engine is idling normally and your foot is firmly pressing the brake pedal.
- Unintended movement of a vehicle could injure those in or near the vehicle. As with all vehicles, you should never exit a vehicle while the engine is running. Before exiting a vehicle, always apply the parking brake, shift the transmission into PARK, and turn the ignition OFF. When the ignition is in the OFF mode, the transmission is locked in PARK, securing the vehicle against unwanted movement.
- When leaving the vehicle, always make sure the ignition is in the OFF mode, remove the key fob from the vehicle, and lock the vehicle.

(Continued)



WARNING! *(Continued)*

- Never leave children alone in a vehicle, or with access to an unlocked vehicle. Allowing children to be in a vehicle unattended is dangerous for a number of reasons. A child or others could be seriously or fatally injured. Children should be warned not to touch the park brake, brake pedal or the transmission gear selector.
- Do not leave the key fob in or near the vehicle (or in a location accessible to children), and do not leave the ignition in the ACC mode. A child could operate power windows, other controls, or move the vehicle.



CAUTION!

- Before moving the transmission gear selector out of PARK, you must push the ignition button to cycle from OFF mode to the ACC mode, and also press the brake pedal. Otherwise, damage to the gear selector could result.
- DO NOT race the engine when shifting from PARK or NEUTRAL into another gear range, as this can damage the drivetrain.

REVERSE (R)

Select this mode only with the vehicle at a standstill.

NEUTRAL (N)

Use this range when the vehicle is standing for prolonged periods with the engine running. The engine may be started in this range. Apply the EPB and shift the transmission into PARK (P) if you must leave the vehicle.



WARNING!

Do not coast in NEUTRAL and never turn off the ignition to coast down a hill. These are unsafe practices that limit your response to changing traffic or road conditions. You might lose control of the vehicle and have a collision.

DRIVE (D)

Use this mode in normal driving conditions.

Shifting from DRIVE (D) to PARK (P) or REVERSE (R) modes must take place only after releasing the accelerator pedal, with vehicle at a standstill and brake pedal pressed.

This mode ensures automatic engagement of the most suitable gears for driving needs and maximum fuel economy in terms of consumption.

In this position, the transmission shifts the gears automatically, selecting the most suitable for forward driving among those available as you go. In this way the vehicle's optimal driving characteristics are provided for all conditions.



AutoStick

In the case of frequent shifting (e.g. for sport driving, when the vehicle is driven with a heavy load, on slopes, when towing heavy trailers), it is recommended to use the AutoStick (sequential shifting) mode to select and keep a lower fixed ratio.

In these conditions, the use of a lower gear improves vehicle performance and prevents overheating.

It is possible to shift from DRIVE (D) mode to AutoStick mode regardless of vehicle speed.

Activation

Starting from DRIVE (D) mode, to activate the sequential drive mode, move the gear selector to the left (- and + indication of the trim). The gear engaged will be shown on the display.

Shifting is made by moving the gear selector forward, toward symbol - or backward, toward symbol +.

Steering Column Mounted Shift Paddles – If Equipped

The gear can be manually shifted also by using the paddles behind the steering wheel, pull the right paddle (+) toward the steering wheel and release it to engage a higher gear, perform the same operation with the left paddle (-) to engage a lower gear.

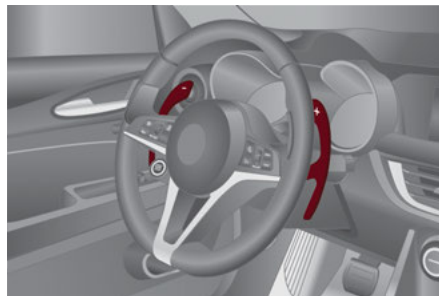

Steering Column Mounted Shift Paddles

NOTE:

If only one manual shift is necessary, the letter D will remain on the display with the engaged gear next to it.

Deactivation

To deactivate the sequential driving mode, bring the gear selector back in position DRIVE (D) ("automatic" driving mode).

**WARNING!**

Do not downshift for additional engine braking on a slippery surface. The drive wheels could lose their grip and the vehicle could skid, causing a collision or personal injury.

NOTE:

- To select the correct gear for maximum deceleration (engine brake), keep the gear paddle pulled (-): the transmission goes to

an operating mode in which the vehicle can slow down easily.

- The vehicle will keep the gear selected by the driver until the safety conditions allow it.
- This means, for example, that the system will try to prevent the engine from switching off, automatically downshifting if the engine speed is too low.

AUTOMATIC TRANSMISSION LIMP HOME MODE

Transmission function is monitored electronically for abnormal conditions. If a condition is detected that could result in transmission damage, Transmission Limp Home Mode is activated.

In this condition, the transmission stays in FOURTH gear, regardless of the selected gear. Positions PARK (P), REVERSE (R) and NEUTRAL (N) still work.

The  symbol might light up in the instrument cluster.

Temporary failure

In the event of a momentary problem, the transmission can be reset to regain all forward gears by performing the following steps:

1. Stop the vehicle.
2. Shift the transmission into PARK (P), if possible. If not, shift the transmission to NEUTRAL (N).

3. Push and hold the ignition until the engine turns off.
4. Wait for about 10 seconds, then restart the engine.
5. Shift into the desired gear range. If the problem is no longer detected, the transmission will return to normal operation.

NOTE:

Even if the transmission can be reset, we recommend that you visit an authorized dealer at your earliest possible convenience. An authorized dealer has diagnostic equipment to determine if the problem could reoccur. If the transmission cannot be reset, service is required at an authorized dealer.

BRAKE TRANSMISSION SHIFT INTERLOCK (BTSI) SYSTEM

This vehicle is equipped with a BTSI that holds the gear selector in PARK (P) unless the brakes are applied.

This system prevents you from moving the gear selector from position PARK (P) unless the brakes are applied.

To shift the transmission out of PARK (P), the ignition must be cycled to the ON/RUN position (engine running or not) and the brake pedal must be pressed.

Brake Transmission Shift Interlock Disabling

Only if strictly necessary (e.g. pushing the vehicle, conveyor vehicle washing systems), inhibit the automatic activation of PARK (P) mode when stopping the engine. To do so, follow the directions below:

1. Bring the vehicle to a standstill.
2. Place the transmission in the NEUTRAL (N) position.
3. Push the ignition button for at least three seconds.

The automatic activation of PARK (P) when the engine is stopped can also be deactivated on the Information and Entertainment system by selecting the following functions on the main menu: "Settings", "Driver Assistance" and "Automatic Parking Brake".

IMPORTANT NOTES

Failure to comply with what is reported below may damage the transmission:

- Shift into PARK (P) mode only with the vehicle at a standstill.
- Select REVERSE (R) mode, or pass from REVERSE to another mode only with the vehicle at a standstill and engine idling.
- Do not change between PARK (P), REVERSE (R), NEUTRAL (N) or DRIVE (D) modes with engine running at a speed above idling.

- Before activating any transmission operating mode, fully press the brake pedal.

NOTE:

The unexpected movement of the vehicle can injure the occupants or people nearby. Do not leave the vehicle with engine running: before getting out of the passenger compartment always engage the EPB, select the PARK (P) mode, stop the engine.



WARNING!

- It is dangerous to shift out of PARK or NEUTRAL if the engine speed is higher than idle speed. If your foot is not firmly pressing the brake pedal, the vehicle could accelerate quickly forward or in reverse. You could lose control of the vehicle and hit someone or something. Only shift into gear when the engine is idling normally and your foot is firmly pressing the brake pedal.
- Unintended movement of a vehicle could injure those in or near the vehicle. As with all vehicles, you should never exit a vehicle while the engine is running. Before exiting a vehicle, always apply the parking brake, shift the transmission into PARK, and turn the ignition OFF. When the ignition is in the OFF mode, the transmission is locked in PARK, securing the vehicle against unwanted movement.

(Continued)



**WARNING!** (Continued)

- When leaving the vehicle, always make sure the ignition is in the OFF mode, remove the key fob from the vehicle, and lock the vehicle.
- Never leave children alone in a vehicle, or with access to an unlocked vehicle. Allowing children to be in a vehicle unattended is dangerous for a number of reasons. A child or others could be seriously or fatally injured. Children should be warned not to touch the parking brake, brake pedal or the transmission gear selector.
- Do not leave the key fob in or near the vehicle (or in a location accessible to children), and do not leave the ignition in the ON/RUN or ACC mode. A child could operate power windows, other controls, or move the vehicle.

**CAUTION!**

- Only engage the gear with engine at idling while fully pressing the brake pedal. If the transmission temperature exceeds the normal operating limits, the transmission control unit may change the gear engagement order and reduce the drive torque. If the transmission overheats, it could operate incorrectly until it cools down.
- When using the vehicle with extremely low external temperatures, the transmission operation may change depending on the engine and transmission temperature, as well as vehicle speed. Activation of the torque converter clutch and of the EIGHTH gear is inhibited until the transmission oil is correctly warmed up. Complete operation of the transmission will be enabled as soon as the fluid temperature reaches the predefined value.

ALFA DNA SELECTOR**ALFA DNA SYSTEM**

This vehicle is equipped with an Alfa DNA system selector (located on the center console). There are up to four modes of

operation to be selected according to driving style and road conditions:

**Alfa DNA Pro System Selector**

- d = Dynamic (sports driving mode).
- n = Natural (mode for driving in normal conditions).
- a = Advanced Efficiency (ECO driving mode for maximum fuel savings).
- RACE = track race driving mode (if equipped).
-  = Adjusts the calibration of the active suspension (if equipped).

Unlike the other modes, the RACE position does not latch; therefore, by rotating the selector to RACE, it will return to its initial position "d".

On the instrument cluster display, the different modes are characterized by different colors:

- Natural - Blue
- Dynamic - Red
- Advanced Efficiency - Green
- RACE - Yellow



Mode Display

Each driving mode is graphically different in frame color and contents of each individual "performance" screen.

DRIVING MODES

"Natural" Mode

"Natural" Mode is characterized by reduced engine performance and ECO shifting strategy for the automatic transmission.

Activation

It is activated by rotating the selector to the letter "n"; the display will light up in blue.



Natural Mode

The "Performance" screen graphically reproduces some parameters closely linked to the efficiency of the driving style, with a view to limiting consumption.

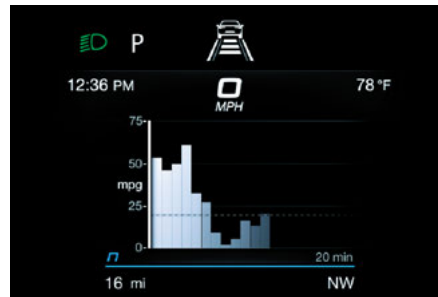

Natural Mode Performance Display

"Dynamic" Mode

Activation

It is activated by rotating the selector to the letter "d"; the display will light up in red.



Dynamic Mode

ESC and ASR systems: intervention thresholds that ensure more enjoyable, sportier driving while guaranteeing the stability of the vehicle.

Engine and transmission: adoption of sports mapping.



WARNING!

In "Dynamic", the sensitivity of the accelerator pedal increases considerably. Consequently, driving is less fluid and comfortable.



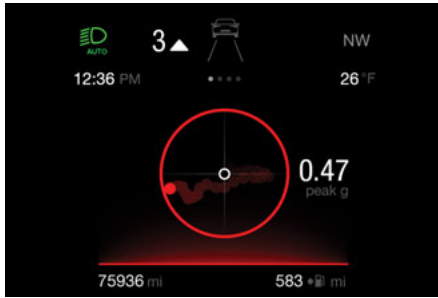

Dynamic Mode Performance Display

The "Performance" screen displays parameters related to vehicle stability, the graphs illustrate the trend of the longitudinal/lateral accelerations (G-meter information), considering gravity acceleration as a reference unit.

Lateral acceleration peaks are displayed on the right.

"Advanced Efficiency" Mode

Activation

It is activated by rotating the selector to the letter "a"; the display will light up in green.



Advanced Efficiency Mode

ESC and ASR systems: intervention thresholds aimed at ensuring maximum safety in low-grip driving conditions. It is advisable to select "Advanced Efficiency" mode in the presence of low-grip road surfaces.

Engine and transmission: standard response.

The "Performance" screen graphically displays some parameters closely related to the vehicle acceleration, deceleration and gear selector.

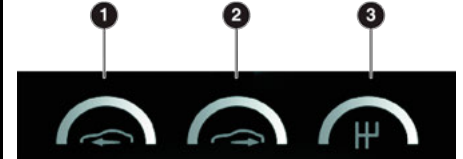

Advanced Efficiency Mode Performance Display

- 1 – Acceleration
- 2 – Deceleration
- 3 – Gear Selector

“RACE” Mode

Activation

“RACE” Mode is activated by rotating the selector to the “RACE” position. The instrument cluster display will light up in yellow.

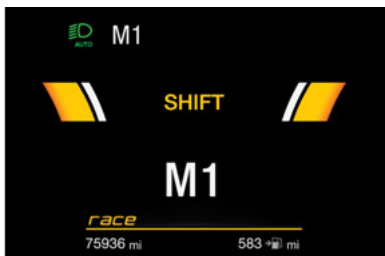

RACE Mode

Engine and transmission: adoption of sports mapping.



WARNING!

- It is recommended to activate this mode at the track.
- In “RACE”, the sensitivity of the accelerator pedal increases considerably. Consequently, driving is less fluid and comfortable.

The “Performance” screen displays parameters related to vehicle stability. The graphs illustrate the trend of the longitudinal/lateral accelerations (G-meter information), considering gravity acceleration as a reference unit.

The screen displays the lateral and longitudinal acceleration peaks.



RACE Mode Performance Display

NOTE:

If the brake system overheats, this is communicated by the Information and Entertainment system. In this case, allow the system to cool for a few minutes by driving the vehicle normally without operating the brakes.

Driving Mode Deactivation

To deactivate any driving mode, simply move the selector to any other mode.

NOTE:

- The next time that the engine is started, the “Advanced Efficiency”, “Dynamic” and “Natural” mode selected previously is retained. The system will reactivate in “Advanced Efficiency”, “Dynamic” or “Natural” mode, depending on which mode was selected before the engine was stopped.
- When the engine is started again, the “RACE” mode selected previously is not retained. The system will reactivate in “Dynamic” mode.

ALFA ACTIVE SUSPENSION (AAS) — IF EQUIPPED

The vehicle’s electronic suspension management system is aimed at optimizing the vehicle’s performance.

The system continuously monitors the damping of the suspensions through the actuator installed on each shock absorber. This way, the calibration of the shock absorbers can be adjusted to the conditions of the road surface and to the dynamic conditions of the vehicle, improving its comfort and road holding.



The driver can choose, even while driving, (only in “Dynamic” mode), between two types of suspension calibration: a more sporty or a more comfortable one.

By pushing the button, the system changes the shock absorber calibration.



Alfa Active Suspension Button

In case of a system failure, the symbol  and a dedicated message will be shown on the instrument cluster display.

STOP/START SYSTEM

The Stop/Start system automatically shuts off the engine during a vehicle stop if the required conditions are met. Releasing the brake pedal or accelerator pedal will automatically restart the engine.

The function was developed to increase vehicle efficiency by reducing fuel consumption, gas emissions, and sound pollution.

NOTE:

When the Stop/Start system stops the engine, the power steering is also disabled.

OPERATING MODE

Stopping The Engine

With the vehicle at a standstill and brake pedal pressed, the engine switches off if the gear selector is in a position other than REVERSE (R).

The system does not operate when the gear selector is in REVERSE (R), in order to make parking maneuvers easier.

In the event of stops uphill, engine switching off is disabled to make the “Hill Start Assist” function available (works only with running engine).

NOTE:

The engine can only be automatically stopped after having run at about 6 mph (10 km/h). After an automatic restart, the vehicle only needs to exceed a speed of 0.3 mph (0.5 km/h) to stop the engine.

Engine stopping is signaled by the  lighting up on the instrument cluster display.

Restarting The Engine

To restart the engine, release the brake pedal or, turn the steering wheel slightly (if equipped).

With the brake pressed and the transmission in automatic mode DRIVE (D), the engine will restart by shifting to REVERSE (R), to PARK (P) or to “AutoStick”  page 96.

With brake pressed if the gear selector is in “AutoStick” mode, the engine will restart by shifting to PARK (P) or by moving the selector to + or -  page 96.

SYSTEM MANUAL ACTIVATION/ DEACTIVATION

To manually activate/deactivate the system, push the button located on the control panel to the left of the steering wheel.



Stop/Start Button

System Activation

The activation of the system is indicated by the  lighting up on the display. In this condition, the light on the button is off.

System Deactivation

A message will appear on the display when the system is deactivated. In this condition, the light on the button is on.

NOTE:

Each time the engine is started, the system is activated regardless of where it was when it was previously switched off.

POSSIBLE REASONS THE ENGINE DOES NOT AUTOSTOP

For higher comfort and increased safety, and to reduce emissions, there are certain conditions where the engine will not autostop despite the system being active, such as:

- Engine still cold.
- Extreme cold outside temperature.
- Battery not sufficiently charged.
- Driver's door not shut.
- Driver's seat belt not fastened.
- REVERSE (R) gear engaged (e.g. for parking maneuvers).
- With the automatic climate control active, an adequate cabin heating or cooling comfort has not been reached or with MAX-DEF function active.
- During the first period of use, to initialize the system.
- Steering angle beyond threshold.

ENGINE RESTARTING CONDITIONS

Due to comfort, emission control, and safety reasons, the engine can restart automatically without any action by the driver, under special conditions, such as:

- Battery not sufficiently charged.
- Reduced braking system vacuum (e.g. if the brake pedal is pressed repeatedly).
- Vehicle moving (e.g. when driving on roads with a grade).
- Engine stopping by the Stop/Start system for more than approximately three minutes.
- With the automatic climate control active, an adjustment in cabin heating or cooling is made or with MAX-DEF function active.

SAFETY FUNCTIONS

When the engine is stopped through the Stop/Start system, if the driver releases their seat belt, opens the driver's or passenger's door, or opens the hood from inside the vehicle, the engine can be restarted only by using the ignition.

This condition is indicated to the driver both through a buzzer and a message on the instrument cluster display.

ENERGY SAVING FUNCTION

If the driver does not carry out any action for more than three minutes after the automatic engine restart, the Stop/Start system will switch off the engine in order to prevent fuel consumption.

In this situation, the engine can only be restarted using the ignition device.

NOTE:

It is possible to keep the engine running by deactivating the system.

IRREGULAR OPERATION

In the event of malfunction, the Stop/Start system is deactivated.

For failure indications → page 75.

VEHICLE INACTIVITY

In the event of vehicle inactivity (or if the battery is replaced), special attention must be paid to the disconnection of the battery power supply.

Proceed as follows:

Remove connector from socket to disconnect sensor (battery status monitoring) installed on the negative pole of the battery. This sensor should never be disconnected from the pole except if the battery is replaced.



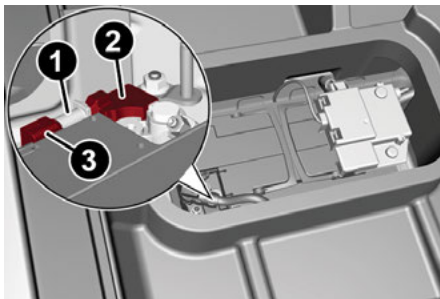

Battery Power Supply

- 1 – Socket
- 2 – Sensor
- 3 – Connector

NOTE:

After setting the ignition to OFF and having closed the driver side door, wait at least one minute before disconnecting the electrical supply from the battery. When reconnecting the electrical supply to the battery, make sure that the ignition is in the OFF mode and the driver side door is closed.

SPEED LIMITER

DESCRIPTION

This feature allows the driver to program the maximum speed of the vehicle.

NOTE:

The maximum set speed can be exceeded by continuing to press the accelerator pedal.

The maximum speed can be set with the vehicle stationary or in motion. The minimum speed that can be set is 18 mph (30 km/h).

When this feature is active, the vehicle speed depends on the pressing of the accelerator pedal until the programmed speed limit is reached → page 106.

ACTIVATION

The feature can be activated/deactivated through the radio system.

Activating The Device

To access this feature, select the “Driver Assistance” widget in the radio system, then select the following items in sequence:

1. “Speed Limiter”
2. “ON”

The activation of this feature is signaled by the illumination of the green Speed Limiter icon, along with the last speed set, in the instrument cluster display. The Speed Limiter feature can remain active concurrently with the Cruise Control system. If a speed limit below the one indicated in the Cruise Control is selected, the Cruise Control speed will be lowered to that of the Speed Limiter. This function remains available in RACE mode.



Speed Limiter Display

SPEED LIMIT PROGRAMMING

The speed limit can be programmed through the radio system.

To access the function on the main menu, select the following items in order:

1. “Driver Assistance”
2. “Speed Limiter - Set Speed”

By turning the Rotary Pad, the speed increases by 5 mph (5 km/h), from a minimum of 18 mph (30 km/h) to a maximum of 112 mph (180 km/h).

EXCEEDING THE PROGRAMMED SPEED

By fully pressing the accelerator pedal, the programmed speed can be exceeded even with the device active (e.g. in the event of overtaking).

The device is disabled until the speed drops below the set limit, after which it reactivates automatically.

PROGRAMMED SPEED ICON FLASHING

The programmed speed will flash in the following scenarios:

- When the accelerator pedal has been fully pressed and the vehicle has exceeded the programmed speed.
- Activating the system after setting a limit below the effective speed of the vehicle.
- In the event of overtake acceleration.

DEACTIVATION

The feature can be activated/deactivated through the radio system.

Deactivating The Device

To access this feature, select the “Driver Assistance” widget in the radio system, then select the following items in sequence:

1. “Speed Limiter”
2. “OFF”

Automatic Deactivation Of The Device

The device deactivates automatically in the event of fault in the system. In this case, contact an authorized dealer.

Temporary Signal Loss

When the device loses the signal, the white symbol without the speed indication illuminates on the display.

System Failure

If there is a system failure, the amber symbol illuminates on the display.

CRUISE CONTROL SYSTEMS – IF EQUIPPED

Your vehicle may be equipped with the Cruise Control system, or the Adaptive Cruise Control (ACC) system:

- Cruise Control will keep your vehicle at a constant preset speed.
- Adaptive Cruise Control (ACC) will adjust the vehicle speed up to the preset speed to maintain a distance with the vehicle ahead.

NOTE:

- In vehicles equipped with ACC, if ACC is not enabled, Fixed Speed Cruise Control will not detect vehicles directly ahead of you. Always be aware of the mode selected.
- Only one Cruise Control feature can operate at a time. For example, if Fixed Speed Cruise Control is enabled, Adaptive Cruise Control will be unavailable, and vice versa.

CRUISE CONTROL

When engaged, the Cruise Control takes over accelerator operations at speeds greater than 20 mph (32 km/h).



Cruise Control On/Off Switch

The Cruise Control buttons are located on the left side of the steering wheel.

While driving downhill, the system could brake the vehicle to keep the set speed the same.



WARNING!

Cruise Control can be dangerous where the system cannot maintain a constant speed. Your vehicle could go too fast for the conditions, and you could lose control and have an accident. Do not use Cruise Control in heavy traffic or on roads that are winding, icy, snow-covered or slippery.

To Activate

To activate the Cruise Control system, push the on/off button located on the left side of the steering wheel.

The activation of the system is signaled by the white warning light illuminating in the instrument cluster display.



Cruise Control Indicator Light

The Cruise Control function can remain active at the same time as the Speed Limiter system. If the set speed is higher than the speed set with the Speed Limiter, the set speed will be lowered to that of the Speed Limiter.



WARNING!

Leaving the Cruise Control system on when not in use is dangerous. You could accidentally set the system or cause it to go faster than you want. You could lose control and have an accident. Always ensure the system is OFF when you are not using it.

To Set A Desired Speed

To set a desired speed, proceed as follows:

1. Turn the Cruise Control on.
2. When the vehicle has reached the desired speed, push the SET switch up or down and release to activate. When the accelerator is released, the vehicle will maintain the selected speed automatically.



SET Switch Location

If needed (when overtaking for instance), you can accelerate beyond the set speed by pressing the accelerator. When you release the pedal, the vehicle goes back to the previously set speed.

When traveling downhill with the system active, the vehicle speed may slightly exceed the set one.

NOTE:

Before pushing the SET switch, the vehicle must be traveling at a constant speed on a flat surface.

To Vary The Speed Setting

To Increase Or Decrease The Set Speed

When the Cruise Control is set, you can increase the speed by pushing the SET switch upward or decrease the speed by pushing the SET switch downward.

U.S. Speed (mph)

- Pushing the SET switch once will result in a 1 mph speed adjustment. Each subsequent movement of the switch results in an adjustment of 1 mph.
- If the switch is continually pushed, the set speed will continue to adjust until the switch is released, then the new set speed will be established.

Metric Speed (km/h)

- Pushing the SET switch once will result in a 1 km/h speed adjustment. Each subsequent movement of the switch results in an adjustment of 1 km/h.
- If the switch is continually pushed, the set speed will continue to adjust until the switch is released, then the new set speed will be established.

NOTE:

Moving the SET switch allows for adjusting of the speed according to the selected unit of measurement set on the radio system. Refer to the Information and Entertainment System Owner's Manual for more information.

To Accelerate For Passing

Press the accelerator as you would normally. When the pedal is released, the vehicle will return to the set speed.

Using Cruise Control On Hills

The transmission may downshift on hills to maintain the vehicle set speed.

NOTE:

The Cruise Control system maintains speed up and down hills. A slight speed change on moderate hills is normal.

On steep hills, a greater speed loss or gain may occur so it may be preferable to drive without Cruise Control.



WARNING!

Cruise Control can be dangerous where the system cannot maintain a constant speed. Your vehicle could go too fast for the conditions, and you could lose control and have an accident. Do not use Cruise Control in heavy traffic or on roads that are winding, icy, snow-covered or slippery.

To Resume Speed

To resume a previously set speed, push the RES button and release. Resume can be used at any speed above 20 mph (32 km/h).

NOTE:

Before returning to the previously set speed, you must accelerate to a speed close to the set speed, then push and release the RES button.



Resume Button Location

In AutoStick (sequential) mode, before resuming the previously set speed, you should accelerate until you are close to that speed. Then, push and release the RES button.

To Deactivate

A tap on the brake pedal deactivates the Cruise Control without deleting the set speed.

The Cruise Control may also be deactivated by applying the Electric Park Brake or when the braking system is operated (e.g. operation of the Electronic Stability Control (ESC) system).

The set speed is deleted in the following cases:

- Pushing the on/off button a second time
- The ignition is placed in the OFF position
- If there is a malfunction with the Cruise Control system

ADAPTIVE CRUISE CONTROL (ACC)

The Adaptive Cruise Control (ACC) is a driver assist system that combines the Cruise Control functions with controlling the distance from the vehicle ahead. ACC increases the driving convenience provided by Cruise Control while traveling on highways and major roadways. However, it is not a safety system and not designed to prevent collisions. The Cruise Control function performs differently [page 107](#).

ACC will allow you to keep Cruise Control engaged in light to moderate traffic conditions without the constant need to reset your Cruise Control. ACC uses a radar sensor located behind the front bumper and a camera located in the center/upper part of the windshield, to detect the presence of a vehicle close ahead.



The system sets and holds the vehicle at the desired speed without needing to press the accelerator. It also sets and holds a distance from the vehicle ahead (these settings are set by the driver).



Front Bumper Radar Location



Windshield Camera Location

If the system detects a vehicle ahead, it will automatically intervene by slightly braking or accelerating in order to maintain the preset distance. It will not exceed the original set speed when adapting to the speed of the vehicle ahead.

NOTE:

Adaptive Cruise Control performance is not guaranteed under the following circumstances, and it is recommended to turn the system off when:

- Driving in fog, heavy rain, or snow.
- Driving in heavy traffic or construction zones.
- Driving on icy, snowy, slippery roads, roads with steep inclines, or roads with numerous turns and bends.
- Entering a turn lane.
- When circumstances do not allow safe driving at a constant speed → page 278.



WARNING!

- Adaptive Cruise Control (ACC) is a convenience system. It is not a substitute for active driver involvement. It is always the driver's responsibility to be attentive of road, traffic, and weather conditions, vehicle speed, distance to the vehicle ahead; and, most importantly, brake operation to ensure safe operation of the vehicle under all road conditions. Your complete attention is always required while driving to maintain safe control of your vehicle. Failure to follow these warnings can result in a collision and death or serious personal injury.
- The ACC system:
 - May react to pedestrians, oncoming vehicles, and stationary objects (e.g., a stopped vehicle in a traffic jam or a disabled vehicle) at speeds between 2 mph and 35 mph (4 km/h and 60 km/h).
 - Cannot take street, traffic, and weather conditions into account, and may be limited upon adverse sight distance conditions.

(Continued)



WARNING! (Continued)

- Does not always fully recognize complex driving conditions, which can result in wrong or missing distance warnings.
- Will bring the vehicle to a complete stop while following a vehicle ahead and hold the vehicle for approximately two minutes in the stop position. If the vehicle ahead does not start moving within two minutes, the parking brake will be activated and the ACC system will be canceled.

You should switch off the ACC system:

- When driving in fog, heavy rain, heavy snow, sleet, heavy traffic, and complex driving situations (i.e., in highway construction zones).
- When entering a turn lane or highway off ramp; when driving on roads that are winding, icy, snow-covered, slippery, or have steep uphill or downhill slopes.
- When circumstances do not allow safe driving at a constant speed.

Activating Adaptive Cruise Control (ACC)

The minimum set speed for the ACC system is 19 mph (30 km/h) and the maximum is 110 mph (180 km/h).

The system **cannot** be activated:

- When pressing the brake pedal.
- When the brakes are overheated.
- When the Electric Park Brake has been operated.
- When either PARK, REVERSE or NEUTRAL is engaged.
- When the engine RPM is above a maximum threshold.
- When the vehicle speed is not within the operational speed range.
- When the Electronic Stability Control (ESC) (or Anti-Lock Brake System (ABS) or other stability control systems) are operating or have just operated.
- When the ESC system is off.
- When the Forward Collision Warning system (if equipped) is braking automatically.
- In the event of a system failure.
- When the engine is off.
- In case of obstruction of the radar sensor (in this case the bumper area where it is located must be cleaned).

If the system is set, the conditions described above also cause a cancellation or deacti-

vation of the system. These situations may vary according to the conditions.

NOTE:

The system will not be deactivated when speeds higher than those set are reached by pressing the accelerator pedal above 110 mph (180 km/h). In these situations, the system may not work correctly and it is recommended to deactivate it.

To Activate/Deactivate

The system has four operating states:

- Enabled (speed not set)
- Activated (speed set)
- Paused
- Deactivated

To Activate

To enable the system, push and release the on/off button located on the left side on the steering wheel.



On/Off Button



When the system is enabled and ready to operate, the display shows the white ACC icon above dashes in place of the speed.



Enabled Icons

Setting a speed activates the system. The display shows the icon in green with the set speed.



WARNING!

Leaving the Adaptive Cruise Control (ACC) system on when not in use is dangerous. You could accidentally set the system or cause it to go faster than you want. You could lose control and have a collision. Always leave the system off when you are not using it.

To Pause/Deactivate

With the feature enabled (speed not set), push the on/off button to disable.

With the feature active (speed set), push the on/off button to pause. The display will show the icon in white with the speed in brackets. To deactivate the feature, push the on/off button a second time.

To Set A Desired Speed

When the vehicle reaches the desired speed, push the RES/SET switch downward and release it to activate the system. When the accelerator is released, the vehicle will maintain the set speed automatically.



SET Switch

While the accelerator pedal is pressed, the system will not be able to control the distance between the vehicle and the one ahead. In this case, the speed will be determined only by the position of the accelerator pedal.

The system will return to normal operation as soon as the accelerator pedal is released.

To Vary The Speed Setting

To Increase Or Decrease The Set Speed

Once the system has been activated, you can increase the speed by pushing the RES/SET switch upward or decrease the speed by pushing the RES/SET switch downward. Each time the switch is pushed, the speed is adjusted by 1 mph.

Pushing and holding the switch upward or downward will cause the set speed to adjust in 5 mph increments until the button is released. The new set speed is reflected in the instrument cluster display.

NOTE:

- Moving the RES/SET switch downward allows you to adjust the speed according to the selected unit of measurement ("U.S." or "Metric") set on the radio system. Refer to the Information and Entertainment System Owner's Manual for more information.
- When the unit of measurement is set to Metric, pushing and holding the RES/SET switch will adjust the speed in 10 km/h increments.
- By keeping the accelerator pedal pressed, the vehicle can continue to accelerate beyond the set speed. In this case, use the RES/SET switch to set the speed to the vehicle's current speed.

- When you push the RES/SET button to reduce the speed, the braking system intervenes automatically if the engine brake does not slow the vehicle down sufficiently to reach the set speed. The device holds the set speed uphill and downhill; however a slight variation is entirely normal, particularly on slight inclines.
- The transmission could shift to a lower gear when driving downhill, or when accelerating. This is normal and necessary to maintain the set speed.
- The system will disable while driving if the brakes overheat.

To Resume

Once the system has been canceled but not deactivated, to resume a previously set speed, simply push the RES/SET switch upward and remove your foot from the accelerator to recall it. The system will be set to the last stored speed.



WARNING!

The Resume function should only be used if traffic and road conditions permit. Resuming a set speed that is too high or too low for prevailing traffic and road conditions could cause the vehicle to accelerate or decelerate too sharply for safe operation. Failure to follow these warnings can result in a collision and death or serious personal injury.

Setting The Distance Between Vehicles

The distance between your vehicle and the vehicle ahead may be set to one bar (short), two bars (medium), three bars (long), or four bars (maximum).



Distance Icons

The distances from the vehicle ahead are proportional to speed.

The interval of time with relation to the vehicle ahead remains constant and varies from one second (for the short distance one-bar setting) to two seconds (for the maximum distance four-bar setting).

The set distance is shown on the display by a dedicated icon.

The setting is four bars (maximum) the first time the system is used. After the distance has been modified by the driver, the new distance will be stored even if the system is deactivated and reactivated.

To Decrease The Distance

Push and release the distance button to decrease the distance setting. The distance setting decreases by one bar (shorter) every time the button is pushed.



Distance Button

The set speed is held if there are no vehicles ahead. Once the shortest distance has been selected, the next push of the button will set the maximum distance.

If a slower vehicle is detected in the same lane, the vehicle icon on the display illuminates from grey to white. The system automatically adjusts the vehicle's speed to keep the set distance, independently of the set speed.

The vehicle holds the set distance until:

- ❑ The vehicle ahead accelerates to a speed higher than the set speed.
- ❑ The vehicle ahead leaves the lane or the detection field of the Adaptive Cruise Control system sensor.
- ❑ The distance setting is changed.
- ❑ The Adaptive Cruise Control system is deactivated/paused.



WARNING!

- ❑ The maximum braking applied by the system is limited. The driver may apply the brakes in all cases if needed.
- ❑ If the system predicts that the braking level is insufficient to hold the set distance, either “BRAKE!” or a dedicated message is displayed to warn the driver of approaching the vehicle ahead. An acoustic signal is also emitted. In this case, it is advised to brake immediately as necessary to hold a safe distance from the vehicle ahead.
- ❑ The driver is responsible for ensuring that there are no pedestrians, other vehicles or objects along the direction of the vehicle. Failure to comply with these precautions may cause serious accidents and injuries.

(Continued)



WARNING! (Continued)

- ❑ The driver is fully responsible for holding a safe distance from the vehicle ahead respecting the highway code in force in the respective country.

Overtake Aid

When driving with ACC engaged and following a vehicle at a speed greater than 45 mph (70 km/h), the system will provide an additional acceleration up to the ACC set speed to assist in passing the vehicle. This additional acceleration is triggered when the driver utilizes the left turn signal and will only be active when passing on the left hand side.

The system detects the direction of traffic automatically when the vehicle passes from left hand traffic to right hand traffic. In this case, the overtaking assist function is only active when the reference vehicle is overtaken on the right. The additional acceleration is deactivated when the driver uses the right direction indicator and returns to the original lane.

“Stop And Go” Function

The “Stop and Go” operating strategy allows you to maintain a safe distance from the vehicle ahead until the vehicle has completely stopped.

In the event that the ACC system brings your vehicle to a standstill while following the vehicle in front, if the vehicle in front starts

moving within two seconds of your vehicle coming to a standstill, your vehicle will resume motion without the need for any driver action.

If the vehicle in front does not start moving within two seconds of your vehicle coming to a standstill, the driver will have to push the RES/SET switch upward to restart.



WARNING!

When the ACC system is resumed, the driver must ensure that there are no pedestrians, vehicles or objects in the path of the vehicle. Failure to follow these warnings can result in a collision and death or serious personal injury.

Deactivation

The system is deactivated and the set speed is canceled if:

- ❑ The on/off button is pushed (when the system is on or paused).
- ❑ The ignition is placed in the OFF position
- ❑ RACE mode is activated (Quadrifoglio models)

The system is canceled (the set speed and distance are stored):

- ❑ When the system is paused → page 111
- ❑ When the conditions shown in the “Activating Adaptive Cruise Control (ACC)” section occur → page 111

Limited Operation Warning

If the dedicated message is shown on the display, a condition limiting the Adaptive Cruise Control operation may have occurred.

This could be due to an obstruction of the vehicle's sensor or camera. It could also be due to a fault in the system. If an obstruction is detected, clean the area of the windshield opposite the interior rearview mirror, where the camera is located, as well as the area of the front fascia/bumper where the sensor is located. Then check that the message has disappeared.

When the conditions limiting the system functions end, normal operation will resume.

Should the fault persist, contact an authorized dealer.

Precautions While Driving With ACC

In certain driving situations, ACC may have detection issues. In these cases, ACC may brake late or unexpectedly. The driver needs to stay alert and may need to intervene. The following are examples of these types of situations:

Towing A Trailer

Towing a trailer is not advised when using ACC.

Offset Driving

ACC may not detect a vehicle in the same lane that is offset from your direct line of travel, or a vehicle merging in from a side lane. There may not be sufficient distance to the vehicle ahead. The offset vehicle may move in and out of the line of travel, which can cause your vehicle to brake or accelerate unexpectedly.

Turns And Bends

When driving on a curve with ACC engaged, the system may increase or decrease the vehicle speed for stability, with no vehicle ahead detected. Once the vehicle is out of the curve the system will resume your original set speed. This is a part of normal ACC system functionality.

NOTE:

- On tight turns ACC performance may be limited. In this case, it is advisable to deactivate the system.
- The system only limits the speed DURING a bend and not BEFORE it.

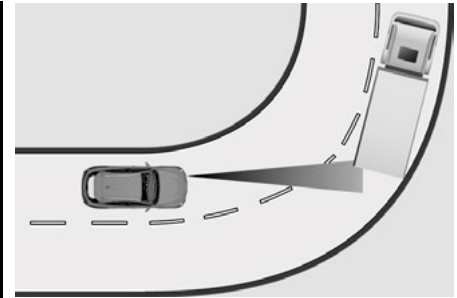

Steering And Curves

Using ACC On Hills

When driving on hills, ACC may not detect a vehicle in your lane. Depending on the speed, vehicle load, traffic conditions, and the steepness of the hills, ACC performance may be limited.

NOTE:

The driver must maintain control of the vehicle, remain alert, and be ready to apply the brakes if needed.

Lane Changing

ACC may not detect a vehicle until it is completely in the lane in which you are traveling. In the lane changing example below, ACC has not yet detected the vehicle changing lanes and it may not detect the vehicle until it's too late for the ACC system to take action. ACC may not detect a vehicle until it is completely in the lane. There may not be sufficient



distance to the lane-changing vehicle. Always be attentive and ready to apply the brakes if necessary.

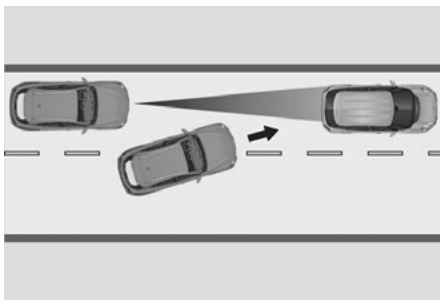

Lane Change

Narrow Vehicles

Some narrow vehicles traveling near the outer edges of the lane or edging into the lane are not detected until they have moved fully into the lane. There may not be sufficient distance to the vehicle ahead.

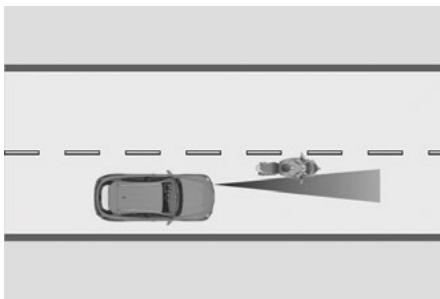

Narrow Vehicles

Stationary Objects And Vehicles

The ACC system can detect stationary vehicles when the vehicle is traveling at speeds between 2 mph and 35 mph (4 km/h and 60 km/h). The driver should always be attentive and be ready to press the brakes if necessary.

Objects And Vehicles Moving In Opposite Or Crosswise Direction

The system cannot detect the presence of objects or vehicles traveling in opposite or crosswise directions and consequently will not activate.

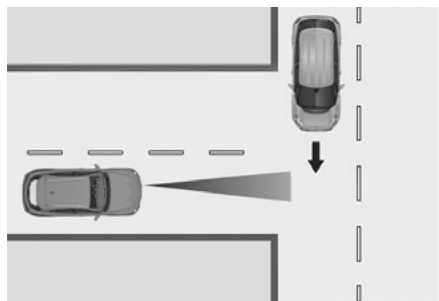

Objects And Vehicles Moving In Opposite Or Crosswise Direction

IFETEL: RCPBOMR 14-0766

La operación de este equipo está sujeta a las siguientes dos condiciones:

1. es posible que este equipo o dispositivo no cause interferencia perjudicial y
2. este equipo o dispositivo debe aceptar cualquier interferencia, incluyendo la que pueda causar su operación no deseada.

Changes or modifications made to this equipment not expressly approved by Robert BOSCH GmbH may void the FCC authorization to operate this equipment.

This equipment has been tested and found to comply with the limits for a Class A digital device, pursuant to Part 15 of the FCC Rules. These limits are designed to provide reasonable protection against harmful interference when the equipment is operated in a commercial environment. This equipment generates, uses, and can radiate radio frequency energy and, if not installed and used in accordance with the instruction manual, may cause harmful interference to radio communications. Operation of this equipment in a residential area is likely to cause harmful interference in which case the user will be required to correct the interference at his own expense.

Toutes modifications apportées à cet équipement qui ne sont pas expressément homologuées par Robert BOSCH GmbH peuvent annuler l'autorisation de la FCC de faire fonctionner cet équipement.

Cet appareil a été vérifié et s'est révélé conforme aux normes applicables aux appareils numériques de catégorie A, en vertu de la section 15 des règlements de la FCC. Ces normes sont définies pour fournir une protection raisonnable contre les interférences nuisibles lorsque l'équipement est utilisé dans les installations résidentielles. Cet appareil génère, utilise et peut émettre des ondes radioélectriques et, s'il n'est pas installé et utilisé conformément au manuel d'instruction, peut causer un brouillage radioélectrique nuisible aux communications radio. Le fonctionnement de cet équipement dans une zone résidentielle est susceptible de causer des interférences nuisibles; dans ce cas, l'utilisateur doit corriger les interférences à ses propres frais.

Radio Frequency Exposure Information

This equipment complies with FCC radiation exposure limits set forth for an uncontrolled environment. This equipment should be installed and operated with minimum distance of 20 cm between the radiator and your body.

This transmitter must not be co-located or operating in conjunction with any other antenna or transmitter.

Déclaration d'exposition aux radiations

Cet équipement est conforme aux limites d'exposition aux rayonnements IC établies pour un environnement non contrôlé. Cet équipement doit être installé et utilisé avec un minimum de 20 cm de distance entre la source de rayonnement et votre corps.

Ce transmetteur ne doit pas être placé au même endroit ou utilisé simultanément avec un autre transmetteur ou antenne.

HIGHWAY ASSIST SYSTEM (HAS) — IF EQUIPPED

The Highway Assist System (HAS) is a driving assistance system that is only available when driving on highways. The system operates up to speeds of 90 mph (145 km/h) when horizontal signs are detected.

The system uses information from the front camera and radar to help keep the vehicle in the center of the lane and at a constant speed.

HAS combines Adaptive Cruise Control (ACC) functions with lane centering logic to control the trajectory of the vehicle. HAS requires the driver's hands to remain on the steering wheel.

Once HAS is activated, a dedicated screen will appear on the instrument cluster display.

TO ACTIVATE/DEACTIVATE

To Activate

To activate the HAS system, push the button located on the left side of the steering wheel.



Highway Assist Button

Suspension Conditions

The following operations will suspend the HAS system:

- Steer manually
- Press the brake pedal
- Disable the ACC device
- Activate the turn signals
- Push the ACC activation setting button for two seconds to activate Cruise Control
- Place the gear selector in PARK, REVERSE, or NEUTRAL

Reactivating the ACC system will reactivate HAS → page 109.



Automatic Deactivation

The system can be deactivated in the following situations:

- If there are narrow bends
- When hands are removed from the steering wheel
- If the left or right turn signal is activated
- If the driver intentionally changes lanes without using the turn signal
- If the driver's seat belt is released
- If the gear selector is placed in DRIVE
- If the "Active Braking" function is activated
↳ page 160
- If the vehicle exits the highway
- If the lane markings are not detected by the camera
- If the ACC device is deactivated
- If the vehicle speed exceeds 90 mph (145 km/h)

NOTE:

- When the HAS system is turned off, the symbol on the display turns red and then grey.
- Hands on the steering wheel are detected by a capacitive sensor installed in it.

When the automatic suspension conditions are over, HAS will be automatically reactivated.

OPERATION

HAS only operates when the driver's hands are on the steering wheel.

If the system detects that the driver's hands have been removed from the steering wheel, the system will alert the driver to place their hands back on the steering wheel
↳ page 119.

If the vehicle crosses the lane boundary, the steering wheel will vibrate and the dedicated screen will appear in the instrument cluster display.

NOTE:

HAS may take up to five seconds to turn on once all conditions are met. During this time, a grey indicator light will appear on the instrument cluster display and the system will automatically activate as soon as all of the conditions are met with no intervention from the driver.

The following conditions must be met before HAS turns on:

- HAS must be enabled by pushing the button on the steering wheel
- The vehicle must be on a highway
- ACC must be activated
- The right and left lane boundaries must be visible
- The vehicle speed must be between 0 and 90 mph (0 and 145 km/h)

- The camera, radar, and radio system must be functioning properly
- The road lane width must be between 8.5 ft and 13.7 ft (2.6 m and 4.2 m)
- The turn signals must not be activated
- HAS must be functioning properly

Other operating limits:

- If the speed of ACC can be set to a higher value (top speed 110 mph (180 km/h), HAS is only available as long as the vehicle speed is equal to or less than 90 mph (145 km/h).
- When the ACC speed is reduced and the vehicle speed is less than 90 mph (145 km/h), the system will automatically reactivate.
- If the ACC speed is set to 90 mph (145 km/h), traveling downhill may increase the vehicle speed. HAS will deactivate until the speed returns to 90 mph (145 km/h).

INDICATIONS ON THE DISPLAY

The HAS status can always be viewed in the instrument cluster display.

The system status is indicated by the color of the symbol on the display.

HAS uses sensors in the steering wheel to detect if the driver's hands are on it.

If the driver's hands are not on the steering wheel, a series of warnings will appear in the instrument cluster display to alert the driver to

reposition their hands on the steering wheel. An acoustic signal will also sound. After a period of time, HAS will disable if the driver's hands do not return to the steering wheel.

After a period of time, HAS will disable if the driver has not repositioned their hands on the steering wheel.

When the system does not detect hands on the steering wheel, it will warn the driver by displaying a dedicated screen on the instrument cluster display.

SYSTEM STATUS

Active System

When the system is active, the screen below will appear in the instrument cluster display.



Highway Assist System Active

If on a different menu screen, a symbol will appear on the instrument cluster display indicating that the system is active.

When the driver's hands are removed from the steering wheel, the system disables after a few seconds. A screen will appear in the instrument cluster display warning the driver to return their hands to the steering wheel.

Active System (Hands Removed From The Steering Wheel For A Short Time)

As soon as the driver removes their hands from the steering wheel, the screen below will appear in the instrument cluster display. The system will remain active at this time.



Hands Removed Initial Warning

If the driver does not return their hands to the steering wheel within a few seconds, the screen below will appear in the instrument cluster display.



Hands Secondary Warning

Active System (Hands Removed From The Steering Wheel For A Long Time)

If the driver still has not returned their hands to the steering wheel after the screen above is displayed, the below screen will now appear in the instrument cluster display, and an acoustic signal will sound until the driver regains control of the vehicle.

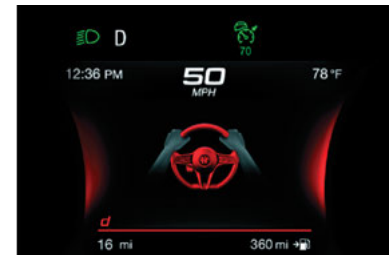

Hands Removed Final Warning

If the driver's hands are not returned to the steering wheel after an extended period of time, a deactivation message will appear on

the instrument cluster display. The steering wheel control will be deactivated.

This display will remain active even when the driver's hands are removed from the steering wheel. The symbol on the display will turn grey.

When HAS is active, the Lane Keeping Assist (LKA)/ Lane Departure Warning (LDW) systems (if equipped), if previously activated, will remain activated.

LIMITED SYSTEM AVAILABILITY/ OPERATION

System Availability

External factors and conditions may affect the proper operation of HAS, such as:

- Narrow, winding, curvy streets
- Poor visibility (due to heavy rain, snow, fog, etc.)
- Front lights of oncoming vehicles or direct sunlight or shade
- Damage or obstructions caused by mud, ice, snow, etc.
- Bumper damaged or not aligned
- Interference with other equipment that causes electromagnetic waves
- Presence of roadwork/road construction sites
- If the indications given by the navigation system (if any) of the radio system are not yet ready and/or if the navigation system is recalculating the route

System Limited Operation

HAS may have limited or reduced functionality when one of the following conditions occur:

- Lane markings are not clear or in conditions of poor visibility (e.g. in heavy rain, snow, fog, etc.)
- Either the camera or radar are damaged, covered, or obstructed (e.g. by mud, ice, snow, etc.)
- When driving on hills or roads with narrow bends
- Near highway toll booths
- When the highway entrance or exit is wider than 20 ft (6 m)
- If the camera is exposed to glare caused by reflections or direct sunlight
- If the navigation system information is unavailable or being recalculated

NOTE:

- If the vehicle approaches a bend that is too narrow with respect to the current speed, HAS will disable.
- If damage to the windshield occurs, have the windshield replaced by an authorized dealer as soon as possible.



WARNING!

To prevent serious injury or death:

- Always remain alert and be ready to take control of the vehicle in the event that HAS disables.
- Always keep your hands on the steering wheel when HAS is activated.
- Maintain a safe distance from other vehicles and pay attention to traffic conditions.

TRAFFIC JAM ASSIST (TJA) SYSTEM — IF EQUIPPED

The Traffic Jam Assist (TJA) system can be activated on all road types. The system uses a camera to detect lane markings and keep the vehicle in the center of the lane.

When the system is unable to detect lane markings, it will still operate using surrounding traffic. This can occur in congested traffic scenarios, when the vehicles ahead or surrounding obstruct the visibility of the lane markings. When the speed is below 12 mph (20 km/h), the system can use a lock-on strategy that allows the vehicle to automatically follow the vehicle ahead.

The TJA system combines Adaptive Cruise Control (ACC) functions with Lane Departure Warning functions to maintain vehicle speed and steering wheel behavior.

NOTE:

Do not use the TJA system while driving in urban areas.

To ACTIVATE/DEACTIVATE

To activate the system, push the button on the left side of the steering wheel.

To deactivate the system, push the button again.



Traffic Jam Assist Button

Suspension Conditions

The following operations will suspend the TJA system:

- Pressing the brake pedal
- Opening the driver's door
- Disabling ACC

- If the vehicle speed exceeds 37 mph (60 km/h)
- Releasing the driver's seat belt
- Placing the gear selector in PARK, REVERSE, or NEUTRAL
- If the Forward Collision Warning system or "Active Braking" intervenes

Automatic Deactivation

System operation will be temporarily disabled under the following conditions:

- When traveling around narrow bends
- If the lane boundaries are not detected
- One of the two lines is interrupted
- The sun is low and reflects on the radar camera
- If the turn signals are activated
- If the driver intentionally changes lanes without using the turn signal
- If manual steering begins
- If the driver's hands are removed from the steering wheel
- When there is no surrounding traffic and there are no horizontal lane boundaries
- If the system is not functioning properly
- If lateral acceleration is high

NOTE:

- When TJA is turned off, the symbol in the instrument cluster display will turn red, and then grey.
- A sensor in the steering wheel detects whether the driver's hands are placed on the steering wheel.

When the automatic suspension conditions are over, the TJA system will be automatically reactivated.

OPERATION

The TJA system can only operate when the driver's hands are on the steering wheel.

If the system detects that the driver's hands have been removed from the steering wheel, a message will appear in the instrument cluster display to alert the driver to place their hands back on the wheel.

NOTE:

- If the vehicle begins to cross the lane boundary, the steering wheel will vibrate and a dedicated screen will appear in the instrument cluster display.
- The TJA system may take up to five seconds to become active once all conditions are met.



The following conditions must be met in order to activate the system:

- The TJA system must be enabled
- The Adaptive Cruise Control (ACC) system must be turned on
- The right and left lane boundaries must be recognized by the system
- The vehicle must be traveling at a speed between 0 and 37 mph (0 and 60 km/h)
- The camera, radar, and radio system must be functioning properly
- The road lane width must be between 8.5 ft and 13.7 ft (2.6 m and 4.2 m)
- The turn signals must be turned off
- The TJA system must be functioning properly
- If the ACC speed is set to 37 mph (60 km/h) or less, traveling downhill may increase the vehicle speed. The system will remain inactive until the speed returns to 37 mph (60 km/h) or less.

INDICATIONS ON THE DISPLAY

The TJA system status is indicated by the color of the symbol in the instrument cluster display.

The system uses sensors in the steering wheel to detect if the driver's hands are present. If the driver's hands are removed, a series of warnings will appear in the instrument cluster

display to alert the driver to reposition their hands on the steering wheel. Acoustic signals will also be emitted.

If the driver's hands are not returned to the steering wheel after a period of time, the system will be disabled.

SYSTEM STATUS

Active System

An active system is indicated by the following screen in the "Driver Assistance" menu on the instrument cluster display.

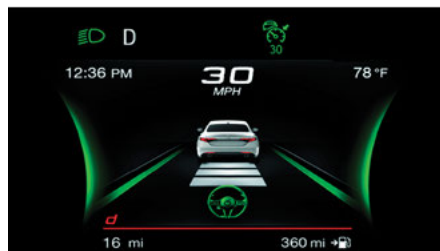

TJA System Active

Active System (Hands Removed From The Steering Wheel For A Short Time)

The following screen will appear in the instrument cluster display immediately after the driver's hands are removed from the steering wheel. The system still remains active at this time.

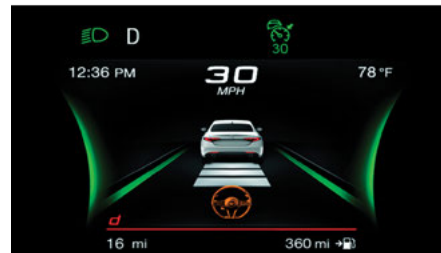

Hands Removed Initial Warning

If the driver does not return their hands to the steering wheel within a few seconds, the following screen will appear in the instrument cluster display.

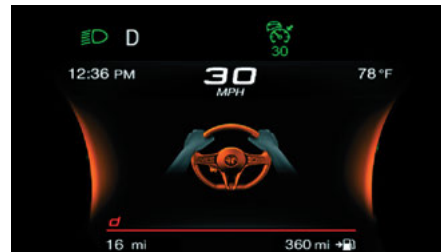

Hands Removed Secondary Warning

Active System (Hands Removed From The Steering Wheel For A Long Time)

If the driver's hands have still not been returned to the steering wheel, the following screen will appear in the instrument cluster display.

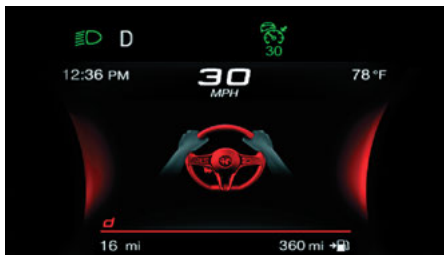

Hands Removed Final Warning

An acoustic signal will sound until the driver regains control of the vehicle (hands on steering wheel). The system is still active at this time.

If the driver's hands are not returned to the steering wheel after a period of time, a deactivation message will appear on the instrument cluster display and the steering wheel control will be deactivated.

Once the symbol on the display turns grey, the system is no longer active and the driver must take control of the vehicle. At this time, the Adaptive Cruise Control (ACC) system and Lane Departure Warning system will also be disabled.

When the TJA system is active, the Lane Keeping Assist (LKA)/Lane Departure Warning (LDW) systems (if equipped) will be temporarily disabled. When TJA is not active, the LKA system (↪ page 132) and LDW system (↪ page 130) will remain active.

LIMITED SYSTEM AVAILABILITY/ OPERATION

System Availability

Performance of the TJA system may be affected by the following factors:

- Narrow, winding, curvy streets
- Lane boundaries that are not clear or in conditions of poor visibility (e.g. heavy rain, snow, fog, etc.)
- If the camera is exposed to glare from direct sunlight or headlights of an oncoming vehicle
- If the camera or sensor is damaged, covered, or obstructed (e.g. by mud, ice, snow, etc.)
- The bumper is damaged or misaligned
- Interference with other equipment causes electromagnetic waves
- Construction sites
- If the indications given by the navigation system of the radio system are not yet ready or if the system is recalculating

System Limited Operation

The TJA system may have limited or reduced functionality when one of the following conditions occurs:

- Lane boundaries are not clear or in conditions of poor visibility (e.g. in heavy rain, snow, fog, etc.)
- Either the camera or radar are damaged, covered, or obstructed (e.g. by mud, ice, snow, etc.)
- When driving on hills or narrow bends
- Near highway toll booths
- When the highway entrance or exit is more than 20 ft (6 m) wide
- If the camera is exposed to glare from reflections or direct sunlight

NOTE:

- If damage to the windshield occurs, have the windshield replaced by an authorized dealer as soon as possible.
- If the vehicle approaches a bend that is too narrow with respect to the current speed, the TJA system will deactivate.



**WARNING!**

To prevent serious injury or death:

- ❑ Always remain alert and be ready to take control of the car in the event that the TJA system disables.
- ❑ Always keep your hands on the steering wheel when the TJA system is activated.
- ❑ Maintain a safe distance from other vehicles and pay attention to traffic conditions.
- ❑ The TJA system should only be used as a driving aid. The driver must always pay attention to their surroundings when the system is operating and be ready to take control of the vehicle at any time.
- ❑ Do not place any objects on the steering wheel (e.g. steering wheel covers) which could interfere with the hand detection sensor on the steering wheel.

TRAFFIC SIGN RECOGNITION (TSR) SYSTEM — IF EQUIPPED

The Traffic Sign Recognition (TSR) system uses a camera mounted on the windshield to detect recognizable road signs such as:

- ❑ Speed limits
- ❑ Signs indicating the end of the situations indicated above

If the camera does not detect valid speed limits, the radio system navigation system may suggest unregulated speed limits.

The system always checks the traffic signs indicating the current speed limit signs. The system is able to recognize and display up to two different road signs in the instrument cluster display.

Depending on the unit of measurement (km or mph) set through the “Unit of Measurement” menu in the radio system, the TSR system will automatically show the indication of the road sign in the unit of measurements selected in the instrument cluster display.

TO ACTIVATE/DEACTIVATE

The TSR system can be activated/deactivated in the radio system in the “Driver Assistance” menu. The system activation is signaled by road signs shown on the instrument cluster display.

NOTE:

- ❑ By selecting “Blinking”, the driver can activate a warning to display when the speed exceeds the limit indicated by the TSR system. The speed road sign on the instrument cluster display will blink until the vehicle speed drops below the displayed limit.
- ❑ Selecting “Offset” will set the speed at which “Blinking” is activated up to a maximum of 6 mph (10 km/h) above the limit detected by the system.

- ❑ If no speed limit signs are found, the system will revert to the speed limit signs that are stored in the NAV system.

INDICATIONS ON THE DISPLAY

The system status can always be viewed through the instrument cluster display.

The instrument cluster display shows only the speed limit indications and consists of the following steps:

- ❑ The new speed limit recognized by the system, which is indicated by means of a predetermined color. The road sign indicating the end of the speed limit or a “Road Sign Not Detected” message may appear in this zone.
- ❑ After a predetermined distance, the previously displayed road sign changes color to inform the driver that the speed limit provided may no longer be valid.

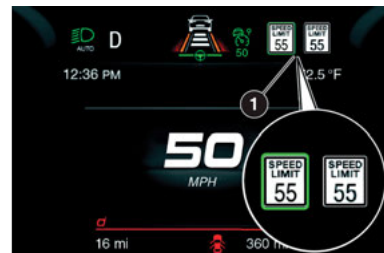

1 — Traffic Sign Recognized



WARNING!

To prevent serious injury or death:

- ❑ Always remain alert and be ready to take control of the vehicle in the event that the TJA system disables.
- ❑ Always keep your hands on the steering wheel when the TJA system is activated.
- ❑ Maintain a safe distance from other vehicles and pay attention to traffic conditions.



CAUTION!

- ❑ Functionality may be limited or the system may not work if the sensor is obstructed.
- ❑ The system may have limited operation or not work at all in weather conditions such as heavy rain, hail, thick fog, and low temperatures. Strong light contrasts can influence the recognition capability of the sensor.
- ❑ The area surrounding the sensor must not be covered with stickers or any other object.

(Continued)



CAUTION! *(Continued)*

- ❑ Do not tamper or perform any operations in the area of the windshield glass directly surrounding the sensor.
- ❑ Clean foreign matters such as bird droppings, insects, snow or ice on the windshield. Use specific detergents and clean cloths to avoid scratching the windshield.

INTELLIGENT SPEED CONTROL (ISC) SYSTEM — IF EQUIPPED

The Intelligent Speed Control (ISC) system is always paired with the Adaptive Cruise Control (ACC) system. The ISC system suggests an automatic speed adjustment to the driver based on the speed limit for the road being traveled. The driver can decide whether to accept or reject the automatic speed adjustment, using the switch on the steering wheel.

If the speed limit is exceeded according to the road signs or traffic conditions, a dedicated graphic message is displayed on the instrument cluster display.



RES/SET Switch

To ACTIVATE/DEACTIVATE

To Activate

The system can be activated in the radio system within the “Driver Assistance” menu. The symbol illuminates in the instrument cluster display when the system is active.



1 — ISC System Active



To Deactivate

The system is deactivated under the following conditions:

- When the Traffic Sign Recognition (TSR) system is deactivated
- When the Adaptive Cruise Control (ACC) system is deactivated

NOTE:

Selecting “Speed Offset” allows the driver to set the speed up to a maximum of 10 mph (16 km/h) above or below the suggested speed set by the ISC system. In this instance, the road sign information shown in the instrument cluster display will continue to be detected by the TSR system.

INDICATIONS ON THE DISPLAY

The system status is indicated by a white or green icon in the instrument cluster display (similar to the Adaptive Cruise Control (ACC) device) to the left of the road sign indications provided by the Traffic Sign Recognition (TSR) system.

ACCEPTANCE/REJECTION OF THE SUGGESTED SPEED

The system can be activated if the driver has activated the following systems beforehand:

- Adaptive Cruise Control (ACC)
- Traffic Sign Recognition (TSR)

When these systems are active, a telltale will display in the instrument cluster display indicating the suggested speed provided by the TSR system. The driver has the option to accept or reject this using the RES/SET switch on the steering wheel.

To accept the proposed speed and adjust the speed set by ACC, move the RES/SET switch up or down in the direction indicated in the telltale.

To reject the proposed speed, move the RES/SET switch up or down in the direction opposite of the arrow in the telltale. The ACC system will continue to regulate to the previously set speed.

If the speed set by the ACC system is the same as the speed detected by the TSR system, the speed limit indicator on the instrument cluster display will be highlighted with a green circle.



1 — Suggested Speed Higher Than Current Speed



2 — Suggested Speed Lower Than Current Speed



1 — Road Sign Recognized

PARKSENSE FRONT/REAR PARK ASSIST SYSTEM — IF EQUIPPED

The ParkSense system provides visual and audible indications of the distance between the rear, and if equipped, the front fascia/rear, and if equipped, the front fascia/rear bumper and a detected obstacle when backing up or moving forward (e.g. during a parking maneuver). The vehicle brakes may be

automatically applied and released when performing a reverse parking maneuver if the system detects a possible collision with an obstacle.

When the REVERSE gear is engaged and the system is on, the front and rear sensors are activated. If the vehicle moves from REVERSE to a forward gear, the rear sensors are deactivated, while the front sensors remain active until the speed of 9 mph (15 km/h) is exceeded.

NOTE:

In certain operating conditions, the system could start detecting an obstacle only after the vehicle has moved slightly (a few inches).



WARNING!

Drivers must be careful when backing up even when using the ParkSense system. Always check carefully behind your vehicle, and be sure to check for pedestrians, animals, other vehicles, obstructions, or blind spots before backing up. You are responsible for the safety of your surroundings and must continue to pay attention while backing up. Failure to do so can result in serious injury or death.



CAUTION!

- The ParkSense system is only a parking aid and it is unable to recognize every obstacle, including small obstacles. Parking curbs might be temporarily detected or not detected at all. Obstacles located above or below the sensors will not be detected when they are in close proximity.
- The vehicle must be driven slowly when using the ParkSense system in order to be able to stop in time when an obstacle is detected. It is recommended that the driver looks over his/her shoulder when using the ParkSense system.

PARKSENSE SENSORS

The ParkSense sensors located in the rear fascia/bumper and (if equipped) in the front fascia/bumper, monitor the area in front and behind the vehicle that is within the sensors' field of view. These sensors detect the presence of any obstacles and warn the driver through an acoustic signal and visual indications, which will be displayed on the instrument cluster display.

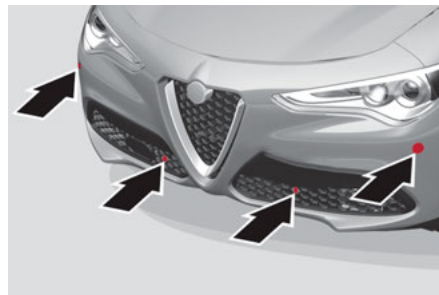

Front Sensor Locations

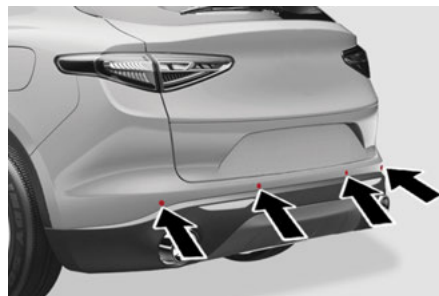

Rear Sensor Locations



PARKSENSE DISPLAY

The driver can select the type of warning they would like to be displayed through the radio system. To access the function on the main menu, select in the following order:

1. “Driver Assistance”
2. “ParkSense”
3. “Mode”
4. “Sound and Display”

Visual Indications

The system indicates the presence of an obstacle by displaying a single red arc in the detected area, in relation to the distance of the object and the position of the vehicle.

If the obstacle is detected in the front or rear central area, a single red arc will be displayed as the obstacle approaches, first constant, then flashing, in addition to an acoustic signal.

If the obstacle is detected in the front or rear left and/or right area, a single red flashing arc will be shown in the corresponding area on the display and the system will emit an acoustic signal, either at frequent intervals or constantly.

In general, the vehicle is closer to the obstacle when a single red flashing arc is shown on the display and the acoustic signal becomes continuous.

If several obstacles are detected simultaneously in the front and rear area, the display will show all of them, regardless of the area in which they were detected.

It is not possible to exit from the display screen while the vehicle is in REVERSE.

Acoustic Signal

In the presence of an obstacle at the front or the rear of the vehicle, an acoustic signal with variable frequency will sound:

- The acoustic signal increases in frequency as the distance between the vehicle and the obstacle decreases.
- The acoustic signal becomes continuous when the distance between the vehicle and the obstacle is less than 11 inches (30 cm), and stops if the distance increases.
- The acoustic signal is constant if the distance between the vehicle and the obstacle is unchanged.

NOTE:

If the sensors detect several front and rear obstacles, the closest obstacle is considered. An intermittent signal will sound if the obstacles are at the same distance (front and rear).

When the system emits an acoustic signal, the volume of the radio system, if activated, is automatically lowered.

An acoustic signal will not sound if the vehicle is in PARK.

ENABLING AND DISABLING PARKSENSE

For vehicles only equipped with rear sensors, to turn the system off, push the ParkSense button located to the left of the headlight switch. The indicator light within the button will illuminate when the system is turned off. Pushing the button a second time will turn the system back on, and the indicator light will turn off.



ParkSense System On/Off Button

For vehicles equipped with front and rear sensors, to turn the front parking sensors off, push the ParkSense button located to the left of the headlight switch. The indicator light within the switch will illuminate when the system is turned off. Pushing the button a second time will turn the front sensors back on, and the indicator light will turn off.

NOTE:

Deactivation of both the front **and** rear parking sensors can only be done through the radio system.

The indicator light within the ParkSense system switch will also be on in case of system failure. If the switch is pushed with a system failure, the indicator light will flash for approximately five seconds. The light will then stay on constantly.

NOTE:

When the ignition is placed in the ON/RUN position, the ParkSense system keeps the last state when the engine was stopped (activated or deactivated) in its memory.

PARKSENSE WARNING DISPLAY

Parking sensor faults, if any, will be indicated when REVERSE is engaged by a message on the instrument cluster display ⇨ page 75.

In case of system failure, a dedicated message appears on the instrument cluster for about five seconds.

- ❑ **Cleaning The Front Or Rear Sensors:** If the display shows a message requiring the sensors to be cleaned, make sure that the outer surface and the underside of the front and rear bumpers are free of debris (e.g. snow, mud, ice, etc.). Once these areas are clear, place the ignition in the OFF position, then return it to ON/RUN. If the message is still displayed, contact an authorized dealer.

- ❑ **Audio System Not Available:** If the display shows a message that the audio system is not available, it means that the acoustic signal will be emitted by the instrument panel, and not through the vehicle's speakers.

OPERATION WITH A TRAILER

The operation of the ParkSense system is automatically deactivated when a trailer's electrical connector is plugged into the vehicle. The sensors are automatically reactivated when the electrical connector is removed.

**WARNING!**

- ❑ Before using the ParkSense system, it is strongly recommended that the ball mount and hitch ball assembly be disconnected from the vehicle when the vehicle is not used for towing. Failure to do so can result in injury or damage to vehicles or obstacles because the hitch ball will be much closer to the obstacle than the rear fascia when the vehicle sounds the continuous tone. Also, the sensors could detect the ball mount and hitch ball assembly, depending on its size and shape, giving a false indication that an obstacle is behind the vehicle.

(Continued)

**WARNING! (Continued)**

- ❑ Drivers must be careful when backing up even when using the ParkSense system. Always check carefully behind your vehicle, look behind you, and be sure to check for pedestrians, animals, other vehicles, obstructions, and blind spots before backing up. You are responsible for safety and must continue to pay attention to your surroundings. Failure to do so can result in serious injury or death.

PARKSENSE SYSTEM USAGE PRECAUTIONS**NOTE:**

Some conditions may influence the performance of the ParkSense system:

- ❑ Reduced sensor sensitivity could be due to the presence of ice, snow, mud, or thick paint on the surface of the sensor.
- ❑ The sensors may detect a false obstacle (echo interference) due to mechanical interference, for example when washing the vehicle or in extreme weather.
- ❑ The signals sent by the sensors can be altered by the presence of ultrasonic systems (e.g. pneumatic brake systems of trucks or pneumatic drills) near the vehicle.



- System performance can be influenced by the position of the sensors. For example, due to a change in the ride setting (caused by wear to the shock absorbers or suspension), by changing tires, overloading the vehicle or operations that require the vehicle to be lowered.
- Be sure not to place bumper stickers or other adhesives over the sensors as this will affect system performance.
- The presence of a trailer hitch without a trailer. This may interfere with the operation of the parking sensors. Before using the ParkSense system, it is recommended to remove or close the trailer hitch assembly when the vehicle is not being used for towing.

LANE DEPARTURE WARNING (LDW) SYSTEM

LANE DEPARTURE WARNING OPERATION

The Lane Departure Warning system uses a forward looking camera located on the windshield to detect lane markings and measure vehicle position within the lane boundaries.

When one or both lane limits are detected and the vehicle passes over one without an activated turn signal, the system emits a visual as well as an acoustic signal.

If the vehicle continues to go beyond the line of the lane without any intervention from the driver, the surpassed line will light up on the display (left or right) to urge the driver to bring the vehicle back into the limits of the lane.



CAUTION!

- Projecting loads on the roof of the vehicle may interfere with the correct operation of the camera. Before starting, make sure the load is correctly positioned in order not to cover the camera operating range.
- Do not cover the operating range of the camera with stickers or other objects.
- Do not tamper with nor operate on the camera. Do not close the openings in the aesthetic cover located under the interior rearview mirror. In the event of a failure of the camera, contact an authorized dealer.
- The camera may have limited or absent operation due to weather conditions such as: heavy rain, hail, thick fog, heavy snow, formation of ice layers on the windshield.

(Continued)



CAUTION! *(Continued)*

- Camera operation may also be compromised by the presence of dust, condensation, dirt or ice on the windshield, by traffic conditions (e.g. vehicles that are driving not aligned with yours, vehicle driving in a transverse or opposite way on the same lane, bend with a small radius of curvature), by road surface conditions and by driving conditions (e.g. off-road driving). Make sure the windshield is always clean. Use specific detergents and clean cloths to avoid scratching the windshield. The camera operation may also be limited or absent in some driving, traffic and road surface conditions.
- If the windshield must be replaced due to scratches, chipping or breakage, contact exclusively an authorized dealer. Do not replace the windshield on your own. It is advisable to replace the windshield if it is damaged in the area of the camera.

TURNING LANE DEPARTURE WARNING ON OR OFF

The system is activated/deactivated by pushing the button located on the end of the multifunction lever, or through the “Driver Assistance” widget through the radio system.

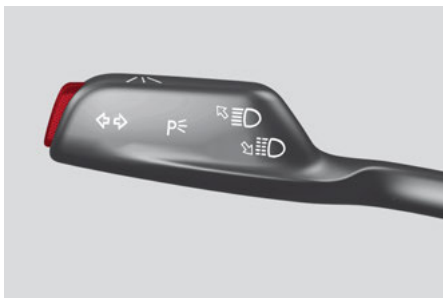

Lane Departure Warning System Activation/Deactivation Button

NOTE:

The Lane Departure Warning system will retain the last system state on or off from the last ignition cycle when the ignition is placed in the ON/RUN position.

Activation Conditions

Once turned on, the system becomes active only if the following conditions are met:

- The vehicle speed is equal to or above 37 mph (60 km/h); the system is deactivated at speeds equal to or greater than 110 mph (180 km/h).

- The lane markings are visible at least on one side.
- There are suitable visibility conditions.
- The road is straight or with wide radius bends.
- A suitable distance is kept from the vehicle in front.
- The turn signal is not active.

LANE DEPARTURE WARNING MESSAGE

The Lane Departure Warning system advises the driver when the vehicle leaves the driving lane by showing symbols and messages on the instrument cluster display.

When the system is active and the lane markings have not been detected, the display shows two grey lane lines.

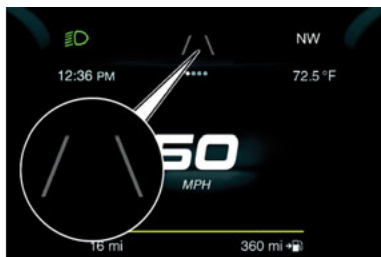

Lane Markings Not Detected

Left Lane Departure — Only Left Lane Detected

When the system is active and only, for example, the left lane marking has been detected, the detected lane illuminates in

white on the display. The system is then ready to provide visual warnings on the display in the event of unintentional exiting of the lane (turn signal not activated) to the left.



Left Lane Marking Detected

When the system detects that the vehicle has approached the lane line and is about to pass it, the left line on the display illuminates in yellow.



Left Lane Marking Approached

The system operates in the same way, but mirrored, in the event of exiting the right lane when only the right lane marking has been detected.

Left Lane Departure — Both Lanes Detected

When the system is active, both lane lines on the display illuminate in white to indicate that both of the lane markings have been detected.

When lane markings are detected, the system is ready to provide indications in case the driver unintentionally leaves the lane (turn signal not activated).

As the Lane Departure Warning system detects the lane markings while the vehicle is in motion, it will adjust the display accordingly (from white to yellow and yellow to white, and increase their thickness).

If a lane line is crossed, the driver is alerted by an audible signal as well as the visual indication in the instrument cluster. The signal is emitted through the speakers on the side of the lane limit which is being crossed (e.g. if the vehicle is exceeding the left line of the lane, the audible signal will come from the speakers on the left of the vehicle).

Limited Operation Warning

If a message appears on the display, a condition limiting the Lane Departure Warning system operation may have occurred. This could be an obstruction of the camera view, or a fault in the system.

If an obstruction is detected, clean the area of the windshield by the interior rearview mirror.

Although the vehicle can still be driven in normal conditions, the system may not function properly.

When the conditions limiting the system are corrected, it will go back to normal operation. Should a fault persist, contact an authorized dealer.

System Failure Warning

If the system turns off and  appears on the display, it means that there is a system fault.

In this case, it is still possible to drive the vehicle, but you are advised to contact an authorized dealer as soon as possible.

CHANGING LANE DEPARTURE WARNING STATUS

The system's sensitivity can be set through the radio system. Sensitivity "High" or "Low" can be selected.

To access the function, from the main menu select the following in order:

1. "Driver Assistance"
2. "Lane Departure Warning"
3. "Sensitivity"

LANE KEEPING ASSIST (LKA) SYSTEM — IF EQUIPPED

The Lane Keeping Assist (LKA) system uses a camera located on the windshield to detect the lane markings and calculate the position of the vehicle within such markings, in order to make sure that the vehicle remains inside the

lane. This is an active system that will apply torque to the steering wheel if it senses that the vehicle is drifting out of the lane.

When one or both lane markings are detected and the vehicle passes over one without a turn signal being applied, the system will apply torque to the steering wheel and a visual signal will be displayed in the instrument cluster display. An audible signal may also sound.

If the vehicle continues to go beyond the lane line without any driver intervention, the surpassed lane line (left or right) will light up on the instrument cluster display to urge the driver to bring the vehicle back inside the lane markings.

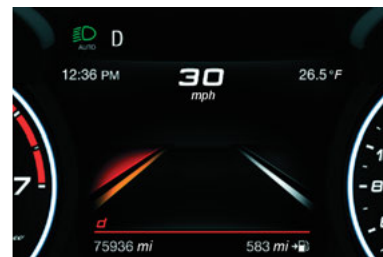

Lane Crossed

TURNING LANE KEEPING ASSIST ON OR OFF

The system is activated/deactivated by pressing the button at the end of the multifunction lever. Each time the engine is

started, the system maintains the operating mode that was selected when it was previously turned off.

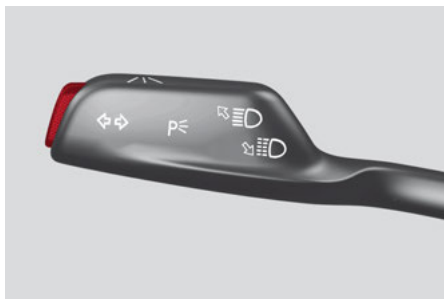

Activation/Deactivation Button

Activation Conditions

Once the activation button is pushed, the system becomes active only if the following conditions are met:

- The car speed is higher than 37 mph (60 km/h). (The system is deactivated at speeds equal to or higher than 110 mph (180 km/h))
- The lane limit lines are visible at least on one side
- There are suitable visibility conditions
- The road is straight or with wide radius bends
- A suitable distance is kept from the vehicle in front
- The turn signal (to indicate leaving the lane) is not active

LANE KEEPING ASSIST WARNING MESSAGE

The Lane Keeping Assist system also advises the driver when the car changes lanes by showing symbols and messages on the instrument cluster display.

The message at the top of the display remains active only until the main reconfigurable area of the display is activated by pressing the TRIP button located on the end of the windshield wiper lever → page 70.

After activating the main reconfigurable area, the Lane Keeping Assist system messages will be shown in the instrument cluster display.

When the system is active and the lane markings have not been detected, the display shows two grey lane lines.



Lane Markings Not Detected

Left Lane Departure — Only Left Lane Detected

When the system is active and only, for example, the left lane marking has been detected, the detected lane lights up in white

on the display; the system is ready to provide visual warnings on the display in the event of unintentional exiting of the lane (turn signal indicator not activated) to the left.



Left Lane Marking Detected

When the system detects that the vehicle has approached the lane marking and is about to pass it, the left line on the display lights up in yellow.



Left Lane Marking Approached

NOTE:

The system operates in the same way, but mirrored, in the event of exiting the right lane when only the right lane marking has been detected.



Left Lane Departure — Both Lanes Detected

When the system is active, both lane lines on the display illuminate in white to indicate the successful detection of both limits.

When lane markings are detected, the system is ready to provide indications in case the driver unintentionally leaves the lane (turn signal not activated).

As the Lane Keeping Assist system detects the lane markings while the vehicle is in motion, it will adjust the display accordingly (from white to yellow and yellow to white, and increase their thickness).

If a lane line is crossed, the driver is alerted by an audible signal as well as the visual indication in the instrument cluster. The signal is emitted through the speakers on the side of the lane marking which is being crossed (e.g. if the vehicle is exceeding the left line of the lane, the audible signal will come from the speakers on the left of the vehicle).

Hands Presence On The Steering Wheel Detection

The system is able to detect the presence of the driver's hands on the steering wheel.

When the system does not detect the presence of hands on the steering wheel for a few seconds (up to 6 seconds), the following screen will be displayed on the instrument cluster display. No acoustic warning will be emitted in this case.

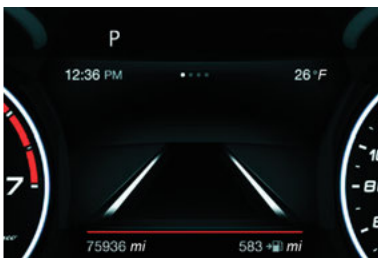
**Hand Presence On The Steering Wheel Not Detected Display (Up To 6 Seconds)**

When the system does not detect the presence of hands on the steering wheel for a few seconds (from 6 to 15 seconds), the following screen will be displayed on the instrument cluster display. A short acoustic signal will sound if hands are not detected on the steering wheel for 6 to 12 seconds.

A continuous signal will sound if hands are not detected on the steering wheel for 12 to 15 seconds.

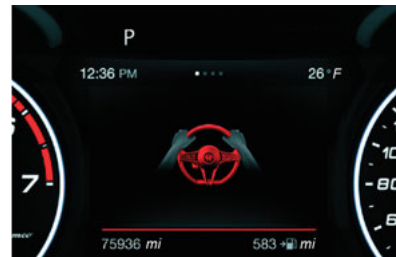
**Hand Presence On The Steering Wheel Not Detected Display (6 To 15 Seconds)**

After 15 seconds with the hands removed from the steering wheel, the LKA system will be deactivated and a dedicated message will be shown on the instrument cluster display. A short acoustic signal will sound in this case.

In any of the situations above where the hands are removed from the steering wheel for more than 6 seconds, it is necessary to reposition the hands on the steering wheel.

Changing The System Sensitivity

The system's sensitivity can be set through the radio system in the "Driver Assistance" menu. Select "Lane Keep Assist - Settings" and then "Keeping sensitivity". Sensitivity "Early" or "Late" can be selected.

Changing The System Strength

The system's strength can be set through the radio system in the "Driver Assistance" menu. Select "Lane Keep Assist - Settings" and then "Strength". Strength "Low" or "High" can be selected.

Limited Operation Warning

If a message appears on the display, a condition limiting the LKA system operation may have occurred. This could be an obstruction of the camera view, or a fault in the system.

If an obstruction is detected, clean the area of the windshield by the interior rearview mirror.

Although the vehicle can still be driven in normal conditions, the system may not function properly.

When the conditions limiting the system are corrected, it will go back to normal operation. Should a fault persist, contact an authorized dealer.

System Failure Signaling

If the system turns off and  appears on the display, it means that there is a system fault.

In this case, it is still possible to drive the vehicle, but you are advised to contact an authorized dealer as soon as possible.



CAUTION!

- ❑ Projecting loads on the roof of the vehicle may interfere with the correct operation of the camera. Before starting, make sure the load is correctly positioned, in order not to cover the camera operating range.
- ❑ If the windshield must be replaced due to scratches, chips or breakage, contact an authorized dealer. Do not replace the windshield on your own; there is risk of malfunction. It is advisable to replace the windshield if it is damaged in the area of the camera.
- ❑ Do not tamper with or operate on the camera. Do not close the openings in the aesthetic cover located under the interior rearview mirror. In the event of a failure of the camera, contact an authorized dealer immediately.
- ❑ Do not cover the operating range of the camera with stickers or other objects. Also pay attention to other objects on the hood (e.g. a layer of snow) and make sure they do not interfere with the camera.

(Continued)



CAUTION! (Continued)

- ❑ The camera may have limited or absent operation due to weather conditions such as: heavy rain, hail, thick fog, heavy snow, formation of ice layers on the windshield.
- ❑ Camera operation may also be compromised by the presence of dust, condensation, dirt or ice on the windshield, traffic conditions (e.g. vehicles that are driving not aligned with yours, vehicle driving in a transverse or opposite way on the same lane, bend with a small radius of curvature), or road surface conditions and driving conditions (e.g. off-road driving). Make sure the windshield is always clean. Use specific detergents and clean cloths to avoid scratching the windshield. The camera operation may also be limited or absent in some driving, traffic and road surface conditions.



REAR BACK UP CAMERA / DYNAMIC GRIDLINES

The Rear Back Up Camera is located on the liftgate, above the rear license plate.



Rear Back Up Camera Location

Camera Activation/Deactivation

To activate the Rear Back Up Camera features, select “Driver Assistance” from the Main Menu of the radio system. Under “Driver Assistance”, Rear Back Up Camera features can be selected:

- View
- Camera Delay
- Camera Guidelines

Selecting “View” will activate the camera view on the display.

Selecting “Camera Delay” will allow the camera view to remain on the display shortly after the vehicle is no longer in REVERSE, followed by the previously active screen.

Selecting “Camera Guidelines” will activate the display of the dynamic guidelines that indicate the route of the vehicle.

When the vehicle is in REVERSE, the radio system display will show the area behind the vehicle, as seen by the Rear Back Up Camera, along with a warning message.



Rear Back Up Camera Display

When enabled in the radio settings, active guidelines are overlaid on the image to illustrate the width of the vehicle and its projected backup path based on the steering wheel position. A dashed center line overlay indicates the center of the vehicle to assist in rear parking maneuvers or trailer hitch alignment. Different colored zones indicate

the distance to the rear of the vehicle.

The following table shows the approximate distances for each zone:

Area	Distance From The Rear Of The Vehicle
Red	0–11.8 inches (0–30 cm)
Yellow	11.8 inches to 3.3 feet (30 cm–1 m)
Green	3.3 feet or more (1 m or more)

Messages On The Display

If the liftgate is opened, the camera will not detect any obstacle behind the vehicle. The display will show a dedicated warning message.

Make sure the liftgate is closed by pushing next to the lock until it clicks.

Important Notes

- Ice, snow or mud on the surface of the camera may reduce its sensitivity. It is important to keep the camera surface clean, and free from debris.
- When parking, be aware of obstacles that may be above or below the camera range.



WARNING!

Drivers must be careful when backing up even when using the Rear Back Up Camera. Always check carefully behind your vehicle, and be sure to check for pedestrians, animals, other vehicles, obstructions, or blind spots before backing up. You are responsible for the safety of your surroundings and must continue to pay attention while backing up. Failure to do so can result in serious injury or death.



CAUTION!

- To avoid vehicle damage, Rear Back Up Camera should only be used as a parking aid. The Rear Back Up Camera is unable to view every obstacle or object in your drive path.
- To avoid vehicle damage, the vehicle must be driven slowly when using the Rear Back Up Camera to be able to stop in time when an obstacle is seen. It is recommended that the driver look frequently over his/her shoulder when using the Rear Back Up Camera.

REFUELING THE VEHICLE

REFUELING THE VEHICLE

Before refueling, make sure that the fuel type is correct.

Also, stop the engine before refueling.

NOTE:

An inefficient catalytic converter leads to harmful exhaust emissions, thus contributing to air pollution.



CAUTION!

Never introduce leaded fuel to the tank, even in small amounts in an emergency, as this would damage the catalytic converter beyond repair.

REFUELING CAPACITY

To ensure that you fill the tank completely, top off twice after the first click of the fuel nozzle.

Further top-off could cause faults in the fuel feeding system.

REFUELING PROCEDURE

The fuel filler door is unlocked when the central door locking system is unlocked. It is automatically locked when the central locking system is applied.

Opening The Fuel Filler Door

To refuel proceed as follows:

1. Open fuel filler door by pushing on the point shown by the arrow.



Fuel Door

2. Remove the fuel filler cap.
3. Insert the fuel nozzle fully into the filler pipe.



- When the fuel nozzle “clicks” or shuts off, before removing the nozzle, wait for at least 10 seconds in order for the fuel to flow inside the tank.
- Remove the fuel filler nozzle, tighten the gas cap about $\frac{1}{4}$ turn until you hear one click. This is an indication that cap is properly tightened.

The label indicates the fuel type (UNLEADED FUEL = gasoline).

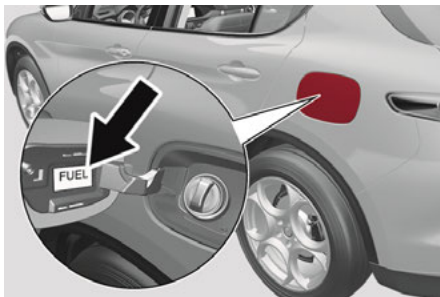

Fuel Door Label

Emergency Fuel Door Opening

In the event of an emergency, the fuel filler door can be opened from inside the liftgate.

Proceed as follows:

Models With Compact Spare Tire

- Open the liftgate and lift up the load floor.



Load Floor

- Unlock the locking device and remove the compact spare tire to reach the emergency opening cable on the side of the fuel door.

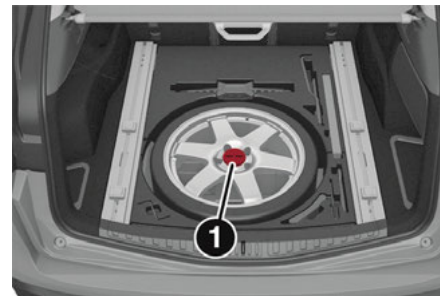

Cargo Area

- Locking Device

- Pull the cable to release the fuel door lock.

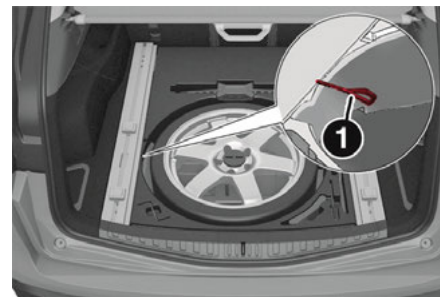

Release Cable

- Release Cable

- Open the fuel door by pushing it.

Models Without Compact Spare Tire

1. Open the liftgate and lift up the load floor.

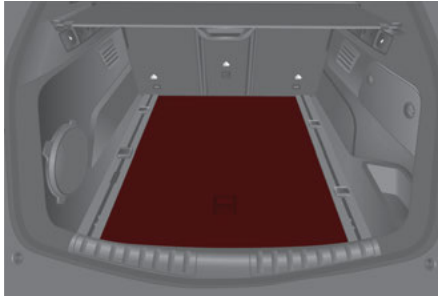

Load Floor

2. Lift up the cover to reach the emergency opening cable on the side of the fuel door.

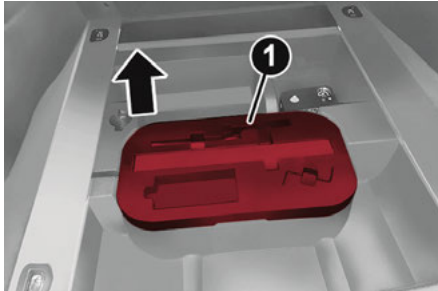

Cargo Box

1 – Cover

3. Pull the cable to release the fuel door lock.

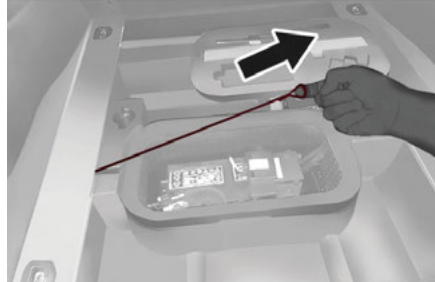
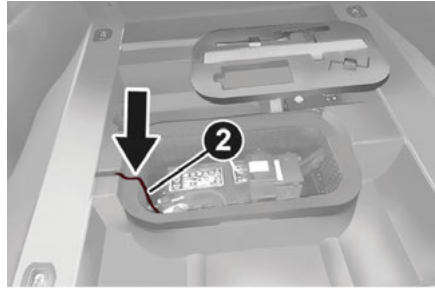

Cargo Box Opened

2 – Release Cable

4. Open the fuel door by pushing it.



WARNING!

- Never have any smoking materials lit in or near the vehicle when the fuel door is open or the tank is being filled.

(Continued)



WARNING! (Continued)

- Never add fuel when the engine is running. This is in violation of most state and federal fire regulations and may cause the Malfunction Indicator Lamp (MIL) to turn on.
- A fire may result if gasoline is pumped into a portable container that is inside of a vehicle. You could be burned. Always place gas containers on the ground while filling.

NOTE:

If the filler compartment is washed with a pressure washer, keep it at a distance of at least 8 inches (20 cm).

VEHICLE LOADING

CERTIFICATION LABEL

As required by National Highway Traffic Safety Administration regulations, your vehicle has a certification label affixed to the driver's side door or pillar.

This label contains the month and year of manufacture, Gross Vehicle Weight Rating (GVWR), Gross Axle Weight Rating (GAWR) front and rear, and Vehicle Identification Number (VIN). A Month-Day-Hour (MDH) number is included on this label and indicates the Month, Day and Hour of manufacture. The bar code that appears on the bottom of the label is your VIN.



Gross Vehicle Weight Rating (GVWR)

The GVWR is the total permissible weight of your vehicle including driver, passengers, vehicle, options and cargo. The label also specifies maximum capacities of front and rear axle systems (GAWR). Total load must be limited so GVWR and front and rear GAWR are not exceeded.

Payload

The payload of a vehicle is defined as the allowable load weight a truck can carry, including the weight of the driver, all passengers, options and cargo.

Gross Axle Weight Rating (GAWR)

The GAWR is the maximum permissible load on the front and rear axles. The load must be distributed in the cargo area so that the GAWR of each axle is not exceeded.

Each axle GAWR is determined by the components in the system with the lowest load carrying capacity (axle, springs, tires or wheels). Heavier axles or suspension components sometimes specified by purchasers for increased durability do not necessarily increase the vehicle's GVWR.

Tire Size

The tire size on the Vehicle Certification Label represents the actual tire size on your vehicle. Replacement tires must be equal to the load capacity of this tire size.

Rim Size

This is the rim size that is appropriate for the tire size listed.

Inflation Pressure

This is the cold tire inflation pressure for your vehicle for all loading conditions up to full GAWR.

Curb Weight

The curb weight of a vehicle is defined as the total weight of the vehicle with all fluids, including vehicle fuel, at full capacity conditions, and with no occupants or cargo loaded into the vehicle. The front and rear curb weight values are determined by weighing your vehicle on a commercial scale before any occupants or cargo are added.

Loading

The actual total weight and the weight of the front and rear of your vehicle at the ground can best be determined by weighing it when it is loaded and ready for operation.

The entire vehicle should first be weighed on a commercial scale to ensure that the GVWR has not been exceeded. The weight on the front and rear of the vehicle should then be determined separately to be sure that the load is properly distributed over the front and rear axle. Weighing the vehicle may show that the GAWR of either the front or rear axles has been exceeded but the total load is within the specified GVWR. If so, weight must be shifted from front to rear or rear to front as

appropriate until the specified weight limitations are met. Store the heavier items down low and be sure that the weight is distributed equally. Stow all loose items securely before driving.

Improper weight distributions can have an adverse effect on the way your vehicle steers and handles and the way the brakes operate.



CAUTION!

Do not load your vehicle any heavier than the GVWR or the maximum front and rear GAWR. If you do, parts on your vehicle can break, or it can change the way your vehicle handles. This could cause you to lose control. Overloading can shorten the life of your vehicle.

TRAILER TOWING

In this section you will find safety tips and information on limits to the type of towing you can reasonably do with your vehicle. Before towing a trailer, carefully review this information to tow your load as efficiently and safely as possible.

To maintain the New Vehicle Limited Warranty coverage, follow the requirements and recommendations in this manual concerning vehicles used for trailer towing.

COMMON TOWING DEFINITIONS

The following trailer towing related definitions will assist you in understanding the following information:

Gross Vehicle Weight Rating (GVWR)

The GVWR is the total allowable weight of your vehicle. This includes driver, passengers, cargo and tongue weight. The total load must be limited so that you do not exceed the GVWR
↳ page 139.

Gross Trailer Weight (GTW)

The GTW is the weight of the trailer plus the weight of all cargo, consumables, and equipment (permanent or temporary) loaded in or on the trailer in its "loaded and ready for operation" condition.

The recommended way to measure GTW is to put your fully loaded trailer on a vehicle scale. The entire weight of the trailer must be supported by the scale.

Gross Combination Weight Rating (GCWR)

The GCWR is the total allowable weight of your vehicle and trailer when weighed in combination.

Gross Axle Weight Rating (GAWR)

The GAWR is the maximum capacity of the front and rear axles. Distribute the load over the front and rear axles evenly. Make sure that

you do not exceed either front or rear GAWR
↳ page 139.



WARNING!

It is important that you do not exceed the maximum front or rear GAWR. A dangerous driving condition can result if either rating is exceeded. You could lose control of the vehicle and have a collision.

Tongue Weight (TW)

The tongue weight is the downward force exerted on the hitch ball by the trailer. You must consider this as part of the load on your vehicle.

Trailer Frontal Area

The frontal area is the maximum height multiplied by the maximum width of the front of a trailer.

Weight-Carrying Hitch

A weight-carrying hitch supports the trailer tongue weight, just as if it were luggage located at a hitch ball or some other connecting point of the vehicle. These kinds of hitches are the most popular on the market today and they are commonly used to tow small and medium sized trailers.

Weight-Distributing Hitch

A weight-distributing hitch system works by applying leverage through spring (load) bars. They are typically used for heavier loads to distribute trailer tongue weight to the tow vehicle's front axle and the trailer axle(s). When used in accordance with the manufacturer's directions, it provides for a more level ride, offering more consistent steering and brake control thereby enhancing towing safety. The addition of a friction/hydraulic sway control also dampens sway caused by traffic and crosswinds and contributes positively to tow vehicle and trailer stability. Trailer Sway Control and a weight-distributing (load equalizing) hitch are recommended for heavier Tongue Weights (TW) and may be required depending on vehicle and trailer configuration/loading to comply with Gross Axle Weight Rating (GAWR) requirements.



WARNING!

- An improperly adjusted weight-distributing hitch system may reduce handling, stability, braking performance, and could result in a collision.
- Weight-distributing hitch systems may not be compatible with surge brake couplers. Consult with the hitch and trailer manufacturer or a reputable Recreational Vehicle dealer for additional information.



TRAILER HITCH CLASSIFICATION

The following chart provides the industry standard for the maximum trailer weight a given trailer hitch class can tow and should be used to assist you in selecting the correct trailer hitch for your intended towing condition.

Trailer Hitch Classification Definitions	
Class	Max. Trailer Hitch Industry Standards
Class I - Light Duty	2,000 lb (907 kg)
Class II - Medium Duty	3,500 lb (1,587 kg)
Class III - Heavy Duty	6,000 lb (2,722 kg)
Class IV - Extra Heavy Duty	10,000 lb (4,535 kg)
Refer to the "Trailer Towing Weights (Maximum Trailer Weight Ratings)" chart for the Maximum Gross Trailer Weight (GTW) towable for your given drivetrain.	
All trailer hitches should be professionally installed on your vehicle.	

TRAILER TOWING WEIGHTS (MAXIMUM TRAILER WEIGHT RATINGS)

Engine/Transmission	Maximum GTW	Maximum TW (See Note)
2.0L Engine	3,000 lb (1360 kg)	300 lb (136 kg)
Refer to local laws for maximum trailer towing speeds.		
NOTE: The trailer tongue weight must be considered as part of the combined weight of occupants and cargo, and should never exceed the weight referenced on the Tire and Loading Information placard.		

TRAILER AND TONGUE WEIGHT

Never exceed the maximum tongue weight stamped on your fascia/bumper or trailer hitch.

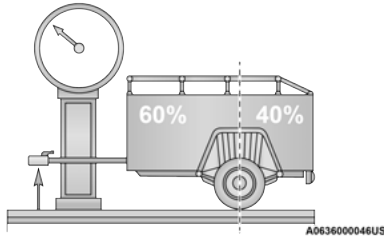

Weight Distribution



CAUTION!

Always load a trailer with 60% of the weight in the front of the trailer. This places 10% of the GTW on the tow hitch of your vehicle. Loads balanced over the wheels or heavier in the rear can cause the trailer to sway severely side to side which will cause loss of control of the vehicle and trailer. Failure to load trailers heavier in front is the cause of many trailer collisions.

Consider the following items when computing the weight on the rear axle of the vehicle:

- The tongue weight of the trailer.
- The weight of any other type of cargo or equipment put in or on your vehicle.
- The weight of the driver and all passengers.

NOTE:

Remember that everything put into or on the trailer adds to the load on your vehicle. Also, additional factory-installed options or dealer-installed options must be considered as part of the total load on your vehicle. Refer to the "Tire And Loading Information" placard for the maximum combined weight of occupants and cargo for your vehicle.

TOWING REQUIREMENTS

To promote proper break-in of your new vehicle drivetrain components, the following guidelines are recommended:



WARNING!

Improper towing can lead to a collision. Follow these guidelines to make your trailer towing as safe as possible:

- Make certain that the load is secured in the trailer and that it will not shift during travel. When trailering cargo that is not fully secured, dynamic load shifts can occur that may be difficult for the driver to control. You could lose control of your vehicle and have a collision.

(Continued)



WARNING! (Continued)

- When hauling cargo, or towing a trailer, do not overload your vehicle or trailer. Overloading can cause a loss of control, poor performance, or damage to brakes, axle, engine, transmission, steering, suspension, chassis structure, or tires.
- Safety chains must always be used between your vehicle and trailer. Always connect the chains to the frame or hook retainers of the vehicle hitch. Cross the chains under the trailer tongue and allow enough slack for turning corners.
- Vehicles with trailers should not be parked on a grade. When parking, apply the parking brake on the tow vehicle. Put the tow vehicle transmission in PARK. Always block or "chock" the trailer wheels.
- GCWR must not be exceeded.
- Total weight must be distributed between the tow vehicle and the trailer such that the following four ratings are not exceeded:
 - GVWR
 - GTW
 - GAWR
 - Tongue weight rating for the trailer hitch utilized.



**CAUTION!**

- ❑ Do not tow a trailer at all during the first 500 miles (805 km) the new vehicle is driven. The engine, axle or other parts could be damaged.
- ❑ Then, during the first 500 miles (805 km) that a trailer is towed, do not drive over 50 mph (80 km/h) and do not make starts at full throttle. This helps the engine and other parts of the vehicle wear in at the heavier loads.

Towing Requirements — Tires

- ❑ Do not attempt to tow a trailer while using a compact spare tire.
- ❑ Do not drive more than 50 mph (80 km/h) when towing while using a full size spare tire.
- ❑ Proper tire inflation pressures are essential to the safe and satisfactory operation of your vehicle.
- ❑ Check the trailer tires for proper tire inflation pressures before trailer usage.
- ❑ Check for signs of tire wear or visible tire damage before towing a trailer.
- ❑ Replacing tires with a higher load carrying capacity will not increase the vehicle's GVWR and GAWR limits.
- ❑ For proper tire inflation procedures
 - page 240.

Towing Requirements — Trailer Brakes

- ❑ Do **not** interconnect the hydraulic brake system or vacuum system of your vehicle with that of the trailer. This could cause inadequate braking and possible personal injury.
- ❑ An electronically actuated trailer brake controller is required when towing a trailer with electronically actuated brakes. When towing a trailer equipped with a hydraulic surge actuated brake system, an electronic brake controller is not required.
- ❑ Trailer brakes are recommended for trailers over 1,000 lb (453 kg) and required for trailers in excess of 2,000 lb (907 kg).

**WARNING!**

- ❑ Do not connect trailer brakes to your vehicle's hydraulic brake lines. It can overload your brake system and cause it to fail. You might not have brakes when you need them and could have an accident.
- ❑ Towing any trailer will increase your stopping distance. When towing, you should allow for additional space between your vehicle and the vehicle in front of you. Failure to do so could result in an accident.

**CAUTION!**

If the trailer weighs more than 1,000 lb (453 kg) loaded, it should have its own brakes and they should be of adequate capacity. Failure to do this could lead to accelerated brake lining wear, higher brake pedal effort, and longer stopping distances.

Towing Requirements — Trailer Lights And Wiring

Whenever you pull a trailer, regardless of the trailer size, stoplights and turn signals on the trailer are required for motoring safety.

The Trailer Tow Package may include a four- and seven-pin wiring harness. Use a factory approved trailer harness and connector.

NOTE:

Do not cut or splice wiring into the vehicle's wiring harness.

The electrical connections are all complete to the vehicle but you must mate the harness to a trailer connector. Refer to the following illustrations.

NOTE:

- ❑ Disconnect trailer wiring connector from the vehicle before launching a boat (or any other device plugged into vehicle's electrical connect) into water.
- ❑ Be sure to reconnect once clear from water area.

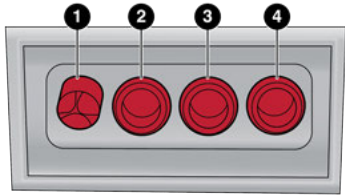

A0636000086US

Four-Pin Connector

- 1 – Ground
- 2 – Park
- 3 – Left Stop/Turn
- 4 – Right Stop/Turn

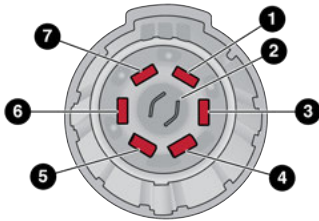

A0636000087US

Seven-Pin Connector

- 1 – Battery
- 2 – Backup Lamps
- 3 – Right Stop/Turn
- 4 – Electric Brakes
- 5 – Ground
- 6 – Left Stop/Turn
- 7 – Running Lamps

TOWING TIPS

Before setting out on a trip, practice turning, stopping, and backing up the trailer in an area located away from heavy traffic.

Automatic Transmission

Select the DRIVE range when towing. The transmission controls include a drive strategy to avoid frequent shifting when towing. However, if frequent shifting does occur while in DRIVE, you can use the AutoStick shift control to manually select a lower gear.

NOTE:

Using a lower gear while operating the vehicle under heavy loading conditions will improve performance and extend transmission life by reducing excessive shifting and heat build-up. This action will also provide better engine braking.

Cruise Control – If Equipped

- Do not use on hilly terrain or with heavy loads.
- When using the Cruise Control, if you experience speed drops greater than 10 mph (16 km/h), disengage until you can get back to cruising speed.
- Use Cruise Control in flat terrain and with light loads to maximize fuel efficiency.

INSTALLING THE RECEIVER

To properly install the receiver, follow the directions below:

1. Retrieve the receiver from the luggage compartment.
2. Push the receiver into the trailer hitch, and secure by inserting the locking pin into the trailer hitch.
3. Insert the safety split ring into the hole on the locking pin.

NOTE:

Ensure that the locking pin is removed from the trailer hitch before installing the receiver.

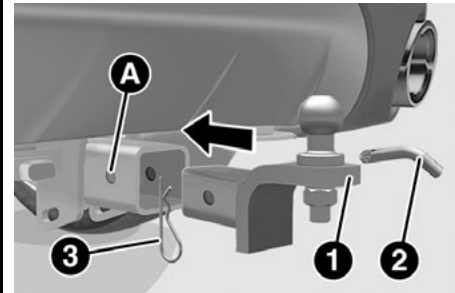

Trailer Hitch And Receiver

- 1 – Receiver
- 2 – Locking Pin
- 3 – Safety Split Ring
- A – Trailer Hitch



CONNECTING THE ELECTRICAL SYSTEM

To connect the trailer's electrical system, follow the directions below:

1. Remove the socket protective cover.
2. Completely insert the plug into the socket.



Electrical Tow Connector

Pin Number	Function
1	Lights ground (Lights GND)
2	Position light, side marker lights, and license plate light
3	Left turn signal and stop light
4	Right turn signal and stop light

REMOVING THE RECEIVER

When the receiver is no longer needed, disconnect the electrical connections and remove it from its position using the directions below:

1. Remove the safety split ring from the locking pin.
2. Pull the locking pin out of the trailer hitch.
3. Remove the receiver from the trailer hitch.

SUGGESTIONS FOR DRIVING

SAVING FUEL

Below are some suggestions which may help you save fuel and lower the amount of harmful emissions released into the atmosphere.

Vehicle Maintenance

Checks and operations should be carried out in accordance with the Maintenance Plan ⇨ page 212.

Tires

Check the tire pressures at least once every four weeks: if the pressure is too low, consumption levels increase as resistance to rolling is higher.

NOTE:

Tire pressure that is too high can cause premature tire wear, reduced control, etc.

Unnecessary Loads

Do not travel with an overloaded liftgate. The weight of the vehicle and its arrangement greatly affect fuel consumption and stability.

Electric Devices

Use electrical systems only for the amount of time needed. The rear window defroster, additional headlights, windshield wipers and heater blower fan require a considerable amount of energy; increasing the current uptake increases fuel consumption (by up to +25% when city driving).

Climate Control System

Using the climate control system will increase consumption: use standard ventilation when the temperature outside permits.

Devices For Aerodynamic Control

The use of non-certified devices for aerodynamic control may adversely affect air drag and consumption levels.

DRIVING STYLE

Starting

Do not warm up the engine at low or high revs when the vehicle is stationary; this causes the engine to warm up more slowly, thereby increasing fuel consumption and emissions. It is therefore advisable to drive off immediately, slowly, avoiding high speeds: by doing this the engine will warm up more quickly.

Unnecessary Actions

Avoid revving up when starting at traffic lights or before stopping the engine. This action is unnecessary and causes increased fuel consumption and pollution.

Gear Selection

Use a high gear when traffic and road conditions allow it. Using a low gear for faster acceleration will increase fuel consumption. Improper use of a high gear increases consumption, emissions and engine wear.

Max. Speed

Fuel consumption considerably increases as speed increases. Maintain a constant speed, avoiding unnecessary braking and acceleration, which cost in terms of both fuel consumption and emissions.

Acceleration

Accelerating violently severely affects consumption and emissions: acceleration should be gradual and should not exceed the maximum torque.

CONDITIONS OF USE

Cold Starting

Short trips and frequent cold starts will not allow the engine to reach optimum operating temperature. This results in a significant increase in consumption levels (from +15 to +30% in city driving) and emissions.

Traffic And Road Conditions

High fuel consumption is caused by heavy traffic, for instance when traveling in traffic with frequent use of low gears or in cities with many traffic lights. Winding mountain roads and rough road surfaces also adversely affect consumption.

Stops In Traffic

During prolonged stops (e.g. railway crossings), turn off the engine.

PERFORMANCE — QUADRIFOGLIO

This vehicle is equipped with an engine capable of delivering exceptionally fast acceleration and speed:

- Peak power: 505 HP at 6,500 RPM.
- Peak torque: 443 ft-lb at 2,500–5,000 RPM.
- Top speed: 176 mph (283 km/h).
- Acceleration from 0 to 60 mph (0 to 100 km/h): 3.6 seconds.

For safe driving, it is essential, particularly during the first days of use, to get to know the car by driving carefully and gradually discovering its performance.

Brakes

The car braking system may be available with four carbon-ceramic material brake discs, one on each wheel.

In order to guarantee the maximum braking capacity for the first use, Alfa Romeo performs

a "run-in" procedure for discs and pads directly at the factory.

The use of carbon-ceramic material brake discs guarantees braking features (better deceleration/pedal load ratio, braking distances, fading resistance) proportional to the dynamic features of the car in addition to considerably decreasing the unsprung component weight.

The materials used and the structural features of the system could generate unusual noises which have absolutely no adverse effect on correct operation and reliability of the braking system.

Greater pressure may need to be applied to the brake pedal the first time to keep the same braking capacities in presence of condensation or salt on the braking surfaces, for example after washing or if the car is not used for a long time.

NOTE:

Given the high technological level of this system, any servicing on it must be performed by an authorized dealer which exclusively has the skills needed for the repair and maintenance operations.

In case of intensive, high-performance use of the car, have the efficiency of the carbon-ceramic material braking system inspected as shown on the Maintenance Plan at an authorized dealer.



Driving On Race Tracks

Before driving on a track using a racing style, it is necessary to:

- Attend a race track driving course.
- Check the liquid levels in the engine compartment ↪ page 212.
- Have the car inspected at an authorized dealer.

Remember that the car was not designed to be driven exclusively on the race track and that this use increases stress and component wear.

NOTE:

Quadrifoglio front brakes are equipped with Non-Asbestos Organic (NAO) type pads. These pads are NOT suitable for high thermal loads (for example track use). If you want to use vehicle on a track it is recommended to use the optional CCM Brakes (Carbon Ceramic Brake disc).

Preheating the carbon ceramic material brake discs

The brake discs must be warmed up to make them fully efficient. You are advised to perform the following procedure to achieve optimal efficiency:

- Brake nine times from 80 mph to 18 mph (130 km/h to 30 km/h) with deceleration equal to 0.7g (the longitudinal acceleration value is shown on the instrument cluster display by setting RACE mode and selecting the “Performance” page) with 20 second intervals between brake applications; keep the car at a speed comprised between 37 mph and 62 mph (60 km/h and 100 km/h) and do not brake for 4 minutes to allow the brakes to cool down.

- Then brake three times from 124 mph to 18 mph (200 km/h to 30 km/h) with deceleration equal to 1.1g (ABS operation) with 30 second intervals between brake applications; keep the car at a speed comprised between 37 mph and 62 mph (60 km/h and 100 km/h) and do not brake for 5 minutes to allow the brakes to cool down.

This very important section describes the safety systems that your vehicle may be equipped with, and provides instructions on how to use them correctly.

ACTIVE SAFETY SYSTEMS

The vehicle may be equipped with the following active safety devices:

- Anti-Lock Brake System (ABS)
- Active Torque Vectoring (ATV) System
- Dynamic Steering Torque (DST) System
- Drive Train Control (DTC) System
- Electronic Stability Control (ESC) System
- Hill Descent Control (HDC) System
- Hill Start Assist (HSA) System
- Panic Brake Assist (PBA) System
- Traction Control System (TCS)

For system operation, see the following pages.

ANTI-LOCK BRAKE SYSTEM (ABS)

An integral part of the braking system, the ABS prevents one or more wheels from locking and slipping in all road surface conditions, regardless of the intensity of the braking action. The system ensures that the vehicle can be controlled even during emergency braking, allowing the driver to optimize stopping distances.

The system intervenes during braking when the wheels are about to lock, typically in emergency braking or low-grip conditions where locking may be more frequent.

The system also improves control and stability of the vehicle when braking on a surface where the grip of the left and right wheels varies, such as in a corner.

The Electronic Braking Force Distribution (EBD) system works with the ABS, allowing the brake force to be distributed between the front and rear wheels.

System Intervention

The ABS equipped on this vehicle is provided with the "Brake-By-Wire", Integrated Brake System (IBS), function. With this system, the command given by pressing the brake pedal is not transmitted hydraulically, but electrically. Therefore, the light pulsation that is felt on the pedal with the traditional system is no longer noticeable.



WARNING!

- The ABS contains sophisticated electronic equipment that may be susceptible to interference caused by improperly installed or high output radio transmitting equipment. This interference can cause possible loss of anti-lock braking capability. Installation of such equipment should be performed by qualified professionals.

(Continued)



WARNING! (Continued)

- Pumping of the Anti-Lock Brakes will diminish their effectiveness and may lead to a collision. Pumping makes the stopping distance longer. Just press firmly on your brake pedal when you need to slow down or stop.
- The ABS cannot prevent the natural laws of physics from acting on the vehicle, nor can it increase braking or steering efficiency beyond that afforded by the condition of the vehicle brakes and tires or the traction afforded.
- The ABS cannot prevent collisions, including those resulting from excessive speed in turns, following another vehicle too closely, or hydroplaning.
- The capabilities of an ABS equipped vehicle must never be exploited in a reckless or dangerous manner that could jeopardize the user's safety or the safety of others.

ACTIVE TORQUE VECTORING (ATV) SYSTEM — IF EQUIPPED

The dynamic drive control is used to optimize and balance the drive torque between the wheels of the same axles. The ATV system improves the grip in turns, sending more drive torque to the external wheel.



Given that, in a turn, the external wheels of the car travel more than the internal ones and therefore turn faster, sending a higher thrust to the external rear wheel allows for the car to be more stable and to not suffer an "understeer" condition. Understeer occurs when the vehicle is turning less than appropriate for the steering wheel position.

DYNAMIC STEERING TORQUE (DST) SYSTEM

DST uses the integration of the Electronic Stability Control (ESC) system with the electric power steering to increase the safety level of the whole vehicle.

In critical situations (e.g. braking on surfaces with different grip conditions), the ESC system influences the steering through the DST function to implement an additional torque contribution on the steering wheel in order to suggest the most correct maneuver to the driver.

The coordinated action of the brakes and steering increases the safety and control of the vehicle.

NOTE:

The DST feature is only meant to help the driver realize the correct course of action through small torques on the steering wheel, which means the effectiveness of the DST feature is highly dependent on the driver's

sensitivity and overall reaction to the applied torque. It is very important to realize that this feature will not steer the vehicle, meaning the driver is still responsible for steering the vehicle.

DRIVE TRAIN CONTROL (DTC) SYSTEM

Some models of this vehicle are equipped with an All-Wheel Drive (AWD) system, which offers an optimal drive for countless driving conditions and road surfaces. The system reduces tire slipping to a minimum, automatically redistributing the torque to the front and rear wheels as needed.

To maximize fuel savings, the vehicle with AWD automatically passes to Rear-Wheel Drive (RWD) when the road and environmental conditions are such that they wouldn't cause the tires to slip. When the road and environmental conditions require better traction, the vehicle automatically switches to AWD mode.

NOTE:

- There may be a brief delay in shifting to AWD mode after a tire slipping event occurs.
- If the system failure symbol switches on, after starting the engine or while driving, it means that the AWD system is not working properly. If the warning message activates frequently, it is recommended to carry out the maintenance operations.

ELECTRONIC STABILITY CONTROL (ESC) SYSTEM

The ESC system improves the directional control and stability of the vehicle in various driving conditions.

The ESC system corrects the vehicle's understeer and oversteer, distributing the brake force on the appropriate wheels. The torque supplied by the engine can also be reduced in order to maintain control of the vehicle.

The ESC system uses sensors installed on the vehicle to determine the path that the driver intends to follow and compares it with the vehicle's effective path. When the real path deviates from the desired path, the ESC system intervenes to counter the vehicle's oversteer or understeer.

- Oversteer* occurs when the vehicle is turning more than it should according to the angle of the steering wheel.
- Understeer* occurs when the vehicle is turning less than it should according to the angle of the steering wheel.

System Intervention

The intervention of the system is indicated by the flashing of the ESC warning light on the instrument panel, to inform the driver that the vehicle stability and grip are critical.



WARNING!

- ❑ Electronic Stability Control (ESC) cannot prevent the natural laws of physics from acting on the vehicle, nor can it increase the traction afforded by prevailing road conditions. ESC cannot prevent accidents, including those resulting from excessive speed in turns, driving on very slippery surfaces, or hydroplaning. ESC also cannot prevent accidents resulting from loss of vehicle control due to inappropriate driver input for the conditions. Only a safe, attentive, and skillful driver can prevent accidents. The capabilities of an ESC equipped vehicle must never be exploited in a reckless or dangerous manner which could jeopardize the user's safety or the safety of others.
- ❑ Vehicle modifications, or failure to properly maintain your vehicle, may change the handling characteristics of your vehicle, and may negatively affect the performance of the ESC system. Changes to the steering system, suspension, braking system, tire type and size or wheel size may adversely affect ESC performance. Improperly inflated and unevenly worn tires may also degrade ESC performance. Any vehicle modification or poor vehicle maintenance that reduces the effectiveness of the ESC system can increase the risk of loss of vehicle control, vehicle rollover, personal injury and death.

HILL DESCENT CONTROL (HDC) SYSTEM — IF EQUIPPED

The HDC function is an integral part of the Electronic Stability Control (ESC) system, keeping the vehicle at a constant speed while descending a hill by actively controlling the brakes.

HDC aims to create vehicle stability and safer driving in various situations, including poor grip conditions and steep descents.

The system has three different modes:

- ❑ Off: the system is deactivated
- ❑ Enabled: the system is enabled and ready to intervene when the activation conditions are met
- ❑ Active: the system actively controls the vehicle speed

Enabling The System

To enable the system, push the HDC switch located on the steering wheel.



HDC Switch

The system is enabled if the car speed is below 20 mph (30 km/h). The system stays enabled until the car speed reaches 37 mph (60 km/h), the system is disabled at speeds above 37 mph (60 km/h).

Activation of the HDC system is indicated by the white  icon appearing in the instrument cluster display.

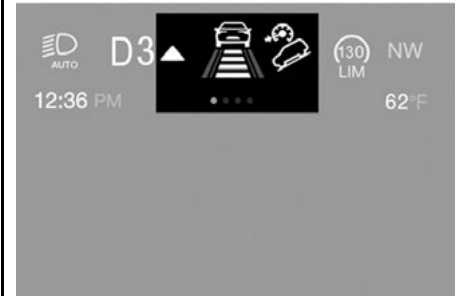

HDC Symbol

Activation Of The System

Once enabled, the HDC system will activate automatically if the vehicle is driven on a downhill slope with sufficient gradient, greater than 8%.

The speed set for the HDC system can be adjusted using the SET switch located on the steering wheel.





HDC Speed SET Switch

Once the desired speed has been reached, release the SET switch and the HDC system will maintain the set speed. After set speed is established, the HDC system will automatically brake to keep the vehicle at the set speed if the accelerator pedal is released and the vehicle gets close to the set speed.

It is possible to reduce the set speed with the brake pedal. When the pedal is released, the system will adjust the set speed to the new current speed.

NOTE:

If the vehicle's speed exceeds 6 mph (10 km/h), but remains below 37 mph (60 km/h) and the accelerator pedal is released, as soon as the vehicle gets close to the set speed the HDC system will automatically brake to keep the vehicle at the set speed.

The driver can cancel HDC system intervention at any time by pressing the accelerator pedal.

System Deactivation

The HDC system will be deactivated, but remain available, if any of the following conditions are met:

- The vehicle is traveling on a downhill slope with a gradient less than 8%, on a level surface, or on an uphill grade.
- PARK (P) mode is engaged.

Disabling The System

The system is disabled if any of the following conditions are met:

- The HDC switch is pressed.
- Cruise Control/Adaptive Cruise Control is activated.
- A vehicle speed of 37 mph (60 km/h) is exceeded.

System deactivation is shown by the icon  on the display turning off.



WARNING!

HDC is only intended to assist the driver in controlling vehicle speed when descending hills. The driver must remain attentive to the driving conditions and is responsible for maintaining a safe vehicle speed.

HILL START ASSIST (HSA) SYSTEM

HSA is an integral part of the Electronic Stability Control (ESC) system that facilitates starting on slopes, activating automatically in the following cases:

- Uphill: the vehicle is stationary on a road with a gradient higher than 5%, the engine is running, the brake is pressed, and the transmission is in NEUTRAL (N) or a gear other than REVERSE (R) is engaged.
- Downhill: the vehicle is stationary on a road with a gradient higher than 5%, the engine is running, the brake is pressed, and the transmission is in REVERSE.

When starting to move forward from a complete stop, the ESC system control unit maintains the braking pressure on the wheels until the engine torque necessary for starting is reached, or in any case for a maximum of two seconds, allowing your right foot to be moved easily from the brake pedal to the accelerator.

The system will automatically deactivate after two seconds without starting, gradually releasing the braking pressure. During this release stage, it is possible to hear a typical mechanical brake release noise, indicating the imminent movement of the vehicle.



WARNING!

There may be situations where the Hill Start Assist (HSA) will not activate and slight rolling may occur, such as on minor hills or with a loaded vehicle, or while pulling a trailer. HSA is not a substitute for active driving involvement. It is always the driver's responsibility to be attentive to distance to other vehicles, people, and objects, and most importantly brake operation to ensure safe operation of the vehicle under all road conditions. Your complete attention is always required while driving to maintain safe control of your vehicle. Failure to follow these warnings can result in a collision or serious personal injury.

PANIC BRAKE ASSIST (PBA) SYSTEM

The PBA system is designed to improve the vehicle's braking capacity during emergency braking.

The system detects emergency braking by monitoring the speed and force with which the brake pedal is pressed, and consequently applies the optimal brake pressure. This can reduce the braking distance: the PBA system therefore complements the ABS.

Maximum assistance from the PBA system is obtained by pressing the brake pedal very quickly. In addition, the brake pedal should be pressed continuously during braking, avoiding intermittent presses, to get the most out of the system. Do not reduce pressure on the brake pedal until braking is no longer necessary.

The PBA system is deactivated when the brake pedal is released.



WARNING!

The Panic Brake Assist (PBA) cannot prevent the natural laws of physics from acting on the vehicle, nor can it increase the traction afforded by prevailing road conditions. PBA cannot prevent collisions, including those resulting from excessive speed in turns, driving on very slippery surfaces, or hydroplaning. The capabilities of a PBA-equipped vehicle must never be exploited in a reckless or dangerous manner, which could jeopardize the user's safety or the safety of others.

TRACTION CONTROL SYSTEM (TCS)

The TCS automatically operates in the event of slipping, loss of grip on wet roads (hydroplaning), and acceleration on one or both drive wheels on roads that are slippery, snowy, icy, etc. Depending on the slipping

conditions, two different control systems are activated:

- If the slipping involves both drive wheels, the system intervenes, reducing the power transmitted by the engine.
- If the slipping only involves one of the drive wheels, the Brake Limited Differential (BLD) function is activated, automatically braking the wheel which is slipping (the behavior of a self-locking differential is simulated). This will increase the engine torque transferred to the wheel which isn't slipping.

System Intervention

The intervention of the system is indicated by the flashing of the ESC warning light on the instrument panel, to inform the driver that the vehicle stability and grip are critical.

AUXILIARY DRIVING SYSTEMS

The following auxiliary driving systems are available in this vehicle:

- Blind Spot Monitoring (BSM) — if equipped
- Active Blind Spot Assist (ABSA) — if equipped
- Forward Collision Warning Plus (FCW+)
- Tire Pressure Monitoring System (TPMS)



The vehicle may also be fitted with the following driving assistance systems:

- Driver Attention Assist (DAA)
- Lane Departure Warning (LDW)
- Lane Keeping Assist (LKA)
- Highway Assist System (HAS)
- Traffic Jam Assist (TJA)
- Adaptive Cruise Control (ACC)
- Intelligent Speed Control (ISC)
- Traffic Sign Recognition (TSR)

For the operation of the DAA, LDW, LKA, HAS, TJA, ACC, ISC, or TSR systems, see [↪ page 88](#).

NOTE:

When driving on two-way roads where there is no lane dividing center line (e.g. on unpaved roads), the use of the ABSA, HAS, TJA, and LKA systems is strongly discouraged as the system could detect the entire road as single-lane dividing lines.

NOTE:

The driving assistance systems are designed to aid in driving the car. The driver must always maintain a sufficient level of attention to the traffic and road conditions and control the trajectory of the car.

BLIND SPOT MONITORING (BSM) SYSTEM — IF EQUIPPED

The BSM system uses radar sensors, located in the rear fascia/bumper, to detect the

presence of other vehicles in the rear side blind spots of your vehicle.

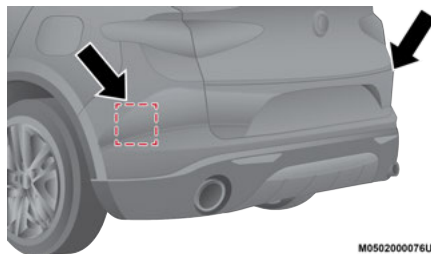

Rear Sensor Location

The system warns the driver about the presence of other vehicles in the detection area by illuminating the warning light located within the door mirror on the side in which the other vehicle was detected. If equipped, an audible chime will also be heard to alert the driver (if option is selected within the radio system).



BSM Indicator Light

When the engine is started, the warning light illuminates briefly to signal the driver that the system is active.

Sensors

The sensors are activated when any forward gear is engaged at a speed higher than approximately 6 mph (10 km/h) or when REVERSE is engaged.

The sensors are temporarily deactivated when the vehicle is stationary or the vehicle is in PARK.

The detection area of the system covers approximately one lane on both sides of the vehicle, which is around 9 ft (3 m).

This area begins from the door mirror and extends for approximately 19 ft (6 m) towards the rear part of the vehicle.

When the sensors are active, the system monitors the detection areas on both sides of the vehicle and warns the driver about the possible presence of vehicles in these areas.

While driving, the system monitors the detection zone in three different situations:

- when you are being overtaken by a vehicle;
 - when you are overtaking a vehicle;
 - when a vehicle approaches from the side;
- to check whether it is necessary to send a signal to the driver on both sides.

NOTE:

- The system does not alert the driver of the presence of fixed objects (e.g. safety barriers, poles, walls, etc.). However, in some circumstances, the system may activate in the presence of these objects. This is normal and does not indicate a system malfunction.
- The system does not alert the driver about the presence of vehicles coming from the opposite direction, in the adjacent lanes.
- If a trailer is hitched to the car, the system automatically deactivates.



WARNING!

The Blind Spot Monitoring system is only an aid to help detect objects in the blind spot zones. The BSM system is not designed to detect pedestrians, bicyclists, or animals. Even if your vehicle is equipped with the BSM system, always check your vehicle's mirrors, glance over your shoulder, and use your turn signal before changing lanes. Failure to do so can result in serious injury or death.

NOTE:

- For the system to operate properly, the rear fascia/bumper area where the radar sensors are located must stay free from snow, ice and dirt gathered from the road surface.
- Do not cover the rear fascia/bumper area where the radar sensors are located with any object (e.g. adhesives, bike rack, etc.).
- If you wish to install a rear tow eye after purchasing the vehicle, you will need to deactivate the system via the radio system. To access the function, select the following items in sequence on the main menu:
 - a. "Driver Assistance"
 - b. "Blind Spot Alert"

Rear View

The system detects vehicles coming from the rear part of your vehicle on both sides and entering the rear detection area with a difference in speed of less than 25 mph (40 km/h) in relation to your vehicle.

Overtaking Vehicles

If another vehicle is overtaken slowly, with a difference in speed of less than approximately 15 mph (25 km/h) and the vehicle stays in the blind spot for approximately 1.5 seconds, the warning light on the door mirror of the corresponding side illuminates.

If the difference in speed between the two vehicles is greater than approximately 15 mph (25 km/h), the warning light does not illuminate.

Rear Cross Path Detection (RCP) System

The Rear Cross Path Detection (RCP) system assists the driver during reverse maneuvers in the case of reduced visibility.

The RCP system monitors the rear detection areas on both sides of the vehicle to detect objects moving toward the sides of the vehicle, with a minimum speed between approximately 1 mph (1 km/h) and 2 mph (3 km/h) and objects moving at a maximum speed of 21 mph (35 km/h), in areas such as parking lots.

The system activation is signaled to the driver by an audible warning.

NOTE:

- If the sensors are covered by objects or vehicles, the system may not work as intended.
- For the system to operate correctly, the rear fascia/bumper area where the radar sensors are located must stay free from snow, ice and dirt gathered from the road surface.
- Do not cover the rear fascia/bumper area where the radar sensors are located with any object (e.g. adhesives, bike rack, etc.).



**WARNING!**

Rear Cross Path Detection (RCP) is not a back up aid system. It is intended to be used to help a driver detect an oncoming vehicle in a parking lot situation. Drivers must be careful when backing up, even when using RCP. Always check carefully behind your vehicle, look behind you, and be sure to check for pedestrians, animals, other vehicles, obstructions, and blind spots before backing up. Failure to do so can result in serious injury or death.

Operating Mode

The system may be activated/deactivated via the radio system. To access the function, select the following items on the main menu in sequence:

1. "Driving Assistance"
2. "Blind Spot Alert"

"Blind Spot Alert", "Visual" Mode

When the system is enabled, the warning light within the door mirror on the side of the detected object illuminates.

The visual warning on the mirror will blink if the driver activates the turn signals, indicating a lane change.

The warning light will be constant if the driver stays in the same lane.

"Blind Spot Alert" Function Deactivation

When the system is deactivated ("Blind Spot Alert" mode off), the BSM or RCP systems will not emit an audible or a visual warning.

The BSM system will store the operating mode that was active when the engine was stopped. Each time the engine is started, the operating mode stored previously will be recalled and used → page 278.

ACTIVE BLIND SPOT ASSIST (ABSA) SYSTEM — IF EQUIPPED

The ABSA system is to help avoid/limit lateral collisions with cars coming from adjacent lanes changing the vehicle's trajectory in order to try to keep it in the detected lane.

The system warns the driver about the presence of other vehicles in the detection area by illuminating the warning light located within the door mirror on the side in which the other vehicle was detected and by means of an acoustic signal and/or vibration on the steering wheel and/or counter-steering torque on the steering wheel (if the respective item on the "Driver Assistance" menu is set up and then "Safety" is selected on the radio system).

When the engine is started, the warning light illuminates briefly to signal the driver that the system is active (the warning light comes on even if the system is activated through the radio system menu).

**ABSA Indicator Light****WARNING!**

- The accident risk persists despite the application of torque to the steering wheel by the ABSA system.
- Applying a torque that corrects the steering wheel alignment does not always prevent an accident. It is always the driver's responsibility to steer, brake or accelerate, especially after the ABSA system warning or after the steering wheel torque intervention. The driver is responsible for ensuring that there are no pedestrians, other vehicles or objects along the direction of the vehicle. Failure to comply with these precautions may cause serious accidents and injuries. The driver is fully responsible for holding a safe distance from the vehicle ahead respecting the highway code in force in the respective country.

(Continued)



WARNING! (Continued)

- In some cases, the system could apply an improper torque to the steering wheel. This application can be interrupted at any time turning the steering wheel in the opposite direction.

Sensors

The system uses radar sensors, located in the rear fascia/bumper, to detect the presence of vehicles (cars, trucks, motorbikes, etc.) in the rear side blind spots of the car.

The sensors are activated when any forward gear is engaged at a speed higher than about 6 mph (10 km/h), or when REVERSE (R) is engaged.

The sensors are temporarily deactivated when the car is stationary and in PARK (P).

The detection area of the system covers about a lane on both sides of the car around 10 ft (3 meters).

This area begins from the door mirror and extends for about 20 ft (6 meters) towards the rear part of the car.

When the sensors are active the system monitors the detection areas on both sides of the car and warns the driver about the possible presence of cars in these areas.

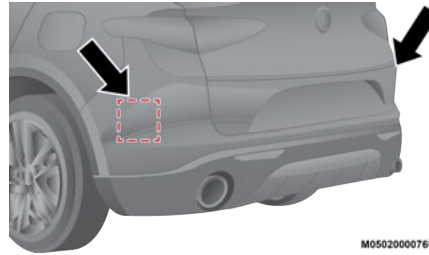

Rear Sensor Location

While driving, the system monitors the detection zone in three different situations:

- when you are being overtaken by a vehicle;
- when you are overtaking a vehicle;
- when a vehicle approaches from the side;

to check if it is necessary to intervene in order to keep the vehicle inside the lane on both sides.

NOTE:

The system does not signal the presence of fixed object (e.g. safety barriers, poles, walls, etc.). However, in some circumstances, the system may activate in the presence of these objects. This is normal and does not indicate a system malfunction.

The system does not warn the driver about the presence of cars coming from the opposite direction, in the adjacent lanes.

Activation/Deactivation

The system can be activated/deactivated using the "Driver Assistance" menu in the radio system. Select signal type, strength levels and sensitivity.

NOTE:

Vehicles with an active system will display the following screen, on the radio system.

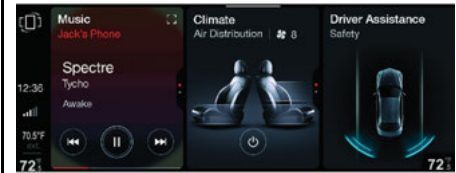

System Intervention

The system intervenes in the following conditions:

- the turn signals have been activated;
- there is a vehicle in the adjacent lane on the same side of the turn signal (blind spot area);
- lane lines are not correctly detected;
- the driver tries to change lanes intentionally.

If the system detects the presence of a vehicle in the rear side blind spots of the car, it applies a torque on the steering wheel (if it has been set through the “Settings” menu of the radio system), in order to warn the driver of the need to keep the car inside the lane and thus avoid collisions with other vehicles.

The application of torque and vibration is however only available with car speed between 37 mph (60 km/h) and 110 mph (180 km/h).

The application of torque, as well as of the vibration, is suppressed/inhibited if:

- The torque given by the driver of the steering wheel is high
- Lateral acceleration is high
- The trailer is connected to the correct control module

- At least one hand is not detected on the steering wheel for longer than a specific time
- The turn signal is turned off

NOTE:

The steering wheel torque is not applied if the system is unable to detect a lane and if the turn signal for the appropriate side has not been switched on.

The steering wheel detects the presence of the driver’s hands by a capacitive sensor installed in the steering wheel and by the applied torque measured on the steering column.

System Availability

Aggressive driving of the car, or driving on the median lines, will prevent the correct operation of the system.

In case of intervention of the stability and braking systems (FCW, ESC, ABS) they will prevent the system from operating.

Lane change will disable the system for a certain period of time.

The road must also comply with some specific characteristics, such as:

- Maximum/minimum lane width.
- Clearly identified and defined double yellow lines and, for a limited period of time, a lane with a single demarcation line.

NOTE:

In some cases, for a limited period of time, the system may be activated by a lane with a single median line.

In cases of good road surface conditions, the system could correctly recognize other types of valid lane markings (e.g. road edges, sidewalks, etc.).

Hands Presence On The Steering Wheel Detection

The system is able to detect the presence of the driver’s hands on the steering wheel.

When the system does not detect the presence of hands on the steering wheel for 0 to 6 seconds, the following screen will be displayed on the instrument cluster display. No acoustic warning will be emitted in this case.

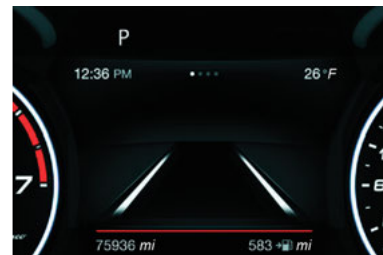

Hand Presence On The Steering Wheel Not Detected Display (Up To 6 Seconds)

When the system does not detect the presence of hands on the steering wheel from 6 to 15 seconds, the following screen will be displayed on the instrument cluster display. A short acoustic signal will sound if hands are not detected on the steering wheel for 6 to 12 seconds. A continuous signal will sound if hands are not detected on the steering wheel for 12 to 15 seconds.



Hand Presence On The Steering Wheel Not Detected Display (6 To 15 Seconds)

After 15 seconds with the hands removed from the steering wheel, the LKA system will be deactivated and a dedicated message will be shown on the instrument cluster display. A short acoustic signal will sound in this case.

In any of the situations above where the hands are removed from the steering wheel for more than 6 seconds, it is necessary to reposition the hands on the steering wheel.

Changing The System Sensitivity

The system's sensitivity can be set through the radio system. Select the "Driver Assistance" menu and then select "Comfort". Sensitivity "High" or "Low" can be selected.

Rear Cross Path Detection (RCP) System

The Rear Cross Path Detection (RCP) system assists the driver during reverse maneuvers in the case of reduced visibility.

When the ABSA system is active, the RCP system monitors the rear detection areas on both sides of the vehicle to detect objects moving towards the sides of the vehicle at a minimum speed between 0.6 mph and 2 mph (1 km/h and 3km/h) from objects moving at a maximum speed of 22 mph (35 km/h).

These are generally occurrences that happen in parking areas.

The system activation is signaled to the driver by means of a visual and audible warning.

NOTE:

If the sensors are covered by objects or vehicles, the system may not work as intended.

Changing The System Sensitivity

To change the sensitivity and the strength of the torque intervention on the steering wheel, refer to "Settings" of the radio system

➔ page 278.

DRIVER ATTENTION ASSIST (DAA) SYSTEM — IF EQUIPPED

The Driver Attention Assist (DAA) system detects when the driver is feeling fatigued and warns the driver to pull over and take a break.

To Activate/Deactivate

The DAA system can be activated and deactivated through the radio system by selecting the following in order:

1. "Driver Assistance"
2. "Driver Attention Assist"



WARNING!

The DAA System is an aid for driving and does not relieve the driver of the responsibility of driving the vehicle. If you experience fatigue while driving, pull over safely for a break without waiting for the DAA to intervene. Only return to the road when you are in the right physical and mental condition to prevent endangering yourself and other drivers.

System Intervention

Using information from the front camera, the system implements two operating logics:

- The first operating logic takes the driving style into account, observing the road and detecting to what extent the driver can continue driving with few lane crossing events.



- The second operating logic measures the time spent behind the wheel with the vehicle speed above 40 mph (60 km/h) and below 110 mph (180 km/h). If the “Standard” option is selected, in these conditions, the “Dozy Driver” message may appear after three hours of driving. If the “Early” option is selected and these conditions occur, the “Dozy Driver” message will be displayed after two hours of driving.

NOTE:

If the conditions described above are not detected continuously during the entire driving period, the “Dozy Driver” message may be displayed later than two or three hours. If the driving style indicates that the driver is unable to follow the road trajectory and respect the horizontal lane markings, the red symbol will appear on the instrument cluster display to suggest that the driver should stop for a break. An audible signal will also sound.

If the driver **accepts** the suggestion provided by the system by pushing the MENU button on the multifunction lever, the message will disappear from the display and the symbol will be displayed in the dedicated area of the instrument cluster display until the next engine shutdown.

If the driver **ignores** the warning provided by the system and does not stop, the message will continue to remain on the display, along with the symbol.

NOTE:

- In the event of a DAA system failure, an amber symbol will appear in the instrument cluster display along with a dedicated message.
- If the ABS system activates, “ABS ACTIVE” will display in place of the DAA symbol and will remain active until the ABS system deactivates.

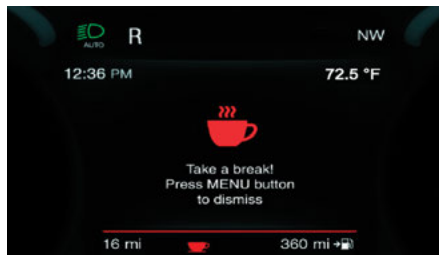
**DAA Warning Message****DAA Warning Icon****Changing The System Sensitivity**

The DAA system intervention sensitivity can be adjusted through the radio system within the “Driver Assistance” menu.

NOTE:

- If “Race” mode (if equipped) is activated, the DAA system will be automatically deactivated.
- The system sensitivity cannot be changed in the event of a camera system failure.

FORWARD COLLISION WARNING PLUS (FCW+) SYSTEM — IF EQUIPPED

This is a driving assistance system composed of a radar located behind the front fascia/bumper and a camera located in the center of the windshield.

**Front fascia/bumper Radar Location**



Windshield Camera Location

In the event of an imminent collision, the system intervenes by automatically applying the vehicle's brakes to prevent a collision or reduce its effects.

The system provides the driver with audible and visual signals through specific messages on the instrument cluster display.

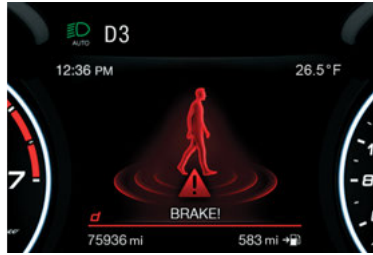
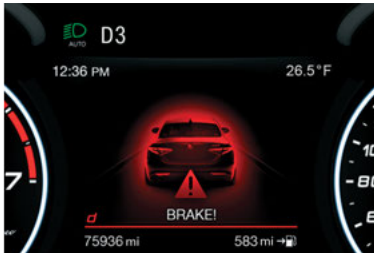

The audible and visual signals warn the driver before the system activates, depending on the vehicle speed.

NOTE:

No warning signals are generated at speeds below 20 mph (30 km/h).

The system may lightly brake to warn the driver if a possible frontal accident is detected (limited braking). Signals and limited braking are intended to allow the driver to react promptly, in order to prevent or reduce the effects of a potential accident.

In situations with the risk of collision, if the system detects no intervention by the driver, it provides automatic braking to help slow the vehicle and mitigate the potential frontal collision (automatic braking). If intervention by the driver on the brake pedal is detected, but not deemed sufficient, the system may

intervene in order to improve the reaction of the braking system, therefore reducing vehicle speed further (additional assistance in braking stage).

The system will intervene automatically in case of imminent collision or impact against a pedestrian crossing the road (speed under 31 mph (50 km/h)).

NOTE:

For safety reasons, when the vehicle has stopped, the brake calipers may remain blocked for about two seconds. Make sure to press the brake pedal if the vehicle moves slightly forward.



WARNING!

Forward Collision Warning (FCW) is not intended to avoid a collision on its own, nor can FCW detect every type of potential collision. The driver has the responsibility to avoid a collision by controlling the vehicle via braking and steering. Failure to follow this warning could lead to serious injury or death.



Engagement/Disengagement

The system may be disengaged (and engaged again) in the "Driver Assistance" menu of the Information and Entertainment system.

The system can be deactivated even with the ignition device in the ON position.

NOTE:

The system status can be changed with car at a standstill only.

Select from among three operating modes:

- Warning and braking:** the system (if active), in addition to the visual and audible warnings, provides limited braking, automatic braking and additional assistance in the braking stage, where the driver does not brake sufficiently in the event of a potential frontal impact.
- Only warning:** the system (if active), does not provide limited braking, but guarantees automatic braking or additional assistance in the braking stage, where the driver does not brake at all or not sufficiently in the event of a potential frontal impact.
- Disabled:** the system does not provide visual and audible warnings, limited braking, automatic braking or additional assistance in the braking stage. The system will therefore provide no indication of a possible collision.

Activation/Deactivation

The Forward Collision Warning system is activated whenever the engine is started regardless of what is shown on the radio system.

Following a deactivation, the system will not warn the driver about the possible collision with a preceding vehicle, regardless of the setting selected in the radio system.

NOTE:

Each time the engine is started, the system is activated regardless of what setting was selected when the engine was turned off.

This function is not active at a speed lower than 4 mph (7 km/h) or higher than 124 mph (200 km/h).

The system is active:

- Each time the engine is started
- When feature is selected within the radio system
- When the ignition is in the ON position
- When the vehicle speed is between 2 mph (4 km/h) and 124 mph (200 km/h)
- When the front seat belts are fastened
- The "Alfa DNA Pro" selector is not in RACE position (if equipped)

NOTE:

If the seat belts of the front seats are not correctly fastened, the system will not inter-

vene on the braking system (only audible and visual signals will be provided).

Changing The System Sensitivity

The sensitivity of the system can be changed through the Information and Entertainment system menu, choosing from one of the following three options: "Near", "Medium" or "Far". Refer to the description in the Information and Entertainment system Supplement for how to change the settings.

The default setting is "Medium". With this setting, the system warns the driver of a possible collision with the vehicle in front when that vehicle is at a standard distance, between that of the other two settings.

With the system sensitivity set to "Far", the system will warn the driver of a possible collision with the vehicle in front when that vehicle is at a greater distance, thus providing the possibility of acting on the brakes more lightly and gradually. This setting provides the driver with the maximum possible reaction time to prevent a potential collision.

With the option set to "Near", the system will alert the driver of a possible collision with the vehicle in front when that vehicle is close. This setting offers the driver a lower reaction time compared to the "Medium" and "Far" settings, in the event of a potential collision, but permits more dynamic driving of the vehicle.

The system sensitivity setting is kept in the memory when the engine is turned off.

System Limited Operation Warning

If a dedicated message is displayed, a condition limiting the system operation may have occurred. The possible reasons of this limitation are something is blocking the camera view or a fault.

If an obstruction is signaled, clean the area of the radar on the front fascia/bumper, and the camera area on the windshield.

If a fault in the system is occurring, it will still be possible to drive the vehicle normally, but automatic braking will not be available in the event of an impending collision.

When the conditions limiting the system functions end, this will go back to normal and complete operation. Should the fault persist, contact an authorized dealer.

System Failure Signaling

If the system turns off and a dedicated message is shown on the display, it means that there is a fault with the system.

In this case, it is still possible to drive the vehicle, but you are advised to contact an authorized dealer as soon as possible.

Radar Indication Not Available

If conditions are such that the radar cannot detect obstacles correctly, the system is deactivated and a dedicated message appears on the display. This generally occurs in the event of poor visibility, such as when it is snowing or raining heavily.

The function of this system can also be temporarily reduced due to obstructions such as mud, dirt or ice on the fascia/bumper. In such cases, a dedicated message will be shown on the display and the system will be deactivated. This message can sometimes appear in conditions of high reflectivity (e.g. tunnels with reflective tiles or ice or snow). When the conditions limiting the system functions end, it will go back to normal and complete operation.

In certain cases, this dedicated message could be displayed when the radar is not detecting any vehicles or objects within its view range.

If atmospheric conditions are not the reason behind this message, check if the sensor is dirty. It could be necessary to clean or remove any obstructions in the area.

If the message appears frequently, even in the absence of atmospheric conditions such as snow, rain, mud or other obstructions, contact an authorized dealer for a sensor alignment check.

In the absence of visible obstructions, manually removing the decorative cover trim and cleaning the radar surface could be required. Have this operation performed at an authorized dealer.

NOTE:

It is recommended that you do not install devices, accessories or aerodynamic attachments in front of the sensor or darken it in any

way, as this can compromise the correct functioning of the system.

Frontal Collision Alarm With Active Braking – If Equipped

If this function is selected, the brakes are operated to reduce the speed of the vehicle in the event of potential frontal impact.

This function applies an additional braking pressure if the braking pressure applied by the driver does not suffice to prevent potential frontal impact.

The function is active with speed above 2 mph (4 km/h).

NOTE:

When using an automatic car wash it is recommended to deactivate the system through the settings of the radio system. The system may detect the presence of a car, a wall or another obstacle and activate.

Driving In Special Conditions

In certain driving conditions, system intervention might be unexpected or delayed. The driver must therefore be very careful, keeping control of the vehicle to drive in complete safety.

- Driving close to a bend.
- The vehicle ahead is leaving a roundabout.
- Vehicles with small dimensions and/or not aligned in the driving lane.



- Lane change by other vehicles.
- Vehicles traveling at right angles to the vehicle.

NOTE:

- In particularly complex traffic conditions, the driver can deactivate the system manually through the Information and Entertainment system.
- If the driver depresses the brake pedal fully or makes an excessive steering maneuver during system operation, the automatic braking function may deactivate (e.g. to allow a possible maneuver to avoid the obstacle).
- The FCW system is automatically deactivated when operating in race mode and a warning message will be displayed on the instrument cluster.

Driving Close To A Bend

When entering or leaving a wide bend, the system may detect a vehicle in front of you, but not driving in the same driving lane. In cases such as these, the system may intervene.

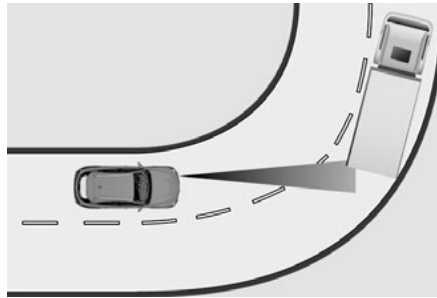
**Driving Around Wide Curves****The Vehicle Ahead Is Leaving A Roundabout**

On a roundabout, the system could intervene when it detects a vehicle ahead that is leaving the roundabout.

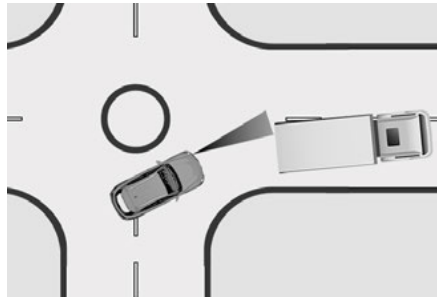
**Driving In Roundabouts****Vehicles With Small Dimensions And/Or Not Aligned In The Driving Lane**

The system cannot detect vehicles in front of the vehicle if they are outside the range of the

radar sensor and may not react to small vehicles, such as bicycles or motorcycles.

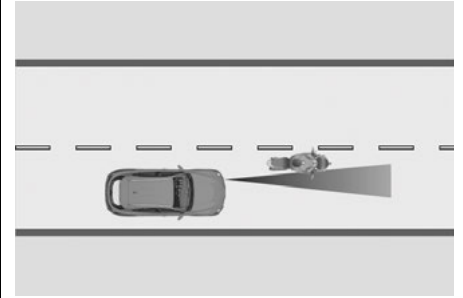
**Driving Near Small Vehicles****Lane Change By Other Vehicles**

Vehicles suddenly changing lanes to enter the same lane as your vehicle within the operating range of the radar sensor, may cause the system to intervene.

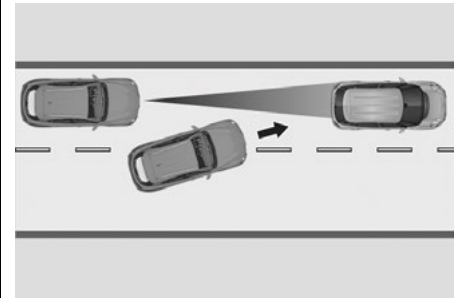
**Other Vehicles Changing Lanes**

Vehicles Traveling At Right Angles To The Vehicle

The system could temporarily react to a vehicle that is passing at right angles through the radar sensor's operating range ⇨ page 278.

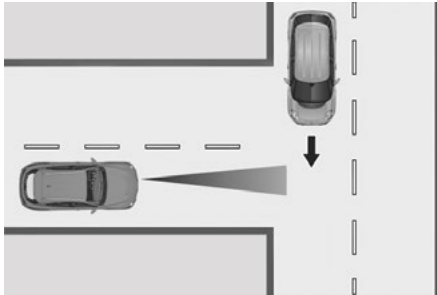

Other Vehicle Passing Through Radar Range



WARNING!

- The system has not been designed to prevent impacts and cannot detect possible conditions leading to an accident in advance. Failure to take into account this warning may lead to serious or fatal injuries.

(Continued)



WARNING! (Continued)

- The system may activate, assessing the trajectory of the vehicle, for the presence of reflecting metal objects different from other vehicles, such as safety barriers, road signs, barriers before parking lots, tollgates, level crossings, gates, railways, objects near road constructions sites or higher than the vehicle (e.g. a fly-over). In the same way, the system may intervene inside multi-story parking lots or tunnels, or due to a glare on the road surface. These possible activations are a consequence of the real driving scenario coverage by the system and must not be regarded as faults.
- The system has been designed for road use only. If the vehicle is driven on a track, the system must be deactivated to avoid unnecessary warnings. Automatic deactivation is signaled by the dedicated warning light/symbol switching on in the instrument panel ⇨ page 75.

TIRE PRESSURE MONITORING SYSTEM (TPMS)

The vehicle is equipped with a Tire Pressure Monitoring System (TPMS) that sends the inflation pressure information of each tire to the control unit, and will signal the driver in the event of insufficient tire pressure.

The TPMS uses wireless technology with wheel rim mounted electronic sensors to monitor tire pressure levels. Sensors, mounted to each wheel as part of the valve stem, transmit tire pressure readings to the receiver module.

Tire pressure will vary with temperature by approximately 1 psi (7 kPa) for every 12 °F (6.5 °C). This means that when the outside temperature decreases, the tire pressure will also decrease. Tire pressure should always be set based on cold inflation tire pressure.

This is defined as the tire pressure after the vehicle has not been driven for at least three hours, or driven less than 1 mile (1.6 km) after a three hour period. The cold tire inflation pressure must not exceed the maximum inflation pressure molded into the tire sidewall. The tire pressure will also increase as the vehicle is driven. This is normal, and there should be no adjustment for this increased pressure.

See ⇨ page 240 for information on how to properly inflate the vehicle's tires.

The TPMS will signal the driver if pressure falls below the warning limit for any reason, including the effects of low temperature and normal loss of pressure from the tire.

The TPMS will stop indicating insufficient tire pressure when pressure is equal to or greater than the prescribed cold inflation level.

Therefore, if insufficient tire pressure is indicated by the () warning light displaying



in the instrument cluster, increase the inflation pressure up to the prescribed cold inflation value.

The system will automatically update, and the TPMS Warning Light will turn off once the system receives the updated tire pressures. The vehicle may need to be driven for up to 20 minutes above 15 mph (24 km/h) in order for the TPMS to receive this information.

NOTE:

The TPMS cannot indicate sudden tire pressure drops (e.g. if a tire bursts). In this case, proceed with caution and avoid abrupt steering.

Operating Example

For example, your vehicle may have a recommended cold (parked for more than three hours) placard pressure of 33 psi (227 kPa). If the ambient temperature is 68° F (20° C), and the measured tire pressure is 28 psi (193 kPa), a temperature drop to 20° F (-7° C) will decrease the tire pressure to approximately 24 psi (165 kPa). This tire pressure is low enough to turn on the "Tire Pressure Monitoring Warning Light." Driving the vehicle may cause the tire pressure to rise to approximately 28 psi (193 kPa), but the TPMS Warning Light will still be on. In this situation, the TPMS Warning Light will turn off only after the tires are inflated to the vehicle's recommended cold placard pressure value.



CAUTION!

- The TPMS has been optimized for the original equipment tires and wheels. TPMS pressures and warning have been established for the tire size equipped on your vehicle. Undesirable system operation or sensor damage may result when using replacement equipment that is not of the same size, type, and/or style. The TPMS sensor is not designed for use on aftermarket wheels and may contribute to a poor overall system performance or sensor damage. Customers are encouraged to use OEM wheels to ensure proper TPMS feature operation.
- Using aftermarket tire sealants may cause the Tire Pressure Monitoring System (TPMS) sensor to become inoperable. After using an aftermarket tire sealant it is recommended that you take your vehicle to an authorized dealer to have your sensor function checked.
- After inspecting or adjusting the tire pressure always reinstall the valve stem cap. This will prevent moisture and dirt from entering the valve stem, which could damage the TPMS sensor.

Insufficient Tire Pressure Indication

If an insufficient pressure value is detected on one or more tires, the (⚠) warning light in the instrument cluster will display alongside the

dedicated messages, the system will highlight the tire or tires with insufficient pressure graphically, and an acoustic signal will be emitted.

In this case, stop the vehicle, check the inflation pressure of each tire, and inflate the necessary tire or tires to the correct cold inflation pressure value, shown on the display or in the dedicated TPMS menu.

TPMS Temporarily Disabled:

TPMS Check Message

When a system fault is detected, the TPMS Warning Light will flash on and off for 75 seconds, and then remain on solid. The system fault will also sound a chime. If the ignition is cycled, this sequence will repeat, provided that the system fault still exists. The TPMS Warning Light will turn off when the fault condition no longer exists. A system fault can occur due to any of the following:

- Jamming due to electronic devices or driving next to facilities emitting the same radio frequencies as the TPMS sensors.
- Installing some form of aftermarket window tinting that affects radio wave signals.
- Packed snow or ice around the wheels or wheel housings.
- Using tire chains on the vehicle.
- Using wheels/tires not equipped with TPMS sensors.

After the punctured tire has been repaired with the original tire sealant contained in the Tire Kit, the previous condition must be restored so that the (U) warning light is off during normal driving.

TPMS Deactivation

The TPMS can be deactivated by replacing all four wheel and tire assemblies (road tires) with wheel and tire assemblies that do not have TPMS sensors, such as when installing winter wheel and tire assemblies on your vehicle.

To deactivate the TPMS, first replace all four wheel and tire assemblies (road tires) with tires not equipped with Tire Pressure Monitoring System (TPMS) sensors. Then, drive the vehicle for 20 minutes above 15 mph (24 km/h). The TPMS will chime, the TPMS Warning Light will flash on and off for 75 seconds and then remain on. The instrument cluster will display the “SERVICE TPM SYSTEM” message and then display dashes (-) in place of the pressure values.

Beginning with the next ignition switch cycle, the TPMS will no longer chime or display the “SERVICE TPM SYSTEM” message in the instrument cluster. Instead, dashes (-) will remain in place of the pressure values.

To reactivate the TPMS, replace all four wheel and tire assemblies (road tires) with tires equipped with TPMS sensors. Then, drive the vehicle for up to 20 minutes above 15 mph (24 km/h). The TPMS will chime, the TPMS Warning Light will flash on and off for

75 seconds and then turn off. The instrument cluster will display the “SERVICE TPM SYSTEM” message and then display pressure values in place of the dashes. On the next ignition switch cycle the “SERVICE TPM SYSTEM” message will no longer be displayed, as long as no system fault exists.

NOTE:

- The TPMS is not intended to replace normal tire care and maintenance, or to provide warning of a tire failure or condition.
- The TPMS should not be used as a tire pressure gauge while adjusting your tire pressure.
- Driving on a significantly underinflated tire will cause the tire to overheat, and can lead to tire failure. Underinflation also reduces fuel efficiency and tire tread life, and may affect the vehicle’s handling and stopping ability.
- The TPMS is not a substitute for proper tire maintenance, and it is the driver’s responsibility to maintain correct tire pressure using an accurate tire pressure gauge, even if underinflation has not reached the level to trigger illumination of the TPMS Warning Light.
- Seasonal temperature changes will affect tire pressure, and the TPMS will monitor the actual tire pressure in the tire → page 278.

OCCUPANT RESTRAINT SYSTEMS

Some of the most important safety features in your vehicle are the restraint systems:

OCCUPANT RESTRAINT SYSTEMS FEATURES

- Seat Belt Systems
- Supplemental Restraint Systems (SRS) Air Bags
- Child Restraints

Some of the safety features described in this section may be standard equipment on some models, or may be optional equipment on others. If you are not sure, ask an authorized dealer.

IMPORTANT SAFETY PRECAUTIONS

Please pay close attention to the information in this section. It tells you how to use your restraint system properly, to keep you and your passengers as safe as possible.

Here are some simple steps you can take to minimize the risk of harm from a deploying air bag:

1. Children 12 years old and under should always ride buckled up in the rear seat of a vehicle with a rear seat.
2. A child who is not big enough to wear the vehicle seat belt properly must be secured in the appropriate child restraint or



belt-positioning booster seat in a rear seating position → page 182.

3. If a child from 2 to 12 years old (not in a rear-facing child restraint) must ride in the front passenger seat, move the seat as far back as possible and use the proper child restraint → page 182.
4. Never allow children to slide the shoulder belt behind them or under their arm.
5. You should read the instructions provided with your child restraint to make sure that you are using it properly.
6. All occupants should always wear their lap and shoulder belts properly.
7. The driver and front passenger seats should be moved back as far as practical to allow the front air bags room to inflate.
8. Do not lean against the door or window. If your vehicle has side air bags, and deployment occurs, the side air bags will inflate forcefully into the space between occupants and the door and occupants could be injured.
9. If the air bag system in this vehicle needs to be modified to accommodate a disabled person, see → page 275 for customer service contact information.



WARNING!

- Never place a rear-facing child restraint in front of an air bag. A deploying passenger front air bag can cause death or serious injury to a child 12 years or younger, including a child in a rear-facing child restraint.
- Never install a rear-facing child restraint in the front seat of a vehicle. Only use a rear-facing child restraint in the rear seat. If the vehicle does not have a rear seat, do not transport a rear-facing child restraint in that vehicle.

SEAT BELT SYSTEMS

Buckle up even though you are an excellent driver, even on short trips. Someone on the road may be a poor driver and could cause a collision that includes you. This can happen far away from home or on your own street.

Research has shown that seat belts save lives, and they can reduce the seriousness of injuries in a collision. Some of the worst injuries happen when people are thrown from the vehicle. Seat belts reduce the possibility of ejection and the risk of injury caused by striking the inside of the vehicle. Everyone in a motor vehicle should be belted at all times.

Enhanced Seat Belt Use Reminder System (BeltAlert)

Driver And Passenger BeltAlert — If Equipped

 BeltAlert is a feature intended to remind the driver and outboard front seat passenger (if equipped with outboard front passenger seat BeltAlert) to buckle their seat belts. The BeltAlert feature is active whenever the ignition switch is in the ON/RUN position.

Initial Indication

If the driver is unbuckled when the ignition switch is first in the ON/RUN position, a chime will signal for a few seconds. If the driver or outboard front seat passenger (if equipped with outboard front passenger seat BeltAlert) is unbuckled when the ignition switch is first in the ON/RUN position the Seat Belt Reminder Light will turn on and remain on until both outboard front seat belts are buckled. The outboard front passenger seat BeltAlert is not active when an outboard front passenger seat is unoccupied.

BeltAlert Warning Sequence

The BeltAlert warning sequence is activated when the vehicle is moving above a specified vehicle speed range and the driver or outboard front seat passenger is unbuckled (if equipped with outboard front passenger seat BeltAlert) (the outboard front passenger seat BeltAlert is not active when the outboard front passenger seat is unoccupied). The BeltAlert warning sequence starts by blinking the Seat Belt

Reminder Light and sounding an intermittent chime. Once the BeltAlert warning sequence has completed, the Seat Belt Reminder Light will remain on until the seat belts are buckled. The BeltAlert warning sequence may repeat based on vehicle speed until the driver and occupied outboard front seat passenger seat belts are buckled. The driver should instruct all occupants to buckle their seat belts.

Change Of Status

If the driver or outboard front seat passenger (if equipped with outboard front passenger seat BeltAlert) unbuckles their seat belt while the vehicle is traveling, the BeltAlert warning sequence will begin until the seat belts are buckled again.

The outboard front passenger seat BeltAlert is not active when the outboard front passenger seat is unoccupied. BeltAlert may be triggered when an animal or other items are placed on the outboard front passenger seat or when the seat is folded flat (if equipped). It is recommended that pets be restrained in the rear seat (if equipped) in pet harnesses or pet carriers that are secured by seat belts, and cargo is properly stowed.

Lap/Shoulder Belts

All seating positions in your vehicle are equipped with lap/shoulder belts.

The seat belt webbing retractor will lock only during very sudden stops or collisions. This feature allows the shoulder part of the seat belt to move freely with you under normal conditions. However, in a collision the seat belt will lock and reduce your risk of striking the inside of the vehicle or being thrown out of the vehicle.



WARNING!

- Relying on the air bags alone could lead to more severe injuries in a collision. The air bags work with your seat belt to restrain you properly. In some collisions, the air bags won't deploy at all. Always wear your seat belt even though you have air bags.
- In a collision, you and your passengers can suffer much greater injuries if you are not properly buckled up. You can strike the interior of your vehicle or other passengers, or you can be thrown out of the vehicle. Always be sure you and others in your vehicle are buckled up properly.
- It is dangerous to ride in a cargo area, inside or outside of a vehicle. In a collision, people riding in these areas are more likely to be seriously injured or killed.
- Do not allow people to ride in any area of your vehicle that is not equipped with seats and seat belts.

(Continued)



WARNING! (Continued)

- Be sure everyone in your vehicle is in a seat and using a seat belt properly. Occupants, including the driver, should always wear their seat belts whether or not an air bag is also provided at their seating position to minimize the risk of severe injury or death in the event of a crash.
- Wearing your seat belt incorrectly could make your injuries in a collision much worse. You might suffer internal injuries, or you could even slide out of the seat belt. Follow these instructions to wear your seat belt safely and to keep your passengers safe, too.
- Two people should never be belted into a single seat belt. People belted together can crash into one another in a collision, hurting one another badly. Never use a lap/shoulder belt or a lap belt for more than one person, no matter what their size.



WARNING!

- A lap belt worn too high can increase the risk of injury in a collision. The seat belt forces won't be at the strong hip and pelvic bones, but across your abdomen. Always wear the lap part of your seat belt as low as possible and keep it snug.

(Continued)



**WARNING!** *(Continued)*

- ❑ A twisted seat belt may not protect you properly. In a collision, it could even cut into you. Be sure the seat belt is flat against your body, without twists. If you can't straighten a seat belt in your vehicle, take it to an authorized dealer immediately and have it fixed.
- ❑ A seat belt that is buckled into the wrong buckle will not protect you properly. The lap portion could ride too high on your body, possibly causing internal injuries. Always buckle your seat belt into the buckle nearest you.
- ❑ A seat belt that is too loose will not protect you properly. In a sudden stop, you could move too far forward, increasing the possibility of injury. Wear your seat belt snugly.
- ❑ A seat belt that is worn under your arm is dangerous. Your body could strike the inside surfaces of the vehicle in a collision, increasing head and neck injury. A seat belt worn under the arm can cause internal injuries. Ribs aren't as strong as shoulder bones. Wear the seat belt over your shoulder so that your strongest bones will take the force in a collision.

(Continued)**WARNING!** *(Continued)*

- ❑ A shoulder belt placed behind you will not protect you from injury during a collision. You are more likely to hit your head in a collision if you do not wear your shoulder belt. The lap and shoulder belt are meant to be used together.
- ❑ A frayed or torn seat belt could rip apart in a collision and leave you with no protection. Inspect the seat belt system periodically, checking for cuts, frays, or loose parts. Damaged parts must be replaced immediately. Do not disassemble or modify the seat belt system. If your vehicle is involved in a collision, or if you have questions regarding seat belt or retractor conditions, take your vehicle to an authorized FCA dealer or authorized FCA Certified Collision Care Program facility for inspection.

Lap/Shoulder Belt Operating Instructions

1. Enter the vehicle and close the door. Sit back and adjust the seat.
2. The seat belt latch plate is above the back of the front seat, and next to your arm in the rear seat (for vehicles equipped with a rear seat). Grab the latch plate and pull out the seat belt. Slide the latch plate up the

webbing as far as necessary to allow the seat belt to go around your lap.

3. When the seat belt is long enough to fit, insert the latch plate into the buckle until you hear a "click."



**Seat Belt Latch Plate Inserted Into
Seat Belt Buckle**

4. Position the lap belt so that it is snug and lies low across your hips, below your abdomen. To remove slack in the lap belt portion, pull up on the shoulder belt. To loosen the lap belt if it is too tight, tilt the latch plate and pull on the lap belt. A snug seat belt reduces the risk of sliding under the seat belt in a collision.
5. Position the shoulder belt across the shoulder and chest with minimal, if any slack so that it is comfortable and not resting on your neck. The retractor will withdraw any slack in the shoulder belt.

6. To release the seat belt, push the red button on the buckle. The seat belt will automatically retract to its stowed position. If necessary, slide the latch plate down the webbing to allow the seat belt to retract fully.

Lap/Shoulder Belt Untwisting Procedure

Use the following procedure to untwist a twisted lap/shoulder belt.

1. Position the latch plate as close as possible to the anchor point.
2. At about 6 to 12 inches (15 to 30 cm) above the latch plate, grab and twist the seat belt webbing 180 degrees to create a fold that begins immediately above the latch plate.
3. Slide the latch plate upward over the folded webbing. The folded webbing must enter the slot at the top of the latch plate.
4. Continue to slide the latch plate up until it clears the folded webbing and the seat belt is no longer twisted.

Adjustable Upper Shoulder Belt Anchorage

In the driver and outboard front passenger seats, the top of the shoulder belt can be adjusted upward or downward to position the seat belt away from your neck. Push or

squeeze the anchorage button to release the anchorage, and move it up or down to the position that serves you best.



Adjustable Upper Shoulder Belt Anchorage

As a guide, if you are shorter than average, you will prefer the shoulder belt anchorage in a lower position, and if you are taller than average, you will prefer the shoulder belt anchorage in a higher position. After you release the anchorage button, try to move it up or down to make sure that it is locked in position.

NOTE:

The adjustable upper shoulder belt anchorage is equipped with an Easy Up feature. This feature allows the shoulder belt anchorage to be adjusted in the upward position without pushing or squeezing the release button.

To verify the shoulder belt anchorage is latched, pull downward on the shoulder belt anchorage until it is locked into position.



WARNING!

- Wearing your seat belt incorrectly could make your injuries in a collision much worse. You might suffer internal injuries, or you could even slide out of the seat belt. Follow these instructions to wear your seat belt safely and to keep your passengers safe, too.
- Position the shoulder belt across the shoulder and chest with minimal, if any slack so that it is comfortable and not resting on your neck. The retractor will withdraw any slack in the shoulder belt.
- Misadjustment of the seat belt could reduce the effectiveness of the safety belt in a crash.
- Always make all seat belt height adjustments when the vehicle is stationary.



Seat Belts And Pregnant Women

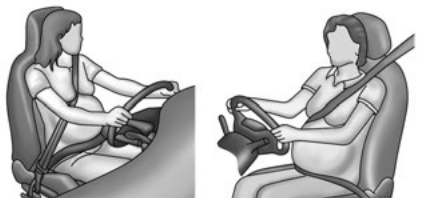

Seat Belts And Pregnant Women

Seat belts must be worn by all occupants including pregnant women: the risk of injury in the event of an accident is reduced for the mother and the unborn child if they are wearing a seat belt.

Position the lap belt snug and low below the abdomen and across the strong bones of the hips. Place the shoulder belt across the chest and away from the neck. Never place the shoulder belt behind the back or under the arm.

Seat Belt Pretensioner

The front outboard seat belt system is equipped with pretensioning devices that are designed to remove slack from the seat belt in the event of a collision. These devices may improve the performance of the seat belt by removing slack from the seat belt early in a collision. Pretensioners work for all size occupants, including those in child restraints.

NOTE:

These devices are not a substitute for proper seat belt placement by the occupant. The seat belt still must be worn snugly and positioned properly.

The pretensioners are triggered by the Occupant Restraint Controller (ORC). Like the air bags, the pretensioners are single use items. A deployed pretensioner or a deployed air bag must be replaced immediately.

Energy Management Feature

The front outboard seat belt system is equipped with an Energy Management feature that may help further reduce the risk of injury in the event of a collision. The seat belt system has a retractor assembly that is designed to release webbing in a controlled manner.

Switchable Automatic Locking Retractors (ALR)

The seat belts in the passenger seating positions are equipped with a Switchable Automatic Locking Retractor (ALR) which is used to secure a child restraint system
 ⇨ page 189.

The figure below illustrates the locking feature for each seating position.

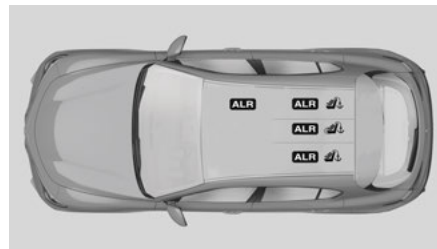

Switchable Automatic Locking Retractor (ALR) Locations

If the passenger seating position is equipped with an ALR and is being used for normal usage, only pull the seat belt webbing out far enough to comfortably wrap around the occupant's mid-section so as to not activate the ALR. If the ALR is activated, you will hear a clicking sound as the seat belt retracts. Allow the webbing to retract completely in this case and then carefully pull out only the amount of webbing necessary to comfortably wrap around the occupant's mid-section. Slide the latch plate into the buckle until you hear a "click."

In Automatic Locking Mode, the shoulder belt is automatically pre-locked. The seat belt will still retract to remove any slack in the shoulder belt. Use the Automatic Locking Mode anytime a child restraint is installed in a seating position that has a seat belt with this feature.

Children 12 years old and under should always be properly restrained in the rear seat of a vehicle with a rear seat.



WARNING!

- Never place a rear-facing child restraint in front of an air bag. A deploying passenger front air bag can cause death or serious injury to a child 12 years or younger, including a child in a rear-facing child restraint.
- Never install a rear-facing child restraint in the front seat of a vehicle. Only use a rear-facing child restraint in the rear seat. If the vehicle does not have a rear seat, do not transport a rear-facing child restraint in that vehicle.

How To Engage The Automatic Locking Mode

1. Buckle the combination lap and shoulder belt.
2. Grab the shoulder portion and pull downward until the entire seat belt is extracted.
3. Allow the seat belt to retract. As the seat belt retracts, you will hear a clicking sound. This indicates the seat belt is now in the Automatic Locking Mode.

How To Disengage The Automatic Locking Mode

Unbuckle the combination lap/shoulder belt and allow it to retract completely to disengage the Automatic Locking Mode and activate the vehicle sensitive (emergency) locking mode.



WARNING!

- The seat belt assembly must be replaced if the switchable Automatic Locking Retractor (ALR) feature or any other seat belt function is not working properly when checked according to the procedures in the Service Manual.
- Failure to replace the seat belt assembly could increase the risk of injury in collisions.
- Do not use the Automatic Locking Mode to restrain occupants who are wearing the seat belt or children who are using booster seats. The locked mode is only used to install rear-facing or forward-facing child restraints that have a harness for restraining the child.

SUPPLEMENTAL RESTRAINT SYSTEMS (SRS)

Some of the safety features described in this section may be standard equipment on some models, or may be optional equipment on others. If you are not sure, ask an authorized dealer.

The air bag system must be ready to protect you in a collision. The Occupant Restraint Controller (ORC) monitors the internal circuits and interconnecting wiring associated with the electrical Air Bag System Components. Your vehicle may be equipped with the following Air Bag System Components:

Air Bag System Components

- Occupant Restraint Controller (ORC)
- Air Bag Warning Light 
- Steering Wheel and Column
- Instrument Panel
- Knee Impact Bolsters
- Driver and Front Passenger Air Bags
- Seat Belt Buckle Switch
- Supplemental Side Air Bags
- Supplemental Knee Air Bags
- Front and Side Impact Sensors
- Seat Belt Pretensioners
- Seat Track Position Sensors



Air Bag Warning Light



The Occupant Restraint Controller (ORC) monitors the readiness of the electronic parts of the air bag system whenever the ignition switch is in the START or ON/RUN position. If the ignition switch is in the OFF position or in the ACC position, the air bag system is not on and the air bags will not inflate.

The ORC contains a backup power supply system that may deploy the air bag system even if the battery loses power or it becomes disconnected prior to deployment.

The ORC turns on the Air Bag Warning Light in the instrument panel for approximately four to eight seconds for a self-check when the ignition switch is first in the ON/RUN position. After the self-check, the Air Bag Warning Light will turn off. If the ORC detects a malfunction in any part of the system, it turns on the Air Bag Warning Light, either momentarily or continuously. A single chime will sound to alert you if the light comes on again after initial startup.

The ORC also includes diagnostics that will illuminate the instrument panel Air Bag Warning Light if a malfunction is detected that could affect the air bag system. The diagnostics also record the nature of the malfunction. While the air bag system is

designed to be maintenance free, if any of the following occurs, have an authorized dealer service the air bag system immediately.

- The Air Bag Warning Light does not come on during the four to eight seconds when the ignition switch is first in the ON/RUN position.
- The Air Bag Warning Light remains on after the four to eight-second interval.
- The Air Bag Warning Light comes on intermittently or remains on while driving.

NOTE:

If the speedometer, tachometer, or any engine related gauges are not working, the Occupant Restraint Controller (ORC) may also be disabled. In this condition the air bags may not be ready to inflate for your protection. Have an authorized dealer service the air bag system immediately.



WARNING!

Ignoring the Air Bag Warning Light in your instrument panel could mean you won't have the air bag system to protect you in a collision. If the light does not come on as a bulb check when the ignition is first turned on, stays on after you start the vehicle, or if it comes on as you drive, have an authorized dealer service the air bag system immediately.

Redundant Air Bag Warning Light



If a fault with the Air Bag Warning Light is detected, which could affect the Supplemental Restraint System (SRS), the Redundant Air Bag Warning Light will illuminate on the instrument panel. The Redundant Air Bag Warning Light will stay on until the fault is cleared. In addition, a single chime will sound to alert you that the Redundant Air Bag Warning Light has come on and a fault has been detected. If the Redundant Air Bag Warning Light comes on intermittently or remains on while driving have an authorized dealer service the vehicle immediately.

For additional information regarding the Redundant Air Bag Warning Light see [page 75](#).

Front Air Bags

This vehicle has front air bags and lap/shoulder belts for both the driver and front passenger. The front air bags are a supplement to the seat belt restraint systems. The driver front air bag is mounted in the center of the steering wheel. The passenger front air bag is mounted in the instrument panel, above the glove compartment.

The words “SRS AIRBAG” or “AIRBAG” are embossed on the air bag covers.



Driver Front Air Bag

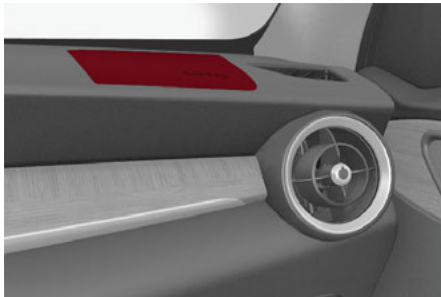

Passenger Front Air Bag



Driver Knee Air Bag Location/Knee Bolster Location



Passenger Knee Air Bag Location/Knee Bolster Location



WARNING!

- Being too close to the steering wheel or instrument panel during front air bag deployment could cause serious injury, including death. Air bags need room to inflate. Sit back, comfortably extending your arms to reach the steering wheel or instrument panel.

(Continued)



WARNING! (Continued)

- Never place a rear-facing child restraint in front of an air bag. A deploying passenger front air bag can cause death or serious injury to a child 12 years or younger, including a child in a rear-facing child restraint.
- Never install a rear-facing child restraint in the front seat of a vehicle. Only use a rear-facing child restraint in the rear seat. If the vehicle does not have a rear seat, do not transport a rear-facing child restraint in that vehicle.

Driver And Passenger Front Air Bag Features

The Advanced Front Air Bag system has multistage driver and front passenger air bags. This system provides output appropriate to the severity and type of collision as determined by the Occupant Restraint Controller (ORC), which may receive information from the front impact sensors (if equipped) or other system components.

The first stage inflator is triggered immediately during an impact that requires air bag deployment. A low energy output is used in less severe collisions. A higher energy output is used for more severe collisions.

This vehicle may be equipped with a driver and/or front passenger seat belt buckle switch that detects whether the driver or front



passenger seat belt is buckled. The seat belt buckle switch may adjust the inflation rate of the Advanced Front Air Bags.

This vehicle may be equipped with driver and/or front passenger seat track position sensors that may adjust the inflation rate of the Advanced Front Air Bags based upon seat position.



WARNING!

- No objects should be placed over or near the air bag on the instrument panel or steering wheel because any such objects could cause harm if the vehicle is in a collision severe enough to cause the air bag to inflate.
- Do not put anything on or around the air bag covers or attempt to open them manually. You may damage the air bags and you could be injured because the air bags may no longer be functional. The protective covers for the air bag cushions are designed to open only when the air bags are inflating.
- Relying on the air bags alone could lead to more severe injuries in a collision. The air bags work with your seat belt to restrain you properly. In some collisions, air bags won't deploy at all. Always wear your seat belts even though you have air bags.

Front Air Bag Operation

Front Air Bags are designed to provide additional protection by supplementing the seat belts. Front air bags are not expected to reduce the risk of injury in rear, side, or rollover collisions. The front air bags will not deploy in all frontal collisions, including some that may produce substantial vehicle damage — for example, some pole collisions, truck underrides, and angle offset collisions.

On the other hand, depending on the type and location of impact, front air bags may deploy in crashes with little vehicle front-end damage but that produce a severe initial deceleration.

Because air bag sensors measure vehicle deceleration over time, vehicle speed and damage by themselves are not good indicators of whether or not an air bag should have deployed.

Seat belts are necessary for your protection in all collisions, and also are needed to help keep you in position, away from an inflating air bag.

When the Occupant Restraint Controller (ORC) detects a collision requiring the front air bags, it signals the inflator units. A large quantity of non-toxic gas is generated to inflate the front air bags.

The steering wheel hub trim cover and the upper passenger side of the instrument panel separate and fold out of the way as the air bags inflate to their full size. The front air bags

fully inflate in less time than it takes to blink your eyes. The front air bags then quickly deflate while helping to restrain the driver and front passenger.

Knee Impact Bolsters

The Knee Impact Bolsters help protect the knees of the driver and front passenger, and position the front occupants for improved interaction with the front air bags.



WARNING!

- Do not drill, cut, or tamper with the knee impact bolsters in any way.
- Do not mount any accessories to the knee impact bolsters such as alarm lights, stereos, citizen band radios, etc.

Supplemental Driver And Front Passenger Knee Air Bags

This vehicle is equipped with a Supplemental Driver Knee Air Bag mounted in the instrument panel below the steering column and a Supplemental Passenger Knee Air Bag mounted in the instrument panel below the glove compartment. The Supplemental Knee Air Bags provide enhanced protection during a frontal impact by working together with the seat belts, pretensioners, and front air bags.

Supplemental Side Air Bags

Supplemental Seat-Mounted Side Air Bags (SABs)

This vehicle is equipped with Supplemental Seat-Mounted Side Air Bags (SABs).

Supplemental Seat-Mounted Side Air Bags (SABs) are located in the outboard side of the front seats. The SABs are marked with “SRS AIRBAG” or “AIRBAG” on a label or on the seat trim on the outboard side of the seats.

The SABs may help to reduce the risk of occupant injury during certain side impacts, in addition to the injury reduction potential provided by the seat belts and body structure.



Front Supplemental Seat-Mounted Side Air Bag

When the SAB deploys, it opens the seam on the outboard side of the seatback’s trim cover. The inflating SAB deploys through the seat seam into the space between the occupant and the door. The SAB moves at a very high speed and with such a high force that it could injure occupants if they are not seated properly, or if items are positioned in the area where the SAB inflates. Children are at an even greater risk of injury from a deploying air bag.



WARNING!

Do not use accessory seat covers or place objects between you and the Side Air Bags; the performance could be adversely affected and/or objects could be pushed into you, causing serious injury.

Supplemental Side Air Bag Inflatable Curtains (SABICs)

This vehicle is equipped with Supplemental Side Air Bag Inflatable Curtains (SABICs).

Supplemental Side Air Bag Inflatable Curtains (SABICs) are located above the side windows. The trim covering the SABICs is labeled “SRS AIRBAG” or “AIRBAG.”



Supplemental Side Air Bag Inflatable Curtain (SABIC) Location

SABICs may help reduce the risk of head and other injuries to front and rear seat outboard occupants in certain side impacts, in addition to the injury reduction potential provided by the seat belts and body structure.

The SABIC deploys downward, covering the side windows. An inflating SABIC pushes the outside edge of the headliner out of the way and covers the window. The SABICs inflate with enough force to injure occupants if they are not belted and seated properly, or if items are positioned in the area where the SABICs inflate. Children are at an even greater risk of injury from a deploying air bag.

The SABICs may help reduce the risk of partial or complete ejection of vehicle occupants through side windows in certain side impact events.



**WARNING!**

- ❑ Do not mount equipment, or stack luggage or other cargo up high enough to block the deployment of the SABICs. The trim covering above the side windows where the SABIC and its deployment path are located should remain free from any obstructions.
- ❑ In order for the SABICs to work as intended, do not install any accessory items in your vehicle which could alter the roof. Do not add an aftermarket sunroof to your vehicle. Do not add roof racks that require permanent attachments (bolts or screws) for installation on the vehicle roof. Do not drill into the roof of the vehicle for any reason.

Side Impacts

The Side Air Bags are designed to activate in certain side impacts. The Occupant Restraint Controller (ORC) determines whether the deployment of the Side Air Bags in a particular impact event is appropriate, based on the severity and type of collision. The side impact sensors aid the ORC in determining the appropriate response to impact events. The system is calibrated to deploy the Side Air

Bags on the impact side of the vehicle during impacts that require Side Air Bag occupant protection. In side impacts, the Side Air Bags deploy independently; a left side impact deploys the left Side Air Bags only and a right-side impact deploys the right Side Air Bags only. Vehicle damage by itself is not a good indicator of whether or not Side Air Bags should have deployed.

The Side Air Bags will not deploy in all side collisions, including some collisions at certain angles, or some side collisions that do not impact the area of the passenger compartment. The Side Air Bags may deploy during angled or offset frontal collisions where the front air bags deploy.

Side Air Bags are a supplement to the seat belt restraint system. Side Air Bags deploy in less time than it takes to blink your eyes.

**WARNING!**

- ❑ Occupants, including children, who are up against or very close to Side Air Bags can be seriously injured or killed. Occupants, including children, should never lean on or sleep against the door, side windows, or area where the side air bags inflate, even if they are in an infant or child restraint.

(Continued)

**WARNING! (Continued)**

- ❑ Seat belts (and child restraints where appropriate) are necessary for your protection in all collisions. They also help keep you in position, away from an inflating Side Air Bag. To get the best protection from the Side Air Bags, occupants must wear their seat belts properly and sit upright with their backs against the seats. Children must be properly restrained in a child restraint or booster seat that is appropriate for the size of the child.

**WARNING!**

- ❑ Side Air Bags need room to inflate. Do not lean against the door or window. Sit upright in the center of the seat.
- ❑ Being too close to the Side Air Bags during deployment could cause you to be severely injured or killed.
- ❑ Relying on the Side Air Bags alone could lead to more severe injuries in a collision. The Side Air Bags work with your seat belt to restrain you properly. In some collisions, Side Air Bags won't deploy at all. Always wear your seat belt even though you have Side Air Bags.

NOTE:

Air bag covers may not be obvious in the interior trim, but they will open during air bag deployment.

Rollover Events

Side Air Bags and seat belt pretensioners are designed to activate in certain rollover events. The Occupant Restraint Controller (ORC) determines whether deployment in a particular rollover event is appropriate, based on the severity and type of collision. Vehicle damage by itself is not a good indicator of whether or not Side Air Bags and seat belt pretensioners should have deployed.

The Side Air Bags and seat belt pretensioners will not deploy in all rollover events. The rollover sensing system determines if a rollover event may be in progress and whether deployment is appropriate. In the event the vehicle experiences a rollover or near rollover event, and deployment is appropriate, the rollover sensing system will deploy the side air bags and seat belt pretensioners on both sides of the vehicle.

The SABICs may help reduce the risk of partial or complete ejection of vehicle occupants through side windows in certain rollover or side impact events.

Air Bag System Components**NOTE:**

The Occupant Restraint Controller (ORC) monitors the internal circuits and interconnecting wiring associated with electrical Air Bag System Components listed below:

- Occupant Restraint Controller (ORC)
- Air Bag Warning Light 
- Steering Wheel and Column
- Instrument Panel
- Knee Impact Bolsters
- Driver and Front Passenger Air Bags
- Seat Belt Buckle Switch
- Supplemental Side Air Bags
- Supplemental Knee Air Bags
- Front and Side Impact Sensors
- Seat Belt Pretensioners
- Seat Track Position Sensors

If A Deployment Occurs

The front air bags are designed to deflate immediately after deployment.

NOTE:

Front and/or side air bags will not deploy in all collisions. This does not mean something is wrong with the air bag system.

If you do have a collision which deploys the air bags, any or all of the following may occur:

- The air bag material may sometimes cause abrasions and/or skin reddening to the occupants as the air bags deploy and unfold. The abrasions are similar to friction rope burns or those you might get sliding along a carpet or gymnasium floor. They are not caused by contact with chemicals. They are not permanent and normally heal quickly. However, if you haven't healed significantly within a few days, or if you have any blistering, see your doctor immediately.
- As the air bags deflate, you may see some smoke-like particles. The particles are a normal by-product of the process that generates the non-toxic gas used for air bag inflation. These airborne particles may irritate the skin, eyes, nose, or throat. If you have skin or eye irritation, rinse the area with cool water. For nose or throat irritation, move to fresh air. If the irritation continues, see your doctor. If these particles settle on your clothing, follow the garment manufacturer's instructions for cleaning.

Do not drive your vehicle after the air bags have deployed. If you are involved in another collision, the air bags will not be in place to protect you.



**WARNING!**

Deployed air bags and seat belt pretensioners cannot protect you in another collision. Have the air bags, seat belt pretensioners, and the seat belt retractor assemblies replaced by an authorized dealer immediately. Also, have the Occupant Restraint Controller System serviced as well.

NOTE:

- Air bag covers may not be obvious in the interior trim, but they will open during air bag deployment.
- After any collision, the vehicle should be taken to an authorized dealer immediately.

Enhanced Accident Response System

In the event of an impact, if the communication network remains intact, and the power remains intact, depending on the nature of the event, the Occupant Restraint Controller (ORC) will determine whether to have the Enhanced Accident Response System perform the following functions:

- Cut off fuel to the engine (if equipped)
- Cut off battery power to the electric motor (if equipped)
- Flash hazard lights as long as the battery has power

- Turn on the interior lights, which remain on as long as the battery has power or for 15 minutes from the intervention of the Enhanced Accident Response System

- Unlock the power door locks

Your vehicle may also be designed to perform any of these other functions in response to the Enhanced Accident Response System:

- Turn off the Fuel Filter Heater, Turn off the HVAC Blower Motor, Close the HVAC Circulation Door
- Cut off battery power to the:
 - Engine
 - Electric Motor (if equipped)
 - Electric power steering
 - Brake booster
 - Electric park brake
 - Automatic transmission gear selector
 - Horn
 - Front wiper
 - Headlamp washer pump

NOTE:

After an accident, remember to cycle the ignition to the OFF position and remove the key from the ignition switch to avoid draining the battery. Carefully check the vehicle for fuel leaks in the engine compartment and on the ground near the engine compartment and fuel tank before resetting the system and starting the engine. If there are no fuel leaks or damage to the vehicle electrical devices (e.g. headlights) after an accident, reset the system by following the procedure described below. If you have any doubt, contact an authorized dealer.

Enhanced Accident Response System Reset Procedure

After the event occurs, when the system is active, a message regarding fuel cutoff is displayed. Turn the ignition switch from ignition ACC or ON/RUN to ignition OFF. Carefully check the vehicle for fuel leaks in the engine compartment and on the ground near the engine compartment and fuel tank before resetting the system and starting the engine.

Depending on the nature of the event the left and right turn signal lights, located in the instrument panel, may both be blinking and will continue to blink. In order to move your vehicle to the side of the road, you must follow the system reset procedure.

Customer Action	Customer Will See
NOTE: Each step MUST BE held for at least two seconds	
1. Turn ignition OFF. (Turn Signal Switch Must be placed in Neutral State).	
2. Turn ignition ACC.	Right turn light BLINKS. Left turn light is OFF.
3. Turn right turn signal switch ON.	Right turn light is ON SOLID. Left turn light BLINKS.
4. Place turn signal in neutral state.	Right turn light is OFF. Left turn light BLINKS.
5. Turn left turn signal switch ON.	Right turn light BLINKS. Left turn light is ON SOLID.
6. Place turn signal in neutral state.	Right turn light BLINKS. Left turn light is OFF.
7. Turn right turn signal switch ON.	Right turn light is ON SOLID. Left turn light BLINKS.
8. Place turn signal in neutral state.	Right turn light is OFF. Left turn light BLINKS.
9. Turn left turn signal switch ON.	Right turn light is ON SOLID. Left turn light is ON SOLID.
10. Turn left turn signal switch OFF. (Turn Signal Switch Must be placed in Neutral State).	Right turn light is OFF. Left turn light is OFF.
11. Turn ignition OFF.	
12. Turn ignition ACC. (Entire sequence needs to be completed within one minute or sequence will need to be repeated).	System is now reset and the engine may be started.
Turn hazard flashers OFF (Manually).	

If a reset procedure step is not completed within 60 seconds, then the turn signal lights will blink and the reset procedure must be performed again in order to be successful.



Maintaining Your Air Bag System



WARNING!

- Modifications to any part of the air bag system could cause it to fail when you need it. You could be injured if the air bag system is not there to protect you. Do not modify the components or wiring, including adding any kind of badges or stickers to the steering wheel hub trim cover or the upper passenger side of the instrument panel. Do not modify the front fascia/bumper, vehicle body structure, or add aftermarket side steps or running boards.
- It is dangerous to try to repair any part of the air bag system yourself. Be sure to tell anyone who works on your vehicle that it has an air bag system.
- Do not attempt to modify any part of your air bag system. The air bag may inflate accidentally or may not function properly if modifications are made. Take your vehicle to an authorized dealer for any air bag system service. If your seat, including your trim cover and cushion, needs to be serviced in any way (including removal or loosening/tightening of seat attachment bolts), take the vehicle to an authorized dealer. Only manufacturer approved seat accessories may be used. If it is necessary to modify the air bag system for persons with disabilities, contact an authorized dealer.

Event Data Recorder (EDR)

This vehicle is equipped with an event data recorder (EDR). The main purpose of an EDR is to record, in certain crash or near crash-like situations, such as an air bag deployment or hitting a road obstacle, data that will assist in understanding how a vehicle's systems performed. The EDR is designed to record data related to vehicle dynamics and safety systems for a short period of time, typically 30 seconds or less. The EDR in this vehicle is designed to record such data as:

- How various systems in your vehicle were operating;
- Whether or not the driver and passenger safety belts were buckled/fastened;
- How far (if at all) the driver was depressing the accelerator and/or brake pedal; and,
- How fast the vehicle was traveling.

These data can help provide a better understanding of the circumstances in which crashes and injuries occur.

NOTE:

EDR data are recorded by your vehicle only if a non-trivial crash situation occurs; no data are recorded by the EDR under normal driving conditions and no personal data (e.g., name, gender, age, and crash location) are recorded. However, other parties, such as law enforcement, could combine the EDR data with the type of personally identifying data routinely acquired during a crash investigation.

To read data recorded by an EDR, special equipment is required, and access to the vehicle or the EDR is needed. In addition to the vehicle manufacturer, other parties, such as law enforcement, that have the special equipment, can read the information if they have access to the vehicle or the EDR.

CHILD RESTRAINTS

Everyone in your vehicle needs to be buckled up at all times, including babies and children. Every state in the United States, and every Canadian province, requires that small children ride in proper restraint systems. This is the law, and you can be prosecuted for ignoring it.

Children 12 years or younger should ride properly buckled up in a rear seat, if available. According to crash statistics, children are safer when properly restrained in the rear seats rather than in the front.



WARNING!

In a collision, an unrestrained child can become a projectile inside the vehicle. The force required to hold even an infant on your lap could become so great that you could not hold the child, no matter how strong you are. The child and others could be badly injured or killed. Any child riding in your vehicle should be in a proper restraint for the child's size.

There are different sizes and types of restraints for children from newborn size to the child almost large enough for an adult safety belt. Always check the child seat Owner's Manual to make sure you have the correct seat for your child. Carefully read and follow all the instructions and warnings in

the child restraint Owner's Manual and on all the labels attached to the child restraint.

Before buying any restraint system, make sure that it has a label certifying that it meets all applicable Safety Standards. You should also make sure that you can install it in the vehicle where you will use it.

NOTE:

- For additional information, refer to <http://www.nhtsa.gov/parents-and-caregivers> or call: 1-888-327-4236
- Canadian residents should refer to Transport Canada's website for additional information: <https://www.tc.gc.ca/en/services/road/child-car-seat-safety.html>

Summary Of Recommendations For Restraining Children In Vehicles

	Child Size, Height, Weight Or Age	Recommended Type Of Child Restraint
Infants and Toddlers	Children who are two years old or younger and who have not reached the height or weight limits of their child restraint	Either an Infant Carrier or a Convertible Child Restraint, facing rearward in a rear seat of the vehicle
Small Children	Children who are at least two years old or who have outgrown the height or weight limit of their rear-facing child restraint	Forward-Facing Child Restraint with a five-point Harness, facing forward in a rear seat of the vehicle
Larger Children	Children who have outgrown their forward-facing child restraint, but are too small to properly fit the vehicle's seat belt	Belt Positioning Booster Seat and the vehicle seat belt, seated in a rear seat of the vehicle
Children Too Large for Child Restraints	Children 12 years old or younger, who have outgrown the height or weight limit of their booster seat	Vehicle Seat Belt, seated in a rear seat of the vehicle

Infant And Child Restraints

Safety experts recommend that children ride rear-facing in the vehicle until they are two years old or until they reach either the height or weight limit of their rear-facing child restraint. Two types of child restraints can be used rear-facing: infant carriers and convertible child seats.

The infant carrier is only used rear-facing in the vehicle. It is recommended for children from birth until they reach the weight or height limit of the infant carrier. Convertible child seats can be used either rear-facing or forward-facing in the vehicle. Convertible child seats often have a higher weight limit in the

rear-facing direction than infant carriers do, so they can be used rear-facing by children who have outgrown their infant carrier but are still less than at least two years old. Children should remain rear-facing until they reach the highest weight or height allowed by their convertible child seat.



**WARNING!**

- Never place a rear-facing child restraint in front of an air bag. A deploying passenger front air bag can cause death or serious injury to a child 12 years or younger, including a child in a rear-facing child restraint.
- Never install a rear-facing child restraint in the front seat of a vehicle. Only use a rear-facing child restraint in the rear seat. If the vehicle does not have a rear seat, do not transport a rear-facing child restraint in that vehicle.

Older Children And Child Restraints

Children who are two years old or who have outgrown their rear-facing convertible child seat can ride forward-facing in the vehicle. Forward-facing child seats and convertible child seats used in the forward-facing direction are for children who are over two years old or who have outgrown the rear-facing weight or height limit of their rear-facing convertible child seat. Children should remain in a forward-facing child seat with a harness for as long as possible, up to the highest weight or height allowed by the child seat.

All children whose weight or height is above the forward-facing limit for the child seat should use a belt-positioning booster seat until the vehicle's seat belts fit properly. If the child cannot sit with knees bent over the vehicle's seat cushion while the child's back is against the seatback, they should use a belt-positioning booster seat. The child and belt-positioning booster seat are held in the vehicle by the seat belt.

**WARNING!**

- Improper installation can lead to failure of an infant or child restraint. It could come loose in a collision. The child could be badly injured or killed. Follow the child restraint manufacturer's directions exactly when installing an infant or child restraint.
- After a child restraint is installed in the vehicle, do not move the vehicle seat forward or rearward because it can loosen the child restraint attachments. Remove the child restraint before adjusting the vehicle seat position. When the vehicle seat has been adjusted, reinstall the child restraint.

(Continued)

**WARNING! (Continued)**

- When your child restraint is not in use, secure it in the vehicle with the seat belt or LATCH anchorages, or remove it from the vehicle. Do not leave it loose in the vehicle. In a sudden stop or accident, it could strike the occupants or seatbacks and cause serious personal injury.

Children Too Large For Booster Seats

Children who are large enough to wear the shoulder belt comfortably, and whose legs are long enough to bend over the front of the seat when their back is against the seatback, should use the seat belt in a rear seat. Use this simple 5-step test to decide whether the child can use the vehicle's seat belt alone:

1. Can the child sit all the way back against the back of the vehicle seat?
2. Do the child's knees bend comfortably over the front of the vehicle seat – while the child is still sitting all the way back?
3. Does the shoulder belt cross the child's shoulder between the neck and arm?

- Is the lap part of the belt as low as possible, touching the child's thighs and not the stomach?
- Can the child stay seated like this for the whole trip?

If the answer to any of these questions was "no," then the child still needs to use a booster seat in this vehicle. If the child is using the lap/

shoulder belt, check seat belt fit periodically and make sure the seat belt buckle is latched. A child's squirming or slouching can move the belt out of position. If the shoulder belt contacts the face or neck, move the child closer to the center of the vehicle, or use a booster seat to position the seat belt on the child correctly.



WARNING!

Never allow a child to put the shoulder belt under an arm or behind their back. In a crash, the shoulder belt will not protect a child properly, which may result in serious injury or death. A child must always wear both the lap and shoulder portions of the seat belt correctly.

Recommendations For Attaching Child Restraints

Restraint Type	Combined Weight of the Child + Child Restraint	Use Any Attachment Method Shown With An "X" Below			
		LATCH – Lower Anchors Only	Seat Belt Only	LATCH – Lower Anchors + Top Tether Anchor	Seat Belt + Top Tether Anchor
Rear-Facing Child Restraint	Up to 65 lbs (29.5 kg)	X	X		
Rear-Facing Child Restraint	More than 65 lbs (29.5 kg)		X		
Forward-Facing Child Restraint	Up to 65 lbs (29.5 kg)			X	X
Forward-Facing Child Restraint	More than 65 lbs (29.5 kg)				X



Lower Anchors And Tethers For Children (LATCH) Restraint System



022668173

LATCH Label



Your vehicle is equipped with the child restraint anchorage system called LATCH, which stands for Lower Anchors and Tethers for CHildren. The LATCH system has three vehicle anchor points for installing

LATCH-equipped child seats. There are two lower anchorages located at the back of the seat cushion where it meets the seatback and one top tether anchorage located behind the seating position. These anchorages are used to install LATCH-equipped child seats without using the vehicle's seat belts. Some seating positions may have a top tether anchorage but no lower anchorages. In these seating positions, the seat belt must be used with the top tether anchorage to install the child restraint. Please see the following table for more information.

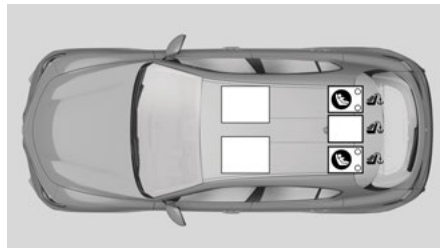
LATCH Positions For Installing Child Restraints In This Vehicle



LATCH Positions

-  Lower Anchorage Symbol
(2 Anchorages Per Seating Position)
-  Top Tether Anchorage Symbol

Frequently Asked Questions About Installing Child Restraints With LATCH

What is the weight limit (child's weight + weight of the child restraint) for using the LATCH anchorage system to attach the child restraint?

65 lbs (29.5 kg)

Use the LATCH anchorage system until the combined weight of the child and the child restraint is 65 lbs (29.5 kg). Use the seat belt and tether anchor instead of the LATCH system once the combined weight is more than 65 lbs (29.5 kg).

Frequently Asked Questions About Installing Child Restraints With LATCH

Can the LATCH anchorages and the seat belt be used together to attach a rear-facing or forward-facing child restraint?	No	Do not use the seat belt when you use the LATCH anchorage system to attach a rear-facing or forward-facing child restraint. Booster seats may be attached to the LATCH anchorages if allowed by the booster seat manufacturer. See your booster seat owner's manual for more information.
Can a child seat be installed in the center position using the inner LATCH lower anchorages from the outboard seating positions?	No	Use the seat belt and tether anchor to install a child seat in the center seating position.
Can two child restraints be attached using a common lower LATCH anchorage?	No	Never "share" a LATCH anchorage with two or more child restraints. If the center position does not have dedicated LATCH lower anchorages, use the seat belt to install a child seat in the center position next to a child seat using the LATCH anchorages in an outboard position.
Can the rear-facing child restraint touch the back of the front passenger seat?	Yes	The child seat may touch the back of the front passenger seat if the child restraint manufacturer also allows contact. See your child restraint owner's manual for more information.
Can the rear head restraints be removed?	Yes	All head restraints can be removed if they interfere with the installation of the child restraint. See "Head Restraints" in "Getting To Know Your Vehicle" for further information.



Locating The LATCH Anchorages



The lower anchorages are round bars that are found at the rear of the seat cushion where it meets the seatback. Each anchorage is under a cover with the anchorage symbol on it. Lift the cover to access the lower anchorage.

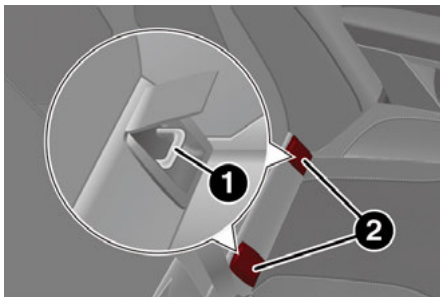

LATCH Anchorage Locations

- 1 – LATCH Anchorage Bar
- 2 – LATCH Anchorage Locations

Locating The Upper Tether Anchorages



There are tether strap anchorages behind each rear seating position located on the back of the seat.

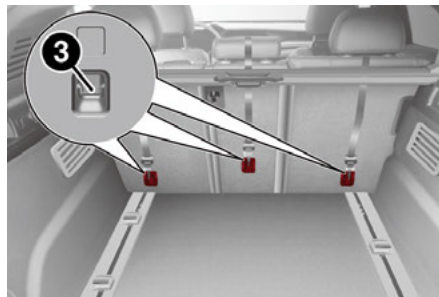

Tether Strap Anchorage Locations

- 3 – Tether Strap Anchorages

LATCH-compatible child restraint systems will be equipped with a rigid bar or a flexible strap on each side. Each will have a hook or connector to attach to the lower anchorage and a way to tighten the connection to the anchorage. Forward-facing child restraints and some rear-facing child restraints will also be equipped with a tether strap. The tether strap will have a hook at the end to attach to the top tether anchorage and a way to tighten the strap after it is attached to the anchorage.

Center Seat LATCH



WARNING!

- Do not install a child restraint in the center position using the LATCH system. This position is not approved for installing child seats using the LATCH attachments. You must use the seat belt and tether anchor to install a child seat in the center seating position.
- Never use the same lower anchorage to attach more than one child restraint. See [page 188](#) for typical installation instructions.

Always follow the directions of the child restraint manufacturer when installing your child restraint. Not all child restraint systems will be installed as described here.

To Install A LATCH-Compatible Child Restraint

If the selected seating position has a Switchable Automatic Locking Retractor (ALR) seat belt, stow the seat belt, following the instructions below. See [page 189](#) to check what type of seat belt each seating position has.

1. Loosen the adjusters on the lower straps and on the tether strap of the child seat so that you can more easily attach the hooks or connectors to the vehicle anchorages.
2. Place the child seat between the lower anchorages for that seating position. If the second row seat can be reclined, you may recline the seat and/or raise the head restraint (if adjustable) to get a better fit. If the rear seat can be moved forward and rearward in the vehicle, you may wish to move it to its rear-most position to make room for the child seat. You may also move the front seat forward to allow more room for the child seat.
3. Attach the lower hooks or connectors of the child restraint to the lower anchorages in the selected seating position.
4. If the child restraint has a tether strap, connect it to the top tether anchorage. See ⇨ page 191 for directions to attach a tether anchor.
5. Tighten all of the straps as you push the child restraint rearward and downward into the seat. Remove slack in the straps according to the child restraint manufacturer's instructions.
6. Test that the child restraint is installed tightly by pulling back and forth on the child seat at the belt path. It should not move more than 1 inch (25.4 mm) in any direction.

How To Stow An Unused Switchable-ALR (ALR) Seat Belt:

When using the LATCH attaching system to install a child restraint, stow all ALR seat belts that are not being used by other occupants or being used to secure child restraints. An unused belt could injure a child if they play with it and accidentally lock the seat belt retractor. Before installing a child restraint using the LATCH system, buckle the seat belt behind the child restraint and out of the child's reach. If the buckled seat belt interferes with the child restraint installation, instead of buckling it behind the child restraint, route the seat belt through the child restraint belt path and then buckle it. Do not lock the seat belt. Remind all children in the vehicle that the seat belts are not toys and that they should not play with them.



WARNING!

- Improper installation of a child restraint to the LATCH anchorages can lead to failure of the restraint. The child could be badly injured or killed. Follow the child restraint manufacturer's directions exactly when installing an infant or child restraint.

(Continued)



WARNING! (Continued)

- Child restraint anchorages are designed to withstand only those loads imposed by correctly-fitted child restraints. Under no circumstances are they to be used for adult seat belts, harnesses, or for attaching other items or equipment to the vehicle.

Installing Child Restraints Using The Vehicle Seat Belt

Child restraint systems are designed to be secured in vehicle seats by lap belts or the lap belt portion of a lap/shoulder belt.



WARNING!

- Improper installation or failure to properly secure a child restraint can lead to failure of the restraint. The child could be badly injured or killed.
- Follow the child restraint manufacturer's directions exactly when installing an infant or child restraint.



The seat belts in the passenger seating positions are equipped with a Switchable Automatic Locking Retractor (ALR) that is designed to keep the lap portion of the seat belt tight around the child restraint so that it is not necessary to use a locking clip. The ALR retractor can be “switched” into a locked mode by pulling all of the webbing out of the retractor and then letting the webbing retract back into the retractor. If it is locked, the ALR will make a clicking noise while the webbing is pulled back into the retractor.

Refer to the “Automatic Locking Mode” description on ⇨ page 172 for additional information on ALR.

Please see the table below and the following sections for more information.

Lap/Shoulder Belt Systems For Installing Child Restraints In This Vehicle

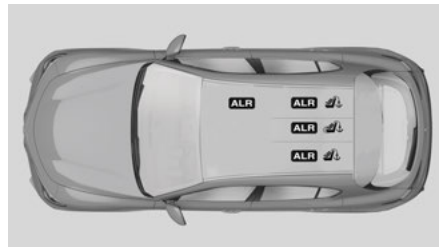

Automatic Locking Retractor (ALR) Locations

ALR — Switchable Automatic Locking Retractor (ALR)

 Top Tether Anchorage Symbol

Frequently Asked Questions About Installing Child Restraints With Seat Belts

What is the weight limit (child's weight + weight of the child restraint) for using the Tether Anchor with the seat belt to attach a forward facing child restraint?	Weight limit of the Child Restraint	Always use the tether anchor when using the seat belt to install a forward facing child restraint, up to the recommended weight limit of the child restraint.
Can the rear-facing child restraint touch the back of the front passenger seat?	Yes	Contact between the front passenger seat and the child restraint is allowed, if the child restraint manufacturer also allows contact.
Can the rear head restraints be removed?	Yes	All head restraints can be removed if they interfere with the installation of the child restraint. See ⇨ page 35 for further information.
Can the buckle stalk be twisted to tighten the seat belt against the belt path of the child restraint?	No	Do not twist the buckle stalk in a seating position with an ALR retractor.

Installing A Child Restraint With A Switchable Automatic Locking Retractor (ALR):

Child restraint systems are designed to be secured in vehicle seats by lap belts or the lap belt portion of a lap/shoulder belt.



WARNING!

- ❑ Improper installation or failure to properly secure a child restraint can lead to failure of the restraint. The child could be badly injured or killed.
- ❑ Follow the child restraint manufacturer's directions exactly when installing an infant or child restraint.

1. Place the child seat in the center of the seating position. If the second row seat can be reclined, you may recline the seat and/or raise the head restraint (if adjustable) to get a better fit. If the rear seat can be moved forward and rearward in the vehicle, you may wish to move it to its rear-most position to make room for the child seat. You may also move the front seat forward to allow more room for the child seat.
2. Pull enough of the seat belt webbing from the retractor to pass it through the belt path of the child restraint. Do not twist the belt webbing in the belt path.

3. Slide the latch plate into the buckle until you hear a "click."
4. Pull on the webbing to make the lap portion tight against the child seat.
5. To lock the seat belt, pull down on the shoulder part of the belt until you have pulled all the seat belt webbing out of the retractor. Then, allow the webbing to retract back into the retractor. As the webbing retracts, you will hear a clicking sound. This means the seat belt is now in the Automatic Locking mode.
6. Try to pull the webbing out of the retractor. If it is locked, you should not be able to pull out any webbing. If the retractor is not locked, repeat step 5.
7. Finally, pull up on any excess webbing to tighten the lap portion around the child restraint while you push the child restraint rearward and downward into the vehicle seat.
8. If the child restraint has a top tether strap and the seating position has a top tether anchorage, connect the tether strap to the anchorage and tighten the tether strap. See ⇨ page 191 for directions to attach a tether anchor.

9. Test that the child restraint is installed tightly by pulling back and forth on the child seat at the belt path. It should not move more than 1 inch (25.4 mm) in any direction.

Any seat belt system will loosen with time, so check the belt occasionally, and pull it tight if necessary.

Installing Child Restraints Using The Top Tether Anchorage:



WARNING!

Do not attach a tether strap for a rear-facing car seat to any location in front of the car seat, including the seat frame or a tether anchorage. Only attach the tether strap of a rear-facing car seat to the tether anchorage that is approved for that seating position, located behind the top of the vehicle seat. See the section "Lower Anchors and Tethers for Children (LATCH) Restraint System" for the location of approved tether anchorages in your vehicle.



1. Look behind the seating position where you plan to install the child restraint to find the tether anchorage. You may need to move the seat forward to provide better access to the tether anchorage. If there is no top tether anchorage for that seating position, move the child restraint to another position in the vehicle if one is available.
2. Route the tether strap to provide the most direct path for the strap between the anchor and the child seat. If your vehicle is equipped with adjustable rear head restraints, raise the head restraint, and where possible, route the tether strap under the head restraint and between the two posts. If not possible, lower the head restraint and pass the tether strap around the outboard side of the head restraint.
3. Attach the tether strap hook of the child restraint to the top tether anchorage as shown in the diagram.

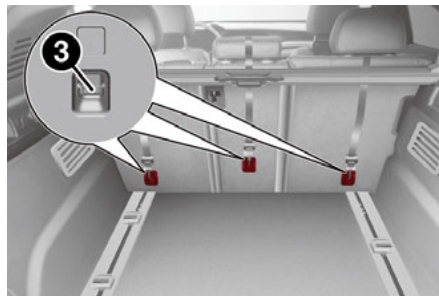

Rear Seat Tether Strap Mounting

3 – Tether Strap Anchorages

4. Remove slack in the tether strap according to the child restraint manufacturer's instructions.



WARNING!

- An incorrectly anchored tether strap could lead to increased head motion and possible injury to the child. Use only the anchorage position directly behind the child seat to secure a child restraint top tether strap.
- If your vehicle is equipped with a split rear seat, make sure the tether strap does not slip into the opening between the seatbacks as you remove slack in the strap.

Center Tether Special Instructions

Center Tether Attachment:

1. If adjustable, lower the adjustable center head restraint to the full down position.
2. Route the tether strap over the seatback and head restraint.
3. Attach the tether strap hook of the child restraint to the center tether anchorage located on the back of the seat.
4. Remove slack in the tether strap according to the child restraint manufacturer's instructions.

SAFETY TIPS

TRANSPORTING PASSENGERS

NEVER TRANSPORT PASSENGERS IN THE CARGO AREA.



WARNING!

- Do not leave children or animals inside parked vehicles in hot weather. Interior heat build-up may cause serious injury or death.
- It is extremely dangerous to ride in a cargo area, inside or outside of a vehicle. In a collision, people riding in these areas are more likely to be seriously injured or killed.

(Continued)



WARNING! (Continued)

- Do not allow people to ride in any area of your vehicle that is not equipped with seats and seat belts.
- Be sure everyone in your vehicle is in a seat and using a seat belt properly.

TRANSPORTING PETS

Air Bags deploying in the front seat could harm your pet. An unrestrained pet will be thrown about and possibly injured, or injure a passenger during panic braking or in a collision.

Pets should be restrained in the rear seat (if equipped) in pet harnesses or pet carriers that are secured by seat belts.

SAFETY CHECKS YOU SHOULD MAKE INSIDE THE VEHICLE



Seat Belts

Inspect the seat belt system periodically, checking for cuts, frays, and loose parts. Damaged parts must be replaced immediately. Do not disassemble or modify the system.

If your vehicle is involved in a collision, or if you have questions regarding the seat belt or retractor conditions, take your vehicle to an

authorized FCA dealer or authorized FCA Certified Collision Care Program facility for inspection.

Air Bag Warning Light

The Air Bag warning light  will turn on for four to eight seconds as a bulb check when the ignition switch is first turned to ON/RUN. If the light is either not on during starting, stays on, or turns on while driving, have the system inspected at an authorized dealer as soon as possible. After the bulb check, this light will illuminate with a single chime when a fault with the Air Bag System has been detected. It will stay on until the fault is removed. If the light comes on intermittently or remains on while driving, have an authorized dealer service the vehicle immediately  page 167.

Defroster

Check operation by selecting the defrost mode and place the blower control on high speed. You should be able to feel the air directed against the windshield. See an authorized dealer for service if your defroster is inoperable.

Floor Mat Safety Information



Always use floor mats designed to fit your vehicle. Only use a floor mat that does not interfere with the operation of the accelerator, brake or clutch pedals. Only use a floor mat that is securely attached using the floor mat fasteners so it cannot slip out of position and

interfere with the accelerator, brake or clutch pedals or impair safe operation of your vehicle in other ways.



WARNING!

An improperly attached, damaged, folded, or stacked floor mat, or damaged floor mat fasteners may cause your floor mat to interfere with the accelerator, brake, or clutch pedals and cause a loss of vehicle control. To prevent **SERIOUS INJURY or DEATH:**

- ALWAYS securely attach  your floor mat using the floor mat fasteners. DO NOT install your floor mat upside down or turn your floor mat over. Lightly pull to confirm mat is secured using the floor mat fasteners on a regular basis.
- ALWAYS REMOVE THE EXISTING FLOOR MAT FROM THE VEHICLE  before installing any other floor mat. NEVER install or stack an additional floor mat on top of an existing floor mat.
- ONLY install floor mats designed to fit your vehicle. NEVER install a floor mat that cannot be properly attached and secured to your vehicle. If a floor mat needs to be replaced, only use a FCA approved floor mat for the specific make, model, and year of your vehicle.

(Continued)



**WARNING!** *(Continued)*

- ONLY use the driver's side floor mat on the driver's side floor area. To check for interference, with the vehicle properly parked with the engine off, fully depress the accelerator, the brake, and the clutch pedal (if present) to check for interference. If your floor mat interferes with the operation of any pedal, or is not secure to the floor, remove the floor mat from the vehicle and place the floor mat in your trunk.
- ONLY use the passenger's side floor mat on the passenger's side floor area.
- ALWAYS make sure objects cannot fall or slide into the driver's side floor area when the vehicle is moving. Objects can become trapped under accelerator, brake, or clutch pedals and could cause a loss of vehicle control.

(Continued)

**WARNING!** *(Continued)*

- NEVER place any objects under the floor mat (e.g., towels, keys, etc.). These objects could change the position of the floor mat and may cause interference with the accelerator, brake, or clutch pedals.
- If the vehicle carpet has been removed and re-installed, always properly attach carpet to the floor and check the floor mat fasteners are secure to the vehicle carpet. Fully depress each pedal to check for interference with the accelerator, brake, or clutch pedals then re-install the floor mats.
- It is recommended to only use mild soap and water to clean your floor mats. After cleaning, always check your floor mat has been properly installed and is secured to your vehicle using the floor mat fasteners by lightly pulling mat.

PERIODIC SAFETY CHECKS YOU SHOULD MAKE OUTSIDE THE VEHICLE**Tires**

Examine tires for excessive tread wear and uneven wear patterns. Check for stones, nails, glass, or other objects lodged in the tread or sidewall. Inspect the tread for cuts and cracks. Inspect sidewalls for cuts, cracks, and bulges. Check the wheel nuts for tightness. Check the tires (including spare) for proper cold inflation pressure.

Lights

Have someone observe the operation of brake lights and exterior lights while you work the controls. Check turn signal and high beam indicator lights on the instrument panel.

Door Latches

Check for proper closing, latching, and locking.

Fluid Leaks

Check area under the vehicle after overnight parking for fuel, coolant, oil, or other fluid leaks. Also, if gasoline fumes are detected or if fuel, or brake fluid leaks are suspected, the cause should be located and corrected immediately.

EXHAUST GAS



WARNING!

Exhaust gases can injure or kill. They contain carbon monoxide (CO), which is colorless and odorless. Breathing it can make you unconscious and can eventually poison you. To avoid breathing (CO), follow these safety tips:

- Do not run the engine in a closed garage or in confined areas any longer than needed to move your vehicle in or out of the area.
- If you are required to drive with the trunk/liftgate/rear doors open, make sure that all windows are closed and the climate control BLOWER switch is set at high speed. DO NOT use the recirculation mode.
- If it is necessary to sit in a parked vehicle with the engine running, adjust your heating or cooling controls to force outside air into the vehicle. Set the blower at high speed.

The best protection against carbon monoxide entry into the vehicle body is a properly maintained engine exhaust system.

Whenever a change is noticed in the sound of the exhaust system, when exhaust fumes can be detected inside the vehicle, or when the underside or rear of the vehicle is damaged, have a competent mechanic inspect the complete exhaust system and adjacent body areas for broken, damaged, deteriorated, or mispositioned parts. Open seams or loose connections could permit exhaust fumes to seep into the passenger compartment. In addition, inspect the exhaust system each time the vehicle is raised for lubrication or oil change. Replace as required.

CARBON MONOXIDE WARNINGS



WARNING!

Carbon monoxide (CO) in exhaust gases is deadly. Follow the precautions below to prevent carbon monoxide poisoning:

- Do not inhale exhaust gases. They contain carbon monoxide, a colorless and odorless gas, which can kill. Never run the engine in a closed area, such as a garage, and never sit in a parked vehicle with the engine running for an extended period. If the vehicle is stopped in an open area with the engine running for more than a short period, adjust the ventilation system to force fresh, outside air into the vehicle.
- Guard against carbon monoxide with proper maintenance. Have the exhaust system inspected every time the vehicle is raised. Have any abnormal conditions repaired promptly. Until repaired, drive with all side windows fully open.



Have a flat tire or a burnt-out bulb?

At times, a problem such as these may interfere with your driving experience.

The section on emergencies can help you to deal with critical situations independently.

In an emergency, we recommend that you call the phone number found in “Helpful Addresses And Telephone Numbers” under “How To Deal With Warranty Problems” in the Warranty Book.

You may also consider contacting an authorized dealer.

HAZARD WARNING FLASHERS

The Hazard Warning Flashers switch is located in the switch bank below the radio screen.

Push the switch once to turn the Hazard Warning Flashers on. When the switch is activated, all directional turn signals will flash on and off to warn oncoming traffic of an emergency. Push the switch a second time to turn the Hazard Warning Flashers off.

This is an emergency warning system and it should not be used when the vehicle is in motion. Use it when your vehicle is disabled and is creating a safety hazard for other motorists.

When you must leave the vehicle to seek assistance, the Hazard Warning Flashers will

continue to operate even though the ignition is cycled to OFF.



Hazard Warning Flashers Switch



CAUTION!

Prolonged use of the Hazard Warning Flashers may discharge the vehicle's battery.

Panic Brake Assist (PBA) System

The PBA system is designed to improve the vehicle's braking capacity during emergency braking → page 153.

SOS — EMERGENCY CALL

Your vehicle has an on-board assistance feature that is designed to provide support in case of an accident and/or emergency. This feature is automatically activated by air bag intervention, or can be activated manually by

pushing the button located on the base of the rear view mirror.

NOTE:

SOS - Emergency Call will only work with an enabled network operator.

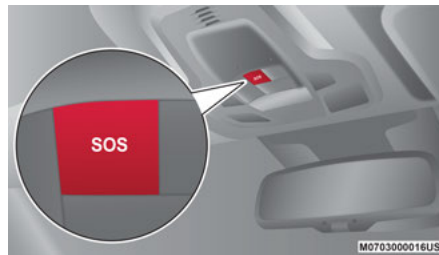

SOS - Emergency Call Button

The SOS - Emergency Call system automatically forwards a call to emergency services in the event of an accident with air bag intervention providing that the ignition device is in RUN position and the air bags are working. When the connection between the vehicle and a public safety operator is made, your vehicle will automatically transmit location and vehicle information to the emergency service operator.

Only a public safety operator can remotely end the SOS - Emergency Call and, if necessary, call the vehicle back through the Emergency Call system. Once the call has ended, you can still call the emergency service operator to

indicate additional information by pushing the button again.

To Use SOS - Emergency Call

Push and hold the SOS - Emergency Call button for a few seconds. The LED, located next to the SOS button, will blink once and then stay on indicating a call has been placed.

NOTE:

If the SOS - Emergency Call button is accidentally pushed, there is a 10 second delay before the call is placed. The system will issue a verbal alert that a call is about to be made. To cancel the call connection, push the SOS - Emergency Call button again.

Once a connection between the vehicle and an emergency service operator is made, the SOS - Emergency Call system will transmit the following important vehicle information to the operator:

- Indication that the occupant placed an SOS - Emergency Call.
- The Vehicle Identification Number (VIN).
- The last known GPS coordinates of the vehicle.

You will then be able to speak with the emergency service operator to determine if additional help is needed.

The SOS - Emergency Call has priority over other audio sources, which will be muted. If you have a phone connected via Bluetooth®, it is disconnected and reconnected at the end of

the SOS - Emergency Call. Voice prompts will guide you during the SOS - Emergency Call. If a connection is made between an emergency service operator and your vehicle, emergency service operators may record conversations and sounds within your vehicle once a connection is made, and by using the service you consent to having this information shared.

NOTE:

If you have not subscribed to the SOS service or if the service is not available or has expired, the Connect system will display a dedicated screen when the button is pressed informing you to contact the national emergency number 9-1-1 (the respective graphic button will be displayed to make the call if you have connected your mobile phone via Bluetooth®). The call to the national emergency number 9-1-1 will be made via the mobile phone by pressing red graphic button shown on the Connect system display.

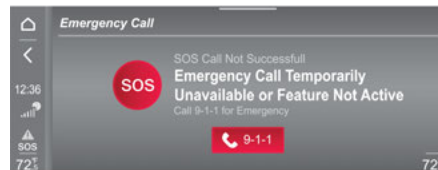

SOS Screen Message

SOS - Emergency Call System Limitations

When the ignition switches to the RUN position, the Emergency Call system runs a routine check. During this check, a red indicator will illuminate for about three seconds. This signal must not be confused with a fault warning. In the event of a malfunction, the red indicator would remain on. If the SOS - Emergency Call system detects a malfunction, any of the following may occur at the time the malfunction is detected:

NOTE:

The SOS Call function may not be available for the first minute after the vehicle is started

- The LED next to the SOS button will be continuously illuminated red.
 - The Emergency Call system is powered by its own non-rechargeable battery to ensure operation, even when the vehicle battery is discharged or disconnected. When system battery is discharged, the instrument cluster display will show a special message, different than other messages referring to other types of faults. In this case, the system works only if powered by the vehicle's battery.
 - The instrument cluster will display a message alerting you to contact the Service Network along with a failure warning light.
- Even if the SOS - Emergency Call system is fully functional, external or uncontrolled factors may prevent or stop SOS - Emergency Call



operation. These include, but are not limited to, the following factors:

- The ignition is in OFF position.
- The vehicle's electrical systems are not intact.
- The SOS - Emergency Call system software and/or hardware is damaged during a vehicle collision.
- There are network problems that could limit or impair service operation (e.g., error by operator, busy network, bad weather, etc.).

If the vehicle battery connection fails due to a collision or accident, the system can support an SOS - Emergency Call for a limited period of time. If the battery is disconnected for service, the system turns off. In this case, it will be possible to make an SOS - Emergency Call only when the battery is reconnected to the vehicle's electrical system.

System Requirements

- Vehicle must have an operable 3G network connection.
- Vehicle must be powered with a properly functioning electrical system.
- The ignition must be in the RUN or ACC position.



WARNING!

- Never place anything on or near the vehicle's 3G and GPS aerials. You could prevent 3G and GPS signal reception, which can prevent your vehicle from placing an emergency call. An operable 3G network connection and a GPS signal is required for the SOS-Emergency Call system to function properly.
- Do not add any aftermarket electrical equipment to the vehicle's electrical system. This may prevent your vehicle from sending a signal to initiate an emergency call. To avoid interference that can cause the SOS-Emergency Call system to fail, never add aftermarket equipment (e.g., two-way mobile radio, CB radio, data recorder, etc.) to your vehicle's electrical system or modify the antennas on your vehicle. IF YOUR VEHICLE AND SYSTEM LOSES BATTERY POWER FOR ANY REASON (INCLUDING DURING OR AFTER AN ACCIDENT) THE SOS FEATURES, APPS AND SERVICES AMONG OTHERS WILL NOT OPERATE.

(Continued)



WARNING! *(Continued)*

- The Occupant Restraint Controller (ORC) turns on the air bag warning light in the instrument cluster if a malfunction in any part of the air bag system is detected. If the air bag warning light is illuminated, the air bag system may not be working properly and the SOS-Emergency Call system may not be able to send a signal to an emergency service operator. If the air bag warning light is illuminated, contact the Service Network to have the air bag system checked immediately.
- Ignoring the LED on the SOS-Emergency Call button could mean you will not have emergency call services if needed. If the LED on SOS-Emergency Call button is illuminated red, contact the Service Network to have the emergency call system checked immediately.
- If anyone in the vehicle could be in danger (e.g., fire or smoke is visible, dangerous road conditions or location), do not wait for voice contact from an emergency service operator. All occupants should exit the vehicle immediately and move to a safe location.
- Failure to perform scheduled maintenance and regularly inspect your vehicle may result in vehicle damage, accident or injury.

Frequently Asked Questions:

What happens if I accidentally push the SOS - Emergency Call Button? You have 10 seconds after pushing the emergency button to cancel the call. To cancel the call, push the button again.

What type of information is sent when I make an SOS - Emergency Call from my vehicle?

Certain vehicle information, such as the VIN, is transmitted along with last known GPS location. Also note that emergency service operators may record conversations and sounds within your vehicle once a connection is made, and by using the service you consent to having this information shared.

EAC **When can I use the SOS - Emergency Call button?** You can **ONLY** use the SOS - Emergency Call button to make a call if you or someone else needs emergency assistance.

JACKING AND TIRE CHANGING



WARNING!

- Do not attempt to change a tire on the side of the vehicle close to moving traffic. Pull far enough off the road to avoid the danger of being hit when operating the jack or changing the wheel.

(Continued)



WARNING! *(Continued)*

- Being under a jacked-up vehicle is dangerous. The vehicle could slip off the jack and fall on you. You could be crushed. Never put any part of your body under a vehicle that is on a jack. If you need to get under a raised vehicle, take it to a service center where it can be raised on a lift.
- Never start or run the engine while the vehicle is on a jack.
- The jack is designed to be used as a tool for changing tires only. The jack should not be used to lift the vehicle for service purposes. The vehicle should be jacked on a firm level surface only. Avoid ice or slippery areas.

GENERAL INSTRUCTIONS

This vehicle can be equipped with a Tire Service Kit → page 202.

As an alternative to the Tire Service Kit, the vehicle may be purchased with a compact spare tire → page 200.

JACK INFORMATION AND USAGE PRECAUTIONS

Jack Information

- The jack weighs 4.4 lb (2 kg).
- The jack requires no adjustment.
- The jack cannot be repaired, and in the event of a fault it must be replaced by another factory replacement.
- No tool other than its extension lever may be fitted on the jack.

Jack Maintenance

- Prevent any dirt from depositing on the "worm screw".
- Keep the "worm screw" lubricated.
- Never modify the jack.

Conditions Of Non-Use Of The Jack

- Temperatures below -40°F (-40°C).
- On sandy or muddy ground
- On uneven ground
- On steep slopes in extreme weather conditions.
- In direct contact with the engine or for repairs under the vehicle
- On boats



CHANGING PROCEDURE

1. Park the vehicle on a firm, level surface. Avoid ice or slippery areas.



WARNING!

Do not attempt to change a tire on the side of the vehicle close to moving traffic. Pull far enough off the road to avoid being hit when operating the jack or changing the wheel.

2. Turn on the Hazard Warning Flashers.
3. Apply the Electric Park Brake.
4. Place the gear selector into PARK (P).
5. Place the ignition in the OFF mode.
6. Block both the front and rear of the wheel diagonally opposite of the jacking position. For example, if changing the right front tire, block the left rear wheel.



Wheels Blocked

0605004822

7. Open the liftgate and lift up the load floor using the handle.
8. Take the warning triangle and position it at a suitable distance from the vehicle to warn oncoming vehicles.
9. Unscrew the locking plate and take out the compact spare tire and the air compressor.

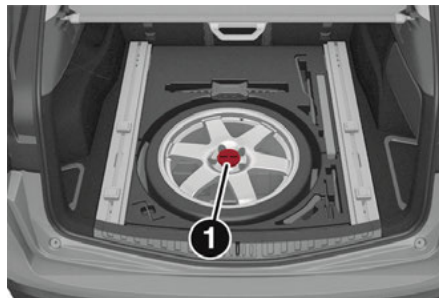

Compact Spare Tire — If Equipped

1 — Locking Plate

10. Remove the damaged wheel by using the wheel wrench to loosen the bolts by one turn.
11. Position the jack under the vehicle, near the wheel to be changed, taking care not to damage the plastic body panel.
12. Lift the extension lever on the wrench.

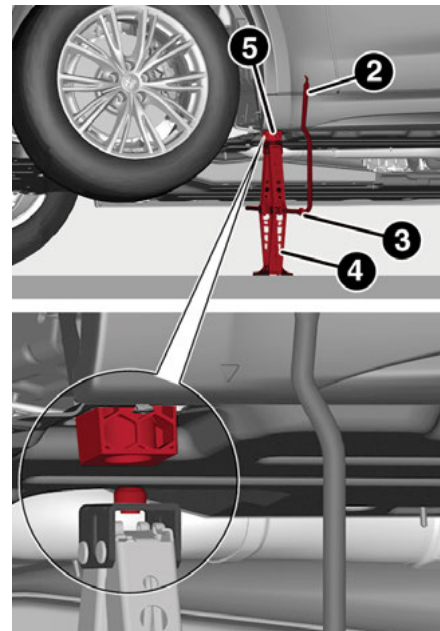

Jacking Location

- 2 — Extension Lever
- 3 — Wrench Head
- 4 — Jack
- 5 — Lifting Block

13. Rotate the extension lever clockwise until the round pin on the jack engages in the hole in the lifting block located about 6 inches (15 cm) from the outside edge of the body. The lifting points are marked by triangles ▽ visible on the plastic body panel.

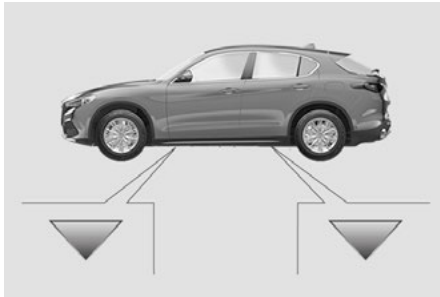

Jacking Point Indicators



CAUTION!

Do not attempt to raise the vehicle by jacking on locations other than those indicated in the Jacking Instructions for this vehicle.

14. Raise the vehicle by turning the jack screw clockwise, using the swivel wrench. Raise the vehicle only until the tire just clears the surface and enough clearance is obtained to install the compact spare tire. Minimum tire lift provides maximum stability.



WARNING!

Raising the vehicle higher than necessary can make the vehicle less stable. It could slip off the jack and hurt someone near it. Raise the vehicle only enough to remove the tire.

15. Remove the five wheel bolts and take the wheel off.
16. Make sure the contact surfaces between compact spare tire and hub are clean so that the fastening bolts will not come loose.
17. Fit the compact spare tire by inserting the first wheel bolt for two threads into the hole closest to the valve.



CAUTION!

Be sure to mount the spare tire with the valve stem facing outward. The vehicle could be damaged if the spare tire is mounted incorrectly.

18. Take the wheel wrench and tighten the wheel bolts.
19. Inflate the compact spare tire by removing the cap from its inflation valve and screwing on the compressor inflation hose fitting.

20. Make sure that the switch on the compressor is in the O (off) position, open the liftgate and insert the plug into the power socket in the cargo area, or on the center console and start the engine. Place the on/off switch in the I (on) position.

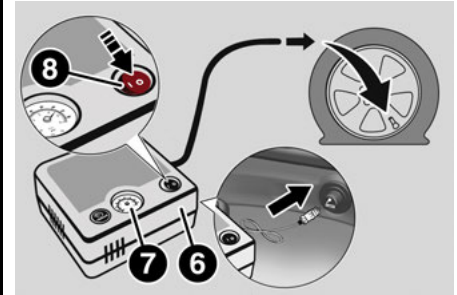

Attaching Compressor To Tire

- 6 – Air Compressor
7 – Pressure Gauge
8 – Power Button

21. Inflate the compact spare tire to a pressure of 43.5 psi (3 bar).

NOTE:

If spare tire is overinflated, be sure to lower the psi in the tire to the recommended amount by using the deflation button on the air compressor.

22. Operate the wheel wrench on the jack to lower the vehicle.

23. Remove the jack.

24. Use the wheel wrench to fully tighten the bolts, passing alternately from one bolt to the diagonally opposite one.



WARNING!

To avoid the risk of forcing the vehicle off the jack, do not tighten the wheel nuts fully until the vehicle has been lowered. Failure to follow this warning may result in serious injury.

To obtain a more accurate reading, it is advisable to check the pressure of the compact spare tire on the pressure gauge with the compressor off.

NOTE:

Do not stow the deflated tire in the compact spare tire location.

The compressor was designed for inflating the compact spare tire. Do not use it for inflating mattresses, rafts, etc.

NOTE:

Spare tires are intended for temporary use only.

Have the full-sized tire repaired or replaced, as soon as possible.



WARNING!

A loose tire or jack thrown forward in a collision or hard stop could endanger the occupants of the vehicle. Always stow the jack parts and the spare tire in the places provided. Have the deflated (flat) tire repaired or replaced immediately.

TIRE SERVICE KIT — IF EQUIPPED

DESCRIPTION

If a tire is punctured, you can make an emergency repair using the Tire Service Kit located in the rear storage area under the load platform.

1. Stop the vehicle in a position where you can repair the tire safely. You should be as far as possible from the side of the road, and in a position that is not dangerous for oncoming traffic. Turn on the Hazard Warning Flashers, remove the safety triangle from the luggage compartment, and place it at a suitable distance from the vehicle to make other drivers aware of your presence.
2. Verify that the valve stem (on the wheel with the deflated tire) is in a position that is near to the ground. This will allow the tire

repair kit hoses to reach the valve stem and keep the tire service kit flat on the ground.

3. Place the gear selector in PARK (P).
4. Apply the electric park brake and turn the engine OFF.

To access the Tire Service Kit, open the liftgate and lift the load floor.



Load Floor

The Tire Service Kit consists of:

- Sealant cartridge containing the sealing fluid
- Filler Tube
- Air compressor, complete with pressure gauge and connectors
- Adhesive label with the writing "Max. 50 mph (80 km/h)", to be attached in a position easily visible to the driver (e.g. on the dashboard) after repairing the tire

- An instruction pamphlet for reference in prompt and correct use of the Tire Service Kit, which must be then given to the personnel dealing with the sealant-treated tire
- A pair of protective gloves
- Some adapters, for inflating different elements

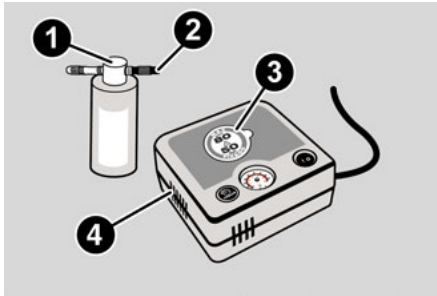

Tire Service Kit Components

- 1 – Sealant Cartridge
- 2 – Filling Hose
- 3 – Adhesive Label
- 4 – Air Compressor

NOTE:

- The sealing fluid is effective with external temperatures of between -40 °F (-40 °C) and 122 °F (50 °C).
- The sealing fluid has an expiration date.

INFLATION PROCEDURE



WARNING!

- Do not attempt to seal a tire on the side of the vehicle closest to traffic. Pull far enough off the road to avoid the danger of being hit when using the Tire Service Kit.
- Do not use Tire Service Kit or drive the vehicle under the following circumstances:
 - If the puncture in the tire tread is approximately 1/4 inch (6 mm) or larger.
 - If the tire has any sidewall damage.
 - If the tire has any damage from driving with extremely low tire pressure.
 - If the tire has any damage from driving on a flat tire.
 - If the wheel has any damage.
 - If you are unsure of the condition of the tire or the wheel.
- Keep Tire Service Kit away from open flames or heat sources.

(Continued)



WARNING! (Continued)

- A loose Tire Service Kit thrown forward in a collision or hard stop could endanger the occupants of the vehicle. Always stow the Tire Service Kit in the place provided. Failure to follow these warnings can result in injuries that are serious or fatal to you, your passengers, and others around you.
- Take care not to allow the contents of Tire Service Kit to come in contact with hair, eyes, or clothing. Tire Service Kit sealant is harmful if inhaled, swallowed, or absorbed through the skin. It causes skin, eye, and respiratory irritation. Flush immediately with plenty of water if there is any contact with eyes or skin. Change clothing as soon as possible, if there is any contact with clothing.
- Tire Service Kit Sealant solution contains latex. In case of an allergic reaction or rash, consult a physician immediately. Keep Tire Service Kit out of reach of children. If swallowed, rinse mouth immediately with plenty of water and drink plenty of water. Do not induce vomiting! Consult a physician immediately.



To use the Tire Service Kit, proceed as follows:

1. Apply the Electric Park Brake.
2. Connect the hose to the sealant cartridge containing the sealing liquid. Unscrew the tire valve cap, take out the filler tube and tighten the fitting on the tire valve.

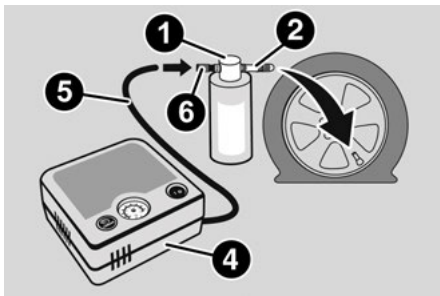

Attaching Filler Tube To Deflated Tire

- 1 – Sealant Cartridge
- 2 – Filler Hose
- 4 – Air Compressor
- 5 – Hose
- 6 – Sealant Cartridge Connector

3. Make sure the power switch of the compressor is in the O (off) position.

4. Insert the plug into the power outlet in the center console, then start the engine.

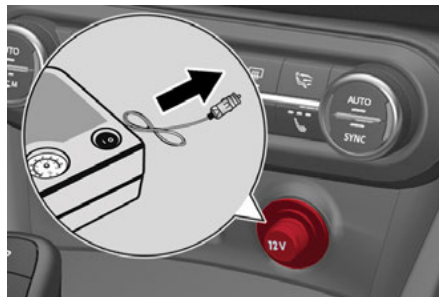

Inserting Plug Into Outlet

5. Start the compressor by placing the power switch in the I (on) position.

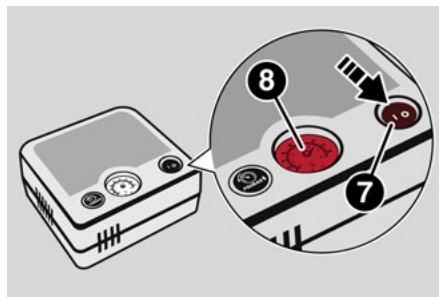

Air Compressor

- 7 – Power Switch
- 8 – Pressure Gauge

6. Inflate the tire to a pressure of at least 32 psi (2.2 bar) ⇨ page 240. In order to obtain a more precise reading, check the pressure value on pressure gauge with the compressor off.
7. If the pressure is not at least 26 psi (1.8 bar) after 15 minutes, disengage the compressor from the valve and power outlet. Then, move the vehicle forwards approximately five tire turns in order to distribute the sealing fluid inside the tire evenly, and then repeat the inflation operation.
8. Drive the vehicle for about 5 miles (8 km), stop, engage the electric park brake, and recheck the tire pressure.
9. If the pressure is less than 19 psi (1.3 bar), **DO NOT** drive the vehicle, and see an authorized dealer.
10. If a pressure value of at least 19 psi (1.3 bar) is detected, restore the correct pressure (with engine running and electric park brake engaged), and drive immediately with great care to an authorized dealer.



WARNING!

Tire Service Kit is not a permanent flat tire repair. Have the tire inspected and repaired or replaced after using Tire Service Kit. Do not exceed 50 mph (80 km/h) until the tire is repaired or replaced. Failure to follow this warning can result in injuries that are serious or fatal to you, your passengers, and others around you. Have the tire checked as soon as possible at an authorized dealer.

1. Apply the adhesive label from the sealant bottle where it can be easily seen by the driver as a reminder that the tire has been treated with a Tire Service Kit, as well as not to exceed the speed restriction for the treated tire.



WARNING!

Do not adhere the speed restriction sticker to the padded area on the steering wheel. Adhering the speed restriction sticker to the padded area on the steering wheel is dangerous because the air bag may not operate (deploy) normally resulting in serious injury. In addition, do not adhere the sticker to areas where warning lights or the speedometer cannot be viewed.

NOTE:

Only use original sealant cartridges, which can be purchased at an authorized dealer.

CHECKING AND RESTORING TIRE PRESSURE

The compressor can also be used to check and, if necessary, restore the tire pressure.

Proceed as follows:

1. Make sure that the power switch is in the O (off) position.
2. Connect the hose directly to the valve on the tire to be inflated.
3. Insert the plug into the socket in the passenger compartment or in the cargo area and start the engine.
4. Start the compressor by putting the power switch to I (on). As soon as the correct pressure is reached, put the power switch to O (off).

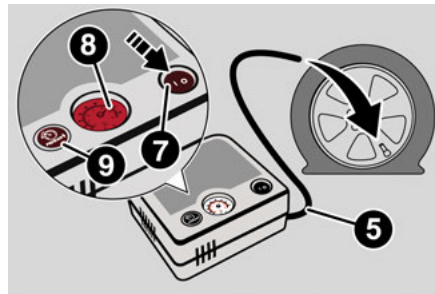

Air Compressor And Components

- 5 – Hose
- 7 – Power Switch
- 8 – Pressure Gauge
- 9 – PSI/BAR Button

If the tire is overinflated, reduce the pressure by pushing the PSI/BAR button and releasing it when the correct pressure is reached.

JUMP STARTING

If your vehicle has a discharged battery, it can be jump started using a set of jumper cables and a battery in another vehicle, or by using a portable battery booster pack. Jump starting can be dangerous if done improperly, so please follow the procedures in this section carefully.

NOTE:

When using a portable battery booster pack, follow the manufacturer's operating instructions and precautions.



**WARNING!**

Do not attempt jump starting if the battery is frozen. It could rupture or explode and cause personal injury.

**CAUTION!**

Do not use a portable battery booster pack or any other booster source with a system voltage greater than 12 Volts or damage to the battery, starter motor, alternator or electrical system may occur.

REMOTE BATTERY CONNECTION POSTS

The remote posts of the battery for jump starting can be found inside the engine compartment. The battery itself is located in the luggage compartment.

The negative terminal (-) is positioned next to the passenger side hood lock.

**Remote Negative (-) Post Location****WARNING!**

Do not connect the jumper cable to the negative (-) post of the discharged battery. The resulting electrical spark could cause the battery to explode and could result in serious injury. Only use the specific ground point, do not use any other exposed metal parts.

The positive post (+) can be accessed by removing the cover, and opening the protective flap.

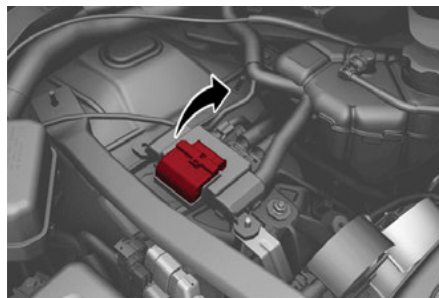
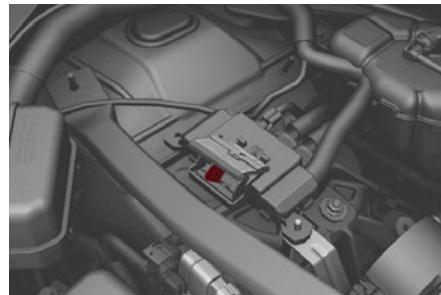
**Protective Flap****Remote Positive (+) Post Location**

To carry out the operation, you need to have the correct cables to connect to the battery of another vehicle or a portable battery booster pack to the remote posts of the discharged battery. Usually, these cables have terminals at the ends and are identified by different sheath colors (red = positive, black = negative).

**WARNING!**

Do not connect the jumper cable to the negative (-) post of the discharged battery. The resulting electrical spark could cause the battery to explode and could result in serious injury. Only use the specific ground point, do not use any other exposed metal parts.

JUMP STARTING PROCEDURE



WARNING!

Failure to follow this jump starting procedure could result in personal injury or property damage due to battery explosion.



CAUTION!

Failure to follow these procedures could result in damage to the charging system of the booster vehicle or the discharged vehicle.

Preparation For Jump Starting:

1. Firmly apply the parking brake, place the gear selector to PARK, place the ignition to the OFF.
2. Turn off all electrical features in the vehicle.
3. If using another vehicle to jump start the battery, park the vehicle within the jumper cables reach, apply the parking brake and make sure the ignition is OFF.



WARNING!

Do not allow vehicles to touch each other as this could establish a ground connection and personal injury could result.

Cable Connection

Proceed as follows to perform a jump starting procedure:

1. Connect the positive (+) end of the jumper cable to the positive (+) post of the vehicle with the discharged battery.
2. Connect the opposite end of the positive (+) jumper cable to the positive (+) post of the booster battery.
3. Connect the negative end (-) of the jumper cable to the negative (-) post of the booster battery.
4. Connect the opposite end of the negative (-) jumper cable to the remote negative (-) post of the vehicle with the discharged battery.



WARNING!

Do not connect the jumper cable to the negative (-) post of the discharged battery. The resulting electrical spark could cause the battery to explode and could result in serious injury. Only use the specific ground point, do not use any other exposed metal parts.

5. Start the engine in the vehicle that has the booster battery, let the engine idle a few minutes, and then start the engine in the vehicle with the discharged battery. If using a portable battery booster pack, before starting the vehicle, wait a few seconds after completing the connection.

Cable Disconnection

Once the engine is started, remove the connection cables in reverse sequence, as described below:

1. Disconnect the negative (-) end of the jumper cable from the remote negative (-) post of the vehicle with the discharged battery.
2. Disconnect the negative end (-) of the jumper cable from the negative (-) post of the booster battery.



3. Disconnect the opposite end of the positive (+) jumper cable from the positive (+) post of the booster battery.
4. Disconnect the positive (+) end of the jumper cable from the positive (+) post of the vehicle with the discharged battery.

If frequent jump starting is required to start your vehicle, you should have the battery and charging system inspected at an authorized dealer.



CAUTION!

Accessories plugged into the vehicle power outlets draw power from the vehicle's battery, even when not in use (i.e., cellular phones, etc.). Eventually, if plugged in long enough without engine operation, the vehicle's battery will discharge sufficiently to degrade battery life and/or prevent the engine from starting.

BUMP STARTING

Never jump start the engine by pushing, towing or coasting downhill.

NOTE:

You cannot start a vehicle with an automatic transmission by pushing it.

ENGINE OVERHEATING

If your vehicle is overheating, it will need to be serviced at an authorized dealer.

Engine overheating may occur in situations such as (but not limited to) extreme environmental temperatures or frequent engine stops/starts. If the engine becomes overheated, the Engine Temperature Warning Light in the instrument cluster will illuminate along with a dedicated message → page 80.

In any of the following situations, you can reduce the potential for overheating by taking the appropriate action.

- On the highways — slow down.
- In city traffic — while stopped, place the transmission in NEUTRAL, but do not increase engine idle speed.

NOTE:

There are steps that you can take to slow down an impending overheat condition:

- If your Air Conditioner (A/C) is on, turn it off. The A/C system adds heat to the engine cooling system and turning the A/C off can help remove this heat.
- You can also turn the temperature control to maximum heat, the mode control to floor and the blower control to high. This allows the heater core to act as a supplement to the radiator and aids in removing heat from the engine cooling system.



WARNING!

You or others can be badly burned by hot engine coolant (antifreeze) or steam from your radiator. If you see or hear steam coming from under the hood, do not open the hood until the radiator has had time to cool. Never try to open a cooling system pressure cap when the radiator or coolant bottle is hot.



CAUTION!

Driving with a hot cooling system could damage your vehicle. If temperature gauge reads “H”, pull over and stop the vehicle. Idle the vehicle with the air conditioner turned off until the pointer drops back into the normal range. If the pointer remains on the “H”, turn the engine off immediately, and call for service.

NOTE:

- If the cooling fan does not operate while the engine is running, the engine temperature will increase. Stop the engine and contact an authorized dealer.
- If the engine continues to overheat or frequently overheats, have the cooling system inspected. The engine could be seriously damaged unless repairs are made. Contact an authorized dealer.

MANUAL PARK RELEASE

See an authorized dealer to disengage the manual park release lever.



WARNING!

A special tool is required to perform this procedure. Damage to the vehicle or serious injury or death may occur if the procedure is performed improperly. Please contact an authorized dealer to have this procedure performed.

TOWING A DISABLED VEHICLE

This section describes procedures for towing a disabled vehicle using a commercial towing service.



CAUTION!

- The vehicle should be transported with all four wheels OFF the ground on the flatbed of a roadside assistance vehicle. Avoid towing with only the front (or rear) wheels lifted. When towing with only the front (or rear) wheels lifted, in addition to damaging the body, it could damage the transmission.

(Continued)



CAUTION! (Continued)

- Do not use sling-type equipment when towing. Vehicle damage may occur.
- When securing the vehicle to a flatbed truck, do not attach to front or rear suspension components. Damage to your vehicle may result from improper towing.
- Ensure that the Electric Park Brake is released, and remain released, while being towed.
- Damage from improper towing is not covered under the New Vehicle Limited Warranty.

NOTE:

If your vehicle is equipped with a Anti-Lift Protection system, you will need to disable the system prior to towing by pushing the button located on the overhead console → page 22.

The operators of the assistance vehicle must be informed with regard to the vehicle's minimum height from ground in order to avoid contact between the ends of the bumpers with the equipment of the breakdown truck.

The following image illustrates the front and rear attachment corners of the vehicle, to be taken into consideration when loading the vehicle on the commercial towing vehicle.





Front And Rear Loading Angles



Front And Rear Loading Angles

	AWD Models
A – Front Loading Angle	21.7°
B – Rear Loading Angle	18.3°

	Quadrifoglio Models
A – Front Loading Angle	20.8°
B – Rear Loading Angle	21.0°

FOUR-WHEEL DRIVE (AWD) MODELS

It is recommended to tow the vehicle with all four wheels OFF the ground on the flatbed of a commercial towing vehicle.



CAUTION!

- DO NOT flat tow this vehicle. Damage to the drivetrain will result.
- DO NOT dolly tow this vehicle. Use of a towing dolly can cause significant damage to your vehicle.

Towing this vehicle in violation of the above requirements can cause severe transmission damage. Damage from improper towing is not covered under the New Vehicle Limited Warranty.

TOW EYES

If the vehicle has been in an accident or has broken down, a tow eye is provided in the tools container located inside the luggage compartment for vehicle towing. Towing is meant only for short distances on a paved road surface.

Proceed as follows to use the tow eye:

1. Unhook the cap on the front grille or rear bumper (if equipped), pushing on the upper part.



Front Tow Eye Cap



Rear Tow Eye Cap

- Remove the tow eye from its housing in the luggage compartment and carefully clean the threaded housing on the vehicle before using it.
- Tighten the vehicle's tow eye in place (about 11 turns).

NOTE:

The largest work angle of a tow cable to fix on the tow eye must not exceed 15°.

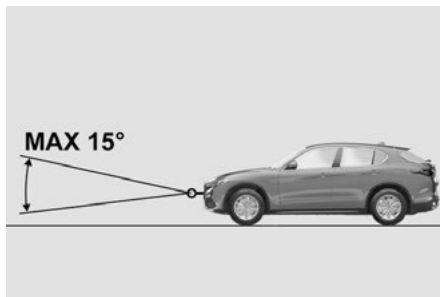

Work Angle Of Tow Cable



WARNING!

Stand clear of vehicles when pulling with tow eyes.

- Do not use a chain with a tow eye. Chains may break, causing serious injury or death.

(Continued)



WARNING! (Continued)

- Do not use a tow strap with a tow eye. Tow straps may break or become disengaged, causing serious injury or death.
- Failure to follow proper tow eye usage may cause components to break resulting in serious injury or death.



CAUTION!

- The tow eye must be used exclusively for roadside assistance operations. Only use the tow eye with an appropriate device in accordance with the highway code (a rigid bar or rope) to flat tow the vehicle for a short distance to the nearest service location.
- Tow eyes **MUST NOT** be used to tow vehicles off the road or where there are obstacles.
- In compliance with the above conditions, towing with a tow eye must take place with two vehicles (one towing, the other towed) aligned as much as possible along the same center line. Damage to your vehicle may occur if these guidelines are not followed.
- When towing, only use a facility that can tow vehicles with low ground clearances as extensive damage can result by using a standard tow truck platform.

ENHANCED ACCIDENT RESPONSE SYSTEM (EARS)

This vehicle is equipped with an Enhanced Accident Response System.

This feature is a communication network that takes effect in the event of an impact
 ⇨ page 180.

EVENT DATA RECORDER (EDR)

This vehicle is equipped with an event data recorder (EDR). The main purpose of an EDR is to record data that will assist in understanding how a vehicle's systems performed under certain crash or near crash-like situations, such as an air bag deployment or hitting a road obstacle ⇨ page 182.



Correct servicing permits the performance of the vehicle to be maintained over time, as well as limited running costs and safeguarding the efficiency of the safety systems.

SCHEDULED SERVICING

Correct servicing is crucial for guaranteeing a long life for the vehicle under the best conditions.

For this reason, Alfa Romeo has planned a series of checks and services for your vehicle at fixed intervals based on distance and time, as described in the Scheduled Servicing Plan.

Before each service, it is always necessary to carefully follow the instructions in the Scheduled Servicing Plan (e.g. periodically check level of fluids, tire pressure, etc.).

Scheduled Servicing is offered by an authorized dealer according to a set time schedule. If, during each operation, in addition to the ones scheduled, the need arises for further replacements or repairs, these may be carried out with the owner's explicit consent only.

NOTE:

Scheduled Servicing intervals are required by the manufacturer. Failure to have them carried out may invalidate the New Vehicle Limited Warranty.

You are advised to inform an authorized dealer of any small operating irregularities without waiting for the next service.

PERIODIC CHECKS

Every month or every 620 miles (1,000 km) or before long trips check and, if necessary, top off:

- Engine coolant level.
- Brake fluid level (if insufficient, see an authorized dealer as soon as possible).
- Windshield washer fluid level.
- Tire inflation pressure and condition.
- Operation of lighting system (headlights, direction indicators, hazard warning lights, etc.).
- Operation of windshield washing/wiping system and positioning/wear of wiper blades.
- Inspect the CV/Universal joints.

Oil consumption of the engine depends on conditions and driving style. For this reason, the engine oil level must be checked every 1,860 miles (3,000 km), and top off if necessary; for further information ⇨ page 219.

HEAVY USAGE OF THE VEHICLE

If the vehicle is used under one of the following conditions:

- Dusty roads.
- Short, repeated journeys less than 4 miles (7 km) at sub-zero outside temperatures.

- Engine often idling or driving long distances at low speeds or long periods of inactivity.
- In the event of a long period of inactivity.

The following checks must be carried out more often than indicated in the Scheduled Servicing Plan:

- Check cleanliness of hood and liftgate locks, cleanliness and lubrication of linkage.
- Visually inspect conditions of: engine, transmission, pipes and hoses (exhaust/fuel system/brakes) and rubber elements (sleeves/bushes, etc.).
- Check battery charge and battery fluid level (electrolyte).
- Visually inspect conditions of the accessory drive belts.
- Check and, if necessary, change engine oil and replace oil filter.
- Check and, if necessary, replace cabin air filter.
- Check and, if necessary, replace air cleaner.

Severe Duty All Models

Change engine oil at 4,000 miles (6,500 km) if the vehicle is operated in a dusty and off-road environment or is operated predominately at idle or only very low engine RPM. This type of vehicle use is considered Severe Duty.

MAINTENANCE PLAN — 2.0L ENGINE

Thousands of miles	10	20	30	40	50	60	70	80	90	100	110	120	130	140	150
Years	1	2	3	4	5	6	7	8	9	10	11	12	13	14	15
Thousands of kilometers	16	32	48	64	80	96	112	128	144	160	176	192	208	224	240
Change engine oil and replace oil filter. ¹															
SOS backup battery replacement. (if equipped) ²					•					•					•
Check battery charge status with the proper instrument.	•	•	•	•	•	•	•	•	•	•	•	•	•	•	•
Check tire condition/wear and adjust pressure, if necessary. Check the tire service kit recharge condition and expiration date.	•	•	•	•	•	•	•	•	•	•	•	•	•	•	•
Check operation of lighting system (headlights, direction indicators, hazard warning lights, deck lid, passenger compartment, glove compartment, instrument panel warning lights, etc.).	•	•	•	•	•	•	•	•	•	•	•	•	•	•	•
Check and, if necessary, top up fluid levels. ³	•	•	•	•	•	•	•	•	•	•	•	•	•	•	•
Check engine control system operation (via diagnostic tool) and engine oil degradation (if equipped). ⁴	•	•	•	•	•	•	•	•	•	•	•	•	•	•	•
Visually inspect conditions of: exterior bodywork, underbody protection, pipes and hoses (exhaust, fuel system, brakes), rubber elements (sleeves, bushes, etc.).		•		•		•		•		•		•		•	
Check position/wear of front windshield wiper blade.	•		•		•		•		•		•		•		•
Check operation of the windshield wiper/washer system and adjust nozzles, if necessary.	•		•		•		•		•		•		•		•
Check cleanliness of hood and luggage compartment locks, cleanliness and lubrication of linkage.		•		•		•		•		•		•		•	



Thousands of miles	10	20	30	40	50	60	70	80	90	100	110	120	130	140	150
Years	1	2	3	4	5	6	7	8	9	10	11	12	13	14	15
Thousands of kilometers	16	32	48	64	80	96	112	128	144	160	176	192	208	224	240
Visually inspect conditions and wear of front/rear disc brake pads and operation of pad wear indicators.	•	•	•	•	•	•	•	•	•	•	•	•	•	•	•
Visually inspect the condition and tensioning of the accessory drive belt(s).	•	•	•		•	•	•		•	•	•		•	•	•
Change engine coolant.															•
Replace transfer case oil (AWD models only).								•							
Replace accessory drive belt(s).															•
Replace air cleaner cartridge. ⁵			•			•			•			•			•
Replace the additional fuel filter (if equipped).	•	•	•	•	•	•	•	•	•	•	•	•	•	•	•
Change the brake fluid. ⁶															
Replace the passenger compartment cleaner. ⁷	0	•	0	•	0	•	0	•	0	•	0	•	0	•	0

Thousands of miles	10	20	30	40	50	60	70	80	90	100	110	120	130	140	150
Years	1	2	3	4	5	6	7	8	9	10	11	12	13	14	15
Thousands of kilometers	16	32	48	64	80	96	112	128	144	160	176	192	208	224	240
Spark plug replacement. ⁸															

1. The actual interval for changing engine oil and replacing the engine oil filter depends on the vehicle usage conditions and is signaled by the warning light or message in the instrument panel. In all cases, never exceed 1 year/10,000 miles (16,000 km).
2. The SOS backup battery must be replaced every five years, regardless of mileage.
3. Top up using the fluids indicated, only after checking that the system is intact → page 272.
4. If oil degradation ratio (data collectible from diagnostic device) is more than 80% (oil quality less than 20%), engine oil and filter replacement is recommended.
5. If the vehicle is used in dusty areas, this engine air cleaner filter must be replaced every 10,000 miles (16,000 km).
6. The brake fluid replacement has to be done every two years, regardless of the mileage.
7. If the vehicle is used in dusty areas, this cleaner filter must be replaced every 10,000 miles (16,000 km).
8. The spark plug change interval is 60,000 miles for NAFTA market or 60,000 km outside NAFTA. Yearly intervals do not apply.

(o) Recommended operations

(●) Mandatory operations



WARNING!

- You can be badly injured working on or around a motor vehicle. Do only service work for which you have the knowledge and the right equipment. If you have any doubt about your ability to perform a service job, take your vehicle to a competent mechanic.
- Failure to properly inspect and maintain your vehicle could result in a component malfunction and effect vehicle handling and performance. This could cause an accident.



MAINTENANCE PLAN — 2.9L ENGINE

Thousands of miles	10	20	30	40	50	60	70	80	90	100	110	120	130	140	150
Years	1	2	3	4	5	6	7	8	9	10	11	12	13	14	15
Thousands of kilometers	16	32	48	64	80	96	112	128	144	160	176	192	208	224	240
SOS backup battery replacement (if equipped). ¹					•					•					•
Check battery charge status with the proper instrument.	•	•	•	•	•	•	•	•	•	•	•	•	•	•	•
Check tire condition/wear and adjust pressure, if necessary. Check the tire repair kit recharge condition and expiration date.	•	•	•	•	•	•	•	•	•	•	•	•	•	•	•
Check operation of lighting system (headlights, direction indicators, hazard warning lights, trunk lid, passenger compartment, glove compartment, instrument panel warning lights, etc.).	•	•	•	•	•	•	•	•	•	•	•	•	•	•	•
Check and, if necessary, top up fluid levels. ²	•	•	•	•	•	•	•	•	•	•	•	•	•	•	•
Check engine control system operation (via diagnostic tool).	•	•	•	•	•	•	•	•	•	•	•	•	•	•	•
Visually inspect conditions of: exterior bodywork, underbody protection, pipes and hoses (exhaust, fuel system, brakes), rubber elements (sleeves, bushes, etc.).		•		•		•		•		•		•		•	
Check position/wear of front windshield wiper blade.	•		•		•		•		•		•		•		•
Check operation of the windshield wiper/washer system and adjust nozzles, if necessary.	•		•		•		•		•		•		•		•
Check cleanliness of hood and luggage compartment locks, cleanliness and lubrication of linkage.		•		•		•		•		•		•		•	
Visually inspect conditions and wear of front/rear disc brake pads and operation of pad wear indicators.	•	•	•	•	•	•	•	•	•	•	•	•	•	•	•

Thousands of miles	10	20	30	40	50	60	70	80	90	100	110	120	130	140	150
Years	1	2	3	4	5	6	7	8	9	10	11	12	13	14	15
Thousands of kilometers	16	32	48	64	80	96	112	128	144	160	176	192	208	224	240
Inspect the CV/Universal joints.	•	•	•	•	•	•	•	•	•	•	•	•	•	•	•
Visually inspect the brake discs surface and edge.	•	•	•	•	•	•	•	•	•	•	•	•	•	•	•
Brake pads/brake discs replacement. ³															
Visually inspect the condition and tensioning of the accessory drive belt(s).	•	•	•		•	•	•		•	•	•		•	•	•
Change engine coolant.															•
Change engine oil and replace oil filter.	•	•	•	•	•	•	•	•	•	•	•	•	•	•	•
Replace transfer case oil (AWD models only).								•							
Replace accessory drive belt/s. ⁴															
Replace air cleaner cartridge. ⁵		•		•		•		•		•		•		•	
Replace the additional fuel filter (if equipped).	•	•	•	•	•	•	•	•	•	•	•	•	•	•	•
Change the brake fluid. ⁶															
Replace the cabin air filter. ⁷	0	•	0	•	0	•	0	•	0	•	0	•	0	•	0
Spark plug replacement. ⁸			•			•			•			•			•

1. The SOS backup battery must be replaced every five years, regardless of mileage.
2. Top off using the fluids indicated only after checking that the system is intact → page 272.
3. The actual interval for changing the brake pads and the carbon ceramic brake discs depends on the vehicle usage conditions and is signaled by the warning light or message on the instrument panel. After each discs replacement, reset the warning light using the diagnostic socket.
4. Areas that are not dusty: recommended maximum mileage 36,000 miles (60,000 km). Regardless of the mileage, the belt must be replaced every 4 years. Dusty areas and/or demanding use of the vehicle (cold climates, town use, long periods of idling): advised maximum mileage 18,000 miles (30,000 km). Regardless of the mileage, the belt must be replaced every 2 years.
5. If the vehicle is used in dusty areas, this engine air cleaner filter must be replaced every 10,000 miles (16,000 km).
6. The brake fluid replacement has to be done every two years, regardless of the mileage.
7. If the vehicle is used in dusty areas, this cleaner filter must be replaced every 10,000 miles (16,000 km).
8. The spark plug change interval is mileage-based only. Yearly intervals do not apply.

ENGINE COMPARTMENT

CHECKING LEVELS — 2.0L ENGINE

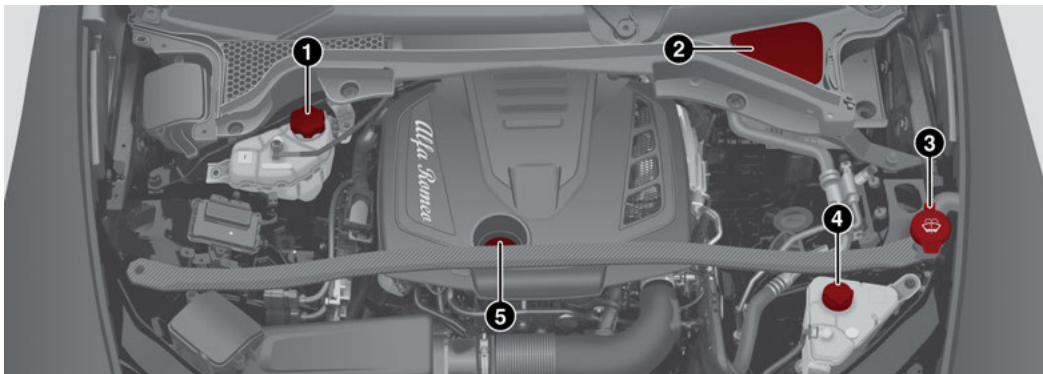

1 - Engine Coolant Reservoir Cap

2 - Brake Fluid Reservoir Access Cover

3 - Windshield/Headlights Washer Fluid Reservoir Cap

4 - Intercooler Coolant Reservoir Cap

5 - Engine Oil Filler Cap

CHECKING LEVELS — 2.9L ENGINE

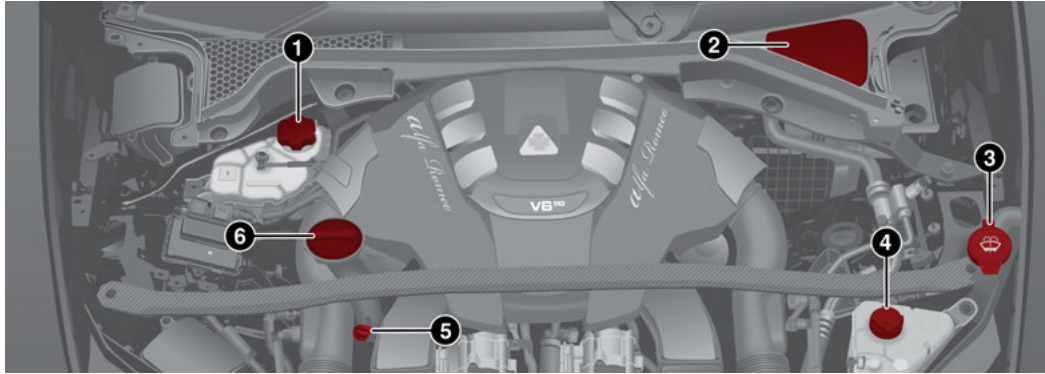

1 – Engine Coolant Reservoir Cap

2 – Brake Fluid Reservoir Cap Access Cover

3 – Windshield/Headlight Washer Fluid Reservoir Cap

4 – Intercooler Coolant Reservoir Cap

5 – Engine Oil Dipstick

6 – Engine Oil Filler

ENGINE OIL

The engine oil level can be seen on the instrument cluster display every time the engine is started, or on the Information and Entertainment system display by activating on the main menu (MENU button) the following functions in sequence:

1. “Vehicle Information”
2. “Engine Oil”

Check that the oil level is between the MIN and MAX level on the instrument cluster display using the 6 notches shown. 1 notch displays the MIN level and 6 notches displays the MAX level.

If the oil level is close to or below the MIN mark, add oil gradually through the filler, (refer to “Top-Up And Oil Level Indication Update On Display” in this section) considering that each notch shown on the display corresponds to approximately 8.8 fl oz (250 ml).

The oil level can also be checked manually on 2.9L Quadrifoglio models.



CAUTION!

Make sure not to add too much oil when topping off the engine. Engine oil in excess may damage the engine. Have the vehicle checked. Never exceed the MAX level when topping off engine oil. It is advisable to check the oil level in intermediate steps using the oil dipstick (2.9L Quadrifoglio Only).

**CAUTION!**

The oil level is not refreshed immediately on the display after topping off. Consequently, wait for the oil level to be refreshed on the display and follow the procedure below.

NOTE:

Always reinstall the oil cap and tighten to proper torque whenever it is removed to add oil to engine. Never run the engine with cap removed as this could cause oil to leak from engine.

Manual Oil Level Checking Procedure – 2.9L Quadrifoglio

Check that the oil level is between the MIN and MAX marks on dipstick, clean it with a lint-free cloth and reinsert it. Extract the dipstick again and check that the level is between the MIN and MAX marks.

Top-Up And Oil Level Indication Update On Display – 2.9L Quadrifoglio

If an engine oil top-off is needed, in order to ensure the correct indication of the oil level on the display, proceed with the process below:

- Leave the car on flat ground with the engine running for approximately five minutes (temperature higher than 198°F (90°C) and shut the engine off.
- Wait for five minutes, turn the ignition to the ACC mode without starting the engine and wait for a few seconds.

NOTE:

If the level indication is not updated after the previously described procedure, repeat the engine adjustment, shut the engine off and wait another five minutes before starting it again. If the indication is not updated after the second start, contact an authorized dealer.

Top-Up And Oil Level Indication Update On Display – 2.0L

If an engine oil top-off is needed, in order to ensure the correct indication of the oil level on the display, proceed with the process below:

- Leave the car on flat ground with the engine running for approximately five minutes (temperature higher than 176°F (80°C) and shut the engine off.
- Start the engine again and idle it for about two minutes.

NOTE:

If you have added the specified amount of oil and the indicator is not reading “Full”, please contact an authorized dealer.

**WARNING!**

If the engine oil is being topped up, wait for the engine to cool down before loosening the filler cap, particularly for vehicles with aluminum cap (if equipped). **WARNING:** risk of burns!

**CAUTION!**

The oil level must never exceed the MAX mark.

If the MAX mark is exceeded (last notch on the right turns red) after the fill-up, go to an authorized dealer as soon as possible to have the oil in excess removed.

Do not add oil with specifications different from those of the oil already in the engine.

Used engine oil and oil filters contain substances which are harmful to the environment. To change the oil and filters, we advise you to contact an authorized dealer.

ENGINE COOLANT FLUID

If the level is too low, unscrew the cap of the reservoir and add the fluid described ↪ page 272.

WASHER FLUID FOR WINDSHIELD/ HEADLIGHTS

The windshield and headlight (if equipped) washer fluid reservoir is equipped with a telescopic filler neck.

If the level is too low, remove reservoir cap and lift the filler neck. Then, add the fluid described ↪ page 272. After filling the reservoir, lower the filler neck and install the reservoir cap until you hear it click.

NOTE:

The headlight washers are activated every 10 activations of the windshield washer.

NOTE:

The headlight washing system will not work if the liquid level is low (situation indicated by the symbol on the instrument cluster display → page 70). The windshield washer will keep working.

On vehicles equipped with headlight washers, there is a reference notch on the dipstick: ONLY the windshield/rear window washer operates with the level below this reference.

BRAKE FLUID

Check that the fluid is at the maximum level. If the fluid level in the tank is low, contact an authorized dealer to have the system checked.

AUTOMATIC TRANSMISSION ACTIVATION SYSTEM OIL

The transmission control oil level should only be checked at an authorized dealer.

USEFUL ADVICE FOR EXTENDING THE LIFE OF YOUR BATTERY

To avoid draining your battery and make it last longer, observe the following instructions:

- When you park the vehicle, ensure that the doors and liftgate are closed properly to prevent any lights from remaining on inside the passenger's compartment.

- Do not keep accessories (e.g. radio, hazard warning lights, etc.) switched on for a long time when the engine is not running.
- Before performing any operation on the electrical system, disconnect the negative battery cable.

If you wish to install electrical accessories after purchasing the vehicle that require permanent electrical supply (e.g. alarm, etc.), or accessories which influence the electrical supply requirements, contact an authorized dealer, who's qualified staff will evaluate the overall electrical consumption.

**CAUTION!**

If the charge level remains under 50% for a long time, the battery may be damaged by sulfation, reducing its capacity and efficiency during the vehicle start. The battery is also more prone to the risk of freezing (at temperatures as high as 14 °F (-10 °C).

NOTE:

After the battery is disconnected, the steering must be initialized. The  steering warning light on the instrument cluster display switches on to indicate this. To carry out this procedure, simply turn the steering wheel all the way from one end to the other, and then turn it back to the central position.

BATTERY

The battery does not require the electrolyte to be topped up with distilled water. A periodic check carried out at an authorized dealer, however, is necessary to check efficiency.

**WARNING!**

- Battery acid is a corrosive solution and can burn or even blind you. Do not allow battery acid to contact your eyes, skin, or clothing. Do not lean over a battery when attaching clamps. If acid splashes in eyes or on skin, flush the area immediately with large amounts of water → page 205.
- Battery gas is flammable and explosive. Keep flame or sparks away from the battery. Do not use a booster battery or any other booster source with an output greater than 12 Volts. Do not allow cable clamps to touch each other.
- Battery posts, terminals, and related accessories contain lead and lead compounds. Wash hands after handling.



PRESSURE WASHING

Cleaning the engine compartment with a high pressure washer is not recommended.

**CAUTION!**

Precautions have been taken to safeguard all parts and connections however, the pressures generated by these machines is such that complete protection against water ingress cannot be guaranteed.

BATTERY RECHARGING**IMPORTANT NOTES****WARNING!**

- Never charge or recharge a frozen battery: it may explode because of the nitrogen trapped inside the ice crystals.
- At all times while charging or recharging the battery, make sure that any sparks or open flames are kept sufficiently far away from the battery.

NOTE:

- Before using the charging device, always make sure that it is appropriate for the installed battery, with constant voltage (below 14.8 Volts) and low amperage (maximum 15 Amps).
- Recharge the battery in a well ventilated environment.
- Before using any devices to charge or to maintain the charge of the battery, carefully follow the instructions provided with the device in order to properly and safely connect it to the vehicle battery.

You can recharge the battery without disconnecting the wires of the vehicle's electrical system.

- To reach the battery, remove the load floor inside the liftgate.

**Load Floor**

- Locate the battery access panel under the load floor.

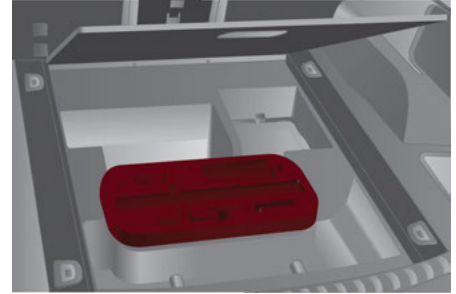
**Battery Access Panel**

- Remove the protective cover and connect the positive cable terminal of the charger (usually red) to the positive terminal (+) of the battery.

- Connect the negative terminal of the charger (usually black) to nut next to the negative terminal (-) of the battery.

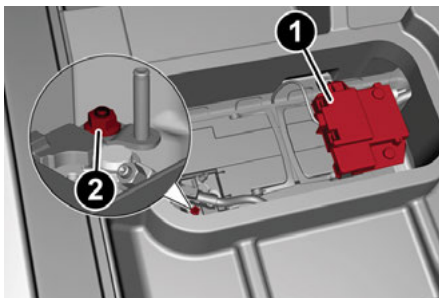

Battery

- 1 – Protective Cover
- 2 – Negative Post (Nut)

The vehicle is equipped with an Intelligent Battery Sensor (IBS), which is able to measure the charge and discharge voltage, calculate the charge level and the general condition of the battery. The sensor is placed next to the negative terminal (-) of the battery.

For a correct charge/discharge procedure, the charge voltage must go through the IBS sensor.

1. Turn the charger on and follow the instructions in the user's manual to completely recharge the battery.
2. When the battery is charged, turn the charger off before disconnecting it from the battery.
3. Disconnect the black cable terminal of the battery charger and then the red cable terminal.
4. Refit the protective cover of the positive terminal of the battery and the access cover to the battery compartment.

NOTE:

If a "quick-type" battery charger is used with the battery fitted on the vehicle, before connecting it disconnect both cables of the battery itself. Do not use a "quick-type" battery charger to provide the starting voltage.

VEHICLE MAINTENANCE

The following pages contain instructions on the required maintenance from the technical personnel who designed the vehicle.

In addition to these specific maintenance instructions specified for routine scheduled servicing, there are other components which may require periodic maintenance or replacement over the vehicle's life cycle.

ENGINE OIL

Engine Oil Level Check

To ensure correct engine lubrication, the oil must always be kept at the prescribed level  page 218.

Check the oil level at regular intervals, for example every 1,864 miles (3,000 km).

It must be checked about five minutes after stopping the engine.

Full operating temperature must be reached. The vehicle must also be parked on as level a surface as possible.



The engine oil level can be checked using the Information and Entertainment system. To access the function, activate the main menu (MENU button) and select the following options in sequence:

1. "Vehicle Information"
2. "Engine Oil"

Ensure that the oil level is within the interval on the dipstick between the minimum and maximum limits (Quadrifoglio only).

Changing The Engine Oil

For the correct servicing intervals
 ⇨ page 213.

Choice Of Engine Oil Type

To ensure optimal performance and maximum protection in all operating conditions, it is advised to use certified engine oils
 ⇨ page 272.

Additives For Engine Oil

It is strongly recommended not to use additives (other than leak detection dyes) with the engine oil.

The engine oil is a product designed specially for the vehicle, and its performance may be deteriorated through the use of further additives.

Disposal Of Used Engine Oil And Filters

For the disposal of the engine oil and filters, contact the appropriate body to determine local regulations.

NOTE:

Incorrectly disposed used engine oil may seriously harm the environment.

ENGINE OIL FILTER

Replacing the Engine Oil Filter

The engine oil filter must be replaced each time the engine oil is changed. It is advised to replace it with a genuine spare part, specifically designed for this vehicle.

ENGINE AIR CLEANER FILTER

Replacing the Engine Air Cleaner Filter

For the correct servicing intervals
 ⇨ page 213. It is advised to replace the engine air cleaner filter with a genuine spare part, specifically designed for this vehicle.

AIR CONDITIONING SYSTEM MAINTENANCE

To ensure the best possible performance, the air conditioning system must be checked and undergo maintenance at an authorized dealer at the beginning of the summer.



CAUTION!

Do not use chemicals to clean the air conditioning system, since the internal components may be damaged. This kind of damage is not covered by warranty.

Replace The Cabin Air Filter

For the correct servicing intervals
 ⇨ page 213. For cleaner replacement, contact an authorized dealer.



WARNING!

Use only refrigerants and compressor lubricants approved by the manufacturer for your air conditioning system. Some unapproved refrigerants are flammable and can explode, injuring you. Other unapproved refrigerants or lubricants can cause the system to fail, requiring costly repairs. Refer to Warranty Information Book, located in your owner's information kit, for further warranty information.

LUBRICATING MOVING PARTS OF THE BODYWORK

Ensure that the locks and bodywork junction points, including components such as the seat guides, door hinges (and rollers), liftgate and hood are periodically lubricated with lithium-based grease to ensure correct, silent operation and to protect them from rust and wear.

Thoroughly clean the components, eliminating every trace of dirt and dust. After lubricating, eliminate excess oil and grease. Also pay particular attention to the hood closing devices, to ensure correct operation.

Operations of the hood are to be carried out with the engine cold. Remember to check, clean and lubricate the locking, release and safety devices.

Lubricate the external lock barrels twice a year. Apply a small amount of high-quality lubricant directly into the lock barrel.

If necessary, contact an authorized dealer as soon as possible.

WINDSHIELD WIPER

Periodically clean the windshield, rear window and rubber profile of the windshield wiper blades, using a sponge or a soft cloth and a non-abrasive detergent. This eliminates the salt or impurities accumulated when driving.

Prolonged operation of the windshield window wipers with dry glass may cause the deterioration of the blades, in addition to abrasion of the surface of the glass. To eliminate the impurities on the dry glass, always operate the windshield washers.

In the event of very low outdoor temperatures, below 0°F (-17.8°C), ensure that the movement of the rubber part in contact with the glass is not obstructed. Use a suitable deicing product to release it if required.

Avoid using the windshield wipers to remove frost or ice.

Also avoid contact of the rubber profile of the blades with petroleum derivatives such as engine oil, gas, etc.



WARNING!

Driving with worn windshield wiper blades is a serious hazard, because visibility is reduced in bad weather conditions.

NOTE:

The life of the windshield wiper blades varies according to the usage frequency. It is advised to replace the blades approximately once a year. When the blades are worn, noise, marks on the glass or streaks of water may be noticed. In the presence of these conditions, clean the windshield wiper blades or, if necessary, replace them.

Raising The Windshield Wiper Blades (“Service Position” Function)

The “service position” function allows the driver to replace the windshield wiper blades easily. It is also recommended to activate this function when it is snowing and to make it easier to remove any dirt deposits in the area where the blades are normally positioned, while washing.

NOTE:

If the windshield wipers are raised while not in the “service position,” it is possible to damage the hood.

Activation Of The Function

To activate this function, disable the windshield wiper before placing the ignition in the OFF position.

This function can only be activated within two minutes of placing the ignition in the OFF position.

To activate this function, move the lever upward for at least three seconds.



Windshield Wiper Stalk

Function Deactivation

The function is deactivated if:

- More than two minutes has passed before placing the ignition in the OFF position after raising the lever and placing the wipers in service position.
- The ignition is placed in the ACC position and the windshield wiper control is used.

If, after using the function, the ignition is set back to ACC with the blades in a position other than rest position (at the base of the windshield), they will only return to rest position following a command given using the stalk (stalk upwards, into unstable position) or when a speed of 3 mph (5 km/h) is exceeded.



Replacing The Windshield Wiper Blades

Proceed as follows:

1. Raise the wiper arm, push tab of the attachment spring and remove the blade from the arm.

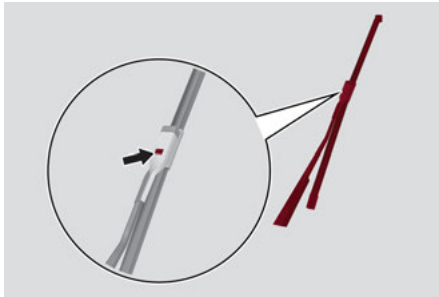

Wiper Release Tab

2. Fit the new blade, inserting the tab in the dedicated housing in the arm and checking that it is locked.
3. Lower the wiper arm onto the windshield.

NOTE:

Do not operate the windshield wiper with the blades lifted from the windshield.

Front/Rear Windshield Washers

The window washer nozzles are fixed. If there is no jet of fluid, first check that there is fluid in the reservoir → page 218.

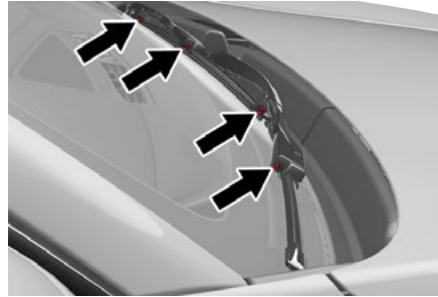

Front Windshield Washers

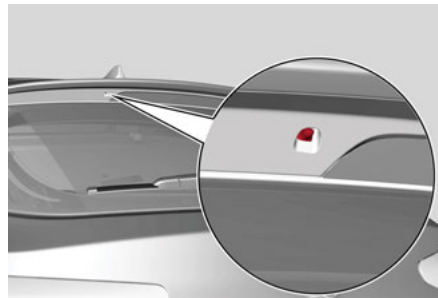

Rear Windshield Washer

Then, check that the nozzle holes are not clogged; use a needle to unblock them if necessary.

EXHAUST SYSTEM

Adequate maintenance of the engine exhaust system represents the best protection against leaks of carbon monoxide into the passenger compartment.

If an unusual noise from the exhaust or the presence of smoke in the passenger compartment is identified, or if the underbody or rear section of the vehicle have been damaged, have the entire exhaust system and adjoining bodywork areas checked at an authorized dealer to identify any components which are broken, damaged, worn or have moved from their correct fitting position.

Open welding or loose connections may permit exhaust gas to enter the passenger compartment.

Have the exhaust system checked every time the vehicle is raised. Replace the components where necessary (for these operations, contact an authorized dealer).

In normal operating conditions, the catalytic converter does not require maintenance. To ensure that it operates correctly, and prevent it from getting damaged, it is extremely important that the engine operates perfectly.

To minimize the risk of damaging the catalytic converter, proceed as follows:

- Do not stop the engine or deactivate the ignition with gear engaged and vehicle in motion.
- Do not attempt to start the engine by bump starting.
- Do not use the vehicle if irregular idling or operating conditions are experienced.



WARNING!

- Exhaust gases can injure or kill. They contain Carbon Monoxide (CO), which is colorless and odorless. Breathing it can make you unconscious and can eventually poison you.
- A hot exhaust system can start a fire if you park over materials that can burn. Such materials might be grass or leaves coming into contact with your exhaust system. Do not park or operate your vehicle in areas where your exhaust system can contact anything that can burn.

COOLING SYSTEM



WARNING!

- You or others can be badly burned by hot engine coolant (antifreeze) or steam from your radiator. If you see or hear steam coming from under the hood, do not open the hood until the radiator has had time to cool. Never open a cooling system pressure cap when the radiator or coolant bottle is hot.
- Keep hands, tools, clothing, and jewelry away from the radiator cooling fan when the hood is raised. The fan starts automatically and may start at any time, whether the engine is running or not.
- When working near the radiator cooling fan, disconnect the fan motor lead or turn the ignition to the OFF mode. The fan is temperature controlled and can start at any time the ignition is in the ON mode.

Coolant Check

Your vehicle has two cooling systems and both need to be checked to ensure they are at proper fill levels → page 218.

Check the engine coolant and intercooler coolant level every oil change or before long trips.

If there are impurities in the engine coolant, the system must be drained, flushed and refilled: contact an authorized dealer.

Check the front part of the condenser for any build-up of insects, leaves or other debris. Should it be dirty, clean by spraying delicately with water.

Check the hoses of the engine/intercooler cooling system to ensure that the rubber has not deteriorated and that there are no cracks, tears, cuts or obstructions in the expansion tank side and radiator side connectors. Should there be any doubt regarding leaks from the system (e.g. if frequent top ups are required), have the seal checked at an authorized dealer.

With the engine off and at normal operating temperature, check that the cooling system radiator cap is closed properly.



WARNING!

- Do not open hot engine cooling system. Never add engine coolant (antifreeze) when the engine is overheated. Do not loosen or remove the cap to cool an overheated engine. Heat causes pressure to build up in the cooling system. To prevent scalding or injury, do not remove the pressure cap while the system is hot or under pressure.

(Continued)



**WARNING!** *(Continued)*

- ❑ Do not use a pressure cap other than the one specified for your vehicle. Personal injury or engine damage may result.

NOTE:

Before removing the coolant reservoir cap, wait for the system to cool down.

Topping Up / Draining / Flushing The Engine/ Intercooler Coolant

If the engine coolant (antifreeze) is dirty, have cleaning and flushing carried out at an authorized dealer.

For the correct servicing intervals
⇨ page 213.

NOTE:

- ❑ For topping off, and proper coolant specifications ⇨ page 272.
- ❑ Do not use pure water, alcohol-based coolants, corrosion inhibitors or additional anti-rust products because they may be incompatible with the engine coolant and cause the clogging of the radiator. The use of propylene glycol-based coolant is also not recommended.

Engine Cooling/Intercooler System Cap

To prevent loss of engine coolant, make sure that the expansion tank cap is closed. If it is open, screw it completely until you reach/hear the click.

Periodically check the cap and clean it from any foreign bodies that may have deposited on the external surface.

**WARNING!**

- ❑ Never add coolant with the engine hot or overheated.
- ❑ Do not attempt to cool an overheated engine by loosening or removing the cap. The heat causes a considerable increase in pressure in the cooling system.
- ❑ To prevent damage to the engine, only use the engine cooling circuit caps provided.

Disposal of Used Coolant

Disposal of engine/intercooler coolant is subject to legal requirements. Contact the appropriate body to determine local regulations.

NOTE:

- ❑ To prevent the fluid from being ingested by children or animals, do not keep it in open containers or pour it on the ground. If ingested, contact a doctor immediately. Eliminate any traces of fluid from the ground immediately.

- ❑ When the vehicle stops after a short trip, steam may be seen coming out from the front of the hood. This is a normal phenomenon which is due to the presence of rain, snow or a lot of moisture on the surface of the radiator.
- ❑ With engine and system cold, do not top up with coolant beyond the maximum level indicated on the reservoir in the engine compartment.

BRAKING SYSTEM

In order to guarantee the efficiency of the braking system, periodically check its components; for this operation, contact an authorized dealer.

For the correct servicing intervals
⇨ page 213.

NOTE:

Driving with your foot resting on the brake pedal may compromise its efficiency, increasing the risk of accidents. When driving, never keep your foot on the brake pedal and don't put unnecessary strain on it to prevent the brakes from overheating. Excess pad wear may cause damage to the braking system.

- ❑ When an insufficient oil level is detected, contact an authorized dealer to have the system checked.
- ❑ Always keep the cap of the brake fluid reservoir (in the engine compartment) completely closed.



WARNING!

- Use only manufacturer's recommended brake fluid → page 272. Using the wrong type of brake fluid can severely damage your brake system and/or impair its performance. The proper type of brake fluid for your vehicle is also identified on the original factory installed hydraulic master cylinder reservoir.
- To avoid contamination from foreign matter or moisture, use only new brake fluid or fluid that has been in a tightly closed container. Keep the master cylinder reservoir cap secured at all times. Brake fluid in an open container absorbs moisture from the air resulting in a lower boiling point. This may cause it to boil unexpectedly during hard or prolonged braking, resulting in sudden brake failure. This could result in a collision.
- Overfilling the brake fluid reservoir can result in spilling brake fluid on hot engine parts, causing the brake fluid to catch fire. Brake fluid can also damage painted and vinyl surfaces, care should be taken to avoid its contact with these surfaces.
- Do not allow petroleum-based fluid to contaminate the brake fluid. Brake seal components could be damaged, causing partial or complete brake failure. This could result in a collision.

AUTOMATIC TRANSMISSION

Use only a transmission oil with the characteristics indicated → page 272.

Special Additives

Do not use any type of additive with the automatic transmission oil. The automatic transmission oil is a product designed specially for this vehicle and its performance may be compromised through the use of further additives.



CAUTION!

Do not use chemical flushes in your transmission as the chemicals can damage your transmission components. Such damage is not covered by the New Vehicle Limited Warranty.

Frequency of Oil Changes

In normal vehicle operating conditions, it is not necessary to change the transmission oil.



CAUTION!

If a transmission fluid leak occurs, visit an authorized dealer immediately. Severe transmission damage may occur. An authorized dealer has the proper tools to adjust the fluid level accurately.

REPLACING THE BATTERY

If necessary, replace the battery with another battery with the same specifications. It is advised to contact an authorized dealer for replacement.

NOTE:

Each time the 12 Volt battery is reconnected, cycle the steering wheel all the way to the left. Then cycle the steering wheel all the way to the right to allow the steering angle sensor to learn the steering angle thresholds.

Follow the battery manufacturer's instructions for maintenance.

NOTE:

It will not be possible to open the liftgate with a key or by pushing the button in the passenger compartment when the battery is disconnected. Always position the manual liftgate opening strap on the liftgate lock before disconnecting the battery. The procedure is described in the "Liftgate Emergency Opening" → page 63.



FUSES**General Information**

The fuses protect electrical systems against excessive current.

When a device does not work, you must check the electrical circuit inside of the fuse for a break/melt.

Also, please be aware that using power outlets for extended periods of time with the engine off may result in vehicle battery discharge.

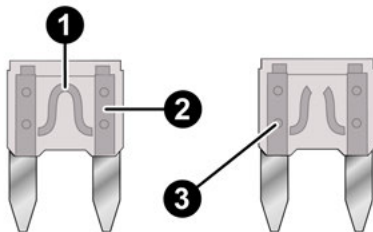
**Blade Fuses**

- 1 – Electrical Circuit
- 2 – Blade Fuse With Good Electrical Circuit
- 3 – Blade Fuse With Bad Electrical Circuit

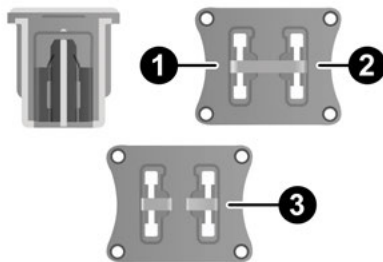
**J-CASE Fuse**

- 1 – Electrical Circuit
- 2 – Case Fuse With Good Electrical Circuit
- 3 – Case Fuse With Bad Electrical Circuit

Fuse Extracting Pliers

To replace a fuse, use the pliers hooked to the fuse box.

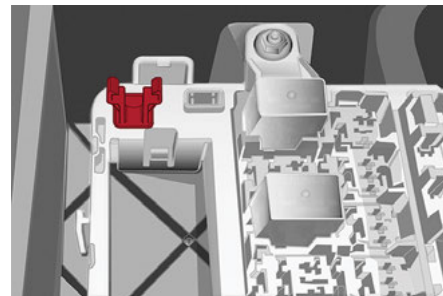
**Fuse Box**

Grab the pliers from the upper tabs, press them, and extract the pliers pulling upwards.

The pliers have two different ends, both of which are specifically designed to remove the different types of fuses present in the vehicle:

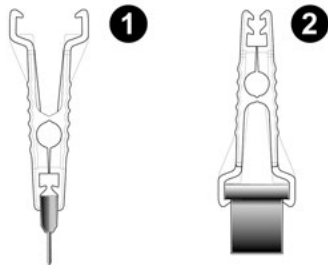

Fuse Extracting Pliers

- 1 – MINI fuse
- 2 – J-CASE fuse

After use, return the pliers to their proper position by following the below procedures:

- Grasp the pliers from the upper tabs and insert them into their housing.
- Push downward on the pliers into their housing until they click into place.



WARNING!

- When replacing a blown fuse, always use an appropriate replacement fuse with the same amp rating as the original fuse. Never replace a fuse with another fuse of higher amp rating. Never replace a blown fuse with metal wires or any other material. Do not place a fuse inside a circuit breaker cavity or vice versa. Failure to use proper fuses may result in serious personal injury, fire and/or property damage.
- Before replacing a fuse, make sure that the ignition is off and that all the other services are switched off and/or disengaged.
- If the replaced fuse blows again, contact an authorized dealer.
- If a general protection fuse for safety systems (air bag system, braking system), power unit systems (engine system, transmission system) or steering system blows, contact an authorized dealer.

Fuse Location

The fuses, which can be replaced by the user, are grouped in two boxes below the passenger side foot board and inside the luggage compartment.

Control Unit Under Passenger Side Footboard

To access the fuses, proceed as follows:

1. Lift the upper end of the footboard on the passenger side, pulling to release the two buttons.

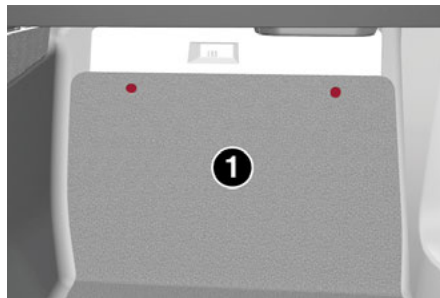

Release Buttons On Footboard

- 1 – Footboard



2. Unscrewing the two hooks, remove the panel pulling downward.

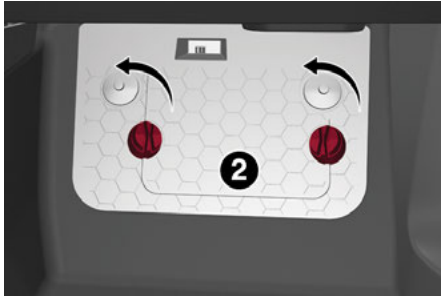

Release Hooks On Footboard

2 – Panel

The fuses are freely accessible on the control unit.

After replacing the fuse, make sure that panel and footboard are correctly locked.

Luggage Compartment Fuse Box

To access the fuses, proceed as follows:

1. Lift the luggage compartment cover.
2. Remove the control unit cover.

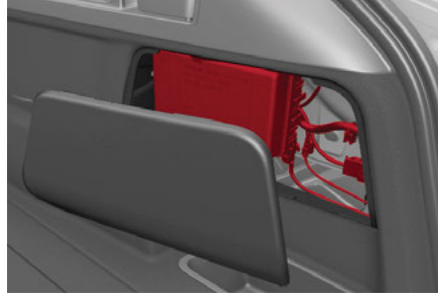

Control Unit

The fuses are freely accessible on the control unit.

The number identifying the electrical component corresponding to each fuse is shown on the cover.

After replacing a fuse, make sure that you have closed the cover correctly.

Control Unit Under Passenger Side Footboard

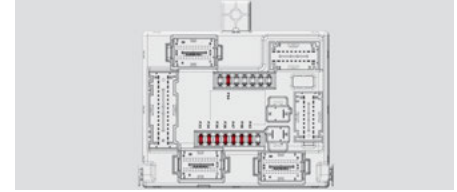

Passenger Side Control Unit

FUNCTION	FUSE	AMPERAGE
Front power window (driver's side)	F33	25
Front power window (passenger side)	F34	25
Supply for Information and Entertainment system, Climate Control system, alarm, power door mirror folding, EOBD system, USB port	F36	15
Safe Lock device (driver side door unlock - if equipped), doors unlock, central lock	F38	20
Windshield washer pump	F43	20
Rear left power window	F47	25
Rear right power window	F48	25
Heater rear window coil	F94	15



Luggage Compartment Fuse Box

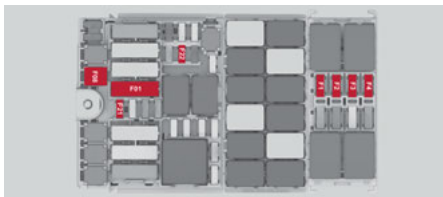

Luggage Compartment Control Unit

FUNCTION	FUSE	AMPERE
Receiver module (TTM/TTEBM)	F01	40
Hi-Fi system	F08	30
I-Drive / USB Socket / AUX / USB Charger	F21	10
KL15/a 12 Volts Power socket in the luggage compartment	F22	20
Trailer light control unit power supply (+30)	F1	20
Trailer light control unit power supply (+30)	F2	15
Trailer socket (only EMEA) (+30)	F3	10
Tow bar (+15)	F4	10

BULB REPLACEMENT

General Instructions







- Before replacing a bulb, check the contacts for oxidation.
- Replace blown bulbs with others of the same type and power.

- After replacing a headlight bulb, always check its alignment.
- When a light is not working, check that the corresponding fuse is intact before changing the bulb.

NOTE:

In some particular climate conditions, such as low temperature, humidity, or after washing the vehicle, a thin condensation layer may form on the internal surfaces of the front and rear headlights. This condensation will disappear after switching on the headlights.

Types Of Bulbs

The vehicle may be equipped with the following bulbs	
Glass Bulbs (Type A): They are press-fitted. Pull to extract.	A 
Bayonet-Type Bulbs (Type B): To remove them from their holder, press the bulb and turn it counterclockwise, then extract it.	B 
Tubular Bulbs (Type C): Release them from their contacts to remove.	C 
Halogen Bulbs (Type D): To remove the bulb, turn the connector to the side and pull it out.	D 
Halogen Bulbs (Type E): To remove the bulb, turn it counterclockwise.	E 
Xenon Gas Discharge Bulb (Type F): to remove the bulb, contact an authorized dealer.	F 



Replacement Bulbs

Light bulbs	Type	Power
Front direction indicators*	PY24W	24W
Rear Fog lights *	H11	55 W
Main beam headlights, front side lights/daylight running lights (DRL)*	H15	55/15W
Dipped beam headlights*	H7	55W
Main beam/dipped beam headlights (Xenon gas discharge)	D3S	35W
Sun visor light	1.5CP	2.1W
Glove compartment light	W5W	4W
Liftgate light	W5W	5W
Puddle lights (under door panel)	W5W	5W

*Only for basic version headlight with halogen main beam/dipped beam headlights

Replacing Exterior Bulbs

NOTE:

Only replace bulbs when the engine is off. Also ensure that the engine is cold, to prevent the risk of burns.

Front Light Cluster

Direction Indicators

Proceed with the directions below to change bulbs:

1. Operating inside the engine compartment, locate the protective cover.

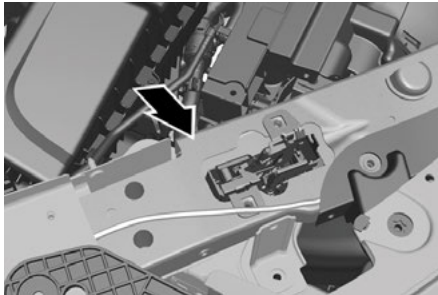

Protective Cover Location

2. Remove protective cover.

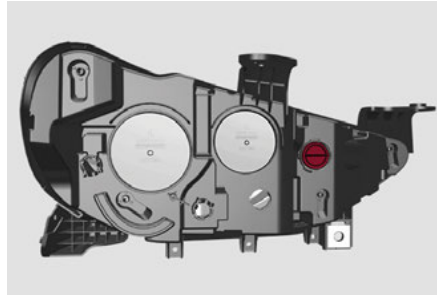

Protective Cover

3. Turn the bulb/connector assembly counterclockwise, and then slide it off the headlight body.

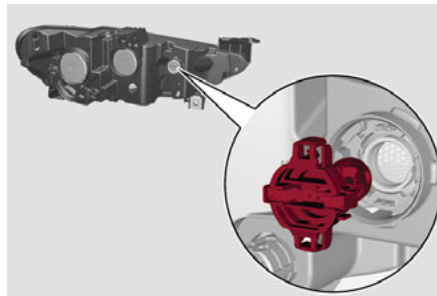

Bulb/Connector

4. Remove the bulb by sliding it off the bulb holder.
5. Install the new bulb, making sure it is correctly inserted in the bulb holder.
6. Insert the bulb/connector assembly in the housing on the headlight body and turn it clockwise, making sure that it is locked correctly.
7. Install the protective cover.

Front Light Cluster With Main Beam Xenon Gas Discharge Headlights

To replace the bulbs of the main beam headlights, contact an authorized dealer.



CAUTION!

Do not touch the new bulb with your fingers. Oil contamination will severely shorten bulb life. If the bulb comes in contact with any oily surface, clean the bulb with rubbing alcohol.



Replacing Interior Bulbs

Courtesy Mirror Light

To replace the bulbs, proceed as follows:

1. Lift the mirror cover and remove the lens, using a suitable tool.

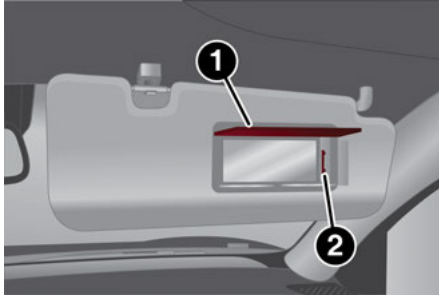

Sun Visor

- 1 – Mirror Cover
- 2 – Lens

2. Change the bulb, releasing it from the side contacts, then insert the new bulb, making sure that it is correctly fastened between the contacts.
3. Install the lens, inserting it first on one side and then pressing on the other side until it clicks into place.

Glove Compartment Light

To replace the bulb, proceed as follows:

1. Open the glove compartment.
2. Remove the courtesy light assembly, using a suitable tool.

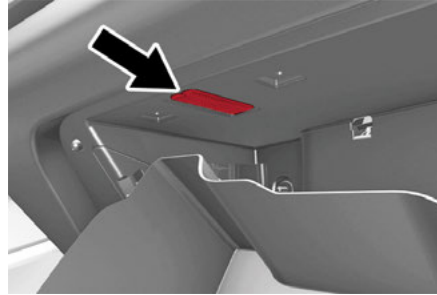

Courtesy Lamp Indent

3. Open protective cover and remove the bulb pulling out of the connector.

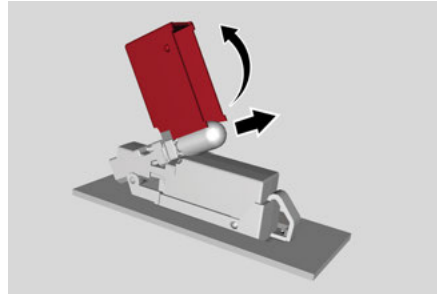

Cover And Bulb Removal Direction

4. Install bulb, making sure that it is correctly inserted fully.
5. Close the protective cover on the lens.
6. Install courtesy light, inserting it first on one side and then pressing on the other side until it clicks into place.

Luggage Compartment Courtesy Lights

To replace the bulbs, proceed as follows:

1. Open the liftgate, and remove the liftgate lamp assembly using a suitable tool.

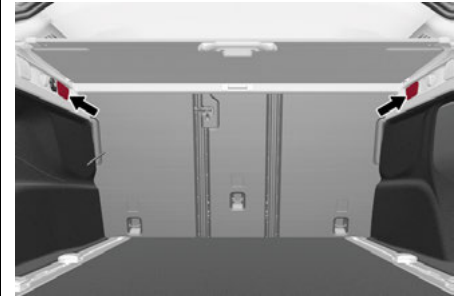

Ceiling Light Indent

2. Open protective cover and remove the bulb pulling out of the connector.

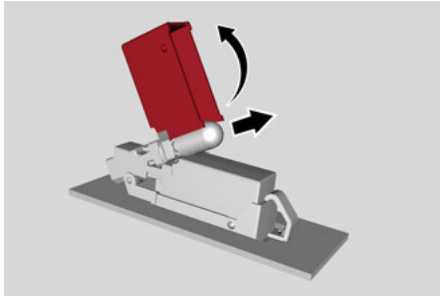

Cover And Bulb Removal Direction

3. Install bulb, making sure that it is correctly inserted fully.
4. Close the protective cover on the lens.
5. Install liftgate lamp in the correct position, inserting it first on one side, and then pressing on the other side until it clicks into place.

Puddle Lights On Door Panel

To replace the bulb, proceed as follows:

1. Open the door and remove the puddle light assembly, using a suitable tool.



Puddle Light Indent

2. Open protective cover and remove the bulb pulling out of the connector.

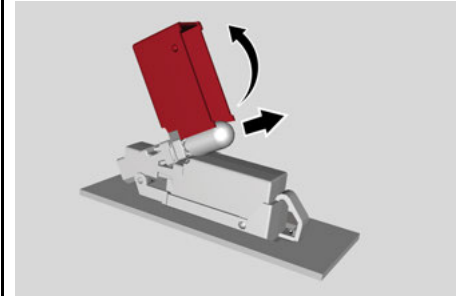

Cover And Bulb Removal Direction

3. Install bulb, making sure that it is correctly inserted fully.
4. Close the protective cover on the lens.
5. Install puddle light in the correct position, inserting it first on one side and then pressing on the other side until it clicks into place.



TIRES

TIRE SAFETY INFORMATION

Tire safety information will cover aspects of the following information: Tire Markings, Tire Identification Numbers, Tire Terminology and Definitions, Tire Pressures, and Tire Loading.

Tire Markings

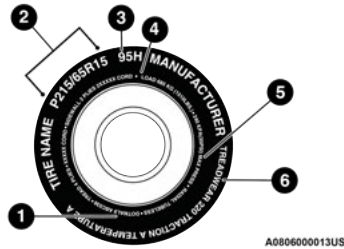

Tire Markings

- 1 – US DOT Safety Standards Code (TIN)
- 2 – Size Designation
- 3 – Service Description
- 4 – Maximum Load
- 5 – Maximum Pressure
- 6 – Treadwear, Traction and Temperature Grades

NOTE:

- P (Passenger) – Metric tire sizing is based on US design standards. P-Metric tires have the letter “P” molded into the sidewall preceding the size designation.
Example: P215/65R15 95H.
- European – Metric tire sizing is based on European design standards. Tires designed to this standard have the tire size molded into the sidewall beginning with the section width. The letter “P” is absent from this tire size designation.
Example: 215/65R15 96H.
- LT (Light Truck) – Metric tire sizing is based on US design standards. The size designation for LT-Metric tires is the same as for P-Metric tires except for the letters “LT” that are molded into the sidewall preceding the size designation.
Example: LT235/85R16.

- Temporary spare tires are designed for temporary emergency use only. Temporary high pressure compact spare tires have the letter “T” or “S” molded into the sidewall preceding the size designation.
Example: T145/80D18 103M.
- High flotation tire sizing is based on US design standards and it begins with the tire diameter molded into the sidewall.
Example: 31x10.5 R15 LT.

Tire Sizing Chart

EXAMPLE:

Example Size Designation: P215/65R15XL 95H, 215/65R15 96H, LT235/85R16C, T145/80D18 103M, 31x10.5 R15 LT

P = Passenger car tire size based on US design standards, or

"....blank...." = Passenger car tire based on European design standards, or

LT = Light truck tire based on US design standards, or

T or S = Temporary spare tire or

31 = Overall diameter in inches (in)

215, 235, 145 = Section width in millimeters (mm)

65, 85, 80 = Aspect ratio in percent (%)

Ratio of section height to section width of tire, or

10.5 = Section width in inches (in)

R = Construction code

"R" means radial construction, or

"D" means diagonal or bias construction

15, 16, 18 = Rim diameter in inches (in)



EXAMPLE:**Service Description:****95** = Load Index
 A numerical code associated with the maximum load a tire can carry
H = Speed Symbol
 A symbol indicating the range of speeds at which a tire can carry a load corresponding to its load index under certain operating conditions

 The maximum speed corresponding to the speed symbol should only be achieved under specified operating conditions (i.e., tire pressure, vehicle loading, road conditions, and posted speed limits)
Load Identification:

Absence of the following load identification symbols on the sidewall of the tire indicates a Standard Load (SL) tire:

 XL = Extra load (or reinforced) tire, or

 LL = Light load tire or

 C, D, E, F, G = Load range associated with the maximum load a tire can carry at a specified pressure
Maximum Load – Maximum load indicates the maximum load this tire is designed to carry**Maximum Pressure** – Maximum pressure indicates the maximum permissible cold tire inflation pressure for this tire

Tire Identification Number (TIN)

The TIN may be found on one or both sides of the tire; however, the date code may only be on one side. Tires with white sidewalls will have the full TIN, including the date code, located on the white sidewall side of the tire. Look for the TIN on the outboard side of black sidewall tires as mounted on the vehicle. If the TIN is not found on the outboard side, then you will find it on the inboard side of the tire.

EXAMPLE:
DOT MA L9 ABCD 0301
DOT = Department of Transportation <input type="checkbox"/> This symbol certifies that the tire is in compliance with the US Department of Transportation tire safety standards and is approved for highway use
MA = Code representing the tire manufacturing location (two digits)
L9 = Code representing the tire size (two digits)
ABCD = Code used by the tire manufacturer (one to four digits)
03 = Number representing the week in which the tire was manufactured (two digits) <input type="checkbox"/> 03 means the 3rd week
01 = Number representing the year in which the tire was manufactured (two digits) <input type="checkbox"/> 01 means the year 2001 <input type="checkbox"/> Prior to July 2000, tire manufacturers were only required to have one number to represent the year in which the tire was manufactured. Example: 031 could represent the 3rd week of 1981 or 1991



Tire Terminology And Definitions

Term	Definition
B-pillar	The vehicle B-pillar is the structural member of the body located behind the front door.
Cold Tire Inflation Pressure	Cold tire inflation pressure is defined as the tire pressure after the vehicle has not been driven for at least three hours, or driven less than 1 mile (1.6 km) after sitting for a minimum of three hours. Inflation pressure is measured in units of PSI (pounds per square inch) or kPa (kilopascals).
Maximum Inflation Pressure	The maximum inflation pressure is the maximum permissible cold tire inflation pressure for this tire. The maximum inflation pressure is molded into the sidewall.
Recommended Cold Tire Inflation Pressure	Vehicle manufacturer's recommended cold tire inflation pressure as shown on the tire placard.
Tire Placard	A label permanently attached to the vehicle describing the vehicle's loading capacity, the original equipment tire sizes and the recommended cold tire inflation pressures.

Tire Loading And Tire Pressure

NOTE:

The proper cold tire inflation pressure is listed on the driver's side B-pillar or the rear edge of the driver's side door.

Check the inflation pressure of each tire, including the spare tire (if equipped), at least monthly and inflate to the recommended pressure for your vehicle.

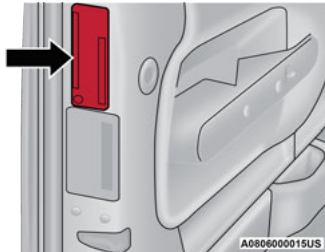

Example Tire Placard Location (Door)

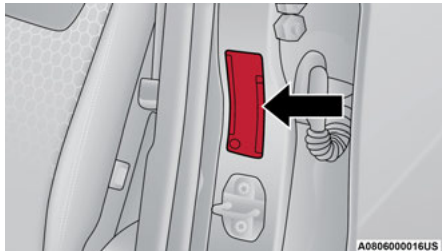

Example Tire Placard Location (B-pillar)

Tire And Loading Information Placard



Tire And Loading Information Placard

This placard tells you important information about the:

1. Number of people that can be carried in the vehicle.
2. Total weight your vehicle can carry.
3. Tire size designed for your vehicle.
4. Cold tire inflation pressures for the front, rear, and spare tires.

Loading

The vehicle maximum load on the tire must not exceed the load carrying capacity of the tire on your vehicle. You will not exceed the tire's load carrying capacity if you adhere to the loading conditions, tire size, and cold tire inflation pressures specified on the Tire and Loading Information placard → page 139.

NOTE:

Under a maximum loaded vehicle condition, gross axle weight ratings (GAWRs) for the front and rear axles must not be exceeded. For further information on GAWRs, vehicle loading, and trailer towing → page 139.

To determine the maximum loading conditions of your vehicle, locate the statement "The combined weight of occupants and cargo should never exceed XXX kg or XXX lbs" on the Tire and Loading Information placard. The combined weight of occupants, cargo/luggage and trailer tongue weight (if applicable) should never exceed the weight referenced here.



Steps For Determining Correct Load Limit—

(1) Locate the statement “The combined weight of occupants and cargo should never exceed XXX kg or XXX lbs.” on your vehicle’s placard.

(2) Determine the combined weight of the driver and passengers that will be riding in your vehicle.

(3) Subtract the combined weight of the driver and passengers from XXX kg or XXX lbs.

(4) The resulting figure equals the available amount of cargo and luggage load capacity. For example, if “XXX” amount equals 1400 lbs. and there will be five 150 lb passengers in your vehicle, the amount of available cargo and luggage load capacity is 650 lbs. (1400-750 (5x150) = 650 lbs.).

(5) Determine the combined weight of luggage and cargo being loaded on the vehicle. That weight may not safely exceed the available cargo and luggage load capacity calculated in Step 4.

(6) If your vehicle will be towing a trailer, load from your trailer will be transferred to your vehicle. Consult this manual to determine how this reduces the available cargo and luggage load capacity of your vehicle.

Metric Example For Load Limit

For example, if “XXX” amount equals 635 kg and there will be five 68 kg passengers in your vehicle, the amount of available cargo and luggage load capacity is 295 kg (635-340 (5x68) = 295 kg) as shown in step 4.

NOTE:

- If your vehicle will be towing a trailer, load from your trailer will be transferred to your vehicle. The following table shows examples on how to calculate total load, cargo/luggage, and towing capacities of your vehicle with varying seating configurations and number and size of occupants. This table is for illustration purposes only and may not be accurate for the seating and load carry capacity of your vehicle.
- For the following example, the combined weight of occupants and cargo should never exceed 865 lbs (392 kg).

Occupants			Combined weight of occupants and cargo from Tire Placard	MINUS	Combined Occupant's weight	=	AVAILABLE Cargo/Luggage and Trailer Tongue Weight
TOTAL	FRONT	REAR					
EXAMPLE 1			↓ 865 lbs	minus	Occupant 1: 200 lbs Occupant 2: 130 lbs Occupant 3: 160 lbs Occupant 4: 100 lbs Occupant 5: 80 lbs TOTAL WEIGHT: 670 lbs	=	↓ 195 lbs
5	2	3					
EXAMPLE 2			↓ 865 lbs	minus	Occupant 1: 210 lbs Occupant 2: 180 lbs Occupant 3: 150 lbs TOTAL WEIGHT: 540 lbs	=	325 lbs
3	2	1					
EXAMPLE 3			↓ 865 lbs	minus	Occupant 1: 200 lbs Occupant 2: 200 lbs TOTAL WEIGHT: 400 lbs	=	465 lbs
2	2	0					

EXAMPLE

811a4d11

⚠ WARNING!

Overloading of your tires is dangerous. Overloading can cause tire failure, affect vehicle handling, and increase your stopping distance. Use tires of the recommended load capacity for your vehicle. Never overload them.



TIRES — GENERAL INFORMATION**Tire Pressure**

Proper tire inflation pressure is essential to the safe and satisfactory operation of your vehicle. Four primary areas are affected by improper tire pressure:

- Safety
- Fuel Economy
- Tread Wear
- Ride Comfort and Vehicle Stability

Safety**WARNING!**

- Improperly inflated tires are dangerous and can cause collisions.
- Underinflation increases tire flexing and can result in overheating and tire failure.
- Overinflation reduces a tire's ability to cushion shock. Objects on the road and chuckholes can cause damage that result in tire failure.
- Overinflated or underinflated tires can affect vehicle handling and can fail suddenly, resulting in loss of vehicle control.

(Continued)

**WARNING! (Continued)**

- Unequal tire pressures can cause steering problems. You could lose control of your vehicle.
- Unequal tire pressures from one side of the vehicle to the other can cause the vehicle to drift to the right or left.
- Always drive with each tire inflated to the recommended cold tire inflation pressure.

Both underinflation and overinflation affect the stability of the vehicle and can produce a feeling of sluggish response or over responsiveness in the steering.

NOTE:

- Unequal tire pressures from side to side may cause erratic and unpredictable steering response.
- Unequal tire pressure from side to side may cause the vehicle to drift left or right.

Fuel Economy

Underinflated tires will increase tire rolling resistance resulting in higher fuel consumption.

Tread Wear

Improper cold tire inflation pressures can cause abnormal wear patterns and reduced tread life, resulting in the need for earlier tire replacement.

Ride Comfort And Vehicle Stability

Proper tire inflation contributes to a comfortable ride. Overinflation produces a jarring and uncomfortable ride.

Tire Inflation Pressures

The proper cold tire inflation pressure is listed on the driver's side B-pillar or rear edge of the driver's side door.

At least once a month:

- Check and adjust tire pressure with a good quality pocket-type pressure gauge. Do not make a visual judgement when determining proper inflation. Tires may look properly inflated even when they are underinflated.
- Inspect tires for signs of tire wear or visible damage.

**CAUTION!**

After inspecting or adjusting the tire pressure, always reinstall the valve stem cap. This will prevent moisture and dirt from entering the valve stem, which could damage the valve stem.

Inflation pressures specified on the placard are always “cold tire inflation pressure”. Cold tire inflation pressure is defined as the tire pressure after the vehicle has not been driven for at least three hours, or driven less than 1 mile (1.6 km) after sitting for a minimum of three hours. The cold tire inflation pressure must not exceed the maximum inflation pressure molded into the tire sidewall.

Check tire pressures more often if subject to a wide range of outdoor temperatures, as tire pressures vary with temperature changes.

Tire pressures change by approximately 1 psi (7 kPa) per 12°F (7°C) of air temperature change. Keep this in mind when checking tire pressure inside a garage, especially in the Winter.

Example: If garage temperature = 68°F (20°C) and the outside temperature = 32°F (0°C) then the cold tire inflation pressure should be increased by 3 psi (21 kPa), which equals 1 psi (7 kPa) for every 12°F (7°C) for this outside temperature condition.

Tire pressure may increase from 2 to 6 psi (13 to 40 kPa) during operation. DO NOT reduce this normal pressure build up or your tire pressure will be too low.

Tire Pressures For High Speed Operation

The manufacturer advocates driving at safe speeds and within posted speed limits. Where speed limits or conditions are such that the vehicle can be driven at high speeds, maintaining correct tire inflation pressure is very important. Increased tire pressure and reduced vehicle loading may be required for high-speed vehicle operation. Refer to an authorized tire dealer or original equipment vehicle dealer for recommended safe operating speeds, loading and cold tire inflation pressures.



WARNING!

High speed driving with your vehicle under maximum load is dangerous. The added strain on your tires could cause them to fail. You could have a serious collision. Do not drive a vehicle loaded to the maximum capacity at continuous speeds above 75 mph (120 km/h).

Recommended Cold Tire Inflation Pressures

For vehicle speeds below 100 mph (160 km/h), recommended cold tire inflation pressures are listed on the Tire And Loading Information Placard located on driver's side B-pillar or the rear edge of the driver's side door.

When driving at speeds 100 mph (160 km/h) and above, increased tire pressures and reduced vehicle loading are required for high-speed vehicle operation.

For driving speeds above 100 mph (160 km/h) recommended cold tire inflation pressures are listed below under "High Speed Tire Inflation Pressure". Vehicle loading condition must not exceed 688 lbs. (312 kg) (driver + three passengers + 88 lbs. (40kg) luggage).



WARNING!

High speed driving with your vehicle under maximum load is dangerous. The added strain on your tires could cause them to fail. You could have a serious collision.



2.0L Engine

Tires	Wheel	Recommended Cold Tire Inflation Pressure		High Speed Tire Inflation Pressure	
		Front	Rear	Front	Rear
235/60 R18 103V	18x8J	30 psi / 210 kPa	33 psi / 230 kPa	33 psi / 230 kPa	38 psi / 260 kPa
235/55 R19 101V & 105V	19x8J	30 psi / 210 kPa	33 psi / 230 kPa	33 psi / 230 kPa	38 psi / 260 kPa
255/45 R20 101H	20x8.5J	33 psi / 230 kPa	36 psi / 250 kPa	35 psi / 240 kPa	39 psi / 270 kPa
255/40 R21 102W XL	21x8.5J	33 psi / 230 kPa	36 psi / 250 kPa	33 psi / 230 kPa	39 psi / 270 kPa
195/75 R18 106P (Compact Spare Tire)	-	43 psi / 300 kPa			

NOTE:

Using tires of a different size, type, brand or design on the front and rear may adversely affect vehicle drive-ability. We recommend using only tires approved by the manufacturer. The manufacturer cannot determine if unapproved tires are suitable for use and therefore cannot guarantee vehicle safety in those conditions.

2.9L Engine

Tires	Wheel	Recommended Cold Tire Inflation Pressure		High Speed Tire Inflation Pressure	
		Front	Rear	Front	Rear
255/45R20 101Y (Original Equipment)	20x9J	36 psi / 250 kPa	-	39 psi / 270 kPa	-
255/40 R21 102Y XL (Original Equipment)	21x9J	39 psi / 270 kPa	-	39 psi / 270 kPa	-
285/40R20 104Y (Original Equipment)	20x10J	-	39 psi / 270 kPa	-	42 psi / 290 kPa
285/35 R21 105Y XL (Original Equipment)	21x10J	-	42 psi / 290 kPa	-	42 psi / 290 kPa

Tires	Wheel	Recommended Cold Tire Inflation Pressure		High Speed Tire Inflation Pressure	
		Front	Rear	Front	Rear
255/45R20 M+S (Snow Tires)	20x9J	36 psi / 250 kpa	-	39 psi / 270 kpa	-
255/40 R21 M+S (Snow Tires)	21x9J	39 psi / 270 kpa	-	39 psi / 270 kpa	-
255/45R20 M+S (Snow Tires)	20x9J	-	39 psi / 270 kpa	-	42 psi / 290 kpa
285/35 R21 M+S (Snow Tires)	21x9J	-	42 psi / 290 kpa	-	42 psi / 290 kpa

Radial Ply Tires



WARNING!

Combining radial ply tires with other types of tires on your vehicle will cause your vehicle to handle poorly. The instability could cause a collision. Always use radial ply tires in sets of four. Never combine them with other types of tires.

Tire Repair

If your tire becomes damaged, it may be repaired if it meets the following criteria:

- The tire has not been driven on when flat.
- The damage is only on the tread section of your tire (sidewall damage is not repairable).
- The puncture is no greater than a ¼ of an inch (6 mm).

Consult an authorized tire dealer for tire repairs and additional information.

Damaged Run Flat tires, or Run Flat tires that have experienced a loss of pressure should be replaced immediately with another Run Flat tire of identical size and service description (Load Index and Speed Symbol). Replace the tire pressure sensor as well as it is not designed to be reused.

Run Flat Tires — If Equipped

Run Flat tires allow you the capability to drive 50 miles (80 km) at 50 mph (80 km/h) after a rapid loss of inflation pressure. This rapid loss of inflation is referred to as the Run Flat mode. A Run Flat mode occurs when the tire inflation pressure is of/or below 14 psi (96 kPa). Once a Run Flat tire reaches the run flat mode it has limited driving capabilities and needs to be replaced immediately. A Run Flat tire is not

repairable. When a run flat tire is changed after driving with underinflated tire condition, please replace the TPM sensor as it is not designed to be reused when driven under run flat mode 14 psi (96 kPa) condition.

NOTE:

TPM Sensor must be replaced after driving the vehicle on a flat tire condition.

It is not recommended driving a vehicle loaded at full capacity or to tow a trailer while a tire is in the run flat mode.

For more information ⇨ page 165.

Tire Spinning

When stuck in mud, sand, snow, or ice conditions, do not spin your vehicle's wheels above 30 mph (48 km/h) or for longer than 30 seconds continuously without stopping.



**WARNING!**

Fast spinning tires can be dangerous. Forces generated by excessive wheel speeds may cause tire damage or failure. A tire could explode and injure someone. Do not spin your vehicle's wheels faster than 30 mph (48 km/h) for more than 30 seconds continuously when you are stuck, and do not let anyone near a spinning wheel, no matter what the speed.

Tread Wear Indicators

Tread wear indicators are in the original equipment tires to help you in determining when your tires should be replaced.

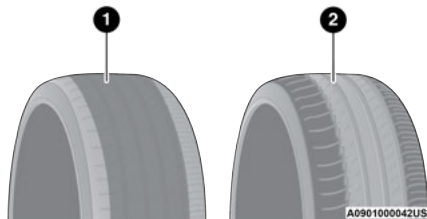
**Tire Tread**

- 1 – Worn Tire
- 2 – New Tire

These indicators are molded into the bottom of the tread grooves. They will appear as bands when the tread depth becomes a 1/16

of an inch (1.6 mm). When the tread is worn to the tread wear indicators, the tire should be replaced.

Life Of Tire

The service life of a tire is dependent upon varying factors including, but not limited to:

- Driving style.
- Tire pressure - Improper cold tire inflation pressures can cause uneven wear patterns to develop across the tire tread. These abnormal wear patterns will reduce tread life, resulting in the need for earlier tire replacement.
- Distance driven.
- Performance tires, tires with a speed rating of V or higher, and Summer tires typically have a reduced tread life. Rotation of these tires per the vehicle scheduled maintenance is highly recommended.

**WARNING!**

Tires and the spare tire should be replaced after six years, regardless of the remaining tread. Failure to follow this warning can result in sudden tire failure. You could lose control and have a collision resulting in serious injury or death.

NOTE:

Wheel valve stem must be replaced as well when installing new tires due to wear and tear in existing tires.

Keep dismantled tires in a cool, dry place with as little exposure to light as possible. Protect tires from contact with oil, grease, and gasoline.

Replacement Tires

The tires on your new vehicle provide a balance of many characteristics. They should be inspected regularly for wear and correct cold tire inflation pressures. The manufacturer strongly recommends that you use tires equivalent to the originals in size, quality and performance when replacement is needed ⇨ page 252. Refer to the Tire and Loading Information placard or the Vehicle Certification Label for the size designation of your tire. The Load Index and Speed Symbol for your tire will be found on the original equipment tire sidewall.

See the Tire Sizing Chart example for more information relating to the Load Index and Speed Symbol of a tire ⇨ page 240.

It is recommended to replace the two front tires or two rear tires as a pair. Replacing just one tire can seriously affect your vehicle's handling. If you ever replace a wheel, make sure that the wheel's specifications match those of the original wheels.

It is recommended you contact an authorized tire dealer or original equipment dealer with any questions you may have on tire specifications or capability. Failure to use equivalent replacement tires may adversely affect the safety, handling, and ride of your vehicle.



WARNING!

- ❑ Do not use a tire, wheel size, load rating, or speed rating other than that specified for your vehicle. Some combinations of unapproved tires and wheels may change suspension dimensions and performance characteristics, resulting in changes to steering, handling, and braking of your vehicle. This can cause unpredictable handling and stress to steering and suspension components. You could lose control and have a collision resulting in serious injury or death. Use only the tire and wheel sizes with load ratings approved for your vehicle.
- ❑ Never use a tire with a smaller load index or capacity, other than what was originally equipped on your vehicle. Using a tire with a smaller load index could result in tire overloading and failure. You could lose control and have a collision.
- ❑ Failure to equip your vehicle with tires having adequate speed capability can result in sudden tire failure and loss of vehicle control.



CAUTION!

Replacing original tires with tires of a different size may result in false speedometer and odometer readings.

SPARE TIRES — If Equipped

NOTE:

For vehicles equipped with Tire Service Kit instead of a spare tire → page 202.



CAUTION!

Because of the reduced ground clearance, do not take your vehicle through an automatic car wash with a compact or limited use temporary spare installed. Damage to the vehicle may result.

Spare Tire Matching Original Equipped Tire And Wheel — If Equipped

Your vehicle may be equipped with a spare tire and wheel equivalent in look and function to the original equipment tire and wheel found on the front or rear axle of your vehicle. This spare tire may be used in the tire rotation for your vehicle. If your vehicle has this option, refer to an authorized tire dealer for the recommended tire rotation pattern.

Compact Spare Tire — If Equipped

The compact spare is for temporary emergency use only. You can identify if your vehicle is equipped with a compact spare by looking at the spare tire description on the Tire and Loading Information Placard located on the driver's side door opening or on the sidewall of the tire. Compact spare tire descriptions begin with the letter "T" or

"S" preceding the size designation. Example: T145/80D18 103M.

T, S = Temporary Spare Tire

Since this tire has limited tread life, the original equipment tire should be repaired (or replaced) and reinstalled on your vehicle at the first opportunity.

Do not install a wheel cover or attempt to mount a conventional tire on the compact spare wheel, since the wheel is designed specifically for the compact spare tire. Do not install more than one compact spare tire and wheel on the vehicle at any given time.



WARNING!

Compact and collapsible spares are for temporary emergency use only. With these spares, do not drive more than 50 mph (80 km/h). Temporary use spares have limited tread life. When the tread is worn to the tread wear indicators, the temporary use spare tire needs to be replaced. Be sure to follow the warnings, which apply to your spare. Failure to do so could result in spare tire failure and loss of vehicle control.

Full Size Spare — If Equipped

The full size spare is for temporary emergency use only. This tire may look like the originally equipped tire on the front or rear axle of your vehicle, but it is not. This spare tire may have limited tread life. When the tread is worn to the tread wear indicators, the temporary use full



size spare tire needs to be replaced. Since it is not the same as your original equipment tire, replace (or repair) the original equipment tire and reinstall on the vehicle at the first opportunity.

Limited Use Spare — If Equipped

The limited use spare tire is for temporary emergency use only. This tire is identified by a label located on the limited use spare wheel. This label contains the driving limitations for this spare. This tire may look like the original equipped tire on the front or rear axle of your vehicle, but it is not. Installation of this limited use spare tire affects vehicle handling. Since it is not the same as your original equipment tire, replace (or repair) the original equipment tire and reinstall on the vehicle at the first opportunity.



WARNING!

Limited use spares are for emergency use only. Installation of this limited use spare tire affects vehicle handling. With this tire, do not drive more than the speed listed on the limited use spare wheel. Keep inflated to the cold tire inflation pressures listed on your Tire and Loading Information Placard located on the driver's side B-pillar or the rear edge of the driver's side door. Replace (or repair) the original equipment tire at the first opportunity and reinstall it on your vehicle. Failure to do so could result in loss of vehicle control.

WHEEL AND WHEEL TRIM CARE

All wheels and wheel trim, especially aluminum and chrome plated wheels, should be cleaned regularly using mild (neutral Ph) soap and water to maintain their luster and to prevent corrosion. Wash wheels with the same soap solution recommended for the body of the vehicle and remember to always wash when the surfaces are not hot to the touch.

Your wheels are susceptible to deterioration caused by salt, sodium chloride, magnesium chloride, calcium chloride, etc., and other road chemicals used to melt ice or control dust on dirt roads. Use a soft cloth or sponge and mild soap to wipe away promptly. Do not use harsh chemicals or a stiff brush. They can damage the wheel's protective coating that helps keep them from corroding and tarnishing.



CAUTION!

Avoid products or automatic car washes that use acidic solutions or strong alkaline additives or harsh brushes. Many aftermarket wheel cleaners and automatic car washes may damage the wheel's protective finish. Such damage is not covered by the New Vehicle Limited Warranty. Only car wash soap is recommended.

When cleaning extremely dirty wheels including excessive brake dust, care must be taken in the selection of tire and wheel cleaning chemicals and equipment to prevent damage to the wheels. Select a non-abrasive, non-acidic cleaner for aluminum or chrome wheels.



CAUTION!

Do not use scouring pads, steel wool, a bristle brush, metal polishes or oven cleaner. These products may damage the wheel's protective finish. Such damage is not covered by the New Vehicle Limited Warranty. Only car wash soap is recommended.

NOTE:

If you intend parking or storing your vehicle for an extended period after cleaning the wheels with wheel cleaner, drive your vehicle and apply the brakes to remove the water droplets from the brake components. This activity will remove the red rust on the brake rotors and prevent vehicle vibration when braking.

Dark Or Low Gloss Wheels



CAUTION!

If your vehicle is equipped with these specialty wheels, **DO NOT USE** wheel cleaners, abrasives, or polishing compounds. They will permanently damage this finish and such damage is not covered by the New Vehicle Limited Warranty. **HAND WASH ONLY USING MILD SOAP AND WATER WITH A SOFT CLOTH.** Used on a regular basis; this is all that is required to maintain this finish.

TIRE TYPES

All Season Tires — If Equipped

All Season tires provide traction for all seasons (Spring, Summer, Autumn, and Winter). Traction levels may vary between different all season tires. All season tires can be identified by the M+S, M&S, M/S or MS designation on the tire sidewall. Use all season tires only in sets of four; failure to do so may adversely affect the safety and handling of your vehicle.

Summer Or Three Season Tires — If Equipped

Summer tires provide traction in both wet and dry conditions, and are not intended to be driven in snow or on ice. If your vehicle is equipped with Summer tires, be aware these tires are not designed for Winter or cold driving conditions. Install Winter tires on your vehicle

when ambient temperatures are less than 40°F (5°C) or if roads are covered with ice or snow. For more information, contact an authorized dealer.

Summer tires do not contain the all season designation or mountain/snowflake symbol on the tire sidewall. Use Summer tires only in sets of four; failure to do so may adversely affect the safety and handling of your vehicle.



WARNING!

Do not use Summer tires in snow/ice conditions. You could lose vehicle control, resulting in severe injury or death. Driving too fast for conditions also creates the possibility of loss of vehicle control.

Snow Tires

Some areas of the country require the use of snow tires during the Winter. Snow tires can be identified by a “mountain/snowflake” symbol on the tire sidewall.



If you need snow tires, select tires equivalent in size and type to the original equipment tires. Use snow tires only in sets of four; failure to do so may adversely affect the safety and handling of your vehicle.

Snow tires generally have lower speed ratings than what was originally equipped with your vehicle and should not be operated at sustained speeds over 75 mph (120 km/h). For speeds above 75 mph (120 km/h) refer to

original equipment or an authorized tire dealer for recommended safe operating speeds, loading and cold tire inflation pressures.

While studded tires improve performance on ice, skid and traction capability on wet or dry surfaces may be poorer than that of non-studded tires. Some states prohibit studded tires; therefore, local laws should be checked before using these tire types.

TIRE CHAINS AND TRACTION DEVICES

It is possible to fit 13 mm chains on all the tires except for R20.

Use of traction devices require sufficient tire-to-body clearance. Follow these recommendations to guard against damage.

NOTE:

- Traction device must be of proper size for the tire, as recommended by the traction device manufacturer.
- Use on rear tires only.
- Check the tension of the snow chains after the first few meters have been driven.
- Using snow chains with tires with non-original dimensions may damage the vehicle.
- Using different tires sizes or types (M+S, snow, etc.) between the front and rear axles may adversely affect vehicle driveability, with the risk of losing control of the vehicle and resulting accidents.



**CAUTION!**

To avoid damage to your vehicle or tires, observe the following precautions:

- Because of restricted traction device clearance between tires and other suspension components, it is important that only traction devices in good condition are used. Broken devices can cause serious damage. Stop the vehicle immediately if noise occurs that could indicate device breakage. Remove the damaged parts of the device before further use.
- Install device as tightly as possible and then retighten after driving about ½ mile (0.8 km).
- Do not exceed 30 mph (48 km/h).
- Drive cautiously and avoid severe turns and large bumps, especially with a loaded vehicle.
- Do not drive for a prolonged period on dry pavement.
- Observe the traction device manufacturer's instructions on the method of installation, operating speed, and conditions for use. Always use the suggested operating speed of the device manufacturer's if it is less than 30 mph (48 km/h).
- Do not use traction devices on a compact spare tire.

TIRE ROTATION RECOMMENDATIONS

Tires on the front and rear axles of vehicles operate at different loads and perform different steering, driving, and braking functions. For these reasons, they wear at unequal rates. These effects can be reduced by timely rotation of tires. Rotation will increase tread life, maintain traction levels and contribute to a smooth, quiet ride.

To resolve this problem, tires should be rotated at each service interval (approximately every 10,000 miles [16,000 km]). More frequent rotation is permissible if desired. The reasons for any rapid or unusual wear should be corrected prior to rotation being performed.

Tire Rotations Not Recommended – If Equipped

Due to different size tires and wheels on front and rear axles tire rotation is not possible for:
2.0T GME Engine equipped with a different front and rear tire size.

**CAUTION!**

Damage to the vehicle may occur if different front and rear tire sizes are rotated

Tire rotation contributes to the preservation of the grip and traction performance on wet,

muddy or snowy roads, guaranteeing optimal driveability of the vehicle.

In the case of irregular wear of the tires identify the cause and correct it as soon as possible, by contacting an authorized dealer.

The rotational direction of the tire must be taken into consideration when rotating the tires. The recommended rotation pattern for directional tires is shown below.

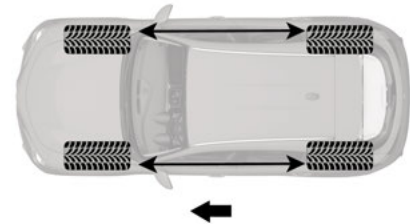
**Tire Rotation**

It is recommended to avoid situations with a large difference in wear between the front and rear tires and to strictly use Winter tires of the sizes given on the tire placard.

The AWD system and the original tires are developed together to ensure the vehicle's best performance. When changing the tires, it is recommended to use the same "AR" marked tires, to maintain the same level of performance and component life.

DEPARTMENT OF TRANSPORTATION UNIFORM TIRE QUALITY GRADES

The following tire grading categories were established by the National Highway Traffic Safety Administration. The specific grade rating assigned by the tire's manufacturer in each category is shown on the sidewall of the tires on your vehicle.

All passenger vehicle tires must conform to Federal safety requirements in addition to these grades.

TREADWEAR

The Treadwear grade is a comparative rating, based on the wear rate of the tire when tested under controlled conditions on a specified government test course. For example, a tire graded 150 would wear one and one-half times as well on the government course as a tire graded 100. The relative performance of tires depends upon the actual conditions of their use, however, and may depart significantly from the norm due to variations in driving habits,

service practices, and differences in road characteristics and climate.

TRACTION GRADES

The Traction grades, from highest to lowest, are AA, A, B, and C. These grades represent the tire's ability to stop on wet pavement, as measured under controlled conditions on specified government test surfaces of asphalt and concrete. A tire marked C may have poor traction performance.



WARNING!

The traction grade assigned to this tire is based on straight-ahead braking traction tests, and does not include acceleration, cornering, hydroplaning, or peak traction characteristics.

TEMPERATURE GRADES

The temperature grades are A (the highest), B, and C, representing the tire's resistance to the generation of heat and its ability to dissipate heat, when tested under controlled conditions on a specified indoor laboratory test wheel. Sustained high temperature can cause the material of the tire to degenerate and reduce tire

life, and excessive temperature can lead to sudden tire failure. The grade C corresponds to a level of performance, which all passenger vehicle tires must meet under the Federal Motor Vehicle Safety Standard No. 109. Grades B and A represent higher levels of performance on the laboratory test wheel, than the minimum required by law.



WARNING!

The temperature grade for this tire is established for a tire that is properly inflated and not overloaded. Excessive speed, underinflation, or excessive loading, either separately or in combination, can cause heat buildup and possible tire failure.

STORING THE VEHICLE

If the vehicle is left inactive for longer than a month, the following precautions should be observed:

- Park the vehicle in an area that is covered and dry, and well-ventilated if possible. Slightly open the windows.
- Check that the Electric Park Brake (EPB) is not activated.
- Carry out the "Liftgate Emergency Opening" procedure ↪ page 63.



- ❑ Disconnect the negative battery terminal and check the battery charge. Repeat this check once every three months during storage.
- ❑ If the battery is not disconnected from the electrical system, check its state of charge every 30 days.
- ❑ Clean and protect the painted parts using protective wax.
- ❑ Clean and protect the shiny metal parts using special compounds available commercially.
- ❑ Sprinkle talcum powder on the windshield wiper rubber blades, and lift them off the glass.
- ❑ Cover the vehicle with a fabric or perforated plastic sheet, paying particular care not to damage the painted surface by dragging any dust that may have accumulated on it. Do not use compact plastic sheets, as they do not allow humidity to evaporate from the surface of the vehicle.
- ❑ Inflate tires to +7.25 psi (+0.5 bar) above the standard prescribed pressure and check it periodically.
- ❑ Do not drain the engine cooling system.
- ❑ Any time the vehicle is left inactive for two weeks or more, operate the air conditioning system with engine idling for at least five minutes, setting external air and with fan set to maximum speed. This operation will ensure appropriate lubrication for the

system, thus minimizing the possibility of damage to the compressor when the system is operated again.

NOTE:

After cycling the ignition to STOP and having closed the driver side door, wait at least one minute before disconnecting the electrical supply from the battery. When reconnecting the electrical supply to the battery, make sure that the ignition is in the STOP position and the driver's side door is closed.

BODYWORK

PROTECTION AGAINST ATMOSPHERIC AGENTS

The vehicle is equipped with the best available technological solutions to protect the bodywork against corrosion.

These include:

- ❑ Painting products and systems which give the vehicle resistance to corrosion and abrasion.
- ❑ Use of galvanized (or pre-treated) steel sheets, with high resistance to corrosion.
- ❑ Spraying of plastic parts, with a protective function in the more exposed points: under door, inner wing, edges, etc.
- ❑ Use of "open" boxed sections to prevent condensation and pockets of moisture which could favor the formation of rust inside.

- ❑ Use of special films to protect against abrasion in exposed areas (e.g. rear wing, doors, etc.).

CORROSION WARRANTY

Your vehicle is covered by Corrosion Warranty against perforation due to rust of any original element of the structure or bodywork. For the general terms of this warranty, refer to the Warranty Booklet.

PRESERVING THE BODYWORK

Paint

Touch up abrasions and scratches immediately to prevent the formation of rust.

Maintenance of paintwork consists of washing the vehicle: the frequency depends on the conditions and environment where the vehicle is used. For example, it is advisable to wash the vehicle more often in areas with high levels of atmospheric pollution or salted roads.

Some parts of the vehicle may be covered with a matte paint which, in order to be maintained intact, requires special care.

To correctly wash the vehicle, follow these instructions:

- ❑ If high pressure jets or cleaners are used to wash the vehicle, keep a distance of at least 15 inches (40 cm) from the bodywork to avoid damage or alteration. Build up of water could cause damage to the vehicle in the long term.

- ❑ To make it easier to remove any dirt deposits in the area where the blades are normally located it is recommended to position the windshield wipers vertically (service position) ⇨ page 223.
- ❑ Wash the bodywork using a low pressure jet of water if possible.
- ❑ Wipe a sponge with a slightly soapy solution over the bodywork, frequently rinsing the sponge.
- ❑ Rinse well with water and dry with a leather chamois.

Dry the less visible parts (e.g. door frames, hood, headlight frames, etc.) with special care, as water may stagnate more easily in these areas. Do not wash the vehicle after it has been left in the sun or with the hood hot: this may alter the shine of the paintwork.

NOTE:

Avoid parking under trees; the resin dropped by trees makes the paintwork go opaque and increases the possibility of corrosion.

Exterior plastic parts must be cleaned in the same way as the rest of the vehicle.

If washing the vehicle in a service that moves the vehicle, for vehicles with automatic transmissions, proceed with the following directions:

- ❑ Ensure that the vehicle is on a flat surface.
- ❑ Disable the automatic engagement of the parking brake ⇨ page 92.
- ❑ With the vehicle stationary, the gear in NEUTRAL (N) and the brake pedal pressed, push the START button.

NOTE:

The vehicle will remain in NEUTRAL (N) for 15 minutes before PARK (P) will be engaged automatically.

Windows

Use specific detergents and clean cloths to prevent scratching or altering the transparency.



CAUTION!

Wipe the rear window inside gently with a cloth following the direction of the filaments to avoid damaging the heating device.

Front Headlights

Use a soft cloth soaked in water and detergent for washing vehicles.

NOTE:

- ❑ Never use aromatic substances (e.g. gasoline) or ketones (e.g. acetone) for cleaning the plastic lenses of the headlights.

- ❑ When cleaning with a pressure washer, keep the pressure washer at least eight inches (20 cm) away from the headlights.

Engine Compartment

At the end of every Winter, wash the engine compartment thoroughly, taking care not to aim the jet of water directly at the electronic control units or at the windshield wiper motors. Have this operation performed at a specialized workshop ⇨ page 222.

NOTE:

The washing should take place with the engine cold and the ignition device in the STOP position. After the washing operation, make sure that the various protections (e.g. rubber caps and guards) have not been removed or damaged.

INTERIORS

Periodically check the cleanliness of the interior, beneath the mats, which could cause oxidation of the sheet metal.

SEATS AND FABRIC PARTS

Remove dust with a soft brush or a vacuum cleaner. It is advised to use a moist brush on velvet upholstery. Rub the seats with a sponge moistened with a solution of water and neutral detergent.



Cleaning heat press images on seats – if equipped:

Due to the color, opacity and wear-resistant protection with which the heat press images on some seats are made, they may be subject to temporary scratching if they are touched by finger nails, keys, or other hard objects. In such cases, the visible signs do not impair the profiled images, and can easily be removed by wiping the affected area with a microfiber cloth moistened with water (not dry) to restore the seat to its original condition. The microfiber cloth must not have been previously soaked in other substances or detergents.

LEATHER SEATS

Remove the dry dirt with a chamois or slightly damp cloth, without exerting too much pressure.

Remove any liquid or grease stains using an absorbent dry cloth, without rubbing. Then clean with a soft cloth or buckskin cloth dampened with water and mild soap. If the stain persists, use specific products and observe the instructions carefully.

NOTE:

Never use alcohol. Make sure that the cleaning products used contain no alcohol or alcohol derivatives, even in small quantities.

PLASTIC AND COATED PARTS

Clean interior plastic parts with a damp cloth (if possible made from microfiber), and a solution of water and neutral, non-abrasive detergent.

To clean oily or persistent stains, use specific products free from solvents and designed to maintain the original appearance and color of the components.

Remove any dust using a microfiber cloth, if necessary moistened with water. The use of paper tissues is not recommended as these may leave residues.

ALCANTARA PARTS — IF EQUIPPED

Alcantara parts maintenance procedure:

- Treat the surface with a microfiber cloth moistened with mild marseille soap and water, taking care to apply a uniform light pressure over the entire area (do not rub vigorously).
- Rinse and wring out the microfiber cloth, and pass it over the entire area again.
- Let it dry, and then brush gently with a soft brush.

**CAUTION!**

Precautions have been taken to safeguard all parts and connections however, the pressures generated by these machines is such that complete protection against water ingress cannot be guaranteed.

GENUINE LEATHER PARTS

Use only water and mild soap to clean these parts. Never use alcohol or alcohol-based products.

Before using a specific product for cleaning interiors, make sure that it does not contain alcohol and/or alcohol based substances.

CARBON FIBER PARTS

To eliminate small scratches and marks on the carbon, contact an authorized dealer. An improperly performed operation may irreparably damage the carbon.

For the enthusiasts, the technician, or those who just want to know every detail of their vehicle, useful information on understanding how your vehicle works is contained in this chapter and illustrated with data, tables, and graphics.

VEHICLE IDENTIFICATION NUMBER (VIN)

The VIN is stamped on a plate on the front left corner of the dashboard trim, which can be seen from outside the vehicle, through the windshield.



Windshield VIN Location

VEHICLE IDENTIFICATION NUMBER (VIN) PLATE

The plates are located on the left side A-pillar and contain the data about:

- Vehicle Identification Number (VIN).
- Vehicle type (USA and Canada only).
- Color code.
- Place of manufacturing of the vehicle (USA and Mexico only).
- Vehicle manufacturing date.
- Maximum permitted weights.
- Permitted tire inflation pressure (USA and Canada only).

ENGINE

2.0L Engine	
Cycle	Four
Number and position of cylinders	4 inline
Piston bore and stroke (mm)	84 / 90
Total displacement (cm ³)	1,995
Compression ratio	10:1
Maximum power (SAE) (HP)	280
Maximum power (kW)	209



2.0L Engine	
Corresponding engine speed (RPM)	5,200
Maximum torque (SAE) (ft-lb)	295
Maximum torque (Nm)	400
Corresponding engine speed (RPM)	2,250 - 4,000
Fuel	87 Octane Minimum (R+M)/2 Method, 91 Recommended, ethanol percentage is 0-15%.

2.9L Engine	
Cycle	Four
Number and position of cylinders	6 / V
Piston bore and stroke (mm)	86.5 × 82
Total displacement (cm ³)	2,891
Compression ratio	9.3:1
Maximum power (SAE) (HP)	505
Maximum power (kW)	375
Corresponding engine speed (RPM)	6,500
Maximum torque (SAE) (ft-lb)	443
Maximum torque (Nm)	600
Corresponding engine speed (RPM)	2,500
Fuel	87 Octane Minimum (R+M)/2 Method, 91 Recommended, ethanol percentage is 0-15%.

POWER SUPPLY

	Power supply
2.0L Engine	Electronic timed sequential injection with knock control

	Power supply
2.9L Engine	Phased sequential electronic injection with knock control and variable intake valve actuation

TRANSMISSION

Version	Transmission	Traction
2.0L Engine	Eight Forward Gears Plus Reverse	All-Wheel Drive
2.0L Engine	Eight Forward Gears Plus Reverse	Rear-Wheel Drive

Version	Transmission	Traction
2.9L Engine	Eight Forward Gears Plus Reverse	All-Wheel Drive



BRAKES

Version	Front brakes	Rear brakes	Parking brake
2.0L Engine	Disc	Disc	Electric

Version	Front brakes	Rear brakes	Parking brake
2.9L Engine	Disc Or Carbon Ceramic Disc	Disc Or Carbon Ceramic Disc	Electric



CAUTION!

- Water, ice and salt spread on the roads may deposit on the brake discs, reducing braking efficiency the first time the brakes are applied.
- To obtain the maximum efficiency of the braking system, a bedding-in period of about 300 miles (500 km) is needed: during this period it is better to avoid sharp, repeated and prolonged braking.

SUSPENSION

Version	Front	Rear
2.0L Engine	Independent wheel double-wishbone suspension	Independent wheel with multilink system

Version	Front	Rear
2.9L Engine	Independent wheel double-wishbone suspension	Independent wheel with multilink system

STEERING

Version	Curb-to-curb turning circle	Type
2.0L Engine	38.55 ft (11.75 m)	Rack and pinion with electric power steering

Version	Curb-to-curb turning circle	Type
2.9L Engine	37.10 ft (11.30 m)	Rack and pinion with electric power steering



DIMENSIONS

Dimensions are expressed in inches and refer to the vehicle equipped with its standard-supplied tires. Height is measured with vehicle unladen.

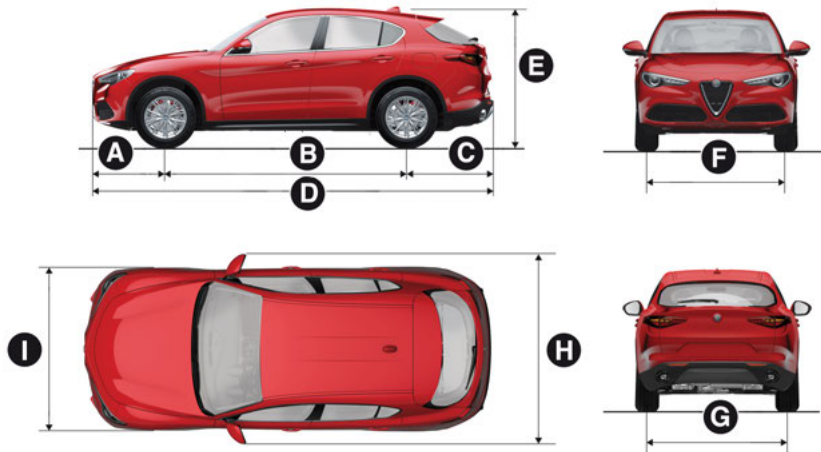

A Front Overhang	B Wheelbase	C Rear Overhang	D Overall Length	E Overall Height	F Front Track	G Rear Track	H Overall Width (Incl Mirrors)	I Overall Width (Excl Mirrors)
33.9 inches (862 mm)	111 inches (2,818 mm)	39.7 inches (1,008 mm)	184.6 inches (4,688 mm)	66 inches (1,677 mm)	63.5 inches (1,612 mm)	65 inches (1,650 mm)	85.2 inches (2,163 mm)	74.9 inches (1,903 mm)

Small variations with respect to the reported values are possible depending on the dimensions of the rims.

Quadrifoglio Model

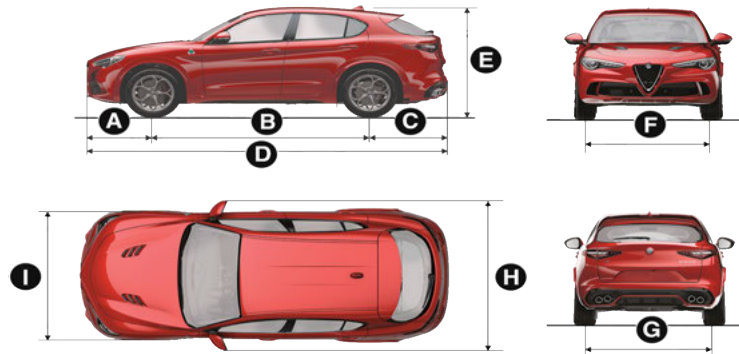

A	B	C	D	E	F	G	H	I
31.3 inches (795 mm)	111 inches (2,818 mm)	40.3 inches (1,023.6 mm)	182.6 inches (4,638 mm)	56.1 inches (1,424.9 mm)	61.2 inches (1,554.5 mm)	63.3 inches (1,607.8 mm)	79.7 inches (2,024.4 mm)	73.7 inches (1,872 mm)



LUGGAGE COMPARTMENT VOLUME**Capacity (VDA standards)***Rear seats not folded*

Vehicle unladen: 18.54 cubic feet (525 liters)

WEIGHTS

Weights (lbs)	2.0L Engine AWD	2.0L Engine RWD
Unladen weight (with all fluids, fuel tank filled to 90% and without optional equipment)	4,007	3,901
Payload including the driver ¹	992	992
Maximum permitted loads ²	242	242
Front axle	2,491	2,403
Rear axle	2,976	2,932
Total	5,247	5,115
Towable loads	-	-
Braked trailer	3,000 lbs (1,360 kg)	3,000 lbs (1,360 kg)
Unbraked trailer	1,000 lbs (454 kg)	1,000 lbs (454 kg)
Maximum load on roof	165 lbs (75 kg)	165 lbs (75 kg)
Maximum load on tow hitch (braked trailer)	300 lbs (136 kg)	300 lbs (136 kg)

1. If special equipment is fitted (trailer towing equipment, etc.) the empty weight will increase and consequently the payload will decrease in relation to the maximum permitted loads.
2. Loads not to be exceeded. The user is responsible for arranging goods in the luggage compartment and/or on the load platform within the maximum permitted loads.

Weights (lbs)	2.9L engine
Unladen weight (with all fluids, fuel tank filled to 90% and without optional equipment)	4,313
Payload including the driver ¹	992
Maximum permitted loads ²	242
- Front axle	2,579
- Rear axle	2,976
- Total	5,423
Maximum load on roof	165 lbs (75 kg)

1. If special equipment is fitted the empty weight will increase and consequently the payload will decrease in relation to the maximum permitted loads.
2. Loads not to be exceeded. The user is responsible for arranging goods in the luggage compartment and/or on the load platform within the maximum permitted loads.

FUEL REQUIREMENTS

91 This engine is designed to meet all emission regulations, and provide satisfactory fuel economy and performance when using high-quality unleaded "Regular" gasoline having a posted octane number of 87 as specified by the (R+M)/2 method. For optimal performance the use of 91 or higher octane "Premium" gasoline is recommended in these engines.

While operating on gasoline with the required octane number, hearing a light knocking sound from the engine is not a cause for concern. However, if the engine is heard making a heavy knocking sound, see an authorized dealer immediately. Use of gasoline with a lower than recommended octane number can cause engine failure and

may void or not be covered by the New Vehicle Limited Warranty.

Poor quality gasoline can cause problems such as hard starting, stalling, and hesitations. If you experience these symptoms, try another brand of gasoline before considering service for the vehicle.

REFORMULATED GASOLINE

Many areas of the country require the use of cleaner burning gasoline referred to as "reformulated gasoline". Reformulated gasoline contains oxygenates and are specifically blended to reduce vehicle emissions and improve air quality.

The use of reformulated gasoline is recommended. Properly blended reformulated gasoline will provide improved performance

and durability of engine and fuel system components.

GASOLINE/OXYGENATE BLENDS

Some fuel suppliers blend unleaded gasoline with oxygenates such as ethanol.

 **CAUTION!**

DO NOT use E-85, gasoline containing methanol, or gasoline containing more than 15% ethanol (E-15). Use of these blends may result in starting and drivability problems, damage critical fuel system components, cause emissions to exceed the applicable standard, and/or cause the Malfunction Indicator Light to illuminate. Please observe pump labels as they should clearly communicate if a fuel contains greater than 15% ethanol (E-15).



Problems that result from using gasoline containing more than 15% ethanol (E-15) or gasoline containing methanol are not the responsibility of the manufacturer and may void or not be covered under New Vehicle Limited Warranty.

CNG AND LP FUEL SYSTEM MODIFICATIONS

Modifications that allow the engine to run on Compressed Natural Gas (CNG) or Liquid Propane (LP) may result in damage to the engine, emissions, and fuel system components. Problems that result from running CNG or LP are not the responsibility of the manufacturer and may void or not be covered under the New Vehicle Limited Warranty.

MMT IN GASOLINE

Methylcyclopentadienyl Manganese Tricarbonyl (MMT) is a manganese-containing metallic additive that is blended into some gasoline to increase octane. Gasoline blended with MMT provides no performance advantage beyond gasoline of the same octane number without MMT. Gasoline blended with MMT reduces spark plug life and reduces emissions system performance in some vehicles. The manufacturer recommends that gasoline without MMT be used in your vehicle. The MMT content of gasoline may not be indicated on the gasoline pump; therefore, you should ask your gasoline retailer whether the gasoline contains MMT. MMT is prohibited in Federal and California reformulated gasoline.

MATERIALS ADDED TO FUEL

Besides using unleaded gasoline with the proper octane rating, gasolines that contain detergents, corrosion and stability additives are recommended. Using gasolines that have these additives will help improve fuel economy, reduce emissions, and maintain vehicle performance.



Designated TOP TIER Detergent Gasoline contains a higher level of detergents to further aid in minimizing engine and fuel system deposits. When available, the usage of TOP TIER Detergent Gasoline is recommended. Visit www.toptiergas.com for a list of TOP TIER Detergent Gasoline Retailers.

Indiscriminate use of fuel system cleaning agents should be avoided. Many of these materials intended for gum and varnish removal may contain active solvents or similar ingredients. These can harm fuel system gasket and diaphragm materials.

FUEL SYSTEM CAUTIONS



CAUTION!

Follow these guidelines to maintain your vehicle's performance:

- The use of leaded gasoline is prohibited by Federal law. Using leaded gasoline can impair engine performance and damage the emissions control system.

(Continued)



CAUTION! *(Continued)*

- An out-of-tune engine or certain fuel or ignition malfunctions can cause the catalytic converter to overheat. If you notice a pungent burning odor or some light smoke, your engine may be out of tune or malfunctioning and may require immediate service. Contact an authorized dealer for service assistance.
- The use of fuel additives, which are now being sold as octane enhancers, is not recommended. Most of these products contain high concentrations of methanol. Fuel system damage or vehicle performance problems resulting from the use of such fuels or additives is not the responsibility of the manufacturer and may void or not be covered under the New Vehicle Limited Warranty.

NOTE:

Intentional tampering with the emissions control system can result in civil penalties being assessed against you.

FLUID CAPACITIES

2.0L Engine		
	US	Metric
Fuel tank	16.9 Gallons	64 Liters
Fuel tank reserve	2.5 Gallons	9.6 Liters
Engine cooling system	2.3 Gallons	8.8 Liters
Intercooler cooling system	1.4 Gallons	5.25 Liters
Engine oil sump and filter	5.5 Quarts	5.2 Liters
Hydraulic brake circuit	0.9 Quarts	0.9 Liters
Windshield washer fluid reservoir	1.1 Gallons	4.1 Liters
Automatic transmission	9.8 Quarts	9.3 Liters
RDU 230-LSD differential	0.9 Quarts	0.9 Liters
RDU 210-eLSD differential (if equipped)	1.4 Quarts	1.3 Liters
RDU 210/215-LSD differential	1.1 Quarts	1.1 Liters
AWD System FAD transfer case	0.5 Quarts	0.5 Liters
AWD System Transfer Case	0.7 Quarts	0.7 Liters

2.9L Engine		
	US	Metric
Fuel tank	16.9 Gallons	64 Liters
Fuel tank reserve	2.5 Gallons	9.6 Liters
Engine cooling system	2.95 Gallons	11.2 Liters
Intercooler cooling system	1.5 Gallons	5.75 Liters
Engine oil sump and filter	7.2 Quarts	7 Liters



2.9L Engine		
	US	Metric
Hydraulic brake circuit	0.9 Quarts	0.9 Liters
Windshield washer fluid reservoir	1.1 Gallons	4.1 Liters
Automatic transmission	9.8 Quarts	9.3 Liters
Differentials and reduction gears RDU 230-TV	Main body: 0.8 Quarts Left TV: 0.64 Quarts Right TV: 0.72 Quarts	Main body: 0.8 Liters Left TV: 0.61 Liters Right TV: 0.68 Liters
AWD System FAD transfer case	0.48 Quarts	0.45 Liters
AWD System Transfer Case	0.7 Quarts	0.7 Liters

ENGINE FLUIDS AND LUBRICANTS

Engine	Features	Specification	Replacement interval
2.0L	Mopar® ILSAC GF-6A/API SP Certified SAE 0W-30 Full Synthetic Engine Oil. If GF-6A/SP Certified Oil is not available, GF-5/SN Plus Certified Oil may be substituted.	FCA Material Standards MS-13340	According To Maintenance Plan
CAUTION!			
Using lubricants that do not meet the recommended ILSAC GF-6A/API SP or equivalent oil specifications can cause engine damage not covered by the vehicle warranty.			
2.9L	5W-40 ACEA C3 API SN	FPT 9.55535-GH2 MS-12991	According To Maintenance Plan

If lubricants conforming to the requested specification are not available, products that meets indicated features can be used to top up; in this case optimal performance of the engine is not guaranteed.

CHASSIS FLUIDS AND LUBRICANTS

Use	Features	Specification	Applications
Lubricants and greases	ZF 8HP 50 – Synthetic ATF	-	Automatic transmission-2.0L / 2.9L
	SAE 75W-85 Synthetic ATF	FPW9.55550-DA9	Differential RDU 195; RDU 230-LSD; RDU 210-eLSD; RDU 210/215-LSD / 2.0L engine
	SAE 75W-80 APL GL-5 Synthetic lubricant	FPW9.55550-DA10	AWD System FAD transfer case / 2.0L Differential and reduction units RDU 230-TV / 2.9L
	SAE 75W Synthetic lubricant	FPW9.55550-DA11	AWD System transfer case
Brake fluid	DOT 4	MS.90039	Hydraulic brakes
Engine coolant	CUNA NC956-16 ASTMD3306	MS.90032	Mix a minimum solution of 50% engine coolant. Not mixable with different formulation products. ¹
Windshield washer fluid	CUNA NC 956-11	MS.90043	To be used diluted or undiluted in windshield washer/wiper systems.
HVAC	R1234yf or R134a (depending on the market)	-	-

1. For particularly harsh climate conditions, a mixture of 60% product and 40% distilled water is recommended.



CAUTION!

The use of products with different specifications than those indicated above could cause damage to the engine that is not covered by the warranty.



PERFORMANCE

Top performance after the initial period of vehicle usage.

Engine	Top speed mph / (km/h)	Acceleration from 0-60 mph / (0-100 km/h) sec.
2.0L AWD Engine	143 / (230) *	5.4 *
2.0L RWD Engine	143 / (230) *	5.5 *
2.9L Engine	176 (283) *	3.6 *

* Based on manufacturer testing.

SUGGESTIONS FOR OBTAINING SERVICE FOR YOUR VEHICLE

PREPARE FOR THE APPOINTMENT

All work to be performed may not be covered by the warranty. Discuss additional charges with the service manager. Keep a maintenance log of your vehicle's service history, as this can often provide a clue to the current problem.

PREPARE A LIST

Make a written list of your vehicle's problems or the specific work you want done. If you've had an accident or work done that is not on your maintenance log, let the service advisor know.

BE REASONABLE WITH REQUESTS

If you list a number of items and you must have your vehicle by the end of the day, discuss the situation with the service advisor and list the items in order of priority. At many authorized dealers, you may obtain a rental vehicle at a minimal daily charge. If you need a rental, it is advisable to make these arrangements when you call for an appointment.

IF YOU NEED ASSISTANCE

FCA US LLC and its authorized dealers are vitally interested in your satisfaction. We want you to be happy with our products and services.

Warranty service must be done by an authorized dealer. We strongly recommend that you take the vehicle to an authorized dealer. They know your vehicle the best, and are most concerned that you get prompt and high quality service. FCA US LLC's authorized dealers have the facilities, factory-trained technicians, special tools, and the latest information to ensure the vehicle is fixed correctly and in a timely manner.

This is why you should always talk to an authorized dealer's service manager first. If for some reason you are still not satisfied, talk to the general manager or owner of the authorized dealer. They want to know if you need assistance. If an authorized dealer is unable to resolve the concern, you may contact FCA US LLC's Customer Assistance center.

Any communication to FCA US LLC's customer center should include the following information:

- Owner's name and address
- Owner's telephone number (mobile, home and office)
- Authorized dealer name
- Vehicle Identification Number (VIN)
- Vehicle delivery date and mileage

ALFA ROMEO CUSTOMER CENTER

P.O. Box 21-8004

Auburn Hills, MI 48321-8004

Phone: 1-844-Alfa-USA (1-844-253-2872)

ALFA ROMEO CUSTOMER CARE (CANADA)

P.O. Box 1621

Windsor, Ontario N9A 4H6

Phone: 1-877-230-0563 (English)

Phone: 1-877-515-9112 (French)

CUSTOMER ASSISTANCE FOR THE HEARING OR SPEECH IMPAIRED (TDD/TTY)

To assist customers who have hearing difficulties, the manufacturer has installed special Telecommunication Devices for the Deaf (TDD) equipment at its customer center. Any hearing or speech impaired customer, who has access to a TDD or a conventional teletypewriter (TTY) in the United States, can communicate with the manufacturer by dialing 1-800-380-2479.

Canadian residents with hearing difficulties that require assistance can use the special needs relay service offered by Bell Canada. For TTY teletypewriter users, dial 711 and for Voice callers, dial 1-800-855-0511 to connect with a Bell Relay Service operator.



SERVICE CONTRACT

You may have purchased a service contract for a vehicle to help protect you from the high cost of unexpected repairs after FCA US LLC's New Vehicle Limited Warranty expires. The Mopar® Vehicle Protection plans are the ONLY vehicle extended protection plans authorized, endorsed and backed by FCA US LLC to provide additional protection beyond your vehicle's warranty. If you purchased a Mopar® Vehicle Protection Plan, you will receive Plan Provisions and an Owner Identification Card in the mail within three weeks of the vehicle delivery date. If you have any questions about the service contract, call FCA US LLC's Service Contract National Customer Hotline at 1-800-521-9922 (Canadian residents, call (800) 465-2001 English / (800) 387-9983 French).

FCA US LLC is not responsible for any service contract you may have purchased from another manufacturer. If you require service after the FCA US LLC New Vehicle Limited Warranty expires, please refer to the contract documents, and contact the person listed in those documents.

We appreciate that you have made a major investment when you purchased the vehicle. An authorized dealer has also made a major investment in facilities, tools, and training to ensure that you are absolutely delighted with the ownership experience.



WARNING!

Engine exhaust (internal combustion engines only), some of its constituents, and certain vehicle components contain, or emit, chemicals known to the State of California to cause cancer and birth defects, or other reproductive harm. In addition, certain fluids contained in vehicles and certain products of component wear contain, or emit, chemicals known to the State of California to cause cancer and birth defects, or other reproductive harm.

You may have purchased additional coverage with an extended service contract. FCA Canada Inc. stands fully behind its service contracts. Be sure that the one you buy is a genuine Canada Inc. service contract. We are not responsible for other companies' contracts. If you purchased a contract other than a genuine FCA Canada Inc. service contract and you have a problem, you will have to contact the administrator of that contract for resolution. If you have any questions about the service contract, call FCA's Service Contract National Customer Hotline at (800) 465-2001 English / (800) 387-9983 French).

We appreciate that you have made a major investment when you purchased the vehicle. An authorized dealer has also made a major

investment in facilities, tools, and training to ensure that you are absolutely delighted with the ownership experience.

WARRANTY INFORMATION

See the Warranty Information for the terms and provisions of FCA US LLC and FCA Canada Inc. warranties applicable to this vehicle and market.

REPORTING SAFETY DEFECTS

IN THE 50 UNITED STATES AND WASHINGTON, D.C.

If you believe that your vehicle has a defect that could cause a crash or cause injury or death, you should immediately inform the National Highway Traffic Safety Administration (NHTSA) in addition to notifying FCA US LLC.

If NHTSA receives similar complaints, it may open an investigation, and if it finds that a safety defect exists in a group of vehicles, it may order a recall and remedy campaign. However, NHTSA cannot become involved in individual problems between you, your authorized dealer or FCA US LLC.

To contact NHTSA, you may call the Vehicle Safety Hotline toll free at 1-888-327-4236 (TTY: 1-800-424-9153); or go to <http://www.safercar.gov>; or write to: Administrator, NHTSA, 1200 New Jersey Avenue, SE., West Building, Washington, D.C. 20590. You can also obtain other information about motor vehicle safety from <http://www.safercar.gov>.

IN CANADA

If you believe that your vehicle has a safety defect, you should contact the Customer Service Department immediately. Canadian customers who wish to report a safety defect to the Canadian government should contact Transport Canada, Motor Vehicle Defect Investigations and Recalls at 1-800-333-0510 or go to www.apps.tc.gc.ca/Saf-Sec-Sur/7/PCDB-BDPP.

PUBLICATION ORDER FORMS

To order the following manuals, you may use either the website or the phone numbers listed below.

Service Manuals

These comprehensive Service Manuals provide a complete working knowledge of the vehicle, system, and/or components and is written in straightforward language with illustrations, diagrams, and charts.

Diagnostic Procedure Manuals

Diagnostic Procedure Manuals are filled with diagrams, charts and detailed illustrations. These manuals make it easy to find and fix problems on computer-controlled vehicle systems and features. They show exactly how to find and correct problems, using step-by-step troubleshooting and drivability procedures, proven diagnostic tests and a complete list of all tools and equipment.

To order a hard copy of your Service or Diagnostic Procedure manuals, visit: www.techauthority.com (US and Canada).

Owner's Manuals

These Owner's Manuals have been prepared with the assistance of service and engineering specialists to acquaint you with specific FCA vehicles.

To access your Owner's Information online, visit www.mopar.com/om (US) or www.owners.mopar.ca (Canada).

Or

Call Tech Authority toll free at:

1-800-890-4038 (US)

Owner's Manuals, Radio Manuals and Warranty Information Books can be ordered through Archway at:

1-800-387-1143 (Canada)



GENERAL INFORMATION

The following regulatory statement applies to all Radio Frequency (RF) devices equipped in this vehicle:

This device complies with Part 15 of the FCC Rules and with Innovation, Science and Economic Development Canada license-exempt RSS standard(s). Operation is subject to the following two conditions:

1. This device may not cause harmful interference, and
2. This device must accept any interference received, including interference that may cause undesired operation.

Le présent appareil est conforme aux CNR d'Innovation, Science and Economic Development applicables aux appareils radio exempts de licence. L'exploitation est autorisée aux deux conditions suivantes:

1. l'appareil ne doit pas produire de brouillage, et
2. l'utilisateur de l'appareil doit accepter tout brouillage radioélectrique subi, même si le brouillage est susceptible d'en compromettre le fonctionnement.

La operación de este equipo está sujeta a las siguientes dos condiciones:

1. es posible que este equipo o dispositivo no cause interferencia perjudicial y
2. este equipo o dispositivo debe aceptar cualquier interferencia, incluyendo la que pueda causar su operación no deseada.

NOTE:

Changes or modifications not expressly approved by the party responsible for compliance could void the user's authority to operate the equipment.

A	Automatic Climate Controls	50	Checks, Safety	192	
Accessories Purchased By The Owner	4	Automatic Dimming Mirror	37	Child Restraint	182
Active Blind Spot Assist	156	Automatic Door Locks	27	Child Restraints	
Active Safety Systems	149	Automatic Headlights	43	Booster Seats	184
Active Torque Vectoring (ATV) System	149	Automatic Temperature Control (ATC)	50	Child Seat Installation	191
Adaptive Cruise Control (ACC)		Automatic Transmission	94	How To Stow An unused	
(Cruise Control)	107, 109	Auxiliary Driving Systems	153	ALR Seat Belt	189
Off	111	Auxiliary Power Outlet	57	Infant And Child Restraints	183
On	111	B		LATCH Positions	186
Additives, Fuel	270	Battery	80, 221	Lower Anchors And Tethers	
Adjust		Charging System Light	80	For Children	186
Forward	30, 33	Keyless Key Fob Replacement	18	Older Children And Child Restraints	184
Rearward	30, 33	Battery Recharging	222	Seating Positions	185
Air Bag	174	Belts, Seat	193	Clean Air Gasoline	269
Air Bag Operation	176	Blind Spot Monitoring	154	Cleaning	
Air Bag Warning Light	174	Bodywork (Cleaning And Maintenance) ...	258	Wheels	254
Driver Knee Air Bag	176	B-Pillar Location	245	Climate Control	49, 55
Enhanced Accident Response	180, 211	Brake System		Automatic	50
Event Data Recorder (EDR)	211	Warning Light	75, 76	Compact Spare Tire	253
Front Air Bag	174	Brakes	264	Contract, Service	276
If Deployment Occurs	179	Brake Fluid Level	221	Cooling System	
Knee Impact Bolsters	176	Brightness, Interior Lights	46	Cooling Capacity	271
Maintaining Your Air Bag System	182	Bulbs, Light	194	Selection Of Coolant (Antifreeze)	271
Maintenance	182	C		Cruise Control (Speed Control)	107, 109
Redundant Air Bag Warning Light	174	Camera, Rear	136	Customer Assistance	275
Side Air Bags	177	Capacities, Fluid	271		
Transporting Pets	193	Carbon Monoxide Warning	195		
Air Bag Light	174, 193	Certification Label	139		
Air Pressure		Chart, Tire Sizing	241		
Tires	248	Check Engine Light			
Alfa Active Suspension (AAS)	103	(Malfunction Indicator Light)	87		
Alfa DNA System	100	Checking Levels	218, 219		
Antifreeze (Engine Coolant)	271	Checking Your Vehicle For Safety	192		
Anti-Lock Braking (ABS) System	149			D	
Anti-Lock Warning Light	77			Daytime Running Lights	43



Door Opener, Garage	39	Engine Oil		H	
Doors.....	23	Level Check	219	Hazard Warning Flashers	196
Drive Train Control (DTC) System.....	150	Enhanced Accident Response		Head Restraints	35
Driving Modes	101	Feature.....	180, 211	Head Rests	35
Dynamic Steering Torque (DST) System...	150	Ethanol.....	269	Headlights	
E		Exhaust Gas Cautions	195	Switch.....	42, 43
Electric Park Brake.....	92	Exhaust System	195	Headlights (Cleaning)	258
Electric Remote Mirrors	38	Exterior Lighting.....	42, 43	Heated Mirrors	39
Electronic Speed Control		Exterior Lights	42, 194	Heated Seats	34
(Cruise Control)	107	F		Heated Steering Wheel	29
Electronic Stability Control (ESC)		Flashers		Heater, Engine Block	91
System	150	Hazard Warning.....	196	Hill Decent Control (HDC) System.....	151
Electronic Throttle Control Warning		Turn Signals.....	45, 79, 194	Hill Start Assist (HSA) System	152
Light	80	Fluid Capacities	271	Hitches	
Emergency		Fluid Leaks.....	194	Trailer Towing.....	142
In Case Of	196, 202	Fluids And Lubricants.....	272	HomeLink (Garage Door Opener)	39
SOS Emergency Call	196	Fog Lights, Rear	44	Hood	
Emergency, In Case Of		Forward Collision Warning	160	Closing.....	62
Jump Starting.....	205	Fuel		Opening.....	62
Overheating.....	208	Additives	270	I	
Towing.....	210	Clean Air.....	269	Ignition.....	20
Emission Control System Maintenance.....	87	Ethanol.....	269	Switch	20
Engine	261	Light	83	Immobilizer (Sentry Key)	19
Block Heater.....	91	Materials Added	270	In Case Of Emergency	196
Engine Coolant Level	220	Methanol.....	269	Installing Electrical/Electronic Devices.....	4
Exhaust Gas Caution	195	Tank Capacity	271	Instrument Cluster	68
Fuel Requirements	269	G		Descriptions.....	69, 70, 79
Oil.....	271	Garage Door Opener (HomeLink)	39	Display	70
Oil Selection	271	Gasoline, Clean Air	269	Reconfigurable Display	70
Overheating.....	208	Gasoline, Reformulated	269	Instrument Panel	
Starting.....	208	Gross Axle Weight Rating.....	141	Features	68
Engine Compartment.....	218	Gross Vehicle Weight Rating.....	141	Interior Lights	45
Engine Compartment (Washing)	258	GVWR	140	Interiors (Cleaning)	259

J	
Jump Starting	205
K	
Keyless Enter-N-Go	24
Passive Entry.....	24
Keys	17
L	
Lane Change And Turn Signals	45
LaneSense.....	130
Lap/Shoulder Belts.....	169
Latches	194
Leaks, Fluid	194
Life Of Tires.....	252
Liftgate.....	63
Light Bulbs.....	194
Types Of Bulbs	235
Lights	194
Air Bag	75, 174, 193
Automatic Headlights	43
Brake Warning	75, 76
Courtesy/Reading.....	45, 46
Daytime Running	43
Electronic Stability Program (ESP) Indicator	77, 80
Exterior	194
Fog	44, 78
Headlight Switch	42, 43
Headlights	42, 43
High Beam.....	43
Instrument Cluster	42, 43

Intensity Control	46
Interior.....	46
Low Fuel.....	83
Malfunction Indicator (Check Engine)	77
Map	45
Oil Temperature.....	76
Park	44, 79
Reading.....	45
Seat Belt Reminder.....	77
Turn Signals.....	45, 79, 194
Warning Instrument Cluster Descriptions	79, 80
Loading Vehicle	139
Tires.....	245
Locks	
Automatic Door.....	27
Child Protection.....	27
M	
Maintenance.....	62
Malfunction Indicator Light (Check Engine).....	77, 87
Manual	
Service	277
Memory Feature (Memory Seats).....	29
Memory Seat.....	29
Methanol.....	269
Mirrors.....	37
Automatic Dimming.....	37
Electric Powered.....	38
Electric Remote	38
Heated	39

O	
Occupant Restraints.....	167
Oil Pressure Light.....	81
Oil, Engine	
Capacity.....	271
Pressure Warning Light.....	81
Recommendation	271
Viscosity	271
Opener, Garage Door (Homelink)	39
Operator Manual	
Owner's Manual	277
Outlet	
Power.....	57
Overheating, Engine	208
P	
Paintwork (Cleaning And Maintenance)...	258
Panic Brake Assist (PBA) System.....	153
Park Assist.....	126
ParkSense System.....	126
Passive Entry.....	24
Performance (Top Speed)	274
Pets.....	193
Placard, Tire And Loading Information	245
Power	
Mirrors	38
Outlet (Auxiliary Electrical Outlet)	57
Seats	33
Sunroof.....	60
Power Seats	
Forward	30, 33
Rearward.....	30, 33
Recline	31, 33



Power Supply	263	Safety, Exhaust Gas	195	Service Assistance	275
Pregnant Women And Seat Belts.....	172	Saving Fuel	146	Service Contract.....	276
Pretensioners		Scheduled Servicing.....	212	Service Manuals	277
Seat Belts	172	Scheduled Servicing Program		Servicing Procedures.....	223
Prolonged Vehicle Inactivity	257	(2.0L T4 MAir Engine Versions)	213	Shoulder Belts.....	169
R		Scheduled Servicing Program		Signals, Turn	45, 79, 194
Radial Ply Tires	251	(2.9L V6 Gasoline Engine Versions).....	216	Snow Chains	255
Radio Transmitters And Mobile Phones	4	Seat Belt Reminder	77	Snow Tires.....	255
Rear Camera	136	Seat Belts.....	168, 193	Spare Tires	253, 254
Rear Cross Path	154	Adjustable Shoulder Belt	171	Speed Control	
Reformulated Gasoline.....	269	Adjustable Upper Shoulder		Accel/Decel.....	108, 109
Refueling Procedure	137	Anchorage.....	171	Accel/Decel (ACC Only)	112
Refueling The Vehicle	137	Adjustable Upper Shoulder Belt		Cancel.....	109
Reminder, Seat Belt.....	168	Anchorage.....	171	Distance Setting (ACC Only).....	113
Remote Control		Child Restraints.....	182	Resume.....	109
Starting System.....	21	Energy Management Feature.....	172	Set	108
Remote Keyless Entry.....	17	Front Seat	168, 169	Speed Control (Cruise Control)	107
Remote Starting		Inspection	193	Starting	208
Exit Remote Start Mode	22	Lap/Shoulder Belt Untwisting	171	Button.....	20
Remote Starting System.....	21, 88	Lap/Shoulder Belts	169	Cold Weather	89
Replacement Tires	252	Pregnant Women.....	172	Remote.....	21
Reporting Safety Defects.....	276	Pretensioners	172	Starting And Operating	208
Restraints, Child.....	182	Rear Seat	169	Starting Procedures	208
Restraints, Head	35	Reminder	168	Starting The Engine	88
Rims And Tires	240	Seat Belt Pretensioner.....	172	Steering	265
Roll Over Warning.....	3	Untwisting Procedure.....	171	Wheel, Heated	29
S		Seats	30, 33	Wheel, Tilt	28
Safety Checks Inside Vehicle	193	Adjustment	30, 33	Stop/Start System	104
Safety Checks Outside Vehicle.....	194	Head Restraints	35	Storage	
Safety Defects, Reporting.....	276	Heated	34	Console	57
Safety Information, Tire	240	Height Adjustment.....	33	Suggestions For Driving.....	146
Safety Tips	192	Power	33	Sun Roof.....	60, 62
		Tilting.....	33	Supplemental Restraint System -	
		Security Alarm.....	22	Air Bag	174

Suspension.....	264
Symbol Glossary.....	14
Symbols.....	6
System, Remote Starting.....	21

T

Telescoping Steering Column.....	28
Tilt Steering Column.....	28
Tire And Loading Information Placard.....	245
Tire Markings.....	240
Tire Safety Information.....	240
Tire Service Kit.....	202
Tires.....	194, 248, 253, 257
Aging (Life Of Tires).....	252
Air Pressure.....	248
Changing.....	202
Compact Spare.....	253
General Information.....	248, 253
High Speed.....	249
Inflation Pressure.....	248
Life Of Tires.....	252
Load Capacity.....	245
Pressure Monitoring System (TPMS).....	78
Quality Grading.....	257
Radial.....	251
Replacement.....	252
Safety.....	240, 248
Sizes.....	241
Snow Tires.....	255
Spare Tires.....	253, 254

Spinning.....	251
Trailer Towing.....	144
Tread Wear Indicators.....	252
Tongue Weight/Trailer Weight.....	143
Towing.....	140, 142
Disabled Vehicle.....	209
Towing Eyes.....	210
TPMS (Tire Pressure Monitoring System).....	165
Traction Control System (TCS).....	153
Trailer Towing.....	140
Hitches.....	142
Minimum Requirements.....	143
Tips.....	145
Trailer And Tongue Weight.....	142, 143
Wiring.....	144
Trailer Towing Guide.....	142
Trailer Weight.....	142
Transmission.....	263
Transporting Pets.....	193
Tread Wear Indicators.....	252
Turn Signals.....	45, 79

U

Uconnect Settings	
Customer Programmable Features.....	24
Passive Entry Programming.....	24
Uniform Tire Quality Grades.....	257
Universal Transmitter.....	39
Untwisting Procedure, Seat Belt.....	171

V

Vehicle Changes/Alterations.....	4
Vehicle Identification Number.....	261
Vehicle Loading.....	139, 245

W

Warning Lights (Instrument Cluster Descriptions).....	77
Warnings, Roll Over.....	3
Warranty Information.....	276
Washer Fluid For Windshield/Headlights.....	220
Washers, Windshield.....	47
Weights.....	268
Wheel And Wheel Tire Care.....	254
Wheel And Wheel Tire Trim.....	254
Wheels And Tires.....	240
Wind Buffeting.....	60
Windows (Cleaning).....	258
Windshield Defroster.....	193
Windshield Washers.....	47
Windshield Wiper	
Replacing Blades.....	226
Windshield Wipers.....	47
Wipers, Rain Sensitive.....	47



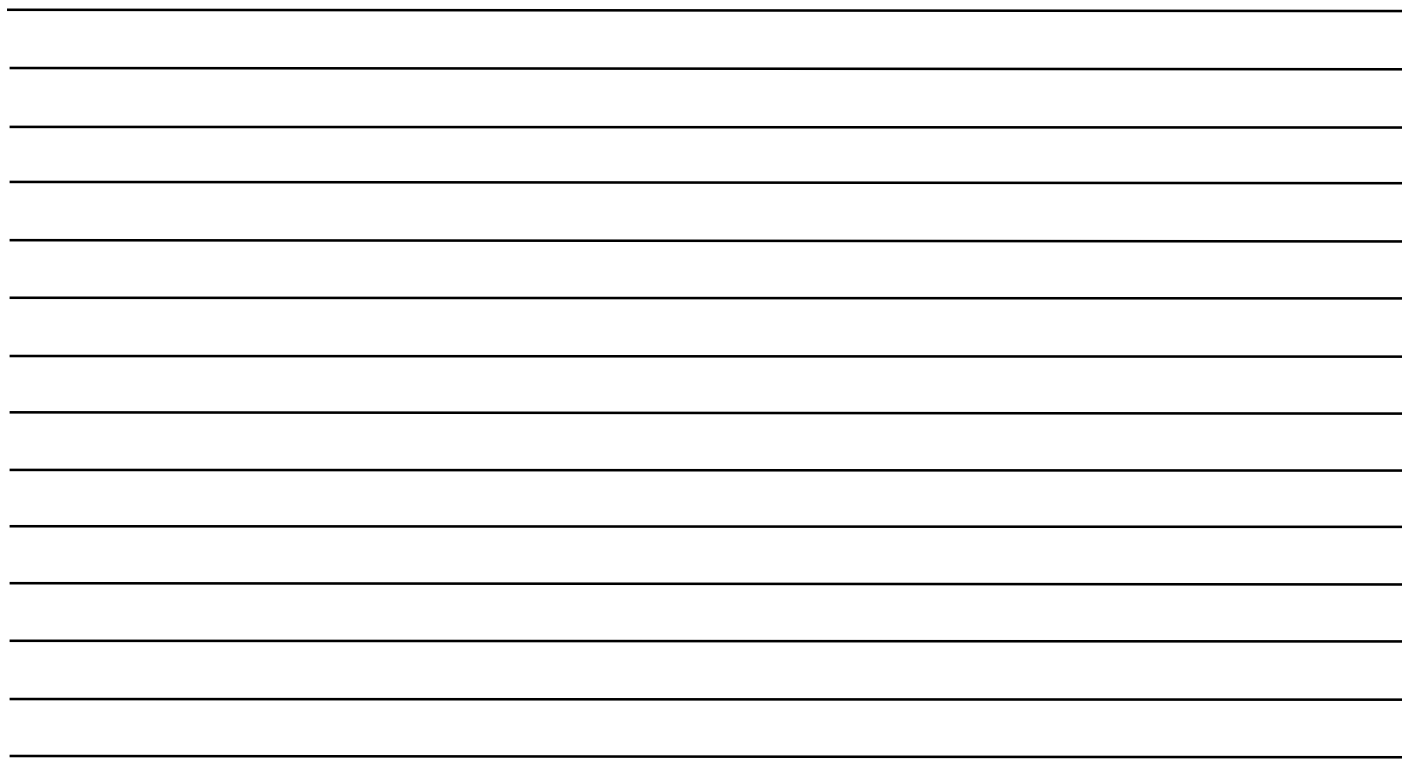

The driver's primary responsibility is the safe operation of the vehicle. Driving while distracted can result in loss of vehicle control, resulting in an accident and personal injury. FCA US LLC strongly recommends that the driver use extreme caution when using any device or feature that may take their attention off the road. Use of any electrical devices, such as cellular telephones, computers, portable radios, vehicle navigation or other devices, by the driver while the vehicle is moving is dangerous and could lead to a serious accident. Texting while driving is also dangerous and should never be done while the vehicle is moving. If you find yourself unable to devote your full attention to vehicle operation, pull off the road to a safe location and stop your vehicle. Some states or provinces prohibit the use of cellular telephones or texting while driving. It is always the driver's responsibility to comply with all local laws.

This Owner's Manual has been prepared to help you get acquainted with your new Alfa Romeo brand vehicle and to provide a convenient reference source for common questions.

Not all features shown in this manual may apply to your vehicle. For additional information, visit www.alfaromeousa.com (U.S.), www.alfaromeo.ca (Canada) or your local Alfa Romeo dealer.

DRIVING AND ALCOHOL

Drunk driving is one of the most frequent causes of accidents. Your driving ability can be seriously impaired with blood alcohol levels far below the legal minimum. If you are drinking, don't drive. Ride with a designated non-drinking driver, call a cab, a friend or use public transportation.

WARNING!

Driving after drinking can lead to an accident. Your perceptions are less sharp, your reflexes are slower and your judgment is impaired when you have been drinking. Never drink and then drive.



La meccanica delle emozioni



Whether it's providing information about specific product features, taking a tour through your vehicle's heritage, knowing what steps to take following an accident or scheduling your next appointment, we know you'll find the app an important extension of your Alfa Romeo brand vehicle. Simply download the app, select your make and model and enjoy the ride. To get this app, go directly to the App Store® or Google Play® Store and enter the search keyword "Alfa Romeo" (U.S. residents only).

U. S.



**[alfaromeousa.com/
owners/owners-service-manual](https://alfaromeousa.com/owners/owners-service-manual)**

Canada



**[alfaromeo.ca/en/
owners/owners-service-manual](https://alfaromeo.ca/en/owners/owners-service-manual)**