

# 2020 OWNER'S MANUAL



*stinger*



The Power to Surprise



**WARNING – California  
Proposition 65**

“Operating, servicing and maintaining a passenger vehicle or off-road vehicle can expose you to chemicals including engine exhaust, carbon monoxide, phthalates, and lead, which are known to the State of California to cause cancer and birth defects or other reproductive harm. To minimize exposure, avoid breathing exhaust, do not idle the engine except as necessary, service your vehicle in a well-ventilated area and wear gloves or wash your hands frequently when servicing your vehicle. For more information go to [www.P65Warnings.ca.gov/passenger-vehicle](http://www.P65Warnings.ca.gov/passenger-vehicle).”



## ***Kia, THE COMPANY***

---

Thank you for becoming the owner of a new Kia vehicle.

As a global car manufacturer focused on building high-quality vehicles with exceptional value, Kia Motors is dedicated to providing you with a customer service experience that exceeds your expectations.

All information contained in this Owner's Manual was accurate at the time of publication. However, Kia reserves the right to make changes at any time so that our policy of continual product improvement can be carried out.

This manual applies to all trims of this vehicle and includes images, descriptions, and explanations of optional as well as standard equipment. As a result, some material in this manual may not be applicable to your specific Kia vehicle. Some images are shown for illustration only and may show features that differ from those on your vehicle.

***Drive safely and enjoy your Kia!*** ■

Thank you for choosing a Kia vehicle.

When you require service, remember that your Kia dealer knows your vehicle best. Your dealer has factory-trained technicians, recommended special tools and genuine Kia replacement parts. It is dedicated to your complete customer satisfaction.

Because subsequent owners require this important information as well, this publication should remain with the vehicle if it is sold.

This manual will familiarize you with operational, maintenance and safety information about your new vehicle. It is supplemented by a Warranty and Consumer Information manual that provides important information on all warranties regarding your vehicle.

We urge you to read these publications carefully and follow the recommendations to help assure enjoyable and safe operation of your new vehicle.

Kia offers a great variety of options, components and features for its various models. Therefore, some of the equipment described in this manual, along with the various illustrations, may not be applicable to your particular vehicle.

The information and specifications provided in this manual were accurate at the time of printing. Kia reserves the right to discontinue or change specifications or design at any time without notice and without incurring any obligation. If you have questions, always check with your Kia dealer.

We assure you of our continuing interest in your motoring pleasure and satisfaction in your Kia vehicle.

© 2019 Kia MOTORS AMERICA, Inc.

All rights reserved. May not be reproduced or translated in whole or in part without the written consent of Kia Motors America, Inc.

Printed in Korea

***TABLE OF CONTENTS***

<b>Introduction</b>	<b>1</b>
<b>Your vehicle at a glance</b>	<b>2</b>
<b>Safety features of your vehicle</b>	<b>3</b>
<b>Features of your vehicle</b>	<b>4</b>
<b>Driving your vehicle</b>	<b>5</b>
<b>What to do in an emergency</b>	<b>6</b>
<b>Maintenance</b>	<b>7</b>
<b>Specifications, Consumer information and Reporting safety defects</b>	<b>8</b>
<b>Index</b>	<b>I</b>

# Introduction

- How to use this manual . . . . . 1-2**
- Fuel requirements . . . . . 1-2**
  - **Gasoline containing alcohol and methanol. . . . . 1-3**
  - **Other fuels . . . . . 1-4**
  - **Gasoline containing MMT . . . . . 1-4**
  - **Do not use methanol . . . . . 1-4**
  - **Fuel additives. . . . . 1-4**
  - **Operation in foreign countries. . . . . 1-5**
- Vehicle modifications . . . . . 1-6**
- Vehicle break-in process . . . . . 1-6**
- Risk of burns when parking or stopping vehicle . 1-6**
- Vehicle data collection and event data recorders . 1-7**

### HOW TO USE THIS MANUAL

We want to help you get the greatest possible driving pleasure from your vehicle. Your Owner's Manual can assist you in many ways. We strongly recommend that you read the entire manual. In order to minimize the chance of death or injury, you must read the WARNING and CAUTION sections in the manual.

Illustrations complement the words in this manual to best explain how to enjoy your vehicle. By reading your manual, you will learn about features, important safety information, and driving tips under various road conditions.

The general layout of the manual is provided in the Table of Contents. Use the index when looking for a specific area or subject; it has an alphabetical listing of all information in your manual.

Sections: This manual has eight sections plus an index. Each section begins with a brief list of contents so you can tell at a glance if that section has the information you want.

You will find various WARNINGS, CAUTIONS, and NOTICES in this manual. These WARNINGS were prepared to enhance your personal safety. You should carefully read and follow ALL procedures and recommendations provided in these WARNINGS, CAUTIONS and NOTICES.

#### **WARNING**

**A WARNING indicates a situation in which harm, serious bodily injury or death could result if the warning is ignored.**

#### **CAUTION**

**A CAUTION indicates a situation in which damage to your vehicle could result if the caution is ignored.**

#### **\* NOTICE**

**A NOTICE indicates interesting or helpful information is being provided.**

### FUEL REQUIREMENTS

For the optimal engine performance, we recommend you use unleaded gasoline which has an octane rating of RON (Research Octane Number) 95/AKI (Anti Knock Index) 91 or higher.

Using Unleaded gasoline with an octane rating lower than RON 95 could result in loss of engine power and increase in fuel consumption.

Your new vehicle is designed to obtain maximum performance with UNLEADED FUEL, as well as minimize exhaust emissions and spark plug fouling.

Never add any fuel system cleaning agents to the fuel tank other than what has been specified. (Consult an authorized Kia dealer for details.)

- Tighten the cap until it clicks one time, otherwise the Check Engine  light will illuminate.

**⚠ WARNING - Refueling**

- Do not "top off" after the nozzle automatically shuts off. Attempts to force more fuel into the tank can cause fuel overflow onto you and the ground causing a risk of fire.
- Always check that the fuel cap is installed securely to prevent fuel spillage, especially in the event of an accident.

***Gasoline containing alcohol and methanol***

Gasohol, a mixture of gasoline and ethanol (also known as grain alcohol), and gasoline or gasohol containing methanol (also known as wood alcohol) are being marketed along with or instead of leaded or unleaded gasoline.

Pursuant to EPA regulations, ethanol may be used in your vehicle.

Do not use gasohol containing more than 15% ethanol, and do not use gasoline or gasohol containing any methanol. Ethanol provides less energy than gasoline and it attracts water, and it is thus likely to reduce your fuel efficiency and could lower your MPG results.

Methanol may cause drivability problems and damage to the fuel system, engine control system and emission control system.

Discontinue using gasohol of any kind if drivability problems occur.

Vehicle damage or drivability problems may not be covered by the manufacturer's warranty if they result from the use of:

1. Gasoline or gasohol containing methanol.
2. Leaded fuel or leaded gasohol.
3. Gasohol containing more than 15% ethanol.

"E85" fuel is an alternative fuel comprised of 85 percent ethanol and 15 percent gasoline, and is manufactured exclusively for use in Flexible Fuel Vehicles. "E85" is not compatible with your vehicle. Use of "E85" may result in poor engine performance and damage to your vehicle's engine and fuel system. Kia recommends that customers do not use fuel with an ethanol content exceeding 15%.

**\* NOTICE**

**Your New Vehicle Limited Warranty does not cover damage to the fuel system or any performance problems caused by the use of "E85" fuel.**

**\* NOTICE**

**Never use any fuel containing methanol. Discontinue use of any methanol containing product which may inhibit proper drivability.**



### ***Other fuels***

Using fuels that contain Silicone (Si), MMT (Manganese, Mn), Ferrocene (Fe), and Other metallic additives, may cause vehicle and engine damage or cause misfiring, poor acceleration, engine stalling, catalyst melting, clogging, abnormal corrosion, life cycle reduction, etc.

Also, the Malfunction Indicator Lamp (MIL) may illuminate.

### **\* NOTICE**

**Damage to the fuel system or performance problem caused by the use of these fuels may not be covered by your New Vehicle Limited Warranty.**

### ***Gasoline containing MMT***

Some gasoline contains harmful manganese-based fuel additives Such as MMT (Methylcyclopentadienyl Manganese Tricarbonyl). Kia does not recommend the use of gasoline containing MMT. This type of fuel can reduce vehicle performance and affect your emission control system. The Malfunction Indicator Lamp on the cluster may come on.

### ***Do not use methanol***

Fuels containing methanol (wood alcohol) should not be used in your vehicle. This type of fuel can reduce vehicle performance and damage components of the fuel system, engine control system and emission control system.

### ***Fuel Additives***

Kia recommends that you use good quality gasolines treated with detergent additives such as TOP TIER Detergent Gasoline, which help prevent deposit formation in the engine. These gasolines will help the engine run cleaner and enhance performance of the Emission Control System. For more information on TOP TIER Detergent Gasoline, please go to the website ([www.toptiergas.com](http://www.toptiergas.com))

For customers who do not use TOP TIER Detergent Gasoline regularly, and have problems starting or the engine does not run smoothly, additives that you can buy separately may be added to the gasoline.

If TOP TIER Detergent Gasoline is not available, one bottle of additive should be added to the fuel tank at every 7,500 miles (12,000 km) or every engine oil change is recommended. Additives are available from your authorized Kia dealer along with information on how to use them. Do not mix other additives.

***Operation in foreign countries***

If you are going to drive your vehicle in another country, be sure to:

- Observe all regulations regarding registration and insurance.
- Determine that acceptable fuel is available.

### **VEHICLE MODIFICATIONS**

This vehicle should not be modified. Modification of your vehicle could affect its performance, safety or durability and may even violate governmental safety and emissions regulations.

In addition, damage or performance problems resulting from any modification may not be covered under warranty.

- If you use unauthorized electronic devices, it may cause the vehicle to operate abnormally, wire damage, battery discharge and fire. For your safety, do not use unauthorized electronic devices.

### **VEHICLE BREAK-IN PROCESS**

No special break-in period is needed. By following a few simple precautions for the first 600 miles (1,000 km) you may add to the performance, economy and life of your vehicle.

- Do not race the engine.
- While driving, keep your engine speed (rpm, or revolutions per minute) between 2,000 rpm and 4,000 rpm.
- Do not maintain a single speed for long periods of time, either fast or slow. Varying engine speed is needed to properly break-in the engine.
- Avoid hard stops, except in emergencies, to allow the brakes to seat properly.
- Don't tow a trailer during the first 1,200 miles (2,000 km) of operation.

### **RISK OF BURNS WHEN PARKING OR STOPPING VEHICLE.**

- Do not park or stop the vehicle near flammable items such as leaves, paper, oil, and tire. Such items placed near the exhaust system can become a fire hazard.
- When an engine idles at a high rpm with the rear side of the vehicle in close proximity of the wall, heat of the exhaust gas can cause discoloration or fire. Keep enough space between the rear part of the vehicle and the wall.
- Be sure not to touch the exhaust/catalytic systems while engine is running or right after the engine is turned off. There is a risk of burns since the systems are extremely hot.

## VEHICLE DATA COLLECTION AND EVENT DATA RECORDERS

This vehicle is equipped with an event data recorder (EDR). The main purpose of an EDR is to record, in certain crash or near crash-like situations, such as an air bag deployment or hitting a road obstacle, data that will assist in understanding how a vehicle's systems performed. The EDR is designed to record data related to vehicle dynamics and safety systems for a short period of time, typically 30 seconds or less. The EDR in this vehicle is designed to record such data as:

- How various systems in your vehicle were operating;
- Whether or not the driver and passenger safety belts were buckled/ fastened;
- How far (if at all) the driver was depressing the accelerator and/or brake pedal; and,
- How fast the vehicle was traveling.

These data can help provide a better understanding of the circumstances in which crashes and injuries occur. NOTE: EDR data are recorded by your vehicle only if a non-trivial crash situation occurs; no data are recorded by the EDR under normal driving conditions and no personal data (e.g., name, gender, age, and crash location) are recorded. However, other parties, such as law enforcement, could combine the EDR data with the type of personally identifying data routinely acquired during a crash investigation.

To read data recorded by an EDR, special equipment is required, and access to the vehicle or the EDR is needed. In addition to the vehicle manufacturer, other parties, such as law enforcement, that have the special equipment, can read the information if they have access to the vehicle or the EDR.

# Your vehicle at a glance

Exterior overview .....	2-2
Interior overview .....	2-4
Instrument panel overview .....	2-5
Engine compartment .....	2-6

## EXTERIOR OVERVIEW

■ Front view



- 1. Hood .....4-39
- 2. Head lamp (Features of your vehicle) ..4-118  
Head lamp (Maintenance) .....7-80
- 3. Wheel and tire (Maintenance) .....7-39  
Wheel and tire (Specification) .....8-4
- 4. Outside rearview mirror .....4-64
- 5. Wide sunroof.....4-45
- 6. Front windshield wiper blades  
(Features of your vehicle) .....4-122  
Front windshield wiper blades  
(Maintenance) .....7-33
- 7. Windows .....4-34
- 8. Parking Distance Warning .....4-111

※ The actual shape may differ from the illustration.

OCK017001N

■ Rear view



1. Door .....	4-16
2. Fuel filler lid .....	4-41
3. Rear combination lamp (Maintenance).....	7-80
4. High mounted stop lamp (Maintenance).....	7-81
5. Liftgate.....	4-21, 4-30
6. Antenna .....	4-169
7. Rear View Monitor .....	4-116
Surround View Monitoring (SVM) system .....	4-117
8. Reverse Parking Distance Warning ....	4-107
Parking Distance Warning .....	4-111

\* The actual shape may differ from the illustration.

OCK017002L

## INTERIOR OVERVIEW

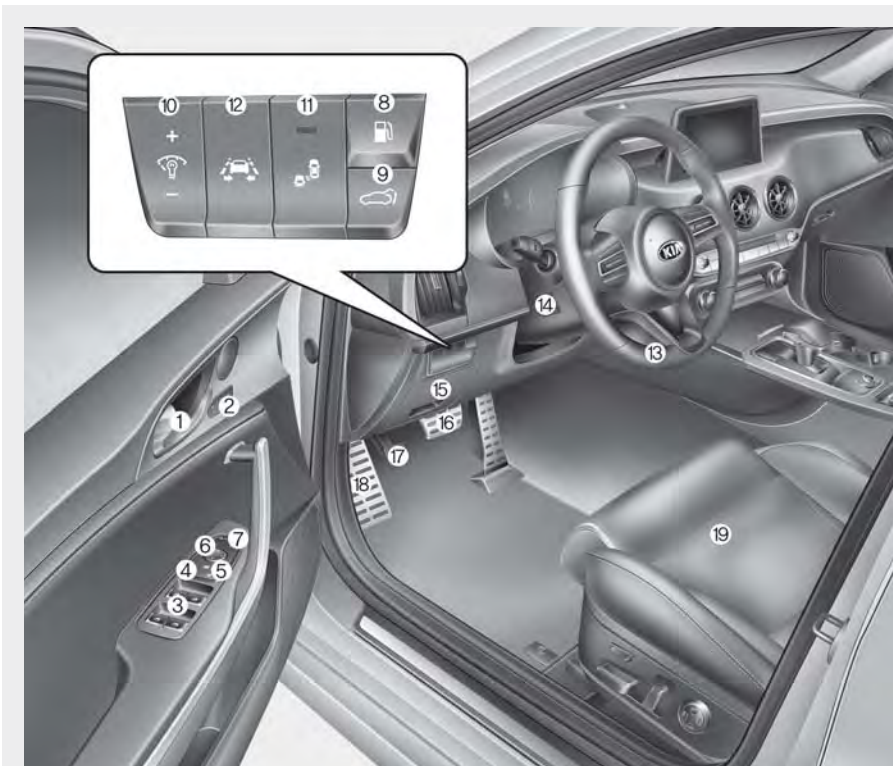

- 1. Door lock/unlock button.....4-17
- 2. Driver position memory system button .3-11
- 3. Power window switches .....4-34
- 4. Central door lock switch .....4-18
- 5. Power window lock button.....4-37
- 6. Outside rearview mirror control switch..4-64
- 7. Outside rearview mirror folding button..4-66
- 8. Fuel filler lid release button .....4-41
- 9. Power liftgate open/close button .....4-23
- 10. Instrument panel illumination control switch .....4-68
- 11. BCW ON/OFF button .....5-124
- 12. LKA ON/OFF button.....5-115
- 13. Steering wheel .....4-51
- 14. Steering wheel tilt control.....4-52
- 15. Inner fuse panel .....7-57
- 16. Brake pedal.....5-43
- 17. Parking brake pedal .....5-45
- 18. Hood release lever .....4-39
- 19. Seat.....3-4

\* The actual shape may differ from the illustration.

OCK018003N



## INSTRUMENT PANEL OVERVIEW



1. Driver's front air bag.....3-60
2. Horn .....4-54
3. Instrument cluster .....4-67
4. Wiper/Washer .....4-122
5. Engine start/stop button .....5-7
6. Cruise control .....5-81  
Smart cruise control system .....5-85
7. Hazard warning flasher switch.....6-2
8. Climate control system .....4-135
9. Automatic transmission.....5-11  
Automatic transmission  
(Shift-By-Wire) .....5-21
10. Heated steering wheel button.....4-53
11. ISG (Idle stop and go) system  
button .....5-104
12. Surround View Monitoring (SVM)  
system .....4-113
13. Seat warmer .....4-158  
Air ventilation switch .....4-159
14. EPB (Electronic parking brake) switch..5-48
15. AUTO HOLD control button .....5-53
16. Parking Distance Warning  
ON/OFF button .....4-111
17. Center console box.....4-155
18. USB charger .....4-162
19. Glove box.....4-155
20. Passenger's front air bag .....3-60
21. Power outlet .....4-161
22. Drive mode control knob .....5-108
23. ESC button .....5-59

\* The actual shape may differ from the illustration.

OCK018004N

## ENGINE COMPARTMENT

### ■ THETA II 2.0L T-GDI (Gasoline engine)



- 1. Engine coolant reservoir.....7-23
- 2. Radiator cap .....7-25
- 3. Engine oil filler cap .....7-21
- 4. Engine oil dipstick.....7-20
- 5. Brake fluid reservoir .....7-26
- 6. Fuse box.....7-59
- 7. Windshield washer fluid reservoir.....7-27
- 8. Air cleaner .....7-29

### ■ Lambda II PE 3.3L T-GDI (Gasoline engine)



※ The actual engine compartment in the vehicle may differ from the illustration.  
※ The battery is in the trunk.

OCK077001/OCK077002

# Safety features of your vehicle

<b>Important safety precautions</b> .....	3-2
• Always wear your seat belt .....	3-2
• Restrain all children .....	3-2
• Air bag hazards .....	3-2
• Driver distraction .....	3-2
• Control your speed .....	3-3
• Keep your vehicle in safe condition .....	3-3
<b>Seat</b> .....	3-4
• Front seat adjustment - power .....	3-8
• Driver position memory system (for power seat)...	3-11
• Headrest (for front seat) .....	3-14
• Seatback pocket .....	3-17
• Rear seat adjustment .....	3-17
<b>Seat belts</b> .....	3-22
• Seat belt restraint system .....	3-22
• Pre-tensioner seat belt .....	3-28
• Seat belt precautions .....	3-31
• Care of seat belts .....	3-32
<b>Child Restraint System (CRS)</b> .....	3-34
• Children always in the rear .....	3-34
• Selecting a Child Restraint System (CRS) .....	3-35
• Installing a Child Restraint System (CRS) .....	3-38

<b>Air bag - advanced supplemental restraint system</b> .....	3-45
• How does the air bag system operate? .....	3-46
• Air bag warning light .....	3-48
• SRS components and functions .....	3-49
• Occupant Detection System (ODS) .....	3-52
• Driver's and passenger's front air bag .....	3-60
• Side air bag .....	3-62
• Curtain air bag .....	3-64
• SRS Care .....	3-70
• Adding equipment to or modifying your air bag-equipped vehicle .....	3-71
• Air bag warning label .....	3-71

## IMPORTANT SAFETY PRECAUTIONS

You will find many safety precautions and recommendations throughout this section, and throughout this manual. The safety precautions in this section are among the most important.

### Always wear your seat belt

A seat belt is your best protection in all types of accidents. Air bags are designed to supplement seat belts, not replace them. So even though your vehicle is equipped with air bags, ALWAYS make sure you and your passengers wear your seat belts, and wear them properly.

### Restrain all children

All children under age 13 should ride in your vehicle properly restrained in a rear seat, not the front seat. Infants and small children should be restrained in an appropriate child restraint. Larger children should use a booster seat with the lap/shoulder belt until they can use the seat belt properly without a booster seat.

### Air bag hazards

While air bags can save lives, they can also cause serious or fatal injuries to occupants who sit too close to them, or who are not properly restrained. Infants, young children, and shorter adults are at the greatest risk of being injured by an inflating air bag. Follow all instructions and warnings in this manual.

### Driver distraction

Driver distraction presents a serious and potentially deadly danger, especially for inexperienced drivers. Safety should be the first concern when behind the wheel and drivers need to be aware of the wide array of potential distractions, such as drowsiness, reaching for objects, eating, personal grooming, other passengers, and using cellular phones.

Drivers can become distracted when they take their eyes and attention off the road or their hands off the wheel to focus on activities other than driving. To reduce your risk of distraction or getting into an accident:

- ALWAYS set up your mobile devices (i.e., MP3 players, phones, navigation units, etc.) when your vehicle is parked or safely stopped.

- ONLY use your mobile device when allowed by laws and when conditions permit safe use. NEVER text or email while driving. Most states have laws prohibiting drivers from texting. Some states and cities also prohibit drivers from using handheld phones.
- NEVER let the use of a mobile device distract you from driving. You have a responsibility to your passengers and others on the road to always drive safely, with your hands on the wheel as well as your eyes and attention on the road.

### **Control your speed**

Excessive speed is a major factor in crash injuries and deaths. Generally, the higher the speed, the greater the risk, but serious injuries can also occur at lower speeds. Never drive faster than is safe for current conditions, regardless of the maximum speed posted.

### **Keep your vehicle in safe condition**

Having a tire blowout or a mechanical failure can be extremely hazardous. To reduce the possibility of such problems, check your tire pressures and condition frequently, and perform all regularly scheduled maintenance.

## SEAT

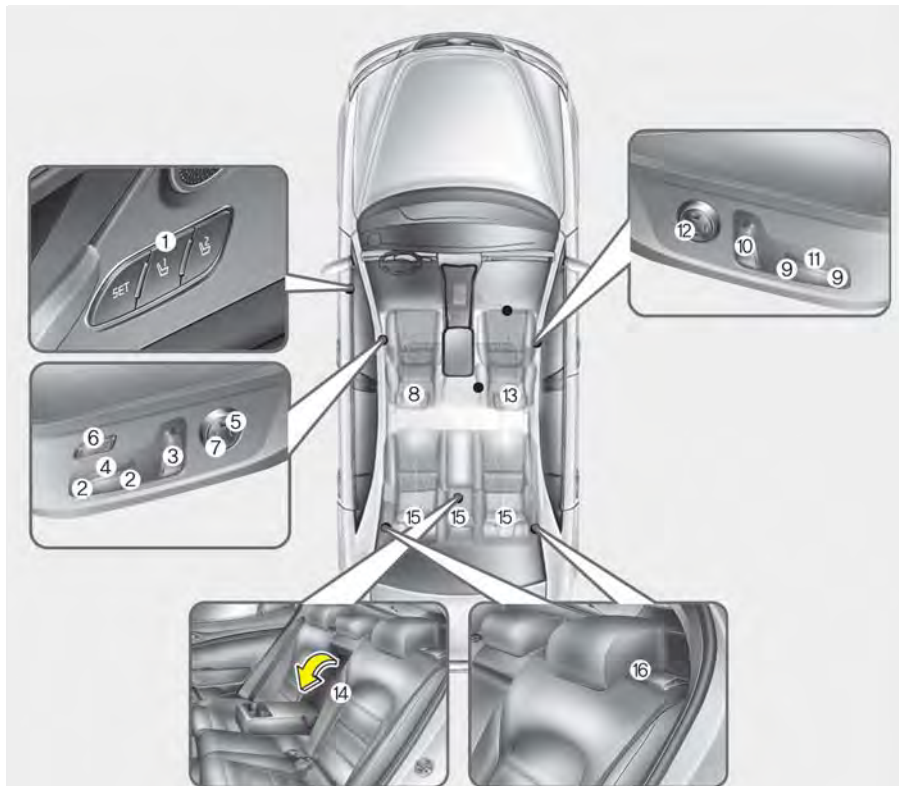

### Driver`s seat

- (1) Driver position memory system\*
- (2) Forward and backward
- (3) Seatback angle
- (4) Seat cushion height
- (5) Lumbar support\*
- (6) Cushion extension\*
- (7) Seat back bolster control \*
- (8) Headrest

### Front Passenger`s seat

- (9) Forward and backward
- (10) Seatback angle
- (11) Seat cushion height
- (12) Lumbar support\*
- (13) Headrest

### Rear seat

- (14) Armrest
- (15) Headrest
- (16) Seatback folding lever

\* : if equipped

※ The actual seat design in the vehicle may differ from the illustration.

OCK037001N

**⚠ WARNING - Loose objects**

Do not place anything in the driver's footwell or under the front seats. Loose objects in the driver's foot area could interfere with the operation of the foot pedals.

**⚠ WARNING - Driver responsibility for passengers**



The driver must advise the passengers to keep the seatback in an upright position whenever the vehicle is in motion. If a seat is reclined during an accident, the restraint system's ability to restrain will be greatly reduced.

**⚠ WARNING - Seat cushion**

Occupants should never sit on aftermarket seat cushions or sitting cushions. The passenger's hips may slide under the lap portion of the seat belt during an accident or a sudden stop.

**⚠ WARNING - Driver's seat**

- Never attempt to adjust the seat while the vehicle is moving. This could result in loss of control of your vehicle.
- Do not allow anything to interfere with the normal position of the seatback. Storing items against the seatback could result in serious or fatal injury in a sudden stop or collision.
- Sit as far back as possible from the steering wheel while still maintaining comfortable control of the your vehicle. A distance of at least 10" from your chest to the steering wheel is recommended. Failure to do so can result in air bag inflation injuries to the driver.

**⚠ WARNING - Rear seatbacks**

Always lock the rear seatback before driving. Failure to do so could result in passengers or objects being thrown forward injuring vehicle occupants.

**⚠ WARNING - Cargo Area**

Do not allow passengers to ride in the cargo area under any circumstance. The cargo area is solely for the purpose of transporting luggage or cargo.

**⚠ WARNING - Luggage and Cargo**

Do not stack pile or stack luggage or cargo higher than the seatback in the cargo area. In an accident the cargo could strike and injury a passenger. If objects are large, heavy or must be piled, they must be secured in the cargo area.



**⚠ WARNING - Seat adjustment**

- Do not adjust the seat while wearing seat belts. Moving the seat forward will cause strong pressure on the abdomen.
- Do not place your hand near the seat bottom or seat track while adjusting the seat. Your hand could get caught in the seat mechanism.

**⚠ WARNING - Small Objects**

Use extreme caution when picking up small objects trapped under the seats or between the seat and the center console. Your hands might be cut or injured by the sharp edges of the seats mechanism.

**Feature of Seat Leather**

- Leather is made from the outer skin of an animal, which goes through a special process to be available for use. Since it is a natural substance, each part differs in thickness or density.  
Wrinkles may appear as a natural result of stretching and shrinking depending on the temperature and humidity.
- The seat cover is made of stretchable material to improve comfort of passengers.
- The parts contacting the body are curved and the side supporting area is high which provides driving comfort and stability.
- Wrinkles may appear naturally from usage. It is not a fault of the product.

**⚠ CAUTION**

- *Belts with metallic accessories, zippers or keys inside your back pants pocket may damage the seat fabric.*
- *Make sure not to wet the seat. It may change the nature of natural leather.*
- *Jeans or clothes which contain bleach may contaminate the surface of the seat covering fabric and cause damage or discoloration.*

**\* NOTICE**

Wrinkles or abrasions which appear naturally from usage are not covered by warranty.

### Front seat adjustment - power

The front seat can be adjusted by using the control switches located on the outside of the seat cushion. Before driving, adjust the seat to the proper position so you can easily control the steering wheel, pedals and switches on the instrument panel.

**⚠ WARNING - Unattended children**

**Do not leave children unattended in the vehicle. Children might operate features of the vehicle that could injure them.**

**⚠ CAUTION - Power seat adjustments**

*The power seating controls function by electronic motor.*

*Excessive operation may cause damage to the electrical equipment.*

**⚠ CAUTION - Power Seating**

*Do not operate two or more power seat control switches at the same time. Doing so may damage the power seat motor or electrical components.*

When in operation, the power seat consumes a large amount of electrical power. To prevent unnecessary system drain, don't adjust the power seat longer than necessary while the engine is not running.

### Forward and backward

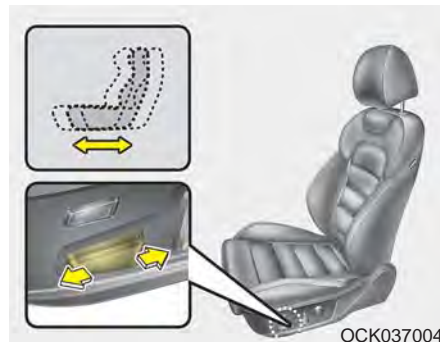

Push the control switch forward or backward to move the seat to the desired position. When the control switch is operated forward, the seat cushion is slightly raised, and the seat cushion lowered when the switch is operated backward.

Release the switch once the seat reaches the desired position.

**Cushion extension  
(for driver's seat, if equipped)**

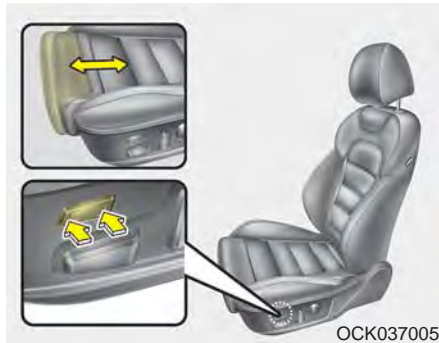

To move the front part of cushion forward:

1. Push the front part of control switch to move the seat cushion to the desired length.
2. Release the switch once the seat cushion reaches the desired length.

To move the front part of cushion rearward:

1. Push the rear part of control switch to move the seat cushion to the desired length.
2. Release the switch once the seat cushion reaches the desired length.

**Seatback angle**

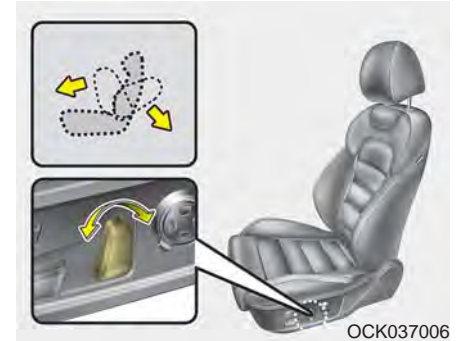

Push the control switch forward or backward to move the seatback to the desired angle. Release the switch once the seat reaches the desired position.

### Seat height

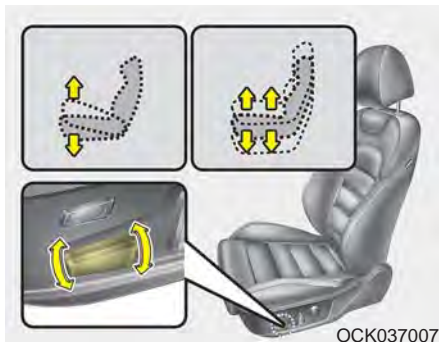

Pull the front portion of the control switch up to raise or press down to lower the front part of the seat cushion. Pull the rear portion of the control switch up to raise or press down to lower the seat cushion. Release the switch once the seat reaches the desired position.

### Lumbar support (if equipped)

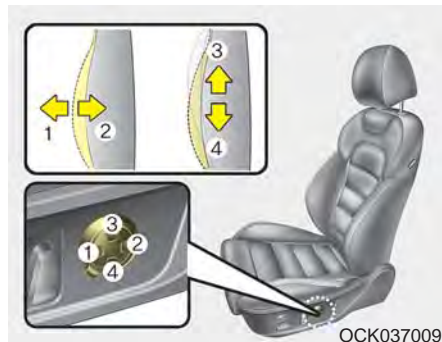

**The lumbar support can be adjusted by pressing the lumbar support switch on the side of the seat.**

1. Press the front portion of the switch to increase support, or the rear portion of the switch to decrease support.
2. Release the switch once it reaches the desired position.

3. Press the upper portion of the switch to move the support position up, or press the lower portion of the switch to move the support position down.
4. Release the switch once it reaches the desired position.

**Seat back bolster control**  
(For driver seat, if equipped)

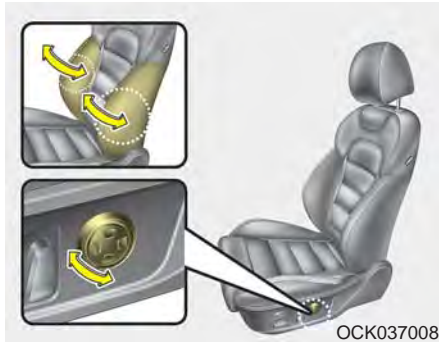

1. Turn the adjustment switch clockwise, the right/left seatback bolsters will be adjusted inward. Turn the switch counterclockwise, the seatback bolster will be adjusted outward.

2. To adjust the bolster height to its maximum in the default state, operate the switch for 8 seconds. After that, release the switch because there is no change in height even if you continue to operate the switch.
3. Once adjustment is done, leave the switch in place.

**Driver position memory system**  
(if equipped, for power seat)



Driver Position Memory System is the facility that enables driver's seat, leg extension, steering wheel, outside rear view mirrors, cluster and head-up display (HUD) to be controlled with a simple button operation, which allows a driver to recall memorized driving positions to suit your preferences.

- Driver's seat/Leg extension/Steering Wheel/Exterior mirrors: Position
- Cluster: Brightness of lighting
- Head Up Display (HUD): Position and brightness.

**⚠ WARNING - Driver  
Position Memory System**

**Never attempt to operate the driver position memory system while the vehicle is moving.**

**This could result in loss of control, and an accident causing death or serious injury.**

***Storing positions into memory  
using the buttons on the door***

**Storing driver's seat positions**

1. Press the Parking button while the engine start/stop button is ON.
2. Adjust the driver's seat, including leg extension if equipped and outside rearview mirrors and head up display comfortable for the driver.
3. Press SET button on the control panel. The system will beep once.
4. Press one of the memory buttons (1 or 2) within 4 seconds after pressing the SET button. The system will beep twice when memory has been successfully stored.

When recalling an adjustment memory button while sitting in the vehicle, you can be surprised by the setting chosen if the memory has been adjusted by someone else. If that occurs, immediately push the seat position control knob in the direction of the desired position to stop further undesired movement.

**Recalling positions from memory**

1. Press the Parking button while the engine start/stop button is ON.
2. To recall the position in the memory, press the desired memory button (1 or 2). The system will beep once, then the driver's seat will automatically adjust to the stored position.

Adjusting the control switch for the driver's seat while the system is recalling the stored position will cause the movement to stop and move in the direction that the control switch is moved.

***Easy access function (if equipped)***

When exiting the vehicle, the steering wheel will move away from the driver and the seat will move rearward when the engine is turned off.

When entering the vehicle, the steering wheel will move toward the driver and the seat will move forward when the Engine Start/Stop Button is pressed to the ACC position or START position.

You can activate or deactivate this feature. Refer to “User settings” in chapter 4.

***Driver position memory system reset***

If the Driver position memory system reset fails to work, initialize the system as follows.

How to initialize:

1. Stop the car and open the driver's door with the Engine start/stop button in ON and the automatic shift lever in P (parking) position.
2. Pull the driver's seat forward as far as possible and have the seatback upright as much as possible using driver's seat forward adjustment and seatback angle (recline) movement switches.
3. Push SET button and seat forward movement switch button for 2 seconds simultaneously.

 **CAUTION**

- ***If alarm sound and driver seat adjustment stop while initialization is in process, re-start initialization.***
- ***Make sure that there are no obstacles around the driver seat before proceeding with initialization.***
- ***Once initialization is completed, adjust seats conforming to your ideal driving position and save the customized seat settings.***

Initialization in the process :

1. Initialization begins as the alarm sounds.
2. The seat and seatback will automatically move backwards. The alarm sound will continue while the system is in operation.
3. Initialization will be all set after the seat and seatback move to the center with alarm sound being raised. If, however, any of the following occur, the initialization process will come to a stop and the alarm sound will stop as well.
  - When pushing driving position memory system button
  - When pushing driver's seat height adjustment switch
  - When changing the shift lever from P position to other positions
  - When the driving speed exceeds 2 mph (3 km/h)
  - When the driver's door is closed

### Headrest (for front seat)

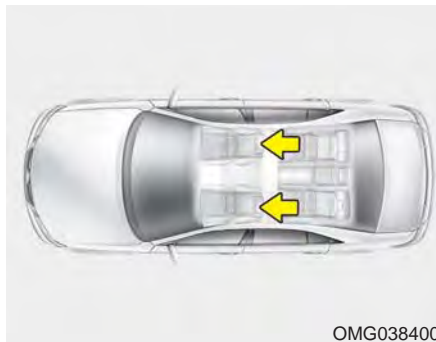

The driver's and front passenger's seats are equipped with a headrest for the occupant's safety and comfort.

The headrest not only provides comfort for the driver and front passenger, but also helps protect the head and neck in the event of a rear-end collision.

For maximum effectiveness in case of an accident, the headrest should be adjusted so the middle of the headrest is at the same height of the center of gravity of an occupant's head. Generally, the center of gravity of most people's head is similar with the height of the top of their eyes. Also, adjust the headrest as close to your head as possible. For this reason, the use of a cushion that holds the body away from the seatback is not recommended.



**⚠ WARNING - Headrest removal/adjustment**

- Do not operate the vehicle with the headrests removed. Headrests can provide critical neck and head support in a crash.
- Do not adjust the headrest height while the vehicle is in motion. Driver may lose control of the vehicle.

**⚠ CAUTION**

*Excessive pulling or pushing may damage the headrest.*

**Adjusting the height up and down**

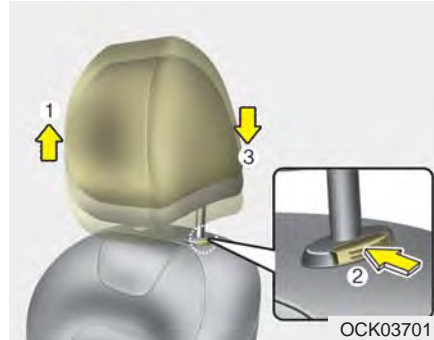

To raise the headrest, pull it up to the desired position (1). To lower the headrest, push and hold the release button (2) on the headrest support and lower the headrest to the desired position (3).

**Forward and backward adjustment**

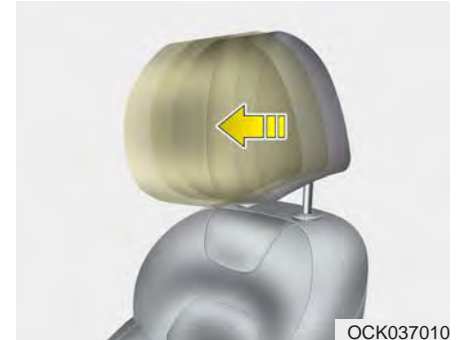

The headrest may be adjusted forward to 4 different positions by pulling the headrest forward to the desired detent.

To adjust the headrest to its furthest backwards position,

Pull the headrest fully forward to the farthest position and release it.

Adjust the headrest so that it properly supports the head and neck.

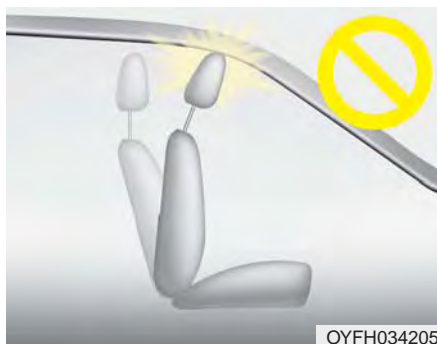

**\* NOTICE**

If you recline the seatback towards the front with the headrest and seat cushion raised, the headrest may come in contact with the sunvisor or other parts of the vehicle.

**Removal and reinstallation**

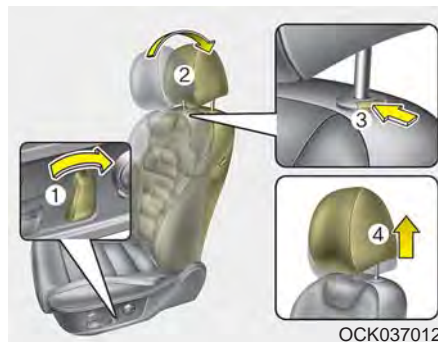

To remove the headrest:

1. Recline the seatback (2) with the recline switch (1).
2. Raise headrest as far as it can go.
3. Press the headrest release button (3) while pulling the headrest up (4).

**⚠ WARNING - Headrest Removal**  
**NEVER** allow anyone to ride in a seat with the headrest removed. Headrests can provide critical neck and head support in a crash.

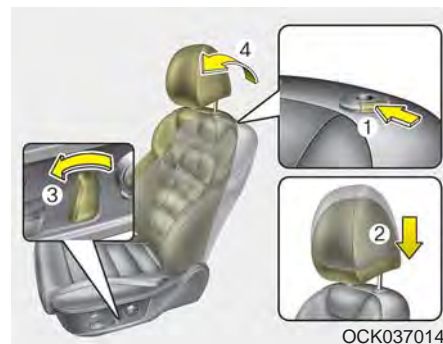

To reinstall the headrest :

1. Put the headrest poles (2) into the holes while pressing the release button (1).
2. Recline the seatback (4) with the recline switch (3).
3. Adjust the headrest to the appropriate height.

**⚠ WARNING - Headrest Reinstallation**  
To reduce the risk of injury to the head or neck, always make sure the headrest is locked into position and adjusted properly after reinstalling.

## Seatback pocket

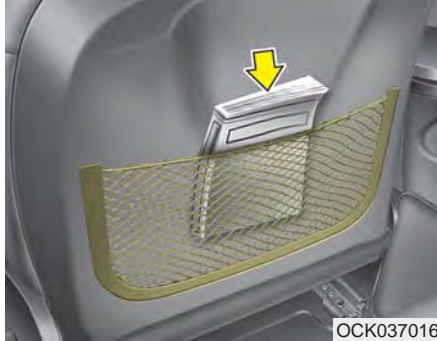

The seatback pocket is provided on the back of the front passenger's and driver's seatbacks.

**⚠ WARNING - Seatback pockets**

**Do not put heavy or sharp objects in the seatback pockets. In an accident they could come loose from the pocket and injure vehicle occupants.**

## Rear seat adjustment

### Headrest

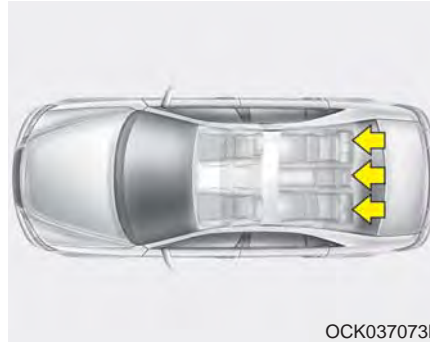

The rear seat is equipped with headrests in all the seating positions for the occupant's safety and comfort.

The headrest not only provides comfort for passengers, but also helps protect the head and neck in the event of a collision.

For maximum effectiveness in case of an accident, the headrest should be adjusted so the middle of the headrest is at the same height of the center of gravity of an occupant's head. Generally, the center of gravity of most people's heads is similar with the height as the top of their eyes.

Also, adjust the headrest as close to your head as possible. For this reason, the use of a cushion that holds the body away from the seatback is not recommended.

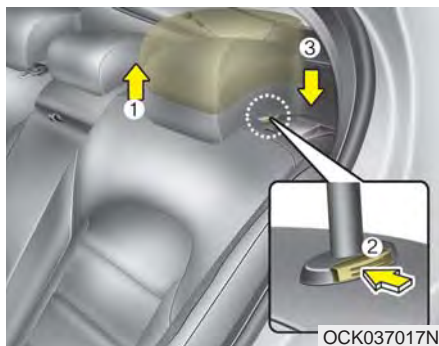

### Adjusting the height up and down

To raise the headrest, pull it up to the desired position (1). To lower the headrest, push and hold the release button (2) on the headrest support and lower the headrest to the desired position (3).

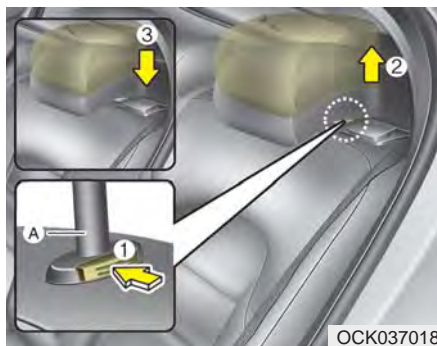

### Removal and reinstallation

To remove the headrest, raise it as far as it can go then press the release button (1) while pulling the headrest upward (2).

To reinstall the headrest, put the headrest poles (3) into the holes while pressing the release button (1). Then adjust it to the appropriate height and ensure that it locks in position.

### Armrest

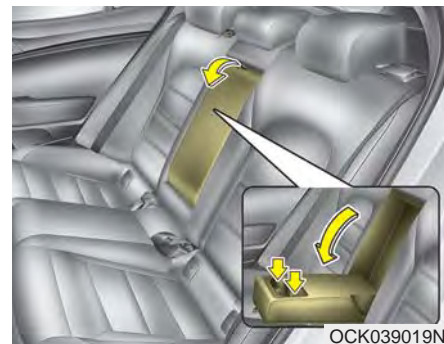

To use the armrest, pull it forward from the seatback.

### Folding the rear seat

The rear seatbacks may be folded to facilitate carrying long items or to increase the luggage capacity of the vehicle.

#### **⚠ WARNING**

The purpose of the fold-down rear seatbacks is to allow you to carry longer objects that could not otherwise be accommodated.

Never allow passengers to sit on top of the folded down seatback while the car is moving as this is not a proper seating position and no seat belts are available for use. This could result in serious injury or death in case of an accident or sudden stop. Objects carried on the folded down seatback should not extend higher than the top of the front seats. This could allow cargo to slide forward and cause injury or damage during sudden stops.

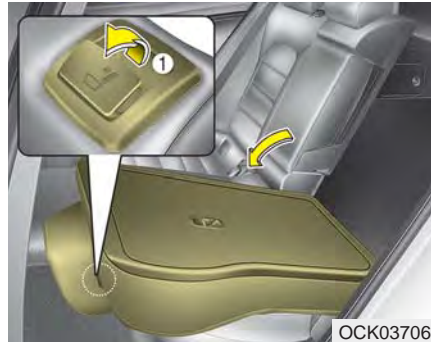

#### To fold down the rear seatback

1. Make sure the rear seat belt webbing is in the guide to prevent the seat belt from being damaged.
2. Set the front seatback to the upright position and if necessary, slide the front seat forward.
3. Lower the rear headrests to the lowest position.
4. Pull on the seatback folding lever(1), then fold the seat toward the front of the vehicle.

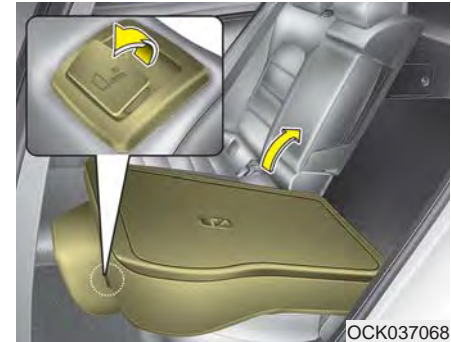

5. To use the rear seat, lift and push the seatback backward. Push the seat back firmly until it clicks into place. Make sure the seatback is locked in place.
6. Return the rear seat belt to the proper position.

#### **⚠ CAUTION**

***Be careful when loading cargo through the rear passenger seats to prevent damage to the vehicle interior.***

**⚠ WARNING**

Unless the driver's position is properly set according to the driver's physical figure, do not fold the rear seat. It may increase body injuries in a sudden stop or collision.

**⚠ WARNING - Uprighting seat**

When you return the seatback to its upright position, hold the seatback and return it slowly. If the seatback is returned without holding it, the back of the seat could spring forward resulting in injury caused by being struck by the seatback.

**⚠ WARNING**

When you return the rear seatback to its upright position after being folded down:

Be careful not to damage the seat belt webbing or buckle. Do not allow the seat belt webbing or buckle to get caught or pinched in the rear seat. Ensure that the seatback is completely locked into its upright position by pushing on the top of the seatback. Otherwise, in an accident or sudden stop, the seat could fold down and allow cargo enter the passenger compartment, which could result in serious injury or death.

**⚠ CAUTION - Damaging rear seat belt buckles**

*When you fold the rear seatback, insert the buckle between the rear seatback and cushion. Doing so can prevent the buckle from being damaged by the rear seatback.*

**⚠ CAUTION - Rear seat belts**

*When returning the rear seatbacks to the upright position, remember to return the rear shoulder belts to their proper position.*

**⚠ WARNING - Cargo**

Cargo should always be secured to prevent it from being thrown about the vehicle in a collision and causing injury to the vehicle occupants. Do not place objects in the rear seats, since they cannot be properly secured and may hit the front seat occupants in a collision.

**⚠ WARNING - Objects**

Objects carried on the folded down seatback should not extend higher than the top of the front seatbacks. This could allow cargo to slide forward and cause injury or damage during sudden stops.

**⚠ WARNING - Cargo loading**

Make sure the engine is off, the transmission is in P (Park) and the parking brake is securely applied whenever loading or unloading cargo. Failure to take these steps may allow the vehicle to move if the shift lever is inadvertently moved to another position.

## SEAT BELTS

### Seat belt restraint system

- For maximum restraint system protection, the seat belts must always be used whenever the vehicle is moving. A properly positioned shoulder belt should be positioned midway over your shoulder across your collarbone.
- Never allow children to ride in the front passenger seat. See child restraint system section for further discussion.

#### **WARNING - Twisted seat belt**

**Make sure your seat belt is not twisted when worn. A twisted seat belt may not properly protect you in an accident and could even cut into your body.**

#### **WARNING - Shoulder Belt**

- **Never wear the shoulder belt under your arm or behind your back. An improperly positioned shoulder belt cannot protect the occupant in a crash.**
- **Always wear both the shoulder portion and lap portion of the lap/shoulder belt.**

#### **WARNING - Damaged seat belt**

**Replace the entire seat belt assembly if any part of the webbing or hardware is damaged as you can no longer be sure that a damaged seat belt will provide protection in a crash.**

Seat belts are designed to bear upon the bony structure of the body, and should be worn low across the front of the pelvis, chest and shoulders, as applicable; wearing the lap section of the belt across the abdominal area must be avoided.

Seat belts should be adjusted as firmly as possible, consistent with comfort, to provide the protection for which they have been designed.

A slack belt will greatly reduce the protection afforded to the wearer.

Care should be taken to avoid contamination of the webbing with polishes, oils and chemicals, and particularly battery acid. Cleaning may safely be carried out using mild soap and water. The belt should be replaced if webbing becomes frayed, contaminated or damaged.

- No modifications or additions should be made by the user which would either prevent the seat belt adjusting devices from operating to remove slack, or prevent the seat belt assembly from being adjusted to remove slack.



- When you fasten the seat belt, be careful not to latch the seat belt in buckles of other seats. It's very dangerous and you may not be protected by the seat belt properly.
- Do not unfasten the seat belt and do not fasten and unfasten the seat belt repeatedly while driving. This could result in loss of control, and an accident causing death, serious injury, or property damage.
- When fastening the seat belt, make sure that the seat belt does not pass over objects that are hard or can break easily.

**⚠ WARNING - Seat belt buckle**

**Do not allow foreign material (gum, crumbs, coins, etc.) to obstruct the seat belt buckle. This may prevent the seat belt from fastening securely.**

**Seat belt warning**



**Driver's seat belt warning**

As a reminder to the driver, the seat belt warning light will illuminate for approximately 6 seconds each time the engine start/stop button is in ON regardless of belt fastening and warning chime will sound for approximately 6 seconds each time the engine start/stop button is in ON when the belt is unfastened.

If a driver continues not to fasten the seat belt and drive 5.6 mph (9 km/h) or more but less than 12 mph (20 km/h), the warning light will stay illuminated.

If a driver continues not to fasten the seat belt while driving over 12 mph (20 km/h), the seat belt warning chime will sound for approximately 100 seconds and the corresponding warning light will blink.

If a driver unfastens the seat belt while driving below 12 mph (20 km/h), the warning light will stay illuminated.

If a driver unfastens the seat belt while driving over 12 mph (20 km/h), the seat belt warning chime will sound for approximately 100 seconds and the corresponding warning light will blink.

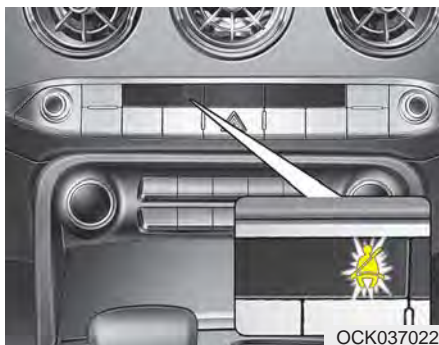

### Front passenger's seat belt warning

As a reminder to the front passenger, the front passenger's seat belt warning lights will illuminate for approximately 6 seconds each time you turn the Engine start/stop button in ON regardless of belt fastening.

If the front passenger continues not to fasten the seat belt and the vehicle is moving 5.6 mph (9 km/h) or more but less than 12 mph (20 km/h), the warning light will stay illuminated.

If the front passenger continues not to fasten the seat belt while the vehicle is moving over 12 mph (20 km/h), the seat belt warning chime will sound for approximately 100 seconds and the corresponding warning light will blink.

If the front passenger unfastens the seat belt while the vehicle is moving below 12 mph (20 km/h), the warning light will stay illuminated.

If the front passenger unfastens the seat belt while the vehicle is moving over 12 mph (20 km/h), the seat belt warning chime will sound for approximately 100 seconds and the corresponding warning light will blink.

### Lap/shoulder belt

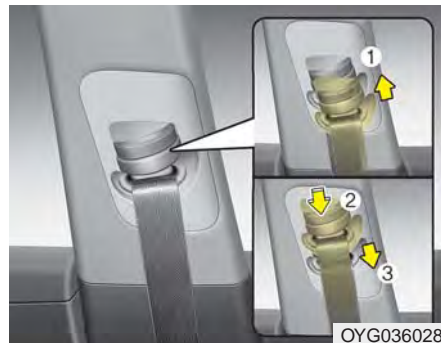

### Height adjustment

You can adjust the height of the shoulder belt anchor to one of 4 positions for maximum comfort and safety.

The height of the adjusting seat belt should not be too close to your neck. Otherwise, you will not be getting the most effective protection. The shoulder portion should be adjusted so that it lies across your chest and mid-way over your shoulder near the door and not your neck.

To adjust the height of the seat belt anchor, lower or raise the height adjuster into an appropriate position.

To raise the height adjuster, pull it up (1). To lower it, push it down (3) while pressing the height adjuster button (2).

Release the button to lock the anchor into position. Try sliding the height adjuster to make sure that it has locked into position.

Improperly positioned seat belts can cause serious injuries in an accident.

**⚠ WARNING**  
**- Shoulder belt positioning**  
**Never position the shoulder belt across your neck or face.**

**⚠ WARNING**  
**- Seat belt replacement**  
**Replace your seat belts after being in an accident. Failure to replace seat belts after an accident could leave you with damaged seat belts that will not provide protection in the event of another collision.**

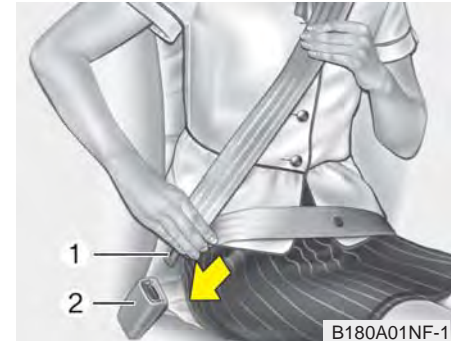

#### To fasten your seat belt:

To fasten your seat belt, pull it out of the retractor and insert the metal tab (1) into the buckle (2). There will be an audible “click” when the tab locks into the buckle.

The seat belt automatically adjusts to the proper length only after the lap belt portion is adjusted manually so that it fits snugly around your hips. If you lean forward in a slow, easy motion, the belt will extend and let you move around. If there is a sudden stop or impact, however, the belt will lock into position. It will also lock if you try to lean forward too quickly.

**\* NOTICE**

If you are not able to pull out the seat belt from the retractor, firmly pull the belt out and release it. Then you will be able to pull the belt out smoothly.

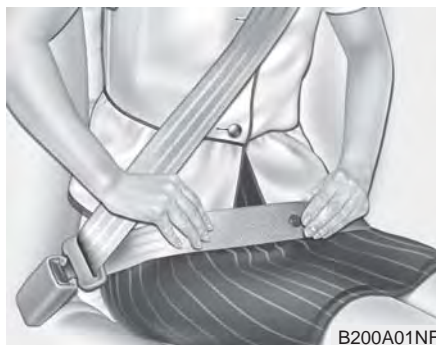

**⚠ WARNING**

You should place the lap belt portion as low as possible and snugly across your hips, not on your waist. If the lap belt is located too high on your waist, it may increase the chance of injury in the event of a collision. Both arms should not be under or over the belt. Rather, one should be over and the other under, as shown in the illustration.

Never wear the seat belt under the arm near the door.

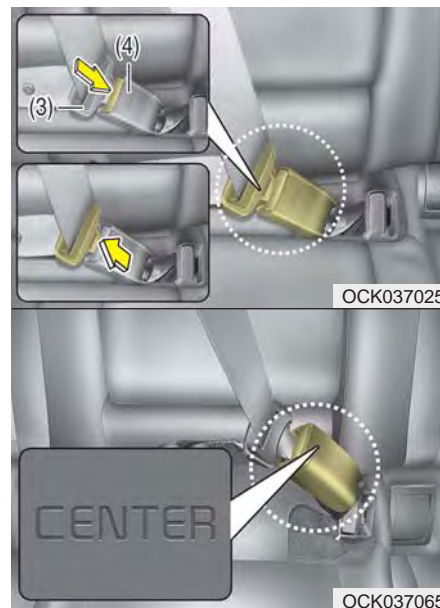

**To fasten seat belts in the rear seats:**

Pull the metal tab (3) and insert it into the buckle (4). There will be an audible “click” when the tab locks into the buckle. Make sure the belt is not twisted.

When using the rear center seat belt the buckle with the “CENTER” mark must be used.

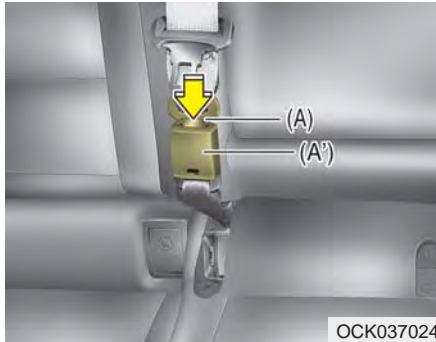

**⚠ WARNING**

**Always have the metal tab(A) inserted into the buckle (A').**

**\* NOTICE**

If you are not able to pull out the safety belt from the retractor, firmly pull the belt out and release it. After release, you will be able to pull the belt out smoothly.

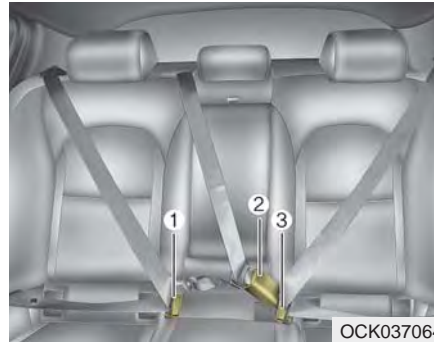

The seat belt should be locked into the buckle on each seat cushion to be properly fastened.

- ① : Rear right seat belt fastening buckle
- ② : Rear center seat belt fastening buckle
- ③ : Rear left seat belt fastening buckle

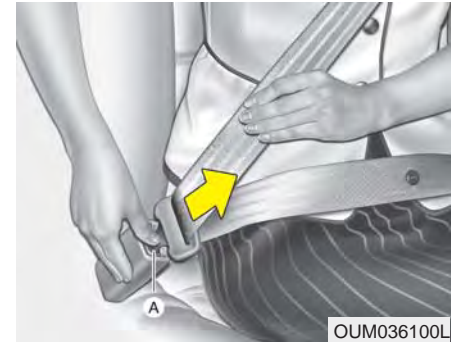

**To release the seat belt:**

The seat belt is released by pressing the release button (A) in the locking buckle. When it is released, the belt should automatically draw back into the retractor.

If this does not happen, check the belt to be sure it is not twisted, then try again.

**⚠ WARNING**

Prior to fastening the rear seat belts, ensure the latch matches the seat belt buckle. Forcefully fastening the left or right seat belt to the center buckle can result in an improper fastening scenario that will not protect you in an accident.

**Pre-tensioner seat belt**



Your vehicle is equipped with driver's and front passenger's pre-tensioner seat belts (retractor pretensioner and EFD (Emergency Fastening Device)). The pre-tensioner seat belts may be activated, when a frontal collision is severe enough, together with the air bags.

When the vehicle stops suddenly, or if the occupant tries to lean forward too quickly, the seat belt retractor may lock into position. In certain frontal collisions, the pre-tensioner will activate and pull the seat belt into tighter contact against the occupant's body.

(1) Retractor Pretensioner

The purpose of the retractor pretensioner is to make sure that the shoulder belts fit in tightly against the occupant's upper body in certain frontal collisions.

(2) EFD (Emergency Fastening Device)

The purpose of the EFD is to make sure that the pelvic belts fit in tightly against the occupant's lower body in certain collisions.

If the system detects excessive tension on the driver or passenger's seat belt when the pre-tensioner system activates, the load limiter inside the retractor pre-tensioner will release some of the pressure on the affected seat belt.

### \* NOTICE

When the pre-tensioner seat belts are activated, a loud noise may be heard with fine dust, which may appear to be smoke, may be visible in the passenger compartment. These are normal operating conditions and are not hazardous.



The seat belt pre-tensioner system consists mainly of the following components. Their locations are shown in the illustration:

- (1) SRS air bag warning light
- (2) Front retractor pre-tensioner assembly
- (3) SRS control module
- (4) Emergency fastening device (EFD)

**⚠ WARNING - Skin Irritation**  
Wash all exposed skin areas thoroughly after an accident in which the pre-tensioner seat belts were activated. The fine dust from the pre-tensioner activation may cause skin irritation and should not be breathed for prolonged periods.

### \* NOTICE

- Both the driver's and front passenger's seat belt pre-tensioner system may be activated not only in certain frontal collisions, but also in certain side collisions or rollovers, if the vehicle is equipped with a side or curtain air bag.
- Because the sensor that activates the SRS air bag is connected with the pre-tensioner seat belt, the SRS air bag warning light  on the instrument panel will illuminate for approximately 6 seconds after the Engine Start/Stop button has been turned to the ON position, and then it should turn off.

If the pre-tensioner seat belt system is not working properly, this warning light will illuminate even if there is not a malfunction with the SRS air bag. If the SRS air bag warning light does not illuminate when the Engine Start/Stop button is turned ON, or if it remains illuminated after illuminating for approximately 6 seconds, or if it illuminates while the vehicle is being driven, have an authorized Kia dealer inspect the pre-tensioner seat belt and SRS air bag system as soon as possible.

### \* NOTICE

Do not attempt to service or repair the pre-tensioner seat belt system in any manner. Do not attempt to inspect or replace the pre-tensioner seat belts yourself. This must be done by an authorized Kia dealer.

### **WARNING - Hot pre-tensioner**

**Do not touch the pre-tensioner seat belt assemblies for several minutes after they have been activated. When the pre-tensioner seat belt mechanism activates during a collision the pre-tensioner becomes hot and can burn you.**

Pre-tensioners are designed to operate only one time. After activation, pre-tensioner seat belts must be replaced. If the pre-tensioner must be replaced, contact an authorized Kia dealer.



## Seat belt precautions

### *Infant or small child*

All 50 states have child restraint laws. You should be aware of the specific requirements in your state. Child and/or infant seats must be properly placed and installed in the rear seat. For more information about the use of these restraints, refer to “Child restraint system” in this section.

### **\* NOTICE**

Small children are best protected from injury in an accident when properly restrained in the rear seat by a child restraint system that meets the requirements of the Federal Motor Vehicle Safety Standards. Before buying any child restraint system, make sure that it has a label certifying that it meets Federal Motor Vehicle Safety Standard 213. The restraint must be appropriate for your child's height and weight. Check the label on the child restraint for this information. Refer to “Child restraint system” in this section.

### *Larger children*

Children who are too large for child restraint systems should always occupy the rear seat and use the available lap/shoulder belts. The lap portion should be fastened and snugged on the hips as low as possible. Check periodically to insure that the belt fits. A child's squirming could put the belt out of position. Children are given the most safety in the event of an accident when they are restrained by a proper restraint system in the rear seat. If a larger child (over age 13) must be seated in the front seat, the child should be securely restrained by the available lap/shoulder belt and the seat should be placed in the rearmost position. Children age 13 and under should be restrained securely in the rear seat. NEVER place a child age 13 and under in the front seat. NEVER place a rear facing child seat in the front seat of a vehicle.

If the shoulder belt portion slightly touches the child's neck or face, try placing the child closer to the center of the vehicle. If the shoulder belt still touches their face or neck they need to be returned to a child restraint system.

**⚠ WARNING - Small children**  
**Do not allow small children to ride in the vehicle without an appropriate child restraint system. If the shoulder belt comes in contact with your child's neck or face, your child is too small to ride in the vehicle. In a crash the seat belt will inflict injury to your child's neck, throat and face.**

### ***Restraint of pregnant women***

Pregnant women should wear lap/shoulder belt assemblies whenever possible according to specific recommendations by their doctors. The lap portion of the belt should be worn **AS SECURELY AND LOW AS POSSIBLE**.

**⚠ WARNING - Pregnant women**

**Pregnant women must never place the lap portion of the seat belt above or on the abdomen where the fetus is located. The force of the seat belt during a collision will crush the fetus.**

### ***Injured person***

A seat belt should be used when an injured person is being transported. When this is necessary, you should consult a physician for recommendations.

### ***One person per belt***

Two people (including children) should never attempt to use a single seat belt. This could increase the severity of injuries in case of an accident.

### ***Do not lie down***

To reduce the chance of injuries in the event of an accident and to achieve maximum effectiveness of the restraint system, all passengers should be sitting up and the front and rear seats should be in an upright position when the vehicle is moving. A seat belt cannot provide proper protection if the person is lying down in the rear seat or if the front and rear seats are in a reclined position.

### **Care of seat belts**

Seat belt systems should never be disassembled or modified. In addition, care should be taken to assure that seat belts and belt hardware are not damaged by seat hinges, doors or other abuse.

**⚠ WARNING - Pinched seat belt**

**Make sure that the webbing and/or buckle does not get caught or pinched in the rear seat when returning the rear seatback to its upright position. A caught or pinched webbing/buckle may become damaged and could fail during a collision or sudden stop.**

***Periodic inspection***

All seat belts should be inspected periodically for wear or damage of any kind. Any damaged parts should be replaced as soon as possible.

***Keep belts clean and dry***

Seat belts should be kept clean and dry. If belts become dirty, they can be cleaned by using a mild soap solution and warm water. Chemical substances should not be used on seat belts to prevent any damage. Heated up seatbelts may burn infants and children.

***When to replace seat belts***

The entire in-use seat belt assembly or assemblies should be replaced if the vehicle has been involved in an accident. This should be done even if no damage is visible. Additional questions concerning seat belt operation should be directed to an authorized Kia dealer.

## CHILD RESTRAINT SYSTEM (CRS)

### Children Always in the Rear

**⚠ WARNING - Restraint Location**

**Never install a child or infant seat on the front passenger's seat. A child riding in the front passenger seat can be forcefully struck by an inflating airbag and seriously injured.**

**⚠ WARNING - Hot Child Restraint**

**A child restraint system can become very hot if it is left in a closed vehicle on a sunny day. Be sure to check the seat cover, buckles and latches before placing a child in the restraint system.**

Children under age 13 must always ride in the rear seats and must always be properly restrained to minimize the risk of injury in an accident, sudden stop or sudden maneuver. According to accident statistics, children are safer when properly restrained in the rear seats than in the front seat. Even with air bags, children can be seriously injured or killed. Children too large for a child restraint must use the seat belts provided.

All 50 states have child restraint laws which require children to travel in approved child restraint devices. The laws governing the age or height/weight restrictions at which seat belts can be used instead of child restraints differs among states, so you should be aware of the specific requirements in your state, and where you are travelling.

Child restraint systems must be properly placed and installed in the rear seat. You must use a commercially available child restraint system that meets the requirements of the Federal Motor Vehicle Safety Standards (FMVSS).

Child restraint systems are generally designed to be secured in a vehicle seat by lap belt portion of a lap/shoulder belt, or by a LATCH system in the rear seats of the vehicle.

### **Child restraint system (CRS)**

Infants and younger children must be restrained in an appropriate rear-facing or forward-facing CRS that has first been properly secured to the rear seat of the vehicle. Read and comply with the instructions for installation and use provided by the manufacturer of the child restraint.

#### **⚠ WARNING**

##### **- Child Restraint Installation**

An improperly secured child restraint can increase the risk of serious injury or death in an accident. Always take the following precautions when using a child restraint system:

- Always follow the child restraint system manufacturer's instructions for installation and use.

(Continued)

#### **(Continued)**

- Always properly restrain your child in the child restraint.
- If the vehicle head restraint prevents proper installation of a child seat (as described in the child restraint system manual), the head restraint of the respective seating position shall be readjusted or entirely removed.
- Do not use an infant carrier or a child safety seat that "hooks" over a seatback, it may not provide adequate protection in an accident.

#### **\* NOTICE**

If the vehicle has an accident, have a Kia dealer check the child restraint system, seat belts, tether anchors and lower anchors.

### **Selecting a Child Restraint System (CRS)**

When selecting a CRS for your child, always:

- Make sure the CRS has a label certifying that it meets applicable Federal Motor Vehicle Safety Standards (FMVSS 213).
- Select a child restraint based on your child's height and weight. The required label or the instructions for use typically provide this information.
- Select a child restraint that fits the vehicle seating position where it will be used.
- Read and comply with the warnings and instructions for installation and use provided with the child restraint system.

**⚠ WARNING - Holding Children**

Never hold a child in your arms or lap when riding in a vehicle. The violent forces created during a crash will tear the child from your arms and throw the child against the car's interior. Always use a child restraint system which is appropriate for your child's height and weight.

**⚠ WARNING - Unattended Children**

Never leave children unattended in a vehicle. The car can heat up very quickly, resulting in injuries to the child in the vehicle.

**⚠ WARNING - Seat Belt Use**

Do not use one seat belt for two occupants at the same time. This will eliminate any safety benefit provided by the seat belt to the occupants.

***Child restraint system types***

There are three main types of child restraint systems: rear-facing seats, forward-facing seats, and booster seats. They are classified according to the child's age, height and weight.

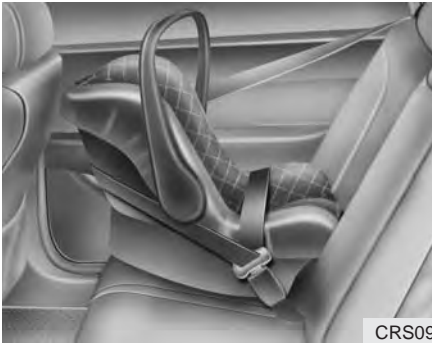

### Rear-facing child seats

A rear-facing child seat provides restraint with the seating surface against the back of the child. The harness system holds the child in place, and in an accident, acts to keep the child positioned in the seat and reduces the stress to the neck and spinal cord.

All children under age one must always ride in a rear-facing infant child restraint.

Convertible and 3-in-1 child seats typically have higher height and weight limits for the rear-facing position, allowing you to keep your child rear-facing for a longer period of time.

Continue to use a rear-facing child seat for as long as your child will fit within the height and weight limits allowed by the child seat manufacturer. It's the best way to keep them safe. Once your child has outgrown the rear-facing child restraint, your child is ready for a forward-facing child restraint with a harness.



### Forward-facing child restraints

A forward-facing child seat provides restraint for the child's body with a harness. Keep children in a forward-facing child seat with a harness until they reach the top height or weight limit allowed by your child restraint's manufacturer.

Once your child outgrows the forward-facing child restraint, your child is ready for a booster seat.

### Booster seats

A booster seat is a restraint designed to improve the fit of the vehicle's seat belt system. A booster seat positions the seat belt so that it fits properly over the lap of your child.

Keep your child in a booster seat until they are big enough to sit in the seat without a booster and still have the seat belt fit properly. For a seat belt to fit properly, the lap belt must lie snugly across the upper thighs, not the stomach. The shoulder belt should lie snug across the shoulder and chest and not across the neck or face. Children under age 13 must always ride in the rear seats and must always be properly restrained to minimize the risk of injury.

### Installing a Child Restraint System (CRS)

After selecting a proper child seat for your child, check to make sure it fits properly in your vehicle. Follow the instructions provided by the manufacturer when installing the child seat. Note these general steps when installing the seat to your vehicle:

- **Properly secure the child restraint to the vehicle.** All child restraints must be secured to the vehicle with the lap part of a lap/shoulder belt or with the LATCH system.
- **Make sure the child restraint is firmly secured.** After installing a child restraint to the vehicle, push and pull the seat forward and from side-to-side to verify that it is securely attached to the seat. A child restraint secured with a seat belt should be installed as firmly as possible. However, some side-to-side movement can be expected.
- **Secure the child in the child restraint.** Make sure the child is properly strapped in the child restraint according to the manufacturer instructions.

### *Lower Anchors and Tether for Children (LATCH) System*

The LATCH system holds a child restraint during driving and in an accident. This system is designed to make installation of the child restraint easier and reduce the possibility of improperly installing your child restraint. The LATCH system uses anchors in the vehicle and attachments on the child restraint. The LATCH system eliminates the need to use seat belts to secure the child restraint to the rear seats.

Lower anchors are metal bars built into the vehicle. There are two lower anchors for each LATCH seating position that will accommodate a child restraint with lower attachments.

To use the LATCH system in your vehicle, you must have a child restraint with LATCH attachments.

The child seat manufacturer will provide you with instructions on how to use the child seat with its attachments for the LATCH lower anchors.



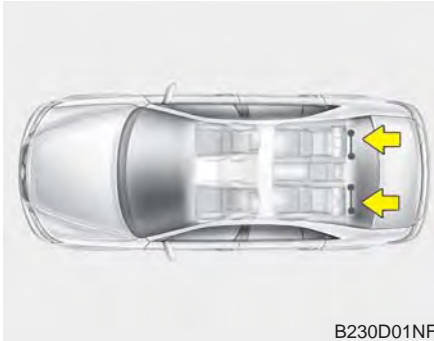

B230D01NF

LATCH anchors have been provided in the left and right outboard rear seating positions. Their locations are shown in the illustration. There are no LATCH anchors provided for the center rear seating position.

**⚠ WARNING - LATCH Lower Anchors**

**Never attempt to attach a LATCH equipped seat in the center seating position. LATCH lower anchors are only to be used in the left and right rear outboard seating positions. You may damage the anchors or the anchors may fail and break in a collision.**

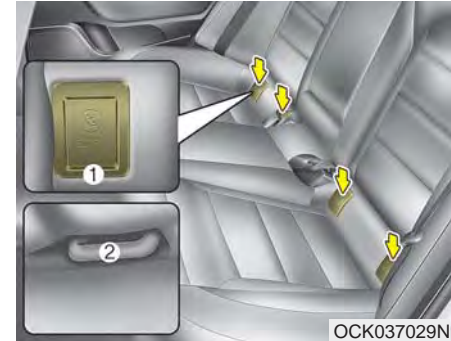

OCK037029N

The lower anchor position indicator symbols are located on the left and right rear seat backs to identify the position of the lower anchors in your vehicle (see arrows in illustration).

The LATCH anchors are located between the seatback and the seat cushion of the rear seat left and right outboard seating positions.

To use the lower anchor, push the upper portion of the lower anchor cover.

- \* (1) : Lower Anchor position indicator
- (2) : Lower Anchor

### ***Securing a child restraint with the LATCH anchors system***

To install a LATCH-compatible child restraint in either of the rear outboard seating positions:

1. Move the seat belt buckle away from the lower anchors.
2. Move any other objects away from the anchors that could prevent a secure connection between the child restraint and the lower anchors.
3. Place the child restraint on the vehicle seat, then attach the seat to the lower anchors according to the instructions provided by the child restraint manufacturer.
4. Follow the child restraint instructions for properly adjusting and tightening the lower attachments on the child restraint to the lower anchors.

### **⚠ WARNING**

**Take the following precautions when using the LATCH system:**

- **Read and follow all installation instructions provided with your child restraint system.**
- **To prevent the child from reaching and taking hold of the unused seat belts, buckle all unused rear seat belts before the child is placed into the vehicle. Lock each unused seat belt following the instructions in the "Automatic locking mode" subsection, and place the webbing behind the child seat or against an unused seat back. Children can be strangled if a shoulder belt becomes wrapped around their neck and the seat belt tightens.**
- **NEVER attach more than one child restraint to a single anchor. This could cause the anchor or attachment to come loose or break.**

**(Continued)**

**(Continued)**

- **Always have the LATCH system inspected by your authorized Kia dealer after an accident. An accident can damage the LATCH system and may not properly secure the child restraint.**

**\* NOTICE**

The recommended maximum weight for the LATCH system is 65 lbs. (30 kg). When selecting a proper child restraint, consider that the maximum total weight of the child plus the child restraint should be less than 65 lbs (30 kg).

As a guide, the MAX child restraint weight should be determined by the following calculation:

Child Restraint Weight =

65 - (child's total weight in lbs.)

*Securing a child restraint seat with "Tether Anchor" system*

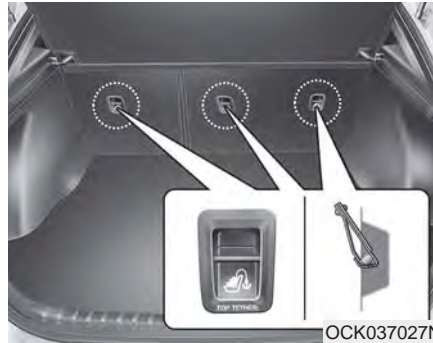

First secure the child restraint with the LATCH lower anchors or the seat belt. If the child restraint manufacturer recommends that the top tether strap be attached, attach and tighten the top tether strap to the top tether strap anchor.

Child restraint hook holders are located on the back of the rear seat-backs.

**⚠ WARNING**

Take the following precautions when installing the tether strap:

- Read and follow all installation instructions provided with your child restraint system.
- **NEVER** attach more than one child restraint to a single tether anchor. This could cause the anchor or attachment to come loose or break.
- Do not attach the tether strap to anything other than the correct tether anchor. It may not work properly if attached to something else.
- Do not use the tether anchors for adult seat belts or harnesses, or for attaching other items or equipment to the vehicle.
- Always fasten the seat belts behind the child restraint seat when they are not used to secure the child seat. Failure to do so may result in child strangulation.



To install the tether anchor:

1. Route the child restraint tether strap over the child restraint seatback. Route the tether strap under the head restraint and between the head restraint posts, or route the tether strap over the top of the vehicle seatback. Make sure the strap is not twisted.
2. Connect the tether strap hook to the tether anchor, then tighten the tether strap according to the child seat manufacturer's instructions to firmly secure the child restraint to the seat.

3. Check that the child restraint is securely attached to the seat by pushing and pulling the seat forward and from side-to-side.

### ***Securing a child restraint with a lap/shoulder belt***

When not using the LATCH system, all child restraints must be secured to a vehicle rear seat with the lap part of a lap/shoulder belt.

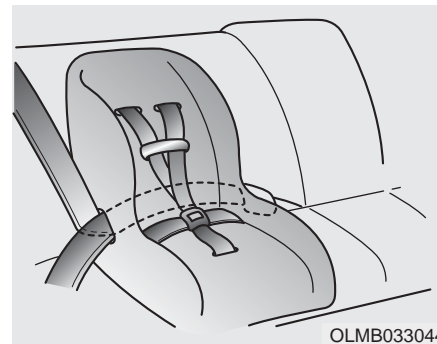

### **Automatic locking mode**

Since all passenger seat belts move freely under normal conditions and only lock under extreme or emergency conditions (emergency locking mode), you must manually pull the seat belt all the way out to shift the retractor to the "Automatic Locking" mode to secure a child restraint.

The "Automatic Locking" mode will help prevent the normal movement of the child in the vehicle from causing the seat belt to loosen and compromise the child restraint system. To secure a child restraint system, use the following procedure.

To install a child restraint system on the rear seats, do the following :

1. Place the child restraint system on a rear seat and route the lap/ shoulder belt around or through the child restraint, following the restraint manufacturer's instructions.

Be sure the seat belt webbing is not twisted.

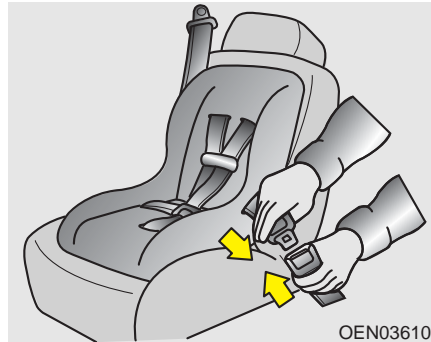

2. Fasten the lap/shoulder belt latch into the buckle. Listen for the distinct "click" sound.

Position the release button so that it is easy to access in case of an emergency.



3. Pull the shoulder portion of the seat belt all the way out. When the shoulder portion of the seat belt is fully extended, it will shift the retractor to the "Automatic Locking" (child restraint) mode.



4. Slowly allow the shoulder portion of the seat belt to retract and listen for an audible “clicking” or “ratcheting” sound. This indicates that the retractor is in the “Automatic Locking” mode. If no distinct sound is heard, repeat steps 3 and 4.

5. Remove as much slack from the belt as possible by pushing down on the child restraint system while feeding the shoulder belt back into the retractor.
6. Push and pull on the child restraint system to confirm that the seat belt is holding it firmly in place. If it is not, release the seat belt and repeat steps 2 through 6.
7. Double check that the retractor is in the “Automatic Locking” mode by attempting to pull more of the seat belt out of the retractor. If you cannot, the retractor is in the “Automatic Locking” mode.

If your CRS manufacturer instructs or recommends you to use a tether anchor with the lap/shoulder belt, refer to the previous pages for more information.

### \* NOTICE

When the seat belt is allowed to retract to its fully stowed position, the retractor will automatically switch from the “Automatic Locking” mode to the emergency lock mode for normal adult usage.

#### **⚠ WARNING - Auto lock mode**

**Set the retractor to Automatic Lock mode when installing any child restraint system. If the retractor is not in the Automatic Locking mode, the child restraint can move when your vehicle turns or stops suddenly.**

To remove the child restraint, press the release button on the buckle and then pull the lap/shoulder belt out of the restraint and allow the seat belt to retract fully.

## AIR BAG - ADVANCED SUPPLEMENTAL RESTRAINT SYSTEM

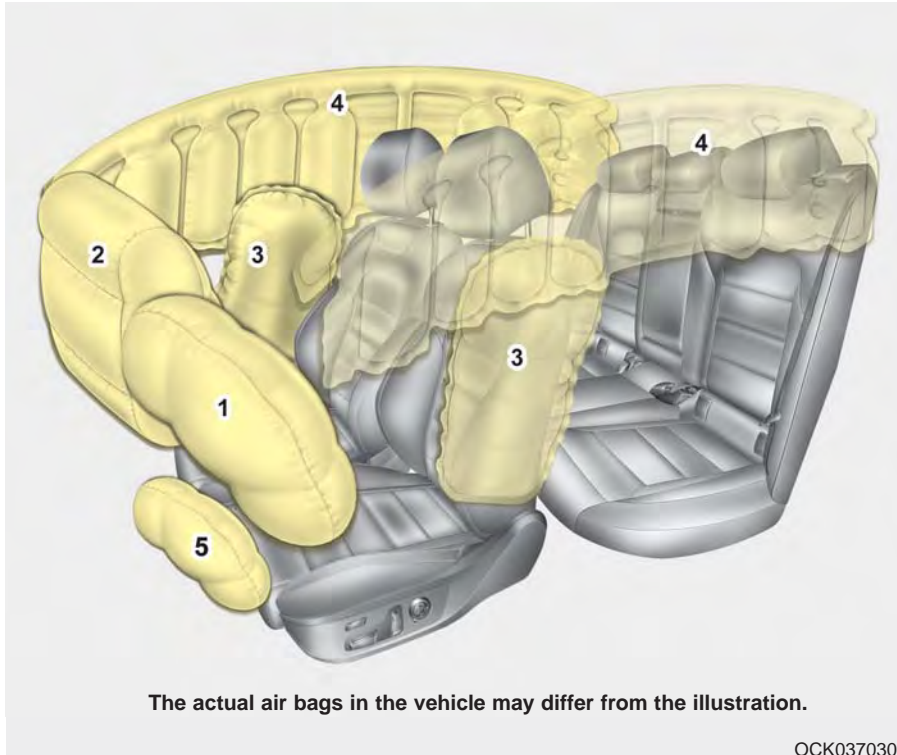

- (1) Driver's front air bag
- (2) Passenger's front air bag
- (3) Side air bag
- (4) Curtain air bag
- (5) Driver's knee air bag

Even in vehicles with air bags, you and your passengers must always wear the safety belts provided in order to minimize the risk and severity of injury in the event of a collision or rollover.

The actual air bags in the vehicle may differ from the illustration.

OCK037030N

### How does the air bag system operate?

- Air bags are activated (able to inflate if necessary) only when the Engine Start/Stop button is turned to the ON or engine is running.
- The appropriate air bags inflate instantly in the event of a serious frontal collision or side collision in order to help protect the occupants from serious physical injury.
- There is no single speed at which the air bags will inflate.

Generally, air bags are designed to inflate based upon the severity of a collision and its direction. These two factors determine whether the sensors produce an electronic deployment/ inflation signal.

- Air bag deployment depends on a number of factors including vehicle speed and angles of impact. The determining factors are not limited to those mentioned above.

- The front air bags will completely inflate and deflate in an instant.

It is virtually impossible for you to see the air bags inflate during an accident.

It is much more likely that you will simply see the deflated air bags hanging out of their storage compartments after the collision.

- In addition to inflating in serious side collisions, side and/or curtain air bags will inflate if the sensing system detects a rollover.
- When a rollover is detected, side and/or curtain air bags will remain inflated longer to help provide protection from ejection, especially when used in conjunction with the seat belts.

- In order to help provide protection, the air bags must inflate rapidly. The speed of the air bag inflation is a consequence of extremely short time in which to inflate the air bag between the occupant and the vehicle structures before the occupant impacts those structures. This speed of inflation reduces the risk of serious or life-threatening injuries and is thus a necessary part of the air bag design.

However, air bag inflation can also cause injuries which can include facial abrasions, bruises and broken bones because the inflation speed also causes the air bags to expand with a great deal of force.

- **There are even circumstances under which contact with the steering wheel or passenger air bag can cause fatal injuries, especially if the occupant is positioned excessively close to the steering wheel or passenger air bag.**



**⚠ WARNING - Airbag inflation**

**Sit as far back as possible from the steering wheel while still maintaining comfortable control of your vehicle. A distance of at least 10" from your chest to the steering wheel is recommended. Failure to do so can result in airbag inflation injuries to the driver.**

**Noise and smoke**

When inflated, the air bags make a loud noise and leave smoke and powder in the air inside the vehicle. This is normal and is a result of the ignition of the air bag inflator. After the air bag inflates, you may feel substantial discomfort in breathing due to the contact of your chest with both the seat belt and the air bag, as well as from breathing the smoke and powder. **Open your doors and/or windows as soon as possible after impact in order to reduce discomfort and prevent prolonged exposure to the smoke and powder.**

Though smoke and powder are non-toxic, it may cause irritation to the skin (eyes, nose and throat, etc). If this is the case, wash and rinse with cold water immediately and consult a doctor if the symptom persists.

**⚠ WARNING - Hot components**

**Do not touch the air bag storage area's internal components immediately after airbag inflation. The air bag related parts in the steering wheel, instrument panel and the roof rails above the front and rear doors are very hot. Hot components can result in burn injuries.**

**⚠ WARNING**

**Do not install or place any accessories near air bag deployment areas, such as the instrument panel, windows, pillars, and roof rails.**

*Do not install a child restraint on the front passenger's seat.*



Never place a rear-facing child restraint in the front passenger's seat. If the air bag deploys, it would impact the rear-facing child restraint, causing serious or fatal injury.

In addition, do not place front-facing child restraints in the front passenger's seat. If the front passenger air bag inflates, it could cause serious or fatal injuries to the child.

### **⚠ WARNING - Air bag deployment**

- When children are seated in the rear outboard seats of a vehicle equipped with side and/or curtain air bags, install the child restraint system as far away from the door side as possible. Inflation of the side and/or curtain air bags could impact the child.
- Do not install or place any accessories near air bag deployment areas, such as the instrument panel, windows, pillars, and roof rails.

### **Air bag warning light**



The purpose of air bag warning light in your instrument panel is to alert you of a potential problem with your air bag system, which could include your side and/or curtain air bags used for rollover protection.

## SRS components and functions

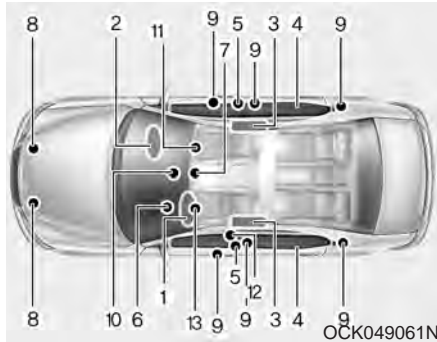

The SRS consists of the following components:

1. Driver's front air bag module
2. Passenger's front air bag module
3. Side air bag modules
4. Curtain air bag modules
5. Retractor pre-tensioner assemblies
6. Air bag warning light
7. SRS control module (SRSCM) / Rollover sensor
8. Front impact sensors

9. Side impact sensors
10. PASSENGER AIR BAG "OFF" indicator (Front passenger's seat only)
11. Occupant detection system (Front passenger's seat only)
12. Emergency fastening device (EFD)
13. Driver's knee air bag module



W7-147

If the air bag warning light is illuminated for more than 6 seconds after the Engine Start/Stop button is turned on, or if it illuminates during vehicle operation, an SRS component may not be functioning properly and you should have your vehicle checked by an authorized Kia dealer.

If any of the following conditions occur, this indicates a malfunction in the air bag system. Have an authorized Kia dealer inspect the air bag system as soon as possible.

- The light does not turn on briefly when you turn the Engine Start/Stop button to the ON position.
- The light stays on after illuminating for approximately 6 seconds.
- The light comes on while the vehicle is in motion.
- The light blinks when the Engine Start/Stop button to the ON position.

Driver's front air bag (1)

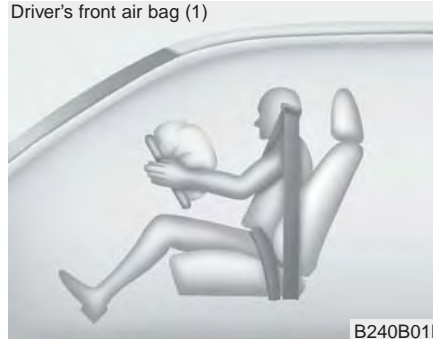

B240B01L

Driver's front air bag (2)



B240B02L

The front air bag modules are located both in the center of the steering wheel and in the front passenger's panel above the glove box. When the SRSCM detects a sufficiently severe impact to the front of the vehicle, it will automatically deploy the front air bags.

Upon deployment, tear seams molded directly into the pad covers will separate under pressure from the expansion of the air bags. Further opening of the covers then allows full inflation of the air bags.

Driver's front air bag (3)

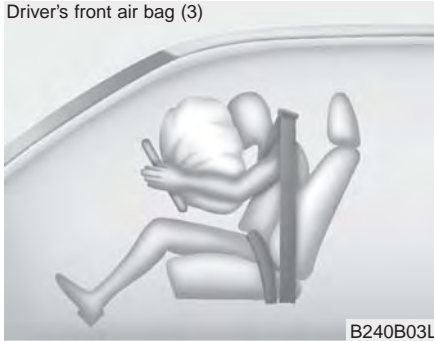

B240B03L

A fully inflated air bag, in combination with a properly worn seat belt, slows the driver's or the passenger's forward motion, reducing the risk of head and chest injury.

After complete inflation, the air bag immediately starts deflating, enabling the driver to maintain forward visibility and the ability to steer or operate other controls.

Passenger's front air bag



B240B05L

**⚠ WARNING - Air bag obstructions**

**Do not install or place any accessories on the steering wheel, instrument panel, or on the front passenger's panel above the glove box in a vehicle. Such objects may become dangerous projectiles if the air bag deploys.**

**⚠ WARNING - Flying objects**

**Do not place any objects (an umbrella, bag, etc.) between the front door and the front seat. Such objects may become dangerous projectiles if the side airbag inflates.**

- If an air bag deploys, there may be a loud noise followed by a fine dust released in the vehicle. These conditions are normal and are not hazardous - the air bags are packed in this fine powder. The dust generated during air bag deployment may cause skin or eye irritation as well as aggravate asthma for some persons. Always wash all exposed skin areas thoroughly with cold water and a mild soap after an accident in which the air bags were deployed.

- The SRS can function only when the Engine Start/Stop button is in the ON position. If the SRS air bag warning light does not illuminate, or continuously remains on after illuminating for about 6 seconds when the ignition switch is turned to the ON position, or after the engine is started, comes on while driving, the SRS is not working properly. If this occurs, have your vehicle immediately inspected by an authorized Kia dealer.

### \* NOTICE

**Before you replace a fuse or disconnect a battery terminal, turn the Engine Start/Stop button to the OFF position.**

**Never remove or replace the air bag related fuse (s) when the Engine Start/Stop button to the ON position. Failure to heed this warning will cause the SRS air bag warning light to illuminate.**

## Occupant Detection System (ODS)

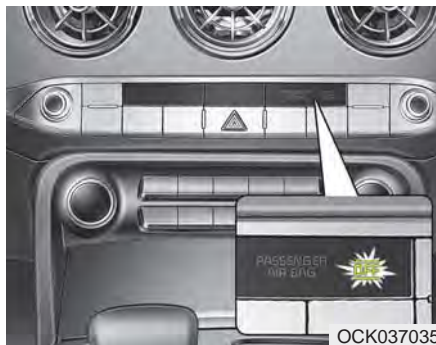

Your vehicle is equipped with an occupant detection system in the front passenger's seat.

The occupant detection system is designed to detect the presence of a properly-seated front passenger and determine if the passenger's front air bag should be enabled (may inflate) or not. Only the front passenger's air bag is controlled by the Occupant Detection System.

Do not put anything in front of the passenger air bag **OFF** indicator.

## *Main components of the occupant detection system*

- An detection device located within the front passenger seat cushion.
- An electronic system which determines whether the passenger air bag systems should be activated or deactivated.
- An indicator light located on the instrument panel which illuminates the words PASSENGER AIR BAG "OFF" indicates the front passenger air bag system is deactivated.
- The instrument panel air bag warning light is interconnected with the occupant detection system.

If the front passenger seat is occupied by a person that the system determines to be of appropriate size, and he/she sits properly (sitting upright with the seatback in an upright position, centered on the seat cushion with their seat belt on, legs comfortably extended and their feet on the floor), the PASSENGER AIR BAG “OFF” indicator will turn off and the front passenger's air bag will be able to inflate, if necessary, in frontal crashes.

You will find the PASSENGER AIR BAG “OFF” indicator on the center facia panel. This system detects the conditions 1 ~ 4 in the following table and activates or deactivates the front passenger air bag based on these conditions.

Always be sure that you and all vehicle occupants are seated and restrained properly (sitting upright with the seat in an upright position, centered on the seat cushion, with the person's legs comfortably extended, feet on the floor, and wearing the safety belt properly) for the most effective protection by the air bag and the safety belt.

- The ODS (Occupant Detection System) may not function properly if the passenger takes actions which can defeat the detection system. These include:
  - (1) Failing to sit in an upright position.
  - (2) Leaning against the door or center console.
  - (3) Sitting towards the sides or the front of the seat.
  - (4) Putting legs on the dashboard or resting them on other locations which reduce the passenger weight on the front seat.
  - (5) Improperly wearing the safety belt.
  - (6) Reclining the seat back.

**Condition and operation in the front passenger occupant detection system**

Condition detected by the occupant classification system	Indicator/Warning light		Devices
	"PASSENGER AIR BAG OFF" indicator light	SRS warning light	Front passenger air bag
1. Adult*1	Off	Off	Activated
2. Child restraint system with child under 12 months old *2 *3 *4	On	Off	Deactivated
3. Unoccupied	On	Off	Deactivated
4. Malfunction in the system	Off	On	Activated

\*1 The system judges a person of adult size as an adult. When a smaller adult sits in the front passenger seat, the system may recognize him/her as a child depending on his/her physique and posture.

\*2 Do not allow children to ride in the front passenger seat. When a larger child who has outgrown a child restraint system sits in the front passenger seat, the system may recognize him/her as an adult depending upon his/her physique or sitting position.

\*3 Never install a child restraint system on the front passenger seat.

\*4 The PASSENGER AIR BAG "OFF" indicator may turn on or off when a child above 12 months to 12 years old (with or without child restraint system) sits in the front passenger seat. This is a normal condition.

**⚠ CAUTION**

- **Do not install a child restraint seat in the passenger seat when the seat is heavily soaked with any type of liquid.**
- **Do not alter or remodel the ODS (Occupant Detection System). This may damage the system and prevent its proper function in a collision.**



**\* NOTICE**

- Do not use car seat cushions that cover up the surface of the seat and aftermarket manufactured passenger seat heaters.
- After conducting car interior cleaning using steam or detergent, the seat should be dried properly. Afterward, check for normal operation of the PASSENGER AIR BAG “OFF” and air bag warning lights.
- Any service related to the passenger seat and the ODS must be done at Kia service center.
- After the passenger seat has been removed or installed for repair purposes, check for normal operation of the PASSENGER AIR BAG “OFF” and air bag warning lights with a person seated or not seated in the passenger seat.

**⚠ WARNING - ODS System**  
Riding in an improper position adversely affects the Occupant Detection System and may result in the deactivation of the front passenger airbag. It is important for the driver to instruct the passenger as to the proper seating instructions as contained in this manual.

**\* NOTICE**

When the PASSENGER AIR BAG “OFF” symbol is illuminated, the passenger air bag system will not operate. The passenger air bag system will operate when necessary if the symbol is not illuminated.

**\* NOTICE**

Do not modify or replace the front passenger seat. Don't place anything on or attach anything such as a blanket, front seat cover or after market seat heater to the front passenger seat. This can adversely affect the occupant detection system.

**⚠ WARNING - ODS System**

Riding in an improper position adversely affects the Occupant Detection System and may result in the deactivation of the front passenger airbag. It is important for the driver to instruct the passenger as to the proper seating instructions as contained in this manual.



- Do not place a heavy load in the front passenger seatback pocket or on the front passenger seat.

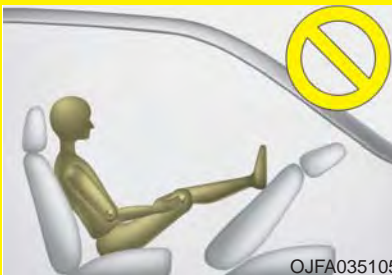

- Do not place feet on the front passenger seatback.



- Never excessively recline the front passenger seatback.



- Never sit with hips shifted towards the front of the seat.



- Never place feet on the dashboard.

(Continued)

(Continued)



- Do not use car seat accessories such as thick blankets and cushions which cover up the car seat surface.



- Never lean on the door or center console.
- Never sit on one side of the front passenger seat.

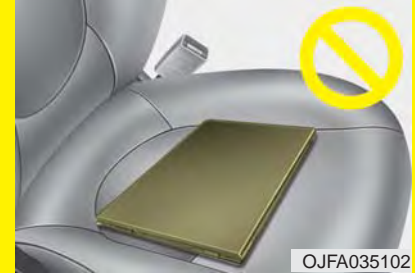

- Do not place electronic devices such as laptops, DVD player, or conductive materials such as water bottles on the passenger seat.
- Do not use electronic devices such as laptops and satellite radios which use inverter chargers.

**⚠ WARNING**  
**- Wet Passenger Seat**

Do not spill liquid in the passenger seat. Spilled liquid on the passenger seat may cause the air bag warning light to illuminate or malfunction. If any liquid is spilled, make sure the seat has been completely dried before driving the vehicle.

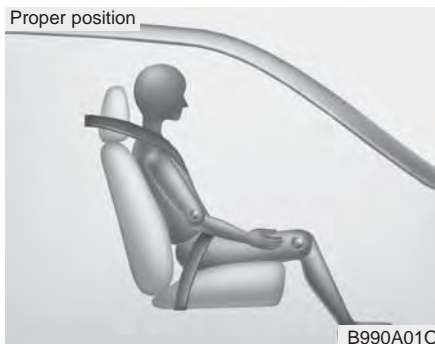

When an adult is seated in the front passenger seat, if the PASSENGER AIR BAG “OFF” indicator is on, turn the Engine Start/Stop button to the OFF position and ask the passenger to sit properly (sitting upright with the seat back in an upright position, centered on the seat cushion with their seat belt on, legs comfortably extended and their feet on the floor). Restart the engine and have the person remain in that position. This will allow the system to detect the person and to enable the passenger air bag. If the PASSENGER AIR BAG “OFF” indicator is still on, ask the passenger to move to the rear seat.

**⚠ WARNING**  
**- “AIR BAG OFF” light**

Do not allow an adult passenger to ride in the front seat when the PASSENGER AIR BAG “OFF” indicator is illuminated, because the air bag will not deploy in the event of a crash. The driver must instruct the passenger to reposition himself in the seat. Failure to properly position yourself may lead to air bag deactivation resulting in air bag non-deployment in a collision. If the PASSENGER AIR BAG “OFF” indicator remains illuminated after the passenger repositions themselves properly and the car is restarted, it is recommended that passenger move to the rear seat because the passenger's front air bag will not deploy.

**\* NOTICE**

The PASSENGER AIR BAG “OFF” indicator illuminates for about 4 seconds after the Engine Start/Stop button is turned to the ON position or after the engine is started. If the front passenger seat is occupied, the occupant detection sensor will then classify the front passenger after several more seconds.

- Even though your vehicle is equipped with the occupant detection system, never install a child restraint system in the front passenger's seat. A deploying air bag can forcefully strike a child resulting in serious injuries or death. Any child age 12 and under should ride in the rear seat. Children too large for child restraints should use the available lap/shoulder belts. No matter what type of crash, children of all ages are safer when restrained in the rear seat.
- If the PASSENGER AIR BAG “OFF” indicator is illuminated when the front passenger's seat is occupied by an adult and he/she sits properly (sitting upright with the seatback in an upright position, centered on the seat cushion with their seat belt on, legs comfortably extended and their feet on the floor), have that person sit in the rear seat.

If the occupant detection system is not working properly, the SRS air bag warning light on the instrument panel will illuminate because the passenger's front air bag is connected with the occupant detection system. If there is a malfunction of the occupant detection system, the PASSENGER AIR BAG “OFF” indicator will not illuminate and the passenger's front air bag will inflate in frontal impact crashes even if there is no occupant in the front passenger's seat.

### Driver's and passenger's front air bag

■ Driver's front air bag



OCK037031L

■ Driver's knee air bag



OCK037032N

■ Passenger's front air bag



OCK037033

Your vehicle is equipped with an Advanced Supplemental Restraint (Air Bag) System and lap/shoulder belts at both the driver and passenger seating position.

The indication of the system's presence are the letters "AIR BAG" located on the air bag pad cover on the steering wheel and the passenger's side front panel pad above the glove box.

The SRS consists of air bags installed under the pad covers in the center of the steering wheel and the passenger's side front panel above the glove box.

The purpose of the SRS is to provide the vehicle's driver and/or the front passenger with additional protection than that offered by the seat belt system alone in case of a frontal impact of sufficient severity. The SRS uses sensors to gather information about the driver's and front passenger's seat belt usage and impact severity.

The seat belt buckle sensors determine if the driver and front passenger's seat belts are fastened.

These sensors provide the ability to control the SRS deployment based on whether or not the seat belts are fastened, and how severe the impact is.

The advanced SRS offers the ability to control the air bag inflation with two levels. A first stage level is provided for moderate-severity impacts. A second stage level is provided for more severe impacts.

The passenger's front air bag is designed to help reduce the injury of children sitting close to the instrument panel in low speed collisions. However, children are safer if they are restrained in the rear seat.

According to the impact severity and seat belt usage, the SRSCM (SRS Control Module) controls the air bag inflation. Failure to properly wear seat belts can increase the risk or severity of injury in an accident.

#### \* NOTICE

**The driver's hands should be placed on the steering wheel at the 9:00 and 3:00 positions. The passenger's arm and hands should be placed on their laps.**

Additionally, your vehicle is equipped with an occupant detection system in the front passenger's seat. The occupant detection system detects the presence of a passenger in the front passenger's seat and will turn off the front passenger's air bag under certain conditions. For more detail, see "Occupant detection system" in this chapter.

Modification to the seat structure can cause the air bag to deploy at a different level than should be provided.

Manufacturers are required by government regulations to provide a contact point concerning modifications to the vehicle for persons with disabilities, which modifications may affect the vehicle's advanced air bag system. That contact is Kia's toll-free Customer Assistance center at 1-800-333-4Kia. However, Kia does not endorse nor will it support any changes to any part or structure of the vehicle that could affect the advanced air bag system, including the occupant detection system.

 **WARNING - Replacement/modifications**

**The front passenger seat, dashboard or door should not be replaced except by an authorized Kia dealer using original Kia parts designed for this vehicle and model. Any other such replacement or modification could adversely affect the operation of the occupant detection system and your advanced air bags.**

Advanced air bags are combined with pre-tensioner seat belts to help provide enhanced occupant protection in frontal crashes. Front air bags are not intended to deploy in collisions in which sufficient protection can be provided by the pre-tensioner seat belt.

**\* NOTICE**

**Air bags can only be used once – have an authorized Kia dealer replace the air bag immediately after deployment.**

Front air bags are not intended to deploy in side-impact, rear-impact or rollover crashes. However, when frontal deployment threshold is satisfied at side-impact, front air bags may deploy. In addition, front air bags will not deploy in frontal crashes below the deployment threshold.

 **WARNING - SRS Wiring**

**Do not tamper with or disconnect SRS wiring or other components of the SRS system. Doing so could result in injury, due to accidental deployment of the air bags or by rendering the SRS inoperative.**

**⚠ WARNING - No attaching objects**

- No objects (such as crash pad cover, cellular phone holder, cup holder, perfume or stickers) should be placed over or near the air bag modules on the steering wheel, instrument panel, windshield glass, and the front passenger's panel above the glove box. Such objects could cause harm if the vehicle is in a crash severe enough to cause the air bags to deploy.

Do not place any objects over the air bag or between the air bag and yourself.

- Never place or insert any object into any small opening near side airbag labels attached to the vehicle seats.

When the air bag deploys, the object may affect the deployment and result in unexpected accident or bodily harm.

### Side air bag

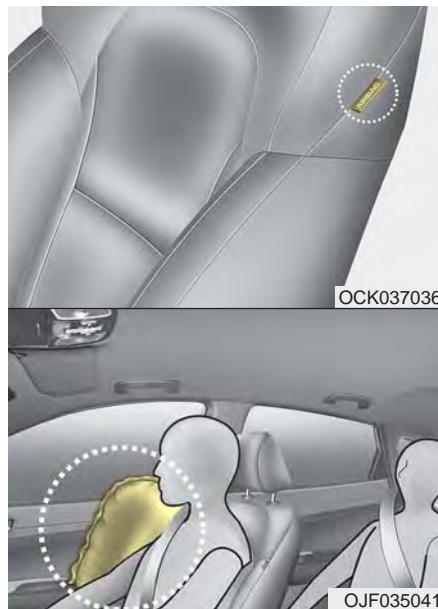

\* The actual air bags in the vehicle may differ from the illustration.

Your vehicle is equipped with a side air bag in each front seat. The purpose of the air bag is to provide the vehicle's driver and/or the front passenger with additional protection than that offered by the seat belt alone.

- The side air bags are designed to deploy during certain side-impact collisions, depending on the crash severity, angle, speed and point of impact. However, when side deployment threshold is satisfied at front-impact, side air bags may deploy.
- The side air bags may deploy on the side of the impact or on both sides.
- The side and/or curtain air bags on both sides of the vehicle will deploy if a rollover or possible rollover is detected.
- The side air bags are not designed to deploy in all side impact or rollover situations.



**⚠ WARNING - Unexpected deployment**

Avoid impact to the side impact airbag sensor when the Engine Start/Stop button is ON to prevent unexpected deployment of the side air bag.

- The side air bag is supplemental to the driver's and the passenger's seat belt systems and is not a substitute for them. Therefore your seat belts must be worn at all times while the vehicle is in operation.
- For best protection from the side air bag system and to avoid being injured by the deploying side air bag, both front seat occupants should sit in an upright position with the seat belt properly fastened. The driver's hands should be placed on the steering wheel at the 9:00 and 3:00 positions. The passenger's arms and hands should be placed on their laps.

**⚠ WARNING - Deployment**

Do not install any accessories including seat covers, on the side or near the side air bag as this may affect the deployment of the side air bags.

- If seat or seat cover is damaged, have the vehicle checked and repaired by an authorized Kia dealer. Inform the dealer that your vehicle is equipped with side air bags and an occupant detection system.

**⚠ WARNING - Flying objects**

Do not place any objects (an umbrella, bag, etc.) between the front door and the front seat. Such objects may become dangerous projectiles if the side airbag inflates.

**⚠ WARNING - No attaching objects**

- Do not place any objects over the air bag or between the air bag and yourself. Also, do not attach any objects around the area the air bag inflates such as the door, side door glass, front and rear pillar.
- Do not put any objects between the side airbag label and seat cushion. It could cause harm if the vehicle is in a crash severe enough to cause the air bags to deploy.
- Never place or insert any object into any small opening near side airbag labels attached to the vehicle seats. When the air bag deploys, the object may affect the deployment and result in unexpected accident or bodily harm.
- Do not install any accessories on the side or near the side air bags.

### Curtain air bag

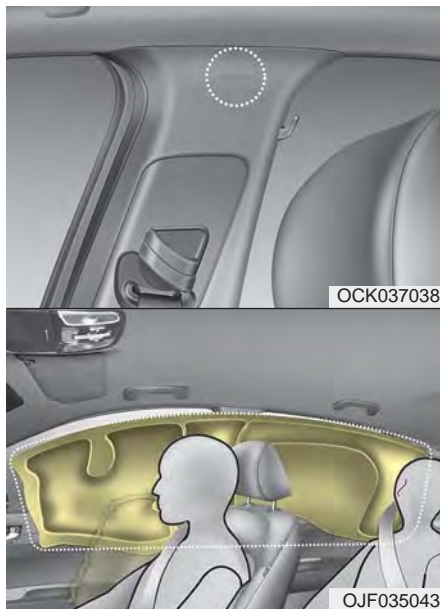

\* The actual air bags in the vehicle may differ from the illustration.

Curtain air bags are located along both sides of the roof rails above the front and rear doors.

They are designed to help protect occupants in certain side impacts and to help prevent them from ejecting out of the vehicle as a result of a rollover, especially when the seatbelts are also in use.

- The curtain air bags are designed to deploy during certain side impact collisions, depending on the crash severity, angle, speed and point of impact. However, when side deployment threshold is satisfied at front-impact, side air bags may deploy.
- The curtain air bags may deploy on the side of the impact or on both sides.
- Also, the curtain air bags on both sides of the vehicle will deploy in certain rollover situations.
- The curtain air bags are not designed to deploy in all side impact or rollover situations.

Do not allow the passengers to lean their heads or bodies against the doors, put their arms on the doors, stretch their arms out of the window or place objects between the doors and passengers when they are seated on seats equipped with side impact and/or curtain air bags.

### \* NOTICE

Never try to open or repair any components of the side and curtain air bag system. This should only be done by an authorized Kia dealer.

### **⚠ WARNING - No attaching objects**

- Do not place any objects over the air bag. Also, do not attach any objects around the area the air bag inflates such as the door, side door glass, front and rear pillar, roof side rail.
- Do not hang hard or breakable objects on the coat hook.

**Why didn't my air bag deploy in a collision? (Inflation and non-inflation conditions of the air bag)**

There are many types of accidents in which the air bag would not be expected to provide additional protection.

These include rear impacts, second or third collisions in multiple impact accidents, as well as low speed impacts.

*Air bag collision sensors*



OCK037039L/OCK037040N/OCK037041L/OCK037042/OCK037043/OCK037044

- (1) SRS control module/  
Rollover sensor
- (2) Front impact sensor

- (3) Side impact sensor
- (4) Side impact sensor
- (5) Side impact sensor

### **⚠ WARNING - Air bag sensors**

- **Do not hit or allow any objects to impact the locations where air bags or sensors are installed.**

**This may cause unexpected air bag deployment, which could result in serious personal injury or death.**

- **If the installation location or angle of the sensors is altered in any way, the air bags may deploy when they should not or they may not deploy when they should.**

**Therefore, do not try to perform maintenance on or around the air bag sensors. Have the vehicle checked and repaired by an authorized Kia dealer.**

Problems may arise if the sensor installation angles are changed due to the deformation of the front bumper, front end module, body or front doors where side collision sensors are installed. Have the vehicle checked and repaired by an authorized Kia dealer.

Installing bumper guards (or side step or running board) or replacing a bumper (or front door module) with non-genuine parts may adversely affect your vehicle's collision and air bag deployment performance.

### ***Air bag inflation conditions***



### **Front air bags**

Front air bags are designed to inflate in a frontal collision depending on the intensity, speed or angles of impact of the front collision.



OCK037046L

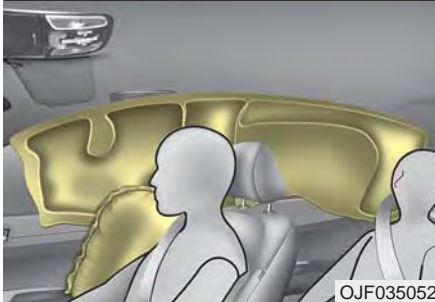

OJF035052

\* The actual air bags in the vehicle may differ from the illustration.

### Side and/or curtain air bags

Side and/or curtain air bags are designed to inflate when an impact is detected by side collision sensors depending on the strength, speed or angles of impact resulting from a side impact collision.

Also, the side and curtain air bags are designed to inflate when a rollover is detected by a rollover sensor.

Although the front air bags (driver's and front passenger's air bags) are designed to inflate in frontal collisions, they also may inflate in other types of collisions if the front impact sensors detect a sufficient frontal force in another type of impact. Side and curtain air bags are designed to inflate in certain side impact collisions. They may inflate in other types of collisions where a side force is detected by the sensors. Side air bag and/or curtain air bags may also inflate where rollover sensors indicate the possibility of a rollover occurring (even if none actually occurs) or in other situations, including when the vehicle is tilted while being towed.

Even where side and/or curtain air bags would not provide impact protection in a rollover, however, they will deploy to prevent ejection of occupants, especially those who are restrained with seat belts.

If the vehicle chassis is impacted by bumps or objects on unpaved roads, the air bags may deploy. Drive carefully on unpaved roads or on surfaces not designed for vehicle traffic to prevent unintended air bag deployment.

## Air bag non-inflation conditions



- In certain low-speed collisions the air bags may not deploy. The air bags are designed not to deploy in such cases because they may not provide benefits beyond the protection of the seat belts in such collisions.



- Air bags are not designed to inflate in rear collisions, because occupants are moved backward by the force of the impact. In this case, inflated air bags would not be able to provide any additional benefit.



- Front air bags may not inflate in side impact collisions, because occupants move to the direction of the collision, and thus in side impacts, frontal air bag deployment would not provide additional occupant protection.



- In an angled collision, the force of impact may direct the occupants in a direction where the air bags would not be able to provide any additional benefit, and thus the sensors may not deploy any air bags.

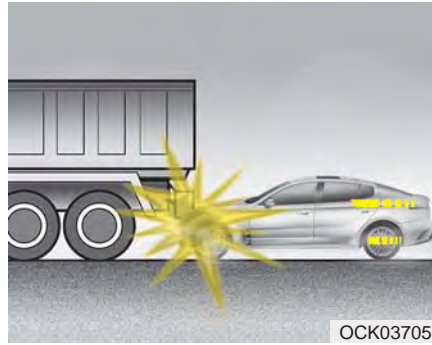

- Just before impact, drivers often brake heavily. Such heavy braking lowers the front portion of the vehicle causing it to “ride” under a vehicle with a higher ground clearance. Air bags may not inflate in this “under-ride” situation because deceleration forces that are detected by sensors may be significantly reduced by such “under-ride” collisions.

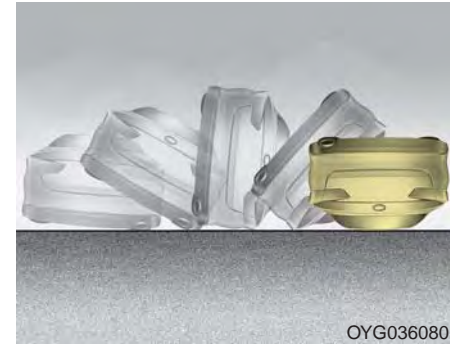

- Front air bags may not inflate in all rollover accidents where the SRSCM indicates that the front air bag deployment would not provide additional occupant protection.

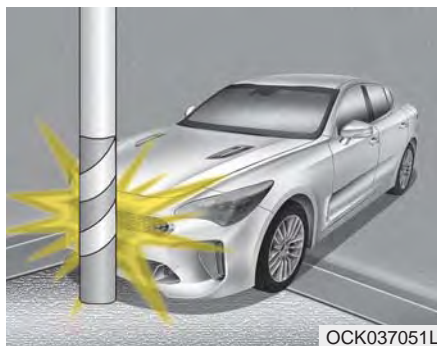

OCK037051L

- Air bags may not inflate if the vehicle collides with objects such as utility poles or trees, where the point of impact is concentrated to one area and the full force of the impact is not delivered to the sensors.

### SRS Care

The SRS is virtually maintenance-free and so there are no parts you can safely service by yourself. If the SRS air bag warning light does not illuminate, or continuously remains on, have your vehicle immediately inspected by an authorized Kia dealer.

Any work on the SRS system, such as removing, installing, repairing, or any work on the steering wheel, the front passenger's panel, front seats and roof rails must be performed by an authorized Kia dealer. Improper handling of the SRS system may result in serious personal injury.

For cleaning the air bag pad covers, use only a soft, dry cloth or one which has been moistened with plain water. Solvents or cleaners could adversely affect the air bag covers and proper deployment of the system.

If components of the air bag system must be discarded, or if the vehicle must be scrapped, certain safety precautions must be observed. An authorized Kia dealer knows these precautions and can give you the necessary information. Failure to follow these precautions and procedures could increase the risk of personal injury.



**⚠ WARNING - Tampering with SRS**

**Do not tamper with or disconnect SRS wiring, or other components of the SRS system.**

**Doing so could result in the accidental inflation of the air bags or render the SRS inoperative.**

**⚠ WARNING - Towing Vehicle**

**Always have the Engine Start/Stop button in the OFF position when your vehicle is being towed. The side air bags may inflate if the vehicle is tilted such as when being towed because of the rollover sensors in the vehicle.**

**Adding equipment to or modifying your air bag-equipped vehicle**

If you modify your vehicle by changing your vehicle's frame, bumper system, front end or side sheet metal or ride height, this may affect the operation of your vehicle's air bag system.

**Air bag warning label**



Air bag warning labels, some required by the U.S. National Highway Traffic Safety Administration (NHTSA), are attached to the sunvisors to alert the driver and passengers of potential risks of the air bag system.

# Features of your vehicle

<b>Smart key</b> . . . . .	4-5	<b>Windows</b> . . . . .	4-34
• Record your key number . . . . .	4-5	• Power windows . . . . .	4-35
• Smart key functions . . . . .	4-5	• Opening the hood . . . . .	4-39
• Remote keyless entry system operations . . . . .	4-8	<b>Hood</b> . . . . .	4-39
• Transmitter precautions . . . . .	4-10	• Closing the hood . . . . .	4-40
• Battery replacement . . . . .	4-11	<b>Fuel filler lid</b> . . . . .	4-41
• Mechanical key operations . . . . .	4-11	• Opening the fuel filler lid . . . . .	4-41
• Immobilizer system . . . . .	4-12	• Closing the fuel filler lid . . . . .	4-41
<b>Theft-alarm system</b> . . . . .	4-14	• Emergency fuel filler lid release . . . . .	4-42
• Armed stage . . . . .	4-14	<b>Wide sunroof</b> . . . . .	4-45
• Theft-alarm stage . . . . .	4-15	• Sunroof open warning . . . . .	4-46
• Disarmed stage . . . . .	4-15	• Sunshade . . . . .	4-47
<b>Door locks</b> . . . . .	4-16	• Sliding the sunroof . . . . .	4-47
• Operating door locks from outside the vehicle . . . . .	4-16	• Tilting the sunroof . . . . .	4-49
• Operating door locks from inside the vehicle . . . . .	4-17	• Closing the sunroof . . . . .	4-49
• Door lock/unlock features . . . . .	4-19	• Resetting the sunroof . . . . .	4-50
• Child-protector rear door lock . . . . .	4-19	<b>Steering wheel</b> . . . . .	4-51
<b>Liftgate</b> . . . . .	4-21	• Electric Power Steering (EPS) . . . . .	4-51
• Non-Powered liftgate . . . . .	4-21	• Tilt and telescopic steering . . . . .	4-52
• Power liftgate . . . . .	4-23	• Heated steering wheel . . . . .	4-53
• Emergency liftgate safety release . . . . .	4-28	• Horn . . . . .	4-54
<b>Smart liftgate</b> . . . . .	4-30		

<b>Mirrors</b> .....	4-55	<b>Reverse Parking Distance Warning</b> .....	4-107
• Inside rearview mirror .....	4-55	• Operation of Reverse Parking Distance Warning .	4-107
• Outside rearview mirror .....	4-64	• Non-operational conditions of Reverse Parking	
<b>Instrument cluster</b> .....	4-67	Distance Warning .....	4-108
• Instrument cluster control .....	4-68	• Reverse Parking Distance Warning precautions .	4-109
• LCD display control .....	4-68	• Self-diagnosis .....	4-110
• Gauges .....	4-69	<b>Parking Distance Warning (PDW) system</b> .....	4-111
• Transmission shift indicator .....	4-72	• Operation of Parking Distance Warning .....	4-111
<b>LCD windows</b> .....	4-73	• Non-operational conditions of Parking Distance	
• Over view .....	4-73	Warning .....	4-113
• Trip information (Trip computer) .....	4-73	• Self-diagnosis .....	4-115
• LCD modes .....	4-77	<b>Rear View Monitor (RVM) system</b> .....	4-116
• Distance to empty .....	4-81	<b>Surround View Monitoring (SVM) system</b> .....	4-117
• User settings mode .....	4-82	<b>Lighting</b> .....	4-118
• Warning messages .....	4-87	• Battery saver function .....	4-118
<b>Warning and indicator lights</b> .....	4-92	• Daytime running light .....	4-118
• Warning lights .....	4-92	• Lighting control .....	4-118
• Indicator lights .....	4-100	• High beam operation .....	4-120
<b>Head Up Display (HUD)</b> .....	4-105	• High Beam Assist (HBA) system .....	4-121
• Description .....	4-105	• Turn signals and lane change signals .....	4-123
• Head Up Display on/off .....	4-106	• Check headlight .....	4-124
• Head Up Display information .....	4-106	• Headlight leveling device .....	4-124
• Head Up Display setting .....	4-106	• Dynamic Bending Light (DBL) .....	4-125

<b>Wipers and washers</b> . . . . .	4-126
• Windshield wipers . . . . .	4-126
• Front windshield washers . . . . .	4-128
<b>Interior lights</b> . . . . .	4-129
• Automatic turn off function . . . . .	4-129
• Room lamp . . . . .	4-129
• Map lamp . . . . .	4-130
• Liftgate room lamp . . . . .	4-131
• Vanity mirror lamp . . . . .	4-131
• Glove box lamp . . . . .	4-131
• Door courtesy lamp . . . . .	4-132
<b>Welcome system</b> . . . . .	4-133
• Headlight (Headlamp) escort function . . . . .	4-133
• Interior light . . . . .	4-133
• Pocket lamp . . . . .	4-133
<b>Defroster</b> . . . . .	4-134
• Rear window defroster . . . . .	4-134
<b>Automatic climate control system</b> . . . . .	4-135
• Automatic heating and air conditioning . . . . .	4-136
• Manual heating and air conditioning . . . . .	4-138
• System operation . . . . .	4-145
• Climate control air filter . . . . .	4-147

• Checking the amount of air conditioner refrigerant and compressor lubricant . . . . .	4-147
• Air Conditioning refrigerant label . . . . .	4-148
• Sunroof inside air recirculation . . . . .	4-149
<b>Windshield defrosting and defogging</b> . . . . .	4-150
• Automatic climate control system . . . . .	4-150
• Defogging logic . . . . .	4-151
• Automatic ventilation . . . . .	4-153
• Smart ventilation . . . . .	4-154
<b>Storage compartments</b> . . . . .	4-155
• Center console storage . . . . .	4-155
• Glove box . . . . .	4-155
• Sunglass holder . . . . .	4-156
<b>Interior features</b> . . . . .	4-157
• Cup holder . . . . .	4-157
• Seat warmer . . . . .	4-158
• Air ventilation seat . . . . .	4-159
• Sunvisor . . . . .	4-160
• Power outlet . . . . .	4-161
• USB charger . . . . .	4-162
• Wireless smart phone charging system . . . . .	4-162
• Coat hook . . . . .	4-166
• Floor mat anchor (s) . . . . .	4-167
• Luggage net (holder) . . . . .	4-168

**Audio system..... 4-169**  
•Antenna..... 4-169  
• AUX, USB port ..... 4-169  
**Declaration of Conformity ..... 4-171**  
• FCC..... 4-171

## SMART KEY

### Record your key number



The key code number is stamped on the key code tag attached to the key set. Should you

lose your keys, this number will enable an authorized Kia dealer to duplicate the keys easily.

Remove the key code tag and store it in a safe place. Also, record the key code number and keep it in a safe and handy place, but not in the vehicle.

**⚠ WARNING - Smart key**  
**Never leave the keys in your vehicle with unsupervised children. Leaving children unattended in a vehicle with a smart key is dangerous. Children copy adults and they could press the start button. The key would enable children to operate power windows or other controls, or even make the vehicle move, which could result in serious bodily injury or death.**

### Smart key functions



1. Door lock
2. Door unlock
3. Liftgate open
4. Panic alarm

With smart key, you can lock or unlock doors (and liftgate) and start the engine without inserting the key. Refer to the following, for more details.

### **Locking**



Pressing the button of the front outside door handles with all doors closed and any door unlocked, locks all the doors. The hazard warning lights will blink and the chime will sound once to indicate that all doors are locked. The button will only operate when the smart key is within 28~40 in. (0.7~1 m) from the outside door handle. If you want to make sure that a door has locked or not, you should check the door lock button inside the vehicle or pull the outside door handle.

In some instances, when the outside door button is selected, the doors will not lock and an audible chime will sound for 3 seconds if any of the following occurs:

- The smart key is in the vehicle.
- The Engine Start/Stop button is in the ACC or ON position.
- Any door is opened.

### **Unlocking**

Pressing the button of the driver's (or front passenger's) outside door handle with all doors closed and locked, unlocks the driver's door.

The hazard warning lights will blink twice to indicate that the driver's door is unlocked. Also, the outside rearview mirrors will automatically unfold if the outside rearview mirror folding switch is in the AUTO position.

The button will only operate when the smart key is within 28~40 in. (0.7~1m) from the outside door handle.

When Two Press Unlock function is activated,

- If you press the driver's outside door handle button, the driver's door will unlock.
- If you press the driver's outside door handle button within four seconds again, then all the doors will unlock.

### **\* NOTICE**

**You can activate or deactivate the Two Press Unlock function. Refer to "User settings" in this chapter.**

### ***Liftgate unlocking***

If you are within 28 ~ 40 in (0.7 ~ 1 m) from the outside liftgate handle, with your smart key in possession, the lift gate will unlock and open when you press the liftgate handle switch.

The hazard warning lights will blink twice to indicate that the liftgate is unlocked.

Also, once the liftgate is opened and then closed, the liftgate will lock automatically.

### ***Smart key precautions***

- If you lose your smart key, you will not be able to start the engine. Tow the vehicle, if necessary, and contact an authorized Kia dealer.
- A maximum of 2 smart keys can be registered to a single vehicle. If you lose a smart key, you should immediately take the vehicle and key to your authorized Kia dealer to protect it from potential theft.
- The smart key will not work if any of following occurs:
  - The smart key is close to a radio transmitter such as a radio station or an airport which can interfere with normal operation of the smart key.
  - The smart key is near a mobile two way radio system or a cellular phone.
  - Another vehicle's smart key is being operated close to your vehicle.



If the smart key does not work correctly, you may lock and unlock the door with the mechanical key.

If you have a problem with the smart key, contact an authorized Kia dealer.

- If the smart key is in close proximity to your cell phone or smart phone, the signal from the smart key could be blocked by normal operation of your cell phone or smart phone.

This is especially important when the phone is active such as making calls, receiving calls, text messaging, and/or sending/receiving emails. Avoid placing the smart key and your cell phone or smart phone in the same pants or jacket pocket and maintain adequate distance between the two devices.

- Do not leave the smart key near metallic objects such as golf bags, metal cases and so on.
- Door Lock/Unlock failure or poor starting can occur when the smart key is placed near metallic objects.

- Always carry your smart key when you leave the car. An unattended smart key close to the vehicle can cause the vehicle battery to be discharged.
- Internal circuit damage may occur when the key comes into contact with moisture (beverage, water etc.) or heat. In this case, warranty repair is not available. Damage to the smart key due to exposure to liquids or heat is not covered by the manufacturer's vehicle warranty.
- When the smart key is left with a bunch of keys, the Lock/Unlock button for doors and liftgate can be accidentally pressed. Pay careful attention to key use.



### **CAUTION - Transmitter**

***Keep the smart key away from water or any liquid as it can become damaged and not function properly.***

## Remote keyless entry system operations



### **Lock (1)**

All doors are locked if the lock button is pressed. If all doors (and liftgate) are closed, the hazard warning lights will blink once to indicate that all doors (and liftgate) are locked.

However, if any door remains open, the hazard warning lights will not operate. But if all doors are closed after the lock button is pressed, the hazard warning lights will blink once.

**Unlock (2)**

All doors (and liftgate) can be unlocked if the unlock button is pressed. The hazard warning lights will blink twice again to indicate that all doors (and liftgate) are unlocked. After pressing this button, the doors will lock automatically unless you open any door within 30 seconds.

When Two Press Unlock function is activated,

- If you press the Door Unlock button (2) on the smart key, the driver's door will unlock.
- If you press Door Unlock button(2) on the smart key within four seconds again, then all the doors will unlock.

**\* NOTICE**

**You can activate or deactivate the Two Press Unlock function. Refer to "User settings" in this chapter.**

**\* NOTICE**

**If the keyless entry system is inoperative due to exposure to water or liquids, it will not be covered by your manufacturer's vehicle warranty.**

**Liftgate unlock (3)**

The liftgate is unlocked if the button is pressed for more than 1 second.

The hazard warning lights will blink twice to indicate that the liftgate is unlocked.

However, after pressing this button, the liftgate will lock automatically unless you open the liftgate within 30 seconds.

Also, once the liftgate is opened and then closed, the liftgate will lock automatically.

**Panic alarm (4)**

The horn sounds and the hazard warning lights blink for about 30 seconds if this button is pressed for more than 0.5 seconds. To stop the horn and lights, press any button on the transmitter.

### Transmitter precautions

The smart key will not work if any of following occurs:

- You exceed the operating distance limit (about 32.8 feet [10 m]).
- The battery in the smart key is weak.
- Other vehicles or objects may be blocking the signal.
- The weather is extremely cold.
- The smart key is close to a radio transmitter such as a radio station or an airport which can interfere with normal operation of the transmitter.

If the smart key does not work correctly, you may lock and unlock the door with the mechanical key. If you have a problem with the smart key, contact an authorized Kia dealer.

- If the transmitter is in close proximity to your cell phone or smart phone, the signal from the transmitter could be blocked by normal operation of your cell phone or smart phone. This is especially important when the phone is active such as making calls, receiving calls, text messaging, and/or sending/receiving emails.

Avoid placing the transmitter and your cell phone or smart phone in the same pants or jacket pocket and maintain adequate distance between the two devices.



#### **CAUTION - Transmitter damage**

***Do not drop, wet or expose the keyless entry system transmitter to heat or sunlight.***

### **This device complies with Part 15 of the FCC rules.**

Operation is subject to the following two conditions:

1. This device may not cause harmful interference, and
2. This device must accept any interference received, including interference that may cause undesired operation.

### **\* NOTICE**

**Changes or modifications not expressly approved by the party responsible for compliance could void the user's authority to operate the equipment. If the keyless entry system is inoperative due to changes or modifications not expressly approved by the party responsible for compliance, it will not be covered by your manufacturer's vehicle warranty.**

## Battery replacement

A battery should last for several years, but if the smart key is not working properly, try replacing the battery with a new one. If you are unsure how to use or replace the battery, contact an authorized Kia dealer.



1. Pry open the smart key center cover using screw (-) driver.
2. Replace the battery with a new battery (CR2032). When replacing the battery, make sure the battery position is correct.
3. Install the battery in the reverse order of removal.

## Mechanical key operations



- Used to lock and unlock the glove box.
- Lock and unlock the doors when the vehicle or smart key battery is discharged.

### **Smart key**

To remove the mechanical key (2), press and hold the release button (1) and remove the mechanical key.

To reinstall the mechanical key, put the key into the hole and push it until a click sound is heard.

### **Immobilizer system**

Your vehicle is equipped with an electronic engine immobilizer system to reduce the risk of unauthorized vehicle use.

Whenever the ENGINE START/STOP button is changed to the ON position, the immobilizer system checks and verifies if the key is valid or not.

If the key is valid, the engine will start.

If the key is invalid, the engine will not start.

### **\* NOTICE**

**In order to prevent theft of your vehicle, do not leave spare keys anywhere in your vehicle. Your Immobilizer password is a customer unique password and should be kept confidential. Do not leave this number anywhere in your vehicle.**

### ***To deactivate the immobilizer system***

Change the ENGINE START/STOP button to the ON position.

### ***To activate the immobilizer system***

Change the ENGINE START/STOP button to the OFF position. The immobilizer system activates automatically. Without a valid smart key for your vehicle, the engine will not start.

In order to prevent theft of your vehicle, do not leave spare keys anywhere in your vehicle.

### **\* NOTICE**

**Keep each key separate in order to avoid a starting malfunction.**

Do not put metal accessories near the smart key.

Metal accessories may interrupt the transponder signal and may prevent the engine from being started.

If you need additional keys or lose your keys, consult an authorized Kia dealer.

 **CAUTION - Immobilizer damage**

*Do not expose your immobilizer system to moisture, static electricity or rough handling. This may damage your immobilizer.*

 **CAUTION - Immobilizer alterations**

*Do not change, alter or adjust the immobilizer system because it could cause the immobilizer system to malfunction.*

**This device complies with Part 15 of the FCC rules.**

Operation is subject to the following two conditions:

1. This device may not cause harmful interference, and
2. This device must accept any interference received, including interference that may cause undesired operation.

**\* NOTICE**

Changes or modifications not expressly approved by the party responsible for compliance could void the user's authority to operate the equipment.

## THEFT-ALARM SYSTEM

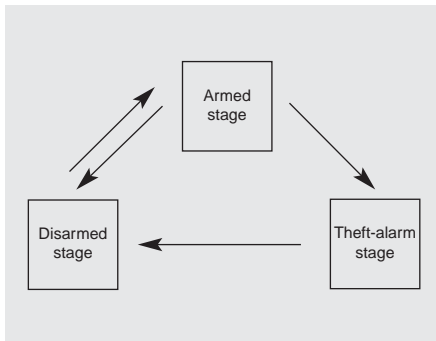

This system is designed to provide protection from unauthorized entry into the vehicle. This system is operated in three stages: the first is the “Armed” stage, the second is the “Theft-alarm” stage, and the third is the “Disarmed” stage. If triggered, the system provides an audible alarm with blinking of the hazard warning lights.

### Armed stage

Park the vehicle and stop the engine. Arm the system as described below.

1. Turn off the engine.
2. Make sure that all doors (and lift-gate) and engine hood are closed and latched.
3. Lock the doors by depressing the door lock button on the smart key.

After completion of the steps above, the hazard warning lights will blink (for smart key, the chime also sounds) once to indicate that the system is armed.

If any door (or liftgate) or engine hood remains open, the hazard warning lights and the chime will not operate and the theft-alarm will not arm. If all doors and liftgate and engine hood are closed after the lock button is pressed, the hazard warning lights blink once.

The system can also be armed by locking the doors with the key from the front doors; however, the hazard warning lights will not blink using this method.

### \* NOTICE

**The theft-alarm system can be deactivated by an authorized Kia dealer. If you want this feature, consult an authorized Kia dealer.**

**Do not arm the system until all passengers have left the vehicle. If the system is armed while a passenger(s) remains in the vehicle, the alarm may be activated when the remaining passenger(s) leave the vehicle. If any door (or liftgate) or engine hood is opened within 30 seconds after the system enters the armed stage, the system is disarmed to prevent an unnecessary alarm.**

## Theft-alarm stage

The alarm will be activated if any of the following occurs while the system is armed.

- A front or rear door is opened without using the smart key.
- The liftgate is opened without using the smart key.
- The engine hood is opened.

The horn will sound and the hazard warning lights will blink continuously for approximately 30 seconds, and repeat the horn 2 times unless the system is disarmed. To turn off the system, unlock the doors with the smart key.

## Disarmed stage

The system will be disarmed when

- The doors (and liftgate) are unlocked with the smart key.

After depressing the unlock button, the hazard warning lights will blink and the chime will sound twice (in smart key) to indicate that the system is disarmed.

After depressing the unlock button, if any door (or liftgate) is not opened within 30 seconds, the system will be rearmed.

- Avoid trying to start the engine while the alarm is activated. The vehicle starting motor is disabled during the theft-alarm stage.

If the system is not disarmed with the smart key, open the doors by using the mechanical key and start the engine by directly pressing the engine Start/Stop button with the smart key.

- If you lose your keys, consult your authorized Kia dealer.



### **CAUTION - Adjusting alarm system**

***Do not change, alter or adjust the theft-alarm system because it could cause the theft-alarm system to malfunction.***

### **\* NOTICE**

**Malfunctions caused by improper alterations, adjustments or modifications to the theft-alarm system are not covered by your vehicle manufacturer warranty.**



## DOOR LOCKS

### Operating door locks from outside the vehicle

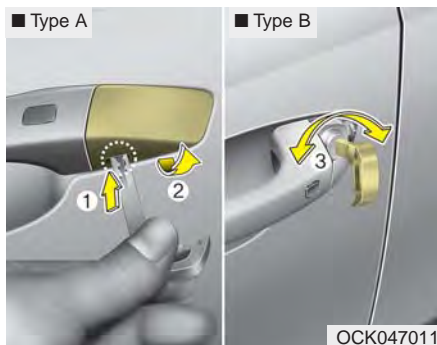

- After removing the cover (2) while pressing the hole (1) using mechanical key or screw driver (-), turn the key (3) toward the front of the vehicle to unlock and toward the rear of the vehicle to lock.
- If you lock/unlock the driver's door with a key, only the driver's door will lock/unlock.
- Once the doors are unlocked, they may be opened by pulling the door handle.

- When closing the door, push the door by hand. Make sure the doors are closed securely.

### \* NOTICE

- In cold and wet climates, door lock and door mechanisms may not work properly due to freezing conditions.
- If the door is locked/unlocked multiple times in rapid succession with either the vehicle key or door lock switch, the system may stop operating temporarily in order to protect the circuit and prevent damage to system components.

### CAUTION

*Do not unnecessarily open and close the door repeatedly or with excessive force. Such action can damage the vehicle door.*

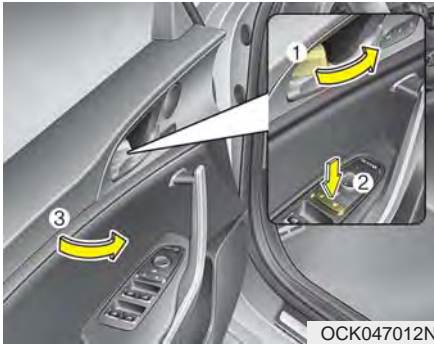

- To lock a door without the key, push the inside door lock button (1) or central door lock switch (2) to the “Lock” position and close the door (3).
- If you lock the door with the central door lock switch (2), all vehicle doors will lock automatically.

### \* NOTICE

Always place the Engine Start/Stop button in the OFF position, engage the parking brake, close all windows, and lock all doors when leaving your vehicle unattended.

## Operating door locks from inside the vehicle

*With the door lock button*

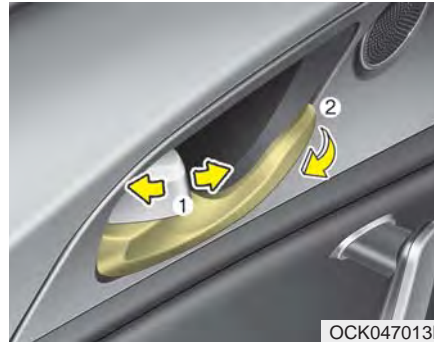

- To unlock a door, push the door lock button (1) to the “Unlock” position. The red mark on the handle will be visible.
- To lock a door, push the door lock button (1) to the “Lock” position. If the door is locked properly, the red mark will not be visible.
- To open a door, pull the door handle (2) outward.

- If the inner door handle of the driver’s (or front passenger’s) door is pulled when the door lock button is in the lock position, the button will unlock and the door will open. (if equipped)
- Front doors cannot be locked if the smart key is in the vehicle and any front door is opened.
- Doors cannot be locked if the smart key is in the vehicle and a door is open.

### **⚠ WARNING**

**Do not pull the inner door handle while the vehicle is moving.**

If a power door lock ever fails to function while you are in the vehicle, try one or more of the following techniques to exit :

- Operate the door unlock feature repeatedly (both electronic and manual) while simultaneously pulling on the door handle.
- Operate the other door locks and handles, front and rear.
- Lower a front window and use the key to unlock the door from outside.

### *With central door lock switch*

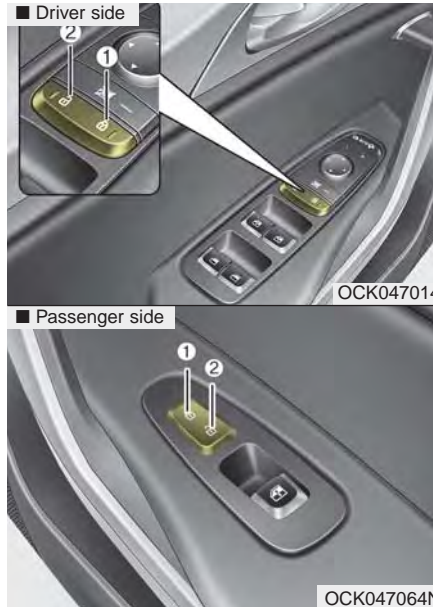

Operate by pressing the central door lock switch.

For Driver's door:

- When pushing down on the right portion (1) of the switch, all vehicle doors will lock.

- When pushing down on left portion (2) of the switch, all vehicle doors will unlock.

For Front Passenger's door:

- When pushing down on the front portion (1) of the switch, all vehicle doors will lock.
- When pushing down on the rear portion (2) of the switch, all vehicle doors will unlock.
- If the smart key is in the vehicle and any front door is opened, the doors will not lock even though the right portion(1, driver's door) of the central door lock switch is pressed.

**⚠ WARNING - Doors**

The doors should always be fully closed and locked while the vehicle is in motion to prevent accidental opening of the door.

**⚠ WARNING - Unattended children/animals**

Never leave children or animals unattended in your vehicle. An enclosed vehicle can become extremely hot, causing death or severe injury to unattended children or animals who cannot escape the vehicle.

**Door lock/unlock features*****Impact sensing door unlock system***

All doors will automatically unlock when an impact causes the air bags to deploy.

***Speed sensing door lock system***

All doors will automatically lock after the vehicle speed exceeds 9 mph (15 km/h).

You can activate or deactivate the auto door lock/unlock features in the vehicle. Refer to “User setting” in this chapter.

**Child-protector rear door lock**

The child safety lock is provided to help prevent children from accidentally opening the rear doors from inside the vehicle. The rear door safety locks should be used whenever children are in the vehicle.

1. Open the rear door.
2. Turn the child safety lock (1) located on the rear edge of the door to the lock (🔒) position. When the child safety lock is in the lock position, the rear door will not open even when the inner door handle is pulled.

### 3. Close the rear door.

To open the rear door, pull the outside door handle (2).

Even though the doors may be unlocked, the rear door will not open by pulling the inner door handle until the rear door child safety lock is unlocked.

 **WARNING - Rear door locks**

**Use the rear door safety locks whenever children are in the vehicle. If a child accidentally opens the rear doors while the vehicle is moving, they may fall out.**

## LIFTGATE

### Non-Powered Liftgate

#### *Opening the liftgate*

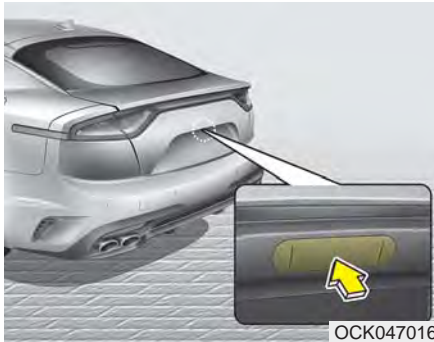

- The liftgate is locked or unlocked when all doors are locked or unlocked with the smart key or central door lock/unlock switch.
- Only the liftgate is unlocked if the liftgate unlock button on the smart key is pressed for approximately 1 second.
- If unlocked, the liftgate can be opened by pressing the handle and pulling it up.

- Once the liftgate is opened and then closed, the liftgate locks automatically. (All doors must be locked.)

#### **⚠ WARNING - Exhaust fumes**

The liftgate should always be kept completely closed while the vehicle is in motion. If it is left open or ajar, exhaust gases may enter the car and serious illness or death may result.

#### **⚠ WARNING**

The liftgate swings upward. Make sure no objects or people are near the rear of the vehicle when opening the liftgate.

#### **\* NOTICE**

In cold and wet climates, liftgate lock and liftgate mechanisms may not work properly due to freezing conditions.

**Closing the liftgate**



Lower and push down the liftgate firmly. Make sure that the liftgate is securely latched.

**CAUTION**

*Make certain that you close the liftgate before driving your vehicle. Possible damage may occur to the liftgate lift cylinders and attached hardware if the liftgate is not closed prior to driving.*

**WARNING**

Make sure your hands, feet and other parts of your body are safely out of the way before closing the liftgate.

**CAUTION**

*Make sure nothing is near the liftgate latch and striker while closing the liftgate. It may damage the liftgate's latch.*

**WARNING - Exhaust fumes**

If you drive with the liftgate open, you will draw dangerous exhaust fumes into your vehicle which can cause serious injury or death to vehicle occupants. If you must drive with the liftgate open, keep the air vents and all windows open so that additional outside air comes into the vehicle.

**WARNING - Riding in cargo area**

Occupants should never ride in the rear cargo area where no restraints are available. To avoid injury in the event of an accident or sudden stops, occupants should always be properly restrained.

**Power liftgate (if equipped)**

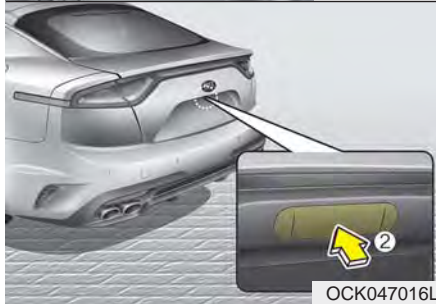
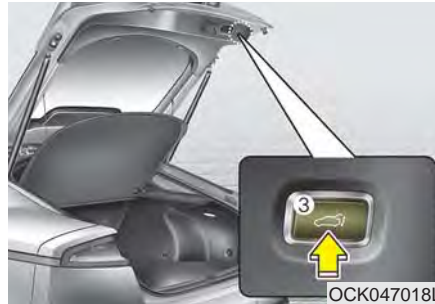
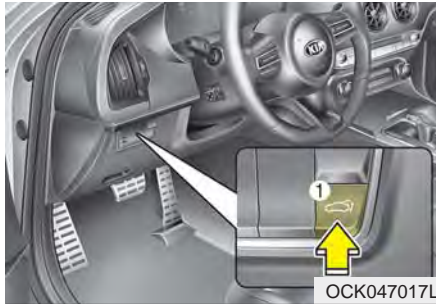

- (1) Power liftgate open/close button
- (2) Power liftgate handle switch
- (3) Power liftgate close button

**\* NOTICE**

If the engine start/stop button is ON, the power liftgate can operate when the automatic transmission is in P (Park).

**⚠ WARNING**

Never leave children or animals unattended in your vehicle.

Children or animals might operate the power liftgate which could result in injury to themselves or others, or damage the vehicle.

**\* NOTICE**

Do not put heavy objects on the power liftgate when you operate.



**⚠ WARNING**



**Make sure that there are no people or objects in the path of the power liftgate (or smart liftgate) prior to use. Serious injury, damage to the vehicle or damage to surrounding objects may result if contact with the power liftgate (or smart liftgate) occurs.**

**⚠ CAUTION**

*Do not close or open the power liftgate manually. This may cause damage to the power liftgate. If it is necessary to close or open the power liftgate manually when the battery is discharged or disconnected, do not apply excessive force.*

*Opening the liftgate*



The power liftgate will open automatically by doing one of the following:

- Press the liftgate unlock button on the smart key for approximately one second.

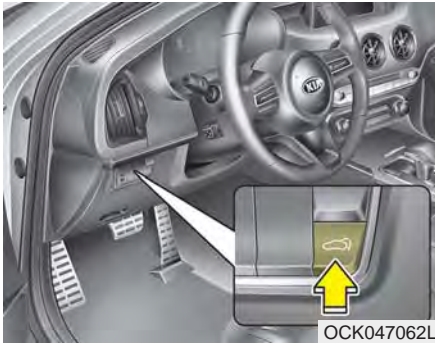

- Press the power liftgate open button for approximately one second.

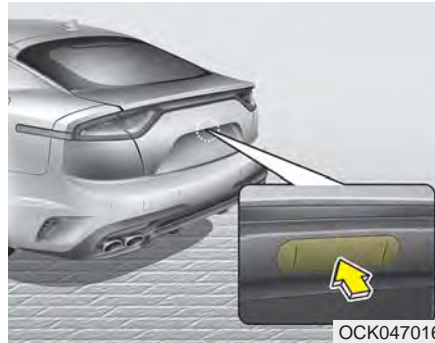

- Press the liftgate handle switch carrying the smart key with you.

### *Closing the liftgate*

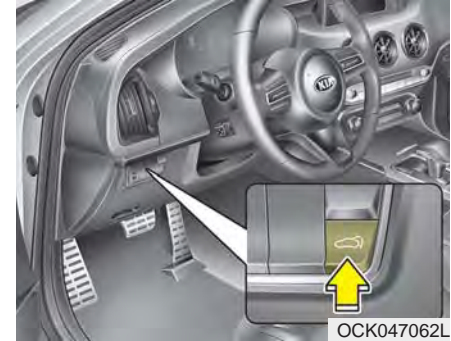

- Press the power liftgate close button for approximately one second when the liftgate is opened. The liftgate will close and lock automatically.



- Press the power liftgate close button for approximately one second when the liftgate is opened. The liftgate will close and lock automatically.

### ***Power liftgate Non-Opening or Closing Conditions :***

- The power liftgate will not open or close automatically, when the vehicle is moving more than 2 mph (3 km/h).
- The power liftgate can be operated when the engine is not running. However, the power liftgate operation consumes large amounts of vehicle electric power. To prevent the battery from draining, do not operate it excessively (e.g., more than approximately 10 times repeatedly).
- Do not modify or repair any part of the power liftgate by yourself. This must be done by an authorized Kia dealer.
- Before jacking up the vehicle to change a tire or repair the vehicle, open the power liftgate. Do not operate the power liftgate when the vehicle is raised or this could cause the power liftgate to operate improperly.

- If there are obstacles such as snow on the power liftgate, it may not open automatically. After removing the obstacle, try to open it again.

### Automatic stop and Reverse



OCK047019L

If, during power opening or closing, the liftgate is blocked by an object or part of someone's body, the power liftgate will detect the resistance and it will stop movement or move to the full open position to allow the object to be cleared.

However, if an object is thin or soft, or the liftgate is near the latched position, the automatic stop and reversal may not detect the resistance and the closing operation will continue. If the power liftgate is forced by a strong impact, the automatic stop and reversal may operate.

If the automatic stop and reverse feature operates more than twice during one opening or closing operation, the power liftgate may stop at that position.

If this occurs, close the liftgate manually and operate the liftgate automatically again.

#### **⚠ WARNING**

**To prevent serious injury and damage take the following precautions when operating the power liftgate :**

- **Keep all faces, hands, arms, body parts and other objects away from the path of the power liftgate.**
- **Do not intentionally place any body parts or objects in the path of the power liftgate to make sure the automatic stop and reversal operates.**
- **Do not allow children to play with the power liftgate.**

### How to reset the power liftgate

If the battery has been discharged or disconnected, or if the related fuse has been replaced or disconnected, for the power liftgate to operate normally, reset the power liftgate as follows:

1. Push the P(Parking) button.
2. While Pressing the liftgate close button, press the liftgate handle switch for more than 3 seconds. (the chime will sound)
3. Close the liftgate manually.

If the power liftgate does not work properly after the above procedure, have the system checked by an authorized Kia dealer.

## Emergency liftgate safety release

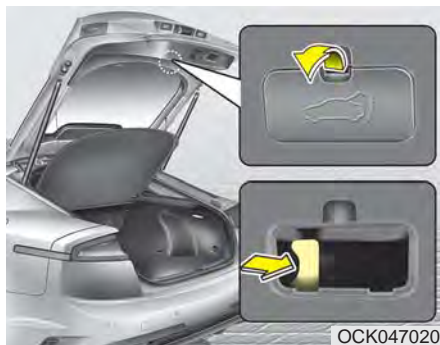

Your vehicle is equipped with the emergency liftgate safety release lever located on the bottom of the liftgate. When someone is inadvertently locked in the luggage compartment, the liftgate can be opened by doing as follows:

1. Remove the cover.
2. Push the release lever to the right.
3. Push up the liftgate.

### **⚠ WARNING**

- For emergencies, be fully aware of the location of the emergency liftgate safety release lever in the vehicle and how to open the liftgate if you are accidentally locked in the luggage compartment.
- No one should be allowed to occupy the luggage compartment of the vehicle at any time. The luggage compartment is a very dangerous location in the event of a crash.
- Use the release lever for emergencies only. Use with extreme caution, especially while the vehicle is in motion.

### **⚠ WARNING**

**NEVER** allow anyone to occupy the rear cargo area of the vehicle at any time. If the liftgate is partially or totally latched and the person is unable to get out, serious injury or death could occur due to lack of ventilation, exhaust fumes and rapid heat build-up, or because of exposure to cold weather conditions. The liftgate is also a highly dangerous location in the event of a crash because it is not a protected occupant space but is a part of the vehicle's crush zone.

- You and your passengers must be aware of the location of the Emergency Liftgate Safety Release lever in this vehicle and how to open the liftgate in case you are accidentally locked in the liftgate.
- Your vehicle should be kept locked and the Smart Key should be kept out of the reach of children.  
Parents should teach their children about the dangers of playing in the rear cargo area or using the liftgate.
- Use the release lever for emergencies only.



## SMART LIFTGATE (IF EQUIPPED)

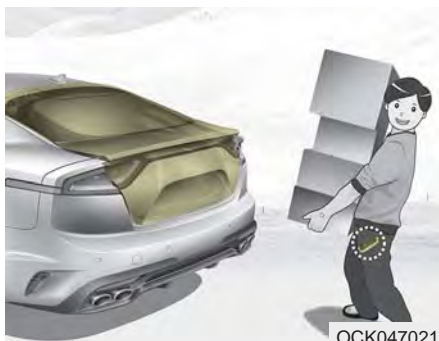

On a vehicle equipped with a smart key, the liftgate can be opened with no-touch activation using the Smart Liftgate system.

### *How to use the Smart Liftgate*

The liftgate can be opened with no-touch activation satisfying all the conditions below.

- After 15 seconds when all doors are closed and locked
- Positioned in the detecting area for more than 3 seconds.

### **\* NOTICE**

- **The Smart Liftgate does not operate when:**
  - **The smart key is detected within 15 seconds after the doors are closed and locked, and is continuously detected.**
  - **The smart key is detected within 15 seconds after the doors are closed and locked, and 60 inches (1.5 m) from the front door handles (for vehicles equipped with Welcome Light).**
  - **A door is not locked or closed.**
  - **The smart key is in the vehicle.**

### 1. Setting

To activate the Smart Liftgate, go to User Settings Mode and select Smart Liftgate on the LCD display.

\* For more details, refer to “LCD Display” in this chapter.

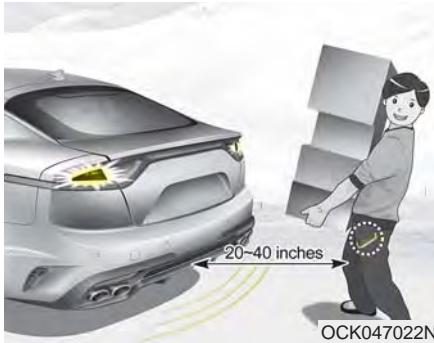

## 2. Detect and Alert

If you are positioned in the detecting area (20 ~ 40 inches (50 ~100 cm) behind the vehicle) carrying a smart key, the hazard warning lights will blink and the chime will sound for about 3 seconds to alert you the smart key has been detected and the liftgate will open.

## \* NOTICE

Do not approach the detecting area if you do not want the liftgate to open. If you have unintentionally entered the detecting area and the hazard warning lights and chime starts to operate, leave the detecting area with the smart key. The liftgate will stay closed.



## 3. Automatic opening

The hazard warning lights will blink and the chime will sound 2 times and then the liftgate will slowly open.

Make certain that you close the liftgate before driving your vehicle.

Make sure there are no people or objects around the liftgate before opening or closing the liftgate.

Make sure to deactivate the Smart liftgate function when washing your vehicle.

Otherwise, the liftgate may open inadvertently.



**⚠ WARNING**

Make sure objects in the rear cargo area do not come out when opening the liftgate as this could cause serious injury.

**\* NOTICE**

The key should be kept out of reach of children. Children may inadvertently open the Smart Liftgate while playing around the rear area of the vehicle.

*How to deactivate the Smart Liftgate function using the smart key*



1. Door lock
2. Door unlock
3. Liftgate open
4. Panic

If you press any button of the smart key during the Detect and Alert stage, the Smart Liftgate function will be deactivated.

Make sure to be aware of how to deactivate the Smart Liftgate function for emergency situations.

**\* NOTICE**

- If you press the door unlock button (2), the Smart Liftgate function will be deactivated temporarily. But, if you do not open any door for 30 seconds, the smart liftgate function will be activated again.
- If you press the liftgate open button (3) for more than 1 second, the liftgate opens.
- If you press the door lock button (1) or liftgate open button (3) when the Smart Liftgate function is not in the Detect and Alert stage, the smart liftgate function will not be deactivated.
- In case you have deactivated the Smart Liftgate function by pressing the smart key button or opening a door, the smart liftgate function can be activated again by closing and locking all doors.

**Detecting area**

- The Smart Liftgate operates with a welcome alert if the smart key is detected within 20 ~ 40 inches (50 ~ 100 cm) from the liftgate.
- The alert stops at once if the smart key is positioned outside the detecting area during the Detect and Alert stage.

**\* NOTICE**

- The Smart Liftgate function will not work if any of the following occurs :
  - The smart key is close to a radio transmitter such as a radio station or an airport which can interfere with normal operation of the transmitter.
  - The smart key is near a mobile two way radio system or a cellular phone.
  - Another vehicle's smart key is being operated close to your vehicle.
- The detecting range may decrease or increase when :
  - One side of the vehicle is raised to replace a tire or to inspect the vehicle.
  - The vehicle is parked on a slope or unpaved road, etc.

## WINDOWS

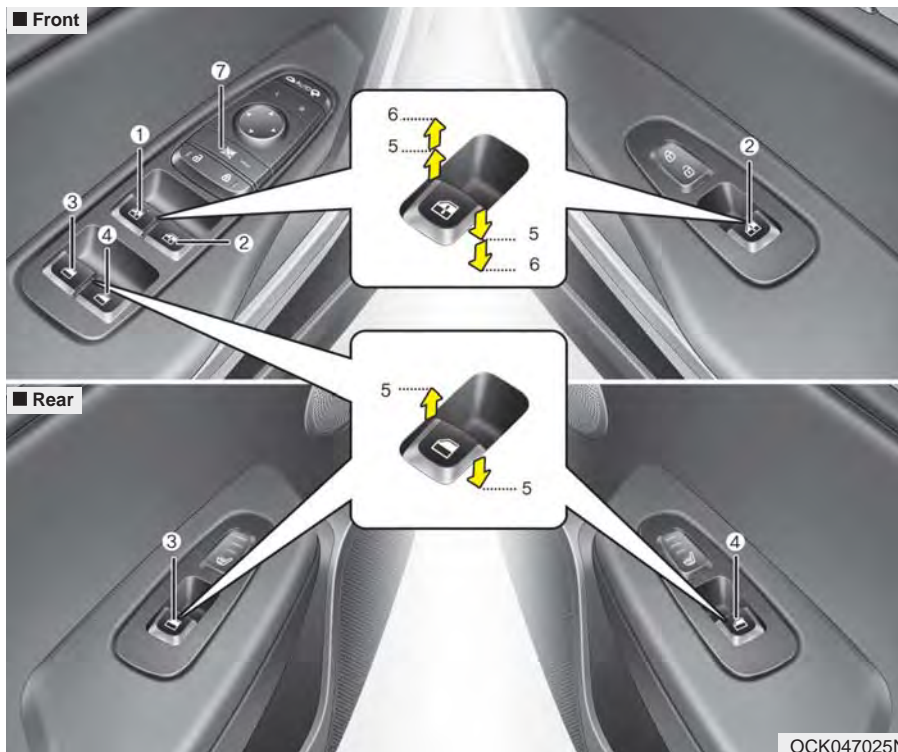

- (1) Driver's door power window switch
- (2) Front passenger's door power window switch
- (3) Rear door (left) power window switch
- (4) Rear door (right) power window switch
- (5) Window opening and closing
- (6) Automatic power window up/down (Driver's and Passenger's window)
- (7) Power window lock button

In cold and wet climates, power windows may not work properly due to freezing conditions.

OCK047025N

## Power windows

The Engine Start/Stop Button must be in the ON position for power windows to operate.

Each door has a power window switch that controls the door's window. The driver has a power window lock button which can block the operation of rear passenger windows.

The power windows can be operated for approximately 30 seconds after the engine start/stop button is set to the ACC or LOCK position.

However, if the front doors are opened, the power windows cannot be operated even within the 30 seconds period.

The driver's door has a master power window switch that controls all the windows in the vehicle.

If the window cannot be closed because it is blocked by objects, remove the objects and close the window.

## \* NOTICE

While driving with the rear windows down or with the sunroof (if equipped) in an open (or partially open) position, your vehicle may demonstrate a wind buffeting or pulsation noise. This noise is a normal occurrence and can be reduced or eliminated by taking the following actions. If the noise occurs with one or both of the rear windows down, partially lower both front windows approximately one inch. If you experience the noise with the sunroof open, slightly reduce the size of the sunroof opening.

## ⚠ CAUTION

***Do not install any accessories in the vehicle that extend into the open window area. Such objects will impact the proper function of the Automatic reversal "jam protection" feature described in this chapter.***

## Window opening and closing



OCK047027

The driver's door has a master power window switch that controls all the windows in the vehicle.

To open or close a window, press down or pull up the front portion of the corresponding switch to the first detent position (5).

## ⚠ WARNING - Power Windows

**Do not extend your face or arms outside of the window opening while the vehicle is in motion. Doing so could result in significant injury.**

### *Auto up/down window (Driver's and Front Passenger's side)*



Pressing or pulling up the power window switch momentarily to the second detent position (6) completely lowers or raises the window even when the switch is released. To stop the window at the desired position while the window is in operation, pull up or press down and release the switch.

If the power window does not operate normally, the automatic power window system must be reset as follows:

1. Press the Engine Start/Stop Button twice to the ON position.
2. Close the driver's and front passenger's window and continue pulling up the driver's power window switch for at least 1 second after the window is completely closed.

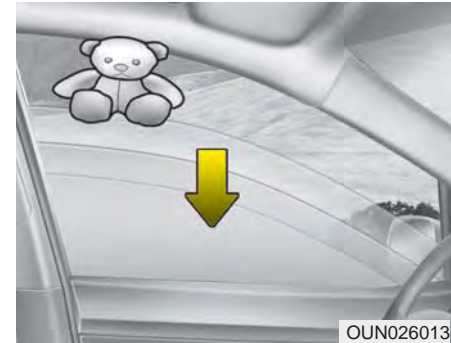

### **Automatic reversal (for Auto up/down window)**

If the upward movement of the window is blocked by an object or part of the body, the window will detect the resistance and will stop upward movement. The window will then lower approximately 11.8 in. (30 cm) to allow the object to be cleared.

The distance may vary based on the size or position of the window. If the window detects the resistance while the power window switch is pulled up continuously, the window will stop upward movement then lower approximately 1 in. (2.5 cm).

If the power window switch is pulled up continuously again within 5 seconds after the window is lowered by the automatic window reversal feature, the automatic window reversal will not operate.

The automatic reverse feature for the driver's and front passenger's window is only active when the "auto up" feature is used by fully pulling up the switch. The automatic reverse feature will not operate if the window is raised using the halfway position on the power window switch.

### **⚠ WARNING**

**Always check for obstructions before raising any window to avoid injuries or vehicle damage. If an object less than 0.16 in. (4 mm) in diameter is caught between the window glass and the upper window channel, the automatic reverse window may not detect the resistance and will not stop and reverse direction.**

### **⚠ WARNING**

**The automatic reverse feature doesn't activate while resetting power window system. Make sure body parts or other objects are safely out of the way before closing the windows to avoid injuries or vehicle damage.**

### **⚠ WARNING**

**Do not install any accessories in the vehicle that extend into the open window area. Such objects could prevent the automatic reverse feature from functioning.**

### **Power window lock button**



- The driver can disable the power window switches on the passenger doors by pressing the power window lock button located on the driver's door to the LOCK position (pressed).
- **When the power window lock button is pressed :**
  - The driver's master control can operate all the power windows.
  - The front passenger's control can operate the front passenger's power window.

- The rear passenger's control cannot operate the rear passenger's power window.

 **CAUTION** - Opening /closing Window

*To prevent possible damage to the power window system, do not open or close two windows or more at the same time. This will also ensure the longevity of the fuse.*

Always double check to make sure all arms, hands, head and other obstructions are safely out of the way before closing a window.

 **WARNING** - Power windows

**Do not allow children to play with the power windows. Keep the power window lock button (on the driver's door) in the LOCK (pressed) position.**

## HOOD

### Opening the hood

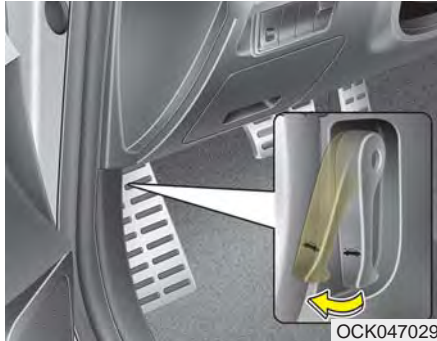

1. Pull the release lever to unlatch the hood. The hood should pop open slightly.

Only open the hood with the vehicle on a flat surface, engine is turned off, shift lever placed in P (Park) position and setting the parking brake.



2. Go to the front of the vehicle, raise the hood slightly, push the secondary latch (1) left side of the hood center and lift the hood (2).
3. Raise the hood. It will completely rise by itself after it has been raised about halfway.

### Hood open warning



The warning message will appear on the LCD display when hood is open.

The warning chime will operate when the vehicle is being driven at or above 2 mph (3 km/h) with the hood open.



### Closing the hood

1. Before closing the hood, check the following:
  - All filler caps in engine compartment must be correctly installed.
  - Gloves, rags or any other combustible material must be removed from the engine compartment.
2. Lower the hood halfway and push down to securely lock in place.
3. Check that the hood has engaged properly. If the hood can be raised slightly, it is not properly engaged. Open it again and close it with a little more force.



#### **CAUTION - Hood obstruction**

*Before closing the hood, ensure that all obstructions are removed from the hood opening. Closing the hood with an obstruction present in the hood opening may result in property damage.*



#### **WARNING - Fire risk**

**Do not leave gloves, rags or any other combustible material in the engine compartment. Doing so may cause a heat-induced fire.**



#### **WARNING - Unsecured engine hood**

**Always double check to be sure that the hood is firmly latched before driving away. If it is not latched, the hood could fly open while the vehicle is being driven, causing a total loss of visibility, which might result in an accident.**

## FUEL FILLER LID

### Opening the fuel filler lid



The fuel filler lid must be opened from inside the vehicle by pressing the fuel filler lid opener button.

If the fuel filler lid does not open because ice has formed around it, tap lightly or push on the lid to break the ice and release the lid. Do not pry on the lid. If necessary, spray around the lid with an approved de-icer fluid (do not use radiator anti-freeze) or move the vehicle to a warm place and allow the ice to melt.

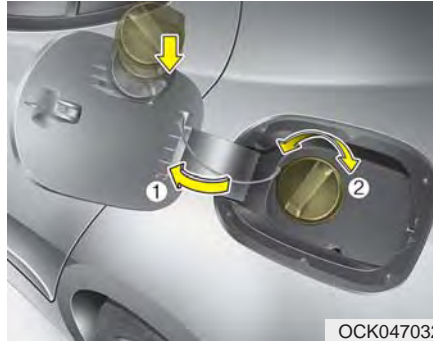

1. Stop the engine.
2. To open the fuel filler lid, push the fuel filler lid opener button.
3. Pull open the fuel filler lid (1).
4. To remove the cap, turn the fuel filler cap (2) counterclockwise.
5. Refuel as needed.

### Closing the fuel filler lid

1. To install the cap, turn it clockwise until it “clicks” once. This indicates that the cap is securely tightened.
2. Close the fuel filler lid and push it in lightly making sure that it is securely closed.

#### \* NOTICE

There may be an intermittent noise near the refueling hole while the engine is idling if the fuel cap is not closed securely. This occurs normally with the OBD system.

#### \* NOTICE

When refueling on unlevel ground, the fuel gauge may not point to the F position.

It is not a malfunction. If you move your vehicle to a level ground, the fuel gauge will move to the full position.

### Emergency fuel filler lid release

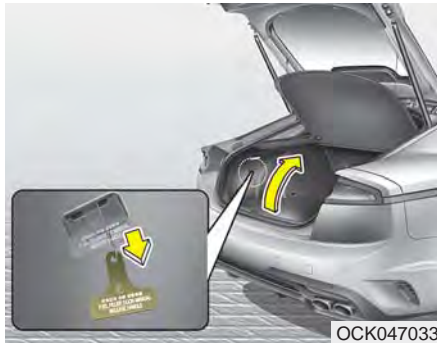

If the fuel filler lid does not open using the fuel filler lid opener button, you can open it manually.

Remove the panel in the cargo area. Pull the handle out slightly.

#### **⚠ CAUTION**

*Do not pull the handle excessively, otherwise the luggage area trim or release handle may be damaged.*

#### **⚠ WARNING - Refueling**

Always remove the fuel cap carefully and slowly. If the cap is venting fuel or if you hear a hissing sound, wait until the condition stops before completely removing the cap. If pressurized fuel sprays out, it can cover your clothes or skin and subject you to the risk of fire and burns.

Always check that the fuel cap is installed securely to prevent fuel spillage in the event of an accident.

#### **\* NOTICE**

Tighten the cap until it clicks once, otherwise the fuel cap open warning indicator  light will illuminate.

#### **⚠ WARNING - Fire/explosion risk**

Read and follow all warnings posted at the gas station facility. Failure to follow all warnings may result in severe personal injury, severe burns or death due to fire or explosion.

**⚠ WARNING - Static electricity**

- Before touching the fuel nozzle, you should eliminate potentially dangerous static electricity discharge by touching another metal part of the vehicle, a safe distance away from the fuel filler neck, nozzle, or other gas source.
- Do not get back into a vehicle once you have begun refueling since you can generate static electricity by touching, rubbing or sliding against any item or fabric (polyester, satin, nylon, etc.) capable of producing static electricity.

(Continued)

(Continued)

Static electricity discharge can ignite fuel vapors resulting in rapid burning. If you must reenter the vehicle, you should once again eliminate potentially dangerous static electricity discharge by touching a metal part of the vehicle, away from the fuel filler neck, nozzle or other gasoline source.

**⚠ WARNING - Portable fuel container**

When using an approved portable fuel container, be sure to place the container on the ground prior to refueling. Static electricity discharge from the container can ignite fuel vapors causing a fire. Once refueling has begun, contact with the vehicle should be maintained until the filling is complete. Use only approved portable plastic fuel containers designed to carry and store gasoline.

 **WARNING - Cell phone fires**

Do not use cellular phones while refueling. Electric current and/or electronic interference from cellular phones can potentially ignite fuel vapors causing a fire.

 **WARNING - Smoking**

**DO NOT** use matches or a lighter and **DO NOT SMOKE** or leave a lit cigarette in your vehicle while at a gas station especially during refueling. Automotive fuel is highly flammable and can, when ignited, result in fire.

 **WARNING - Refueling & Vehicle fires**

When refueling, always shut the engine off. Sparks produced by electrical components related to the engine can ignite fuel vapors causing a fire. Once refueling is complete, check to make sure the filler cap and filler door are securely closed, before starting the engine.

Make sure to refuel your vehicle according to the “Fuel requirements” suggested in chapter 1.

If the fuel filler cap requires replacement, use only a genuine Kia cap or the equivalent specified for your vehicle. An incorrect fuel filler cap can result in a serious malfunction of the fuel system or emission control system.

 **CAUTION - Exterior paint**

*Do not spill fuel on the exterior surfaces of the vehicle. Any type of fuel spilled on painted surfaces may damage the paint.*

## WIDE SUNROOF (IF EQUIPPED)



OCK047034

If your vehicle is equipped with a sunroof, you can slide or tilt your sunroof with the sunroof control lever located on the overhead console.

The sunroof can be operated for approximately 30 seconds after the Engine Start/Stop button is in the OFF position.

However, if the driver's door is opened, the sunroof cannot be operated even within the 30 second period.



### **CAUTION - Sunroof motor damage**

*To prevent damage to the sunroof, periodically remove any dirt that may accumulate on the guide rail.*

In cold and wet climates, the sunroof may not work properly due to freezing conditions.

After the vehicle is washed or in a rainstorm, be sure to wipe off any water that is on the sunroof before operating it.



### **CAUTION - Sunroof control lever**

*Do not continue to press the sunroof control lever after the sunroof is fully opened, closed, or tilted. Damage to the motor or system components could occur.*

The sunroof cannot slide when it is in the tilt position nor can it be tilted while in an open or slide position.



### **WARNING - Roof cargo**

**Do not operate the sun roof while using the roof rack to transport cargo. This may cause the cargo to come loose and distract the driver.**

**⚠ WARNING**  
Never adjust the sunroof or sunshade while driving. This could result in loss of control and an accident that may cause death, serious injury, or property damage.

**⚠ WARNING**  
Do not allow children to operate the sunroof. This may result in injury to the child.

**⚠ WARNING**  
In order to prevent accidental operation of the sunroof, especially by a child, do not let a child operate the sunroof.

**⚠ WARNING**  
Do not sit on the top of the vehicle. It may cause vehicle damage.

**⚠ CAUTION**  
*Do not extend any luggage outside the sunroof while driving.*

### Sunroof open warning



If the driver turns off the engine when the sunroof is not fully closed, the warning chime will sound for a few seconds and the above warning illustration will appear on the LCD display. Close the sunroof securely when leaving your vehicle.

**⚠ CAUTION**  
*Make sure the sunroof is fully closed when leaving your vehicle. If the sunroof is opened, rain or snow may leak through the sunroof and wet the interior as well as allow theft to occur.*

## Sunshade



### *To open the sunshade*

Push the sunroof control lever backward to the 1st detent position.

### *To close the sunshade when the sunroof glass is closed*

Push the sunroof control lever forward to the 1st detent position.

To stop the sliding at any point, press the sunshade control switch momentarily.

## \* NOTICE

Wrinkles formed on the sunshade as material characteristic are normal.



### **CAUTION - Automatic sunroof shade**

- *Do not pull or push the sunshade by hand as such action may damage the sunshade or cause it to malfunction.*
- *Close the sunroof when driving in dusty environments. Dust may cause a malfunction of the vehicle system.*

## Sliding the sunroof



### *When the sunshade is closed*

Pull the sunroof control lever backward to the 2nd detent position, and both the sunshade and sunroof glass will slide all the way open.



### *When the sunshade is opened*

Pull the sunroof control lever back ward to the 1st or 2nd detent position, the sunroof glass will slide all the way open. To stop the sunroof movement at any point, push the sunroof control lever momentarily.

### *Automatic reversal*

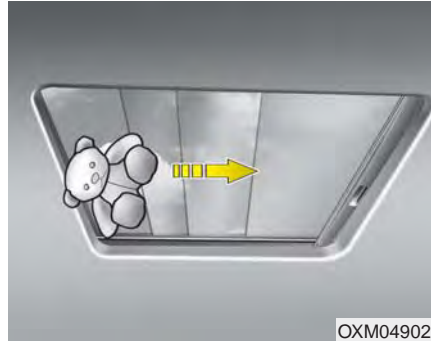

If an object or part of the body is detected while the sunroof is closing automatically, it will reverse the direction, and then stop.

The auto reverse function may not work if a tiny obstacle is lodged between the sliding glass and the sunroof sash.

You should always check that all passengers and objects are away from the sunroof before closing it.

Objects less than 0.16 inch (4 mm) in diameter caught between the sunroof glass and the front glass channel may not be detected by the automatic reverse glass and the glass will not stop and reverse direction.

#### **⚠ WARNING - Sunroof**

- Be careful that no head, hands and body parts are obstructed by a closing sunroof.
- Do not extend the face, neck, arms or body outside the sunroof while driving.

#### **⚠ WARNING - Sunroof Operation**

**When closing the sunroof, make sure there are no body parts in the movement range of the sliding roof. Parts of the body could become trapped or crushed.**

**⚠ CAUTION**

*To prevent damage to the sunroof, periodically remove any dirt that may accumulate on the guide rail.*

**\* NOTICE**

If you drive with the sunroof opened right after a vehicle wash or rain, water may get inside the vehicle.

**⚠ CAUTION - Sunroof motor damage**

*If you try to open the sunroof when the temperature is below freezing or when the sunroof is covered with snow or ice, the glass or the motor could be damaged.*

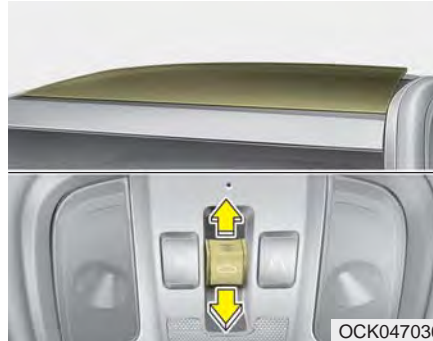
**Tilting the sunroof*****When the sunshade is closed***

Push the sunroof control lever upward, the sunshade will slide all the way open then the sunroof glass will tilt.

To stop the sunroof movement at any point, push the sunroof control lever momentarily.

***When the sunshade is opened***

Push the sunroof control lever upward, the sunroof glass will tilt.

To stop the sunroof movement at any point, push the sunroof control lever momentarily.

**Closing the sunroof**

***To close the sunroof glass with the sunshade***

Push the sunroof control lever forward to the first detent position.

***To close the sunroof glass only***

Push the sunroof control lever forward to the second detent position. The sunroof glass will close then the sunshade close automatically.

To stop the sunroof movement at any point, push the sunroof control lever momentarily.

### Resetting the sunroof

Whenever the vehicle battery is disconnected or discharged, you must reset your sunroof system as follows:

1. Start the engine.
2. Close the sunshade and sunroof completely if opened.
3. Release the sunroof control lever.
4. Push the sunroof control lever forward in the direction of close (about 10 seconds) until the sunshade slightly moves. Then, release the lever.
5. Push the sunroof control lever forward in the direction of close, until the sunroof operates as follows again:

Sunshade open → Glass slide open → Glass slide close → Sunshade close

Then, release the lever.

When this is complete, the sunroof system has been reset and one touch open and close should be restored.

### \* NOTICE

**If the Resetting the Sunroof procedure is not correctly followed, the sunroof may not operate properly.**

## STEERING WHEEL

### Electric power steering (EPS)

The power steering uses a motor to assist you in steering the vehicle. If the engine is off or if the power steering system becomes inoperative, the vehicle may still be steered, but it will require increased steering effort.

The EPS is controlled by a power steering control unit which senses the steering wheel torque and vehicle speed to command the motor.

The steering becomes heavier as the vehicle's speed increases and becomes lighter as the vehicle's speed decreases for optimum steering control.

Should you notice any change in the effort required to steer during normal vehicle operation, have the power steering checked by an authorized Kia dealer.

- When you operate the steering wheel in low temperature, noise may occur. If temperature rises, the noise will likely disappear. This is a normal condition.
- When the vehicle is stationary, and the steering wheel is turned all the way to the left or right continuously, the steering wheel becomes harder to turn. The power assist is limited to protect the motor from overheating.

As time passes, the steering wheel will return to its normal condition.

### \* NOTICE

The following symptoms may occur during normal vehicle operation:

- The EPS warning light does not illuminate.
- The steering gets heavy immediately after turning the ignition switch on. This happens as the system performs the EPS system diagnostics. When the diagnostics are completed, the steering wheel will return to its normal condition.
- A click noise may be heard from the EPS relay after the Engine Start/Stop button is turned to the ON or OFF position.
- A motor noise may be heard when the vehicle is at a stop or at a low driving speed.
- If the Electric Power Steering System does not operate normally, the warning light will illuminate on the instrument cluster. The power steering system will not operate and steering effort can increase. Take your vehicle to an authorized Kia dealer and have the vehicle checked as soon as possible.

(Continued)

(Continued)

- When the charging system warning light comes on due to low voltage (when the alternator or battery do not operate normally or malfunction), the steering wheel may require increased steering effort.

### Tilt and telescopic steering

Tilt and telescopic steering allows you to adjust the steering wheel before you drive. You can also raise it to give your legs more room when you exit and enter the vehicle.

The steering wheel should be positioned so that it is comfortable for you to drive, while permitting you to see the instrument panel warning lights and gauges.

**⚠ WARNING - Steering wheel adjustment**  
**Never adjust the angle and height of the steering wheel while driving. You may lose steering control.**

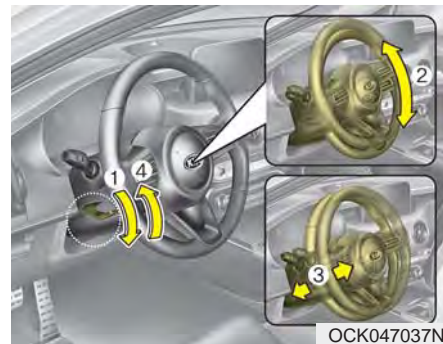

#### ► Manual type

To change the steering wheel angle, pull down the lock-release lever (1), adjust the steering wheel to the desired angle (2) and height (3) then pull up the lock-release lever to lock (4) the steering wheel in place. Be sure to adjust the steering wheel to the desired position before driving.

#### \* NOTICE

After adjustment, sometimes the lock release lever may not lock the steering wheel. It is not a malfunction. This occurs when two gears are not engaged correctly. In this case, adjust the steering wheel again and then lock the steering wheel.

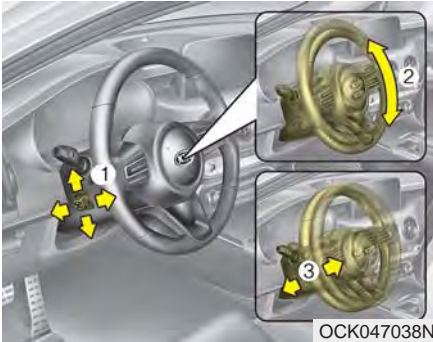

► Electric type (if equipped)

Adjust the steering wheel angle (2) and position (3) with the switch (1) on the steering column. Move the steering wheel, so it points toward your chest, not toward your face. Make sure you can see the instrument panel warning lights and gauges.

After adjusting, push the steering wheel both up and down to be certain it is locked in position. Always adjust the position of the steering wheel before driving.

**\* NOTICE**

To prevent discharge of the battery, do not operate when the engine is stopped.

**Heated steering wheel (if equipped)**



With the Engine Start/Stop Button in the ON position, pressing the heated steering wheel button warms the steering wheel. The indicator on the button will illuminate.

To turn the heated steering wheel off, press the button once again. The indicator on the button will turn off.

**⚠ WARNING**

If the steering wheel becomes too warm, turn the system off. The heated steering wheel may cause burns even at low temperatures, especially if used for long periods of time.

**\* NOTICE**

The heated steering wheel will turn off automatically approximately 30 minutes after the heated steering wheel is turned on.

**⚠ CAUTION**

- *Do not install any type of grip cover for the steering wheel, it may impair the function of the heated steering wheel system.*
- *When cleaning the heated steering wheel, do not use an organic solvent such as paint thinner, benzene, alcohol and gasoline. Doing so may damage the surface of the steering wheel.*
- *If the surface of the steering wheel is damaged by a sharp object, damage to the heated steering wheel components could occur.*

**Horn**



To sound the horn, press the horn symbols on your steering wheel. Check the horn regularly to be sure it operates properly.

**\* NOTICE**

To sound the horn, press the area indicated by the horn symbol on your steering wheel (see illustration). The horn will operate only when this area is pressed.

## MIRRORS

### Inside rearview mirror

Adjust the rearview mirror so that the center view through the rear window is seen. Make this adjustment before you start driving.

Do not place objects in the rear seat or cargo area which would interfere with your vision through the rear window.

**⚠ WARNING - Mirror adjustment**

**Do not adjust the rearview mirror while the vehicle is moving. This could result in loss of control.**

**⚠ WARNING**

**Do not modify the inside mirror and don't install a wide mirror. It could result in injury during an accident or deployment of the air bag.**

### *Electrochromic mirror (ECM) (if equipped)*

The electric rearview mirror automatically controls the glare from the headlights of the vehicles behind you in nighttime or low light driving conditions. The sensor mounted in the mirror senses the light level around the vehicle, and automatically controls the headlight glare from the vehicles behind you.

Whenever the shift lever is shifted into reverse (R), the mirror will automatically go to the brightest setting in order to improve the driver's view behind the vehicle.

**⚠ CAUTION**

***When cleaning the mirror, use a paper towel or similar material dampened with glass cleaner. Do not spray glass cleaner directly on the mirror. It may cause the liquid cleaner to enter the mirror housing.***



OOCK047059L

### To operate the electric rearview mirror:

- The mirror defaults to the ON position whenever the Engine Start/Stop Button is in the ON position.
- Press the ON/OFF button (1) to turn the automatic dimming function off. The mirror indicator light (2) will turn off. Press the ON/OFF button (1) to turn the automatic dimming function on. The mirror indicator light (2) will illuminate.

\* (2) : Indicator, (3) : Sensor



### **Electric chromic mirror (ECM) with HomeLink® system and com- pass (if equipped)**

Your vehicle may be equipped with a Gentex Automatic-Dimming Mirror with a Z-Nav® Electronic Compass Display and an Integrated HomeLink® Wireless Control System.

During nighttime driving, this feature will automatically detect and reduce rearview mirror glare while the compass indicates the direction the vehicle is pointed. The HomeLink® Universal Transceiver allows you to activate your garage door(s), electric gate, home lighting, etc.



- (1) Channel 1 button
- (2) Channel 2 button
- (3) Status indicator LED
- (4) Channel 3 button
- (5) Rear light sensor
- (6) Dimming ON/OFF button
- (7) Compass control button
- (8) Compass display

### **Automatic-Dimming Night Vision Safety™ (NVS®) Mirror**

The NVS® Mirror in your vehicle is the most advanced way to reduce annoying glare in the rearview mirror during any driving situation. For more information regarding NVS® mirrors and other applications, please refer to the Gentex website:

[www.gentex.com](http://www.gentex.com)



\* Night Vision Safety™ is a registered trademark of Gentex Corporation.

#### **⚠ CAUTION**

***The NVS® Mirror automatically reduces glare during driving conditions based upon light levels monitored in front of the vehicle and from the rear of the vehicle. These light sensors are visible through openings in the front and rear of the mirror case. Any object that obstructs either light sensor will degrade the automatic dimming control feature.***

**Automatic-dimming function**

Your mirror will automatically dim upon detecting glare from the vehicles traveling behind you. The auto-dimming function can be controlled by the Dimming ON/OFF Button:

1. Pressing the  button turns the auto-dimming function OFF which is indicated by the green Status Indicator LED turning off.
2. Pressing the  button again turns the auto-dimming function ON which is indicated by the green Status Indicator LED turning on.

**\* NOTICE**

The mirror defaults to the ON position each time the vehicle is started.



**Z-Nav™ Compass Display**

The NVS® Mirror in your vehicle is also equipped with a Z-NAV™ Compass that shows the vehicle Compass heading in the Display Window using the 8 basic cardinal headings (N, NE, E, SE, etc.).

\* Z-Nav™ is a registered trademark of Gentex Corporation.

**Compass function**

The Compass can be turned ON and OFF and will remember the last state when the ignition is cycled. To turn the display feature ON/OFF:



1. Press and release the  button to turn the display feature OFF.
2. Press and release the  button again to turn the display back ON.

Additional options can be set with press and hold sequences of the button and are detailed below.

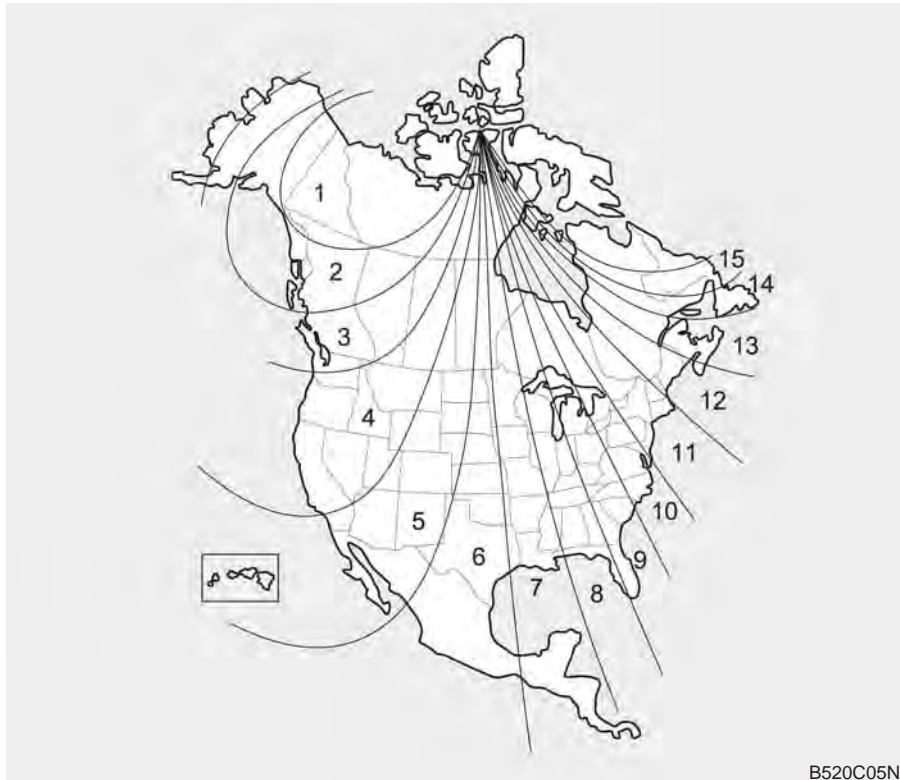
There is a difference between magnetic north and true north. The compass in the mirror can compensate for this difference when it knows the Magnetic Zone in which it is operating. This is set either by the dealer or by the user. The operating Zone Numbers for North America are shown in the figure on the following section.



To adjust the Zone setting:

1. Determine the desired Zone Number based upon your current location on the Zone Map.
2. Press and hold the  button for more than 3, but less than 6 seconds, the current Zone Number will appear on the display.
3. Pressing and holding the  button again will cause the numbers to increment (Note: they will repeat ...13, 14, 15, 1, 2, ...). Releasing the button when the desired Zone Number appears on the display will set the new Zone.
4. Within about 5 seconds, the compass will start displaying a compass heading again.

There are some conditions that can cause changes to the vehicle magnets, such as installing a ski rack or a CB antenna. Body repair work on the vehicle can also cause changes to the vehicle's magnetic field. In these situations, the compass will need to be re-calibrated to quickly correct for these changes. To re-calibrate the compass:

1. Press and hold the  button for more than 6 seconds. When the compass memory is cleared, a "C" will appear in the display.
2. To calibrate the compass, drive the vehicle in 2 complete circles at less than 5 mph (8 km/h).

### **Integrated HomeLink® Wireless Control System**

The HomeLink® Wireless Control System provides a convenient way to replace up to three hand-held radio-frequency (RF) transmitters with a single built-in device. This innovative feature will learn the radio frequency codes of most current transmitters to operate devices such as gate operators, garage door openers, entry door locks, security systems, even home lighting. Both standard and rolling code-equipped transmitters can be programmed by following the outlined procedures. Additional HomeLink® information can be found at: [www.homelink.com](http://www.homelink.com) or by calling 1-800-355-3515.

\* HomeLink® is a registered trademark of Johnson Controls, Inc.

Retain the original transmitter of the RF device you are programming for use in other vehicles as well as for future HomeLink® programming. It is also suggested that upon the sale of the vehicle, the programmed HomeLink® buttons be erased for security purposes.

### Programming HomeLink®

#### \* NOTICE

- When programming a garage door opener, it is advised to park the vehicle outside of the garage.
- It is recommended that a new battery be placed in the hand-held transmitter of the device being programmed to HomeLink® for quicker training and accurate transmission of the radio-frequency signal.
- Some vehicles may require the ignition switch to be turned to the second position for programming and/or operation of HomeLink®.
- In the event that there are still programming difficulties or questions after following the programming steps listed below, contact HomeLink® at: [www.homelink.com](http://www.homelink.com) or 1-800-355-3515.

### Standard programming

To train most devices, follow these instructions:

1. For first-time programming, press and hold the two outside buttons, HomeLink® Channel 1 and Channel 3 Buttons, until the indicator light begins to flash (after 20 seconds). Release both buttons. Do not hold the buttons for longer than 30 seconds.
2. Position the end of your hand-held transmitter 1-3 inches (2-8 cm) away from the HomeLink® buttons while keeping the indicator light in view.
3. Simultaneously press and hold both the HomeLink® and hand-held transmitter button. DO NOT release the buttons until step 4 has been completed.
4. While continuing to hold the buttons the red Indicator Status LED will flash slowly and then rapidly after HomeLink® successfully trains to the frequency signal from the hand-held transmitter. Release both buttons.
5. Press and hold the just-trained HomeLink® button and observe the red Status Indicator LED. If the indicator light stays on constantly, programming is complete and your device should activate when the HomeLink® button is pressed and released.
6. To program the remaining two HomeLink® buttons, follow steps 2 through 5.

## Rolling code programming

Rolling code devices which are “code-protected” and manufactured after 1996 may be determined by the following:

- Reference the device owner's manual for verification.
- The handheld transmitter appears to program the HomeLink® Universal Transceiver but does not activate the device.
- Press and hold the trained HomeLink® button. The device has the rolling code feature if the indicator light flashes rapidly and then turns solid after 2 seconds.

To train rolling code devices, follow these instructions:

1. At the garage door opener receiver (motor-head unit) in the garage, locate the “learn” or “smart” button. This can usually be found where the hanging antenna wire is attached to the motor-head unit. Exact location and color of the button may vary by garage door opener brand.  
If there is difficulty locating the training button, reference the device owner's manual or please visit our web site at [www.home-link.com](http://www.home-link.com).
2. Firmly press and release the “learn” or “smart” button (which activates the “training light”).

### \* NOTICE

There are 30 seconds in which to initiate step 3.

3. Return to the vehicle, firmly press and hold for two seconds the desired HomeLink® button then release. Repeat the “press/hold/release” sequence a second time to complete the programming. (Some devices may require you to repeat this sequence a third time to complete the programming.)
4. Press and hold the just-trained HomeLink® button and observe the red Status Indicator LED. If the indicator light stays on constantly, programming is complete and your device should activate.
5. To program the remaining two HomeLink® buttons, follow either steps 1 through 4 above for other Rolling Code devices or steps 2 through 5 in Standard Programming for standard devices.

### **Gate operator & Canadian programming**

During programming, your handheld transmitter may automatically stop transmitting. Continue to press the Integrated HomeLink® Wireless Control System button (note steps 2 through 4 in the Standard Programming portion of this document) while you press and re-press (“cycle”) your handheld transmitter every two seconds until the frequency signal has been learned. The indicator light will flash slowly and then rapidly after several seconds upon successful training.

### **Operating HomeLink®**

To operate, simply press and release the programmed HomeLink® button. Activation will now occur for the trained device (i.e. garage door opener, gate operator, security system, entry door lock, home/office lighting, etc.). For convenience, the hand-held transmitter of the device may also be used at any time.

### **Reprogramming a single HomeLink® button**

To program a new device to a previously trained HomeLink® button, follow these steps:

1. Press and hold the desired HomeLink® button. Do NOT release until step 4 has been completed.
2. When the indicator light begins to flash slowly (after 20 seconds), position the handheld transmitter 1 to 3 inches away from the HomeLink® surface.
3. Press and hold the handheld transmitter button. The HomeLink® indicator light will flash, first slowly and then rapidly.
4. When the indicator light begins to flash rapidly, release both buttons.
5. Press and hold the just-trained HomeLink® button and observe the red Status Indicator LED. If the indicator light stays on constantly, programming is complete and your new device should activate.

### Erasing HomeLink® buttons

Individual buttons cannot be erased. However, to erase all three programmed buttons:

1. Press and hold the two outer HomeLink® buttons until the indicator light begins to flash-after 20 seconds.
2. Release both buttons. Do not hold for longer than 30 seconds.

The Integrated HomeLink® Wireless Control System is now in the training (learn) mode and can be programmed at any time following the appropriate steps in the Programming sections above.

**FCC ID: NZLZTVHL3**

**IC: 4112A-ZTVHL3**

### Pursuant to Code of Federal Regulations, Title 47, Part 15 (“FCC Rules”)

Operation is subject to the following two conditions:

1. This device may not cause harmful interference, and
2. This device must accept any interference received, including interference that may cause undesired operation.

The transceiver has been tested and complies with FCC and Industry Canada rules. Changes or modifications not expressly approved by the party responsible for compliance could void the user's authority to operate the device.

NVS® and Z-NAV™ are registered trademarks. Nav® are of Gentex Corporation, Zeeland, Michigan.

HomeLink® is a registered trademark owned by Johnson Controls Technology Company, Holland, Michigan.



### Outside rearview mirror

Be sure to adjust the mirror angles before driving.

Your vehicle is equipped with both left-hand and right-hand outside rearview mirrors. The mirrors can be adjusted remotely with the remote switch. The mirror heads can be folded back to prevent damage during an automatic vehicle wash or when passing through a narrow street.

The right outside rearview mirror is convex. Objects seen in the mirror are closer than they appear.

Use your interior rearview mirror or direct observation to determine the actual distance of following vehicles when changing lanes.

#### **CAUTION - Rearview mirror**

*Do not scrape ice off the mirror face; this may damage the surface of the glass. If ice should restrict the movement of the mirror, do not force the mirror for adjustment. To remove ice, use a deicer spray, a sponge or soft cloth with very warm water.*

If the mirror is jammed with ice, do not adjust the mirror by force. Use an approved spray de-icer (not radiator antifreeze) to release the frozen mechanism or move the vehicle to a warm place and allow the ice to melt.

#### **WARNING - Mirror adjustment**

**Do not adjust or fold the outside rearview mirrors while the vehicle is moving. This could result in loss of control.**

### Adjusting outside rearview mirror



The electric remote control mirror switch allows you to adjust the position of the left and right outside rearview mirrors. To adjust the position of either mirror, press the R or L button (1) to select the right side mirror or the left side mirror, then press a corresponding point (▲) on the mirror adjustment control to position the selected mirror up, down, left or right. After adjustment, press the R or L button again to prevent the inadvertent adjustment.

**⚠ CAUTION - Outside mirror**

- *The mirrors stop moving when they reach the maximum adjusting angles, but the motor continues to operate while the switch is pressed.*

*Do not press the switch longer than necessary, the motor may be damaged.*

- *Do not attempt to adjust the outside rearview mirror by hand. Doing so may damage the parts.*

**Reverse parking aid function (if equipped)**

While the vehicle is moving in reverse, the outside rearview mirror(s) will tilt downward to aid reverse parking. According to the position of the outside rearview mirror switch (1), the outside rearview mirror(s) will operate as follows:

**L/R** : When the remote control outside rearview mirror switch (1) is selected to the L (left) or R (right) position, both outside rearview mirrors will tilt downward.

**Neutral** : When the remote control outside rearview mirror switch is placed in the middle position, the outside rearview mirrors will not operate while the vehicle is moving rearward.

The outside rearview mirrors will automatically revert to their original positions under the following conditions:

1. The Engine Start/Stop button is in the OFF position.
2. Shift lever is moved to any position except R (Reverse).
3. Remote control outside rearview mirror switch is placed in the middle position.

### Folding the outside rearview mirror



#### Electric type

The outside rearview mirror can be folded or unfolded by pressing the switch as below.

**Left (1)** : The mirror will unfold.

**Right (2)** : The mirror will fold.

#### Center (AUTO, 3) :

The mirror will fold or unfold automatically as follows:

- The mirror will fold or unfold when the door is locked or unlocked by the smart key.
- The mirror will fold or unfold when the door is locked or unlocked by the button on the outside door handle.
- The mirror will unfold when you approach the vehicle (all doors closed and locked) with a smart key in possession.



#### **CAUTION - Electric type outside rearview mirror**

*The electric type outside rearview mirror operates even though the engine start/stop button is in the OFF position. However, to prevent unnecessary battery discharge, do not adjust the mirrors longer than necessary while the engine is not running.*

*Do not fold the electric type outside rearview mirror by hand. This could cause motor failure.*

## INSTRUMENT CLUSTER

### ■ Type A



1. Tachometer
2. Speedometer
3. Engine coolant temperature gauge
4. Fuel gauge
5. LCD display
6. Warning and indicator lights

### ■ Type B



- ※ The actual cluster in the vehicle may differ from the illustration.  
For more details, refer to the “Gauges” in this chapter.

OCK047100N/OCK047101N

## Instrument Cluster Control

### Adjusting Instrument Cluster Illumination

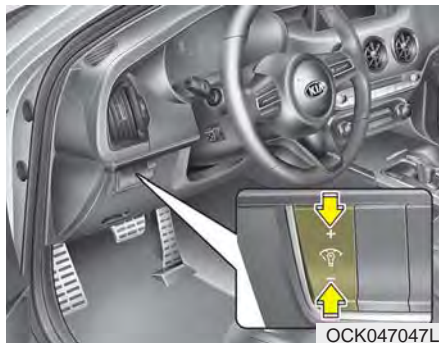

The brightness of the instrument panel illumination is changed by pressing the illumination control button (“+” or “-”) when the Engine Start/Stop button is ON, or the taillights are turned on.



- If you hold the illumination control button (“+” or “-”), the brightness will be changed continuously.
- If the brightness reaches to the maximum or minimum level, an alarm will sound.

## LCD Display Control



### ■ Type A



### ■ Type B



The LCD display modes can be changed by using the control buttons on the steering wheel.

- (1)  : MODE button for changing modes
- (2)  /  / OK : SELECT scroll switch for setting the selected item and RESET scroll switch for resetting items

\* For the LCD modes, refer to “LCD Window” in this chapter.

## Gauges

### Speedometer

■ Type A



OCK047102N

■ Type B



OCK047469N

The speedometer indicates the speed of the vehicle and is calibrated in miles per hour (mph) and/or kilometers per hour (km/h).

### Tachometer



OCK047103

The tachometer indicates the approximate number of engine revolutions per minute (rpm).

Use the tachometer to select the correct shift points and to prevent lugging and/or over-revving the engine.

#### CAUTION - Red zone

***Do not operate the engine within the tachometer's RED ZONE. This may cause severe engine damage.***

### Engine Coolant Temperature Gauge



This gauge indicates the temperature of the engine coolant when the Engine Start/Stop button is ON.

If the gauge pointer moves beyond the normal range area toward the “H” position, it indicates overheating that may damage the engine.

Do not continue driving with an overheated engine. If your vehicle overheats, refer to “If the Engine Overheats” in chapter 6.

**⚠ WARNING - Hot radiator**  
Never remove the radiator cap when the engine is hot. The engine coolant is under pressure and could cause severe burns. Wait until the engine is cool before adding coolant to the reservoir.

### Fuel Gauge



This gauge indicates the approximate amount of fuel remaining in the fuel tank.

### \* NOTICE

- The fuel tank capacity is given in chapter 8.
- The fuel gauge is supplemented by a low fuel warning light which will illuminate when the fuel tank is nearly empty.
- On inclines or curves, the fuel gauge pointer may fluctuate or the low fuel warning light may come on earlier than usual due to the movement of fuel in the tank.

**\* NOTICE - Fuel gauge**

Running out of fuel can expose vehicle occupants to danger. You must stop and obtain additional fuel as soon as possible after the warning light comes on or when the gauge indicator comes close to the “E (Empty)” level.

**⚠ CAUTION - Low fuel**

*Avoid driving with an extremely low fuel level. Running out of fuel could cause the engine to misfire damaging the catalytic converter.*

**\* NOTICE**

The fuel display may not be accurate if the vehicle is on an incline.

**Odometer**



The odometer indicates the total distance that the vehicle has been driven and should be used to determine when periodic maintenance should be performed.

- Odometer range : 0 ~ 999999 miles or 0 ~ 1599999 kilometers.

**Outside Temperature Gauge**



This gauge indicates the current outside air temperatures by 1°F (1°C).

- Temperature range : -40°F ~ 140°F (-40°C ~ 60°C)



The outside temperature on the display may not change immediately like a general thermometer to prevent the driver from being distracted.

The temperature unit can be changed (from °C to °F or from °F to °C) by using the "User Settings" mode of the LCD Window.

\* For more details, refer to "LCD Window" in this chapter.

### Transmission Shift Indicator

#### *Automatic Transmission Shift Indicator*



- Park : P
- Reverse : R
- Neutral : N
- Drive : D
- Sports Mode : 1, 2, 3, 4, 5, 6, 7, 8

This indicator displays which automatic transmission shift lever is selected.

## LCD WINDOWS (IF EQUIPPED)

### Over view

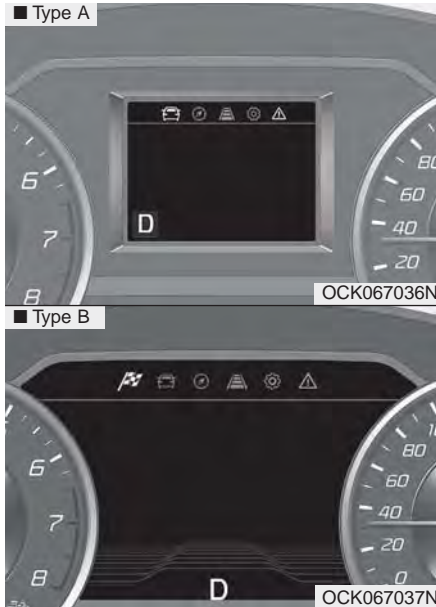

LCD windows show the following information to drivers.

- Trip information
- LCD modes
- Warning messages

### Trip information (Trip computer)

The trip computer is a microcomputer-controlled driver information system that displays information related to driving.

#### \* NOTICE

Some driving information stored in the trip computer (for example Average Fuel Economy) resets if the battery is disconnected.

### Trip Modes

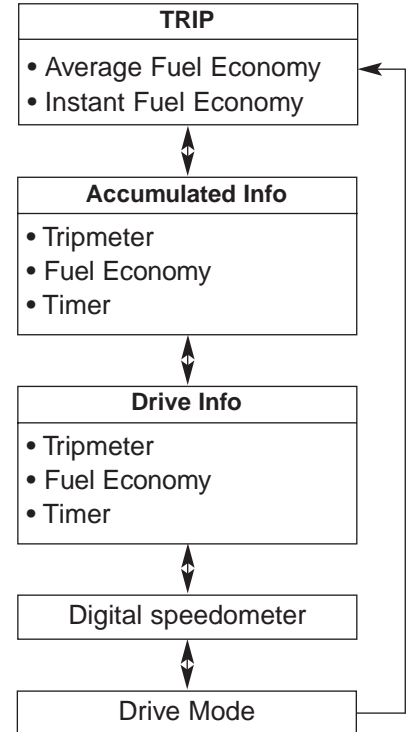

### *Fuel Economy*



#### **Average Fuel Economy (1)**

- The average fuel economy is calculated by the total driving distance and fuel consumption since the last average fuel economy reset.
  - Fuel economy range: 0.0 ~ 99.9 MPG or L/100km
- The average fuel economy can be reset both manually and automatically.

### **\* NOTICE**

The fuel economy may vary significantly based on driving conditions, driving habits, and condition of the vehicle.

#### *Manual reset*

To clear the average fuel economy manually, press the OK button (reset) on the steering wheel for more than 1 second when the average fuel economy is displayed.

### *Automatic reset*

To make the average fuel economy be reset automatically whenever refueling, select the “Fuel economy auto reset” mode in User Setting menu of the LCD window (Refer to “LCD window”).

- OFF - You may set to default manually by using the trip switch reset button.
- When driving - The vehicle will automatically set to default once 4 hours pass after the Engine Start/Stop Button is in the ACC or OFF position.
- When refueling - After refueling more than 2 gallons (6 liters) and driving over 1 mph (1 km/h), the vehicle will reset to default automatically.

### **\* NOTICE**

**For a more accurate calculation of the average fuel economy, the vehicle must be continuously driven more than 10 seconds and 50 meters (0.03 miles).**

### **Instant Fuel Economy (2)**

- This mode displays the instant fuel economy during the last few seconds when the vehicle speed is more than 4.9 mph (8 km/h).
  - Fuel economy range : 0 ~ 50 (MPG), 0 ~ 30 (km/L, L/100 km).



### **CAUTION - Low Fuel Level**

***Level warning light on or with the fuel level below “E” can cause the engine to misfire and damage the catalytic converter (if equipped).***

### Accumulated driving information mode



Displays accumulated information starting from mileage/fuel efficiency/time default point.

- Accumulated information is calculated after the vehicle has run for more than 0.19 mi (300 meters).
- If you press “OK” button for more than 1 second after the Cumulative Information is displayed, the information will be reset.
- If the engine is running, even when the vehicle is not in motion, the information will be accumulated.

### One time driving information mode



The vehicle will display Driving Information once per one ignition cycle.

- Fuel efficiency is calculated after the vehicle has run for more than 0.19 mi (300 meters).
- The Driving Information will be reset 4 hours after ignition has been turned off. So, when the vehicle ignition is turned on within 4 hours, the information will not be reset.
- If you press “OK” button for more than 1 second after the Driving Information is displayed, the information will be reset.

- If the engine is running, even when the vehicle is not in motion, the information will be accumulated.

**Digital speedometer**

This mode displays the current speed of the vehicle.

**Smart Shift (if equipped)**

This mode displays the currently selected drive mode.

**LCD Modes**

(1) SPORT mode (if equipped)  
This mode displays Gauge, Lap Timer, G-Force.

(2) Trip Computer mode  
This mode displays driving information such as the tripmeter, fuel economy, and so on.

\* For more details, refer to “Trip Computer” in this chapter.

(3) Turn by Turn mode (if equipped)  
This mode displays the state of the navigation.

### (4) Assist mode (if equipped)

This mode displays the status of the following features:

- Smart Cruise Control (SCC)
- Lane Keeping Assist (LKA)
- Driver Attention Warning (DAW)
- Tire Pressure

\* For more details, refer to “Smart Cruise Control with Stop & Go”, “Lane Keeping Assist (LKA) system”, “Driver Attention Warning (DAW) system” in chapter 5 and “Tire Pressure Monitoring System (TPMS)” in chapter 6.

### (5) User Settings mode

On this mode, you can change settings of the doors, lamps and so on.

### (6) Master warning mode

This mode informs of warning messages related to Low tire pressure or malfunction of Blind-Spot Collision Warning and so on.

\* For controlling the LCD modes, refer to “LCD window Control” in this chapter.

### *SPORT mode(if equipped)*

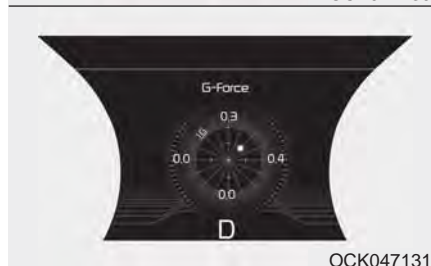

This mode displays Gauge, Lap Timer, G-Force.

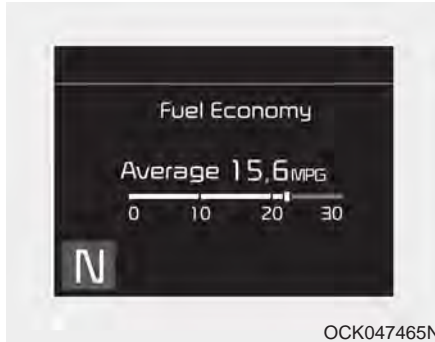
**Trip computer mode**

This mode displays driving information like the tripmeter, fuel economy, and so on.

\* For more details, refer to “Trip Computer” in this chapter.

**Turn By Turn Mode (if equipped)**

This mode displays the state of the navigation.

**Assist mode (if equipped)****SCC/LKA/DAW**

This mode displays the state of the Smart Cruise Control (SCC), Lane Keeping Assist (LKA) and Driver Attention Warning (DAW).

\* For more details, refer to each system information in chapter 5.





### Tire Pressure

This mode displays information related to Tire Pressure.

\* For more details, refer to "Tire Pressure Monitoring System (TPMS)" in chapter 6.

### Service mode



When Service Required is set, the remaining distance/time before service is required appears on the LCD screen.

From the point at which the remaining distance to drive amounts to 900 mi. (1,500 km) or the remaining time amounts to 3 days, the Service Required message automatically displays and remains on the LCD screen for a number of seconds every time the engine start/stop button is ON.

When Service Required is set, a Service Required Alarm message pops up when an aggregated amount of miles/time driven reaches a certain point.

With Service Required mode, press OK button for more than 1 second.

The values will return to initial setting values.

\* See User Settings

Mode in this chapter for further information about Service Required Setting.

\* Service Required Setting

If the Battery Cable is disconnected, Fuse Switch is turned OFF, the Service Required Setting values (an amount of miles/time driven) may change. In this situation, re-enter Service Required settings.

### Master warning mode (if equipped)



- This warning light informs the driver of the following situations:
  - LED head lamp malfunction (if equipped)
  - Smart Cruise Control with Stop & Go malfunction (if equipped)
  - Forward Collision-Avoidance Assist malfunction (if equipped)
  - Blind-Spot Collision Warning radar blind (if equipped)
  - Smart Cruise Control with Stop & Go radar blind (if equipped)
  - Lamp malfunction
  - High Beam Assist (HBA) system malfunction (if equipped)
  - Windshield washer fluid low

The Master Warning Light illuminates if one or more of the above warning situations occur. At this time, the LCD Modes Icon will change from (⚙️) to (⚠️).

If the warning situation is solved, the master warning light will be turned off and the LCD Modes Icon will be changed back to its previous icon (⚙️).

### Distance to empty

■ Type A

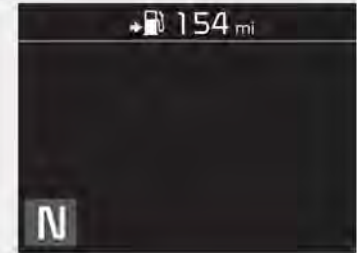

OCK047143N

■ Type B



OCK047156N

- The distance to empty is the estimated distance the vehicle can be driven with the remaining fuel.
  - Distance range : 1 ~ 9,999 mi. (1 ~ 9,999 km)

- If the estimated distance is below 1 mi. (1 km), the trip computer will display “---” as distance to empty.

### \* NOTICE

- If the vehicle is not on level ground or the battery power has been interrupted, the distance to empty function may not operate correctly.
- The distance to empty may differ from the actual driving distance as it is an estimate of the available driving distance.
- The trip computer may not register additional fuel if less than 1.6 gallons (6 liters) of fuel are added to the vehicle.
- The fuel economy and distance to empty may vary significantly based on driving conditions, driving habits, and condition of the vehicle.

## User Settings Mode

### Description



On this mode, you can change setting of the doors, lamps, and so on.

### **⚠ WARNING**

**Do not adjust the User Setting while driving. You may lose your steering control which could cause an accident and severe bodily injury.**

### *Shift to P to edit settings*



This warning message appears if you try to adjust the User Settings while driving.

For your safety, change the User Settings after parking the vehicle, applying the parking brake by pressing the parking “P” button.

**Head-Up Display (HUD) (if equipped)**

- Enable Head-Up Display : If this item is checked, Head-Up Display will be activated.
- Display Height : Adjust the height of the HUD image on the windshield glass.
- Rotation : Adjust the degree of the HUD rotation.
- Brightness : Adjust the intensity of the HUD brightness.
- Content Selection : If below items are checked, the items will be activated.
  - Turn by Turn
  - Traffic Signs
  - Driving Assist Info
  - Lane Safety Info
  - Blind-Spot Safety Info
- Speed size :  
Small/Medium/Large
- Speed color :  
White/Orange/Green

**Driver Assistance**

- SCC Reaction (if equipped)
  - Choose the sensitivity (slow, normal, fast) of the smart cruise control.
- \* For more details, refer to “Smart Cruise Control with Stop & Go” in chapter 5.
- Driver Attention Warning (if equipped) : Choose the alert stage (Off/Normal/Early stage) of the Driver Attention Warning.
- Lane Safety (if equipped) :
  - Active LKA : To activate the active LKA mode.
  - Standard LKA : To activate the standard LKA mode.
  - Lane Departure Warning : To activate the lane departure warning function.
- \* For more details, refer to “Lane Keeping Assist (LKA) system” in chapter 5.

- Forward Collision-Avoidance Assist (FCA, if equipped) :
  - To activate or deactivate the FCA system.
- \* For more details, refer to “Forward Collision-Avoidance Assist (FCA) system” in chapter 5.
- Forward Collision Warning (FCW, if equipped)
  - Choose the sensitivity of the forward collision warning.  
(Late/Normal/Early)
- \* For more details, refer to “Forward Collision-Avoidance Assist (FCA) system” in chapter 5.
- Blind-Spot Collision Warning (if equipped)
  - If this item is checked, Blind-Spot Collision Warning function will be activated.
- \* For more details, refer to “Blind-Spot Collision Warning (BCW) system” in chapter 5.

- Blind-Spot Collision Warning Sound (if equipped)
  - If this item is checked, Blind-Spot Collision Warning sound function will be activated.
- \* For more details, refer to “Blind-Spot Collision Warning (BCW) system” in chapter 5.

### *Door*

- Automatically Lock :
  - Enable on Speed : All doors will be automatically locked when the vehicle speed exceeds 9.3 mph (15 km/h).
  - Enable on Shift : All doors will be automatically locked if the automatic transmission shift lever is shifted from the P (Park) position to the R (Reverse), N(Neutral), or D (Drive) position.
- Automatically Unlock :
  - Disable : The auto door unlock operation will be canceled.
  - Vehicle Off : All doors will be automatically unlocked when the Engine Start/Stop Button is set to the OFF position.
  - On Shift to P : All doors will be automatically unlocked if the automatic transmission shift lever is in the parking position by pressing “P”button.

- Two Press Unlock (if equipped)
  - If this item checked, the Two Press Unlock function will be activated. (Only the driver’s door will unlock when unlock button is pressed once and all doors will unlock when the same button is pressed again within 4 seconds.)
- Power Liftgate (if equipped)
  - If this item is checked, the power liftgate function will be activated.
  - \* For more details, refer to “Power Liftgate” in this chapter.
- Smart Liftgate (if equipped)
  - If this item is checked, the smart liftgate function will be activated.
  - If the power liftgate function is not activated, you cannot activate this function.
  - \* For more details, refer to “Smart Liftgate” in this chapter.

### *Light*

- One Touch Turn Signal :
  - Off: The one touch turn signal function will be deactivated.
  - 3, 5, 7 Flashes : The lane change signals will blink 3, 5 or 7 times when the turn signal lever is moved slightly.
- ※ For more details, refer to “Light” in this chapter.
- Ambient Light Brightness (if equipped) : Adjust the brightness of the Ambient light.
  - Off/Level 1,2,3,4
- Ambient Light Color (if equipped) : Select the color of the ambient light.
  - White, Yellow, Red, Green, Blue, Violet
- Head Light Delay :
  - If this item is checked, the head light delay function will be activated.

### *Sound*

- Parking Distance Warning Volume (if equipped)
  - Adjust the Parking Distance Warning volume. (Level 1 ~ 3)
- ※ For more details, refer to “Parking Distance Warning” in this chapter.
- Welcome Sound (if equipped) :
  - If this item checked, the welcome sound function will be activated.

### *Convenience*

- Seat Easy Access (if equipped)
  - Off : The seat easy access function will be deactivated.
  - Normal/Extended : When you turn off the engine, the driver's seat will automatically move rear for you to enter or exit the vehicle more comfortably.

If you change the Engine Start/Stop Button from OFF position to the ACC function, the driver's seat will return to the original position.

- ※ For more details, refer to “Driver Position Memory System” in chapter 3.

- **Steering Easy Access** (if equipped)
  - On (checked) : The steering wheel will automatically move to the top of Steering column when leaving the vehicle and move to the last saved position when entering the vehicle for the driver to enter or exit the vehicle comfortably.
  - Off (unchecked) : The steering easy access function will be deactivated.
- **Gear Position Pop-up** (if equipped) : If this item is checked, the gear position pop-up display will be activated.
- **Icy road warning** (if equipped) : If this item is checked, the Icy road warning display will be activated.
- **Lateral seat support enhancement** (if equipped)
  - If this item checked, it increases lateral seat bolster support.

\*For more details, refer to “Driver Position Memory System” in chapter 3.

- **Welcome Mirror/Light** (if equipped) :
  - If this item is checked, the welcome Mirror/light function will be activated.
- **Wiper/Light Display** (if equipped) : If this item is checked, the Wiper/Light Display will be activated.

### *Service interval*

- **Service Interval**  
If this item checked, it displays an alert when a specified service interval is reached.
- **Adjust Interval**  
To set the service interval reminder time and distance.
- **Reset**  
To reset the service interval reminder time and distance.

### *Other features*

- **Fuel Economy Auto Reset**
  - Off : The average fuel economy will not reset automatically whenever refueling.
  - After Ignition : The average fuel economy will reset automatically whenever it has passed 4 hours after turning OFF the engine.
  - After Refueling : The average fuel economy will reset automatically when refueling.

\*For more details, refer to “Trip Computer” in this chapter.

- **Fuel Economy Unit**
  - Choose the fuel economy unit. (US gallon, UK gallon)
- **Temperature Unit**
  - Choose the temperature unit. (°C, °F)

- Tire Pressure Unit (if equipped)
  - Choose the tire pressure unit. (psi, kPa, bar)
- Torque Unit(if equipped)
  - Choose the torque unit. (N·m, lb·ft)

### ***Language***

Choose the language

### ***Reset***

You can reset the menus in the User Settings Mode. All menus in the User Settings Mode are initialized, except language and service interval.

### **Warning Messages (if equipped)**

#### ***Shift to P***

- This warning message illuminates if you try to turn off the engine without the transmission in P (Park) position.
- At this time, the Engine Start/Stop Button turns to the ACC position (If you press the Engine Start/Stop Button once more, it will turn to the ON position).

#### ***Low Key Battery***

- This warning message illuminates if the battery of the smart key is discharged when the Engine Start/Stop Button changes to the OFF position.

### ***Press brake pedal to start engine***

- This warning message illuminates if the Engine Start/Stop Button changes to the ACC position twice by pressing the button repeatedly without depressing the brake pedal.
- It means that you should depress the brake pedal to start the engine.

### ***Key not in vehicle***

- This warning message illuminates if the smart key is not in the vehicle when you press the Engine Start/Stop Button.
- It means that you should always have the smart key with you.



### ***Key not detected***

- This warning message illuminates if the smart key is not detected when you press the Engine Start/Stop Button.

### ***Press start button again***

- This warning message illuminates if you can not operate the Engine Start/Stop Button when there is a problem with the Engine Start/Stop Button system.
- It means that you could start the engine by pressing the Engine Start/ Stop Button once more.
- If the warning illuminates each time you press the Engine Start/Stop Button, have the vehicle inspected by an authorized Kia dealer.

### ***Press start button with key***

- This warning message illuminates if you press the Engine Start/Stop Button while the warning message “Key not detected” is illuminating.
- At this time, the immobilizer indicator light blinks.

### ***Check BRAKE SWITCH fuse***

- This warning message illuminates if the brake switch fuse for stop lamp is disconnected.
- In this case, the Engine does not start by pressing brake pedal and Engine Start/Stop button.
- If you cannot replace the fuse with a new one and want to start the Engine, press Engine Start/Stop button once to ACC position. Then press the Engine Start/Stop button for 10 seconds in the ACC position and you can start the Engine.
- It is dangerous to drive the vehicle when the stop lamp does not operate. You should replace the fuse with a new one immediately.

### ***Shift to P or N to start engine***

- This warning message illuminates if you try to start the engine with the transmission not in the P (Park) or N (Neutral) position.

### **\* NOTICE**

**You can start the engine with the transmission in the N (Neutral) position. But, for your safety, we recommend that you start the engine with the transmission in the P (Park) position.**

**Door, Hood, Liftgate Open**



- It means that a door, hood, or liftgate is open.
- The hood warning message will appear on the LCD display when hood is open.

The warning chime will operate when the vehicle is being driven at or above 2 mph (3 km/h) with the hood open.

**Sunroof Open (if equipped)**



- This warning message illuminates if you turn off the engine and then open the driver's door when the sunroof is open.

**Icy Road Warning Light (if equipped)**



This warning pop-up message and light are to warn the driver the road may be icy.

When the Outside Temperature is below approximately 39°F (4°C),

- The warning light (including Outside Temperature) blinks 5 times and then illuminates.
- The warning pop-up message displays, and the warning chime sounds once at the same time only once for each ignition cycle.

**\* NOTICE**

**If the icy road warning light appears while driving, you should drive more attentively and refraining from speeding, rapid acceleration, sudden braking or sharp turning.**

***Check headlight LED***

This warning message illuminates if LED headlamp malfunctions.

***Check headlight cooling fan***

This warning message illuminates if LED headlamp cooling fan malfunctions.

***Check shift lever  
(if SBW equipped)***

If there is a problem with the SBW (Shift-By-Wire) system, this warning message is displayed.

***Low Washer Fluid***

- This warning message illuminates on the service reminder mode if the washer fluid level in the reservoir is nearly empty.
- It means that you should refill the washer fluid.

***Turn on FUSE SWITCH***

- This warning message illuminates if the fuse switch under the steering wheel is OFF.
- It means that you should turn the fuse switch on.

\* For more details, refer to “Fuses” in chapter 7.

***Check headlights (if equipped)***

This warning message illuminates if there is a malfunction (burned-out bulb or circuit malfunction) with the head lights (high and low beam). In this case, have the vehicle inspected by an authorized Kia dealer.

**\* NOTICE**

- **When replacing the bulb, use the same wattage bulb.**  
For more information, refer to “BULB WATTAGE” in chapter 8.
- **If the different wattage bulb is equipped with the vehicle, this warning message is not displayed.**

***Low Fuel***

- This warning message illuminates if the fuel tank is nearly empty.
  - When the low fuel level warning light is illuminated, add fuel as soon as possible.

***Device in Wireless Charger (if equipped)***

If a smart phone is still left in the wireless charging pad unattended, even when the Engine Start/Stop Button is in the ACC or OFF position, a warning message will appear on the instrument panel.

- ※ For more details, refer to “Smart Phone Wireless Charger” in this chapter.

## WARNING AND INDICATOR LIGHTS

### Warning lights

#### \* NOTICE - Warning lights

Make sure that all warning lights are OFF after starting the engine. If any light is still ON, this indicates a situation that needs attention.

#### *Air bag Warning Light*



**This warning light illuminates:**

- Once you set the Engine Start/Stop Button to the ON position.
  - It illuminates for approximately 6 seconds and then goes off.
- When there is a malfunction with the SRS.

In this case, have the vehicle inspected by an authorized Kia dealer.

#### *Seat Belt Warning Light*



This warning light informs the driver that the seat belt is not fastened.

\*For more details, refer to the “Seat Belts” in chapter 3.

### ***Parking Brake & Brake Fluid Warning Light***



#### **This warning light illuminates:**

- Once you set the Engine Start/Stop Button to the ON position.
  - It illuminates for approximately 3 seconds
- When the parking brake is applied, the warning light will remain on.
- When the brake fluid level in the reservoir is low.
  - If the warning light illuminates with the parking brake released, it indicates the brake fluid level in reservoir is low.

#### **If the brake fluid level in the reservoir is low:**

1. Drive carefully to the nearest safe location and stop your vehicle.
2. With the engine stopped, check the brake fluid level immediately and add fluid as required (For more details, refer to “Brake Fluid” in chapter 7). Then check all brake components for fluid leaks. If any leak on the brake system is still found, the warning light remains on, or the brakes do not operate properly, do not drive the vehicle.

In this case, have your vehicle towed to an authorized Kia dealer and inspected.

#### **Dual-diagonal braking system**

Your vehicle is equipped with dual-diagonal braking systems. This means you still have braking on two wheels even if one of the dual systems should fail.

With only one of the dual systems working, greater pedal pressure will be required to stop the vehicle.

Also, the vehicle will require increased stopping distance with only a portion of the brake system working.

If the brakes fail while you are driving, shift to a lower gear for additional engine braking and stop the vehicle as soon as it is safe to do so.

Driving the vehicle with a warning light ON is dangerous. If the Parking Brake & Brake Fluid Warning Light illuminate with the parking brake released, this indicates that the brake fluid level is low.

In this case, have your vehicle inspected by an authorized Kia dealer.

**Anti-lock Brake System (ABS) Warning Light**



**This warning light illuminates:**

- Once you set the Engine Start/Stop Button to the ON position.
  - It illuminates for approximately 3 seconds and then goes off.
- When there is a malfunction with the ABS, the warning light will remain on. The braking system will be operational without the assistance of the anti-lock brake system.

In this case, have the vehicle inspected by an authorized Kia dealer.

**Electronic Brake force Distribution (EBD) System Warning Light**



**These two warning lights illuminate at the same time while driving:**

- When the ABS and regular brake system may not work normally.  
In this case, have the vehicle inspected by an authorized Kia dealer.

**⚠ WARNING - Electronic Brake force Distribution (EBD) System Warning Light**

**When both ABS and Parking Brake & Brake Fluid Warning Lights are on, the brake system will not work normally and you may experience an unexpected and dangerous situation during sudden braking thereby increasing the risk of a crash and injury.**

**In this case, avoid high speed driving and abrupt braking.**

**Have your vehicle inspected by an authorized Kia dealer as soon as possible.**

**\* NOTICE - Electronic Brake force Distribution (EBD) System Warning Light**

When the ABS Warning Light is on or both the ABS and the Parking Brake & Brake Fluid Warning Lights are on, the speedometer, odometer, or tripmeter may not work. Also, the EPS Warning Light may illuminate and the steering effort may increase or decrease. In this case, have the vehicle inspected by an authorized Kia dealer.

**Electronic Power Steering (EPS) Warning Light**



**This warning light illuminates:**

- Once you set the Engine Start/Stop Button to the ON position.
  - It remains on until the engine is started.
- When there is a malfunction with the EPS.

In this case, have the vehicle inspected by an authorized Kia dealer.

**Malfunction Indicator Lamp (MIL)**



**This warning light illuminates:**

- Once you set the Engine Start/Stop Button to the ON position.
  - It remains on until the engine is started.
- When there is a malfunction with the emission control system.

In this case, have the vehicle inspected by an authorized Kia dealer.



 **CAUTION - Malfunction Indicator Lamp (MIL)**

*Driving with the Malfunction Indicator Lamp (MIL) on may cause damage to the emission control systems which could effect drivability and/or fuel economy.*

 **CAUTION**

*If the Malfunction Indicator Lamp (MIL) illuminates, potential catalytic converter damage is possible which could result in loss of engine power.*

*In this case, have the vehicle inspected by an authorized Kia dealer.*

**Charging System Warning Light**

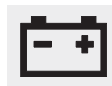

**This warning light illuminates:**

- Once you set the Engine Start/Stop Button to the ON position.
  - It remains on until the engine is started.
- When there is a malfunction with either the alternator or electrical charging system.

**If there is a malfunction with either the alternator or electrical charging system:**

1. Drive carefully to the nearest safe location and stop your vehicle.
2. Turn the engine off and check the alternator drive belt for looseness or breakage.

If the belt is adjusted properly, there may be a problem in the electrical charging system.

In this case, have the vehicle inspected by an authorized Kia dealer.

**Engine Oil Pressure Warning Light**



**This warning light illuminates:**

- Once you set the Engine Start/Stop Button to the ON position.
  - It remains on until the engine is started.
- When the engine oil pressure is low.

**If the engine oil pressure is low:**

1. Drive carefully to the nearest safe location and stop your vehicle.
2. Turn the engine off and check the engine oil level (For more details, refer to “Engine Oil” in chapter 7). If the level is low, add oil as required. If the warning light remains on after adding oil or if oil is not available, have the vehicle inspected by an authorized Kia dealer.

**CAUTION - Engine Overheating**

***Do not continue driving with the engine overheated. Otherwise the engine may be damaged.***

**CAUTION - Engine damage**

***If the engine is not stopped immediately after the engine oil pressure warning light is illuminated and stays on while the engine is running, serious engine damage may result.***

**Low Fuel Level Warning Light****This warning light illuminates:**

When the fuel tank is nearly empty.

**If the fuel tank is nearly empty:**

Add fuel as soon as possible.

**CAUTION - Low Fuel Level**

***Driving with the Low Fuel Level warning light on or with the fuel level below “E” can cause the engine to misfire and damage the catalytic converter (if equipped).***

### Low Tire Pressure Warning Light



#### This warning light illuminates:

- Once you set the Engine Start/Stop Button to the ON position.
  - It illuminates for approximately 3 seconds and then goes off.
- When one or more of your tires are significantly underinflated (The location of the underinflated tires are displayed on the LCD display).

\*For more details, refer to “Tire Pressure Monitoring System (TPMS)” in chapter 6.

- The TPMS cannot alert you to severe and sudden tire damage caused by external factors.
- If you notice any vehicle instability, immediately take your foot off the accelerator pedal, apply the brakes gradually with light force, and slowly move to a safe position off the road.

This warning light remains on after blinking for approximately 60 seconds or repeats blinking on and off at the intervals of approximately 3 seconds:

- When there is a malfunction with the TPMS.

In this case, have the vehicle inspected by an authorized Kia dealer.

\*For more details, refer to “Tire Pressure Monitoring System (TPMS)” in chapter 6.

#### **WARNING - Low tire pressure**

- **Significantly low tire pressure makes the vehicle unstable and can contribute to loss of vehicle control and increased braking distances.**
- **Continued driving on low pressure tires will cause the tires to overheat and fail.**

### LED Headlamp Warning Light (if equipped)



#### This warning light illuminates:

- Once you set the Engine Start/Stop Button to the ON position.
  - It illuminates for approximately 3 seconds and then goes off.
- When there is a malfunction with the LED headlamp.

In this case, have the vehicle inspected by an authorized Kia dealer.

#### This warning light blinks:

- When there is a malfunction with a LED headlamp related part.

In this case, have the vehicle inspected by an authorized Kia dealer.

#### \* NOTICE

Continuous driving with the LED Headlamp Warning Light on or blinking can reduce LED headlamp (low beam) life.

**Forward Collision-Avoidance Assist Warning Light (FCA, if equipped)**



**This indicator light illuminates:**

- When there is a malfunction with FCA.

In this case, have the vehicle inspected by an authorized Kia dealer.

**All Wheel Drive (AWD) Warning Light (if equipped)**

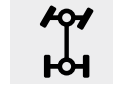

**This indicator light illuminates:**

- When there is a malfunction with the AWD system.

In this case, have the vehicle inspected by an authorized Kia dealer.

**Master Warning Light**



**This indicator light illuminates:**

- When there is a malfunction on the pre-safe seat belt, electronic control suspension, or Smart Cruise Control with Stop & Go or other systems etc. To identify the details of the warning, look at the LCD display.

**Dynamic Bending Light (DBL) Warning Light (if equipped)**



**This warning light blinks:**

- When there is a malfunction with the Dynamic Bending Light (DBL).

**If there is a malfunction with the Dynamic Bending Light (DBL):**

1. Drive carefully to the nearest safe location and stop your vehicle.
2. Turn the engine off and restart the engine. If the warning light remains on, have the vehicle inspected by an authorized Kia dealer.

**Electronic Parking Brake (EPB) Warning Light (if equipped)**



**This warning light illuminates:**

- Once you set the Engine Start/Stop Button to the ON position.
  - It illuminates for approximately 3 seconds and then goes off.
- When there is a malfunction with the EPB.

In this case, have the vehicle inspected by an authorized Kia dealer.

**\* NOTICE - Electronic Parking Brake (EPB) Warning Light**

The Electronic Parking Brake (EPB) Warning Light may illuminate when the Electronic Stability Control (ESC) Indicator Light comes on to indicate that the ESC is not working properly (This does not indicate malfunction of the EPB).

**Indicator Lights**

**Electronic Stability Control (ESC) Indicator Light**



**This indicator light illuminates:**

- Once you set the Engine Start/Stop Button to the ON position.
  - It illuminates for approximately 3 seconds and then goes off.
- When there is a malfunction with the ESC system.

In this case, have the vehicle inspected by an authorized Kia dealer.

**This indicator light blinks:**

While the ESC is operating.

\*For more details, refer to “Electronic Stability Control (ESC)” in chapter 5.

### Electronic Stability Control (ESC) OFF Indicator Light



#### This indicator light illuminates:

- Once you set the Engine Start/Stop Button to the ON position.
  - It illuminates for approximately 3 seconds and then goes off.
- When you deactivate the ESC system by pressing the ESC OFF button.

\*For more details, refer to “Electronic Stability Control (ESC)” in chapter 5.

### Auto stop Indicator Light



This indicator will illuminate when the engine enters the Idle Stop mode of the ISG (Idle Stop and Go) system.

When the automatic starting occurs, the auto stop indicator on the cluster will blink for 5 seconds.

\*For more details, refer to the ISG (Idle Stop and Go) system in chapter 5.

### \* NOTICE

When the engine automatically starts by the ISG system, some warning lights (ABS, ESC, ESC OFF, EPS or Parking brake warning light) may turn on for a few seconds.

This happens because of the low battery voltage. It does not mean the system is malfunctioning.

### Immobilizer Indicator Light (With Smart Key)



#### This indicator light illuminates for up to 30 seconds:

- When the vehicle detects the smart key in the vehicle properly while the Engine Start/Stop Button is ACC or ON.
  - At this time, you can start the engine.
  - The indicator light goes off after starting the engine.

#### This indicator light blinks for a few seconds:

- When the smart key is not in the vehicle.
  - At this time, you can not start the engine.

### **This indicator light illuminates for 2 seconds and goes off:**

- When the vehicle can not detect the smart key which is in the vehicle while the Engine Start/Stop Button is ON.

In this case, have the vehicle inspected by an authorized Kia dealer.

### **This indicator light blinks:**

- When the battery of the smart key is weak.
  - At this time, you can not start the engine. However, you can start the engine if you press the Engine Start/Stop Button with the smart key. (For more details, refer to “Starting the Engine” in chapter 5).
- When there is a malfunction with the immobilizer system.

In this case, have the vehicle inspected by an authorized Kia dealer.

### **Turn Signal Indicator Light**



### **This indicator light blinks:**

- When you switch on the turn signal light on.

If any of the following occurs, there may be a malfunction with the turn signal system. In this case, have the vehicle inspected by an authorized Kia dealer.

- The indicator light does not blink but illuminates.
- The indicator light blinks more rapidly.
- The indicator light does not illuminate at all.

### **High Beam Indicator Light**



### **This indicator light illuminates:**

- When the headlights are on and in the high beam position
- When the turn signal lever is pulled into the Flash-to-Pass position.

**Light ON Indicator Light****This indicator light illuminates:**

- When the tail lights or headlights are on.

**High Beam Assist (HBA) system Indicator Light (if equipped)****This warning light illuminates:**

- When the high beam is on with the light switch in the AUTO light position.
- If your vehicle detects oncoming or preceding vehicles, High Beam Assist (HBA) system will switch the high beam to low beam automatically.

\*For more details, refer to “High Beam Assist (HBA) system” in chapter 4.

**AUTO HOLD Indicator Light (if equipped)****This indicator light illuminates:**

- [White] When you activate the auto hold system by pressing the AUTO HOLD button.
- [Green] When you stop the vehicle completely by depressing the brake pedal with the auto hold system activated.
- [Yellow] When there is a malfunction with the auto hold system.

In this case, have the vehicle inspected by an authorized Kia dealer.

\*For more details, refer to “Auto Hold” in chapter 5.



### ***Lane Keeping Assist (LKA) system Indicator Light (if equipped)***



The LKA indicator will illuminate when you turn the Lane Keeping Assist system on by pressing the LKA button.

If there is a problem with the system, the yellow LKA indicator will illuminate.

\* For more details, refer to “Lane Keeping Assist (LKA) system” in chapter 5.

### **⚠ WARNING - Distracted driving**

**Driving while distracted can result in a loss of vehicle control that may lead to an accident, severe personal injury, and death. The driver's primary responsibility is in the safe and legal operation of a vehicle, and use of any handheld devices, other equipment, or vehicle systems which take the driver's eyes, attention and focus away from the safe operation of a vehicle or which are not permissible by law should never be used during operation of the vehicle.**

## HEAD UP DISPLAY (HUD) (IF EQUIPPED)

### Description



The Head Up Display is a transparent display which projects some information of the instrument cluster and navigation on the windshield glass.

- The Head Up Display image on the windshield glass may not be visible when:
    - Sitting posture prevents visibility.
    - Wearing polarized sunglasses.
    - There is an object on the cover of the head up display.
    - Driving on a wet road.
    - Lighting is turned on inside the vehicle.
    - Any light comes from the outside.
    - Wearing inadequate glasses for your eyesight.
  - If the Head Up Display image is not shown well, adjust the height, rotation or illumination of the Head Up Display in the LCD window.
- ✳ For more details, refer to “LCD window” in this chapter.
- When the Head Up Display needs inspection or repair, consult an authorized Kia dealer.
  - Do not place any accessories on the dashboard or attach any objects on the windshield glass.

### \* NOTICE

Installing window tint or any other type of metallic coating on the windshield can prevent the driver from seeing the Head Up Display images.

### **⚠ WARNING - Head Up Display**

**The Head Up Display is a supplemental system. Do not solely rely on the system, always drive safely, and pay attention to the driving conditions on the road.**

### \* NOTICE

When replacing the front windshield glass of vehicles equipped with the head up display, replace it with a windshield glass designed for the Head Up Display operation. Otherwise, duplicated images may be displayed on the windshield glass.

## Head Up Display ON/OFF



The HUD display will be activated or deactivated in user setting mode while engine is ON.

## Head Up Display Information



1. Turn By Turn navigation information
2. Road signs
3. Speedometer
4. Cruise setting speed
5. Smart Cruise Control (SCC) information
6. Blind-Spot Collision Warning (BCW) system information
7. Warning lights (Low fuel)
8. AV mode information

## Head Up Display Setting

On the LCD display, you can change the head up display settings as follows.

1. Display height
2. Rotation
3. Brightness
4. Content select
5. Speedometer size
6. Speedometer color

\* For more details, refer to “LCD window” in this chapter.

## REVERSE PARKING DISTANCE WARNING (IF EQUIPPED)



Reverse Parking Distance Warning assists the driver during backward movement of the vehicle by chiming if any object is sensed within a distance of 120 cm (47 in.) behind the vehicle.

This system is a supplemental system and it is not intended to nor does it replace the need for extreme care and attention of the driver. The sensing range and objects detectable by the back sensors (1) are limited. Whenever backing-up, pay as much attention to what is behind you as you would in a vehicle without Reverse Parking Distance Warning.



### **⚠ WARNING**

**Reverse Parking Distance Warning is a supplementary function only. The operation of Reverse Parking Distance Warning can be affected by several factors (including environmental conditions). It is the responsibility of the driver to always check the area behind the vehicle before and while backing up.**

### **Operation of Reverse Parking Distance Warning**

#### *Operating condition*

- This system will activate when backing up with the ignition switch ON.  
If the vehicle is moving at a speed over 5 km/h (3 mph), the system may not be activated correctly.
- The sensing distance while Reverse Parking Distance Warning is in operation is approximately 120 cm (47 in.).
- When more than two objects are sensed at the same time, the closest one will be recognized first.

Types of warning sound	Indicator*
When an object is 120 cm to 61 cm (47 in. to 24 in.) from the rear bumper: Buzzer beeps intermittently.	
When an object is 60 cm to 31 cm (23 in. to 12 in.) from the rear bumper: Buzzer beeps more frequently.	
When an object is within 30 cm (11 in.) of the rear bumper: Buzzer sounds continuously.	

\* if equipped

**\* NOTICE**

The indicator may differ from the illustration as objects or sensors status.

If the indicator blinks, the system should be checked by an authorized Kia dealer.

**Non-operational conditions of Reverse Parking Distance Warning**

**Reverse Parking Distance Warning may not operate properly when:**

1. Moisture is frozen to the sensor. (It will operate normally when the moisture has been cleared.)
2. The sensor is covered with foreign matter, such as snow or water, or the sensor cover is blocked. (It will operate normally when the material is removed or the sensor is no longer blocked.)
3. Driving on uneven road surfaces (unpaved roads, gravel, bumps, gradient).
4. Objects generating excessive noise (vehicle horns, loud motorcycle engines, or truck air brakes) are within range of the sensor.
5. Heavy rain or water spray exists.
6. Wireless transmitters or mobile phones are within range of the sensor.
7. The sensor is covered with snow.
8. Trailer towing

**The detecting range may decrease when:**

1. The sensor is stained with foreign matter such as snow or water. (The sensing range will return to normal when removed.)
2. Outside air temperature is extremely hot or cold.

**The following objects may not be recognized by the sensor:**

1. Sharp or slim objects such as ropes, chains or small poles.
2. Objects which tend to absorb the sensor frequency such as clothes, spongy material or snow.
3. Undetectable objects smaller than 1 m (40 in.) in height and narrower than 14 cm (6 in.) in diameter.

## Reverse Parking Distance Warning precautions

- Reverse Parking Distance Warning may not sound consistently depending on the speed and shapes of the objects detected.
- Reverse Parking Distance Warning may malfunction if the vehicle bumper height or sensor installation has been modified or damaged. Any non-factory installed equipment or accessories may also interfere with the sensor performance.
- The sensor may not recognize objects less than 30 cm (11 in.) from the sensor, or it may sense an incorrect distance. Use caution.
- When the sensor is frozen or stained with snow, dirt, or water, the sensor may be inoperative until the stains are removed using a soft cloth.
- Do not push, scratch or strike the sensor. Sensor damage could occur.

## \* NOTICE

This system can only sense objects within the range and location of the sensors; It can not detect objects in other areas where sensors are not installed. Also, small or slim objects, such as poles or objects located between sensors may not be detected by the sensors.

Always visually check behind the vehicle when backing up.

Be sure to inform any drivers of the vehicle that may be unfamiliar with the system regarding the systems capabilities and limitations.

## WARNING

Pay close attention when the vehicle is driven close to objects on the road, particularly pedestrians, and especially children. Be aware that some objects may not be detected by the sensors, due to the object's distance, size or material, all of which can limit the effectiveness of the sensor. Always perform a visual inspection to make sure the vehicle is clear of all obstructions before moving the vehicle in any direction.

### **Self-diagnosis**

If you don't hear an audible warning sound or if the buzzer sounds intermittently when shifting the gear to the R (Reverse) position, this may indicate a malfunction in Reverse Parking Distance Warning. If this occurs, have your vehicle checked by an authorized Kia dealer as soon as possible.

### **\* NOTICE**

**Your new vehicle warranty does not cover any accidents or damage to the vehicle or injuries to its occupants due to Reverse Parking Distance Warning malfunction.**  
Always drive safely and cautiously.

## PARKING DISTANCE WARNING (PDW) SYSTEM (IF EQUIPPED)

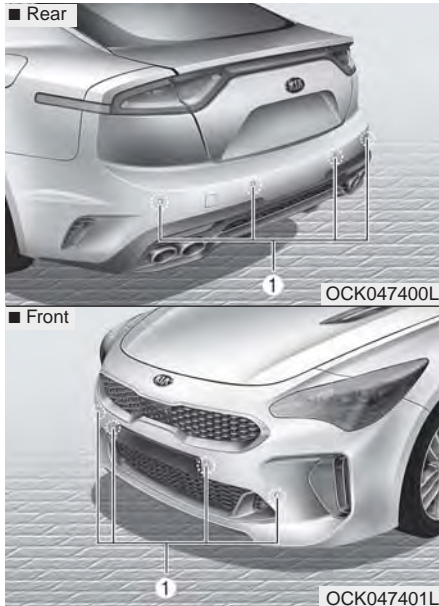

Parking Distance Warning assists the driver during movement of the vehicle by chiming if any object is sensed within the distance of 39 in. (100 cm) in front and 47 in. (120 cm) behind the vehicle.

This system is a supplemental system and it is not intended to nor does it replace the need for extreme care and attention of the driver.

The sensing range and objects detectable by the sensors (①) are limited. Whenever moving pay as much attention to what is in front and behind of you as you would in a vehicle without Parking Distance Warning.

### **⚠ WARNING**

**Parking Distance Warning is a supplemental system only.**

**The operation of Parking Distance Warning can be affected by several factors (including environmental conditions).**

**It is the responsibility of the driver to always check the areas around the vehicle before and while parking.**

## Operation of Parking Distance Warning

### Operating condition



- This system activates when Parking Distance Warning button is pressed with the ignition switch ON.
- The indicator of Parking Distance Warning button turns on automatically and activates Parking Distance Warning when you shift the gear to the R (Reverse) position. It will turn off automatically when you drive above 12.4 mph (20 km/h).









- The sensing distance while backing up is approximately 47 in. (120 cm) when you are driving less than 6.2 mph (10 km/h).
- The sensing distance while moving forward is approximately 39 in. (100 cm) when you are driving less than 6.2 mph (10 km/h).
- When more than two objects are sensed at the same time, the closest one will be recognized first.
- The side sensors are activated when you shift the gear to the R (Reverse) position.
- If the vehicle speed is above 12.4 mph (20 km/h), the system automatically turns off. To activate again, push the button.

### \* NOTICE

The system may detect an object if the vehicle's distance from the object is already less than approximately 10 in. (25 cm) when the system is turned ON.

### *Type of warning indicator and sound*

Distance from object		Warning indicator		Warning sound
		When driving forward	When driving rearward	
39 ~ 24 inch	Front		-	Buzzer beeps intermittently
47 ~ 24 inch	Rear	-		Buzzer beeps intermittently
23 ~12 inch	Front			Buzzer beeps frequently
	Rear	-		Buzzer beeps frequently
11 inch	Front			Buzzer sounds continuously
	Rear	-		Buzzer sounds continuously

### \* NOTICE

- The actual warning sound and indicator may differ from the illustration according to objects or sensor status.
- Do not wash the vehicle's sensor with high pressure water.

**\* NOTICE**

- This system can only sense objects within the range and location of the sensors; It can not detect objects in other areas where sensors are not installed. Also, small or slim objects, such as poles or objects located between sensors may not be detected by the sensors. Always visually check behind the vehicle when backing up.
- Be sure to inform any drivers of the vehicle that may be unfamiliar with the system regarding the systems capabilities and limitations.

**Non-operational conditions of Parking Distance Warning*****Parking Distance Warning may not operate when:***

1. Moisture is frozen to the sensor. (It will operate normally when the ice melts.)
2. Sensor is covered with foreign matter, such as snow or water, or the sensor cover is blocked. (It will operate normally when the material is removed or the sensor is no longer blocked.)
3. Driving on uneven road surfaces such as unpaved roads, gravel, bumps, or gradient.
4. Objects generating excessive noise such as vehicle horns, loud motorcycle engines, or truck air brakes can interfere with the sensor.
5. The weather conditions produce heavy rain or water spray.
6. Wireless transmitters or mobile phones present near the sensor.

***Detecting range may decrease when:***

1. Outside air temperature is extremely hot or cold.
2. The sensor is covered with foreign matter such as snow or water. (The sensing range will return to normal when removed.)

***The following objects may not be recognized by the sensor:***

1. Sharp or slim objects such as ropes, chains or small poles.
2. Objects, which tend to absorb sensor frequency such as clothes, spongy material or snow.
3. Undetectable objects smaller than 4 in. (1 m) and narrower than 5.5 in. (14 cm) in diameter.

### **\* NOTICE**

- 1. The warning may not sound sequentially depending on the speed and shapes of the objects detected.**
- 2. Parking Distance Warning system may malfunction if the vehicle bumper height or sensor installation has been modified. Any non-factory installed equipment or accessories may also interfere with the sensor performance.**
- 3. Sensor may not recognize objects less than 12 in. (30 cm) from the sensor, or it may sense an incorrect distance. Use with caution.**
- 4. When the sensor is frozen or stained with snow or water, the sensor may be inoperative until the stains are removed using a soft cloth.**
- 5. Do not push, scratch or strike the sensor with any hard objects that could damage the surface of the sensor. Sensor damage could occur.**

### **\* NOTICE**

**This system can only sense objects within the range and location of the sensors, it can not detect objects in other areas where sensors are not installed. Also, small or slim objects, or objects located between sensors may not be detected.**

**Always visually check in front and behind the vehicle when driving.**

**Be sure to inform any drivers in the vehicle that may be unfamiliar with the system regarding the system's capabilities and limitations.**

Pay close attention when the vehicle is driven close to objects on the road, particularly pedestrians, and especially children. Be aware that some objects may not be detected by the sensors, due to the objects distance, size or material, all of which can limit the effectiveness of the sensor. Always perform a visual inspection to make sure the vehicle is clear of all obstructions before moving the vehicle in any direction.

## Self-diagnosis

When you shift the gear to the R (Reverse) position and if one or more of the below occurs you may have a malfunction in Parking Distance Warning system.

- You don't hear an audible warning sound or if the buzzer sounds intermittently.
-  is displayed. (if equipped)  
(blinks)

If this occurs, we recommend that the system be checked by an authorized Kia dealer.

## \* NOTICE

**Your new vehicle warranty does not cover any accidents or damage to the vehicle or injuries to its occupants. Always drive safely and cautiously.**

## REAR VIEW MONITOR (RVM) SYSTEM (IF EQUIPPED)

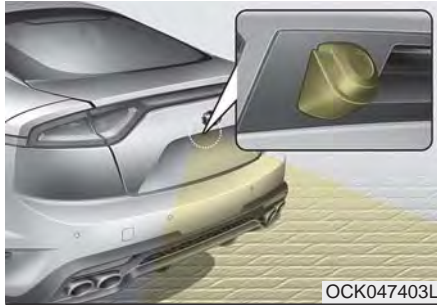

Rear View Monitor will activate with the ignition switch ON, engine ON and the shift lever in the R (Reverse) position.

This system is a supplemental system that shows the area behind the vehicle on the audio screen while backing up. If the vehicle is equipped with a navigation system, then will display the image on the navigation screen.

- This system is a supplemental system only. It is the responsibility of the driver to always check the inside/outside rearview mirrors and the area behind the vehicle before and while backing up.
- Always keep the camera lens clean. If lens is covered with foreign matter, the camera may not operate normally.

**⚠ WARNING - Backing & using camera**

**Never rely solely on Rear View Monitor. You must always use methods of viewing the area behind you including looking over both shoulders as well as continuously checking all three rear view mirrors. Due to the difficulty of ensuring that the area behind you remains clear, always back up slowly and stop immediately if you suspect that a person, and especially a child, might be behind you.**

## SURROUND VIEW MONITORING (SVM) SYSTEM (IF EQUIPPED)

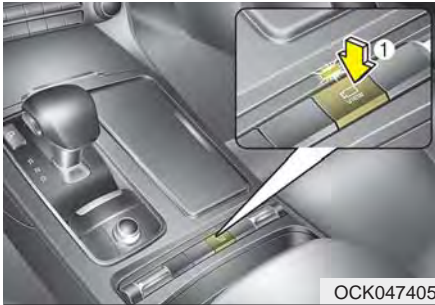

OCK047405



OCK048468N

Surround View Monitoring (SVM) system is not a substitute for proper and safe parking procedures. Surround View Monitoring (SVM) system may not detect every object surrounding the vehicle. Always drive safely and use caution when parking.

Surround View Monitoring (SVM) system can assist in parking by allowing the driver to see around the vehicle. Push the button into the [ON] position to operate the system.

To cancel the system, push the button again.

### Operating conditions

- When the Engine Start/Stop Button is ON position
- When the shift lever is on D, N or R
- When the vehicle moves backwards, SVM operates automatically.
- When the liftgate and driver/passenger door are opened and the outside mirror is folded, a warning is illuminated in SVM system.
- If SVM system is not operating normally, the system should be checked by an authorized Kia dealer.

### **⚠ WARNING**

**This system is a supplemental system only. It is the responsibility of the driver to always check the area around the vehicle before and while moving.**

## LIGHTING

### Battery saver function

- The purpose of this feature is to prevent the battery from being discharged if the lights are left in the ON position. The system automatically shuts off the parking lights 30 seconds after the ignition key is removed and the driver's door is opened and closed.
- With this feature, the parking lights will turn off automatically if the driver parks on the side of the road at night and opens the driver's side door. If necessary, to keep the parking lights on when the ignition key is removed, perform the following:
  - 1) Open the driver-side door.
  - 2) Turn the parking lights OFF and ON again using the light switch on the steering column.

### Daytime running light

The Daytime Running Lights (DRL) can make it easier for others to see the front of your vehicle during the day. DRL can be helpful in many different driving conditions, and it is especially helpful after dawn and before sunset. The DRL system will turn the dedicated lamp OFF when :

1. The headlight switch is on
  - It includes that the headlight is on in the dark when the headlight switch is in the auto light position.
2. The engine is off
3. Engaging the Parking Brake

### Lighting control



The light switch has a Headlight and a Parking light position.

To operate the lights, turn the knob at the end of the control lever to one of the following positions:

- (1) OFF position
- (2) Auto light position
- (3) Parking & Tail light
- (4) Headlight position

**Parking & Tail light (☰☷)**



When the light switch is in the parking light position, the tail, license and parking lights will turn ON.

**Headlight position (☰☷)**



When the light switch is in the headlight position, the head, tail, license lights will turn ON.

**\* NOTICE**

The ignition switch must be in the ON position to turn on the headlights.

**Auto light/DBL position**

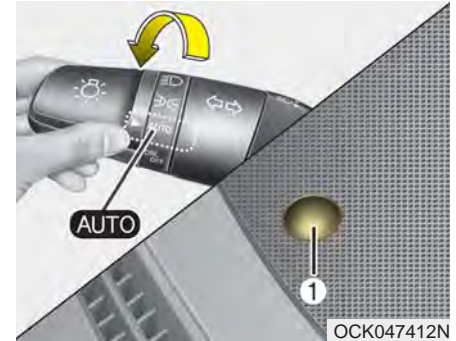

When the light switch is in the AUTO light position, the taillights and headlights will turn ON or OFF automatically depending on the amount of light outside the vehicle.

If your vehicle is equipped with the dynamic bending light (DBL), it will also operate when the headlamp is ON.



**⚠ CAUTION**

- *Never place anything over the sensor (1) located on the instrument panel, this will ensure better auto-light system control.*
- *Don't clean the sensor using a window cleaner, the cleaner may leave a light film which could interfere with sensor operation.*
- *If your vehicle has window tint or other types of metallic coating on the front windshield, the Auto light system may not work properly.*

**High beam operation**



To turn on the high beam headlamp, push the lever away from you.

The high beam indicator will light when the headlight high beams are switched on.

To prevent the battery from being discharged, do not leave the lights on for a prolonged time while the engine is not running.

**⚠ WARNING - High beams**

Do not use high beam when there are other vehicles in front of your vehicle. Using high beam could obstruct the other driver's vision.



OCK047413N

To flash the headlights, pull the lever towards you. It will return to the normal (low beam) position when released. The headlight switch does not need to be on to use this flashing feature.

### High Beam Assist (HBA) system (if equipped)



OCK047416N

High Beam Assist (HBA) system is a system that automatically adjusts the headlamp range (switches between high beam and low beam) according to the brightness of other vehicles and road conditions.

### Operating condition

1. Place the light switch in the AUTO position.
2. Turn on the high beam by pushing the lever away from you.

The High Beam Assist (HBA) system indicator (  ) will illuminate.

3. High Beam Assist (HBA) system will turn on when vehicle speed is above 25 mph (40 km/h).

- If the lever is pushed away when High Beam Assist (HBA) system is operating, High Beam Assist (HBA) system will turn off and the high beam will be on continuously. The High Beam Assist (HBA) system indicator (  ) will turn off.
- If the lever is pulled towards you when High Beam Assist (HBA) system is operating, High Beam Assist (HBA) system will turn off.

4. If the light switch is placed to the headlamp position, High Beam Assist (HBA) system will turn off and the low beam will be on continuously.

The high beam switches to low beam in the following conditions:

- When High Beam Assist (HBA) system is off.
- When the light switch is not in the AUTO position.
- When the headlamp is detected from the on-coming vehicle.
- When the tail lamp is detected from the front vehicle.
- When the surrounding is bright enough that high beams are not needed.
- When streetlights or other lights are detected.
- When vehicle speed is below 15 mph (24 km/h).
- When headlamp / taillamp of bicycle/motorcycle is detected

The system may not operate in the following conditions:

- When the light from a vehicle is not detected because of lamp damage, or because it is hidden from sight, etc.
- When the lamp of a vehicle is covered with dust, snow or water.
- When the light from a vehicle is not detected because of exhaust fume, smoke, fog, snow, etc.
- When the front window is covered with foreign matters such as ice, dust, fog, or is damaged.
- When there is a similar shape lamp with the front vehicle's lamps.
- When it is hard to see because of fog, heavy rain or snow.
- When the headlamp is not repaired or replaced at an authorized dealer.
- When headlamp aiming is not properly adjusted.
- When driving on a narrow curved road or rough road.

- When driving downhill or uphill.
- When only part of the vehicle in front is visible on a crossroad or curved road.
- When there is a traffic light, reflecting sign, flashing sign or mirror.
- When the road conditions are bad such as being wet or covered with snow.
- When the front vehicle's headlamps are off but the fog lamps on.
- When a vehicle suddenly appears from a curve.
- When the vehicle is tilted from a flat tire or being towed.
- When Lane Keeping Assist (LKA) system warning light illuminates. (if equipped)

**\* NOTICE**

- Do not place any accessories, stickers or tint on the windshield.
- Have the windshield glass replaced by an authorized dealer.
- Do not remove or damage related parts of High Beam Assist (HBA) system.
- Be careful that water doesn't get into High Beam Assist (HBA) system unit.
- Do not place objects on the dashboard that reflect light such as mirrors, white paper, etc. The system may not be able to function if sunlight is reflected.
- At times, High Beam Assist (HBA) system may not operate due to system limitations. Always check the road conditions for your safety. When the system does not operate normally, manually change between the high beam and low beam.

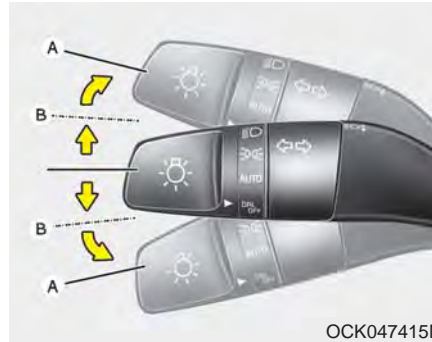
**Turn signals and lane change signals**

The ignition switch must be on for the turn signals to function. To turn on the turn signals, move the lever up or down (A). The green arrow indicators on the instrument panel indicate which turn signal is operating.

They will self-cancel after a turn is completed. If the indicator continues to flash after a turn, manually return the lever to the OFF position.

To signal a lane change, move the turn signal lever slightly and hold it in position (B). The lever will return to the OFF position when released.

If an indicator stays on and does not flash or if it flashes abnormally, one of the turn signal bulbs may be burned out and will require replacement.

**\* NOTICE**

If an indicator flash is abnormally quick or slow, a bulb may be burned out or have a poor electrical connection in the circuit.

### ***One-touch lane change function***

To activate an one-touch lane change function, move the turn signal lever slightly and then release it. The lane change signals will blink 3, 5 or 7 times.

You can choose one-touch lane change blinking function in “One touch turn lamp” of “User setting”. Refer to “User setting” in chapter 4

### **\* NOTICE**

**If the turn signal indicator stays on and does not flash, or if it flashes abnormally, a bulb may be burned out or have a poor electrical connection in the circuit. The bulb may require replacement.**

### **Check headlight**

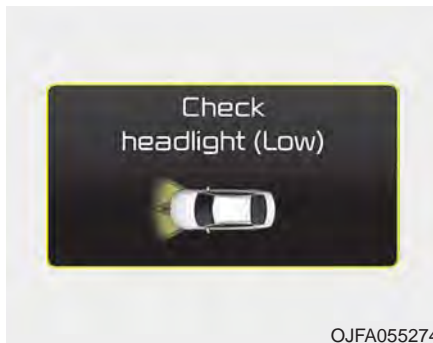

This warning message illuminates if there is a malfunction (burned-out bulb except LED lamp or circuit malfunction) with the headlamp. In this case, have your vehicle inspected by an authorized Kia dealer.

### **\* NOTICE**

- **When replacing the bulb, use the same wattage bulb.**  
For more information, refer to “BULB WATTAGE” in chapter 8.
- **If a different wattage bulb is installed on the vehicle, this warning message is not displayed.**

### **Headlight leveling device (if equipped)**

#### ***Automatic type***

To ensure the proper headlight beam is used under various conditions, the headlight beam levels are automatically adjusted depending on the number of passengers, the weight in the liftgate, and other driving conditions.

### **\* NOTICE**

**If it does not work properly even though your car is inclined backward according to passenger's posture, or the headlight beam is irradiated to the high or low position, have the system be inspected by an authorized Kia dealer.**

**Do not attempt to inspect or replace the wiring yourself.**

## Dynamic Bending Light (DBL) (if equipped)

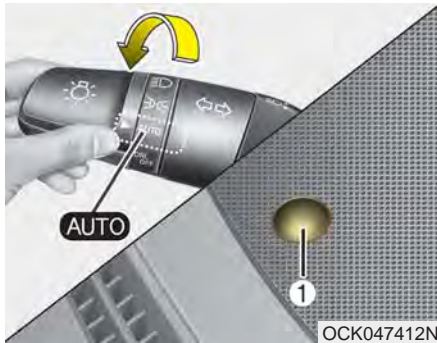

Dynamic Bending Light (DBL) uses the steering angle and vehicle speed, to keep your field of vision wide by swiveling and leveling the headlamp.

Change the switch to the AUTO position when the engine is running. The dynamic Bending Light (DBL) will operate when the headlamp is ON. To turn off the DBL, change the switch to other positions. After turning the DBL off, headlamp swiveling no longer occurs, but leveling operates continuously.

If the DBL malfunction indicator comes on, the DBL is not working properly. Drive to the nearest safe location and restart the engine. If the indicator continuously remains on, have your vehicle checked by an authorized Kia dealer as soon as possible.

## WIPERS AND WASHERS

### Windshield wiper/washer

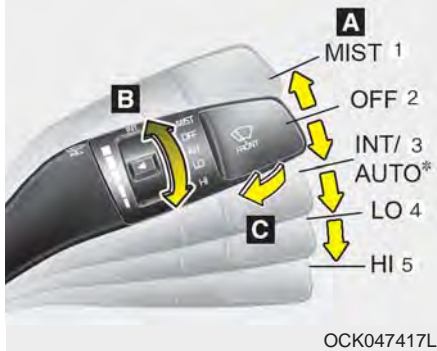

#### A : Wiper speed control (front)

- MIST – Single wipe
- OFF – Off
- INT – Intermittent wipe
- AUTO\* – Auto control wipe
- LO – Low wiper speed
- HI – High wiper speed

#### B : Intermittent control wipe time adjustment

#### C : Wash with brief wipes (front)\*

\* if equipped

### Windshield wipers

Operates as follows when the ignition switch is turned ON.

**MIST :** For a single wiping cycle, move the lever to this (MIST) position and release it. The wipers will operate continuously if the lever is held in this position.

**OFF :** Wiper is not in operation

**INT :** Wiper operates intermittently at the same wiping intervals. Use this mode in light rain or mist. To vary the speed setting, turn the speed control knob.

**LO :** Normal wiper speed

**HI :** Fast wiper speed

### \* NOTICE

If there is heavy accumulation of snow or ice on the windshield, defrost the windshield for about 10 minutes, or until the snow and/or ice is removed before using the windshield wipers to ensure proper operation. If you do not remove the snow and/or ice before using the wiper and washer, it may damage the wiper and washer system.

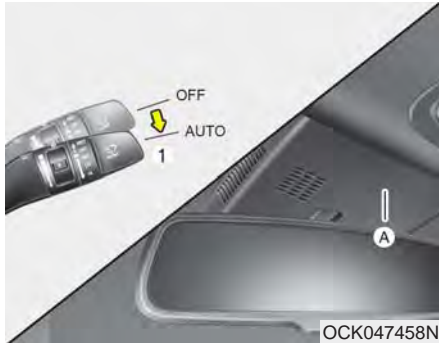
**Auto control (if equipped)**

The rain sensor (A) located on the upper end of the windshield glass senses the amount of rainfall and controls the wiping cycle for the proper interval. The more it rains, the faster the wiper operates. When the rain stops, the wiper stops.

To vary the speed setting, turn the speed control knob (1).

If the wiper switch is set in AUTO mode when the ignition switch is ON, the wiper will operate once to perform a self-check of the system. Set the wiper to OFF position when the wiper is not in use.

**⚠ WARNING**

When the ignition switch is ON and the windshield wiper switch is placed in the AUTO mode, use caution in the following situations to avoid any injury to the hands or other parts of the body:

- Do not touch the upper end of the windshield glass facing the rain sensor.
- Do not wipe the upper end of the windshield glass with a damp or wet cloth.
- Do not put pressure on the windshield glass.

**⚠ CAUTION**

- When washing the vehicle, set the wiper switch in the OFF position to stop the auto wiper operation.

*The wiper may operate and be damaged if the switch is set in the AUTO mode while washing the vehicle.*

- Do not remove the sensor cover located on the upper end of the passenger side windshield glass. Damage to system parts could occur and may not be covered by your vehicle warranty.
- When starting the vehicle in winter, set the wiper switch in the OFF position. Otherwise, wipers may operate and ice may damage the windshield wiper blades. Always remove all snow and ice and defrost the windshield properly prior to operating the windshield wipers.



### Front windshield washers



In the OFF position, pull the lever gently toward you to spray washer fluid on the windshield and to run the wipers 1-3 cycles.

Use this function when the windshield is dirty.

The spray and wiper operation will continue until you release the lever.

If the washer does not work, check the washer fluid level. If the fluid level is not sufficient, you will need to add appropriate non-abrasive windshield washer fluid to the washer reservoir.

The reservoir filler neck is located in the front of the engine compartment on the passenger side.

**⚠ CAUTION - Washer pump**  
*To prevent possible damage to the washer pump, do not operate the washer when the fluid reservoir is empty.*

**⚠ WARNING - Obscured visibility**  
**Do not use the washer in freezing temperatures without first warming the windshield with the defrosters; the washer solution could freeze on the windshield and obscure your vision.**

**⚠ CAUTION - Wipers & windshields**

- *To prevent possible damage to the wipers or windshield, do not operate the wipers when the windshield is dry.*
- *To prevent damage to the wiper blades, do not use gasoline, kerosene, paint thinner, or other solvents on or near them.*
- *To prevent damage to the wiper arms and other components, do not attempt to move the wipers manually.*

## INTERIOR LIGHTS

Do not use the interior lights for extended periods when the engine is not running.

It may cause battery discharge.

### **⚠ WARNING - Interior Lights**

**Do not use the interior lights when driving in the dark. Accidents could happen because the view may be obscured by interior lights.**

### **Automatic turn off function (if equipped)**

The interior lights automatically turn off approximately 20 minutes after the ignition switch is turned off, if the lights are in the ON position.

If your vehicle is equipped with the theft alarm system, the interior lights automatically turn off approximately 5 seconds after the system is armed.

### **Room lamp**



-  : The light stays on at all times.

## Map lamp

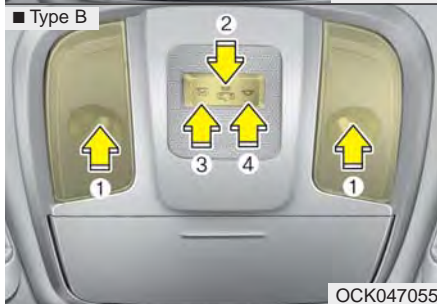



- Press the lens (1) to turn ON the map lamp.  
To turn the map lamp OFF press the lens (1) again.

-  (2) : DOOR mode
  - The map lamp and room lamp come on when a door is opened. The lamps go out after approximately 30 seconds.
  - The map lamp and room lamp come on for approximately 30 seconds when doors are unlocked with a transmitter or smart key as long as the doors are not opened.
  - The map lamp and room lamp will stay on for approximately 20 minutes if a door is opened with the ignition switch in the ACC or LOCK/OFF position.
  - The map lamp and room lamp will stay on continuously if the door is opened with the ignition switch in the ON position.
  - The map lamp and room lamp will go out immediately if the ignition switch is changed to the ON position or all doors are locked.
  - To turn off the DOOR mode, press the DOOR button (2) once again (not pressed).

## \* NOTICE

The DOOR mode and ROOM mode can not be selected at the same time.

### Front Room Lamp:

- Type A
  -  (3): Press this switch to turn the front and rear room lamps on and off.
- Type B
  -  (3): Press this switch to turn the front and rear room lamps on.
  -  (4): Press this switch to turn the front and rear room lamps off.

### Liftgate room lamp



The liftgate room lamp comes on when the liftgate is opened.

The liftgate room lamp comes on as long as the liftgate lid opens. To prevent unnecessary battery drain, close the liftgate lid securely after using the liftgate room.

### Vanity mirror lamp

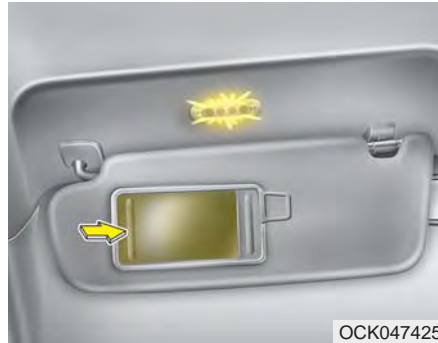

Opening the lid of the vanity mirror will automatically turn on the mirror light.

\* The actual sunvisor lamp in the vehicle may differ from the illustration.



#### **CAUTION - Vanity mirror lamp**

***Always have the switch in the off position when the vanity mirror lamp is not in use. If the sunvisor is closed without the lamp off, it may discharge the battery or damage the sunvisor.***

### Glove box lamp

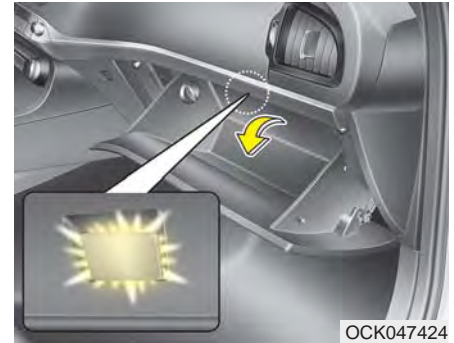

The glove box lamp comes on when the glove box is opened.

To prevent unnecessary battery drain, close the glove box securely after using the glove box.

### Door courtesy lamp

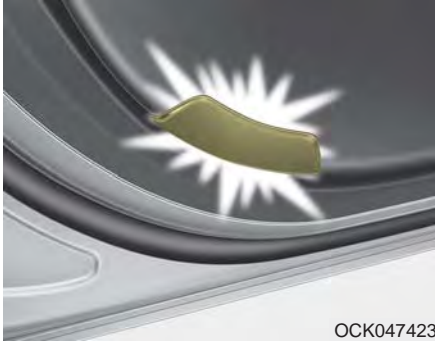

OCK047423

The door courtesy lamp comes ON when the door is opened to assist entering or exiting the vehicle. It also serves as a warning to passing vehicles that the vehicle door is open.

## WELCOME SYSTEM (IF EQUIPPED)

### Headlight (Headlamp) escort function

When the headlight(light switch in the headlight or AUTO position) is on and all doors (and liftgate) are locked and closed, the position light and headlight will come on for 15 seconds if any of the below is performed.

- With the smart key system
  - When the door unlock button is pressed on the smart key.

At this time, if you press the door lock or unlock button, the position light and headlight will turn off immediately.

### Interior light

When the interior light switch is in the DOOR position and all doors (and liftgate) are locked and closed, the room lamp will come on for 30 seconds if any of the below is performed.

- With the smart key system
  - When the door unlock button is pressed on the smart key.
  - When the button of the outside door handle is pressed.

At this time, if you press the door lock button, the lamps will turn off immediately.

### Pocket lamp (if equipped)

When all the doors (and liftgate) are locked and closed, the pocket lamp and puddle lamp will come on for about 15 seconds if any of the below is performed.

- With the smart key system
  - When the vehicle is approached with the smart key in possession.

## DEFROSTER

### CAUTION - Conductors

*To prevent damage to the conductors bonded to the inside surface of the rear window, never use sharp instruments or window cleaners containing abrasives to clean the window.*

If you want to defrost and defog the front windshield, refer to “Windshield defrosting and defogging” in this section.

### Rear window defroster



The defroster heats the window to remove frost, fog and thin ice from the rear window, while the engine is running.

To activate the rear window defroster, press the rear window defroster button located in the center facia switch panel. The indicator on the rear window defroster button illuminates when the defroster is ON.

If there is heavy accumulation of snow on the rear window, brush it off before operating the rear defroster.

The rear window defroster automatically turns off after approximately 20 minutes or when the ignition switch is turned off. To turn off the defroster, press the rear window defroster button again.

### *Outside rearview mirror defroster*

If your vehicle is equipped with the outside rearview mirror defrosters, they will operate at the same time you turn on the rear window defroster.

## AUTOMATIC CLIMATE CONTROL SYSTEM

### ■ Front seat



1. Driver's temperature control knob
2. AUTO (automatic control) button
3. Front windshield defroster button
4. Rear window/mirrors defroster button
5. Air conditioning button
6. Air intake control buttons
7. OFF button
8. Fan speed control buttons
9. Mode selection button
10. Passenger's temperature control knob
11. SYNC temperature control selection button
12. Climate control display
13. Rear temperature control knob

### ■ Rear seat



### **⚠ CAUTION**

***Operating the blower when the ignition switch is in the ON position could cause the battery to discharge. Operate the blower when the engine is running.***

OCK047300/OCK047322



## Automatic heating and air conditioning



1. Press the AUTO button. The modes, fan speeds, air intake and air-conditioning will be controlled automatically by setting the temperature.

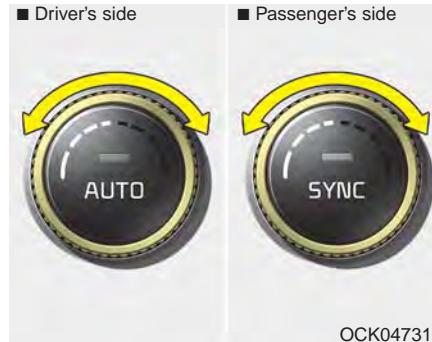

2. Turn the temperature control knob to the desired temperature.

### \* NOTICE

- To turn the automatic operation off, select any button or switch of the following:
  - Mode selection button
  - Air conditioning button
  - Front windshield defroster button (Press the button one more time to deselect the front windshield defroster function. The 'AUTO' sign will illuminate on the information display once again.)
  - Air intake control button
  - Fan speed control switchThe selected function will be controlled manually while other functions operate automatically.
- For your convenience and to improve the effectiveness of the climate control, use the AUTO button and set the temperature to 73°F (23°C).



**\* NOTICE**



Never place anything over the sensor located on the instrument panel to ensure better control of the heating and cooling system.

## Manual heating and air conditioning

The heating and cooling system can be controlled manually by pressing buttons or turning knob(s) other than the AUTO button. In this case, the system works sequentially according to the order of buttons or knob(s) selected.

1. Start the engine.
2. Set the mode to the desired position.

For improving the effectiveness of heating and cooling;

- Heating: 
- Cooling: 

3. Set the temperature control to the desired position.
4. Set the air intake control to the outside (fresh) air position.
5. Set the fan speed control to the desired speed.
6. If air conditioning is desired, turn the air conditioning system on.

Press the AUTO button in order to convert to full automatic control of the system.

## Mode selection

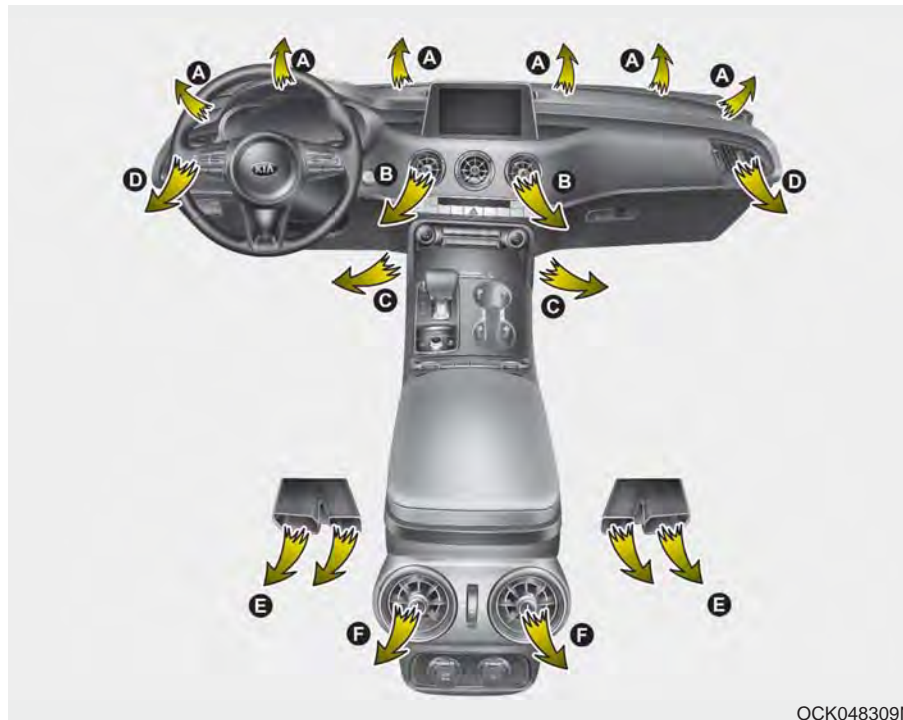

OCK048309N

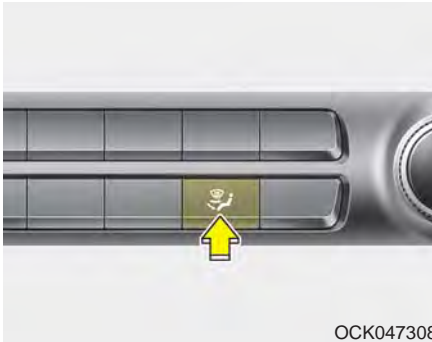

OCK047308

The mode selection button controls the direction of the air flow through the ventilation system.

The air flow outlet port is converted as follows:



**Face-Level (B, D, F)**

Air flow is directed toward the upper body and face. Additionally, each outlet can be controlled to direct the air discharged from the outlet.



**Floor-Level (A, C, D, E, F)**

Most of the air flow is directed to the floor, with a small amount of the air being directed to the windshield and side window defrosters.



**Bi-Level (B, C, D, E, F)**

Air flow is directed towards the face and the floor.



**Floor/Defrost-Level (A, C, D, E, F)**

Most of the air flow is directed to the floor and the windshield with a small amount directed to the side window defrosters.



## Defrost-Level

Most of the air flow is directed to the windshield with a small amount of air directed to the side window defrosters.

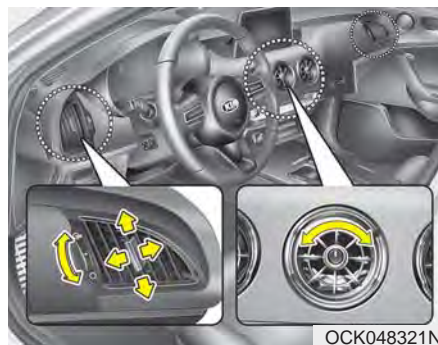

## Instrument panel vents

The outlet vents can be opened or closed separately using the thumbwheel (if equipped).

Also, you can adjust the direction of air delivery from these vents using the vent control lever as shown.

## Temperature control

### ■ Front seat

#### • Driver's side



#### • Passenger's side



OCK047311

### ■ Rear seat



OCK047323

#### • Front seat

The temperature will increase to the maximum (HI) by turning the knob to the extreme right.

The temperature will decrease to the minimum (Lo) by turning the knob to the extreme left.

When turning the knob, the temperature will increase or decrease by 1°F/0.5°C. When set to the lowest temperature setting, the air conditioning will operate continuously.

- Rear seat

Turn the rear seat temperature control knob to adjust temperature.

The front and rear seat side temperature is adjusted individually.



OOCK047312

#### Adjusting the driver and passenger side temperature equally

- Press the “SYNC” button to adjust the driver and passenger side temperature equally.

The passenger side temperature will be set to the same temperature as the driver side temperature.

- Turn the driver side temperature control knob. The driver and passenger side temperature will be adjusted equally.

#### Adjusting the driver and passenger side temperature individually

- Press the “SYNC” button again to adjust the driver and passenger side temperature individually. The illumination of button turns off.
- Operate the driver side temperature control knob to adjust the driver side temperature.
- Operate the passenger side temperature control knob to adjust the passenger side temperature.

#### Temperature conversion

You can switch the temperature mode from Centigrade to Fahrenheit as follows:

While pressing the OFF button, press the AUTO button for 3 seconds or more.

The display will change from Centigrade to Fahrenheit, or from Fahrenheit to Centigrade.

If the battery has been discharged or disconnected, the temperature mode display will reset to Fahrenheit.

## Air intake control

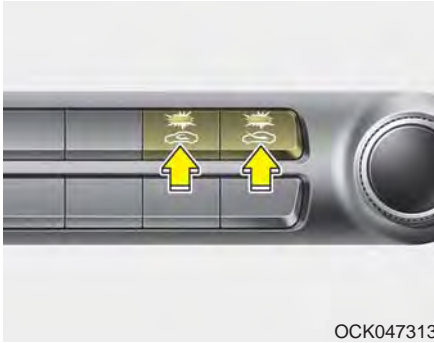

This is used to select the outside (fresh) air position or recirculated air position.

To change the air intake control position, push the control button.

### Outside (fresh) air position



With the outside (fresh) air position selected, air enters the vehicle from outside and is heated or cooled according to the function selected.

### Recirculated air position



With the recirculated air position selected, air from the passenger compartment will be drawn through the heating system and heated or cooled according to the function selected.

Prolonged operation of the heater in the recirculated air position (without air conditioning selected) may cause fogging of the windshield and side windows and the air within the passenger compartment may become stale.

In addition, prolonged use of the air conditioning with the recirculated air position selected will result in excessively dry air in the passenger compartment.

### Sunroof inside air recirculation (if equipped)

If the sunroof opens while the heater or Air Conditioning system operates, the outside (fresh) air will be selected automatically for ventilating the car. Then, if you select the recirculated air position, the outside (fresh) air will be selected automatically after 3 minutes.

If you close the sunroof, the intake mode will be changed to the previous selected mode.

### Fan speed control

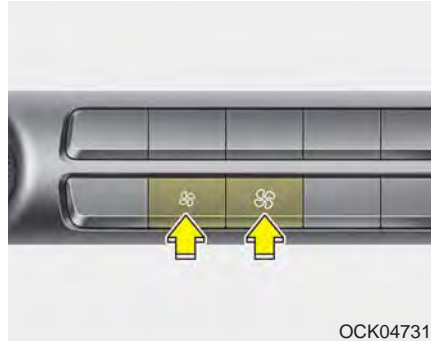

OCK047314

The fan speed can be set to the desired speed by operating the fan speed control button.

To change the fan speed, press (⬆) the button for higher speed, or push (⬇) the button for lower speed. To turn the fan speed control off, press the front blower OFF button.

### Air conditioning

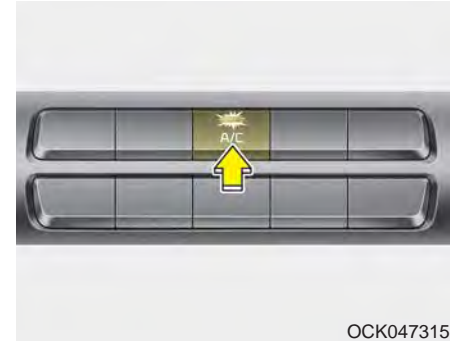

OCK047315

Press the A/C button to turn the air conditioning system on (indicator light will illuminate).

Press the button again to turn the air conditioning system off.

#### **⚠ WARNING - Reduced Visibility**

**Continuous use of the climate control system in the recirculated air position may allow humidity to increase inside the vehicle which may fog the glass and obscure visibility.**



**⚠ WARNING - Recirculated Air**

Continued use of the climate control system in the recirculated air position can cause drowsiness or sleepiness, and loss of vehicle control. Set the air intake control to the outside (fresh) air position as much as possible while driving.

**⚠ WARNING - Sleeping with AC on**

Do not sleep in a vehicle with the air conditioning or heating on as this may cause serious harm or death due to a drop in the oxygen level and/or body temperature.

*OFF mode*

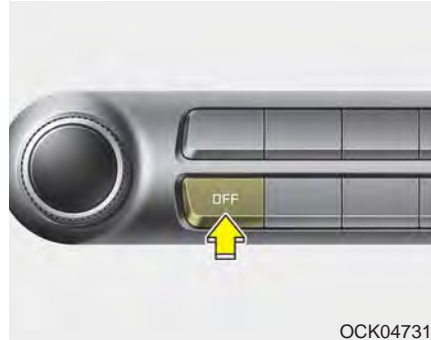

Press the front blower OFF button to turn off the front air climate control system. However, you can still operate the mode and air intake buttons as long as the ignition switch is in the ON position.

*Climate information screen selection (if equipped)*

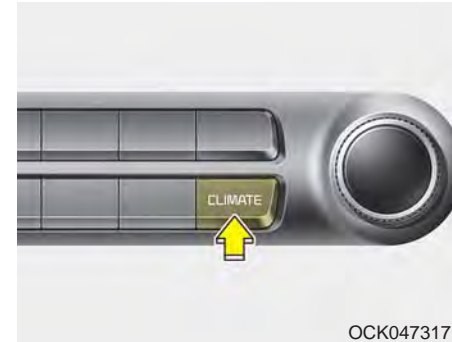



Press the climate information screen selection button to display climate information on the screen.

## System operation

### Ventilation

1. Set the mode to the  position.
2. Set the air intake control to the outside (fresh) air position.
3. Set the temperature control to the desired position.
4. Set the fan speed control to the desired speed.

### Heating

1. Set the mode to the  position.
2. Set the air intake control to the outside (fresh) air position.
3. Set the temperature control to the desired position.
4. Set the fan speed control to the desired speed.
5. If dehumidified heating is desired, turn the air conditioning system (if equipped) on.
  - If the windshield fogs up, set the mode to the  or  position.

### Operation Tips

- To keep dust or unpleasant fumes from entering the vehicle through the ventilation system, temporarily set the air intake control to the recirculated air position. Be sure to return the control to the fresh air position when the irritation has passed to keep fresh air in the vehicle. This will help keep the driver alert and comfortable.
- Air for the heating/cooling system is drawn in through the grilles just ahead of the windshield. Care should be taken that these are not blocked by leaves, snow, ice or other obstructions.
- To prevent interior fog on the windshield, set the air intake control to the fresh air position and fan speed to the desired position, turn on the air conditioning system, and adjust the temperature control to desired temperature.

### Air conditioning

All Kia Air Conditioning Systems are filled with R-1234yf refrigerant.

1. Start the engine. Press the air conditioning button.
  2. Set the mode to the  position.
  3. Set the air intake control to the outside air or recirculated air position.
  4. Adjust the fan speed control and temperature control to maintain maximum comfort.
- When maximum cooling is desired, set the temperature control to the extreme left position, then set the fan speed control to the highest speed.

 **CAUTION - Excessive A/C Use**

*When using the air conditioning system, monitor the temperature gauge closely while driving up hills or in heavy traffic when outside temperatures are high. Air conditioning system operation may cause engine overheating. Continue to use the blower fan but turn the air conditioning system off if the temperature gauge indicates engine overheating.*

**\* NOTICE**

When opening the windows in humid weather, air conditioning may create water droplets inside the vehicle. Since excessive water droplets may cause damage to electrical equipment, air conditioning should only be used with the windows closed.

**Air conditioning system operation tips**

- If the vehicle has been parked in direct sunlight during hot weather, open the windows for a short time to let the hot air inside the vehicle escape.
- To help reduce moisture inside of the windows on rainy or humid days, decrease the humidity inside the vehicle by operating the air conditioning system.
- During air conditioning system operation, you may occasionally notice a slight change in engine speed as the air conditioning compressor cycles. This is a normal system operation characteristic.
- Use the air conditioning system every month only for a few minutes to ensure maximum system performance.
- When using the air conditioning system, you may notice clear water dripping (or even puddling) on the ground under the passenger side of the vehicle. This is a normal system operation characteristic.
- Operating the air conditioning system in the recirculated air position provides maximum cooling, however, continual operation in this mode may cause the air inside the vehicle to become stale.
- During cooling operation, you may occasionally notice a misty air flow because of rapid cooling and humid air intake. This is a normal system operation characteristic.

## Climate control air filter

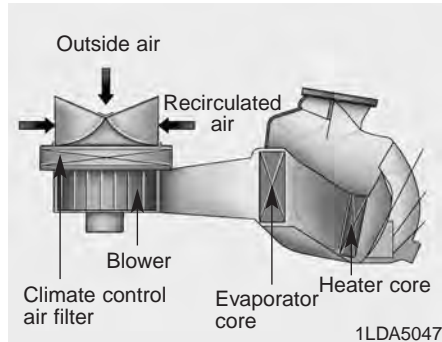

The climate control air filter installed behind the glove box, filters dust or other pollutants that come into the vehicle from the outside through the heating and air conditioning system. If dust or other pollutants accumulate in the filter over a period of time, air flow from the air vents may decrease, resulting in moisture accumulation on the inside of the windshield even when the outside (fresh) air position is selected. If this happens, have the climate control air filter replaced by an authorized Kia dealer.

## \* NOTICE

- Replace the filter every 15,000 miles or once a year. If the vehicle is being driven in severe conditions such as dusty or rough roads, more frequent air conditioner filter inspections and changes are required.
- When the air flow rate suddenly decreases, the system should be checked at an authorized Kia dealer.

## Checking the amount of air conditioner refrigerant and compressor lubricant

When the amount of refrigerant is low, the performance of the air conditioning is reduced. Overfilling also has a negative impact on the air conditioning system.

Therefore, if abnormal operation is found, have the system inspected by an authorized Kia dealer.

**⚠ WARNING - Vehicles equipped with R-1234yf**



Since the refrigerant is mildly inflammable and operated at high pressure, the air conditioning system should only be serviced by trained and certified technicians. (Refer to the SAE J2845)



It is important that the correct type and amount of oil and refrigerant are used.

All refrigerants should be reclaimed with proper equipment.

Venting refrigerants directly to the atmosphere is harmful to individuals and environment.

Failure to heed these warnings can lead to serious injuries.

**⚠ WARNING**

The oil and refrigerant in your vehicle's air conditioning system is under very high pressure. If proper service procedures are not followed an explosion may result. To reduce the risk of serious injury or death, the air conditioning system in your vehicle should only be serviced by trained and certified technicians.

**⚠ CAUTION - A/C repair**

*It is important that the correct type and amount of oil and refrigerant is used, otherwise damage to the vehicle may occur. To prevent damage, the air conditioning system in your vehicle should only be serviced by trained and certified technicians.*

**Air Conditioning refrigerant label**

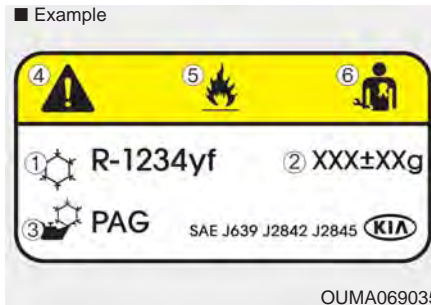

\* The actual Air Conditioning refrigerant label in the vehicle may differ from the illustration.

Each symbol and specification on the air conditioning refrigerant label is represented below :

1. Classification of refrigerant
2. Amount of refrigerant
3. Classification of Compressor Lubricant
4. Caution
5. Flammable Refrigerant
6. Requires Registered Technician to Service Air Conditioning system

\* Refer to chapter 8 for more detail on the location of air conditioning refrigerant label.



### **Sunroof inside air recirculation (if equipped)**

The outside (fresh) air position is automatically selected, when the sunroof is opened.

When you select the recirculated air position, the system maintains the recirculated air position for 3 minutes and then automatically converts to the outside (fresh) air position. When the sunroof is closed, the air intake position will return to the original position that was selected.

## WINDSHIELD DEFROSTING AND DEFOGGING

### **⚠ WARNING - Windshield heating**

Do not use the  or  position during cooling operation in extremely humid weather. The difference between the temperature of the outside air and the windshield could cause the outer surface of the windshield to fog up, causing loss of visibility. In this case, set the mode selection to the  position and fan speed control to the lower speed.

- For maximum defrosting, set the temperature control to the extreme right/hot position and the fan speed control to the highest speed.
- If warm air to the floor is desired while defrosting or defogging, set the mode to the floor-defrost position.
- Before driving, clear all snow and ice from the windshield, rear window, outside rear view mirrors, and all side windows.
- Clear all snow and ice from the hood and air inlet in the cowl grill to improve heater and defroster efficiency and to reduce the probability of fogging up the inside of the windshield.

### Automatic climate control system

#### *To defog inside windshield*

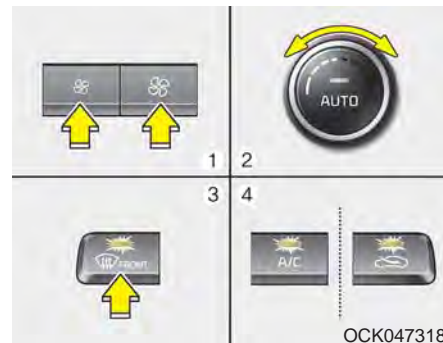

1. Set the fan speed to the desired position.
2. Select desired temperature.
3. Press the defroster button ().
4. The outside (fresh) air position will be selected automatically and the air conditioning will turn on according to the detected ambient temperature.

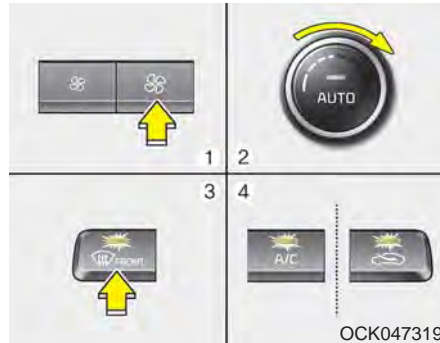

If the air conditioning and outside (fresh) air position are not selected automatically, adjust the corresponding button manually. If the  position is selected, lower fan speed is adjusted to a higher fan speed.

### To defrost outside windshield



1. Set the fan speed to the highest position.
2. Set the temperature to the extreme hot (HI) position.
3. Press the defroster button (.
4. The outside (fresh) air position will be selected automatically and the air conditioning will turn on according to the detected ambient temperature.

### Defogging logic

To reduce the possibility of fogging up the inside of the windshield, the air intake or air conditioning is controlled automatically according to certain conditions such as  or  position. To cancel automatic defogging logic or return to the automatic defogging logic, do the following.



## Automatic climate control system

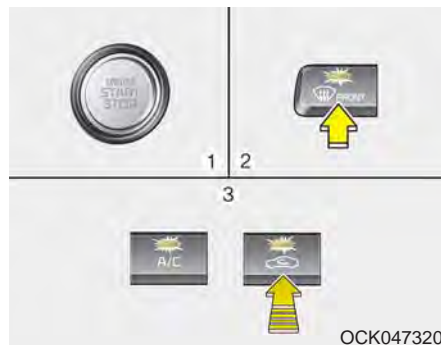

1. Turn the ignition switch to the ON position.
2. Press the defroster button (  ).
3. While pressing the air conditioning button (A/C), press the air intake control button at least 5 times within 3 seconds.

The recirculation indicator blinks 3 times with 0.5 second of interval. It indicates that the defogging logic is canceled or returned to the programmed status.

If the battery has been discharged or disconnected, it resets to the defog logic status.

## Auto defogging system



Auto defogging reduces the probability of fogging up the inside of the windshield by automatically sensing the moisture of inside the windshield. The auto defogging system operates when the heater or air conditioning is on.

The auto defogging system does not work if you push the Air intake control button, Air conditioning button, or Mode selection button with the Auto Defogging system in operation. To ensure a proper view, do not press the following buttons while the auto defogging system is in operation.



This indicator illuminates when the auto defogging system senses the moisture on the inside of the windshield and operates.

The Auto defogging system addresses excess moisture on the inside of the windshield in stages. For example, if auto defogging does not defog inside the windshield at step 1 Outside air position, it tries to defog again at step 2 Operating the air conditioning.

- Step 1 : Outside air position
- Step 2 : Operating the air conditioning
- Step 3 : Blowing air flow toward the windshield
- Step 4 : Increasing air flow toward the windshield

### To cancel or reset the Auto Defogging System

Press the front windshield defroster button for 3 seconds when the ignition switch is in the ON position.

When the ADS system is canceled, Indicator on the button will blink 3 times per 0.5 sec and the position "ADS OFF" will be displayed on the climate control information screen.

When the ADS system is reset, Indicator on the button will blink 6 times per 0.25sec and the position "ADS OFF" will be disappeared on the climate control information screen.

You can set or release the Auto Defogging System on the AVN Climate Information selection screen.

If the battery is discharged or detached, the auto defogging system will be reset. Adjust the feature accordingly.



### CAUTION

***Do not remove the sensor cover located on the upper end of the passenger side windshield glass. Damage to the system parts could occur and may not be covered by your vehicle warranty.***

### Automatic ventilation (if equipped)

The system automatically selects the outside (fresh) air position when the climate control system operates over a certain period of time (approximately 30 minutes) in low temperature with the recirculated air position selected.

#### ***To cancel or reset the Automatic Ventilation***

When the air conditioning system is on, select Face Level  mode and while pressing the A/C button, press the recirculated air position button five times within three seconds.

When the automatic ventilation is canceled, the indicator blinks 3 times. When the automatic ventilation is activated, the indicator blinks 6 times.

If the battery is discharged or detached, the automatic ventilation will be reset. Adjust the feature accordingly.

### **Smart ventilation (if equipped)**

The smart ventilation system maintains pleasant/fresh air condition inside the passenger compartment by automatically detecting/controlling the temperature and humidity when you drive the vehicle with the climate control system in the OFF position.

When the smart ventilation system starts to operate, the message, "SMART VENTILATION ON" appears for 5 seconds.

- The smart ventilation system stops operating, when the OFF button of the climate control system is selected.
- The smart ventilation system stops operating, when any button of the climate control system is selected for operation.
- The smart ventilation system may not operate, when the vehicle is driven at low speed.

## STORAGE COMPARTMENTS

These compartments can be used to store small items required by the driver or passengers.

- To avoid possible theft, do not leave valuables in the storage compartment.
- Always keep the storage compartment covers closed while driving. Do not attempt to place so many items in the storage compartment that the storage compartment cover can not close securely.

**⚠ WARNING - Flammable materials**

**Do not store, propane cylinders or other flammable/explosive materials in the vehicle. These items may catch fire and/or explode if the vehicle is exposed to hot temperatures for extended periods.**

### Center console storage

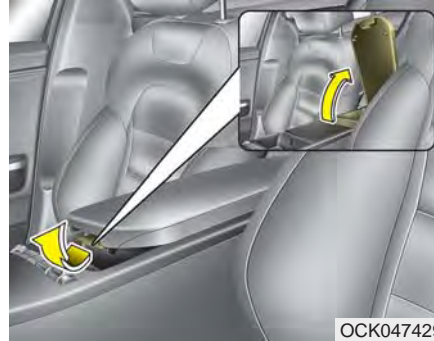

To open the center console storage, pull up the lever.

### Glove box

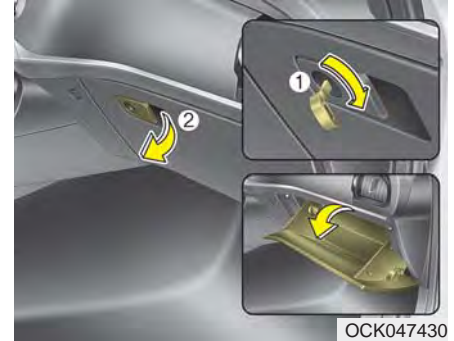

The glove box can be locked and unlocked with a master key (1). (if equipped)

To open the glove box, pull the lever (2) and the glove box will automatically open. Close the glove box after use.

**⚠ WARNING - Glove Box**

To reduce the risk of injury in an accident or sudden stop, always keep the glove box door closed while driving.

**\* NOTICE**

If the temperature control knob is in the warm or hot position, warm or hot air will flow into the glove box.

**Sunglass holder**

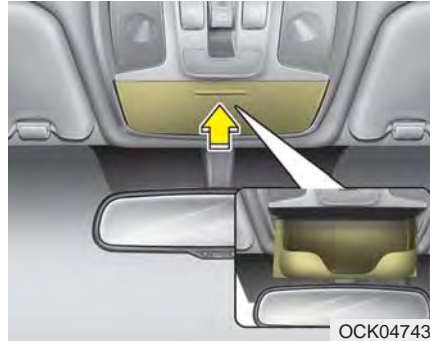

To open the sunglass holder, press the cover and the holder will slowly open. Place your sunglasses with the lenses facing out.

To close the sunglass holder push it up.

**⚠ WARNING - Sunglass holder**

Do not keep objects except sunglasses inside the sunglass holder. Heavier objects can be thrown from the holder in the event of a sudden stop or an accident, possibly injuring the passengers.

## INTERIOR FEATURES

### Cup holder

#### **⚠ WARNING - Hot liquids**

Do not place uncovered cups with hot liquid in the cup holder while the vehicle is in motion. If the hot liquid spills, you may burn yourself. Such a burn to the driver could lead to loss of control of the vehicle.

#### **⚠ CAUTION**

Keep your drinks sealed while driving to prevent spilling your drink. If liquid spills, it may get into the vehicle's electrical/electronic system and damage electrical/electronic parts.

#### **⚠ CAUTION**

When cleaning spilled liquids, do not use heat to dry the cup holders. This may damage the cup holder.

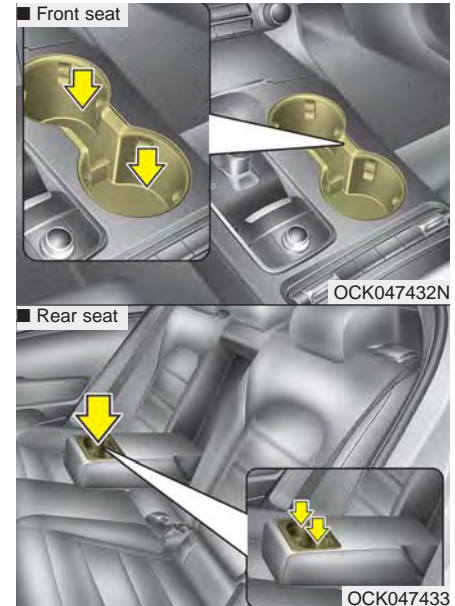

Cups or small beverage cans may be placed in the cup holders.

## Seat warmer (if equipped)

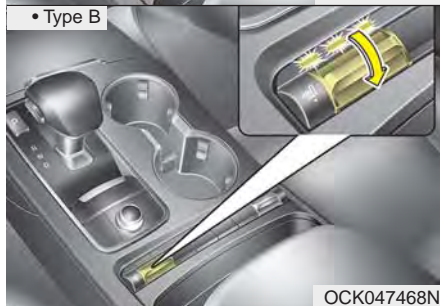
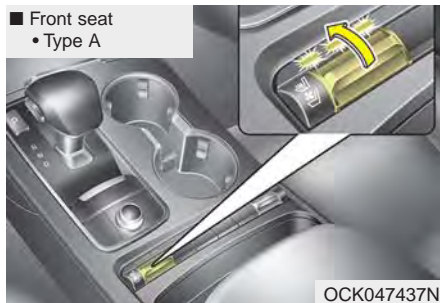

The seat warmer is provided to warm the front seats during cold weather. With the ignition switch in the ON position, push up or down either of the switches to warm the driver's seat or the front passenger's seat.

During mild weather or under conditions where the operation of the seat warmer is not needed, keep the switches in the "OFF" position.

### ► Temperature control (Manual)

- Each time you push up or press the switch, the temperature setting of the seat will change as follows :

#### ■ Front seat

OFF → HIGH (☀☀☀) → MIDDLE (☀☀) → LOW (☀)  
↑

#### ■ Rear seat

OFF → HIGH (☀☀☀) → MIDDLE (☀☀) → LOW (☀)  
↑

- The seat warmer defaults to the OFF position whenever the ignition switch is turned on.

► Temperature control(Automatic)

The seat warmer starts to automatically control the seat temperature in order to prevent low-temperature burns after being manually turned ON.



You may manually push up the button to increase the seat temperature. However, it soon returns to the automatic mode again.

- When pushing up the switch for more than 1.5 seconds with the seat warmer operating, the seat warmer will turn OFF.
- The seat warmer defaults to the OFF position whenever the Engine Start/Stop button is in the ON position.

**\* NOTICE**

With the seat warmer switch in the ON position, the heating system in the seat turns off or on automatically depending on the seat temperature.

**⚠️ WARNING - Seat warmer burns**

The seat warmer may cause burns, even at low temperatures, if used over a long period of time. Never allow passengers who may not be able to take care of themselves to be exposed to the risk of seat heater burns. These include:

1. Infants, children, elderly or disabled persons, or hospital outpatients
2. Persons with sensitive skin or those that burn easily
3. Fatigued individuals
4. Intoxicated individuals
5. Individuals taking medication that can cause drowsiness or sleepiness (sleeping pills, cold tablets, etc.)

**Air ventilation seat (if equipped)**



The temperature setting of the seat changes according to the switch position.

- If you want to ventilate your seat cushion, push down the switch (blue color).
- Each time you push down the button, the airflow will change as follows:

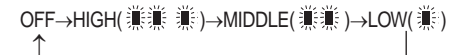



- The seat warmer (with air ventilation) defaults to the OFF position whenever the ignition switch is turned on.

### **⚠ CAUTION - Seat damage**

- *When cleaning the seats, do not use an organic solvent such as paint thinner, benzene, alcohol and gasoline. Doing so may damage the air ventilation seat.*
- *Do not place heavy or sharp objects on the seat. Those things may damage the air ventilation seat.*
- *Be careful not to spill liquid such as water or beverages on the seat. If you spill some liquid, wipe the seat with a dry towel. Before using the air ventilation seat, dry the seat completely.*

### Sunvisor



Use the sunvisor to shield direct light through the front or side windows.

To use the sunvisor, pull it downward.

To use the sunvisor for the side window, pull it downward, unsnap it from the bracket (1) and swing it to the side (2).

To use the vanity mirror, pull down the visor and slide the mirror cover (3).

Adjust the sunvisor extension forward or backward (4).

The ticket holder (5) is provided for holding a tollgate ticket. (if equipped)

- \* The actual sunvisor lamp in the vehicle may differ from the illustration.

### **⚠ CAUTION - Vanity mirror lamp**

*If you use the vanity mirror lamp, turn off the lamp before returning the sunvisor to its original position, otherwise it could result in battery discharge and possible sunvisor damage.*

## Power outlet

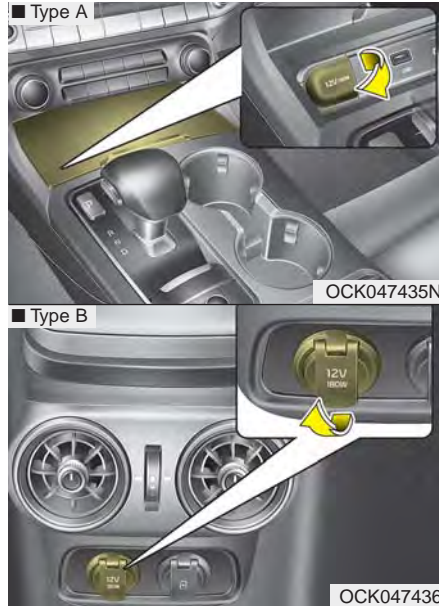

The power outlet is designed to provide power for mobile devices.

The devices should draw less than 10 amps with the engine running.

- Use the power outlet only when the engine is running and remove the accessory plug after use. Using the accessory plug for prolonged periods of time with the engine off could cause the battery to discharge.
- Only use 12V electric accessories which are less than 10A in electric capacity.
- Close the cover when not in use.
- Some electronic devices can cause electronic interference when plugged into a vehicle's power outlet. These devices may cause excessive audio static and malfunctions in other electronic systems or devices used in your vehicle.
- Push the plug in as far as it will go. If good contact is not made, the plug may overheat and the fuse may open.
- Plug in battery equipped electronic devices with reverse current protection. The current from the battery may flow into the vehicle's electrical/electronic system and cause system malfunction.

**⚠ WARNING - Electric shock**  
**Do not put a finger or a foreign object (pen, etc.) into a power outlet and do not touch with a wet hand. You may receive an electric shock.**

### USB charger

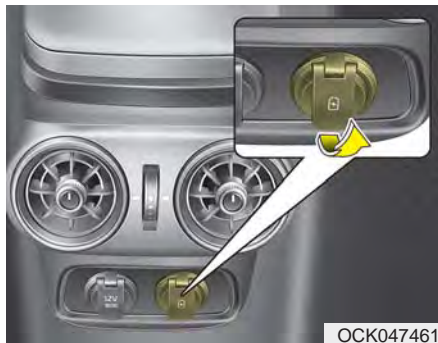

The USB charger is designed to recharge devices using a USB cable.

The electrical devices can be recharged when the Engine Start/Stop button is in ACC/ON/START position.

The battery charging state may be monitored on the electrical device.

Disconnect the USB cable from the USB port after use.

- Use the USB charger when the engine is running to prevent battery discharge.
- Only devices that fits the USB port can be used.
- The USB charger can be used only for battery charging purposes.

### Wireless smart phone charging system (if equipped)

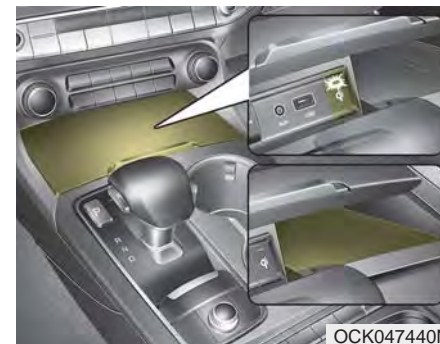

A wireless smart phone charging system is located in front of the center console.

Firmly close all doors, and turn the ignition to ACC or IGN ON. To start wireless charging, place the smart phone equipped with wireless charging function on the wireless charging pad.

For best wireless charging results, place the smart phone on the center of the charging pad.

The wireless charging system is designed for one smart phone equipped with Qi. Please refer to the smart phone accessory cover or the smart phone manufacturer home-page to check whether your smart phone supports Qi function.

### ***Wireless smart phone charging***

1. Remove any object on the smart phone charging pad including the smart key. If there is any foreign object on the pad other than a smart phone, the wireless charging function may not operate properly.
2. Place the smart phone on the center of the wireless charging pad.
3. The indicator light will change to orange once the wireless charging begins. After the charging is complete, the orange light will change to green.
4. You can choose to turn the wireless charging function to either ON or OFF by selecting the USM on the instrument cluster. (Please refer to "Instrument Cluster" for details).

If the wireless charging does not work, gently move your smart phone around the pad until the charging indicator light turns yellow. Depending on the smart phone, the charging indicator light may not turn green even after the charging is complete.

If the wireless charging is not functioning properly, the orange light will blink and flash for ten seconds then turn off. In such cases, remove the smart phone from the pad and replace it on the pad again, or double check the charging status.

If you leave the smart phone on the charging pad when the vehicle ignition is in OFF, the vehicle will alert you through warning messages and sound (applicable for vehicles with voice guidance function) after the 'Good bye' function on the instrument cluster ends.

**⚠ WARNING - Distracted driving**

Driving while distracted can result in a loss of vehicle control that may lead to an accident, severe personal injury, and death. The driver's primary responsibility is in the safe and legal operation of a vehicle, and use of any handheld devices, other equipment, or vehicle systems which take the driver's eyes, attention and focus away from the safe operation of a vehicle or which are not permissible by law should never be used during operation of the vehicle.

**⚠ CAUTION - Liquid in Wireless Smart Phone Charger**

*To prevent liquid from damaging the wireless smart phone charging system in your vehicle, securely close the tray cover when charging your phone.*

**⚠ WARNING - Metal in Wireless Charging System**

If any metallic object such as coins placed between the wireless charging system and the smart phone, the charging may be disrupted. Also, the metallic object may heat up and potentially damage the charging system. If there is any metallic object between the smart phone and the charging pad, immediately remove the smart phone. Remove the metallic object after it has cooled down.

**\* NOTICE**

- If it is not possible to close the tray cover due to the size of your smart phone or because the tray cover has been broken, do not use the wireless smart phone charging function.
- Even if you're not charging your smart phone, keep the tray cover closed at all times when it is left in the tray. Driving with the tray cover opened will increase the chance of accidents and result in injury as you're highly likely to get distracted by the smart phone.
- When the interior temperature of the wireless charging system rises above a set temperature, the wireless charging will cease to function. After the interior temperature drops below the threshold, the wireless charging function will resume.
- The wireless charging may not function properly when there is a heavy accessory cover on the smart phone.

(Continued)

(Continued)

- The wireless charging will stop when the smart key is moved out of the vehicle with the ignition in ON.
- Charging may be temporarily interrupted when smart key detection is activated. (when turning on ignition, opening or closing the doors)
- The wireless charging will stop when the vehicle is turned OFF.
- The wireless charging will stop when the smart phone is not in complete contact with the wireless charging pad.
- Items equipped with magnetic components such as credit cards, telephone cards, bank-books, or a transportation ticket may become damaged during wireless charging.
- Place the smart phone on the center of the charge pad for best results. The smart phone may not charge when placed near the rim of the charging pad. When the smart phone does get charged, it may heat up excessively.

(Continued)

(Continued)

- For smart phones without built-in wireless charging system, an appropriate accessory has to be equipped in order to use the vehicle's wireless charging system.
- Cellphones that are not certified for wireless smart phone charging standards (Qi) may not be able to charge.
- Self-protection features in some smart phones could slow down or stop charging.
- In some cases, the wireless charging indicator could not turn green even when the phone is fully charged.
- Smart phones of some manufacturers may display messages on weak current. This is due to the particular characteristic of the smart phone and does not imply a malfunction on wireless charging function.

(Continued)

(Continued)

- The indicator light of some manufacturers' smart phones may still be yellow after the smart phone is fully charged. This is due to the particular characteristic of the smart phone and not a malfunction of the wireless charging system.
- When any smart phone without a wireless charging function or a metallic object is placed on the charging pad, a small noise may sound. This small sound is due to the vehicle discerning compatibility of the object placed on the charging pad. It does not affect your vehicle or the smart phone in any way.

**This device complies with Part 15 of the FCC rules.**

Operation is subject to the following two conditions:

1. This device may not cause harmful interference, and
2. This device must accept any interference received, including interference that may cause undesired operation

**Coat hook**

■ Type A

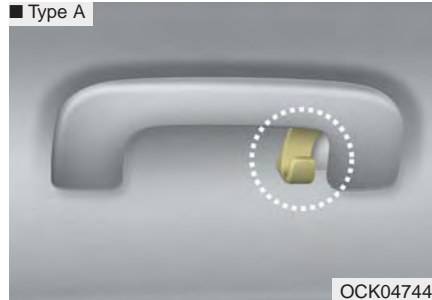

■ Type B



※ This actual feature may differ from the illustration.

To use the coat hook, pull down the upper portion of hanger.



**CAUTION - Hanging clothing**

*Do not hang heavy clothes, since they may damage the hook.*

**⚠ WARNING**

OPS046500

Do not hang other objects such as hangers or hard objects except clothes. Also, do not put heavy, sharp or breakable objects in the pockets of the clothing. In an accident or when the curtain air bag is inflated, it may cause vehicle damage or personal injury.

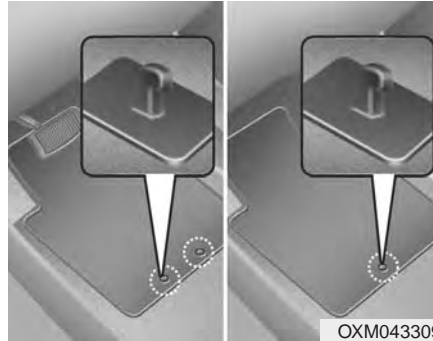
**Floor mat anchor (s)  
(if equipped)**

OXM043309

When using a floor mat on the front floor carpet, make sure it attaches to the floor mat anchor(s) in your vehicle. This keeps the floor mat from sliding forward.

**⚠ WARNING - After market  
floor mat**

Do not install aftermarket floor mats that are not capable of being securely attached to the vehicle's floor mat anchors.

Unsecured floor mats can interfere with pedal operation.

The following must be observed when installing ANY floor mat to the vehicle.

- Ensure that the floor mats are securely attached to the vehicle's floor mat anchor(s) before driving the vehicle.
- Do not use ANY floor mat that cannot be firmly attached to the vehicle's floor mat anchors.
- Do not stack floor mats on top of one another (e.g. all-weather rubber mat on top of a carpeted floor mat). Only a single floor mat should be installed in each position.



### Luggage net (holder) (if equipped)



To keep items from shifting in the cargo area, you can use the holders located in the cargo area to attach the luggage net.

### CAUTION

*To prevent damage to the goods or the vehicle, care should be taken when carrying fragile or bulky objects in the luggage compartment.*

### WARNING

To avoid eye injury, DO NOT overstretch the luggage net. ALWAYS keep your face and body out of the luggage net's recoil path. DO NOT use the luggage net when the strap has visible signs of wear or damage.

## AUDIO SYSTEM

### \* NOTICE

If you install an after market HID head lamp, your vehicle's audio and electronic device may malfunction.

\* If your vehicle is equipped with AVN(Audio, Video and Navigation) system, refer to a separately supplied manual for detailed information.

### Antenna

#### *Shark fin antenna*



The shark fin antenna will receive both AM and FM signals and the transmit data.

### AUX, USB port



You can use an AUX port to connect audio devices and a USB port to plug in a USB or iPod®.

### \* NOTICE

When using a portable audio device connected to the power outlet, noise may occur during playback. If this happens, use the power source of the portable audio device.

\* iPod® is a trademark of Apple Inc.

**⚠ WARNING - Distracted driving**

Driving while distracted can result in a loss of vehicle control that may lead to an accident, severe personal injury, and death. The driver's primary responsibility is in the safe and legal operation of a vehicle, and use of any handheld devices, other equipment, or vehicle systems which take the driver's eyes, attention and focus away from the safe operation of a vehicle or which are not permissible by law should never be used during operation of the vehicle.

## Declaration of Conformity

### FCC

This equipment has been tested and found to comply with the limits for a Class B digital device, pursuant to part 15 of the FCC Rules. These limits are designed to provide reasonable protection against harmful interference in a residential installation.

This equipment generates, uses and can radiate radio frequency energy and, if not installed and used in accordance with the instructions, may cause harmful interference to radio communications. However, there is no guarantee that interference will not occur in a particular installation. If this equipment does cause harmful interference to radio or television reception, which can be determined by turning the equipment off and on, the user is encouraged to try to correct the interference by one or more of the following measures :

- Reorient or relocate the receiving antenna.
- Increase the separation between the equipment and receiver.
- Connect the equipment into an outlet on a circuit different from that to which the receiver is connected.
- Consult the dealer or an experienced radio/TV technician for help.

Caution: Any changes or modifications to this device not explicitly approved by manufacturer could void your authority to operate this equipment.

This device complies with part 15 of the FCC Rules. Operation is subject to the following two conditions :

(1) This device may not cause harmful interference, and (2) this device must accept any interference received, including interference that may cause undesired operation.

This equipment complies with FCC radiation exposure limits set forth for an uncontrolled environment.

This equipment should be installed and operated with minimum 20cm between the and your body. This transmitter must not be collocated or operating in conjunction with any other antenna or transmitter unless authorized to do so by the FCC.

# Driving your vehicle

<b>Before driving</b> . . . . .	5-5	<b>Limited Slip Differential (LSD)</b> . . . . .	5-42
• Before entering vehicle . . . . .	5-5	<b>Brake system</b> . . . . .	5-43
• Necessary inspections . . . . .	5-5	• Power brakes . . . . .	5-43
• Before starting . . . . .	5-5	• Parking brake – Foot type . . . . .	5-45
<b>Engine start/stop button</b> . . . . .	5-7	• Electronic parking brake (EPB) . . . . .	5-47
• Illuminated engine start/stop button . . . . .	5-7	• Auto hold . . . . .	5-53
• Engine start/stop button position . . . . .	5-7	• Warning messages . . . . .	5-56
• Starting the engine with a smart key . . . . .	5-9	• Anti-lock Brake System (ABS) . . . . .	5-57
<b>Automatic transmission</b> . . . . .	5-11	• Electronic Stability Control (ESC) . . . . .	5-59
• Automatic transmission operation . . . . .	5-11	• Vehicle Stability Management (VSM) . . . . .	5-63
• Good driving practices . . . . .	5-17	• Hill-start Assist Control (HAC) . . . . .	5-64
• Launch control . . . . .	5-18	• Good braking practices . . . . .	5-65
<b>Automatic transmission (shift-by-wire)</b> . . . . .	5-21	<b>Forward Collision-avoidance Assist (FCA)</b>	
• Automatic transmission operation . . . . .	5-21	system . . . . .	5-67
• Parking . . . . .	5-28	• System setting and activation . . . . .	5-67
• LCD display messages . . . . .	5-28	• FCA warning message and system control . . . . .	5-70
• Good driving practices . . . . .	5-31	• Brake operation . . . . .	5-71
• Launch control . . . . .	5-33	• FCA sensor (Front Camera/Front Radar) . . . . .	5-72
<b>The Eco-coasting system</b> . . . . .	5-36	• System malfunction . . . . .	5-73
• The Eco-Coasting system setting . . . . .	5-36	• Limitation of the system . . . . .	5-74
• Eco-Coasting operation conditions . . . . .	5-36	<b>Cruise Control system</b> . . . . .	5-81
• The Eco-Coasting system release conditions . . . . .	5-37	• To set cruise control speed . . . . .	5-82
<b>All wheel drive (AWD)</b> . . . . .	5-38	• To increase cruise control set speed . . . . .	5-82
• Using All Wheel Drive (AWD) . . . . .	5-38	• To decrease the cruising speed . . . . .	5-83
• Emergency precautions . . . . .	5-40	• To temporarily accelerate with the cruise control on . . . . .	5-83

- To cancel cruise control ..... 5-83
- To resume cruising speed at more than approximately 20 mph (30 km/h) ..... 5-84
- To turn cruise control off ..... 5-84
- Smart Cruise Control with stop & go system . . . 5-85**
  - Smart Cruise Control switch ..... 5-87
  - Speed setting ..... 5-87
  - Vehicle to vehicle distance setting ..... 5-92
  - When the lane ahead is clear ..... 5-93
  - When there is a vehicle ahead of you in your lane . 5-93
  - To adjust the sensitivity of Smart Cruise Control system ..... 5-97
  - To convert to Cruise Control mode ..... 5-97
  - Limitations of the system ..... 5-98
- ISG (Idle Stop and Go) system ..... 5-104**
  - Auto stop ..... 5-104
  - Auto start ..... 5-105
  - Condition of ISG system operation ..... 5-106
  - ISG system deactivation ..... 5-106
  - ISG system malfunction ..... 5-107
- Drive mode integrated control system ..... 5-108**
- Lane Keeping Assist (LKA) system ..... 5-113**
  - LKA system operation ..... 5-115
  - Driver's attention. .... 5-119
- LKA system malfunction ..... 5-120
- LKA system Function Change..... 5-121
- Blind-spot Collision Warning (BCW)/  
Rear Cross-Traffic Collision Warning  
(RCCW) ..... 5-123**
  - System description. .... 5-123
  - BCW (Blind-Spot Collision Warning)..... 5-124
  - RCCW (Rear Cross-Traffic Collision Warning) .. 5-127
  - Driver's attention..... 5-130
- Driver Attention Warning (DAW) system ..... 5-132**
  - System setting and activation..... 5-132
  - Resetting the system ..... 5-134
  - System disabled ..... 5-134
  - System malfunction..... 5-135
- Economical operation ..... 5-137**
- Special driving conditions ..... 5-139**
  - Hazardous driving conditions ..... 5-139
  - Rocking the vehicle ..... 5-139
  - Smooth cornering ..... 5-140
  - Driving at night ..... 5-140
  - Driving in the rain..... 5-141
  - Driving in flooded areas ..... 5-142
  - Driving off-road..... 5-142
  - Highway driving ..... 5-142

**Winter driving** ..... 5-143

- Snowy or icy conditions ..... 5-143
- Use high quality ethylene glycol coolant ..... 5-145
- Check battery and cables ..... 5-145
- Change to "winter weight" oil if necessary ..... 5-146
- Check spark plugs and ignition system ..... 5-146
- To keep locks from freezing ..... 5-146
- Use approved window washer anti-freeze in system ..... 5-146
- Don't let your parking brake freeze ..... 5-146
- Don't let ice and snow accumulate underneath ... 5-147
- Carry emergency equipment ..... 5-147

**Vehicle load limit** ..... 5-148

- Tire and loading information label ..... 5-148
- Certification label ..... 5-152

**Vehicle weight** ..... 5-153

- Base curb weight ..... 5-153
- Vehicle curb weight ..... 5-153
- Cargo weight ..... 5-153
- GAW (Gross Axle Weight) ..... 5-153
- GAWR (Gross Axle Weight Rating) ..... 5-153
- GVW (Gross Vehicle Weight) ..... 5-153
- GVWR (Gross Vehicle Weight Rating) ..... 5-153



### **Be sure the exhaust system does not leak.**

The exhaust system should be checked whenever the vehicle is raised to change the oil or for any other purpose. If you hear a change in the sound of the exhaust or if you drive over something that strikes the underneath side of the vehicle, have the exhaust system checked as soon as possible by an authorized Kia dealer.

### **WARNING - Engine exhaust**

**Do not inhale exhaust fumes or leave your engine running in a enclosed area for a prolonged time. Exhaust fumes contain carbon monoxide, a colorless, odorless gas that can cause unconsciousness and death by asphyxiation.**

### **WARNING - Open liftgate**

**Do not drive with the liftgate open. Poisonous exhaust gases can enter the passenger compartment. If you must drive with the liftgate open proceed as follows:**

- 1. Close all windows.**
- 2. Open side vents.**
- 3. Set the air intake control at “Fresh”, the air flow control at “Floor” or “Face” and the fan at the highest speed.**

## BEFORE DRIVING

### Before entering vehicle

- Be sure that all windows, outside mirror(s), and outside lights are clean.
- Check the condition of the tires.
- Check under the vehicle for any sign of leaks.
- Be sure there are no obstacles behind you if you intend to back up.

### Necessary inspections

Fluid levels, such as engine oil, engine coolant, brake fluid, and washer fluid should be checked on a regular basis, at the exact interval depending on the fluid. Further details are provided in chapter 7, "Maintenance".

 **WARNING - Distracted driving**

**Focus on the road while driving. The driver's primary responsibility is in the safe and legal operation of the vehicle. Use of any handled devices, other equipment or vehicle systems that distract the driver should not be used during vehicle operation.**

### Before starting

- Close and lock all doors.
- Position the seat so that all controls are easily reached.
- Buckle your seat belt.
- Adjust the inside and outside rearview mirrors.
- Be sure that all lights work.
- Check all gauges.
- Check the operation of warning lights when the ignition switch is turned to the ON position.
- Release the parking brake and make sure the brake warning light goes out.

For safe operation, be sure you are familiar with your vehicle and its equipment.

**⚠ WARNING - Fire risk**

When you intend to park or stop the vehicle with the engine on, be careful not to depress the accelerator pedal for a long period of time. It may overheat the engine or exhaust system and cause fire.

**⚠ WARNING - Check surroundings**

Always check the surrounding areas near your vehicle for people, especially children, before putting a vehicle into D (Drive) or R (Reverse).

**⚠ WARNING - Loose objects**

Securely store items in your vehicle. When you make a sudden stop or turn the steering wheel rapidly, loose objects may drop on the floor and it could interfere with the operation of the foot pedals, possibly causing an accident.

**⚠ WARNING - Proper footwear**

Always wear appropriate shoes when operating your vehicle.

Unsuitable shoes (high heels, ski boots, sandals, etc.) may interfere with your ability to use the brake and accelerator pedals.

**⚠ WARNING - Driving while intoxicated**

Do not drive while intoxicated. Drinking and driving is dangerous. Even a small amount of alcohol will affect your reflexes, perceptions and judgment.

Driving while under the influence of drugs is as dangerous as or more dangerous than driving drunk.

## ENGINE START/STOP BUTTON

### Illuminated engine start/stop button



OCK057001

Whenever the front door is opened, the engine start/stop button will illuminate for your convenience. The light will go off after about 30 seconds when the door is closed.

When all doors are closed and you lock the vehicle by using the transmitter or the smart key, the light will go off immediately.

### Engine start/stop button position

#### OFF

To turn off the engine (START/RUN position) or vehicle power (ON position), press the engine start/stop button with the shift lever in the P (Park) position. When you press the engine start/stop button without the shift lever in the P (Park) position, the engine start/stop button will not change to the OFF position but to the ACC position.

In an emergency situation while the vehicle is in motion, you are able to turn the engine off and to the ACC position by pressing the engine start/stop button for more than 2 seconds or 3 times successively within 3 seconds. If the vehicle is still moving, you can restart the engine without depressing the brake pedal by pressing the engine start/stop button with the shift lever in the N (Neutral) position.

### ACC(Accessory)



OCK057163

Press the engine start/stop button while it is in the OFF position without depressing the brake pedal.

If the engine start/stop button is in the ACC position for more than 1 hour, the button is turned off automatically to prevent battery discharge.

Accessory is displayed on the LCD of the cluster.

### **ON**

Press the engine start/stop button while it is in the ACC position without depressing the brake pedal.

The warning lights can be checked before the engine is started. Do not leave the engine start/stop button in the ON position for an extended period of time. The battery may discharge, because the engine is not running.

### **START/RUN**

To start the engine, depress the brake pedal and press the ENGINE START/ STOP button with the shift lever in the P (Park) or the N (Neutral) position. For your safety, start the engine with the shift lever in the P (Park) position.

If you press the engine start/stop button without depressing the brake pedal, the engine will not start and the engine start/stop button changes as follow:

OFF → ACC → ON → OFF or ACC

### **\* NOTICE**

If you leave the ENGINE START/STOP button in the ACC or ON position for an extended period of time, the battery will discharge.



#### **WARNING - Starting vehicle**

**Never press the engine start/stop button while the vehicle is in motion except in an emergency. This would result in loss of directional control and braking function, which could cause an accident.**

## Starting the engine with a smart key

1. Carry the smart key or place it inside the vehicle.
2. Make sure the parking brake is firmly applied
3. Place the shift lever in P (Park). Depress the brake pedal fully.

*You can also start the engine when the shift lever is in the N (Neutral) position.*

4. Press the engine start/stop button while depressing the brake pedal.
5. Do not wait for the engine to warm up while the vehicle remains stationary.

Start driving at moderate engine speeds. (Steep accelerating and decelerating should be avoided.)

- Even if the smart key is in the vehicle, if it is far away from you, the engine may not start.
- When the ENGINE START/STOP button is in the ACC or ON position and any door is opened, the system checks for the presence of the smart key. If the smart key is not in the vehicle, a message “key is not in the vehicle” will appear on the LCD display. And if all doors are closed, the chime will sound for 5 seconds. The indicator or warning will turn off while the vehicle is moving. Always have the smart key with you.

### **WARNING - Unintended vehicle movement**

**Never leave the smart key in the vehicle with children or vehicle occupants who are unfamiliar with the vehicle operation. Pushing the engine start/stop button while the smart key is in the vehicle may result in unintended engine activation and/or unintended vehicle movement.**

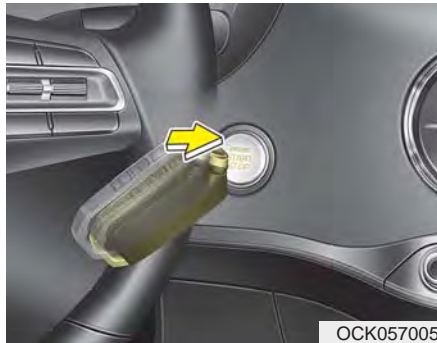

- If the smart key battery is weak or the smart key does not work correctly, you can start the engine by pressing the engine start/stop button with the smart key.

The side with the lock button should contact the engine start/stop button directly.

When you press the engine start/stop button directly with the smart key, the smart key should contact the button at a right angle.

- When the stop lamp fuse is blown, you can't start the engine normally. Replace the fuse with a new one. If it is not possible, you can start the engine by pressing the engine start/stop button for 10 seconds while it is in the ACC position. The engine can start without depressing the brake pedal. But for your safety always depress the brake pedal before starting the engine.

Do not press the ENGINE START/STOP button for more than 10 seconds except when the stop lamp fuse is blown.

## AUTOMATIC TRANSMISSION

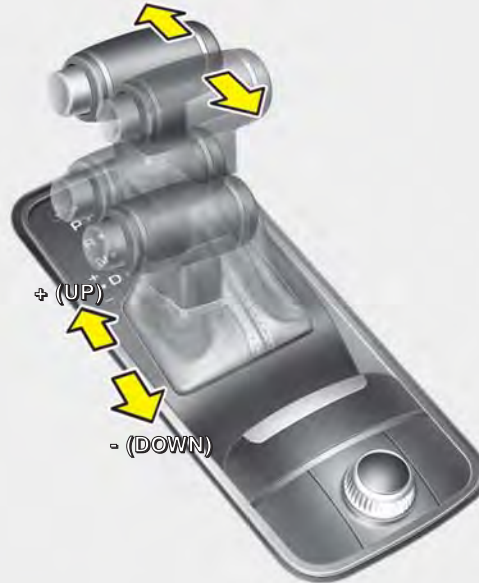
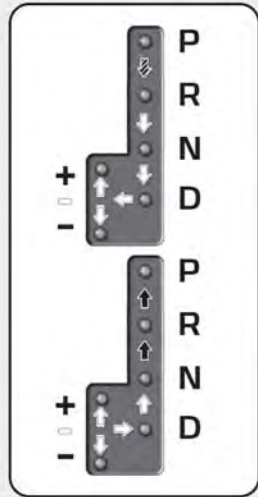



### Automatic transmission operation

The automatic transmission has 8 forward speeds and one reverse speed. The individual speeds are selected automatically, depending on the position of the shift lever.

### \* NOTICE

The first few shifts on a new vehicle, if the battery has been disconnected, may be somewhat abrupt. This is a normal condition, and the shifting sequence will adjust after shifts are cycled a few times by the TCM (Transmission Control Module) or PCM (Powertrain Control Module).

*For smooth operation, depress the brake pedal and the lock release button when shifting from N (Neutral) to a forward or reverse gear.*

-  Depress the brake pedal and the lock release button when shifting.
-  Press the lock release button when shifting.
-  The shift lever can be shifted freely.

OCK057164



**⚠ WARNING - Leaving Vehicle**

Before leaving the driver's seat, always make sure the shift lever is in the P (Park) position; then set the parking brake fully and shut the engine off. Do not use the P position in place of the parking brake. Always make sure the shift lever is locked in the P position and set the parking brake fully. Unexpected and sudden vehicle movement can occur if these precautions are not followed.

**⚠ CAUTION - Transmission**

*To avoid damage to your transmission, do not accelerate the engine in R (Reverse) or any forward gear position with the brakes on. The transmission may be damaged if you shift into P (Park) while the vehicle is in motion.*

When stopped on an incline, do not hold the vehicle with the engine power. Use the service brake or the parking brake.

***Transmission ranges***

The indicator in the instrument cluster displays the shift lever position when the ignition switch is in the ON position.

**P (Park)**

Always come to a complete stop before shifting into P (Park). This position locks the transmission and prevents the drive wheels from rotating.

Shifting into P (Park) while the vehicle is in motion will cause the drive wheels to lock and will cause you to lose control of the vehicle.

**R (Reverse)**

Use this position to drive the vehicle backward.

 **CAUTION - Shifting**

*Always come to a complete stop before shifting into or out of R (Reverse); you may damage the transmission if you shift into R (Reverse) while the vehicle is in motion, except when “Rocking the vehicle” explained in this chapter.*

**N (Neutral)**

The wheels and transmission are not engaged. The vehicle will roll freely even on the slightest incline unless the parking brake or service brakes are applied.

**- Parking in N (Neutral) gear**

Follow the steps below when parking and you want the vehicle to move when pushed.

1. After stopping your vehicle, depress the brake pedal and move the transmission shift lever to [P] with the ignition button in [ON] or while the engine is running.
2. If the parking brake is applied, release the parking brake.
  - For EPB (Electronic Parking Brake) equipped vehicles, depress the brake pedal with the ignition button in [ON] or while the engine is running to disengage the parking brake. If [AUTO HOLD] function is used while driving (If [AUTO HOLD] indicator is on in the cluster), press [AUTO HOLD] switch and [AUTO HOLD] function will be turned off.
3. While depressing the brake pedal, turn the ignition button [OFF].
  - For smart key equipped vehicles, the ignition switch can be moved to [OFF] only when the shift lever is in [P].

4. Change the gear shift lever to [N] (Neutral) while depressing the brake pedal and inserting a tool (e.g. flathead screw-driver) into the [SHIFT LOCK RELEASE] access hole at the same time. Then, the vehicle will move when external force is applied.

 **WARNING - Parking In Neutral**

- **With the exception of parking in neutral gear, always park the vehicle in [P] (Park) for safety and apply the parking brake.**
- **Before parking in [N] (Neutral) gear, make sure the parking ground is level and flat. Do not park in [N] gear on any slopes or gradients. If parked and left in [N], the vehicle may move and cause serious damage or injury.**

### \* NOTICE

- After the ignition switch has been turned off, the EPB (Electronic Parking Brake) cannot be released.
- For EPB (Electronic Parking Brake) equipped vehicles with [AUTO HOLD] function used while driving, if the ignition button has been turned [OFF], the EPB (Electronic Parking Brake) will be engaged automatically. Therefore, [AUTO HOLD] function should be turned off before the ignition button is turned off.

### ⚠ CAUTION - Starter

*If the engine stalls while the vehicle is in motion, do not attempt to move the shift lever to the P (Park) position. If the traffic and road conditions permit, you may put the shift lever in the N (Neutral) position while the vehicle is still moving and press the ENGINE START/STOP button in an attempt to restart the engine.*

### D (Drive)

This is the normal forward driving position. The transmission will automatically shift through an 8-gear sequence, providing the best fuel economy and power.

For extra power when passing another vehicle or climbing grades, depress the accelerator fully, at which time the transmission will automatically downshift to the next lower gear.



### Manual mode

Whether the vehicle is stationary or in motion, manual mode is selected by pushing the shift lever from the D (Drive) position into the manual gate. To return to D (Drive) range operation, push the shift lever back into the main gate.

In manual mode, moving the shift lever backwards and forwards will allow you to make gearshifts rapidly. In contrast to a manual transmission, the manual mode allows gearshifts with the accelerator pedal depressed.

Up (+) : Push the lever forward once to shift up one gear.

Down (-) : Pull the lever backwards once to shift down one gear.

- In manual mode, the driver must execute upshifts in accordance with road conditions, taking care to keep the engine speed below the red zone.
- In manual mode, only the 8 forward gears can be selected. To reverse or park the vehicle, move the shift lever to the R (Reverse) or P (Park) position as required.

- In manual mode, downshifts are made automatically when the vehicle slows down. When the vehicle stops, 1st gear is automatically selected.
- In manual mode, when the engine rpm approaches the red zone, shift points are varied to upshift automatically.
- To maintain the required levels of vehicle performance and safety, the system may not execute certain gearshifts when the shift lever is operated.
- When driving on a slippery road, push the shift lever forward into the + (up) position. This causes the transmission to shift into the higher gears which is better for smooth driving on a slippery road. Push the shift lever to the - (down) side to shift back to the 1st gear.

### *Paddle shifter*



The paddle shifter is available when the shift lever is in the D position or the manual mode.

### **With the shift lever in the D position**

Pull the [+] or [-] paddle shifter once to shift up or down one gear and the system changes from automatic mode to manual mode.

To change back to the automatic shift mode from manual shift mode, do one the following :

- Move the shift lever from D (Drive) to manual mode and move it from manual mode to D again.
- Gently depress the accelerator pedal for more than 5 seconds except for SPORT mode.
- Drive the vehicle under 4 mph (7 km/h).
- Pull and hold the right side paddle shifter more than 1 second.

### **With the shift lever in the manual mode**

Pull the [+] or [-] paddle shifter once to shift up or down one gear.

### **\* NOTICE**

**If you pull the [+] and [-] paddle shifters at the same time, you cannot shift the gear.**

### **Shift lock system**

For your safety, the automatic transmission has a shift lock system which prevents shifting the transmission from P (Park) into R (Reverse) unless the brake pedal is depressed.

To shift the transmission from P (Park) into R (Reverse):

1. Depress and hold the brake pedal.
2. Start the engine or turn the ignition switch to the ON position.
3. Move the shift lever.

If the brake pedal is repeatedly depressed and released with the shift lever in the P (Park) position, a chattering noise & vibration near the shift lever may be heard. It is a normal condition.

 **WARNING - Shifting from park**

**Always fully depress the brake pedal before and while shifting out of the P (Park) position into another position to avoid inadvertent motion of the vehicle which could injure persons in or around the vehicle.**

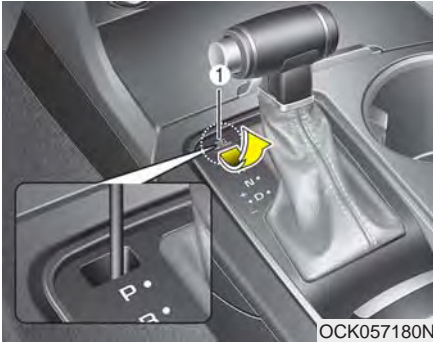

### Shift-lock override

If the shift lever cannot be moved from the P (Park) position into R (Reverse) position with the brake pedal depressed, continue depressing the brake, then do the following:

1. Place the ignition switch in the LOCK/OFF position.
2. Apply the parking brake.
3. Carefully remove the cap (1) covering the shift-lock release access hole.
4. Insert a tool (e.g. flathead screwdriver) into the access hole and press down on the tool.

5. Move the shift lever.

6. Remove the tool from the shiftlock override access hole then install the cap.

7. We recommend that the system be inspected by an authorized Kia dealer.

### Ignition key interlock system

The ignition key cannot be removed unless the shift lever is in the P (Park) position. Even if the ignition switch is in the LOCK position, the key cannot be removed.

If your vehicle is equipped with engine start/stop button, the button will not change to the OFF position unless the shift lever is in the P (Park) position.

### Good driving practices

- Never move the gear shift lever from P (Park) to any other position with the accelerator pedal depressed.
- Never move the gear shift lever into P (Park) when the vehicle is in motion.
- Slow down before shifting to a lower gear. Otherwise, the lower gear may not be engaged.
- Always use the parking brake. Do not depend on placing the transmission in P (Park) to keep the vehicle from moving.
- Optimum vehicle performance and economy is obtained by smoothly depressing and releasing the accelerator pedal.

### \* NOTICE - Kickdown Mechanism

Use the kickdown mechanism for maximum acceleration. Depress the accelerator pedal beyond the pressure point. The automatic transmission will shift to a lower gear depending on the engine speed.

### ***Moving up a steep grade from a standing start***

To move up a steep grade from a standing start, depress the brake pedal, release the parking brake, and shift the shift lever to D (Drive). Depress the accelerator gradually while releasing the brake pedal.

## **Launch Control**

### ***Launch Control Operation***

- When using Launch Control, a driver should always make sure that the engine's cooling water is warmed up and reaches a recommended temperature.
- To operate ESC Off state 2, Press and hold ESC button for more than 3 seconds in Sports mode. (Status Display on Cluster Screen)
- For launching, stop the vehicle and keep the steering wheel straight.
- Footbrakes, EPB and Auto Hold must be released for smooth launching.



- Press the brake firmly with your left foot in transmission D mode, while pressing the accelerator pedal down fully with your right foot. Then, the Launch Control Ready (1) will be in place.



OCK047157L

- Do not operate both brake and accelerator pedals simultaneously for longer than 4 seconds.
  - When re-using Launch Control, a driver should have the vehicle cool down sufficiently by driving.
- To start a vehicle, with your right foot pressing the accelerator pedal down fully, remove your left foot from the brake. (within 4 seconds) (Launch Control Active (2) Status Display on Cluster Screen)
  - If both the brakes and accelerator pedals were applied and the driver removes his foot only from the accelerator pedal, Launch Control will be automatically deactivated. Or, if the vehicle does not start after 4 seconds with a driver's feet on both brake and accelerator pedals, Launch Control will automatically deactivate as well

### **Limited use of Launch Control (3)**



OCK047158L

- A warning message will pop up on the screen if the transmission fluid temperature is above a certain level while using Launch Control. Also, Launch Control will be automatically deactivated.
- To address the issue as above, a driver should cool down the transmission fluid temperature by driving the vehicle. (Driving at a constant speed over 37 mph (60 km/h) is highly recommended, but this should only be done if traffic and road conditions permit the driver to do so safely.)



**⚠ WARNING**

It is the responsibility of the driver to make sure it is safe before using Launch Control. Do not use Launch Control on public roads or when pedestrian congestion is present. Doing so could result in an accident that causes serious injuries.

**\* NOTICE**

Launch performance can vary depending on fuel, environment, tire, and loading conditions.

**⚠ CAUTION**

*Constant use of Launch Control can put enormous stress on transmission, engine, and drive shafts and can result in vehicle damage. It is highly recommended that Launch Control is used after completion of the vehicle brake-in process.*

## AUTOMATIC TRANSMISSION (SHIFT-BY-WIRE) (IF EQUIPPED)



### Automatic transmission operation

The automatic transmission has 8 forward speeds and one reverse speed.

The individual speeds are selected automatically in the D (Drive) position.

When you move the shift lever (1), depress the brake pedal while pressing the UNLOCK button (2).

To shift the gear to P (Park), press the [P] button(3).

OCK057008L

**⚠ WARNING**

To reduce the risk of serious injury or death:

- **ALWAYS** check the surrounding areas near your vehicle for people, especially children, before shifting a vehicle into D (Drive) or R (Reverse).
- Before leaving the driver's seat, always make sure the shift lever is in the P (Park) position, then set the parking brake, and place the engine start/stop button in the OFF position. Unexpected and sudden vehicle movement can occur if these precautions are not followed.
- Do not use engine braking (rapidly shifting from a high gear to lower gear) on slippery roads. The vehicle may slip causing an accident.

**Transmission ranges**

The indicator in the instrument cluster displays the shift lever position when the engine start/stop button is in the ON position.

However, if the gear is in N (Neutral) or P (Park), the position is displayed on the instrument cluster when the engine start/stop button is in the OFF or ACC position.

**⚠ CAUTION - Transmission**

*To avoid damage to your transmission, do not accelerate the engine in R (Reverse) or any forward gear position with the brakes on. The transmission may be damaged if you shift into P (Park) while the vehicle is in motion.*



**P (Park)**

Always come to a complete stop before shifting into P (Park).

To shift the gear from R (Reverse), N (Neutral), D (Drive) or Manual mode to P (Park), press the [P] button.

If you turn off the engine in D (Drive) or R (Reverse), the shifting automatically changes to P (Park).

When you park the vehicle, press the [P] button while depressing the brake pedal and then apply the parking brake.

To reduce rollaway risk, do not use the P (Park) Position in place of the parking brake.

### ⚠ WARNING

- Shifting into P (Park) while the vehicle is in motion may cause you to lose control of the vehicle.
- Do not use the P (Park) position in place of the parking brake.

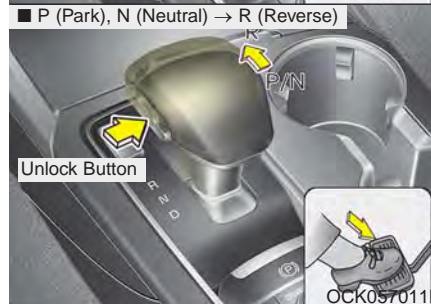
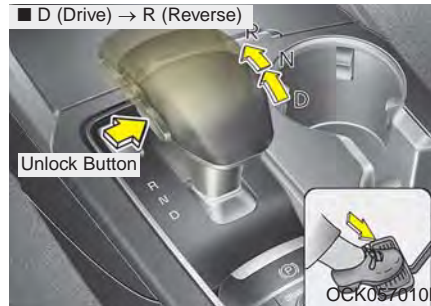

### R (Reverse)

Use this position to drive the vehicle backward.

To move the shift lever to R (Reverse), press the [UNLOCK] button while depressing the brake pedal and then move the shift lever forward.

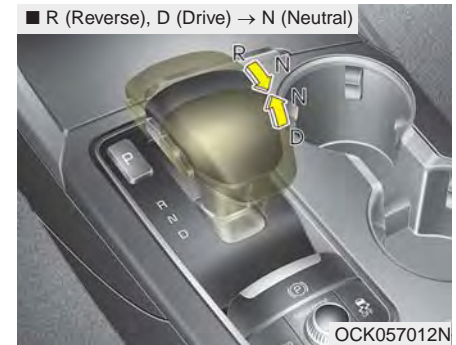

### N (Neutral)

The wheels and transmission are not engaged.

Use N (Neutral) if you need to restart a stalled engine, or if it is necessary to stop with the engine ON. Shift into P (Park) if you need to leave your vehicle for any reason.

Always depress the brake pedal when you are shifting from N (Neutral) to another gear.

To turn off the engine, re-press the engine start/stop button to the ON position, press the [P] button, and press the engine start/stop button to the OFF position.

When either the driver's door or the front passenger's door is opened with the engine start/stop button in the ACC position and the shift lever in N (Neutral) position, the engine is automatically turned OFF and the transmission automatically changes to the P (Park) position.

### **⚠ WARNING**

- **To avoid inadvertent vehicle movement, do not shift into gear unless your foot is firmly on the brake pedal.**
- **Do not permit your vehicle to idle in the N (Neutral) position for an extended period of time as this will preclude the wheels and the transmission from engaging. While parking the vehicle with the engine running, depress the brake pedal, shift the vehicle to the P (Park) position and apply the parking brake.**
- **Do not drive with the shift lever in N (Neutral). The engine brake will not work and may lead to an accident.**

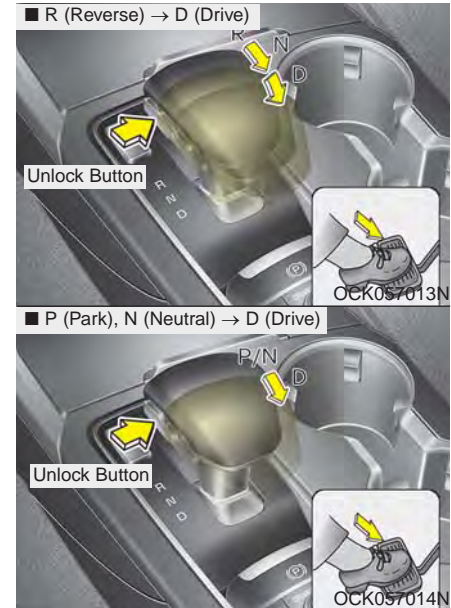

### **D (Drive)**

This is the normal driving position. The transmission will automatically shift through a 8-gear sequence, providing the best fuel economy and power.

For extra power when passing another vehicle or driving uphill, depress the accelerator pedal further until you feel the transmission downshift to a lower gear.

To shift into D (Drive), depress the brake pedal and press the [UNLOCK] button on the shift lever. Move the shift lever backward.

To shift into D (Drive) from N (Neutral), you must depress the brake pedal.

### \* NOTICE

**Always come to complete stop before shifting into D (Drive).**

### - Parking in N (Neutral) gear

Follow the steps below when parking and you want the vehicle to move when pushed.

1. After parking your vehicle, step on the brake pedal and press the [P] button with the ignition button in [ON] or while the engine is running.
2. If the parking brake is applied unlock the parking brake.
  - For EPB (Electronic Parking Brake) equipped vehicles, push the brake pedal with the ignition button in [ON] or while the engine is running to disengage the parking brake. If [AUTO HOLD] function is used while driving (If [AUTO HOLD] indicator is on in the cluster), press [AUTO HOLD] switch and [AUTO HOLD] function will be turned off.
3. While pressing the brake pedal, turn the ignition button [OFF].
  - For smart key equipped vehicles, the ignition switch can be [OFF] only after pressing the [P] button.

4. Remove the cap-cover and insert a tool (e.g. flathead screwdriver) into the access hole and press down on the tool while depressing the brake pedal. Then, the gear will change to the N (Neutral) position. It should be pressed within 3 minutes after turning OFF the engine.

### \* NOTICE

**When moving the shift lever to N(Neutral) position, a normal mechanical sound will occur.**

### CAUTION

***For EPB (Electronic Parking Brake) equipped vehicles with [AUTO HOLD] function used while driving, if the ignition button has been turned [OFF], the electronic parking brake will be engaged automatically. Therefore, [AUTO HOLD] function should be turned off before the ignition button is turned off.***

**⚠ WARNING**

- With the exception of parking in neutral gear, always park the vehicle in [P] (Park) for safety and apply the parking brake.
- Before parking in [N] (Neutral) gear, first make sure the parking ground is level and flat. Do not park in [N] gear on any slopes or gradients. If parked and left in [N], the vehicle may move and cause serious damage or injury.

**\* NOTICE**

After the ignition switch has been turned off, the electronic parking brake cannot be disengaged.

***Paddle shifter (Manual mode)***



The paddle shifter is available when the shift lever is in the D (Drive) position.

Pull the [+] or [-] paddle shifter once to shift up or down one gear and the system changes from automatic mode to manual mode.

To change back to the automatic shift mode from manual shift mode, do one the following :

- Move the shift lever down.
- Gently depress the accelerator pedal for more than 5 seconds except for SPORT mode.
- Drive the vehicle under 4 mph (7 km/h).
- Pull and hold the right side paddle shifter more than 1 second.

**\* NOTICE**

**If the [+] and [-] paddle shifters are pulled at the same time, gear shift may not occur.**

**Shift-lock system**

For your safety, the automatic transmission has a shift-lock system which prevents shifting the transmission from P (Park) into R (Reverse) or D (Drive) unless the [UNLOCK] button is pressed while depressing the brake pedal.

To shift the transmission from P (Park) into R (Reverse) or D (Drive):

1. Depress and hold the brake pedal.
2. Start the engine or place the engine start/stop button in the ON position.
3. Move the shift lever to R (Reverse) or D (Drive) while pressing the [UNLOCK] button.

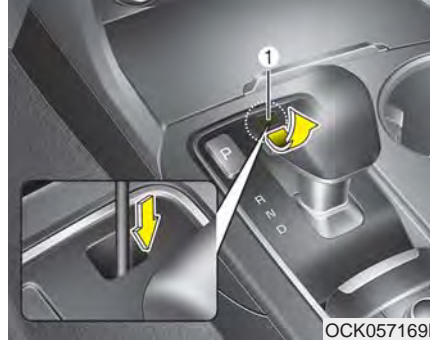
**When the battery is discharged:**

You can move the shift lever, when the battery is discharged. However, it will not change the gear from P (Parking) to N (Neutral) or others.

In emergencies, do the following to move the shift lever to N (Neutral) on a level ground.

1. Connect the cables between the jump-starting terminals inside the engine compartment and the battery terminals of another vehicle/ supplementary battery.

For more information refer to "Jump Starting" in chapter 6.

2. Release the parking brake with the engine start/stop button in the ON position.
3. Press the engine start/stop button to the OFF position.
4. Remove the cap-cover (1) and insert a tool (e.g. flathead screwdriver) into the access hole and press down on the tool while depressing the brake pedal. Then, the gear will change to the N (Neutral) position. It should be pressed within 3 minutes after turning OFF the engine.



### \* NOTICE

In situations where the gear needs to be changed from P (Park) to N (Neutral) when the engine start/stop button is in the OFF position, refer to step 4.

The actuators work to shift the gear into the N (Neutral) or P (Parking) and make a normal mechanical sound.

### Parking

Always come to a complete stop and continue to depress the brake pedal. Move the shift lever into the P (Park) position, apply the parking brake, and place the engine start/stop button in the OFF position. Take the Key with you when exiting the vehicle.

#### **⚠ WARNING**

- Do not depress the accelerator pedal while sitting in the vehicle with the engine running. Depressing the accelerator pedal for a long period of time may cause the engine or exhaust system to overheat and start a fire.
- The exhaust gas and the exhaust system are very hot. Keep away from the exhaust system components. Do not stop or park over flammable materials, such as dry grass, paper or leaves. They may ignite and cause a fire.

### LCD display messages

#### *Shifter Malfunction*



The warning message appears on the LCD display, when the transmission or the shift lever does not properly operate in the P (Park) position. In this case, have the vehicle inspected by an authorized Kia dealer immediately.

**Check shift lever**

The warning message appears on the LCD display, when there is a malfunction with one of the key transmission components.

In this case, have the vehicle inspected by an authorized Kia dealer immediately.

**Shifting conditions not met**

The warning message appears on the LCD display, when engine RPM is too high, or when driving speed is too fast to shift the gear.

We recommend you decrease your RPM level or slow down before shifting the gear.

**Press brake pedal to change gear**

The warning message appears on the LCD display, when the brake pedal is not depressed while shifting the gear.

We recommend you depress the brake pedal and then shift the gear.

## *Shift to P after stopping*



The warning message appears on the LCD display, when the brake pedal is not depressed while shifting the gear.

We recommend you depress the brake pedal and then shift the gear.

## *Press UNLOCK to change gear*



The warning message appears on the LCD display, when the [UNLOCK] button is not pressed while shifting the gear.

We recommend you press the [UNLOCK] button and then shift the gear.

## *PARK engaged*



The message appears on the LCD display, when the P (Park) position is engaged.

**NEUTRAL engaged**

The message appears on the LCD display, when the N (Neutral) position is engaged.

**Good driving practices**

- Never move the shift lever from P (Park) or N (Neutral) to any other position with the accelerator pedal depressed.
- Never move the shift lever into P (Park) when the vehicle is in motion.

Be sure the vehicle is completely stopped before you attempt to shift into R (Reverse) or D (Drive).

- Do not move the shift lever to N (Neutral) when driving. Doing so may result in an accident because of a loss of engine braking and the transmission could be damaged.
- Do not drive with your foot resting on the brake pedal. Even light, but consistent pedal pressure can result in the brakes overheating, brake wear and possibly even brake failure.

- Depressing both accelerator and brake pedals at the same time can trigger logic for engine power reduction to assure vehicle deceleration. Vehicle acceleration will resume after the brake pedal is released.
- When driving in Sports Mode, slow down before shifting to a lower gear. Otherwise, the lower gear may not be engaged if the engine rpms are outside of the allowable range.
- Always apply the parking brake when leaving the vehicle. Do not depend on placing the transmission in P (Park) to keep the vehicle from moving.

- Exercise extreme caution when driving on a slippery surface. Be especially careful when braking, accelerating or shifting gears. On a slippery surface, an abrupt change in vehicle speed can cause the drive wheels to lose traction and may cause loss of vehicle control resulting in an accident.
- Optimum vehicle performance and economy is obtained by smoothly depressing and releasing the accelerator.

### **WARNING**

To reduce the risk of **SERIOUS INJURY** or **DEATH**:

- **ALWAYS** wear your seatbelt. In a collision, an unbelted occupant is significantly more likely to be seriously injured or killed than a properly belted occupant.
- Avoid high speeds when cornering or turning.
- Do not make quick steering wheel movements, such as sharp lane changes or fast, sharp turns.
- The risk of rollover is greatly increased if you lose control of your vehicle at highway speeds.

(Continued)

(Continued)

- Loss of control often occurs if two or more wheels drop off the roadway and the driver over steers to reenter the roadway.
- In the event your vehicle leaves the roadway, do not steer sharply. Instead, slow down before pulling back into the travel lanes.
- Do not attempt sudden or abrupt driving maneuvers on slippery surfaces. Attempting such maneuvers can result in loss of vehicle control and accidents.

### **\* NOTICE**

Kia recommends you follow all posted speed limits.

**\* NOTICE****- Kickdown Mechanism**

Use the kickdown mechanism for maximum acceleration. Depress the accelerator pedal beyond the pressure point. The automatic transmission will shift to a lower gear depending on the engine speed.

**Launch Control*****Launch Control Operation***

- When using Launch Control, a driver should always make sure that the engine's cooling water is warmed up and reaches a recommended temperature.
- To operate ESC Off state 2, Press and hold ESC button for more than 3 seconds in Sports mode. (Status Display on Cluster Screen)
- For launching, stop the vehicle and keep the steering wheel straight.
- Footbrakes, EPB and Auto Hold must be released for smooth launching.



- Press the brake firmly with your left foot in transmission D mode, while pressing the accelerator pedal down fully with your right foot. Then, the Launch Control Ready (1) will be in place.



OCK047157L

- Do not operate both brake and accelerator pedals simultaneously for longer than 4 seconds.
  - When re-using Launch Control, a driver should have the vehicle cool down sufficiently by driving.
- To start a vehicle, with your right foot pressing the accelerator pedal down fully, remove your left foot from the brake. (within 4 seconds) (Launch Control Active (2) Status Display on Cluster Screen)
  - If both the brakes and accelerator pedals were applied and the driver removes his foot only from the accelerator pedal, Launch Control will be automatically deactivated. Or, if the vehicle does not start after 4 seconds with a driver's feet on both brake and accelerator pedals, Launch Control will automatically deactivate as well.

### **Limited use of Launch Control (3)**



OCK047158L

- An warning message will pop up on the screen if the transmission fluid temperature is above a certain level while using Launch Control. Also, Launch Control will be automatically deactivated.
- To address the issue as above, a driver should cool down the transmission fluid temperature by driving the vehicle. (Driving at a constant speed over 37 mph (60 km/h) is highly recommended, but this should only be done if traffic and road conditions permit the driver to do so safely.)

**⚠ WARNING**

It is the responsibility of the driver to make sure it is safe before using Launch Control. Do not use Launch Control on public roads or when pedestrian congestion is present. Doing so could result in an accident that causes serious injuries.

**⚠ CAUTION**

*Constant use of Launch Control can put enormous stress on transmission, engine, and drive shafts and can result in vehicle damage. It is highly recommended that Launch Control is used after completion of the vehicle brake-in process.*

**\* NOTICE**

Launch performance can vary depending on fuel, environment, tire, and loading conditions.



## THE ECO-COASTING SYSTEM (IF EQUIPPED)

When certain conditions are met, the engine is automatically decoupled from the transmission while the shift lever is remained in D (Drive). In this ECO Coasting mode, the engine stays at idling speed to reduce fuel consumption and increase coasting distance. The engine is automatically coupled back again when ECO Coasting deactivation conditions are met. Please refer to ECO Coasting activation and deactivation conditions.

### The Eco-Coasting system setting

The Eco-Coasting system activates if select the Eco-Coasting system from AVN : "Setting → Vehicle → Coasting" (Please refer to AVN manual for more details.)

When the Eco-Coasting system is activated, the message "Coasting" appears at the top center of the cluster.

### CAUTION

- *If the accelerator pedal is pressed quickly for accelerating with the Eco-Coasting system in operation, acceleration may occur after the engagement of the clutch inside the transmission. In turn, the driver may continue to feel acceleration even after the system is turned off.*
- *Driving with the Eco-Coasting system off may be required in some cases since the engine brake is not applied while the Eco-Coasting system is in operation.*
- *Operation the AVN screen to activate or deactivate Eco-Coasting system while driving may be dangerous as the driver's attention is dispersed.*

### Eco-Coasting operation conditions

The Eco-Coasting system is activated when the accelerator pedal is depressed and released under the following conditions.

- When the driving mode is ECO mode.
- When driver acceleration is SMART ECO in SMART mode.
- When the shift lever is in the D (Drive) position.
- When Cruise Control/Smart Cruise Control button is OFF.
- The accelerator or brake pedal is not depressed.
- When the vehicle speed is within the range of 35 mph (55 km/h) to 100 mph (160 km/h).
- If the road gradient is within the range of -5% to +5%.
- In SMART mode, if the distance between the vehicle ahead and the relative speed is within a certain range (if Smart Cruise Control system is equipped)

- \* If the front radar for Smart Cruise Control system cannot operate normally, the inter-vehicle distance and relative speed condition are automatically ignored.
- \* The Eco-Coasting system works after the engine is turned on, the transmission is warmed up, and the engine sensor selfdiagnosis is completed after starting.
- \* Depending on the driving situation, Eco-Coasting operation may be temporarily delayed even if the above conditions are met.

### **The Eco-Coasting system release conditions**

The Eco-Coasting system will be automatically released when the following conditions are met.

- When the drive mode is COMFORT or SPORT mode.
- In SMART mode, when driver acceleration is SMART COMFORT or SMART SPORT.
- When using the paddle shift of the steering wheel.
- When the Cruise Control/Smart Cruise Control button is on (The /CRUISE indicator is on.).
- When pressing the accelerator pedal or brake pedal.
- When the vehicle speed is outside the range of 35 mph (55 km/h) to 100 mph (160 km/h).
- Road inclination is less than -5% or exceeds +5%.
- In SMART mode, if the headway distance to the vehicle ahead is too close of the relative speed changes momentarily (if Smart Cruise Control system is equipped)

- If lane change is predicated in SMART mode (LKA warning by turn signal lamp operation or steering wheel).
- \* It is recommended to turn off the Eco-Coasting system in the driving condition where frequent acceleration or deceleration is repeated.  
Change the drive mode to COMFORT or SPORT mode, or disable Eco-Coasting mode on the AVN screen.



## ALL WHEEL DRIVE (AWD) (IF EQUIPPED)

### Using All Wheel Drive (AWD)

The All Wheel Drive (AWD) System delivers engine power to front and rear wheels for maximum traction. AWD is useful when extra traction is required, such as when driving slippery, muddy, wet, or snow-covered roads.

If the system determines there is a need for four wheel drive, the engine's driving power is distributed to all four wheels automatically.

#### **WARNING**

If the AWD warning light () stays on the instrument cluster, your vehicle may have a malfunction with the AWD system. When the AWD warning light () illuminates, we recommend that the vehicle be checked by an authorized Kia dealer as soon as possible.

#### **WARNING**

To reduce the risk of **SERIOUS INJURY** or **DEATH**:

- Do not drive in conditions that exceed the vehicle's intended design such as challenging off-road conditions.

(Continued)

(Continued)

- Avoid high speeds when cornering or turning.
- Do not make quick steering wheel movements, such as sharp lane changes or fast, sharp turns.
- The risk of a rollover is greatly increased if you lose control of your vehicle at highway speeds.
- Loss of control often occurs if two or more wheels drop off the roadway and the driver over steers to reenter the roadway.
- In the event your vehicle leaves the roadway, do not steer sharply. Instead, slow down before pulling back into the travel lanes.

**\* NOTICE**

- Do not drive in water if the level is higher than the bottom of the vehicle.
- Check your brake condition once you are out of mud or water. Depress the brake pedal several times as you move slowly until you feel normal braking return.
- Shorten your scheduled maintenance interval if you drive in off-road conditions such as sand, mud or water (see "Maintenance Under Severe Usage Conditions" in chapter 7).
- Make sure that AWD vehicle is towed by a flatbed tow truck.

***For safe AWD operation*****Before driving**

- Make sure all passengers are wearing seat belts.
- Sit upright and closer to the steering wheel than usual. Adjust the steering wheel to a position comfortable for you to drive.

**Driving on snow-covered or icy roads**

- Start off slowly by applying the accelerator pedal gently.
- Use snow tires or tire chains.
- Keep sufficient distance between your vehicle and the vehicle in front of you.
- Use engine braking during deceleration.
- Avoid speeding, rapid acceleration, sudden brake applications, and sharp turns to prevent skids.

**Driving in sand or mud**

- Maintain slow and constant speed.
- Use tire chains driving in mud if necessary.
- Keep sufficient distance between your vehicle and the vehicle in front of you.
- Reduce vehicle speed and always check the road condition.
- Avoid speeding, rapid acceleration, sudden brake applications, and sharp turns to prevent getting stuck.

**\* NOTICE**

When the vehicle is stuck in snow, sand or mud, place a non-slip material under the drive wheels to provide traction OR slowly spin the wheels in forward and reverse directions which causes a rocking motion that may free the vehicle. See the Section "Rocking the Vehicle" for more details. However, avoid running the engine continuously at high rpm, which could damage the AWD system.

**\* NOTICE**

- When using Snow Tires, mount them on all four wheels.
- When using Tire Chains, install them on all four tires. However, if you are in a situation to use only two tire chains, install them on the rear tires. In this case, do not drive more than a short distance to prevent damage to the AWD system.
- If tire chains must be used, use AutoSock (fabric snow chain) and install the tire chain after reviewing the instructions provided with the tire chains.

\* For more information on Snow Tires and Tire Chains, refer to "Winter Driving" in this chapter.

**Driving up or down hills**

- Driving uphill
  - Before starting off, check if it is possible to drive uphill.
  - Drive as straight as possible.
- Driving downhill
  - Do not change gear while driving downhill. Select gear before driving downhill.
  - Drive slowly using engine braking while driving downhill.
  - Drive as straight as possible.

**⚠ WARNING**

**Exercise extreme caution driving up or down steep hills. The vehicle's tires could lose traction depending on the grade, terrain and water/mud conditions.**

**Emergency precautions**

*Tires*

**⚠ WARNING**

**Do not use tires and wheels of a different size and type than the ones originally installed on your vehicle. It can affect the safety and performance of your vehicle, which could lead to increased steering difficulty or rollover causing serious injury.**

When replacing the tires, be sure to equip all four tires with the tire and wheel of the same size, type, tread, brand and load-carrying capacity.

In case of emergency such as tire puncture, repair it using TMK (Tire Mobility Kit) for temporary use. Afterwards, have the tire be inspected by an authorized Kia dealer.

**⚠ WARNING**

**Never start or run the engine while an AWD vehicle is raised on a jack. The vehicle can slip or roll off of a jack causing serious injury or death to you or those nearby.**

***Towing***

AWD vehicles must be towed with a wheel lift and dollies or flatbed equipment with all the wheels off the ground. For more information, refer to "Towing" in chapter 6.

***Vehicle inspection***

- When the vehicle is on a car lift, do not operate the front and rear wheels separately. All four wheels should be operated.
- Never engage the parking brake while running the engine on a car lift. This may damage the AWD system.

### ***Dynamometer testing***

An AWD vehicle must be tested on a special four wheel chassis dynamometer.

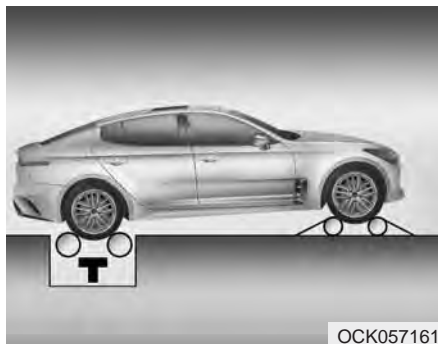

An AWD vehicle should not be tested on a 2WD roll tester. If a 2WD roll tester must be used, perform the following procedure:

1. Check the tire pressures recommended for your vehicle.
2. Place the rear wheels on the roll tester for a speedometer test as shown in the illustration.
3. Release the parking brake.
4. Place the front wheels on the temporary free roller as shown in the illustration.

### **⚠ WARNING**

**Keep away from the front of the vehicle while the vehicle is in gear on the dynamometer. The vehicle can jump forward and cause serious injury or death.**

### **LIMITED SLIP DIFFERENTIAL (LSD) (IF EQUIPPED)**

Limited Slip Differential (LSD) refers to a system equipped with a mechanism that controls the differential functions of the wheels in the Rear-Differential. It allows for an enhancement in handling performance during turning.

Never run wheels with one of them lifted by the jack. It is extremely dangerous for a vehicle equipped with Limited Slip Differential.

Be sure to inject oil for exclusive use of LSD when replacing Rear Differential (for LSD) Oil.

### **\* NOTICE**

There could be slight noises coming from friction plates inside LSD when the LSD-equipped vehicle is turning around, but it is a normal sound in the process of LSD operation and the noises don't indicate vehicle failure.

Oil change is highly recommended in case that the sound becomes louder.

## BRAKE SYSTEM

### Power brakes

Your vehicle has power-assisted brakes that adjust automatically through normal usage.

In the event that the power-assisted brakes lose power because of a stalled engine or some other reason, you can still stop your vehicle by applying greater force to the brake pedal than you normally would. The stopping distance, however, will be longer.

When the engine is not running, the reserve brake power is partially depleted each time the brake pedal is applied. Do not pump the brake pedal when the power assist has been interrupted.

Pump the brake pedal only when necessary to maintain steering control on slippery surfaces.



#### **CAUTION - Brake Pedal**

***Do not drive with your foot resting on the brake pedal. This will create abnormally high brake temperatures which can cause excessive brake lining and pad wear.***



#### **WARNING - Steep hill braking**

**Avoid continuous application of the brakes when descending a long or steep hill by shifting to a lower gear. Continuous brake application will cause the brakes to overheat and could result in a temporary loss of braking performance.**

Wet brakes may impair the vehicle's ability to safely slow down; the vehicle may also pull to one side when the brakes are applied. Applying the brakes lightly will indicate whether they have been affected in this way. Always test your brakes in this fashion after driving through deep water. To dry the brakes, apply them lightly while maintaining a safe forward speed until brake performance returns to normal.



### *In the event of brake failure*

If the service brakes fail to operate while the vehicle is in motion, you can make an emergency stop with the parking brake. The stopping distance, however, will be much greater than normal.

#### **WARNING - Parking brake**

**Avoid applying the parking brake to stop the vehicle while it is moving except in an emergency situation. Applying the parking brake while the vehicle is moving at normal speeds can cause a sudden loss of control of the vehicle. If you must use the parking brake to stop the vehicle, use great caution in applying the brake.**

### *Disc brakes wear indicator*

When your brake pads are worn and new pads are required, you will hear a high-pitched warning sound from your front brakes or rear brakes. You may hear this sound come and go or it may occur whenever you depress the brake pedal.

Please remember that some driving conditions or climates may cause a brake squeal when you first apply (or lightly apply) the brakes. This is normal and does not indicate a problem with your brakes.

Always replace the front or rear brake pads as pairs.

#### **CAUTION - Replace brake pads**

***Do not continue to drive with worn brake pads. Continuing to drive with worn brake pads can damage the braking system and result in costly brake repairs.***

 **WARNING - Brake wear**  
**Do not ignore high pitched wear sounds from your brakes. If you ignore this audible warning, you will eventually lose braking performance, which could lead to a serious accident.**

**Brembo Brake (if equipped)**

It is normal for vehicles equipped with high-performance brakes (Large-diameter Brembo brakes for enhanced braking performance) to generate braking noises.

Also, Circular patterns caused by disc surface friction may occur. These patterns are normal and do not affect braking performance.

 **CAUTION**

***Excessive, high speed, repetitive braking may cause abnormal deformation and wear of parts even if high performance brakes are equipped on the vehicle. This wear can cause vehicle vibration when braking. Drivers should obey speed limits and avoid excessive, high speed, repetitive braking to prevent damage. The limited warranty does not cover damage caused by excessive, high speed, repetitive braking, track driving, racing, or other abuse or misuse of the vehicle.***

**Parking brake – Foot type (if equipped)****Applying the parking brake**

To engage the parking brake, first apply the foot brake and then depress the parking brake pedal down as far as possible.

**⚠ CAUTION - Parking brake**  
*Driving with the parking brake applied will cause excessive brake pad (or lining) and brake rotor wear.*

**Releasing the parking brake**



To release the parking brake, depress the parking brake pedal a second time while applying the foot brake. The pedal will automatically extend to the fully released position.

**⚠ WARNING - Parking brake use**

- Never allow a passenger to touch the parking brake. If the parking brake is released unintentionally, serious injury may occur.
- All vehicles should always have the parking brake fully engaged when parked to avoid inadvertent movement of the vehicles which can injure occupants or pedestrians.



Check the brake warning light by turning the ignition switch ON (do not start the engine). This light will be illuminated when the parking brake is applied with the ignition switch in the START or ON position.

Before driving, be sure the parking brake is fully released and the brake warning light is off.

If the brake warning light remains on after the parking brake is released while the engine is running, there may be a malfunction in the brake system. Immediate attention is necessary.

If at all possible, cease driving the vehicle immediately. If that is not possible, use extreme caution while operating the vehicle and only continue to drive the vehicle until you can reach a safe location or repair shop.

### **Electronic parking brake (EPB) (if equipped)**

#### *Applying the parking brake*

**To apply the EPB (electronic parking brake):**

1. Depress the brake pedal.
2. Pull up the EPB switch.

Make sure the warning light comes on.

Also, the EPB is applied automatically if the Auto Hold button is on when the engine is turned off. However, if you pull up the EPB switch after the engine is turned off, the EPB will not be Applied.

### \* NOTICE

On a steep incline or when pulling a trailer, if the vehicle does not remain at a standstill, do as follows:

1. Apply the EPB.
2. Pull up the EPB switch for more than 3 seconds.

Do not operate the parking brake/EPB while the vehicle is moving except in an emergency situation.

### \* NOTICE

A click or electric brake motor whine sound may be heard while operating or releasing the EPB. These conditions are normal and indicate that the EPB is functioning properly.

### Releasing the parking brake

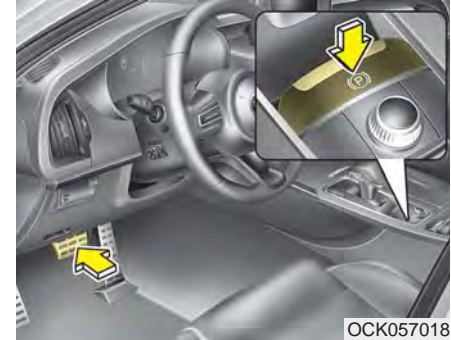

To release the EPB (electronic parking brake), press the EPB switch while doing the following:

- Have the ignition switch or engine start/stop button in the ON position.
  - Depress the brake pedal.
  - The shift lever must be in P (Park).
- Make sure the brake warning light goes off.

To release EPB (electronic parking brake) automatically:

- Shift lever in P (Park)
 

With the engine running depress the brake pedal and shift out of P (Park) to R (Reverse) or D (Drive).
- Shift lever in N (Neutral)
 

With the engine running depress the brake pedal and shift out of N (Neutral) to R (Reverse) or D (Drive).
- Automatic Transmission
  1. Close the driver's door, engine hood and liftgate.
  2. Fasten the driver's seat belt.
  3. Start the engine.
  4. Depress the accelerator pedal while the shift lever is in R (Reverse), D (Drive) or Sports mode.

Make sure the brake warning light goes off.

### \* NOTICE

- For your safety, you can engage the EPB even though the ignition switch or engine stop/start button is in the OFF position, but you cannot release it.
- For your safety, depress the brake pedal and release the parking brake manually with the EPB switch when you drive downhill or when backing up the vehicle.

Do not follow the above procedure when driving on a flat level ground. The vehicle may suddenly move forward.

### \* NOTICE

If the parking brake warning light is still on even though the EPB has been released, have the system checked by an authorized Kia dealer.

### CAUTION

***Do not drive your vehicle with the EPB applied. It may cause excessive brake pad and brake rotor wear.***

EPB (electronic parking brake) may be automatically applied when:

- The EPB is overheated
- Requested by other systems

### \* NOTICE

For EPB (Electronic Parking Brake) equipped vehicles with AUTO HOLD function used while driving, if the ignition button has been turned OFF, the EPB will be engaged automatically. Therefore, AUTO HOLD function should be turned off before the ignition button is turned off.

### System warning



- If you try to drive off depressing the accelerator pedal with the EPB applied, but the EPB doesn't release automatically, a warning will sound and a message will appear.
- If the driver's seat belt is not fastened and the engine hood, driver's door or liftgate is opened, a warning will sound and a message will appear.
- If there is a problem with the vehicle, a warning may sound and a message may appear.

If the above situation occurs, depress the brake pedal and release EPB by pressing the EPB switch.



### **WARNING - Parking Brake Use**

**All vehicles should always have the parking brake fully engaged when parked to avoid inadvertent movement of the car which can injure occupants or pedestrians.**

- A click or electric brake motor whine sound may be heard while operating or releasing the EPB. These conditions are normal and indicate that the EPB is functioning properly.
- When leaving your keys with a parking lot attendant or valet, make sure to inform him/her how to operate the EPB.
- The EPB may malfunction if you drive with the EPB applied.
- When you automatically release EPB by depressing the accelerator pedal, depress it slowly.

**System warning**

When the conversion from Auto Hold to EPB is not working properly, a warning will sound and a message will appear.

**\* NOTICE**

**Depress the brake pedal when the above message appears for the Auto Hold and EPB may not activate.**

**System warning**

If the EPB is applied while Auto Hold is activated because of an ESC (Electronic Stability Control) signal, a warning will sound and a message will appear.

**EPB malfunction indicator (if equipped)**

This warning light illuminates if the engine start/stop button is changed to the ON position and goes off in approximately 3 seconds if the system is operating normally.

If the EPB malfunction indicator remains on, comes on while driving, or does not come on when the ignition switch or the engine start/stop button is changed to the ON position, this indicates that the EPB may have malfunctioned.



If this occurs, have your vehicle checked by an authorized Kia dealer as soon as possible.

The EPB malfunction indicator may illuminate when the ESC indicator comes on to indicate that the ESC is not working properly, but it does not indicate a malfunction of the EPB.

- The EPB warning light may illuminate if the EPB switch operates abnormally. Shut the engine off and turn it on again after a few minutes. The warning light will go off and the EPB switch will operate normally. However, if the EPB warning light is still on, have the system checked by an authorized Kia dealer.
- If the parking brake warning light does not illuminate or blinks even though the EPB switch was pulled up, the EPB is not applied.
- If the parking brake warning light blinks when the EPB warning light is on, press the EPB switch, then pull it up. Once more press it back to its original position and pull it back up. If the EPB warning does not go off, have the system checked by an authorized Kia dealer.

### ***Emergency braking***

If there is a problem with the brake pedal while driving, emergency braking is possible by pulling up and holding the EPB switch. Braking is possible only while you are holding the EPB switch.

#### **WARNING**

**Do not operate the electronic parking brake while the vehicle is moving except in an emergency situation. Applying the electronic parking brake while the vehicle is moving at normal speeds can cause a sudden loss of control of the vehicle. If you must use the electronic parking brake to stop the vehicle, use great caution in applying the brake.**

**\* NOTICE**

During emergency braking by the EPB, the parking brake warning light will illuminate to indicate that the system is operating.

If you notice a continuous noise or burning smell when the EPB is used for emergency braking, have your vehicle checked by an authorized Kia dealer.

***When the EPB (electronic parking brake) is not released***

If the EPB does not release normally, take your vehicle to an authorized Kia dealer by loading the vehicle on a flatbed tow truck and have the system checked.

**AUTO HOLD (if equipped)**

The Auto Hold maintains the vehicle in a standstill even though the brake pedal is not depressed after the driver brings the vehicle to a complete stop by depressing the brake pedal.

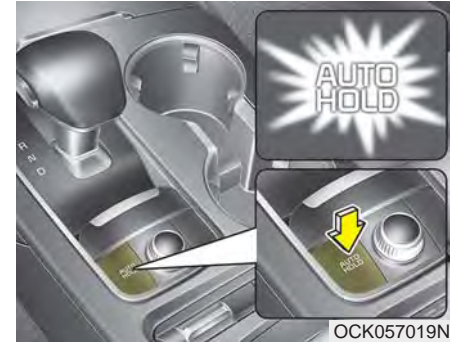

1. Depress the brake pedal, start the engine and then press the AUTO HOLD button. The white AUTO HOLD indicator will come on indicating the system is in standby.

Before the Auto Hold will engage, the driver's door and engine hood must be closed and the driver's seat belt must be fastened.

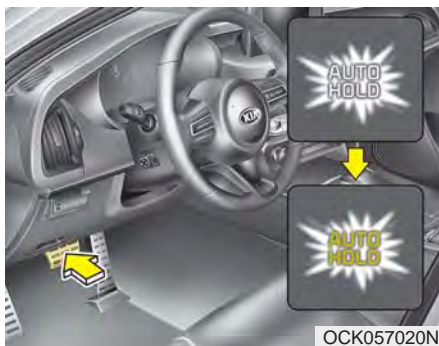

2. When coming to a complete stop by depressing the brake pedal, the AUTO HOLD indicator changes from white to green indicating the AUTO HOLD is engaged. The vehicle will remain at a standstill even if you release the brake pedal.
3. If EPB is applied, Auto Hold will be released.

4. If you press the accelerator pedal with the shift lever in D (Drive) or manual mode, the Auto Hold will be released automatically and the vehicle will start to move. The indicator changes from green to white indicating the Auto Hold is in standby and the EPB is released.

When driving off from Auto Hold by depressing the accelerator pedal, always check the surrounding area near your vehicle.

Slowly depress the accelerator pedal for a smooth launch.

### **Cancel**

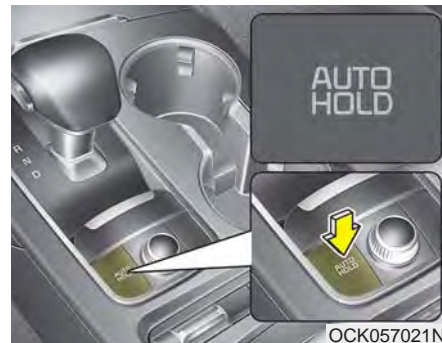

To cancel the AUTO HOLD operation, press the Auto Hold switch. The AUTO HOLD indicator will go out.

To cancel the Auto Hold operation when the vehicle is at a standstill, press the AUTO HOLD switch while depressing the brake pedal.

**\* NOTICE**

- The following are conditions when the Auto Hold will not engage (AUTO HOLD light will not turn green and the Auto Hold system remains in stand by):
  - The driver's seat belt is unfastened and driver's door is opened
  - The engine hood is opened
  - The shift lever is in P (Park) or R (Reverse)
  - The EPB is applied
- For your safety, the Auto Hold automatically switches to EPB under any of the following conditions (AUTO HOLD light remains white and the EPB automatically applies):
  - The driver's seat belt is unfastened and driver's door is opened
  - The engine hood is opened
  - The vehicle is in a standstill for more than 10 minutes
  - The vehicle is standing on a steep slope
  - The vehicle moved for a few seconds

(Continued)

(Continued)

- In these cases, the brake warning light comes on, the AUTO HOLD indicator changes from green to white, and a warning sounds and a message will appear to inform you that EPB has been automatically engaged. Before driving off again, press foot brake pedal, check the surrounding area near your vehicle and release parking brake manually with the EPB switch.
- If the AUTO HOLD indicator lights up yellow, the Auto Hold is not working properly. Take your vehicle to an authorized Kia dealer and have the system checked.

**⚠ WARNING**

To reduce the risk of an accident, do not activate Auto Hold while driving downhill, backing up or parking your vehicle.

If there is a malfunction with the driver's door or engine hood open detection system, the Auto Hold may not work properly.

Take your vehicle to an authorized Kia dealer and have the system checked.

**\* NOTICE**

A click or electric brake motor whine sound may be heard while operating or releasing the EPB, but these conditions are normal and indicate that the EPB is functioning properly.

## Warning messages



When the EPB is applied from Auto Hold, a warning will sound and a message will appear.



When the conversion from Auto Hold to EPB is not working properly a warning will sound and a message will appear.

### \* NOTICE

When this message is displayed, the Auto Hold and EPB may not operate. For your safety, depress the brake pedal.



If you do not apply the brake pedal when you release the Auto Hold by pressing the [AUTO HOLD] switch, a warning will sound and a message will appear.



When you press the [AUTO HOLD] switch, if the driver's door and engine hood are not closed or the driver's seat belt is unfastened, a warning will sound and a message will appear on the LCD display. At this moment, press the [AUTO HOLD] button after closing the driver's door and engine hood and fastening the seat belt.

### Anti-lock brake system (ABS)

ABS (or ESC) will not prevent accidents due to improper or dangerous driving maneuvers. Even though vehicle control is improved during emergency braking, always maintain a safe distance between you and objects ahead. Vehicle speeds should always be reduced during extreme road conditions. The vehicle should be driven at reduced speeds in the following circumstances:

- When driving on rough, gravel or snow-covered roads
- When driving with tire chains installed
- When driving on roads where the road surface is pitted or has different surface heights.

Driving in these conditions increases the stopping distance for your vehicle.

The ABS continuously senses the speed of the wheels. If the wheels are going to lock, the ABS system repeatedly modulates the hydraulic brake pressure to the wheels.

When you apply your brakes under conditions which may lock the wheels, you may hear a “tik-tik” sound from the brakes, or feel a corresponding sensation in the brake pedal. This is normal and it means your ABS is active.

In order to obtain the maximum benefit from your ABS in an emergency situation, do not attempt to modulate your brake pressure and do not try to pump your brakes. Press your brake pedal as hard as possible to allow the ABS to control the force being delivered to the brakes.

### \* NOTICE

**A click sound may be heard in the engine compartment when the vehicle begins to move after the engine is started. These conditions are normal and indicate that the anti-lock brake system is functioning properly.**

- Even with the anti-lock brake system, your vehicle still requires sufficient stopping distance. Always maintain a safe distance from the vehicle in front of you.
- Always slow down when cornering. The anti-lock brake system cannot prevent accidents resulting from excessive speeds.
- On loose or uneven road surfaces, operation of the anti-lock brake system may result in a longer stopping distance than for vehicles equipped with a conventional brake system.

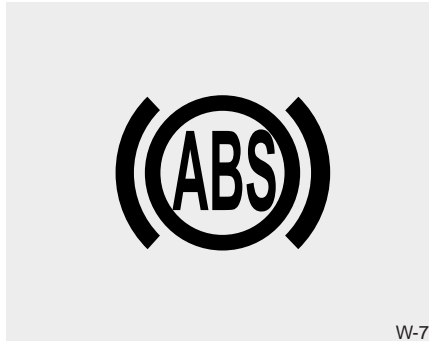

The ABS warning light will stay on for approximately 3 seconds after the ignition switch is ON. During that time, the ABS will go through self-diagnosis and the light will go off if everything is normal. If the light stays on, you may have a problem with your ABS. Contact an authorized Kia dealer as soon as possible.

- When you drive on a road having poor traction, such as an icy road, and have operated your brakes continuously, the ABS will be active continuously and the ABS warning light may illuminate. Pull your vehicle over to a safe place and stop the engine.
- Restart the engine. If the ABS warning light goes off, then your ABS system is normal. Otherwise, you may have a problem with the ABS. Contact an authorized Kia dealer as soon as possible.

### \* NOTICE

**When you jump start your vehicle because of a drained battery, the engine may not run as smoothly and the ABS warning light may turn on at the same time. This happens because of low battery voltage. It does not mean your ABS has malfunctioned.**

- **Do not pump your brakes!**
- **Have the battery recharged before driving the vehicle.**

## Electronic stability control (ESC)

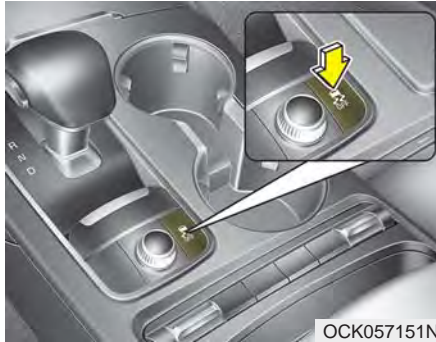

The Electronic Stability Control (ESC) system is designed to stabilize the vehicle during cornering maneuvers. ESC checks where you are steering and where the vehicle is actually going. ESC applies the brakes on individual wheels and intervenes with the engine management system to stabilize the vehicle.

Electronic Stability Control (ESC) will not prevent accidents. Excessive speed in turns, abrupt maneuvers and hydroplaning on wet surfaces can still result in serious accidents. Only a safe and attentive driver can prevent accidents by avoiding maneuvers that cause the vehicle to lose traction. Even with ESC installed, always follow all the normal precautions for driving - including driving at safe speeds for the conditions.

### **⚠ WARNING**

**For maximum protection, always wear your seat belt. No system, no matter how advanced, can compensate for all driver error and/or driving conditions. Always drive responsibly.**

The Electronic Stability Control (ESC) system is an electronic system designed to help the driver maintain vehicle control under adverse conditions. It is not a substitute for safe driving practices. Factors including speed, road conditions and driver steering input can all affect whether ESC will be effective in preventing a loss of control. It is still your responsibility to drive and corner at reasonable speeds and to leave a sufficient margin of safety.

When you apply your brakes under conditions which may lock the wheels, you may hear a “tik-tik” sound from the brakes, or feel a corresponding sensation in the brake pedal. This is normal and it means your ESC is active.

### **\* NOTICE**

**A click sound may be heard in the engine compartment when the vehicle begins to move after the engine is started. These conditions are normal and indicate that the Electronic Stability Control System is functioning properly.**



## **ESC operation**

### **ESC ON condition**

- • When the ignition is turned ON, ESC and ESC OFF indicator lights illuminate for approximately 3 seconds, then ESC is turned on.
- Press the ESC OFF button for at least half a second after turning the ignition ON to turn ESC off. (ESC OFF indicator will illuminate). To turn the ESC on, press the ESC OFF button (ESC OFF indicator light will go off).
- When starting the engine, you may hear a slight ticking sound. This is the ESC performing an automatic system self-check and does not indicate a problem.

### **When operating**



When the ESC is in operation, the ESC indicator light blinks.

- When the Electronic Stability Control is operating properly, you can feel a slight pulsation in the vehicle. This is only the effect of brake control and indicates nothing unusual.
- When moving out of the mud or driving on a slippery road, pressing the accelerator pedal may not cause the engine rpm (revolutions per minute) to increase.

### **ESC operation off**

#### **ESC OFF state**





There are 2 types of ESC OFF states; Traction Control disabled and Traction & Stability Control disabled.

If the ignition is turned off when ESC is off, ESC remains off.

Upon restarting the engine, the ESC will automatically turn on again.



### • ESC off state 1



To cancel ESC operation, press the ESC OFF button (ESC OFF ) shortly (ESC OFF indicator light (ESC OFF ) illuminates). At this state, the engine control function does not operate. It means the traction control function does not operate. Brake control function only operates.

### • ESC off state 2



To cancel ESC operation, press the ESC OFF button (ESC OFF ) for more than 3 seconds. ESC OFF indicator light (ESC OFF ) illuminates and ESC OFF warning chime will sound. At this state, the engine control function and brake control function do not operate. It means the car stability control function does not operate any more.

### Indicator light

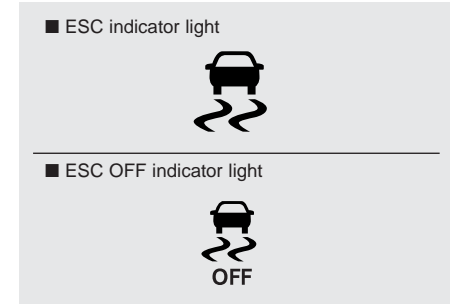

When ignition switch is turned to ON, the indicator light illuminates, then goes off if the ESC system is operating normally.

The ESC indicator light blinks whenever ESC is operating or illuminates when ESC fails to operate.

The ESC OFF indicator light comes on when the ESC is turned off with the button.

**⚠ WARNING - Electronic stability control**

Drive carefully even though your vehicle has Electronic Stability Control. It can only assist you in maintaining control under certain circumstances.

**ESC OFF usage**

**When driving**

- ESC should be turned on for daily driving whenever possible.
- To turn ESC off while driving, press the ESC OFF button while driving on a flat road surface.

**⚠ WARNING - Operating ESC**

Never press the ESC OFF button while ESC is operating (ESC indicator light blinks).

If ESC is turned off while ESC is operating, the vehicle may slip out of control.

**\* NOTICE**

- When operating the vehicle on a dynamometer, ensure that the ESC is turned off (ESC OFF light illuminated). If the ESC is left on, it may prevent the vehicle speed from increasing, and result in false diagnosis.
- Turning the ESC off does not affect ABS or brake system operation.

## Vehicle stability management (VSM)

This system provides further enhancements to vehicle stability and steering responses when a vehicle is driving on a slippery road or a vehicle detects changes in coefficient of friction between right wheels and left wheels when braking.

### **WARNING - Tire/ Wheel size**

**When replacing tires and wheels, make sure they are the same size as the original tires and wheels installed. Driving with varying tire or wheel sizes may diminish any supplemental safety benefits of the VSM system.**

### *VSM operation*

When the VSM is in operation, ESC indicator light () blinks.

When the vehicle stability management is operating properly, you can feel a slight pulsation in the vehicle and/or abnormal steering responses (EPS- Electronic Power Steering). This is only the effect of brake and EPS control and indicates nothing unusual.

### **The VSM does not operate when:**

- Driving on a sloping road such as a gradient or incline
- Driving in reverse
- ESC OFF indicator light () remains on the instrument cluster
- EPS indicator light remains on the instrument cluster

### *VSM operation off*

If you press the ESC OFF button to turn off the ESC, the VSM will also cancel and the ESC OFF indicator light () illuminates.

To turn on the VSM, press the button again. The ESC OFF indicator light goes out.

### **WARNING - Vehicle stability management**

**Drive carefully even though your vehicle has Vehicle stability management. It can only assist you in maintaining control under certain circumstances.**

### **Malfunction indicator**

The VSM can be deactivated even if you don't cancel the VSM operation by pressing the ESC OFF button. It indicates that a malfunction has been detected somewhere in the Electric Power Steering system or VSM system. If the ESC indicator light (  ) or EPS warning light remains on, take your vehicle to an authorized Kia dealer and have the system checked.

### **\* NOTICE**

- The VSM is designed to function above approximately 13 mph (22 km/h) on curves.
- The VSM is designed to function above approximately 6 mph (10 km/h) when a vehicle is braking on a split-mu surface. A split-mu surface is made of two surfaces which have different friction forces.

- The Vehicle Stability Management system is not a substitute for safe driving practices but a supplementary function only. It is the responsibility of the driver to always check the speed and the distance to the vehicle ahead. Always hold the steering wheel firmly while driving.
- Your vehicle is designed to activate according to the driver's intention, even with installed VSM. Always follow all the normal precautions for driving at safe speeds for the conditions - including driving in inclement weather and on a slippery road.

### **WARNING**

**For maximum protection, always wear your seat belt. No system, no matter how advanced, can compensate for all driver error and/or driving conditions. Always drive responsibly.**

### **Hill-start assist control (HAC)**

A vehicle has the tendency to roll back on a steep hill when it starts to go after stopping. The Hill-start Assist Control (HAC) prevents the vehicle from rolling back by applying the brakes automatically for about 2 seconds. The brakes are released when the accelerator pedal is depressed or after about 2 seconds.

The HAC is activated only for about 2 seconds, so when the vehicle is starting off always depress the accelerator pedal.

**⚠ WARNING - Maintaining  
Brake Pressure on Incline**

**HAC does not replace the need to apply brakes while stopped on an incline. While stopped, make sure you maintain brake pressure sufficient to prevent your vehicle from rolling backward and causing an accident. Don't release the brake pedal until you are ready to accelerate forward.**

### Good braking practices

- Check to be sure the parking brake is not engaged and the parking brake indicator light is out before driving away.
- Driving through water may get the brakes wet. They can also get wet when the vehicle is washed. Wet brakes can be dangerous! Your vehicle will not stop as quickly if the brakes are wet. Wet brakes may cause the vehicle to pull to one side. To dry the brakes, apply the brakes lightly until the braking action returns to normal, taking care to keep the vehicle under control at all times. If the braking action does not return to normal, stop as soon as it is safe to do so and call an authorized Kia dealer for assistance.
- Don't coast down hills with the vehicle out of gear. This is extremely hazardous. Keep the vehicle in gear at all times, use the brakes to slow down, then shift to a lower gear so that engine braking will help you maintain a safe speed.

- Don't "ride" the brake pedal. Resting your foot on the brake pedal while driving can be dangerous because the brakes might overheat and lose their effectiveness. It also increases the wear of the brake components.
- If a tire goes flat while you are driving, apply the brakes gently and keep the vehicle pointed straight ahead while you slow down. When you are moving slowly enough for it to be safe to do so, pull off the road and stop in a safe place.
- If your vehicle is equipped with an Automatic Transmission, don't let your vehicle creep forward. To avoid creeping forward, keep your foot firmly on the brake pedal when the vehicle is stopped.

- Be cautious when parking on a hill. Firmly engage the parking brake and place the shift lever in P (automatic transmission). If your vehicle is facing downhill, turn the front wheels into the curb to help keep the vehicle from rolling.  
If your vehicle is facing uphill, turn the front wheels away from the curb to help keep the vehicle from rolling. If there is no curb or if it is required by other conditions to keep the vehicle from rolling, block the wheels.
- Under some conditions your parking brake can freeze in the engaged position. This is most likely to happen when there is an accumulation of snow or ice around or near the rear brakes or if the brakes are wet. If there is a risk that the parking brake may freeze, apply it only temporarily while you put the shift lever in P (automatic transmission) and block the rear wheels so the vehicle cannot roll. Then release the parking brake.
- Do not hold the vehicle on an incline with the accelerator pedal. This can cause the transmission to overheat. Always use the brake pedal or parking brake.

## FORWARD COLLISION-AVOIDANCE ASSIST (FCA) SYSTEM (IF EQUIPPED)

FCA system is designed to detect and monitor a vehicle ahead or detect a pedestrian in the roadway through radar signals and camera recognition to warn the driver that a collision is imminent, and if necessary, apply emergency braking.

### **WARNING - Forward Collision-Avoidance Assist (FCA) Limitations**

FCA system is a supplemental system and is not a substitute for safe driving practices. It is the responsibility of the driver to always check the speed and distance to the vehicle ahead and to be prepared to apply the brakes.

### **WARNING**

Take the following precautions when using Forward Collision-Avoidance Assist (FCA) system:

- This system is only a supplemental system and it is not intended to, nor does it replace the need for extreme care and attention of the driver. The sensing range and objects detectable by the sensors are limited. Pay attention to the road conditions at all times.
- NEVER drive too fast in accordance with the road conditions or while cornering.
- Always drive cautiously to prevent unexpected and sudden situations from occurring. FCA does not stop the vehicle completely and does not avoid collisions.

## System setting and activation

### *System setting*

The driver can activate FCA by placing the ignition switch to the ON position and by selecting 'User Settings', 'Driver Assistance', and 'Forward Collision-Avoidance Assist'. FCA deactivates, when the driver cancels the system setting.





The warning light illuminates on the LCD display, when you cancel FCA system. The driver can monitor the FCA ON/OFF status on the LCD display. Also, the warning light illuminates when the ESC(Electronic Stability Control) is turned off (Traction & Stability control disabled.). When the warning light remains ON with FCA activated, have the system checked by an authorized Kia dealer.

The driver can select the initial warning activation time in the User Settings in the instrument cluster LCD display. The options for the initial Forward Collision Warning include the following:

- EARLY - When this condition is selected, the initial Forward Collision Warning is activated earlier than normal. This setting maximizes the amount of distance between the vehicle or pedestrian ahead before the initial warning occurs. If the 'EARLY' condition feels too sensitive, change it into 'NORMAL'.
- LATE - When this condition is selected, the initial Forward Collision Warning is activated later than normal. This setting reduces the amount of distance between the vehicle or pedestrian ahead before the initial warning occurs. Select this condition only when traffic is light, and you are driving slowly.
- NORMAL - When this condition is selected, the initial Forward Collision Warning is activated normally. This setting allows for a smaller amount of distance between the vehicle or pedestrian ahead before the initial warning occurs than EARLY mode.

**Prerequisite for activation**

FCA will activate when FCA is selected on the LCD display, and when the following prerequisites are satisfied:

- The ESC (Electronic Stability Control) is activated.
- The driving speed is over 6 mph (10 km/h). (FCA only works within a certain range of vehicle speeds)
- When FCA recognizes a vehicle or the pedestrian in front. (FCA may not recognize every obstacle or provide warnings and braking in every situation, so do not rely on FCA to stop the vehicle in instances where the driver sees an obstacle and has the ability to apply the brakes)

**WARNING**

**To avoid driver distractions, do not attempt to set or cancel FCA while operating the vehicle.**

- FCA automatically activates upon placing the ignition switch to the ON position. The driver can deactivate FCA by canceling the system setting on the LCD display.
- FCA automatically deactivates upon canceling the ESC. When the ESC is canceled, FCA cannot be activated on the LCD display.  
In this situation, FCA warning light will illuminate.
- FCA may not operate properly according to the frontal situation, the direction of pedestrian speed.
- If you select “Warning only”, FCA system activates and produces only warning alarms in accordance with the collision risk levels.

## FCA warning message and system control

FCA system produces warning messages, warning alarms, and emergency braking based on the level of risk of a frontal collision, such as when a vehicle ahead suddenly brakes, or when the system detects that a collision with a pedestrian is imminent.

### *Collision Warning (1st warning)*



- The warning message appears on the LCD display with the warning alarms.
- FCA controls the brakes within certain limit to reduce the impact from the collision.
- If you select “Warning only”, FCA system activates and produces only warning alarms in accordance with the collision risk levels. You should control the brake directly because FCA system do not control the brake.

### *Emergency braking (2nd warning)*



- The warning message appears on the LCD display with the warning alarms.
- FCA controls the brakes within certain limit to reduce the impact from the collision.
- FCA controls the maximum brakes just before the collision.
- If you select “Warning only”, FCA system activates and produces only warning alarms in accordance with the collision risk levels. You should control the brake directly because FCA system do not control the brake.

## Brake operation

- In an urgent situation, the braking system enters into the ready status for prompt reaction against the driver's depressing the brake pedal.
- FCA provides additional braking power for optimum braking performance when the driver depresses the brake pedal.
- The braking control is automatically deactivated, when the driver sharply depresses the accelerator pedal, or when the driver abruptly operates the steering wheel.
- The braking control is automatically canceled when risk factors disappear.

### CAUTION

*The driver should always exercise caution when operating the vehicle, even though there is no warning message or warning alarm. While other beeps such as the seat belt warning sound are in operation and override FCA alarming system, FCA beeps may not occur.*

### WARNING

**FCA is a supplemental system and cannot completely stop the vehicle in all situations or avoid all collisions. It is the responsibility of the driver to safely drive and control the vehicle.**

### WARNING

**Never deliberately drive dangerously to activate the system as such conduct increases the risk of an accident.**

## \* NOTICE

FCA system assesses the risk of a collision by monitoring several variables such as the distance to the vehicle/pedestrian ahead, the speed of the vehicle/pedestrian ahead, and the driver's operation of the vehicle. Certain conditions such as inclement weather and road conditions may affect the operation of FCA system.

## FCA sensor (Front Camera/Front Radar)



In order for FCA system to operate properly, always make sure the sensor or sensor cover is clean and free of dirt, snow, and debris.

Dirt, snow, or foreign substances on the lens may adversely affect the sensing performance of the sensor.

### \* NOTICE

- Do not install any accessories, such as a license plate bracket or bumper sticker near the sensor area. Do not replace the bumper by yourself. Doing so may adversely affect the sensing performance.
- Always keep the sensor/bumper area clean.
- Use only a soft cloth to wash the vehicle. Also, do not spray highly pressurized water on the sensor installed on the bumper.
- Be careful not to apply unnecessary force on the frontal sensor area. When the sensor moves out of the correct position due to external force, the system may not operate correctly and may not provide a warning light or message. In this case, we recommend you have the vehicle inspected by an authorized Kia dealer.

(Continued)

(Continued)

- Use only the genuine Kia sensor cover. Do not arbitrarily apply paint on the sensor cover.
- Do not tint the window or install stickers, or accessories around the inside mirror where the camera is installed.
- Make sure the frontal camera installation point does not get wet.
- Do not impact or arbitrarily remove any radar/camera components.
- Do not place reflective objects(white paper or mirror etc.) on the dashboard. The system may activate unnecessarily due to reflection of the sunlight.
- Excessive audio system volume may prevent occupants from hearing FCA system warning alarm.
- If the front bumper becomes damaged in the area around the radar sensor, FCA system may not operate properly. We recommend you have the vehicle inspected by authorized Kia dealer.

### Warning message and warning light



When the sensor is covered or the sensor lens is dirty with foreign substances, such as snow or rain, FCA system may not be able to detect vehicles or pedestrians. In this case, a warning message ("Forward Collision Avoidance Assist (FCA) system disabled. Radar blocked") will appear to notify the driver. Remove the foreign substances to allow FCA system to function.

Remove any dirt, snow, or debris and clean the radar sensor cover before operating FCA system.

FCA may not properly operate in an area (e.g. open terrain), where any substances are not detected after turning ON the engine.

Even if this warning does not occur, the system may not operate.

FCA system may not activate according to the road conditions, inclement weather, driving conditions or traffic conditions.

### System malfunction



- When FCA is not working properly, FCA warning light (🚨) will illuminate and the warning message will appear for a few seconds. After the message disappears, the master warning light (⚠️) will illuminate. In this case, have the vehicle inspected by an authorized Kia dealer.
- FCA warning message may appear along with the illumination of the ESC warning light.

**⚠ WARNING**

**FCA is only a supplemental system for the driver's convenience.**

**It is the driver's responsibility to control the vehicle. Do not solely depend on FCA system. Rather, maintain a safe braking distance, and, if necessary, depress the brake pedal to lower the driving speed.**

- Due to sensing limitation, FCA may not produce warning messages or warning alarms in certain situations. Read the section "Limitation of the system" for more information.
- When there is a malfunction with FCA, the automatic braking control does not operate even with other braking systems normally operating.

- FCA only recognizes vehicles and pedestrians in front of it while driving forward. It does not identify any animals or vehicles in the opposite direction.
- FCA can not recognize cross-traffic or parked vehicles presenting a sideprofile.
- FCA system may not activate if the driver applies the brake pedal to avoid the risk of a collision.
- FCA system does not operate when the vehicle is in reverse. In these cases, you must maintain a safe braking distance, and if necessary, depress the brake pedal to reduce the driving speed.
- FCA system does not always operate against all vehicles or pedestrians.

**Limitation of the system**

FCA system is designed to monitor the vehicle ahead or a pedestrian on the roadway through radar signals and camera recognition to warn the driver that a collision is imminent, and if necessary, apply emergency braking. In certain situations, the radar sensor or the camera may not be able to detect the vehicle or pedestrian ahead. In these cases, FCA system may not operate. The driver must pay careful attention in the following situations where FCA operation may be limited:

### ***Recognizing vehicles***

#### **The sensor may be limited when:**

- The radar or the camera is contaminated with foreign substances.
- It heavily rains or snows.
- There is electromagnetic interference.
- Something in the path of travel deflects the radar waves.
- The vehicle in front has a narrow body. (i.e. motor cycle and bicycle)
- The driver's view is not clear due to backlight, reflected light, or darkness.
- The camera cannot contain the full image of the vehicle in front.
- The vehicle in front is a special vehicle, such as a heavily-loaded truck or a trailer.
- The outside brightness is greatly changed, such as entering/exiting a tunnel.
- The vehicle driving is on a rough or bumpy road.
- The radar/camera sensor recognition is limited.
- The vehicle in front is driving erratically
- The vehicle is driven near areas containing metal substances such as a construction zone, railroad, etc.
- Moisture on the windshield is not completely removed or frozen.
- The weather is misty.
- The vehicle in front does not turn ON the rear lights, does not have rear lights, has asymmetric rear lights, or has rear lights out of angle.
- The vehicle is on unpaved or uneven rough surfaces, or roads with sudden gradient changes.
- The vehicle is moving under ground level or inside a building.
- If a sudden change in the sensor recognition takes place while driving over a speed bump,
- When the vehicle is severely shaken,
- When driving around a circular intersection with a vehicle or object in front.
- If the front of the camera lens is contaminated by front glass tinting, film, water repellent coating, damage on glass, or foreign matter (sticker, insect, etc.)
- The radar or camera or camera lens is damaged.
- If the headlights of the vehicle are not used at night or in a tunnel section, or the light is too weak
- If street light or the light of a vehicle coming from the opposite direction is reflected or when sunlight is reflected by water on the road surface
- When the back light is projected in the direction of the vehicle's motion (including the headlights of vehicles)
- Road sign, shadow on the road, tunnel entrance, toll gate, partial pavement



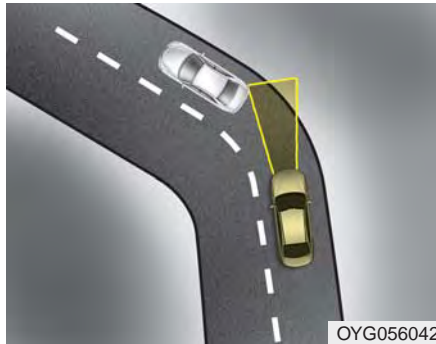

### - Driving on a curve

FCA performance may be limited while driving on a curve. FCA may not recognize the vehicle in front even if in the same lane. It may produce the warning message and the warning alarm prematurely, or it may not produce the warning message or the warning alarm at all. When driving on a curve, exercise caution, maintain a safe braking distance, and if necessary, depress the brake pedal to reduce your driving speed in order to maintain a safe distance.

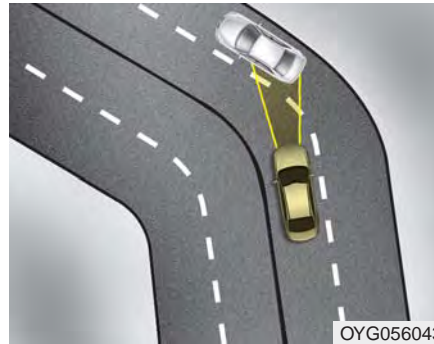

FCA system may recognize a vehicle in an adjacent lane when driving on a curved road. In this case, the system may apply the brake. Always pay attention to road and driving conditions while driving. If necessary, depress the brake pedal to reduce your driving speed in order to maintain a safe distance. Also, when necessary, you may depress the accelerator pedal to prevent the system from unnecessarily decelerating your vehicle. Always check the traffic conditions around the vehicle.

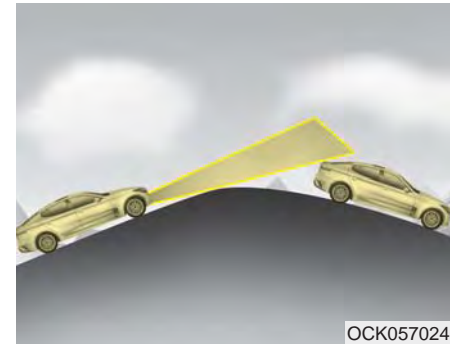

### - Driving on a slope

FCA performance may be limited while driving upward or downward on a slope, and may not recognize a vehicle in front in the same lane. It may produce the warning message and the warning alarm prematurely, or it may not produce the warning message and the warning alarm at all.

When FCA suddenly recognizes the vehicle in front while passing over a slope, you may experience sharp deceleration.

Always keep your eyes forward while driving upward or downward on a slope, and, if necessary, depress the brake pedal to reduce your driving speed in order to maintain a safe distance.

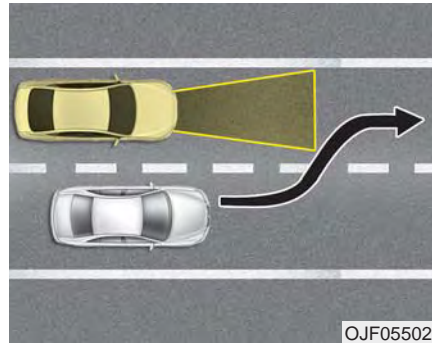

#### - Changing lanes

When a vehicle changes lanes in front of you, the FCA system may not immediately detect the vehicle, especially if the vehicle changes lanes abruptly. In this case, you must maintain a safe braking distance, and if necessary, depress the brake pedal to reduce your driving speed in order to maintain a safe distance.

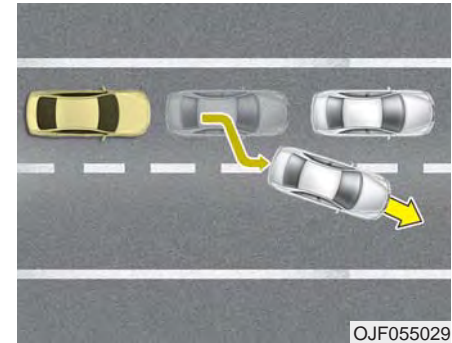

When driving in stop-and-go traffic, and a stopped vehicle in front of you merges out of the lane, the FCA system may not immediately detect the new vehicle that is now in front of you. In this case, you must maintain a safe braking distance, and if necessary, depress the brake pedal to reduce your driving speed in order to maintain a safe distance.

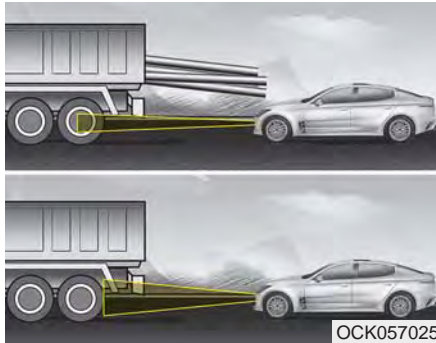

### - Recognizing the vehicle

If the vehicle in front of you has cargo that extends rearward from the cab, or when the vehicle in front of you has higher ground clearance, additional special attention is required. FCA system may not be able to recognize the cargo extending from the vehicle. In these instances, you must maintain a safe braking distance from the rearmost object, and if necessary, depress the brake pedal to reduce your driving speed in order to maintain distance.

## **Recognizing pedestrians**

### **The sensor may be limited when:**

- The pedestrian is not fully detected by the camera recognition system, for example, if the pedestrian is leaning over or is not fully walking upright
- The pedestrian is moving very quickly or appears abruptly in the camera detection area
- The pedestrian is wearing clothing that easily blends into the background, making it difficult to be detected by the camera recognition system
- The outside lighting is too bright (e.g. when driving in bright sunlight or in sun glare) or too dark (e.g. when driving on a dark rural road at night)

- There is an item similar to a person's body structure
- The pedestrian is small
- The pedestrian has impaired mobility
- The sensor recognition is limited
- It is difficult to detect and distinguish the pedestrian from other objects in the surroundings, for example, when there is a group of pedestrians or a large crowd
- If a sudden change in the sensor recognition takes place while driving over a speed bump,
- When the vehicle is severely shaken,
- When driving around circular intersection,
- If the front of the camera lens is contaminated by front glass tinting, film, water repellent coating, damage on glass, or foreign matter (sticker, insect, etc.)
- The camera or camera lens or radar is damaged.

- If the headlights of the vehicle are not used at night or in a tunnel section, or the light is too weak
- If street light or the light of a vehicle coming from the opposite direction is reflected or when sunlight is reflected by the water on the road surface
- When the back light is projected in the direction of the vehicle's motion (including the headlights of vehicles)
- Road sign, shadow on the road, tunnel entrance, toll gate, partial pavement
- If the moist on the front windshield is not entirely removed or it is frozen
- The weather is foggy
- The radar/camera sensor recognition is limited.
- In case of a large number of pedestrians are gathered.

** WARNING**

**FCA cannot avoid all collisions. FCA might not completely stop the vehicle before a collision, due to ambient weather and road conditions. The driver has the responsibility to drive safely and control the vehicle.**

** WARNING**

**Never try to test the operation of FCA system. Doing so may cause severe injury or death.**

** WARNING**

- Do not use FCA system when towing a vehicle. Cancel the FCA in the User Settings on the LCD display before towing. Brake application by FCA system while towing may adversely affect your safety.
- Use extreme caution when the vehicle in front of you has cargo that extends rearward from the cab, or when the vehicle in front of you has higher ground clearance.
- FCA system is designed to detect and monitor the vehicle ahead or detect a pedestrian in the roadway through radar signals and camera recognition. It is not designed to detect bicycles, motorcycles, or smaller wheeled objects such as luggage bags, shopping carts, or strollers.

### **\* NOTICE**

**In some instances, FCA system may be canceled when subjected to electromagnetic interference.**

- When replacing or reinstalling the windshield, front bumper or radar/camera after removal, have the vehicle inspected by an authorized Kia dealer.

## CRUISE CONTROL SYSTEM (IF EQUIPPED)



OOCK057027L

The cruise control system allows you to program the vehicle to maintain a constant speed without depressing the accelerator pedal.

This system is designed to function above approximately 20 mph (30 km/h).

- If the cruise control is left on, (cruise indicator light is illuminated), the cruise control can be switched on accidentally. Keep the cruise control system off when the cruise control is not in use, to avoid inadvertently setting a speed.
- Use the cruise control system only when traveling on open highways in good weather.
- Do not use the cruise control when it may not be safe to keep the vehicle at a constant speed, for instance, driving in heavy or varying traffic, or on slippery (rainy, icy or snow-covered) or winding roads or over 6% up-hill or down-hill roads.
- Pay particular attention to the driving conditions whenever using the cruise control system.
- Be careful when driving downhill using the cruise control system, which may increase the vehicle speed.

### \* NOTICE

- During normal cruise control operation, when the SET switch is activated or reactivated after applying the brakes, the cruise control will activate after approximately 3 seconds. This delay is normal.
- To activate cruise control, depress the brake pedal at least once after turning the ignition switch to the ON position or starting the engine.

### **⚠ WARNING - Misuse of Cruise Control**

**Do not use cruise control if the traffic situation does not allow you to drive safely at a constant speed and with sufficient distance to the vehicle in front.**

### To set cruise control speed:



OCK057028L

1. Press the CRUISE button on the steering wheel to turn the system on. The CRUISE indicator light in the instrument cluster will illuminate.
2. Accelerate to the desired speed, which must be more than 20 mph (30 km/h).



OCK057033L

3. Move the lever down (to SET-), and release it at the desired speed. The cruise indicator and set speed on the LCD screen will illuminate. Release the accelerator at the same time. The desired speed will automatically be maintained.

*On a steep grade, the vehicle may slow down slightly when driving uphill or speed up slightly while going downhill.*

### To increase cruise control set speed:



OCK057034L

Follow either of these procedures:

- Move the lever up (to RES+) and hold it. Your vehicle set speed will increase by 5 mph (10 km/h). Release the lever at the speed you want.
- Move the lever up (to RES+) and release it immediately. The cruising speed will increase by 1.0 mph (1 km/h) each time the lever is operated in this manner.

### To decrease the cruising speed:



Follow either of these procedures:

- Move the lever down (to SET-) and hold it. Your vehicle set speed will decrease by 5 mph (10 km/h). Release the lever at the speed you want.
- Move the lever down (to SET-) and release it immediately. The cruising speed will decrease by 1.0 mph (1 km/h) each time the lever is operated in this manner.

### To temporarily accelerate with the cruise control on:

If you want to speed up temporarily when the cruise control is on, depress the accelerator pedal. Increased speed will not interfere with the cruise control operation or change the set speed.

To return to the set speed, take your foot off the accelerator.

### To cancel cruise control, do one of the following:



- Depress the brake pedal.
- Shift into N (Neutral) with an Automatic transmission.
- Press the CANCEL switch.
- Decrease the vehicle speed lower than the set speed by 12 mph (20 km/h).
- Decrease the vehicle speed to less than approximately 15 mph (25 km/h).



Each of these actions will cancel cruise control operation (The set speed on the LCD will disappear and the CRUISE indicator will illuminate continuously.), but it will not turn the system off. If you wish to resume cruise control operation, move the lever up (to RES+). You will return to your previously preset speed.

**To resume cruising speed at more than approximately 20 mph (30 km/h):**



If any method other than the CRUISE ON-OFF switch was used to cancel cruising speed and the system is still activated, the most recent set speed will automatically resume when you move the lever up.

It will not resume, however, if the vehicle speed has dropped below approximately 20 mph (30 km/h).

**To turn cruise control off, do one of the following:**



- Press the CRUISE button (the CRUISE indicator light in the instrument cluster will go off).
- Turn the ignition off.

*Both of these actions will cancel the cruise control operation. If you want to resume the cruise control operation, repeat the steps provided in "To set cruise control speed" on the previous page.*

## SMART CRUISE CONTROL WITH STOP & GO SYSTEM (IF EQUIPPED)



- ① Cruise indicator
- ② Set speed
- ③ Vehicle-to-vehicle distance

Smart Cruise Control system allows you to program the vehicle to maintain a constant speed and a predetermined distance to the vehicle ahead without depressing the accelerator or brake pedal.

### **⚠ WARNING**

- Smart Cruise Control system Inadvertent Activation

If Smart Cruise Control system is left on (CRUISE indicator in the instrument cluster illuminated), it can be activated inadvertently. Keep Smart Cruise Control system off (CRUISE indicator off) when Smart Cruise Control system is not in use to avoid setting a speed which the driver is not aware of.

### **⚠ WARNING**

- Smart Cruise Control system Limitations

- Smart Cruise Control system is a supplemental system and is not a substitute for safe driving practices. It is the responsibility of the driver to always check the speed and distance to the vehicle ahead.
- Use Smart Cruise Control system only when traveling on open highways in good weather.
- Do not use Smart Cruise Control system when it may not be safe to keep the car at a constant speed. For instance.
  - Highway interchange and tollgate
  - Road surrounded by multiple steel constructions (subway construction, steel tunnel, etc)

(Continued)

**(Continued)**

- Parking lot
- Lanes beside guard rail on a road
- Slippery road with rain, ice, or snow
- Abrupt curved road
- Steep hills
- Windy roads
- Off roads
- Roads under construction
- Rumble strip
- When driving near crash barriers
- When driving on a sharp curve
- When the vehicle sensing ability decreases due to vehicle modification resulting level difference of the vehicle's front and rear

**(Continued)**

**(Continued)**

- When driving in heavy traffic or when traffic conditions make it difficult to drive at a constant speed
- Limited visibility (rain, snow, smog, etc.)
- Smart Cruise Control system cannot recognize a stopped vehicle, pedestrians or an oncoming vehicle. Always look ahead cautiously to prevent unexpected and sudden situations from occurring.
- Pay particular attention to the driving conditions whenever using Smart Cruise Control system.
- Be careful when driving downhill using the SCC.
- Cruise function should not be used when the vehicle is being towed to prevent any damage.

**(Continued)**

**(Continued)**

- Always set the vehicle speed under the speed limit.
- Always pay continuous attention to road and driving even when Smart Cruise Control system is being operated.

### Smart Cruise Control switch

**CANCEL** : Cancels cruise control operation.

**CRUISE** : Turns cruise control system on or off.

**RES +** : Resumes or increases cruise control speed.

**SET -** : Sets or decreases cruise control speed.

 : Sets vehicle-to-vehicle distance

### Speed setting

*To set Smart Cruise Control Speed:*



1. Press the CRUISE button to turn the system on. The CRUISE indicator in the instrument cluster will illuminate.
2. Accelerate to the desired speed.
  - 20 mph (30 km/h) ~ 120 mph (200 km/h) : when there is no vehicle in front
  - 0 mph (0 km/h) ~ 120 mph (200 km/h) : when there is a vehicle in front



3. Move the lever down (to SET-), and release it at the desired speed. The set speed and vehicle to vehicle distance on the LCD screen will illuminate.
4. Release the accelerator pedal. The desired speed will automatically be maintained.

*If there is a vehicle in front of you, the speed may decrease to maintain the distance to the vehicle ahead.*

*On a steep grade, the vehicle may slow down or speed up slightly while going uphill or downhill.*

Vehicle speed may decrease on an upward slope and increase on a downward slope.

The speed will be set to 20 mph (30 km/h) when there is a vehicle ahead and your vehicle speed is 0 ~ 20 mph (0 ~ 30 km/h).

### ***To increase cruise control set speed:***



Follow either of these procedures:

- Move the lever up (to RES+), and hold it. Your vehicle set speed will increase by 5 mph (10 km/h). Release the lever at the speed you want.
- Move the lever up (to RES+), and release it immediately. The cruising speed will increase by 1 mph (1.0 km/h) each time you move the lever up (to RES+) in this manner.
- Smart Cruise Control system will operate to a maximum setting of 120 mph (200 km/h). However all local speed limit laws must be followed.

### ***To decrease the cruise control set speed:***



Follow either of these procedures:

- Move the lever down (to SET-), and hold it. Your vehicle set speed will decrease by 5 mph (10 km/h). Release the lever at the speed you want.
- Move the lever down (to SET-), and release it immediately. The cruising speed will decrease by 1 mph (1.0 km/h) each time you move the lever down (to SET-) in this manner.
- You can set the cruise control to above 20 mph (30 km/h).

**To temporarily accelerate with the Smart Cruise Control on:**

If you want to speed up temporarily when Smart Cruise Control is on, depress the accelerator pedal. Increased speed will not interfere with Smart Cruise Control operation or change the set speed.

To return to the set speed, take your foot off the accelerator.

If you move the lever down (to SET-) at increased speed, the cruising speed will be set again.

**\* NOTICE**

**Be careful when accelerating temporarily, because the speed is not regulated automatically at this time even if there is a vehicle in front of you.**

**Smart Cruise Control system will be temporarily canceled when:**

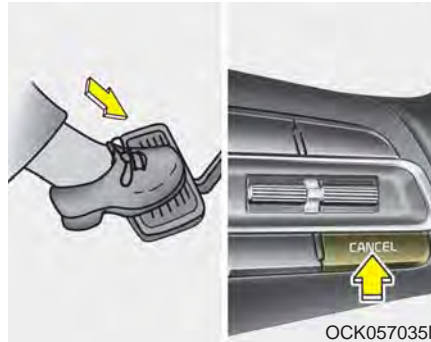

**Cancelled manually**

Smart Cruise Control system is temporarily canceled when the brake pedal is depressed or the CANCEL button is pressed. The speed and vehicle to vehicle distance indicator on the cluster will disappear and the CRUISE indicator is illuminated continuously.

**Cancelled automatically**

- The driver's door is opened.
- The shift lever is shifted to N (Neutral), R (Reverse) or P(Parking).
- The EPB (electronic parking brake) is applied.
- The vehicle speed is over 130 mph (210 km/h)
- The ESC, ABS or TCS is operating.
- The ESC is turned off.
- The sensor or the cover is dirty or blocked with foreign matter.
- When the vehicle is stopped for over 5 minutes.
- The driver starts driving by pushing the lever up (RES +) or down (SET -) or depressing the accelerator pedal approximately 3 seconds after the vehicle is stopped by Smart Cruise Control system with no other vehicle ahead or a vehicle stopped far away in front.
- The engine speed is in a dangerous range.

- Smart Cruise Control system has malfunctioned.
  - The accelerator pedal is continuously depressed for long time.
  - When activating the ISG mode.
  - When the braking control is operated for Forward Collision-Avoidance Assist(FCA)
  - The vehicle stops and goes repeatedly for a long period of time.
  - When the parking brake is locked.
- Engine has some problems.  
Each of these actions will cancel Smart Cruise Control system operation. (The set speed and vehicle-to-vehicle distance on the LCD display will go off.)  
If Smart Cruise Control system is cancelled automatically, Smart Cruise Control system will not resume even though the RES+ or SET- lever is moved.

If Smart Cruise Control system is canceled during a scenario that is not discussed in the preceding "Cancelled automatically" section, have the system checked by an authorized Kia dealer.



### \* NOTICE

**If the system is automatically cancelled, the warning chime will sound and a message will appear for a few seconds. You must adjust the vehicle speed by depressing the accelerator or brake pedal according to the road and driving conditions ahead. Always check the road conditions. Do not rely on the warning chime.**

**To resume Smart Cruise Control set speed:**



If any method other than the CRUISE button was used to cancel cruising speed and the system is still activated, the cruising speed will automatically resume when you move the lever up/down (to RES+ or SET-).

If you move the lever up (to RES+), the speed will resume to the recently set speed. If the vehicle speed is below 20 mph (30 km/h), it will resume only when a vehicle is in the front.

**⚠ WARNING - Following Distance**

- To avoid collisions, always be aware of the selected speed and vehicle to vehicle distance settings when activating your Smart Cruise Control system.
- Always maintain sufficient braking distance and decelerate your vehicle by applying the brakes if necessary.

**To turn Smart Cruise Control off:**



Press the CRUISE button. (the CRUISE indicator in the instrument cluster will go off).

When Smart Cruise Control system is not needed, press the [CRUISE] switch and deactivate the system.



## Vehicle to vehicle distance setting

*To set vehicle to vehicle distance:*



This function allows you to program the vehicle to maintain relative distance to the vehicle ahead without depressing the accelerator pedal or brake pedal.

The vehicle to vehicle distance will automatically activate when Smart Cruise Control system is on.

Select the appropriate distance according to road conditions and vehicle speed.

Each time the button is pressed, the vehicle to vehicle distance changes as follows:

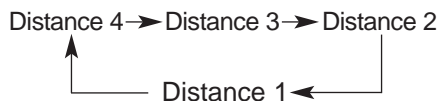

For example, if you drive at 56 mph (90 km/h), the distance is maintained as follows;

Distance 4 - approximately 172 feet (52.5 m)

Distance 3 - approximately 130 feet (40 m)

Distance 2 - approximately 106 feet (32.5 m)

Distance 1 - approximately 82 feet (25 m)

### \* NOTICE

**The distance is set to the last set distance when the system is used for the first time after starting the engine.**

When the lane ahead is clear :



The vehicle speed will maintain the set speed.

When there is a vehicle ahead of you in your lane :



- The vehicle will maintain the set speed, when the lane ahead is clear.
- The vehicle will slow down or speed up within selected speed to maintain the selected distance, when there is a vehicle ahead of you in the lane. (A vehicle will appear in front of your vehicle in the LCD display only when there is an actual vehicle in front of you)
- If the vehicle ahead speeds up, your vehicle will travel at a steady cruising speed after accelerating to the selected speed.
- The warning chime sounds and LCD display blinks if it is hard to maintain the selected distance to the vehicle ahead.
- If the warning chime sounds, actively adjust the vehicle speed by depressing the brake pedal according to the road condition ahead and driving condition.
- Even if the warning chime is not activated, always pay attention to the driving conditions to prevent dangerous situations from occurring.



OCK057107L

If the vehicle ahead (vehicle speed: less than 20 mph (30 km/h)) moves to the next lane, the warning chime will sound and a message will appear.

Adjust your vehicle speed for vehicles or objects that can suddenly appear in front of you by depressing the brake pedal according to the road and driving conditions ahead.

### CAUTION

***While other beeps such as the seat belt warning sound are in operation and override the SCC alarming system, SCC beeps may not occur.***

### *In heavy traffic*



OCK057108L

Use switch or pedal to accelerate

- In traffic, your vehicle will stop if the vehicle ahead of you stops. Also, if the vehicle ahead of you starts moving, your vehicle will start as well. However, if the vehicle stops for more than 3 seconds, you must depress the accelerator pedal or push up the toggle switch (RES+) to start driving.

- If you push Smart Cruise Control toggle switch (RES+ or SET-) while Auto Hold and Smart Cruise Control is operating, the Auto Hold will be released regardless of accelerator pedal operation and the vehicle will start to move. The AUTO HOLD indicator changes from green to white. (if equipped with EPB (Electronic Parking Brake))

### ***Radar to detect distance to the vehicle ahead***



OCK057023L

Smart Cruise Control (SCC) system uses a sensor to detect distance to the vehicle ahead.

If the sensor is covered with dirt or other foreign matter, the vehicle to vehicle distance control may not operate correctly.

Always keep the sensor clean.

### ***Warning message***



OCK057109L

### **Smart Cruise Control disabled. Radar blocked**

When the sensor lens cover is blocked with dirt, snow, or debris, Smart Cruise Control system operation may stop temporarily. If this occurs, a warning message will appear on the LCD display. Remove any dirt, snow, or debris and clean the radar sensor lens cover before operating Smart Cruise Control system. Smart Cruise Control system may not properly activate, if the radar is totally contaminated, or if any substance is not detected after turning ON the engine (e.g. in an open terrain).

### **Smart Cruise Control system malfunction message**



#### **Check Smart Cruise Control System**

The message will appear when the vehicle to vehicle distance control system is not functioning normally.

Take your vehicle to an authorized Kia dealer and have the system checked.

- Always keep the sensor and bumper clean.
- Use only a genuine Kia sensor cover for your vehicle.
- Do not install accessories around the sensor and do not replace the bumper by yourself. It may interfere with the sensor performance.
- Impact damage to the sensor or sensor area may cause the sensor to move slightly off position and result in Smart Cruise Control system not operating correctly without any warning or indicator from the cluster. If this occurs, have your vehicle checked by an authorized Kia dealer as soon as possible.
- Use only a genuine Kia sensor cover for your vehicle. Do not paint anything on the sensor cover.
- If the front bumper becomes damaged in the area around the radar sensor, Smart Cruise Control system may not operate properly.



#### **CAUTION - Sensor Damage**

***To prevent sensor cover damage from occurring, wash the car with a soft cloth.***

## To adjust the sensitivity of Smart Cruise Control system

The sensitivity of vehicle speed when following the front vehicle to maintain the set distance can be adjusted. Go to the User Settings Mode (Driver Assistance) and select SCC (Smart Cruise Control). You may select one of the three stages you prefer.

- Slow:

Vehicle speed to the vehicle ahead to maintain the set distance is slower than normal speed.

- Normal:

Vehicle speed to the vehicle ahead to maintain the set distance is normal

- Fast:

Vehicle speed to the vehicle ahead to maintain the set distance is faster than normal speed.

### \* NOTICE

The system remembers the last selected mode.

## To convert to Cruise Control mode:



The driver may choose to only use Cruise Control mode (speed control function) by doing as follows:

1. Turn Smart Cruise Control system on (the cruise indicator light will be on but the system will not be activated).
2. Push the distance to distance switch for more than 2 seconds.
3. Choose between “Smart Cruise Control (SCC) mode” and “Cruise Control (CC) mode”.

When using the cruise control mode, you must manually assess the distance to other vehicles as the system will not automatically brake to slow down for other vehicles.

When the system is canceled using the CRUISE button or the CRUISE button is used after the engine is turned on, Smart Cruise Control mode will turn on.

### **⚠ WARNING**

**When using Cruise Control mode, you must manually assess the distance to other vehicles as the system will not automatically brake to slow down for other vehicles.**

## Limitations of the system

Smart Cruise Control system may have limits to its ability to detect distance to the vehicle ahead due to road and traffic conditions.

### *On curves*

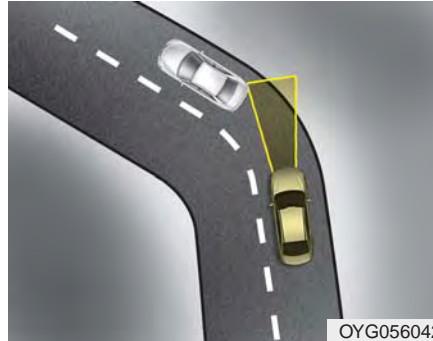

- On curves, Smart Cruise Control system may not detect a moving vehicle in your lane, and then your vehicle could accelerate to the set speed. Also, the vehicle speed will rapidly slow down when the vehicle ahead is recognized suddenly.
- Select the appropriate set speed on curves and adjust your vehicle speed by depressing the accelerator or brake pedal according to the road and driving conditions ahead.

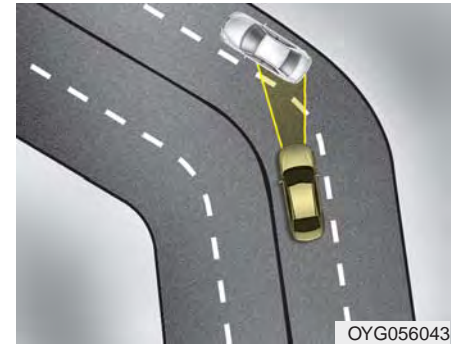

- Your vehicle speed can be reduced due to a vehicle in the adjacent lane. Adjust your vehicle speed by depressing the brake pedal according to the road and driving conditions ahead. Apply the accelerator pedal and select the appropriate set speed. Check to be sure that the road conditions permit safe operation of Smart Cruise Control system.

### On inclines

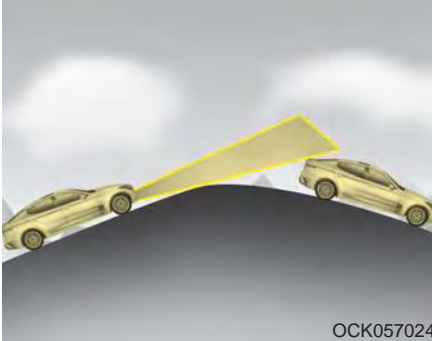

- During uphill or downhill driving, Smart Cruise Control system may not immediately detect a moving vehicle in your lane, and may cause your vehicle to accelerate to the set speed. Also, the vehicle speed will rapidly slow down when the vehicle ahead is recognized suddenly.
- Select the appropriate set speed on inclines and adjust your vehicle speed by depressing the accelerator or brake pedal according to the road condition ahead.

### Lane changing

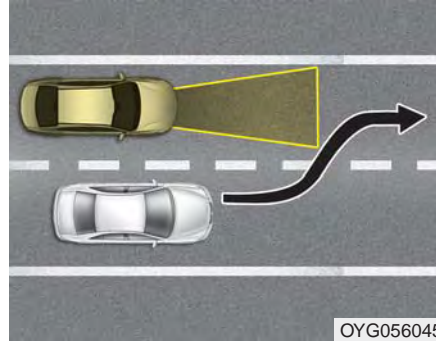

- A vehicle which moves into your lane from an adjacent lane cannot be recognized by the sensor until it is in the sensor's detection range.
- The sensor may not detect immediately when a vehicle cuts in suddenly. Always pay attention to the traffic, road and driving conditions.
- If a vehicle which moves into your lane is slower than your vehicle, reduce your speed to maintain the distance to the vehicle ahead.

- If a vehicle which moves into your lane is faster than your vehicle, your vehicle will continue to maintain the selected speed.



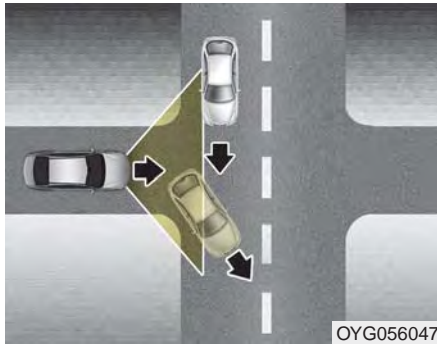

- Your vehicle may accelerate when a vehicle ahead of you disappears.
- When you are warned that the vehicle ahead of you is not detected, drive with caution.

## Vehicle recognition

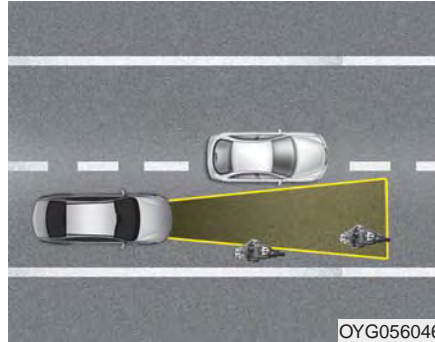

Some vehicles ahead in your lane cannot be recognized by the sensor as follows:

- Narrow vehicles such as motorcycles or bicycles
- Vehicles offset to one side
- Slow-moving vehicles or sudden-decelerating vehicles
- Stopped vehicles
- Vehicles with small rear profiles such as trailers with no loads

A vehicle ahead cannot be recognized correctly by the sensor if any of following occurs:

- When the vehicle is pointing upwards due to overloading in the trunk or luggage area.
- While making turns by steering
- When driving to one side of the lane
- When driving on narrow lanes or on curves

Adjust your vehicle speed by depressing the brake pedal according to the road condition ahead and driving condition.

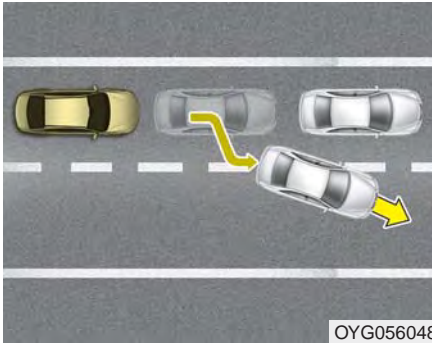

- When vehicles are at a standstill and the vehicle in front of you changes to the next lane, be careful when your vehicle starts to move because it may not immediately recognize the stopped vehicle in front of you.

In this case, you must maintain a safe braking distance, and if necessary, depress the brake pedal to reduce your driving speed in order to maintain a safe distance.

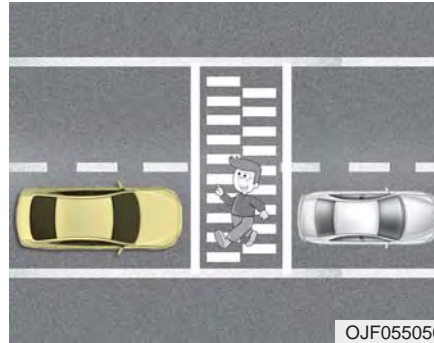

- Always look out for pedestrians when your vehicle is maintaining a distance with the vehicle ahead.

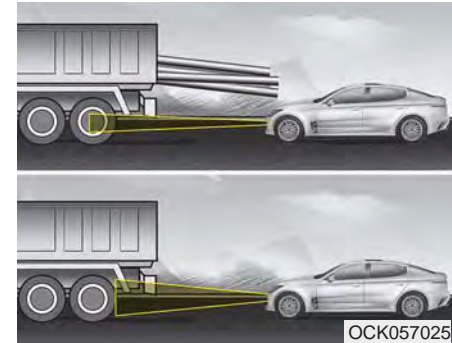

- Always be cautious when approaching vehicles that are taller with higher clearance, or vehicles carrying loads that stick out of the back of the vehicle.

**⚠ WARNING**

**- Safe Use of Smart Cruise Control system**

Smart Cruise Control system can provide you with an additional level of safety and fatigue reduction. However, you must maintain careful observation of the roadway in front and around you and maintain control of your vehicle and spacing around other vehicles as you normally would. For example, this will require you to apply the brakes as needed when coming upon a slower moving vehicle, or when a vehicle from another lane drives quickly in front of you.

**⚠ WARNING - Emergency Stops**

Smart Cruise Control system may not be able to completely stop the vehicle or avoid a collision in every situation. If an emergency stop is necessary, you must apply the brakes.

**⚠ WARNING - Inclines & Towing**

Do not use Smart Cruise Control system on steep inclines or when towing another vehicle or trailer since such extreme loading can interfere with your vehicle's ability to maintain the selected speed.

- After an engine start, please stop for several seconds. If system initialization is not completed, Smart Cruise Control system will not operate.
- After an engine start, if the sensor cover is obscured with foreign substances, there is a possibility that Smart Cruise Control system may not work.
- The following conditions may cause a malfunction: over-loading the liftgate, suspension modification, tire replacement with unauthorized tires or tires with different tread wear and pressure levels.
- Keep a safe distance according to road conditions and vehicle speed. If the vehicle to vehicle distance is too close during a high-speed driving, a serious collision may result.
- Smart Cruise Control system cannot recognize a stopped vehicle, pedestrians or an oncoming vehicle. Always look ahead cautiously to prevent unexpected and sudden situations from occurring.

- When other vehicles are changing lanes in front of you frequently, there may be a delay in the system's reaction. Always look ahead cautiously to prevent unexpected and sudden situations from occurring.
- Smart Cruise Control system is a supplemental system only and is not a substitute for safe driving practices but a convenience function only. It is the responsibility of the driver to always check the speed and the distance to the vehicle ahead.
- Always be aware of the selected speed and vehicle to vehicle distance.
- Always maintain sufficient braking distance and decelerate your vehicle by applying the brakes if necessary.

**This device complies with Part 15 of the FCC rules.**

Operation is subject to the following three conditions:

1. This device may not cause harmful interference, and
2. This device must accept any interference received, including interference that may cause undesired operation.
3. Changes or modifications not expressly approved by the party responsible for compliance could void the user's authority to operate the device.

**Radio frequency radiation exposure information:**

This equipment complies with FCC radiation exposure limits set forth for an uncontrolled environment.

This equipment should be installed and operated with minimum distance of 20 cm between the radiator (antenna) and your body.

This transmitter must not be co-located or operating in conjunction with any other antenna or transmitter.

## ISG (IDLE STOP AND GO) SYSTEM

Your vehicle may be equipped with the ISG system, which reduces fuel consumption by automatically shutting down the engine, when the vehicle is at a standstill. (For example : red light, stop sign and traffic jam)

The engine starts automatically as soon as the starting conditions are met.

The ISG system is ON whenever the engine is running.

### \* NOTICE

When the engine automatically starts by the ISG system, some warning lights (ABS, ESC, ESC OFF, EPS or Parking brake warning light) may turn on for a few seconds.

This happens because of the system logic whenever the engine start. It does not mean the system has malfunctioned.

### Auto stop

*To stop the engine in idle stop mode*



Stop the vehicle completely by pressing the brake pedal when the shift lever is in the D (Drive) or N (Neutral) position.

The engine will stop and the green AUTO STOP(A) indicator on the instrument cluster will illuminate.



### \* NOTICE

If you open the engine hood in auto stop mode, the following will happen:

- The ISG system will deactivate (the light on the ISG OFF button will illuminate).
- A message will appear on the LCD display.

(Continued)



(Continued)

- If you move the transmission lever from N to D (manual mode) or R without depressing the brake pedal after stopping engine automatically, the engine does not restart automatically and a warning chime alarms. When this happens, press the brake pedal for auto start.

## Auto start

To restart the engine from idle stop mode

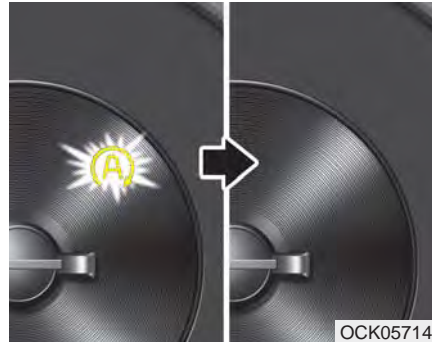

- Release the brake pedal.  
or
- Move the shift gear to the R (Reverse) position or the manual mode while depressing the brake pedal.

The engine will start and the green AUTO STOP indicator ((A)) on the instrument cluster will go out.

*The engine will also restart automatically without any driver actions if the following occurs:*

- The brake vacuum pressure is low
- The engine has stopped for about 5 minutes
- The air conditioning is ON with the fan speed set to the highest position
- The front defroster is ON
- The battery is weak
- The cooling and heating performance of the climate control system is unsatisfactory
- The vehicle is shifted to P (Park) when Auto Hold is activated
- The door is opened or the seatbelt is unfastened when Auto Hold is activated
- The EPB switch is pressed when Auto Hold is activated

## Condition of ISG system operation

*The ISG system will operate under the following condition:*

- The driver's seatbelt is fastened
- The driver's door and hood are closed
- The brake vacuum pressure is adequate
- The battery sensor is activated and the battery is sufficiently charged
- Outside temperature is not too low or too high
- The vehicle is driven over a constant speed and stops
- The climate control system satisfies the conditions
- The vehicle is sufficiently warmed up
- The incline is gradual
- The steering wheel is turned less than 180 degrees and then the vehicle stops

## \* NOTICE

- If the ISG system does not meet the operation condition, the ISG system is deactivated. The light on the ISG OFF button will illuminate and a message "Auto Stop conditions not met" will appear on the LCD display.
- If the light or notice comes on continuously, please check the operation condition.

## ISG system deactivation

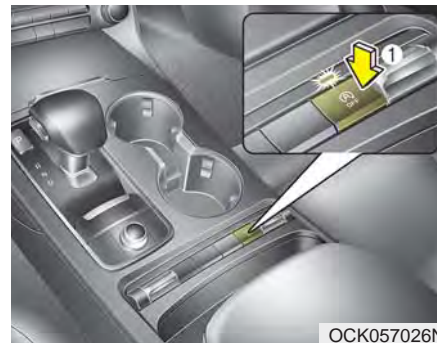

- If you wish to deactivate the ISG system, press the ISG OFF button (1). The light on the ISG OFF button will illuminate.
- If you press the ISG OFF button again, the system will be activated and the light on the ISG OFF button will turn off.

## ISG system malfunction

*The system may not operate when:*



The system may not operate when an ISG related sensor or system error occurs.

The following will happen:

- The yellow AUTO STOP ((A)) indicator on the instrument cluster will stay on after blinking for 5 seconds.
- The light on the ISG OFF button will illuminate.

## \* NOTICE

If the ISG OFF button light is not turned off by pressing the ISG OFF button again or if the ISG system continuously does not work correctly, have your vehicle inspected by an authorized Kia dealer.

When the engine is in Idle Stop mode, it's possible to restart the engine without the driver taking any action. Before leaving the car or doing anything in the engine compartment, stop the engine by turning the ignition switch to the LOCK/OFF position or removing the ignition key.

## \* NOTICE

If the AGM battery is reconnected or replaced, ISG function will not operate immediately.

If you want to use the ISG function, the battery sensor needs to be calibrated for approximately 4 hours with the ignition off. After calibration, turn the engine on and off 2 or 3 times.



## DRIVE MODE INTEGRATED CONTROL SYSTEM

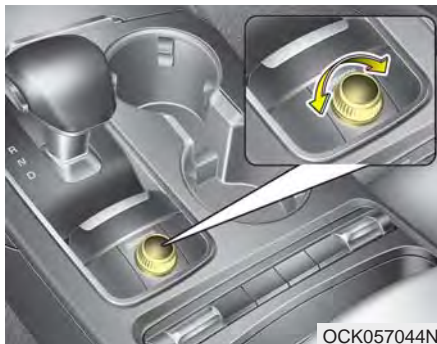

OCK057044N

The drive mode may be selected according to the driver's preference or road condition.

The mode changes whenever the DRIVE MODE button is turned.

- **SMART mode** : SMART mode automatically adjusts the driving mode (ECO ↔ COMFORT ↔ SPORT) in accordance with the driver's driving habits.
- **COMFORT mode** : COMFORT mode provides smooth driving and a comfortable ride.
- **SPORT mode** : SPORT mode provides a sporty but firm ride.
- **CUSTOM mode** : CUSTOM mode allows the driver to mix aspects of other driving modes to make a customized mode.
- **ECO mode** : ECO mode improves fuel efficiency for eco-friendly driving.

If it is in ECO mode, ECO mode will be set when the engine is restarted. (However, if it is in SMART/COMFORT/SPORT/CUSTOM mode, the drive mode will be set to COMFORT mode when the engine is restarted.)

### *SMART mode*



OCK057045L



OCK057046L



OCK057047L

**SMART**

SMART mode selects the proper drive mode among ECO, COMFORT and SPORT by judging the driver's driving habits (i.e. mild or dynamic) from the brake pedal depression or the steering wheel operation.

- Rotate the DRIVE MODE dial knob to activate SMART mode. When SMART mode is activated, the indicator illuminates on the instrument cluster.
- The indicator illuminates in blue, when the driver's driving is categorized to be mild. It illuminates in white, when the driver's driving is categorized to be normal. It illuminates in red, when the driver's driving is categorized to be dynamic during abrupt braking or sharp curves.
- The vehicle starts in COMFORT mode, if the engine was turned OFF in SMART mode.
- SMART mode automatically controls the vehicle's characteristics, such as gear shifting patterns, engine torque, ride quality (if equipped with the electronic suspension system), and power distribution (if equipped with the All-Wheel Drive (AWD) system), in accordance with the driver's driving habits.

**\* NOTICE**

- **When you mildly drive the vehicle in SMART mode, the drive mode changes to ECO mode to improve fuel efficiency. However, the actual fuel efficiency may differ in accordance with your driving situations (i.e. upward/downward slope, vehicle deceleration/acceleration).**
- **When you dynamically drive the vehicle in SMART mode by abruptly decelerating or sharply turning, the drive mode changes to SPORT mode. However, it may adversely affect fuel economy.**

### **Various drive situations, which you may encounter in SMART mode**

- The drive mode automatically changes to ECO mode after a certain period of time, when you gently depress the accelerator pedal (Your drive is categorized to be mild.).
- The drive mode automatically changes from SMART ECO mode to SMART COMFORT mode after a certain period of time, when you sharply or repetitively depress the accelerator pedal.
- The drive mode automatically changes to SMART COMFORT mode with the same driving patterns, when the vehicle starts to drive on an upward slope of a certain angle. The drive mode automatically returns to SMART ECO mode, when the vehicle enters a leveled road.

- The drive mode automatically changes to SMART SPORT, when you abruptly accelerate the vehicle or repetitively operate the steering wheel (Your driving is categorized to be sporty.). In this mode, your vehicle drives in a lower gear for abrupt accelerating/decelerating and increases the engine brake performance.
- You may still sense the engine brake performance, even when you release the accelerator pedal in SMART SPORT mode. It is because your vehicle remains in a lower gear over a certain period of time.
- The drive mode automatically changes to SMART SPORT mode only in dynamic driving situations. In most of the normal driving situations, the drive mode sets to be either in SMART ECO mode or in SMART COMFORT mode.

### **Limitation of SMART mode**

The SMART mode may be limited in following situations. (The OFF indicator illuminates in those situations.)

- The driver manually moves the shift lever : It deactivates SMART mode.
- The cruise control is activated : The cruise system may deactivate the SMART mode. (SMART mode is not automatically deactivated just by activating the cruise system.)
- The transmission oil temperature is either extremely low or extremely high : The SMART mode can be active in most of the normal driving situations. However, an extremely high/ low transmission oil temperature may temporarily deactivate the SMART mode, because the transmission condition is out of normal operation condition.

**SPORT mode****SPORT**

SPORT mode manages the driving dynamics by automatically adjusting the steering effort, and the engine and transmission control logic for enhanced driver performance.

- When SPORT mode is selected by pressing the DRIVE MODE button, the SPORT indicator (orange color) will illuminate.
- Whenever the engine is restarted, the Drive Mode will revert back to COMFORT mode. If SPORT mode is desired, re-select SPORT mode from the DRIVE MODE button.
- When SPORT mode is activated:
  - The engine rpm will tend to remain raised over a certain length of time even after releasing the accelerator
  - Upshifts are delayed when accelerating

**\* NOTICE**

In SPORT mode, the fuel efficiency may decrease.

**CUSTOM mode****CUSTOM**

CUSTOM mode enables driver to build their own customized mode. Driver can choose between different Engine/Transmission, Steering, Suspension, AWD, and Active Engine Sound settings.

- To access CUSTOM mode settings rotate the Drive Mode knob until getting to CUSTOM mode. A Graphic picture of Kia Stinger will pop up on main screen with a setting button. Press the setting button and change different settings to build your own mode.
- Once the CUSTOM mode settings are chosen they will be saved and will remain that way until changed again in settings.
- Whenever the engine is restarted, the Drive Mode will revert back to COMFORT mode. If CUSTOM mode is desired, re-select CUSTOM mode from the DRIVE MODE button.

**ECO mode****ECO**

When the Drive Mode is set to ECO mode, the engine and transmission control logic are changed to maximize fuel efficiency.

- When ECO mode is selected by pressing the DRIVE MODE button, the ECO indicator (green color) will illuminate.
- If the vehicle is set to ECO mode, when the engine is turned OFF and restarted the Drive Mode setting will remain in ECO mode.

**\* NOTICE**

Fuel efficiency depends on the driver's driving habits and road condition.

### **When ECO mode is activated:**

- The acceleration response may be slightly reduced if the accelerator pedal is depressed moderately.
- The air conditioner performance may be limited.
- The shift pattern of the automatic transmission may change.
- The engine noise may get louder.

The above situations are normal conditions when ECO mode is activated to improve fuel efficiency.

### **Limitation of ECO mode operation:**

If the following conditions occur while ECO mode is operating, the system operation is limited even though there is no change in the ECO indicator.

- When the coolant temperature is low:

The system will be limited until engine performance becomes normal.

- When driving up a hill:

The system will be limited to gain power when driving uphill because engine torque is restricted.

- When driving the vehicle with the automatic transmission gear shift lever in manual mode.

The system will be limited according to the shift location.

## LANE KEEPING ASSIST (LKA) SYSTEM (IF EQUIPPED)

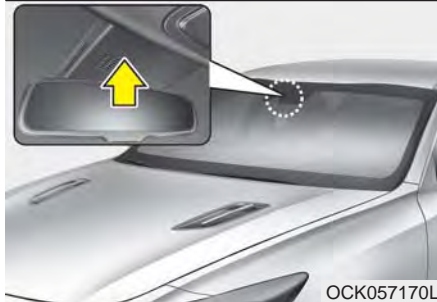
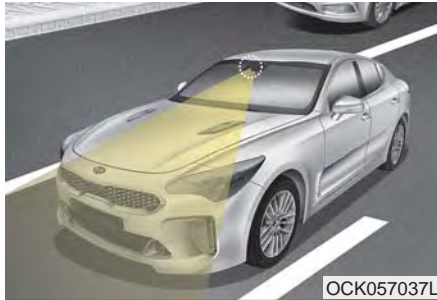

Lane Keeping Assist (LKA) system is designed to detect the lane markers on the road with a front view camera at the front windshield, and assists the driver's steering to help keep the vehicle in the lanes.

When the system detects the vehicle straying from its lane, it alerts the driver with a visual and audible warning, while applying a slight counter-steering torque, trying to prevent the vehicle from moving out of its lane.

### **⚠ WARNING**

**Do not turn the steering wheel suddenly when the vehicle is being directed by LKA system. This can result in a sudden loss of control and crash of the vehicle.**

### **⚠ WARNING**

**LKA system is a supplemental system and is not a substitute for safe driving practices. It is the responsibility of the driver to always pay attention and drive safely.**

### **\* NOTICE**

**Driver is responsible for being aware of surroundings and steering the vehicle, and safe driving practices.**

- Do not disassemble the front view camera temporarily for tinted windows or attaching any types of coatings and accessories. If you disassemble the camera and assemble it again, take your vehicle to an authorized Kia dealer and have the system checked.
  - When you replace the windshield glass, front view camera or system, take your vehicle to an authorized Kia dealer and have the system checked.
  - The system is designed to detect lane markers using a front view camera. If the lane markers are hard to detect, then the system may be limited. Always be cautious when using the system.
  - When the lane markers are hard to detect, please refer to “Driver’s Attention”.
  - Do not remove or damage the related parts of LKA system.
  - Do not place objects on the dashboard that reflect light such as mirrors, white paper, etc. This may prevent the system from functioning.
  - You may not hear warning sound of LKA system because of excessive audio sound.
  - If you drive with your hands off the steering wheel, LKA system will stop controlling the steering wheel after the hands off alarm. Afterwards, if you drive with your hands on the steering wheel, the control will be activated again.
- \* NOTICE**
- **If the vehicle speed is high, steering torque for assistance will not be enough to keep your vehicle within the lane. If so, the vehicle may move out of its lane. Obey speed limit when using LKA system.**
  - **If you attach objects to the steering wheel, the system may not assist steering.**
  - **If you attach objects to the steering wheel, hands off alarm may not work properly.**

## LKA system operation



To activate/deactivate LKA system:

With the ignition switch in the ON position, press LKA system button located on the instrument panel on the lower left hand side of the driver.

The indicator in the cluster display will initially illuminate white.

When the indicator (white) activated in the previous ignition cycle, the system turns on without any control.

If you press LKA system button again, the indicator on the cluster display will go off.

The color of indicator will change depend on the condition of LKA system.

- White : Sensor does not detect the lane marker or vehicle speed is less than 40 mph (64 km/h).
- Green : Sensor detects the lane marker and system is able to control the steering.

## LKA system activation

- To see LKA system screen on the LCD display in the cluster, Tab to the Assist mode (  ).
- For further details, refer to "User Setting Mode" in chapter 4.
- After LKA system is activated, if both lane markers are detected, vehicle speed is over 40 mph (64 km/h) and all the activation conditions are satisfied, a green steering wheel indicator will illuminate and the steering wheel will be controlled.

### WARNING

**LKA system is a system to help prevent the driver from leaving the lane. However, the driver should not solely rely on the system but always check the road conditions when driving.**





- If the speed of the vehicle is over 40 mph (64 km/h) and the system detects lane markers, the color changes from gray to white.

When the conditions below are met, LKA system will be enabled to assist steering.

- Vehicle speed is above 40 mph (64 km/h).
- Both lane markers are detected by LKA system.
- The vehicle is between the lane markers.

If LKA system can assist steering, a green steering wheel indicator will illuminate.

## Warning



- If the vehicle leaves a lane, the lane marker you cross will blink on the LCD display.

- If the vehicle moves out its lane because steering torque for assistance is not enough, the line indicator will blink.
- If all the conditions to activate LKA system are not satisfied, the system will convert to Lane Departure Warning (LDW) system and only warn the driver when the driver crosses the lane lines. In this scenario, LDW system does not provide any steering inputs into the vehicle for you. Accordingly, you must take the necessary steps to maintain control of the vehicle and keep it within the lanes.



If the driver takes hands off the steering wheel for several seconds while LKA is activated, the system will warn the driver.

### \* NOTICE

- Always keep your hands on the steering wheel while driving.
- If you hold the steering wheel with a light grip, the system may also generate the hands off warning.

If the driver still does not have their hands on the steering wheel after several seconds, the system will only warn the driver when the driver crosses the lane lines. In this scenario, the system does not provide any steering inputs into the vehicle for you. Accordingly, you must take the necessary steps to maintain control of the vehicle and keep it within the lanes.

However, if the driver has their hands on the steering wheel again, the system will again provide steering inputs if it detects the vehicle leaving the lane.

**⚠ WARNING**

- LKA system is a supplemental system only. It is the responsibility of the driver to safely steer the vehicle and to maintain it in its lane.
- Even though the steering is assisted by the system, the driver may control the steering wheel.
- Turn off LKA system and drive without the use of the system in the following situations:
  - In bad weather
  - In bad road conditions
  - When the steering wheel needs to be controlled by the driver frequently.
- The steering wheel may feel heavier when the steering wheel is assisted by the system than when it is not.

**\* NOTICE**

- Even though the steering is assisted by the system, the driver may control the steering.
- The steering wheel may feel heavier when the steering wheel is assisted by the system than when it is not.

**The system will be cancelled when:**

- You change lanes with the turn signal.
- Using the turn signal to change lanes.
- If you change lanes without the turn signal on, the steering wheel control may be affected by LKA.
- LKA system can transit to steering assist mode when the car is near to middle of the lane after system on or the lane was changed.
- LKA system can not assist steering if the vehicle follows lane marker too close continuously before transition to steering assist mode.
- The control of ESC (Electronic Stability Control) or VSM (Vehicle Stability Management) is activated.
- The steering will not be assisted when you drive fast on a sharp curve.
- The steering will not be assisted when vehicle speed is below 40 mph (64 km/h) and over 110 mph (180 km/h). Always obey all traffic laws and drive safely.

- The steering will not be assisted when you change lanes quickly.
- The steering will not be assisted when you brake suddenly.
- The steering will not be assisted when the lane is very wide or narrow.
- The steering will not be assisted when only one side lane marker is detected.
- There are more than two lane markers such as a construction area.
- Radius of a curve is too small.
- When you turn steering wheel suddenly, LKA system will be disabled temporarily.
- Driving on a steep slope or hill.

### Driver's attention

The driver must be cautious in the following situations because the system is limited when recognition of the lane marker is poor or limited:

- ▶ When lane and road condition is poor
  - It is difficult to distinguish the lane marker from road when the lane marker is covered with dust or sand.
  - It is difficult to distinguish the color of the lane marker from road.
  - There is something that looks like a lane marker.
  - The lane marker is indistinct or damaged.
  - The number of lanes increases/decreases or the lane lines are crossing (Driving through a toll plaza/toll gate, merged/divided lane).
  - There are more than two lane markers.

- The lane marker is very thick or thin.
- The lane marker is not visible due to snow, rain, stain, a puddle or other factors.
- A shadow is on the lane marker because of a median strip, guardrail, noise barriers or other objects.
- When the lane markers are complicated or a structure substitutes for the lines such as a construction area.
- There are crosswalk signs or other symbols on the road.
- The lane suddenly disappears such as at the intersection.
- The lane marker in a tunnel is covered with dirt or oil and etc.

- ▶ When external condition is intervened
  - The brightness of outside changes suddenly when entering/exiting a tunnel or passing under a bridge.
  - The headlamps are not on at night or in a tunnel, or light level is low.
  - There is a boundary structure in the roadway.
  - The light reflects from water on the road.
  - When light shines brightly from behind the vehicle.
  - The distance from the vehicle ahead is very short or the vehicle ahead covers up the lane line.
  - You drive on a steep grade or a sharp curve.
  - The vehicle vibrates heavily.
  - The temperature near inside mirror is very high due to direct sun light and etc.

- ▶ When front visibility is poor
  - The lens or windshield is covered by foreign materials.
  - The sensor cannot detect the lane because of fog, heavy rain or snow.
  - The windshield is fogged by humid air in the vehicle.
  - There is an object on the dashboard that interferes with the camera.

### **⚠ WARNING**

**LKA system is a system to help prevent the driver from leaving the lane. However, the driver should not solely rely on the system but always take the necessary actions for safe driving practices.**

### **LKA system malfunction**



If there is a problem with the system a message will appear. If the problem continues LKA system fail indicator will illuminate.

***LKA system fail indicator***

LKA system fail indicator (yellow) will illuminate with an audible warning if LKA system is not working properly. In this case, have the system checked by an authorized Kia dealer.

**When there is a problem with the system do one of the following:**

- Turn the system on after turning the engine off and on again.
- Check if the ignition switch is in the ON position.
- Check if the system is affected by the weather. (ex: fog, heavy rain, etc.)
- Check if there is foreign matter on the camera lens

If the problem is not solved, have the system checked by an authorized Kia dealer.

**LKA system Function Change**

The driver can change LKA to Lane Departure Warning (LDW) system or change LKA system mode between Standard LKA and Active LKA from the User Settings Mode on the LCD display.

The driver can choose them by placing the ignition switch to the ON position and by selecting 'User Settings', 'Driver Assistance', and 'Lane Keeping Assist'.

The system is automatically set to Standard LKA.

### ***Lane Departure***

LDW alerts the driver with a visual and acoustic warning when the system detects the vehicle leaving the lane. In this mode, the system will not provide steering inputs. When the vehicle's front wheel contacts the inside edge of lane line, LKA system issues the lane departure warning.

### ***Standard LKA***

The Standard LKA mode guides the driver to keep the vehicle within the lanes. It provides inputs to the steering when the vehicle is about to deviate from the lanes.

### ***Active LKA***

The active inputs to LKA mode provides more frequent steering in comparison with the Standard LKA mode.

## BLIND-SPOT COLLISION WARNING (BCW)/REAR CROSS-TRAFFIC COLLISION WARNING (RCCW) (IF EQUIPPED)

### System description

#### *Blind-Spot Collision Warning (BCW)*

Blind-Spot Collision Warning (BCW) system uses radar sensors in the rear bumper to monitor and warn the driver of an approaching vehicle in the driver's blind spot area.

The system monitors the rear area of the vehicle and provides information to the driver with an audible alert and a indicator on the outside rearview mirrors.

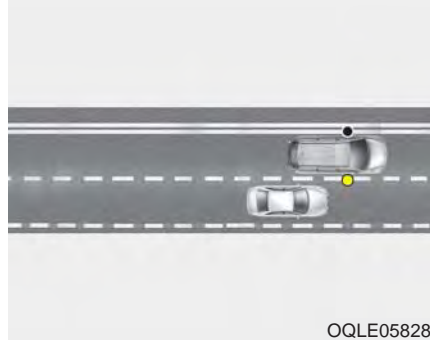

(1) Blind spot area

BCW range varies relative to vehicle speed. Note that if your vehicle is traveling much faster than the vehicles around you, the warning will not occur.

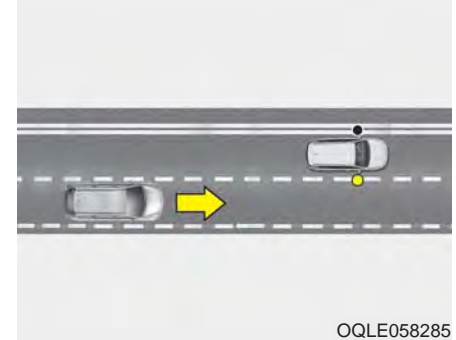

(2) Closing at high speed

BCW will alert you when it detects a vehicle is approaching in an adjacent lane at a high rate of speed. If the driver activates the turn signal when the system detects an oncoming vehicle, the system sounds an audible alert.



### Rear Cross-Traffic Collision Warning (RCCW)

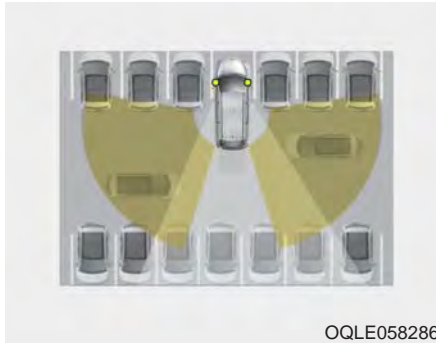

RCCW feature monitors approaching cross traffic from the left and right side of the vehicle when your vehicle is in reverse. The feature will operate when the vehicle is moving in reverse below about 6 mph (10 km/h). If oncoming cross traffic is detected a warning chime will sound.

### **⚠ WARNING** - BCW Limitations

- BCW system is a supplemental system. Do not solely rely on the system and always pay attention to drive safely.
- BCW system may not detect every object alongside the vehicle and is not a substitute for proper and safe lane changing procedures. Always drive safely and use caution when changing lanes.

### BCW (Blind-Spot Collision Warning)

#### Operating conditions

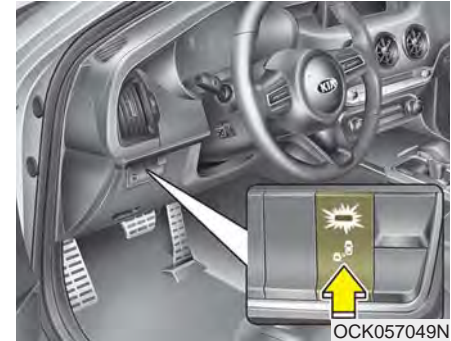

The indicator on the switch will illuminate when BCW system switch is pressed with the engine start/stop Button ON.

If vehicle speed exceeds 20 mph (30 km/h), the system will activate.

If you press the switch again, the switch indicator and system will be turned off.

If the vehicle is turned off, the system will remember the last settings upon restart.

When the system is not used turn the system off by turning off the switch.

When the system is turned on the warning light will illuminate for 3 seconds on the outside rearview mirror.

### **Warning type**

The system will activate when:

1. The system is on.
2. Vehicle speed is above 20 mph (30 km/h).
3. Other vehicles are detected in the rear side.

### **⚠ WARNING**

**BCW system and Rear Cross-Traffic Collision Warning is not a substitute for proper and safe driving procedures.**

**Always drive safely and use caution when changing lanes or backing up. BCW system and Rear Cross-Traffic Collision Warning may not detect every object alongside the vehicle.**

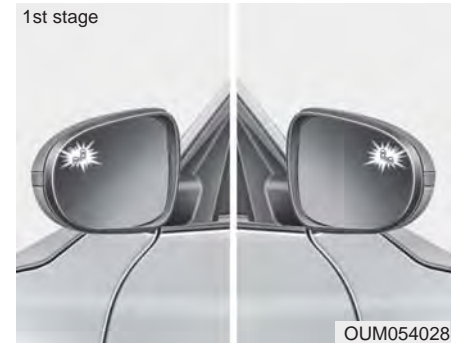

### **First stage alert**

If a vehicle is detected within the boundary of the system, a warning light will illuminate on the outside rearview mirror.

If the detected vehicle is not in detecting range, the warning will turn off.

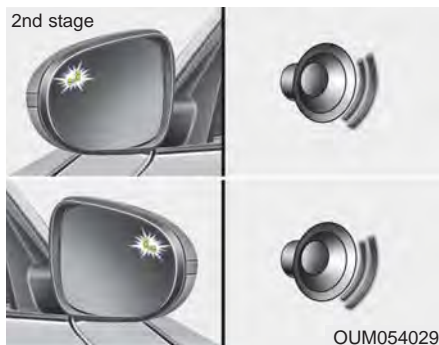

### Second stage alert

The second stage alarm will activate when:

1. The first stage alert is on
2. The turn signal is on to change a lane

When the second stage alert is activated, a warning light will blink on the outside rearview mirror and an alarm will sound.

If you move the turn signal switch to the original position, the second stage alert will be deactivated.

- The second stage alarm can be deactivated.
- To activate the alarm:  
Go to the User Settings Mode → Driver Assistance and select "Blind-Spot Collision Warning Sound" on the LCD display.
- To deactivate the alarm:  
Go to the User Settings Mode → Driver Assistance and deselect "Blind-Spot Collision Warning Sound" on the LCD display.

### \* NOTICE

**The alarm function helps alert the driver. Deactivate this function only when it is necessary**

### *Detecting sensor*



The sensors are located inside of the rear bumper.

Always keep the rear bumper clean for the system to work properly.

## RCCW (Rear Cross-Traffic Collision Warning)

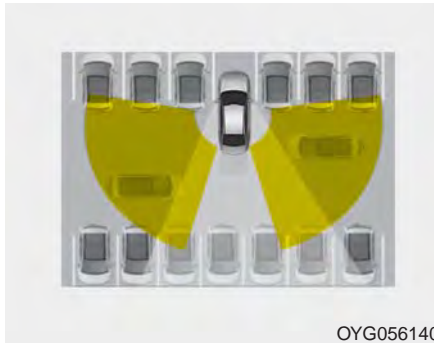

When your vehicle moves backwards from a parking position, the sensor detects approaching vehicles to the left or right side direction and gives information to the driver.

### Operating conditions

- Select RCCW (Rear Cross-Traffic Collision Warning) in “User Settings” under “Driver Assistance” on the instrument cluster. The system will turn on and standby to activate.
- Select RCCW again, to turn the system off.
- If the vehicle is turned off, RCCW system will remember the last settings upon restart.
- The system operates when the vehicle speed is below 6 mph (10km/h) with the shift lever in R (Reverse).
- RCCW (Rear Cross-Traffic Collision Warning) detecting range is 1.6 feet ~ 65 feet (0.5 m ~ 20 m) based on the side direction. If the approaching vehicle speed is 2.5 mph (4 km/h) ~ 22 mph (36 km/h) within sensing range, it is detected. However, the system sensing range can vary based on conditions. Always pay attention to your surroundings.

### Warning type

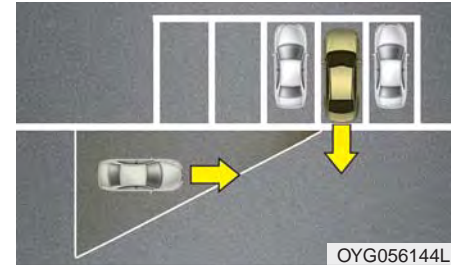

- If the vehicle detected by sensors approaches your vehicle, the warning chime will sound and the warning light will blink on the outside rearview mirror.
- If the detected vehicle is out of detection range, moving away in the opposite direction or moving slow, or if the vehicle is right behind your vehicle, if the direction of the other vehicle is not heading towards your vehicle, the warning is cancelled.
- The system may not operate properly due to other factors or circumstances. Always pay attention to your surroundings.
- \* If your vehicle's left or right side bumper is blinded by a barrier or vehicles, the system sensing ability may be limited.

### **WARNING**

- **BCW system and Rear Cross-Traffic Collision Warning is not a substitute for proper driving procedures. Always drive safely and use caution when changing lanes or backing up. BCW system and Rear Cross-Traffic Collision Warning may not detect every object alongside the vehicle.**
- **When BCW system is being activated, the warning light on the outside rearview mirror will illuminate whenever a vehicle is detected by the system. To avoid accidents, do not focus only on the warning light and neglect to see the surrounding of the vehicle.**

**(Continued)**

**(Continued)**

- **Drive safely even though the vehicle is equipped with BCW system. Do not solely rely on the system but check for yourself before changing lanes. The system may not alert the driver in some conditions so always check the surroundings while driving.**

**\* NOTICE**

- The system may not work properly if the bumper has been replaced or if repair work has been done near the sensor.
- The detection area differs according to the road's width. If the road is narrow the system may detect other vehicles in the next lane.
- If the road is very wide the system may not detect other vehicles.
- The system may turn off due to strong electromagnetic interference.

**Warning message**

The message will appear to notify the driver if there are foreign substances on the surface or inside the rear bumper or it is hot near the rear bumper. The light on the switch and the system will be turned off automatically.

Remove the foreign substance on the rear bumper.

After the foreign substance is removed, if you drive for approximately 10 minutes, the system will work normally.

If the system does not work normally even though the foreign substance, trailer or carrier, or other equipment is removed, have the system checked by an authorized Kia dealer.

It is possible to get the message with no foreign substance on the rear bumper, for example, when driving in a rural or open area, such as desert, where there is insufficient data for operation.

This message may also activate during heavy rain or due to road spray.

In this case, the vehicle does not need service.

When the cargo area or other equipment is being used, turn all functions of the system [OFF].



If the system does not work properly, a warning message will appear and the light on the switch will turn off. The system will turn off automatically.

We recommend that the system be checked by an authorized Kia dealer.

### ***Non-operating condition***

Outside rearview mirror may not alert the driver when:

- The outside rearview mirror housing is damaged or covered with debris.
- The window is covered with debris.
- The windows are severely tinted.

### **Driver's attention**

The driver must be cautious in the below situations, because the system may not detect other vehicles or objects in certain circumstances.

- The vehicle drives on a curved road or through a tollgate.
- The sensor is covered with rain, snow, mud, etc.
- The rear bumper, in which the sensor is located, is covered or blocked with a foreign matter such as a sticker, a bumper guard, a bicycle stand, etc.
- The rear bumper is damaged, or the sensor is out of the original default position.
- The vehicle height gets lower or higher due to heavy loading in a lift-gate, abnormal tire pressure, etc.
- The vehicle drives in a bad weather such as heavy rain or snow.
- There is a fixed object near the vehicle, such as a guardrail, pedestrian, animal, tunnel, etc.
- A big vehicle is near such as a bus or truck.

- A motorcycle or bicycle is near.
- A flat trailer is near.
- If the vehicle has started at the same time as the vehicle next to you and has accelerated.
- When the other vehicle passes at a very fast speed.
- While changing lanes.
- When going down or up a steep road where the height of the lane is different.
- When the other vehicle approaches very close.
- When a trailer or carrier is installed.
- When the temperature of the rear bumper is very high or low.
- When the sensors are blocked by other vehicles, walls or parking-lot pillars.
- When the detected vehicle also moves back, as your vehicle drives back.
- If there are small things like Shopping cart, baby carriage and pedestrians.
- If there is low height vehicle like sport vehicle.
- When other vehicles are close to your vehicle.
- When the vehicle in the next lane moves two lanes away from you OR when the vehicle two lanes away moves to the next lane from you.
- When driving through a narrow road with many plants.
- When driving on wet surface.
- The vehicle is driven near areas containing metal substances such as a construction zone, railroad, etc.
- When the surrounding vehicle or structure is driving in a wide area (desert, field, suburb etc.)

**This device complies with Part 15 of the FCC rules.**

Operation is subject to the following two conditions:

1. This device may not cause harmful interference, and
2. This device must accept any interference received, including interference that may cause undesired operation.



## DRIVER ATTENTION WARNING (DAW) SYSTEM (IF EQUIPPED)

Driver Attention Warning (DAW) system is designed to warn the driver of potentially hazardous driving situations if it detects inattentive driving practices.

### System setting and activation

#### *System setting*

- Driver Attention Warning system is set in the OFF position when your vehicle is first delivered to you from the factory.
- To turn ON Driver Attention Warning system, turn on the engine, and then select 'User Settings → Driver Assistance → Driver Attention Warning → Normal/Early' on the LCD display.

- The driver can select Driver Attention Warning system mode.
  - Off : Driver Attention Warning system is deactivated.
  - Normal : Driver Attention Warning system alerts the driver of his/her fatigue level or inattentive driving practices.
  - Early : Driver Attention Warning system alerts the driver of his/her fatigue level or inattentive driving practices faster than Normal mode.
- The set-up of Driver Attention Warning system will be maintained when the engine is re-started.

### Display of the driver's attention level



OCK057137L



OCK057138L

- The driver can monitor their driving conditions on the LCD display.

- Select 'User Settings Mode' and then 'Driver Assistance' on the LCD display. (For more information, refer to "LCD Display" in chapter 4.)

- The driver's attention level is displayed on the scale of 1 to 5. The lower the number is, the more inattentive the driver is.
- The number decreases when the driver does not take a break for a certain period of time.
- The number increases when the driver attentively drives for a certain period of time.
- When the driver turns on the system while driving, it displays 'Last Break time'.

### Take a break



OCK057139L

- The "Consider taking a break" message appears on the LCD display and a warning sounds to suggest that the driver take a break when the driver's attention level is below 1.
- Driver Attention Warning system will not suggest a break when the total driving time is shorter than 10 minutes.

### Resetting the system



- The last break time is set to 00:00 and the driver's attention level is set to 5 (very attentive) when the driver resets Driver Attention Warning system.
- Driver Attention Warning system resets in the following situations.

- The engine is turned OFF.
- The driver unfastens the seat belt and then opens the driver's door.
- The driver takes a break from driving that lasts more than 10 minutes.
- The driver attention warning system operates again, when the driver restarts driving.

### System disabled

Driver Attention Warning system enters the ready status and displays the 'Disabled' screen in the following situations.

- The camera sensor is unable to detect the lanes.
- Driving speed remains under 37mph (60 km/h) or over 112 mph (180 km/h).

## System malfunction



When the “Check System” warning message appears, the system is not working properly. In this case, have the vehicle inspected by an authorized Kia dealer.

### **⚠ WARNING**

- Driver Attention Warning system is not a substitute for safe driving practices. It is the responsibility of the driver to always drive cautiously to prevent unexpected and sudden situations from occurring. Pay attention to the road conditions at all times.
- The driver who feels fatigued should take a break even though there is no break suggestion by Driver Attention Warning system.

### **\* NOTICE**

It may suggest a break according to the driver’s driving pattern or habits even if the driver doesn’t feel fatigued.

### **\* NOTICE**

Driver Attention Warning system utilizes the camera sensor on the front windshield for its operation. To keep the camera sensor in the best condition, you should observe the followings:

- Do not disassemble camera temporarily for tinted window or attaching any types of coatings and accessories. If you disassemble a camera and assemble it again, take your vehicle to an authorized Kia dealer and have the system checked to need a calibration.
- Do not locate any reflective objects (i.e. white paper, mirror) over the dashboard. Any light reflection may prevent Driver Attention Warning (DAW) system from functioning.
- Pay extreme caution to keep the camera sensor out of water.
- Do not disassemble the camera assembly or apply any impact on the camera assembly.
- Playing the vehicle audio system at high volume may offset Driver Attention Warning system warning sounds.

**\* NOTICE**

Driver Attention Warning system may not provide alerts in the following situations:

- The lane detection performance is limited. (For more information, refer to “Lane Keeping Assist (LKA) system” in this chapter.)
- The vehicle is driven erratically or is abruptly turned for obstacle avoidance (e.g. construction area, other vehicles, fallen objects, bumpy road).
- Forward drivability of the vehicle is severely undermined (possibly due to wide variation in tire pressures, uneven tire wear-out, toe-in/toe-out alignment).
- The vehicle drives on a curvy road.
- The vehicle drives on a bumpy road.
- The vehicle drives through a windy area.

(Continued)

(Continued)

- The vehicle is controlled by the following driving assist systems:
  - Lane Keeping Assist (LKA) system
  - Forward Collision-Avoidance Assist (FCA) System.
  - Smart Cruise Control (SCC) System

**\* NOTICE**

Driver Attention Warning (DAW) system does not detect actual driver fatigue or drowsiness. The system monitors driving and provides a warning if it detects inattentive driving practices.

## ECONOMICAL OPERATION

Your vehicle's fuel economy depends mainly on your style of driving, where you drive and when you drive.

Each of these factors affects how many miles (kilometers) you can get from a gallon (liter) of fuel. To operate your vehicle as economically as possible, use the following driving suggestions to help save money in both fuel and repairs:

- Drive smoothly. Accelerate at a moderate rate. Don't make "jack-rabbit" starts or full-throttle shifts and maintain a steady cruising speed. Don't race between stoplights. Try to adjust your speed to the traffic so you don't have to change speeds unnecessarily. Avoid heavy traffic whenever possible. Always maintain a safe distance from other vehicles so you can avoid unnecessary braking. This also reduces brake wear.
- Drive at a moderate speed. The faster you drive, the more fuel your vehicle uses. Driving at a moderate speed, especially on the highway, is one of the most effective ways to reduce fuel consumption.
- Don't "ride" the brake pedal. This can increase fuel consumption and also increase wear on these components. In addition, driving with your foot resting on the brake pedal may cause the brakes to overheat, which reduces their effectiveness and may lead to more serious consequences.
- Take care of your tires. Keep them inflated to the recommended pressure. Incorrect inflation, either too much or too little, results in unnecessary tire wear. Check the tire pressures at least once a month.
- Be sure that the wheels are aligned correctly. Improper alignment can result from hitting curbs or driving too fast over irregular surfaces. Poor alignment causes faster tire wear and may also result in other problems as well as greater fuel consumption.
- Keep your vehicle in good condition. For better fuel economy and reduced maintenance costs, maintain your vehicle in accordance with the maintenance schedule in chapter 7. If you drive your vehicle in severe conditions, more frequent maintenance is required (see chapter 7 for details).
- Keep your vehicle clean. For maximum service, your vehicle should be kept clean and free of corrosive materials. It is especially important that mud, dirt, ice, etc. not be allowed to accumulate on the underside of the vehicle. This extra weight can result in increased fuel consumption and also contribute to corrosion.
- Travel lightly. Don't carry unnecessary weight in your vehicle. Weight reduces fuel economy.
- Don't let the engine idle longer than necessary. If you are waiting (and not in traffic), turn off your engine and restart only when you're ready to go.

- Remember, your vehicle does not require extended warm-up. After the engine has started, allow the engine to run for 10 to 20 seconds prior to placing the vehicle in gear. In very cold weather, however, give your engine a slightly longer warm-up period.
- Don't "lug" or "over-rev" the engine. Lugging is driving too slowly in a very high gear resulting in engine bucking. If this happens, shift to a lower gear. Over-revving is racing the engine beyond its safe limit. This can be avoided by shifting at the recommended speed.
- Use your air conditioning sparingly. The air conditioning system is operated by engine power so your fuel economy is reduced when you use it.
- Open windows at high speeds can reduce fuel economy.
- Fuel economy is less in crosswinds and headwinds. To help offset some of this loss, slow down when driving in these conditions.

Keeping a vehicle in good operating condition is important both for economy and safety. Therefore, have an authorized Kia dealer perform scheduled inspections and maintenance.

 **WARNING - Engine off during motion**

**Never turn the engine off to coast down hills or anytime the vehicle is in motion. The power steering and power brakes will not function properly without the engine running. In addition, turning off the ignition while driving could lead to out of working power driven steering wheel and hard to control steering wheel. Keep the engine on and down-shift to an appropriate gear for an engine braking effect.**

## SPECIAL DRIVING CONDITIONS

### Hazardous driving conditions

When hazardous driving conditions are encountered such as water, snow, ice, mud, sand, or similar hazards, follow these suggestions:

- Drive cautiously and allow extra distance for braking.
- Avoid sudden braking or steering.
- When braking with non-ABS brakes pump the brake pedal with a light up-and-down motion until the vehicle is stopped.

Do not pump the brake pedal on a vehicle equipped with ABS.

- If stalled in snow, mud, or sand, use the second gear. Accelerate slowly to avoid spinning the drive wheels.
- Use sand, rock salt, or other non-slip material under the drive wheels to provide traction when stalled in ice, snow, or mud.

 **WARNING - Downshifting**  
**Do not downshift with an automatic transmission while driving on slippery surfaces. The sudden change in tire speed could cause the tires to skid and result in an accident.**

### Rocking the vehicle

If it is necessary to rock the vehicle to free it from snow, sand, or mud, first turn the steering wheel right and left to clear the area around your front wheels. Then, shift back and forth between R (Reverse) and any forward gear in vehicles equipped with an Automatic Transmission. Do not race the engine, and spin the wheels as little as possible. If you are still stuck after a few tries, have the vehicle pulled out by a tow vehicle to avoid engine overheating and possible damage to the transmission.

 **WARNING - Sudden Vehicle Movement**  
**Do not attempt to rock the vehicle if people or objects are nearby. The vehicle may suddenly move forward or backwards as it becomes unstuck.**



**⚠ CAUTION - Vehicle rocking**  
*Prolonged rocking may cause engine overheating, transmission damage or failure, and tire damage.*

**⚠ CAUTION - Spinning tires**  
*Do not spin the wheels, especially at speeds more than 35 mph (56 km/h). Spinning the wheels at high speeds when the vehicle is stationary could cause a tire to overheat which could result in tire damage that may injure bystanders.*

The ESC system should be turned OFF prior to rocking the vehicle.

### Smooth cornering

Avoid braking or gear changing in corners, especially when roads are wet. Ideally, corners should always be taken under gentle acceleration. If you follow these suggestions, tire wear will be held to a minimum.

### Driving at night



Because night driving presents more hazards than driving in the daylight, here are some important tips to remember:

- Slow down and keep more distance between you and other vehicles, as it may be more difficult to see at night, especially in areas where there may not be any street lights.

- Adjust your mirrors to reduce the glare from other driver's headlights.
- Keep your headlights clean and properly aimed. (On vehicles not equipped with the automatic headlight aiming feature.) Dirty or improperly aimed headlights will make it much more difficult to see at night.
- Avoid staring directly at the headlights of oncoming vehicles. You could be temporarily blinded, and it will take several seconds for your eyes to readjust to the darkness.

### Driving in the rain

Rain and wet roads can make driving dangerous, especially if you're not prepared for the slick pavement. Here are a few things to consider when driving in the rain:

- A heavy rainfall will make it harder to see and will increase the distance needed to stop your vehicle, so slow down.
  - Keep your windshield wiping equipment in good shape. Replace your windshield wiper blades when they show signs of streaking or missing areas on the windshield.
  - If your tires are not in good condition, making a quick stop on wet pavement can cause a skid and possibly lead to an accident. Be sure your tires are in good shape.
  - Turn on your headlights to make it easier for others to see you.
- Driving too fast through large puddles can affect your brakes. If you must go through puddles, try to drive through them slowly.
  - If you believe you may have gotten your brakes wet, apply them lightly while driving until normal braking operation returns.

## Driving in flooded areas

Avoid driving through flooded areas unless you are sure the water is no higher than the bottom of the wheel hub. Drive through any water slowly. Allow adequate stopping distance because brake performance may be affected.

After driving through water, dry the brakes by gently applying them several times while the vehicle is moving slowly.

## Driving off-road

Drive carefully off-road because your vehicle may be damaged by rocks or roots of trees. Become familiar with the off-road conditions where you are going to drive before you begin driving.

## Highway driving

### *Tires*

Adjust the tire inflation pressures to specification. Low tire inflation pressures will result in overheating and possible failure of the tires.

Avoid using worn or damaged tires which may result in reduced traction or tire failure.

Never exceed the maximum tire inflation pressure shown on the tires.

### **WARNING - Under/over inflated tires**

**Always check the tires for proper inflation before driving. Underinflated or overinflated tires can cause poor handling, loss of vehicle control, and sudden tire failure leading to accidents, injuries, and even death. For proper tire pressures, refer to "Tires and wheels" in chapter 8.**

 **WARNING - Tire tread**  
**Always check the tire tread before driving your vehicle. Worn-out tires can result in loss of vehicle control. Worn-out tires should be replaced as soon as possible. For further information and tread limits, refer to "Tires and wheels" in chapter 7.**

### *Fuel, engine coolant and engine oil*

High speed travel consumes more fuel than urban motoring. Do not forget to check both the engine coolant and engine oil.

### *Drive belt*

A loose or damaged drive belt may result in overheating of the engine.

## WINTER DRIVING

Severe weather conditions in the winter result in greater wear and other problems. To minimize the problems of winter driving, you should follow these suggestions:

### **WARNING - Driving with summer tires**

Summer tires are equipped to provide the best driving performance on dry roads, varying according to specification.

Do not use summer tires at temperatures below 45°F (7°C) or when driving on snow or ice. At temperatures below 45°F (7°C), summer tires can lose elasticity, and therefore traction and braking power as well. Change the tires on your vehicle to winter or all-weather tires of the same size as the standard tires of the vehicle. Both types of tires are identified by the M+S (Mud and Snow) marking. Using summer tires at very cold temperatures could cause cracks to form, thereby damaging the tires permanently.

### **Snowy or icy conditions**

To drive your vehicle in deep snow, it may be necessary to use snow tires or to install tire chains on your tires. If snow tires are needed, it is necessary to select tires equivalent in size and type of the original equipment tires. Failure to do so may adversely affect the safety and handling of your vehicle. Furthermore, speeding, rapid acceleration, sudden brake applications, and sharp turns are potentially very hazardous practices.

During deceleration, use engine braking to the fullest extent. Sudden brake applications on snowy or icy roads may cause skids to occur. You need to keep sufficient distance between the vehicle in operation in front of your vehicle. Also, apply the brake gently. It should be noted that installing tire chains on the tire will provide a greater driving force, but will not prevent side skids.

Tire chains are not legal in all states. Check state laws before fitting tire chains.

### **Snow tires**

If you mount snow tires on your vehicle, make sure they are radial tires of the same size and load range as the original tires. Mount snow tires on all four wheels to balance your vehicle's handling in all weather conditions. Keep in mind that the traction provided by snow tires on dry roads may not be as high as your vehicle's original equipment tires. You should drive cautiously even when the roads are clear. Check with the tire dealer for maximum speed recommendations.

*Do not install studded tires without first checking local, state and municipal regulations for possible restrictions against their use.*

### **WARNING - Snow tire size**

**Snow tires should be equivalent in size and type to the vehicle's standard tires. Otherwise, the safety and handling of your vehicle may be adversely affected.**

### Tire chains



Since the sidewalls on some radial tires are thinner than other types of tires, they may be damaged by mounting certain types of tire chains on them. Therefore, the use of snow tires is recommended instead of tire chains. Do not mount tire chains on vehicles equipped with aluminum wheels; if unavoidable, use AutoSock (fabric snow chain). Install the tire chain after reviewing the instructions provided with the tire chains.

Damage to your vehicle caused by improper tire chain use is not covered by your vehicle manufacturer's warranty.

### \* NOTICE

- Install AutoSock (fabric snow chain) on the rear tires for 2WD vehicles or for AWD vehicles. It should be noted that installing AutoSock (fabric snow chain) on the tires will provide a greater driving force, but will not prevent side skids.
- Do not install studded tires without first checking local and municipal regulations for possible restrictions against their use.

### ⚠ CAUTION

*When using AutoSock (fabric snow chain):*

- *Wrong size chains or improperly installed chains can damage your vehicle's brake lines, suspension, body and wheels.*
- *To prevent body damage, retighten the chains after driving 0.3 ~ 0.6 miles (0.5 ~ 1.0 km).*

### \* NOTICE

If you hear noise caused by chains contacting the body, retighten the chain to prevent contact with the vehicle body.

### Chain installation

When installing AutoSock (fabric snow chain), follow the manufacturer's instructions and mount them as tightly as possible. Drive slowly (less than 20 mph (30 km/h)) with chains installed. If you hear the chains contacting the body or chassis, stop and tighten them. If they still make contact, slow down until the noise stops. Remove the AutoSock (fabric snow chain) as soon as you begin driving on cleared roads.

When mounting snow chains, park the vehicle on level ground away from traffic. Turn on the vehicle Hazard Warning flashers and place a triangular emergency warning device behind the vehicle if available. Always place the vehicle in P (Park), apply the parking brake and turn off the engine before installing snow chains.

- The use of chains may adversely affect vehicle handling.
- Do not exceed 20 mph (30 km/h) or the chain manufacturer's recommended speed limit, whichever is lower.
- Drive carefully and avoid bumps, holes, sharp turns, and other road hazards, which may cause the vehicle to bounce.
- Avoid sharp turns or locked-wheel braking.



#### **CAUTION - Snow chains**

- ***Chains that are the wrong size or improperly installed can damage your vehicle's brake lines, suspension, body and wheels.***
- ***Stop driving and retighten the chains any time you hear them hitting the vehicle.***

### Use high quality ethylene glycol coolant

Your vehicle is delivered with high quality ethylene glycol coolant in the cooling system. It is the only type of coolant that should be used because it helps prevent corrosion in the cooling system, lubricates the water pump and prevents freezing. Be sure to replace or replenish your coolant in accordance with the maintenance schedule in chapter 7. Before winter, have your coolant tested to assure that its freezing point is sufficient for the temperatures anticipated during the winter.

### Check battery and cables

Winter puts additional burdens on the battery system. Visually inspect the battery and cables as described in chapter 7. The level of charge in your battery can be checked by an authorized Kia dealer or a service station.

### **Change to "winter weight" oil if necessary**

In some climates it is recommended that a lower viscosity "winter weight" oil be used during cold weather. See chapter 8 for recommendations. If you aren't sure what weight oil you should use, consult an authorized Kia dealer.

### **Check spark plugs and ignition system**

Inspect your spark plugs as described in chapter 7 and replace them if necessary. Also check all ignition wiring and components to be sure they are not cracked, worn or damaged in any way.

### **To keep locks from freezing**

To keep the locks from freezing, squirt an approved de-icer fluid or glycerine into the key opening. If a lock is covered with ice, squirt it with an approved de-icing fluid to remove the ice. If the lock is frozen internally, you may be able to thaw it out by using a heated key. Handle the heated key with care to avoid injury.

### **Use approved window washer anti-freeze in system**

To keep the water in the window washer system from freezing, add an approved window washer anti-freeze solution in accordance with instructions on the container. Window washer anti-freeze is available from an authorized Kia dealer and most auto parts outlets. Do not use engine coolant or other types of anti-freeze as these may damage the paint finish.

### **Don't let your parking brake freeze**

Under some conditions your parking brake can freeze in the engaged position. This is most likely to happen when there is an accumulation of snow or ice around or near the rear brakes or if the brakes are wet. If there is a risk the parking brake may freeze, apply it only temporarily while you put the gear shift lever in P (Park, Automatic Transmission) and block the rear wheels so the vehicle cannot roll. Then release the parking brake.

### **Don't let ice and snow accumulate underneath**

Under some conditions, snow and ice can build up under the fenders and interfere with the steering. When driving in severe winter conditions where this may happen, you should periodically check underneath the vehicle to be sure the movement of the front wheels and the steering components are not obstructed.

### **Carry emergency equipment**

Depending on the severity of the weather, you should carry appropriate emergency equipment. Some of the items you may want to carry include tow straps or chains, flashlight, emergency flares, sand, shovel, jumper cables, window scraper, gloves, ground cloth, coveralls, blanket, etc.

## **TRAILER TOWING**

**We do not recommend using this vehicle for trailer towing.**



# VEHICLE LOAD LIMIT

## Tire and loading information label

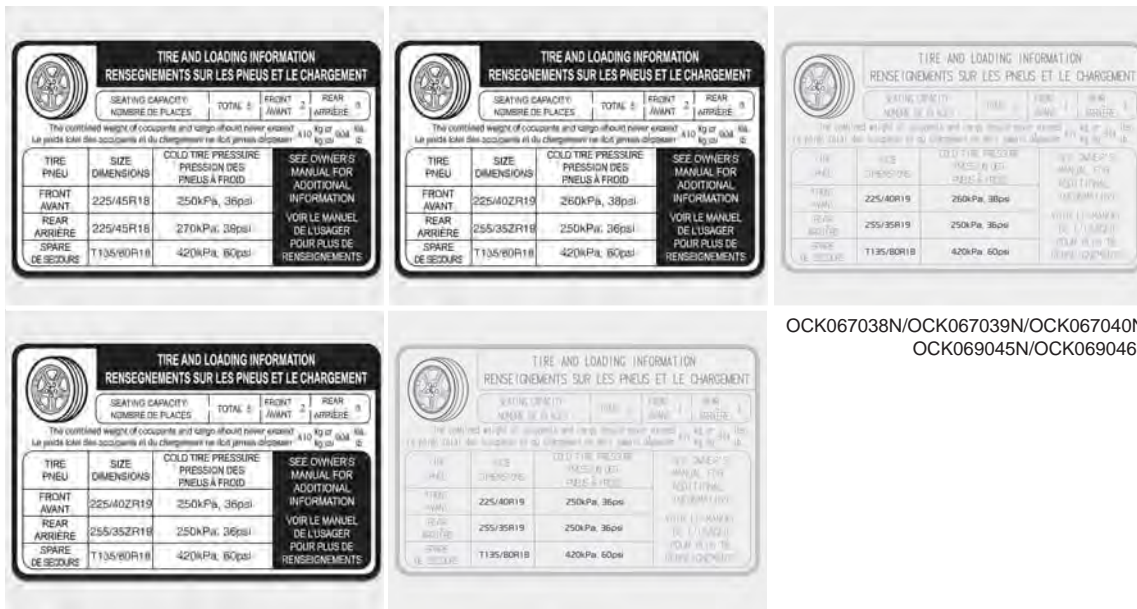

OCK067038N/OCK067039N/OCK067040N/  
OCK069045N/OCK069046N

The label located on the driver's door sill gives the original tire size, cold tire pressures recommended for your vehicle, the number of people that can be in your vehicle and vehicle capacity weight.

**Vehicle capacity weight:**

904 lbs. (410 kg)

Vehicle capacity weight is the maximum combined weight of occupants and cargo. If your vehicle is equipped with a trailer, the combined weight includes the tongue load.

**Seating capacity:**

Total : 5 persons

(Front seat : 2 persons,  
Rear seat : 3 persons)

Seating capacity is the maximum number of occupants including a driver, your vehicle may carry.

However, the seating capacity may be reduced based upon the weight of all of the occupants, and the weight of the cargo being carried or towed.

Do not overload the vehicle as there is a limit to the total weight, or load limit including occupants and cargo, the vehicle can carry.

**Towing capacity:**

**We do not recommend using this vehicle for trailer towing.**

**Cargo capacity:**

The cargo capacity of your vehicle will increase or decrease depending on the weight and the number of occupants.

**Steps For Determining Correct Load Limit -**

1. Locate the statement "The combined weight of occupants and cargo should never exceed XXX kg or XXX lbs." on your vehicle's placard.
2. Determine the combined weight of the driver and passengers that will be riding in your vehicle.
3. Subtract the combined weight of the driver and passengers from XXX kg or XXX lbs.
4. The resulting figure equals the available amount of cargo and luggage load capacity. For example, if the "XXX" amount equals 1400 lbs. and there will be five 150 lb passengers in your vehicle, the amount of available cargo and luggage load capacity is 650 lbs.  
(1400-750 (5 x 150) = 650 lbs.)

5. Determine the combined weight of luggage and cargo being loaded on the vehicle. That weight may not safely exceed the available cargo and luggage load capacity calculated in Step 4.
6. If your vehicle will be towing a trailer, load from your trailer will be transferred to your vehicle. Consult this manual to determine how this reduces the available cargo and luggage load capacity of your vehicle.

 **WARNING - Loose cargo**

**Do not travel with unsecured blunt objects in the passenger compartment of your vehicle (e.g. suit cases or unsecured child seats). These items may strike occupant during a sudden stop or crash.**

**Example 1**

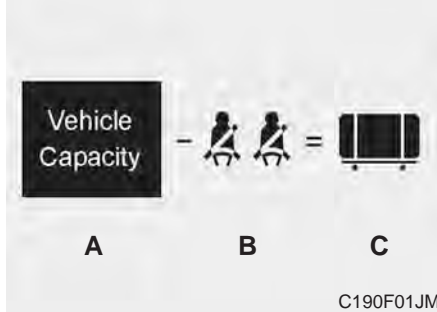

Item	Description	Total
A	Vehicle Capacity Weight	849 lbs (385 kg)
B	Subtract Occupant Weight 150 lbs (68 kg) × 2	300 lbs (136 kg)
C	Available Cargo and Luggage weight	549 lbs (249 kg)

**Example 2**

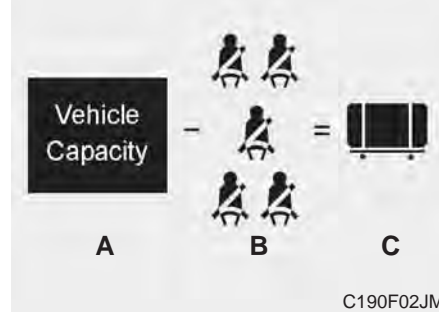

Item	Description	Total
A	Vehicle Capacity Weight	849 lbs (385 kg)
B	Subtract Occupant Weight 150 lbs (68 kg) × 5	750 lbs (340 kg)
C	Available Cargo and Luggage weight	99 lbs (45 kg)

**Example 3**

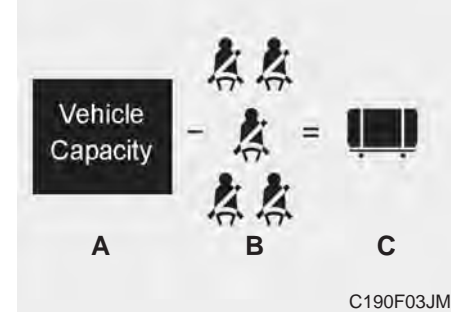

Item	Description	Total
A	Vehicle Capacity Weight	849 lbs (385 kg)
B	Subtract Occupant Weight 161 lbs (73 kg) × 5	805 lbs (365 kg)
C	Available Cargo and Luggage weight	44 lbs (20 kg)

Refer to your vehicle's tire and loading information label for specific information about your vehicle's capacity weight and seating positions. The combined weight of the driver, passengers and cargo should never exceed your vehicle's capacity weight.

### Certification label



The certification label is located on the driver's door sill at the center pillar.

This label shows the maximum allowable weight of the fully loaded vehicle. This is called the GVWR (Gross Vehicle Weight Rating). The GVWR includes the weight of the vehicle, all occupants, fuel and cargo.

This label also tells you the maximum weight that can be supported by the front and rear axles, called Gross Axle Weight Rating (GAWR).

To find out the actual loads on your front and rear axles, you need to go to a weigh station and weigh your vehicle. Your dealer can help you with this. Be sure to spread out your load equally on both sides of the centerline.

**⚠ WARNING - Over loading**  
Never exceed the GVWR for your vehicle, the GAWR for either the front or rear axle and vehicle capacity weight. Exceeding these ratings can affect your vehicle's handling and braking ability.

The label will help you decide how much cargo and installed equipment your vehicle can carry.

If you carry items inside your vehicle - like suitcases, tools, packages, or anything else - they are moving as fast as the vehicle. If you have to stop or turn quickly, or if there is a crash, the items will keep going and can cause an injury if they strike the driver or a passenger.

**⚠ WARNING - Over loading**  
Do not overload your vehicle. Overloading your vehicle can cause heat buildup in your vehicle's tires and possible tire failure, increased stopping distances and poor vehicle handling--all of which may result in a crash.

### \* NOTICE

Overloading your vehicle may cause damage. Repairs would not be covered by your warranty. Do not overload your vehicle.

## VEHICLE WEIGHT

This chapter will guide you in the proper loading of your vehicle and/or trailer, to keep your loaded vehicle weight within its design rating capability, with or without a trailer. Properly loading your vehicle will provide maximum return of the vehicle design performance. Before loading your vehicle, familiarize yourself with the following terms for determining your vehicle's weight ratings, with or without a trailer, from the vehicle's specifications and the compliance label:

### Base curb weight

This is the weight of the vehicle including a full tank of fuel and all standard equipment. It does not include passengers, cargo, or optional equipment.

### Vehicle curb weight

This is the weight of your new vehicle when you picked it up from your dealer plus any aftermarket equipment.

### Cargo weight

This figure includes all weight added to the Base Curb Weight, including cargo and optional equipment.

### GAW (Gross axle weight)

This is the total weight placed on each axle (front and rear) - including vehicle curb weight and all payload.

### GAWR (Gross axle weight rating)

This is the maximum allowable weight that can be carried by a single axle (front or rear). These numbers are shown on the compliance label. The total load on each axle must never exceed its GAWR.

### GVW (Gross vehicle weight)

This is the Base Curb Weight plus actual Cargo Weight plus passengers.

### GVWR (Gross vehicle weight rating)

This is the maximum allowable weight of the fully loaded vehicle (including all options, equipment, passengers and cargo). The GVWR is shown on the certification label located on the driver's door sill.

# What to do in an emergency

Road warning . . . . .	6-2
• Hazard warning flasher . . . . .	6-2
In case of an emergency while driving. . . . .	6-3
• If the engine stalls at a crossroad or crossing. . . . .	6-3
• If you have a flat tire while driving. . . . .	6-3
• If the engine stalls while driving . . . . .	6-3
If the engine will not start . . . . .	6-4
• If engine doesn't turn over or turns over slowly . . . .	6-4
• If engine turns over normally but does not start . . . .	6-4
Emergency starting . . . . .	6-5
• Jump starting. . . . .	6-5
• Push-starting . . . . .	6-6
If the engine overheats. . . . .	6-7
Tire Pressure Monitoring System (TPMS) . . . . .	6-8
• Check tire pressure . . . . .	6-8
• Low tire pressure telltale . . . . .	6-10
• Changing a tire with TPMS. . . . .	6-12
If you have a flat tire (with spare tire). . . . .	6-14
• Jack and tools . . . . .	6-14
• Removing and storing the spare tire. . . . .	6-15
• Changing tires . . . . .	6-16

If you have a flat tire (with Tire Mobility Kit) . .	6-23
• Introduction . . . . .	6-24
• Notes on the safe use of the Tire Mobility Kit . . . . .	6-25
• Components of the Tire Mobility Kit (TMK). . . . .	6-26
• Using the Tire Mobility Kit . . . . .	6-27
• Distributing the sealant. . . . .	6-30
• Checking the tire inflation pressure . . . . .	6-31
• Technical Data . . . . .	6-31
Towing . . . . .	6-33
• Towing service . . . . .	6-33
• Removable towing hook . . . . .	6-35
• Emergency towing. . . . .	6-35

## ROAD WARNING

### Hazard warning flasher

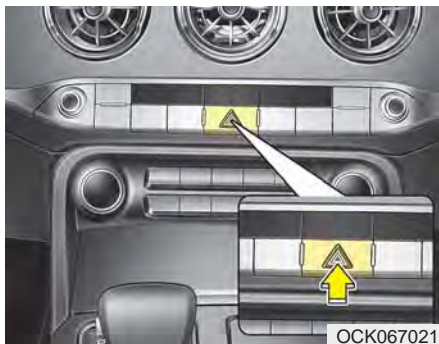

- The hazard warning flasher operates whether your vehicle is running or not.
- The turn signals do not work when the hazard flasher is on.
- Care must be taken when using the hazard warning flasher while the vehicle is being towed.

The hazard warning flasher serves as a warning to other drivers to exercise extreme caution when approaching, overtaking, or passing your vehicle.

It should be used whenever emergency repairs are being made or when the vehicle is stopped near the edge of a roadway.

Depress the flasher switch with the ignition switch in any position. The flasher switch is located in the center fascia panel. All turn signal lights will flash simultaneously.



## IN CASE OF AN EMERGENCY WHILE DRIVING

### If the engine stalls at a cross-road or crossing

If the engine stalls at a crossroad or crossing, set the shift lever in the N (Neutral) position and then push the vehicle to a safe place.

### If you have a flat tire while driving

If a tire goes flat while you are driving:

1. Take your foot off the accelerator pedal and let the vehicle slow down while driving straight ahead. Do not apply the brakes immediately or attempt to pull off the road as this may cause a loss of control. When the vehicle has slowed to such a speed that it is safe to do so, brake carefully and pull off the road. Drive off the road as far as possible and park on firm level ground. If you are on a divided highway, do not park in the median area between the two traffic lanes.

2. When the vehicle is stopped, turn on your emergency hazard flashers, set the parking brake and put the transmission in P.
3. Have all passengers get out of the vehicle. Be sure they all get out on the side of the vehicle that is away from traffic.
4. When changing a flat tire, follow the instruction provided later in this section.

### If the engine stalls while driving

1. Reduce your speed gradually, keeping a straight line. Move cautiously off the road to a safe place.
2. Turn on your emergency flashers.
3. Try to start the engine again. If your vehicle will not start, contact an authorized Kia dealer or seek other qualified assistance.

### \* NOTICE

**If there was a check engine light and loss of power or stall and if safe to do so, wait at least 10 seconds to restart the vehicle after it stalls. This may reset the car so it will no longer run at low power (limp home) condition.**

## IF THE ENGINE WILL NOT START

### If engine doesn't turn over or turns over slowly

1. Be sure the shift lever is in N (Neutral) or P (Park) and the emergency brake is set.
2. Check the battery connections to be sure they are clean and tight.
3. Turn on the interior light. If the light dims or goes out when you operate the starter, the battery is discharged.
4. Check the starter connections to be sure they are securely tightened.
5. Do not push or pull the vehicle to start it. See instructions for "Jump starting".



### **WARNING - Push/ pull start**

**Do not push or pull the vehicle to start it. Push or pull starting may cause the catalytic converter to overload and create a fire hazard.**

### If engine turns over normally but does not start

1. Check the fuel level.
2. With the Engine Start/Stop Button in the OFF position, check all connectors at the ignition coils and spark plugs. Reconnect any that may be disconnected or loose.
3. Check the fuel line in the engine compartment.
4. If the engine still does not start, call an authorized Kia dealer or seek other qualified assistance.

## EMERGENCY STARTING

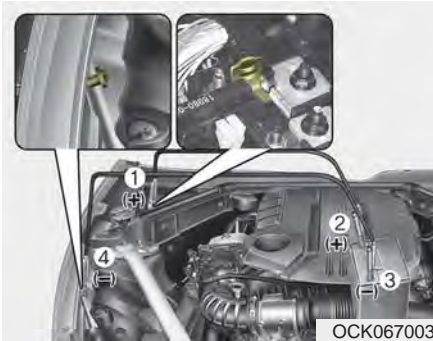

OCK067003

Connect cables in numerical order and disconnect in reverse order.

### Jump starting

Jump starting can be dangerous if done incorrectly. Therefore, to avoid harm to yourself or damage to your vehicle or battery, follow these jump starting procedures. If in doubt, we strongly recommend that you have a competent technician or towing service jump start your vehicle.

#### **⚠ CAUTION - Push/pull start to 12 Volt Battery**

*Use only a 12-volt jumper system. You can damage a 12-volt starting motor, ignition system, and other electrical parts beyond repair by use of a 24-volt power supply (either two 12-volt batteries in series or a 24-volt motor generator set).*

#### **⚠ WARNING - Battery**

Never attempt to check the electrolyte level of the battery as this may cause the battery to rupture or explode.

#### **⚠ WARNING - Frozen batteries**

Do not attempt to jump start the vehicle if the discharged battery is frozen or if the electrolyte level is low as the battery may rupture or explode.

#### **⚠ WARNING - Battery**

Keep all flames or sparks away from the battery. The battery produces hydrogen gas which will explode if exposed to flame or sparks.

#### **⚠ WARNING - Sulfuric acid risk**

When jump starting your vehicle, be careful not to get acid on yourself, your clothing or on the vehicle. Automobile batteries contain sulfuric acid. This is poisonous and highly corrosive.

### ***Jump starting procedure***

1. Make sure the booster battery is 12-volt and that its negative terminal is grounded.
2. If the booster battery is in another vehicle, do not allow the vehicles to come in contact.
3. Turn off all unnecessary electrical loads.
4. Connect the jumper cables in the exact sequence shown in the illustration. First connect one end of a jumper cable to the positive terminal of the discharged battery (1), then connect the other end to the positive terminal of the booster battery (2).

Proceed to connect one end of the other jumper cable to the negative terminal of the booster battery (3), then the other end to a solid, stationary, metallic point (for example, the engine lifting bracket) away from the battery (4). Do not connect it to or near any part that moves when the engine is cranked.

Do not allow the jumper cables to contact anything except the correct battery terminals or the correct ground. Do not lean over the battery when making connections.

### **WARNING - Battery cables**

**Do not connect the jumper cable from the negative terminal of the booster battery to the negative terminal of the discharged battery. This can cause the discharged battery to overheat and crack, releasing battery acid.**

**Make sure to connect one end of the jumper cable to the negative terminal of the booster battery, and the other end to a metallic point, far away from the battery.**

5. Start the engine of the vehicle with the booster battery and let it run at 2,000 rpm, then start the engine of the vehicle with the discharged battery.

*If the cause of your battery discharging is not apparent, you should have your vehicle checked by an authorized Kia dealer.*

### **Push-starting**

Vehicles equipped with automatic transmission lock system cannot be push-started.

Follow the directions in this section for jump-starting.

### **WARNING - Tow starting vehicle**

**Never tow a vehicle to start it. When the engine starts, the vehicle can suddenly surge forward and could cause a collision with the tow vehicle.**

## IF THE ENGINE OVERHEATS

If your temperature gauge indicates overheating, you experience a loss of power, or hear loud pinging or knocking, the engine will probably be too hot. If this happens, you should:

1. Pull off the road and stop as soon as it is safe to do so.
2. Place the shift lever in P and set the parking brake. If the air conditioning is on, turn it off.
3. If engine coolant is running out under the vehicle or steam is coming out from underneath the hood, stop the engine. Do not open the hood until the coolant has stopped running or the steaming has stopped. If there is no visible loss of engine coolant and no steam, leave the engine running and check to be sure the engine cooling fan is operating. If the fan is not running, turn the engine off.

4. Check to see if the water pump drive belt is missing. If it is not missing, check to see that it is tight. If the drive belt seems to be satisfactory, check for coolant leaking from the radiator, hoses or under the vehicle. (If the air conditioning had been in use, it is normal for cold water to be draining from it when you stop).

### **WARNING - Under the hood**



**While the engine is running, keep hair, hands and clothing away from moving parts such as the fan and drive belts to prevent injury.**

5. If the water pump drive belt is broken or engine coolant is leaking out, stop the engine immediately and call the nearest authorized Kia dealer for assistance.

### **WARNING - Radiator cap**



**Do not remove the radiator cap when the engine is hot. This may result in coolant being blown out of the opening and cause serious burns.**

6. If you cannot find the cause of the overheating, wait until the engine temperature has returned to normal. If coolant has been lost, carefully add coolant to the reservoir to bring the fluid level in the reservoir up to the halfway mark.
7. Proceed with caution, keeping alert for further signs of overheating. If overheating happens again, call an authorized Kia dealer for assistance.

Serious loss of coolant indicates there is a leak in the cooling system and this should be checked as soon as possible by an authorized Kia dealer.

## TIRE PRESSURE MONITORING SYSTEM (TPMS)

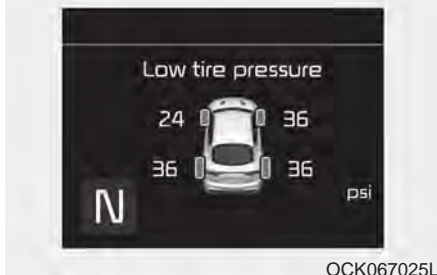
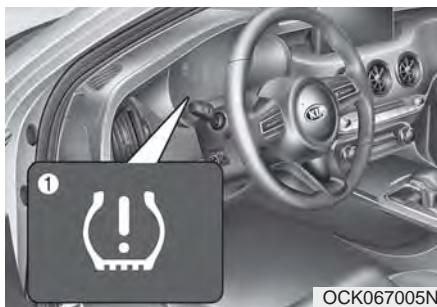

### Check tire pressure

- You can check the tire pressure in the information mode on the cluster.
  - Refer to “User settings mode” in chapter 4.
- Tire pressure is displayed 1~2 minutes later after driving.
- If tire pressure is not displayed when the vehicle is stopped, “Drive to display” message displays. After driving, check the tire pressure.
- You can change the tire pressure unit in the user settings mode on the cluster.
  - psi, kpa, bar (Refer to “User settings mode” in chapter 4).

### \* NOTICE

- The tire pressure may change due to factors such as parking condition, driving style, and altitude above sea level.
- Low tire pressure warning may sound when a tire’s pressure unit is equal or higher than nearby tires. This is a normal occurrence, which is due to the change in tire pressure along with tire temperature.
- The tire pressure shown on the dashboard may differ from the tire pressure measured by tire pressure gauge.

- (1) Low tire pressure telltale/  
TPMS malfunction indicator
- (2) Low tire pressure position telltale  
(Shown on the LCD display)

Each tire, including the spare (if provided), should be checked monthly when cold and inflated to the inflation pressure recommended by the vehicle manufacturer on the vehicle placard or tire inflation pressure label. (If your vehicle has tires of a different size than the size indicated on the vehicle placard or tire inflation pressure label, you should determine the proper tire inflation pressure for those tires.)

As an added safety feature, your vehicle has been equipped with a tire pressure monitoring system (TPMS) that illuminates a low tire pressure telltale when one or more of your tires is significantly under-inflated. Accordingly, when the low tire pressure telltale illuminates, you should stop and check your tires as soon as possible, and inflate them to the proper pressure. Driving on a significantly under-inflated tire causes the tire to overheat and can lead to tire failure. Under-inflation also reduces fuel efficiency and tire tread life, and may affect the vehicle's handling and stopping ability.

Please note that the TPMS is not a substitute for proper tire maintenance, and it is the driver's responsibility to maintain correct tire pressure, even if under-inflation has not reached the level to trigger illumination of the TPMS low tire pressure telltale.

Your vehicle has also been equipped with a TPMS malfunction indicator to indicate when the system is not operating properly. The TPMS malfunction indicator is combined with the low tire pressure telltale. When the system detects a malfunction, the telltale will flash for approximately one minute and then remain continuously illuminated. This sequence will continue upon subsequent vehicle start-ups as long as the malfunction exists. When the malfunction indicator is illuminated, the system may not be able to detect or signal low tire pressure as intended. TPMS malfunctions may occur for a variety of reasons, including the installation of replacement or alternate tires or wheels on the vehicle that prevent the TPMS from functioning properly.

Always check the TPMS malfunction telltale after replacing one or more tires or wheels on your vehicle to ensure that the replacement or alternate tires and wheels allow the TPMS to continue to function properly.

**\* NOTICE**

If the TPMS, Low Tire Pressure indicator does not illuminate for 3 seconds when the Engine Start/Stop button is turned to the ON, or engine is running, or if they remain illuminated after coming on for approximately 3 seconds, take your vehicle to your nearest authorized Kia dealer and have the system checked.

**Low tire pressure telltale**

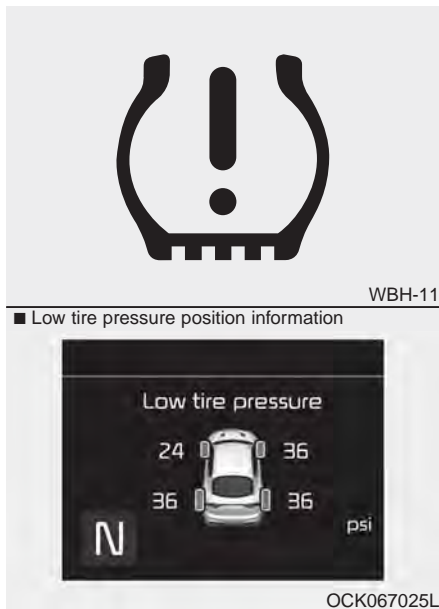

When the tire pressure monitoring system warning indicators are illuminated, one or more of your tires is significantly under-inflated.

If the telltale illuminates, immediately reduce your speed, avoid hard cornering and anticipate increased stopping distances. You should stop and check your tires as soon as possible.

Inflate the tires to the proper pressure as indicated on the vehicle's placard or tire inflation pressure label located on the driver's side center pillar outer panel. If you cannot reach a service station or if the tire cannot hold the newly added air, replace the low pressure tire with the spare tire.

Then the TPMS malfunction indicator and the Low Tire Pressure telltale may turn on and illuminate after restarting and about 20 minutes of continuous driving before you have the low pressure tire repaired and replaced on the vehicle.

In winter or cold weather, the low tire pressure telltale may be illuminated if the tire pressure was adjusted to the recommended tire inflation pressure in warm weather. It does not mean your TPMS is malfunctioning because the decreased temperature leads to a proportional lowering of tire pressure.



When you drive your vehicle from a warm area to a cold area or from a cold area to a warm area, or the outside temperature is greatly higher or lower, you should check the tire inflation pressure and adjust the tires to the recommended tire inflation pressure.

When filling tires with more air, conditions to turn off the low tire pressure telltale may not be met. This is because a tire inflator has a margin of error in performance. The low tire pressure telltale will be turned off if the tire pressure is above the recommended tire inflation pressure.

**⚠ WARNING - Low pressure damage**

**Do not drive on low pressure tires. Significantly low tire pressure can cause the tires to overheat and fail making the vehicle unstable resulting in increased braking distances and a loss of vehicle control.**



***TPMS (Tire Pressure Monitoring System) malfunction indicator***

The low tire pressure telltale will illuminate after it blinks for approximately one minute when there is a problem with the Tire Pressure Monitoring System. If the system is able to correctly detect an underinflation warning at the same time as system failure then it will illuminate both the TPMS malfunction and low tire pressure position telltales e.g. if Front Left sensor fails, the TPMS malfunction indicator illuminates, but if the Front Right, Rear Left, or Rear Right tire is under-inflated, the low tire pressure position telltales may illuminate together with the TPMS malfunction indicator.

Have the system checked by an authorized Kia dealer as soon as possible to determine the cause of the problem.

- The TPMS malfunction indicator may be illuminated if the vehicle is moving around electric power supply cables or radios transmitters such as at police stations, government and public offices, broadcasting stations, military installations, airports, or transmitting towers, etc. This can interfere with normal operation of the Tire Pressure Monitoring System (TPMS).
- The TPMS malfunction indicator may be illuminated if snow chains are used or some separate electronic devices such as notebook computer, mobile charger, remote starter or navigation etc., are used in the vehicle. This can interfere with normal operation of the Tire Pressure Monitoring System (TPMS).

### Changing a tire with TPMS

If you have a flat tire, the Low Tire Pressure telltale will come on. Have the flat tire repaired by an authorized Kia dealer as soon as possible or replace the flat tire with the spare tire.



#### **CAUTION - Repair Agents**

***Never use a puncture-repairing agent not approved by Kia to repair and/or inflate a low pressure tire. The sealant not approved by Kia may damage the tire pressure sensor.***

Each wheel is equipped with a tire pressure sensor mounted inside the tire behind the valve stem. You must use TPMS specific wheels. It is recommended that you always have your tires serviced by an authorized Kia dealer.

Even if you replace the low pressure tire with the spare tire, the Low Tire Pressure telltale will remain on until the low pressure tire is repaired and placed on the vehicle.

After you replace the low pressure tire with the spare tire, the TPMS malfunction indicator may illuminate after a few minutes because the TPMS sensor mounted on the spare wheel is not initiated.

Once the low pressure tire is inflated again to the recommended pressure and installed on the vehicle or the TPMS sensor mounted on the replaced spare wheel is initiated by an authorized Kia dealer, the TPMS malfunction indicator and the low tire pressure telltale will turn off within a few minutes of driving.

If the indicator has not disappeared after a few minutes of driving, please visit an authorized Kia dealer.

If an original mounted tire is replaced with the spare tire, the TPMS sensor on the replaced spare wheel should be initiated and the TPMS sensor on the original mounted wheel should be deactivated. If the TPMS sensor on the original mounted wheel located in the spare tire carrier still activates, the tire pressure monitoring system may not operate properly. Have the tire with TPMS serviced or replaced by an authorized Kia dealer.

You may not be able to identify a low tire by simply looking at it. Always use a good quality tire pressure gauge to measure the tire's inflation pressure. Please note that a tire that is hot (from being driven) will have a higher pressure measurement than a tire that is cold (from sitting stationary for at least 3 hours and driven less than 1 mile (1.6 km) during that 3 hour period).

Allow the tire to cool before measuring the inflation pressure. Always be sure the tire is cold before inflating to the recommended pressure.

A cold tire means the vehicle has been sitting for 3 hours and driven for less than 1 mile (1.6 km) in that 3 hour period.

Never use tire sealant if your vehicle is equipped with a Tire Pressure Monitoring System. The liquid sealant not approved by Kia may damage the tire pressure sensors.

- The TPMS cannot alert you to severe and sudden tire damage caused by external factors such as nails or road debris.
- If you feel any vehicle instability, immediately take your foot off the accelerator, apply the brakes gradually and with light force, and slowly move to a safe position off the road.

**\* NOTICE - Protecting TPMS**

**Tampering with, modifying, or disabling the Tire Pressure Monitoring System (TPMS) components may interfere with the system's ability to warn the driver of low tire pressure conditions and/or TPMS malfunctions. Tampering with, modifying, or disabling the Tire Pressure Monitoring System (TPMS) components may void the warranty for that portion of the vehicle.**

**This device complies with Part 15 of the FCC rules.**

Operation is subject to the following two conditions:

1. This device may not cause harmful interference, and
2. This device must accept any interference received, including interference that may cause undesired operation.

## IF YOU HAVE A FLAT TIRE (WITH SPARE TIRE)

### Jack and tools

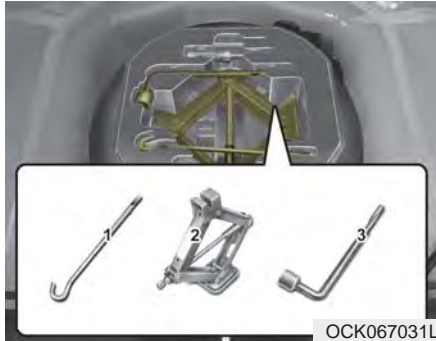

The jack and wheel lug nut wrench are stored in the luggage compartment.

Remove the panel indicated in the illustration.

- (1) Jack handle
- (2) Jack
- (3) Wheel lug nut wrench

### Jacking instructions

The jack is provided for emergency tire changing only.

To prevent the jack from “rattling” while the vehicle is in motion, store it properly.

Follow jacking instructions to reduce the possibility of personal injury.

#### **⚠ WARNING - Tire Jack**

**Do not place any portion of your body under a vehicle that is only supported by a jack since the vehicle can easily roll off the jack. Use vehicle support stands.**

#### **⚠ WARNING - Changing tires**

**Never attempt vehicle repairs in the traffic lanes of a public road or highway.**

- Always move the vehicle completely off the road and onto the shoulder before trying to change a tire. The jack should be used on a firm level ground. If you cannot find a firm, level place off the road, call a towing service company for assistance.
- Be sure to use the correct front and rear jacking positions on the vehicle; never use the bumpers or any other part of the vehicle for jack support.
- Do not allow anyone to remain in the vehicle while it is on the jack.
- Make sure any children present are in a secure place away from the road and from the vehicle to be raised with the jack.

#### **⚠ WARNING - Running vehicle on jack**

**Do not start or run the engine of the vehicle while the vehicle is on the jack as this may cause the vehicle to fall off the jack.**

## Removing and storing the spare tire



Turn the tire hold-down wing bolt counterclockwise.

Store the tire in the reverse order of removal.

To prevent the spare tire and tools from “rattling” while the vehicle is in motion, store them properly.



If it is hard to loosen the tire hold-down wing bolt by hand, you can loosen it easily using the jack handle.

1. Put the jack handle (1) inside of the tire hold-down wing bolt.
2. Turn the tire hold-down wing bolt counterclockwise with the jack handle.

Use caution when utilizing the sharp jack handle.

## **⚠ WARNING - Touching luggage room floor surface**



**Do not touch luggage room metal surface while the engine is operating or hot. Doing so could result in serious personal injury.**

**Turn the engine off and wait until it cools down or wear gloves to remove the spare tire from the luggage room.**

## Changing tires



1. Park on a level surface and apply the parking brake firmly.
2. Place the transmission shift lever in P (Park).
3. Activate the hazard warning flashers.



4. Remove the wheel lug nut wrench, jack and spare tire from the vehicle.
5. Block both the front and rear of the wheel that is diagonally opposite from the jack position.

**⚠ WARNING - Jack location**  
To reduce the possibility of injury, be sure to use only the jack provided with the vehicle in the correct jack position; never use any other part of the vehicle for jack support.

**⚠ WARNING - Changing a tire**

- To prevent vehicle movement while changing a tire, always set the parking brake fully, and always block the wheel diagonally opposite the wheel being changed.
- We recommend that the wheels of the vehicle be blocked, and that no person remain in a vehicle that is being jacked.



OCK067026L

6. Loosen the wheel lug nuts counterclockwise one turn each, but do not remove any nut until the tire has been raised off the ground.

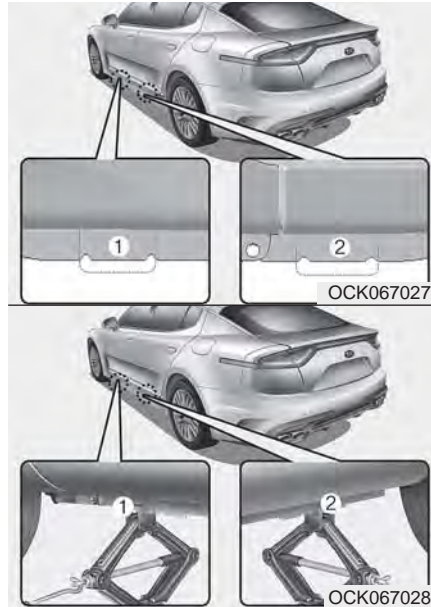

7. Place the jack at the front (1) or rear (2) jacking position closest to the tire you are changing. Place the jack at the designated locations under the frame. The jacking positions are plates welded to the frame with two tabs and a raised dot to line up with the jack.



8. Insert the wheel lug nut wrench into the jack and turn it clockwise, raising the vehicle until the tire just clears the ground. This measurement is approximately 1 in. (30 mm).

Before removing the wheel lug nuts, make sure the vehicle is stable and that there is no chance for movement or slippage.

9. Loosen the wheel nuts and remove them with your fingers. Slide the wheel off the studs and lay it flat so it cannot roll away. To put the wheel on the hub, pick up the spare tire, line up the holes with the studs and slide the wheel onto them. If this is difficult, tip the wheel slightly and get the top hole in the wheel lined up with the top stud. Jiggle the wheel back and forth until the wheel can slide over the other studs.

Wheels may have sharp edges. Handle them carefully to avoid possible severe injury. Before putting the wheel into place, be sure that there is nothing on the hub or wheel (such as mud, tar, gravel, etc.) that prevents the wheel from fitting solidly against the hub.

 **WARNING - Installing a wheel**

**Make sure the wheel makes good contact with the hub when installed. If the contact of the mounting surface between the wheel and hub is not good, the wheel nuts could come loose and cause the loss of a wheel. Loss of a wheel may result in loss of control of the vehicle.**

10. To install the wheel, hold it on the studs, put the wheel nuts on the studs and tighten them finger tight. Jiggle the tire to be sure it is completely seated, then tighten the nuts as much as possible with your fingers again.

11. Insert the wrench into the jack and lower the vehicle to the ground by turning the wheel nut wrench counterclockwise.





OCK067030L

Position the wrench as shown in the drawing and tighten the wheel nuts. Be sure the socket is seated completely over the nut. Do not stand on the wrench handle or use an extension pipe over the wrench handle. Go around the wheel, tightening every nut following the numerical sequence shown in the image until they are all tight. Double-check each nut for tightness. After changing wheels, have an authorized Kia dealer tighten the wheel nuts to their proper torque as soon as possible.

### Wheel nut tightening torque:

79~94 lbf·ft  
(11~13 kgf·m, 107~127 N·m)

If you have a tire gauge, remove the valve cap and check the air pressure. If the pressure is lower than recommended, drive slowly to the nearest service station and inflate to the correct pressure. If it is too high, adjust it until it is correct. Always reinstall the valve cap after checking or adjusting the tire pressure. If the cap is not replaced, dust and dirt may get into the tire valve and air may leak from the tire. If you lose a valve cap, buy another and install it as soon as possible.

After you have changed the wheels, always secure the flat tire in its place and return the jack and tools to their proper storage locations.

### CAUTION - Reusing lug nuts

***Make certain during wheel removal that the same nuts that were removed are reinstalled - or, if replaced, that nuts with metric threads and the same chamfer configuration are used. Your vehicle has metric threads on the wheel studs and nuts. Installation of a non-metric thread nut on a metric stud will not secure the wheel to the hub properly and will damage the stud so that it must be replaced.***

Note that most lug nuts do not have metric threads. Be sure to use extreme care in checking for thread style before installing aftermarket lug nuts or wheels. If in doubt, consult an authorized Kia dealer.

### **⚠ WARNING - Wheel studs**

**If the studs are damaged, they may lose their ability to retain the wheel. This could lead to the loss of the wheel and a collision resulting in serious injuries.**

To prevent the jack, wheel lug nut wrench and spare tire from rattling while the vehicle is in motion, store them properly.

Check the inflation pressures as soon as possible after installing the spare tire. Adjust it to the specified pressure, if necessary. Refer to “Tires and wheels” in section 7.

### ***Important - use of compact spare tire***

Your vehicle is equipped with a compact spare tire. This compact spare tire takes up less space than a regular-size tire. This tire is smaller than a conventional tire and is designed for temporary use only.

- You should drive carefully when the compact spare is in use. The compact spare should be replaced by the proper conventional tire and rim at the first opportunity.
- The operation of this vehicle is not recommended with more than one compact spare tire in use at the same time.

### **⚠ WARNING - Spare tire**

**The compact spare tire is for emergency use only. Do not operate your vehicle on this compact spare at speeds over 50 mph (80 km/h). The original tire should be repaired or replaced as soon as possible to avoid failure of the spare possibly leading to personal injury or death.**

The compact spare should be inflated to 60 psi (420 kPa).

### **\* NOTICE**

**Check the inflation pressure after installing the spare tire. Adjust it to the specified pressure, as necessary.**

When using a compact spare tire, observe the following precautions:

- Under no circumstances should you exceed 50 mph (80 km/h); a higher speed could damage the tire.
- Ensure that you drive slowly enough for the road conditions to avoid all hazards. Any road hazard, such as a pothole or debris, could seriously damage the compact spare.
- Any continuous road use of this tire could result in tire failure, loss of vehicle control, and possible personal injury.
- Do not exceed the vehicle's maximum load rating or the load-carrying capacity shown on the sidewall of the compact spare tire.
- Avoid driving over obstacles. The compact spare tire diameter is smaller than the diameter of a conventional tire and reduces the ground clearance approximately 1 inch (25 mm), which could result in damage to the vehicle.
- Do not take this vehicle through an automatic vehicle wash while the compact spare tire is installed.
- Do not use tire chains on the compact spare tire. Because of the smaller size, a tire chain will not fit properly. This could damage the vehicle and result in loss of the chain.
- Do not use the compact spare tire on any other vehicle because this tire has been designed especially for your vehicle.
- The compact spare tire's tread life is shorter than a regular tire. Inspect your compact spare tire regularly and replace worn compact spare tires with the same size and design, mounted on the same wheel.
- The compact spare tire should not be used on any other wheels, nor should standard tires, snow tires, wheel covers or trim rings be used with the compact spare wheel. If such use is attempted, damage to these items or other vehicle components may occur.
- Do not use more than one compact spare tire at a time.
- Do not tow a trailer while the compact spare tire is installed.

## Jack label

### ■ Example

#### • Type A

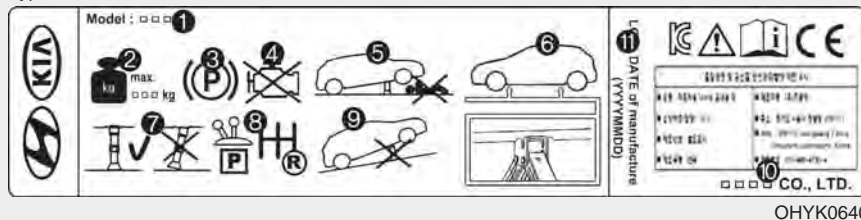

OHYK064001

#### • Type B

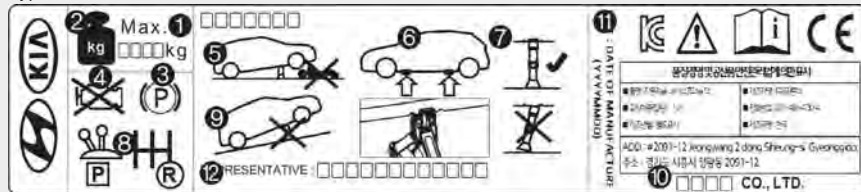

OHYK064005

#### • Type C



OHYK064002

1. Model Name
2. Maximum allowable load
3. When using the jack, set your parking brake.
4. When using the jack, stop the engine.
5. Do not get under a vehicle that is supported by a jack.
6. The designated locations under the frame
7. When supporting the vehicle, the base plate of jack must be vertical under the lifting point.
8. Move the shift lever to the P position on vehicles with automatic transmission.
9. The jack should be used on firm level ground.
10. Jack manufacturer
11. Production date
12. Representative company and address

※ The actual Jack label in the vehicle may differ from the illustration. For more detailed specifications, refer to the label attached to the jack.

## IF YOU HAVE A FLAT TIRE (WITH TIRE MOBILITY KIT) (IF EQUIPPED)

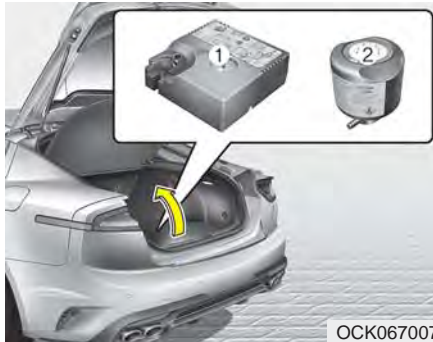

Please read the instructions before using the Tire Mobility Kit.

- (1) Compressor
- (2) Sealant bottle

The Tire Mobility Kit is a temporary fix to the tire and the tire should be inspected by an authorized Kia dealer as soon as possible.



**CAUTION** - One sealant for one tire

*When two or more tires are flat, do not use the Tire Mobility Kit because the canister of sealant in the Tire Mobility Kit only contains enough sealant for one flat tire.*



**WARNING** - Tire wall

Do not use the Tire Mobility Kit to repair large punctures or damage to the tire sidewalls. In these situations, the tire cannot be sealed completely and air will leak from the tire. This can result in tire failure.



**WARNING** - Speed with temporary fix

Do not exceed a speed of 50 mph (80 km/h) when driving with a tire sealed with the Tire Mobility Kit. While driving, if you experience any unusual vibration, ride disturbance or noise, reduce your speed and drive with caution until you can safely pull off of the side of the road.



**WARNING** - Temporary fix

Have your tire repaired as soon as possible. The tire may lose air pressure at any time after inflating with the Tire Mobility Kit.

**⚠ CAUTION**

- ***When replacing or repairing the tire after using tire sealant, make certain to remove the sealant attached to the inner part of the tire and wheel. If the sealant is not removed, noise and vibration may occur.***
- ***If the TPMS warning light illuminates after using the Tire Mobility Kit, have your vehicle inspected by an authorized Kia dealer.***
- ***When repairing a flat tire with the Tire Mobility Kit (TMK), quickly remove the sealant on the tire pressure sensor and wheel. When installing the repaired tire and wheel, tighten the wheel nut to a torque value of 11 ~ 13 kgf-m.***

**Introduction**



With the Tire Mobility Kit (TMK) you stay mobile even after experiencing a tire puncture.

The system compressor and sealing compound effectively seal most punctures in a passenger car tire caused by nails or similar objects and re-inflate the tire.

After you ensure that the tire is properly sealed, you can drive cautiously on the tire (up to 120 miles (200 km)) at a max. speed of 50 mph (80 km/h) in order to reach a vehicle or tire dealer to have the tire replaced.

It is possible that some tires, especially with larger punctures or damage to the sidewall, cannot be sealed completely.

Air pressure loss in the tire may adversely affect tire performance.

For this reason, you should avoid abrupt steering or other driving maneuvers, especially if the vehicle is heavily loaded or if a trailer is in use.

The Tire Mobility Kit is not designed or intended as a permanent tire repair method and is to be used for one tire only.

This instruction shows you step by step how to temporarily seal the puncture.

Read the section "Notes on the safe use of the Tire Mobility Kit".

**⚠ WARNING**

**Do not use the Tire Mobility Kit if a tire is severely damaged.**

**Only punctured areas located within the tread region of the tire can be sealed using the Tire Mobility Kit.**

**Notes on the safe use of the Tire Mobility Kit**

- Park your car at the side of the road so that you can work with the Tire Mobility Kit away from moving traffic. Place your warning triangle in a prominent place to make passing vehicles aware of your location.
- To be sure your vehicle will not move, even when you're on fairly level ground, always set your parking brake.
- Only use the Tire Mobility Kit for sealing/inflation passenger car tires. Do not use on motorcycles, bicycles or any other type of tires.
- Do not remove any foreign objects- such as nails or screws -that have penetrated the tire.
- Before using the Tire Mobility Kit, read the precautionary advice printed on the sealant bottle!
- Provided the car is outdoors, leave the engine running. Otherwise operating the compressor may eventually drain the car battery.
- Never leave the Tire Mobility Kit unattended while it is being used.
- Do not leave the compressor running for more than 10 min. at a time or it may overheat.
- Do not use the Tire Mobility Kit if the ambient temperature is below -22°F (-30°C).
- When the tire and wheel are damaged, do not use Tire Mobility Kit for your safety.

**⚠ WARNING**

- If sealant comes into contact with skin, wash the affected areas thoroughly. Seek medical attention if irritation develops and persists.
- If sealant comes into contact with the eyes, flush eyes with water for at least 15 minutes. Seek medical attention if irritation persists.
- If sealant is swallowed, call a physician or poison control center immediately.  
Exposure to the sealant for a long time may cause damage to the bodily tissues.

**Components of the Tire Mobility Kit (TMK)**

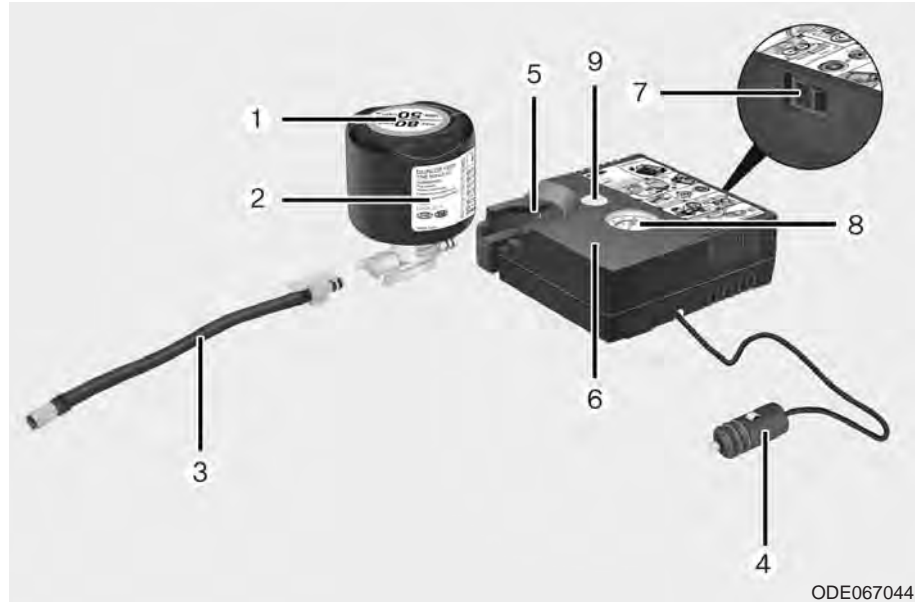

- |  |  |
|--|--|
| 1. Speed restriction label                         | 4. Connectors and cable for the power outlet direct connection |
| 2. Sealant bottle and label with speed restriction | 5. Holder for the sealant bottle                               |
| 3. Filling hose from sealant bottle to wheel       | 6. Compressor  |
|  | 7. On/off switch   |



8. Pressure gauge for displaying the tire inflation pressure
9. Button for reducing tire inflation pressure

Connectors and cable are stored in the compressor housing.

**⚠ WARNING - Expired sealant**

**Do not use the tire sealant after the sealant has expired (after the expiration date on the sealant container). This can increase the risk of tire failure.**

**⚠ WARNING - Sealant**

- Keep out of reach of children.
- Avoid contact with eyes.
- Do not swallow.

**\* NOTICE**

The sealant container and insert hose (3) cannot be reused. Purchase an extra after use.

**Using the Tire Mobility Kit**

1. Detach the speed restriction label (1) from the sealant bottle (2), and place it in a highly visible place inside the vehicle such as on the steering wheel to remind the driver not to drive too fast.
2. Filling the sealant Strictly follow the specified sequence, otherwise the sealant may escape under high pressure.



**⚠ CAUTION**

*Before using the Tire Mobility Kit, please read carefully the instruction attached on the sealant case. Detach the speed limit label on the sealant case and put it on a highly visible place. Always drive within the speed limit.*



3. Shake the sealant bottle.

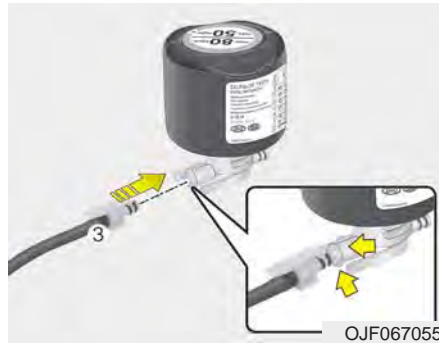

4. Connect the filling hose (3) onto the connector of the sealant bottle.  
5. Ensure that button (7) on the compressor is not pressed.



6. Unscrew the valve cap from the valve of the defective wheel and screw filling hose (3) of the sealant bottle onto the valve.



OJF067057

7. Insert the sealant bottle into the housing (5) of the compressor so that the bottle is upright.
8. Ensure that the compressor is switched off.

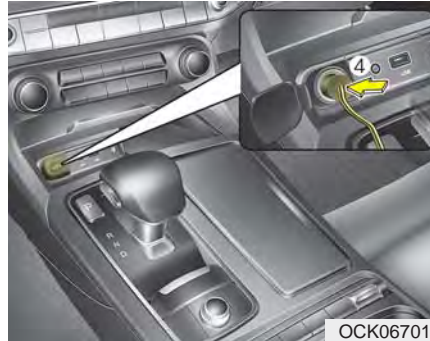

OCK067011

9. Connect between compressor and the vehicle power outlet using the cable and connectors (4).

10. With the engine start/stop button position on: switch on the compressor and let it run for approximately 5–7 minutes to fill the sealant up to proper pressure (refer to the "Tires and wheels" in chapter 8). Be careful not to over-inflate the tire and stay away from the tire when filling it. When the tire and wheel are damaged, do not use Tire Mobility Kit for your safety.

**⚠ WARNING - Tire pressure**  
**Do not attempt to drive your vehicle if the tire pressure is below 29 psi (200 kPa, 2 bar).**  
**This could result in an accident due to sudden tire failure.**

11. Switch off the compressor.
12. Detach the hose from the sealant bottle connector and from the tire valve.

Return the Tire Mobility Kit to its storage location in the vehicle.

 **WARNING**

**Carbon monoxide poisoning and suffocation is possible if the engine is left running in a poorly ventilated or unventilated location (such as inside a building).**

### Distributing the sealant

13. Immediately drive approximately 4 ~ 6 miles (7 ~ 10 km or, about 10 min) to evenly distribute the sealant in the tire.

 **CAUTION**

***Do not exceed a speed of 50 mph (80 km/h). If possible, do not fall below a speed of 12 mph (20 km/h).***

***While driving, if you experience any unusual vibration, ride disturbance or noise, reduce your speed and drive with caution until you can safely pull off of the side of the road. Call for road side service or towing.***

***When you use the Tire Mobility Kit, the wheel may be stained by sealant. Therefore, remove the tire pressure sensors and have your vehicle inspected by an authorized Kia dealer.***

## Checking the tire inflation pressure

1. After driving approximately 4 ~ 6 miles (7 ~ 10 km or about 10 minutes), stop at a suitable location.
2. Connect the filling hose (3) of the compressor (clip mounted side) directly and then connect the filling hose (3) (opposite side) to the tire valve.
3. Connect between compressor and the vehicle power outlet using the cable and connectors.
4. Adjust the tire inflation pressure to 29 psi (200 kPa). With the Engine Start/Stop button ON position, proceed as follows.
  - **To increase the inflation pressure:** Switch on the compressor, position I. To check the current inflation pressure setting, briefly switch off the compressor.

### **WARNING**

**Do not let the compressor run for more than 10 minutes, otherwise the device will overheat and may be damaged.**

**- To reduce the inflation pressure:** Press the button (9) on the compressor.

### **WARNING**

**The tire inflation pressure must be at least 29 psi (200 kPa, 2 bar). If it is not, do not continue driving. Call for road side service or towing.**

## Technical Data

System voltage: DC 12 V

Working voltage: DC 10 - 15 V

Amperage rating: max. 15 A ± 1A (at DC 12V operation)

Suitable for use at temperatures:

-22 ~ +158°F (-30 ~ +70°C)

Max. working pressure:

6 bar (87 psi)

Size

Compressor: 161 x 150 x 55.8 mm  
(6.3 x 5.9 x 2.2 in.)

Sealant bottle: 104 x 85 ø mm  
(4.1 x 3.3 ø in.)

Compressor weight:

805g ± 30g (1.77 lbs ± 0.07 lbs)

Sealant volume:

300 ml (18.3 cu. in.)

\* Sealant and spare parts can be obtained and replaced at an authorized vehicle or tire dealer. Empty sealant bottles may be disposed of at home. Liquid residue from the sealant should be disposed of by your vehicle or tire dealer or in accordance with local waste disposal regulations.

## TOWING

### Towing service

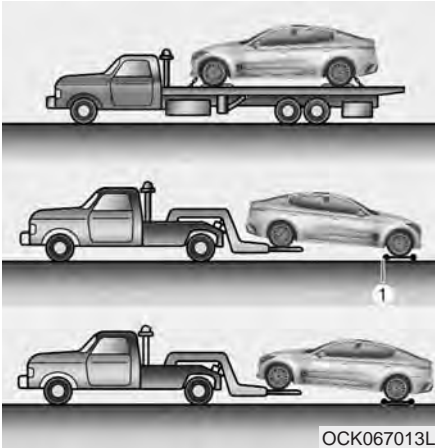

If emergency towing is necessary, we recommend having it done by an authorized Kia dealer or a commercial tow-truck service. Proper lifting and towing procedures are necessary to prevent damage to the vehicle. The use of wheel dollies(1) or flatbed is recommended.

On AWD vehicles, your vehicle must be towed with a wheel lift and dollies or flatbed equipment with all the wheels off the ground.

### CAUTION

*The AWD vehicle should never be towed with the wheels on the ground. This can cause serious damage to the transmission or the AWD system.*

If any of the loaded wheels or suspension components are damaged or the vehicle is being towed with the front wheels on the ground, use a towing dolly under the front wheels.

When being towed by a commercial tow truck and wheel dollies are not used, the rear of the vehicle should always be lifted, not the front.

### \* NOTICE

If the EPB does not release normally, take your vehicle to an authorized Kia dealer by loading the vehicle on a flatbed tow truck and have the system checked.



- Ensure any metal parts on the tiedown straps do not contact painted surfaces or the face of the wheels.
- Do not place straps over the body panels or through the wheels.

### **⚠ CAUTION**

***Attaching straps to the chassis, suspension or other parts of the body can cause damage.***

### **⚠ WARNING - Side and curtain Air bag**

**If your vehicle is equipped with side and curtain air bag, set the the Engine Start/Stop button to ACC position when the vehicle is being towed.**

**The side and curtain air bag may deploy when the ignition is ON, and the rollover sensor detects the situation as a rollover.**

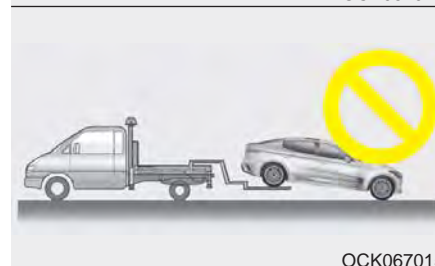
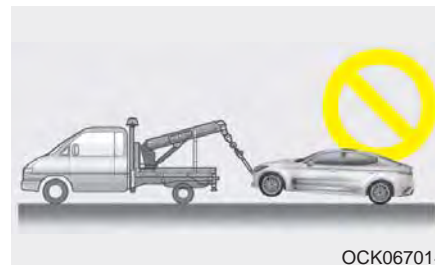

### **⚠ CAUTION - Towing**

- ***Do not tow the vehicle backwards with the rear wheels on the ground as this may cause damage to the vehicle.***
- ***Do not tow with sling-type equipment. Use wheel lift or flatbed equipment.***



When towing your vehicle in an emergency without wheel dollies :

1. Set the Engine Start/Stop button to ACC position.
2. Place the transmission shift lever in N (Neutral).
3. Release the parking brake.

**⚠ CAUTION - Towing gear position**

***Failure to place the transmission shift lever in N (Neutral) may cause internal damage to the transmission.***

**Removable towing hook**

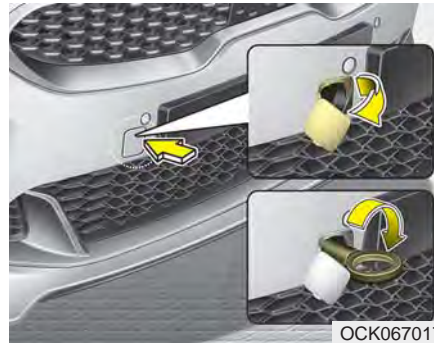

1. Open the liftgate, and remove the towing hook from the tool case.
2. Remove the hole cover pressing the right side part or lower part of the cover on the bumper.
3. Install the towing hook by turning it clockwise into the hole until it is fully secured.
4. Remove the towing hook and install the cover after use.

**Emergency towing**

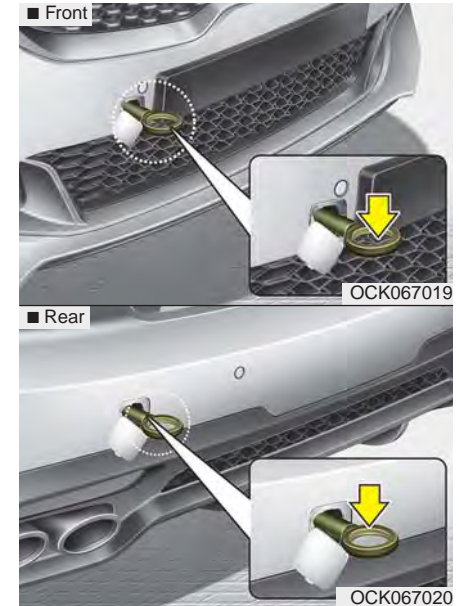

**If towing is necessary, have it done by an authorized Kia dealer or a commercial tow truck service.**

If towing service is not available in an emergency, your vehicle may be temporarily towed using a cable or chain secured to the emergency towing hook under the front (or rear) of the vehicle. Use extreme caution when towing the vehicle. A driver must be in the vehicle to steer it and operate the brakes.

Towing in this manner may be done only on hard-surfaced roads for a short distance and at low speed. Also, the wheels, axles, power train, steering and brakes must all be in good condition.

- Do not use the tow hooks to pull a vehicle out of mud, sand or other conditions from which the vehicle cannot be driven out under its own power.
- Avoid towing a vehicle heavier than the vehicle doing the towing.
- The drivers of both vehicles should communicate with each other frequently.

- Attach a towing strap to the tow hook.
- Use only a cable or chain specifically intended for use in towing vehicles. Securely fasten the cable or chain to the towing hook provided.
- Accelerate or decelerate the vehicle in a slow and gradual manner while maintaining tension on the tow rope or chain to start or drive the vehicle, otherwise tow hooks and the vehicle may be damaged.
- Before emergency towing, check if the hook is not broken or damaged.
- Fasten the towing cable or chain securely to the hook.
- Do not jerk the hook. Apply it steadily and with even force.
- To avoid damaging the hook, do not pull from the side or at a vertical angle. Always pull straight ahead.

### CAUTION

***Using a portion of the vehicle other than the tow hooks for towing may damage the body of your vehicle.***

**⚠ WARNING - Emergency Towing Precautions**

Use extreme caution when towing the vehicle.

- Avoid sudden starts or erratic driving maneuvers which would place excessive stress on the emergency towing hook and towing cable or chain. The hook and towing cable or chain may break and cause serious injury or damage.
- If the disabled vehicle is unable to be moved, do not forcibly continue the towing. In this case, contact an authorized Kia dealer or a commercial tow truck service for assistance.
- Tow the vehicle as straight ahead as possible.
- Keep away from the vehicle during towing.

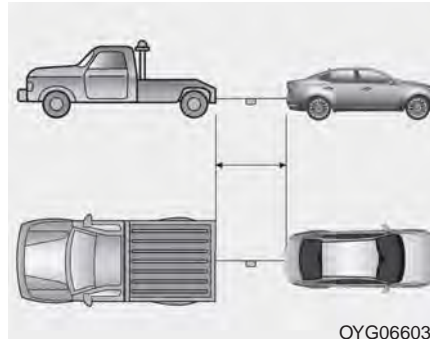

- Use a towing strap less than 16 feet (5 m) long. Attach a white or red cloth (about 12 inches (30 cm) wide) in the middle of the strap for easy visibility.
- Drive carefully so that the towing strap is not loosened during towing.
- The driver must be in the vehicle for steering and braking operations when the vehicle is towed and passengers other than the driver must not be allowed to be on board.

***Emergency towing precautions***

- Turn the Engine Start/Stop button to ACC position so the steering wheel isn't locked.
- Place the transmission shift lever in N (Neutral).
- Release the parking brake.
- Press the brake pedal with more force than normal since you will have reduced brake performance.
- More steering effort will be required because the power steering system will be disabled.
- If you are driving down a long hill, the brakes may overheat and brake performance will be reduced. Stop often and let the brakes cool off.
- The vehicle should be towed at a speed of 15 mph (25 km/h) or less within the distance of 12 miles (20 km).

- If the car is being towed with all four wheels on the ground, it can be towed only from the front. Be sure that the transmission is in neutral. Be sure the steering is unlocked by placing the Engine Start/Stop button to ACC position. A driver must be in the towed vehicle to operate the steering and brakes.



### **CAUTION - Automatic transmission**

- *To avoid serious damage to the automatic transmission, limit the vehicle speed to 10 mph (15 km/h) and drive less than 1 mile (1.5 km) when towing.*
- *Before towing, check the automatic transmission for fluid leaks under your vehicle. If the automatic transmission fluid is leaking, flatbed equipment or a towing dolly must be used.*

# Maintenance

Engine compartment . . . . .	7-3	Climate control air filter . . . . .	7-30
Maintenance services . . . . .	7-4	• Filter inspection . . . . .	7-30
• Owner's responsibility . . . . .	7-4	Wiper blades . . . . .	7-32
• Owner maintenance precautions . . . . .	7-5	• Blade inspection . . . . .	7-32
Owner maintenance . . . . .	7-7	• Blade replacement . . . . .	7-32
• Owner maintenance schedule . . . . .	7-7	Battery . . . . .	7-35
Scheduled maintenance service . . . . .	7-9	• Battery replacement . . . . .	7-35
Explanation of scheduled maintenance items . . . . .	7-16	• For best battery service . . . . .	7-35
Checking fluid levels . . . . .	7-19	• Recharging the battery . . . . .	7-37
Engine oil . . . . .	7-20	• Reset items . . . . .	7-38
• Checking the engine oil level . . . . .	7-20	Tires and wheels . . . . .	7-39
• Changing the engine oil and filter . . . . .	7-21	• Tire care . . . . .	7-39
Engine coolant . . . . .	7-22	• Recommended cold tire inflation pressures . . . . .	7-39
• Checking the coolant level . . . . .	7-22	• Tire pressure . . . . .	7-40
• Changing the coolant . . . . .	7-25	• Checking tire inflation pressure . . . . .	7-40
Brake fluid . . . . .	7-26	• Tire rotation . . . . .	7-41
• Checking the brake fluid level . . . . .	7-26	• Wheel alignment and tire balance . . . . .	7-42
Washer fluid . . . . .	7-27	• Flat Spots . . . . .	7-43
• Checking the washer fluid level . . . . .	7-27	• Tire replacement . . . . .	7-43
Parking brake . . . . .	7-28	• Wheel replacement . . . . .	7-44
• Checking the parking brake . . . . .	7-28	• Tire traction . . . . .	7-44
Air cleaner . . . . .	7-29	• Tire maintenance . . . . .	7-44
• Filter replacement . . . . .	7-29	• Tire sidewall labeling . . . . .	7-45
		• Tire terminology and definitions . . . . .	7-48
		• All season tires . . . . .	7-51

- Summer tires ..... 7-51
- Snow tires ..... 7-52
- Tire chains ..... 7-52
- Radial-ply tires ..... 7-52
- Low aspect ratio tire ..... 7-53
- Fuses** ..... 7-55
  - Inner panel fuse replacement ..... 7-57
  - Engine compartment fuse replacement ..... 7-59
  - Fuse/relay panel description ..... 7-61
- Light bulbs** ..... 7-78
  - Bulb replacement precaution ..... 7-78
  - Light bulb position (Front) ..... 7-80
  - Light bulb position (Rear) ..... 7-80
  - Light bulb position (Side) ..... 7-81
  - Headlamp (LED type) replacement
    - (Headlamp Type B) ..... 7-82
  - Side marker bulb replacement (Headlamp Type A) . 7-82
  - Position lamp + DRL (LED type) bulb replacement
    - (Headlamp Type A) ..... 7-82
  - Headlamp (Low/High beam) bulb replacement
    - (Headlamp Type A) ..... 7-83
  - Front turn signal lamp bulb replacement
    - (Headlamp Type A) ..... 7-84
  - Stop and tail lamp (LED type) bulb replacement .. 7-85
  - Rear side marker (LED type) bulb replacement . . 7-86
- Rear turn signal lamp (LED type) bulb
  - replacement ..... 7-86
- Rear turn signal lamp (bulb type) bulb
  - replacement ..... 7-86
- Back-up lamp bulb replacement ..... 7-88
- High mounted stop lamp (LED type) bulb
  - replacement ..... 7-90
- License plate lamp (LED type) bulb replacement .. 7-90
- Side repeater lamp (LED type) bulb replacement .. 7-90
- Map lamp (LED type) bulb replacement ..... 7-91
- Vanity mirror lamp (LED type) bulb replacement . 7-91
- Room lamp (LED type) bulb replacement ..... 7-91
- Glove box lamp (LED type) bulb replacement .... 7-92
- Luggage room lamp (LED type) bulb replacement. 7-92
- Appearance care** ..... 7-93
  - Exterior care ..... 7-93
  - Interior care ..... 7-98
- Emission control system** ..... 7-101
  - Crankcase emission control system ..... 7-101
  - Evaporative emission control (including ORVR:
    - Onboard Refueling Vapor Recovery) system .... 7-101
  - Exhaust emission control system ..... 7-102

## ENGINE COMPARTMENT

### ■ THETA II 2.0L T-GDI (Gasoline engine)



1. Engine coolant reservoir
2. Radiator cap
3. Engine oil filler cap
4. Engine oil dipstick
5. Brake fluid reservoir
6. Fuse box
7. Windshield washer fluid reservoir
8. Air cleaner

### ■ Lambda II PE 3.3L T-GDI (Gasoline engine)

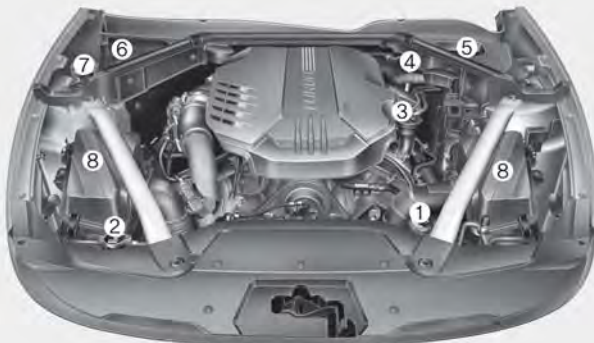

- \* The actual engine room in the vehicle may differ from the illustration.
- \* The battery is in the trunk.

OCK077001/OCK077002

## MAINTENANCE SERVICES

You should exercise the utmost care to prevent damage to your vehicle and injury to yourself whenever performing any maintenance or inspection procedures.

Should you have any doubts concerning the inspection or servicing of your vehicle, we strongly recommend that you have an authorized Kia dealer perform this work.

An authorized Kia dealer has factory-trained technicians and genuine Kia parts to service your vehicle properly. For expert advice and quality service, see an authorized Kia dealer.

Inadequate, incomplete or insufficient servicing may result in operational problems with your vehicle that could lead to vehicle damage, an accident, or personal injury.

### Owner's responsibility

#### \* NOTICE

**Maintenance Service and Record Retention are the owner's responsibility.**

**You should retain documents that show proper maintenance has been performed on your vehicle in accordance with the scheduled maintenance service charts shown on the following pages. You need this information to establish your compliance with the servicing and maintenance requirements of your vehicle warranties.**

**Detailed warranty information is provided in your Warranty & Consumer Information manual.**

Repairs and adjustments required as a result of improper maintenance or a lack of required maintenance are not covered.

We recommend you have your vehicle maintained and repaired by an authorized Kia dealer. An authorized Kia dealer meets Kia's high service quality standards and receives technical support from Kia in order to provide you with a high level of service satisfaction.

#### \* NOTICE - NHTSA Safety Corrosion Alert

**The National Highway Traffic Safety Administration (NHTSA) has issued a general warning to all vehicle owners of all brands regarding the risks associated with vehicle underbody corrosion. From your initial purchase, take the following steps to prevent unsafe corrosion damage to your vehicle:**

**(Continued)**



(Continued)

- Wash the undercarriage of your vehicle regularly during the winter and whenever your vehicle has been exposed to such salts or chemicals.
  - Do a thorough washing of the undercarriage at the end of the winter.
  - Use professional service technicians or governmental inspection stations to annually inspect for corrosion.
  - Immediately seek an inspection of your vehicle if you become visually aware of corrosion flaking or scaling or if you become aware of a change in vehicle performance, such as soft or spongy brakes, fluids leaking, impairment of directional control, suspension noises or rattling metal straps.
- NHTSA further advises that after a vehicle is 7 years old, it is essential that you take these indicated maintenance steps to ensure that you protect yourself from unsafe corrosion conditions.

### Owner maintenance precautions

Improper or incomplete service may result in problems. This section gives instructions only for the maintenance items that are easy to perform.

As explained earlier in this section, several procedures can be done only by an authorized Kia dealer with special tools.

### \* NOTICE

Improper owner maintenance during the warranty period may affect warranty coverage. For details, read the separate Warranty & Consumer Information manual provided with the vehicle. If you're unsure about any servicing or maintenance procedure, have it done by an authorized Kia dealer.

### **WARNING** - Maintenance work

**Do not wear jewelry or loose clothing while working under the hood of your vehicle with the engine running. These could become entangled in moving parts. If you must run the engine while working under the hood, make certain that you remove all jewelry (especially rings, bracelets, watches, and necklaces) and all neckties, scarves, and similar loose clothing before getting near the engine or cooling fans.**

**⚠ WARNING - Touching  
metal parts**

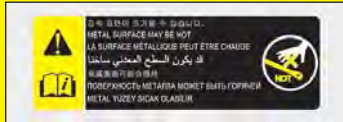

**Do not touch metal parts (including strut bars) while the engine is operating or hot. Doing so could result in serious personal injury. Turn the engine off and wait until the metal parts cool down to perform maintenance work on the vehicle.**

## OWNER MAINTENANCE

The following lists are vehicle checks and inspections that should be performed by the owner or an authorized Kia dealer at the frequencies indicated to help ensure safe, dependable operation of your vehicle.

Any adverse conditions should be brought to the attention of your dealer as soon as possible.

These Owner Maintenance Checks are generally not covered by warranties and you may be charged for labor, parts and lubricants used.

### Owner maintenance schedule

#### *When you stop for fuel:*

- Check the engine oil level.
- Check the coolant level in coolant reservoir.
- Check the windshield washer fluid level.
- Look for low or under-inflated tires.

 **WARNING - Hot coolant**  
**Be careful when checking your engine coolant level when the engine is hot. Scalding hot coolant and steam may blow out under pressure.**

#### *While operating your vehicle:*

- Note any changes in the sound of the exhaust or any smell of exhaust fumes in the vehicle.
- Check for vibrations in the steering wheel. Notice any increased steering effort or looseness in the steering wheel, or change in its straight-ahead position.
- Notice if your vehicle constantly turns slightly or “pulls” to one side when traveling on smooth, level road.
- When stopping, listen and check for unusual sounds, pulling to one side, increased brake pedal travel or “hard-to-push” brake pedal.
- If any slipping or changes in the operation of your transmission occurs, check the transmission fluid level.
- Check the automatic transmission P (Park) function.
- Check the parking brake.
- Check for fluid leaks under your vehicle (water dripping from the air conditioning system during or after use is normal).

### ***At least monthly:***

- Check the coolant level in the engine coolant reservoir.
- Check the operation of all exterior lights, including the stoplights, turn signals and hazard warning flashers.
- Check the inflation pressures of all tires including the spare for tires that are worn, show uneven wear, or are damaged.
- Check for loose wheel lug nuts.

### ***At least twice a year (i.e., every Spring and Fall) :***

- Check the radiator, heater and air conditioning hoses for leaks or damage.
- Check the windshield washer spray and wiper operation. Clean the wiper blades with clean cloth dampened with washer fluid.
- Check the headlight alignment.
- Check the muffler, exhaust pipes, shields and clamps.
- Check the lap/shoulder belts for wear and function.

### ***At least once a year :***

- Clean the body and door drain holes.
- Lubricate the door hinges and check the hood hinges.
- Lubricate the door and hood locks and latches.
- Lubricate the door rubber weatherstrips.
- Check the air conditioning system.
- Inspect and lubricate automatic transmission linkage and controls.
- Clean the battery and terminals.
- Check the brake fluid level.

## SCHEDULED MAINTENANCE SERVICE

Follow the Normal Maintenance Schedule if the vehicle is usually operated where none of the following conditions apply. If any of the following conditions apply, follow the Maintenance Under Severe Usage Conditions.

- Repeated driving short distance of less than 5 miles (8 km) in normal temperature or less than 10 miles (16 km) in freezing temperature
- Extensive engine idling or low speed driving for long distances
- Driving on rough, dusty, muddy, unpaved, graveled or salt-spread roads
- Driving in areas using salt or other corrosive materials or in very cold weather
- Driving in heavy dust condition
- Driving in heavy traffic area
- Driving on uphill, downhill, or mountain road repeatedly
- Towing a trailer or using a camper, or roof rack
- Driving as a patrol car, taxi, other commercial use of vehicle towing
- Driving over 106 mph (170 km/h)
- Frequently driving in stop-and-go condition

*If your vehicle is operated under the above conditions, you should inspect, replace or refill more frequently than the following Normal Maintenance Schedule. After 120 months or 150,000 miles continue to follow the prescribed maintenance intervals.*

### Normal Maintenance Schedule - Turbo Models

The following maintenance services must be performed to ensure good emission control and performance. Keep receipts for all vehicle emission services to protect your warranty. Where both mileage and time are shown, the frequency of service is determined by whichever occurs first.

MAINTENANCE INTERVALS		Number of months or driving distance, whichever comes first															
		Months	12	24	36	48	60	72	84	96	108	120	132	144	156	168	180
MAINTENANCE ITEM	Miles×1,000	6	12	18	24	30	36	42	48	54	60	66	72	78	84	90	
	Km×1,000	10	20	30	40	50	60	70	80	90	100	110	120	130	140	150	
Drive belts *1		At first, inspect at 60,000 miles (100,000 km) or 72 months, after that, inspect every 12,000 miles (20,000 km) or 24 months															
Engine oil and engine oil filter	Theta II 2.0L T-GDI	R	R	R	R	R	R	R	R	R	R	R	R	R	R	R	
	Lambda II PE 3.3L T-GDI	R	R	R	R	R	R	R	R	R	R	R	R	R	R	R	
Fuel additives *2		Add every 6,000 miles (10,000 km) or 12 months															
Air cleaner filter		-	I	-	R	-	I	-	R	-	I	-	R	-	I	-	
Spark plugs	Theta II 2.0L T-GDI	Replace every 42,000 miles (70,000 km)															
	Lambda II PE 3.3L T-GDI	Replace every 42,000 miles (70,000 km)															

I : Inspect and if necessary, adjust, correct, clean or replace.

R : Replace or change.

\*1 : The drive belt should be replaced when cracks occur or tension is reduced.

\*2 : If TOP TIER Detergent Gasoline is not available, one bottle of additive is recommended. Additives are available from your authorized Kia dealer along with information on how to use them. Do not mix other additives.

### Normal Maintenance Schedule - Turbo Models (CONT.)

MAINTENANCE INTERVALS  MAINTENANCE ITEM	Number of months or driving distance, whichever comes first															
	Months	12	24	36	48	60	72	84	96	108	120	132	144	156	168	180
	Miles×1,000	6	12	18	24	30	36	42	48	54	60	66	72	78	84	90
	Km×1,000	10	20	30	40	50	60	70	80	90	100	110	120	130	140	150
Valve clearance *3	Theta II 2.0L T-GDI	Inspect every 60,000 miles (100,000 km) or 72 months														
	Lambda II PE 3.3L T-GDI	Inspect every 60,000 miles (100,000 km) or 72 months														
Rotate tires	Rotate every 6,000 miles (10,000 km)															
Climate control air filter	R	R	R	R	R	R	R	R	R	R	R	R	R	R	R	R
Vacuum hose	I	I	I	I	I	I	I	I	I	I	I	I	I	I	I	I
Engine coolant	At first, replace at 120,000 miles (200,000 km) or 10 years : after that, replace every 30,000 miles (50,000 km) or 24 months															
Battery condition	I	I	I	I	I	I	I	I	I	I	I	I	I	I	I	I
Brake lines, hoses and connections	I	I	I	I	I	I	I	I	I	I	I	I	I	I	I	I
Disc brakes and pads	I	I	I	I	I	I	I	I	I	I	I	I	I	I	I	I
Steering gear rack, linkage and boots	I	I	I	I	I	I	I	I	I	I	I	I	I	I	I	I
Driveshaft and boots	I	I	I	I	I	I	I	I	I	I	I	I	I	I	I	I

I : Inspect and if necessary, adjust, correct, clean or replace.

R : Replace or change.

\*3 : Inspect for excessive valve noise and/or engine vibration and adjust if necessary. Have an authorized Kia dealer perform the operation.

**Normal Maintenance Schedule - Turbo Models (CONT.)**

MAINTENANCE INTERVALS		Number of months or driving distance, whichever comes first														
		Months	12	24	36	48	60	72	84	96	108	120	132	144	156	168
MAINTENANCE ITEM	Miles×1,000	6	12	18	24	30	36	42	48	54	60	66	72	78	84	90
	Km×1,000	10	20	30	40	50	60	70	80	90	100	110	120	130	140	150
Suspension mounting bolts																
Air conditioner refrigerant																
Air conditioner compressor																
Propeller shaft																
Exhaust pipe and muffler																
Intercooler, in/out hose, air intake hose	Theta II 2.0L T-GDI															
	Lambda II PE 3.3L T-GDI															
Cooling system		-	-	-		-		-		-		-		-		-
Automatic transmission fluid		No check, No service required														
Differential oil (rear) *5, *6	Without LSD	-	-	-	-	-		-	-	-	-	-		-	-	-
	With LSD	-	-	-	-	-	R	-	-	-	-	-	R	-	-	-
Differential oil (front) (AWD) *5		-	-	-	-	-		-	-	-	-	-		-	-	-

I : Inspect and if necessary, adjust, correct, clean or replace.

R : Replace or change.

\*5 : Front/rear differential oil should be changed anytime they have been submerged in water.

\*6 : When replacing differential oil with LSD, use only specified LSD oil.



### Normal Maintenance Schedule - Turbo Models

MAINTENANCE INTERVALS  MAINTENANCE ITEM	Number of months or driving distance, whichever comes first															
	Months	12	24	36	48	60	72	84	96	108	120	132	144	156	168	180
	Miles×1,000	6	12	18	24	30	36	42	48	54	60	66	72	78	84	90
	Km×1,000	10	20	30	40	50	60	70	80	90	100	110	120	130	140	150
Transfer case oil (AWD)	No check, No service required															
Vapor hose, fuel filler cap and fuel tank		I		I		I		I		I		I		I		
Fuel tank air filter *4		I		I		I		I		I		I		I		
Fuel lines, hoses and connections				I				I				I				
Parking brake		I		I		I		I		I		I		I		
Brake fluid		I		I		I		I		I		I		I		

I : Inspect and if necessary, adjust, correct, clean or replace.

R : Replace or change.

\*4 : Fuel tank air filter are considered to be maintenance free but periodic inspection is recommended for this maintenance schedule depends on fuel quality.

### Maintenance Under Severe Usage Conditions - Turbo Models

The following items must be serviced more frequently on cars normally used under severe driving conditions. Refer to the chart below for the appropriate maintenance intervals.

R : Replace    I : Inspect and, after inspection, clean, adjust, repair or replace if necessary

MAINTENANCE ITEM		MAINTENANCE OPERATION	MAINTENANCE INTERVALS	DRIVING CONDITION
Engine oil and engine oil filter	Theta II 2.0L T-GDI	R	Every 3,000 miles (5,000 km) or 6 months	A, B, C, D, E, F, G, H, I, J, K
	Lambda II PE 3.3L T-GDI	R	Every 3,000 miles (5,000 km) or 6 months	A, B, C, D, E, F, G, H, I, J, K
Air cleaner filter		I	More frequently	C, E
Spark plugs		R	More frequently	A, B, F, G, H, I, K
Automatic transmission fluid		R	Every 60,000 miles (100,000 km)	A, C, D, E, F, G, H, I, J
Front brake disc/pads, calipers		I	More frequently	C, D, E, G, H
Rear brake disc/pads		I	More frequently	C, D, E, G, H
Parking brake		I	More frequently	C, D, G, H
Steering gear box, linkage & boots/ Lower arm ball joint, upper arm ball joint		I	More frequently	C, D, E, F, G

MAINTENANCE ITEM		MAINTENANCE OPERATION	MAINTENANCE INTERVALS	DRIVING CONDITION
Drive shafts and boots		I	More frequently	C, D, E, F, G, H, I, J
Differential oil (rear)	Without LSD	R	Every 72,000 miles (120,000 km)	C, E, G, H, I, J
	With LSD	R	Every 36,000 miles (60,000 km)	C, E, G, H, I, J
Differential oil (front) (AWD)		R	Every 72,000 miles (120,000 km)	C, E, G, H, I, J
Climate control air filter (for evaporator and blower unit)		R	More frequently	C, E, G
Propeller shaft		I	More frequently	C, E

### Severe driving conditions

- A - Repeatedly driving short distance of less than 5 miles (8 km) in normal temperature or less than 10 miles (16 km) in freezing temperature
- B - Extensive engine idling or low speed driving for long distances
- C - Driving on rough, dusty, muddy, unpaved, graveled or salt-spread roads
- D - Driving in areas using salt or other corrosive materials or in very cold weather

E - Driving in heavy dust condition

F - Driving in heavy traffic area

G - Driving on uphill, downhill, or mountain road repeatedly

H - Towing a Trailer, or using a camper, or roof rack

I - Driving as a patrol car, taxi, other commercial use or vehicle towing

J - Driving over 106 mph (170 km/h)

K - Frequently driving in stop-and-go conditions

## EXPLANATION OF SCHEDULED MAINTENANCE ITEMS

### Engine oil and filter

The engine oil and filter should be changed at the intervals specified in the maintenance schedule. If the vehicle is being driven in severe conditions, more frequent oil and filter changes are required.

### Drive belts

Inspect all drive belts for evidence of cuts, cracks, excessive wear or oil saturation and replace if necessary. Drive belts should be checked periodically for proper tension and adjusted as necessary.

### Fuel filter (for gasoline)

Kia gasoline vehicle is equipped a lifetime fuel filter that integrated with the fuel tank. Regular maintenance or replacement is not needed but depends on fuel quality. If there are some important safety matters like fuel flow restriction, surging, loss of power, hard starting problem etc, fuel filter inspection or replace is needed.

The fuel filter be Inspected or replaced by an authorized Kia dealer.

### Fuel lines, fuel hoses and connections

Check the fuel lines, fuel hoses and connections for leakage and damage. Have an authorized Kia dealer replace any damaged or leaking parts immediately.

### Vapor hose and fuel filler cap

The vapor hose and fuel filler cap should be inspected at those intervals specified in the maintenance schedule. Make sure that a new vapor hose or fuel filler cap is correctly replaced.

### Vacuum crankcase ventilation hoses

Inspect the surface of hoses for evidence of heat and/or mechanical damage. Hard and brittle rubber, cracking, tears, cuts, abrasions, and excessive swelling indicate deterioration. Particular attention should be paid to examine those hose surfaces nearest to high heat sources, such as the exhaust manifold.

Inspect the hose routing to assure that the hoses do not come in contact with any heat source, sharp edges or moving component which might cause heat damage or mechanical wear. Inspect all hose connections, such as clamps and couplings, to make sure they are secure, and that no leaks are present. Hoses should be replaced immediately if there is any evidence of deterioration or damage.

### Air cleaner filter

A Genuine Kia air cleaner filter is recommended when the filter is replaced.

### Spark plugs

Make sure to install new spark plugs of the correct heat range.

### Valve clearance (if equipped)

Inspect excessive valve noise and/or engine vibration and adjust if necessary. An authorized Kia dealer should perform the operation.

### Cooling system

Check the cooling system components, such as the radiator, coolant reservoir, hoses and connections for leakage and damage. Replace any damaged parts.

### Coolant

The coolant should be changed at the intervals specified in the maintenance schedule.

### Automatic transmission fluid

Automatic transmission fluid should not be checked under normal usage conditions.

But in severe conditions, the fluid should be changed at an authorized Kia dealer in accordance to the scheduled maintenance at the beginning of this chapter.

### \* NOTICE

**Automatic transmission fluid color is basically red.**

**As the vehicle is driven, the automatic transmission fluid will begin to look darker.**

**It is normal condition and you should not judge the need to replace the fluid based upon the changed color.**

### CAUTION

***Use only specified automatic transmission fluid. The use of a non-specified fluid could result in a transmission malfunction and failure. (Refer to "Recommended lubricants and capacities" in chapter 8.)***

### Brake hoses and lines

Visually check for proper installation, chafing, cracks, deterioration and any leakage. Replace any deteriorated or damaged parts immediately.

**\* NOTICE - NHTSA Safety Corrosion Alert**

NHTSA has warned all vehicle owners of all brands that they must maintain their vehicles in a manner which will prevent brake hose and brake line failures due to corrosion when such vehicles are exposed to winter road salt and related chemicals. While serious corrosion conditions typically only manifest themselves as safety issues after 7 years of vehicle use, the corrosion process starts immediately and thus underbody cleaning maintenance must commence from your vehicle's first exposure to road salts and chemicals. NHTSA urges vehicle owners to take the following steps to prevent corrosion:

(Continued)

(Continued)

1. Wash the undercarriage of your vehicle regularly throughout the winter and do a thorough washing in the spring to remove road salt and other de-icing chemicals.
2. Monitor the brake system for signs of corrosion by having regular professional inspections and watching for signs of problems, including loss of brake fluid, unusual leaks and soft or spongy feel in the brake pedal.
3. Replace the entire brake pipe assembly if you find severe corrosion that causes scaling or flaking of brake components.

**Brake fluid**

Check the brake fluid level in the brake fluid reservoir. The level should be between "MIN" and "MAX" marks on the side of the reservoir. Use only hydraulic brake fluid conforming to DOT 3 or DOT 4 specification.

**Parking brake**

Inspect the parking brake system including the parking brake pedal and cables.

### **Brake discs, pads, calipers and rotors**

Check the pads for excessive wear, discs for run out and wear, and calipers for fluid leakage.

### **Exhaust pipe and muffler**

Visually inspect the exhaust pipes, muffler and hangers for cracks, deterioration, or damage. Start the engine and listen carefully for any exhaust gas leakage. Tighten connections or replace parts as necessary.

### **Suspension mounting bolts**

Check the suspension connections for looseness or damage. Retighten to the specified torque.

### **Steering gear box, linkage & boots/lower arm ball joint**

With the vehicle stopped and engine off, check for excessive free-play in the steering wheel.

Check the linkage for bends or damage. Check the dust boots and ball joints for deterioration, cracks, or damage. Replace any damaged parts.

### **Drive shafts and boots**

Check the drive shafts, boots and clamps for cracks, deterioration, or damage. Replace any damaged parts and, if necessary, repack the grease.

### **Air conditioning refrigerant**

Check the air conditioning lines and connections for leakage and damage.

## **CHECKING FLUID LEVELS**

When checking engine oil, engine coolant, brake fluid, and washer fluid, always be sure to clean the area around any filler plug, drain plug, or dipstick before checking or draining any lubricant or fluid. This is especially important in dusty or sandy areas and when the vehicle is used on unpaved roads. Cleaning the plug and dipstick areas will prevent dirt and grit from entering the engine and other mechanisms that could be damaged.

## ENGINE OIL

### Checking the engine oil level

■ THETA II 2.0L T-GDI (Gasoline engine)

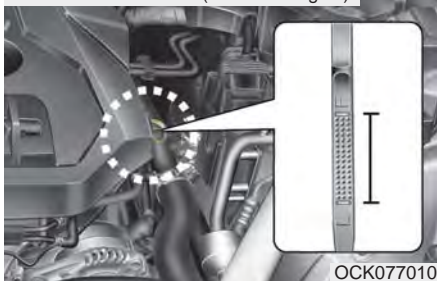

■ Lambda II PE 3.3L T-GDI (Gasoline engine)

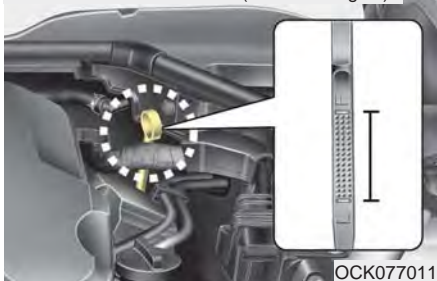

1. Be sure the vehicle is on level ground.
2. Start the engine and allow it to reach normal operating temperature.

3. Turn the engine off and wait for a few minutes (about 5 minutes) for the oil to return to the oil pan.
4. Pull the dipstick out, wipe it clean, and reinsert it fully.

**⚠ WARNING - Radiator hose**  
Be very careful not to touch the radiator hose when checking or adding the engine oil as it may be hot enough to burn you.

5. Pull the dipstick out again and check the level. The level should be between F and L.

**⚠ CAUTION - Replacing engine oil**

*Do not overfill the engine oil. It may damage the engine.*



■ THETA II 2.0L T-GDI (Gasoline engine)



■ Lambda II PE 3.3L T-GDI (Gasoline engine)

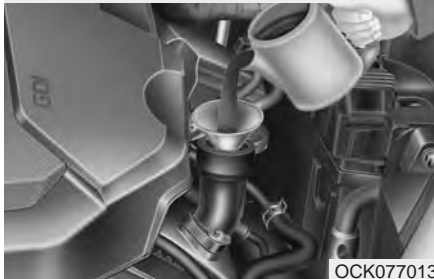

If it is near or at L, add enough oil to bring the level to F. **Do not overfill.**

**Use a funnel to help prevent oil from being spilled on engine components.**

*Use only the specified engine oil. (Refer to "Recommended lubricants and capacities" in chapter 8.)*

## Changing the engine oil and filter

Have engine oil and filter changed by an authorized Kia dealer according to the Maintenance Schedule at the beginning of this chapter.

### **⚠ WARNING - Used engine oil**

**Used engine oil may cause irritation or cancer of the skin if left in contact with the skin for prolonged periods of time. Always protect your skin by washing your hands thoroughly with soap and warm water as soon as possible after handling used oil.**

## ENGINE COOLANT

The high-pressure cooling system has a reservoir filled with year round antifreeze coolant. The reservoir is filled at the factory.

Check the antifreeze protection and coolant level at least once a year: at the beginning of the winter season, and before traveling to a colder climate.

### **CAUTION - Radiator cap**

*Never attempt to remove the radiator cap while the engine is operating or hot. Doing so might lead to cooling system and engine damage.*

### Checking the coolant level

#### **WARNING**



#### **Removing radiator cap**

**Never attempt to remove the radiator cap while the engine is operating or hot. Doing so might lead to cooling system and engine damage and could result in serious personal injury from escaping hot coolant or steam.**

- Turn the engine off and wait until it cools down. Use extreme care when removing the radiator cap. Wrap a thick towel around it, and turn it counterclockwise slowly to the first stop. Step back while the pressure is released from the cooling system.

When you are sure all the pressure has been released, press down on the cap, using a thick towel, and continue turning counterclockwise to remove it.

- Even if the engine is not operating, do not remove the radiator cap or the drain plug while the engine and radiator are hot. Hot coolant and steam may still blow out under pressure, causing serious injury.

**⚠ WARNING - Cooling fan**

Use caution when working near the blade of the cooling fan. The electric motor (cooling fan) is controlled by engine coolant temperature, refrigerant pressure and vehicle speed. It can operate even when the engine is not running.

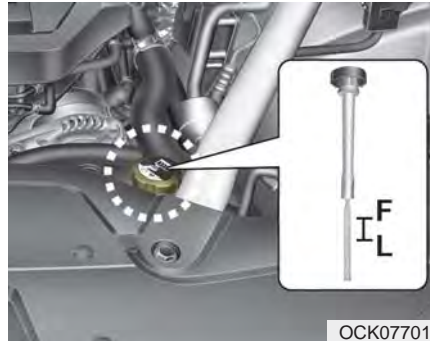

OCK077016

Check the condition and connections of all cooling system hoses and heater hoses. Replace any swollen or deteriorated hoses.

The coolant level should be filled between F and L marks on the coolant level gauge when the engine is cool.

If the coolant level is low, add enough specified coolant to provide protection against freezing and corrosion. Bring the level to F, but do not overfill. If frequent additions are required, see an authorized Kia dealer for a cooling system inspection.

**\* NOTICE**

Make sure the coolant cap is properly closed after refill of coolant. Otherwise the engine could be overheated while driving.

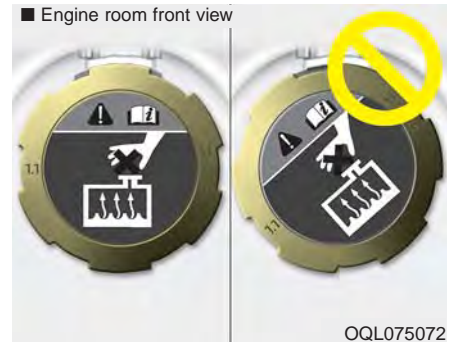

OQL075072

1. Check if the radiator cap label is on straight.

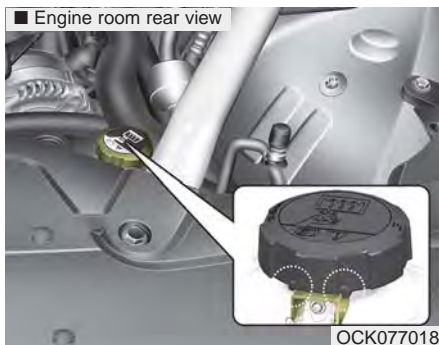

2. Make sure that the tiny protrusions inside the coolant cap are securely interlocked.

**Recommended engine coolant**

- When adding coolant, use only deionized water or soft water for your vehicle and never mix hard water in the coolant filled at the factory. An improper coolant mixture can result in serious malfunction or engine damage.
- The engine in your vehicle has aluminum engine parts and must be protected by an ethylene-glycol with phosphate based coolant to prevent corrosion and freezing.
- DO NOT USE alcohol or methanol coolant or mix them with the specified coolant.
- Do not use a solution that contains more than 60% antifreeze or less than 35% antifreeze. This would reduce the effectiveness of the solution.

For mixture percentage, refer to the following table.

Ambient Temperature	Mixture Percentage (volume)	
	Antifreeze	Water
5°F (-15°C)	35	65
-13°F (-25°C)	40	60
-31°F (-35°C)	50	50
-49°F (-45°C)	60	40

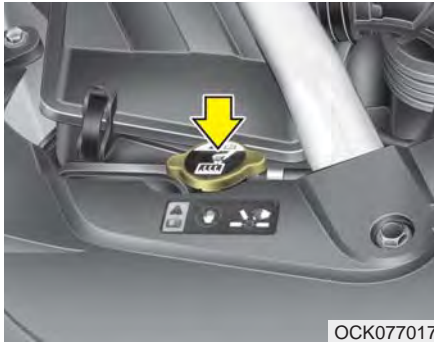

## Changing the coolant

Have the coolant changed by an authorized Kia dealer according to the Maintenance Schedule at the beginning of this chapter.

### CAUTION

*Put a thick cloth or fabric around the radiator cap before refilling the coolant in order to prevent the coolant from overflowing into engine parts such as the generator.*

### WARNING



#### Radiator cap

Do not remove the radiator cap when the engine and radiator are hot. Scalding hot coolant and steam may blow out under pressure which may result in serious injury.

## BRAKE FLUID

### Checking the brake fluid level

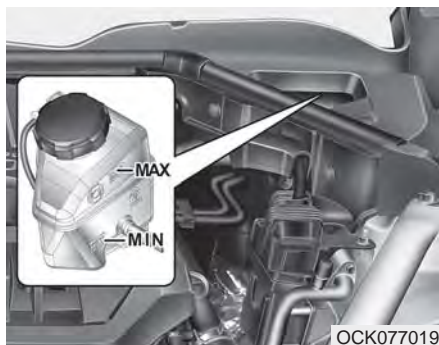

Check the fluid level in the reservoir periodically. The fluid level should be between MAX (Maximum) and MIN (Minimum) marks on the side of the reservoir.

Before removing the reservoir cap and adding brake fluid, clean the area around the reservoir cap thoroughly to prevent brake fluid contamination.

**⚠ CAUTION - Proper fluid**  
*Only use brake fluid in brake system. Small amounts of improper fluids (such as engine oil) can cause damage to the brake system.*

If the level is low, add fluid to the MAX (Maximum) level. The level will fall with accumulated mileage. This is a normal condition associated with the wear of brake linings. If the fluid level is excessively low, have the brake system checked by an authorized Kia dealer.

*Use only the specified brake fluid. (Refer to "Recommended lubricants and capacities" in chapter 8.)*

*Never mix different types of fluid.*

In the event the brake system requires frequent additions of fluid, the vehicle should be inspected by an authorized Kia dealer.

When changing and adding brake fluid, handle it carefully. Do not let it come in contact with your eyes. If brake fluid should come in contact with your eyes, immediately flush them with a large quantity of fresh tap water. Have your eyes examined by a doctor as soon as possible.

**⚠ CAUTION - Brake fluid**  
*Do not allow brake fluid to contact the vehicle's body paint, as paint damage will result.*

Brake fluid, which has been exposed to open air for an extended time should never be used as its quality cannot be guaranteed. It should be disposed of properly.

## WASHER FLUID

### Checking the washer fluid level

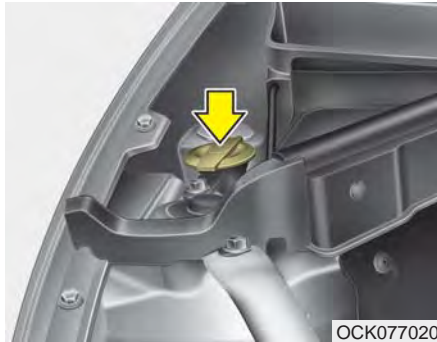

If washer fluid is insufficient, the warning message will be popped up on LCD display.

In this case, add washer fluid to the reservoir tank.

Plain water may be used if washer fluid is not available. However, use washer solvent with antifreeze characteristics in cold climates to prevent freezing.

#### **⚠ WARNING - Flammable fluid**

Do not allow the washer fluid to come in contact with open flames or sparks. The windshield washer fluid reservoir is flammable under certain circumstances. This can result in a fire.

#### **⚠ WARNING - Coolant**

- Do not use radiator coolant or antifreeze in the washer fluid reservoir.
- Radiator coolant can severely obscure visibility when sprayed on the windshield and may cause loss of vehicle control.

#### **⚠ WARNING - Windshield fluid**

Do not drink the windshield washer fluid. The windshield washer fluid is poisonous to humans and animals.

## PARKING BRAKE

### Checking the parking brake (if equipped)



Check whether the stroke is within specification when the parking brake pedal is depressed with 44 lbs, 196 N (20 kg) of force. Also, the parking brake alone should securely hold the vehicle on a fairly steep grade. If the stroke is more or less than specified, have the parking brake adjusted by an authorized Kia dealer.

**Stroke : 3 notch**



## AIR CLEANER

### Filter replacement

■ THETA II 2.0L T-GDI (Gasoline engine)

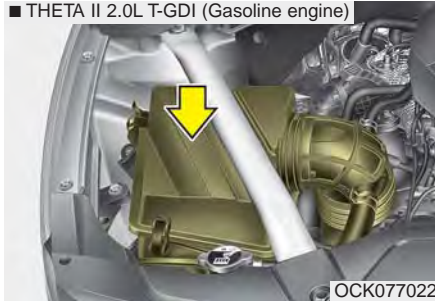

■ Lambda II PE 3.3L T-GDI (Gasoline engine)  
(Passenger side)

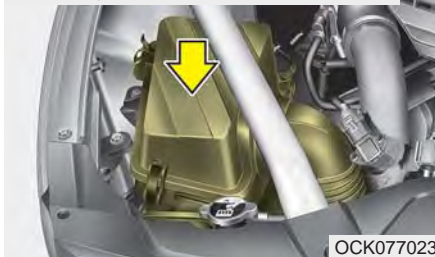

The air filter must be replaced when necessary, and should not be washed.

Have the air cleaner filter inspected or replaced by an authorized Kia dealer.

■ Lambda II PE 3.3L T-GDI (Gasoline engine)  
(Driver side)

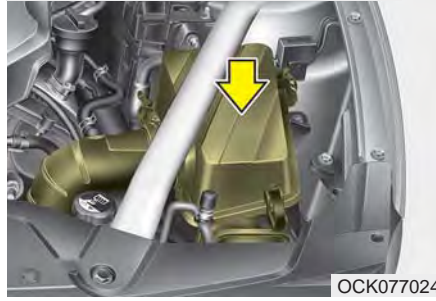

Replace the filter according to the Maintenance Schedule.

*If the vehicle is operated in extremely dusty or sandy areas, replace the element more often than the usual recommended intervals. (Refer to "Maintenance under severe usage conditions" in this chapter.)*

#### **⚠ CAUTION - Air filter maintenance**

- **Do not drive with the air cleaner removed; this will result in excessive engine wear.**
- **When removing the air cleaner filter, be careful that dust or dirt does not enter the air intake, or damage may result.**
- **Use a Kia genuine part. Use of a non-genuine part could damage the air flow sensor.**

## CLIMATE CONTROL AIR FILTER

### Filter inspection

The climate control air filter should be replaced according to the Maintenance Schedule. If the vehicle is operated in severely air-polluted cities or on dusty rough roads for a long period, it should be inspected more frequently and replaced earlier. When you replace the climate control air filter, replace it performing the following procedure, and be careful to avoid damaging other components.

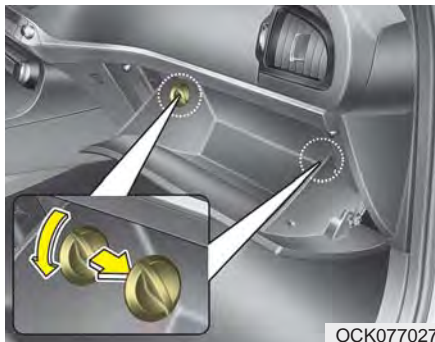

1. Open the glove box and remove the stoppers on both sides.

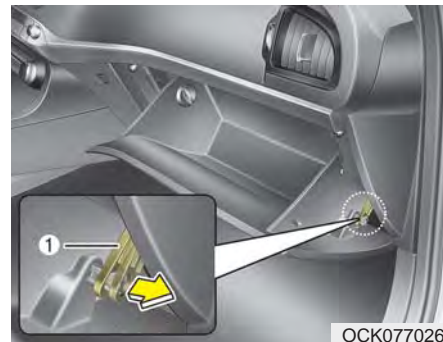

2. With the glove box open, pull the support strap (1).



3. Remove the climate control air filter cover while pressing the lock on the left side of the cover.



4. Replace the climate control air filter.
5. Reassemble in the reverse order of disassembly.

When replacing the climate control air filter install it properly. Otherwise, the system may produce noise and the effectiveness of the filter may be reduced.

## WIPER BLADES

### Blade inspection

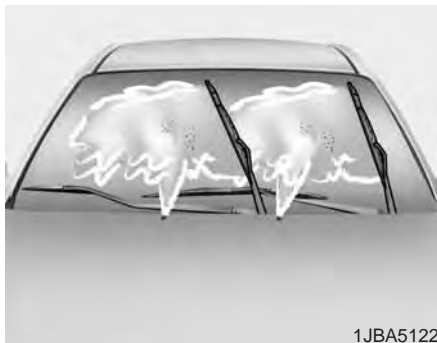

Commercial hot waxes applied by automatic car washes have been known to make the windshield difficult to clean.

Contamination of either the windshield or the wiper blades with foreign matter can reduce the effectiveness of the windshield wipers. Common sources of contamination are insects, tree sap, and hot wax treatments used by some commercial car washes. If the blades are not wiping properly, clean both the window and the blades with a good cleaner or mild detergent, and rinse thoroughly with clean water.



### **CAUTION - Wiper blades**

***To prevent damage to the wiper blades, do not use gasoline, kerosene, paint thinner, or other solvents on or near them.***

### Blade replacement

When the wipers no longer clean adequately, the blades may be worn or cracked, and require replacement.

To prevent damage to the wiper arms or other components, do not attempt to move the wipers manually.

The use of a non-specified wiper blade could result in wiper malfunction and failure.

## Front windshield wiper blade

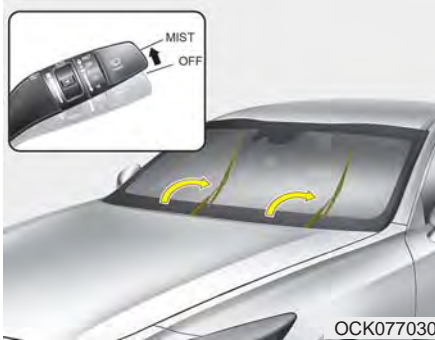

For your convenience, move the windshield wiper blades to the service position as follows;

After turning off the engine, move the wiper switch to the single wiping (MIST) position within 20 seconds and hold the switch more than 2 seconds until the wiper blade is in the fully up position.



**CAUTION - Wiper arms**  
*Do not allow the wiper arm to fall against the windshield, since it may chip or crack the windshield.*

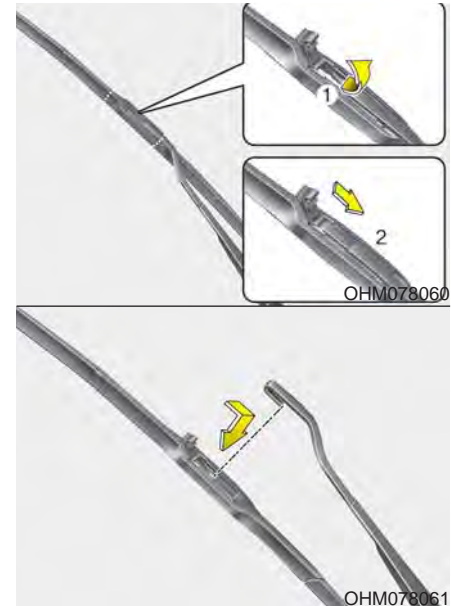

1. Raise the wiper arm.
2. Lift up the wiper blade clip. Then pull down the blade assembly and remove it.
3. Install the new blade assembly.

4. Return the wiper arm on the windshield.
5. Turn ignition to the ON position and wiper arms will return to the normal operating position.

## BATTERY

### Battery replacement



OCK077031

The battery is in the trunk under the compartment cover.

When replacing the battery, disconnect the negative (-) cable (1) and remove the positive (+) battery fuse box (2).

Remove the battery mounting bracket (3).

**⚠ WARNING**  
- Touching metal surfaces in the trunk under the compartment cover

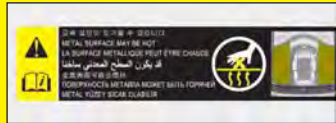

**Do not touch metal surfaces in the trunk under the compartment cover while the engine is operating or hot. Doing so could result in serious personal injury. Turn the engine off and wait until it cools down or wear gloves to replace the battery from the luggage room.**

### For best battery service

- Keep the battery securely mounted.
- Keep the battery top clean and dry.
- Keep the terminals and connections clean, tight, and coated with petroleum jelly or terminal grease.
- Rinse any spilled electrolyte from the battery immediately with a solution of water and baking soda.
- If the vehicle is not going to be used for an extended time, disconnect the battery cables.

**⚠ WARNING - Risk of explosion**



Keep lit cigarettes and all other flames or sparks away from the battery.



The battery contains hydrogen -- a highly combustible gas which will explode if it comes in contact with a flame or spark.



Keep batteries out of the reach of children because batteries contain highly corrosive **SULFURIC ACID** and electrolytes. Do not allow battery acid to contact your skin, eyes, clothing or paint finish.



Wear eye protection when charging or working near a battery. Always provide ventilation when working in an enclosed space.



Always read the following instructions carefully when handling a battery.



If any electrolyte gets into your eyes, flush your eyes with clean water for at least 15 minutes and get immediate medical attention.

If electrolyte gets on your skin, thoroughly wash the contacted area. If you feel pain or burning sensation, get medical attention immediately.



An inappropriately disposed battery can be harmful to the environment and human health. Dispose the battery according to your local law(s) or regulation.



The battery contains lead. Do not dispose of it after use. Please return the battery to an authorized Kia dealer to be recycled.

Never attempt to recharge the battery when the battery cables are connected.

**⚠ WARNING - Risk of electrocution**

Never touch the electrical ignition system while the vehicle is running. This system works with high voltage which can shock you.

**⚠ WARNING - Recharging Battery**

Never attempt to recharge the battery when the battery cables are connected.



**⚠ WARNING - Battery lead compound**

**Battery posts, terminals, and related accessories contain lead and lead compounds. Wash hands after handling.**

**\* NOTICE**

If you connect unauthorized electronic devices to the battery, the battery may be discharged. Never use unauthorized devices.

## Recharging the battery

Your vehicle has a maintenance-free, calcium-based battery.

- If the battery becomes discharged in a short time (because, for example, the headlamps or interior lamps were left on while the vehicle was not in use), recharge it by slow charging (trickle) for 10 hours.
- If the battery gradually discharges because of high electric load while the vehicle is being used, recharge it at 20-30A for two hours.

When recharging the battery, observe the following precautions:

- The battery must be removed from the vehicle and placed in an area with good ventilation.
- Do not allow cigarettes, sparks, or flame near the battery.
- Watch the battery during charging, and stop or reduce the charging rate if the battery cells begin gassing (boiling) violently or if the temperature of the electrolyte of any cell exceeds 120°F (49°C).
- Wear eye protection when checking the battery during charging.
- Disconnect the battery charger in the following order.
  1. Turn off the battery charger main switch.
  2. Unhook the negative clamp from the negative battery terminal.
  3. Unhook the positive clamp from the positive battery terminal.

- Before performing maintenance or recharging the battery, turn off all accessories and stop the engine.
- The negative battery cable must be removed first and installed last when the battery is disconnected.

### **Reset items**

Items should be reset after the battery has been discharged or the battery has been disconnected.

- Auto up/down window
- Sunroof
- Trip computer
- Climate control system
- Driver position memory system

## TIRES AND WHEELS

### Tire care

For proper maintenance, safety, and maximum fuel economy, you must always maintain recommended tire inflation pressures and stay within the load limits and weight distribution recommended for your vehicle.

### Recommended cold tire inflation pressures

All tire pressures (including the spare) should be checked when the tires are cold. "Cold Tires" means the vehicle has not been driven for at least three hours or driven less than 1 mile (1.6 km).

Recommended pressures must be maintained for the best ride, top vehicle handling, and minimum tire wear.

For recommended inflation pressure refer to "Tire and wheels" in chapter 8.

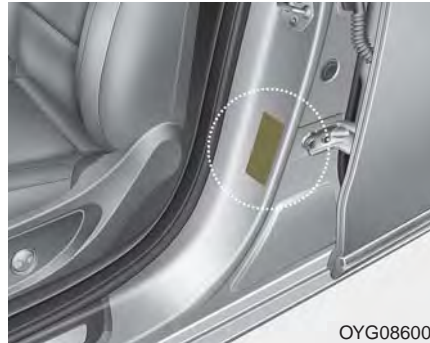

All specifications (sizes and pressures) can be found on a label attached to the driver's side center pillar.

### **⚠️ WARNING**

**- Checking the tire inflation pressure**

**Inflate your tires consistent with the instructions provided in this manual.**

**Regularly check the tire inflation pressure, and correct it as needed: at least twice a month and before a long trip.**

**If you fail to observe this precaution, you may be driving on tires with incorrect tire pressures, a condition that may not only compromise your vehicle's driving stability, but also lead to tire damage and the risk of an accident.**

**This risk is much higher on hot days and when driving for long periods at high speeds.**

- Underinflation also results in excessive wear, poor handling and reduced fuel economy. Wheel deformation also is possible. Keep your tire pressures at the proper levels. If a tire frequently needs refilling, have it checked by an authorized Kia dealer.
- Overinflation produces a harsh ride, excessive wear at the center of the tire tread, and a greater possibility of damage from road hazards.
- Warm tires normally exceed recommended cold tire pressures by 4 to 6 psi (28 to 41 kPa). Do not release air from warm tires to adjust the pressure or the tires will be underinflated.
- Be sure to reinstall the tire inflation valve caps. Without the valve cap, dirt or moisture could get into the valve core and cause air leakage. If a valve cap is missing, install a new one as soon as possible.

### Tire pressure

Always observe the following:

- Check tire pressure when the tires are cold. (After vehicle has been parked for at least three hours or hasn't been driven more than 1 mile (1.6 km) since startup.)
- Check the pressure of your spare tire each time you check the pressure of other tires.
- Never overload your vehicle. Be careful not to overload a vehicle luggage rack if your vehicle is equipped with one.

**⚠ WARNING - Tire Inflation**  
**Overinflation or underinflation can reduce tire life, adversely affect vehicle handling, and lead to sudden tire failure. This could result in loss of vehicle control and potential injury.**

### Checking tire inflation pressure

Check your tires once a month or more.

Also, check the tire pressure of the spare tire.

#### *How to check*

Use a good quality gauge to check tire pressure. You can not tell if your tires are properly inflated simply by looking at them. Radial tires may look properly inflated even when they're underinflated.

Check the tire's inflation pressure when the tires are cold. - "Cold" means your vehicle has been sitting for at least three hours or driven no more than 1 mile (1.6 km).

Remove the valve cap from the tire valve stem. Press the tire gauge firmly onto the valve to get a pressure measurement. If the cold tire inflation pressure matches the recommended pressure on the tire and loading information label, no further adjustment is necessary. If the pressure is low, add air until you reach the recommended amount.

If you overfill the tire, release air by pushing on the metal stem in the center of the tire valve. Recheck the tire pressure with the tire gauge. Be sure to put the valve caps back on the valve stems. They help prevent leaks by keeping out dirt and moisture.

- Inspect your tires frequently for proper inflation as well as wear and damage. Always use a tire pressure gauge.
- Tires with too much or too little pressure wear unevenly causing poor handling, loss of vehicle control, and sudden tire failure leading to accidents, injuries, and even death. The recommended cold tire pressure for your vehicle can be found in this manual and on the tire label located on the driver's side center pillar.
- Remember to check the pressure of your spare tire. Kia recommends that you check the spare every time you check the pressure of the other tires on your vehicle.

### **Tire rotation**

To equalize tread wear, it is recommended that the tires be rotated every 6,000 miles (10,000 km) or sooner if irregular wear develops.

During rotation, check the tires for correct balance.

When rotating tires, check for uneven wear and damage. Abnormal wear is usually caused by incorrect tire pressure, improper wheel alignment, out-of-balance wheels, severe braking or severe cornering. Look for bumps or bulges in the tread or side of tire. Replace the tire if you find either of these conditions. Replace the tire if fabric or cord is visible. After rotation, be sure to bring the front and rear tire pressures to specification and check lug nut tightness.

Refer to "Tire and wheels" in chapter 8.

## ■ 18inch tire

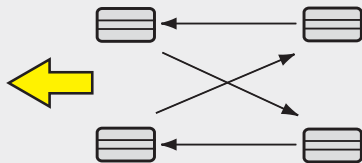

OBH078040

## ■ 19inch tire

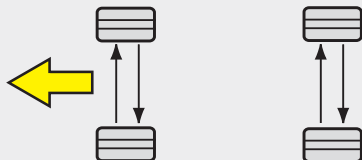

OBK079038

*Disc brake pads should be inspected for wear whenever tires are rotated.*

Rotate radial tires that have an asymmetric tread pattern only from front to rear and not from right to left.

### **⚠ WARNING - Mixing tires**

- Do not use the compact spare tire (if equipped) for tire rotation.
- Do not mix bias ply and radial ply tires under any circumstances. This may cause unusual handling characteristics.

## **Wheel alignment and tire balance**

The wheels on your vehicle were aligned and balanced carefully at the factory to give you the longest tire life and best overall performance.

In most cases, you will not need to have your wheels aligned again. However, if you notice unusual tire wear or your vehicle pulling one way or the other, the alignment may need to be reset.

If you notice your vehicle vibrating when driving on a smooth road, your wheels may need to be rebalanced.

**⚠ CAUTION - Wheel weight**  
*Improper wheel weights can damage your vehicle's aluminum wheels. Use only approved wheel weights.*

## Flat Spots

If a vehicle is parked/not operated for a long period of time, tires may develop “flat spots”. Once the vehicle is driven again, these flat spots may cause a vibration which typically disappears gradually as the tires warm up and regain their original shape. To minimize tire flat spots developing during periods of extended storage, inflate the tires to the maximum pressure as indicated on the tire’s sidewall. When the vehicle is made ready to drive again, lower the tire pressure to the recommended levels as shown on the Tire and Loading Information label in the driver’s side center pillar for your vehicle (Refer to “Tire specification and pressure label” in chapter 8).

## Tire replacement



If the tire is worn evenly, a tread wear indicator (A) will appear as a solid band across the tread. This shows there is less than 1/16 inch (1.6 mm) of tread left on the tire. Replace the tire when this happens.

Do not wait for the band to appear across the entire tread before replacing the tire.

The ABS (Anti-lock Brake System) works by comparing the speed of the wheels. The tire size affects wheel speed. When replacing tires, all 4 tires must use the same size originally supplied with the vehicle. Using tires of a different size can cause the ABS and ESC (Electronic Stability Control) to work irregularly.

### \* NOTICE

**We recommend that when replacing tires, use the same which were originally supplied with the vehicle. If not, driving performance could be altered.**

### ***Compact spare tire replacement***

A compact spare tire has a shorter tread life than a regular size tire. Replace it when you can see the tread wear indicator bars on the tire. The replacement compact spare tire should be the same size and design tire as the one provided with your new vehicle and should be mounted on the same compact spare tire wheel. The compact spare tire is not designed to be mounted on a regular size wheel, and the compact spare tire wheel is not designed for mounting a regular size tire.

### **Wheel replacement**

When replacing the metal wheels for any reason, make sure the new wheels are equivalent to the original factory units in diameter, rim width and offset.

A wheel that is not the correct size may adversely affect wheel and bearing life, braking and stopping abilities, handling characteristics, ground clearance, body-to-tire clearance, snow chain clearance, speedometer and odometer calibration, headlight aim and bumper height.



#### **CAUTION - Wheel**

***Wheels that do not meet Kia's specifications may fit poorly and result in damage to the vehicle or unusual handling and poor vehicle control.***

### **Tire traction**

Tire traction can be reduced if you drive on worn tires, tires that are improperly inflated or on slippery road surfaces. Tires should be replaced when tread wear indicators appear. Slow down whenever there is rain, snow or ice on the road, to reduce the possibility of losing control of the vehicle.

### **Tire maintenance**

In addition to proper inflation, correct wheel alignment helps to decrease tire wear. If you find a tire is worn unevenly, have your dealer check the wheel alignment.

When you have new tires installed, make sure they are balanced. This will increase vehicle ride comfort and tire life. Additionally, a tire should always be rebalanced if it is removed from the wheel.



## Tire sidewall labeling

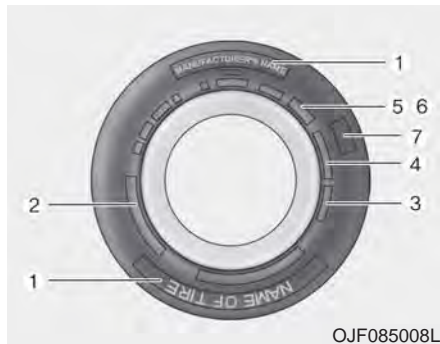

OJF085008L

This information identifies and describes the fundamental characteristics of the tire and also provides the tire identification number (TIN) for safety standard certification. The TIN can be used to identify the tire in case of a recall.

### 1. *Manufacturer or brand name*

Manufacturer or Brand name is shown.

### 2. *Tire size designation*

A tire's sidewall is marked with a tire size designation. You will need this information when selecting replacement tires for your car. The following explains what the letters and numbers in the tire size designation mean.

Example tire size designation:

(These numbers are provided as an example only; your tire size designator could vary depending on your vehicle.)

#### **P205/55R16 89H**

P - Applicable vehicle type (tires marked with the prefix "P" are intended for use on passenger vehicles or light trucks; however, not all tires have this marking).

205 - Tire width in millimeters.

55 - Aspect ratio. The tire's section height as a percentage of its width.

R - Tire construction code (Radial).

16 - Rim diameter in inches.

89 - Load Index, a numerical code associated with the maximum load the tire can carry.

H - Speed Rating Symbol. See the speed rating chart in this section for additional information.

### **Wheel size designation**

Wheels are also marked with important information that you need if you ever have to replace one. The following explains what the letters and numbers in the wheel size designation mean.

Example wheel size designation:

#### **6.0JX16**

6.0 - Rim width in inches.

J - Rim contour designation.

16 - Rim diameter in inches.

**Tire speed ratings**

The chart below lists many of the different speed ratings currently being used for passenger vehicles. The speed rating is part of the tire size designation on the sidewall of the tire. This symbol corresponds to that tire's designed maximum safe operating speed.

Speed Rating Symbol	Maximum Speed
S	112 mph (180 km/h)
T	118 mph (190 km/h)
H	130 mph (210 km/h)
V	149 mph (240 km/h)
W	168 mph (270 km/h)
Y	186 mph (300 km/h)
Z	Above 149 mph (240 km/h)

**3. Checking tire life (TIN : Tire Identification Number)**

Any tires that are over 6 years old, based on the manufacturing date, (including the spare tire) should be replaced by new ones. You can find the manufacturing date on the tire sidewall (possibly on the inside of the wheel), displaying the DOT Code. The DOT Code is a series of numbers on a tire consisting of numbers and English letters. The manufacturing date is designated by the last four digits (characters) of the DOT code.

**DOT : XXXX XXXX OOOO**

The front part of the DOT means a plant code number, tire size and tread pattern and the last four numbers indicate week and year manufactured.

For example:

DOT XXXX XXXX 1619 represents that the tire was produced in the 16th week of 2019.

**⚠ WARNING - Tire age**  
**Replace tires within the recommended time frame. Failure to replace tires as recommended can result in sudden tire failure, which could lead to a loss of control and an accident.**

**4. Tire ply composition and material**

The number of layers or plies of rubber-coated fabric in the tire. Tire manufacturers also must indicate the materials in the tire, which include steel, nylon, polyester, and others. The letter "R" means radial ply construction; the letter "D" means diagonal or bias ply construction; and the letter "B" means belted-bias ply construction.

### ***5. Maximum permissible inflation pressure***

This number is the greatest amount of air pressure that should be put in the tire. Do not exceed the maximum permissible inflation pressure. Refer to the Tire and Loading Information label for recommended inflation pressure.

### ***6. Maximum load rating***

This number indicates the maximum load in kilograms and pounds that can be carried by the tire. When replacing the tires on the vehicle, always use a tire that has the same load rating as the factory installed tire.

### ***7. Uniform tire quality grading***

Quality grades can be found where applicable on the tire sidewall between tread shoulder and maximum section width.

For example:

TREADWEAR 440

TRACTION A

TEMPERATURE A

### **Tread wear**

The tread wear grade is a comparative rating based on the wear rate of the tire when tested under controlled conditions on a specified government test course. For example, a tire graded 150 would wear one-and-a-half times ( $1\frac{1}{2}$ ) as well on the government course as a tire graded 100.

The relative performance of tires depends upon the actual conditions of their use, however, and may depart significantly from the norm due to variations in driving habits, service practices and differences in road characteristics and climate.

Tires degrade over time, even when they are not being used. Regardless of the remaining tread, we recommend that tires be replaced after approximately six (6) years of normal service. Heat caused by hot climates or frequent high loading conditions can accelerate the aging process.

These grades are molded on the side-walls of passenger vehicle tires. The tires available as standard or optional equipment on your vehicles may vary with respect to grade.

### **Traction - AA, A, B & C**

The traction grades, from highest to lowest, are AA, A, B and C. Those grades represent the tires ability to stop on wet pavement as measured under controlled conditions on specified government test surfaces of asphalt and concrete. A tire marked C may have poor traction performance.

The traction grade assigned to this tire is based on straight-ahead braking traction tests, and does not include acceleration, cornering, hydroplaning, or peak traction characteristics.

### **Temperature -A, B & C**

The temperature grades are A (the highest), B and C representing the tire's resistance to the generation of heat and its ability to dissipate heat when tested under controlled conditions on a specified indoor laboratory test wheel.

Sustained high temperature can cause the material of the tire to degenerate and reduce tire life, and excessive temperature can lead to sudden tire failure. The grade C corresponds to a level of performance which all passenger car tires must meet under the Federal Motor Vehicle Safety Standard No. 109. Grades B and A represent higher levels of performance on the laboratory test wheel than the minimum required by law.

### **Tire terminology and definitions**

**Air Pressure:** The amount of air inside the tire pressing outward on the tire. Air pressure is expressed in kilopascal (kPa) or pounds per square inch (psi).

**Accessory Weight:** This means the combined weight of optional accessories. Some examples of optional accessories are, automatic transmission, power seats, and air conditioning.

**Aspect Ratio:** The relationship of a tire's height to its width.

**Belt:** A rubber coated layer of cords that is located between the plies and the tread. Cords may be made from steel or other reinforcing materials.

**Bead:** The tire bead contains steel wires wrapped by steel cords that hold the tire onto the rim.

**Bias Ply Tire:** A pneumatic tire in which the plies are laid at alternate angles less than 90 degrees to the centerline of the tread.

**Cold Tire Pressure:** The amount of air pressure in a tire, measured in kilopascals (kPa) or pounds per square inch (psi) before a tire has built up heat from driving.

**Curb Weight:** This means the weight of a motor vehicle with standard and optional equipment including the maximum capacity of fuel, oil and coolant, but without passengers and cargo.

**DOT Markings:** A code molded into the sidewall of a tire signifying that the tire is in compliance with the U.S. Department of Transportation motor vehicle safety standards. The DOT code includes the Tire Identification Number (TIN), an alphanumeric designator which can also identify the tire manufacturer, production plant, brand and date of production.

**GVWR:** Gross Vehicle Weight Rating

**GAWR FRT:** Gross Axle Weight Rating for the Front Axle.

**GAWR RR:** Gross Axle Weight Rating for the Rear axle.

**Intended Outboard Sidewall:** The side of an asymmetrical tire, that must always face outward when mounted on a vehicle.

**Kilopascal (kPa):** The metric unit for air pressure.

**Light truck(LT) tire:** A tire designated by its manufacturer as primarily intended for use on lightweight trucks or multipurpose passenger vehicles.

**Load Index:** An assigned number ranging from 1 to 279 that corresponds to the load carrying capacity of a tire.

**Load ratings:** The maximum load that a tire is rated to carry for a given inflation pressure.

**Maximum Inflation Pressure:** The maximum air pressure to which a cold tire may be inflated. The maximum air pressure is molded onto the sidewall.

**Maximum Load Rating:** The load rating for a tire at the maximum permissible inflation pressure for that tire.

**Maximum Loaded Vehicle Weight:** The sum of curb weight; accessory weight; vehicle capacity weight; and production options weight.

**Normal Occupant Weight:** The number of occupants a vehicle is designed to seat multiplied by 150 lbs. (68kg).

**Occupant Distribution:** Designated seating positions.

**Outward Facing Sidewall:** The side of a asymmetrical tire that has a particular side that faces outward when mounted on a vehicle. The outward facing sidewall bears white lettering or bears manufacturer, brand, and/or model name molding that is higher or deeper than the same moldings on the inner facing sidewall.

**Passenger (P-Metric) Tire:** A tire used on passenger cars and some light duty trucks and multipurpose vehicles.

**Ply:** A layer of rubber-coated parallel cords

**Pneumatic tire:** A mechanical device made of rubber, chemicals, fabric and steel or other materials, that, when mounted on an automotive wheel, provides the traction and contains the gas or fluid that sustains the load.

**Production options weight:** The combined weight of installed regular production options weighing over 5 lb.(2.3 kg) in excess of the standard items which they replace, not previously considered in curb weight or accessory weight, including heavy duty brakes, ride levelers, roof rack, heavy duty battery, and special trim.

**Recommended Inflation Pressure:** Vehicle manufacturer's recommended tire inflation pressure and shown on the tire placard.

**Radial Ply Tire:** A pneumatic tire in which the ply cords that extend to the beads are laid at 90 degrees to the centerline of the tread.

**Rim:** A metal support for a tire and upon which the tire beads are seated.

**Sidewall:** The portion of a tire between the tread and the bead.

**Speed Rating:** An alphanumeric code assigned to a tire indicating the maximum speed at which a tire can operate.

**Traction:** The friction between the tire and the road surface. The amount of grip provided.

**Tread:** The portion of a tire that comes into contact with the road.

**Treadwear Indicators:** Narrow bands, sometimes called "wear bars," that show across the tread of a tire when only 1/16 inch of tread remains.

**UTQGS:** Uniform Tire Quality Grading Standards, a tire information system that provides consumers with ratings for a tire's traction, temperature and treadwear. Ratings are determined by tire manufacturers using government testing procedures. The ratings are molded into the sidewall of the tire.

**Vehicle Capacity Weight:** The number of designated seating positions multiplied by 150 lbs. (68kg) plus the rated cargo and luggage load.

**Vehicle Maximum Load on the**

**Tire:** Load on an individual tire due to curb and accessory weight plus maximum occupant and cargo weight.

**Vehicle Normal Load on the Tire:**

Load on an individual tire that is determined by distributing to each axle its share of the curb weight, accessory weight, and normal occupant weight and driving by 2.

**Vehicle Placard:** A label permanently attached to a vehicle showing the original equipment tire size and recommended inflation pressure.

**All season tires**

Kia specifies all season tires on some models to provide good performance for use all year round, including snowy and icy road conditions. All season tires are identified by ALL SEASON and/or M+S (Mud and Snow) on the tire sidewall. Snow tires have better snow traction than all season tires and may be more appropriate in some areas.

**Summer tires**

Kia specifies summer tires on some models to provide superior performance on dry roads. Summer tire performance is substantially reduced in snow and ice. Summer tires do not have the tire traction rating M+S (Mud and Snow) on the tire side wall. If you plan to operate your vehicle in snowy or icy conditions, Kia recommends the use of snow tires or all season tires on all four wheels.

 **WARNING**

**Do not use summer tires at temperatures below 45°F (7°C) or when driving on snow or ice. At temperatures below 45°F (7°C), summer tires can lose elasticity, and therefore traction and braking power as well. Change the tires on your vehicle to winter or all-weather tires of the same size as the standard tires of the vehicle. Both types of tires are identified by the M+S (Mud and Snow) marking. Using summer tires at very cold temperatures could cause cracks to form, thereby damaging the tires permanently.**

### Snow tires

If you equip your car with snow tires, they should be the same size and have the same load capacity as the original tires. Snow tires should be installed on all four wheels; otherwise, poor handling may result.

Snow tires should carry 4 psi (28 kPa) more air pressure than the pressure recommended for the standard tires on the tire label on the driver's side of the center pillar, or up to the maximum pressure shown on the tire sidewall, whichever is less.

Do not drive faster than 75 mph (120 km/h) when your vehicle is equipped with snow tires.

### Tire chains

Tire chains, if necessary, should be installed on the rear wheels.

Be sure that the chains are installed in accordance with the manufacturer's instructions.

To minimize tire and chain wear, do not continue to use tire chains when they are no longer needed.

- When driving on roads covered with snow or ice, drive at less than 20 mph (30 km/h).
- Use AutoSock fabric snow chain.
- If you hear noise caused by chains contacting the body, retighten the chain to avoid contact with the vehicle body.
- To prevent body damage, retighten the chains after driving 0.3~0.6 miles (0.5~1.0 km).

### Radial-ply tires

Radial-ply tires provide improved tread life, road hazard resistance and smoother high speed ride. The radial-ply tires used on this vehicle are of belted construction and are selected to complement the ride and handling characteristics of your vehicle.

Radial-ply tires have the same load carrying capacity as bias-ply or bias belted tires of the same size and use the same recommended inflation pressure. Mixing of radial-ply tires with bias-ply or bias belted tires is not recommended. Any combinations of radial-ply and bias-ply or bias belted tires when used on the same vehicle will seriously deteriorate vehicle handling. The best rule to follow is: identical radial-ply tires should always be used as a set of four.

Longer wearing tires can be more susceptible to irregular tread wear. It is very important to follow the tire rotation interval shown in this section to achieve the tread life potential of these tires.



Cuts and punctures in radial-ply tires are repairable only in the tread area, because of sidewall flexing. Consult your tire dealer for radial-ply tire repairs.

### **Low aspect ratio tire (if equipped)**

Low aspect ratio tires, whose aspect ratio is lower than 50, are provided for sporty looks.

Because the low aspect ratio tires are optimized for handling and braking, it may be more uncomfortable to ride in and there is more noise compare with normal tires.

### **CAUTION**

***Because the sidewall of the low aspect ratio tire is shorter than the normal, the wheel and tire of the low aspect ratio tire is easier to be damaged. So, follow the instructions below.***

- ***When driving on a rough road or off road, drive cautiously because tires and wheels may be damaged. And after driving, inspect tires and wheels.***
- ***When passing over a pothole, speed bump, manhole, or curb stone, drive slowly so that the tires and wheels are not damaged.***
- ***If the tire is impacted, we recommend that you inspect the tire condition or contact an authorized Kia dealer.***
- ***To prevent damage to the tire, inspect the tire condition and pressure every 1,900 miles (3,000 km).***

- It is not easy to recognize the tire damage with your own eyes. But if there is the slightest hint of tire damage, even though you cannot see it, have the tire checked or replaced because the tire damage may cause air leakage from the tire.
- If the tire is damaged by driving on a rough road, off road, pothole, manhole, or curb stone, it will not be covered by the warranty.
- You can find out the tire information on the tire sidewall.

## FUSES

### ■ Blade type



### ■ Cartridge type



### ■ Multi fuse



### ■ Fusible link



OCK077071

\* Left side : Normal , Right side : Blown

A vehicle's electrical system is protected from electrical overload damage by fuses.

This vehicle has 4 (or 5) fuse panels, one located in the driver's side panel bolster, the other in the engine compartment near the battery.

If any of your vehicle's lights, accessories, or controls do not work, check the appropriate circuit fuse. If a fuse has blown, the element inside the fuse will melt.

If the electrical system does not work, first check the driver's side fuse panel.

Always replace a blown fuse with one of the same rating.

If the replacement fuse blows, this indicates an electrical problem. Avoid using the system involved and immediately consult an authorized Kia dealer.

*Three kinds of fuses are used: blade type for lower amperage rating, cartridge type, and multi fuse for higher amperage ratings.*

### **⚠ WARNING - Fuse replacement**

- **Never replace a fuse with anything but another fuse of the same rating.**
- **A higher capacity fuse could cause damage and possibly a fire.**
- **Never install a wire or aluminum foil instead of the proper fuse - even as a temporary repair. It may cause extensive wiring damage and a possible fire.**

- Do not arbitrarily modify or add-on electric wiring to the vehicle.

### **⚠ CAUTION**

***Do not use a screwdriver or any other metal object to remove fuses because it may cause a short circuit and damage the system.***

**\* NOTICE**

- When replacing fuse, turn the ignition “OFF” and turn off switches of all electrical devices then remove battery (-) terminal.
- The actual fuse/relay panel label may differ from equipped items.

**⚠ WARNING - Electrical Fire**  
Always ensure replacements fuses and relays are securely fastened when installed. Failure to do so can result in a vehicle fire.

**⚠ CAUTION**

- *When replacing a blown fuse or relay, make sure the new fuse or relay fits tightly into the clips. Failure to tightly install the fuse or relay may cause damage to the wiring and electric systems.*
- *Do not remove fuses, relays and terminals fastened with bolts or nuts. The fuses, relays and terminals may not be fastened correctly which may cause vehicle damage.*

**⚠ CAUTION**

- *Do not input any other objects except fuses or relays into fuse/relay terminals such as a driver or wiring. It may cause contact failure and system malfunction.*
- *Do not plug in screwdrivers or aftermarket wiring into the terminal originally designed for fuse and relays only. The electrical system and wiring of the vehicle interior may be damaged or burned due to contact failure.*
- *If you directly connect the wire on the taillight or replace the bulb which is over the regulated capacity to install trailers etc., the inner junction block can get burned.*

**⚠ CAUTION**

*Visually inspect the battery cap to ensure it is securely closed. If the battery cap is not securely closed, moisture may enter the system and damage the electrical components.*

**⚠ WARNING****- Electrical wiring repairs**

All electrical repairs should be performed by authorized Kia dealerships using approved Kia parts. Using other wiring components, especially when retrofitting AVN or theft alarm system, remote engine control, car phone or radio may cause vehicle damage and increase the risk of a vehicle fire.

**\* NOTICE - Remodeling Prohibited**

Do not rewire your vehicle in any way as doing so may affect the performance of several safety features in your vehicle. Rewiring your vehicle may also void your warranty and cause you to be responsible for any subsequent vehicle damage which may result.

**\* NOTICE - Window tinting precaution**

Window tint(especially metallic film) might cause communication disorder or poor radio reception, and malfunction of the automatic lighting system due to excessive change of illumination inside the vehicle. The solution used might also flow into electric, electronic devices causing disorder and failure.

**Inner panel fuse replacement**

1. Turn the ignition switch and all other switches off.
  2. Open the fuse panel cover.
- If the switch is located in the "OFF" position, a caution indicator will be displayed in the cluster.

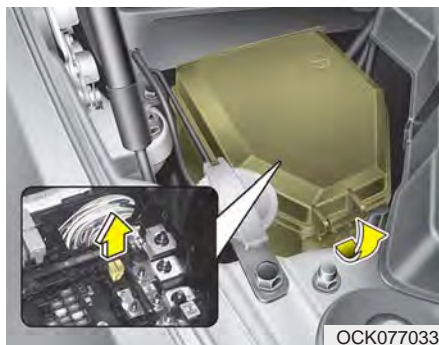

3. Pull the suspected fuse straight out. Use the removal tool provided on the engine compartment fuse panel cover.

4. Check the removed fuse; replace it if it is blown.

*Spare fuses are provided in the engine compartment fuse panel.*

5. Push in a new fuse of the same rating, and make sure it fits tightly in the clips.

If it fits loosely, consult an authorized Kia dealer.

*If you do not have a spare, use a fuse of the same rating from a circuit you may not need for operating the vehicle, such as the power outlet fuse.*

If the head lamp, turn signal lamp, stop signal lamp, fog lamp, DRL, tail lamp, HMSL do not work and the fuses are OK, check the fuse panel in the engine compartment. If a fuse is blown, it must be replaced.

### \* NOTICE

**If the headlamp, fog lamp, turn signal lamp, or tail lamp malfunction even without any problem to the lamps, have the vehicle checked by an authorized Kia dealer for assistance.**

### Fuse switch

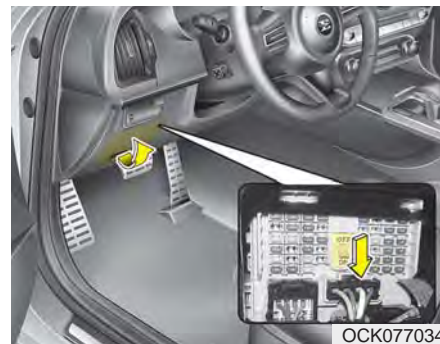

Always set the fuse switch to the ON position before using the vehicle.

If you move the switch to the OFF position, some items such as audio and digital clock must be reset and transmitter (or smart key) may not work properly. When the switch is Off, the caution indicator will be displayed on the instrument cluster.

Always place the fuse switch in the ON position while driving the vehicle.

If the switch is located in the "OFF" position, a caution indicator will be displayed in the cluster.

**⚠ CAUTION - Fuse Panel Covers**

*The contact points of the switches may wear out with excessive use. Please refrain from excessive use of the switches (except for long-term parking for over 1 month).*

**\* NOTICE**

- Set all switches to ON before driving.
- If the vehicle is going to be unused for over 1 month, set all switches to OFF to prevent the batteries from draining.

**Engine compartment fuse replacement**

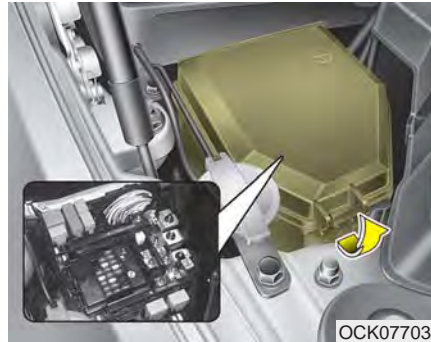

1. Turn the ignition switch and all other switches off.
2. Remove the fuse panel cover by pressing the tab and pulling the cover up. When the blade type fuse is disconnected, remove it by using the clip designed for changing fuses located in the engine compartment fuse box. Upon removal, securely insert reserve fuse of the same rating.

3. Check the removed fuse; replace it if it is blown. To remove or insert the fuse, use the fuse puller in the engine compartment fuse panel.
4. Push in a new fuse of the same rating, and make sure it fits tightly in the clips. If it fits loosely, consult an authorized Kia dealer.

**⚠ CAUTION**

*Always securely install the fuse panel cover in the engine compartment to protect against electrical failure which may occur from water contact. Listen for the audible clicking sound to ensure fuse panel cover is securely fastened.*

### Multi fuse

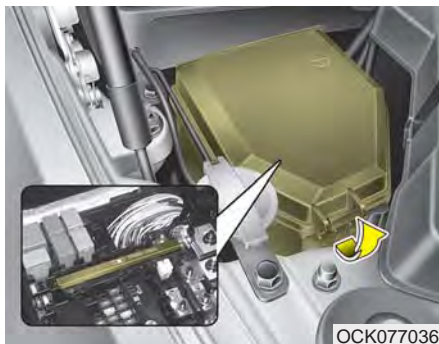

If the multi fuse is blown, it must be removed as follows:

1. Turn off the engine.
2. Disconnect the negative battery cable.
3. Remove the nuts shown in the picture above.
4. Replace the fuse with a new one of the same rating.
5. Reverse these steps to reinstall the multi fuse.

### \* NOTICE

Do not disassemble nor assemble the multi fuse when it is secured with nuts and bolts. Incorrect or partial assembly torque may cause a fire. Have the vehicle checked by an authorized Kia dealer.

### Main fuse



If the main fuse is blown, it must be removed as follows:

1. Turn off the engine.
2. Disconnect the negative battery cable.
3. Remove the nuts shown in the picture above.
4. Replace the fuse with a new one of the same rating.
5. Reverse these steps to reinstall the main fuse.



**\* NOTICE**

The electronic system may not function correctly even when the engine compartment and internal fuse box's individual fuses are not disconnected. In such case the cause of the problem may be disconnection of the main fuse.

Since the main fuse is designed more intricately than other parts, have the vehicle checked by an authorized Kia dealer.

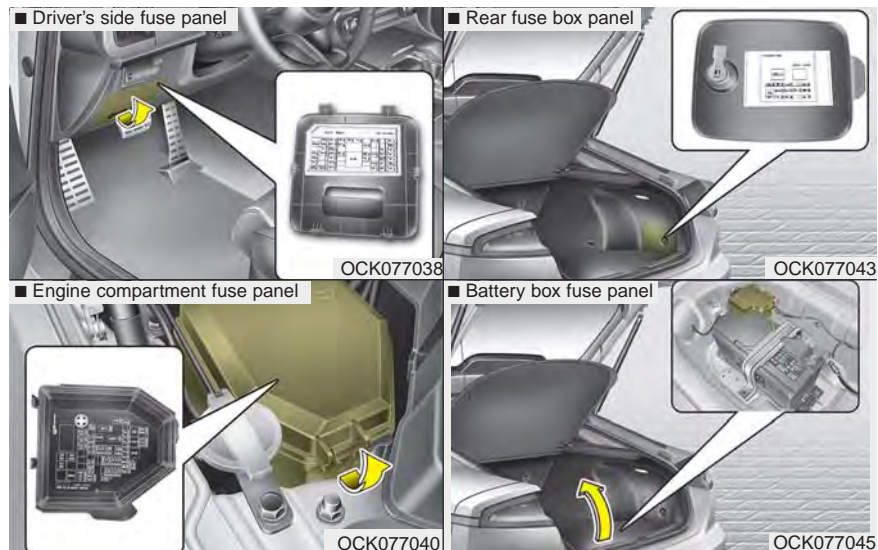
**Fuse/relay panel description**

Inside the fuse/relay panel covers, you can find the fuse/relay label describing fuse/relay name and capacity.

**\* NOTICE**

Not all fuse panel descriptions in this manual may be applicable to your vehicle. It is accurate at the time of printing. When you inspect the fuse panel in your vehicle, refer to the fuse panel label.

Driver's side fuse panel

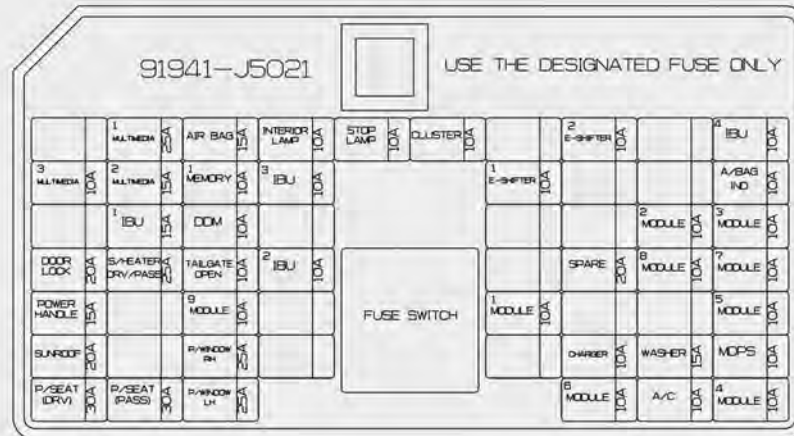

OCK078093N

## Instrument panel (Driver's side fuse panel)

Fuse Name	Fuse rating	Circuit Protected
MULTI MEDIA 1	25A	Low DC-DC Converter (Audio)
AIR BAG	15A	SRS (Supplemental Restraint System) Control Module
INTERIOR LAMP	10A	Overhead Console Lamp, Center Room Lamp, Room Lamp, Vanity Lamp Switch Left Handle side/Right Handle side, Luggage Lamp Left Handle side/Right Handle side, Glove Box Lamp, Driver/Passenger Door Mood Lamp, Driver/Passenger Door Lamp, Driver/Passenger Foot Lamp
STOP LAMP	10A	IBU, Stop Lamp Switch
CLUSTER	10A	Instrument Cluster, Head-Up Display
E-SHIFTER 2	10A	Electronic Auto Transmission Shift Lever (IG1)
IBU 4	10A	IBU (IG1)
MULTI MEDIA 3	10A	Instrument Cluster, Head-Up Display, Air Conditioner Switch
MULTI MEDIA 2	15A	Audio
MEMORY 1	10A	Air Conditioner Control Module, Air Conditioner Switch, Security Indicator, Head-Up Display
IBU 3	10A	IBU (B+)

Fuse Name	Fuse rating	Circuit Protected
E-SHIFTER 1	10A	Electronic Auto Transmission Shift Lever (B+)
A/BAG IND.	10A	Instrument Cluster, Passenger Air Bag IND.
IBU 1	15A	IBU (B+)
DDM	10A	Driver Door Module, Driver/Passenger Power Outside Mirror
MODULE 2	10A	IBU (IG2)
MODULE 3	10A	Auto Transmission Shift Lever Switch, Driver Door Module, Stop Lamp Switch
DOOR LOCK	20A	Door Lock Relay, Door Unlock Relay, Two Turn Unlock Relay
S/HEATER DRV/PASS	25A	Front Air Ventilation Seat Control Module, Front Seat Warmer Control Module
TAIL GATE	10A	Tail Gate Lid Relay, Fuel Lid Relay, Crash Pad Switch
IBU 2	10A	Rain Sensor
SPARE	20A	SPARE

Fuse Name	Fuse rating	Circuit Protected
MODULE 8	10A	Cooling Fan Controller (BLDC Motor), Around View Monitor, Front Air Ventilation Seat Control Module, Front/Rear Seat Warmer Control Module
MODULE 7	10A	IBU, ECS Unit, AWD (All Wheel Drive) ECM (Electronic Control Module), Smart Cruise Control Module, Auto Transmission Shift Lever Indicator, Console Switch (Front/Upper), Blind-Spot Collision Warning Unit Left Handle side/Right Handle side, Steering Angle Sensor, Steering Tilt & Telescopic Module, Multi-Function Camera Unit, Crash Pad Switch
POWER HANDLE	15A	Steering Tilt & Telescopic Module
MODULE 9	10A	Driver Air Lumbar Control Unit
MODULE 1	10A	Data Link Connector, Console Switch (Upper), Mood Lamp Control Unit
MODULE 5	10A	Air Conditioner Control Module, Air Conditioner Switch, Audio, Head Lamp Left Handle side/Right Handle side, Low DC-DC Converter (Audio/AMP (Amplifier)), Electro Chromic Mirror, AMP (Amplifier), Driver Integrated memory system Control Module, Front Air Ventilation Seat Control Module, Front/Rear Seat Warmer Control Module
SUNROOF	20A	Sunroof Control Unit (Glass)
P/WINDOW RH	25A	Passenger Power Window Module, Rear Power Window Module Right Handle side
CHARGER	10A	Front/Rear USB Charger

Fuse Name	Fuse rating	Circuit Protected
WASHER	15A	Multifunction Switch
MDPS	10A	MDPS (Motor Driven Power Steering) Unit (R-MDPS (Motor Driven Power Steering))
P/SEAT (DRV)	30A	Driver Integrated memory system Control Module, Drive Seat Module
P/SEAT (PASS)	30A	Passenger Seat Module
P/WINDOW LH	25A	Driver Power Window Module, Rear Power Window Module Left Handle side
MODULE 6	10A	IBU, Low DC-DC Converter (Audio/AMP (Amplifier)), Electronic Auto Transmission Shift Lever (SBW (Shift By Wire)), Engine Room Junction Block (RLY. 4 - Power Outlet Relay)
A/C	10A	Air Conditioner Control Module, Air Conditioner Switch, Engine Room Junction Block (Blower Relay)
MODULE 4	10A	Head Lamp Left Handle side/Right Handle side, AFS Control Unit, Auto Head Lamp Leveling Device Module





### Engine room compartment fuse panel

Fuse Name	Fuse rating	Circuit Protected
ALT	175A 200A	Alternator, Multi Fuse - COOLING FAN 1 / B+5 / B+4 / B+3 / OPCU / ESC1 / ESC2 / BLOWER / POWER TAIL GATE
COOLING FAN 2	100A	[BLDC (Brushless Direct Current) Motor] Cooling Fan Controller
START	30A	Start Relay
COOLING FAN 1	80A	[BLDC (Brushless Direct Current) Motor] Cooling Fan Controller
B+5	50A	Instrument Panel Junction Block (Fuse - STOP LAMP / Leak Current Autocut Device Fuse / INTERIOR LAMP)
B+4	50A	Instrument Panel Junction Block (Fuse - DOOR LOCK / POWER HANDLE / SUNROOF / P/SEAT (DRV) / P/SEAT (PASS))
B+3	50A	Instrument Panel Junction Block (Fuse - S/HEATER DRV/PASS / TAIL GATE / MODULE9 / P/WINDOW RH / P/WINDOW LH)
OPCU	50A	Electric Oil Pump Inverter
ESC 1	40A	ESC (Electronic Stability Control) Control Module
ESC 2	40A	ESC (Electronic Stability Control) Control Module, Multipurpose Check Connector
BLOWER	40A	Blower Relay
POWER TAIL GATE	30A	Power Tail Gate Module

## Maintenance

---

Fuse Name	Fuse rating	Circuit Protected
MDPS	100A	MDPS (Motor Driven Power Steering) Unit
B+6	60A	Engine Control Relay, Fuse - HORN / WIPER1 / H/LAMP H / B/ALARM HORN)
B+1	60A	Instrument Panel Junction Block (Fuse - IBU1 / IBU2)
B+2	50A	Instrument Panel Junction Block (Fuse - E-SHIFTER1 / MODULE1)
E-CVVT 1	40A	[THETA II 2.0L T-GDI Engine] E-CVVT Relay
VACUUM PUMP	20A	Vacuum Pump Relay
AWD	20A	AWD (All Wheel Drive) ECM (Electronic Control Module)
IG 2	20A	IG2 Relay
POWER OUTLET 2	20A	Front Power Outlet #2
POWER OUTLET 1	20A	Front Power Outlet #1
A/C	10A	Air Conditioner Control Module
E-CVVT 3	20A	[THETA II 2.0L T-GDI Engine] ECM (Engine Control Module)

Fuse Name	Fuse rating	Circuit Protected
E-CVVT 2	20A	[THETA II 2.0L T-GDI Engine] ECM (Engine Control Module)
ESC 3	10A	ESC (Electronic Stability Control) Control Module, Multipurpose Check Connector
ECU 3	10A	ECM (Engine Control Module)
ECU 2	15A	ECM (Engine Control Module)
HORN	20A	Horn Relay
WIPER 1	30A	Wiper Power Relay
TCU 2	15A	TCM (Transmission Control Module)
SENSOR 4	10A	Brake Vacuum Switch, Vacuum Pump Relay, Electric Oil Pump Inverter
TCU 1	20A	TCM (Transmission Control Module)
WIPER 2	10A	IBU (Integrated Body Control Unit), ECM (Electronic Control Module)
SENSOR 1	15A	Rear Sub Junction Block (Fuel Pump Relay)
SENSOR5	20A	[THETA II 2.0L T-GDI Engine] Ignition Coil #1/#2/#3/#4 [Lambda II PE 3.3L T-GDI Engine] Ignition Coil #1/#2/#3/#4/#5/#6

## Maintenance

Fuse Name	Fuse rating	Circuit Protected
H/LAMP HI	10A	Head Lamp (High) Relay
ECU 1	20A	ECM (Engine Control Module)
SENSOR 3	15A	[THETA II 2.0L T-GDI Engine] Oxygen Sensor (Up) [Lambda II PE 3.3L T-GDI Engine] Oxygen Sensor #2/#4
SENSOR 2	10A	[THETA II 2.0L T-GDI Engine] Electronic Thermostat, Oil Control Valve, Purge Control Solenoid Valve, RCV (Recirculation Valve Control) Control Solenoid Valve, Canister Close Valve [Lambda II PE 3.3L T-GDI Engine] Electronic Thermostat, Oil Pressure Solenoid Valve, Oil Control Valve #1/#2/#3/#4 (Intake/Exhaust), RCV (Recirculation Valve Control) Control Solenoid Valve, Purge Control Solenoid Valve, Canister Close Valve
B/ALARM HORN	15A	Burglar Alarm Horn Relay

**Relay**

<b>Relay Name</b>	<b>Type</b>
Vacuum Pump Relay	ISO HC MICRO
B/Alarm Horn Relay	ISO MICRO
Power Outlet Relay	ISO HC MICRO
Blower Relay	ISO HC MICRO
Start Relay	ISO HC MICRO
E-CVVT Relay (G4KL)	ISO MICRO

*Rear fuse box panel*

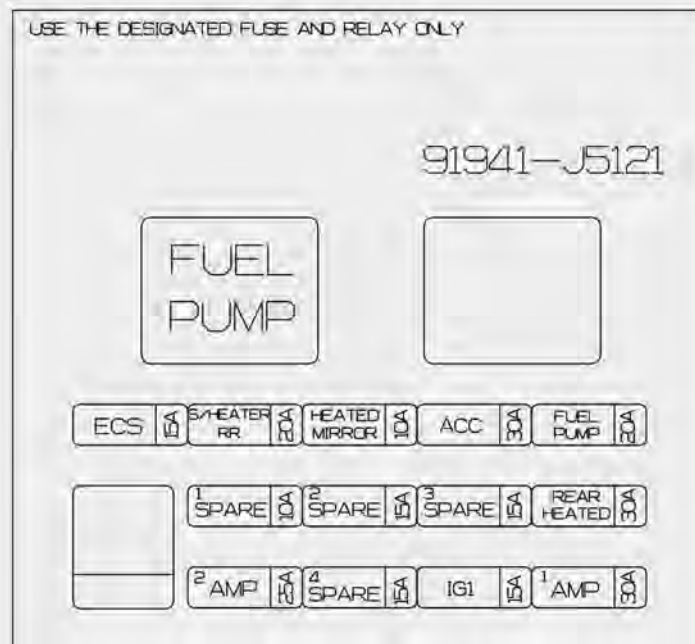

OCK078095N

**Rear fuse box panel**

<b>Fuse Name</b>	<b>Fuse rating</b>	<b>Circuit Protected</b>
ECS	15A	ECS (Electronic Control Suspension) Unit
S/HEATER REAR	20A	Rear Seat Warmer Control Module
HEATED MIRROR	10A	Air Conditioner Switch, Driver/Passenger Power Outside Mirror
FUEL PUMP	20A	Fuel Pump Relay
SPARE1	10A	-
SPARE2	15A	-
SPARE3	15A	-
REAR HEATED	30A	Rear Heated Relay
AMP 2	25A	AMP (Amplifier) (MOBIS/PREMIUM)
SPARE4	15A	-
AMP 1	30A	Low DC-DC Converter (AMP (Amplifier))
IG 1	15A	IG1 Relay
ACC	30A	ACC Relay

Battery box fuse panel



OCK077046



**Battery box fuse panel**

<b>Fuse Name</b>	<b>Fuse rating</b>	<b>Circuit Protected</b>
B+1	80A	Rear Sub Junction Block (Fuse - FUEL PUMP / REAR HEATED/ AMP1)
B+2	80A	Rear Sub Junction Block (Fuse - ECS / S/HEATER REAR / IG1)
START	40A	Engine Room Junction Block (Power Outlet Relay), Fuse -START / ECU2 / TCU1)
AMS	10A	Battery Sensor

## LIGHT BULBS

### Bulb replacement precaution

Please keep extra bulbs on hand with appropriate wattage ratings in case of emergencies.

Refer to “Bulb Wattage” in chapter 8.

When changing lamps, first turn off the engine at a safe place, firmly apply the parking brake and detach the battery’s negative (-) terminal.

**⚠ WARNING - Working on the lights**

**Prior to working on the light, firmly apply the parking brake, ensure that the ignition switch is turned to the LOCK position and turn off the lights to avoid sudden movement of the vehicle burns to your skin or fingers, or an electric shock.**

*Use only bulbs of the specified wattage.*

**⚠ CAUTION - Light replacement**

***Be sure to replace the burned-out bulb with one of the same wattage rating. Otherwise, it may cause damage to the fuse or electric wiring system.***

**⚠ CAUTION - Headlamp Lens**

***To prevent damage, do not clean the headlamp lens with chemical solvents or strong detergents.***

**• Lamp part malfunction due to net-work failure**

The headlamp, taillight, and fog light may light up when the head lamp switch is turned ON, and not light up when the taillight or fog light switch is turned ON. This may be caused by network failure or vehicle electrical control system malfunction. If there is a problem, we recommend the system be serviced by an authorized Kia dealer.

**• Lamp part malfunction due to electrical control system stabilization**

A normally functioning lamp may flicker momentarily. This momentary occurrence is due to the stabilization function of the vehicle's electrical control system. If the lamp stops flickering after a few moments, the vehicle does not require service.

However, if the lamp goes out after the momentary flickering, or the flickering continues, we recommend the system be serviced by an authorized Kia dealer.

**\* NOTICE**

- If the light bulb or lamp connector is removed while the lamp is still on, the fuse box's electronic system may log it as a malfunction. Therefore, a lamp malfunction incident may be recorded as a Diagnostic Trouble Code (DTC) in the fuse box.
- It is normal for an operating lamp to flicker momentarily. This is due to a stabilization function of the vehicle's electronic control device. If the lamp lights up normally after momentarily blinking, then it is functioning as normal. However, if the lamp continues to flicker several times or turns off completely, there may be an error in the vehicle's electronic control device. Please have the vehicle checked by an authorized Kia dealer immediately.

**\* NOTICE**

You can find moisture inside the lens of lamps after a car wash or driving in the rain. It is a natural event caused by the temperature difference between the inside and the outside of the lamp and does not mean a problem with its functions. The moisture inside the lamp would disappear if you drive the vehicle with the headlamp turned on, however, the level at which the moisture is removed may differ depending on the size/location/condition of the lamp. If the moisture continues to stay inside the lamp, we recommend that you have the vehicle checked by an authorized Kia dealer.

If you don't have the necessary tools, the correct bulbs and the expertise, consult an authorized Kia dealer. In many cases, it is difficult to replace vehicle light bulbs because other parts of the vehicle must be removed before you can get to the bulb. This is especially true if you have to remove the headlamp assembly to get to the bulb(s).

Removing/installing the headlamp assembly can result in damage to the vehicle.

If non-genuine parts or substandard bulbs are used, it may lead to blowing a fuse or other wiring damages.

Do not install extra lamps or LEDs to the vehicle. If additional lights are installed, it may lead to lamp malfunctions and flickering. Additionally, the fuse box and other wiring may be damaged.

### Light bulb position (Front)

■ Head lamp - Type A

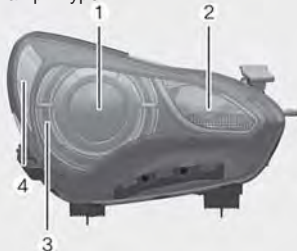

OCK077096L

■ Head lamp - Type B



OCK077097L

- (1) Headlamp (Low/High) (bulb type)
- (2) Front turn signal lamp (bulb type)
- (3) Day time running lamp / Position lamp (LED type)
- (4) Side marker (bulb type)

- (5) Headlamp (Low/High) (LED type)
- (6) Headlamp (Low/High assist) (LED type)
- (7) Front turn signal lamp (LED type)
- (8) Day time running lamp / Position lamp (LED type)
- (9) Side marker (LED type)

### Light bulb position (Rear)

■ Rear combination lamp - Type A

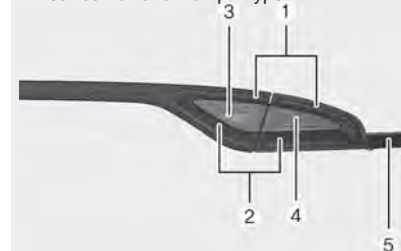

OCK077098L

■ Rear combination lamp - Type B

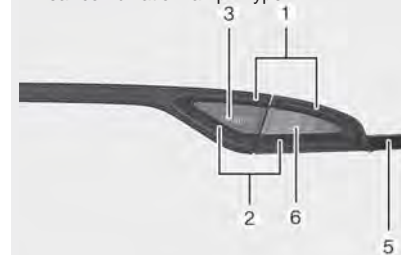

OCK078099N

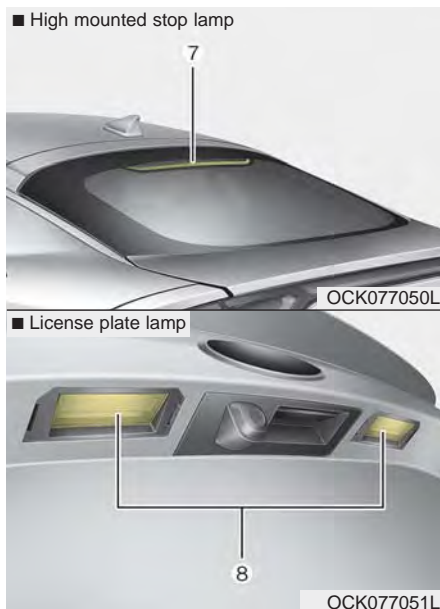

- (7) High mounted stop lamp (LED type)
- (8) License plate lamp (LED type)

### Light bulb position (Side)

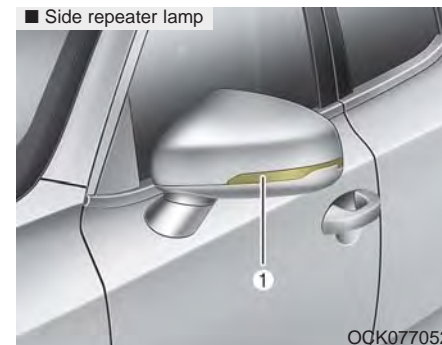

- (1) Side repeater lamp (LED type)

- (1) Stop and tail lamp (LED type)
- (2) Stop lamp (LED type)
- (3) Back-up lamp (bulb type)
- (4) Rear turn signal lamp (bulb type)
- (5) Side marker (LED type)
- (6) Rear turn signal lamp (LED type)

### Headlamp (LED type) replacement (Headlamp Type B)

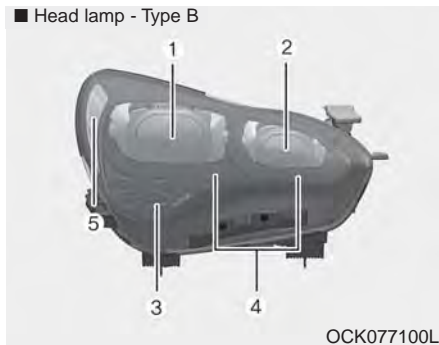

If the Low/High beam lamp (1, 2), Front turn signal lamp (3), Day time running lamp/Position lamp (4), and/or Side marker (5) do not operate, have the vehicle checked by an authorized Kia dealer.

The LED lamps cannot be replaced as a single component because they are part of an integrated unit. The LED lamps have to be replaced with the unit.

A skilled technician should check or repair the head lamp (LED), for it may damage related parts of the vehicle.

### Side marker bulb replacement (Headlamp Type A)



If the side marker (1) does not operate, have the vehicle checked by an authorized Kia dealer. A skilled technician should check or repair the side marker, for it may damage related parts of the vehicle.

### Position lamp + DRL (LED type) bulb replacement (Headlamp Type A)

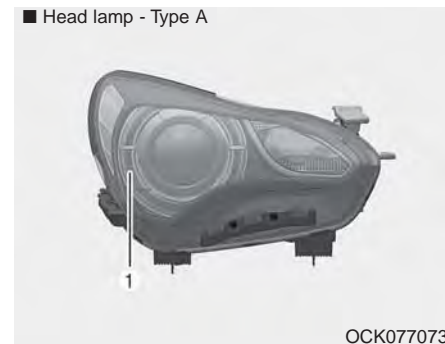

If the position lamp + DRL (LED) (1) does not operate, have the vehicle checked by an authorized Kia dealer. The LED lamps cannot be replaced as a single component because they are part of an integrated unit. The LED lamps have to be replaced with the unit.

A skilled technician should check or repair the position lamp + DRL (LED), for it may damage related parts of the vehicle.

## Headlamp (Low/High beam) bulb replacement (Headlamp Type A)

■ Head lamp - Type A

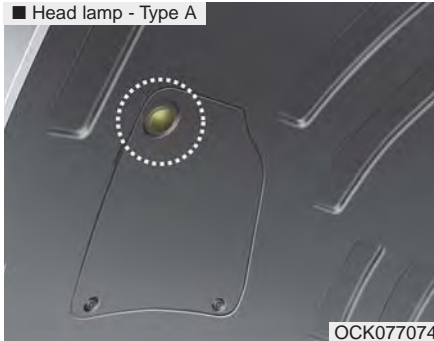

1. Remove the service cover clip on the wheel housing.

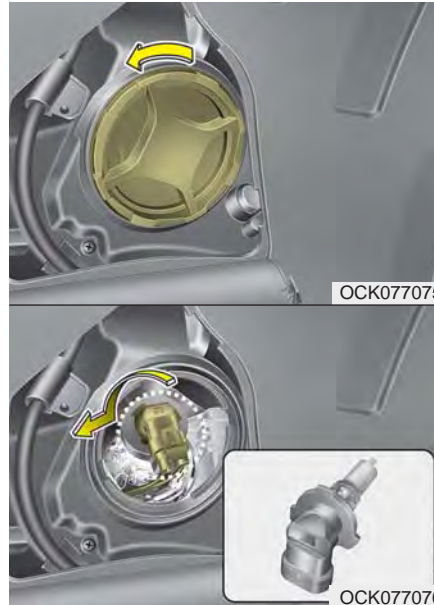

2. Remove the headlamp bulb cover by turning it counterclockwise.
3. Disconnect the headlamp bulb socket connector.

4. Remove the bulb-socket from the headlamp assembly by turning the bulb-socket counterclockwise until the tabs on the bulb-socket align with the slots on the headlamp assembly.
5. Install a new bulb-socket assembly in the headlamp assembly by aligning the tabs on the bulb-socket with the slots in the headlamp assembly. Push the bulb-socket into the headlamp assembly and turn the bulb-socket clockwise.
6. Connect the headlamp bulb socket-connector.
7. Install the headlamp bulb cover by turning it clockwise.
8. Install the clip on the service cover.

\* If it is difficult to replace light bulbs, have the vehicle checked by an authorized Kia dealer.

### Headlamp bulb

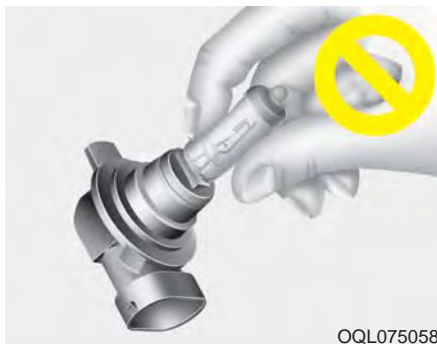

**⚠ WARNING - Halogen bulbs**

- Halogen bulbs contain pressurized gas that will produce flying pieces of glass if broken.
- Always handle them carefully, and avoid scratches and abrasions. If the bulbs are lit, avoid contact with liquids.

- Never touch the glass with bare hands. Residual oil may cause the bulb to overheat and burst when lit. A bulb should be operated only when installed in a headlight.
- If a bulb becomes damaged or cracked, replace it immediately and carefully dispose of it.
- Wear eye protection when changing a bulb. Allow the bulb to cool down before handling it.

### Front turn signal lamp bulb replacement (Headlamp Type A)

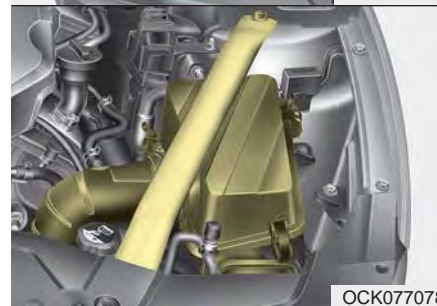

1. Open the hood.
2. Remove the strut bar and the air cleaner assembly.



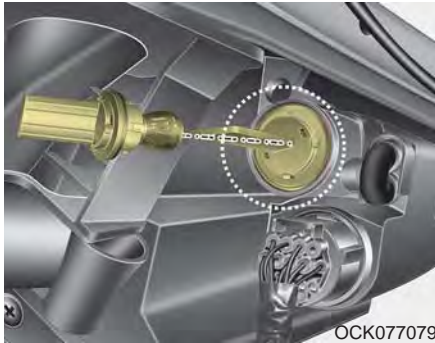

OCK077079

3. Remove the bulb-socket from the headlamp assembly by turning the bulb-socket counterclockwise until the tabs on the bulb-socket align with the slots on the headlamp assembly.
4. Remove the bulb from the bulb-socket by pressing it in and rotating it counterclockwise until the tabs on the bulb align with the slots in the bulb-socket. Pull the bulb out of the bulb-socket.
5. Insert a new bulb by inserting it into the bulb-socket and rotating it until it locks into place.

6. Install the socket in the headlamp assembly by aligning the tabs on the bulb-socket with the slots in the assembly. Push the bulb-socket into the headlamp assembly and turn the socket clockwise.

7. Install the strut bar and the air cleaner assembly.

※ If it is difficult to replace light bulbs, have the vehicle checked by an authorized Kia dealer.

## Stop and tail lamp (LED type) bulb replacement

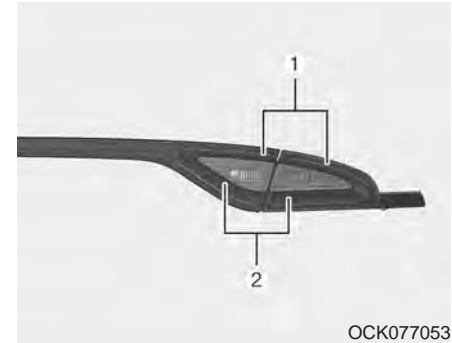

OCK077053

If the stop and tail lamp (LED) (1, 2) does not operate, have the vehicle checked by an authorized Kia dealer. The LED lamps cannot be replaced as a single component because they are part of an integrated unit. The LED lamps have to be replaced with the unit.

A skilled technician should check or repair the stop and tail lamp (LED), for it may damage related parts of the vehicle.

### Rear side marker (LED type) bulb replacement



If the rear side marker (LED) (1) does not operate, have the vehicle checked by an authorized Kia dealer. The LED lamps cannot be replaced as a single component because they are part of an integrated unit. The LED lamps have to be replaced with the unit.

A skilled technician should check or repair the rear side marker (LED), for it may damage related parts of the vehicle.

### Rear turn signal lamp (LED type) bulb replacement



If the rear turn signal lamp (LED) (1), does not operate, have the vehicle checked by an authorized Kia dealer. The LED lamps cannot be replaced as a single component because they are part of an integrated unit. The LED lamps have to be replaced with the unit.

A skilled technician should check or repair the rear turn signal lamp (LED), for it may damage related parts of the vehicle.

### Rear turn signal lamp (bulb type) bulb replacement

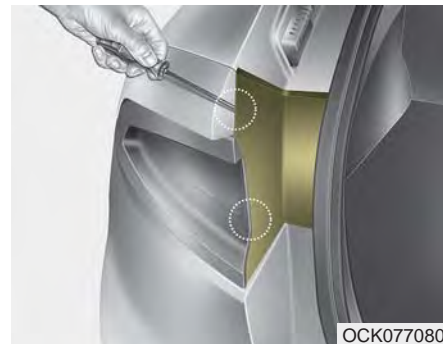

1. Open the liftgate.
2. Open the service cover.

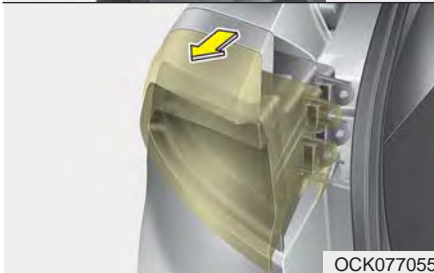

3. Loosen the light assembly retaining screws with a cross-tip screwdriver or spanner.
4. Remove the rear combination lamp assembly from the body of the vehicle.
5. Disconnect the rear combination lamp connector.

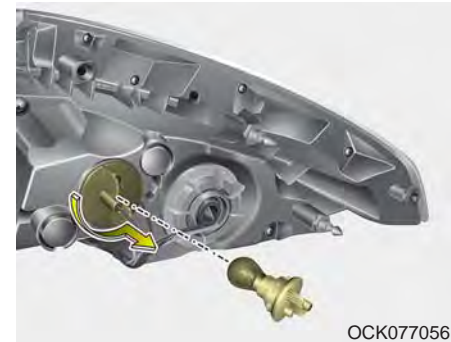

6. Remove the socket from the assembly by turning the socket counterclockwise until the tabs on the socket align with the slots on the assembly.
7. Remove the bulb from the socket by pressing it in and rotating it counterclockwise until the tabs on the bulb align with the slots in the socket. Pull the bulb out of the socket.
8. Insert a new bulb by inserting it into the socket and rotating it until it locks into place.

9. Install the socket in the assembly by aligning the tabs on the socket with the slots in the assembly. Push the socket into the assembly and turn the socket clockwise.
10. Install the rear combination lamp assembly to the body of the vehicle.
11. Install the service cover.

## Back-up lamp bulb replacement



1. Open the liftgate.
2. Remove the service cover of both side (drive side and passenger side).

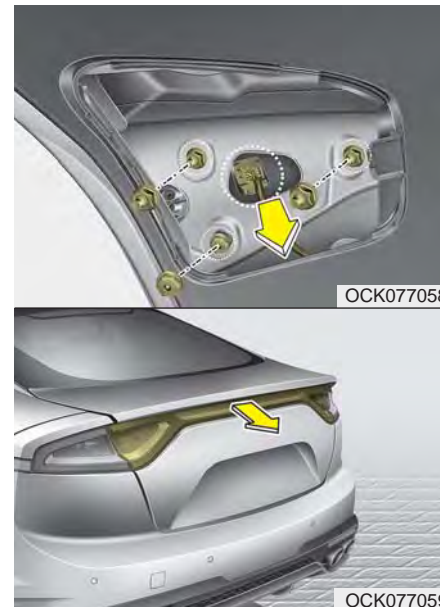

3. Remove the nuts from rear combination lamp of both side (drive side and passenger side).
4. Disconnect the connector from rear combination lamp of both side (drive side and passenger side).

5. Remove the rear combination lamp assembly from the body of the vehicle.



6. Remove the socket from the assembly by turning the socket counterclockwise until the tabs on the socket align with the slots on the assembly.
7. Remove the bulb from the socket by pressing it in and rotating it counterclockwise until the tabs on the bulb align with the slots in the socket. Pull the bulb out of the socket.
8. Insert a new bulb by inserting it into the socket and rotating it until it locks into place.
9. Install the socket in the assembly by aligning the tabs on the socket with the slots in the assembly. Push the socket into the assembly and turn the socket clockwise.
10. Install the rear combination lamp assembly to the body of the vehicle.
11. Install the service cover by putting it into the service hole.

### High mounted stop lamp (LED type) bulb replacement



If the high mounted stop lamp (LED) (1) does not operate, have the vehicle checked by an authorized Kia dealer.

The LED lamps cannot be replaced as a single component because they are part of an integrated unit. The LED lamps have to be replaced with the unit.

A skilled technician should check or repair the high mounted stop lamp (LED), for it may damage related parts of the vehicle.

### License plate lamp (LED type) bulb replacement

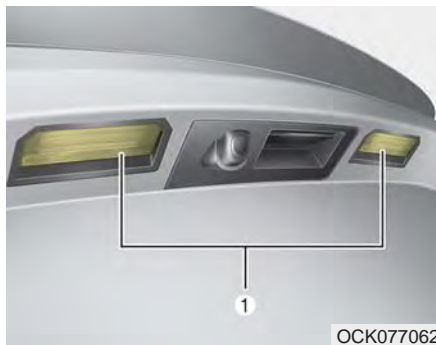

If the license plate lamp (LED) (1) does not operate, have the vehicle checked by an authorized Kia dealer.

The LED lamps cannot be replaced as a single component because they are part of an integrated unit. The LED lamps have to be replaced with the unit.

A skilled technician should check or repair the license plate lamp (LED), for it may damage related parts of the vehicle.

### Side repeater lamp (LED type) bulb replacement

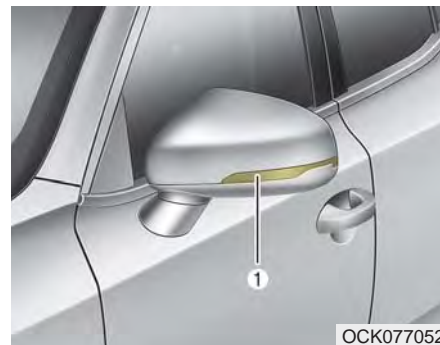

If the side repeater lamp (LED) (1) does not operate, have the vehicle checked by an authorized Kia dealer.

The LED lamps cannot be replaced as a single component because they are part of an integrated unit. The LED lamps have to be replaced with the unit.

A skilled technician should check or repair the side repeater lamp (LED), for it may damage related parts of the vehicle.

### Map lamp (LED type) bulb replacement



If the map lamp (LED) (1) does not operate, have the vehicle checked by an authorized Kia dealer.

The LED lamps cannot be replaced as a single component because they are part of an integrated unit. The LED lamps have to be replaced with the unit.

A skilled technician should check or repair the map lamp (LED), for it may damage related parts of the vehicle.

### Vanity mirror lamp (LED type) bulb replacement

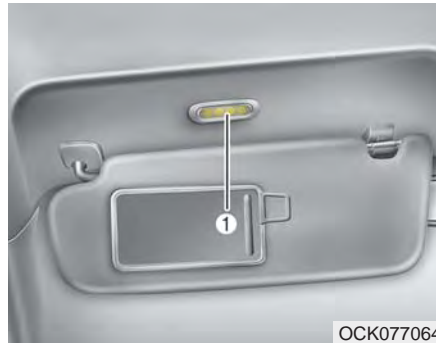

If the vanity mirror lamp (LED) (1) does not operate, have the vehicle checked by an authorized Kia dealer.

The LED lamps cannot be replaced as a single component because they are part of an integrated unit. The LED lamps have to be replaced with the unit.

A skilled technician should check or repair the vanity mirror lamp (LED), for it may damage related parts of the vehicle.

### Room lamp (LED type) bulb replacement



If the room lamp (LED) (1) does not operate, have the vehicle checked by an authorized Kia dealer.

The LED lamps cannot be replaced as a single component because they are part of an integrated unit. The LED lamps have to be replaced with the unit.

A skilled technician should check or repair the room lamp (LED), for it may damage related parts of the vehicle.

### Glove box lamp (LED type) bulb replacement

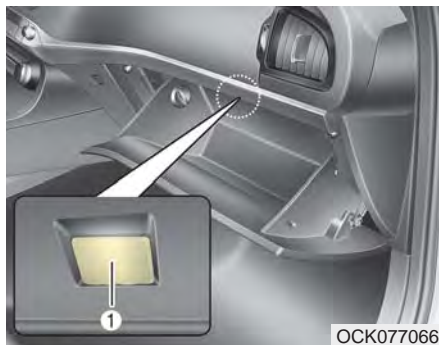

If the glove box lamp (LED) (1) does not operate, have the vehicle checked by an authorized Kia dealer. The LED lamps cannot be replaced as a single component because they are part of an integrated unit. The LED lamps have to be replaced with the unit.

A skilled technician should check or repair the glove box lamp (LED), for it may damage related parts of the vehicle.

### Luggage room lamp (LED type) bulb replacement

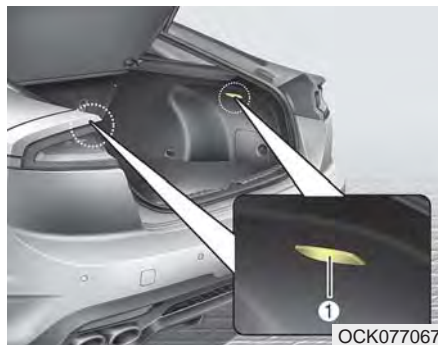

If the luggage room lamp (LED) (1) does not operate, have the vehicle checked by an authorized Kia dealer. The LED lamps cannot be replaced as a single component because they are part of an integrated unit. The LED lamps have to be replaced with the unit.

A skilled technician should check or repair the luggage room lamp (LED), for it may damage related parts of the vehicle.



## APPEARANCE CARE

### Exterior care

#### *Exterior general caution*

It is very important to follow the label directions when using any chemical cleaner or polish. Read all warning and caution statements that appear on the label.

#### *Finish maintenance*

##### **Washing**

To help protect your vehicle's finish from rust and deterioration, wash it thoroughly and frequently at least once a month with lukewarm or cold water.

If you use your vehicle for off-road driving, you should wash it after each off-road trip. Pay special attention to the removal of any accumulation of salt, dirt, mud, and other foreign materials. Make sure the drain holes in the lower edges of the doors and rocker panels are kept clear and clean.

Insects, tar, tree sap, bird droppings, industrial pollution and similar deposits can damage your vehicle's finish if not removed immediately.

Even prompt washing with plain water may not completely remove all these deposits. A mild soap, safe for use on painted surfaces, may be used.

After washing, rinse the vehicle thoroughly with lukewarm or cold water. Do not allow soap to dry on the finish.

After washing the vehicle, test the brakes while driving slowly to see if they have been affected by water. If braking performance is impaired, dry the brakes by applying them lightly while maintaining a slow forward speed.

### High-pressure washing

- When using high-pressure washers, make sure to maintain sufficient distance from the vehicle.

Insufficient clearance or excessive pressure can lead to component damage or water penetration.

- Do not spray the camera, sensors or its surrounding area directly with a high pressure washer. Shock applied from high pressure water may cause the device to not operate normally.
- Do not bring the nozzle tip close to boots (rubber or plastic covers) or connectors as they may be damaged if they come into contact with high pressure water.



#### **CAUTION - Wet engine**

- ***Water washing in the engine compartment including high pressure water washing may cause the failure of electrical circuits located in the engine compartment.***
- ***Never allow water or other liquids to come in contact with electrical/electronic components inside the vehicle as this may damage them.***

### Waxing

Wax the vehicle when water will no longer bead on the paint.

Always wash and dry the vehicle before waxing. Use a good quality liquid or paste wax, and follow the manufacturer's instructions. Wax all metal trim to protect it and to maintain its luster.

Removing oil, tar, and similar materials with a spot remover will usually strip the wax from the finish. Be sure to re-wax these areas even if the rest of the vehicle does not yet need waxing.

Do not apply wax on embossed unpainted unit, as it may tarnish the unit.

**⚠ CAUTION - Drying vehicle**

- *Wiping dust or dirt off the body with a dry cloth will scratch the finish.*
- *Do not use steel wool, abrasive cleaners, acid detergents or strong detergents containing high alkaline or caustic agents on chrome-plated or anodized aluminum parts. This may result in damage to the protective coating and cause discoloration or paint deterioration.*

***Finish damage repair***

Deep scratches or stone chips in the painted surface must be repaired promptly. Exposed metal will quickly rust and may develop into a major repair expense.

If your vehicle is damaged and requires any metal repair or replacement, be sure the body shop applies anti-corrosion materials to the parts repaired or replaced.

***Bright-metal maintenance***

- To remove road tar and insects, use a tar remover, not a scraper or other sharp object.
- To protect the surfaces of bright-metal parts from corrosion, apply a coating of wax or chrome preservative and rub to a high luster.
- During winter weather or in coastal areas, cover the bright metal parts with a heavier coating of wax or preservative. If necessary, coat the parts with non-corrosive petroleum jelly or other protective compound.

***Underbody maintenance***

Road salt and other corrosive chemicals are used in cold weather states to melt snow and prevent ice accumulation. If these chemicals are not regularly removed, they will corrode the vehicle underbody and over time damage fuel lines, the fuel tank retention system, the vehicle suspension, the exhaust system, and even the body frame. The National Highway Traffic Safety Administration has warned all vehicle owners of all brands of the need to take the following steps:

- Wash the undercarriage of your vehicle regularly during the winter and whenever your vehicle has been exposed to such salts or chemicals.

- Do a thorough washing of the undercarriage at the end of the winter.
- Use professional service technicians or governmental inspection stations to annually inspect for corrosion.
- Immediately seek an inspection of your vehicle if you become visually aware of corrosion flaking or scaling or if you become aware of a change in vehicle performance, such as soft or spongy brakes, fluids leaking, impairment of directional control, suspension noises or rattling metal straps.

### ***Aluminum wheel maintenance***

The aluminum wheels are coated with a clear protective finish.

- Do not use any abrasive cleaner, polishing compound, solvent, or wire brushes on aluminum wheels. They may scratch the finish.
- Clean the wheel when it has cooled.
- Use only a mild soap or neutral detergent, and rinse thoroughly with water. Also, be sure to clean the wheels after driving on salted roads. This helps prevent corrosion.
- Avoid washing the wheels with highspeed vehicle wash brushes.
- Do not use any alkaline or acid detergents. It may damage and corrode the aluminum wheels coated with a clear protective finish.

### ***Corrosion protection***

#### **Protecting your vehicle from corrosion**

By using the most advanced design and construction practices to combat corrosion, we produce vehicles of the highest quality. However, this is only part of the job. To achieve the long-term corrosion resistance your vehicle can deliver, the owner's cooperation and assistance is also required.

#### **Common causes of corrosion**

The most common causes of corrosion on your vehicle are:

- Road salt, dirt and moisture that is allowed to accumulate underneath the vehicle.
- Removal of paint or protective coatings by stones, gravel, abrasion or minor scrapes and dents which leave unprotected metal exposed to corrosion.

### High-corrosion areas

If you live in an area where your vehicle is regularly exposed to corrosive materials, corrosion protection is particularly important. Some of the common causes of accelerated corrosion are road salts, dust control chemicals, ocean air and industrial pollution.

### Moisture breeds corrosion

Moisture creates the conditions in which corrosion is most likely to occur. For example, corrosion is accelerated by high humidity, particularly when temperatures are just above freezing. In such conditions, the corrosive material is kept in contact with the vehicle's surface by moisture that evaporates slowly.

Mud is particularly corrosive because it dries slowly and holds moisture in contact with the vehicle. Although the mud appears to be dry, it can still retain the moisture and promote corrosion.

High temperatures can also accelerate corrosion of parts that are not properly ventilated so the moisture can be dispersed. For all these reasons, it is particularly important to keep your vehicle clean and free of mud or accumulations of other materials. This applies not only to the visible surfaces but particularly to the underside of the vehicle.

### To help prevent corrosion

You can help prevent corrosion from beginning by observing the following:

### Keep your vehicle clean

The best way to prevent corrosion is to keep your vehicle clean and free of corrosive materials. Attention to the underside of the vehicle is particularly important.

- If you live in a high-corrosion area — where road salts are used, near the ocean, areas with industrial pollution, acid rain, etc.—, you should take extra care to prevent corrosion. In winter, hose off the underside of your vehicle at least once a month and be sure to clean the underside thoroughly when winter is over.
- When cleaning underneath the vehicle, give particular attention to the components under the fenders and other areas that are hidden from view. Do a thorough job; just dampening the accumulated mud rather than washing it away will accelerate corrosion rather than prevent it. Water under high pressure and steam are particularly effective in removing accumulated mud and corrosive materials.

- When cleaning lower door panels, rocker panels and frame members, be sure that drain holes are kept open so that moisture can escape and not be trapped inside to accelerate corrosion.

### **Keep your garage dry**

Don't park your vehicle in a damp, poorly ventilated garage. This creates a favorable environment for corrosion. This is particularly true if you wash your vehicle in the garage or drive it into the garage when it is still wet or covered with snow, ice or mud. Even a heated garage can contribute to corrosion unless it is well ventilated so moisture is dispersed.

### **Keep paint and trim in good condition**

Scratches or chips in the finish should be covered with "touch-up" paint as soon as possible to reduce the possibility of corrosion. If bare metal is showing through, the attention of a qualified body and paint shop is recommended.

**Bird droppings :** Bird droppings are highly corrosive and may damage painted surfaces in just a few hours. Always remove bird droppings as soon as possible.

### **Don't neglect the interior**

Moisture can collect under the floor mats and carpeting and cause corrosion. Check under the mats periodically to be sure the carpeting is dry. Use particular care if you carry fertilizers, cleaning materials or chemicals in the vehicle.

These should be carried only in proper containers and any spills or leaks should be cleaned up, flushed with clean water and thoroughly dried.

### **Interior care**

#### *Interior general precautions*

Prevent chemicals such as perfume, cosmetic oil, sun cream, hand cleaner, and air freshener from contacting the interior parts because they may cause damage or discoloration. If they do contact the interior parts, wipe them off immediately. If necessary, use a vinyl cleaner, see product instructions for correct usage.

 **CAUTION - Electrical components**

***Never allow water or other liquids to come in contact with electrical/electronic components inside the vehicle as this may damage them.***

 **CAUTION - Leather**

***When cleaning leather products (steering wheel, seats etc.), use neutral detergents or low alcohol content solutions. If you use high alcohol content solutions or acid/alkaline detergents, the color of the leather may fade or the surface may get stripped off.***

***Taking care of leather seats***

- Vacuum the seat periodically to remove dust and sand on the seat. It will prevent abrasion or damage of the leather and maintain its quality.
- Wipe the natural leather seat cover often with dry or soft cloth.
- Sufficient use of a leather protective may prevent abrasion of the cover and helps maintain the color. Be sure to read the instructions and consult a specialist when using leather coating or protective agents.
- Leather with bright colors (beige, cream beige) is easily contaminated and clear in appearance. Clean the seats frequently.
- Avoid wiping with wet cloth. It may cause the surface to crack.

***Cleaning the leather seats***

- Remove all contaminations instantly. Refer to instructions below for removal of each contaminant.
- Cosmetic products (sunscreen, foundation, etc.)
  - Apply cleansing cream on a cloth and wipe the contaminated point. Wipe off the cream with a wet cloth and remove water with a dry cloth.
- Beverages (coffee, soft drink, etc.)
  - Apply a small amount of neutral detergent and wipe until contaminations do not smear.
- Oil
  - Remove oil instantly with absorbable cloth and wipe with stain remover for natural leather only.
- Chewing gum
  - Harden the gum with ice and remove gradually.

### ***Fabric seat cover using precautions (If equipped)***

Please clean the fabric seats regularly with a vacuum cleaner in consideration of fabric material characteristics. If they are heavily soiled with beverage stains, etc., use a suitable interior cleaner. To prevent damage to seat covers, wipe off the seat covers down to the seams with a large wiping motion and moderate pressure using a soft sponge or microfiber cloth.

Velcro closures on clothing or sharp objects may cause snagging or scratches on the surface of the seats. Make sure not to rub such objects against the surface.

### ***Cleaning the upholstery and interior trim***

#### **Vinyl**

Remove dust and loose dirt from vinyl with a whisk broom or vacuum cleaner. Clean vinyl surfaces with a vinyl cleaner.

#### **Fabric**

Remove dust and loose dirt from fabric with a whisk broom or vacuum cleaner. Clean with a mild soap solution recommended for upholstery or carpets. Remove fresh spots immediately with a fabric spot cleaner. If fresh spots do not receive immediate attention, the fabric can be stained and its color can be affected. Also, its fire-resistant properties can be reduced if the material is not properly maintained.

Using anything but recommended cleaners and procedures may affect the fabric's appearance and fire-resistant properties.

### ***Cleaning the lap/shoulder belt webbing***

Clean the belt webbing with any mild soap solution recommended for cleaning upholstery or carpet. Follow the instructions provided with the soap. Do not bleach or re-dye the webbing because this may weaken it.

### ***Cleaning the interior window glass***

If the interior glass surfaces of the vehicle become fogged (that is, covered with an oily, greasy or waxy film), they should be cleaned with a glass cleaner. Follow the directions on the glass cleaner container.

 **CAUTION - Rear window**  
***Do not scrape or scratch the inside of the rear window. This may result in damage of the rear window defroster grid.***



## EMISSION CONTROL SYSTEM

The emission control system of your vehicle is covered by a written limited warranty. Please see the warranty information contained in the Warranty & Consumer Information manual in your vehicle.

Your vehicle is equipped with an emission control system to meet all applicable emission regulations.

There are three emission control systems, as follows.

- (1) Crankcase emission control system
- (2) Evaporative emission control system
- (3) Exhaust emission control system

In order to assure the proper function of the emission control systems, it is recommended that you have your vehicle inspected and maintained by an authorized Kia dealer in accordance with the maintenance schedule in this manual.

### Caution for the Inspection and Maintenance Test (With Electronic Stability Control (ESC) system)

- **To prevent the vehicle from misfiring during dynamometer testing, turn the Electronic Stability Control (ESC) system off by pressing the ESC switch.**
- **After dynamometer testing is completed, turn the ESC system back on by pressing the ESC switch again.**

### 1. Crankcase emission control system

The positive crankcase ventilation system is employed to prevent air pollution caused by blow-by gases being emitted from the crankcase. This system supplies fresh filtered air to the crankcase through the air intake hose. Inside the crankcase, the fresh air mixes with blow-by gases, which then pass through the PCV valve into the induction system.

### 2. Evaporative emission control (including ORVR: Onboard Refueling Vapor Recovery) system

The Evaporative Emission Control System is designed to prevent fuel vapors from escaping into the atmosphere.

(The ORVR system is designed to allow the vapors from the fuel tank to be loaded into a canister while refueling at the gas station, preventing the escape of fuel vapors into the atmosphere.)

### **Canister**

Fuel vapors generated inside the fuel tank are absorbed and stored in the onboard canister. When the engine is running, the fuel vapors absorbed in the canister are drawn into the surge tank through the purge control solenoid valve.

### **Purge Control Solenoid Valve (PCSV)**

The purge control solenoid valve is controlled by the Engine Control Module (ECM); when the engine coolant temperature is low during idling, the PCSV closes so that evaporated fuel is not taken into the engine. After the engine warms up during ordinary driving, the PCSV opens to introduce evaporated fuel to the engine.

## **3. Exhaust emission control system**

The Exhaust Emission Control System is a highly effective system which controls exhaust emissions while maintaining good vehicle performance.

### **Engine exhaust gas precautions (carbon monoxide)**

- Carbon monoxide can be present with other exhaust fumes. Therefore, if you smell exhaust fumes of any kind inside your vehicle, have it inspected and repaired immediately. If you ever suspect exhaust fumes are coming into your vehicle, drive it only with all the windows fully open. Have your vehicle checked and repaired immediately.

**⚠ WARNING - Exhaust**  
**Engine exhaust gases contain carbon monoxide (CO). Though colorless and odorless, it is dangerous and could be lethal if inhaled. Follow the instructions on this page to avoid CO poisoning.**

- Do not operate the engine in confined or closed areas (such as garages) any more than what is necessary to move the vehicle in or out of the area.
- When the vehicle is stopped in an open area for more than a short time with the engine running, adjust the ventilation system (as needed) to draw outside air into the vehicle.
- Never sit in a parked or stopped vehicle for any extended time with the engine running.
- When the engine stalls or fails to start, excessive attempts to restart the engine may cause damage to the emission control system.

### *Operating precautions for catalytic converters (if equipped)*

#### **⚠ WARNING - Catalytic converter**

**Keep away from the catalytic converter and exhaust system while the vehicle is running or immediately thereafter. The exhaust and catalytic systems are very hot and may burn you.**

#### **⚠ WARNING - Fire**

- **Do not park, idle or drive the vehicle over or near flammable objects, such as grass, vegetation, paper, leaves, etc. A hot exhaust system can ignite flammable items under your vehicle.**
- **Also, do not remove the heat sink around the exhaust system, do not seal the bottom of the vehicle or do not coat the vehicle for corrosion control. It may present a fire risk under certain conditions.**

Your vehicle is equipped with a catalytic converter emission control device.

Therefore, the following precautions must be observed:

- Use only UNLEADED FUEL for gasoline engines.
- Do not operate the vehicle when there are signs of engine malfunction, such as misfire or a noticeable loss of performance.
- Do not misuse or abuse the engine. Examples of misuse are coasting with the ignition off and descending steep grades in gear with the ignition off.
- Do not operate the engine at high idle speed for extended periods (5 minutes or more).
- Do not modify or tamper with any part of the engine or emission control system. All inspections and adjustments must be made by an authorized Kia dealer.
- Avoid driving with an extremely low fuel level. Running out of fuel could cause the engine to misfire, damaging the catalytic converter.

Failure to observe these precautions could result in damage to the catalytic converter and to your vehicle. Additionally, such actions could void your warranties.

---

## **CALIFORNIA PERCHLORATE NOTICE**

Perchlorate Material-special handling may apply, See [www.dtsc.ca.gov/hazardouswaste/perchlorate](http://www.dtsc.ca.gov/hazardouswaste/perchlorate).

Notice to California Vehicle Dismantlers:

Perchlorate containing materials, such as air bag inflators, seatbelt pretensioners and keyless remote entry batteries, must be disposed of according to Title 22 California Code of Regulations Chapter 67384.10 (a).

# Specifications, Consumer information and Reporting safety defects

Dimensions .....	8-2	Reporting safety defects (U.S. only) .....	8-16
Engine .....	8-2	Online factory authorized manuals (U.S. only) ..	8-16
Bulb wattage .....	8-3	• Service manual .....	8-16
Tires and wheels .....	8-4	• Electrical troubleshooting manual .....	8-16
Gross vehicle weight .....	8-6	• Owner's manual .....	8-16
Luggage volume .....	8-6		
Air conditioning system .....	8-6		
Recommended lubricants and capacities .....	8-7		
• Recommended SAE viscosity number .....	8-9		
Vehicle Identification Number (VIN) .....	8-10		
Vehicle certification label .....	8-10		
Tire specification and pressure label .....	8-11		
Engine number .....	8-11		
Refrigerant label .....	8-11		
Consumer assistance (U.S. only) .....	8-12		
• Toll free consumer assistance .....	8-12		
• Emergency roadside assistance .....	8-12		
• Trip interruption .....	8-13		
• Registering your vehicle in a foreign country .....	8-14		
Electrical equipment (U.S. only) .....	8-15		
• Installation of a mobile two-way radio system .....	8-15		

## DIMENSIONS

Item		Length (mm)	
Overall length		4,830	
Overall width		1,870	
Overall height		1,400	
Tread	Front	225/45R18	1,596
		225/40R19	1,596
		225/40ZR19	1,596
	Rear	225/45R18	1,647
		255/35R19	1,619
		255/35ZR19	1,619
Wheelbase		2,905	

## ENGINE

Item	Gasoline Engine	
	Lambda II PE 3.3L T-GDI	Theta II 2.0 T-GDI
Displacement [cu.in (cc)]	203.94 (3,342)	121.9 (1,998)
Bore x Stroke [in. (mm)]	3.62 x 3.30 (92 x 83.8)	3.39 x 3.39 (86 x 86)
Firing order	1-2-3-4-5-6	1-3-4-2
No. of cylinders	6, V-type	4. In-line

## BULB WATTAGE

Light Bulb		Wattage (W)	Bulb type	
Front	Headlamps (Low/High)	Bulb type	60W	HB3
		LED type	LED	LED
	Front turn signal lamps	Bulb type	21W	PY21W
		LED type	LED	LED
	Front position lamps		LED	LED
	Daytime running light		LED	LED
	Side Repeater lamps	Bulb type	5W	WY5W
		LED type	LED	LED
	Side Marker lamps	Bulb type	5W	W5W
		LED type	LED	LED
Rear	Rear Stop/Tail lamps (Outside)		LED	LED
	Rear tail lamps (Inside)		LED	LED
	Rear turn signal lamps	Bulb type	21W	PY21W
		LED type	LED	LED
	Back-up lamps		16W	W16W
	Side Marker lamps		LED	LED
	High mounted stop lamp		LED	LED
License plate lamps		LED	LED	
Interior	Map lamps		LED	LED
	Room lamps		LED	LED
	Vanity lamps		LED	LED
	Glove box lamp		5W	FESTOON
	Liftgate lamp		LED	LED



## TIRES AND WHEELS

Item	Tire size	Wheel size	Load Capacity		Speed capacity		Inflation pressure [bar (psi, kPa)]				Wheel lug nut torque kgf-m (lbf-ft, N-m)
			LI *1	lbs (kg)	SS *2	mph (km/h)	Normal load *3		Maximum load or Over 100 mph (160 km/h)		
							Front	Rear	Front	Rear	
Full size tire	225/45R18	8.0J X 18	95	1,521 (690)	V	149 (240)	2.5 (36, 250)	2.7 (39, 270)	2.6 (38, 260)	2.7 (39, 270)	11~13 (79 ~ 94, 107 ~ 127)
	225/40R19	8.0J X 19	93	1,433 (650)	W	167 (270)	2.5 (36, 250)	-	2.6 (38, 260)	-	
							2.6 *4 (38, 260)	-	2.6 (38, 260)	-	
	255/35R19	8.5J X 19	96	1,565 (710)	W	167 (270)	-	2.5 (36, 250)	-	2.7 (39, 270)	
	225/40ZR19	8.0J X 19	93	1,433 (650)	Y	186 (300)	2.5 (36, 250)	-	2.6 (38, 260)	-	
2.6 *4 (38, 260)							-	2.6 (38, 260)	-		
255/35ZR19	8.5J X 19	96	1,565 (710)	Y	186 (300)	-	2.5 (36, 250)	-	2.7 (39, 270)		
Compact spare tire (if equipped)	T135/80R18	4.0T X 18	104	1,984 (900)	M	80 (130)	4.2 (60, 420)	4.2 (60, 420)	4.2 (60, 420)	4.2 (60, 420)	

\*1: Load Index

\*2: Speed Symbol

\*3: Normal load : Up to 3 persons

\*4: It is applied to Lambda II PE 3.3L T-GDI AWD vehicle.

 **CAUTION**

*When replacing tires, use the same size originally supplied with the vehicle.  
Using tires of a different size can damage the related parts or make them work irregularly.*

**\* NOTICE**

- It is permissible to add 3 psi (21 kPa) to the standard tire pressure specification if colder temperatures are expected soon.  
Tires typically lose 1 psi (7 kPa) for every 12°F (-11°C) temperature drop. If extreme temperature variations are expected, re-check your tire pressure as necessary to keep them properly inflated.
- We recommend that when replacing tires, use the same originally supplied with the vehicles. If not, that affects driving performance.
- When driving in high altitude grades, it is natural for the atmospheric pressure to decrease. Therefore, please check the tire pressure and add more air when necessary.  
Additionally required tire air pressure per km above sea level: 1.5 psi (10.5 kPa)/km
- Speeds above 100 mph (160 km/h)  
In order to drive at maximum speeds in excess of 100 mph (160 km/h), please observe, and, if necessary, adjust tire pressures for speeds exceeding 100 mph (160 km/h) from the above table. Otherwise tire damage and accidents could occur.

## GROSS VEHICLE WEIGHT

ITEM		lbs (kg)
Theta II 2.0L T-GDI	2WD	4,773 (2,165)
	AWD	4,927 (2,235)
Lambda II PE 3.3L T-GDI	2WD	5,004 (2,270)
	AWD	5,148 (2,335)

## LUGGAGE VOLUME

ITEM	Volume
SAE	23.31 cu ft (660 L)

## AIR CONDITIONING SYSTEM

ITEM		Weight of volume	Classification
Refrigerant	R-1234yf oz. (g)	20.1 ± 0.9 (570 ± 25g)	R-1234yf
Compressor lubricant oz. (g)		3.5 ± 0.4 (100 ± 10g)	FD46XG (IDEMITSU)

We recommend that you contact an authorized Kia dealer for more details.

## RECOMMENDED LUBRICANTS AND CAPACITIES

To help achieve proper engine and powertrain performance and durability, use only lubricants of the proper quality. The correct lubricants also help promote engine efficiency that results in improved fuel economy.

These lubricants and fluids are recommended for use in your vehicle.

Lubricant		Volume	Classification	
Engine oil *1 *2 (drain and refill)  Recommends 	Gasoline Engine	Lambda II PE 3.3L T-GDI	7.29 US qt. (6.9 l)	ACEA A5/B5 *3
		Theta II 2.0L T-GDI	6.02 US qt. (5.7 l)	API SN
Automatic transmission fluid	Gasoline Engine	Theta II 2.0L T-GDI	9.71 US qt. (9.2 l)	GS ATF SP-IV-RR KIA genuine ATF SP-IV-RR
		Lambda II PE 3.3L T-GDI		
Coolant	Gasoline Engine	Theta II 2.0L T-GDI	9.29 US qt. (8.8 l)	Mixture of antifreeze and distilled water (Ethylene glycol base coolant for aluminum radiator)
		Lambda II PE 3.3L T-GDI	12.25 US qt. (11.6 l)	
Brake fluid			0.42 US qt. (0.395 l)	FMVSS116 DOT 3 or DOT 4

Lubricant		Volume	Classification
Rear differential oil (without LSD) (Theta II 2.0L T-GDI) *4		1.27 US qt. (1.2 l)	HYPOID GEAR OIL API GL-5 SAE 75W/85 (SK HK SYN GEAR OIL 75W85)
Rear differential oil (without LSD) (Lambda II PE 3.3L T-GDI) *4		1.37 US qt. (1.3 l)	
Rear differential oil (with LSD) (Theta II 2.0L T-GDI) *4 *5		1.37 US qt. (1.3 l)	HYPOID GEAR OIL API GL-5 SAE 75W/85 (SK HK JL SYN LSD GEAR OIL 75W85 PLUS)
Rear differential oil (with LSD) (Lambda II PE 3.3L T-GDI) *4 *5		1.48 US qt. (1.4 l)	
Front differential oil (AWD) *4		0.74 US qt. (0.7 l)	HYPOID GEAR OIL API GL-5 SAE 75W/85 (SK HK SYN GEAR OIL 75W85)
Transfer oil (AWD)	Gear/ Clutch	0.60 US qt. (0.57 l)	SHELL TF 0870B
	Actuator	0.26 US qt. (0.25 l)	
Fuel	Gasoline Engine	63.36 US qt. (60 l)	Refer to Fuel requirements in chapter 1

\*1 : Refer to the recommended SAE viscosity numbers on the next page.

\*2 : Engine oils labeled Energy Conserving Oil are now available. Along with other additional benefits, they contribute to fuel economy by reducing the amount of fuel necessary to overcome engine friction. Often, these improvements are difficult to measure in everyday driving, but in a year's time, they can offer significant cost and energy savings.

\*3 : If the ACEA A5/B5 engine oil is not available in your country, you are able to use API Latest, ILSAC Latest.

\*4 : Regardless of oil change intervals, replace oil immediately if Rear-Differential or Front-Differential is submerged.

\*5 : Be sure to inject oil for exclusive use of LSD when replacing Rear Differential (for LSD) Oil.

### Recommended SAE viscosity number

Engine oil viscosity (thickness) has an effect on fuel economy and cold weather operating (engine start and engine oil flowability). Lower viscosity engine oils can provide better fuel economy and cold weather performance; however, higher viscosity engine oils are required for satisfactory lubrication in hot weather. Using oils of any viscosity other than those recommended could result in engine damage. When choosing an oil, consider the range of temperature your vehicle will be operated in before the next oil change. Proceed to select the recommended oil viscosity from the chart.

Temperature		Temperature Range for SAE Viscosity Numbers									
		°C	-30	-20	-10	0	10	20	30	40	50
		(°F)	-10	0	20	40	60	80	100	120	
Gasoline Engine Oil	Lambda II PE 3.3L T-GDI *1	10W-30									
		5W-30									
	Theta II 2.0L T-GDI *2	20W-50									
		15W-40									
		10W-30									
		0/5W-30, 5W-40									



An engine oil displaying this API Certification Mark conforms to the international Lubricant Specification Advisory Committee (ILSAC). It is recommended to only use engine oils that uphold this API Certification Mark.

\*1 : For better fuel economy, it is recommended to use the engine oil of a viscosity grade SAE 5W 30 (ACEA A5/B5). However, if the engine oil is not available in your country, select the proper engine oil using the engine oil viscosity chart.

\*2: For better fuel economy, it is recommended to use the engine oil of a viscosity grade SAE 0W 30 (API SN or above). However, if the engine oil is not available in your country, select the proper engine oil using the engine oil viscosity chart.

## VEHICLE IDENTIFICATION NUMBER (VIN)

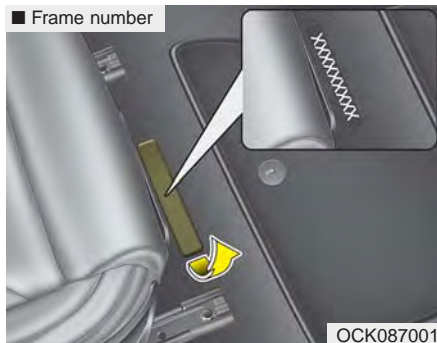

The vehicle identification number (VIN) is the number used in registering your vehicle and in all legal matters pertaining to its ownership, etc.

The number is punched under driver or front passenger seat.

To check the number, open the cover.

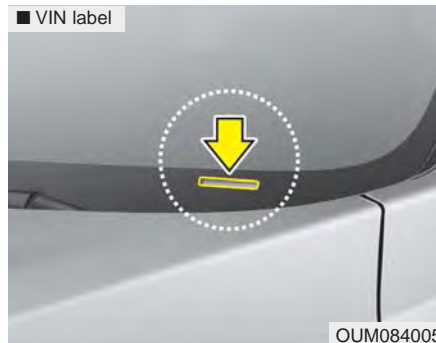

The VIN is also on a plate attached to the top of the dashboard. The number on the plate can easily be seen through the windshield from outside.

## VEHICLE CERTIFICATION LABEL



The vehicle certification label attached on the driver's side center pillar gives the vehicle identification number (VIN).

## TIRE SPECIFICATION AND PRESSURE LABEL



OMG055004

The tires supplied on your new vehicle are chosen to provide the best performance for normal driving.

The tire label located on the driver's side center pillar gives the tire pressures recommended for your vehicle.

## ENGINE NUMBER

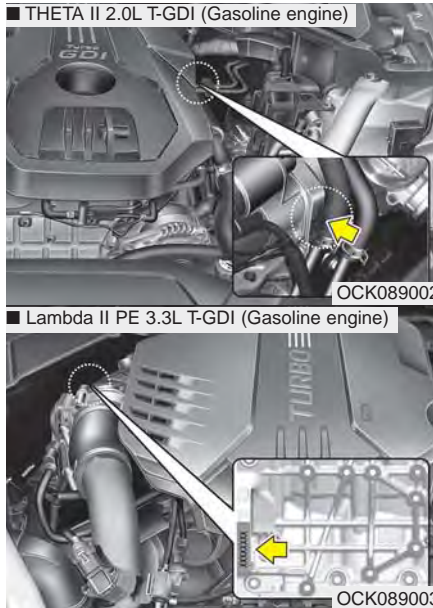

The engine number is stamped on the engine block as shown in the drawing.

## REFRIGERANT LABEL

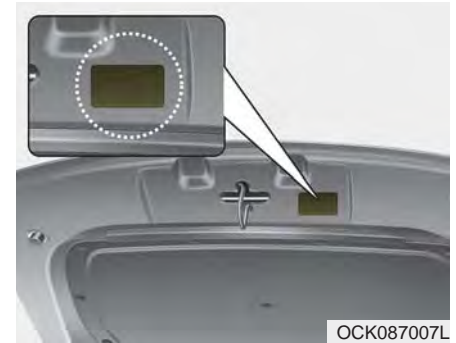

OCK087007L

The refrigerant label is located on the underside of the hood.

\* For more details, refer to “Air Conditioning refrigerant label” in chapter 4.



## **CONSUMER ASSISTANCE (U.S. ONLY)**

Roadside Assistance is provided on all new current model year Kia Vehicles from the date the vehicle is delivered to the first retail buyer or otherwise put into use (in-service date), whichever is earlier, for a period of 60 months or 60,000 miles, whichever is earlier, subject to the terms, conditions and exclusions set forth in the Kia Warranty and Consumer Information Manual applicable to your model year vehicle.

KMA reserves the right to limit or deny services or other benefits to any owner or driver when, in KMA's judgment, the claims and/or service requests are excessive in frequency or type of occurrence.

### **Toll free consumer assistance**

Kia's toll-free Consumer Assistance hot line is staffed from 5:00 AM to 6:00 PM PST, Monday through Friday and is accessible by dialing 1-800-333-4Kia (4542).

For more information regarding assistance available, please refer to your Kia Warranty & Consumer Information Manual.

### **Emergency roadside assistance**

Kia's toll free Roadside Assistance hot line is staffed 24 hours a day, 365 days a year and is accessible by dialing 1-800-333-4Kia (4542).

Please note that you must provide your Vehicle Identification Number (VIN) to verify coverage at the time of your call. The VIN can be found on the dash of your vehicle on the driver's side, on the door jamb of the driver's door, your vehicle's registration or proof of insurance card.

Kia utilizes a network of over 30,000 roadside assistance providers. Should you accidentally run out of fuel, require a battery jump, or need help changing a tire, a Kia Roadside Assistance Representative will dispatch someone to deliver a small quantity of gas, change a flat tire with your inflated spare, or arrange a battery jump to allow you to proceed to your destination. We have access to a network of over 10,000 locksmiths to help you should you become locked out of your Kia.

In the event that mechanical difficulty renders your vehicle undriveable due to a warranty-related concern, Kia's Roadside Assistance Representative will arrange to transport your vehicle to the nearest Kia dealer or to an authorized Kia alternative service location.

Your vehicle must be accessible to our dispatch transport vehicle, as determined by our driver, to receive this service.

**\* NOTICE**

**Roadside Assistance benefits are not available for any Kia vehicle that has ever been or should be issued a “salvage” title or similar “branded” title under any state’s law or has been declared a “total loss” or equivalent by a financial institution or insurance company.**

**Trip interruption**

Trip interruption expense benefits are provided in the event that a warranty-related disablement occurs more than 150 miles from your home, and the repairs require more than 24 hours to complete. Reasonable reimbursement is included for meals, lodging, or rental vehicle expenses. Trip interruption coverage is limited to \$100 per day subject to a three day maximum limit per incident. You must contact the Kia Roadside Assistance Center to obtain pre-authorization of expenses. Once the Kia Roadside Assistance Center gives authorization for trip interruption benefits, they will assist you in making the necessary arrangements. Insurance deductibles, expenses, and claims paid by your insurance company or other providers are not eligible for reimbursement.

Fleet vehicles are excluded from reimbursement under Kia’s Trip Interruption Policy.

### **Registering your vehicle in a foreign country**

If you plan to register your vehicle in a foreign country, you should confirm that it conforms to the regulations in that country. Even if you successfully register the vehicle in a foreign country, you may experience the following problems and should therefore consider the possibility of having to deal with them:

1. The fuel specified for your vehicle may be unavailable. If other than the specified fuel is used, it could cause damage to the engine, the fuel injection system, and other fuel-related parts which may not be covered under your New Vehicle Emissions Limited Warranty.
2. We must, therefore, clearly state that when you leave the country in which you purchased your Kia new and register it in another country, problems arising from the use of fuel other than the specified fuel are not subject to manufacturer's warranty. Because vehicles like yours may not be marketed in the new country of registration, parts, servicing techniques and tools necessary to maintain and repair your vehicle may be unavailable.

Even if vehicles like yours are sold there, mechanical specifications required by the government may vary enough from the country of purchase to cause additional problems.

3. There may not be an Authorized Kia Dealer in the area in which you plan to register your vehicle. You may additionally experience difficulty in obtaining services in a foreign country for any number of reasons.

Further, we cannot assume any responsibility for problems that result from unsatisfactory service or lack of service outside of the United States.

## **ELECTRICAL EQUIPMENT (U.S. ONLY)**

The electrical system of your vehicle is designed to perform under all reasonably expected operating conditions. However, before any additional electrical equipment is installed in your vehicle, consult an Authorized Kia Dealer, in order to ensure that you do not void your warranty.

Certain electrical equipment, or the way in which it is installed, may adversely affect the operation of your vehicle, including such systems as the engine control system, the audio system and the electrical charging system and thus potentially void all or part of your warranty.

We assume no responsibility for any expense you may incur or for any malfunction of your vehicle or any of its components or systems that may result from the installation of additional electrical equipment that is not supplied, or recommended for installation by, Kia.

### **Installation of a mobile two-way radio system**

If a mobile two-way radio system is installed improperly, or if an excessively powerful type of system is used, other electronic systems may be adversely affected. To avoid damage to your vehicle, consult an Authorized Kia Dealer concerning the proper equipment and installation.

Kia motor vehicles are designed and manufactured to meet or exceed all applicable safety standards.

For your safety, however, we strongly urge you to read and follow all directions in this Owner's Manual, particularly the information under the headings "NOTICE", "CAUTION" and "WARNING".

If, after reading this manual, you have any questions regarding the operation of your vehicle, safety issues and defects please contact your Kia's toll-free Consumer Assistance hot line as below:

National Consumer Affairs Manager  
Kia Motors America, Inc.  
P.O. Box 52410  
Irvine, CA 92619-2410  
1-800-333-4Kia (4542)

## **REPORTING SAFETY DEFECTS (U.S. ONLY)**

If you believe that your vehicle has a defect which could cause a crash or could cause injury or death, you should immediately inform the National Highway Traffic Safety Administration (NHTSA) in addition to notifying Kia Motors America, Inc.

If NHTSA receives similar complaints, it may open an investigation, and if it finds that a safety defect exists in a group of vehicles, it may order a recall and remedy campaign. However, NHTSA cannot become involved in individual problems between you, your dealer, or Kia Motors America, Inc.

To contact NHTSA, you may call the Vehicle Safety Hotline toll-free at 1-888-327-4236 (TTY: 1-800-424-9153); go to <http://www.safercar.gov>; download the SaferCar mobile application; or write to: Administrator, NHTSA, 1200 New Jersey Ave. SE., Washington, DC 20590. You can also obtain other information about motor vehicle safety from <http://www.safercar.gov>.

## **ONLINE FACTORY AUTHORIZED MANUALS (U.S. ONLY)**

The following publications are available on [www.KiaTechinfo.com](http://www.KiaTechinfo.com)

### **Service manual:**

This manual covers maintenance and recommended procedures for repair to engine and chassis components. It is written for the Journeyman mechanic, but is simple enough for most mechanically inclined owners to understand.

### **Electrical troubleshooting manual:**

This manual complements the Service Manual by providing indepth troubleshooting information for each electrical circuit in your vehicle.

### **Owner's manual:**

This manual describes the overall features and operating procedures for the vehicle.

# Index

**A**

Air bag - advanced supplemental restraint system . . . 3-45

    Adding equipment to or modifying your  
        air bag-equipped vehicle . . . . . 3-71

    Air bag warning label. . . . . 3-71

    Air bag warning light. . . . . 3-48

    Curtain air bag . . . . . 3-64

    Driver's and passenger's front air bag . . . . . 3-60

    How does the air bag system operate?. . . . . 3-46

    Occupant Detection System (ODS). . . . . 3-52

    Side air bag. . . . . 3-62

    SRS Care . . . . . 3-70

    SRS components and functions . . . . . 3-49

Air cleaner . . . . . 7-29

    Filter replacement. . . . . 7-29

Air conditioning system . . . . . 8-6

All wheel drive (AWD). . . . . 5-38

    Emergency precautions . . . . . 5-40

    Using All Wheel Drive (AWD) . . . . . 5-38

Appearance care . . . . . 7-93

    Exterior care. . . . . 7-93

    Interior care . . . . . 7-98

Audio system . . . . . 4-169

    Antenna . . . . . 4-169

    AUX, USB port . . . . . 4-169

Automatic climate control system . . . . . 4-135

    Air Conditioning refrigerant label . . . . . 4-148

    Automatic heating and air conditioning. . . . . 4-136

    Checking the amount of air conditioner refrigerant and  
        compressor lubricant . . . . . 4-147

    Climate control air filter. . . . . 4-147

    Manual heating and air conditioning . . . . . 4-138

    Sunroof inside air recirculation . . . . . 4-149

    System operation . . . . . 4-145

Automatic transmission . . . . . 5-11

    Automatic transmission operation . . . . . 5-11

    Good driving practices. . . . . 5-17

    Launch control . . . . . 5-18

Automatic transmission (shift-by-wire) . . . . . 5-21

    Automatic transmission operation . . . . . 5-21

    Good driving practices. . . . . 5-31

    Launch control . . . . . 5-33

    LCD display messages. . . . . 5-28

    Parking . . . . . 5-28

**B**

Battery. . . . . 7-35

    Battery replacement . . . . . 7-35

    For best battery service . . . . . 7-35

    Recharging the battery . . . . . 7-37

    Reset items . . . . . 7-38

Before driving . . . . .	5-5
Before entering vehicle . . . . .	5-5
Before starting . . . . .	5-5
Necessary inspections . . . . .	5-5
Blind-spot Collision Warning (BCW)/Rear Cross-Traffic Collision Warning (RCCW) . . . . .	5-123
BCW (Blind-Spot Collision Warning) . . . . .	5-124
Driver's attention . . . . .	5-130
RCCW (Rear Cross-Traffic Collision Warning) . . . . .	5-127
System description . . . . .	5-123
Brake fluid . . . . .	7-26
Checking the brake fluid level . . . . .	7-26
Brake system . . . . .	5-43
Anti-lock Brake System (ABS) . . . . .	5-57
Auto hold . . . . .	5-53
Electronic parking brake (EPB) . . . . .	5-47
Electronic Stability Control (ESC) . . . . .	5-59
Good braking practices . . . . .	5-65
Hill-start Assist Control (HAC) . . . . .	5-64
Parking brake – Foot type . . . . .	5-45
Power brakes . . . . .	5-43
Vehicle Stability Management (VSM) . . . . .	5-63
Warning messages . . . . .	5-56
Bulb wattage . . . . .	8-3

## C

Checking fluid levels . . . . .	7-19
Child Restraint System (CRS) . . . . .	3-34
Children always in the rear . . . . .	3-34
Installing a Child Restraint System (CRS) . . . . .	3-38
Selecting a Child Restraint System (CRS) . . . . .	3-35
Climate control air filter . . . . .	7-30
Filter inspection . . . . .	7-30
Consumer assistance (U.S. only) . . . . .	8-12
Emergency roadside assistance . . . . .	8-12
Registering your vehicle in a foreign country . . . . .	8-14
Toll free consumer assistance . . . . .	8-12
Trip interruption . . . . .	8-13
Cruise Control system . . . . .	5-81
To cancel cruise control . . . . .	5-83
To decrease the cruising speed . . . . .	5-83
To increase cruise control set speed . . . . .	5-82
To resume cruising speed at more than approximately 20 mph (30 km/h) . . . . .	5-84
To set cruise control speed . . . . .	5-82
To temporarily accelerate with the cruise control on . . . . .	5-83
To turn cruise control off . . . . .	5-84



**D**

Declaration of Conformity . . . . . 4-171  
    FCC . . . . . 4-171  
Defroster . . . . . 4-134  
    Rear window defroster . . . . . 4-134  
Dimensions . . . . . 8-2  
Door locks . . . . . 4-16  
    Child-protector rear door lock . . . . . 4-19  
    Door lock/unlock features . . . . . 4-19  
    Operating door locks from inside the vehicle . . . . . 4-17  
    Operating door locks from outside the vehicle . . . . . 4-16  
Drive mode integrated control system . . . . . 5-108  
Driver Attention Warning (DAW) system . . . . . 5-132  
    Resetting the system . . . . . 5-134  
    System disabled . . . . . 5-134  
    System malfunction . . . . . 5-135  
    System setting and activation . . . . . 5-132

**E**

Economical operation . . . . . 5-137  
Electrical equipment (U.S. only) . . . . . 8-15  
    Installation of a mobile two-way radio system . . . . . 8-15  
Emergency starting . . . . . 6-5  
    Jump starting . . . . . 6-5  
    Push-starting . . . . . 6-6

Emission control system . . . . . 7-101  
    Crankcase emission control system . . . . . 7-101  
    Evaporative emission control (including ORVR:  
        Onboard Refueling Vapor Recovery) system . . . . . 7-101  
    Exhaust emission control system . . . . . 7-102  
Engine . . . . . 8-2  
Engine compartment . . . . . 2-6, 7-3  
Engine coolant . . . . . 7-22  
    Changing the coolant . . . . . 7-25  
    Checking the coolant level . . . . . 7-22  
Engine number . . . . . 8-11  
Engine oil . . . . . 7-20  
    Changing the engine oil and filter . . . . . 7-21  
    Checking the engine oil level . . . . . 7-20  
Engine start/stop button . . . . . 5-7  
    Engine start/stop button position . . . . . 5-7  
    Illuminated engine start/stop button . . . . . 5-7  
    Starting the engine with a smart key . . . . . 5-9  
Explanation of scheduled maintenance items . . . . . 7-16  
Exterior overview . . . . . 2-2

**F**

Forward Collision-avoidance Assist (FCA) system . . . . . 5-67  
    Brake operation . . . . . 5-71  
    FCA sensor (Front Camera/Front Radar) . . . . . 5-72  
    FCA warning message and system control . . . . . 5-70

Limitation of the system . . . . .	5-74
System malfunction . . . . .	5-73
System setting and activation . . . . .	5-67
Fuel filler lid . . . . .	4-41
Closing the fuel filler lid . . . . .	4-41
Emergency fuel filler lid release . . . . .	4-42
Opening the fuel filler lid . . . . .	4-41
Fuel requirements . . . . .	1-2
Do not use methanol . . . . .	1-4
Fuel additives . . . . .	1-4
Gasoline containing alcohol and methanol . . . . .	1-3
Gasoline containing MMT . . . . .	1-4
Operation in foreign countries . . . . .	1-5
Other fuels . . . . .	1-4
Fuses . . . . .	7-55
Engine compartment fuse replacement . . . . .	7-59
Fuse/relay panel description . . . . .	7-61
Inner panel fuse replacement . . . . .	7-57

**G**

Gross vehicle weight . . . . .	8-6
--------------------------------	-----

**H**

Head Up Display (HUD) . . . . .	4-105
Description . . . . .	4-105
Head Up Display information . . . . .	4-106

Head Up Display on/off . . . . .	4-106
Head Up Display setting . . . . .	4-106
Hood . . . . .	4-39
Closing the hood . . . . .	4-40
How to use this manual . . . . .	1-2

**I**

If the engine overheats . . . . .	6-7
If the engine will not start . . . . .	6-4
If engine doesn't turn over or turns over slowly . . . . .	6-4
If engine turns over normally but does not start . . . . .	6-4
If you have a flat tire (with spare tire) . . . . .	6-14
Changing tires . . . . .	6-16
Jack and tools . . . . .	6-14
Removing and storing the spare tire . . . . .	6-15
If you have a flat tire (with Tire Mobility Kit) . . . . .	6-23
Checking the tire inflation pressure . . . . .	6-31
Components of the Tire Mobility Kit (TMK) . . . . .	6-26
Distributing the sealant . . . . .	6-30
Introduction . . . . .	6-24
Notes on the safe use of the Tire Mobility Kit . . . . .	6-25
Technical Data . . . . .	6-31
Using the Tire Mobility Kit . . . . .	6-27
Important safety precautions . . . . .	3-2
Air bag hazards . . . . .	3-2
Always wear your seat belt . . . . .	3-2
Control your speed . . . . .	3-3

Driver distraction . . . . .	3-2
Keep your vehicle in safe condition . . . . .	3-3
Restrain all children . . . . .	3-2
In case of an emergency while driving . . . . .	6-3
If the engine stalls at a crossroad or crossing . . . . .	6-3
If the engine stalls while driving . . . . .	6-3
If you have a flat tire while driving . . . . .	6-3
Instrument cluster . . . . .	4-67
Gauges . . . . .	4-69
Instrument cluster control . . . . .	4-68
LCD display control . . . . .	4-68
Transmission shift indicator . . . . .	4-72
Instrument panel overview . . . . .	2-5
Interior features . . . . .	4-157
Air ventilation seat . . . . .	4-159
Coat hook . . . . .	4-166
Cup holder . . . . .	4-157
Floor mat anchor (s) . . . . .	4-167
Luggage net (holder) . . . . .	4-168
Power outlet . . . . .	4-161
Seat warmer . . . . .	4-158
Sunvisor . . . . .	4-160
USB charger . . . . .	4-162
Wireless smart phone charging system . . . . .	4-162
Interior lights . . . . .	4-129
Automatic turn off function . . . . .	4-129
Door courtesy lamp . . . . .	4-132
Glove box lamp . . . . .	4-131

Liftgate room lamp . . . . .	4-131
Map lamp . . . . .	4-130
Room lamp . . . . .	4-129
Vanity mirror lamp . . . . .	4-131
Interior overview . . . . .	2-4
ISG (Idle Stop and Go) system . . . . .	5-104
Auto start . . . . .	5-105
Auto stop . . . . .	5-104
Condition of ISG system operation . . . . .	5-106
ISG system deactivation . . . . .	5-106
ISG system malfunction . . . . .	5-107

## L

Lane Keeping Assist (LKA) system . . . . .	5-113
Driver's attention . . . . .	5-119
LKA system Function Change . . . . .	5-121
LKA system malfunction . . . . .	5-120
LKA system operation . . . . .	5-115
LCD windows . . . . .	4-73
Distance to empty . . . . .	4-81
LCD modes . . . . .	4-77
Over view . . . . .	4-73
Trip information (Trip computer) . . . . .	4-73
User settings mode . . . . .	4-82
Warning messages . . . . .	4-87

- Liftgate . . . . . 4-21
    - Emergency liftgate safety release. . . . . 4-28
    - Non-Powered liftgate . . . . . 4-21
    - Power liftgate . . . . . 4-23
  - Light bulbs . . . . . 7-78
    - Back-up lamp bulb replacement . . . . . 7-88
    - Bulb replacement precaution . . . . . 7-78
    - Front turn signal lamp bulb replacement
      - (Headlamp Type A) . . . . . 7-84
    - Glove box lamp (LED type) bulb replacement . . . . 7-92
    - Headlamp (LED type) replacement
      - (Headlamp Type B) . . . . . 7-82
    - Headlamp (Low/High beam) bulb replacement
      - (Headlamp Type A) . . . . . 7-83
    - High mounted stop lamp (LED type) bulb replacement . . . . . 7-90
    - License plate lamp (LED type) bulb replacement . . 7-90
    - Light bulb position (Front). . . . . 7-80
    - Light bulb position (Rear) . . . . . 7-80
    - Light bulb position (Side) . . . . . 7-81
    - Luggage room lamp (LED type) bulb replacement. 7-92
    - Map lamp (LED type) bulb replacement . . . . . 7-91
    - Position lamp + DRL (LED type) bulb replacement
      - (Headlamp Type A) . . . . . 7-82
    - Rear side marker (LED type) bulb replacement . . . 7-86
    - Rear turn signal lamp (bulb type) bulb replacement . 7-86
    - Rear turn signal lamp (LED type) bulb replacement . . . . . 7-86
    - Room lamp (LED type) bulb replacement. . . . . 7-91
    - Side marker bulb replacement (Headlamp Type A). 7-82
    - Side repeater lamp (LED type) bulb replacement . . 7-90
    - Stop and tail lamp (LED type) bulb replacement . . 7-85
    - Vanity mirror lamp (LED type) bulb replacement. . 7-91
  - Lighting. . . . . 4-118
    - Battery saver function . . . . . 4-118
    - Check headlight . . . . . 4-124
    - Daytime running light . . . . . 4-118
    - Dynamic Bending Light (DBL). . . . . 4-125
    - Headlight leveling device. . . . . 4-124
    - High Beam Assist (HBA) system. . . . . 4-121
    - High beam operation . . . . . 4-120
    - Lighting control . . . . . 4-118
      - Turn signals and lane change signals. . . . . 4-123
  - Limited Slip Differential (LSD) . . . . . 5-42
  - Luggage volume . . . . . 8-6
- M**
- Maintenance services . . . . . 7-4
    - Owner maintenance precautions . . . . . 7-5
    - Owner's responsibility . . . . . 7-4
  - Mirrors . . . . . 4-55
    - Inside rearview mirror . . . . . 4-55
    - Outside rearview mirror . . . . . 4-64

**O**

Online factory authorized manuals (U.S. only) . . . . . 8-16  
    Electrical troubleshooting manual . . . . . 8-16  
    Owner's manual . . . . . 8-16  
    Service manual . . . . . 8-16  
Owner maintenance . . . . . 7-7  
    Owner maintenance schedule . . . . . 7-7

**P**

Parking brake . . . . . 7-28  
    Checking the parking brake . . . . . 7-28  
Parking Distance Warning (PDW) system . . . . . 4-111  
    Non-operational conditions of Parking Distance  
    Warning . . . . . 4-113  
    Operation of Parking Distance Warning . . . . . 4-111  
    Self-diagnosis . . . . . 4-115

**R**

Rear View Monitor (RVM) system . . . . . 4-116  
Recommended lubricants and capacities . . . . . 8-7  
    Recommended SAE viscosity number . . . . . 8-9  
Refrigerant label . . . . . 8-11  
Reporting safety defects (U.S. only) . . . . . 8-16

Reverse Parking Distance Warning . . . . . 4-107  
    Non-operational conditions of Reverse Parking  
    Distance Warning . . . . . 4-108  
    Operation of Reverse Parking Distance Warning . . . . . 4-107  
    Reverse Parking Distance Warning precautions . . . . . 4-109  
    Self-diagnosis . . . . . 4-110  
Risk of burns when parking or stopping vehicle . . . . . 1-6  
Road warning . . . . . 6-2  
    Hazard warning flasher . . . . . 6-2

**S**

Scheduled maintenance service . . . . . 7-9  
Seat . . . . . 3-4  
    Driver position memory system (for power seat) . . . . . 3-11  
    Front seat adjustment - power . . . . . 3-8  
    Headrest (for front seat) . . . . . 3-14  
    Rear seat adjustment . . . . . 3-17  
    Seatback pocket . . . . . 3-17  
Seat belts . . . . . 3-22  
    Care of seat belts . . . . . 3-32  
    Pre-tensioner seat belt . . . . . 3-28  
    Seat belt precautions . . . . . 3-31  
    Seat belt restraint system . . . . . 3-22  
Smart Cruise Control with stop & go system . . . . . 5-85  
    Limitations of the system . . . . . 5-98  
    Smart Cruise Control switch . . . . . 5-87  
    Speed setting . . . . . 5-87

To adjust the sensitivity of Smart Cruise Control system . . . . .	5-97
To convert to Cruise Control mode . . . . .	5-97
Vehicle to vehicle distance setting . . . . .	5-92
When the lane ahead is clear . . . . .	5-93
When there is a vehicle ahead of you in your lane . . . . .	5-93
Smart key . . . . .	4-5
Battery replacement . . . . .	4-11
Immobilizer system . . . . .	4-12
Mechanical key operations . . . . .	4-11
Record your key number . . . . .	4-5
Remote keyless entry system operations . . . . .	4-8
Smart key functions . . . . .	4-5
Transmitter precautions . . . . .	4-10
Smart liftgate . . . . .	4-30
Special driving conditions . . . . .	5-139
Driving at night . . . . .	5-140
Driving in flooded areas . . . . .	5-142
Driving in the rain . . . . .	5-141
Driving off-road . . . . .	5-142
Hazardous driving conditions . . . . .	5-139
Highway driving . . . . .	5-142
Rocking the vehicle . . . . .	5-139
Smooth cornering . . . . .	5-140
Steering wheel . . . . .	4-51
Electric Power Steering (EPS) . . . . .	4-51
Heated steering wheel . . . . .	4-53

Horn . . . . .	4-54
Tilt and telescopic steering . . . . .	4-52
Storage compartments . . . . .	4-155
Center console storage . . . . .	4-155
Glove box . . . . .	4-155
Sunglass holder . . . . .	4-156
Surround View Monitoring (SVM) system . . . . .	4-117

## T

The Eco-coasting system . . . . .	5-36
Eco-Coasting operation conditions . . . . .	5-36
The Eco-Coasting system release conditions . . . . .	5-37
The Eco-Coasting system setting . . . . .	5-36
Theft-alarm system . . . . .	4-14
Armed stage . . . . .	4-14
Disarmed stage . . . . .	4-15
Theft-alarm stage . . . . .	4-15
Tire Pressure Monitoring System (TPMS) . . . . .	6-8
Changing a tire with TPMS . . . . .	6-12
Check tire pressure . . . . .	6-8
Low tire pressure telltale . . . . .	6-10
Tire specification and pressure label . . . . .	8-11
Tires and wheels . . . . .	8-4
Tires and wheels . . . . .	7-39
All season tires . . . . .	7-51
Checking tire inflation pressure . . . . .	7-40
Flat Spots . . . . .	7-43

Low aspect ratio tire . . . . .	7-53
Radial-ply tires . . . . .	7-52
Recommended cold tire inflation pressures . . . . .	7-39
Snow tires . . . . .	7-52
Summer tires . . . . .	7-51
Tire care . . . . .	7-39
Tire chains . . . . .	7-52
Tire maintenance . . . . .	7-44
Tire pressure . . . . .	7-40
Tire replacement . . . . .	7-43
Tire rotation . . . . .	7-41
Tire sidewall labeling . . . . .	7-45
Tire terminology and definitions . . . . .	7-48
Tire traction . . . . .	7-44
Wheel alignment and tire balance . . . . .	7-42
Wheel replacement . . . . .	7-44
Towing . . . . .	6-33
Emergency towing . . . . .	6-35
Removable towing hook . . . . .	6-35
Towing service . . . . .	6-33

## V

Vehicle break-in process . . . . .	1-6
Vehicle certification label . . . . .	8-10
Vehicle data collection and event data recorders . . . . .	1-7
Vehicle Identification Number (VIN) . . . . .	8-10
Vehicle load limit . . . . .	5-148

Certification label . . . . .	5-152
Tire and loading information label . . . . .	5-148
Vehicle modifications . . . . .	1-6
Vehicle weight . . . . .	5-153
Base curb weight . . . . .	5-153
Cargo weight . . . . .	5-153
GAW (Gross Axle Weight) . . . . .	5-153
GAWR (Gross Axle Weight Rating) . . . . .	5-153
GVW (Gross Vehicle Weight) . . . . .	5-153
GVWR (Gross Vehicle Weight Rating) . . . . .	5-153
Vehicle curb weight . . . . .	5-153

## W

Warning and indicator lights . . . . .	4-92
Indicator lights . . . . .	4-100
Warning lights . . . . .	4-92
Washer fluid . . . . .	7-27
Checking the washer fluid level . . . . .	7-27
Welcome system . . . . .	4-133
Headlight (Headlamp) escort function . . . . .	4-133
Interior light . . . . .	4-133
Pocket lamp . . . . .	4-133
Wide sunroof . . . . .	4-45
Closing the sunroof . . . . .	4-49
Resetting the sunroof . . . . .	4-50
Sliding the sunroof . . . . .	4-47
Sunroof open warning . . . . .	4-46

---

Sunshade . . . . .	4-47
Tilting the sunroof . . . . .	4-49
Windows . . . . .	4-34
Opening the hood . . . . .	4-39
Power windows . . . . .	4-35
Windshield defrosting and defogging . . . . .	4-150
Automatic climate control system . . . . .	4-150
Automatic ventilation . . . . .	4-153
Defogging logic . . . . .	4-151
Smart ventilation . . . . .	4-154
Winter driving . . . . .	5-143
Carry emergency equipment . . . . .	5-147
Change to "winter weight" oil if necessary . . . . .	5-146
Check battery and cables . . . . .	5-145
Check spark plugs and ignition system . . . . .	5-146
Don't let your parking brake freeze . . . . .	5-146
Don't let ice and snow accumulate underneath . . . . .	5-147
Snowy or icy conditions . . . . .	5-143
To keep locks from freezing . . . . .	5-146
Use approved window washer anti-freeze in system . . . . .	5-146
Use high quality ethylene glycol coolant . . . . .	5-145
Wiper blades . . . . .	7-32
Blade inspection . . . . .	7-32
Blade replacement . . . . .	7-32
Wipers and washers . . . . .	4-126
Front windshield washers . . . . .	4-128
Windshield wipers . . . . .	4-126



