

stinger

FEATURES & FUNCTIONS GUIDE





GETTING TO KNOW YOUR STINGER

Congratulations on Your New Kia Purchase!

Your new Kia vehicle has been designed, engineered and manufactured to provide you with years of comfortable and dependable driving. Kia is committed to quality, innovation, safety and — above all — your satisfaction.

Using This Guide

The information contained in this guide is a brief overview that will help you become familiar with the operation and features of your new Kia vehicle. The flipbook format facilitates information access, while the detailed illustrations ensure the instructions are easy to follow. This Features & Functions Guide and the specific operational and safety information it provides are not a substitute for your Owner's Manual. In the interest of your safety and that of your family, and to help you avoid risks that may result in death or serious injury, Kia reminds you to carefully read your Owner's Manual in order to fully familiarize yourself with the important information it contains.

While the information contained in this guide is accurate at the time of printing, Kia may change vehicle specifications without notice in advance of or after the fact, and assumes no liability in connection with such changes.



Available on the App Store, the Kia AR Owner's Manual App uses AR (Augmented Reality) technology to provide tips and useful information about your vehicle.

To use the Kia AR Owner's Manual App:

- Simply scan the interior or engine (motor) room of your vehicle with your smart phone or tablet, select feature/component and view the video guide.
- If you are unable to scan the vehicle, use the AR Manual (without scan) menu, select feature/component and view the video guide.



Driving while distracted can result in a loss of vehicle control that may lead to an accident, severe personal injury and death. The driver's primary responsibility is in the safe and legal operation of a vehicle, and use of any handheld devices, other equipment or vehicle systems which take the driver's eyes, attention and focus away from the safe operation of a vehicle or that are not permissible by law should never be used during operation of the vehicle.

www.kia.com

Consumer Affairs - Roadside Assistance^{†††}: 1-855-4KIAVIP (855-454-2847) or 1-800-333-4KIA (800-333-4542)

Always check the Owner's Manual for complete operating information and safety warnings.

See Back Pages for Vehicle Maintenance Schedule.

† LEGAL DISCLAIMERS ON BACK INSIDE COVER

Essential Features

Automatic Climate Control System	31	Smart Key	39
Automatic Transmission / Sport Shift Mode (Shift by Cable)	32	Smart Power Liftgate*	40
Aux/USB/iPod® Port, Power Outlets & USB Charger	30	Steering Wheel Adjustment	19
Bluetooth® Wireless Technology	24	Tire Pressure Monitoring System (TPMS)	06
Front Seat Headrest Adjustment	37	UVO eServices / UVO eServices w/ Premium Navigation*	29
Head-Up Display (HUD)*	10	Windshield Wipers and Washers	21
Smart Cruise Control (SCC) with Stop & Go*	22		

Videos & QR Codes 02

Instrument Cluster 03-09

Instrument Cluster Overview / Indicators & Warning Lights	03
Drive Mode Integrated Control System	04
Fuel Economy	05
Driver Attention Warning (DAW)	05
Tire Pressure Monitoring System (TPMS)	06
LCD Instrument Cluster Modes	07
Trip Information / Trip Computer	07
User Settings	08
Service Mode	08
Forward Collision-Avoidance Assist-Pedestrian (FCA-Ped)* / Forward Collision Warning (FCW)*	09

Driver's Panel 10-18

Head-Up Display (HUD)*	10
Idle, Stop and Go (ISG)*	11
Launch Control	11
Instrument Cluster Control (Instrument Panel Dimmer)	12
Electronic Stability Control (ESC) / Traction Control System (TCS)	12
Hill-Start Assist Control (HAC)	12
Blind-Spot Collision Warning (BCW)	13
Lane Keeping Assist (LKA) / Lane Departure Warning (LDW)*	14
Reverse Parking Aid Function	15
Fuel Door Release Button	15
Parking Distance Warning-Reverse	16
Rear View Monitor*	16
Power Windows, Window Lock & Central Door Lock	17
Power Folding Outside Mirrors	17
Heated Outside Mirrors	17
Auto Door Lock/Unlock	17
Engine Start/Stop Button	18

Steering Wheel Controls 19-26

Tilt/Telescoping Steering Wheel	19
Heated Steering Wheel	19
Headlights & High Beams	20
Windshield Wipers & Washers	21
Turn Signals & Fog Lights	21
Smart Cruise Control (SCC) with Stop & Go*	22
Bluetooth® Wireless Technology	24
Audio Controls	26

Audio Systems 27-29

UVO eServices Activation	27
Android Auto™ / Apple CarPlay® Setup*	27
UVO eServices*	28
UVO eServices with Premium Navigation*	29

Center Panel 30-35

Clock	30
Aux/USB/iPod® Port, Power Outlets & USB Charger	30
Wireless Smartphone Charging System*	30
Automatic Climate Control System	31
Automatic Transmission / Sport Shift Mode (Shift by Cable)	32
Electric Parking Brake (EPB)	33
Auto Hold	34
Surround View Monitoring (SVM) System*	35

Seating 36-38

Seat Warmers / Ventilated Seats	36
Power Adjustable Driver's Seats	37
Front Seat Headrest Adjustment	38
Driver Position Memory System	38

Other Key Features 39-46

Smart Key	39
Smart Power Liftgate*	40
Map / Room Lamps	42
Sunroof Operation	43
HomeLink® with Auto-Dimming Rearview Mirror	44
Sunvisor	45
Hood Release Lever and Latch	45
Fuel Cap/Malfunction Indicator (Check Engine Light)	46
Child-Protector Rear Door Lock	46

Safety Features 47

Seat Belts	47
Pre-Safe Seat Belt (PSB)*	47
Occupant Detection System (ODS) / Passenger Airbag Off Indicator	47

Normal Maintenance Schedule 48

Legal Disclaimers (See Inside Back Cover)

Driving while distracted can result in a loss of vehicle control that may lead to an accident, severe personal injury and death. The driver's primary responsibility is in the safe and legal operation of a vehicle, and use of any handheld devices, other equipment or vehicle systems which take the driver's eyes, attention and focus away from the safe operation of a vehicle or that are not permissible by law should never be used during operation of the vehicle.

QR Codes

Kia provides a number of video resources to assist you with becoming familiar with the features and functions found in your Kia vehicle. You can access these resources by snapping the QR Codes with your smartphone/tablet (mobile devices) or by visiting the following website: www.youtube.com/KiaFeatureVideos. Continue reading for a more in-depth look at QR Codes and for instructions on how to use them.

What are QR Codes?

A QR Code is a square, 2-dimensional Bar Code that can be read by mobile devices loaded with an appropriate Bar Code or QR Code Reader app. The app reads the Bar Code image and then launches/uploads the specific information the code contains, such as URLs, text, photos, videos and so much more.

How to Use QR Codes

If you have a mobile device with a QR Code Reader App, you can snap the code with your phone and you'll be provided a video with additional information pertaining to the topic. For example, in the Kia One-Click Fuel Cap section, if you would like additional information, just snap the code with your mobile device to view the selected Kia Features & Functions Video.

How to snap a QR Code

1. With your mobile device, download a QR Code Reader App. With many devices, you can do this through an App Store or Marketplace
2. Open the QR Code Reader App on your mobile device
3. The app will utilize your device's camera. Center the code in the camera viewing area:
 - With some apps, as soon as the app recognizes the code, it will launch the corresponding video
 - With other apps, you will have to snap or "take a picture" of the code. The app will then launch the corresponding video
 - For operation specifics, refer to the instructions that come with the QR Code Reader app

ONE-CLICK FUEL CAP VIDEO

To view a video on your mobile device, snap this QR Code or visit the listed website. Refer to page 2 for more information.



www.youtube.com/KiaFeatureVideos

Quick Tips

1. If you're having trouble scanning codes, check the following:
 - The code should be centered and focused in your mobile device's camera screen
 - Consider moving your device closer to or farther away from the code
 - The code should be well lit, without significant shadow
 - Avoid scanning from a significant angle
 - Confirm that the device's app supports 2D QR Code scanning
 - Try another QR Code Reader app; not all apps are created equal
2. After scanning, you may experience a "connecting" message appears and then nothing happens or there's a "connection error" message. These messages typically indicate that your device is having trouble connecting to the Internet.

REMINDER: When accessing videos on your mobile device, standard cellular data rates may apply.

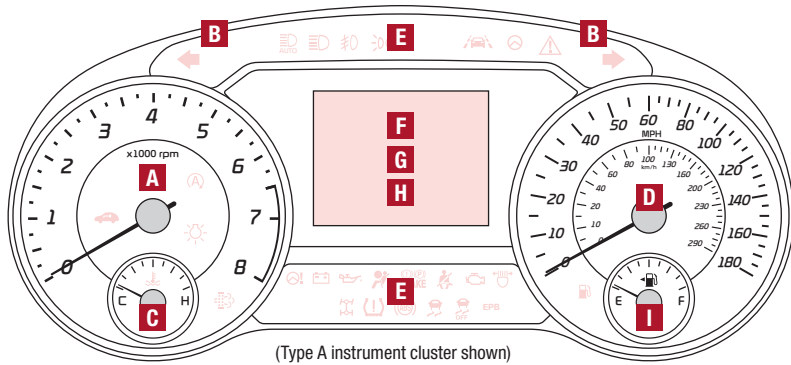

(Type A instrument cluster shown)

Instrument Cluster Overview

- | | | |
|---------------------------------|--|------------------------|
| A Tachometer | D Speedometer | G Odometer |
| B Turn Signal Indicators | E Indicator & Warning Lights | H Trip Computer |
| C Temperature Gauge | F Gear Shift Position Indicator | I Fuel Gauge |

Indicators & Warning Lights

- | | | |
|--|---|---|
| Light ON Indicator | Parking Brake & Brake Fluid Warning Light | Electronic Brake Force Distribution (EBD) System Warning Light – (Two separate indicators on Instrument Cluster lit at same time) |
| Cruise Indicator | Door Ajar Warning Light | Forward Collision-Avoidance Assist (FCA) Warning (or OFF) Indicator |
| Lane Keeping Assist (LKA) Indicator* | Airbag Warning Light | ECO / SPORT / SMART Mode Indicator |
| Electric Parking Brake | Low Windshield Washer Fluid | Master Warning Light |
| Immobilizer Indicator | Turn Signal Indicators | Low Beam Assist (LBA) / Dynamic Bending Light (DBL)* |
| High Beam Indicator | Anti-Lock Braking System (ABS) Warning Light | High Beam Assist (HBA) Indicator* |
| LED Headlamp Warning Light* | Auto Hold Indicator | Auto-Stop Indicator (ISG) |
| Electronic Stability Control (ESC) Warning Light | Charging System Warning Light | AWD System Warning Light* |
| Electronic Stability Control (ESC) OFF Light | Cruise Set Indicator | Electric Power Steering (EPS) Warning Indicator |
| Malfunction Indicator Light | Engine Oil Pressure Warning Light | |
| Low Tire Pressure Indicator / Tire Pressure Monitoring System (TPMS) Malfunction Light | Engine Coolant Temperature Warning Light | |
| Liftgate Open Warning Light | Low Fuel Level Warning Light | |
| Seat Belt Warning Light | Exhaust System (GPF) Warning Light (Gasoline Engine)* | |

Your vehicle's instrument cluster & indicator light locations may differ from those in the images. Type B cluster not shown. See your Owner's Manual for more information.

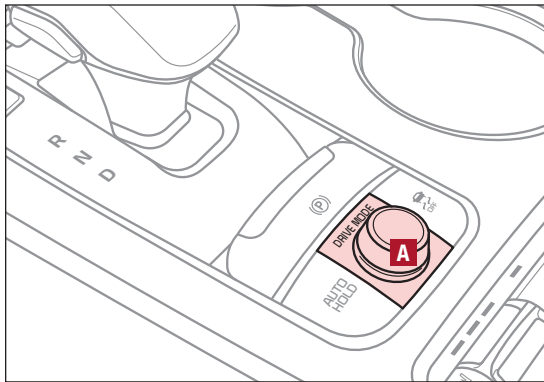

Drive Mode Integrated Control System

SMART, COMFORT, SPORT/CUSTOM* and ECO drive modes may be changed according to the driver's preference or road conditions. To change the drive mode, rotate the DRIVE MODE knob **A**.

COMFORT Mode – The system's default mode is COMFORT mode and is not displayed on the instrument cluster nor the audio system's screen.

ECO Mode – A green ECO indicator will illuminate on the instrument cluster. To deactivate, rotate the DRIVE MODE knob **A** again to change the selection to another setting.

SPORT/CUSTOM Mode – A yellow SPORT/CUSTOM indicator will illuminate on the instrument cluster. To deactivate, rotate the DRIVE MODE knob **A** again to change the selection to another setting.

SMART Mode – When SMART mode is activated, the system automatically selects the drive mode best suited to the current driving style. A SMART indicator will illuminate on the instrument cluster. The color of the SMART indicator (green, white, red) depends on the current driving style. To deactivate, rotate the DRIVE MODE knob **A** again to change the selection to another setting.

DRIVE MODE VIDEO

To view a video on your mobile device, snap this QR Code or visit the listed website. Refer to page 2 for more information.



www.youtube.com/KiaFeatureVideos



Quick Tip

When the Engine Start/Stop button is turned off, the system will default to COMFORT mode and each mode will need to be selected again when the vehicle restarts.

REMINDERS:

When ECO mode is selected, the following may occur to help improve fuel economy:

- Acceleration may be slightly reduced even when the accelerator is fully depressed
- Air conditioner performance may be limited
- Shift pattern of the automatic transmission may change
- Engine noise may increase
- System's power will be limited when driving uphill

When SPORT mode is selected, fuel economy may decrease.

Fuel Economy

Several factors contribute to your vehicle's fuel economy, including maintenance of your vehicle, driving style, environmental conditions, vehicle weight and vehicle aerodynamics. Below are tips on how to help improve fuel economy:

- Keep your vehicle in good condition with regular maintenance
- Don't let the engine idle longer than necessary
- Drive at a moderate speed, accelerating smoothly
- Keep tires inflated to the recommended pressure
- Travel lightly, without carrying unnecessary weight in your vehicle
- Avoid placing large or heavy items on roof racks
- Avoid hilly, winding or poorly maintained roads

FUEL ECONOMY VIDEO

To view a video on your mobile device, snap this QR Code or visit the listed website. Refer to page 2 for more information.



www.youtube.com/KiaFeatureVideos

For more information on Fuel Economy, you can snap the QR Code above to view a video or refer to the Owner's Manual.

Driver Attention Warning (DAW)^{†6}

The DAW system is designed to detect a drowsy or fatigued driver and, in certain situations, can give a warning signal to take a break if needed.

The DAW System is set to OFF by default. To turn the DAW System ON, turn the ignition on and then select User Settings in the LCD Display on the Instrument Cluster. Then go to Driving Assist and select Driver Attention Warning. Set the DAW System to Normal or High Sensitivity.

Driver Attention Warning (DAW) System modes:

Off: The Driver Attention Warning system is deactivated **A**.

Normal Sensitivity: The Driver Attention Warning system alerts the driver if it detects driver fatigue or inattentive driving practices.

High Sensitivity: The Driver Attention Warning system alerts the driver if it detects driver fatigue or inattentive driving practices faster than Normal mode.

If the DAW System is activated, the DAW information will appear on the LCD Display **B** when you select the ASSIST mode .

A message, "Consider taking a break," appears on the LCD display and a warning sounds to suggest the driver to take a break when the driver's attention level is below one bar **C**.

REMINDERS:

- The set-up of the DAW System will be maintained, as selected, when the ignition is cycled
- When activated, the DAW System does not display "Consider taking a break" message when the total trip driving time is less than 10 minutes
- The DAW System will enter a standby mode if the camera does not detect the lanes and/or the driving speed remains under 40 mph

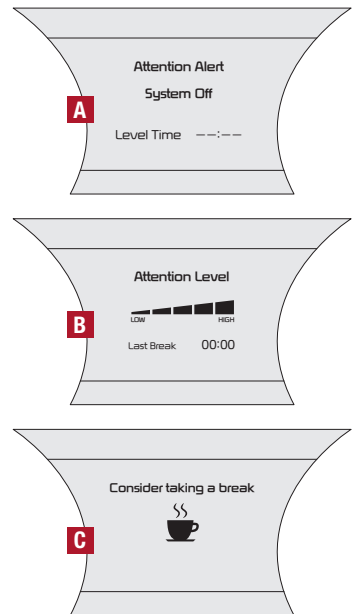

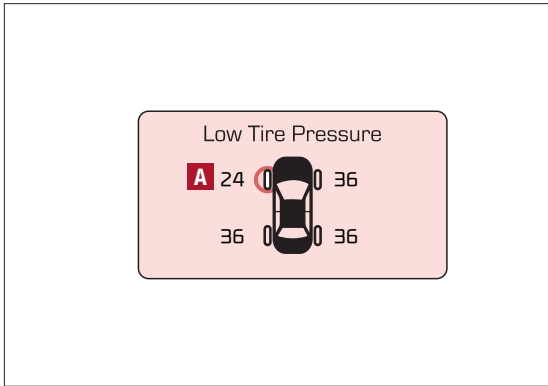

Driver Attention Warning is not a substitute for safe driving and may not detect all instances of driver fatigue or inattentive driving practices. Failure to pay attention to travel conditions and vehicle operation could result in loss of vehicle control. Always drive safely and use caution.



Tire Pressure Monitoring System (TPMS)^{†26}

The TPMS indicator  functions as both Low Tire Pressure Light and TPMS Malfunction Indicator.

The TPMS indicator  is designed to illuminate if it detects one or more tires is significantly underinflated, if a spare tire has been installed that does not have a TPMS device, or when the outside temperature drops considerably.

The LCD screen in the instrument cluster will display the Low Tire Pressure indicator  showing which tire(s) are underinflated.

- Inflate tire(s) to specifications using an accurate digital tire pressure gauge. See front driver's door jamb for PSI specification
- When there is a problem with the TPMS, the TPMS Malfunction Indicator will blink for approximately one minute then illuminate. See dealer for service.

TIRE PRESSURE MONITORING VIDEO

To view a video on your mobile device, snap this QR Code or visit the listed website. Refer to page 2 for more information.



www.youtube.com/KiaFeatureVideos

Quick Tips

- Even with TPMS, tire pressure should be checked manually at least once a month. Only adjust tire pressure on "cold tires"
- For proper maintenance, safety and optimal fuel economy, maintain recommended tire inflation pressure and stay within the load limits and weight distribution recommended for your vehicle
- In winter or cold weather, the TPMS light may illuminate if the tire pressure was adjusted to the recommended tire inflation pressure during warm weather

REMINDERS:

- Check the recommended tire pressure label located on the left side of driver's door jam, visible when the door is open.
- Consult your dealer for service if Low Tire Pressure Light remains illuminated after inflating your tire(s).

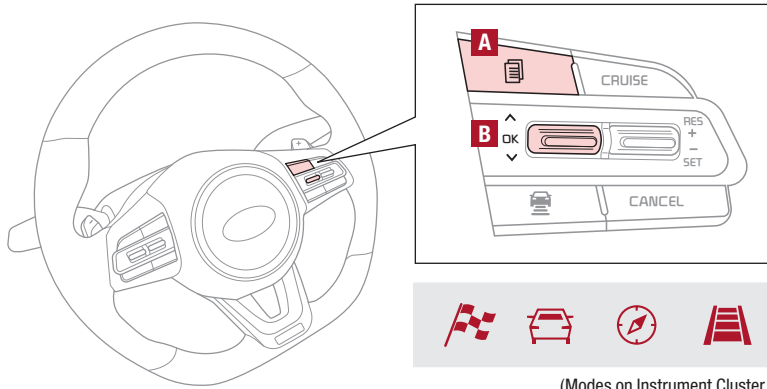







(Modes on Instrument Cluster LCD)

LCD Instrument Cluster Modes*

The LCD Instrument Cluster modes can be changed by using the mode button **A** on the right side of the steering wheel.

Modes (Type B Instrument Cluster):

-  **Sport Mode***: This mode displays Gauge, Lap Timer, G-Force.
-  **Trip Computer Mode**: Displays driving information for tripmeter, fuel economy, etc.
-  **Turn-by-Turn Mode***: Displays the state of the navigation
-  **Smart Cruise Control (SCC) with Stop & Go / Lane Keeping Assist (LKA)***: Displays the state of the SCC and LKA
-  **User Settings Mode**: Change settings of the doors, lamps and other features
-  **Master Warning Mode**: Informs of warning messages related to washer fluid or malfunction of Blind-Spot Collision Warning (BCW), etc.

Your vehicle's steering wheel buttons and LCD modes may differ from those in the illustrations.

Driving while distracted is dangerous and should be avoided. Drivers should remain attentive to driving and always exercise caution when using the steering wheel mounted controls while driving.

Trip Information / Trip Computer

The Trip Computer is a driver information system that displays information related to driving when the Engine Start/Stop button is in the ON position.

To cycle through the LCD Instrument Cluster modes, press the Mode button **A** on the right side of the steering wheel.

When in the Trip Computer mode , press the Select/Reset (OK) button **B** to cycle through the screens. When displaying TRIP A or TRIP B screens, press and hold the **OK** button to reset the Tripmeter to zero.

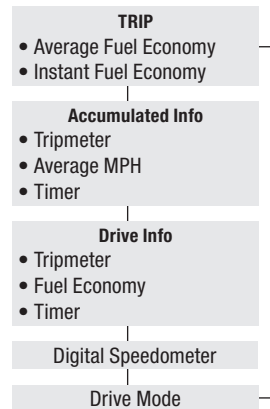

REMINDERS:

- Appearance of Tripmeter display may differ as equipped
- All stored driving information (except Odometer and Range) is reset if the battery is disconnected

User Settings

To enter the User Settings mode in the LCD Instrument Cluster Modes, press the Mode button **A** when the vehicle is at a standstill and with the Engine Start/Stop button in the ON position and select User Settings .

You can navigate the selections on the display by pressing the Select/Reset (OK) button **B** up or down, and then pressing again to enter.

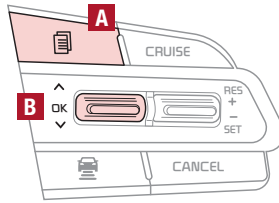

(Button layout on right of steering wheel)

User Settings Modes:

Head-Up Display (HUD)*: Enable HUD, Display Height, Rotation, Brightness, Contents Selection, Speed Size, Speed Color

Driving Assist: Smart Cruise Control with Stop & Go Response, Driver Attention Warning, Lane Keeping Assist*, Forward Collision-Avoidance Assist, Forward Collision Warning (FCW), Blind-Spot Collision Warning* Rear Cross-Traffic Collision Warning, Blind-Spot Collision Warning* Sound

Door/Liftgate: Automatic Lock, Automatic Unlock, Two-press Unlock, Ambient Light Brightness, Ambient Light Color,

Lights: One-Touch Turn Signal, Headlamp Delay

Sound: Parking Distance Warning-Reverse*, Welcome Sound*

Convenience: Seat Easy Access*, Steering Easy Access*, Welcome Mirror/Light*, Wiper/Light Display*, Gear Position Pop-Up*, Icy Road Warning*

Service Interval: Service Interval On/Off, Adjust Service Interval, Reset

Other Features: Fuel Economy Auto Reset, Fuel Economy Unit, Temperature Unit, Tire Pressure Unit, Torque Unit*

Language: Choose the language

Reset: Reset User Settings to factory default

To view videos on your mobile device, snap these QR Codes or visit the listed website. Refer to page 2 for more information.

LCD DISPLAY VIDEO



LCD DISPLAY: MAINTENANCE VIDEO



www.youtube.com/KiaFeatureVideos

Service Mode

When Service Mode is activated, set and vehicle service is required, the following message will be displayed on the LCD, **Service Required**, and display the remaining days/miles till service is due.

Service Mode ON and Interval Setting

To activate Service Mode and set the interval, press the Mode button **A**, scroll to User Settings  and press Select/Reset (OK) button **B** to enter. Then press the **OK** button **B** up/down to scroll to Service Mode and again to enter. Press **OK** button **B** up/down to select the option to set the interval. Adjust interval and press **OK** button **B** to save. To reset the Service Mode system, press and hold the **OK** button **B** for more than 1 second.

Service Mode Off

To turn Service Required OFF, go to User Settings and scroll to Service Mode, press **OK** button **B** to enter. Select option to deactivate and press **OK** button **B** to save.

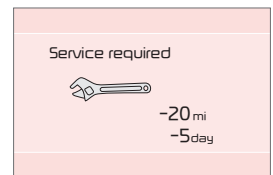

Forward Collision-Avoidance Assist-Pedestrian (FCA-Ped)*†9 / Forward Collision Warning (FCW)*†9

The FCA-Ped is designed to help alert the driver, and under certain conditions if necessary, apply emergency braking, when rapidly approaching a vehicle that is slowing down, braking or stopped. Initially, the FCA-Ped provides Forward Collision Warning (FCW) when it detects a potential collision with a vehicle in front emitting an audible warning and visual alert on the instrument cluster **A**. Adjust the alert settings (Early, Normal, Late) in the User Settings. To turn the FCA-Ped/FCW off, go to User Settings again and turn off.

If the collision risk increases, the Forward Collision-Avoidance Assist-Pedestrian (FCA-Ped) automatically applies the brakes to reduce your speed, helping to minimize the effects of a possible collision. FCA-Ped can be turned ON in the User Settings menu on the Instrument Cluster display.

The FCA-Ped/FCW will become active when the:

- Engine Start/Stop button is ON
- Vehicle is traveling more than 5 mph
- Electronic Stability Control (ESC) is ON.

LED Warning Messages:

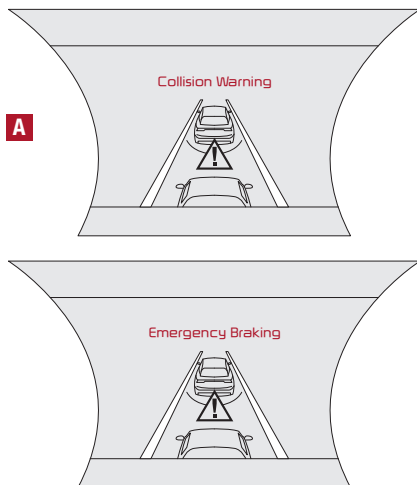

REMINDERS:

- The FCA-Ped/FCW will be activated by default when the ignition is cycled ON, even when previous setting was OFF
- The FCA-Ped/FCW will not operate when the vehicle is traveling more than approximately 45/50 mph, respectively
- If the FCA-Ped is operating and the ESC (Electronic Stability Control) is turned off **B**, the FCA-Ped system is automatically turned off.
- When FCA-Ped system is off, the FCA-Ped warning indicator is on in the Instrument Cluster .

The Forward Collision-Avoidance Assist-Pedestrian (FCA-Ped) / Forward Collision Warning (FCW) are not substitutes for safe and proper driving. Always drive safely and use Caution.

FCA-Ped and FCW may not always alert the driver when the vehicle is approaching another vehicle.

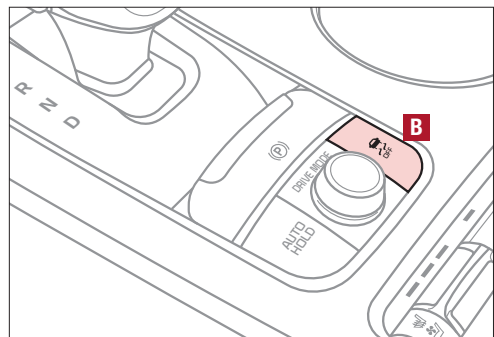

(Button is located in center console)

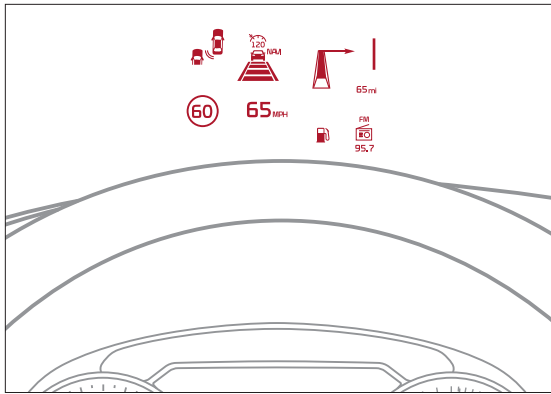

Head-Up Display (HUD)*† 12

The Head-Up Display (HUD) is a transparent display that projects a snippet of information from the instrument cluster and navigation system* onto the windshield glass.

To turn HUD ON or OFF, go to User Settings in the LCD Modes.

The HUD displays:

- Turn By Turn (TBT) navigation information
- Road signs
- Speedometer
- Cruise setting speed
- AV mode information
- Smart Cruise Control (SCC) information*
- Blind-Spot Collision Warning (BCW) system information*
- Warning lights (low fuel)

Head-Up Display (HUD) User Settings

Drivers can adjust the HUD settings from the LCD Instrument Cluster modes in User Settings. HUD settings include:

- Display Height: Adjust the height of the HUD image on the windshield glass
- Rotation: Adjust the degree of HUD rotation
- Brightness: Adjust the intensity of the HUD brightness
- Contents Select: Activate or deactivate HUD content (TBT**, SCC, LDW, BSCW)
- Speedometer Size: Choose the size of the HUD speedometer (Small, Medium, Large)
- Speedometer Color: Choose the color of the HUD speedometer (White, Amber, Green)

REMINDERS:

- The HUD image on the windshield glass may not be visible when:
 - The driver has poor sitting posture
 - The driver is wearing polarized sunglasses
 - There is an object covering the HUD
 - Driving on a wet road
 - Excessive lighting inside or outside the vehicle
 - Modifications made to the windshield, such as tinting or other aftermarket treatments, could affect the HUD. When replacing the front windshield glass of vehicles equipped with the HUD, owners must replace it with windshield glass designed for HUD operation. Otherwise, duplicated images may be displayed on the windshield glass.
 - If Turn By Turn (TBT) navigation information is selected as HUD content, TBT information will not be displayed on the LCD.

The head up display is a supplemental system. Do not solely rely on the system, always drive safely, and pay attention to the driving conditions on the road.

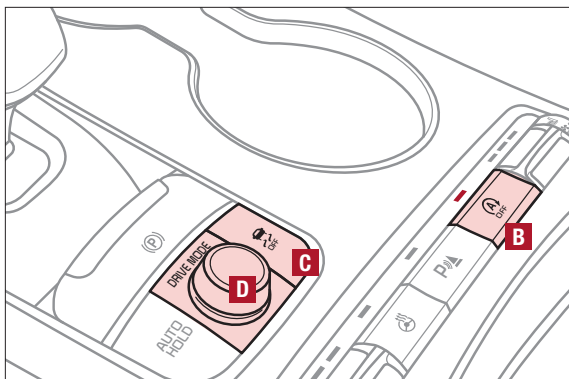
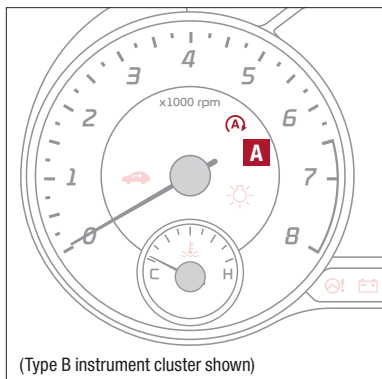

Idle, Stop and Go (ISG) System

The ISG system is designed to reduce fuel consumption by automatically shutting down the engine when the vehicle is at a standstill.

When the ISG system is ON and the vehicle is at a standstill the engine will stop, and the green AUTO STOP indicator (A) on the instrument cluster will illuminate.

The engine will restart when the brake pedal is released or the shift lever is moved from D (Drive) to the R (Reverse) position or to Sport Shift mode*. When engine restarts, the green AUTO STOP indicator on the instrument cluster will turn off.

To deactivate the ISG System, press the ISG OFF button (B). If you press again, the system will be activated.

For more information on Idle, Stop and Go System, refer to your Owner's Manual or contact your local dealership.

Launch Control

Launch control aids in controlling acceleration to help the vehicle accelerate smoothly and fast, while avoiding slipping of the drive wheels and other engine, clutch and gearbox issues.

To turn on, press and hold the ESC OFF button (C) for more than three seconds while DRIVE MODE (D) is in SPORT Mode.

To activate, with the left foot press brake firmly while gear shift is in D (Drive) and then press the accelerator pedal fully to the floor. The LCD will display a ready status.

REMINDERS:

- When launching, stop vehicle and keep steering wheel straight
- Brake pedal, EPB and Auto Hold must be released for smooth launching

IDLE, STOP AND GO VIDEO

To view videos on your mobile device, snap these QR Codes or visit the listed website. Refer to page 2 for more information.



LAUNCH CONTROL VIDEO



www.youtube.com/KiaFeatureVideos

Quick Tips

- The ISG system is disabled when:
 - A seat belt is unfastened
 - The hood or a door is opened
 - Battery condition is poor
 - The front or rear defroster is turned on
 - Engine coolant temperature is low
 - The outside ambient temperature is too low/high
 - Emission control devices activate
 - The vehicle is on a steep slope

REMINDERS:

- ISG is active by default at vehicle start-up. When ignition is cycled, ISG will turn ON again
- Under certain conditions, the engine will restart automatically
- If the AUTO STOP indicator (A) is continuously blinking yellow and the ISG button LED is on, please contact an authorized Kia dealer

See Owner's Manual for more detailed operating instructions and information.

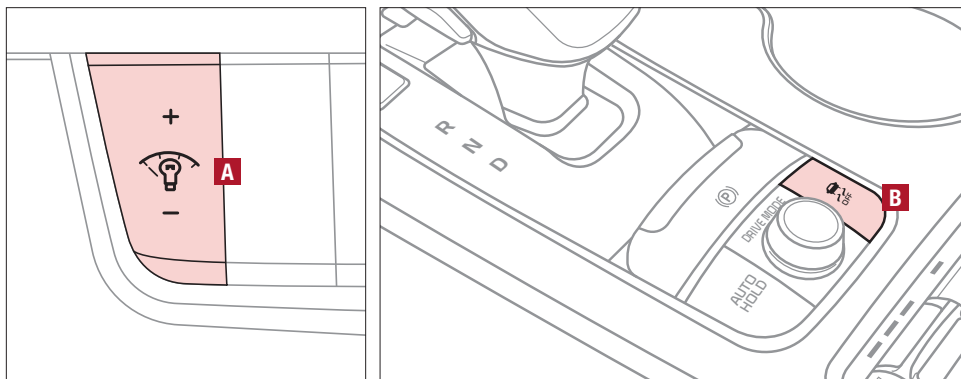

Instrument Cluster Control (Instrument Panel Dimmer)

With parking lights/headlights ON, press **A** (+) or (-) to adjust the brightness of the Instrument panel illumination.

REMINDER: The Instrument Cluster Control (Instrument Panel Dimmer) does not adjust brightness on the navigation system screen. Use navigation setup to adjust brightness on the navigation system.

Electronic Stability Control (ESC)^{†7} / Traction Control System (TCS)^{†7}

Electronic Stability Control (ESC) is designed to help stabilize the vehicle during certain cornering maneuvers. Traction Control System (TCS) can help improve traction. It is a good idea to keep both ESC and TCS turned on for daily driving whenever possible.

Press the ESC button **B** to turn Traction Control System OFF/ON.

To turn both Electronic Stability Control and Traction Control System OFF, press and hold the ESC button for more than 3 seconds. Press again to turn ON.

REMINDEERS:

- ESC is active by default at vehicle start-up. When ignition is cycled, ESC will turn ON again
- The ESC indicator light in the instrument cluster will be lit momentarily whenever ESC is active

ELECTRONIC STABILITY CONTROL VIDEO

To view a video on your mobile device, snap this QR Code or visit the listed website. Refer to page 2 for more information.



www.youtube.com/KiaFeatureVideos

For more information on Electronic Stability Control (ESC) and its specific features and operations, please refer to your Owner's Manual.

Hill-start Assist Control (HAC)^{†7}

Hill-start Assist Control (HAC) is designed to prevent the vehicle from rolling backwards when accelerating from a stop while on a steep incline.

HAC automatically activates whether ESC is OFF or ON but does NOT activate when ESC has malfunctioned.

REMINDER: HAC does not operate when the gear shift is in P (Park) or N (Neutral) position.

Quick Tip

When HAC is active (e.g., during initial acceleration from a stop on an incline), you may notice that the brakes will momentarily remain engaged after you depress the accelerator. HAC does not replace the need to apply brakes while stopped on an incline.

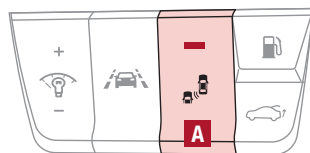
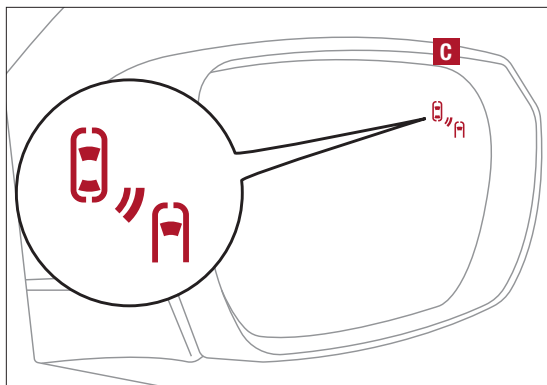

(Button located on driver's panel, left of the steering wheel)

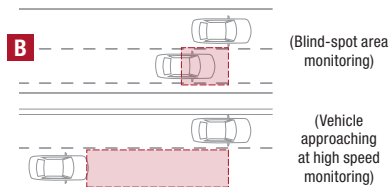

Blind-Spot Collision Warning (BCW)^{†6}

The Blind-Spot Collision Warning (BCW) system uses radar sensors in the rear bumper to monitor and warn the driver if it detects an approaching vehicle in the driver's blind spot area.

The system will activate when the vehicle is traveling more than 20 mph and will alert the driver if another vehicle is detected by the radar sensor.

BCW

With the Engine Start/Stop button in the ON position, press the BCW button **A** to turn the system ON. The button light will illuminate. The outside rearview mirror warning lights will also illuminate for 3 seconds.

1st-stage alert: When another vehicle is detected within the BCW system warning boundary **B**, a yellow indicator will illuminate on the outside rearview mirrors **C**.

2nd-stage alert: When 1st stage alert is on and the driver activates a turn signal, a flashing yellow indicator will illuminate on the outside rearview mirrors and the system will sound an alert.

Rear Cross-Traffic Collision Warning (RCCW)^{†6}

If the Rear Cross-Traffic Collision Warning (RCCW) system sensors detect vehicles approaching from the left or right side **D**, the system will sound an audible alert, the warning indicators on the outside rearview mirror will illuminate and a message will appear on the LCD screen, under these conditions:

- When the vehicle is in Reverse
- When the vehicle moves backwards from a parked position
- When the vehicle is moving less than 6 mph

BLIND-SPOT COLLISION WARNING VIDEO

To view a video on your mobile device, snap this QR Code or visit the listed website. Refer to page 2 for more information.



www.youtube.com/KiaFeatureVideos

Quick Tip

- The BCW system will activate when:
 - The system is turned on
 - Vehicle speed is above approximately 20 mph
 - Other vehicles are detected on the rear sides of the vehicle

REMINDERS:

- The BCW system will not issue a warning if the vehicle speed is 6 mph or more above the surrounding vehicles
- When the BCW is ON and the ignition is cycled, the BCW system returns to its previous state
- The BCW and RCCW systems are supplemental systems. Do not solely rely on these systems and always pay attention to drive safely.

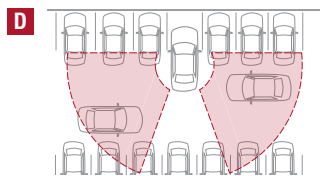

REMINER: The RCCW feature can be turned OFF/ON in User Settings. When vehicle power is cycled, the RCCW will remain in the previous state

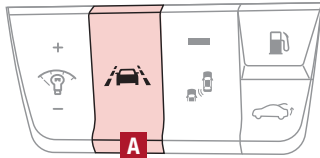

(Button located on driver's panel, left of the steering wheel)

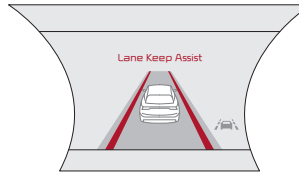

When the front camera detects the lane traveling in, both lanes are illuminated

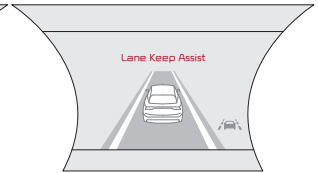

When the front camera does not detect the lane traveling in the lanes are not illuminated

When the front camera detects the vehicle moving outside of the lane traveling in, a vehicle crossing lane indicator will blink, either on the left or right lane (as shown in both images to the right)

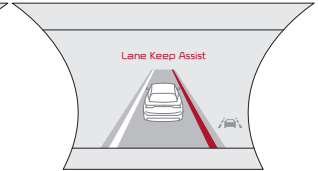
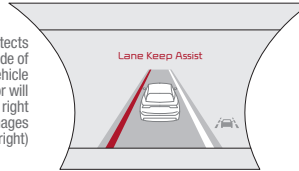

Lane Keeping Assist (LKA)^{†6} / Lane Departure Warning (LDW)^{*†6}

With the Engine Start/Stop button* in the ON position, press the LKA/LDW button **A** to turn system ON. The instrument cluster indicator  will initially illuminate white. It will remain white when the vehicle is traveling less than 40 mph and the system does not detect the lane markers. When the system detects the lane markers and can assist the steering, the LKA icon will illuminate green.

If the LKA detects that you are moving outside of your lane, the system may give an audible warning and display a LDW (Lane Departure Warning) alert on the instrument cluster. If the vehicle continues to move outside of the lane, the LKA will apply a slight adjustment to the steering, trying to prevent the vehicle from moving outside its lane.

Standard LKA is the operating mode by default when the LKA button is depressed to ON. To switch between modes (Standard LKA, Active LKA and Lane Departure), go to User Settings in the Instrument Cluster.

All systems will operate under the following conditions:

- The vehicle exceeds approximately 37 mph
- The LKA system recognizes both sides of the lane markers the vehicle is traveling in
- The vehicle is between the lane markers

LANE DEPARTURE WARNING VIDEO

To view a video on your mobile device, snap this QR Code or visit the listed website. Refer to page 2 for more information.



www.youtube.com/KiaFeatureVideos

REMINDERS:

- The LKA/LDW will not issue a warning if the turn signal or hazard signal is activated
- LKA/LDW will return to its previous state when the ignition is cycled
- The LKA/LDW are not substitutes for safe and proper driving. Always drive safely and use caution.
- LKA/LDW may not always alert the driver if the vehicle is about to be driven outside of its lane. Refer to the Owner's Manual for more information.

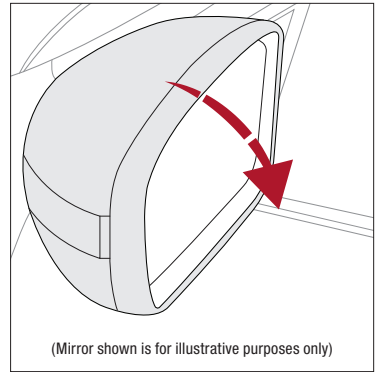
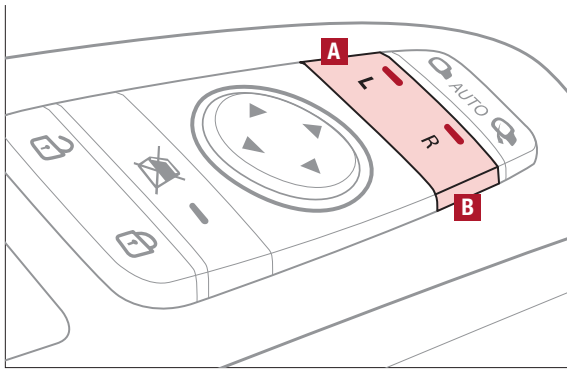

Reverse Parking Aid Function

When the gear shift lever is moved into R (Reverse) and the vehicle is moving backwards, the outside rearview mirrors will rotate downward to aid in reverse parking.

To turn the Reverse Parking Aid Function ON, press the L (Left) **A** or R (Right) **B** outside rearview mirror button (LED lit).

To turn OFF, press button(s) again.

The outside rearview mirrors will automatically return to their original positions when:

- The Engine Start/Stop button is in the OFF position
- The gear shift lever is moved out of R (Reverse)
- The outside rearview mirror switches are OFF (LED not lit)

REMINDER: When the buttons are not pressed, the Reverse Parking Aid Function will not operate and the outside rearview mirrors will not rotate downward.

Fuel Door Release Button

Press the Fuel Door Release button **C** to open the fuel door.

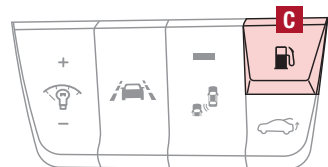

(Button located on driver's panel, left of the steering wheel)

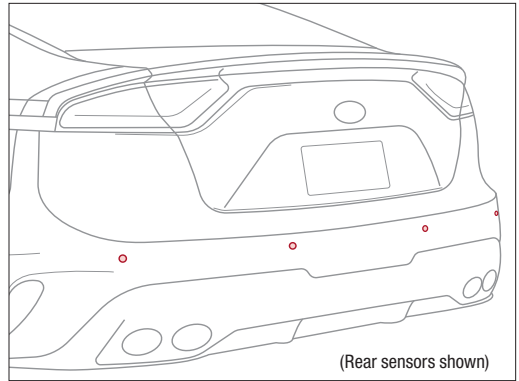
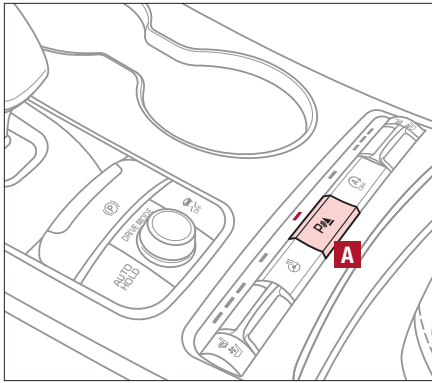

Parking Distance Warning-Reverse^{†6}

The Parking Distance Warning-Reverse **A** is a supplemental system that is designed to assist the driver by chiming if an object is detected within the sensing areas in the front or rear of the vehicle when parking or backing up.

When the Engine Start/Stop button is ON and the shift lever is in R (Reverse), the system is activated and the Parking Distance Warning-Reverse button indicator is illuminated.

REMINDERS:

- If the vehicle is moving at speeds over 6 mph, the system may not activate
- When more than two objects are sensed at the same time, the closest one will be recognized first
- The Parking Distance Warning-Reverse is not a substitute for proper and safe backing-up procedures. Always drive safely and use caution when backing up. The Parking Assist System may not detect every object behind or in front of the vehicle

Rear View Monitor^{*†6}

The Rear View Monitor system is not a safety device. It is a supplemental system that displays the view behind the vehicle through the Navigation screen^{*} while the vehicle is in Reverse.

The Rear View Monitor activates when the:

- Engine Start/Stop button is in the ON position
- Gear Shift Lever is in the R (Reverse) position

REMINDERS:

- The Rear View Monitor is not a substitute for proper and safe backing-up procedures.
- The Rear View Monitor may not display every object behind the vehicle.
- Always drive carefully and use caution when backing up.

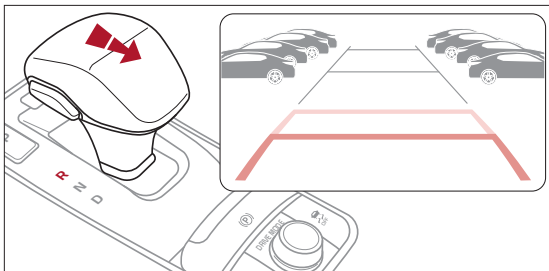

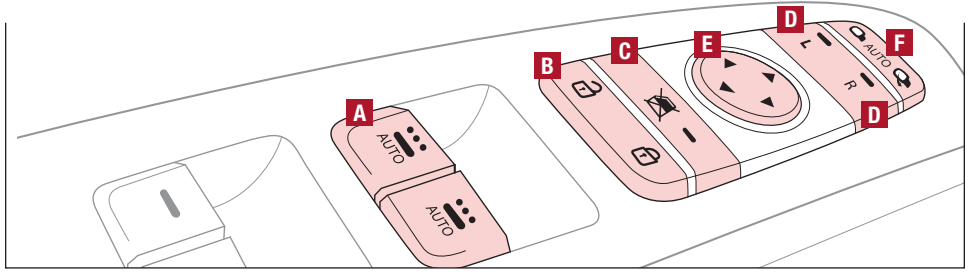

Power Windows, Window Lock & Central Door Lock

- A** Pull/Press to operate driver and front passenger's window auto up/down
- B** Press to unlock/lock all doors
- C** Press to disable the rear passenger window controls

Quick Tips

- Press button **A** again to stop Auto Up/Down function
- Auto Door Lock/Unlock* will engage when gear shift is moved in to or out of the P (Park) position
- To turn Auto Door Lock/Unlock* OFF, go to User Settings* in the LCD Instrument Cluster Modes

REMINDER: When pressed **C**, the rear window controls for the Rear Passenger Windows are disabled

Button configuration may vary depending on vehicle model

Power Folding Outside Mirrors

- D** Press the L or R buttons to select the mirror to adjust
- E** Press button arrows left/right or up/down to adjust mirror position
- F** Toggle button left/right to unfold/fold the outside rearview mirrors
- F** Toggle button to center to automatically fold/unfold mirrors when:
 - Smart Key lock/unlock buttons are pressed
 - Outside door handle button is pressed
 - Driver approaches the vehicle with the Smart Key (if activated in User Settings)

Quick Tip

The mirrors will automatically unfold when the Smart Key* is within close proximity to the vehicle (if activated in User Settings).

REMINDEES:

- When the mirror toggle button is in the center, press the lock button twice on the Smart Key to automatically fold mirrors when exiting vehicle
- To lock the mirror position, toggle button to the neutral (center) position

Heated Outside Mirrors

Mirror heaters automatically turn ON/OFF at the same time the Rear Window Defroster is turned ON/OFF. Rear Window Defroster button* is located on climate control system panel.

Auto Door Lock/Unlock

Auto Door Lock/Unlock will engage when gear shift is moved in to or out of the P (Park) position. Refer to the User Settings on how to turn Auto Door Lock/Unlock ON/OFF.

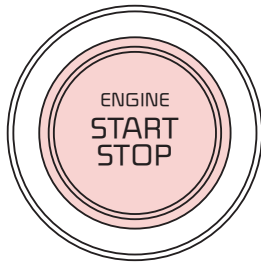

Engine Start/Stop Button†⁸

To start the engine:

1. Depress the brake pedal
2. Press the ENGINE START/STOP button while gear shift is in P (Park)

To turn the engine OFF, press the ENGINE START/STOP button while the gear shift is in P (Park).

To use the ENGINE START/STOP button, you must have the Smart Key on your person or inside the vehicle.

REMINDERS:

- If Smart Key fob battery is dead, you can still start the engine by pressing the ENGINE START/STOP button with the Lock-button end of the Smart Key. The Smart Key must contact the ENGINE START/STOP button directly, at a right angle
- In an emergency situation while the vehicle is in motion, you are able to turn the engine off and to the ACC position by pressing the ENGINE START/STOP button for more than 2 seconds or 3 times successively within 3 seconds

ENGINE START/STOP BUTTON AND SMART KEY VIDEO

To view a video on your mobile device, snap this QR Code or visit the listed website. Refer to page 2 for more information.



www.youtube.com/KiaFeatureVideos

Quick Tips

- To use electrical accessories:
 - ACC position
 - When in the OFF position and without depressing the brake pedal, press the ENGINE START/STOP button once.
 - ON position
 - When already in the ACC position and without depressing the brake pedal, press the ENGINE START/STOP button again.
 - When in the OFF position and without depressing the brake pedal, press the ENGINE START/STOP button twice.
- Keeping the vehicle in ACC or ON position too long can discharge the vehicle's battery.

Tilt/Telescoping Steering Wheel†25

To adjust the Steering Wheel, push the lock-release lever **A** down and adjust the desired angle **B** and distance **C**.

When finished, pull the lock-release lever **A** up to lock Steering Wheel in place.

Quick Tip

It may be helpful to pull/push the bottom of the Steering Wheel towards/away from you to adjust to the desired distance

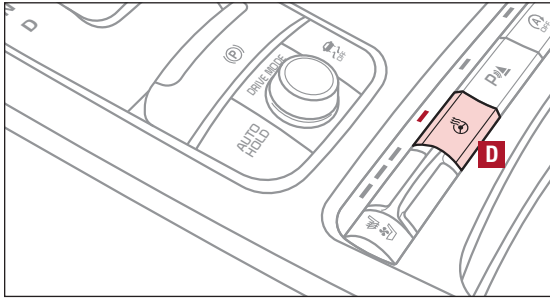
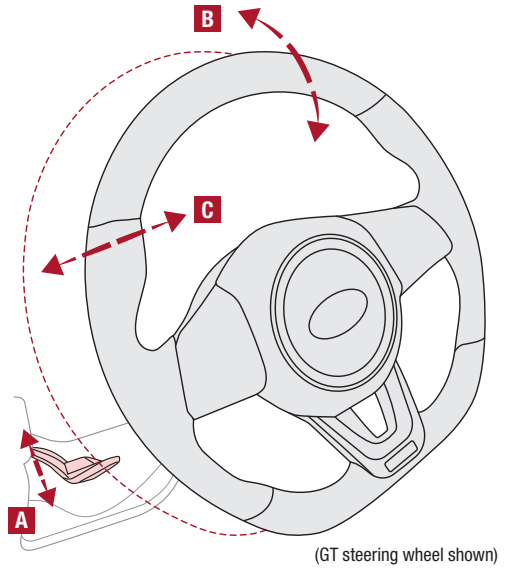

Heated Steering Wheel

While the Engine Start/Stop button is in the ON position, press **D** to turn the steering wheel heater ON. The button indicator will illuminate.

The steering wheel heater will turn off automatically in 30 minutes, or when the button is pressed again to deactivate.

REMINDER: If the steering wheel becomes too warm, turn the system off. The heated steering wheel may cause burns even at low temperatures, especially if used for long periods of time.

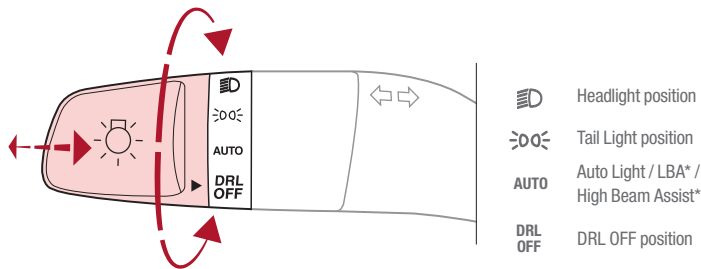

Headlights & High Beams

AUTO Light – When the light switch is in the AUTO Light position, the tail lights and headlights will turn ON/OFF automatically depending on the amount of light outside the vehicle.

Low Beam Assist-Dynamic (LBA) / Dynamic Bending Light (DBL)* – LBA can help improve visibility during nighttime driving by aiming the low-beam headlights toward the direction the vehicle is moving. LBA controls the aiming direction based on steering angle and speed.

When the light switch is in the AUTO light position, LBA will activate.

REMINDER: When the LBA indicator illuminates on the instrument cluster, the LBA is not working properly. See authorized Kia dealer for service.

Daytime Running Lights (DRL) – DRL can make it easier for others to see the front of your vehicle during the day. The lights will be on automatically unless one of the following occurs:

- Headlights are on
- Parking brake is applied
- Switch is in the DRL OFF position
- Engine is turned off

Headlight / High Beam Lever Operation

- Rotate lever switch to change the headlight function:

- ☰ Headlight position
- ☰ Tail Light position
- AUTO Auto Light* / LBA position
- DRL/OFF OFF or DRL OFF position

- Press lever away from you to turn high beam headlights ON
- Pull lever to flash headlights/high beams

High Beam Assist (HBA)* – High Beam Assist is designed to automatically adjust the headlight range by switching between high and low beams based on light from other vehicles and road conditions.

To enable HBA, toggle the light switch to the AUTO Light position and turn on the high beams by pushing the lever away from you. The High Beam Assist indicator will illuminate.

REMINDEERS:

- HBA will operate when vehicle speed exceeds 25 mph
- If the lever is pushed away from you while HBA is operational, HBA will turn off and the high beams will be on continuously. If the lever is pulled toward you while HBA is operational, HBA will turn off
- If the light switch is switched to the headlight position, HBA will turn off low beams will be on continuously

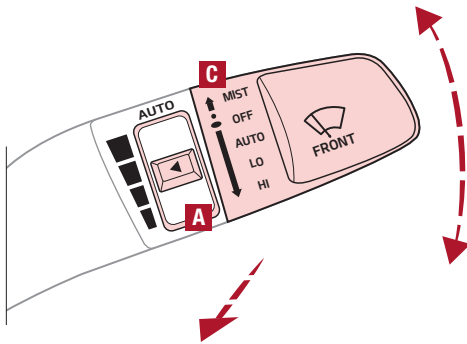

- MIST:** Single wipe
- OFF:** Wiper off
- AUTO:** Auto Rain Sensing
- LO:** Slow wipe
- HI:** Fast wipe

Turn Signals

To operate:

- Move lever up/down for right/left turn signal
- Slightly move lever up/down to activate one-touch lane change signal

REMINDERS:

- One-touch lane change signal is activated by moving the turn signal lever slightly for less than 1 second and then releasing. The lane change signal will blink 3 times
- To change how many times the lane change signal blinks (3/5/7), go to User Settings in the LCD instrument cluster modes

For more information on the User Settings Mode, please refer to your Owner's Manual.

Windshield Wipers & Washers

To operate:

- Move lever up/down to change wiper modes
 - MIST:** Single wipe
 - LO:** Slow wipe
 - OFF:** Wiper off
 - HI:** Fast wipe
 - AUTO:** Auto Rain Sensing
- Pull to spray and wipe

Auto Rain Sensing*

The rain sensor located on the upper end of the windshield glass is designed to sense the amount of rainfall and control the wiping cycle for the proper interval. The more it rains, the faster the wiper operates. When the rain stops, the wiper stops.

To turn ON the auto rain sensing wipers, move lever up/down to AUTO.

To adjust the auto rain sensing wiper speed setting, move the speed control switch **A** up/down.

Quick Tips

- When the Engine Start/Stop button is in the ON position and the wiper switch is in AUTO mode, the wiper will automatically operate once to perform a self-check of the system
- Set the wiper to the OFF position when the wiper is not in use
- If going through a car wash, remind the attendant to keep the vehicle in Neutral (N) and keep the engine running. Also, disable the Smart Power Liftgate* lid control, turn off the auto rain sensing wipers and fold in the mirrors
- Moving lever to HI increases Intermittent wipe frequency and wipe speed. Moving lever to LO decreases frequency of wipes.
- Pressing button **A** up increases Intermittent wipe frequency and wipe speed. Pressing button down decreases frequency of wipes.

Wiper Service Mode

To inspect or replace the windshield wiper blades without damaging the hood, move the blades to the service position **B**. After turning the ignition OFF, within 20 seconds, move the wiper switch to the MIST position **C** and hold the switch for more than two seconds until the wiper blade is in the fully up position.

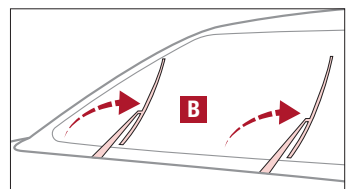

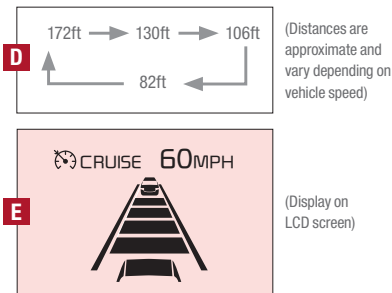
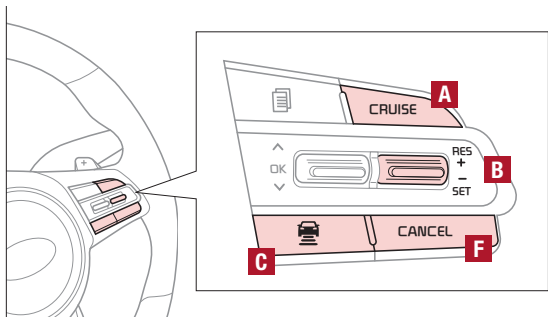

Smart Cruise Control (SCC) with Stop & Go*†6

The Smart Cruise Control (SCC) with Stop and Go system is designed to maintain a predetermined distance from vehicles detected ahead by automatically adjusting the driving speed as needed.

To set/adjust the SCC speed:

- Press the CRUISE button **A** to turn the system ON. The CRUISE indicator will illuminate on the instrument cluster
- Accelerate/decelerate to the desired speed
- Press the SET - button **B** to set the speed. Press the RES+/-/SET- button **B** up/down to increase/decrease the set speed

To set the vehicle-to-vehicle distance:

- Press the SCC button **C** on the steering wheel.
- Each time you press **C** the vehicle-to-vehicle distance will change **D**, indicated by the number of bars that appear on the display **E**

To cancel SCC operation: Press the CANCEL button **F** or press the brake pedal. The LCD screen will display a message that the SCC operation is cancelled.

To turn SCC system OFF: Press the CRUISE button **A**. The CRUISE indicator on the instrument cluster will turn OFF.

REMINDERS:

- CRUISE indicator must be ON in order to operate SCC
- The cruise control system will not activate until the brake pedal has been depressed at least once after the ignition is ON or engine starting
- For the SCC System to operate, you must be traveling at a minimum speed of 20 mph, when no vehicle is in front.
- The SCC system remains ON when ignition is cycled. The speed setting will need to be reset when ignition is cycled
- The distance settings are approximations and may vary depending on vehicle speed. See the owner's manual for more information.

SMART CRUISE CONTROL WITH STOP & GO VIDEO

To view a video on your mobile device, snap this QR Code or visit the listed website. Refer to page 2 for more information.



www.youtube.com/KiaFeatureVideos

Quick Tips

- The speed setting for the SCC can be adjusted under the following conditions:
 - With no vehicle in front, you must be travelling at a minimum speed of 20 mph
 - When following a vehicle, there is no minimum speed requirement
- When following a vehicle, the system can automatically adjust your cruise speed based on the vehicle detected in front. It will even bring the vehicle to a complete stop if necessary. If the vehicle remains at a standstill for more than 3 seconds, you must depress the accelerator pedal or press the RES+/-/SET- button up/down to start the vehicle.
- To change the cruise control mode from SCC to standard cruise control, press and hold button **C**. Repeat to switch back to SCC mode. (The SCC system must not be activated to change modes).

- The SCC is also canceled when the driver's door is opened, gear shift is changed out of D (Drive), EPB is activated and various other conditions. See owner's manual for other conditions.
- If the SCC system is left on, it can be activated inadvertently. Keep the system off when not in use to avoid setting a speed which the driver is not aware of.
- The SCC system is a supplemental system and is not a substitute for safe driving. It is the responsibility of the driver to always check the speed and distance to the vehicle ahead.

Smart Cruise Control (SCC) with Stop & Go* (Continued)

Standard Cruise Control

- A Cruise Control ON/OFF button:** Press up to turn the cruise control ON/OFF
- B Resume Cruising Speed button:** Press up to resume or increase cruising speed
- B Set Cruising Speed button:** Press down to set or decrease cruising speed
- D Cruise Control Cancel button:** To cancel cruise control setting, do one of the following:
 - Press the brake pedal
 - Press the CANCEL button

Quick Tips

- The standard cruise control system is designed to function above approximately 20 mph only
- The Cruise Control system will not activate until the brake pedal has been depressed at least once after ignition ON or engine start

Your vehicle's steering wheel buttons may differ from those in the illustrations. See your Owner's Manual for more details.

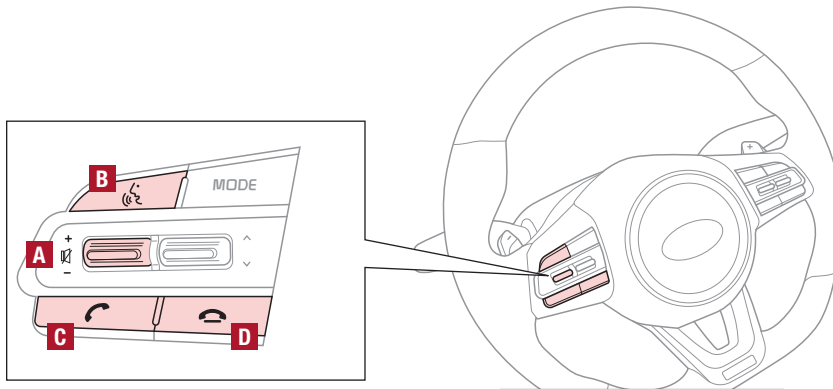

Bluetooth® Wireless Technology†5,23

- A Volume button:** Press up/down to raise/lower speaker volume
Mute button: Press to mute the microphone during a call
- B Talk button:** Press to activate Voice Recognition
- C Receive/Place Call button:** Press to place/receive/answer incoming calls. Press to pair a phone (If no phone is paired; UVO with Premium Navigation only)
- D End Call button:** Press down to end a call or cancel a function

Quick Tips

- When using the voice command feature, wait for the system BEEP before speaking the command
- Phonebook transfer upload time varies by phone model and with number of phonebook entries
- Because of differences in phone quality, service providers and Bluetooth® wireless technology chip programming, functionality may differ from one phone to another

Your vehicle's steering wheel buttons may differ from those in the image. See your Owner's Manual for more details.

Driving while distracted is dangerous and should be avoided. Drivers should remain attentive to driving and always exercise caution when using the steering wheel mounted controls while driving.

For more information, refer to the Car Multimedia System User's Manual. For Bluetooth® wireless technology FAQs, go to www.kia.com, Owners section.

Bluetooth® Wireless Technology (Continued)

Pairing a Phone

For instructions on how to pair a phone, refer to the audio system's user's guide.

How to Place a Call

There are two options for placing a call:

- Option 1: Press the Receive/Place Call button **C** to place a call using the touchscreen
- Option 2: Press on the Talk button **B**. Then say the command "Call {name}" or "Dial {number}"

When using the voice command feature, wait for the system BEEP before speaking the command.

Voice Recognition and Phone Contact Tips

To help optimize the Bluetooth® Wireless Technology Voice Recognition system, below are some tips and reminders. Improve the performance by making a few simple changes to your phone contacts.

The system may have difficulty understanding some accents or uncommon names. Below are other tips to optimize using the voice recognition:

- Use full names (first and last names) vs. short or single-syllable names ("John Smith" vs. "Dad," "Smith Residence" vs. "Home")
- Avoid using special characters, emojis or hyphenated names (@, &, #, /, -, *, +, etc.)
- Avoid using acronyms ("In Case of Emergency" vs. "ICE") or words with all capital letters
- Spell words completely, no abbreviations ("Doctor Smith" vs. "Dr. Smith")

VOICE RECOGNITION TIPS VIDEO

To view a video on your mobile device, snap this QR Code or visit the listed website. Refer to page 2 for more information.



www.youtube.com/KiaFeatureVideos

Quick Tips

- During the pairing process, be sure to accept the connection requests on the phone for phonebook download and to allow acceptance of all future Bluetooth® connection requests
- When placing a call, speak in a natural, moderate tone, with clear pronunciation. The system may have trouble recognizing commands if you speak too soft or too loud
- Always wait for the beep before speaking any commands
- Close windows and sunroof and turn off A/C; open windows, sunroof, weather (wind/rain), or an A/C fan operating at higher speeds can interfere with Voice Recognition
- Press the talk button and say "Help" to get a list of available commands

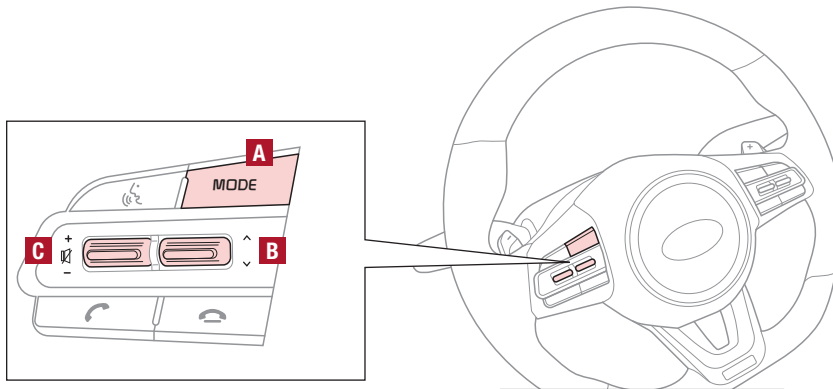

Audio Controls†‡

- A Audio System MODE button:** Press to cycle through FM/AM/SiriusXM®†‡/USB Music/Aux/iPod®/Bluetooth® Audio
 - B Seek/Presets buttons:**
 - FM/AM/SiriusXM® Mode: Press to advance through preset stations. Press and hold to auto seek
 - Media Modes: Press to move track up/down. Press and hold to fast forward/rewind
 - C Volume buttons:** Press up/down arrows to raise/lower volume
- Mute button:** Press to mute all audio (Media pauses in some Media modes when pressed)

Quick Tips

- Pressing the Audio System Mode button for more than 1 second will turn Audio Mode ON/OFF
- Surround Sound can be turned on or off

REMINDERS:

- Your vehicle's steering wheel buttons may differ from those in the images. See your Owner's Manual for more details
- Driving while distracted is dangerous and should be avoided. Drivers should remain attentive to driving and always exercise caution when using the steering-wheel-mounted controls while driving
- To help minimize driver distraction, some audio system functionalities have been modified while the vehicle is in Drive, Reverse or moved out of Park.

UVO eServices Activation^{†1}

Using a compatible smartphone to access your app store or marketplace, download the Kia UVO app.

1. In your smartphone's settings, ensure that location services are enabled.
2. Using the Kia UVO app, register for a new MyUVO.com account.
3. Follow the In Car Setup Instructions on the Kia UVO app to complete the UVO eServices Activation.

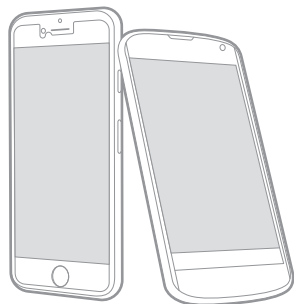

Android Auto™+3 / Apple CarPlay® Setup*+4

Android Auto™*

Setting up Android Auto™:

1. From an Android Auto™ compatible device, download the Android Auto™ app from the Google Play™ Store^{†11}.
2. Open the Android Auto™ app and proceed with the on-screen instructions to complete setup on the mobile device.

How to start Android Auto™:

1. Press the SETUP key on your audio control unit's control panel.
2. Press the Phone Projection or Connectivity button , select Android Auto™ then select ENABLE ANDROID AUTO. Accept all terms, conditions and requests on the head unit and phone in order to use Android Auto™.
3. Connect the Android™ device with the vehicle's USB port using the manufacturer's cable provided with your phone.
4. From the vehicle's home screen, select the Android Auto™ button, where you'll see all the Android Auto™ supported apps.

For further UVO eServices operations, refer to the Car Multimedia System User's Manual.

Apple CarPlay®*

Setting up and starting Apple CarPlay®:

1. On the head unit, press the SETUP key.
2. Press the Phone Projection or Connectivity button , select Apple CarPlay® then select ENABLE APPLE CARPLAY. [Accept all terms, conditions and requests on the head unit and phone in order to use Apple CarPlay®]
3. Connect the Apple CarPlay® compatible iPhone^{†14} with the vehicle's USB port using the manufacturer's cable provided with your iPhone
4. From the vehicle's home screen, select the Apple CarPlay® button, where you'll see all the Apple CarPlay® supported apps

REMINDERS:

- Android Auto compatibility requirements: Micro-USB cable that came with your phone, OS Android™ 5.0 or higher, compatible Android smartphone and data and wireless plan for applicable feature(s).
- Apple CarPlay compatibility requirements: Apple Lightning® cable, latest iOS software, iPhone 5 or later and data and wireless plan for applicable feature(s)
- It is recommended to always update your phone to the latest operating system release
- Driving while distracted can result in a loss of vehicle control that may lead to an accident, severe bodily injury, and death. The driver's primary responsibility is in the safe and legal operation of a vehicle, and use of any handheld devices, other equipment, or vehicle systems which take the driver's eyes, attention and focus away from the safe operation of a vehicle or which are not permissible by law should never be used during operation of the vehicle.

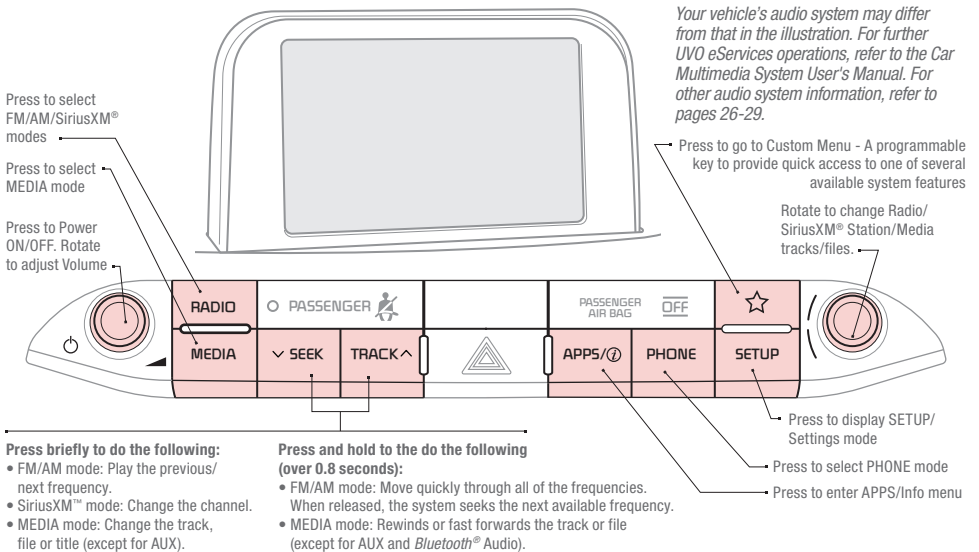

UVO eServices*† 1

FM/AM/SiriusXM^{†22}/Media (USB, iPod^{†14}, Aux, Bluetooth[®] Audio, My Music)

Sound Settings – To adjust the sound settings:

1. Press the SETUP key on the audio control unit or the on-screen MENU button, when in MEDIA mode.
2. Select the on-screen SOUND button, or SOUND SETTINGS
3. Select the menu item (Position, Volume, Tone, Priority, Advanced, Default)
4. Use the onscreen buttons to adjust settings. Press the return button \Rightarrow to save settings

Radio Presets – You can listen to FM, AM and SiriusXM radio and save frequently used stations.

How to Save a Preset - Press and hold the desired slot. This saves the current station in the selected slot

SiriusXM Smart Favorites - For the first ten favorite SiriusXM channels, you may play live or repeat from the beginning of a song or a program segment. In Radio mode, choose **SiriusXM**, then select any of the first six favorites. During song or program play, tap the **Skip Backward** icon to start from the beginning of the song or program. Tap the **Play Live** icon to return to the live broadcast.

Custom Button ☆: A programmable key to provide quick access to one of several available system features.

To Program the Custom Button: Press the SETUP button, then press the Custom button. Select one of the available features you would like the Custom button to open.

Your vehicle's audio system may differ from that in the illustration. For further UVO eServices operations, refer to the Car Multimedia System User's Manual. For other audio system information, refer to pages 26-29.

UVO ESERVICES VIDEO

To view a video on your mobile device, snap this QR Code or visit the listed website. Refer to page 2 for more information.



www.youtube.com/KiaFeatureVideos

Quick Tips

- Navigation may be available when connected to Android Auto or Apple CarPlay supported smartphones
- When using the voice command feature, wait for the system to BEEP before speaking the command
- At any time, you can interrupt Command Feedback by pressing the TALK button
- Prolonged use of the audio control unit in ACC mode may drain the vehicle's battery
- A warning screen may appear periodically to remind users that the UVO eServices should be operated when the engine is running to prevent battery discharge

REMINDER: Driving while distracted is dangerous and should be avoided. Drivers should remain attentive to driving and always exercise caution when using the audio system controls while driving. To help minimize driver distraction, some audio system functionalities have been modified while the vehicle is in Drive, Reverse or moved out of Park.

*IF EQUIPPED
†LEGAL DISCLAIMERS ON BACK INSIDE COVER

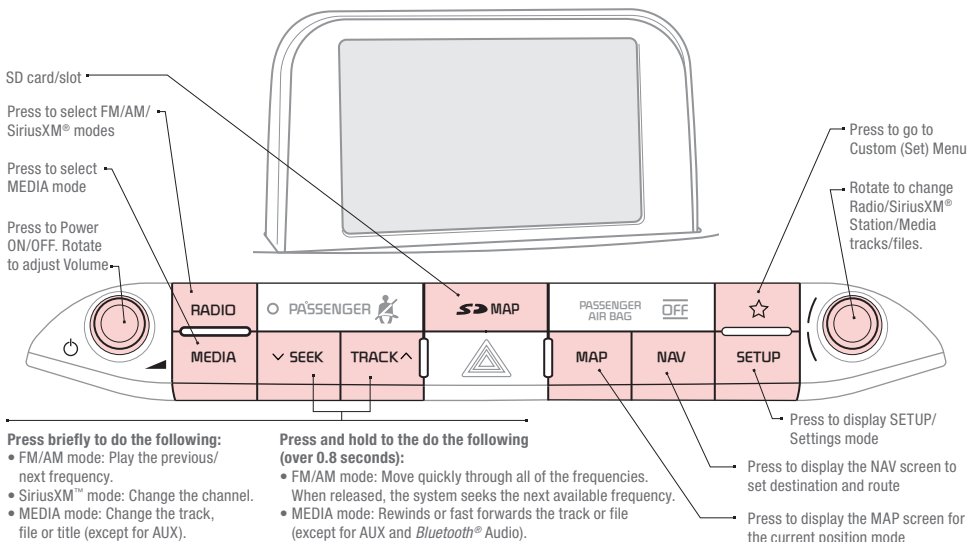

UVO eServices with Premium Navigation^{†1,15}

FM/AM/SiriusXM^{®†22}/Media (USB, iPod^{®†14}, Aux, Bluetooth[®] Audio)

Sound Settings – To adjust the sound settings:

1. Press the SETUP key on the audio control unit
2. Select the on-screen SOUND button
3. Select the menu item (Volume Levels, Tone, Priority, Navigation, Advanced, Default, Beep)
4. Use the onscreen buttons to adjust settings

Radio Presets – You can listen to FM, AM and SiriusXM radio and save frequently used stations.

How to Save a Preset - Press and hold the desired slot. This saves the current station in the selected slot

SiriusXM Smart Favorites - For the first ten favorite SiriusXM channels, you may play live or repeat from the beginning of a song or a program segment. In Radio mode, choose **SiriusXM**, then select any of the first six favorites. During song or program play, tap the **Skip Backward** icon to start from the beginning of the song or program. Tap the **Play Live** icon to return to the live broadcast.

Custom Button ☆ is a programmable key to provide quick access to one of several available system features. To Program the Custom button:

1. Press the SETUP button, then press the ☆ Custom button
2. Select one of the available features you would like the Custom button to open

UVO ESERVICES WITH PREMIUM NAVIGATION SYSTEM VIDEO

To view a video on your mobile device, snap this QR Code or visit the listed website. Refer to page 2 for more information.



www.youtube.com/KiaFeatureVideos

Quick Tips

- Prolonged use of the navigation system in ACC mode may drain the vehicle's battery. A warning screen may appear periodically to remind users that the navigation system should be operated with the engine running to prevent battery discharge
- When using the voice command feature, wait for the system BEEP before speaking the command
- Surround Sound can be turned on or off
- At any time, you can interrupt UVO eServices System Command Feedback by pressing the TALK button on the steering wheel

Your vehicle's audio system may differ from that in the illustration. For further UVO eServices operations, refer to the Car Multimedia System User's Manual. For other audio system information, refer to pages 26-28.

Clock

Select SETUP key on audio control unit. Then scroll to and select DATE/TIME, and adjust.

Refer to the Car Multimedia System User's Manual for more information.

REMINDERS:

- Daylight Savings must be enabled or disabled in the Clock Settings screen.
- To access manual date and time setting, turn GPS Time OFF

in the Clock Settings (UVO eServices with Premium Navigation*)

Aux/USB/iPod® Ports, Power Outlets & USB Charger

Power Outlets A: Use the power outlets for mobile phones and other devices designed to operate on a 12V (180W max) power outlet.

Aux/USB/iPod® Port B: Use the Aux port to connect audio devices and the USB port to connect USB audio devices, smartphones and iPod® devices.

USB Charger C: Devices can be recharged using a USB cable. The Engine Start/Stop button needs to be in the ACC/ON/START position to operate the USB Charger.

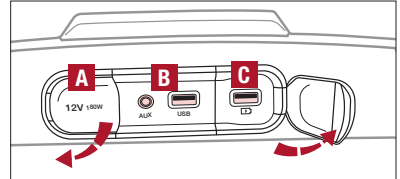

(Located in center console in front of gearshift)

REMINDERS:

- Using the power outlets (accessory plugs) for prolonged periods of time with the Engine Start/Stop button in the ACC position (Engine OFF) may cause the battery to discharge
- Use manufacturer cables only that came with your device. Third party cables may cause damage to device. It is recommended to always update your phone to the latest operating system release

Quick Tip

The power outlets are inactive when ignition is in the OFF position.

For more information on the Aux/USB/iPod® Port, Power Outlets and USB Charger, refer to the Owner's Manual.

Wireless Smartphone Charging System*

1. Slide open tray cover **D**
2. Place compatible smartphone on the center of the charging pad **E**
3. Indicator light **F** will change to amber once the wireless charging begins
4. Once charging is complete, the orange light **F** will change to green

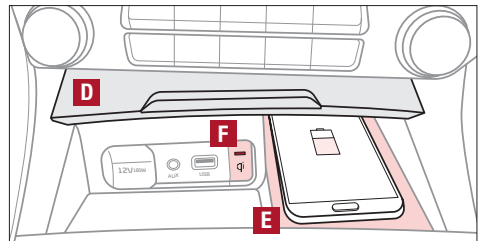

REMINDERS:

- The smartphone must be a compatible phone with Qi function available
- Avoid placing other metal items in the bin while charging as to not impede the charging area
- This vehicle is equipped with wireless charging technology which allows for a device to be charged using inductive charging, however, device compatibility varies. See your owner's manual for more detailed information and the back page for legal disclaimers
- Inductive charging systems are less efficient than conventional charging through cable. As a result, higher device operating temperatures may be experienced during use
- Charging Performance – Device position on the wireless charging system can affect charging performance. Other factors that may affect the charging rate includes foreign objects, such as coins or pens, and phone case thickness
- Typically this feature will operate unless ignition is on or in the ACC position

WIRELESS CHARGING VIDEO



www.youtube.com/KiaFeatureVideos

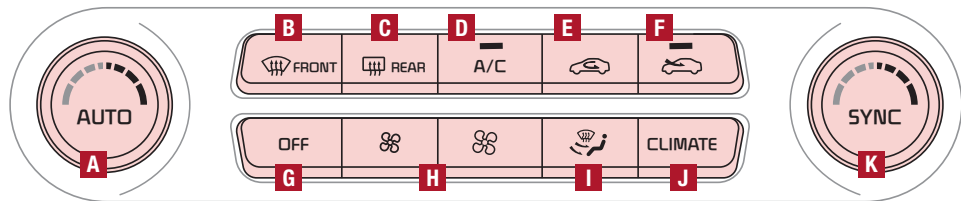

Automatic Climate Control System

Front Climate Control

- A** AUTO (Automatic) Climate Control button
- B** Front Windshield Defrost button
- C** Rear Window Defrost button
- D** Air Conditioning button
- E** Recirculated Air button
- F** Fresh Air button

- G** System OFF button
- H** Fan Speed Control buttons
- I** Mode Select button
- J** Climate Control System button
- K** SYNC (Synchronize All Zones) Temperature Control button

Climate Control Auto Function

Press AUTO **A** to select full auto operation. In AUTO mode the driver and front passenger have full control of their own temperature zones. The mode, fan speed, air intake and air conditioning will activate and adjust accordingly to achieve the temperature settings for each zone.

To set temperatures:

- Turn **A** to set the driver's zone temperature
- Turn **K** to set the front passenger's zone temperature

Dual-Zone Climate Control

Pressing the SYNC button **K** synchronizes both climate control zones (driver and passenger) to the driver's temperature control.

REMINDERS:

- Pressing any button during AUTO operation will deactivate the AUTO function and switch to manual mode, except for Temperature Control
- When in AUTO mode, Air Flow Mode and Fan Speed do not display on the Climate Control Display
- Warm air may flow in through vents if Recirculated Air button is not pressed ON (LED lit).

Air Flow Modes

To select air flow modes, press the Mode Select button **I**:

-  Face-Level
-  Floor-Level
-  Bi-Level
-  Floor/Defrost-Level

Defrost Outside Windshield

1. Set **fan speed** to the highest position **H**
2. Set **temperature** to hot **A**
3. Press the **front defrost button B**

Defog Inside Windshield

1. Set desired **fan speed H**
2. Set desired **temperature A**
3. Press the **front defrost button B**

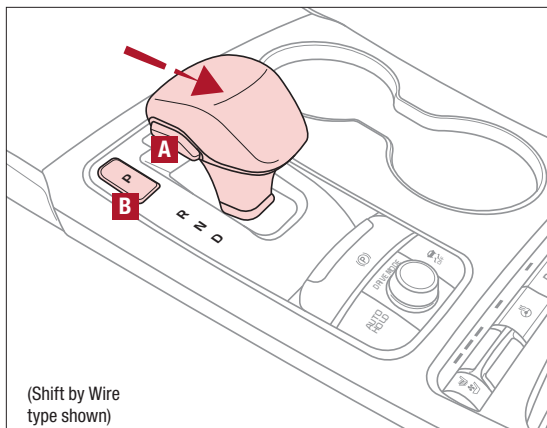

(Shift by Wire type shown)

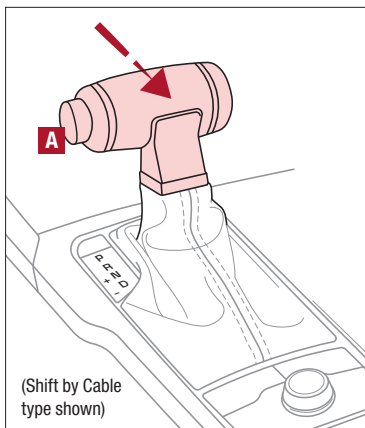

(Shift by Cable type shown)

Automatic Transmission (Shift by Cable* / Shift by Wire*) and Sport Shift Mode (Shift by Cable only)

To shift into any gear from Park, depress the brake pedal, then press the Unlock button **A**, located on the side of the gear shift lever, and shift.

P: Park – To shift into Park from any gear, press the P button **B** on the gear shift while vehicle is stationary and the brake pedal is depressed (Shift by Wire only).

R: Reverse – To shift into Reverse, depress brake pedal, press the Unlock button **A**, and move the shift lever forward twice to skip over Neutral and into Reverse.

N: Neutral

D: Drive

[+]: Sport Shift Mode Upshift*

[-]: Sport Shift Mode Downshift*

Paddle Shifters: With the gear shift in Drive, pull the paddle shifter to manually change gears.

[+]: Manual Mode Upshift

[-]: Manual Mode Downshift

REMINDERS:

- Press and hold the [+] right paddle shifter to return to Automatic mode (Shift by Wire* only)
- When in Sport Shift mode, pulling the left and right paddle shifters at the same time will NOT shift gears

AUTOMATIC TRANSMISSION CONTROL (SHIFT BY WIRE) VIDEO

To view a video on your mobile device, snap this QR Code or visit the listed website. Refer to page 2 for more information.



www.youtube.com/KiaFeatureVideos

Quick Tips

- Press the Unlock button **A** when shifting from P (Park) to any gear
- The instrument cluster and the light on top of the shift lever identifies the gear the vehicle is currently in

REMINDERS:

- When in P (Park), if the Unlock button is not pressed while shifting, the transmission does not shift
- If the vehicle is turned off while in Neutral without shifting into Park, it will remain in Neutral until the driver's door is opened. At that point it will automatically shift into Park
- If going through a car wash, remind the attendant to keep the vehicle in Neutral (N) and keep the engine running. Also, disable the power liftgate lid control, turn off the auto rain sensing wipers and fold in the mirrors

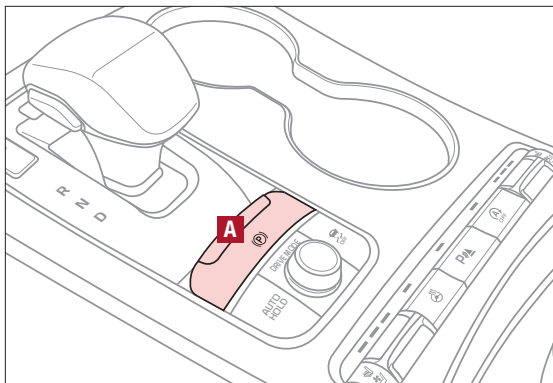

Electric Parking Brake (EPB)

The Electric Parking Brake (EPB) system utilizes an electric motor to engage the parking brake.

Applying the Parking Brake

Depress the brake pedal and pull up the EPB switch **A**. Ensure that the indicator light  is illuminated on the instrument cluster.

Releasing the Parking Brake

The EPB will automatically release when the shifter is placed in Reverse or Drive. To release EPB manually, depress the brake pedal, then press the EPB switch **A**, with the ignition switch in the ON position. Ensure that the indicator light  is OFF.

ELECTRIC PARKING BRAKE / AUTO HOLD VIDEO

To view a video on your mobile device, snap this QR Code or visit the listed website. Refer to page 2 for more information.



www.youtube.com/KiaFeatureVideos

Quick Tips

- Pull up and hold EPB switch again to increase brake pressure if parked on a decline or incline.
- When leaving your keys with parking lot attendants or valet, make sure to inform them how to operate the EPB
- If parked on a steep incline, pull up the EPB switch for more than 3 seconds for a firmer EPB application

REMINDERS:

- As a bulb check, the EPB malfunction indicator will illuminate for approximately 3 seconds when the ignition switch is turned ON
- If the warning light does not illuminate temporarily or remains continuously lit, take your vehicle to an authorized Kia dealer and have the system checked
- The EPB should not be operated while the vehicle is moving
- A click or electric brake motor sound may be heard while operating or releasing the EPB. These conditions are normal and indicate that the EPB is functioning properly
- EPB will not release unless the hood, liftgate and all doors are closed and seat belts are fastened

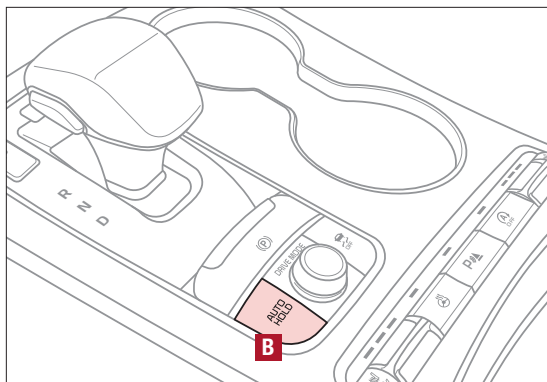

Auto Hold

Auto Hold temporarily maintains the vehicle at a standstill even if the brake pedal is not depressed after the driver brings the vehicle to a complete stop by depressing the brake pedal. Auto Hold can be turned On/Off using the AUTO HOLD switch **B** on the center panel. Before Auto Hold will operate, the driver's door, engine hood and liftgate must be closed and the driver's seat belt must be fastened.

Depress the brake pedal, start the engine and then press the AUTO HOLD switch **B**. The white Auto Hold indicator will come on indicating the system is in standby.

The Auto Hold indicator, which is in the instrument cluster, has four states:

White: Standby – With vehicle at a standstill, and AUTO HOLD switch **B** turned ON, the indicator will illuminate white. While driving the vehicle (vehicle is not at a standstill), the Auto Hold indicator will remain white.

Green: Engaged – When coming to a complete stop by depressing the brake pedal, the Auto Hold indicator changes from white to green.

OFF (not illuminated) – The indicator will turn OFF when the AUTO HOLD switch **B** is manually turned OFF or when the EPB is manually turned ON.

Yellow: Malfunction – When the indicator is illuminated yellow, there may be a system malfunction. Take your vehicle to a local Kia dealer.

ELECTRIC PARKING BRAKE / AUTO HOLD VIDEO

To view a video on your mobile device, snap this QR Code or visit the listed website. Refer to page 2 for more information.



www.youtube.com/KiaFeatureVideos

REMINDER: To reduce the risk of an accident, do not activate Auto Hold while driving downhill, backing up or parking your vehicle

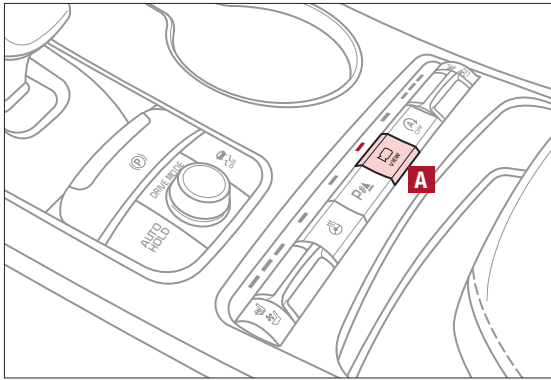

Surround View Monitoring (SVM) System*





The Surround View Monitoring (SVM) System is a parking support system that shows the areas around the front, rear, left and right sides of the vehicle via four cameras displayed onto the navigation screen.

Press **A** to turn the SVM system ON/OFF.





- When OFF: The camera view will automatically display on the navigation screen when the vehicle is shifted into Reverse. The camera view will turn off when the vehicle is shifted out of Reverse
- When ON: The camera view will display on the navigation screen in both Drive and Reverse. In Drive, the camera view will continue to display until the vehicle is traveling at speeds above approximately 13 mph. If you keep the SVM system on, the camera view will reappear on the navigation screen whenever the vehicle speed drops below approximately 13 mph

Camera View Modes – To change camera view modes, use the touch screen or rotate the controller and push to select the mode.

When in Drive & Neutral:

-  Displays the front side and SVM images simultaneously on the screen
-  Displays the front side image on the screen
-  Displays the front side and left side images simultaneously on the screen
-  Displays the front side and right side images simultaneously on the screen

When in Reverse:

-  Displays the rear view and SVM images simultaneously on the screen
-  Displays the rear side image on the screen
-  Displays the rear and left side images simultaneously on the screen
-  Displays the rear and right side images simultaneously on the screen

SURROUND VIEW MONITORING (SVM) SYSTEM VIDEO

To view a video on your mobile device, snap this QR Code or visit the listed website. Refer to page 2 for more information.



www.youtube.com/KiaFeatureVideos

REMINDER: The SVM camera is equipped with an optical lens to provide a wider range of vision and may appear different from the actual distance. The Surround View Monitoring system is only a supplemental device. Drivers should not rely solely on the SVM information when parking and backing up. Drivers should always pay attention and directly check the left/right and rear.

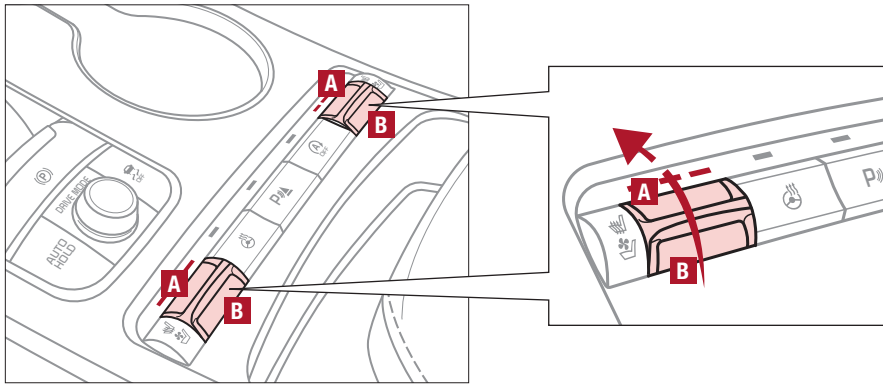

Seat Warmers^{†21} / Ventilated Seats*

Front Seats

Seat Warmers:

- Press button **A** up once for high setting (3 LEDs lit).
- Press twice for medium setting (2 LEDs lit).
- Press a third time for low setting (1 LED lit) and again to turn OFF.

Ventilated Seats:

- Press button **B** down once for high setting (3 LEDs lit).
- Press twice for medium setting (2 LEDs lit).
- Press a third time for low setting (1 LED lit) and again to turn OFF.

SEAT WARMERS AND VENTILATED SEATS VIDEO

To view a video on your mobile device, snap this QR Code or visit the listed website. Refer to page 2 for more information.



www.youtube.com/KiaFeatureVideos

Quick Tip

With the seat warmer switch in the ON position, the heating system in the seat turns OFF or ON automatically depending on the seat temperature.

REMINDER: Use extreme caution when using the seat warmers to avoid burns. Refer to the Owner's Manual for more information.

Power Adjustable Driver's Seat*†19

Move/Press controls to adjust Seat, Seat forward/backward, Seat Cushion tilt up/down, Seatback forward/backward, Lumbar up/down/forward/backward or Seat Cushion Extension forward/backward.

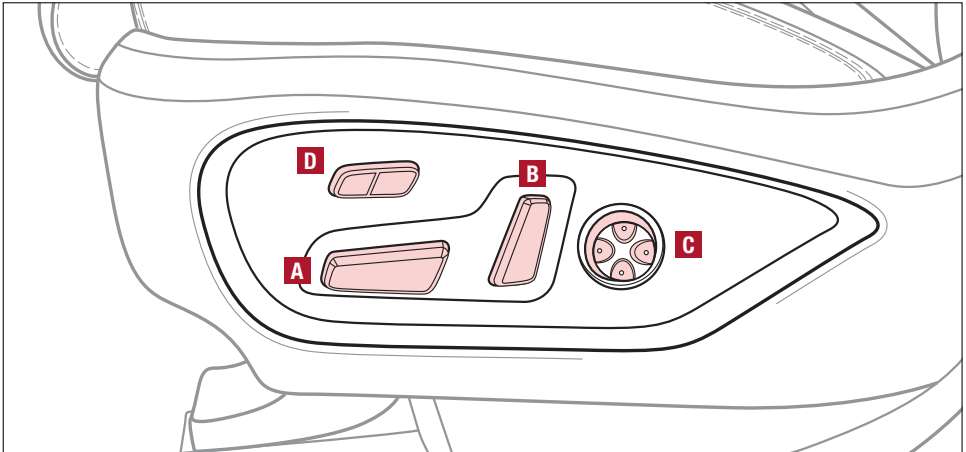
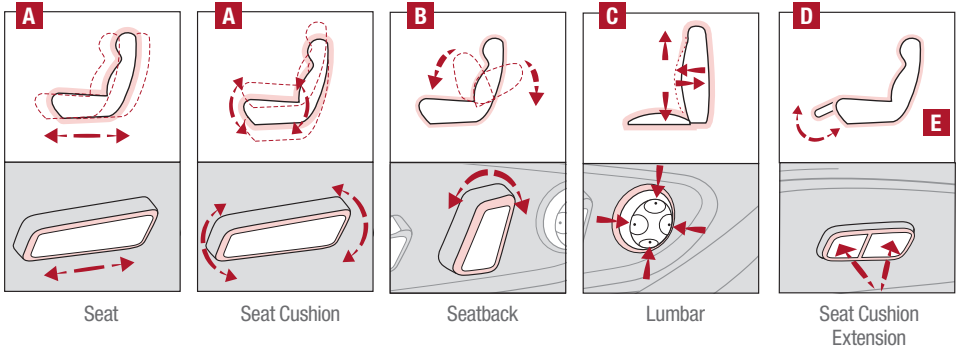

REMINDER: Do not attempt to adjust the seat while the vehicle is moving. This could result in loss of control of the vehicle.

Front Seat Headrest Adjustment*†10

To raise headrest: Pull headrest up.

To lower headrest: Press lock **E**, then press the headrest down.

REMINDERS:

- Button may be hard to see if headrest is in its lowest position.
- Do not operate the vehicle with the headrests removed. Headrests can provide critical neck and head support in an accident.

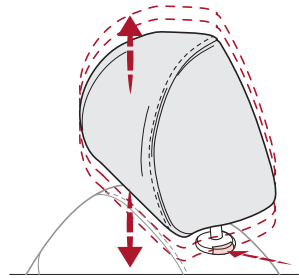

Driver Position Memory System*

The integrated system stores into memory the position of the driver's seat, outside rearview mirrors, and steering wheel positions. To store positions into memory, first place the gear shift into P (Park) while the Engine Start/Stop button is in the ON position. Then:

1. Adjust the driver's seat, outside rearview mirrors, settings and steering wheel positions
2. Press the SET button **A** on the control panel. System will beep once
3. Press one of the memory buttons 1 or 2 **B** within 4 seconds. The system will beep twice when memory has been stored

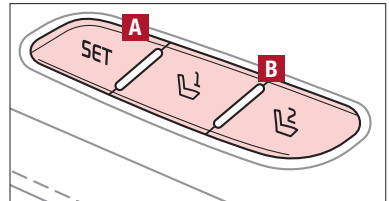

(Located on driver's door control panel)

REMINDEr: Do not operate the vehicle with the headrests removed. Headrests can provide critical neck and head support in an accident.

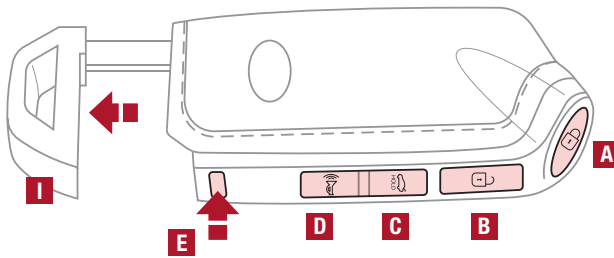

Smart Key^{†8}

- A** Press to lock all doors
- B** Press to unlock driver's door. Press twice within 4 seconds to unlock all doors
- C** Press and hold for more than 1 second to unlock Liftgate and open manually (or automatically if Smart Power Liftgate)

REMINDERS:

- Liftgate lid will partially open. To fully open, lift up manually
- The Liftgate unlocks when the Smart Key is within close proximity of the vehicle

- D** Press and hold more than a half a second for panic alarm. To turn off alarm, press any button
- E** Press to release mechanical key **I**

Driver's Door Lock/Unlock Button **G**:

To unlock door(s):

- Press button once to unlock driver's door
- Press again within 4 seconds to unlock all doors

To lock all doors:

- Press again to lock all doors

Mechanical Key:

- Use to unlock/lock driver's door:
 1. Remove door handle keyhole cover with mechanical key by pressing up into slot as shown **H**
 2. Insert mechanical key **I** and turn right to unlock driver's door.
 3. Insert mechanical key **I** and turn left to lock driver's door.
 4. Return mechanical key to its original location.
- Use to lock and unlock glove box

KIA KEY FOB VIDEO

To view videos on your mobile device, snap these QR Codes or visit the listed website. Refer to page 2 for more information.



ENGINE STOP/START BUTTON & SMART KEY VIDEO



www.youtube.com/KiaFeatureVideos

Quick Tips

- If the Smart Key battery is weak or not working properly, hold the Smart Key fob up to the Engine Start/Stop button (lock button side closest) and press to start engine
- The Smart Key's signal can be blocked by the normal operation of a cellular phone or smartphone. To help prevent this, store each device separately
- When reinserting the mechanical key into the fob, make sure it is pushed all the way in until there is a click sound

REMINDER: Remote button configuration may vary depending on vehicle options.

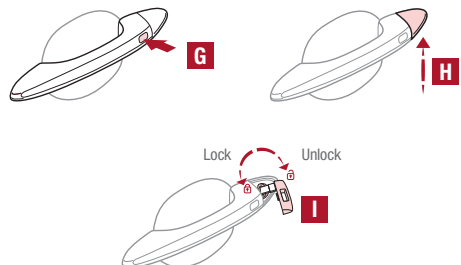

Smart Power Liftgate*†17

The Smart Power Liftgate can be operated from several controls to either open, close or lock the Liftgate. The Smart Power Liftgate Lock button will close the Liftgate, lock all doors and Liftgate and then arm the vehicle.

To turn the Smart Power Liftgate features ON, go to User Setting mode in the LCD Instrument Cluster Modes and set to ON.

Opening from Inside the Vehicle:

Press the Smart Power Liftgate Open/Close button* **A** to automatically open/close the Liftgate.

Opening from Outside the Vehicle:

To open Smart Power Liftgate* automatically, press the Liftgate Release button **B** on exterior of the Liftgate.

Automatically close by pressing Smart Power Liftgate Close button* **C**.

Quick Tip

During the Smart Liftgate alert, the Smart Liftgate can be deactivated with the Smart Key by pressing any button on the key fob.

REMINDERS:

- All doors are closed and locked after about 15 seconds
- The Smart Power Liftgate feature will not operate when the following occurs:
 - Doors are recently closed and locked
 - The Smart Key is still detected after 15 seconds near the vehicle or within 60 inches of the door handles
 - A door is not locked or closed
 - The Smart Key is in the vehicle
- Pulling the Liftgate upward by the handle or pressing the button a second time will interrupt the automatic opening of the Smart Power Liftgate

For more information on the Smart Power Liftgate operation, please refer to the Owner's Manual.

SMART POWER LIFTGATE VIDEO

To view a video on your mobile device, snap this QR Code or visit the listed website. Refer to page 2 for more information.



www.youtube.com/KiaFeatureVideos

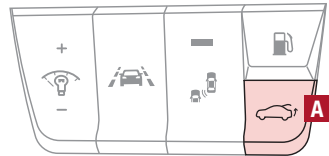

(Button located on driver's panel, left of the steering wheel)

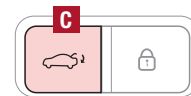
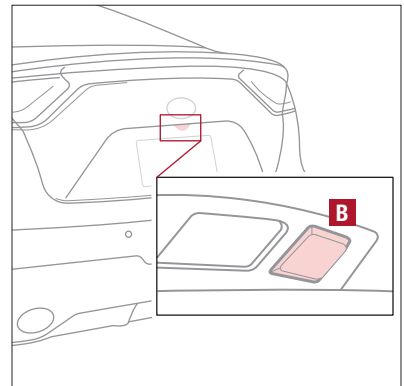

(located inside Liftgate lid)

Smart Power Liftgate* (Continued)

Opening with no-touch activation:

When the Smart Key fob is on your person and you are near the back of the vehicle, within close proximity, the hazard lights will blink and a chime will sound for about 3 seconds as an alert that the Smart Power Liftgate* is about to open.

Then the alert system will blink and chime two additional times before opening the Smart Power Liftgate*.

The Smart Power Liftgate* feature is OFF by default. To enable the Smart Power Liftgate*, go to User Settings in the LCD Instrument Cluster modes.

Smart Key:

To open the Smart Power Liftgate*, press and hold the Smart Key Liftgate button **D** until the Liftgate begins opening. Press again and hold to close.

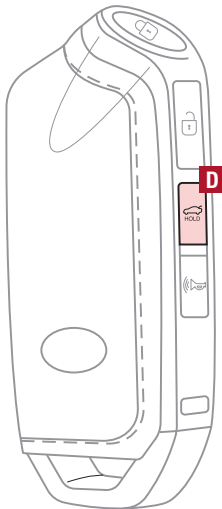

KIA KEY FOB VIDEO

To view a video on your mobile device, snap this QR Code or visit the listed website. Refer to page 2 for more information.



www.youtube.com/KiaFeatureVideos

Quick Tips

- The Liftgate must be unlocked before it can be opened by the Liftgate Release button
- The Liftgate unlocks automatically and then can be opened manually when the Smart Key is within close proximity to the vehicle

REMINDERS:

- Smart Power Liftgate may be damaged if attempting to open or close manually
- When not in use, keep the Liftgate Lid Control button in the OFF position
- If going through a car wash, remind the attendant to keep the vehicle in Neutral (N) and keep the engine running. Also, disable the Smart Power Liftgate lid control using the button inside the glove compartment, turn off the auto rain-sensing wipers and fold in the mirrors
- Ensure all obstacles are out of the way of the Liftgate lid when operating the Smart Power Liftgate

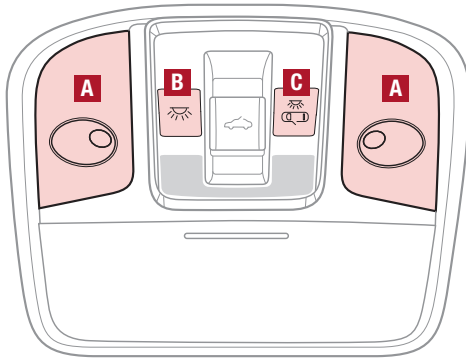

Map/Room Lamps

Automatic Turn Off Function

The interior lights automatically turn off approximately 20 seconds after the Engine Start/Stop button is turned OFF.

Map/Room Lamp Operation

Map Lamps – These lights produce spot beams for convenient use as map lamps or as personal lamps for the driver or the front passenger. Press the buttons **A** to turn the map lamps ON/OFF.

Room button – Press the button **B** to turn the front and rear lamps ON/OFF.

Door button – When the Door button **C** is pressed the front and rear lamps will turn ON as follows:

- When a door is opened or doors are unlocked with the Smart Key, the lamps will turn ON for approximately 30 seconds
- If the Engine Start/Stop button is in the ACC/OFF position and a door is open, the lamps will stay ON for approximately 20 minutes
- If the Engine Start/Stop button is in the ACC/ON position and a door is open, the lamps will stay ON

The lamps will turn OFF immediately if the Engine Start/Stop button is turned ON or all doors are locked.

Quick Tips

- When doors are unlocked by the Smart Key, the lamp turns ON for approximately 30 seconds
- If your vehicle is equipped with the theft alarm system, the interior lights automatically turn off approximately 3 seconds after the system is in armed stage
- Using interior lights for an extended period of time may cause battery discharge

REMINDER: When room lamp lens is pressed ON it will remain ON, even when the map lamp switch is in the OFF position.

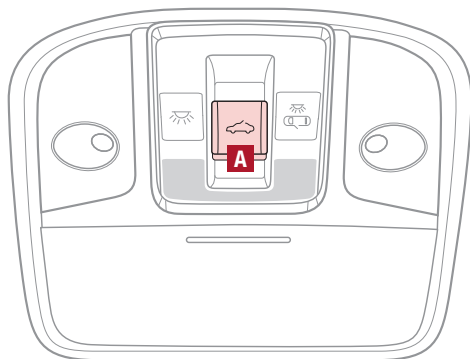

Sunroof Operation*

The sunroof and sunshade operation is controlled by a multi-directional switch/lever **A**. The ignition needs to be in the ON position to operate the sunroof/sunshade.

Slide the sunshade and sunroof:

Auto Open – Slide lever backward to the farthest position and release.

Auto Close – Slide the lever forward to the farthest position and release.

Slide the sunshade:

Auto Open – Slide the lever backward to the first detent position.

Auto Close – Slide the lever forward to the farthest position.

Slide the sunroof (with sunshade open):

Auto Open – Slide the lever backward and release.

Auto Close – Slide the lever forward to the first detent position or pull the lever downward.

Tilt the sunroof:

Raise – Press lever upward.

Lower – Pull lever downward.

Auto-close sunroof and sunshade:

Slide the lever forward to the farthest position.

SUNROOF OPERATION VIDEO

To view a video on your mobile device, snap this QR Code or visit the listed website. Refer to page 2 for more information.



www.youtube.com/KiaFeatureVideos

Quick Tip

To stop the sunroof/sunshade at any position, press or pull the sunroof control lever in any direction.

REMINDERS:

- Sunshade must remain OPEN while sunroof is open and vehicle is moving.
- If the ignition is turned off with the Sunroof not fully closed, the Instrument Cluster LCD will display a warning message and a chime will sound for a few seconds.
- Do not adjust the sunroof or sunshade while driving. This could result in loss of control of the vehicle.

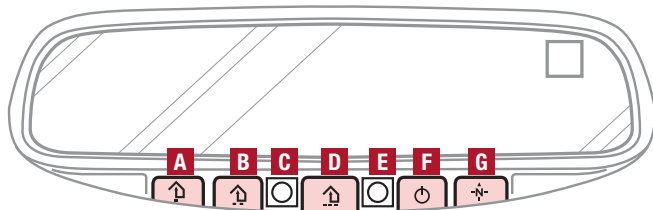

HomeLink® with Auto-Dimming Rearview Mirror†¹³

- A** HomeLink® button
- B** HomeLink® button
- C** Indicator light
- D** HomeLink® button

- E** Glare detection sensor
- F** Automatic dimming ON/OFF
- G** Compass control button

Auto-Dimming Rearview Mirror

Designed to help reduce glare from a vehicle's headlights located in the rear and also connect up to three electronic transmitters in one location.

REMINDER: Mirror indicator light will illuminate when automatic dimming is ON.

HomeLink® Setup – How to Sync Transmitter

If programming for the first time, begin with Step 1 (repeating this step will delete all information).

To program non-rolling and rolling code garage door openers and other devices:

1. Press and hold the left **A** and center **D** buttons simultaneously until the indicator light **C** begins to flash (to reprogram buttons, skip this step)
2. Press and hold the desired button **A**, **B** or **D** and hold the button on the transmitter while it is approximately 1 to 3 inches away from the mirror. The HomeLink® Indicator light **C** will flash rapidly once the frequency signal has been successfully programmed

To finish programming rolling code garage door openers, complete these steps:

3. Locate the “learn” or “smart” button on the garage door's motor head unit. Press and release the button and complete Step 4 within 30 seconds.
4. Firmly press and release the programmed HomeLink® button up to three times.

Operating HomeLink®:

Press one of the programmed HomeLink® buttons.

Erasing programmed buttons:

Press and hold the left **A** and center **D** buttons simultaneously for approximately 20 seconds, and then release both buttons within 30 seconds.

HOMELINK REARVIEW MIRROR SETUP VIDEO

To view a video on your mobile device, snap this QR Code or visit the listed website. Refer to page 2 for more information.



www.youtube.com/KiaFeatureVideos

Quick Tips

- You can reprogram a single HomeLink® button by repeating Step 2
- Erasing programmed buttons will delete all trained transmitters

If your garage door opener was manufactured in 2011 or later, and you're unable to program your vehicle's HomeLink® system, you may need to purchase a HomeLink Repeater Kit. For more information, go to www.HomeLink.com or call (800) 355-3515.

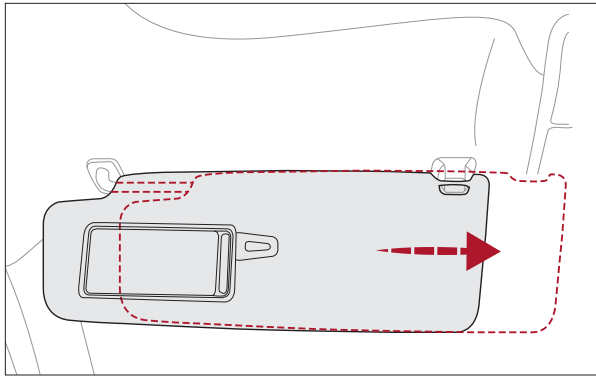

Sunvisor†24

Use the sunvisor to shield direct light through the front or side windows.

Slide the sunvisor out and adjust as needed.

REMINDERS:

- Sunvisor may not shield all direct light
- Sunvisor may impair visibility if not adjusted properly
- Be aware of seating position when adjusting or swinging sunvisor around to or from the front or side windows
- Do not operate the vehicle if the sunvisor is impairing your visibility

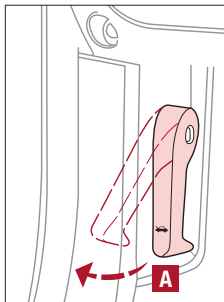

(Located on Driver side kick panel)

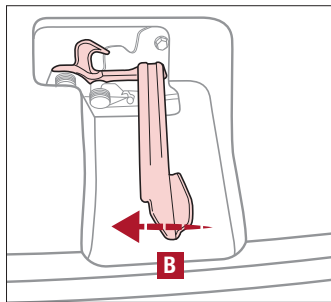

(Located inside of Hood's center)

Hood Release Lever and Latch

Opening the Hood:

1. Pull the hood release lever **A** to unlatch the hood
2. In the front of the vehicle, lift the hood slightly, push the secondary latch **B** inside of the hood's center and lift the hood.

Closing the Hood:

Lower the hood about halfway and then press down to securely lock in place.

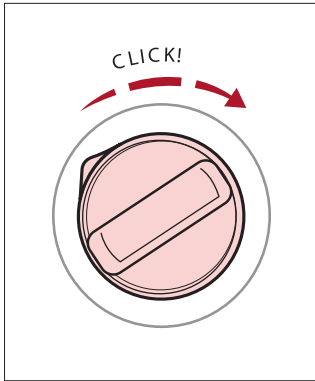

Fuel Cap / Malfunction Indicator (Check Engine Light)

Tighten for **ONE CLICK** to prevent malfunction indicator  from illuminating.

REMINDERS:

- The Fuel Filler Door Release button is located on the lower part of the driver's door sill
- It is normal operation when tightening to hear one click and then when Fuel Cap is released, it clicks back

ONE-CLICK FUEL CAP VIDEO

To view a video on your mobile device, snap this QR Code or visit the listed website. Refer to page 2 for more information.



www.youtube.com/KiaFeatureVideos

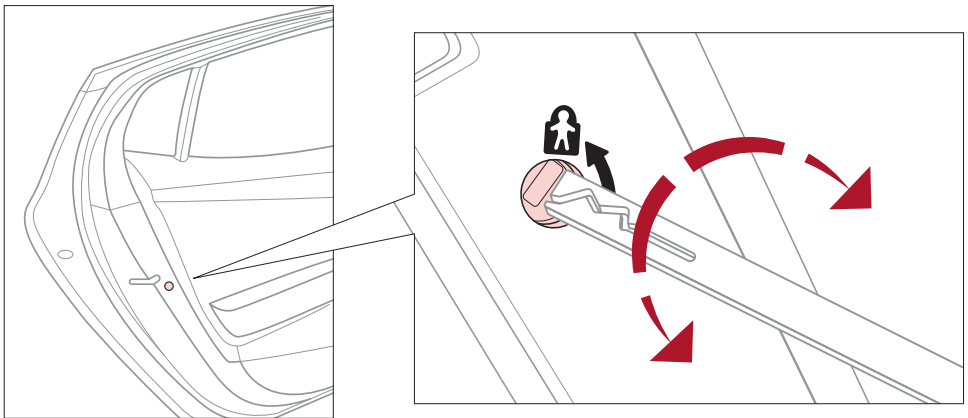

Child-Protector Rear Door Lock

Located on the rear edge of the rear passenger doors, move the Child-Protector Rear Door Lock to the lock position  to disable the inner door handles from opening the rear doors.

REMINDER: Child-Protector Rear Door Lock is located on rear passenger door jamb.

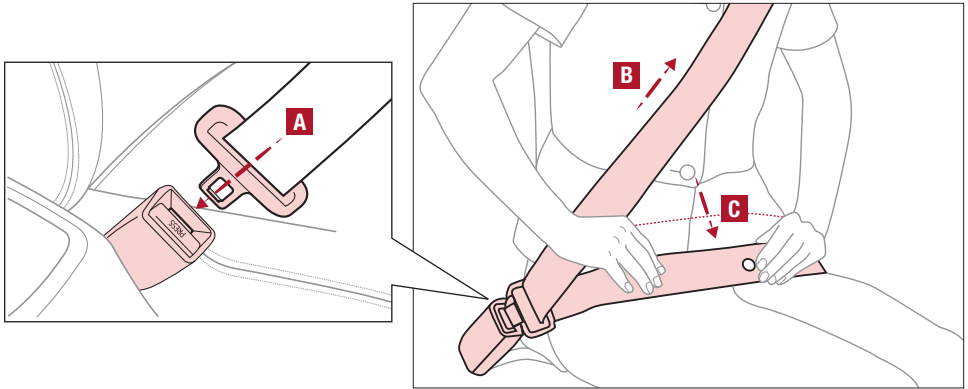

Seat Belts^{†2,20}

To properly fasten your safety belts:

1. Insert the belt tongue plate **A** into the buckle until it clicks
2. Position the lap portion of the belt across your lap as LOW ON THE HIPS as possible **C**. Adjust the belt to a SNUG FIT by pulling up on the shoulder portion **B**

Seat Belt Retractor Locks

Retractor locks allow lap/shoulder safety belts to remain unlocked during normal vehicle operation for freedom of movement and increased comfort.

During a STRONG STOP, SUDDEN TURN OR CERTAIN COLLISIONS, seat belt retractors will automatically lock the belts to help reduce the risk of injury.

Quick Tip

The seat belt warning chime operates for the driver's seat only.

REMINDER: For maximum protection, always wear your seatbelt

For more detailed information regarding your vehicle's safety belts, please refer to your Owner's Manual and the separate brochure titled "Understanding Your Safety Belt & Supplemental Restraint System."

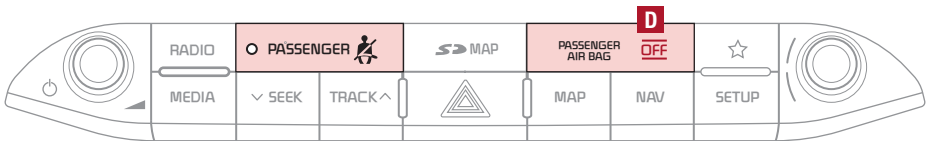

Occupant Detection System (ODS) / Passenger Airbag Off Indicator^{†2,16}

ODS is designed to detect the presence and position of the front passenger and is designed to adjust or turn off airbag deployment accordingly.

Depending on the situation and type of accident, the system may:

- Deploy airbag (Adult)
- Not deploy the airbag (Unoccupied)

If the system determines that the airbag should not be deployed, the "PASSENGER AIRBAG OFF" light will illuminate **D**.

REMINDER: Do not allow an adult passenger to ride in the front seat when the Passenger Airbag Indicator is illuminated OFF because the airbag will not deploy in the event of a crash. The driver must instruct the passenger to reposition her/himself in the seat.

STINGER NORMAL MAINTENANCE SCHEDULE **TURBO**

(up to 60,000 miles)^A

MAINTENANCE ITEMS	MAINTENANCE INTERVALS (MILES)			
	6,000	12,000	18,000	24,000
Add fuel additive ^C	P	P	P	P
Rotate tires	P	P	P	P
Engine oil and filter	R	R	R	R
Climate control air filter	R	R	R	R
Battery condition	I	I	I	I
Brake lines, hoses and connections	I	I	I	I
Disc brakes and pads	I	I	I	I
Vacuum hose	I	I	I	I
Steering gear rack, linkage & boots	I	I	I	I
Drive shafts and boots	I	I	I	I
Suspension mounting joints	I	I	I	I
Air conditioner compressor/refrigerant	I	I	I	I
Propeller shaft	I	I	I	I
Exhaust pipe and muffler	I	I	I	I
Intercooler, in/out hose, air intake hose	I	I	I	I
Air cleaner filter		I		R
Brake fluid		I		I
Fuel tank air filter ^{‡D}		I		I
Parking brake		I		I
Vapor hose, fuel filler cap and fuel tank		I		I
Cooling System				I
Fuel lines, fuel hoses and connections				I
Differential oil, rear (without LSD)				
Differential oil, rear (with LSD)				
Differential oil, front (AWD) ^E				
Spark Plugs				
Valve clearance ^F				
Drive belts (First 60,000 miles, then every 12,000 miles) ^G				

‡ If equipped.

A. See the Owner's Manual for complete maintenance schedule.

B. And, if necessary, adjust, correct, clean or replace

C. If TOP TIER detergent gasoline is not available, one bottle of additive is recommended. Additives are available from your authorized Kia dealer along with information on how to use them. Do not mix other additives.

D. Fuel filter & fuel tank air filter are considered to be maintenance free but periodic inspection is recommended for this maintenance schedule depends on fuel quality. If there are some important safety matters like fuel flow restriction, surging, loss of power, hard starting problem etc., replace the fuel filter immediately regardless of maintenance schedule and consult an authorized Kia dealer for details.

E. Front/rear differential oil should be changed anytime they have been submerged in water.

F. Inspect for excessive tappet noise and/or engine vibration and adjust if necessary.

G. The drive belt should be replaced when cracks occur or tension is reduced excessively.

See your Owner's Manual for more details and complete maintenance information, including severe maintenance schedule. Warranty may be voided if maintenance schedule is not followed.

P=Perform • R=Replace • I=Inspect[®]

MAINTENANCE INTERVALS (MILES)					
30,000	36,000	42,000	48,000	54,000	60,000
P	P	P	P	P	P
P	P	P	P	P	P
R	R	R	R	R	R
R	R	R	R	R	R
I	I	I	I	I	I
I	I	I	I	I	I
I	I	I	I	I	I
I	I	I	I	I	I
I	I	I	I	I	I
I	I	I	I	I	I
I	I	I	I	I	I
I	I	I	I	I	I
I	I	I	I	I	I
I	I	I	I	I	I
I	I	I	I	I	I
I	I	I	I	I	I
	I		R		I
	I		I		I
	I		I		I
	I		I		I
	I		I		I
	I		I		I
			I		
	I				
	R				
	I				
		R			
					I
					I

Quick Tip

Check your Maintenance Schedule or schedule an appointment with a dealer using your UVO eServices account by logging into your UVO App or your account on MyUVO.com (Vehicles equipped with UVO eServices only – See page 21 for setup information).

Driving while distracted is dangerous and should be avoided. Drivers should remain attentive to driving and always exercise caution when using the steering-wheel-mounted controls while driving.

Driving while distracted can result in a loss of vehicle control that may lead to an accident, severe personal injury and death. The driver's primary responsibility is in the safe and legal operation of a vehicle, and use of any handheld devices, other equipment or vehicle systems which take the driver's eyes, attention and focus away from the safe operation of a vehicle or that are not permissible by law should never be used during operation of the vehicle.

Safety Features: No system, no matter how advanced, can compensate for all driver error and/or driving conditions. Always drive responsibly.

1. **UVO eServices:** Purchase/lease of a new 2019 Kia Stinger vehicle with UVO eServices or UVO eServices with Premium Navigation includes a complimentary 5 year subscription starting from new vehicle retail sale/lease date as recorded by the dealer. After your complimentary 5 year UVO eServices or UVO eServices with Premium Navigation subscription expires, continued access to UVO eServices or UVO eServices with Premium Navigation will require a paid subscription at the then current subscription rate or your use of UVO eServices or UVO eServices with Premium Navigation will immediately terminate. Use of UVO is subject to agreement to the UVO Privacy Policy (available at <https://www.myuvo.com/legal/privacy-policy.shtml>) and Terms of Service (available at <https://www.myuvo.com/legal/terms-of-service.shtml>). UVO eServices or UVO eServices with Premium Navigation transferrable to subsequent owner during the original UVO eServices or UVO eServices with Premium Navigation service term. Only use UVO eServices or UVO eServices with Premium Navigation when safe to do so. UVO link App is available from the App Store® or Google Play™ Store. Kia Motors America, Inc. reserves the right to change or discontinue UVO eServices or UVO eServices with Premium Navigation at any time without prior notification or incurring any future obligation. Message and data rates may apply. Cellular and GPS coverage is required to use most features. UVO eServices or UVO eServices with Premium Navigation features may vary by model, model year, and trim level. Features, specifications, and fees are subject to change. For more on details and limitations, visit myuvo.com or your authorized Kia dealer. Google and logos are trademarks of Google, Inc. App Store is a service mark of Apple, Inc.
2. **Airbags:** For maximum protection, always wear your seat belt.
3. **Android Auto™:** Android Auto is a trademark of Google, Inc. Android™ is a registered trademark of Google, Inc. Distracted driving can result in a loss of vehicle control. Never use a handheld device or vehicle system that takes your focus away from safe vehicle operation.
4. **Apple CarPlay®:** Apple CarPlay® a registered trademark of Apple Inc. Distracted driving can result in a loss of vehicle control. Never use a handheld device or vehicle system that takes your focus away from safe vehicle operation.
5. **Bluetooth® Wireless Technology:** The Bluetooth® word mark and logos are registered trademarks owned by Bluetooth SIG Inc., and any use of such marks by Kia is pursuant to license. A Bluetooth® enabled cell phone is required to use Bluetooth® wireless technology.
6. **Driver Assist Features – Blind-Spot Collision Warning (BCW) with Lane Change Assist, Rear Cross-Traffic Collision Warning (RCCW), Lane Keeping Assist (LKA) / Lane Departure Warning (LDW), Rear View Monitor, Parking Distance Warning-Reverse, Smart Cruise Control (SCC) with Stop & Go, Driving Attention Warning (DAW):** These features are not substitutes for safe driving, and may not detect all objects surrounding vehicle. Always drive safely and use caution.
7. **Electronic Stability Control (ESC) / Traction Control System (TCS)/Hill-start Assist Control (HAC):** No system, no matter how advanced, can compensate for all driver error and/or driving conditions. Always drive responsibly.
8. **Engine Start/Stop Button with Smart Key:** Always come to a complete stop before turning the engine on or off. However, if you have an emergency while the vehicle is in motion and must turn the engine off, you can turn the engine off to the ACC position by pressing the Start/Stop button for more than 3 seconds or 3 times in succession. If the vehicle is still moving, you can restart the engine by pressing the Start/Stop button with the shift lever in Neutral (N). With the engine off, hydraulic power assist for steering and braking will be disabled and the vehicle will be more difficult to control.
9. **Forward Collision-Avoidance Assist (FCA) / Forward Collision Warning (FCW):** These systems are not substitutes for safe driving, and may not detect all objects in front of vehicle. Always drive safely and use caution.
10. **Front Seat Headrest Adjustment:** Never attempt to adjust headrests when vehicle is in motion.
11. **Google Play™ Store** is a trademark of Google, Inc. ©2018 Google Inc. All rights reserved. Google and the Google Logo are registered trademarks of Google Inc.
12. **Head-Up Display (HUD):** Failure to pay attention to travel conditions and vehicle operation could result in loss of vehicle control. Always drive safely and use caution.
13. **HomeLink®:** HomeLink® is a registered trademark of Gentex Corporation.
14. **iPhone®/iPod®:** iPhone and iPod are registered trademarks of Apple Inc. Distracted driving can result in a loss of vehicle control. Never use a handheld device or vehicle system that takes your focus away from safe vehicle operation.
15. **Navigation:** Distracted driving can result in a loss of vehicle control. When operating a vehicle, never use a vehicle system that takes your focus away from safe vehicle operation. Navigation is for information purposes only, and Kia does not make any warranties about the accuracy of the information.
16. **Occupant Detection System (ODS):** Kia vehicles use a number of different ODS types that vary by model.
17. **Power Liftgate* / Smart Liftgate*:** Driving with the liftgate open may be unlawful and can draw dangerous exhaust fumes into your vehicle.
18. **Roadside Assist:** 24-hour Enhanced Roadside Assistance is a service plan provided by Kia Motors America, Inc. Certain limitations apply. Coverage details are available in the Kia Warranty and Consumer Information Manual. For access to Enhanced Roadside Assistance, a connected mobile phone via Bluetooth® within the cellular service coverage area is required.
19. **Seat adjustments:** Reclining the passenger seats can reduce the effectiveness of the safety restraint system and may lead to additional injury in an accident.
20. **Seat belts:** For maximum protection, always wear your seatbelt.
21. **Seat warmers:** Use extreme caution when using the seat warmers to avoid burns. Refer to the Owner's Manual for more information.
22. **SiriusXM®:** SiriusXM Satellite Radio, SiriusXM Traffic and SiriusXM Travel Link each require a subscription sold separately, or as a package, by SiriusXM Radio Inc. **If you decide to continue your service at the end of your trial subscription, the plan you choose will automatically renew and bill at then-current rates until you call 1-866-635-2349 to cancel. See SiriusXM Customer Agreement for complete terms at www.siriusxm.com.** Other fees and taxes will apply. All fees and programming are subject to change. Not all vehicles or devices are capable of receiving all services offered by SiriusXM. Data displays and individual product availability vary by vehicle hardware. Current information and features may not be available in all locations, or on all receivers. Weather Forecast, Current Conditions may not be available in all locations. Images above are for representative purposes only and are not real products. For actual features and images of real products, consult the vehicle manufacturer. SiriusXM is not responsible for any errors or inaccuracies in the data services or their use in the vehicle. Travel Link Stocks displays current price and daily delta of around 7,000 actively reported securities traded on the NYSE®, NASDAQ® and AMEX®. The service is delayed approximately 20 minutes. SiriusXM satellite service is available only for those at least 18 years of age in the 48 contiguous USA, DC, and Puerto Rico (with coverage limitations). SiriusXM Internet Radio service is available throughout our satellite service area and in AK and HI. ©2018 SiriusXM Radio Inc. Sirius, XM and all related marks and logos are trademarks of SiriusXM Radio Inc.
23. **Steering-wheel-mounted controls:** Driving while distracted is dangerous and should be avoided. Remain attentive to driving and be cautious when using steering-wheel-mounted controls while driving.
24. **Sunvisors:** Sunvisor may not shield all direct light. Do not operate the vehicle if sunvisor is impairing your visibility.
25. **Tilt/Telescoping Steering Wheel:** Never attempt to adjust steering wheel position when vehicle is in motion.
26. **Tire Pressure Monitoring System (TPMS):** Even with Tire Pressure Monitoring System, check tire pressure on a regular basis.



STINGER CUSTOMER DELIVERY CHECKLIST

Key Feature Walkthrough

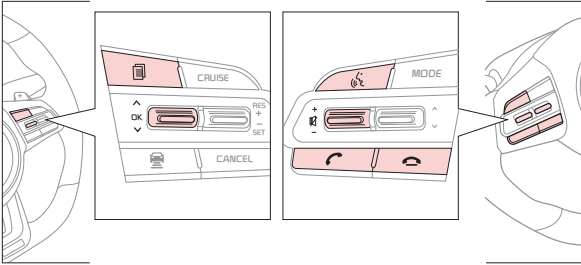

- Smart Cruise Control (SCC) with Stop & Go* – page 22**
Demonstrate operation

- Bluetooth® Wireless Technology – pages 24-25**
Demonstrate operation

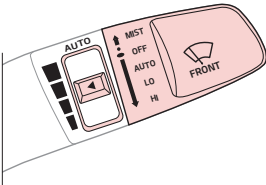

- Windshield Wipers & Washers – page 21**

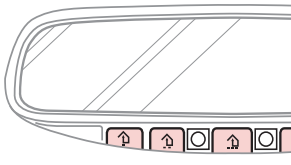

- Auto-Dimming Rearview Mirror with HomeLink® – page 44**

- Aux/USB/iPod® Port, Power Outlets & USB Charger – page 30
- Blind-Spot Collision Warning (BCW)* – page 13
- Clock Setup – page 30
- Electric Parking Brake (EPB) / Auto Hold* - pages 33-34
- Engine Start/Stop Button – page 18
- Head-Up Display (HUD)* – page 10
- Sunroof Operation – page 43
- Parking Distance Warning - Reverse* – page 16
- Passenger Air Bag Off Indicator – page 47
- Front Seat Headrest Adjustment* – page 38
- Seat Warmers/Ventilated Seats – page 36
- Smart Key – page 39
- Sunvisor – page 45
- Tire Pressure Monitoring System (TPMS) – page 6

During Delivery

- Explain first service process and schedule first service appointment
- Tour Parts & Service departments, introduce staff and explain value of Kia Parts and Service
- Review recommended maintenance schedule and maintenance requirements to validate warranty
- Review business hours and Customer 360° Care
- Review the Kia 10-year/100,000-mile warranty program
- Ensure 100% satisfaction with sales and delivery process and no problems with the vehicle
- Confirm time and best contact number for initial dealer follow-up

Sales Consultant: _____

Date: _____

Sales Manager: _____

Date: _____

Customer: _____

Date: _____



STINGER CUSTOMER DELIVERY CHECKLIST

Owner's Name: _____ VIN: _____

Mileage: _____ Dealership Name: _____

Sales Consultant: _____ Date: _____

Before Delivery

- Confirm "Good Battery" with battery tester
- Verify all tire pressures are to spec (see driver's door label) LF _____ LR _____ RF _____ RR _____
- Verify proper operation of Smart Key* lock/unlock
- Ensure floor mats are snapped into place (if applicable)
- Verify vehicle is clean (interior and exterior), in good condition, free of chips and scratches
- Ensure all key documents are in the vehicle (Owner's Manual, Warranty and Consumer Information booklet, Tire Warranty booklet, Features & Functions Guide and any supplemental audio/video/navigation user's guides)

Key Feature Walkthrough

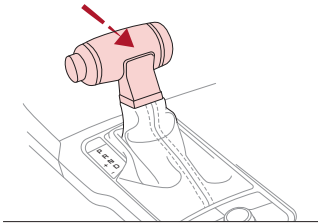

- Automatic Transmission / Sport Shift Mode* – page 32**

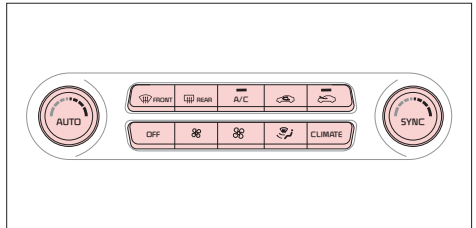

- Automatic Climate Control – page 31**
Demonstrate Air Flow Modes, Defog and Defrosting Windshield Fan Speed.

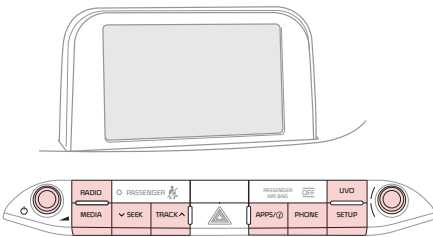

- UVO eServices – pages 27-28**
For further system operation, refer to the Car Multimedia System User's Manual.

- UVO eServices Activation* – page 27**

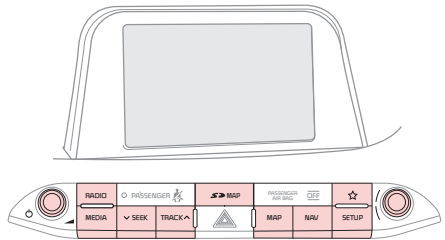

- UVO eServices with Premium Navigation System – page 29** For further system operation, refer to the Car Multimedia System User's Manual.

- Android Auto™ / Apple CarPlay® Setup* – page 27**

