

OPTIMA

hybrid / plug-in hybrid
Features & Functions Guide



Delivery First
The priority that delivers more

GETTING TO KNOW YOUR **OPTIMA HYBRID** AND **PLUG-IN HYBRID**

Congratulations on Your New Kia Purchase!

Your new Kia vehicle has been designed, engineered and manufactured to provide you with years of comfortable and dependable driving. Kia is committed to quality, innovation, safety and — above all — your satisfaction.

Using This Guide

The information contained in this guide is a brief overview that will help you become familiar with the operation and features of your new Kia vehicle. The flipbook format facilitates information access, while the detailed illustrations help to ensure the instructions are easy to follow.

This **Features & Functions Guide**, and the specific operational and safety information it provides, is not a substitute for your Owner's Manual. In the interest of your safety and that of your family, and to help you avoid risks that may result in death or serious injury, Kia reminds you to carefully read your Owner's Manual in order to fully familiarize yourself with the important information it contains.

While Kia endeavors to ensure that the information contained in this guide is accurate at the time of printing, Kia may change vehicle specifications without notice in advance or after the fact, and assumes no liability in connection with such changes.



Available on the App Store, the Kia AR Owner's Manual App uses AR (Augmented Reality) technology to provide tips and useful information about your vehicle.

To use the Kia AR Owner's Manual App:

- Simply scan the interior or engine (motor) room of your vehicle with your smart phone or tablet, select feature/component and view the video guide.
- If you are unable to scan the vehicle, use the AR Manual (without scan) menu, select feature/component and view the video guide.

www.kia.com

Consumer - Roadside Assistance¹¹⁶
1-800-333-4KIA (4542)

See Back Pages for Vehicle
Maintenance Schedule

*Always check the Owner's Manual for complete
operating information and safety warnings.*

ESSENTIAL FEATURES

Air Conditioning / Climate Control	33
Audio System – Android Auto™ / Apple CarPlay® Setup*	28
Audio System – UVO eServices* / UVO eco Activation*	29
Audio System – UVO eServices*	30
Audio System – UVO eServices w/ Premium Navigation*	31
Audio System – UVO eco with Navigation*	32
Aux/USB/iPod® Port & Power Outlets	33
<i>Bluetooth®</i> Wireless Technology	23
Charging the Plug-In Hybrid EV Battery*	14
Cruise Control	25
Digital Clock	33
ECO Mode (Active ECO)	10
Fuel Economy	08
Hybrid/Plug-In Hybrid Displays	11
Instrument Cluster - Hybrid/Plug-In Displays	12
Passenger Airbag Off Indicator	47
Tire Mobility Kit	46
Tire Pressure Monitoring System (TPMS)	05
Windshield Wipers & Washers	22

Driving while distracted can result in a loss of vehicle control that may lead to an accident, severe personal injury and death. The driver's primary responsibility is in the safe and legal operation of a vehicle, and use of any handheld devices, other equipment or vehicle systems which take the driver's eyes, attention and focus away from the safe operation of a vehicle or that are not permissible by law should never be used during operation of the vehicle.



OPTIMA HYBRID / PLUG-IN HYBRID FEATURES & FUNCTIONS GUIDE

VIDEOS & QR CODES	02
INSTRUMENT CLUSTER	
Instrument Cluster Overview	03
Indicators & Warning Lights	04
Tire Pressure Monitoring System (TPMS)	05
Hybrid/Plug-In Indicators at Startup	06
LCD Instrument Cluster Modes	07
Trip Modes/Trip Computer	07
Fuel Economy	08
User Settings	09
Service Interval Mode	09
Drive Mode Integrated Control System* (Hybrid) / Active ECO System* (Plug-In Hybrid)	10
HYBRID / PLUG-IN SYSTEM	
UVO eServices with Premium Navigation* / UVO eco with Navigation Display*	11
Instrument Cluster–Energy Flow	12
Charging the Plug-In Hybrid Vehicle*	14
DRIVER'S PANEL	
Blind-Spot Collision Warning (BCW) w/ RCCW*	16
Lane Departure Warning (LDW)*	17
Forward Collision-Avoidance Assist (FCA) / Forward Collision Warning (FCW)*	18
Instrument Panel Dimmer	18
Electronic Stability Control (ESC)	18
Hill-Start Assist Control (HAC)	19
Engine Start/Stop Button	19
Power Windows, Window Lock & Central Door Lock	20
Automatic Door Lock/Unlock	20
Power/Heated Outside Mirrors*	20
Power Folding Outside Mirrors*	20
STEERING WHEEL CONTROLS	
Headlights & High Beams	21
High Beam Assist*	21
Turn Signals & Fog Lights	21
Windshield Wipers & Washers	22
Heated Steering Wheel Button*	22
<i>Bluetooth®</i> Wireless Technology	23
Audio Controls	25
Cruise Control	25
Smart Cruise Control (SCC) with Stop & Go*	26
Tilt/Telescoping Steering Wheel	27

AUDIO SYSTEM	
Android Auto™ / Apple CarPlay® Setup*	28
UVO eServices / UVO eco Activation	29
UVO eServices	30
UVO eServices with Premium Navigation*	31
UVO eco with Navigation*	32
CENTER PANEL	
Digital Clock	33
Aux/USB/iPod® Port & Power Outlets	33
Automatic Climate Control (UVO eServices)*	34
Automatic Climate Control (Systems with Navigation*)	35
Automatic Gear Shift with Sportmatic® Shifting	36
Seat Warmers / Ventilated Seats*	36
Electric Parking Brake (EPB)*	37
Auto Hold	37
SEATING	
Driver Position Memory System*	38
Front Seat Headrest Adjustment	38
Power Adjustable Driver's Seat*	39
6-Way Manual Adjustable Driver's Seat*	39
OTHER KEY FEATURES	
Smart Key	40
Double-Turn Lock/Unlock All	40
Smart Power Trunk*	41
Map / Room Lamps	42
Panoramic Sunroof Operation*	42
Hood Release Lever and Latch	43
Fuel Door and Trunk Release	43
Fuel Cap / Malfunction Indicator	43
Sunvisor	43
Parking Distance Warning-Reverse*	44
Rear-Camera Display*	44
Hybrid/Plug-In Battery Air Intake	45
Child-Protector Rear Door Lock	46
Tire Mobility Kit	46
SAFETY FEATURES	
Occupant Detection System (ODS) / Passenger Airbag Off Indicator	47
Seat Belts	47
Seat Belt Retractor Locks	47
LEGAL DISCLAIMERS (See Inside Back Cover)	
MAINTENANCE SCHEDULE (See Back Cover)	

*IF EQUIPPED

Kia provides a number of video resources to assist you with becoming familiar with the features and functions found in your Kia vehicle. You can access these resources by snapping the QR Codes with your smartphone/tablet (mobile devices) or by visiting the following website: www.youtube.com/KiaFeatureVideos. Continue reading for a more in-depth look at QR Codes and for instructions on how to use them.

What are QR Codes?

A QR Code is a square, two-dimensional barcode that can be read by mobile devices loaded with an appropriate barcode or QR Code Reader App. The app reads the barcode image and then launches/uploads the specific information the code contains, such as URLs, text, photos, videos and so much more.

How to Use QR Codes

If you have a mobile device with a QR Code Reader App, you can snap the code with your phone and you'll be provided a video with additional information pertaining to the topic. For example, in the Fuel Cap section, if you would like additional information, just snap the code with your mobile device to view the selected Kia Features & Functions Video.

How to Snap a QR Code

1. With your mobile device, download a QR Code Reader App. With many devices, you can do this through an app store or marketplace
2. Open the QR Code Reader App on your mobile device
3. The app will utilize your device's camera. Center the code in the camera viewing area:
 - With some apps, as soon as the app recognizes the code, it will launch the corresponding video
 - With other apps, you will have to snap or take a picture of the code. The app will then launch the corresponding video
 - For operation specifics, refer to the instructions that come with the QR Code Reader App

QR CODE

One Click Fuel Cap Video

To view a video on your mobile device, snap this QR Code or visit the listed website.



www.youtube.com/KiaFeatureVideos

REMINDER: When accessing videos on your mobile device, standard cellular data rates may apply.

QUICK TIPS

1. If you're having trouble scanning codes, check the following:
 - The code should be centered and focused in your mobile device's camera screen
 - Consider moving your device closer to or farther away from the code
 - The code should be well lit, without significant shadow
 - Avoid scanning from a significant angle
 - Confirm that the device's app supports 2D QR Code scanning
 - Try another QR Code Reader App; not all apps are created equal
2. After scanning, if a "connecting" message appears and then nothing happens or there's a "connection error" message, this typically indicates that your device is having trouble connecting to the Internet

Instrument Cluster Overview

- A** ECO Guide
- B** State of Charge (SOC) Gauge
- C** Turn Signal Indicators
- D** Gear Shift Position Indicator
- E** Indicator and Warning Lights
- F** Speedometer
- G** Fuel Gauge

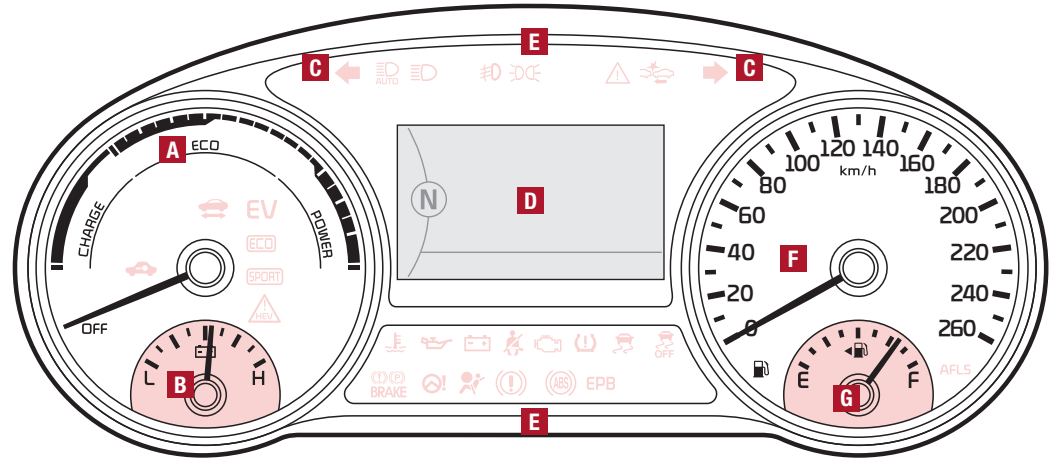

Your vehicle's instrument cluster & indicator light locations may differ from those in the illustrations. For more information on the instrument cluster, the LCD Warning Messages and the function of all indicator and warning lights, please refer to the Owner's Manual.

This illustration is for demonstration purposes only. Some indicators and warning lights may not appear in illustration. On the vehicle, they may appear in the LCD.

Indicators & Warning Lights

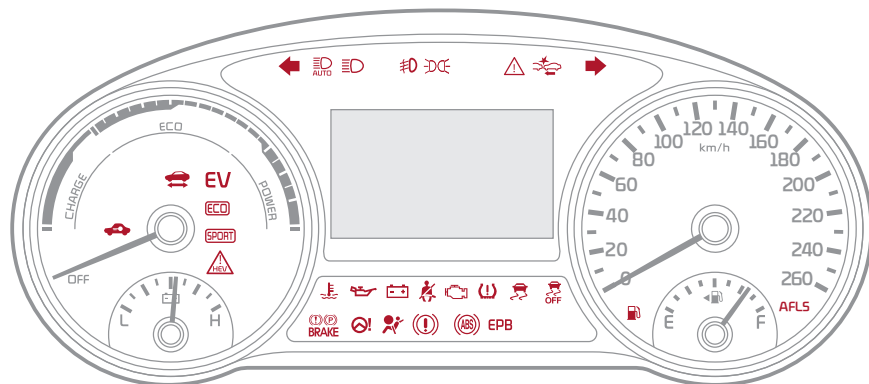

Your vehicle's instrument cluster & indicator light locations may differ from those in the illustrations. For more information on the instrument cluster, the LCD Warning Messages and the function of all indicator and warning lights, please refer to the Owner's Manual.

This illustration is for demonstration purposes only. Some indicators and warning lights may not appear in illustration. On the vehicle, they may appear in the LCD.

- | | | | | | |
|--|---|--|--|--|---|
| | High Beam Assist Indicator* | | Active ECO Indicator | | Electronic Power Steering (EPS) System Warning Light* |
| | High Beam Indicator | | SPORT Mode Indicator Light* | | Airbag Warning Light |
| | Tail Light Indicator | | Hybrid System Warning Light* | | Parking Brake Light |
| | Front Fog Light Indicator* | | Engine Coolant Temperature Warning Light* | | Anti-lock Braking System (ABS) Warning Light |
| | Master Warning Light* | | Engine Oil Pressure Warning Light | | EPB Electronic Parking Brake Indicator |
| | Forward Collision-Avoidance Assist (FCA)* | | 12V Charging System Warning Light | | Low Fuel Level Warning Light |
| | Lane Departure Warning (LDW) On/Off Indicator Light | | Seat Belt Warning Light | | CRUISE Cruise ON/OFF Indicator* |
| | Electronic Brake Force (EBD) System Warning Light
(Two separate indicators on Instrument Cluster lit at same time) | | Malfunction Indicator | | Trunk Open Warning Light |
| | Immobilizer Indicator* | | Low Tire Pressure Light/Tire Pressure Monitoring System (TPMS) Malfunction Indicator | | AUTO HOLD Auto Hold Indicator |
| | READY Indicator | | Electronic Stability Control (ESC) Indicator/ESC Malfunction Indicator | | Door Ajar Warning Light |
| | EV Mode Indicator | | Electronic Stability Control (ESC) OFF Indicator | | (EBC) (system color) Regenerative Brake Warning Light |
| | | | Parking Brake & Brake Fluid Warning Light | | AFLS Adaptive Front-Lighting System-Height (AFS-H) Light* |

Tire Pressure Monitoring System (TPMS)^{†25}



The TPMS indicator (⚠️) functions as both Low Tire Pressure Light and TPMS Malfunction Indicator. The indicator (⚠️) is designed to illuminate if it detects one or more tires is significantly underinflated, the vehicle has a spare tire installed without TPMS or the outside temperature becomes significantly lower.

The LCD screen in the instrument cluster will display the Low Tire Pressure indicator **A** showing which tire(s) is underinflated. Inflate tire(s) to specifications using an accurate digital tire pressure gauge to turn off Low Tire Pressure Light (⚠️). See front driver's door jamb for PSI specification.

When there is a problem with the TPMS, the TPMS Malfunction Indicator (⚠️) will blink for approximately one minute and then illuminate—see dealer for service.

QUICK TIP

- Even with TPMS, tire pressure should be checked manually at least once a month. Only adjust tire pressure on “cold tires”
- For proper maintenance and optimal fuel economy, maintain recommended tire inflation pressures and stay within the load limits and weight distribution recommended for your vehicle
- In winter or cold weather, the TPMS light may illuminate if the tire pressure was adjusted to the recommended tire inflation pressure during warm weather

REMINDERS:

- Check the recommended tire pressure label located on the left side of driver's door jamb, which is visible when the door is opened.
- Consult your dealer for service if Low Tire Pressure Light remains illuminated after inflating your tire(s).
- Personal electronic devices (such as laptops, wireless chargers, remote start systems, etc.) that have electronic noise may interfere with TPMS system, which may cause the Malfunction Warning Indicator (Check Engine Light) to illuminate.

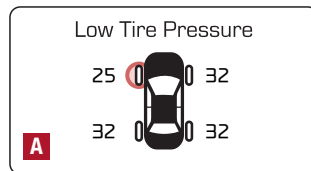

QR CODE

Tire Pressure Monitoring System Video

To view a video on your mobile device, snap this QR Code or visit the listed website.

Refer to page 2 for more information.



www.youtube.com/KiaFeatureVideos

Hybrid / Plug-In Indicators at Startup

A ECO Guide - Indicates how economically the vehicle is being driven.

- **Blue zone:** High-efficiency range
- **Green zone:** Normal-efficiency range
- **White zone:** Low-efficiency range

B EV Mode - Illuminates when the electric motor is powering the vehicle.

C Ready - Illuminates when the Hybrid/Plug-In system is operational. Even if the engine is off, the vehicle can be driven.

D State of Charge (SOC) - Displays the Hybrid/Plug-In battery charge status.

E Active ECO - Automatically activated each time the vehicle is started. Turn system ON/OFF using the ECO button on the center console.

- **Active ECO ON** (Eco indicator illuminated): Adjusts the engine, transaxle and A/C system to help conserve fuel
- **Active ECO OFF** (Eco indicator not illuminated): Provides more power when driving up steep roads or carrying heavy loads

F Service Indicator - Illuminates when a malfunction occurs in the vehicle's Hybrid/Plug-In system. Have an authorized Kia dealer address the concern as soon as possible.

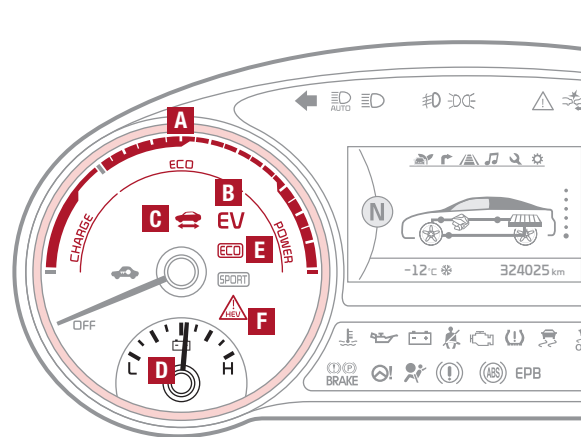

QUICK TIP

If Active ECO is turned off, switch back to Active ECO as soon as possible to help enhance fuel efficiency and to restore the ECO ON center display.

REMINDER: Avoid starting or driving the vehicle when the fuel tank is empty. As the engine will be incapable of charging the high-voltage Hybrid/Plug-In battery, the battery will lose its charge and may be damaged.

Your vehicle's instrument cluster & indicator light locations may differ from those in the illustrations. For more information on the instrument cluster, please refer to the Owner's Manual.

This illustration is for demonstration purposes only. Some indicators and warning lights may not appear in illustration. On the vehicle, they may appear in the LCD.

LCD Instrument Cluster Modes

Press Mode button **A** to scroll through different LCD Instrument Cluster Modes.

 **Trip Computer Mode:** Displays driving information for tripmeter, fuel economy, etc.

 **Turn-by-Turn Mode*:** Displays the state of the navigation

 **SCC/LDW* Mode:** Displays the state of the Smart Cruise Control with Stop & Go and the Lane Departure Warning (LDW)

 **A/V Mode*:** Displays the state of the A/V System

 **Service Modes:** Informs on upcoming service intervals, tire pressure status, warning messages related to TPMS, Blind-Spot Collision Warning malfunction and when any door is not securely closed

 **User Settings Mode:** Change settings of the doors, lamps and other features

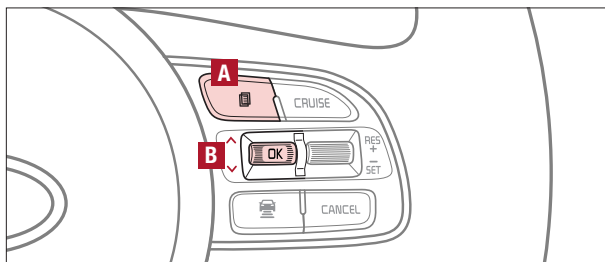

(Buttons located on Steering Wheel – Type A shown)

Your vehicle's steering wheel buttons may differ from those in the illustrations.

Driving while distracted is dangerous and should be avoided. Drivers should remain attentive to driving and always exercise caution when using the steering wheel mounted controls while driving.

ALWAYS CHECK THE OWNER'S MANUAL FOR COMPLETE OPERATING INFORMATION AND SAFETY WARNINGS.

Trip Modes / Trip Computer

The Trip Computer is a driver information system that displays information related to driving. It appears on the display when the Engine Start/Stop button is in the ON position.

To cycle through the Trip modes, press the Mode button **A**.

When in the Trip Computer mode , press the Select/Reset button **B** to cycle through the screens. When displaying TRIP A or TRIP B screens, press and hold the Select/Reset button **B** to reset the Tripmeter to zero.

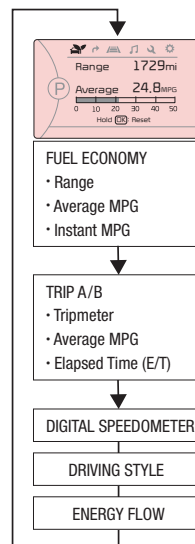

(Hybrid screen shown above)

REMINDERS:

- Appearance of Trip Computer display may differ as equipped
- All stored driving information (except Odometer and Range) is reset if the battery is disconnected

Your vehicle's instrument cluster & indicator light locations may differ from those in the illustrations. For more information on the instrument cluster, please refer to the Owner's Manual.

This illustration is for demonstration purposes only. Some indicators and warning lights may not appear in illustration. On the vehicle, they may appear in the LCD.

Your vehicle's steering wheel buttons may differ from those in the illustrations.

Fuel Economy

There are several factors that contribute to your vehicle's fuel economy, including maintenance of your vehicle, driving style, environmental conditions, vehicle weight and vehicle aerodynamics. Below are tips on how to help improve fuel economy:

- Keep your vehicle in good condition with regular maintenance
- Don't let the engine idle longer than necessary
- Drive at a moderate speed, accelerating smoothly and at a moderate rate
- Keep tires inflated to the recommended pressure
- Travel lightly, without carrying unnecessary weight in your vehicles
- Avoid placing large or heavy items on roof racks
- Avoid hilly, winding or poorly maintained roads

For more information on Fuel Economy, you can snap the QR Code at right to view a video or refer to the Owner's Manual.

When the Instrument Cluster LCD screen is in the Trip Computer mode, the screen displays fuel economy information related to the driving range and average fuel economy.

To change modes, go to User Settings in the LCD Instrument Cluster modes.

Range - Estimates how far you can go before refueling is required.

Average Fuel Consumption - Calculates average fuel consumption from the distance driven and amount of fuel injected into the engine/total fuel used.

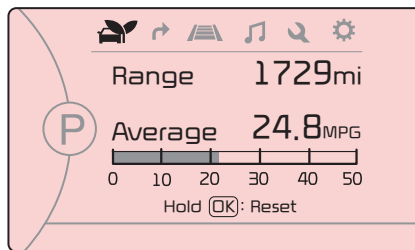

Your vehicle's instrument cluster & indicator light locations may differ from those in the illustrations. For more information on the instrument cluster, please refer to the Owner's Manual.

This illustration is for demonstration purposes only. Some indicators and warning lights may not appear in illustration. On the vehicle, they may appear in the LCD.

QR CODE

Fuel Economy Video

To view a video on your mobile device, snap this QR Code or visit the listed website.

Refer to page 2 for more information.



www.youtube.com/KiaFeatureVideos

User Settings

To enter the User Settings mode in the LCD Instrument Cluster Modes, press the Mode button **A** when the vehicle is at a standstill and with the Engine Start/Stop button* in the ON position and select User Settings .

You can navigate the selections on the display by pressing the Select/Reset button **B** up/down, and then selecting the item by pressing the Select/Reset button **B** again.

Driving Assist:

- Smart Cruise Control Response*
- Rear Cross-Traffic Collision Warning (RCCW)*
- Forward Collision-Avoidance Assist (FCA)*
- FCW (Forward Collision Warning)*
- Coasting Guide*

Door/Trunk:

- Automatically Lock
- Automatically Unlock
- Smart Trunk*
- Two Press Unlock*
- Horn Feedback*

Lights:

- One-Touch Turn Signal*
- Headlamp Delay
- Welcome Light*

Sound:

- Parking Distance Warning-Reverse* Volume*
- Blind-Spot Collision Warning (BCW) Sound*
- Welcome Sound*
- Cluster Voice Guidance*

Convenience:

- Easy Seat Access*
- Steering Position
- Wireless Charging System*
- Wiper/Light Display*

Other features:

- Fuel Economy Auto Reset
- Fuel Economy Unit
- Temperature Unit
- Tire Pressure Unit*
- Language*

Service Interval:

- Adjust Interval*
- Reset

Your vehicle's instrument cluster & indicator light locations may differ from those in the illustrations. For more information on the instrument cluster, please refer to the Owner's Manual.

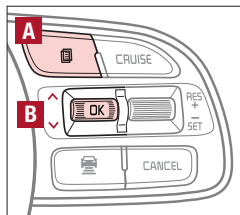

(Buttons located on Steering Wheel – Type A)

Service Interval Mode

To enter Service Interval mode, press the Mode button **A**, scroll to Service Interval mode  and press Select/Reset button **B**. System will display number of miles remaining until next service is due, as well as type of service.

When service is required, the following will be displayed:

Service Required

To reset the Service Interval mode system, press and hold the Select/Reset button **B** for more than 1 second.

To turn Service In OFF, go to User Settings.

Service Interval Setting

To set the service interval when in User Settings mode:

- Press the Select/Reset button **B** up/down and scroll to Service Interval. Press the Select/Reset button **B** to enter
- Press the Select/Reset button **B** up/down and toggle to ON, then press the Select/Reset button **B** again. Then press the Select/Reset button **B** to scroll and select the desired miles or months for your next service
- Press the Select/Reset button **B** again to enter

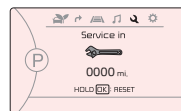
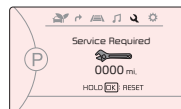

QR CODES

To view a video on your mobile device, snap these QR Codes or visit the listed website.

Refer to page 2 for more information.

LCD Display Video



www.youtube.com/KiaFeatureVideos

LCD Display: Maintenance Video



www.youtube.com/KiaFeatureVideos

These illustrations are for demonstration purposes only. Some indicators and warning lights may not appear in illustration. On the vehicle, they may appear in the LCD.

Drive Mode Integrated Control System* (Hybrid) / Active ECO System* (Plug-In Hybrid)

The Drive Mode may be selected based on the driver's preferences and road conditions.

To cycle through the different Drive Modes **A**, press the DRIVE MODE*/ACTIVE ECO* button **B**. The instrument cluster will display SPORT* or ECO when selected. When in NORMAL mode, it will not display in the instrument cluster.

Hybrid*

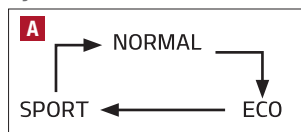

(Buttons located below Gear Shift - Type B shown)

Plug-in Hybrid*

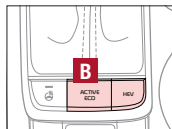
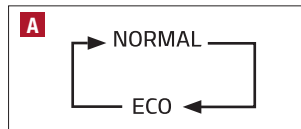

REMINDERS:

- The system is turned ON and in ECO mode when ignition is in the ON position
- When NORMAL mode is selected, the indicator will display and system remains on. When ignition is cycled, the system will default to ECO.
- When ECO mode is selected, the following may occur to help improve fuel economy:
 - Acceleration may be slightly reduced even when the accelerator is fully depressed
 - Air conditioner performance may be limited
 - Shift pattern of the automatic transmission may change
 - Engine noise may increase
 - System's power will be limited when driving uphill
- Steering effort may be slightly increased in Sport mode

ECO Mode (Active ECO)

Active ECO is designed to help improve fuel economy by controlling several vehicle components. When activated, it optimizes drivetrain operations such as engine power and transmission.

To turn ON, press the DRIVE MODE*/ACTIVE ECO* button **A**. The button light will turn on, and the green ECO indicator light **B** in the instrument cluster will illuminate (indicating that you are getting optimal fuel efficiency). Active ECO system will remain on even when the ignition is cycled.

To turn the Active ECO system OFF, press the button **A** again.

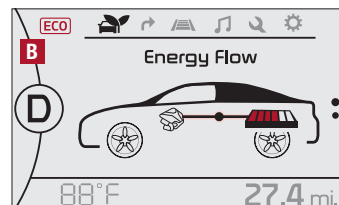

(Located in Instrument Cluster; image may vary)

QUICK TIPS

- To help improve your fuel economy:
- Drive at a moderate speed, accelerating smoothly and at a moderate rate
 - Keep tires inflated to the recommended pressure
 - Be sure the wheels are properly aligned

QR CODE

Drive Mode System Video

To view a video on your mobile device, snap this QR code or visit the listed website.

Refer to page 2 for more information.



www.youtube.com/KiaFeatureVideos

For more information on Active ECO, refer to your Owner's Manual or contact your local dealership.

Your vehicle's instrument cluster & indicator light locations may differ from those in the illustrations. For more information on the instrument cluster, please refer to the Owner's Manual.

These illustrations are for demonstration purposes only. Some indicators and warning lights may not appear in illustration. On the vehicle, they may appear in the LCD.

UVO eServices with Premium Navigation* / UVO eco with Navigation Display*

When equipped, the UVO eServices with Premium Navigation system (Hybrids only) and the UVO eco with Navigation Display (Plug-In Hybrids only) provide information on economical driving and system modes.

To enter the display mode to see this information, press the INFO key on the audio control unit. Press the HYBRID/PHEV button. Then select one of the three menus **A** – FUEL ECONOMY*, ECO DRIVING or ENERGY FLOW.

A System Home Screens

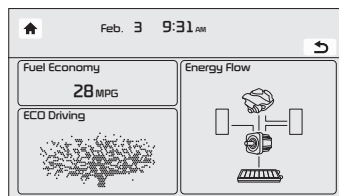

Hybrid Screen

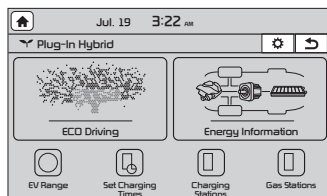

Plug-In Hybrid Screen*

ECO Level - The more economically you drive, the more the ECO Level increases.

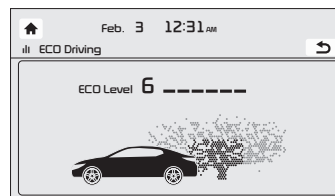

Hybrid Screen

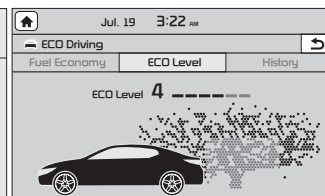

Plug-In Hybrid Screen

Energy Flow - Displays the current flow of power between the Hybrid's/Plug-In Hybrid's main powertrain components.

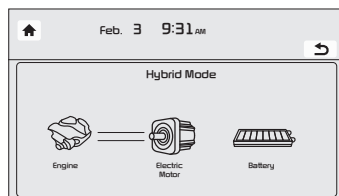

Hybrid Screen

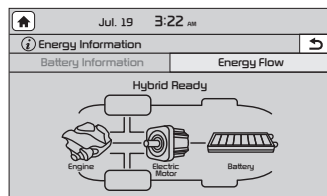

Plug-In Hybrid Screen*

Fuel Economy - Displays the average fuel economy over the duration of a trip.

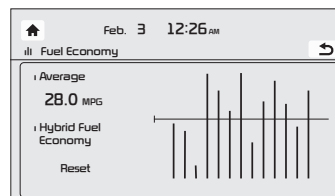

Hybrid Screen

Your vehicle's instrument cluster & indicator light locations may differ from those in the illustrations. For more information on the instrument cluster, please refer to the Owner's Manual.

These illustrations are for demonstration purposes only. Some indicators and warning lights may not appear in illustration. On the vehicle, they may appear in the LCD.

Instrument Cluster – Energy Flow

Optima Hybrid/Plug-In's instrument cluster displays the following Hybrid/Plug-In system modes to inform the driver of its status. To change modes, go to User Settings in the LCD Instrument Cluster modes.

EV Propulsion - The electric motor is moving the vehicle.

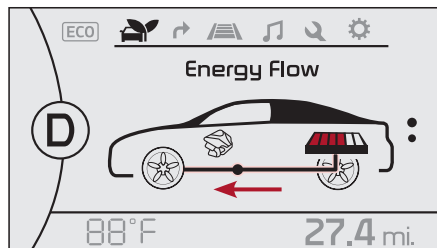

Engine-Only Propulsion - The engine is moving the vehicle.

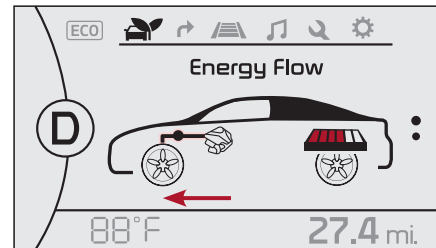

Power Assist - Both the electric motor AND the engine are moving the vehicle.

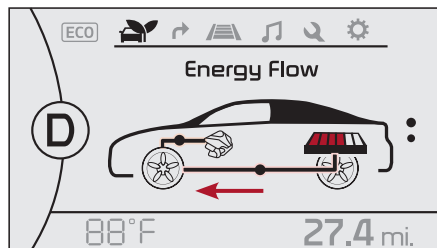

Engine Generation - While the vehicle is stopped, the engine is charging the Hybrid/Plug-In battery.

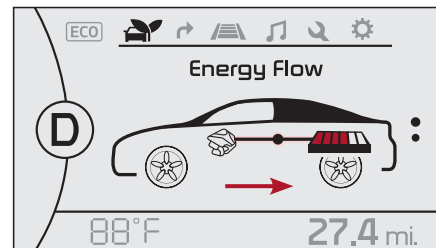

Your vehicle's instrument cluster & indicator light locations may differ from those in the illustrations. For more information on the instrument cluster, please refer to the Owner's Manual.

These illustrations are for demonstration purposes only. Some indicators and warning lights may not appear in illustration. On the vehicle, they may appear in the LCD.

Instrument Cluster – Energy Flow

Optima Hybrid/Plug-In's instrument cluster LCD screen displays the following Hybrid/Plug-In system modes to inform the driver of its status. To change modes, go to User Settings in the LCD Instrument Cluster modes.

Power Reserve - While the engine powers the vehicle, it is also recharging the Hybrid/Plug-In battery.

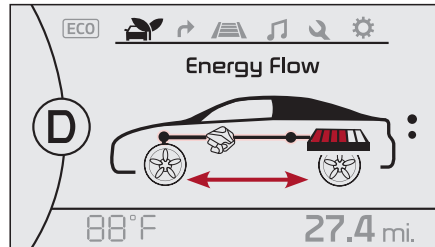

Engine Brake/Regeneration - The regenerative braking system is recharging the Hybrid/Plug-In battery.

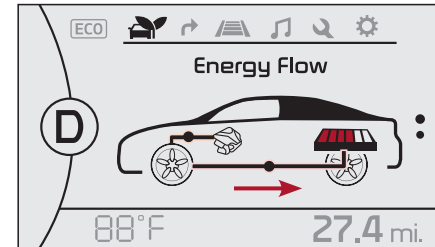

Vehicle Stop - The vehicle's Hybrid/Plug-In system is standing by.

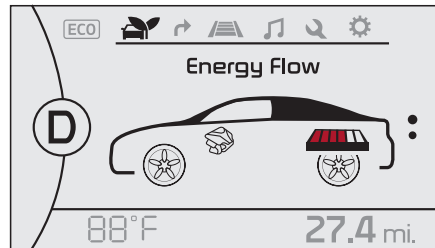

Engine Generation/Regeneration - The engine and the regenerative braking system are both recharging the Hybrid/Plug-In battery.

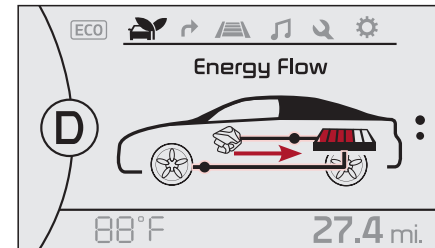

Your vehicle's instrument cluster & indicator light locations may differ from those in the illustrations. For more information on the instrument cluster, please refer to the Owner's Manual.

These illustrations are for demonstration purposes only. Some indicators and warning lights may not appear in illustration. On the vehicle, they may appear in the LCD.

Charging the Plug-In Hybrid Vehicle*

Level 1 Charging – “Trickle” Charge

A Level 1 or “trickle” charger is the most common type of charging system for a Plug-In Hybrid. This type of charger uses 110 volts of household electricity and takes up to 9 hours for a full charge.

Trickle Charger Indicators:

A ICCB - In-Cable Control Box

C Charge - Indicates that the vehicle is charging.

B Power - Indicates that the charger is plugged in and functioning.

D Fault - Indicates charge failure.

REMINDER: Do not use an extension cord. Plug Trickle charger directly into wall socket.

Level 2 Charging – “Normal” Charge

A Level 2 or “normal” 240-volt charger is the recommended charging system for your Optima Plug-In Hybrid. This type of charger uses 240 volts of electricity and takes approximately 2.5-3 hours for a full charge based on Kia Motors Corporation testing with SAE J1772 charger performed at 3.3kW. This charger can possibly be installed at your home or found at a public charging station.

REMINDER: Shape of charger and how to use the charger may be different for each manufacturer. Please see Owner’s Manual for more information.

QUICK TIPS

A Level 2 or “normal” 240-volt charger is recommended for regular charging of the vehicle.

REMINDER: For more detail and/or subsequent steps in charging your vehicle, please see the Owner’s Manual.

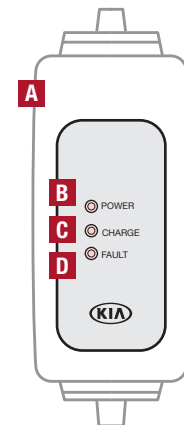

(Control box on charging cable)

Charging the Plug-In Hybrid Vehicle* (Continued)

To charge the Optima Plug-In Hybrid vehicle using a normal/trickle charger:

1. Connect the ICCB **A** plug to an electrical outlet
2. Check if the power light (green) **B** on the ICCB turns on
3. Press the brake pedal and engage the parking brake
4. Turn off all switches, put the shift lever in P (Park), and turn off the vehicle
5. Open the charging door **E** by pressing the charging door (Ensure doors are unlocked)
6. Remove any dust on the charging connector and charging inlet **F**
7. Hold the charging connector handle **G** and connect it to the vehicle's trickle charging inlet **F** by pushing the connector until you hear a "clicking" sound
8. Charging begins automatically (Ensure the charge indicator light **S** is illuminated on your instrument cluster, indicating the vehicle is charging)

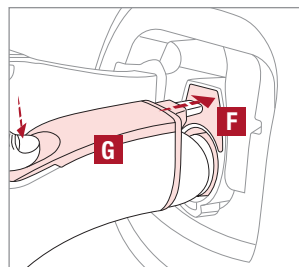
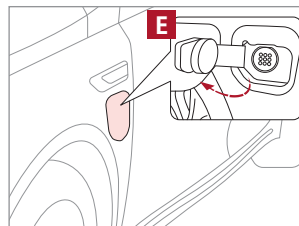

Checking the Charging Status

The charging status can be checked by viewing the charging status indicator on the dash panel. The lights will progressively become lit as the vehicle approaches a full charge.

After charging has started, the estimated charging time is displayed on the Instrument Cluster LCD **I** for about 1 minute. It is also displayed when the driver's door is opened with charging in progress.

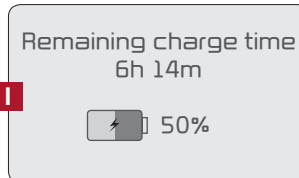

REMINDERS:

- For more detail and/or subsequent steps in charging your vehicle please see the Owner's Manual.
- The charge door lock will unlock/open only when driver's side door is unlocked

Blind-Spot Collision Warning (BCW) w/ RCCW*†6

The BCW system uses radar sensors to help alert the driver in certain situations before changing lanes. The light on the BCW button **A** will illuminate when turned ON. The outside rearview mirror warning lights will also illuminate for 3 seconds.

The system will become active when the vehicle is traveling faster than 18 mph and will alert the driver if another vehicle is detected by the radar sensor.

1st-stage alert: When another vehicle is detected within the BCW System boundary **B**, a yellow indicator will illuminate on the outside rearview mirrors.

2nd-stage alert: When 1st-stage alert is on and the driver activates a turn signal, a flashing yellow indicator will illuminate on the outside rearview mirrors and the system will sound an alert.

Rear Cross-Traffic Collision Warning (RCCW)*

If the RCCW system sensors detect approaching vehicles from the left or right side **C**, the system will sound an audible alert, the warning indicators on the outside rearview mirror will illuminate and a message will appear on the LCD screen. The RCCW system is active under the following conditions:

- When the vehicle is in Reverse
- When the vehicle moves in reverse from a parking position
- When the vehicle is moving slower than 6 mph

REMINDERS:

- The BCW system will not show a warning if the vehicle speed is only 6 mph above the surrounding vehicles
- If the BCW is turned ON and the ignition is cycled, the BCW system returns to ON
- The RCCW feature can be turned OFF/ON in User Settings and will remain in OFF/ON as selected
- The RCCW system will show a warning if the approaching vehicle speed is between 2.5-22 mph within sensing range. See owner's manual for other conditions.

The BCW and RCCW systems are supplemental systems. Do not solely rely on these systems and always pay attention to drive safely. For more information on Blind-Spot Collision Warning, please refer to the Owner's Manual.

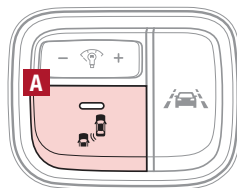

(Buttons are located left of the Steering Wheel)

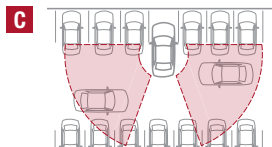
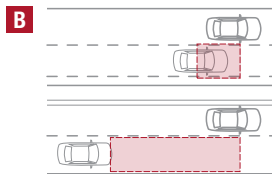

REMINDER: The above images are for illustration purposes only and may not reflect actual operation.

QR CODE

Blind-Spot Collision Warning w/ RCCW Video

To view a video on your mobile device, snap this QR Code or visit the listed website.

Refer to page 2 for more information.



www.youtube.com/KiaFeatureVideos

Lane Departure Warning (LDW)*†6

With the ENGINE START/STOP button in the ON position, press the LDW button **A** to turn system ON. The instrument cluster indicator  will initially illuminate white. It will remain white when vehicle is traveling slower than 40 mph and the system does not detect lane markers. When the system detects lane markers, the LDW icon will illuminate green.

If the LDW detects that you are moving outside of your lane, the system may issue a warning on the LCD screen and an alert may sound.

All systems will operate under the following conditions:

- The vehicle exceeds approximately 55 mph
- The LDW system recognizes both lane markers the vehicle is traveling in
- The vehicle is between the lane markers
- LDW will stay on when the ignition is cycled

REMINDERS:

- LDW will not issue a warning if the turn signal is activated
- The BCW and RCCW systems are supplemental systems. Do not solely rely on these systems and always drive safely

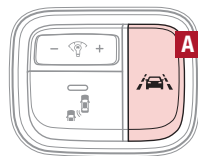

(Buttons are located left of the Steering Wheel)



When the LDW sensor detects the lane traveled in, both lanes are illuminated



When the LDW sensor does not detect the lane traveled in, the lanes are not illuminated



When the LDW sensor detects the vehicle moving outside of the lane being traveled in, a yellow indicator will illuminate either on the left or right lane (shown in both images above)



QR CODE

Lane Departure Warning Video

To view a video on your mobile device, snap this QR Code or visit the listed website.

Refer to page 2 for more information.



www.youtube.com/KiaFeatureVideos

The LDW is not a substitute for safe and proper driving. Always drive safely and use caution. LDW may not always alert the driver if the vehicle is about to be driven outside of its lane. Refer to the Owner's Manual for more information.

Your vehicle's instrument cluster & indicator light locations may differ from those in the illustrations. For more information on the instrument cluster, please refer to the Owner's Manual.

These illustrations are for demonstration purposes only. Some indicators and warning lights may not appear in illustration. On the vehicle, they may appear in the LCD.

Forward Collision-Avoidance Assist (FCA)/Forward Collision Warning (FCW) are not substitutes for safe driving, and may not detect all objects in front of vehicle. Always drive safely and use caution.

Forward Collision-Avoidance Assist (FCA) / Forward Collision Warning (FCW)^{†9}

The FCA is designed to help alert the driver and, under certain conditions if necessary, apply emergency braking when rapidly approaching a vehicle that is slowing down, braking or stopped. Initially, the Forward Collision Warning (FCW) will provide a warning when it detects a potential collision with a vehicle in front and emit an audible warning and visual alert on the instrument cluster. Adjust the alert settings (Early, Normal, Late) in the User Settings. To turn the FCA/FCW off, go to User Settings again and turn off.

If the system detects that the collision risk increases, the Forward Collision-Avoidance Assist (FCA) automatically applies the brakes to reduce your speed, helping minimize the effects of a possible collision.

If the system detects that the collision risk increases, the Forward Collision-Avoidance Assist (FCA) automatically applies the brakes to reduce your speed, helping minimize the effects of a possible collision.

FCA can be turned ON in the User Settings menu on the Instrument Cluster display. The FCA/FCW will become active when the:

- Engine Start/Stop button is ON
- Vehicle is traveling faster than 5 mph
- Electronic Stability Control (ESC) is ON

REMEMINDERS:

- The FCA/FCW will be activated by default when the ignition is cycled ON, even when previously set to OFF
- The FCA/FCW will not operate when the vehicle is traveling more than approximately 50 mph
- If the FCA is operating and the ESC (Electronic Stability Control) is turned off, the FCA system is automatically turned off
- When FCA system is off, the FCA warning indicator is on in the Instrument Cluster

The Forward Collision-Avoidance Assist (FCA)/Forward Collision Warning System (FCWS) are not substitutes for safe and proper driving. Always drive safely and use caution. FCA and FCW may not always alert the driver when the vehicle is approaching another vehicle.*



Instrument Panel Dimmer

Toggle switch **A** up or down to adjust display brightness of the instrument panel illumination.

REMINDER: The Instrument Panel Dimmer does not adjust brightness on the audio system screens; use the system's setup menu to adjust brightness on the screens.

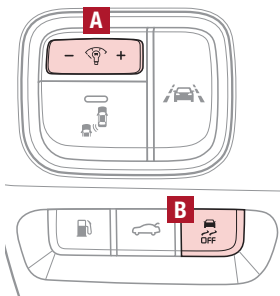

(Located left of Steering Wheel)

Electronic Stability Control (ESC)^{†7}

The ESC system is designed to help stabilize the vehicle during certain cornering maneuvers. It is a good idea to keep the ESC turned ON for daily driving whenever possible. Press ESC OFF button **B** to disable Traction Control in ESC (ESC OFF indicator will illuminate).

To turn both Traction Control and Stability Control off, press and hold ESC OFF button **B** (ESC OFF indicator will illuminate, and an alert sounds).

REMININDERS:

- ESC is active by default at vehicle start-up
- The ESC Indicator Light  in the instrument cluster will illuminate whenever the ESC is in operation

For more information on Electronic Stability Control (ESC) and its specific features and operations, please refer to your Owner's Manual.

QR CODE

Forward Collision Warning Video

To view a video on your mobile device, snap this QR Code or visit the listed website.

Refer to page 2 for more information.



www.youtube.com/KiaFeatureVideos

Hill-Start Assist Control (HAC)⁺⁷

HAC is designed to prevent the vehicle from rolling backward when accelerating from a stop while on a steep incline.

The HAC automatically activates whether the ESC is OFF or ON but does NOT activate when the ESC has malfunctioned.

REMINDERS:

- The HAC does not operate when the gear shift is in the P (Park) or the N (Neutral) position.
- In the event of a HAC system malfunction, see an Authorized Kia Dealer for service.
- HAC does not replace the need to apply brakes while stopped on an incline.

QUICK TIPS

- When HAC is active (e.g., accelerating from a stop on an incline), you may notice that the brakes will momentarily remain engaged after you depress the accelerator
- HAC provides a 2-second delay before the vehicle may start rolling backward

Engine Start/Stop Button⁺⁸

To start the engine:

1. Depress the brake pedal
2. Press the ENGINE START/STOP button while gear shift is in P (Park)

To turn the vehicle OFF, press the ENGINE START/STOP button.

To use the ENGINE START/STOP button, you must have the Smart Key fob on your person.

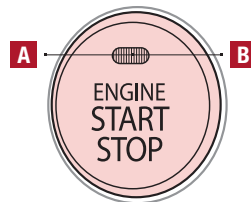

QUICK TIPS

To use electrical accessories:

ACC position

- When in the OFF position and without depressing the brake pedal, press the ENGINE START/STOP button once (amber light **A**)

ON position

- When already in the ACC position (amber light **A**) and without depressing the brake pedal, press the ENGINE START/STOP button again (red light **B**)
- When in the OFF position and without depressing the brake pedal, press the ENGINE START/STOP button twice (red light **B**)

Keeping the vehicle in ACC or ON position without turning engine on may discharge the vehicle's battery.

REMINDERS:

- In an emergency situation while the vehicle is in motion, you are able to turn the engine off and to the ACC position by pressing the ENGINE START/STOP button for more than 2 seconds or 3 times successively within 3 seconds
- If the Smart Key battery is weak or not working properly, hold the Smart Key fob up to the ENGINE START/STOP button (Lock button side closest) and press to start engine

QR CODE

Engine Start/Stop Button & Smart Key Video

To view a video on your mobile device, snap this QR Code or visit the listed website.

Refer to page 2 for more information.



www.youtube.com/KiaFeatureVideos

Power Windows, Window Lock & Central Door Lock

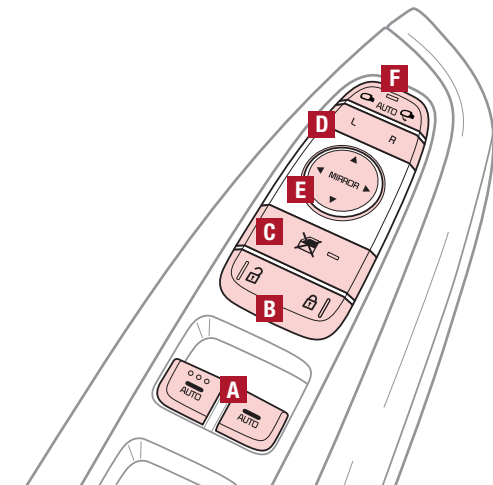

A Pull/Press to operate Driver's and Front Passenger's Windows Auto-Up/Down*

QUICK TIP

Press button again to stop Auto Up/Down function.

B Press to Unlock/Lock All Doors

C Press to disable Rear Passenger Windows

REMINDER: When pressed **C**, window controls for the Rear Passenger Windows are disabled.

Automatic Door Lock/Unlock

Auto Door Lock/Unlock will engage when the gear shift is moved into or out of the P (Park) position. Refer to the User Settings in the LCD Instrument Cluster modes on how to turn Auto Door Lock/Unlock ON/OFF.

Power/Heated Outside Mirrors*

Mirror heaters controlled with Rear Defroster.

Power Folding Outside Mirrors*

Press L or R buttons **D** (left or right) to select mirrors. Then press arrows **E** to adjust mirror position.

To both fold and unfold the outside rearview mirrors, press the folding mirror button **F** as pictured:

- Left - The mirrors will unfold.
- Right - The mirrors will fold.
- Center - The mirrors will fold/unfold automatically when doors are locked/unlocked with the Smart Key or a door handle button is pressed. Also, the mirrors will unfold when approaching the vehicle with the Smart Key fob in proximity.

QUICK TIP

To automatically fold mirrors when exiting vehicle, press the LOCK button once on the Smart Key*.

REMINDER: To lock position of mirrors, toggle switch to the neutral (center) position.

Headlights & High Beams

To operate:

- Rotate lever to change the Headlight function
- Push lever to turn High Beams ON
- Pull lever to flash Headlights/High Beams

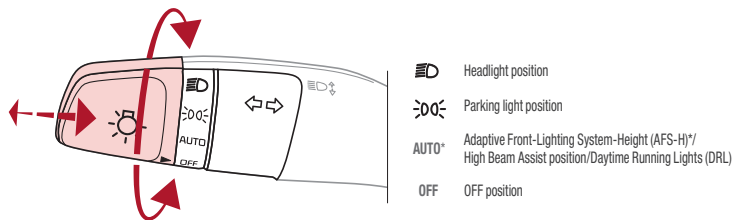

Adaptive Front-Lighting System-Height (AFS-H)* - When switch is in the AUTO position and the vehicle's ignition or the Engine Start/Stop button* is on, the AFS-H system will operate. To turn the system off, change the switch setting. After turning the system off, headlamp swiveling no longer occurs, but leveling operates continuously.

High Beam Assist (HBA)* - The High Beam Assist is designed to automatically adjust the brightness depending on light detected of oncoming vehicles and road conditions.

When switch is in the AUTO position and the vehicle's ignition or the Engine Start/Stop button* is on, the High Beam Assist will operate. To turn HBA off, change the switch setting.

Daytime Running Lights (DRL)* - DRL may help others to see the front of your vehicle during the day. The lights will be on automatically when the ignition or ENGINE START/STOP button* is ON and the headlight switch is in the AUTO position, unless one of the following occurs:

- Headlights are on
- Parking brake is applied
- Fog lights are on
- Engine is turned off

ALWAYS CHECK THE OWNER'S MANUAL FOR COMPLETE OPERATING INFORMATION AND SAFETY WARNINGS.

Turn Signals & Fog Lights

To operate:

- Turn Signals - Move lever Up/Down for Right/Left Turn Signal
- Fog Lights - Rotate lever ring to turn Fog Lights ON/OFF

REMINDER: Headlights must be ON for Fog Light operation.

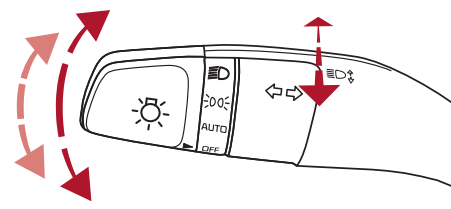

One-Touch Lane Change Signal is activated by moving the Turn Signal Lever slightly for less than 1 second and then releasing. The lane change signal will blink 3 times.

To change how many times (3/5/7) the Lane Change Signal blinks, go to User Settings Mode in the LCD Instrument Cluster modes.

REMINDEES:

- DRL only operates during the daytime
- The DRL system turns off when the headlights are ON, parking brake is applied or the front fog lights are turned on

*IF EQUIPPED

Windshield Wipers & Washers

To operate:

- Move lever Up/Down to change Wiper modes
- Press switch **A** Up/Down to adjust Intermittent Wipe Speed
- Pull lever to spray and wipe

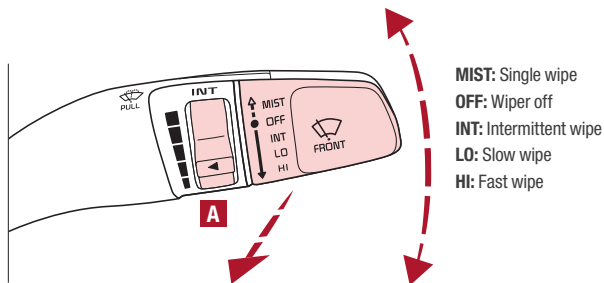

QUICK TIPS

- Pressing the lever up increases Intermittent wipe frequency and wipe speed. Pressing the lever down decreases frequency of wipes
- Set the wiper to OFF position when the wiper is not in use

Heated Steering Wheel Button*

Press button **B** to turn ON/OFF steering wheel heater, while the ignition or ENGINE START/STOP button is in the ON position.

The steering wheel heater will turn off automatically in 30 minutes, or when the button is pressed again to deactivate.

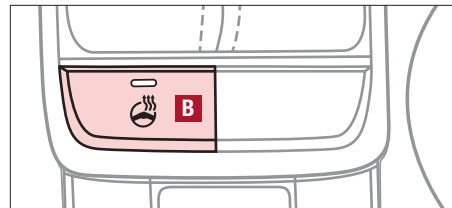

(Located below gear shift. Button location may vary)

QUICK TIP

If ignition is turned OFF, then ON again, within 30 minutes of steering wheel heater being turned on, the system will automatically be set ON again.

REMINDER: If the steering wheel becomes too warm, turn the system off. The heated steering wheel may cause burns even at low temperatures, especially if used for long periods of time.

Bluetooth® Wireless Technology†5,22

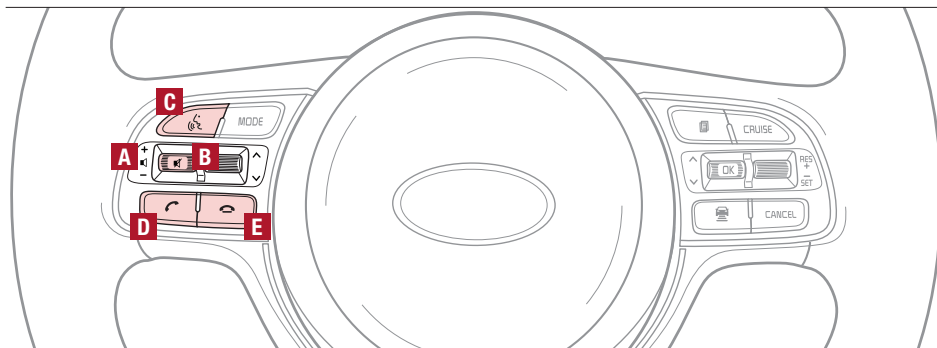

(Type A shown)

- A Volume button:** Press up/down to raise/lower speaker volume
- B Mute button:** Press to mute the microphone during a call
- C Talk button:** Press to activate voice recognition/bring up menus/place calls with minimal voice command prompts from the system

QUICK TIP

When using the voice command feature, wait for the system BEEP before speaking the command.

- D Receive/Place Call button:** Press to receive/place/transfer calls. Press to place a call using voice command prompts from the system or to answer an incoming call
- E End Call button:** Press to end a call or cancel a function

QUICK TIPS

- Phonebook transfer upload time varies by phone model and with number of phonebook entries
- Because of differences in phone quality, service providers and Bluetooth® Wireless Technology chip programming, functionality may differ from one phone to another
- Changing language setting may delete paired phones

Your vehicle's steering wheel buttons may differ from those in the illustrations. See your Owner's Manual for more details

Driving while distracted is dangerous and should be avoided. Drivers should remain attentive to driving and always exercise caution when using the steering-wheel-mounted controls while driving

For more information, if equipped, refer to the Car Multimedia System User's Manual or the UVO System User's Manual. For Bluetooth® Wireless Technology FAQs, go to www.kia.com, Owners section, or call Consumer Information for Bluetooth® Technology at (800) 333-4KIA. Refer to your Owner's Manual for more specific Bluetooth® Wireless Technology phone pairing and operation instructions.

Bluetooth® Wireless Technology

Pairing a Phone

For instructions on how to pair a phone, refer to the Car Multimedia System User's Manual or your vehicle's Quick Start Guide.

QUICK TIP

During the pairing process, be sure to accept the connection requests on the phone for contacts download and to allow acceptance of all future *Bluetooth*® connection requests.

How to Place a Call

There are two options for placing a call:

- Option 1: Press the Receive/Place Call button **D** (displays the phone screen with number keypad)
- Option 2: Press the Talk button **C**. Then say the command “Call {name}” or “Dial {number}”

QUICK TIP

When using the voice command feature, wait for the system BEEP before speaking the command.

Voice Recognition and Phone Contact Tips

The Kia Voice Recognition System may have difficulty understanding some accents or uncommon names. When using Voice Recognition to place a call, speak in a moderate tone, with clear pronunciation.

Help your *Bluetooth*® Wireless Technology Voice Recognition performance by making a few simple changes to your phone contacts:

- Use full names vs. short or single-syllable names (“John Smith” vs. “Dad”; “Smith Residence” vs. “Home”)
- Avoid using special characters, emojis or hyphens (@, &, #, /, -, *, +, etc.)
- Avoid using acronyms (“In Case Emergency” vs. “ICE”)
- Spell words completely, no abbreviations (“Doctor Goodman” vs. “Dr. Goodman”)

QR CODE

Voice Recognition Tips Video

To view a video on your mobile device, snap this QR Code or visit the listed website.

Refer to page 2 for more information.



www.youtube.com/KiaFeatureVideos

Audio Controls†22

Cruise Control†22

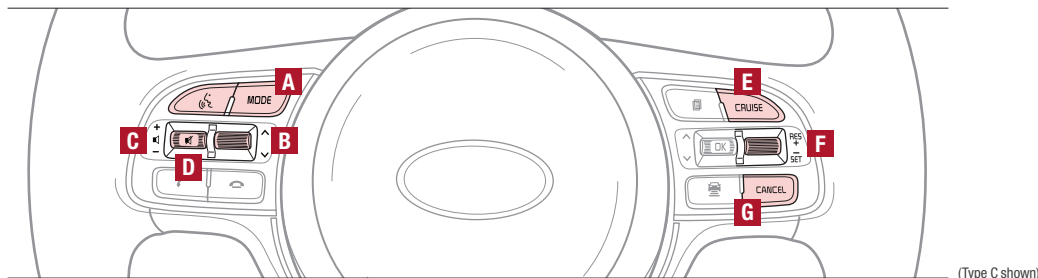

A Audio MODE button: Press to cycle through FM/AM/SAT/USB/Aux/iPod®
Audio System ON/OFF: Press and hold to turn power on; Press to turn power off

B Seek/Preset button:
Radio Mode: Press to advance through Preset Stations. Press and hold to auto seek
Media Mode: Press to move Track Up/Down. Press & hold to FF/REW (except for *Bluetooth®* Audio)

C Volume button: Press up/down to raise/lower volume

D Mute button: Press to mute all audio

QUICK TIP

Pressing the Audio Mode button for more than 1 second will turn Audio Mode ON/OFF.

Driving while distracted is dangerous and should be avoided. Drivers should remain attentive to driving and always exercise caution when using the steering-wheel-mounted controls while driving.

For further audio system operations, refer to pages 28-32.

E CRUISE Control ON/OFF button: Press to turn the Cruise Control ON/OFF

F Resume Cruising Speed button: Press up to resume or increase Cruising Speed

F Set Cruising Speed button: Press down to set or decrease Cruising Speed

G Cruise Control CANCEL button: To cancel Cruise Control setting, do one of the following:

- Press the brake pedal
- Press the CANCEL button

QUICK TIPS

- Cruise Control is designed to function above 25 mph
- The Cruise Control system will not activate until the brake pedal has been depressed at least once after ignition ON or engine start

Your vehicle's steering wheel buttons may differ from those in the illustrations. See your Owner's Manual for more details

Smart Cruise Control (SCC) with Stop & Go*+6

The Smart Cruise Control (SCC) with Stop and Go system is designed to maintain a predetermined distance from vehicles detected ahead by automatically adjusting the driving speed as needed.

To set/adjust the SCC speed:

- Push the CRUISE button **A** to turn system ON. The CRUISE indicator will illuminate on the instrument cluster
- Accelerate/decelerate to the desired speed
- Press button **B** down to set the speed. Press the RES+/SET- button **B** up/down to increase/decrease the set speed

To adjust the vehicle-to-vehicle distance setting **C**, press the SCC button **D** on the steering wheel. The images on the LCD screen **E** and the Instrument Cluster **F** will change when scrolling through the settings. Each time the button is pressed, the vehicle-to-vehicle distance changes.

To cancel SCC operation: Press the CANCEL button **G** or press the brake pedal. The LCD screen will display a message that the SCC operation is canceled.

To turn system OFF, press the CRUISE button **A**. The CRUISE indicator on the instrument cluster will turn OFF and the LCD screen SCC image will show canceled **H**.

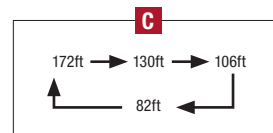
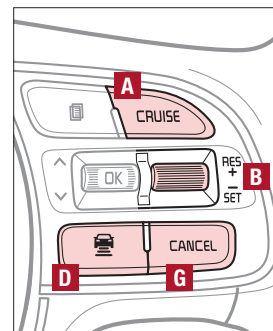

(Distances are approximate and vary depending on vehicle speed)

QR CODE

Smart Cruise Control with Stop & Go Video

To view a video on your mobile device, snap this QR Code or visit the listed website.

Refer to page 2 for more information.



www.youtube.com/KiaFeatureVideos

QUICK TIPS

To change the Cruise Control mode from SCC to standard Cruise Control, press and hold button **A**. Repeat to switch modes again (The SCC system must not be activated to change modes).

For the SCC System to operate:

- When no vehicle is in front, you must be travelling at a minimum speed of 20 mph
- When following a vehicle, there is no minimum speed requirement

When following a vehicle, the system will automatically adjust your cruise speed based on the vehicle detected in front. It can even bring the vehicle to a complete stop if necessary.

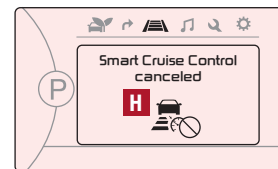
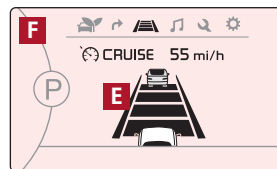

The SCC system is a supplemental system and is not a substitute for safe driving. It is the responsibility of the driver to always check the speed and distance to the vehicle ahead.

REMINDERS:

- Cruise Control button must be ON in order to turn SCC ON/OFF
- SCC system is activated when ignition is turned on. Speed will need to be reset when ignition is cycled on
- The distance settings are approximations and may vary depending on factory settings at the time. See Owner's Manual for more information
- If the SCC system is left on, it can be activated inadvertently. Keep the system off when not in use to avoid setting a speed that the driver is not aware of.

Tilt/Telescoping Steering Wheel†24

To adjust the Steering Wheel, push the lock-release lever **A** down and adjust the desired angle **B** and distance **C**.

When finished, pull the lock-release lever **A** up to lock Steering Wheel in place.

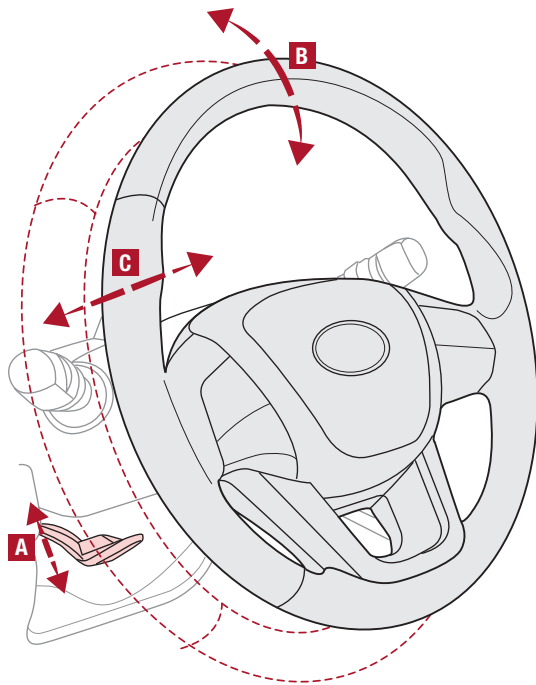

Android Auto™+3 / Apple CarPlay®+4 Setup*

Android Auto™*

Setting up Android Auto™:

1. From an Android Auto™ compatible device, download the Android Auto™ app from the Google Play™+11 Store
2. Open the Android Auto™ app and proceed with the on-screen instructions to complete setup on the mobile device

How to start Android Auto™:

1. Press the SETUP key on your audio control unit's control panel
2. Press the PHONE PROJECTION button , select Android Auto™ and then select ENABLE ANDROID AUTO. Accept all terms, conditions and requests on the head unit and phone in order to use Android Auto™
3. Connect the Android™ device with the vehicle's USB port using the manufacturer's cable provided with your phone
4. From the vehicle's home screen, select the Android Auto™ button, where you'll see all the Android Auto™ supported apps

Apple CarPlay®*

Setting up and starting Apple CarPlay®:

1. Connect the Apple CarPlay® compatible iPhone® with the vehicle's USB port using the manufacturer's cable provided with your iPhone®
2. On the audio control unit's control panel, press the SETUP key
3. Press the PHONE PROJECTION button , on the screen and select Apple CarPlay®
4. Select ENABLE APPLE CARPLAY. Accept all terms, conditions and requests on the head unit and phone in order to use Apple CarPlay®
5. From the vehicle's home screen, select the Apple CarPlay® button, where you'll see all the Apple CarPlay® supported apps

REMINDERS:

- Android Auto™ compatibility requirements: Micro-USB cable that came with your phone, OS Android™ 5.0 or higher, compatible Android™ smartphone and data and wireless plan for applicable feature(s)
- Apple CarPlay® compatibility requirements: Apple Lightning® cable, latest iOS software, iPhone® 5 or later and data and wireless plan for applicable feature(s)
- It is recommended to always update your phone to the latest operating system release

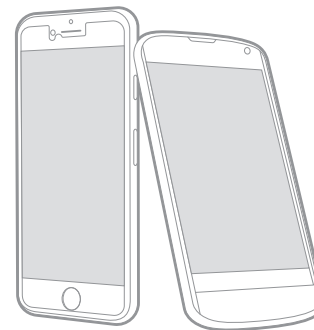

Driving while distracted can result in a loss of vehicle control that may lead to an accident, severe bodily injury, and death. The driver's primary responsibility is in the safe and legal operation of a vehicle, and use of any handheld devices, other equipment, or vehicle systems which take the driver's eyes, attention and focus away from the safe operation of a vehicle or which are not permissible by law should never be used during operation of the vehicle.

For further UVO eServices/UVO eco operations, refer to the Car Multimedia System User's Manual. For other audio system information, refer to pages 29-32.

UVO eServices Activation*^{+1A} (Hybrid Only)

1. Using a compatible smartphone to access your app store or marketplace, download the Kia UVO app
2. In your smartphone's settings, ensure that location services are enabled. Using the Kia UVO app, register for a new MyUVO.com account
3. Follow the In Car Setup Instructions on the Kia UVO app to complete the UVO Activation

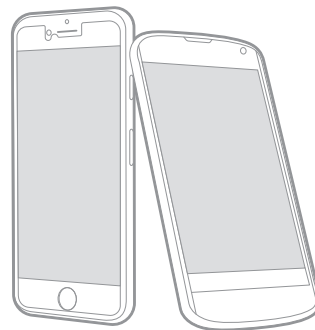

UVO eco Activation*^{+1B} (Plug-In Hybrid Only)

1. Enter the activation screen:
 - a. Press SETUP key
 - b. Press UVO icon
 - c. Press UVO ACTIVATION
2. Agree to Terms of Service and Privacy Policy and press SUBMIT
3. Enter smartphone number or email address to receive a security PIN, then press SUBMIT

Follow these steps if using your phone number to receive your PIN:

1. Check your phone for a SMS (text message)
2. Open the link in your SMS. A page will open to display your PIN
3. Enter the PIN in the head unit and press ACTIVATE
4. On your phone, go back to the page that gave you the PIN, press I HAVE ENTERED MY PIN
5. Enter email and password to complete your account setup and press CREATE ACCOUNT
6. A link will be provided to download the appropriate UVO app from your app store. After installing the UVO app, log in and enjoy

Follow these steps if using your email to receive your PIN:

1. Check your email. The email will be from reset@notifications.myuvo.com
2. Open link inside email. A page will open to display your PIN
3. Enter the PIN in the head unit and press ACTIVATE
4. Go back to the page that gave you the PIN, press I HAVE ENTERED MY PIN
5. Enter your phone number and password to complete your account setup and press CREATE ACCOUNT
6. A link will be provided to download the appropriate UVO app from your app store. After installing the UVO app, log in and enjoy

For further system operations, refer to the Car Multimedia System User's Manual. For other audio system information, refer to pages 28-32.

Driving while distracted can result in a loss of vehicle control that may lead to an accident, severe bodily injury, and death. The driver's primary responsibility is in the safe and legal operation of a vehicle, and use of any handheld devices, other equipment, or vehicle systems which take the driver's eyes, attention and focus away from the safe operation of a vehicle or which are not permissible by law should never be used during operation of the vehicle.

UVO eServices*^{+1A} (Available on Hybrid)*

FM/AM/SiriusXM®/Media (USB, iPod®, AUX, *Bluetooth*® Audio, My Music)

Press briefly to do the following:

- FM/AM mode: Play the previous/next frequency
- SiriusXM® mode: Change the channel
- MEDIA mode: Change the track, file or title (except for AUX)

Press and hold to do the following (over 0.8 seconds):

- FM/AM mode: Move quickly through all of the frequencies. When released, the system seeks the next available frequency
- MEDIA mode: Rewinds or fast forwards the track or file (except for AUX and *Bluetooth*® Audio)

Press to enter PHONE Mode

Press to select MEDIA mode

Press to select FM/AM/SiriusXM® modes

Press to Power ON/OFF. Rotate to adjust Volume

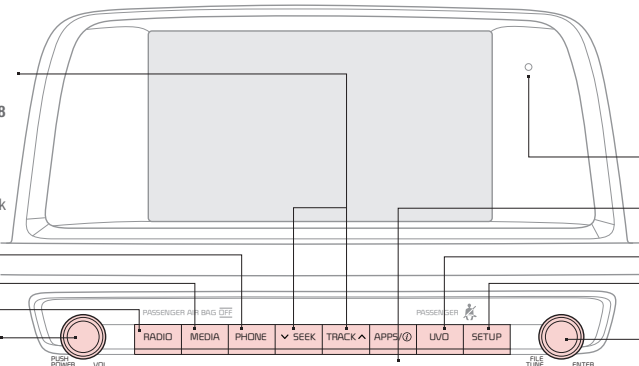

Your vehicle's audio system may differ from that in the illustrations.

Press and hold to reset the system settings

Press to enter APPS/Info menu

Press to enter UVO menu

Press to display SETUP/Settings mode

Rotate to change Radio/SiriusXM® Station/Media tracks/files

QR CODE

UVO eServices System Videos

To view a video on your mobile device, snap this QR Code or visit the listed website. Refer to page 2 for more information.



www.youtube.com/KiaFeatureVideos

Sound Settings: To adjust the audio system sound settings:

1. Press the SETUP key on the audio control unit or the on-screen MENU button, when in MEDIA mode
2. Select the on-screen SOUND button, or SOUND SETTINGS
3. Select the menu item (Position, Volume, Tone, Priority, Advanced, Default)
4. Use the onscreen buttons to adjust settings. Press the return button \Rightarrow to save settings

Radio Presets: You can listen to FM, AM and SiriusXM® radio and save frequently used stations.

How to Save a Preset: Press and hold the desired slot. This saves the current station in the selected slot in FM, AM or SiriusXM®

Smart Favorites: For the first ten favorite SiriusXM® channels, you may play live or repeat from the beginning of a song or a program segment. In **Radio** mode, choose SiriusXM®, then select any of the first six favorites. During song or program play, tap the Skip Backward icon to start from the beginning of the song or program. Tap the Play Live icon to return to the live broadcast.

Custom Button ☆: A programmable key to provide quick access to one of several available system features.

To Program the Custom Button: Press the SETUP button, then press the Custom button. Select one of the available features you would like the Custom button to open.

QUICK TIPS

- Using Android Auto™ or Apple CarPlay® and a supported smartphone, the phone's Navigation App may be displayed on the head unit
- At any time, you can interrupt Command Feedback by pressing the TALK button
- Prolonged use of the audio control unit in ACC mode may drain the vehicle's battery
- A warning screen may appear periodically to remind users that UVO eServices should be operated when the engine is running to prevent battery discharge

REMINDER: Driving while distracted is dangerous and should be avoided. Drivers should remain attentive to driving and always exercise caution when using the steering wheel-mounted controls while driving. To help minimize driver distraction, some audio system functionalities have been modified while the vehicle is in Drive, Reverse or moved out of Park.

For further UVO eServices operations, refer to the Car Multimedia System User's Manual. For other audio system information, refer to pages 28-32.

UVO eServices with Premium Navigation (Available on Hybrid)^{†1A}

FM/AM/SiriusXM®/Media (USB, iPod®, AUX, *Bluetooth*® Audio, My Music)

Press briefly to do the following:

- FM/AM mode: Play the previous/next frequency
- SiriusXM® mode: Change the channel
- MEDIA mode: Change the track, file or title (except for AUX)

Press and hold to do the following (over 0.8 seconds):

- FM/AM mode: Move quickly through all of the frequencies. When released, the system seeks the next available frequency
- MEDIA mode: Rewinds or fast forwards the track or file (except for AUX and *Bluetooth*® Audio)

A programmable key to provide quick access to one of several available system features

Press to select FM/AM/SiriusXM® modes

Press to Power ON/OFF. Rotate to adjust Volume

Press to select MEDIA mode

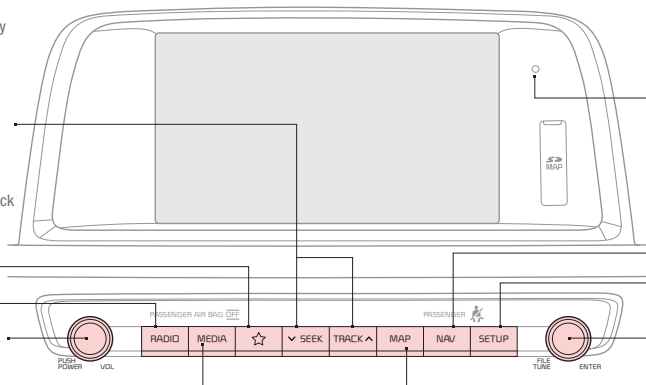

Your vehicle's audio system may differ from that in the illustrations.

Press and hold to reset the system settings

Press to enter NAV menu

Press to display SETUP/Settings mode

Rotate to change Radio/SiriusXM® Station/Media tracks/files

Press to enter Map menu

Sound Settings: To adjust the audio system sound settings:

1. Press the SETUP key on the audio control unit or the on-screen MENU button, when in MEDIA mode
2. Select the on-screen SOUND button
3. Select the menu item (Position, Volume, Tone, Priority, Navigation, Advanced, Default)
4. Use the onscreen buttons to adjust settings

Radio Presets: You can listen to FM, AM and SiriusXM® radio and save frequently used stations.

How to Save a Preset: Press and hold the desired slot. This saves the current station in the selected slot in FM, AM or SiriusXM®

Smart Favorites: For the first ten favorite SiriusXM® channels, you may play live or repeat from the beginning of a song or a program segment. In **Radio** mode, choose SiriusXM®, then select any of the first six favorites. During song or program play, tap the Skip Backward icon to start from the beginning of the song or program. Tap the Play Live icon to return to the live broadcast.

Custom Button ☆: A programmable key to provide quick access to one of several available system features.

To Program the Custom Button: Press the SETUP button, then press the Custom button. Select one of the available features you would like the Custom button to open.

QR CODE

UVO eServices with Premium Navigation Videos

To view a video on your mobile device, snap this QR Code or visit the listed website. Refer to page 2 for more information.



www.youtube.com/KiaFeatureVideos

QUICK TIPS

- At any time, you can interrupt the Voice Command Feedback by pressing the TALK button on the steering wheel
- Prolonged use of the navigation system in ACC mode may drain the vehicle's battery. A warning screen may appear periodically to remind users that the navigation system should be operated when the engine is running to prevent battery discharge

REMINDER: Driving while distracted is dangerous and should be avoided. Drivers should remain attentive to driving and always exercise caution when using the steering-wheel-mounted controls while driving. To help minimize driver distraction, some audio system functionalities have been modified while the vehicle is in Drive, Reverse or moved out of Park.

For further UVO eServices with Premium Navigation operations, refer to the Car Multimedia System User's Manual. For other audio system information, refer to pages 28-32.

UVO eco with Navigation (Available on Plug-In Hybrid)*†1B

FM/AM/SiriusXM®†22 /Media (USB, iPod®†14, My Music, AUX, *Bluetooth*® Audio)

Press briefly to do the following:

- FM/AM mode: Play the previous/next frequency
- SiriusXM® mode: Change the channel
- MEDIA mode: Change the track, file or title (except for AUX)

Press and hold to do the following (over 0.8 seconds):

- FM/AM mode: Move quickly through all of the frequencies. When released, the system seeks the next available frequency
- MEDIA mode: Rewinds or fast forwards the track or file (except for AUX and *Bluetooth*® Audio)

A programmable key to provide quick access to one of several available system features

Press to select FM/AM/SiriusXM® modes

Press to Power ON/OFF. Rotate to adjust Volume

Press to select MEDIA mode

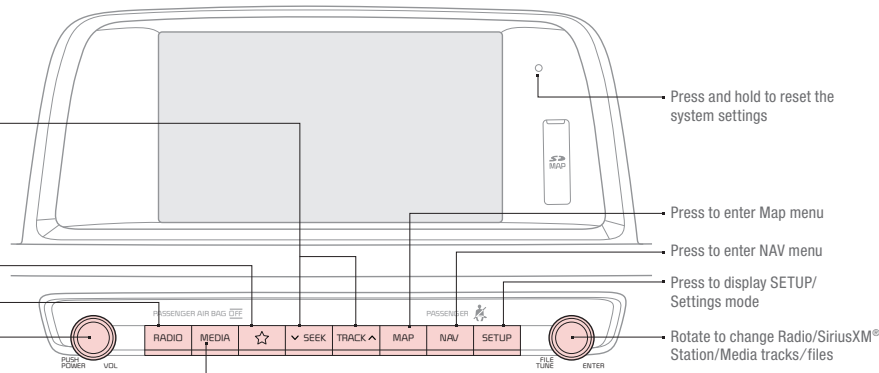

Your vehicle's audio system may differ from that in the illustrations. For further UVO eco Navigation operations, refer to the Car Multimedia System User's Manual.

Sound Settings: To adjust the audio system sound settings:

1. Press the SETUP key on the audio control unit or the on-screen MENU button, when in MEDIA mode
2. Select the on-screen SOUND button
3. Select the menu item (Position, Volume, Tone, Priority, Navigation, Advanced, Default)
4. Use the onscreen buttons to adjust settings

Radio Presets: You can listen to FM, AM and SiriusXM® radio and save frequently used stations.

Smart Favorites: For the first ten favorite SiriusXM® channels, you may play live or repeat from the beginning of a song or a program segment. In **Radio** mode, choose SiriusXM®, then select any of the first six favorites. During song or program play, tap the Skip Backward icon to start from the beginning of the song or program. Tap the Play Live icon to return to the live broadcast.

Custom Button ☆: A programmable key to provide quick access to one of several available system features.

How to Save a Preset: Press and hold the desired slot. This saves the current station in the selected slot in FM, AM or SiriusXM®

To Program the Custom Button: Press the SETUP button, then press the Custom button. Select one of the available features you would like the Custom button to open.

QUICK TIPS

- At any time, you can interrupt the Voice Command Feedback by pressing the TALK button on the steering wheel
- Prolonged use of the navigation system in ACC mode may drain the vehicle's battery. A warning screen may appear periodically to remind users that the navigation system should be operated when the engine is running to prevent battery discharge
- When using the voice command feature, wait for the system BEEP before speaking the command

REMINDER: Driving while distracted is dangerous and should be avoided. Drivers should remain attentive to driving and always exercise caution when using the steering-wheel-mounted controls while driving. To help minimize driver distraction, some audio system functionalities have been modified while the vehicle is in Drive, Reverse or moved out of Park.

For other audio system information, refer to pages 28-31.

Digital Clock

Clock Setup:

Press the SETUP key on the head unit. Then press the on-screen Clock icon to enter clock settings. Follow the onscreen options to adjust the clock settings.

QUICK TIP

Press the on-screen return icon to save changes.

REMINDERS:

- Daylight Savings must be enabled or disabled in the Clock Settings screen.
- To access manual date and time setting, turn GPS time OFF in the Clock Settings (systems with navigation only).

Aux/USB/iPod® Port & Power Outlets

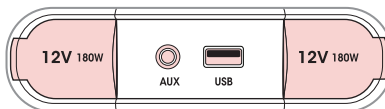

Use the Aux port to connect audio devices and the USB port to connect USB audio devices, smartphones and iPod® devices.

QUICK TIP

The power outlets are inactive when ignition is in the OFF position.

REMINDERS:

- Using the power outlet (accessory plug) for prolonged periods of time with the engine off could cause the battery to discharge.
- Only use cables made by your device manufacturer. Third party cables may damage your device.

For more information on the Aux/USB/iPod® Port & Power Outlets, refer to the Owner's Manual.

USB Charger*

The USB charger is located inside the Center Console and on the rear of the Center Console.

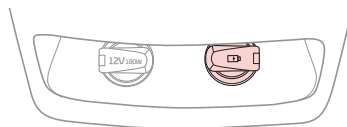

(Rear of Center Console shown)

Automatic Climate Control*

(Type A)

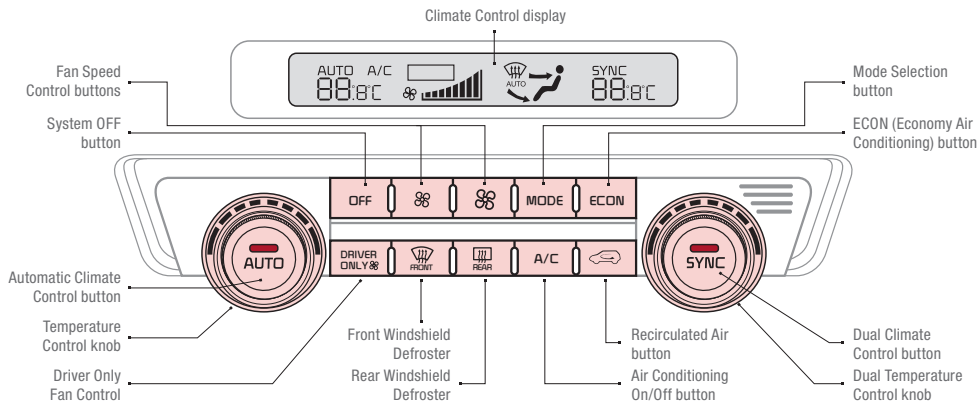

Climate Control Auto Function

1. Press AUTO to select Full Auto Operation. The Auto setting automatically controls the airflow modes, fan speeds, air intake and air conditioning according to the temperature setting selected
2. Set desired Temperature
3. Press SYNC to synchronize driver and passenger temperature

QUICK TIPS

- Defrost mode activates A/C and opens Fresh Air Vent to help dehumidify the air and improve Defroster performance
- During Auto Operation, the A/C indicator will NOT illuminate. The fan speed, air intake, air flow and air conditioning may automatically be engaged at any time to reach desired temperature and reduce humidity
- Keep inside glass as clean as possible to reduce window fogging

Your Automatic Climate Control system may differ from those in the illustrations. See your Owner's Manual for more details.

Air Flow Modes:

To select Air Flow Modes, press the Mode selection buttons:

- Face-Level
- Bi-Level
- Floor-Level
- Floor/Defrost-Level

Defrost Outside Windshield:

1. Set Fan Speed to the highest position
2. Set Temperature to Hot
3. Press the Front Defrost button

Defog Inside Windshield:

1. Set Fan Speed to desired position
2. Set desired Temperature
3. Press the Front Defrost button

REMINDERS:

- MAX A/C Mode automatically engages Recirculated Air
- Pressing any button during AUTO operation will deactivate the AUTO function and switch to manual mode, except for Temperature Control
- When in AUTO mode, Air Flow mode and Fan Speed do not display on the Climate Control Display
- Warm air may flow in through vents if Recirculated Air button is not pressed ON (LED lit)

Automatic Climate Control*

(Type B)

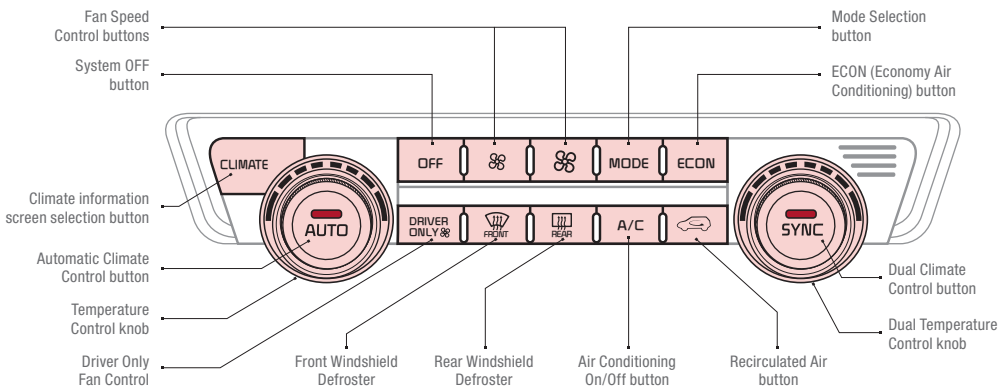

Climate Control Auto Function

1. Press AUTO to select Full Auto Operation. The Auto setting automatically controls the airflow modes, fan speeds, air intake and air conditioning according to the temperature setting selected
2. Set desired Temperature
3. Press SYNC to synchronize driver and passenger temperature

QUICK TIPS

- Defrost mode activates A/C and opens Fresh Air Vent to help dehumidify the air and improve Defroster performance
- During Auto Operation, the A/C indicator will NOT illuminate. The fan speed, air intake, air flow and air conditioning may automatically be engaged at any time to reach desired temperature and reduce humidity
- Keep inside glass as clean as possible to reduce window fogging

Your Automatic Climate Control system may differ from those in the illustrations. See your Owner's Manual for more details.

ALWAYS CHECK THE OWNER'S MANUAL FOR COMPLETE OPERATING INFORMATION AND SAFETY WARNINGS

Air Flow Modes:

To select Air Flow Modes, press the Mode selection buttons:

- Face-Level
- Bi-Level
- Floor-Level
- Floor/Defrost-Level

Defrost Outside Windshield:

1. Set Fan Speed to the highest position
2. Set Temperature to Hot
3. Press the Front Defrost button

Defog Inside Windshield:

1. Set Fan Speed to desired position
2. Set desired Temperature
3. Press the Front Defrost button

REMINDERS:

- MAX A/C Mode automatically engages Recirculated Air
- Pressing any button during AUTO operation will deactivate the AUTO function and switch to manual mode, except for Temperature Control
- When in AUTO mode, Air Flow mode and Fan Speed do not display on the Climate Control Display
- Warm air may flow in through vents if Recirculated Air button is not pressed ON (LED lit)

*IF EQUIPPED

Automatic Gear Shift with Sportmatic® Shifting

- P:** Park
- R:** Reverse
- N:** Neutral
- D:** Drive
- [+]:** Manual Mode Upshift
- [-]:** Manual Mode Downshift

Manual Mode: To enter Manual mode, move shift lever from D to left gate. To shift while in Manual mode, move shift lever up [+] to upshift or down [-] to downshift.

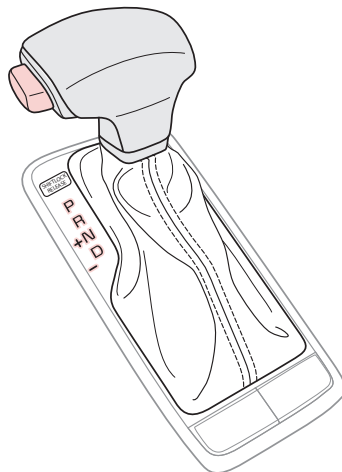

QUICK TIPS

- Press brake pedal and depress release button to move gearshift from N to P, N to R or from P to any gear
- Manual mode downshifts are made automatically when the vehicle slows down. When the vehicle stops, 1st gear is automatically selected

Seat Warmers*†19

Press button once for high setting (2 LEDs lit), again for low setting (1 LED lit) and again to turn OFF.

Seat Warmers/Ventilated Seats* A

Seat Warmers:

- Press top of button for high setting (3 LEDs lit)
- Press button twice for medium setting (2 LEDs lit)
- Press a third time for low setting (1 LED lit) and again to turn OFF

Ventilated Seats:

- Press bottom of button once for high setting (3 LEDs lit)
- Press twice for medium setting (2 LEDs lit)
- Press a third time for low setting (1 LED lit) and again to turn OFF

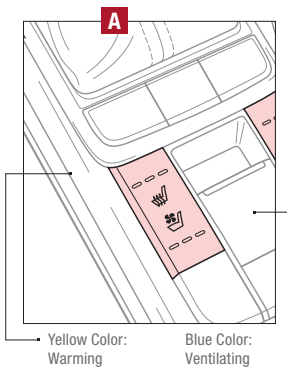

Yellow Color:
Warming

Blue Color:
Ventilating

QR CODES

To view these videos on your mobile device, snap these QR codes. Refer to page 2 for more information.

Sportmatic® Shifting Video



Heated and Ventilated Seats Video



www.youtube.com/KiaFeatureVideos

QUICK TIPS

- With the seat warmer switch in the ON position, the heating system in the seat turns OFF or ON automatically depending on the seat temperature
- System is OFF by default

REMINDER: Use extreme caution when using the seat warmers to avoid burns. Refer to the Owner's Manual for more information.

Electric Parking Brake (EPB)*

The Electric Parking Brake (EPB) system utilizes an electric motor to engage the parking brake.

Applying the Parking Brake

Depress the brake pedal and pull up the EPB switch **A**. Ensure that the indicator light  **BRAKE** is illuminated on the instrument cluster.

Releasing the Parking Brake

The EPB will automatically release when the shifter is placed in Reverse or Drive.

To release EPB manually, depress the brake pedal, then press the EPB switch **A**, with the ignition switch in the ON position. Ensure that the indicator light  **BRAKE** is OFF.

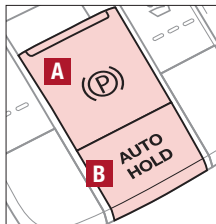

(Located on Center Panel)

Auto Hold*

Auto Hold temporarily maintains the vehicle at a standstill even if the brake pedal is released. Auto Hold can be turned ON/OFF using the AUTO HOLD switch **B** on the driver's panel. Before Auto Hold will operate, the driver's door, engine hood and trunk must be closed, and the driver's seat belt must be fastened.

The Auto Hold indicator has four states:

White: Standby - With vehicle at a standstill, and AUTO HOLD switch **B** turned ON, the indicator will illuminate white. While driving the vehicle (vehicle is not at a standstill), the Auto Hold indicator will remain white.

Green: Engaged - When coming to a complete stop by depressing the brake pedal, the Auto Hold indicator changes from white to green.

OFF (not illuminated) - The indicator will turn OFF when the AUTO HOLD switch **B** is turned OFF or when the EPB is manually turned ON.

Yellow: Malfunction - When the indicator is illuminated yellow, there may be a system malfunction. Take your vehicle to a local Kia dealer.

REMINDER: To reduce the risk of an accident, do not activate Auto Hold while driving downhill, backing up or parking your vehicle.

Refer to page 4 for location of Instrument Cluster indicators.

QR CODE

Electric Parking Brake Video

To view a video on your mobile device, snap this QR Code or visit the listed website.

Refer to page 2 for more information.



www.youtube.com/KiaFeatureVideos

QUICK TIPS

- When leaving your keys with parking lot attendants or valet, make sure to inform them how to operate the EPB
- If parked on a steep incline, pull up the EPB switch for more than 3 seconds for a firmer EPB application
- Pull up and hold EPB switch a second time to increase brake pressure if parked on a decline or incline

REMINDERS:

- EPB will not release unless the hood, trunk and all doors are closed and seat belts are fastened
- As a bulb check, the EPB malfunction indicator will illuminate for approximately 3 seconds when the ignition switch is turned ON
- If the warning light does not illuminate temporarily, or continues to remain lit, take your vehicle to an authorized Kia dealer and have the system checked
- The EPB should not be operated while the vehicle is moving
- A click or electric brake motor sound may be heard while operating or releasing the EPB, but these conditions are normal and indicate that the EPB is functioning properly

Driver Position Memory System*

To store a seating position into memory, first place the shifter into P (Park) while the ignition switch is ON. Then:

1. Adjust the driver's seat
2. Press the SET button **A** on the control panel. System will beep once
3. Press one of the memory buttons **B** within 5 seconds. The system will beep twice when memory has been stored
4. "Driver (1 or 2) set is memorized" will appear on the instrument cluster LCD screen

REMINDER: Do not attempt to operate the driver position memory system while the vehicle is moving. This could result in loss of control of the vehicle.

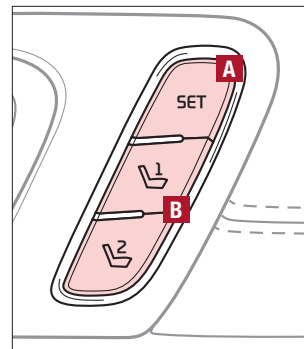

Front Seat Headrest Adjustment^{†10}

To raise headrest: Pull headrest up.

To lower headrest: Press lock **C**, then press the headrest down.

REMINDER: Do not operate the vehicle with the headrests removed. Headrests can provide critical neck and head support in an accident.

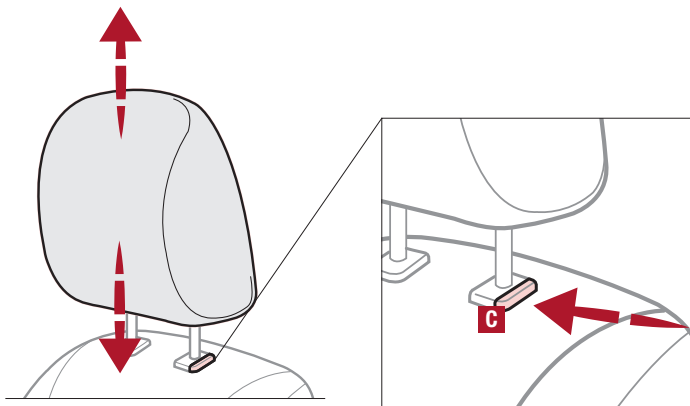

Power Adjustable Driver's Seat*†17

Move/Press controls to adjust Seat forward/backward, Seat Cushion tilt up/down, Seatback forward/backward or Lumbar up/down/forward/backward

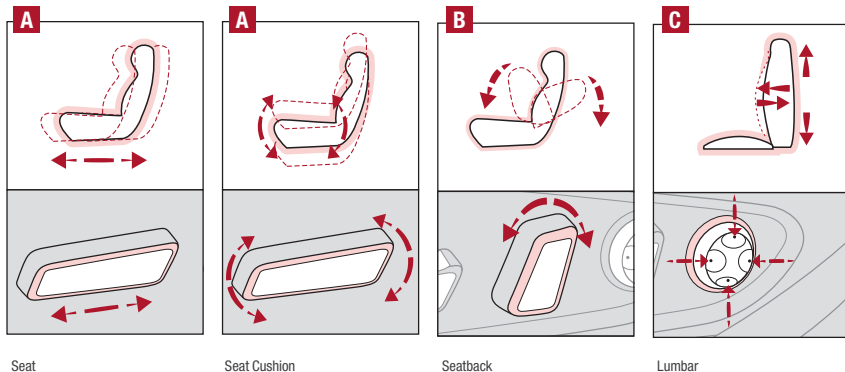

Seat

Seat Cushion

Seatback

Lumbar

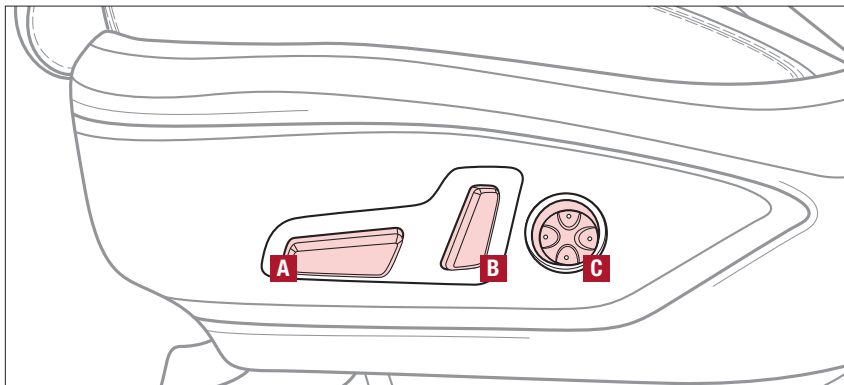

REMINDER: Do not attempt to adjust the seat while the vehicle is moving. This could result in loss of control of the vehicle.

6-Way Manual Adjustable Driver's Seat*†17

Pull lever **D** to slide Seat forward/backward.

Pull lever **E** up several times to raise Seat Height.

Push lever **E** down several times to lower Seat Height.

Pull lever **F** to adjust Seatback recline.

Press **G** to adjust Lumbar support.

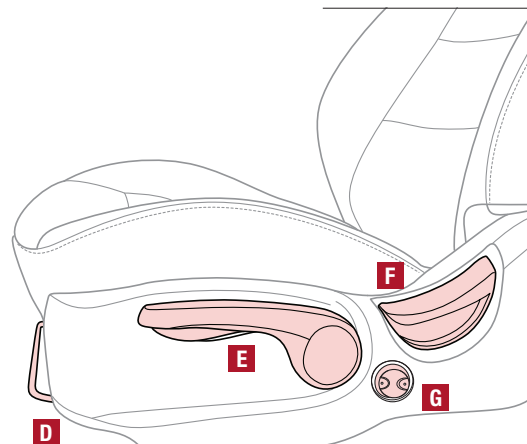

QUICK TIP

When adjusting seat forward or backward, ensure seat clicks or locks into place before driving vehicle.

Smart Key^{†8}

Smart Key Fob:

- A** Press to lock All Doors; Press twice within 2 seconds to sound the horn
- B** Press to unlock Driver's Door. Press twice in 4 seconds to unlock All Doors
- C** Press and hold for more than 1 second to unlock Trunk. Then lift the lid to manually open Trunk

REMINDERS:

- The Trunk unlocks when the Smart Key fob is within close proximity of the vehicle
- Trunk lid will partially open. To fully open, lift up manually

- D** Press and hold more than 1 second for Panic Alarm. To turn off Alarm, press any button

- E** Press to release Mechanical Key (button on reverse side of fob)

Driver's Door Lock/Unlock button **G**:

- Press button once to unlock Driver's Door
- Press again within 4 seconds to unlock All Doors
- Press again to lock All Doors

Mechanical Key **F**:

- Use to unlock/lock Driver's Door:
 1. Remove door handle keyhole cover with Mechanical Key by pressing up into slot as shown
 2. Insert Mechanical Key and turn right to Unlock Driver's Door. Turn twice within 4 seconds to Unlock all doors
 3. Insert Mechanical Key and turn left to Lock Driver's Door
 4. Return keyhole cover to its original position
- Use to enable/disable Child Safety Locks

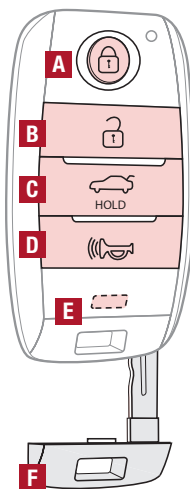

REMEMBER: Remote button configuration may vary depending on vehicle options.

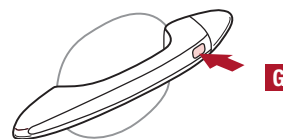

Mechanical Key

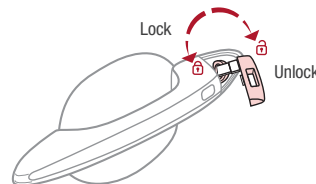
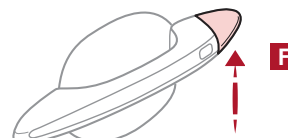

QR CODES

To view these videos on your mobile device, snap these QR codes. Refer to page 2 for more information.

Engine Start/Stop Button & Smart Key Video



Kia Key Fob Video



www.youtube.com/KiaFeatureVideos

QUICK TIPS

- If the Smart Key battery is weak or not working properly, hold the Smart Key fob up to the ENGINE START/STOP button (Lock button side closest) and press to start engine
- The Smart Key's signal can be blocked by the normal operation of a cell phone or smartphone. To help prevent this, store each device separately

Power Trunk / Smart Power Trunk*†15

Smart Key:

To open the Power Trunk, press and hold the Trunk button **A** until the Trunk begins opening. Press again to cancel.

REMINDER: Pulling the Trunk upward by the handle or pressing the button a second time will interrupt the automatic opening of the Power Trunk.

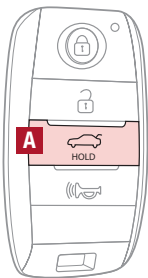

Outside the Vehicle:

To open Power Trunk automatically, press the Trunk Release button **B** located underneath the Trunk lid.

Mechanical Key can also be used to open trunk **C**.

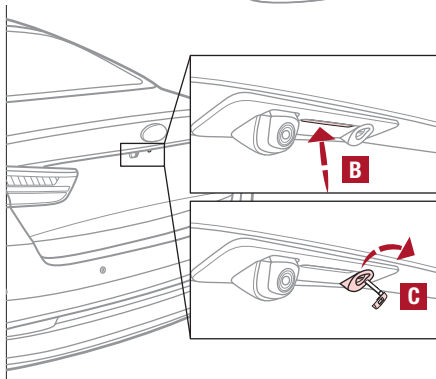

Inside the Vehicle:

Press and hold the Power Trunk Open button **D** to open the Trunk.

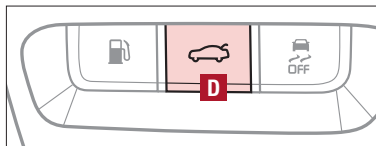

(Button located on Driver's Panel left of Steering Wheel)

Smart Power Trunk*

When the Smart Key fob is on your person and you are near the back of the vehicle, within close proximity, the hazard lights will blink and a chime will sound for about 3 seconds as an alert that the Smart Power Trunk is about to open. Then the alert system will blink and chime two additional times before opening the Smart Power Trunk.

The Smart Power Trunk feature is off by default. To enable the Smart Power Trunk, go to User Settings in the LCD Instrument Cluster modes.

QUICK TIP

During the Smart Power Trunk alert, the Smart Power Trunk can be deactivated with the Smart Key by pressing any button on the key fob.

REMINDEES:

- All doors are closed and locked after about 15 seconds
- The Smart Power Trunk feature will not operate when:
 - The doors are recently closed and locked, and the Smart Key is still detected after 15 seconds near the vehicle or within 60 inches of the door handles
 - A door is not locked or closed
 - The Smart Key is in the vehicle
- Ensure obstacles and people are of the way of the Power Trunk

For more information on the Smart Power Trunk operation, please refer to the Owner's Manual.

Map/Room Lamps

Automatic turn off function*

The interior lights automatically turn off approximately 30 seconds after the ENGINE START/STOP button is OFF.

Map/Personal Lamp

Push the lens **A** to turn the Map Lamp ON/OFF. This light produces a spot beam for convenient use as a Map Lamp or Personal Lamp for the driver or front passenger.

Room Lamp

: When pressed **B**, the lamp turns ON when any door is opened.

: When pressed **C**, the lamp stays on continuously.

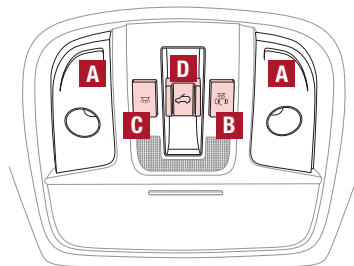

(Type B)

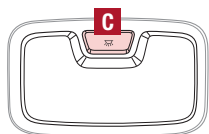

(Type A)

QUICK TIPS

- When doors are unlocked by the Smart Key*, the lamp turns ON for approximately 30 seconds
- If your vehicle is equipped with the theft alarm system, the interior lights automatically turn off approximately 3 seconds after the system is in armed stage
- Using interior lights for an extended period of time may cause battery discharge

Panoramic Sunroof Operation

The Sunroof and Sunshade operation is controlled through a multi-directional switch/lever, and the ignition needs to be in the ON position to operate the Sunroof/Sunshade.

Slide the Sunshade and Sunroof:

- Auto Open: Slide lever backward to the farthest position and release
- Auto Close (Sunroof only): Slide the lever **D** forward to the farthest position and release

Slide the Sunshade:

- Open: Slide the lever **D** partially backward to the first detent position
- Auto Close: Slide the lever **D** forward to the farthest position

Slide the Sunroof (with Sunshade open):

- Open: Slide the lever **D** backward to the first detent and release
- Close: Slide the lever **D** partially forward to the first detent position

Tilt the Sunroof:

- Raise: Push lever **D** upward
- Lower: Push lever **D** forward
- Auto Close: Slide the lever **D** forward to the farthest position

QUICK TIP

To stop the Sunroof/Sunshade at any position, push or pull the Sunroof control lever in any direction.

REMINDERS:

- Sunshade needs to remain OPEN while Sunroof is open and vehicle is moving
- Do not adjust the sunroof or sunshade while driving. This could result in loss of control of the vehicle

QR CODE

Sunroof Operation Video

To view a video on your mobile device, snap this QR Code or visit the listed website.

Refer to page 2 for more information.



www.youtube.com/KiaFeatureVideos

Hood Release Lever and Latch

Opening the Hood:

1. Pull the Hood Release Lever **A** to unlatch the Hood
2. In the front of the vehicle, lift the Hood slightly, pull the secondary Latch **B** inside of the Hood's center and lift the Hood

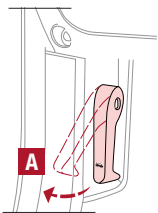

(Located on Driver side kick panel)

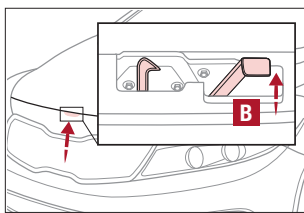

(Latch located inside hood)

Closing the Hood: Lower the Hood about halfway and then press down to securely lock in place.

Fuel Door and Trunk Release

Press the button **C** to release the fuel door.

Pull the button **D** to open the trunk.

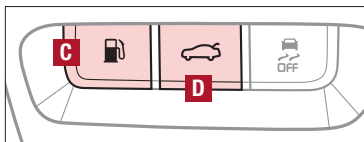

(Buttons located on Driver's Door)

Fuel Cap / Malfunction Indicator (Check Engine Light)

Tighten for ONE CLICK to prevent Malfunction Indicator  from illuminating.

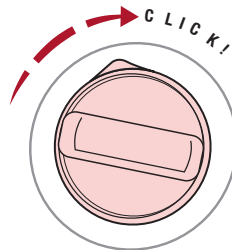

REMINDER: The Fuel Filler Door Release button is located on the lower part of the driver's door panel.

QR CODE

One-Click Fuel Cap Video

To view a video on your mobile device, snap this QR Code or visit the listed website.

Refer to page 2 for more information.



www.youtube.com/KiaFeatureVideos

Sunvisor^{†23}

Use the Sunvisor to shield direct light through the front or side windows. Slide the Sunvisor out and adjust as needed.

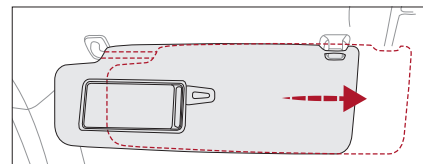

REMINDEMS:

- Sunvisor may not shield all direct light
- Do not operate the vehicle if Sunvisor is impairing your visibility
- Be aware of your seating position when adjusting or swinging Sunvisor around from the front or side windows

Parking Distance Warning-Reverse*†6

The Parking Distance Warning-Reverse is a supplemental system that is designed to assist the driver by chiming if any object is detected within the sensing area to the rear and side of the vehicle when backing up. When the ignition is ON, the system is activated.

REMINDERS:

- If the vehicle is moving at speeds over 3 mph, the system may not activate correctly
- When more than two objects are sensed at the same time, the closest one will be recognized first

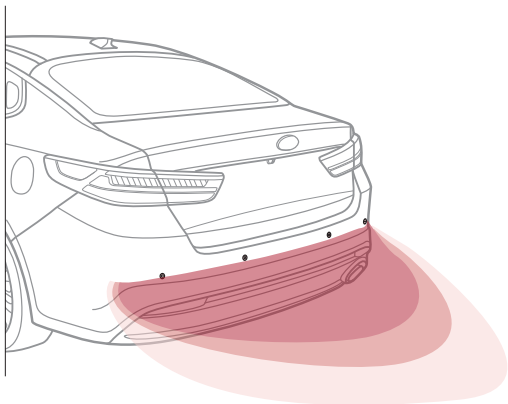

The above images are for illustration purposes only and may not reflect actual operation.

The Parking Distance Warning-Reverse is not a substitute for proper and safe backing-up procedures. Always drive safely and use caution when backing up. The Parking Distance Warning-Reverse may not detect every object behind the vehicle.

Rear-Camera Display*†6

The Rear-Camera Display is a supplemental system that displays the view behind the vehicle through the rearview display mirror or the audio control unit screens while the vehicle is in Reverse.

The Rear-Camera Display activates when the:

- Engine Start/Stop button is in the ON position (green light)
- Gear Shift Lever is in the R (Reverse) position

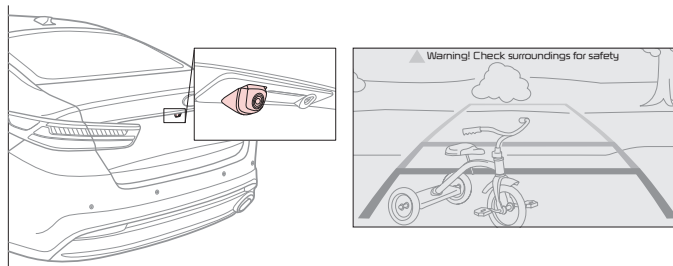

REMINDER: Always drive carefully and use caution when backing up.

The Rear-Camera Display is not a substitute for proper and safe backing-up procedures. The Rear-Camera Display may not display every object behind the vehicle.

The above images are for illustration purposes only and may not reflect actual operation.

Hybrid / Plug-In Air Intake

The Hybrid/Plug-In Battery Air Intake, located underneath the rear seats, is used to cool down the Hybrid/Plug-In battery. For safety reasons, this vent should never be blocked. Doing so may cause the battery to overheat.

Hybrid*

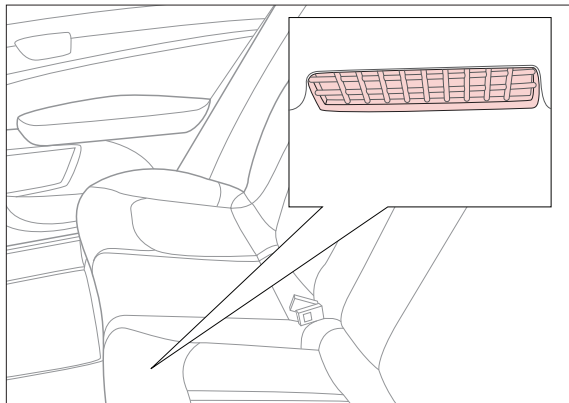

(Vent located underneath rear seats)

QUICK TIP

Clean the air intake for the Hybrid/Plug-In battery regularly with a dry cloth

PRECAUTION: Never clean the battery vent with a WET cloth or spill liquid over the air intake. This could cause an electric shock, which could cause serious damage, injury or death.

Plug-In Hybrid*

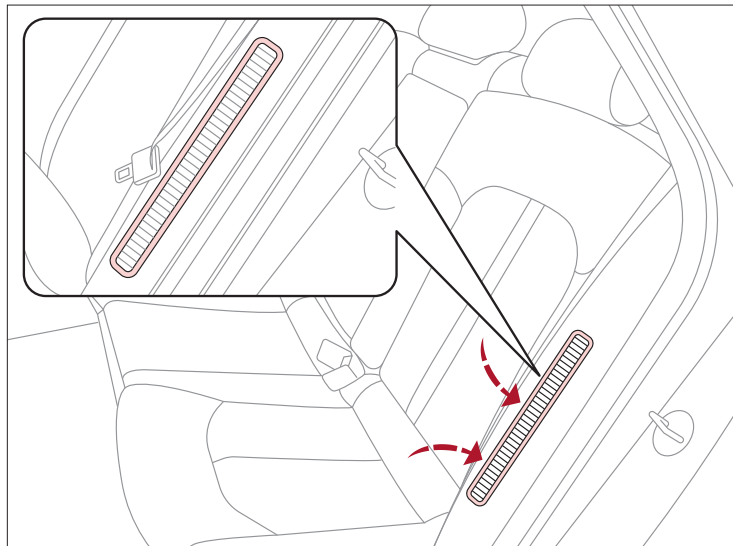

(Vent located on left side of rear seats)

Child-Protector Rear Door Lock

Locate these locks on the rear edge of the rear passenger doors. Turn the safety lock to the LOCK position to disable the inner door handles from opening the rear doors.

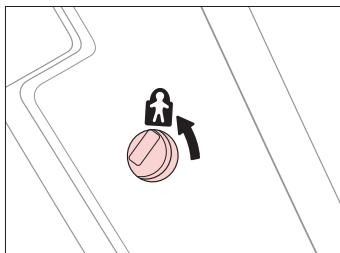

REMINDER: Child-Protector Rear Door Lock is located on rear passenger's door jamb.

Tire Mobility Kit

The Tire Mobility Kit may temporarily seal certain types of tire damage.

For operational information, please refer to the Owner's Manual.

A Sealant Bottle

B Compressor

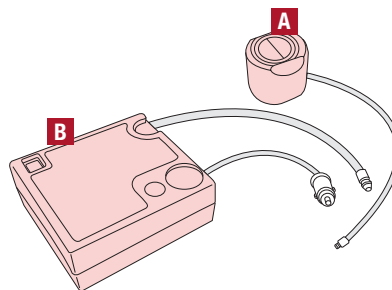

QR CODE

Tire Mobility Kit Video

To view a video on your mobile device, snap this QR Code or visit the listed website.

Refer to page 2 for more information.



www.youtube.com/KiaFeatureVideos

QUICK TIPS

- The Tire Mobility Kit is a temporary fix and is to be used for one tire only; the tire should be inspected as soon as possible
- The kit should only be used for sealing/inflating passenger car tires; do not use for inflating any other type of tires
- Some damaged tires cannot be sealed completely; do not use the kit if it appears a tire is damaged beyond repair

REMINDEERS:

- The above images are for illustration purposes only and may not reflect actual operation
- After tire is properly sealed, drive cautiously at a maximum speed of 50 mph for a maximum distance of up to 120 miles

Occupant Detection System (ODS)^{+14/} Passenger Airbag Off Indicator⁺²

ODS is designed to detect the presence and position of the front passenger and is designed to adjust or turn off airbag deployment accordingly.

Depending on the situation and type of accident, the system may:

- Deploy airbag (Adult)
- Not deploy the airbag (Unoccupied)

If the system determines that the airbag should not be deployed, the “PASSENGER AIR BAG OFF” light will illuminate.

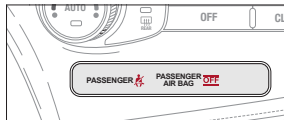

REMINDER: Do not allow an adult passenger to ride in the front seat when the Passenger Airbag Indicator is illuminated OFF because the airbag will not deploy in the event of a crash. The driver must instruct the passenger to reposition her/himself in the seat.

Seat Belts⁺¹⁸

To properly fasten your safety belts:

1. Insert the belt tongue plate **A** into the buckle **B** until it clicks
2. Position the lap portion of the belt across your lap as **LOW ON THE HIPS** as possible **C**. Adjust the belt to a **SNUG FIT** by pulling up on the shoulder portion **D**

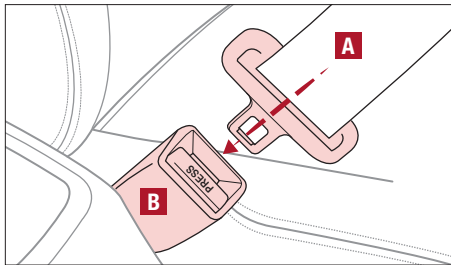

QUICK TIP

The Seat Belt warning chime operates for driver's seat only.

REMINDER: For maximum protection, always wear your Seat Belt.

Seat Belt Retractor Locks⁺¹⁸

Retractor locks allow lap/shoulder seat belts to remain unlocked during normal vehicle operation for freedom of movement and increased comfort.

During a **STRONG STOP, SUDDEN TURN OR CERTAIN COLLISIONS**, seat belt retractors will automatically lock the belts to reduce the risk of injury.

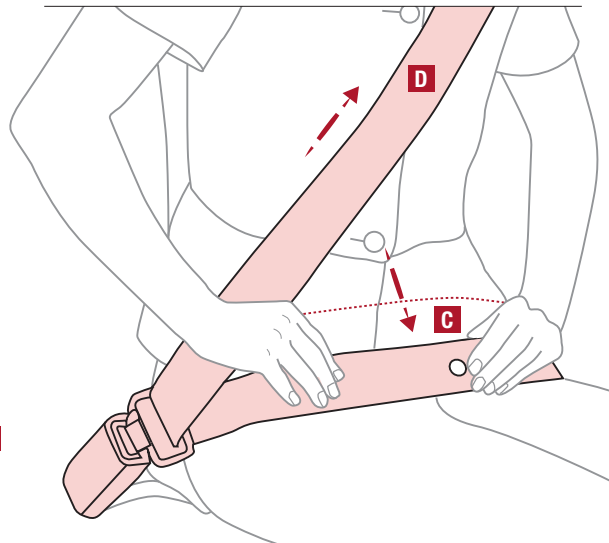

LEGAL DISCLAIMERS

Driving while distracted is dangerous and should be avoided. Drivers should remain attentive to driving and always exercise caution when using the steering-wheel-mounted controls while driving.

Driving while distracted can result in a loss of vehicle control that may lead to an accident, severe personal injury and death. The driver's primary responsibility is in the safe and legal operation of a vehicle, and use of any handheld devices, other equipment or vehicle systems which take the driver's eyes, attention and focus away from the safe operation of a vehicle or that are not permissible by law should never be used during operation of the vehicle.

Safety Features: No system, no matter how advanced, can compensate for all driver error and/or driving conditions. Always drive responsibly.

- 1A. **UVO eServices (Hybrid model):** Purchase/lease of a new 2019 Kia Optima Hybrid vehicle with UVO eServices includes a complimentary 5-year subscription starting from new vehicle retail sale/lease date as recorded by the dealer. After your complimentary 5-year UVO eServices, the subscription expires and your access to UVO eServices will immediately terminate. Use of UVO eServices is subject to agreement to the UVO Privacy Policy (available at <https://www.myuvo.com/legal/privacy-policy.shtml>) and Terms of Service (available at <https://www.myuvo.com/legal/terms-of-service.shtml>). UVO eServices is transferable to subsequent owner during the original UVO eServices service term. Only use UVO eServices when safe to do so. UVO eServices App is available from the App Store® or Google Play™ Store. Kia Motors America, Inc. reserves the right to change or discontinue UVO eServices at any time without prior notification or incurring any future obligation. Message and data rates may apply. Cellular and GPS coverage is required to use most features. UVO eServices features may vary by model, model year, and trim level. Features and specifications are subject to change. For more on details and limitations, visit <https://www.myuvo.com/> or your authorized Kia dealer. Google and logos are trademarks of Google, Inc. App Store is a service mark of Apple, Inc.
- 1B. **UVO eco (Plug-In Hybrid model):** Purchase/lease of a new 2019 Kia Optima Plug-In Hybrid vehicle with UVO eco includes a complimentary 3-year subscription starting from new vehicle retail sale/lease date as recorded by the dealer. After your complimentary 3-year UVO eco, the subscription expires and your access to UVO eco will immediately terminate. Use of UVO eco is subject to agreement to the UVO Privacy Policy (available at <https://www.myuvo.com/legal/privacy-policy.shtml>) and Terms of Service (available at <https://www.myuvo.com/legal/terms-of-service.shtml>). UVO eco is transferable to subsequent owner during the original UVO eco service term. Only use UVO eco when safe to do so. UVO eco App is available from the App Store® or Google Play™ Store. Kia Motors America, Inc. reserves the right to change or discontinue UVO eco at any time without prior notification or incurring any future obligation. Message and data rates may apply. Cellular and GPS coverage is required to use most features. UVO eco features may vary by model, model year, and trim level. Features and specifications are subject to change. For more on details and limitations, visit <https://www.myuvo.com/> or your authorized Kia dealer. Google and logos are trademarks of Google, Inc. App Store is a service mark of Apple, Inc.
2. **Airbags:** For maximum protection, always wear your seat belt.
3. **Android Auto™:** Android Auto is a trademark of Google, Inc. Android™ is a registered trademark of Google, Inc. Distracted driving can result in a loss of vehicle control. Never use a handheld device or vehicle system that takes your focus away from safe vehicle operation.
4. **Apple CarPlay®:** Apple CarPlay® a registered trademark of Apple Inc. Distracted driving can result in a loss of vehicle control. Never use a handheld device or vehicle system that takes your focus away from safe vehicle operation.
5. **Bluetooth® Wireless Technology:** The Bluetooth® word mark and logos are registered trademarks owned by Bluetooth SIG Inc., and any use of such marks by Kia is pursuant to license. A Bluetooth® enabled cell phone is required to use Bluetooth® wireless technology.
6. **Driver Assist Features – Blind Spot Collision Warning with Lane Change Assist, Rear Cross-Traffic Collision Warning (RCW), Lane Keeping Assist (LKA), Rear-Camera Display, Parking Distance Warning-Reverse, Smart Cruise Control (SCC) with Stop & Go, Forward Collision-Avoidance Assist (FCA) / Forward Collision Warning (FCW):** These features are not substitutes for safe driving, and may not detect all objects surrounding vehicle. Always drive safely and use caution.
7. **Electronic Stability Control (ESC)/ Traction Control System (TCS)/Hill-start Assist Control (HAC):** No system, no matter how advanced, can compensate for all driver error and/or driving conditions. Always drive safely.
8. **Engine Start/Stop Button with Smart Key:** Always come to a complete stop before turning the engine on or off. However, if you have an emergency while the vehicle is in motion and must turn the engine off, you can turn the engine off to the ACC position by pressing the Start/Stop button for more than 3 seconds or 3 times in succession. If the vehicle is still moving, you can restart the engine by pressing the Start/Stop button with the shift lever in Neutral (N). With the engine off, hydraulic power assist for steering and braking will be disabled and the vehicle will be more difficult to control.
9. **Forward Collision-Avoidance Assist (FCA) / Forward Collision Warning (FCW):** These systems are not substitutes for safe driving, and may not detect all objects in front of vehicle. Always drive safely and use caution.
10. **Front Seat Headrest Adjustment:** Never attempt to adjust headrests when vehicle is in motion.
11. **Google Play™ Store** is a trademark of Google, Inc. ©2018 Google Inc. All rights reserved. Google and the Google Logo are registered trademarks of Google Inc.
12. **iPhone®/iPod®:** iPhone and iPod are registered trademarks of Apple Inc. Distracted driving can result in a loss of vehicle control. Never use a handheld device or vehicle system that takes your focus away from safe vehicle operation.
13. **Navigation:** Distracted driving can result in a loss of vehicle control. When operating a vehicle, never use a vehicle system that takes your focus away from safe vehicle operation. Navigation is for information purposes only, and Kia does not make any warranties about the accuracy of the information.
14. **Occupant Detection System (ODS):** Kia vehicles use a number of different ODS types that vary by model.
15. **Power Trunk / Smart Power Trunk™:** Driving with the liftgate open may be unlawful and can draw dangerous exhaust fumes into your vehicle; if you choose to do so, keep air vents and all windows open for proper ventilation.
16. **Roadside Assist:** 24-hour Enhanced Roadside Assistance is a service plan provided by Kia Motors America, Inc. Certain limitations apply. Coverage details are available in the Kia Warranty and Consumer Information Manual. For access to Enhanced Roadside Assistance, a connected mobile phone via Bluetooth® within the cellular service coverage area is required.
17. **Seat adjustments:** Reclining the passenger seats can reduce the effectiveness of the safety restraint system and may lead to additional injury in an accident.
18. **Seat belts:** For maximum protection, always wear your seatbelt.
19. **Seat warmers:** Use extreme caution when using the seat warmers to avoid burns. Refer to the Owner's Manual for more information.
20. **SiriusXM®:** SiriusXM Satellite Radio, SiriusXM Traffic and SiriusXM Travel Link each require a subscription sold separately, or as a package, by SiriusXM Radio Inc. **If you decide to continue your service at the end of your trial subscription, the plan you choose will automatically renew and bill at then-current rates until you call 1-866-635-2349 to cancel. See SiriusXM Customer Agreement for complete terms at www.siriusxm.com.** Other fees and taxes will apply. All fees and programming are subject to change. Not all vehicles or devices are capable of receiving all services offered by SiriusXM. Data displays and individual product availability vary by vehicle hardware. Current information and features may not be available in all locations, or on all receivers. Weather Forecast, Current Conditions may not be available in all locations. Images above are for representative purposes only and are not real products. For actual features and images of real products, consult the vehicle manufacturer. SiriusXM is not responsible for any errors or inaccuracies in the data services or their use in the vehicle. Travel Link Stocks displays current price and daily delta of around 7,000 actively reported securities traded on the NYSE®, NASDAQ® and AMEX®. The service is delayed approximately 20 minutes. SiriusXM satellite service is available only to those at least 18 years of age in the 48 contiguous USA, DC, and Puerto Rico (with coverage limitations). SiriusXM Internet Radio service is available throughout our satellite service area and in AK and HI. © 2018 SiriusXM Radio Inc. Sirius, XM and all related marks and logos are trademarks of SiriusXM Radio Inc.
21. **Sportmatic®** is a registered trademark of Kia Motors America.
22. **Steering-wheel-mounted controls:** Driving while distracted is dangerous and should be avoided. Remain attentive to driving and be cautious when using steering-wheel-mounted controls while driving.
23. **Sunvisors:** Sunvisor may not shield all direct light. Do not operate the vehicle if sunvisor is impairing your visibility.
24. **Tilt/Telescoping Steering Wheel:** Never attempt to adjust steering wheel position when vehicle is in motion.
25. **Tire Pressure Monitoring System (TPMS):** Even with Tire Pressure Monitoring System, check tire pressure on a regular basis.



**OPTIMA HYBRID
PLUG-IN HYBRID** CUSTOMER DELIVERY CHECKLIST

KEY FEATURE WALKTHROUGH

- UVO eServices* – page 30

For further operational information, refer to the Car Multimedia System User's Manual.



- UVO eServices with Premium-Navigation* – page 31

For further operational information, refer to the Car Multimedia System User's Manual.

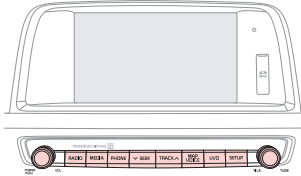

- UVO eco with Navigation* – page 32

For further operational information, refer to the Car Multimedia System User's Manual.

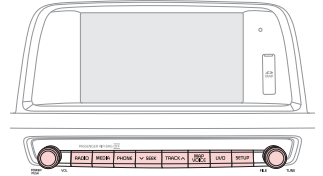

- UVO eServices / eco Activation / Android Auto™ / Apple CarPlay® Setup* – page 28-29

Walk customer through the registration/activation process for UVO eServices.

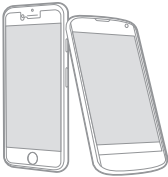

- Cruise Control – page 25

Demonstrate operation

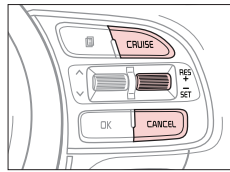

- Bluetooth® Wireless Technology – page 23

Demonstrate operation, and pair customer's phone.

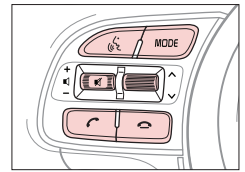

- Tire Pressure Monitoring System (TPMS) – page 5
- Trip Modes / Trip Computer – page 7
- Fuel Economy – page 8
- ECO Mode (Active ECO) – page 10
- Engine Start/Stop Button – page 19
- Audio Controls – page 25
- Digital Clock – page 33
- Seat Warmers/Ventilated Seats* – page 36

- Smart Key – page 40
- Panoramic Sunroof Operation* – page 42
- Sunvisor – page 43
- Rear Camera Display – page 44
- Parking Distance Warning-Reverse* – page 44
- Tire Mobility Kit – page 46
- Passenger Airbag Off Indicator – page 47

- Aux/USB/iPod® Port – page 33

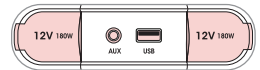

DURING DELIVERY

- Explain first service process and schedule first service appointment
- Tour Parts & Service departments, introduce staff & explain value of Kia Parts and Service
- Review recommended maintenance schedule and maintenance requirements to validate warranty
- Review business hours & Customer 360° Care
- Review the Kia 10-year/100,000-mile warranty program
- Ensure 100% satisfaction with sales and delivery process and no problems with the vehicle
- Confirm time and best contact number for initial dealer follow-up

*IF EQUIPPED

Sales Consultant: _____ Date: _____

Sales Manager: _____ Date: _____

Customer: _____ Date: _____



OPTIMA HYBRID / PLUG-IN HYBRID CUSTOMER DELIVERY CHECKLIST

Owner's Name: _____ VIN: _____ Mileage: _____

Dealership Name: _____ Sales Consultant: _____ Date: _____

BEFORE DELIVERY

- Confirm "Good Battery" with Kia battery tester
- Verify all tire pressures are to spec (see driver's door label) LF _____ LR _____ RF _____ RR _____
- Verify proper operation of Remote Keyless Entry and Smart Key lock/unlock
- Ensure floor mats are snapped into place (if applicable)
- Verify vehicle is clean (interior and exterior), in good condition and free of chips and scratches
- Ensure all key documents are in the vehicle (Owner's Manual, Warranty and Consumer Information booklet, Tire Warranty booklet and Features & Functions Guide and any supplemental audio user's guides)

KEY FEATURE WALKTHROUGH

- Instrument Cluster / Hybrid/Plug-In Displays – page 3

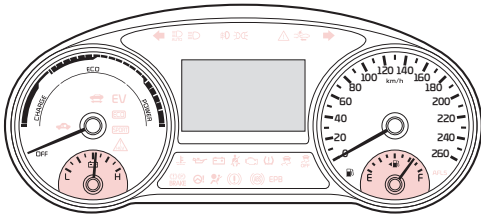

- Hybrid/Plug-In Displays on the Audio Control Unit – page 11

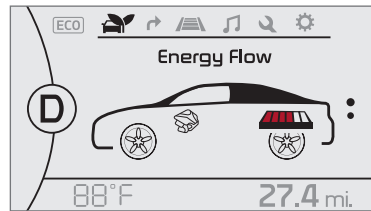

- Climate Control System* – page 34
Demo Defrost and Defog Windshield

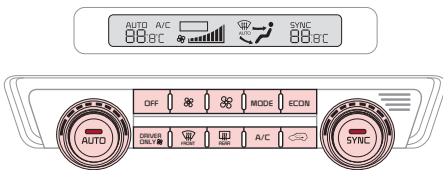

Type A shown

Automatic Climate Control with Standard Audio and UVO eServices shown

- Windshield Wipers & Washers – page 22
Move lever Up/Down to change Wiper modes. Rotate level to adjust Intermittent Wipe Speed.

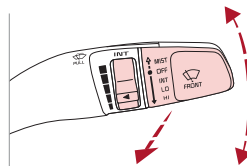

MIST: Single wipe
 OFF: Wipe off
 INT: Intermittent wipe
 LO: Slow wipe
 HI: Fast wipe

Pull to spray and wipe.



OPTIMA HYBRID / PLUG-IN HYBRID NORMAL MAINTENANCE SCHEDULE

P=Perform • R=Replace • I=Inspect^B

(up to 60,000 miles)^A

MAINTENANCE INTERVALS (MILES)

MAINTENANCE ITEMS	7,500	15,000	22,500	30,000	37,500	45,000	52,500	60,000
Add fuel additive ^C	P	P	P	P	P	P	P	P
Rotate tires	P	P	P	P	P	P	P	P
Engine oil and filter	R	R	R	R	R	R	R	R
Climate control air filter	R	R	R	R	R	R	R	R
Brake lines, hoses and connections	I	I	I	I	I	I	I	I
Brake discs and pads	I	I	I	I	I	I	I	I
Vacuum hose	I	I	I	I	I	I	I	I
Steering gear rack, linkage & boots	I	I	I	I	I	I	I	I
Drive shafts and boots	I	I	I	I	I	I	I	I
Suspension ball joints	I	I	I	I	I	I	I	I
Air conditioner compressor/refrigerant	I	I	I	I	I	I	I	I
Exhaust system	I	I	I	I	I	I	I	I
Air cleaner filter	I	I	I	R	I	I	I	R
HSG belt ^D	I	I	I	R	I	I	I	R
Brake fluid		I		I		I		I
Fuel tank air filter ^E		I		I		I		I
Parking brake (foot type)		I		I		I		I
Vapor hose and fuel filler cap		I		I		I		I
Cooling System				I		I		I
Fuel lines, fuel hoses and connections				I				I

QUICK TIP

Check your Maintenance Schedule or schedule an appointment with a dealer using your UVO eServices/eco account by logging into your UVO eServices/eco App or your account on MyUVO.com (Vehicles equipped with UVO eServices/eco only – See page 29 for setup information)

‡ If equipped.

A. See the Owner's Manual for complete maintenance schedule.

B. And, if necessary, adjust, correct, clean or replace.

C. If TOP TIER detergent gasoline is not available, one bottle of additive is recommended. Additives are available from your authorized Kia dealer along with information on how to use them. Do not mix other additives.

D. Inspect HSG belt for evidence of cuts, cracks, excessive wear or oil saturation and replace if necessary. If HSG belt noise occurred, readjust HSG belt tension before replace.

E. Both the fuel filter & fuel tank air filter are generally considered to be maintenance free, depending on fuel quality being used. However, periodic inspection is recommended. If your vehicle is having issues like fuel flow restriction, power surging, loss of power, difficulty starting, etc., replace the fuel filter immediately and consult an authorized Kia dealer for service.

See your Owner's Manual for more details and complete maintenance information, including severe maintenance schedule. Warranty may be voided if maintenance schedule is not followed.

© 2018 Kia Motors America, Inc. All rights reserved.
Consumer - Roadside Assistance^{1*}: 1-800-333-4KIA (4542)

Part Number: UH190-PS-004

†LEGAL DISCLAIMERS ON BACK INSIDE COVER