

OPTIMA

Features & Functions Guide



Delivery First

The priority that delivers more



GETTING TO KNOW YOUR **OPTIMA**

Congratulations on Your New Kia Purchase!

Your new Kia vehicle has been designed, engineered and manufactured to provide you with years of comfortable and dependable driving. Kia is committed to quality, innovation, safety and — above all — your satisfaction.

Using This Guide

The information contained in this guide is a brief overview that will help you become familiar with the operation and features of your new Kia vehicle. The flipbook format facilitates information access, while the detailed illustrations help to ensure the instructions are easy to follow.

This **Features & Functions Guide**, and the specific operational and safety information it provides, is not a substitute for your Owner's Manual. In the interest of your safety and that of your family, and to help you avoid risks that may result in death or serious injury, Kia reminds you to carefully read your Owner's Manual in order to fully familiarize yourself with the important information it contains.

While Kia endeavors to ensure that the information contained in this guide is accurate at the time of printing, Kia may change vehicle specifications without notice in advance or after the fact, and assumes no liability in connection with such changes.

www.kia.com

Consumer - Roadside Assistance^{†16}
1-800-333-4KIA (4542)

See Back Pages for Vehicle Maintenance Schedule

Always check the Owner's Manual for complete operating information and safety warnings.

†LEGAL DISCLAIMERS ON BACK INSIDE COVER

ESSENTIAL FEATURES

Air Conditioning / Climate Control	28
Android Auto™ / Apple CarPlay® Setup	22
Audio System – Standard Audio System*	23
Audio System – UVO link*	24
Audio System – UVO link with Navigation*	25
Audio System – UVO link Activation*	22
Aux/USB/iPod®* Port* & Power Outlets	27
Bluetooth® Wireless Technology	18
Cruise Control	21
Digital Clock	27
ECO Mode (Active ECO)*	09
Passenger Airbag Off Indicator	42
Service Interval Mode	08
Smart Cruise Control (SCC) with Stop & Go*	20
Smart Key*	35
Tire Mobility Kit*	41
Tire Pressure Monitoring System (TPMS)	05
Trip Modes / Trip Computer	06
User Settings	08
Windshield Wipers & Washers	17

Driving while distracted can result in a loss of vehicle control that may lead to an accident, severe personal injury and death. The driver's primary responsibility is in the safe and legal operation of a vehicle, and use of any handheld devices, other equipment or vehicle systems which take the driver's eyes, attention and focus away from the safe operation of a vehicle or that are not permissible by law should never be used during operation of the vehicle.

*IF EQUIPPED



VIDEOS & QR CODES	02
-----------------------------	----

INSTRUMENT CLUSTER

Instrument Cluster Overview	03
Indicators & Warning Lights	04
Tire Pressure Monitoring System (TPMS)	05
LCD Instrument Cluster Modes	06
Trip Modes / Trip Computer	06
Instant Fuel Consumption Mode*	07
Fuel Economy	07
User Settings	08
Service Interval Mode	08
Drive Mode Integrated Control System*	09
ECO Mode (Active ECO)*	09

DRIVER'S PANEL

Blind-Spot Collision Warning (BCW) w/ RCCW*	10
Instrument Cluster Control*	11
Electronic Stability Control (ESC)	11
Hill-Start Assist Control (HAC)	11
Lane Keeping Assist (LKA)*	12
Forward Collision-Avoidance Assist (FCA) / Forward Collision Warning (FCW)	13
Engine Start/Stop Button*	14
Power Windows, Window Lock & Central Door Lock*	15
Automatic Door Lock/Unlock	15
Power/Heated Outside Mirrors	15
Power Folding Outside Mirrors*	15

STEERING WHEEL CONTROLS

Turn Signals & Fog Lights*	16
Headlights & High Beams	16
Windshield Wipers & Washers	17
Heated Steering Wheel Button*	17
Tilt/Telescoping Steering Wheel	17
Bluetooth® Wireless Technology	18
Smart Cruise Control (SCC) with Stop & Go	20
Audio Controls	21
Cruise Control	21

AUDIO SYSTEMS

Android Auto™ / Apple CarPlay® Setup	22
UVO link Activation*	22
Standard Audio System*	23
UVO link*	24
UVO link with Navigation*	25

LEGAL DISCLAIMERS	Inside Back Cover
-----------------------------	-------------------

CENTER PANEL

Surround View Monitoring (SVM) System*	26
Digital Clock	27
Aux/USB/iPod® Port & Power Outlets	27
USB Charger*	27
Wireless Smartphone Charging System*	27
Automatic Climate Control*	28
Manual Climate Control*	29
Electric Parking Brake (EPB)*	30
Auto Hold*	30
Automatic Gear Shift with Sportmatic® Shifting	31
Paddle Shifters*	31
Dual Clutch Transmission*	32
Seat Warmers / Ventilated Seats*	32

SEATING

Front Seat Headrest Adjustment	33
Driver Position Memory System*	33
Power Adjustable Driver's Seat*	33
6-Way Manual Adjustable Driver's Seat*	34

OTHER KEY FEATURES

Smart Key*	35
Remote Keyless Entry (Folding Key)*	36
Double-Turn Lock/Unlock All	36
Fuel Cap / Malfunction Indicator (Check Engine Light)	36
Sunvisor	36
Driver Attention Warning (DAW)*	37
Map/Room Lamps	38
Panoramic Sunroof with Power Sunshade	38
Fuel Filler Lid and Trunk Release	39
Trunk Release Button (Exterior)	39
Smart Power Trunk*	39
Hood Release Lever and Latch	40
Child-Protector Rear Door Locks	40
Parking Distance Warning-Reverse*	40
Rear-Camera Display*	41
Tire Mobility Kit	41

SAFETY FEATURES

Occupant Detection System (ODS) / Passenger Airbag Off Indicator	42
Seat Belts	42
Seat Belt Retractor Locks	42

TURBO MAINTENANCE CHART	44
-----------------------------------	----

NON-TURBO MAINTENANCE CHART	Back Cover
---------------------------------------	------------

Kia provides a number of video resources to assist you with becoming familiar with the features and functions found in your Kia vehicle. You can access these resources by snapping the QR Codes with your smartphone/tablet (mobile devices) or by visiting the following website: www.youtube.com/KiaFeatureVideos. Continue reading for a more in-depth look at QR Codes and for instructions on how to use them.

What are QR Codes?

A QR Code is a square, two-dimensional barcode that can be read by mobile devices loaded with an appropriate barcode or QR Code Reader App. The app reads the barcode image and then launches/uploads the specific information the code contains, such as URLs, text, photos, videos and so much more.

How to Use QR Codes

If you have a mobile device with a QR Code Reader App, you can snap the code with your phone and you'll be provided a video with additional information pertaining to the topic. For example, in the Fuel Cap section, if you would like additional information, just snap the code with your mobile device to view the selected Kia Features & Functions Video.

How to Snap a QR Code

1. With your mobile device, download a QR Code Reader App. With many devices, you can do this through an app store or marketplace
2. Open the QR Code Reader App on your mobile device
3. The app will utilize your device's camera. Center the code in the camera viewing area:
 - With some apps, as soon as the app recognizes the code, it will launch the corresponding video
 - With other apps, you will have to snap or take a picture of the code. The app will then launch the corresponding video
 - For operation specifics, refer to the instructions that come with the QR Code Reader App

QR CODE

One Click Fuel Cap Video

To view a video on your mobile device, snap this QR Code or visit the listed website.



www.youtube.com/KiaFeatureVideos

REMINDER: When accessing videos on your mobile device, standard cellular data rates may apply.

QUICK TIPS

1. If you're having trouble scanning codes, check the following:
 - The code should be centered and focused in your mobile device's camera screen
 - Consider moving your device closer to or farther away from the code
 - The code should be well lit, without significant shadow
 - Avoid scanning from a significant angle
 - Confirm that the device's app supports 2D QR Code scanning
 - Try another QR Code Reader App; not all apps are created equal
2. After scanning, if a "connecting" message appears and then nothing happens or there's a "connection error" message, this typically indicates that your device is having trouble connecting to the Internet
3. When accessing videos on your mobile device, standard cellular data rates will apply

Instrument Cluster Overview

- A** Tachometer
- B** Indicator & Warning Lights
- C** Speedometer
- D** LCD Screen
- E** Turn Signal Indicators
- F** Engine Temperature Gauge
- G** Fuel Gauge
- H** Gear Shift Position Indicator

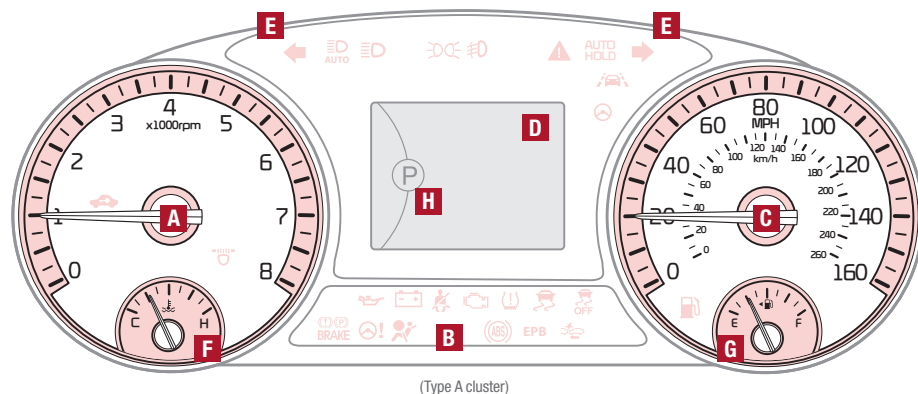

This illustration is for demonstration purposes only. Some indicators and warning lights may not appear in illustration. On the vehicle, they may appear in the LCD.

Your vehicle's instrument cluster & indicator light locations may differ from those in the illustrations. For more information on the instrument cluster, the LCD Warning Messages and the function of all indicator and warning lights, please refer to the Owner's Manual.

Indicators & Warning Lights

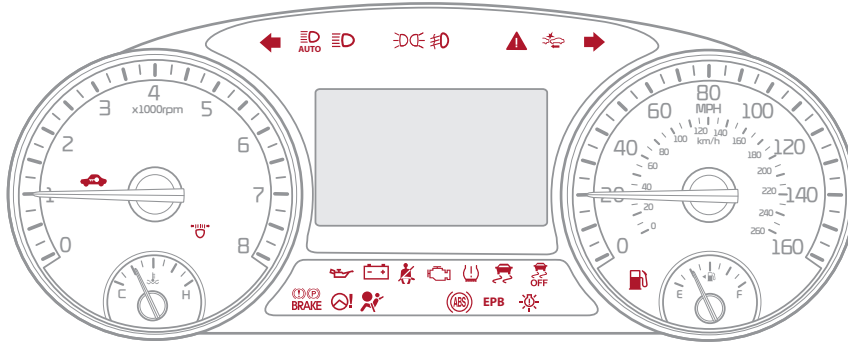

(Type B cluster)

This illustration is for demonstration purposes only. Some indicators and warning lights may not appear in illustration. On the vehicle, they may appear in the LCD.

Your vehicle's instrument cluster & indicator light locations may differ from those in the illustrations. For more information on the instrument cluster, the LCD Warning Messages and the function of all indicator and warning lights, please refer to the Owner's Manual.

 Immobilizer Indicator Light*

 ECO Mode Indicator Light*

 SPORT Mode Indicator Light*

 High Beam Assist Indicator*

 High Beam Indicator

 Low Beam Indicator Light*

 Light ON Indicator Light

 Parking Brake & Brake Fluid Warning Light

 Engine Oil Pressure Warning Light

 Electric Power Steering (EPS) Warning Light

 Charging System Warning Light

 Airbag Warning Light

 Seat Belt Warning Light

 Malfunction Indicator Lamp (MIL)

 Low Tire Pressure Indicator / TPMS Malfunction Indicator

 Anti-lock Braking System (ABS) Warning Light

 Electronic Stability Control (ESC) Indicator Light

 Electronic Stability Control (ESC) OFF Indicator Light

 Electronic Parking Brake (EPB) Warning Light*

 LED Headlamp Warning Light*

 Dynamic Bending Light (DBL) Warning Light*

 Master Warning Light*

 Forward Collision-Avoidance Assist (FCA) Light*

 Lane Keeping Assist (LKA) Indicator Light*

 Low Fuel Level Warning Light

 Electronic Brake force Distribution (EBD) System Warning Light (Two separate indicators on Instrument Cluster lit at same time)

 CRUISE Cruise Indicator Light



 SET Cruise SET Indicator Light*

 AUTO HOLD Indicator Light*

 AFLS (AFLS) Warning Light*

  Front Fog Light Indicator

Tire Pressure Monitoring System (TPMS)*†‡5

The TPMS indicator  functions as both Low Tire Pressure Light and TPMS Malfunction Indicator **A**. The indicator  is designed to illuminate if it detects one or more tires is significantly underinflated, the vehicle has a spare tire installed without TPMS or the outside temperature becomes significantly lower.

The Low Tire Pressure Position Indicator **B** is displayed on the LCD screen in the Instrument Cluster when the tire(s) is underinflated. Inflate tire(s), using an accurate digital tire pressure gauge, to specifications to turn off Low Tire Pressure Position Indicator **B**; see the front driver's door jamb for PSI specification.

When there is a problem with the TPMS, the TPMS Malfunction Indicator  will blink for approximately one minute and then illuminate—see dealer for service.

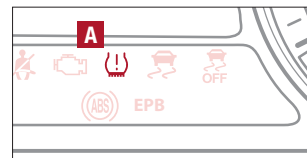

(Indicator located on Instrument Cluster)

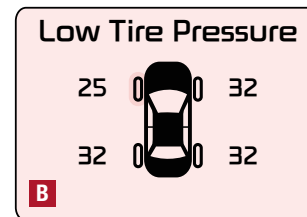

(Type B cluster screen shown)

QUICK TIPS

- Even with TPMS, tire pressure should be checked manually at least once a month. Only adjust tire pressure on “cold tires”
- For proper maintenance and optimal fuel economy, maintain recommended tire inflation pressures and stay within the load limits and weight distribution recommended for your vehicle
- In winter or cold weather, the TPMS light may illuminate if the tire pressure was adjusted to the recommended tire inflation pressure during warm weather

REMINDERS:

- Check the recommended tire pressure label located on the left side of driver's door jamb, which is visible when the door is open
- Consult your dealer for service if Low Tire Pressure Light remains illuminated after inflating your tire(s)
- Personal electronic devices (such as laptops, wireless chargers, remote start systems, etc.) can emit frequencies that may interfere with TPMS system, which may cause the Malfunction Warning Indicator (Check Engine Light) to illuminate

QR CODE

Tire Pressure Monitoring System Video

To view a video on your mobile device, snap this QR Code or visit the listed website.

Refer to page 2 for more information.



www.youtube.com/KiaFeatureVideos

LCD Instrument Cluster Modes*

Press Mode button **A** to scroll through different LCD Instrument Cluster Modes.

Type B cluster:



Trip Computer Mode: Displays driving information for tripmeter, fuel economy, etc.



Turn-by-Turn Mode*: Displays the state of the navigation



Assist Mode*: Displays the state of the SCC with S&G, Lane Keeping Assist, TPMS, Driver Attention Warning (DAW)



Master Warning Mode: Informs on low tire pressure warnings, Blind-Spot Collision Warning (BCW) system malfunction and other systems



User Settings Mode: Change settings of the doors, lamps and other features

Driving while distracted is dangerous and should be avoided. Drivers should remain attentive to driving and always exercise caution when using the steering-wheel-mounted controls while driving.

Trip Modes / Trip Computer

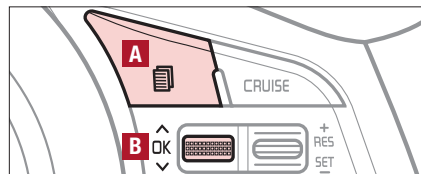

(Type B; Buttons located on Steering Wheel)

The Trip Computer is a system to relay pertinent driving information. It appears on the display when the ignition switch or the Engine Start/ Stop button* is in the ON position.

To cycle through the Trip Modes, press the Mode button **A**.

To select and enter Trip Computer mode , press the OK button **B** up/down and then press OK button **B** again to enter. To cycle through different screens (Fuel Economy, Trip A, Trip B), press the OK button **B** up/down and press again to enter. When displaying TRIP A or TRIP B screens, press and hold the OK button **B** to reset the Tripmeter to zero.

REMINDERS:

- Appearance of Tripmeter display may differ as equipped
- All stored driving information (except Odometer and Range) is reset if the battery is disconnected

Your vehicle's steering wheel buttons may differ from those in the illustrations.

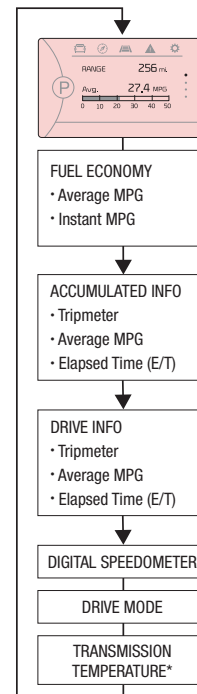

(Type B Cluster)

Instant Fuel Consumption Mode

Press button **A** to cycle to the Trip Computer screen, then toggle up or down with the OK button **B** to cycle to the Fuel Economy screen. The bar at the bottom of the screen displays the calculated Fuel Consumption during the past few seconds when the vehicle speed is more than approximately 6 mph.

1. Keep your vehicle in good condition with regular maintenance
2. Travel lightly, without carrying unnecessary weight in your vehicle
3. Don't let the engine idle longer than necessary

REMINDERS:

- Not to be used in calculating or as a reference for AVERAGE fuel economy
- If the vehicle speed exceeds 1 mph (1.6 km/h) after being refueled with more than 1.6 gallons (6 liters), the average fuel economy will be cleared to zero (---)

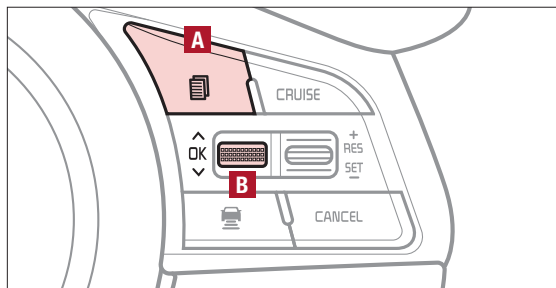

(Type A - Buttons located on Steering Wheel)

Your vehicle's steering wheel buttons may differ from those in the illustrations.

Fuel Economy

There are several factors that contribute to your vehicle's fuel economy, including maintenance of your vehicle, driving style, environmental conditions, vehicle weight and vehicle aerodynamics. Below are tips on how to help improve fuel economy:

- Keep your vehicle in good condition with regular maintenance
- Don't let the engine idle longer than necessary
- Drive at a moderate speed, accelerating smoothly and at a moderate rate
- Keep tires inflated to the recommended pressure
- Travel lightly, without carrying unnecessary weight in your vehicle
- Avoid placing large or heavy items on roof racks
- Avoid hilly, winding or poorly maintained roads

For more information on Fuel Economy, you can snap the QR Code above to view a video or refer to the Owner's Manual.

QR CODE

Fuel Economy Video

To view a video on your mobile device, snap this QR Code or visit the listed website.

Refer to page 2 for more information.



www.youtube.com/KiaFeatureVideos

User Settings

To enter the User Settings mode in the LCD Instrument Cluster Modes, press the Mode button **A** when the vehicle is at a standstill and with the ignition switch or the Engine Start/Stop button* in the ON position, and select User Settings .

You can navigate the selections on the display by pressing the Select/Reset (OK) button **B** up and down, and then selecting the item by pressing the OK button **B** again.

Driving Assistance*:

- Highway Auto Speed*
- Driver Attention Warning*
- Lane Safety*
- Rear Cross-Traffic Collision Warning (RCCW)*
- Forward Collision Warning (FCW)*
- Forward Collision-Avoidance Assist (FCA)*
- Blind-Spot Collision Warning*
- Smart Cruise Control Reaction*

Door/Trunk:

- Automatically Lock
- Automatically Unlock
- Smart Power Trunk*
- Two-Press Unlock
- Horn Feedback

Convenience:

- Seat-Easy Access*
- Welcome Mirror/Light*
- Wireless Charging System*
- Wiper/Light Display*
- Gear Position Pop-Up*
- Icy-Road Warning*

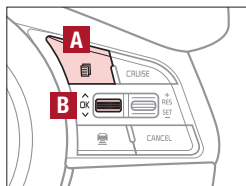

(Type B; Located on Steering Wheel)

Lights:

- Ambient Light Brightness*
- Ambient Light Color*
- One-Touch Turn Signal*
- Headlamp Delay
- Welcome Light*

Sound:

- Parking Distance Warning-Reverse* System Volume*
- Welcome Sound*

Service Interval:

- Enable Service Interval
- Adjust Interval
- Reset

Language:

- Choose the language

Other Features:

- Fuel Economy Auto Reset
- Fuel Economy Unit
- Temperature Unit
- Tire Pressure Unit*

Reset:

- Reset User Setting menus

Service Interval Mode

To enter Service Interval mode, press the Mode button **A**, scroll using the OK button **B** to User Settings  and press the OK button **B** to enter. Then scroll to Service Interval and press OK button again **B**. System will display number of miles remaining until next service is due, as well as type of service.

When service is required, the following will be displayed: **Service Required**.

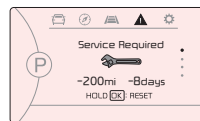

To reset the Service Interval mode system, press and hold the OK button **B** for more than 1 second.

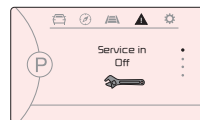

To turn Service In OFF, go to User Settings.

Service Interval Setting

To set the service interval when in User Settings mode:

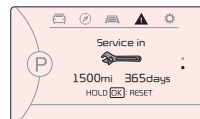

(Type B cluster)

- Press the OK button **B** up/down and scroll to Service Interval. Press the OK button **B** again to enter
- Press the OK button **B** and toggle to ON, then press the OK button **B** again to set. Then press the Move button **B** up/down to scroll and select the desired miles or months for your next service
- Press the OK button **B** again to enter

QR CODES

To view a video on your mobile device, snap these QR Codes or visit the listed website.

Refer to page 2 for more information.

LCD Display Video



www.youtube.com/KiaFeatureVideos

LCD Display: Maintenance Video



www.youtube.com/KiaFeatureVideos

Drive Mode Integrated Control System

SMART, COMFORT, SPORT and ECO drive modes **A** may be changed according to the driver's preference or road conditions. To cycle through drive modes, press the DRIVE MODE button **B**.

COMFORT Mode – The system's default mode is COMFORT mode and may not be displayed on the instrument cluster nor the audio system's screen.

ECO Mode – An ECO indicator will illuminate on the instrument cluster. To deactivate, press the DRIVE MODE button **B** again to change the selection to another setting.

SPORT Mode – A SPORT indicator will illuminate on the instrument cluster. To deactivate, press the DRIVE MODE button **B** again to change the selection to another setting.

SMART Mode* – When SMART mode is activated, the system automatically selects the drive mode best suited to the current driving style (economic, average, spirited). A SMART indicator will illuminate on the instrument cluster. The color of the SMART indicator (green, white, red) depends on the current driving style. To deactivate, press the DRIVE MODE button **B** again to change the selection to another setting.

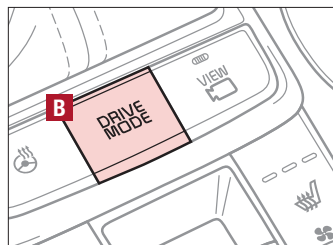
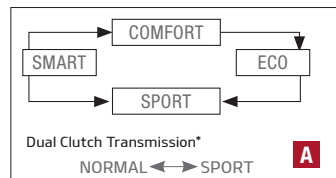

REMINDERS:

- When ECO mode is selected, the following may occur to help improve fuel economy:
 - Acceleration may be slightly reduced even when the accelerator is fully depressed
 - Air conditioner performance may be limited
 - Shift pattern of the automatic transmission may change
 - Engine noise may increase
 - System's power will be limited when driving uphill
- Steering effort may be slightly increased in SPORT mode
- When SPORT mode is selected, fuel economy may decrease

ECO Mode (Active ECO)*

The Active ECO system is designed to help improve fuel economy by controlling several vehicle components. When activated, it modifies drivetrain operations such as engine power and transmission.

To turn ON, press the DRIVE MODE button **B** and scroll through options until in the ECO mode. The ECO mode indicator light in the LCD cluster will illuminate, indicating that the vehicle is in ECO mode and Active ECO is operating. The Active ECO system will remain on even when the ignition is cycled.

To turn the Active ECO system OFF, press the DRIVE MODE button **B** again and change to another mode.

For more information on ECO Mode, refer to your Owner's Manual or contact your local dealership.

ALWAYS CHECK THE OWNER'S MANUAL FOR COMPLETE OPERATING INFORMATION AND SAFETY WARNINGS.

QR CODE

Drive Mode Integrated Control System Video

To view a video on your mobile device, snap this QR Code or visit the listed website.

Refer to page 2 for more information.



www.youtube.com/KiaFeatureVideos

QUICK TIPS

When the Engine Start/Stop button is turned off, the system will default to COMFORT mode and each mode will need to be selected again when the vehicle restarts.

To help improve your fuel economy:

- Drive at a moderate speed, accelerating smoothly and at a moderate rate
- Keep tires inflated to the recommended pressure
- Be sure the wheels are properly aligned

*IF EQUIPPED

Blind-Spot Collision Warning (BCW) w/ RCCW*†6

The BCW system uses radar sensors in the rear bumper to monitor and warn the driver if it detects an approaching vehicle in the driver's blind spot area and before changing lanes. The light on the BCW button **A** will illuminate when turned ON. The outside rearview mirror warning lights will also illuminate for 3 seconds.

The system will become active when the vehicle is traveling faster than approximately 18 mph and will alert the driver if another vehicle is detected by the radar sensor.

Blind-Spot Collision Warning (BCW) / Lane Change Assist (LCA)*

1st-stage alert: When another vehicle is detected within the BCW System boundary **B**, or when a vehicle is detected within the LCA boundary **C** approaches at a high speed, a yellow indicator will illuminate on the outside rearview mirrors **C**.

2nd-stage alert: When 1st-stage alert is on and the driver activates a turn signal, a flashing yellow indicator will illuminate on the outside rearview mirrors and the system will sound an alert.

Rear Cross-Traffic Collision Warning (RCCW)*†6

If the RCCW system sensors detect approaching vehicles from the left or right side **D**, the system will sound an alert, the warning indicators on the outside rearview mirror will illuminate and a message will appear on the LCD screen, when these conditions are met:

- The shift is moved into (R) Reverse
- The vehicle is moving slower than 6 mph

REMINDERS:

- The RCCW feature can be turned OFF/ON in User Settings
- The RCCW system will show a warning if the approaching vehicle speed is between 2.5 - 22 mph within sensing range. See Owner's Manual for other conditions
- When vehicle power is cycled, the RCCW will remain in the previous state

For more information on the Blind-Spot Collision Warning, please refer to the Owner's Manual.

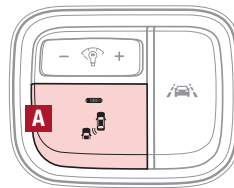

(Located left of Steering Wheel)

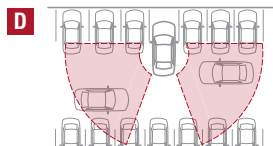
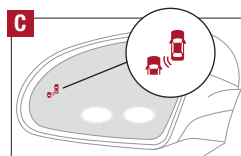
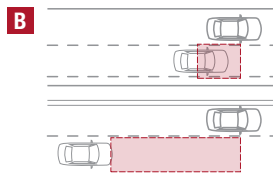

The above images are for illustration purposes only and may not reflect actual operation.

QR CODE

Blind-Spot Collision Warning w/ RCCW Video

To view a video on your mobile device, snap this QR Code or visit the listed website.

Refer to page 2 for more information.



www.youtube.com/KiaFeatureVideos

The BCW and RCCW systems are supplemental systems. Do not solely rely on these systems and always pay attention to drive safely.

Instrument Cluster Control

Press left/right side of switch **A** to adjust the display brightness of the instrument panel illumination.

REMINDER: Instrument Cluster Control does not change brightness when lights are turned off.

Electronic Stability Control (ESC)^{†7}

The ESC system is designed to help stabilize the vehicle during certain cornering maneuvers. It is a good idea to keep the ESC turned ON for daily driving whenever possible.

Press ESC OFF button **B** to disable Traction Control in ESC (ESC OFF indicator will illuminate).

To turn both Traction Control and Stability Control off, press and hold ESC OFF button **B** (ESC OFF indicator will illuminate, and an alert sounds).

REMINDEERS:

- ESC is active by default at vehicle start-up. When ignition is cycled, ESC will turn ON again
- The ESC Indicator Light  in the Instrument Cluster will illuminate whenever the ESC is in operation

For more information on Electronic Stability Control (ESC) and its specific features and operations, please refer to your Owner's Manual.

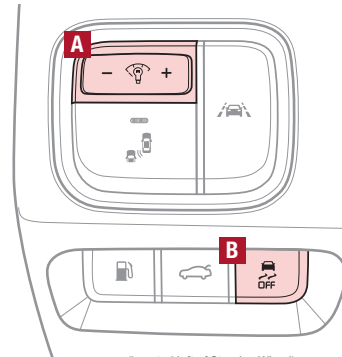

(Located left of Steering Wheel)

Hill-Start Assist Control (HAC)^{†7}

HAC helps prevent the vehicle from rolling backward when accelerating from a stop while on a steep incline.

The HAC automatically activates whether the ESC is OFF or ON but does NOT activate when the ESC has malfunctioned.

REMINDEERS:

- The HAC does not operate when the gear shift is in the P (Park) or the N (Neutral) position
- In the event of HAC system malfunction, see authorized Kia dealer for service
- HAC does not replace the need to apply brakes while the vehicle is stopped on an incline

QUICK TIPS

- When HAC is active (e.g., accelerating from a stop on an incline), you may notice that the brakes will momentarily remain engaged after you depress the accelerator
- HAC provides a 2-second delay before the vehicle may start rolling backward

Lane Keeping Assist (LKA)*†6

With the Engine Start/Stop button in the ON position, press the LKA button **A** to turn system ON. The instrument cluster indicator  will illuminate green.

If the LKA detects that you are moving outside of your lane, the system may issue a warning on the LCD screen and an alert may sound, while applying a slight adjustment to the steering, trying to prevent the vehicle from moving outside its lane.

Standard LKA is the operating mode by default when the button is depressed to ON. To switch to between modes (Standard LKA, Active LKA and Lane Departure), go to User Settings in the Instrument Cluster.

All systems will operate under the following conditions:

- The vehicle speed exceeds approximately 37 mph
- The LKA system recognizes the lane the vehicle is traveling in
- The vehicle is between the lane markers

REMINDERS:

- LKA will not issue a warning if the turn signal or hazard lights are activated
- If the LKA button is ON and ignition is cycled, the system will turn ON again. If the LKA button is OFF, the system remains OFF

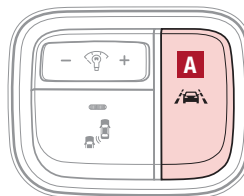

(Located left of Steering Wheel)



When the LKA sensor detects the lane traveling in



When the LKA sensor does not detect the lane traveling in



When the LKA sensor detects the vehicle veering outside of the lane traveling in, a yellow indicator will illuminate

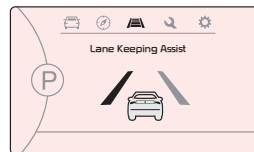

QR CODE

Lane Keeping Assist (LKA) Video

To view a video on your mobile device, snap this QR Code or visit the listed website. Refer to page 2 for more information.



www.youtube.com/KiaFeatureVideos

The Lane Keeping Assist (LKA) is not a substitute for safe and proper driving. Always drive safely and use caution. LKA may not always alert the driver if the vehicle is about to be driven outside of its lane.

Forward Collision-Avoidance Assist (FCA)^{†9} / Forward Collision Warning (FCW)^{†9}

The FCA is designed to help alert the driver and, under certain conditions if necessary, apply emergency braking when rapidly approaching a vehicle that is slowing down, braking or stopped. Initially, the Forward Collision Warning (FCW) will provide a warning when it detects a potential collision with a vehicle in front and emits an audible warning and visual alert on the instrument cluster. Adjust the alert settings (Early, Normal, Late) in the User Settings. To turn the FCA/FCW off, go to User Settings again and turn off.

If the system detects that the collision risk increases, the Forward Collision-Avoidance Assist (FCA) automatically applies the brakes to reduce your speed, helping to minimize the effects of a possible collision. FCA can be turned ON in the User Settings menu on the Instrument Cluster display.

The FCA/FCW will become active when the:

- Engine Start/Stop button is ON
- Vehicle is traveling faster than 5 mph
- Electronic Stability Control (ESC) is ON

REMINDERS:

- The FCA will be activated by default when vehicle power is cycled on, even when previously set to off
- The FCW will not operate when the vehicle is traveling faster than approximately 50 mph
- If the FCA is operating and the ESC (Electronic Stability Control) is turned off, the FCA system is automatically turned off.
- When FCA system is off, the FCA warning indicator is on in the Instrument Cluster



The Forward Collision-Avoidance Assist (FCA) / Forward Collision Warning (FCW)* are not substitutes for safe and proper driving. Always drive safely and use caution. FCA and FCW may not always alert the driver when the vehicle is approaching another vehicle.*

Engine Start/Stop Button*†8

To start the engine:

1. Depress the brake pedal
2. Press the ENGINE START/STOP button **A** while gear shift is in P (Park) or N (Neutral)

To turn the engine OFF, press the ENGINE START/STOP button.

To use the ENGINE START/STOP button, you must have the Smart Key fob on your person.

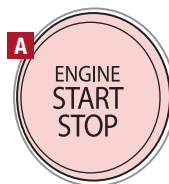

QUICK TIPS

To use electrical accessories:

ACC position

- When in the OFF position and without depressing the brake pedal, press the ENGINE START/STOP button once

ON position

- When already in the ACC position and without depressing the brake pedal, press the ENGINE START/STOP button again
- When in the OFF position and without depressing the brake pedal, press the ENGINE START/STOP button twice

Keeping the vehicle in ACC or ON position without turning engine on may discharge the vehicle's battery

REMINDERS:

- In an emergency situation while the vehicle is in motion, you are able to turn the engine off and to the ACC position by pressing the ENGINE START/STOP button for more than 2 seconds or 3 times successively within 3 seconds
- If the Smart Key battery is weak or not working properly, hold the Smart Key fob up to the ENGINE START/STOP button (Lock button side closest) and press to start engine

QR CODE

Engine Start/Stop Button & Smart Key Video

To view a video on your mobile device, snap this QR Code or visit the listed website.

Refer to page 2 for more information.



www.youtube.com/KiaFeatureVideos

Power Windows, Window Lock & Central Door Lock

A Pull/Press to operate Driver's and Front Passenger's Windows Auto-Up/Down*

QUICK TIP

Press button again to stop Auto-Up/Down function.

B Press to Unlock/Lock All Doors

C Press to disable Rear Passenger Windows

REMINDER: When pressed **C**, window controls for the Rear Passenger Windows are disabled

Button configuration may vary depending on vehicle model.

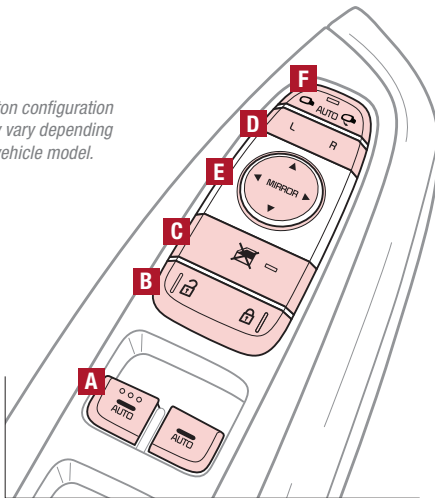

Automatic Door Lock/Unlock

Auto Door Lock/Unlock will engage when the gear shift is moved into or out of the P (Park) position. Refer to the User Settings in the LCD Instrument Cluster modes on how to turn Auto Door Lock/Unlock ON/OFF.

Power/Heated Outside Mirrors

Mirror heaters controlled with Rear Defroster. Use mirror to defog/deice side mirrors.

Power Folding Outside Mirrors*

Press L (left) or R (right) buttons **D** left or right to select mirror. Then press arrows **E** left/right or up/down to adjust mirror position.

To both fold and unfold the outside rearview mirror, press the folding mirror button **F** as pictured:

- Left: The mirrors will unfold
- Right: The mirrors will fold

Toggle button **F** to center to automatically fold/unfold mirrors when:

- Smart Key* lock/unlock buttons are pressed
- Outside door handle button is pressed
- Driver approaches the vehicle with the Smart Key*

REMINDEMS:

- When mirror button **F** is in the center, press the Lock button on the Smart Key to automatically fold the mirrors
- To lock position of mirrors, toggle switch to the neutral (center) position

QUICK TIP

To automatically fold mirrors when exiting vehicle, press the LOCK button once on the key fob or Smart Key*.

Turn Signals & Fog Lights*

To operate:

- Turn signals - Move lever Up/Down for Right/Left Turn Signal
- Fog Lights - Press switch **A** up/down to turn Fog Lights ON/OFF

REMINDER: Headlights must be ON for fog light operation.

One-Touch Lane Change Signal

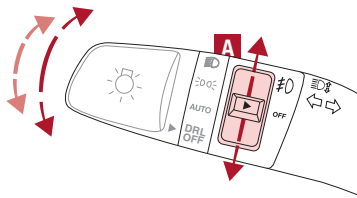

One-Touch Lane Change Signal is activated by moving the Turn Signal Lever slightly for less than 1 second and then releasing. The lane change signal will blink 3 times.

To change how many times the Lane Change Signal blinks (3/5/7), go to User Settings Mode in the LCD Instrument Cluster modes.

For more information on the User Settings Mode, please refer to your Owner's Manual.

Headlights & High Beams

To operate:

- Rotate lever to change the Headlight function
- Push lever to turn High Beams ON
- Pull lever to flash Headlights/High Beams

Daytime Running Lights (DRL)* -

DRL may help others to see the front of your vehicle during the day. The lights will be on automatically when the ignition or Engine Start/Stop button is ON and the headlight switch is in the AUTO position, unless one of the following occurs:

- Headlights are on
- Engine is turned off
- Parking brake is applied
- Switch is in the DRL OFF position



AUTO Light position – When the light switch is in the AUTO Light position, the taillights and headlights will turn ON/OFF automatically depending on the amount of light outside the vehicle.

Adaptive Front-Lighting System-Height (AFS-H)* – The AFS-H can help improve visibility during nighttime driving by aiming the low beam headlights toward the direction the vehicle is moving. AFS-H controls the aiming direction based on steering angle and speed. When the headlight switch is in the AUTO Light position, the AFS-H will activate.

REMINDER: When the AFS-H indicator illuminates on the instrument cluster, the AFS-H is not working properly. See an authorized Kia dealer for service.

High Beam Assist (HBA)* – High Beam Assist is designed to automatically adjust the headlight range by switching between high and low beams based on light detected from other vehicles and road conditions.

To enable HBA, toggle the light switch to the AUTO Light position and turn on the high beams by pushing the lever away from you. The High Beam Assist indicator  will illuminate.

-  Headlight position
-  Parking light position
- AUTO* Auto Light / HBA* / AFS-H*
- DRL OFF OFF position

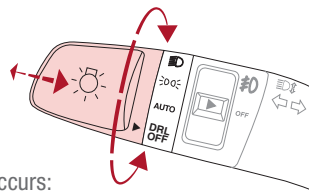

QR CODE

Adaptive Front-Lighting System-Height (AFS-H) Video

To view a video on your mobile device, snap this QR Code or visit the listed website.

Refer to page 2 for more information.



www.youtube.com/KiaFeatureVideos

REMINDEERS:

- DRL only operates during the daytime
- When the AFS-H indicator illuminates on the instrument cluster, the AFS-H is not working properly. See an authorized Kia dealer for service
- HBA will operate when vehicle speed exceeds 25 mph
- If the lever is pushed away from you while HBA is operational, HBA will turn off and the high beams will be on continuously. If the lever is pulled toward you while HBA is operational, HBA will turn off
- If the light switch is switched to the headlight position, HBA will turn off and low beams will be on continuously

Windshield Wipers & Washers

To operate:

- Move lever Up/Down to change Wiper modes
- Press switch **A** Up/Down to adjust Intermittent Wipe Speed
- Pull lever to spray and wipe

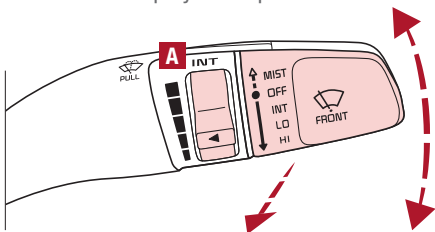

MIST: Single wipe
OFF: Wiper off
INT: Intermittent wipe
LO: Slow wipe
HI: Fast wipe

QUICK TIPS

- Pressing lever up increases Intermittent wipe frequency and wipe speed. Pressing lever down decreases frequency of wipes
- Set the wiper to OFF position when the wiper is not in use

Heated Steering Wheel Button*

Press button **B** to turn ON/OFF steering wheel heater, while the ignition or Engine Start/Stop button is in the ON position.

Steering wheel heater will turn off automatically in 30 minutes or when button is pressed again to deactivate.

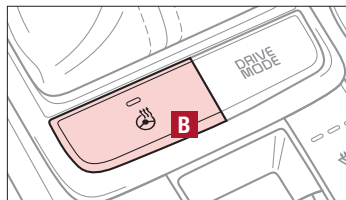

(Located below gear shift)

REMINDER: If the steering wheel becomes too warm, turn the system off. The heated steering wheel may cause burns even at low temperatures, especially if used for long periods of time

Tilt/Telescoping Steering Wheel†‡4

To adjust the Steering Wheel, push the lock-release lever **A** down and adjust to the desired angle **B** and distance **C**.

When finished, pull the lock-release lever **A** up to lock Steering Wheel in place.

QUICK TIP

It may be helpful to pull/push bottom of Steering Wheel towards/away from you to adjust desired distance prior to adjusting the angle.

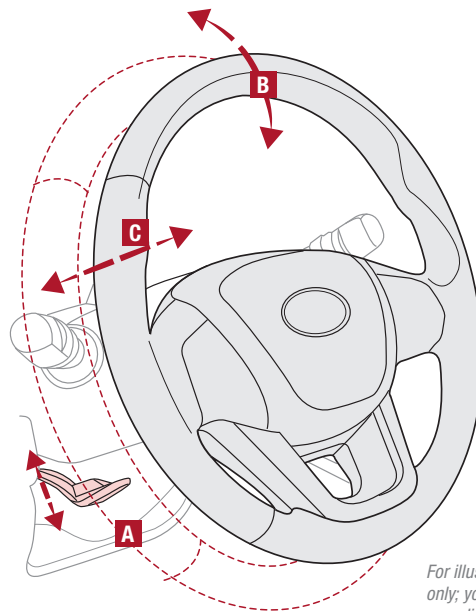

For illustrative purposes only; your steering wheel may differ.

Bluetooth® Wireless Technology†5,22

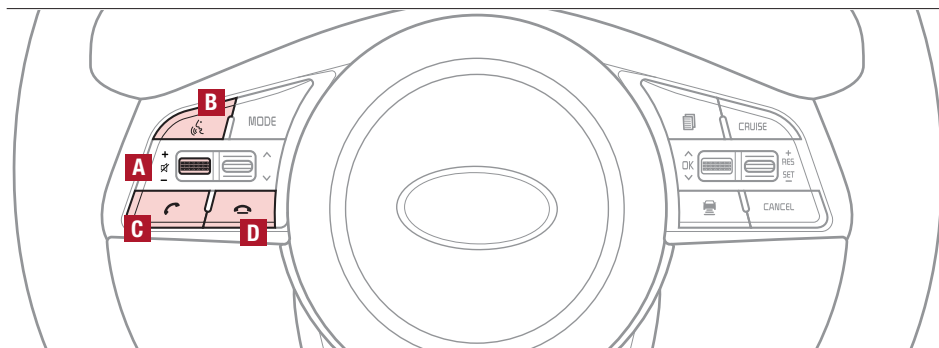

(Type B shown)

A Volume button: Press up/down to raise/lower speaker volume
Mute button: Press to mute the microphone during a call and to mute the audio system speakers

B Talk button: Press to activate voice recognition (UVO link* / UVO link with Navigation* only)

QUICK TIP

When using the voice command feature, wait for the system BEEP before speaking the command.

C Receive/Place Call button: Press to receive/place/answer calls. In vehicles with navigation, if no phone is paired, press button to pair a phone

D End Call button: Press to end a call or cancel a function

For more information, if equipped, refer to the Car Multimedia System User's Manual or the UVO System User's Manual. For Bluetooth® Wireless Technology FAQs, go to www.kia.com, or call Consumer Information for Bluetooth® Technology at (800) 333-4KIA. Refer to your Owner's Manual for more specific Bluetooth® Wireless Technology phone pairing and operation instructions.

QUICK TIPS

- Phonebook transfer upload time varies by phone model and with number of phonebook entries
- Because of differences in phone quality, service providers and **Bluetooth®** Wireless Technology chip programming, functionality may differ from one phone to another

Your vehicle's steering wheel buttons may differ from those in the illustrations. See your Owner's Manual for more details.

Driving while distracted is dangerous and should be avoided. Drivers should remain attentive to driving and always exercise caution when using the steering-wheel-mounted controls while driving.

Bluetooth® Wireless Technology (continued)

Pairing a Phone

For instructions on how to pair a phone, refer to the audio system's user's guide or your vehicle's Quick Start Guide.

QUICK TIP

During the pairing process, be sure to accept the connection requests on the phone for phonebook download and to allow acceptance of all future *Bluetooth*® connection requests.

How to Place a Call

When using the voice command feature, wait for the system BEEP before speaking the command.

There are two options for placing a call:

- Option 1: Press the Receive/Place Call button **C** (displays the phone screen with call history)
- Option 2: Press the Talk button **B**. Then say the command "Call {name}" or "Dial {number}", followed by contact name or number

Voice Recognition and Phone Contact Tips

To help optimize the *Bluetooth*® Wireless Technology Voice Recognition system, below are some tips and reminders. Improve the performance by making a few simple changes to your phone contacts:

- Use full names (first and last names) vs. short or single-syllable names ("John Smith" vs. "Dad," "Smith Residence" vs. "Home")
- Avoid using special characters, emojis or hyphenated names (@, &, #, /, -, *, +, etc.)
- Avoid using acronyms ("In Case of Emergency" vs. "ICE") or words with all capital letters
- Spell words completely, no abbreviations ("Doctor Smith" vs. "Dr. Smith")

The system may have difficulty understanding some accents or uncommon names. Below are other tips to optimize using the voice recognition.

QUICK TIPS

- When placing a call, speak in a natural, moderate tone, with clear pronunciation. The system may have trouble recognizing commands if you speak too softly or too loudly
- Always wait for the beep before speaking any commands
- Close windows and sunroof and turn off A/C – open windows, sunroof, weather (wind/rain), or an A/C fan operating at higher speeds can interfere with Voice Recognition
- Press the talk button and say "Help" to get a list of available commands

QR CODE

Voice Recognition Tips Video

To view a video on your mobile device, snap this QR Code or visit the listed website.

Refer to page 2 for more information.



www.youtube.com/KiaFeatureVideos

Smart Cruise Control (SCC) with Stop & Go*†6,22

The Smart Cruise Control (SCC) with Stop & Go system is designed to maintain a predetermined distance from vehicles detected ahead by automatically adjusting the driving speed as needed.

To set/adjust the SCC speed:

- Push the CRUISE button **A** to turn system ON. The CRUISE indicator will illuminate on the instrument cluster
- Accelerate/decelerate to the desired speed and press button **B** down to set speed
- Press the RES+/SET- button **B** up/down to increase/decrease the set speed. The SET indicator light, set speed and vehicle-to-vehicle distance will illuminate on the instrument cluster's LCD screen

To set the vehicle-to-vehicle distance: Press the SCC button **C** on the steering wheel. The images on the LCD screen **D** and the Instrument Cluster **E** will change when scrolling through the settings. Each time the button is pressed, the vehicle-to-vehicle distance changes.

To cancel SCC operation: Press the CANCEL button **F** or press the brake pedal. The LCD screen will display a message that the SCC operation is canceled.

To turn SCC system OFF: Press the CRUISE button **A**. The CRUISE indicator on the instrument cluster will turn OFF.

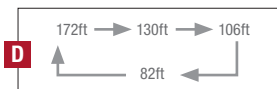
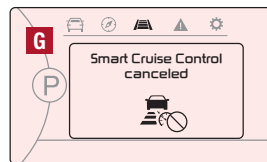
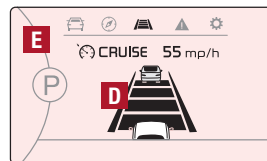
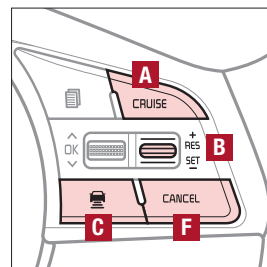

(Distances are approximate and vary according to vehicle speed)

REMINDERS:

- The SCC is also canceled when the driver's door is opened, gear shift is changed out of D (Drive), EPB is activated and various other conditions. See Owner's Manual for other conditions
- CRUISE button must be pressed ON in order to turn SCC ON
- SCC system is activated when ignition is turned on. Speed will need to be reset when ignition is cycled
- The distance settings are approximations and may vary depending on factory settings at the time. See Owner's Manual for more information
- If the SCC system is left on, it can be activated inadvertently. Keep the system off when not in use to avoid setting a speed which the driver is not aware of

QR CODE

Smart Cruise Control (SCC) with Stop & Go Video

To view a video on your mobile device, snap this QR Code or visit the listed website.

Refer to page 2 for more information.



www.youtube.com/KiaFeatureVideos

The SCC system is a supplemental system and is not a substitute for safe driving. It is the responsibility of the driver to always check the speed and distance to the vehicle ahead.

QUICK TIPS

To change the SCC mode to standard Cruise Control press the **C** button for more than two seconds. Hold button again to return to SCC.

For the SCC System to operate:

- When no vehicle is in front, you must be traveling at a minimum speed of 20 mph
- When following a vehicle, there is no minimum speed requirement

When following a vehicle, the system can automatically adjust your cruise speed based on the vehicle in front. It will even bring the vehicle to a complete stop if necessary. If the vehicle detected stops for more than 3 seconds, the system will disable.

Audio Controls^{†22}

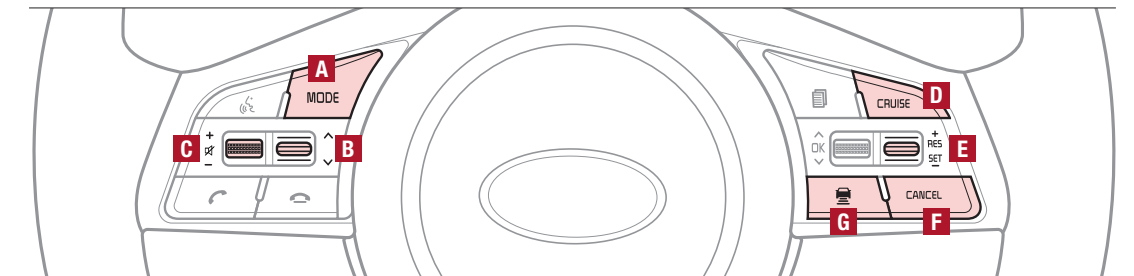

A Audio MODE button: Press to cycle through FM/AM/SiriusXM^{®†20}/Media modes
Audio System ON/OFF: Press and hold to turn power on; Press and hold to turn power off

B Seek/Presets button:
FM/AM/SiriusXM[®] Modes: Press to advance through Preset Stations. Press and hold to auto seek
Media Modes: Press to move track up/down. Press & hold to forward/rewind (except for Bluetooth[®] Audio)

C Volume button: Press up/down to raise/lower volume
Mute button: Press to mute all audio

QUICK TIP

Pressing the Audio Mode button for more than 1 second will turn Audio Mode ON/OFF.

Driving while distracted is dangerous and should be avoided. Drivers should remain attentive to driving and always exercise caution when using the steering-wheel-mounted controls while driving. To help minimize driver distraction, some audio system functionalities have been modified while the vehicle is in Drive, Reverse or moved out of Park.

Your vehicle's steering wheel buttons may differ from those in the illustrations. See your Owner's Manual for more details. For further audio system operations, refer to pages 22-25.

Cruise Control^{†22}

D CRUISE Control ON/OFF button: Press to turn the Cruise Control ON/OFF

E Resume Cruising Speed button: Press up to resume set speed or increase Cruising Speed

Set Cruising Speed button: Press down to set or decrease Cruising Speed

F Cruise Control CANCEL button: To cancel Cruise Control setting, do one of the following:

- Press the brake pedal
- Press the CANCEL button

QUICK TIP

- Cruise Control is designed to function above 25 mph

REMINDER: Standard Cruise Control is a part of the Smart Cruise Control (SCC) with Stop & Go[®] and can be set as the operating mode. To switch from SCC to standard Cruise Control, press and hold the SCC button **G** (the SCC system must not be activated to change modes). Repeat to switch back to SCC mode.

Android Auto™^{†3} / Apple CarPlay®^{†4} Setup*

Android Auto™* – Setting up Android Auto™:

1. From an Android Auto™ compatible device, download the Android Auto™ app from the Google Play™ Store^{†1}
2. Open the Android Auto™ app and proceed with the on-screen instructions to complete setup on the mobile device

How to start Android Auto™:

1. Press the SETUP key on the audio control unit
2. Press the PHONE PROJECTION button , select Android Auto™ and then select ENABLE ANDROID AUTO. Accept all terms, conditions and requests on the head unit and phone in order to use Android Auto™
3. Connect the Android™ device with the vehicle's USB port using the manufacturer's cable provided with your phone
4. From the vehicle's home screen, select the Android Auto™ button, where you'll see all the Android Auto™ supported apps

Apple CarPlay®* – Setting up and starting Apple CarPlay®:

1. Connect the Apple CarPlay® compatible iPhone® with the vehicle's USB port using the manufacturer's cable provided with your iPhone
2. On the audio control unit, press the SETUP key
3. Press the PHONE PROJECTION button  on the screen and select Apple CarPlay®
4. Select ENABLE APPLE CARPLAY. Accept all terms, conditions and requests on the head unit and phone in order to use Apple CarPlay®
5. From the vehicle's home screen, select the Apple CarPlay® button, where you'll see all the Apple CarPlay® supported apps

REMINDERS:

- Android Auto™ compatibility requirements: Micro-USB cable that came with your phone, OS Android™ 5.0 or higher, compatible Android smartphone and data and wireless plan for applicable feature(s)
- Apple CarPlay compatibility requirements: Apple Lightning® cable, latest iOS software, iPhone® 5 or later and data and wireless plan for applicable feature(s)
- It is recommended to always update your phone to the latest operating system release

UVO link Activation* (Systems equipped with UVO link only):

1. Enter the activation screen:
 - a. Press SETUP key
 - b. Press UVO icon
 - c. Press UVO ACTIVATION
2. Agree to Terms of Service and Privacy Policy and press SUBMIT
3. Enter smartphone number or email address to receive a security PIN, then press SUBMIT

Follow these steps if using your phone number to receive your PIN:

1. Check your phone for an SMS (text message)
2. Open the link in your SMS. A page will open to display your PIN
3. Enter the PIN in the head unit and press ACTIVATE
4. On your phone, go back to the page that gave you the PIN, press I HAVE ENTERED MY PIN
5. Enter email and password to complete your account setup and press CREATE ACCOUNT
6. A link will be provided to download the appropriate UVO app from your app store. After installing the UVO app, log in and enjoy.

Follow these steps if using your email to receive your PIN:

1. Check your email. The email will be from reset@notifications.myuvo.com
2. Open link inside email. A page will open to display your PIN
3. Enter the PIN in the head unit and press ACTIVATE
4. Go back to the page that gave you the PIN, press I HAVE ENTERED MY PIN
5. Enter your phone number and password to complete your account setup and press CREATE ACCOUNT
6. A link will be provided to download the appropriate UVO app from your app store. After installing the UVO app, log in and enjoy.

For further UVO link operations, refer to the Car Multimedia System User's Manual. For other audio system information, refer to pages 24-25.

Driving while distracted can result in a loss of vehicle control that may lead to an accident, severe bodily injury, and death. The driver's primary responsibility is in the safe and legal operation of a vehicle, and use of any handheld devices, other equipment, or vehicle systems which take the driver's eyes, attention and focus away from the safe operation of a vehicle or which are not permissible by law should never be used during operation of the vehicle.

Standard Audio System*

FM/AM/Media (USB, iPod^{®†12}, AUX, Bluetooth[®] Audio, My Music)*

Press briefly to do the following:

- FM/AM mode: Play the previous/next frequency
- MEDIA mode: Change the track, file or title (except for AUX)

Press and hold to do the following (over 0.8 seconds):

- FM/AM mode: Move quickly through all of the frequencies. When released, the system seeks the next available frequency
- MEDIA mode: Rewinds or fast forwards the track or file (except for AUX and Bluetooth[®] Audio)

- A programmable key to provide quick access to one of several available system features
- Press to Power ON/OFF. Rotate to adjust Volume
- Press to select FM/AM modes
- Press to select MEDIA mode

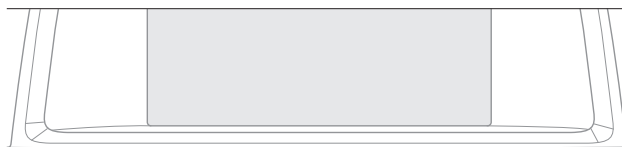

Your audio system may differ from those in the illustrations.

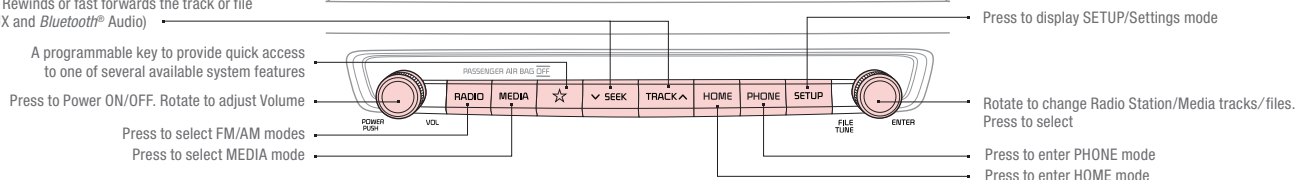

Audio System Setup Options – Press the SETUP key, then using the touchscreen, press the menu item to enter (Display, Sound, Clock/Calendar, Phone, System Info). Adjust the available settings for each equipped audio system setup option by pressing the on-screen buttons/arrows. Audio system setup options may include the following:

- **Display settings** – Adjusting the Brightness, Mode Pop up, MP3 Information Display
- **Sound settings** – Sound Settings, Speed Dependent Volume Control, Voice Recognition Volume, Touchscreen Beep
- **Clock/Calendar settings** – Clock Settings, Time Format, Calendar Settings, Clock Display
- **System settings** – Memory Information, Prompt Feedback, Language

Custom Key ☆: A programmable key to provide quick access to one of several available system features

To Program the Custom Key: Press the SETUP key, then press the Custom button. Select one of the available features you would like the Custom button to open

Your vehicle's audio system may differ from that in the illustration. For further audio system operations, refer to pages 22-25 or see your Owner's Manual.

Sound Settings – To adjust the Standard Audio Systems sound settings:

1. Press the SETUP key on the audio control unit or the on-screen MENU button, when in MEDIA mode
2. Select the on-screen SOUND button
3. Select the menu item (Position, Volume, Priority, Advanced, Default)
4. Using the touchscreen, press arrows to adjust the settings

QUICK TIPS

- When connected to Android Auto[™] or Apple CarPlay[®] on your smartphone, the smartphone's navigation system may also be available
- A warning screen may appear periodically to remind users that the audio system should be operated when the engine is running to prevent battery discharge
- Prolonged use of the audio control unit in ACC mode may drain the vehicle's battery

REMINDER: Driving while distracted is dangerous and should be avoided. Drivers should remain attentive to driving and always exercise caution when using the steering-wheel-mounted controls while driving. To help minimize driver distraction, some audio system functionalities have been modified while the vehicle is in Drive, Reverse or moved out of Park.

UVO link*†1,26 – FM/AM/SiriusXM® †20/Media (USB, iPod®†12, AUX, Bluetooth® Audio, My Music)

Press briefly to do the following:

- FM/AM mode: Play the previous/next frequency
- SiriusXM® mode: Change the channel
- MEDIA mode: Change the track, file or title (except for AUX)

Press and hold to do the following (over 0.8 seconds):

- FM/AM mode: Move quickly through all of the frequencies. When released, the system seeks the next available frequency
- MEDIA mode: Rewinds or fast forwards the track or file (except for AUX and Bluetooth® Audio)

- Press to enter Phone Mode
- Press to select MEDIA mode
- Press to select FM/AM/SiriusXM® modes
- Press to Power ON/OFF. Rotate to adjust Volume

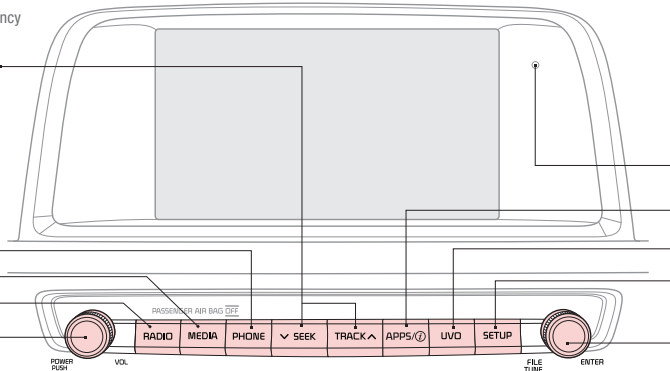

Your audio system may differ from those in the illustrations.

- Press and hold to reset the system settings
- Press to enter APPS/Info menu
- Press to select UVO link mode
- Press to display SETUP/Settings mode
- Rotate to change Radio/SiriusXM® Station/Media tracks/files. Press to select

QR CODE

UVO link Videos

To view a video on your mobile device, snap this QR Code or visit the listed website.

Refer to page 2 for more information.



www.youtube.com/KiaFeatureVideos

Sound Settings: To adjust the audio system sound settings:

1. Press the SETUP key on the audio control unit or the on-screen MENU button, when in MEDIA mode
2. Select the on-screen SOUND button, or SOUND SETTINGS
3. Select the menu item (Position, Volume, Tone, Priority, Advanced, Default)
4. Use the on-screen buttons to adjust settings. Press the return button \Rightarrow to save settings

Radio Presets: You can listen to FM, AM and SiriusXM® radio and save frequently used stations

How to Save a Preset: Press and hold the desired slot. This saves the current station in the selected slot in FM, AM or SiriusXM®

Smart Favorites: For the first ten favorite SiriusXM® channels, you may play live or repeat from the beginning of a song or a program segment. In **Radio** mode, choose SiriusXM®, then select any of the first six favorites. During song or program play, tap the Skip Backward icon to start from the beginning of the song or program. Tap the Play Live icon to return to the live broadcast

Driving while distracted can result in a loss of vehicle control that may lead to an accident, severe bodily injury, and death. The driver's primary responsibility is in the safe and legal operation of a vehicle, and use of any handheld devices, other equipment, or vehicle systems which take the driver's eyes, attention and focus away from the safe operation of a vehicle or which are not permissible by law should never be used during operation of the vehicle.

QUICK TIPS

- Using Android Auto™ or Apple CarPlay® and a supported smartphone, the phone's Navigation App may be displayed on the head unit
- At any time, you can interrupt the System Command Feedback by pressing the TALK button on the steering wheel
- Prolonged use of the navigation system in ACC mode may drain the vehicle's battery
- A warning screen may appear periodically to remind users that the UVO link should be operated when the engine is running to prevent battery discharge

For further navigation system operations, refer to the Car Multimedia System User's Manual. For further audio system operations, refer to pages 22-25.

UVO link with Navigation*+1,13,26

FM/AM/SiriusXM®+20/Media (USB, iPod®+12, My Music, AUX, Bluetooth® Audio)

Press briefly to do the following:

- FM/AM mode: Play the previous/next frequency
- SiriusXM® mode: Change the channel
- MEDIA mode: Change the track, file or title (except for AUX)

Press and hold to do the following (over 0.8 seconds):

- FM/AM mode: Move quickly through all of the frequencies. When released, the system seeks the next available frequency
- MEDIA mode: Rewinds or fast forwards the track or file (except for AUX and Bluetooth® Audio)

A programmable key to provide quick access to one of several available system features

Press to select MEDIA mode

Press to select FM/AM/SiriusXM® modes

Press to Power ON/OFF.
Rotate to adjust Volume

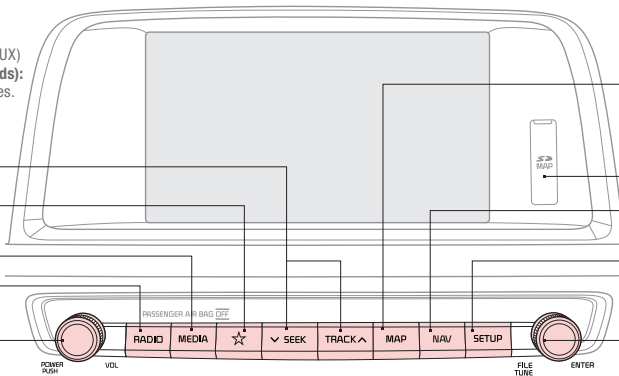

Your audio system may differ from those in the illustrations.

Press to display the MAP screen for the current position mode

SD MAP card insert slot

Press to select navigation mode

Press to display SETUP/Settings mode

Rotate to change Radio/SiriusXM® Station/Media tracks/files. Press to select

QR CODE

UVO link with Navigation Videos

To view a video on your mobile device, snap this QR Code or visit the listed website.

Refer to page 2 for more information.



www.youtube.com/KiaFeatureVideos

Sound Settings: To adjust the audio system sound settings:

1. Press the SETUP key on the audio control unit or the on-screen MENU button, when in MEDIA mode
2. Select the on-screen SOUND button
3. Select the menu item (Position, Volume, Tone, Priority, Navigation, Advanced, Default)
4. Use the on-screen buttons to adjust settings

Radio Presets: You can listen to FM, AM and SiriusXM® radio and save frequently used stations

How to Save a Preset: Press and hold the desired slot. This saves the current station in the selected slot in AM, FM, or SiriusXM®

Smart Favorites: For the first ten favorite SiriusXM® channels, you may play live or repeat from the beginning of a song or a program segment. In **Radio** mode, choose SiriusXM®, then select any of the first six favorites. During song or program play, tap the Skip Backward icon to start from the beginning of the song or program. Tap the Play Live icon to return to the live broadcast

Custom Button ☆: A programmable key to provide quick access to one of several available system features

To Program the Custom Button: Press the SETUP button, then press the Custom button. Select one of the available features you would like the Custom button to open

For further navigation system operations, refer to the Car Multimedia System User's Manual. For further audio system operations, refer to pages 22-24.

QUICK TIPS

- At any time, you can interrupt the Voice Command Feedback by pressing the TALK button on the steering wheel
- Prolonged use of the navigation system in ACC mode may drain the vehicle's battery. A warning screen may appear periodically to remind users that the navigation system should be operated when the engine is running to prevent battery discharge

Driving while distracted can result in a loss of vehicle control that may lead to an accident, severe bodily injury, and death. The driver's primary responsibility is in the safe and legal operation of a vehicle, and use of any handheld devices, other equipment, or vehicle systems which take the driver's eyes, attention and focus away from the safe operation of a vehicle or which are not permissible by law should never be used during operation of the vehicle.

Surround View Monitoring (SVM) System*

The Surround View Monitoring (SVM) system is a parking support system that shows the areas around the front, rear, left, and right sides of the vehicle via four cameras displayed onto the navigation screen. The SVM system will turn on when the SVM button **A** is pressed and the LED is illuminated.

- The Front SVM camera is ON when the Engine Start/Stop button is On, the gear shift is in Drive or Neutral and the SVM button is pressed ON
- **Rear SVM:** The camera view will automatically display on the navigation screen when the vehicle is shifted into Reverse. The camera view will turn off when the vehicle is shifted out of Reverse
- **Front SVM:** The camera view will display on the navigation screen in both Drive and Neutral. In Drive, the camera view will continue to display until the vehicle speed is above approximately 12 mph
- **Camera View Modes:** To change camera view modes, press the icons shown below on the navigation screen to select the mode.

REMINDER: The SVM camera is equipped with an optical lens to provide a wider range of vision and may appear different from the actual distance.

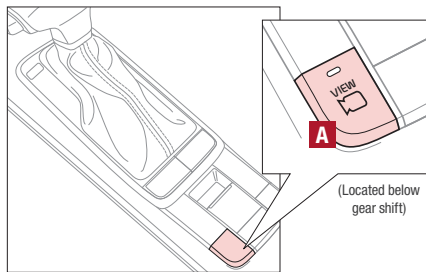

QR CODE

Surround View Monitoring Video





To view a video on your mobile device, snap this QR Code or visit the listed website.

Refer to page 2 for more information.







www.youtube.com/KiaFeatureVideos

Front SVM - when in Drive & Neutral:

-  Displays the front side and SVM images simultaneously on the screen
-  Displays the front side image on the screen
-  Displays the front side and left side images simultaneously on the screen
-  Displays the front side and right side images simultaneously on the screen

Rear SVM - when in Reverse:

-  Displays the rear view and SVM images simultaneously on the screen
-  Displays the rear side image on the screen
-  Displays the rear and left side images simultaneously on the screen
-  Displays the rear and right side images simultaneously on the screen

QUICK TIP

The Front SVM camera will turn off when the gear shift is moved into Park or Reverse or the SVM button is pressed.

The Surround View Monitoring system is only a supplemental device. Drivers should not rely solely on the SVM information when parking and backing up. Drivers should always pay attention and directly check the left/right and rear.

Surround View Monitoring is not a substitute for safe driving and may not display all objects around vehicle. Always drive safely and use caution.

Digital Clock*

Press the SETUP key, then the DATE/TIME button to display the Clock setting screen. Then use the on-screen buttons to navigate through setup. To access manual date and time setting, turn GPS time OFF in the Clock Settings (UVO link with Navigation*).

REMINDER: When needed, Daylight Savings must be enabled in the Clock Settings screen

Aux/USB/iPod®+12 Port & Power Outlets

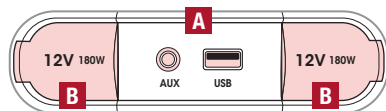

QUICK TIP

The power outlets are inactive when ignition is in the OFF position.

A Use the Aux port to connect audio devices and the USB port to connect USB audio devices, smartphones and iPod® devices. If equipped, additional power outlets are located inside the center console

B Use the power outlets for mobile phones and other devices designed to operate on a 12V (180W max) power outlet

REMINDEERS:

- Using the power outlet (accessory plug) for prolonged periods of time with the Engine Start/Stop button in the ACC position (Engine OFF) and AC Inverter for prolonged periods of time with the Engine Start/Stop button in the IGN Position (Engine OFF) could cause the battery to discharge
- Use manufacturer cables only that came with your device. Third party cables may cause damage to device

For more information on the Aux/USB/iPod® Port & Power Outlets, refer to the Owner's Manual.

USB Charger*

The USB charger is located inside the Center Console and on rear of the Center Console **C**.

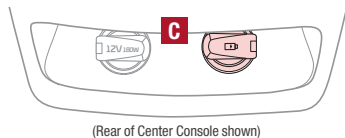

(Rear of Center Console shown)

Wireless Smartphone Charging System*

1. Slide open tray cover
2. Place compatible smartphone on the center of the charging pad
3. Indicator light **D** will change to amber once the wireless charging begins
4. Once charging is complete, the amber light will change to green

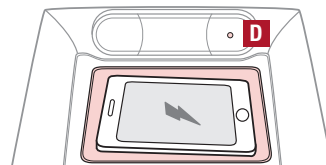

(Located in front of Gear Shift)

REMINDEERS:

- The smartphone must be a compatible phone with Qi function available
- Avoid placing other metal items in the bin while charging as to not impede the charging area
- This vehicle is equipped with wireless charging technology which allows for a device to be charged using inductive charging, however, device compatibility varies. See your Owner's Manual for more detailed information and the back page for legal disclaimers
- Inductive charging systems are less efficient than conventional charging through cable. As a result, higher device operating temperatures may be experienced during use
- Charging Performance – Device position on the wireless charging system can affect charging performance. Other factors that may affect the charging rate include foreign objects, such as coins or pens, and phone case thickness

QR CODE

Wireless Charging Video

To view a video on your mobile device, snap this QR Code or visit the listed website.

Refer to page 2 for more information.



www.youtube.com/KiaFeatureVideos

QUICK TIPS

- Wireless charging must be enabled in user settings
- For wireless charging to occur, all doors (excluding rear hatch) must be closed & the Smart Key Fob must be detected inside the vehicle
- For best results, place smartphone on the center of the charging pad
- If wireless charging does not work, move smartphone around the pad until the charging indicator turns amber. Avoid placing other metal items in the bin while charging as to not impede the charging area.

Automatic Climate Control*

(Type B)

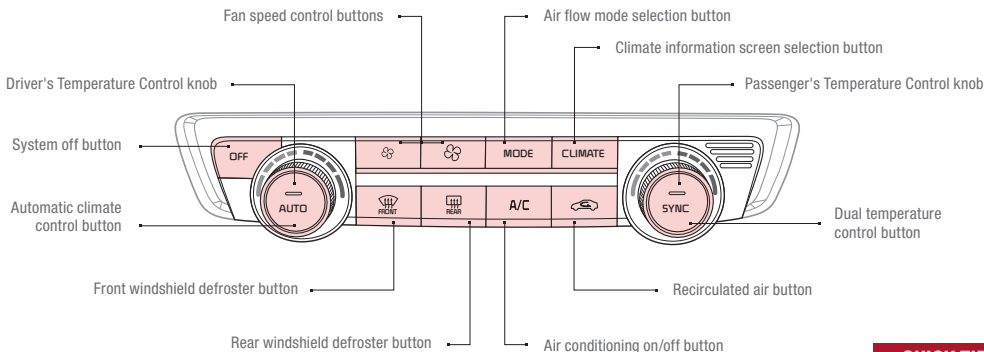

Climate Control Auto Function

1. Press **AUTO** to select Full Auto Operation. The Auto setting automatically controls the airflow modes, fan speeds, air intake and air conditioning according to the temperature setting selected
2. Set desired **Temperature**
3. Press **SYNC** to synchronize driver and passenger temperature

Defrost Outside Windshield:

1. Set **Fan Speed** to the highest position
2. Set **Temperature** to **Hot**
3. Press the **Front Defrost** button 

Defog Inside Windshield:

1. Set **Fan Speed** to desired position
2. Set desired **Temperature**
3. Press the **Front Defrost** button 

Air Flow Modes

To select Air Flow Modes, press the Mode selection buttons:

-  Face-Level
-  Bi-Level
-  Floor-Level
-  Floor/Defrost-Level

QUICK TIPS

- Defrost mode  activates A/C and opens Fresh Air Vent to help dehumidify the air and improve Defroster performance
- During Auto Operation, the A/C indicator will NOT illuminate. The fan speed, air intake, air flow and air conditioning may automatically be engaged at any time to reach desired temperature and reduce humidity
- Keep inside glass as clean as possible to reduce window fogging

REMINDERS:

- Pressing any button during AUTO operation will deactivate the AUTO function and switch to manual mode, except for Temperature Control
- When in AUTO mode, Air Flow mode and Fan Speed do not display on the Climate Control Display
- Warm air may flow in through vents if Recirculated Air button is not pressed ON (LED lit)

Your Automatic Climate Control system may differ from those in the illustrations. See your Owner's Manual for more details.

Manual Climate Control*

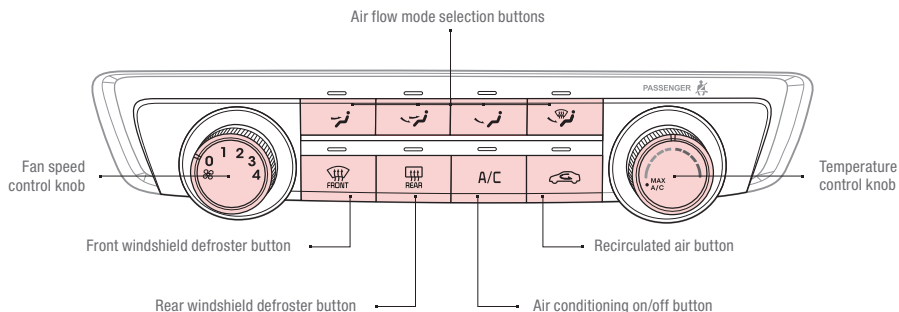

Defrost Outside Windshield:

1. Set **Fan Speed** to the highest position
2. Set **Temperature** to **Hot**
3. Press the **Front Defrost** button 



Your Manual Climate Control system may differ from those in the illustrations. See your Owner's Manual for more details.

Defog Inside Windshield:

1. Set **Fan Speed** to desired position
2. Set desired **Temperature**
3. Press the **Front Defrost** button 

Air Flow Modes

To select Air Flow Modes, press the Mode selection buttons:

-  Face-Level
-  Bi-Level
-  Floor-Level
-  Floor/Defrost-Level

QUICK TIPS

- Defrost mode activates A/C and opens Fresh Air Vent to help dehumidify the air and improve Defroster performance
- Keep inside glass as clean as possible to reduce window fogging
- MAX A/C mode automatically engages Recirculated Air

REMINDER:

Warm air may flow in through vents if **Recirculated Air** button is not pressed ON (LED lit)

Electric Parking Brake (EPB)*

The Electric Parking Brake (EPB) system utilizes an electric motor to engage the parking brake.

Applying the Parking Brake

Depress the brake pedal and pull up the EPB switch. Ensure that the indicator light  is illuminated on the instrument cluster.

Releasing the Parking Brake

The EPB will automatically release when the shifter is placed in Reverse or Drive.

To release EPB manually, depress the brake pedal, then press the EPB switch **A**, with the ignition switch in the ON position. Ensure that the indicator light is OFF.

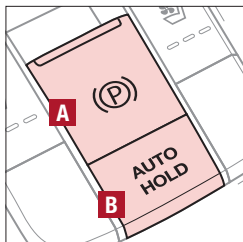

(Located below gear shift)

QUICK TIPS

- When leaving your keys with parking lot attendants or valet, make sure to inform them how to operate the EPB
- Pull up and hold EPB switch for 3 seconds to increase brake pressure if parked on a decline or incline

REMINDERS:

- As a bulb check, the EPB malfunction indicator will illuminate for approximately 3 seconds when the ignition switch is turned ON
- If the warning light does not illuminate temporarily, or continues to remain lit, take your vehicle to an authorized Kia dealer and have the system checked
- The EPB should not be operated while the vehicle is moving
- A click or electric brake motor sound may be heard while operating or releasing the EPB, but these conditions are normal and indicate that the EPB is functioning properly

Auto Hold*

Auto Hold temporarily maintains the vehicle at a standstill even though the brake pedal is not depressed after the driver brings the vehicle to a complete stop by depressing the brake pedal. Auto Hold can be turned On/Off using the AUTO HOLD button **B** on the center panel below gear shift. Before Auto Hold will operate, the driver's door, engine hood and trunk must be closed.

The AUTO HOLD indicator on the Instrument Cluster has four states:

White: Standby - With vehicle at a standstill, when the AUTO HOLD button **B** is pressed on, the indicator will illuminate white. While driving the vehicle (vehicle is not at a standstill), the Auto Hold indicator will remain white.

Green: Engaged - When coming to a complete stop by depressing the brake pedal, the Auto Hold indicator changes from white to green.

Off (not illuminated) - The indicator will turn Off when the AUTO HOLD button **B** is manually pressed Off or when the EPB is manually turned On.

Yellow: Malfunction - When the indicator is illuminated yellow, there may be a system malfunction. Take your vehicle to a local Kia dealer.

REMINDERS:

- Auto Hold only operates when vehicle is in Drive or Neutral
- To reduce the risk of an accident, do not activate Auto Hold while driving downhill, backing up or parking your vehicle.

Refer to page 4 for location of Instrument Cluster indicators.

QR CODE

Electric Parking Brake (EPB) Video

To view a video on your mobile device, snap this QR Code or visit the listed website.

Refer to page 2 for more information.



www.youtube.com/KiaFeatureVideos

Automatic Gear Shift with Sportmatic® Shifting†21

P: Park

R: Reverse

N: Neutral

D: Drive

[+]: Manual Mode Upshift

[-]: Manual Mode Downshift

Manual Mode: To enter Manual mode, move shift lever from D to left gate **A**.

To shift while in Manual mode, move shift lever up [+] to upshift or down [-] to downshift.

QUICK TIPS

- Press brake pedal and depress release lock button to move gearshift from N to P, N to R or from P to any gear
- Manual mode downshifts are made automatically when the vehicle slows down. When the vehicle stops, 1st gear is automatically selected

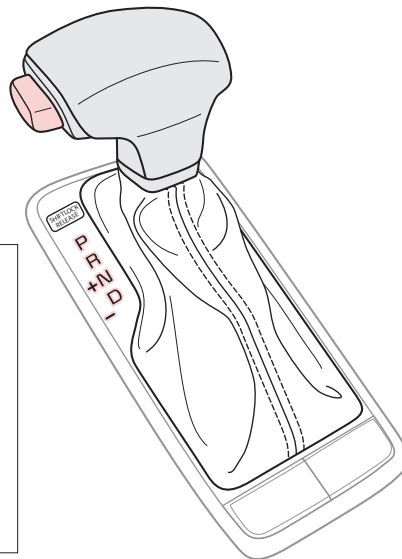
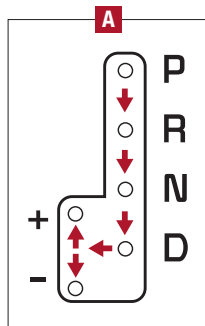

Paddle Shifters*

Paddle Shifters are operable when the shift lever is moved into the left gate of the D position (Manual mode).

Paddle Shifting: Pull the [+] or [-] paddle shifter once to shift up or down one gear.

REMEMBER: When in Manual mode, pulling the left and right paddle shifters at the same time will NOT shift gears

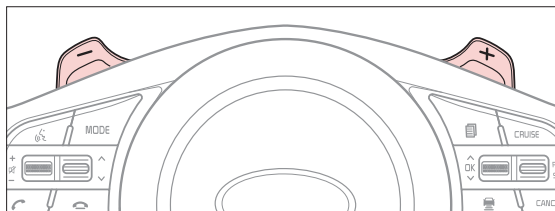

QR CODES

To view videos on your mobile device, snap these QR Codes or visit the listed website.

Refer to page 2 for more information.

Sportmatic® Shifting Video



Paddle Shifters* Video



www.youtube.com/KiaFeatureVideos

Dual Clutch Transmission*

Some Kia vehicles are equipped with Dual Clutch Transmission (DCT) for automatic transmissions.

The following are unique driving tips of the Dual Clutch Transmission:

- To hold the vehicle stationary on an incline, the service brake or parking brake **MUST** be used or the gear shift **MUST** be in the (P) Park position. If the vehicle is held stationary by applying the accelerator pedal on a slope, the clutch/transmission may overheat, resulting in damage
- Avoid aggressive launches on steep grades as this may result in an overheated clutch and transmission
- A slight time lag may be experienced at takeoff from stand still during aggressive acceleration maneuvers

If the clutch is overheating an amber warning light  will be displayed in the instrument cluster. **Should this condition occur, pull over and place the vehicle in Park and idle the engine.**

Refer to the Owner's Manual for additional information on DCT operation or call Kia Consumer Affairs for additional information.

Seat Warmers*†19

Press button once for high setting (3 LEDs lit), again for medium setting (2 LEDs lit), again for low setting (1 LED lit) and again to turn OFF.

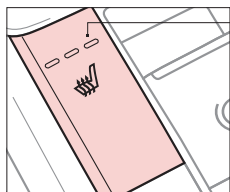

Yellow Color:
Warming

(Buttons located below gear shift)

Seat Warmers / Ventilated Seats*†19

Seat Warmers - Press top of button once for high setting (3 LEDs lit), again for medium setting (2 LEDs lit), again for low setting (1 LED lit) and again to turn OFF.

Ventilated Seats - Press setting (3 again for medium LEDs lit), bottom of button once for high setting (2 LEDs lit), again for low setting (1 LED lit) and again to turn OFF.

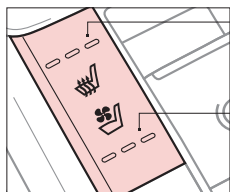

Yellow Color:
Warming

Blue Color:
Ventilating

(Buttons located below gear shift)

REMINDER: Use extreme caution when using the seat warmers to avoid burns. Refer to the Owner's Manual for more information.

QR CODE

Heated and Ventilated Seats Video

To view a video on your mobile device, snap this QR Code or visit the listed website.

Refer to page 2 for more information.



www.youtube.com/KiaFeatureVideos

QUICK TIPS

- With the seat warmer switch in the ON position, the heating system in the seat turns OFF or ON automatically depending on the seat temperature
- System is OFF by default. To turn system ON again, press the Heated Steering Wheel button.

Front Seat Headrest Adjustment^{†10}

To raise headrest: Pull headrest up to the desired position.

To lower headrest: Press lock **A**, then press the headrest down.

REMEMINDERS:

- Button may be hard to see if headrest is in its lowest position
- Do not operate the vehicle with the headrests removed. Headrests can provide critical neck and head support in an accident

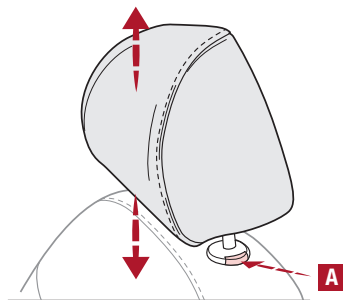

Driver Position Memory System*

The integrated system stores into memory the position of the Driver's Seat and the Outside Rearview Mirrors.

To store a seating position into memory, first place the shifter into P (Park) while the ignition is ON. Then:

1. Adjust the driver's seat and outside mirrors
2. Press the SET button **B** on the control panel. System will beep once
3. Press one of the memory buttons **C** within 5 seconds. The system will beep twice when memory has been stored
4. "Driver (1 or 2) set is memorized" will appear on the instrument cluster LCD screen

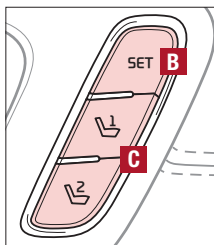

(Buttons located on Driver's Door Panel)

REMINDER: Do not attempt to operate the driver position memory system while the vehicle is moving. This could result in loss of control of the vehicle.

Power Adjustable Driver's Seat^{*†17}

Move/Press controls to adjust Seat forward/backward, Seat Cushion tilt up/down, Seatback forward/backward or Lumbar up/down/forward/backward

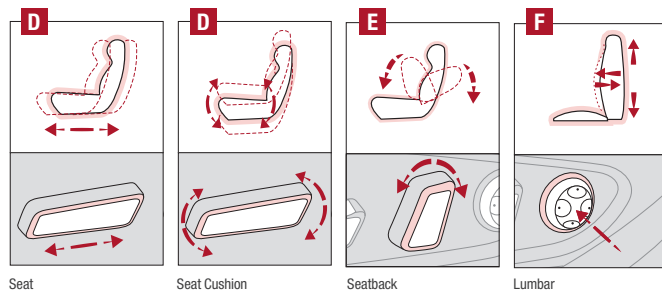
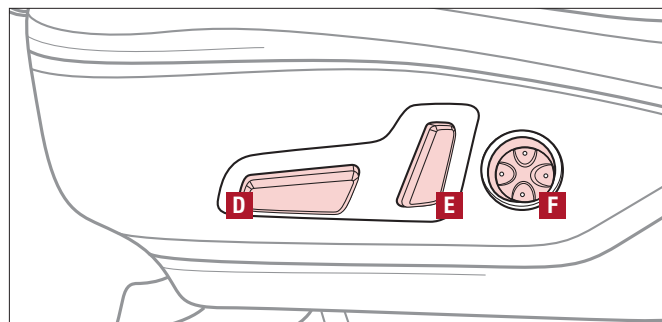

REMINDER: Do not attempt to adjust the seat while the vehicle is moving. This could result in loss of control of the vehicle.

6-Way Manual Adjustable Driver's Seat^{*†17}

Pull lever **A** to slide Seat forward/backward.

Pull lever **B** up several times to raise Seat Height. Push lever **B** down several times to lower Seat Height.

Pull lever **C** to adjust Seatback recline.

Press **D** to adjust Lumbar support*

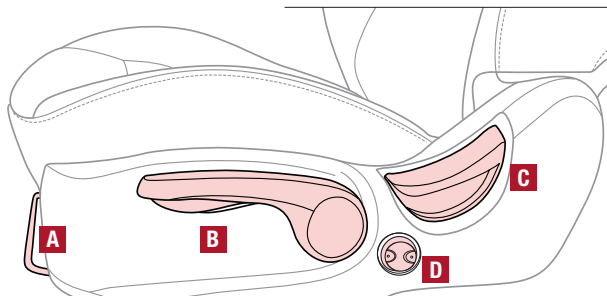

QUICK TIP

When adjusting seat forward or backward, ensure seat clicks or locks into place before driving vehicle.

Do not attempt to adjust the seat while the vehicle is moving. This could result in loss of control of the vehicle.

Smart Key*†‡

Smart Key Fob:

- A** Press to lock All Doors
- B** Press to unlock Driver's Door. Press twice in 4 seconds to unlock All Doors
- C** Press and hold to open Trunk. Then lift by the handle
- REMINDER:** The Trunk unlocks when the Smart Key fob is within close proximity to the vehicle.
- D** Press and hold more than 1 second for Panic Alarm.
- To turn off Alarm, press any button
- E** Press to release Mechanical Key (on reverse side of fob)
- F** Mechanical Key

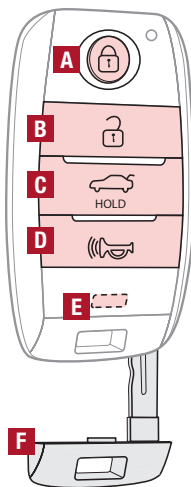

REMINDER: Remote button configuration may vary depending on vehicle options

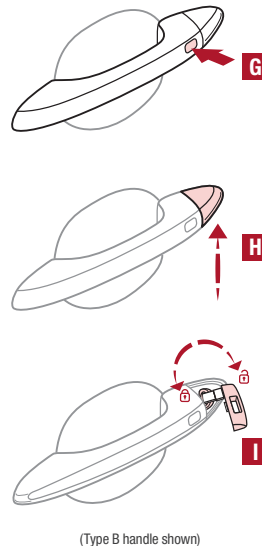

Driver's Door Lock/Unlock button **G**:

- Press button once to unlock Driver's Door
- Press again within 4 seconds to unlock All Doors
- Press again to lock All Doors

Mechanical Key: Use to unlock/lock Driver's Door:

1. Pull out door handle
2. Remove door handle keyhole cover with Mechanical Key by pressing up into slot as shown **H**
3. Insert Mechanical Key **I** and turn right to Unlock Driver's Door
4. Turn twice within 4 seconds to Unlock all doors
5. Insert Mechanical Key and turn left to Lock Driver's Door
6. Return keyhole cover to its original position

Use to unlock trunk, lock glove box and to turn Child Protector Rear-Door Locks

REMINDER: When reinserting the mechanical key, make sure it is pushed all the way in until there is a click sound

QR CODES

To view videos on your mobile device, snap these QR Codes or visit the listed website. Refer to page 2 for more information.

Engine Start/Stop Button & Smart Key Video



Key Fob Video



www.youtube.com/KiaFeatureVideos

QUICK TIPS

- If the Smart Key battery is weak or not working properly, hold the Smart Key fob up to the Engine Start/Stop button (Lock button side closest) and press to start engine
- The Smart Key's signal can be blocked by the normal operation of a cell phone or smartphone. To help prevent this, store each device separately

Remote Keyless Entry (Folding Key)*

- A** Press to release Folding Key
- B** Press to lock All Doors
- C** Press to unlock Driver's Door.
Press twice in 4 seconds to unlock All Doors
- D** Press and hold to unlock Trunk and manually open
- E** Press and hold more than 1 second for Panic Alarm. To turn off Alarm, press any button

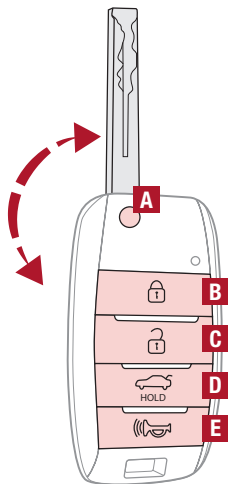

Remote button configuration may vary depending on vehicle options.

Double-Turn Lock/Unlock All

- Turn clockwise once to unlock Driver's Door
- Turn clockwise again within 4 seconds to unlock All Doors
- Turn counterclockwise once to lock All Doors

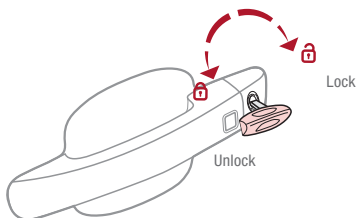

Fuel Cap / Malfunction Indicator (Check Engine Light)

Tighten for ONE CLICK to prevent Malfunction Indicator  from illuminating.

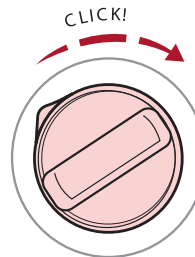

REMINDERS:

- The Fuel Filler Door Release button is located on the lower part of the driver's door panel
- It is normal operation when tightening to hear one click, and then when Fuel Cap is released, it clicks back

QR CODE

One-Click Fuel Cap Video

To view a video on your mobile device, snap this QR Code or visit the listed website.

Refer to page 2 for more information.



www.youtube.com/KiaFeatureVideos

Sunvisor†12

Use the Sunvisor to shield direct light through the front or side windows. Slide the Sunvisor out and adjust as needed.

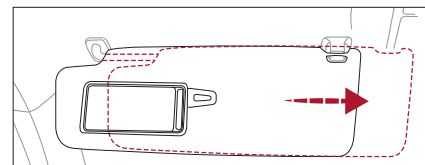

REMINDERS:

- The Sunvisor may impair visibility if not adjusted properly
- Sunvisor may not shield all direct light
- Do not operate the vehicle if Sunvisor is impairing your visibility
- Be aware of your seating position when adjusting or swinging Sunvisor around from the front or side windows

Driver Attention Warning (DAW)*†6

The DAW system is designed to detect a drowsy or fatigued driver and, in certain situations, can give a warning signal to take a break if needed.

The DAW System is set to OFF by default. To turn the DAW System ON, turn the ignition on and then select User Settings in the LCD Display on the Instrument Cluster. Then go to Driving Assist and select Driver Attention Warning. Set the DAW System to Normal or High Sensitivity.

Driver Attention Warning (DAW) System modes:

OFF: The Driver Attention Warning system is deactivated **A**

Normal Sensitivity: The Driver Attention Warning system alerts the driver of his/her fatigue level or inattentive driving practices

High Sensitivity: The Driver Attention Warning system alerts the driver of his/her fatigue level or inattentive driving practices faster than in Normal mode

If the DAW System is activated, the DAW information will appear on the LCD Display **B** when you select the ASSIST mode .

A message, “Consider taking a break,” appears on the LCD display and a warning sounds to advise the driver to take a break when the driver’s attention level is below one bar **C**.



REMINDERS:

- The setup of the DAW System will be maintained, as selected, when the ignition is cycled
- When activated, the DAW System does not display “Consider taking a break” message when the total trip driving time is less than 10 minutes
- The DAW System will enter a standby mode if the camera does not detect the lanes and/or the driving speed remains under 40 mph

Driver Attention Warning is not a substitute for safe driving and may not detect all instances of driver fatigue or inattentive driving practices. Failure to pay attention to travel conditions and vehicle operation could result in loss of vehicle control. Always drive safely and use caution.

Map/Room Lamps

Automatic turn off function*

The interior lights automatically turn off approximately 30 seconds after the ignition or Engine Start/Stop button* is OFF.

Map Lamp/Room Lamp

Operation – Push the lens **A** to turn the map lamp ON/OFF. This light produces a spot beam for convenient use as a map lamp or as a personal lamp for the driver or the front passenger.

Map/Room Lamp Button –

Press button **B** to turn the front and rear room lamps on and off.

Door Mode Button – Press button **C**, to enable or disable Door Mode. In Door Mode, the map and room lamps turn on when any door is opened. When all doors are locked or the ignition is on, the map and room lamp will turn off immediately.

Rear Room Lamps – Press the button **D** to turn the rear passenger lamp ON/OFF.

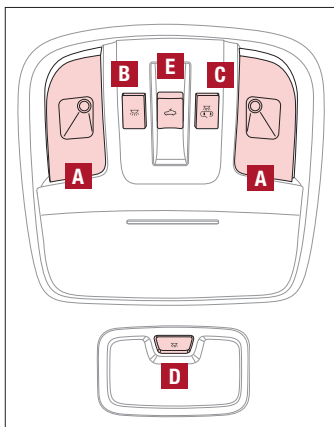

(Type B)

QUICK TIP

- When doors are unlocked by the Smart Key, the lamp turns ON for approximately 30 seconds
- If your vehicle is equipped with the theft alarm system, the interior lights automatically turn off approximately 3 seconds after the system is in armed stage
- Using interior lights for an extended period of time may cause battery discharge

Panoramic Sunroof with Power Sunshade*

The Sunroof and Sunshade operation is controlled through a multidirectional switch/lever. The ignition or Engine Start/Stop button* needs to be in the ON position to operate the sunroof.

To slide the sunshade and sunroof:

- Auto Open: Slide the lever **E** backward to the farthest position and release
- Auto Close (sunroof only): Slide the lever **E** forward to the farthest position and release

To slide the sunshade only:

- Open: Slide the lever **E** partially backward to the first detent position and release
- Auto Close: Slide the lever **E** partially forward to the first detent position and release

To slide the sunroof (with sunshade open):

- Open: Slide the lever **E** backward to the first detent position and release
- Close: Slide the lever **E** forward to the first detent position and release to close sunroof glass only. Slide the lever forward to the farthest position and release to close sunroof glass and sunshade

To tilt the sunroof:

- Raise: Push lever **E** upward
- Lower: Push lever **E** forward

REMINDER: Sunshade needs to remain OPEN while sunroof is open and vehicle is moving

QR CODE

Sunroof Operation Video

To view a video on your mobile device, snap this QR Code or visit the listed website.

Refer to page 2 for more information.



www.youtube.com/KiaFeatureVideos

QUICK TIP

To stop the sunroof/sunshade at any position, push or pull the sunroof control lever in any direction.

Fuel Filler Lid and Trunk Release

Press the button **A** to release the fuel door.

Press the button **B** to open the trunk.

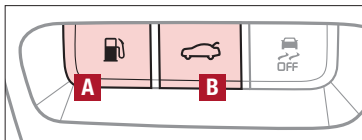

(Buttons located on Driver's Panel left of Steering Wheel)

Trunk Release Button (Exterior)

Located underneath the Trunk lid. With Trunk unlocked, press the Trunk Release button **C** and pull the Trunk lid up by the handle to open.

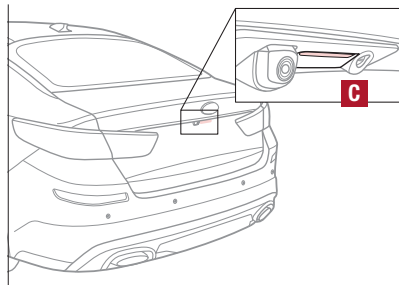

QUICK TIPS

- The Trunk must be unlocked before it can be opened by the Trunk Release Button
- Smart Key* - The Trunk unlocks automatically, and can then be opened manually, when the Smart Key fob* is within close proximity to the vehicle

Smart Power Trunk*+15

When the Smart Key fob is on your person and you are near the back of the vehicle, within close proximity, the hazard warning lights will blink and a chime will sound for about 3 seconds as an alert that the Smart Trunk is about to open.

Then the alert system will blink and chime two additional times before opening the Smart Power Trunk.

The Smart Power Trunk feature is OFF by default. To enable the Smart Power Trunk, go to User Settings in the LCD Instrument Cluster modes.

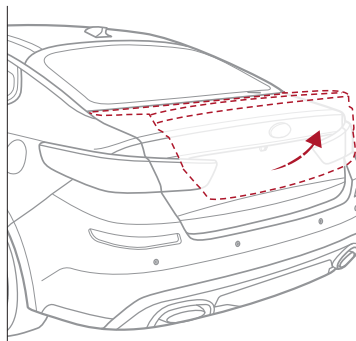

QUICK TIPS

During the Smart Power Trunk alert, the Smart Power Trunk can be deactivated with the Smart Key by pressing any button on the key fob.

REMINDERS:

- The Smart Key must be outside of the vehicle for the Smart Power Trunk to operate
- All doors are closed and locked after about 15 seconds
- The Smart Power Trunk feature will not operate when the doors are recently closed and locked, and the Smart Key is still detected after 15 seconds near the vehicle or within 60 inches of the door handles, a door is not locked or closed or the Smart Key is in the vehicle
- Press any button on the Smart Key fob during the Detect and Alert stage to deactivate the Smart Power Trunk function
- When ignition is on, the Smart Power Trunk will only operate with the gear shift in the Park (P) position
- Ensure obstacles and people are out of the way of the Trunk

For more information on the Smart Power Trunk operation, please refer to the Owner's Manual.

Hood Release Lever and Latch

Opening the Hood:

1. Pull the Hood Release Lever **A** to unlatch the Hood
2. In the front of the vehicle, lift the Hood slightly, push the secondary Latch **B** to the left inside of the Hood's center and lift the Hood

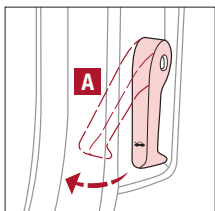

(Located on Driver side kick panel)

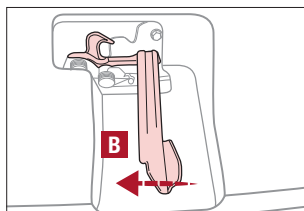

(Located inside of Hood's center)

REMINDER: Open the Hood only after turning the engine off, on a flat surface, with the gear shift in P (Park) position and setting the parking brake.

Closing the Hood:

Lower the Hood about halfway and then press down to securely lock in place.

Child-Protector Rear Door Locks

Locate these locks on the rear edge of the rear passenger doors. Turn the Child-Protector Rear Door Lock to the LOCK position to disable the inner door handles from opening the rear doors.

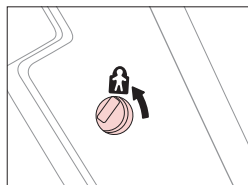

REMINDER: Child-Protector Rear Door Locks are located on rear passenger's door jamb.

Parking Distance Warning-Reverse^{*†6}

The Parking Distance Warning-Reverse is a supplemental system that is designed to assist the driver by chiming if any object is detected within the sensing area to the rear and side of the vehicle when backing up. When the ignition is ON, the system is activated.

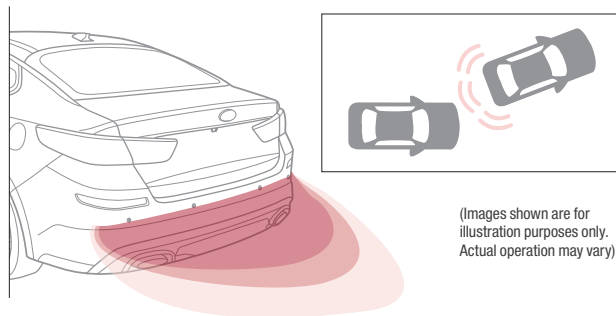

(Images shown are for illustration purposes only. Actual operation may vary)

REMINDEES:

- If the vehicle is moving at speeds over 3 mph, the system may not activate correctly
- When more than two objects are sensed at the same time, the closest one will be recognized first

The Parking Distance Warning-Reverse is not a substitute for proper and safe backing-up procedures. Always drive safely and use caution when backing up. The Parking Distance Warning-Reverse may not detect every object behind the vehicle.

Rear-Camera Display†6

The Rear-Camera Display system is a supplemental system that displays the view behind the vehicle through the audio control unit screens while the vehicle is in Reverse.

The Rear-Camera Display activates when the:

- Engine Start/Stop button* is in the ON position
- Gear Shift Lever is in the R (Reverse) position

REMINDERS:

- The Rear-Camera Display is ON by default when ignition is cycled
- The screen image above is for illustration purposes only. The actual image or graphics may differ in your vehicle

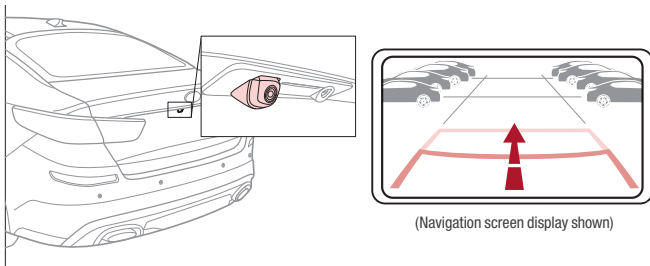

(Navigation screen display shown)

The Rear-Camera Display is not a substitute for proper and safe backing-up procedures. The Rear-Camera Display may not display every object behind the vehicle. Always drive safely and use caution when backing up.

Tire Mobility Kit*

The Tire Mobility Kit may temporarily seal certain types of tire damage.

For operational information, please refer to the Owner's Manual.

A Sealant Bottle

B Compressor

REMINDERS:

- The Tire Mobility Kit requires the use of the 12V/15A/180W Power Outlet, which is located on the right side of the outlet/aux port area
- After tire is properly sealed, drive cautiously at a maximum speed of 50 mph for no longer than a maximum distance of 120 miles

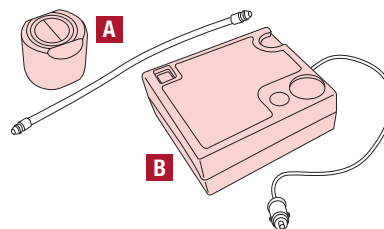

QUICK TIPS

- The Tire Mobility Kit is a temporary fix and is to be used for one tire only; the tire should be inspected as soon as possible
- The kit should only be used for sealing/inflating passenger car tires; do not use for inflating any other type of tires
- Some damaged tires cannot be sealed completely; do not use the kit if it appears a tire is damaged beyond repair

QR CODE

Tire Mobility Kit Video

To view a video on your mobile device, snap this QR Code or visit the listed website.

Refer to page 2 for more information.



www.youtube.com/KiaFeatureVideos

Occupant Detection System (ODS) / Passenger Airbag Off Indicator^{†2,14}

ODS is designed to detect the presence and position of the front passenger and adjusts or turns off airbag deployment accordingly.

Depending on the situation and type of accident, the system may:

- Deploy airbag (Adult)
- Not deploy the airbag (Unoccupied)

If the system determines that the airbag should not be deployed, the “PASSENGER AIR BAG OFF” light will illuminate.

REMINDER: Do not allow an adult passenger to ride in the front seat when the Passenger Airbag Indicator is illuminated OFF because the airbag will not deploy in the event of a crash. The driver must instruct the passenger to reposition her/himself in the seat



Seat Belts^{†18}

To properly fasten your safety belts:

1. Insert the belt tongue plate **A** into the buckle **B** until it clicks
2. Position the lap portion of the belt across your lap as **LOW ON THE HIPS** as possible **C**. Adjust the belt to a **SNUG FIT** by pulling up on the shoulder portion **D**

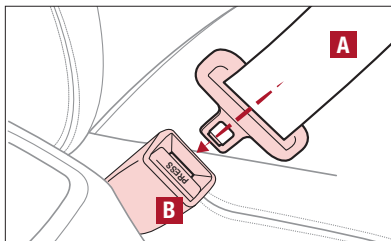

QUICK TIP

The Seat Belt warning chime operates for driver's seat only.

REMINDER: For maximum protection, always wear your Seat Belt.

Seat Belt Retractor Locks^{†18}

Retractor locks allow lap/shoulder safety belts to remain unlocked during normal vehicle operation for freedom of movement and increased comfort.

During a **STRONG STOP, SUDDEN TURN OR CERTAIN COLLISIONS**, seat belt retractors will automatically lock the belts to help reduce the risk of injury.

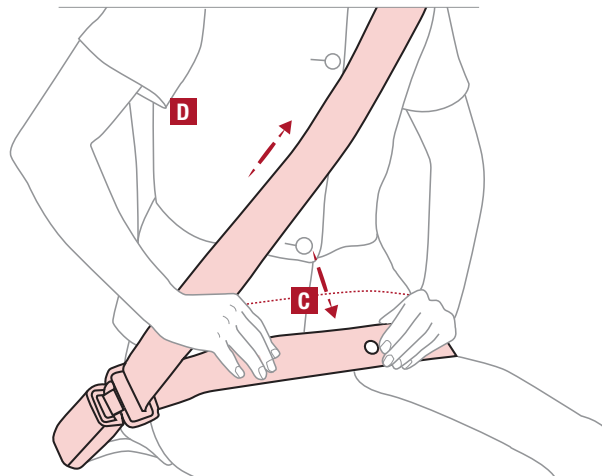

(up to 60,000 miles)^A

For Non-Turbo maintenance, see back cover

MAINTENANCE INTERVALS (MILES)

MAINTENANCE ITEMS - TURBO	6,000	12,000	18,000	24,000	30,000	36,000	42,000	48,000	54,000	60,000
Add fuel additive ^C	P	P	P	P	P	P	P	P	P	P
Rotate tires	P	P	P	P	P	P	P	P	P	P
Engine Oil & Oil Filter	R	R	R	R	R	R	R	R	R	R
Climate control air filter	R	R	R	R	R	R	R	R	R	R
Battery condition	I	I	I	I	I	I	I	I	I	I
Brake lines, hoses and connections	I	I	I	I	I	I	I	I	I	I
Brake discs and pads	I	I	I	I	I	I	I	I	I	I
Vacuum hose	I	I	I	I	I	I	I	I	I	I
Steering gear rack, linkage & boots	I	I	I	I	I	I	I	I	I	I
Driveshaft and boots	I	I	I	I	I	I	I	I	I	I
Suspension mounting joints	I	I	I	I	I	I	I	I	I	I
Air conditioner compressor/refrigerant	I	I	I	I	I	I	I	I	I	I
Exhaust system	I	I	I	I	I	I	I	I	I	I
Intercooler, in/out hose, air intake hose	I	I	I	I	I	I	I	I	I	I
Air cleaner filter	I	I	I	R	I	I	I	R	I	I
Brake fluid		I		I				I		I
Fuel tank air filter ¹⁰		I		I			I			I
Parking brake (foot type)		I		I			I			I
Vapor hose and fuel filler cap		I					I			I
Cooling System				I			I			I
Dual clutch transmission fluid				I				I		
Fuel lines, hoses and connections				I				I		
Spark Plugs							R			
Valve clearance ^E										I
Drive belts (First 60,000 miles, then every 12,000 miles) ^F										I

QUICK TIP Check your Maintenance Schedule or schedule an appointment with a dealer using your UVO link account by logging into your UVO link App or your account on MyUVO.com (Vehicles equipped with UVO link only – See page 22 for setup information)

‡ If equipped.

- A. See the Owner's Manual for complete maintenance schedule. These are approximate estimated intervals. Refer to vehicle mileage for maintenance item schedule.
- B. And, if necessary, adjust, correct, clean or replace.
- C. If TOP TIER detergent gasoline is not available, one bottle of additive is recommended. Additives are available from your authorized Kia dealer along with information on how to use them. Do not mix other additives.
- D. Both the fuel filter & fuel tank air filter are generally considered to be maintenance free,

depending on fuel quality being used. However, periodic inspection is recommended. If your vehicle is having issues like fuel flow restriction, power surging, loss of power, difficulty starting, etc., replace the fuel filter immediately and consult an authorized Kia dealer for service.

- E. Inspect for excessive tappet noise and/or engine vibration and adjust if necessary.
- F. The drive belt should be replaced when cracks occur or tension is reduced excessively. See your Owner's Manual for more details and complete maintenance information, including severe maintenance schedule. Warranty may be voided if maintenance schedule is not followed.

Driving while distracted is dangerous and should be avoided. Drivers should remain attentive to driving and always exercise caution when using the steering-wheel-mounted controls while driving.

Driving while distracted can result in a loss of vehicle control that may lead to an accident, severe personal injury and death. The driver's primary responsibility is in the safe and legal operation of a vehicle, and use of any handheld devices, other equipment or vehicle systems which take the driver's eyes, attention and focus away from the safe operation of a vehicle or that are not permissible by law should never be used during operation of the vehicle.

Safety Features: No system, no matter how advanced, can compensate for all driver error and/or driving conditions. Always drive responsibly.

- 1. UVO Link:** Purchase/lease of a new 2019 Kia Optima vehicle with UVO link or UVO link with Premium Navigation includes a complimentary 1 year subscription starting from new vehicle retail sale/lease date as recorded by the dealer. After your complimentary 1 year UVO link or UVO link with Premium Navigation subscription expires, continued access to UVO link or UVO link with Premium Navigation will require a paid subscription at the then current subscription rate or your use of UVO link or UVO link with Premium Navigation will immediately terminate. Use of UVO is subject to agreement to the UVO Privacy Policy (available at <https://www.myuvo.com/legal/privacy-policy.shtml>) and Terms of Service (available at <https://www.myuvo.com/legal/terms-of-service.shtml>). UVO link or UVO link with Premium Navigation transferrable to subsequent owner during the original UVO link or UVO link with Premium Navigation service term. Only use UVO link or UVO link with Premium Navigation when safe to do so. UVO link App is available from the App Store® or Google Play™ Store. Kia Motors America, Inc. reserves the right to change or discontinue UVO link or UVO link with Premium Navigation at any time without prior notification or incurring any future obligation. Message and data rates may apply. Cellular and GPS coverage is required to use most features. UVO link or UVO link with Premium Navigation features may vary by model, model year, and trim level. Features, specifications, and fees are subject to change. For more on details and limitations, visit myuvo.com or your authorized Kia dealer. Google and logos are trademarks of Google, Inc. App Store is a service mark of Apple, Inc.
- 2. Airbags:** For maximum protection, always wear your seat belt.
- 3. Android Auto™:** Android Auto is a trademark of Google, Inc. Android™ is a registered trademark of Google, Inc. Distracted driving can result in a loss of vehicle control. Never use a handheld device or vehicle system that takes your focus away from safe vehicle operation.
- 4. Apple CarPlay®:** Apple CarPlay® is a registered trademark of Apple Inc. Distracted driving can result in a loss of vehicle control. Never use a handheld device or vehicle system that takes your focus away from safe vehicle operation.
- 5. Bluetooth® Wireless Technology:** The *Bluetooth®* word mark and logos are registered trademarks owned by Bluetooth SIG Inc., and any use of such marks by Kia is pursuant to license. A *Bluetooth®* enabled cell phone is required to use *Bluetooth®* wireless technology.
- 6. Driver Assist Features – Blind Spot Collision Warning with Lane Change Assist, Rear Cross-Traffic Collision Warning (RCCW), Lane Keeping Assist (LKA), Rear-Camera Display, Parking Distance Warning-Reverse, Smart Cruise Control (SCC) with Stop & Go, Driver Attention Warning (DAW):** These features are not substitutes for safe driving, and may not detect all objects surrounding vehicle. Always drive safely and use caution.
- 7. Electronic Stability Control (ESC)/ Traction Control System (TCS)/Hill-start Assist Control (HAC):** No system, no matter how advanced, can compensate for all driver error and/or driving conditions. Always drive responsibly.
- 8. Engine Start/Stop Button with Smart Key:** Always come to a complete stop before turning the engine on or off. However, if you have an emergency while the vehicle is in motion and must turn the engine off, you can turn the engine off to the ACC position by pressing the Start/Stop button for more than 3 seconds or 3 times in succession. If the vehicle is still moving, you can restart the engine by pressing the Start/Stop button with the shift lever in Neutral (N). With the engine off, hydraulic power assist for steering and braking will be disabled and the vehicle will be more difficult to control.
- 9. Forward Collision-Avoidance Assist (FCA) / Forward Collision Warning (FCW):** These systems are not substitutes for safe driving, and may not detect all objects in front of vehicle. Always drive safely and use caution.
- 10. Front Seat Headrest Adjustment:** Never attempt to adjust headrests when vehicle is in motion.
- 11. Google Play™ Store** is a trademark of Google, Inc. ©2018 Google Inc. All rights reserved. Google and the Google Logo are registered trademarks of Google Inc.
- 12. iPhone®/iPod®:** iPhone and iPod are registered trademarks of Apple Inc. Distracted driving can result in a loss of vehicle control. Never use a handheld device or vehicle system that takes your focus away from safe vehicle operation.
- 13. Navigation:** Distracted driving can result in a loss of vehicle control. When operating a vehicle, never use a vehicle system that takes your focus away from safe vehicle operation. Navigation is for information purposes only, and Kia does not make any warranties about the accuracy of the information.
- 14. Occupant Detection System (ODS):** Kia vehicles use a number of different ODS types that vary by model.
- 15. Power Trunk* / Smart Power Trunk*:** Driving with the trunk open may be unlawful and can draw dangerous exhaust fumes into your vehicle; if you choose to do so, keep air vents and all windows open for proper ventilation.
- 16. Roadside Assist:** 24-hour Enhanced Roadside Assistance is a service plan provided by Kia Motors America, Inc. Certain limitations apply. Coverage details are available in the Kia Warranty and Consumer Information Manual. For access to Enhanced Roadside Assistance, a connected mobile phone via *Bluetooth®* within the cellular service coverage area is required.
- 17. Seat adjustments:** Reclining the passenger seats can reduce the effectiveness of the safety restraint system and may lead to additional injury in an accident.
- 18. Seat belts:** For maximum protection, always wear your seatbelt.
- 19. Seat warmers:** Use extreme caution when using the seat warmers to avoid burns. Refer to the Owner's Manual for more information.
- 20. SiriusXM®:** SiriusXM Satellite Radio, SiriusXM Traffic and SiriusXM Travel Link each require a subscription sold separately, or as a package, by SiriusXM Radio Inc. **If you decide to continue your service at the end of your trial subscription, the plan you choose will automatically renew and bill at then-current rates until you call 1-866-635-2349 to cancel. See SiriusXM Customer Agreement for complete terms at www.siriusxm.com.** Other fees and taxes will apply. All fees and programming are subject to change. Not all vehicles or devices are capable of receiving all services offered by SiriusXM. Data displays and individual product availability vary by vehicle hardware. Current information and features may not be available in all locations, or on all receivers. Weather Forecast, Current Conditions may not be available in all locations. Images above are for representative purposes only and are not real products. For actual features and images of real products, consult the vehicle manufacturer. SiriusXM is not responsible for any errors or inaccuracies in the data services or their use in the vehicle. Travel Link Stocks displays current price and daily delta of around 7,000 actively reported securities traded on the NYSE®, NASDAQ® and AMEX®. The service is delayed approximately 20 minutes. SiriusXM satellite service is available only to those at least 18 years of age in the 48 contiguous USA, DC, and Puerto Rico (with coverage limitations). SiriusXM Internet Radio service is available throughout our satellite service area and in AK and HI. © 2018 SiriusXM Radio Inc. Sirius, XM and all related marks and logos are trademarks of SiriusXM Radio Inc.
- 21. Sportmatic®** is a registered trademark of Kia Motors America.
- 22. Steering-wheel-mounted controls:** Driving while distracted is dangerous and should be avoided. Remain attentive to driving and be cautious when using steering-wheel-mounted controls while driving.
- 23. Sunvisors:** Sunvisor may not shield all direct light. Do not operate the vehicle if sunvisor is impairing your visibility.
- 24. Tilt/Telescoping Steering Wheel:** Never attempt to adjust steering wheel position when vehicle is in motion.
- 25. Tire Pressure Monitoring System (TPMS):** Even with Tire Pressure Monitoring System, check tire pressure on a regular basis.
- 26. Vehicle Diagnostics:** Vehicle Diagnostics checks powertrain, chassis and air bag systems, and is not a substitute for maintenance. See UVO link Maintenance Feature or Owner's Manual for maintenance schedule.



KEY FEATURE WALKTHROUGH

Demonstrate the following with the customer

- Standard Audio System* – page 23
For more information, refer to the Car Multimedia System User's Manual.

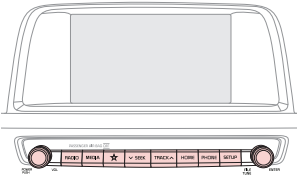

- UVO link* – page 24
For more information, refer to the Car Multimedia System User's Manual.



- UVO link with Navigation* – page 25
For more information, refer to the Car Multimedia System User's Manual.



- Android Auto™ / Apple CarPlay® Setup* – page 22

- UVO link Activation* – page 22

For further UVO operations, refer to the Car Multimedia System User's Manual. For other audio system information, refer to pages 23-25

- Smart Cruise Control with Stop & Go* – page 20
Demonstrate operation.

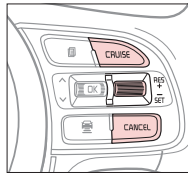

- Wireless Smartphone Charging System* – page 27

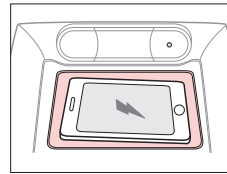

- Bluetooth® Wireless Technology* – page 18
Demonstrate operation.

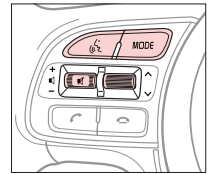

- ECO Mode (Active ECO)* – page 9
- Tire Pressure Monitoring System (TPMS) – page 5
- Engine Start/Stop Button* – page 14
- Aux/USB/iPod® Port – page 27
- Digital Clock – page 27
- Seat Warmers/Ventilated Seats* – page 32
- Sunvisor – page 36

- Panoramic Sunroof with Power Sunshade* – page 38
- Parking Distance Warning-Reverse* – page 40
- Smart Key* – page 35
- Rear-Camera Display* – page 41
- Passenger Airbag Off Indicator – page 42
- Tire Mobility Kit* – page 41

DURING DELIVERY

- Explain first service process and schedule first service appointment
- Tour Parts & Service departments, introduce staff & explain value of Kia Parts and Service
- Review recommended maintenance schedule and maintenance requirements to validate warranty
- Review business hours & Customer 360° Care
- Review the Kia 10-year/100,000-mile warranty program
- Ensure 100% satisfaction with sales and delivery process and no problems with the vehicle
- Confirm time and best contact number for initial dealer follow-up

*IF EQUIPPED

Sales Consultant: _____ Date: _____

Sales Manager: _____ Date: _____

Customer: _____ Date: _____



OPTIMA CUSTOMER DELIVERY CHECKLIST

Owner's Name: _____ VIN: _____ Mileage: _____

Dealership Name: _____ Sales Consultant: _____ Date: _____

BEFORE DELIVERY

- Confirm "Good Battery" with a Kia battery tester
- Verify all tire pressures are to spec (see driver's door label) LF _____ LR _____ RF _____ RR _____
- Verify proper operation of Remote Keyless Entry and Smart Key lock/unlock
- Ensure floor mats are snapped into place (if applicable)
- Verify vehicle is clean (interior and exterior), in good condition and free of chips and scratches
- Ensure all key documents are in the vehicle (Owner's Manual, Warranty and Consumer Information booklet, Tire Warranty booklet and Features & Functions Guide and any supplemental audio user's guides)

KEY FEATURE WALKTHROUGH

- Air Conditioning / Climate Control – pages 28-29
Demonstrate Air Flow modes, Defog and Defrosting Windshield.

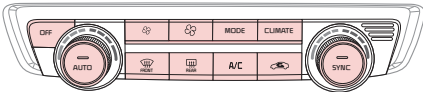

Automatic Climate Control

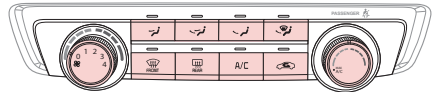

Manual Climate Control

- Electric Parking Brake (EPB)* and Auto Hold* – page 30
Demonstrate operation.

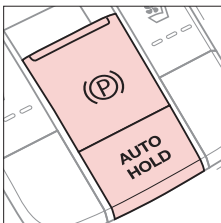

- Windshield Wipers & Washers* – page 17

To operate:

- Move lever Up/Down to change Wiper modes
- Press switch Up/Down to adjust Intermittent Wipe Speed
- Pull lever to spray and wipe

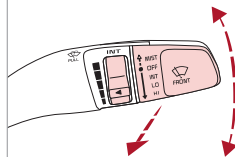

- MIST:** Single wipe
- OFF:** Wiper off
- INT:** Intermittent wipe
- LO:** Slow wipe
- HI:** Fast wipe

(up to 60,000 miles)^A

For Turbo maintenance, see page 44

MAINTENANCE ITEMS	MAINTENANCE INTERVALS (MILES)							
	7,500	15,000	22,500	30,000	37,500	45,000	52,500	60,000
Add fuel additive ^C	P	P	P	P	P	P	P	P
Rotate tires	P	P	P	P	P	P	P	P
Engine oil & oil filter	R	R	R	R	R	R	R	R
Climate control air filter	R	R	R	R	R	R	R	R
Battery condition	I	I	I	I	I	I	I	I
Brake lines, hoses and connections	I	I	I	I	I	I	I	I
Brake discs and pads	I	I	I	I	I	I	I	I
Vacuum hose	I	I	I	I	I	I	I	I
Steering gear rack, linkage & boots	I	I	I	I	I	I	I	I
Driveshaft and boots	I	I	I	I	I	I	I	I
Suspension ball joints	I	I	I	I	I	I	I	I
Air conditioner compressor/refrigerant	I	I	I	I	I	I	I	I
Exhaust system	I	I	I	I	I	I	I	I
Air cleaner filter	I	I	I	R	I	I	I	R
Brake fluid		I		I		I		I
Fuel tank air filter ¹⁰		I		I		I		I
Parking brake (foot type)		I		I		I		I
Vapor hose and fuel filler cap		I		I		I		I
Cooling System				I		I		I
Dual clutch transmission fluid				I				I
Fuel lines, fuel hoses and connections				I				I
Valve clearance ^E								I
Drive belts (First 60,000 miles, then every 12,000 miles) ^F								I

QUICK TIP

Check your Maintenance Schedule or schedule an appointment with a dealer using your UVO link account by logging into your UVO link App or your account on MyUVO.com (Vehicles equipped with UVO link only – See page 22 for setup information)

[‡] If equipped.

A. See the Owner's Manual for complete maintenance schedule. These are approximate estimated intervals.

Refer to vehicle mileage for maintenance item schedule. For Turbo Maintenance intervals, see page 44.

B. And, if necessary, adjust, correct, clean or replace

C. If TOP TIER detergent gasoline is not available, one bottle of additive is recommended. Additives are available from your authorized Kia dealer along with information on how to use them. Do not mix other additives

D. Both the fuel filter & fuel tank air filter are generally considered to be maintenance free, depending on fuel quality being used. However, periodic inspection is recommended. If your vehicle is having issues like fuel flow restriction, power surging, loss of power, difficulty starting, etc., replace the fuel filter immediately and consult an authorized Kia dealer for service.

E. Inspect for excessive tappet noise and/or engine vibration and adjust if necessary

F. The drive belt should be replaced when cracks occur or tension is reduced excessively

See your Owner's Manual for more details and complete maintenance information, including severe maintenance schedule. Warranty may be voided if maintenance schedule is not followed.

© 2018 Kia Motors America, Inc. All rights reserved.
Consumer - Roadside Assistance: 1-800-333-4KIA (4542)

Part Number: UT190-PS-004R1