

niro

hybrid / plug-in hybrid

Features & Functions Guide



Delivery First
The priority that delivers more

GETTING TO KNOW YOUR **NIRO PLUG-IN HYBRID**

Congratulations on Your New Kia Purchase!

Your new Kia vehicle has been designed, engineered and manufactured to provide you with years of comfortable and dependable driving. Kia is committed to quality, innovation, safety and — above all — your satisfaction.

Using This Guide

The information contained in this guide is a brief overview that will help you become familiar with the operation and features of your new Kia vehicle. The flipbook format facilitates information access, while the detailed illustrations help to ensure the instructions are easy to follow.

This **Features & Functions Guide**, and the specific operational and safety information it provides, is not a substitute for your Owner's Manual. In the interest of your safety and that of your family, and to help you avoid risks that may result in death or serious injury, Kia reminds you to carefully read your Owner's Manual in order to fully familiarize yourself with the important information it contains.

While Kia endeavors to ensure that the information contained in this guide is accurate at the time of printing, Kia may change vehicle specifications without notice in advance or after the fact, and assumes no liability in connection with such changes.



Available on the App Store, the Kia AR Owner's Manual App uses AR (Augmented Reality) technology to provide tips and useful information about your vehicle.

To use the Kia AR Owner's Manual App:

- Simply scan the interior or engine (motor) room of your vehicle with your smart phone or tablet, select feature/component and view the video guide.
- If you are unable to scan the vehicle, use the AR Manual (without scan) menu, select feature/component and view the video guide.

www.kia.com

Consumer - Roadside Assistance^{†14}
1-800-333-4KIA (4542)

See Back Pages for Vehicle
Maintenance Schedule

*Always check the Owner's Manual for complete
operating information and safety warnings.*

†LEGAL DISCLAIMERS ON BACK INSIDE COVER

ESSENTIAL FEATURES

Air Conditioning / Climate Control	36
Android Auto™ / Apple CarPlay® Setup	31
Audio System – UVO eServices* / UVO eco* Activation	32
Audio System – UVO eServices* / UVO eco*	32
Audio System – UVO eServices with Premium Navigation* / UVO eco with Navigation*	34
Aux/USB/iPod® Port & Power Outlets	35
Bluetooth® Wireless Technology	26
Charging the Plug-In Hybrid Vehicle	15
Cruise Control	28
Digital Clock	35
Sport/ECO Modes	10
Fuel Economy	08
Hybrid / Plug-In Hybrid Displays	12
Instrument Cluster / Plug-In Hybrid Displays	12
Passenger Airbag Off Indicator	48
Tire Mobility Kit	47
Tire Pressure Monitoring System (TPMS)	05
Windshield Wipers & Washers	25

Driving while distracted can result in a loss of vehicle control that may lead to an accident, severe personal injury and death. The driver's primary responsibility is in the safe and legal operation of a vehicle, and use of any handheld devices, other equipment or vehicle systems which take the driver's eyes, attention and focus away from the safe operation of a vehicle or that are not permissible by law should never be used during operation of the vehicle.

*IF EQUIPPED



NIRO HYBRID / PLUG-IN HYBRID FEATURES & FUNCTIONS GUIDE

VIDEOS & QR CODES	02
-----------------------------	----

INSTRUMENT CLUSTER

Instrument Cluster Overview	03
Indicators & Warning Lights	04
Tire Pressure Monitoring System (TPMS)	05
Hybrid / Plug-In Hybrid Indicators at Startup	06
Hybrid / Plug-In Hybrid Modes	06
LCD Instrument Cluster Modes	07
Trip Modes / Trip Computer	07
Fuel Economy	08
User Settings	09
Service Interval Mode	09
Sport/ECO Modes	10

HYBRID / PLUG-IN HYBRID SYSTEMS

Audio Control Unit Display	11
Instrument Cluster - Energy Flow	12
Emergency Starting* (Hybrid)	14
Charging the Plug-In Hybrid Vehicle	15
Charging Connector Auto/Lock Mode	17
Scheduled Charging*	17

DRIVER'S PANEL

Blind-Spot Collision Warning (BCW) w/ RCCW*	18
Lane Keeping Assist (LKA)*	19
Forward Collision-Avoidance Assist (FCA)* / Forward Collision Warning (FCW)*	20
Instrument Cluster Control	21
Electronic Stability Control (ESC)	21
Hill-Start Assist Control (HAC)	21
Reverse Parking Aid Function*	22
Engine Start/Stop Button	22
Power Windows, Window Lock & Central Door Lock	23
Automatic Door Lock/Unlock	23
Power/Heated Outside Mirrors*	23
Power Folding Outside Mirrors*	23

STEERING WHEEL CONTROLS

Headlights & High Beams	24
Turn Signals & Fog Lights*	24
Windshield / Rear Wipers & Washers	25
Heated Steering Wheel Button*	25
Bluetooth® Wireless Technology	26
Audio Controls	28
Standard Cruise Control	28
Smart Cruise Control (SCC)*	29
Tilt/Telescoping Steering Wheel	30

AUDIO SYSTEMS

UVO eco* / UVO eServices* Activation	31
UVO eServices* / UVO eco* Activation	32
UVO eServices* (Hybrid) / UVO eco* (Plug-In Hybrid)	33
UVO eServices with Premium Navigation* (Hybrid) / UVO eco with Navigation* (Plug-In Hybrid)	34

CENTER PANEL

Digital Clock	35
USB Charger*	35
Aux/USB/iPod® Port & Power Outlets	35
AC Inverter*	35
Wireless Smartphone Charging System*	36
Automatic Climate Control	37
Automatic Gear Shift with Sportmatic® Shifting	38
Dual Clutch Transmission*	38
Seat Warmers / Ventilated Seats*	39

SEATING

Driver Position Memory System*	39
Front Seat Headrest Adjustment	39
Power Adjustable Driver's Seat*	40
6-Way Manual Adjustable Driver's Seat*	40
Folding Rear Seats	41

OTHER KEY FEATURES

Remote Keyless Entry (Folding Key)*	41
Smart Key*	42
Double-Turn Lock/Unlock All	42
Map/Room Lamps	43
Sunroof Operation	43
Hood Release Lever and Latch	44
Fuel Filler Lid	44
Fuel Cap / Malfunction Indicator	44
Sunvisor	44
Parking Distance Warning-Forward*	45
Rear-Camera Display*	45
Driver Attention Warning (DAW)*	46
High Voltage Battery Air Intake	46
Liftgate Release Button	47
Child-Protector Rear Door Lock	47
Tire Mobility Kit	47

SAFETY FEATURES

Occupant Detection System (ODS) / Passenger Airbag Off Indicator	48
Seat Belts	48
Seat Belt Retractor Locks	48

NORMAL MAINTENANCE SCHEDULE Back Cover

LEGAL DISCLAIMERS Inside Back Cover

Kia provides a number of video resources to assist you with becoming familiar with the features and functions found in your Kia vehicle. You can access these resources by snapping the QR Codes with your smartphone/tablet (mobile devices) or by visiting the following website: www.youtube.com/KiaFeatureVideos. Continue reading for a more in-depth look at QR Codes and for instructions on how to use them.

What are QR Codes?

A QR Code is a square, 2-dimensional barcode that can be read by mobile devices loaded with an appropriate barcode or QR Code Reader App. The app reads the barcode image and then launches/uploads the specific information the code contains, such as URLs, text, photos, videos and so much more.

How to Use QR Codes

If you have a mobile device with a QR Code Reader App, you can snap the code with your phone and you'll be provided a video with additional information pertaining to the topic. For example, in the Fuel Cap section, if you would like additional information, just snap the code with your mobile device to view the selected Kia Features & Functions Video.

How to Snap a QR Code

1. With your mobile device, download a QR Code Reader App. With many devices, you can do this through an app store or marketplace
2. Open the QR Code Reader App on your mobile device
3. The app will utilize your device's camera. Center the code in the camera viewing area:
 - With some apps, as soon as the app recognizes the code, it will launch the corresponding video
 - With other apps, you will have to snap or take a picture of the code. The app will then launch the corresponding video
 - For operation specifics, refer to the instructions that come with the QR Code Reader App

QR CODE

One Click Fuel Cap Video

To view a video on your mobile device, snap this QR Code or visit the listed website.



www.youtube.com/KiaFeatureVideos

REMINDER: When accessing videos on your mobile device, standard cellular data rates may apply.

QUICK TIPS

1. If you're having trouble scanning codes, check the following:
 - The code should be centered and focused in your mobile device's camera screen
 - Consider moving your device closer to or farther away from the code
 - The code should be well lit, without significant shadow
 - Avoid scanning from a significant angle
 - Confirm that the device's app supports 2D QR Code scanning
 - Try another QR Code Reader App; not all apps are created equal
2. After scanning, if a "connecting" message appears and then nothing happens or there's a "connection error" message, this typically indicates that your device is having trouble connecting to the Internet

Instrument Cluster Overview

- A** Hybrid / Plug-In Hybrid system gauge
- B** Fuel gauge
- C** Speedometer
- D** Warning and indicator lights
- E** LCD display (including Trip computer)
- F** Hybrid / Plug-In Hybrid Battery SOC (State of Charge) gauge
- G** Distance to empty

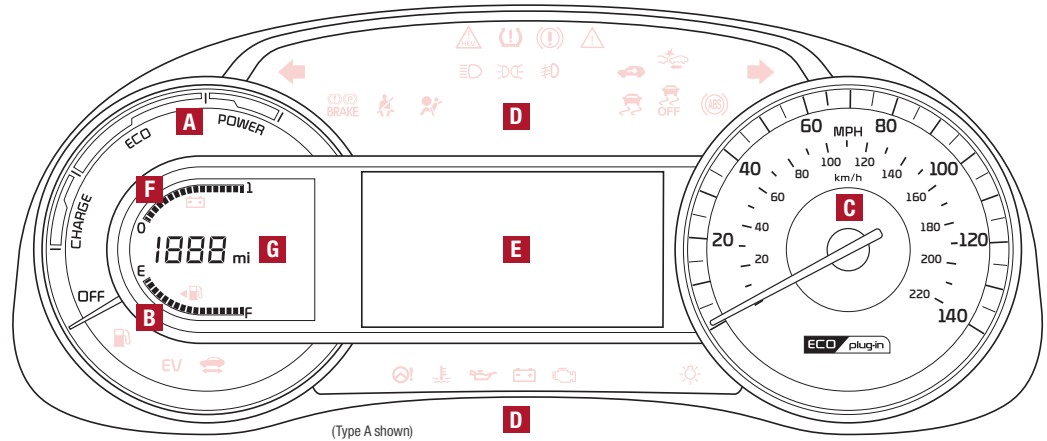

Your vehicle's instrument cluster & indicator light locations may differ from those in the illustrations. For more information on the instrument cluster, the LCD Warning Messages and the function of all indicator and warning lights, please refer to the Owner's Manual.

This illustration is for demonstration purposes only. Some indicators and warning lights may not appear in illustration. On the vehicle, they may appear in the LCD.

Indicators & Warning Lights

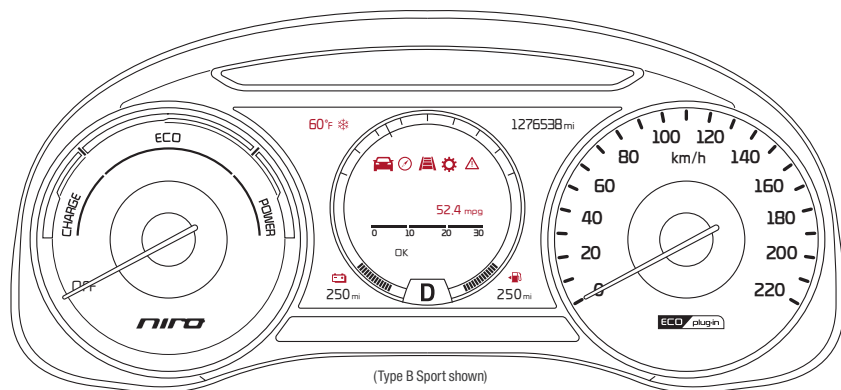

- | | | | | | |
|--|---|--|--|--|---|
| | High Beam Indicator | | SPORT Mode Indicator | | Airbag Warning Indicator |
| | Light ON Indicator | | Hybrid System Warning Indicator | | Parking Brake Indicator |
| | Front Fog Light Indicator* | | Engine Coolant Temperature Warning | | Anti-lock Braking System (ABS) Warning Indicator |
| | Master Warning Indicator | | Engine Oil Pressure Warning Indicator | | Low Fuel Level Warning Indicator |
| | FCA/FCW Indicator* | | Charging System Warning Indicator | | CRUISE Indicator* |
| | Lane Keeping Assist (LKA) Indicator | | Seat Belt Warning Indicator | | Trunk Open Warning Indicator |
| | Electronic Brake Force (EBD) System Warning Indicator
(Two separate indicators on Instrument Cluster lit at same time) | | Malfunction Indicator | | Door Ajar Warning Indicator |
| | Immobilizer Indicator* | | Low Tire Pressure Light / Tire Pressure Monitoring System (TPMS) Malfunction Indicator | | Regenerative Brake Warning Indicator (Two separate indicators on Instrument Cluster lit at same time) |
| | READY Indicator | | Electronic Stability Control (ESC) Indicator / ESC Malfunction Indicator | | Cruise SET Indicator |
| | EV Mode Indicator | | Electronic Stability Control (ESC) OFF Indicator | | Icy Road Warning Indicator |
| | ECO Indicator | | Parking Brake & Brake Fluid Warning Indicator | | LED Headlamp Warning Indicator* |
| | | | Electronic Power Steering (EPS) Warning Indicator | | Charging Cable Connection Indicator (Plug-In Hybrid)* |

Your vehicle's instrument cluster & indicator light locations may differ from those in the illustrations. For more information on the instrument cluster, the LCD Warning Messages and the function of all indicator and warning lights, please refer to the Owner's Manual.

This illustration is for demonstration purposes only. Some indicators and warning lights may not appear in illustration. On the vehicle, they may appear in the LCD.

Tire Pressure Monitoring System (TPMS)^{†22}



The TPMS indicator (⚠️) functions as both Low Tire Pressure Light and TPMS Malfunction Indicator. The indicator (⚠️) will illuminate if it detects one or more tires is significantly underinflated, the vehicle has a spare tire installed without TPMS or the outside temperature becomes significantly lower.

The LCD screen in the instrument cluster will display the Low Tire Pressure indicator **A** showing which tire(s) are underinflated. Inflate tire(s) to specifications using an accurate digital tire pressure gauge to turn off Low Tire Pressure Light (⚠️). See front driver's door jamb for PSI specification.

When there is a problem with the TPMS, the TPMS Malfunction Indicator (⚠️) will blink for approximately one minute then illuminate - See dealer for service.

QUICK TIP

- Even with TPMS, tire pressure should be checked manually at least once a month. Only adjust tire pressure on "cold tires"
- For proper maintenance and optimal fuel economy, maintain recommended tire inflation pressures and stay within the load limits and weight distribution recommended for your vehicle
- In winter or cold weather, the TPMS light may illuminate if the tire pressure was adjusted to the recommended tire inflation pressure during warm weather

REMINDERS:

- Check the recommended tire pressure label located on the left side of driver's door jam, visible when the door is open.
- Consult your dealer for service if Low Tire Pressure Light remains illuminated after inflating your tire(s).

Personal electronic devices (such as laptops, wireless chargers, remote start systems, etc.) that have electronic noise may interfere with TPMS system, which may cause the Malfunction Warning Indicator (Check Engine Light) to illuminate.

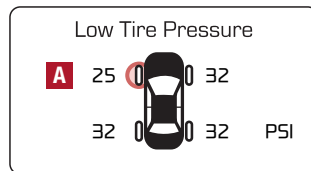

QR CODE

Tire Pressure Monitoring System Video

To view a video on your mobile device, snap this QR Code or visit the listed website.

Refer to page 2 for more information.



www.youtube.com/KiaFeatureVideos

Hybrid/Plug-In Hybrid Indicators at Startup

A Hybrid System Gauge — Indicates how economically the vehicle is being driven.

- **CHARGE (Blue zone):** High-efficiency range
- **ECO (Green zone):** Normal-efficiency range
- **POWER (Grey zone):** Low-efficiency range

B EV Mode — Illuminates when the electric motor is powering the vehicle.

C Ready — Illuminates when the hybrid system is operational. Even if the engine is off, the vehicle can be driven.

D State of Charge (SOC) — Displays the hybrid battery charge status.

REMINDER: Avoid starting or driving the vehicle when the fuel tank is empty. As the engine will be incapable of charging the high-voltage hybrid battery, the battery will lose its charge and may be damaged.

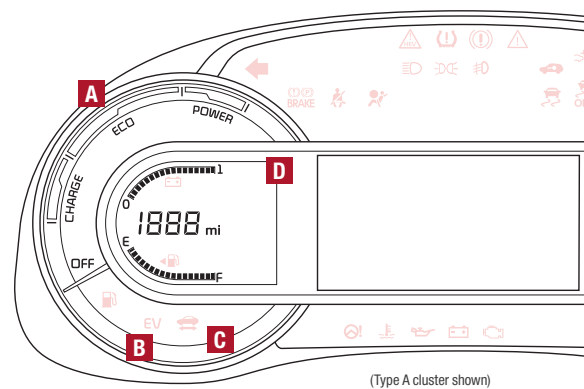

Hybrid/Plug-In Hybrid Modes





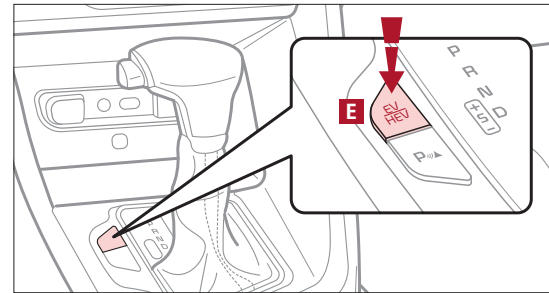

To change the Plug-In Hybrid Mode, press the EV/HEV button **E**; switch between Electric (EV) mode and Hybrid (HEV) mode each time the button is pressed. The LCD on the Instrument Cluster will display the following messages:

- **EV Electric Mode - Charge Depleting:** The high-voltage (hybrid) battery is being used to drive the vehicle.
- **HEV Hybrid mode - Charge Sustaining:** The high-voltage (hybrid) battery and gasoline engine is being used to drive the vehicle.



LCD Instrument Cluster Modes*

Press Mode button **A** to scroll through different LCD Instrument Cluster Modes.

-  **Trip Computer Mode:** Displays driving information for tripmeter, fuel economy, MPH, energy flow, etc.
-  **Turn-by-Turn Mode*:** Displays the state of the navigation
-  **LKA/Driver Attention Warning (DAW)/SCC* Mode:** Displays the state of the Smart Cruise Control (SCC), Lane Keeping Assist (LKA) and Driver Attention Warning (DAW)
-  **Audio Mode:** Displays the selected audio source
-  **Service/Master Warning/Door Open Modes:** Inform on any upcoming service intervals, tire pressure status, warning messages related to TPMS, BCW malfunction and when any door is not securely closed.
-  **Service/Master Warning/Door Open Modes:** Inform on any upcoming service intervals, tire pressure status, warning messages related to TPMS, BCW malfunction and when any door is not securely closed.
-  **User Settings Mode:** Change settings of the Driving Assist, Doors, Lights, Sound, Convenience and Service Interval

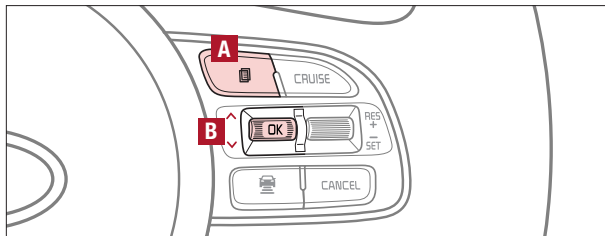

(Buttons located on Steering Wheel – Type A shown)

Your vehicle's steering wheel buttons may differ from those in the illustrations.

Driving while distracted is dangerous and should be avoided. Drivers should remain attentive to driving and always exercise caution when using the steering wheel mounted controls while driving.

Trip Modes / Trip Computer

The Trip Computer is a driver information system that displays information related to driving. It appears on the display when the Engine Start/Stop button is in the ON position.

To cycle through the Trip modes, press the Mode button **A**.

When in the Trip Computer mode , press the Select/Reset (OK) button **B** to cycle through the screens. When displaying ACCUMULATED INFO or DRIVE INFO screens, press and hold the OK button **B** to reset to zero.

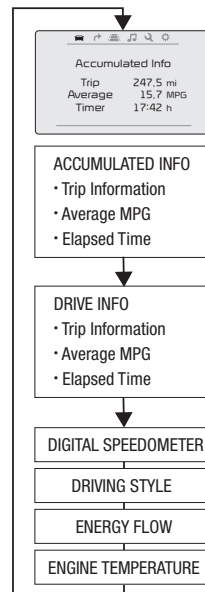

REMINDERS:

- Appearance of Trip Computer display may differ as equipped
- All stored driving information (except Odometer and Range) is reset if the battery is disconnected

Your vehicle's steering wheel buttons may differ from those in the illustrations.

Fuel Economy

There are several factors that contribute to your vehicle's fuel economy, including maintenance of your vehicle, driving style, environmental conditions, vehicle weight and vehicle aerodynamics. Below are tips on how to help improve fuel economy:

- Keep your vehicle in good condition with regular maintenance
- Don't let the engine idle longer than necessary
- Drive at a moderate speed, accelerating smoothly and at a moderate rate
- Keep tires inflated to the recommended pressure
- Travel lightly, without carrying unnecessary weight in your vehicles
- Avoid placing large or heavy items on roof racks
- Avoid hilly, winding or poorly maintained roads

For more information on Fuel Economy, you can snap the QR Code on this page to view a video or refer to the Owner's Manual.

When the Instrument Cluster LCD screen is in the Trip Computer mode, the screen displays fuel economy information related to the driving range and average fuel economy.

To change modes, go to User Settings in the LCD Instrument Cluster modes.

Average Fuel Consumption - Calculates average fuel consumption from the distance driven and amount of fuel injected into the engine / total fuel used.

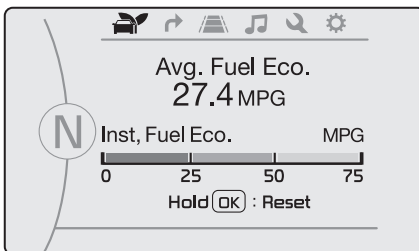

(Actual vehicle's LCD screen may vary)

QR CODE

Fuel Economy Video

To view a video on your mobile device, snap this QR Code or visit the listed website.

Refer to page 2 for more information.



www.youtube.com/KiaFeatureVideos

User Settings

To enter the User Settings mode in the LCD Instrument Cluster Modes, press the Mode button **A** when the vehicle is at a standstill and the Engine Start/Stop button is on and select User Settings .

You can navigate the selections on the display by pressing the OK button **B** up/down, and then selecting the item by pressing the OK button **B** again.

Driving Assist*:

- Lane Keeping Assist (LKA)*
- Driver Attention Warning (DAW)*
- Smart Cruise Control (SCC)
- Forward Collision-Avoidance Assist (FCA)*
- Forward Collision Warning (FCW)*
- Blind-Spot Collision Warning (BCW) w/ RCCW*
- Coasting Guide*

Door:

- Automatically Lock
- Automatically Unlock
- Two Press Unlock

Service Interval:

- Enable Service Interval
- Adjust Interval
- Reset

Reset

- Choosing reset will restore defaults for all User Settings menus

Lights:

- One-Touch Turn Signal
- Headlamp Delay
- Welcome Light

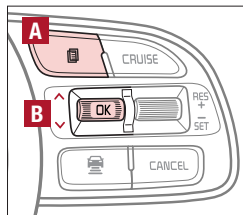

(Buttons located on Steering Wheel – Type B)

Convenience:

- Seat Easy Access*
- Wireless Charging System*
- Wiper/Light Display*
- Gear Pop-Up*



Sound:

- Parking Distance Warning-Forward* Volume

Other features:

- Fuel Economy Auto Reset
- Fuel Economy Unit
- Temperature Unit
- Tire Pressure Unit
- Instrument Cluster Layout
- Aux. Battery Saver+

Service Interval Mode

To enter Service Interval mode, press the Mode button **A**, User Settings , then scroll to Service Mode  and press the OK button **B**. System will display number of miles remaining until next service is due, as well as type of service.

When service is required, the following will be displayed:

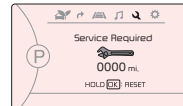

Service Required

To reset the Service Interval mode system, press and hold the OK button **B** for more than 1 second.



To turn Service In OFF, go to User Settings.

Service Interval Setting

To set the service interval when in User Settings mode:

- Press the OK button **B** up/down and scroll to Service Interval. Press the OK button **B** to enter
- Press the OK button **B** up/down and toggle to ON, then press the OK button **B** again. Then press the OK button **B** to scroll and select the desired miles or months for your next service
- Press the OK button **B** again

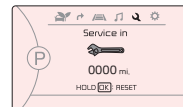

QR CODES

To view a video on your mobile device, snap these QR Codes or visit the listed website.

Refer to page 2 for more information.

LCD Display Video



LCD Display: Maintenance Video



www.youtube.com/KiaFeatureVideos

Sport/ECO Modes

The mode can be changed **A** between Sport and ECO by moving the shift lever from D to the left gate and back:

(D) - ECO Mode

(S) - Sport Mode - When shift lever is moved into the left gate from (D). If shift lever is not moved through the gears, then the vehicle will shift automatically. Sport Mode changes the Niro's shift points and steering feel, and makes it more fun to drive

The LCD screen **B** on the instrument cluster will display the mode the vehicle is in.

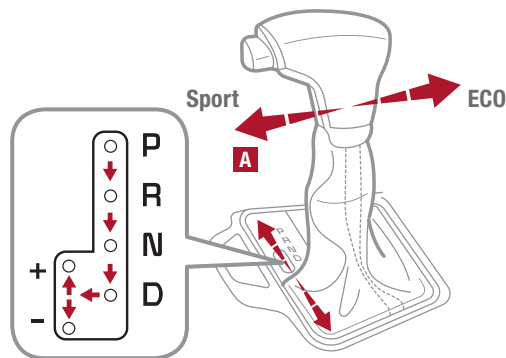

ECO Mode (Active ECO)

Active ECO is designed to help improve fuel economy by controlling several vehicle components. When in ECO Mode, it is designed to optimize drivetrain operations such as engine power and transmission to help improve fuel economy in a variety of conditions.



QUICK TIPS

To help improve your fuel economy:

- Drive at a moderate speed, accelerating smoothly and at a moderate rate
- Keep tires inflated to the recommended pressure
- Be sure the wheels are properly aligned

REMINDER: Steering effort may be slightly increased in Sport mode.

For more information on Active ECO, refer to your Owner's Manual or contact your local dealership.

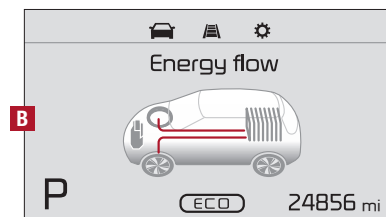

(Located in Instrument Cluster)

Audio Control Unit Display

When equipped, the audio control unit screen also provides information on economical operation and hybrid system modes. To enter the Plug-In Hybrid display mode, press the HEV/PHEV button. Then select one of the menus **A** - ECO Driving, Energy Information, Charging Settings, Charging Stations, Gas Stations and EV Range* (Systems with Navigation only).

A Plug-In Hybrid System Home Screen - Fuel Economy, ECO Driving and Energy Flow

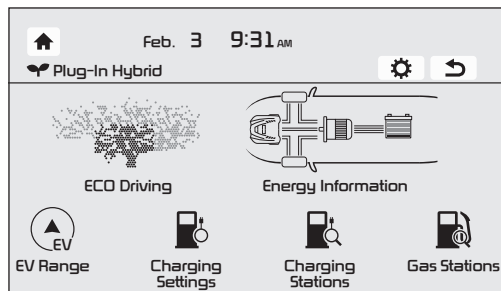

Energy Flow - Displays the current flow of power between the main powertrain components.

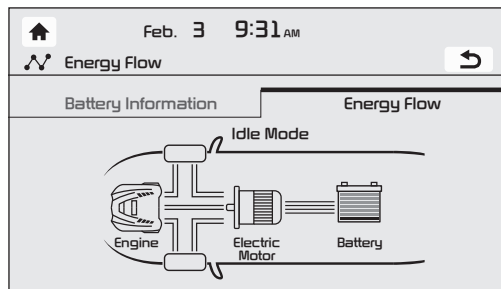

ECO Level - The more economically you drive, the more the ECO Level increases.

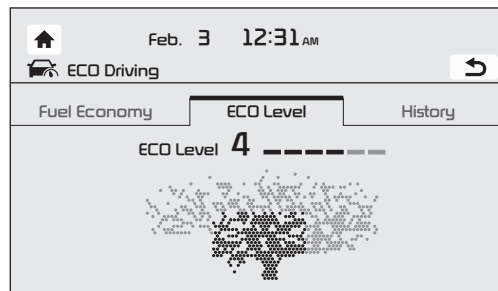

Fuel Economy - Displays the average fuel economy over the duration of a trip.

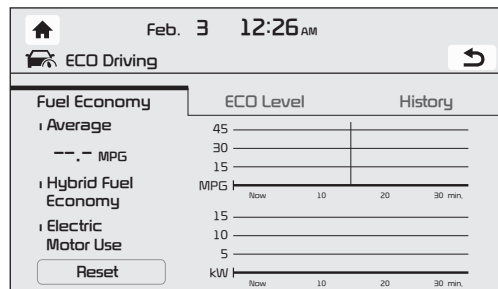

The images shown are for illustration purposes only. Not all available displays are shown. Screens may vary.

Instrument Cluster – Energy Flow

The instrument cluster LCD screen displays the following plug-in hybrid system modes to inform the driver of its status. To change modes, go to User Settings in the LCD Instrument Cluster modes.

EV Propulsion - The electric motor is moving the vehicle.

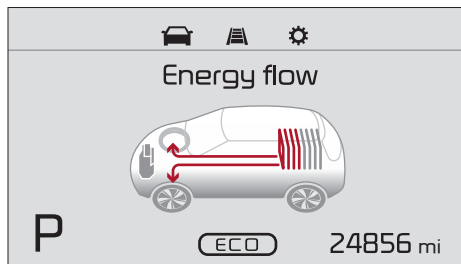

Engine-Only Propulsion - The engine is moving your vehicle.

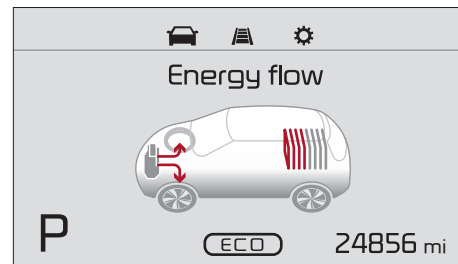

Power Assist - Both the electric motor AND the engine are moving the vehicle.

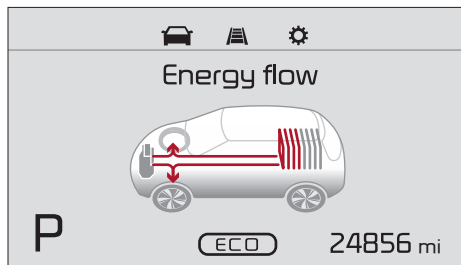

Engine Generation - While the vehicle is stopped, the engine is charging the hybrid battery.

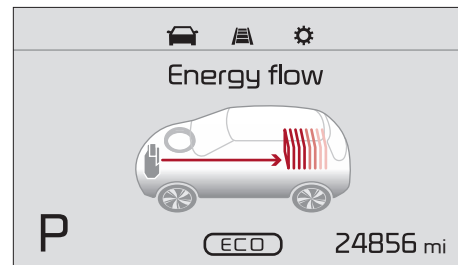

Instrument Cluster – Energy Flow

The instrument cluster LCD screen displays the following plug-in hybrid system modes to inform the driver of its status. To change modes, go to User Settings in the LCD Instrument Cluster modes.

Power Reserve - While the engine powers the vehicle, it is also recharging the hybrid battery.

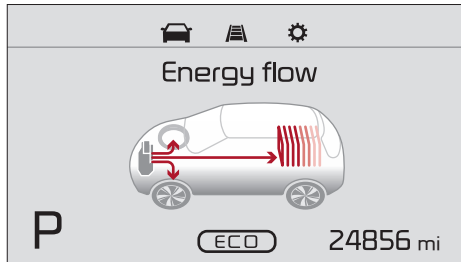

Engine Brake/Regeneration - The regenerative braking system is recharging the hybrid battery.

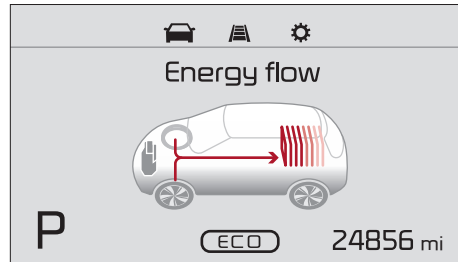

Vehicle Stop - The vehicle's hybrid system is standing by.

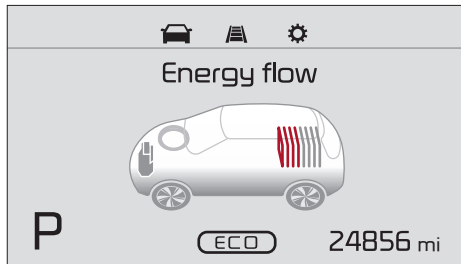

Engine Generation/Regeneration - The engine and the regenerative braking system are both recharging the hybrid battery.

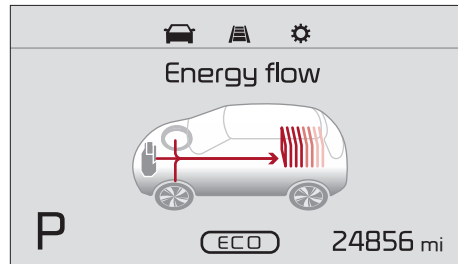

Emergency Starting (Hybrid only)

Before Jump Starting:

1. If the vehicle appears to have a dead battery, first press the 12V Battery Reset button **A**. Then immediately start the vehicle by pressing the brake and turning the ignition on or pressing the Engine Start/Stop button.
2. If the vehicle does not start after completing the above steps, then jump start the vehicle (as described below).

REMINDERS:

- After starting, idle or drive the vehicle for more than 30 minutes to help charge the 12-volt battery
- If the vehicle does not start immediately after pressing the 12V Battery Reset button **A**, then the power of the 12V battery is automatically disconnected to save any additional discharge
- Repeated use of the 12V Battery Reset button may cause over discharge which will prevent the vehicle from starting

Jump Starting:

1. Remove the fusebox cover **B** under the front hood
2. The {+} jump start terminal **C** is located in the fuse box; the suitable ground point **D** is located in the engine compartment (See Owner's Manual for detailed description)
3. Connect cables coming from the battery booster source in the following order and disconnect in reverse order:
 - Connect the {+} clamp of your jumper cable to the {+} jump start terminal **C**
 - Connect the {-} clamp of your jumper cable to the suitable ground point **D**
4. Then immediately start the vehicle by pressing the brake and turning the ignition on or pressing the Engine Start/Stop button

REMINDER: Jump starting your vehicle can be dangerous if done incorrectly. Follow the above jump starting procedures to avoid harm to yourself or damage to your vehicle and any of its components. You should also consult your Owner's Manual for further detailed instructions for jump starting your vehicle. If in doubt, we strongly recommend that you have a competent technician or towing service jump start your vehicle.

For more information on Emergency Starting, please refer to the Owner's Manual.

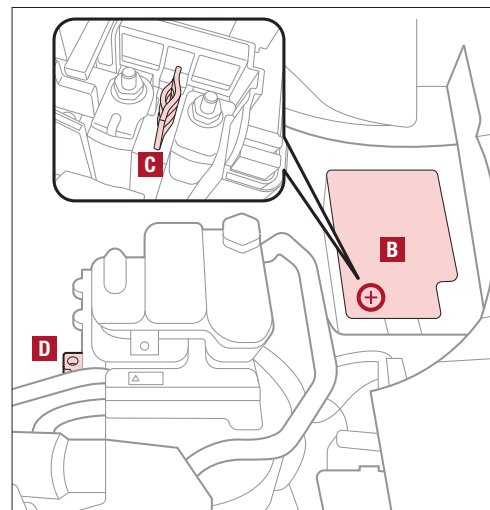
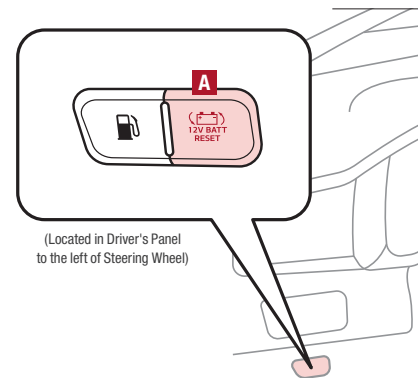

(Niro engine compartment shown, right side)

Charging the Plug-In Hybrid Vehicle (Plug-In Hybrid Only)

Level 1 Charging – “Trickle” Charge

A Level 1 or “trickle” charger is the most common type of charging system for a Plug-In Hybrid. This type of charger uses 110 volts of household electricity and takes up to 9 hours for a full charge.

Trickle Charger Indicators:

- A** ICCB – In-Cable Control Box
- B** Power – Indicates that the charger is plugged in and functioning.
- C** Charge Level – Indicates the level of charge - L (8A), M (10A), or H (12A)
- D** Fault – Indicates charge failure.
- E** Charge Level – Indicates the level of charge - L (8A), M (10A), or H (12A)

REMINDER: Do not use an extension cord. Plug Trickle charger directly into wall socket. Do not charge to a receptacle that is old, damaged, corroded or cracked

Level 2 Charging – “Normal” Charge

A Level 2 or “normal” 240-volt charger is the recommended charging system for the Plug-In Hybrid. This type of charger uses 240 volts of electricity and takes approximately 2.5-3 hours for a full charge (Based on Kia Motors Corporation testing with SAE J1772 charger performed at 3.3kW). This charger may be able to be installed at your home or found at a public charging station.

REMINDER: Shape of charger and how to use the charger may be different for each manufacturer. Please see Owner’s Manual for more information

QUICK TIP

A Level 2 or “normal” 240-volt charger is recommended for regular charging of the vehicle.

REMINDER: For more detail and/or subsequent steps in charging your vehicle, please see the Owner’s Manual

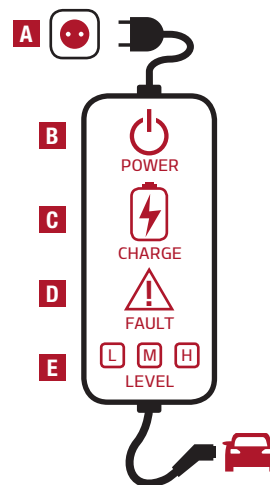

Charging the Plug-In Hybrid Vehicle (Continued)

To charge the Plug-In Hybrid vehicle using a normal/trickle charger:

1. Connect the ICCB **A** plug to an electrical outlet
2. Check if the power light (green) **B** on the ICCB turns on
3. Press the brake pedal and engage the parking brake
4. Turn off all switches, put the shift lever in P (Park), and turn off the vehicle
5. Open the charging door **E** by pressing the charging door (Ensure doors are unlocked)
6. Remove any dust on the charging connector and charging inlet **F**
7. Hold the charging connector handle **G** and connect it to the vehicle's trickle charging inlet **F** by pushing the connector until you hear a “clicking” sound
8. Charging begins automatically (Ensure the charge indicator light **S** is illuminated on your instrument cluster, indicating the vehicle is charging)

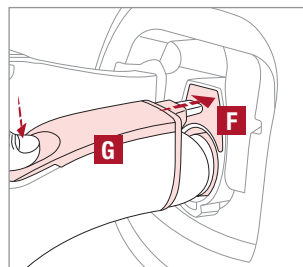
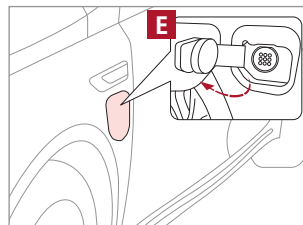

Checking the Charging Status

The charging status can be checked by viewing the charging status indicator on the dash panel. The lights will progressively become lit as the vehicle approaches a full charge.

After charging has started, the estimated charging time is displayed on the Instrument Cluster LCD **H** for about 1 minute. It is also displayed, when the driver's door is opened with charging in progress.

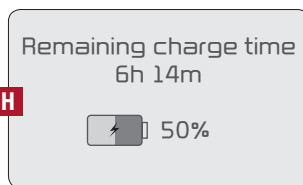

REMINDER: For more detail and/or subsequent steps in charging your vehicle, please see the Owner's Manual

Charging Connector Auto/Lock Mode (Plug-In Hybrid Only)

The Charging Connector can be set to be locked or unlocked while in the charging inlet. Press the AUTO  button **A** (LED lit) for the connector to lock while charging and unlock automatically when charging is complete.

When the AUTO  button **A** is not pressed (LED not lit), the mode will be set to LOCK. The connector will be locked when charging and remain locked until all doors are unlocked.

QUICK TIPS

- If charging connector unlocks but charging cable is not disconnected within 10 seconds, the connector will be automatically locked again.
- If charging connector is unlocked but all doors are locked again, immediately, the connector will be automatically locked again.

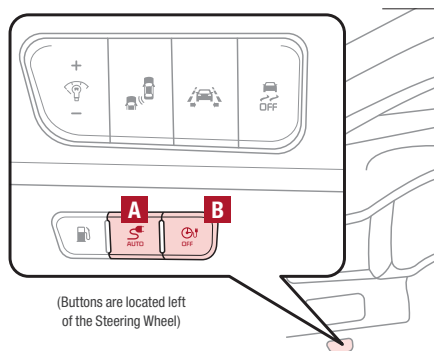

(Buttons are located left of the Steering Wheel)

Scheduled Charging (Plug-In Hybrid Only)

Charging times can be set using the UVO eco with Navigation* settings when in EV Mode. You can also use the Scheduled Charging* App on your smartphone.

Charging with the UVO eco Smartphone App:

The UVO eco smartphone app can help you find the nearest charging station, displays charging-status and the Scheduled Charging information. On your Smartphone, go to an app store or marketplace to download the UVO eco Smartphone app.

REMINDER: When Scheduled Charging is set and the charger is plugged in, charging of the electric vehicle will not begin until the time and date set.

Deactivate Scheduled Charging - Depress the Deactivate Scheduled Charging button **B** to disable the scheduled charging feature when immediate charging is required.

QUICK TIP

When you press the Deactivate Scheduled Charging button the reserved charging setting will temporarily disable, and start immediate charging mode. If you need to completely deactivate the scheduled charge setting, change the setting from the audio control unit.

REMINDER: For more detail and/or subsequent steps in charging your vehicle, please see the Owner's Manual.

Blind-Spot Collision Warning (BCW) w/ RCCW*†6

The BCW system uses radar sensors to help alert the driver in certain situations and if it detects an approaching vehicle in the driver's blind spot before changing lanes. The light on the BCW button **A** will illuminate when turned ON. The outside rearview mirror warning lights will also illuminate for 3 seconds.

The system will become active when the vehicle is traveling more than approximately 18 mph and will alert the driver if another vehicle is detected by the radar sensor.

Blind-Spot Collision Warning (BCW) / Lane Change Assist (LCA)

1st-stage alert: When another vehicle is detected within the BCW boundary **B**, or when a vehicle is detected within the LCA boundary **C** approaches at a high speed, a yellow indicator will illuminate on the outside rearview mirrors.

2nd-stage alert: When 1st-stage alert is on and the driver activates a turn signal, a flashing yellow indicator will illuminate on the outside rearview mirrors and the system will sound an alert.

Rear Cross-Traffic Collision Warning (RCCW)*

If the RCCW system sensors detect approaching vehicles from the left or right side **D**, the system will sound an audible alert, the warning indicators on the outside rearview mirror will illuminate and a message will appear on the LCD screen, with these conditions:

- When gear shift is in Reverse
- When the vehicle is moving slower than 6 mph
- When the vehicle moves in reverse from a parking position

REMINDERS:

- The BCW system will not show a warning if the vehicle speed is only 6 mph above the surrounding vehicles
- If the BCW is turned ON and the ignition is cycled, the BCW system returns to ON
- The RCCW feature can be turned OFF/ON in User Settings
- The RCCW system will show a warning if the approaching vehicle speed is between 2.5-22 mph within sensing range. See owner's manual for other conditions

For more information on the Blind-Spot Collision Warning*, please refer to the Owner's Manual.

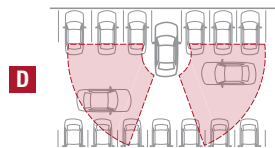
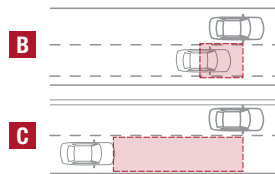
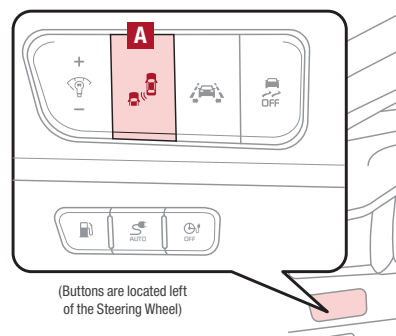

REMINDER: The above images are for illustration purposes only and may not reflect actual operation.

QR CODE

Blind Spot Detection w/RCCW Video

To view a video on your mobile device, snap this QR Code or visit the listed website.

Refer to page 2 for more information.



www.youtube.com/KiaFeatureVideos

The BCW and RCCW systems are supplemental systems. Do not solely rely on these systems and always drive safely.

Lane Keeping Assist (LKA)^{†6}

With the Engine Start/Stop button in the ON position, press the LKA button **A** to turn system ON. The instrument cluster indicator  will initially illuminate white. It will remain white when the vehicle is traveling less than 40 mph or the system does not detect the lane markers. When the LKA system detects the lane markers and can assist the steering, the LKA icon will illuminate green.

If the LKA detects that you are moving outside of your lane, the system may give an audible warning and display a LDW (Lane Departure Warning) alert on the instrument cluster. If the vehicle continues to move outside of the lane, the LKA will apply a slight adjustment to the steering, trying to prevent the vehicle from moving outside its lane.

Standard LKA is the operating mode by default when the LKA button is depressed to ON. To switch between modes (Standard LKA, Active LKA and Lane Departure), go to User Settings in the Instrument Cluster.

All systems will operate under the following conditions:

- The vehicle exceeds approximately 40 mph
- The LKA system recognizes both sides of the lane markers the vehicle is traveling in
- The vehicle is between the lane markers

REMINDERS:

- LKA will not issue a warning if the turn signal or hazard signal is activated
- LKA will stay on when the ignition is cycled

Lane Keeping Assist is not a substitute for safe driving, and may not always alert the driver if the vehicle is moving outside of its lane. Always drive safely and use caution.

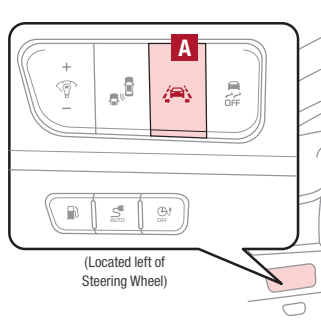

When the LKA sensor detects the lane traveled in, both lanes are illuminated

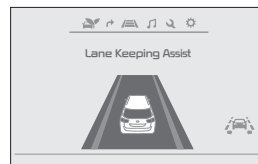

When the LKA sensor does not detect the lane traveled in the lanes are not illuminated



When the LKA sensor detects the vehicle moving outside of the lane being traveled in, a yellow indicator will illuminate either on the left or right lane (shown in both images above)



Your vehicle's instrument cluster & indicator light locations may differ from those in the illustrations. For more information on the instrument cluster, please refer to the Owner's Manual.

These illustrations are for demonstration purposes only. Some indicators and warning lights may not appear in illustration. On the vehicle, they may appear in the LCD.

QR CODE

Lane Keeping Assist Video

To view a video on your mobile device, snap this QR Code or visit the listed website.

Refer to page 2 for more information.



www.youtube.com/KiaFeatureVideos

Forward Collision-Avoidance Assist (FCA) / Forward Collision Warning (FCW)^{†6}

The FCA is designed to help alert the driver, and under certain conditions, apply emergency braking, when rapidly approaching a vehicle that is slowing down, braking or stopped. Initially, the FCA provides Forward Collision Warning (FCW) when it detects a potential collision with a vehicle in front, emitting an audible warning and visual alert on the instrument cluster.

Adjust the alert settings (Early, Normal, Late) in the User Settings. To turn the FCA/FCW off, go to User Settings again and turn it off.

If the collision risk increases, the Forward Collision-Avoidance Assist (FCA) automatically applies the brakes to reduce your speed, helping to minimize the effects of a possible collision. FCA can be turned ON in the User Settings menu on the Instrument Cluster display.

The FCA/FCW will become active when the:

- Engine Start/Stop button is ON
- Vehicle is traveling more than 5 mph
- Electronic Stability Control (ESC) is ON



REMINDERS:

- The FCA will be activated by default when vehicle power is cycled on, even when previously set to off
- The FCW will not operate when the vehicle is traveling faster than approximately 50 mph
- If the FCA is operating and the ESC (Electronic Stability Control) is turned off, the FCA system is automatically turned off
- When FCA system is off, the FCA warning indicator is on in the Instrument Cluster

The Forward Collision-Avoidance Assist (FCA) / Forward Collision Warning (FCW) are not substitutes for safe and proper driving. Always drive safely and use caution. FCA/FCW may not always alert the driver when the vehicle is approaching another vehicle.*

QR CODE

Forward Collision-Avoidance Assist Video

To view a video on your mobile device, snap this QR Code or visit the listed website.



www.youtube.com/KiaFeatureVideos

Instrument Cluster Control

Press switch **A** up or down to adjust display brightness of the instrument panel illumination.

REMINDERS:

- Dimmer does not change brightness when lights are turned off
- The Dimmer does not adjust brightness on the audio system screens; use the system's setup menu to adjust brightness on the screens.

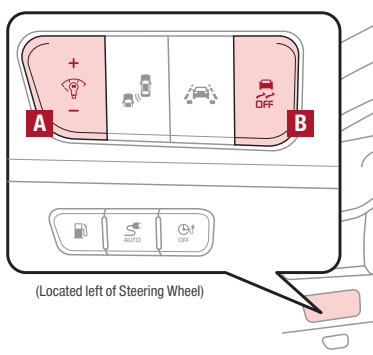

Electronic Stability Control (ESC)^{†7}

The ESC system is designed to help stabilize the vehicle during certain cornering maneuvers. It is a good idea to keep the ESC turned ON whenever possible.

Press ESC OFF button **B** to disable Traction Control in ESC (ESC OFF indicator will illuminate).

To turn both Traction Control and Stability Control off, press and hold ESC OFF button **B** (ESC OFF indicator will illuminate, and an alert sounds).

REMINDERS:

- ESC is active by default at vehicle start-up
- The ESC Indicator Light  in the instrument cluster will illuminate whenever the ESC is in operation

For more information on Electronic Stability Control (ESC) and its specific features and operations, please refer to your Owner's Manual.

Hill-Start Assist Control (HAC)^{†7}

HAC is designed to help prevent the vehicle from rolling backward when accelerating from a stop while on a steep incline.

The HAC automatically activates whether the ESC is OFF or ON but does NOT activate when the ESC has malfunctioned.

REMINDERS:

- The HAC does not operate when the gear shift is in the P (Park) or the N (Neutral) position
- In the event of HAC system malfunction, see Authorized Kia Dealer for service

QUICK TIPS

- When HAC is active (e.g., accelerating from a stop on an incline), you may notice that the brakes will momentarily remain engaged after you depress the accelerator. This is normal HAC operation
- HAC provides a 2-second delay before the vehicle may start rolling backward

HAC does not replace the need to apply brakes while the vehicle is stopped on an incline.

Reverse Parking Aid Function*

When the gear shift lever is moved into R (Reverse) and the vehicle is driven backwards, the outside rearview mirrors **A** will rotate downward to aid in reverse parking.

To turn ON the Reverse Parking Aid Function, depress either L or R mirror buttons **B**.

To turn OFF, depress the same buttons again.

The outside rearview mirrors will automatically return to their original positions when:

- The Engine Start/Stop button is in the OFF position
- The gear shift lever is moved to any position except R (Reverse)
- The L or R mirror buttons are not depressed.

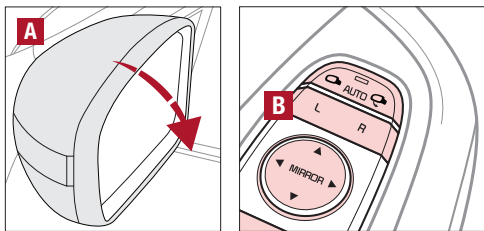

(Buttons panel located on Driver's Door)

REMINDER: When the outside rearview mirror buttons are not depressed, the Reverse Parking Aid Function will not operate and the outside rearview mirrors will not rotate downward.

Engine Start/Stop Button†⁸

To start the engine:

1. Depress the brake pedal
2. Press the ENGINE START/STOP button while gear shift is in P (Park) or (N) Neutral

To turn the vehicle OFF, press the ENGINE START/STOP button.

To use the ENGINE START/STOP button, you must have the Smart Key fob on your person.

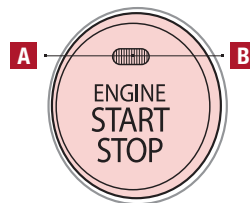

QUICK TIPS

To use electrical accessories:

ACC position

- When in the OFF position and without depressing the brake pedal, press the ENGINE START/STOP button once (amber light **A**)

ON position

- When already in the ACC position (amber light **A**) and without depressing the brake pedal, press the ENGINE START/STOP button again (red light **B**)
- When in the OFF position and without depressing the brake pedal, press the ENGINE START/STOP button twice (red light **B**)

Keeping the vehicle in ACC or ON position without turning engine on may discharge the vehicle's battery.

REMINDEERS:

- In an emergency situation while the vehicle is in motion, you are able to turn the engine off and to the ACC position by pressing the ENGINE START/STOP button for more than 2 seconds or 3 times successively within 3 seconds
- If the Smart Key battery is weak or not working properly, hold the Smart Key fob up to the ENGINE START/STOP button (Lock button side closest) and press to start engine

QR CODE

To view videos on your mobile device, snap these QR Codes or visit the listed website. Refer to page 2 for more information.

Engine Start/Stop Button & Smart Key Video



Kia Key Fob Video



www.youtube.com/KiaFeatureVideos

Power Windows, Window Lock & Central Door Lock

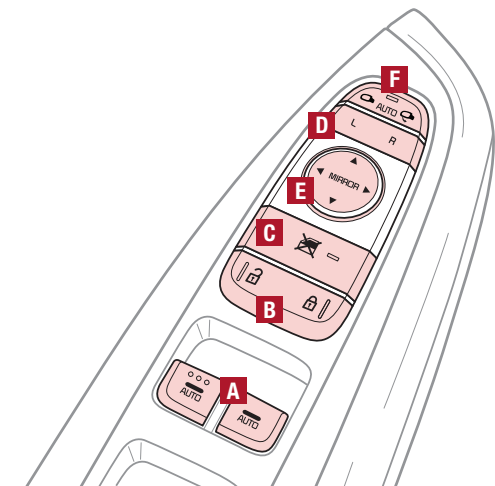

A Pull/Press to operate Driver's and Front Passenger's Windows Auto-Up/Down*

QUICK TIP

Press button again to stop Auto Up/Down function.

B Press to Unlock/Lock All Doors

C Press to disable Rear Passenger Windows

REMINDER: When pressed **C**, window controls for the Rear Passenger Windows are disabled.

Automatic Door Lock/Unlock

Auto Door Lock/Unlock will engage when the gear shift is moved in to or out of the P (Park) position. Refer to the User Settings in the LCD Instrument Cluster modes on how to turn Auto Door Lock/Unlock ON/OFF.

Power/Heated Outside Mirrors*

Mirror heaters automatically turn ON/OFF at the same time the Rear Window Defroster is turned ON/OFF. Rear Window Defroster button* is located on climate control system panel.

Power Folding Outside Mirrors*

Press L or R buttons **D** (left or right) to select mirrors. Then press arrows **E** to adjust mirror position.

To both fold and unfold the outside rearview mirrors, press the folding mirror button **F** as pictured:

- Left – The mirrors will unfold.
- Right – The mirrors will fold.
- Center – The mirrors will fold/unfold automatically when doors are locked/unlocked with the Smart Key or a door handle button is pressed. Also, the mirrors will unfold when approaching the vehicle with the Smart Key fob in proximity.

QUICK TIP

To automatically fold mirrors when exiting vehicle, press the LOCK button once on the Smart Key.

REMINDER: To lock position of mirrors, toggle switch to the neutral (center) position.

Headlights & High Beams

To operate:

- Rotate lever to change the Headlight function
- Push lever to turn High Beams ON
- Pull lever to flash Headlights/High Beams



AUTO Light position — When the light switch is in the AUTO Light position, the tail lights and headlights will turn ON/OFF automatically depending on the amount of light outside the vehicle.

Daytime Running Lights (DRL)* — DRL may help others to see the front of your vehicle during the day. The lights will be on automatically when the ignition or ENGINE START/STOP button* is ON and the headlight switch is in the AUTO position, unless one of the following occurs:

- Headlights are on
- Parking brake is applied
- Fog lights are on
- Engine is turned off

REMINDERS:

- DRL only operates during the daytime
- The DRL system turns off when the headlights are ON, parking brake is applied or the front fog lights are turned on

Turn Signals & Fog Lights*

To operate:

- Turn Signals - Move lever Up/Down for Right/Left Turn Signal
- Fog Lights - Press switch **A** to turn Fog Lights ON/OFF

REMINDER: Headlights must be ON for Fog Light operation.

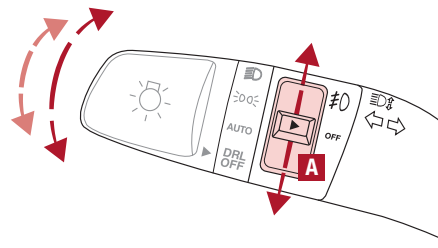

One-Touch Lane Change Signal is activated by moving the Turn Signal Lever slightly for less than 1 second and then releasing. The lane change signal will blink 3 times.

To change how many times (3/5/7) the Lane Change Signal blinks, go to User Settings Mode in the LCD Instrument Cluster modes.

Windshield/Rear Wipers & Washers

To operate Windshield Wipers and Washers:

- Move lever Up/Down to change Wiper modes
- Press switch **B** Up/Down to adjust Intermittent Wipe Speed
- Pull lever to spray and wipe

Windshield

MIST: Single wipe
OFF: Wiper off
INT: Intermittent wipe
LO: Slow wipe
HI: Fast wipe

Rear

HI: Continuous wipe
LO: Intermittent* wipe
OFF: Wiper off

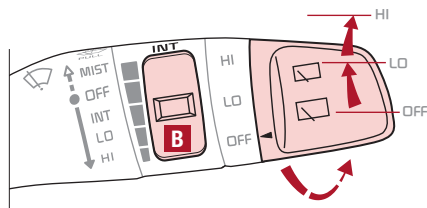

QUICK TIPS

- Pressing lever up increases Intermittent wipe frequency and wipe speed. Pressing lever down decreases frequency of wipes
- Set the wiper to OFF position when the wiper is not in use
- LO and HI sets wiper speed. No intermittent wipe function on Rear Wipers.

To operate Rear Wiper & Washer:

- Rotate Rear Wiper switch to change Wiper modes
- Push to spray and wipe

Heated Steering Wheel Button*

Press button **B** to turn ON/OFF steering wheel heater, while the ignition or Engine Start/Stop button is in the ON position.

Steering wheel heater will turn off automatically in 30 minutes, or when button is pressed again to deactivate. Steering wheel heater will turn ON or OFF automatically depending on the steering wheel temperature.

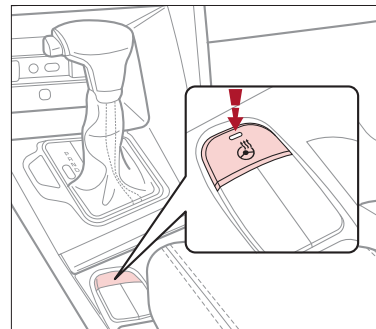

(Located below gear shift)

QUICK TIP

If ignition is cycled, the Heated Steering Wheel turns OFF. Press button again to turn ON.

REMINDER: If the steering wheel becomes too warm, turn the system off. The heated steering wheel may cause burns even at low temperatures, especially if used for long periods of time.

Bluetooth® Wireless Technology†5,19

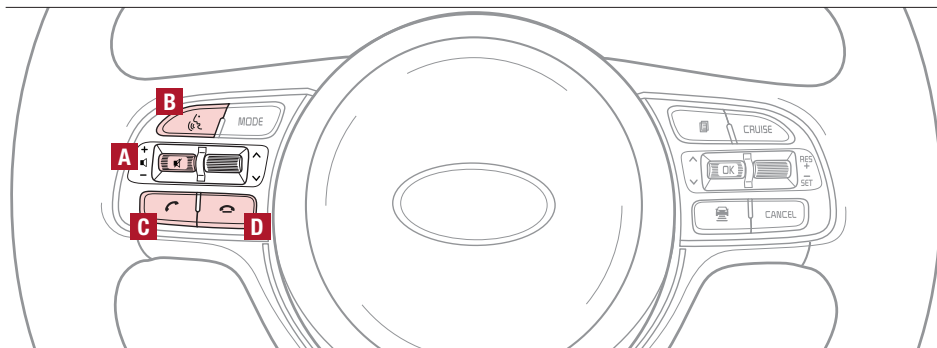

(Type B shown)

- A Volume button:** Press up/down to raise/lower speaker volume
Mute button: Press to mute the microphone during a call
- B Talk button:** Press to activate voice recognition
- C Receive/Place Call button:** Press to receive/place/answer calls.
In vehicles with navigation, if no phone is paired, press button to pair a phone.
- D End Call button:** Press to end a call or cancel a function

QUICK TIPS

- Phonebook transfer upload time varies by phone model and with number of phonebook entries
- When using the voice command feature, wait for the system BEEP before speaking the command.
- Because of differences in phone quality, service providers and Bluetooth® Wireless Technology chip programming, functionality may differ from one phone to another

Your vehicle's steering wheel buttons may differ from those in the illustrations. See your Owner's Manual for more details.

Driving while distracted is dangerous and should be avoided. Drivers should remain attentive to driving and always exercise caution when using the steering-wheel-mounted controls while driving.

For more information, if equipped, refer to the Car Multimedia System User's Manual. For Bluetooth® Wireless Technology FAQs, go to www.kia.com, Owners section, or call Consumer Information for Bluetooth® Technology at (800) 333-4KIA. Refer to your Owner's Manual for more specific Bluetooth® Wireless Technology phone pairing and operation instructions.

Bluetooth® Wireless Technology^{†5,19}

Pairing a Phone

For instructions on how to pair a phone, refer to the Car Multimedia System User's Manual or your vehicle's Quick Start Guide.

QUICK TIP

During the pairing process, be sure to accept the connection requests on the phone for contacts download and to allow acceptance of all future *Bluetooth*® connection requests

How to Place a Call

- Option 1: Press the Receive/Place Call button **C** (displays the phone screen with call history)
- Option 2: Press the Talk button **B**. Then say the command "Call {name}" or "Dial {number}" followed by contact name or number

QUICK TIP

When using the voice command feature, wait for the system BEEP before speaking the command

Voice Recognition and Phone Contact Tips

To help optimize the *Bluetooth*® Wireless Technology Voice Recognition system, below are some tips and reminders. Improve the performance by making a few simple changes to your phone contacts:

- Use full names (first and last names) vs. short or single-syllable names ("John Smith" vs. "Dad," "Smith Residence" vs. "Home")
- Avoid using special characters, emojis or hyphenated names (@, &, #, /, -, *, +, etc.)
- Avoid using acronyms ("In Case of Emergency" vs. "ICE") or words with all capital letters
- Spell words completely, no abbreviations ("Doctor Smith" vs. "Dr. Smith")

The system may have difficulty understanding some accents or uncommon names. Below are other tips to optimize using the voice recognition.

QUICK TIPS

- When placing a call, speak in a natural, moderate tone, with clear pronunciation. The system may have trouble recognizing commands if you speak too soft or too loud
- Always wait for the beep before speaking any commands
- Close windows and turn off A/C - Open windows, weather (wind/rain), or an A/C fan operating at higher speeds can interfere with Voice Recognition
- Press the talk button and say "Help" to get a list of available commands

QR CODE

Voice Recognition Tips Video

To view a video on your mobile device, snap this QR Code or visit the listed website.

Refer to page 2 for more information.



www.youtube.com/KiaFeatureVideos

Audio Controls^{†20}

Standard Cruise Control^{†19}

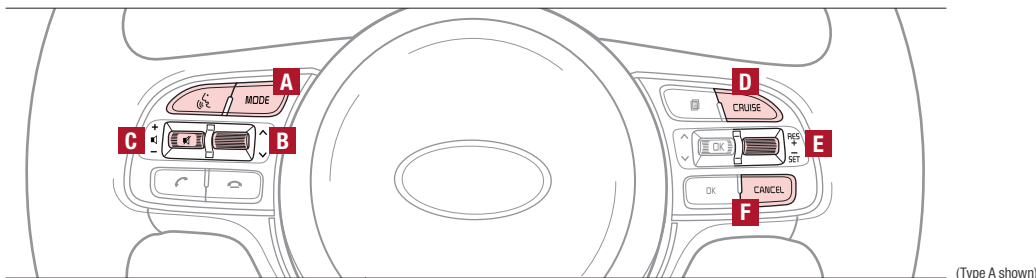

A Audio MODE button: Press to cycle through FM/AM/SiriusXM®/Media modes
Audio System ON/OFF: Press and hold to turn power on; Press to turn power off

B Seek/Presets button:
FM/AM/SiriusXM® Modes: Press up/down to advance through Preset Stations. Press and hold to auto seek
Media Mode: Press up/down to move Track Up/Down. Press & hold up/down to fast forward/rewind (except for *Bluetooth®* Audio)

C Volume button: Press up/down to raise/lower volume
Mute button: Press to mute all audio

QUICK TIP

Pressing the Audio Mode button for more than 1 second will turn Audio Mode ON/OFF.

Driving while distracted is dangerous and should be avoided. Drivers should remain attentive to driving and always exercise caution when using the steering-wheel-mounted controls while driving. To help minimize driver distraction, some audio system functionalities have been modified while the vehicle is in Drive, Reverse or moved out of Park.

For further audio system operations, refer to pages 29-31.

Your vehicle's steering wheel buttons may differ from those in the illustrations. See your Owner's Manual for more details.

D CRUISE Control ON/OFF button: Press to turn the Cruise Control ON/OFF

E Resume Cruising Speed button: Press up to resume or increase Cruising Speed
Set Cruising Speed button: Press down to set or decrease Cruising Speed

F Cruise Control CANCEL button: To cancel Cruise Control setting, do one of the following:

- Press the brake pedal
- Press the CANCEL button

QUICK TIPS

- Cruise Control is designed to function above 20 mph
- The Cruise Control system will not activate until the brake pedal has been depressed at least once after ignition ON or engine start

REMINDER: Standard Cruise Control is a part of the Smart Cruise Control (SCC) and can be set as the operating mode. To switch from SCC to Standard Cruise Control, press and hold the SCC button (page 29) for two seconds (the SCC system must not be activated to change modes). Repeat to switch back to SCC mode.

Smart Cruise Control (SCC)^{+6,20}

The Smart Cruise Control (SCC) system allows you to set the vehicle to maintain a speed so long as it is not limited by traffic. When traffic is encountered, the vehicle may be slowed to help maintain a set distance behind traffic detected ahead without the driver depressing the brake pedal.

To set/adjust the SCC speed:

- Push the CRUISE button **A** to turn system ON. The CRUISE indicator will illuminate on the instrument cluster
- Accelerate/decelerate to the desired speed
- Press button **B** down to set the speed. Press the RES+/SET- button **B** up/down to increase/decrease the set speed

To adjust the vehicle-to-vehicle distance setting **C:** Press the SCC button **D** on the steering wheel. The images on the LCD screen **E** and the Instrument Cluster **F** will change when scrolling through the settings. Each time the button is pressed, the vehicle-to-vehicle distance changes.

To cancel SCC operation: Press the CANCEL button **G** or press the brake pedal. The LCD screen will display a message that the SCC operation is canceled **H**.

To turn SCC system OFF: Press the CRUISE button **A**. The CRUISE indicator on the instrument cluster will turn OFF.

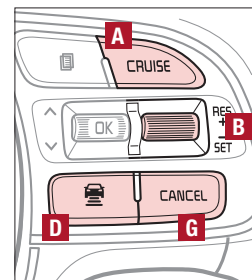

(Type B shown)

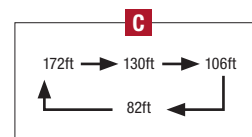

(Distances are approximate and vary depending on vehicle speed)

QR CODE

Smart Cruise Control Video

To view a video on your mobile device, snap this QR Code or visit the listed website.

Refer to page 2 for more information.



www.youtube.com/KiaFeatureVideos

QUICK TIPS

- To change the Cruise Control mode from SCC to standard Cruise Control, press and hold button **D**. Repeat to switch modes again (The SCC system must not be activated to change modes).
- For the SCC System to operate, you must be traveling at a minimum speed of 20 mph, when no vehicle is in front.
- The Smart Cruise Control System (SCC) is deactivated when driving under the speed of 6.0 mph
- When following a vehicle, the system will automatically adjust your cruise speed based on the vehicle detected in front.

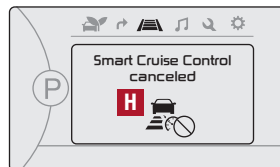
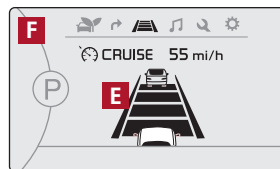

(Actual screen on vehicle may vary)

REMINDERS:

- In standard Cruise Control, the driver needs to manually assess the distance from other vehicles as the system will not apply brakes to slow down automatically in order to turn SCC ON/OFF
- SCC system is activated when ignition is turned on. Speed will need to be reset when ignition is cycled on
- The distance settings are approximations and may vary depending on factory settings at the time. See owner's manual for more information
- The SCC is also canceled when the driver's door is opened, gear shift is changed out of D (Drive) and various other conditions. See owner's manual for other conditions.
- If the SCC system is left on, it can be activated inadvertently. Keep the system off when not in use to avoid setting a speed which the driver is not aware of.

The SCC system is a supplemental system and is not a substitute for safe driving. It is the responsibility of the driver to always check the speed and distance to the vehicle ahead.

Tilt/Telescoping Steering Wheel†21

To adjust the Steering Wheel, push the lock-release lever **A** down and adjust the desired angle **B** and distance **C**.

When finished, pull the lock-release lever **A** up to lock Steering Wheel in place.

QUICK TIP

It may be helpful to pull/push bottom of Steering Wheel towards/away from you to adjust desired distance

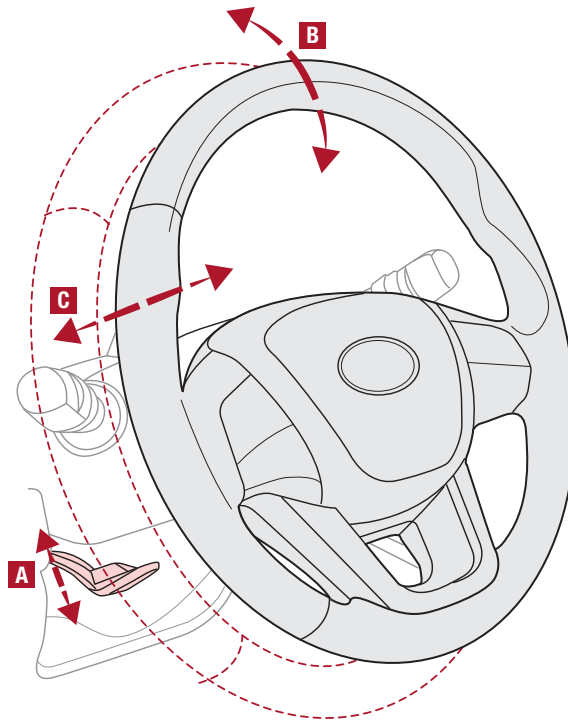

Android Auto™+3 / Apple CarPlay®+4 Setup*

Android Auto™*

Setting up Android Auto™:

1. From an Android Auto™ compatible device, download the Android Auto™ app from the Google Play™+11 Store.
2. Open the Android Auto™ app and proceed with the on-screen instructions to complete setup on the mobile device.

How to start Android Auto™:

1. Press the SETUP key on your audio control unit's control panel.
2. Press the PHONE PROJECTION button , select Android Auto™ then select ENABLE ANDROID AUTO. Accept all terms, conditions and requests on the head unit and phone in order to use Android Auto™.
3. Connect the Android™ device with the vehicle's USB port using the manufacturer's cable provided with your phone.
4. From the vehicle's home screen, select the Android Auto™ button, where you'll see all the Android Auto™ supported apps.

Apple CarPlay®*

Setting up and starting Apple CarPlay®:

1. Connect the Apple CarPlay® compatible iPhone with the vehicle's USB port using the manufacture's cable provided with your iPhone.
2. On the audio control unit's control panel, press the SETUP key.
3. Press the PHONE PROJECTION button  on the screen and select Apple CarPlay®.
4. Select ENABLE APPLE CARPLAY. Accept all terms, conditions and requests on the head unit and phone in order to use Apple CarPlay®
5. From the vehicle's home screen, select the Apple CarPlay® button, where you'll see all the Apple CarPlay® supported apps

REMINDERS:

- Android Auto compatibility requirements: Micro-USB cable that came with your phone, OS Android™ 5.0 or higher, compatible Android smartphone and data and wireless plan for applicable feature(s).
- Apple CarPlay compatibility requirements: Apple Lightning® cable, latest iOS software, iPhone 5 or later and data and wireless plan for applicable feature(s)
- It is recommended to always update your phone to the latest operating system release

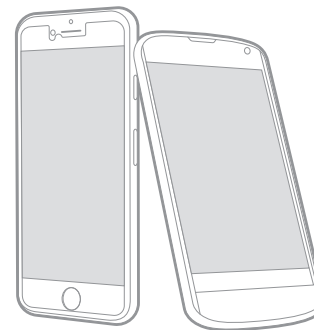

For further UVO eServices / UVO eco operations, refer to the Car Multimedia System User's Manual. For other audio system information, refer to page 32-34.

UVO eServices Activation*†1 (Hybrid Only)

1. Using a compatible smartphone to access your app store or marketplace, download the Kia UVO app.
2. In your smartphone's settings, ensure that location services are enabled. Using the Kia UVO app, register for a new MyUVO.com account.
3. Follow the In Car Setup Instructions on the Kia UVO app to complete the UVO Activation.

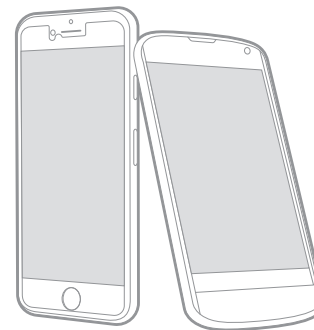

UVO eco Activation*†1 (Plug-In Hybrid Only)

1. Enter the activation screen:
 - a. Press SETUP key
 - b. Press UVO icon
 - c. Press UVO ACTIVATION
2. Agree to Terms of Service and Privacy Policy and press SUBMIT
3. Enter Smartphone Phone Number or Email address to receive a security PIN, then press SUBMIT

Follow these steps if using your phone number to receive your PIN:

1. Check your phone for a SMS (text message)
2. Open the link in your SMS. A page will open to display your PIN
3. Enter the PIN in the head unit and press ACTIVATE
4. On your phone, go back to the page that gave you the PIN, press I have entered my PIN
5. Enter email and password to complete your account setup and press the CREATE ACCOUNT
6. A link will be provided to download the appropriate UVO app from your app store. After installing the UVO app, log in and enjoy.

Follow these steps if using your email to receive your PIN:

1. Check your email. The email will be from reset@notifications.myuvo.com
2. Open link inside email. A page will open to display your PIN
3. Enter the PIN in the head unit and press ACTIVATE
4. Go back to the page that gave you the PIN, press I have entered my PIN
5. Enter you phone # and password to complete your account setup and press the CREATE ACCOUNT
6. A link will be provided to download the appropriate UVO app from your app store. After installing the UVO app, log in and enjoy.

For further system operations, refer to the Car Multimedia System User's Manual. For other audio system information, refer to pages 31-34.

Driving while distracted can result in a loss of vehicle control that may lead to an accident, severe bodily injury, and death. The driver's primary responsibility is in the safe and legal operation of a vehicle, and use of any handheld devices, other equipment, or vehicle systems which take the driver's eyes, attention and focus away from the safe operation of a vehicle or which are not permissible by law should never be used during operation of the vehicle.

UVO eServices*†1 (Hybrid) / UVO eco*†1 (Plug-In Hybrid)

– FM/AM/SiriusXM®†18/Media (USB, iPod®, AUX, Bluetooth® Audio, My Music)

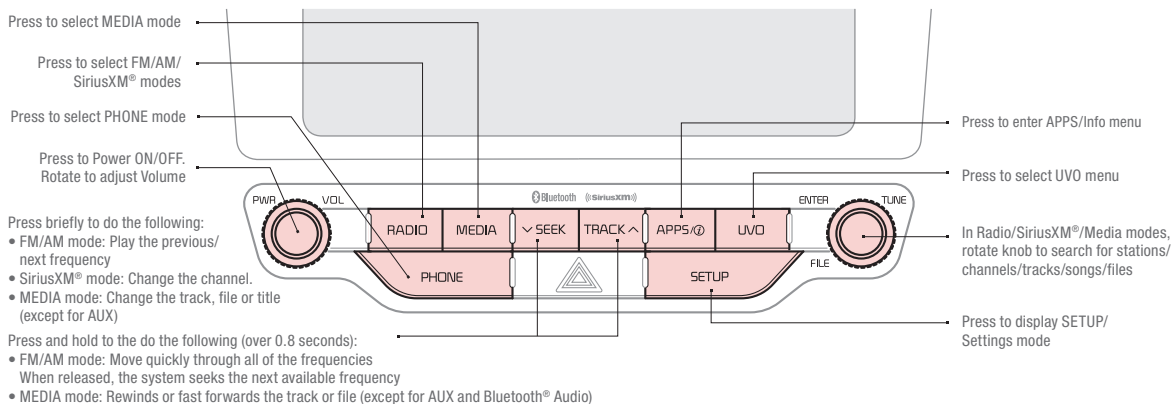

QR CODE

UVO eServices Videos

To view a video on your mobile device, snap this QR Code or visit the listed website. Refer to page 2 for more information.



www.youtube.com/KiaFeatureVideos

Sound Settings

To adjust the audio system sound settings:

1. Press the SETUP key on the audio control unit
2. Select the on-screen SOUND button, or SOUND SETTINGS
3. Select the menu item (Position, Tone, Priority, Advanced, Default)
4. Use the onscreen buttons to adjust settings. Press the return button \Rightarrow to save settings

Radio Presets: You can listen to FM, AM and SiriusXM radio and save frequently used stations

How to Save a Preset: Press and hold the desired slot. This saves the current station in the selected slot

SiriusXM® Smart Favorites: For the first ten favorite SiriusXM channels, you may play live or repeat from the beginning of a song or a program segment. In Radio mode, choose SiriusXM, then select any of the first six favorites. During song or program play, tap the Skip Backward icon to start from the beginning of the song or program. Tap the Play Live icon to return to the live broadcast

QUICK TIPS

- Using Android™ Auto or Apple CarPlay® and a supported smartphone, the phones Navigation App may be displayed on the head unit
- At any time, you can interrupt Command Feedback by pressing the TALK button
- Prolonged use of the audio system in ACC mode may drain the vehicle's battery
- A warning screen may appear periodically to remind users that the audio system should be operated when the engine is running to prevent battery discharge

REMINDER:

To help minimize driver distraction, some audio system functionalities have been modified while the vehicle is in Drive, Reverse or moved out of Park.

Your audio system may differ from those in the illustrations. For further UVO eServices/eco operations, refer to the Car Multimedia System User's Manual. For further audio system operations, refer to pages 31-34.

UVO eServices with Premium Navigation*^{+1,12} (Hybrid) / UVO eco with Navigation*^{+1,12} (Plug-In Hybrid)
 – FM/AM/SiriusXM®/Media (USB, iPod®, AUX, Bluetooth® Audio)

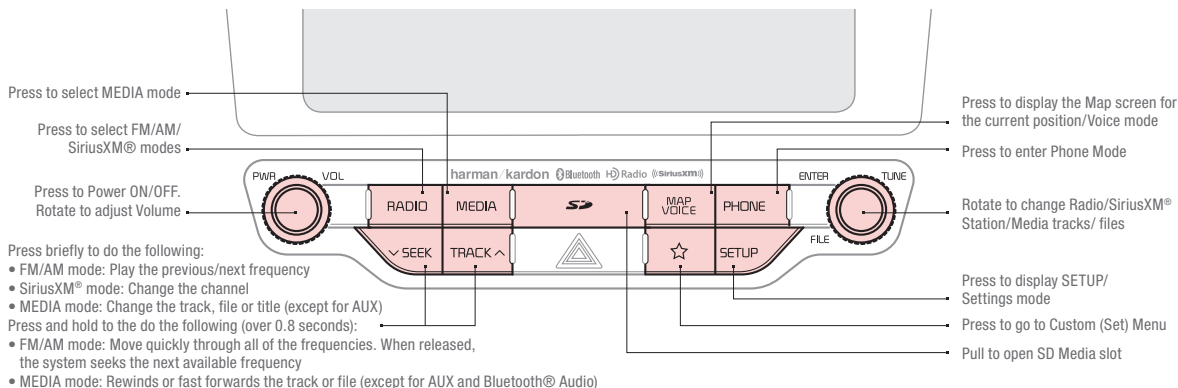

Sound Settings – To adjust the sound settings:

1. Press the SETUP key on the audio control unit. Select the on-screen SOUND button
3. Select the menu item (Position, Tone, Priority, Advanced, Default)
4. Use the onscreen buttons to adjust settings. Press the return button \Rightarrow to save settings

Radio Presets: You can listen to FM, AM and SiriusXM radio and save frequently used stations

How to Save a Preset: Press and hold the desired slot. This saves the current station in the selected slot

SiriusXM® Smart Favorites: For the first ten favorite SiriusXM channels, you may play live or repeat from the beginning of a song or a program segment. In Radio mode, choose SiriusXM, then select any of the first six favorites. During song or program play, tap the Skip Backward icon to start from the beginning of the song or program. Tap the Play Live icon to return to the live broadcast.

Custom button ☆ – A programmable key to provide quick access to one of several available system features. **To Program the Custom Key:** Press the SETUP key, then press the Custom button ☆. Select one of the available features you would like the Custom button to open.

QUICK TIPS

- Using Android™ Auto or Apple CarPlay® and a supported smartphone, the phone's Navigation App may be displayed on the head unit
- At any time, you can interrupt Command Feedback by pressing the TALK button
- Prolonged use of the audio system in ACC mode may drain the vehicle's battery
- A warning screen may appear periodically to remind users that the audio system should be operated when the engine is running to prevent battery discharge

Your audio system may differ from those in the illustrations. For further UVO eServices/eco operations, refer to the Car Multimedia System User's Manual. For further audio system operations, refer to pages 31-33.

QR CODE

UVO eServices with Navigation Videos

To view a video on your mobile device, snap this QR Code or visit the listed website. Refer to page 2 for more information.



www.youtube.com/KiaFeatureVideos

REMINDER: Driving while distracted is dangerous and should be avoided. Drivers should remain attentive to driving and always exercise caution when using the audio system controls while driving. To help minimize driver distraction, some audio system functionalities have been modified while the vehicle is in Drive, Reverse or moved out of Park.

Digital Clock

Press the SETUP key on the head unit. Then press the on-screen Clock icon to enter clock settings. Follow the on-screen options to adjust the clock settings.

QUICK TIPS

- Daylight Savings must be enabled or disabled in the Clock Settings screen
- To access manual date and time setting, turn GPS Time OFF in the Clock Settings (UVO eServices/eco with Navigation*)

USB Charger*

The USB charger is located inside the Center Console.

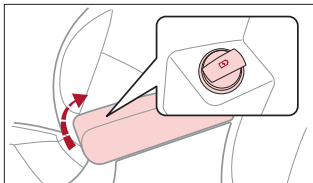

(Rear of Center Console shown)

Aux/USB/iPod® Port & Power Outlets

Aux/USB/iPod® Port **A**

Use the Aux port to connect audio devices and the USB port to connect USB audio devices, smartphones and iPod® devices.

Power Outlets **B**

Use the power outlets for mobile phones and other devices designed to operate on a 12V (180W max) power outlet.

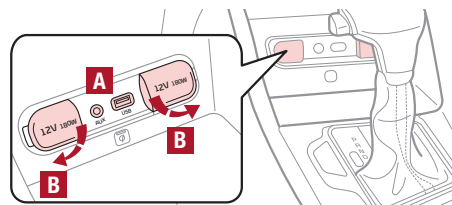

QUICK TIP

The power outlets are inactive when ignition is in the OFF position.

For more information on the Aux/USB/iPod® Port & Power Outlets, refer to the Owner's Manual.

REMINDERS:

- Using the power outlets (accessory plugs) for prolonged periods of time with the Engine Start/Stop button in the ACC position (Engine OFF) may cause the battery to discharge
- Only use cables made by your device manufacturer. Third party cables may damage your device

AC Inverter*

The AC inverter supplies 115V/150W electric power to operate accessories or devices.

To use the AC inverter, open the AC inverter cover and connect a plug to it.

The AC inverter is ON when the vehicle is on.

For more information on AC Inverter usage and safety, see the Owner's Manual.

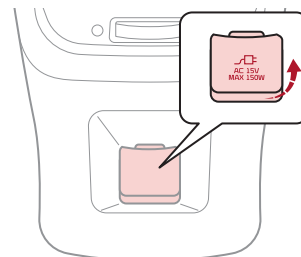

Wireless Smartphone Charging System*

1. Place a compatible smartphone on the center of the charging pad
2. Indicator light **A** will change to amber once the wireless charging begins
3. Once charging is complete, the orange light will change to green

QUICK TIPS

- The smartphone must be a compatible phone with Qi function available
- Wireless charging must be enabled in user settings
- If wireless charging does not work, move smartphone around the pad until the charging indicator turns amber. Avoid placing other metal items in the bin while charging as to not impede the charging area.
- For wireless charging to occur, all doors (excluding rear hatch) must be closed & the Smart Key Fob must be detected inside the vehicle

REMINDERS:

- This vehicle is equipped with wireless charging technology which allows for a device to be charged using inductive charging, however, device compatibility varies. See your owner's manual for more detailed information and the back page for legal disclaimers
- Inductive charging systems are less efficient than conventional charging through cable. As a result, higher device operating temperatures may be experienced during use
- Charging Performance - Device position on the wireless charging system can affect charging performance. Other factor that may affect the charging rate includes foreign objects, such as coins or pens, and phone case thickness

Requires Qi enabled device or Qi enabled case

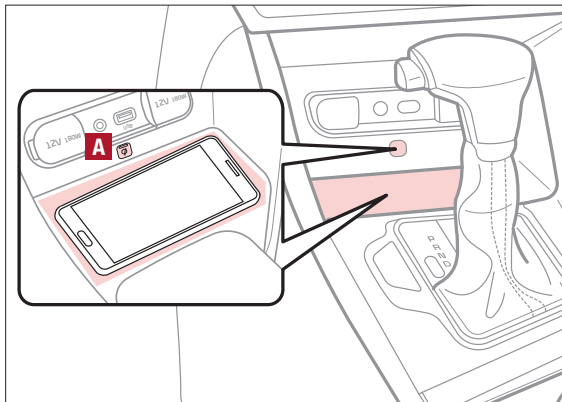

(Located in front of Gear Shift)

QR CODE

Wireless Charging Video

To view a video on your mobile device, snap this QR Code or visit the listed website.

Refer to page 2 for more information.



www.youtube.com/KiaFeatureVideos

Automatic Climate Control

- A** Driver Only Fan Control
- B** Temperature Control knob
- C** Automatic Climate Control button
- D** Front Windshield Defroster
- E** Rear Windshield Defroster
- F** Air Conditioning On/Off button
- G** Recirculated Air button
- H** Mode Selection button
- I** Dual Temperature Control knob
- J** Dual Climate Control Button (SYNC)
- K** CLIMATE information screen selection button
- L** Fan Speed Control buttons
- M** System OFF button

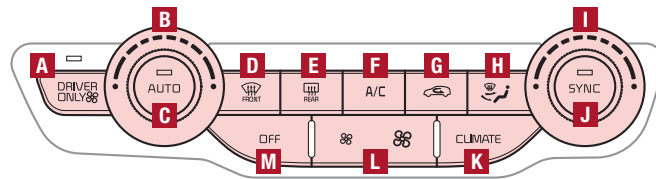

Your Automatic Climate Control system may differ from those in the illustration. See your Owner's Manual for more details.

Climate Control Auto Function

1. Press AUTO to select Full Auto Operation. The Auto setting automatically controls the airflow modes, fan speeds, air intake and air conditioning according to the temperature setting selected
2. Set desired Temperature
3. Press SYNC to synchronize driver and passenger temperature control

QUICK TIPS

- Defrost mode activates A/C and opens Fresh Air Vent to help dehumidify the air and improve Defroster performance
- During Auto Operation, the A/C indicator will NOT illuminate. The fan speed, air intake, air flow and air conditioning may automatically be engaged at any time to reach desired temperature and reduce humidity
- Keep inside glass as clean as possible to reduce window fogging

Driver Only Ventilation:

Driver Only Ventilation restricts air flow to the driver's side vents only. This can help to optimize driving range by limiting the power drawn from the battery. Press DRIVER ONLY button to enable air flow through the driver's side vents only.

REMINDERS:

- MAX A/C Mode automatically engages Recirculated Air
- Pressing any button during AUTO operation will deactivate the AUTO function and switch to manual mode, except for Temperature Control
- When in AUTO mode, Air Flow mode and Fan Speed do not display on the Climate Control Display
- Cold or warm ambient air may flow in through vents if Recirculated Air button is not pressed ON (LED lit)

Air Flow Modes:

To select Air Flow Modes, press the Mode selection buttons:

- Face-Level
- Bi-Level
- Floor-Level
- Floor/Defrost-Level

Defrost Outside Windshield:

1. Set Temperature to Hot
2. Press the **Front Defrost** button

Defog Inside Windshield:

1. Set **Fan Speed** to desired position
2. Set desired **Temperature**
3. Press the **Front Defrost** button

Automatic Gear Shift with Sportmatic® Shifting

- P: Park
- R: Reverse
- N: Neutral
- D: Drive (ECO Mode)
- D: Drive, left gate (Sport Mode)
- [+]: Manual Sport Mode Upshift
- [-]: Manual Sport Mode Downshift

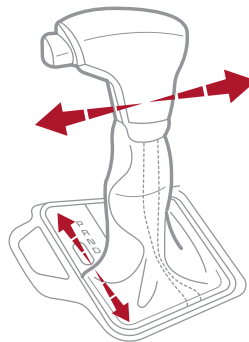
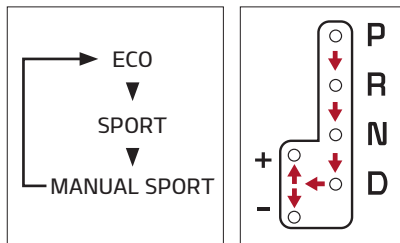

Manual Sport Mode: To enter Manual Sport Mode, move shift lever from D to left gate. When in Manual Sport Mode, if the shift lever is not moved up or down, then the vehicle will automatically shift gears. To shift while in Manual Sport mode, move shift lever up [+] to upshift or down [-] to downshift. See page 10 for more information on the Drive Modes.

Dual Clutch Transmission*

The Dual Clutch Transmission (DCT) gives the driving feel of a manual transmission, yet provides the ease of a fully automatic transmission.

The following are unique driving tips of the Dual Clutch Transmission:

To hold the vehicle stationary on an incline, the service brake or parking brake **MUST** be used or the gear shift **MUST** be in the (P) Park position.

If the vehicle is held stationary by applying the accelerator pedal on a slope, the clutch/transmission may overheat, resulting in damage

Avoid aggressive launches on steep grades as this may result in an overheated clutch and transmission

A slight time lag may be experienced at takeoff from stand still during aggressive acceleration maneuvers

If the clutch is over-heating, an amber-colored warning light  will be displayed in the instrument cluster. **Should this condition occur, pull over and place the vehicle in Park and idle the engine.**

Refer to the Owner's Manual for additional information on DCT operation or call Kia Consumer Affairs for additional information.

QR CODES

Sportmatic® Shifting Video

To view a video on your mobile device, snap this QR Code or visit the listed website.

Refer to page 2 for more information.



www.youtube.com/KiaFeatureVideos

Seat Warmers / Ventilated Seats*†17

Seat Warmers — Press top of button once for high setting (3 LEDs lit), again for middle setting (2 LEDs lit), again for low setting (1 LED lit). Press again to turn OFF.

Ventilated Seats — Press bottom of button once for high setting (3 LEDs lit), again for middle setting (2 LEDs lit), again for low setting (1 LED lit). Press again to turn OFF.

REMINDER: Use extreme caution when using the seat warmers to avoid burns. Refer to the Owner's Manual for more information.

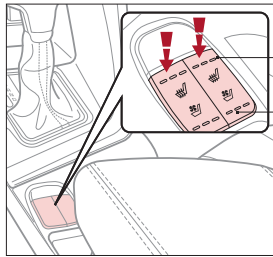

Yellow Color:
Warming

Blue Color:
Ventilating

QUICK TIPS

- With the seat warmer switch in the ON position, the heating system in the seat turns OFF or ON automatically depending on the seat temperature
- System is OFF by default

QR CODES

Seat Warmers/Ventilated Seats Video

To view a video on your mobile device, snap this QR Code or visit the listed website.

Refer to page 2 for more information.



www.youtube.com/KiaFeatureVideos

Driver Position Memory System*

To store a seating position into memory, first place the shifter into P (Park) while the ignition switch is ON. Then:

1. Adjust the driver's seat
2. Press the SET button **A** on the control panel. System will beep once
3. Press one of the memory buttons **B** within 5 seconds. The system will beep twice when memory has been stored
4. "Driver (1 or 2) set is memorized" will appear on the instrument cluster LCD screen

Do not attempt to operate the driver position memory system while the vehicle is moving. This could result in a loss of control of the vehicle.

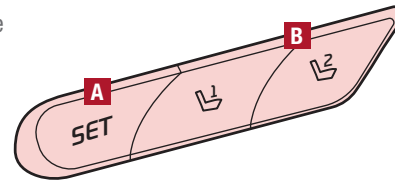

Front Seat Headrest Adjustment†16

To raise headrest: Pull headrest up.

To lower headrest: Press lock **C**, then press the headrest down.

QUICK TIP

For easy adjustments, hold a headrest post with one hand while using the other hand to pull the headrest from underneath.

Do not operate the vehicle with the headrests removed. Headrests can provide critical neck and head support in an accident.

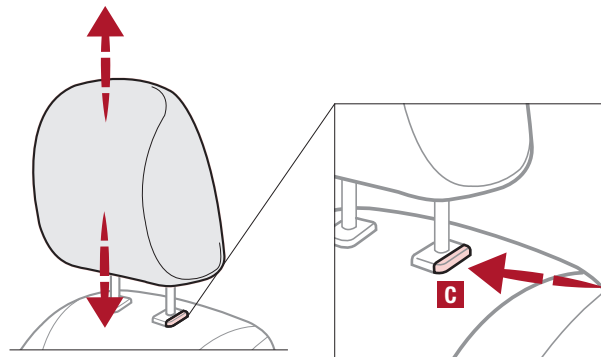

Power Adjustable Driver's Seat^{*†15}

Move/Press controls to adjust Seat forward/backward, Seat Cushion tilt up/down, Seatback forward/backward or Lumbar forward/backward

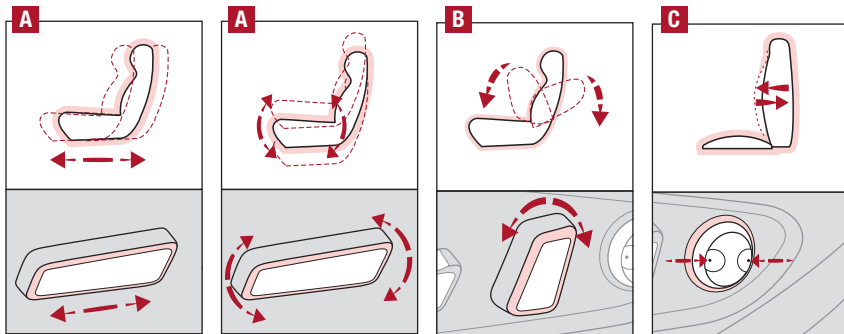
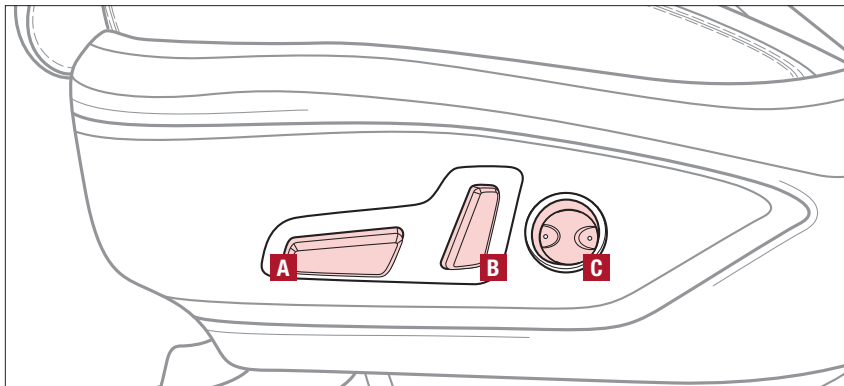

Seat

Seat Cushion

Seatback

Lumbar

REMINDER: Do not attempt to adjust the seat while the vehicle is moving. This could result in loss of control of the vehicle.

6-Way Manual Adjustable Driver's Seat^{*†15}

Pull lever **D** to slide Seat forward/backward.

Pull/press lever **E** up/down one or more times to adjust Seat height.

Pull lever **F** to adjust Seatback recline.

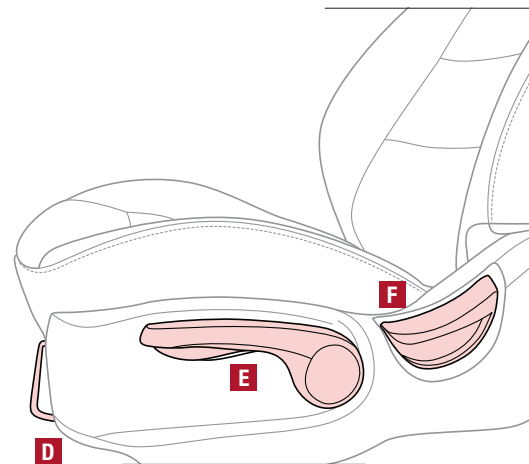

QUICK TIP

When adjusting seat forward or backwards, ensure seat clicks or locks into place before driving vehicle.

Do not attempt to adjust the seat while the vehicle is moving. This could result in loss of control of the vehicle.

Folding Rear Seats

To Fold:

1. Ensure the belt strap is out of way of the Seatback folding **A**. Insert the metal seat belt tab into the holder **B**.
2. Adjust the Front Seatback to the upright position and lower the rear headrest to the lowest position.
3. Pull on the Rear Seatback lock release lever **C**, then fold the seat toward the front.

To Unfold:

1. Pull the lock release lever **C** and lift the Seatback backward until it clicks firmly in place.
2. Return the rear seat belt to the proper position.

QUICK TIPS

- It may be necessary to adjust the front seatbacks to fully lower rear seats.
- Ensure seat is locked by pressing down on Seatback and ensuring red line is NOT visible on bottom of Folder Lever.

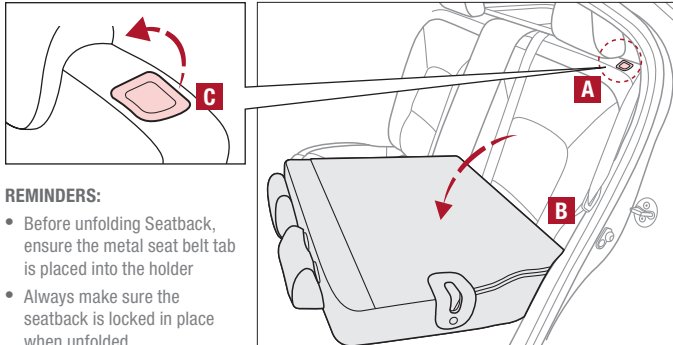

REMINDERS:

- Before unfolding Seatback, ensure the metal seat belt tab is placed into the holder.
- Always make sure the seatback is locked in place when unfolded.

For illustration purposes only. Actual vehicle might be slightly different.

Remote Keyless Entry (Folding Key)*

- D** Press the release button to unfold the key.
- E** Press to lock All doors; Press twice within two seconds to sound the horn.
- F** Press to unlock Driver's Door: Press twice in 4 seconds to unlock All Doors and Rear Hatch.
- G** Press and hold for more than 1 second to unlock Liftgate. Then lift by the handle to manually open Liftgate.
- H** Press and hold more than a half second for Panic Alarm. To turn off Alarm, press any button.

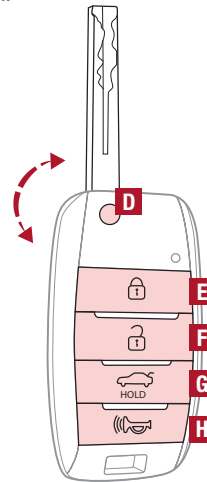

Remote button configuration may vary depending on vehicle options. To turn OFF Alarm, press any button.

QR CODES

Kia Key Fob Video

To view a video on your mobile device, snap this QR Code or visit the listed website.

Refer to page 2 for more information.



www.youtube.com/KiaFeatureVideos

Smart Key*†8

Smart Key Fob:

- A** Press to lock All Doors; Press twice within 2 seconds to sound the horn
- B** Press to unlock Driver's Door. Press twice in 4 seconds to unlock All Doors
- C** Press and hold for more than 1 second to unlock Liftgate. Then lift the lid to manually open Liftgate.

REMINDER:

The Liftgate unlocks when the Smart Key fob is within close proximity of the vehicle.

- D** Press and hold more than 1 second for Panic Alarm. To turn off Alarm, press any button
- E** Press to release Mechanical Key (on reverse side of fob)

Driver's Door Lock/Unlock button **F**:

- Press button once to unlock Driver's Door
- Press again within 4 seconds to unlock All Doors
- Press again to lock All Doors

Mechanical Key **G**:

- Use to unlock Driver's Door
- Use to enable/disable Child Safety Locks

QUICK TIPS

- If the Smart Key battery is weak or not working properly, hold the Smart Key fob up to the Engine Start/Stop button (Lock button side closest) and press to start engine
- The Smart Key's signal can be blocked by the normal operation of a cell phone or smartphone. To help prevent this, store each device separately

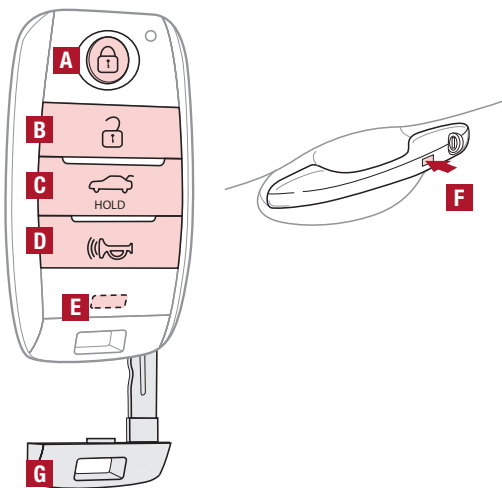

Double-Turn Lock/Unlock All

- Turn clockwise once to unlock Driver's Door
- Turn clockwise again within 4 seconds to unlock All Doors
- Turn counterclockwise once to lock All Doors

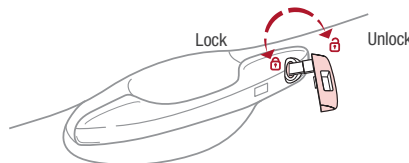

REMINDER: Remote button configuration may vary depending on vehicle options.

QR CODE

To view videos on your mobile device, snap these QR Codes or visit the listed website. Refer to page 2 for more information.

Engine Start/Stop Button & Smart Key Video



Kia Key Fob Video



www.youtube.com/KiaFeatureVideos

Map/Room Lamps

Automatic turn off function*

The interior lights automatically turn off approximately 30 seconds after the Engine Start/Stop button is OFF.

Map Lamp/Room Lamp Operation

Push the lens **A** to turn the map lamp ON/OFF. This light produces a spot beam for convenient use as a map lamp or as a personal lamp for the driver or the front passenger.

Map/Room Lamp Button – Press button **B**, to turn the front and rear room lamps on and off.

Door Mode Button – Press button

C, to enable or disable Door Mode. In Door Mode the map and room lamps turn on when any door is opened. When all doors are locked or the ignition is on, the map and room lamp will turn off immediately.

Rear Room Lamps – Press the button **D** to turn the rear passenger lamp ON/OFF.

QUICK TIPS

- When doors are unlocked by the Smart Key*, the lamp turns ON for approximately 30 seconds
- If your vehicle is equipped with the theft alarm system, the interior lights automatically turn off approximately 3 seconds after the system is in armed stage
- Using interior lights for an extended period of time may cause battery discharge

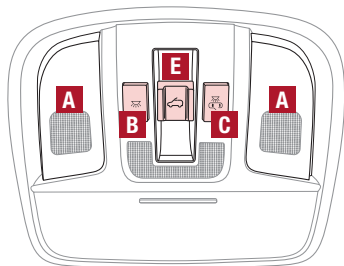

(Type B)

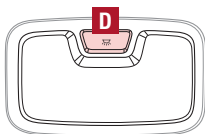

(Type A)

Sunroof Operation*

The Sunroof and Sunshade operation is controlled through a multi-directional switch/lever, and the ignition needs to be in the ON position to operate the Sunroof/Sunshade.

Slide the Sunshade and Sunroof:

- Auto Open: Slide lever **E** backward to the farthest position and release.
- Auto Close (Sunroof only): Slide the lever **E** forward to the farthest position and release.

Slide the Sunroof (with Sunshade open):

- Open: Press the Sunroof lever **E** backward and press again forward/backward until you reach the desired detent position (manual slide feature).
- Close: Press the Sunroof lever **E** forward and press again forward/backward until you reach the desired detent position (manual slide feature)

Tilt the Sunroof:

- **Raise:** Push lever **E** upward.
- **Lower:** Push lever **E** forward.

QUICK TIP

To stop the Sunroof at any position, push or pull the Sunroof control lever in any direction.

REMINDER: Sunshade needs to remain OPEN while Sunroof is open and vehicle is moving.

Do not adjust the sunroof or sunshade while driving. This could result in loss of control of the vehicle.

QR CODES

Sunroof Video

To view a video on your mobile device, snap this QR Code or visit the listed website. Refer to page 2 for more information.



www.youtube.com/KiaFeatureVideos

Hood Release Lever and Latch

Opening the Hood:

1. Pull the Hood Release Lever **A** to unlatch the Hood
2. In the front of the vehicle, lift the Hood slightly, pull the secondary Latch **B** inside of the Hood's center and lift the Hood

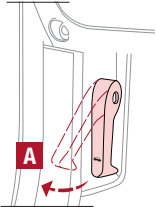

(Located on Driver side kick panel)

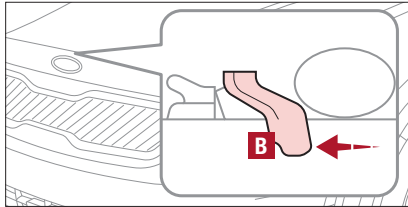

(Latch located inside hood)

Closing the Hood: Lower the Hood about halfway and then press down to securely lock in place.

Fuel Filler Lid

1. Stop the engine
2. Press the Fuel Filler Lid button **C** to open the Fuel Filler Lid. The LCD may display this message: *Wait until fuel door opens.* Once the Fuel Filler Lid is open, the LCD may display this message: *Fuel door open.*
3. Pull open the Fuel Filler Lid
4. Remove cap by turning counterclockwise



(Buttons located on Driver's Panel to the left of the Steering Wheel)

QUICK TIP

There may be a delay in Fuel Filler Lid opening for about 20 seconds due to depressurization

Fuel Cap / Malfunction Indicator (Check Engine Light)

Tighten for ONE CLICK to prevent Malfunction Indicator  from illuminating.

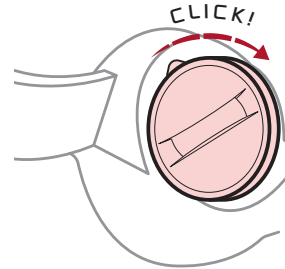

REMINDER: The Fuel Filler Door Release button is located on the left side of the Steering Wheel on the lower button panel

QR CODES

One-Click Fuel Cap Video

To view a video on your mobile device, snap this QR Code or visit the listed website.

Refer to page 2 for more information.



www.youtube.com/KiaFeatureVideos

Sunvisor†20

Use the Sunvisor to shield direct light through the front or side windows. Slide the Sunvisor out and adjust as needed.

REMINDS:

- Sunvisor may not shield all direct light
- Do not operate the vehicle if Sunvisor is impairing your visibility
- Be aware of your seating position when adjusting or swinging Sunvisor around from the front or side windows

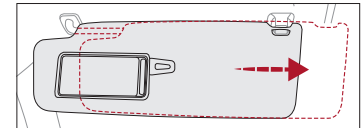

Parking Distance Warning-Forward*†6

The Parking Distance Warning-Forward* is a supplemental system that is designed to assist the driver by chiming if any object is detected within the sensing area to the front, rear and side of the vehicle when moving forward or backing up.

The system is activated when the ignition is ON/READY and the vehicle is in R (Reverse). To deactivate the system, press the Parking Distance Warning-Forward* button **A** (LED illuminated), when vehicle is in D (Drive) or R (Reverse).

To activate, press button **A** again (LED not illuminated).

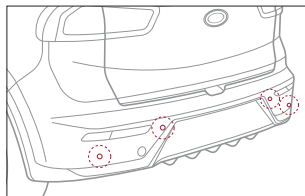
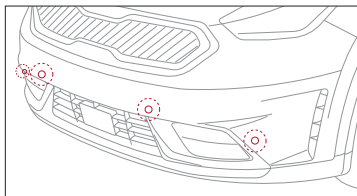
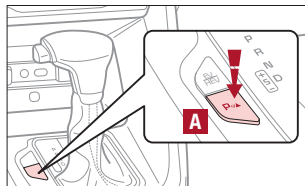

REMINDERS:

- If the vehicle is moving at speeds over 3 mph, the system may not activate correctly
- When more than two objects are sensed at the same time, the closest one will be recognized first
- The above images are for illustration purposes only and may not reflect actual operation

The Parking Distance Warning-Forward is not a substitute for proper and safe parking and backing-up procedures. Always drive safely and use caution when backing up. The Parking Distance Warning-Forward* may not detect every object in front of or behind the vehicle.*

Rear-Camera Display*†6

The Rear-Camera Display is a supplemental system that displays the view behind the vehicle through the rearview display mirror or the audio system screens while the vehicle is in Reverse.

The Rear-Camera Display activates when the:

- Engine Start/Stop button is in the ON/READY position
- Gear Shift Lever is in the R (Reverse) position

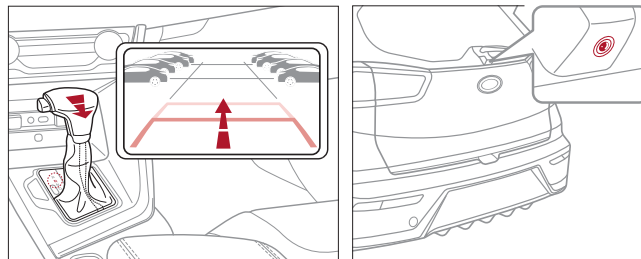

REMINDERS:

- The above images are for illustration purposes only and may not reflect actual operation
- UVO eco / UVO eServices — While camera is active, only the audio controls on the Audio System can be operated.
- UVO eServices with Premium Navigation / UVO eco with Navigation* — While camera is active, only the Audio System can be operated on the Steering Wheel and Audio Control Unit. All other features are disabled.

The Rear-Camera Display is not a substitute for proper and safe backing-up procedures. The Rear-Camera Display may not display every object behind the vehicle. Always drive safely and use caution when backing up

Driver Attention Warning (DAW)*†6

The DAW system is designed to alert the driver if it detects a drowsy or fatigued driver and, in certain situations, can give a warning signal to take a break.

The DAW is set to OFF by default. To turn the DAW ON, turn the ignition on and then select User Settings in the LCD Display on the Instrument Cluster. Then go to Driving Assist and select Driver Attention Warning. Set the DAW to Normal or High Sensitivity.

Driver Attention Warning (DAW) modes:

Off: The DAW is deactivated **A**

Normal: The DAW alerts the driver of his/her fatigue level or inattentive driving practices.

High Sensitivity: The DAW alerts the driver of his/her fatigue level or inattentive driving practices faster than Normal mode.

If the DAW is activated, the DAW information will appear on the LCD Display **B** when you select the ASSIST mode .

A message, “Consider taking a break,” appears on the LCD display and a warning sounds to suggest the driver to take a break when the driver’s attention level is below one bar **C**.

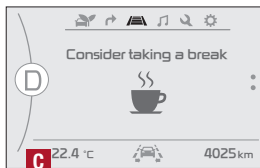
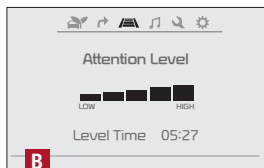
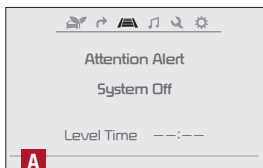

REMINDERS:

- The set-up of the DAW will be maintained, as selected, when the ignition is cycled
- When activated, the DAW does not display “Consider taking a break” message when the total trip driving time is less than 10 minutes
- The DAW will enter a standby mode if the camera does not detect the lanes and/or the driving speed remains under 40 mph

Driver Attention Warning is not a substitute for safe driving and may not detect all instances of driver fatigue or inattentive driving practices. Failure to pay attention to travel conditions and vehicle operation could result in loss of vehicle control. Always drive safely and use caution.

High Voltage Battery Air Intake

The Hybrid Battery Air Intake, located on the side underneath the left rear seat, is used to cool down the hybrid battery. For safety reasons, this vent should never be blocked. Doing so may cause the battery to overheat.

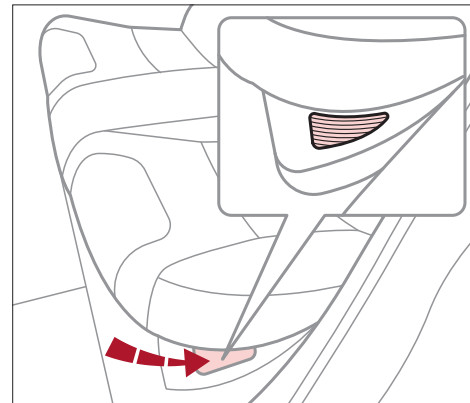

QUICK TIP

Clean the air intake for the hybrid battery regularly with a dry cloth

PRECAUTION: Never clean the battery vent with a WET cloth or spill liquid over the air intake. This could cause an electric shock, which could cause serious damage, injury or death.

Liftgate Release Button*

Button is located on the bottom of the Liftgate lid. With doors unlocked, press the Liftgate Release button **A** and pull the Liftgate up by the handle to open.

QUICK TIPS

- The Liftgate must be unlocked before it can be opened by the Liftgate Release Button
- The Liftgate unlocks automatically and then can be opened manually when the Smart Key* is within close proximity to the vehicle

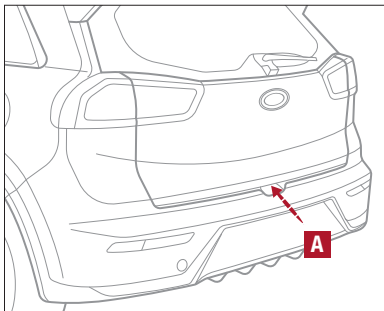

Child-Protector Rear Door Lock

Locate these locks on the rear edge of the rear passenger doors. Turn the safety lock to the LOCK position to disable the inner door handles from opening the rear doors.

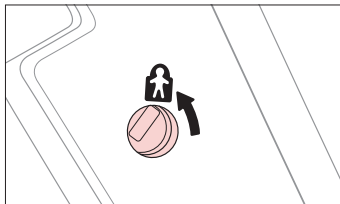

REMINDER: Child-Protector Rear Door Lock is located on rear passenger's door jamb.

Tire Mobility Kit

The Tire Mobility Kit may temporarily seal certain types of tire damage.

For operational information, please refer to the Owner's Manual.

B Sealant Bottle

C Compressor

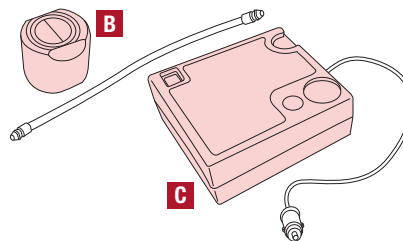

QUICK TIPS

- The Tire Mobility Kit is a temporary fix and is to be used for one tire only; the tire should be inspected as soon as possible
- The kit should only be used for sealing/inflating passenger car tires; do not use for inflating any other type of tires
- Some damaged tires cannot be sealed completely; do not use the kit if it appears a tire is damaged beyond repair

REMINDEES:

- The above images are for illustration purposes only and may not reflect actual operation
- After tire is properly sealed, drive cautiously at a maximum speed of 50 mph for a maximum distance of up to 120 miles.

QR CODE

Tire Mobility Kit Video

To view a video on your mobile device, snap this QR Code or visit the listed website.

Refer to page 2 for more information.



www.youtube.com/KiaFeatureVideos

Occupant Detection System (ODS)^{†12} / Passenger Airbag Off Indicator^{†2,16}

ODS is designed to detect the presence and position of the front passenger and adjusts or turns off airbag deployment accordingly.

Depending on the situation and type of accident, the system may:

- Deploy airbag (Adult)
- Not deploy the airbag (Unoccupied)

If the system determines that the airbag should not be deployed, the “PASSENGER AIR BAG OFF” light will illuminate.



REMINDER: Do not allow an adult passenger to ride in the front seat when the Passenger Airbag Indicator is illuminated OFF because the airbag will not deploy in the event of a crash. The driver must instruct the passenger to reposition her/himself in the seat.

Seat Belts^{†16}

To properly fasten your safety belts:

1. Insert the belt tongue plate **A** into the buckle **B** until it clicks
2. Position the lap portion of the belt across your lap as LOW ON THE HIPS as possible **C**. Adjust the belt to a SNUG FIT by pulling up on the shoulder portion **D**.

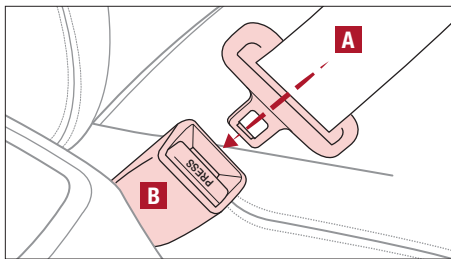

QUICK TIP

The Seat Belt warning chime operates for driver's seat only.

REMINDER: For maximum protection, always wear your Seat Belt.

Seat Belt Retractor Locks

Retractor locks allow lap/shoulder seat belts to remain unlocked during normal vehicle operation for freedom of movement and increased comfort.

During a STRONG STOP, SUDDEN TURN OR CERTAIN COLLISIONS, seat belt retractors will automatically lock the belts to reduce the risk of injury.

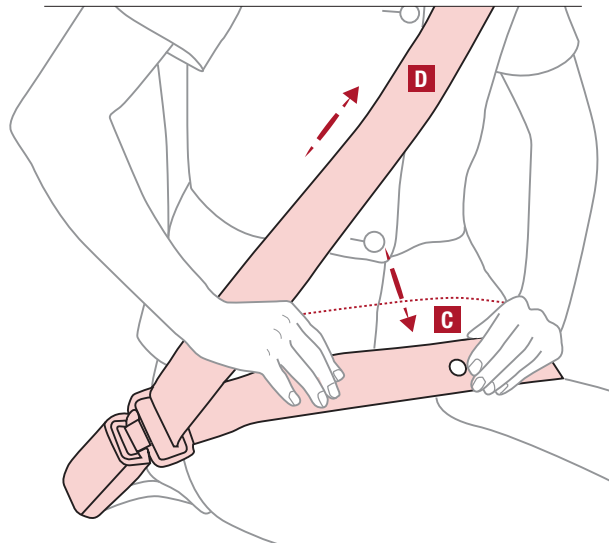

LEGAL DISCLAIMERS

Driving while distracted can result in a loss of vehicle control that may lead to an accident, severe personal injury and death. The driver's primary responsibility is in the safe and legal operation of a vehicle, and use of any handheld devices, other equipment or vehicle systems which take the driver's eyes, attention and focus away from the safe operation of a vehicle or that are not permissible by law should never be used during operation of the vehicle.

Safety Features: No system, no matter how advanced, can compensate for all driver error and/or driving conditions. Always drive responsibly.

- 1A. UVO eServices (Hybrid model):** Purchase/lease of a new 2019 Kia Niro Hybrid vehicle with UVO eServices includes a complimentary 5-year subscription starting from new vehicle retail sale/lease date as recorded by the dealer. After your complimentary 5-year UVO eServices, the subscription expires and your access to UVO eServices will immediately terminate. Use of UVO eServices is subject to agreement to the UVO Privacy Policy (available at <https://www.myuvo.com/legal/privacy-policy.shtml>) and Terms of Service (available at <https://www.myuvo.com/legal/terms-of-service.shtml>). UVO eServices is transferable to subsequent owner during the original UVO eServices service term. Only use UVO eServices when safe to do so. UVO eServices App is available from the App Store® or Google Play™ Store. Kia Motors America, Inc. reserves the right to change or discontinue UVO eServices at any time without prior notification or incurring any future obligation. Message and data rates may apply. Cellular and GPS coverage is required to use most features. UVO eServices features may vary by model, model year, and trim level. Features and specifications are subject to change. For more on details and limitations, visit <https://www.myuvo.com/> or your authorized Kia dealer. Google and logos are trademarks of Google, Inc. App Store is a service mark of Apple, Inc.
 - 1B. UVO eco (Plug-In Hybrid model):** Purchase/lease of a new 2019 Kia Niro Plug-In Hybrid vehicle with UVO eco includes a complimentary 3-year subscription starting from new vehicle retail sale/lease date as recorded by the dealer. After your complimentary 3-year UVO eco, the subscription expires and your access to UVO eco will immediately terminate. Use of UVO eco is subject to agreement to the UVO Privacy Policy (available at <https://www.myuvo.com/legal/privacy-policy.shtml>) and Terms of Service (available at <https://www.myuvo.com/legal/terms-of-service.shtml>). UVO eco is transferable to subsequent owner during the original UVO eco service term. Only use UVO eco when safe to do so. UVO eco App is available from the App Store® or Google Play™ Store. Kia Motors America, Inc. reserves the right to change or discontinue UVO eco at any time without prior notification or incurring any future obligation. Message and data rates may apply. Cellular and GPS coverage is required to use most features. UVO eco features may vary by model, model year, and trim level. Features and specifications are subject to change. For more on details and limitations, visit <https://www.myuvo.com/> or your authorized Kia dealer. Google and logos are trademarks of Google, Inc. App Store is a service mark of Apple, Inc.
-
- 2. Airbags:** For maximum protection, always wear your seat belt.
 - 3. Android Auto™:** Android Auto is a trademark of Google, Inc. Android™ is a registered trademark of Google, Inc. Distracted driving can result in a loss of vehicle control. Never use a handheld device or vehicle system that takes your focus away from safe vehicle operation.
 - 4. Apple CarPlay®:** Apple CarPlay® a registered trademark of Apple Inc. Distracted driving can result in a loss of vehicle control. Never use a handheld device or vehicle system that takes your focus away from safe vehicle operation.
 - 5. Bluetooth® Wireless Technology:** The Bluetooth® word mark and logos are registered trademarks owned by Bluetooth SIG Inc., and any use of such marks by Kia is pursuant to license. A Bluetooth® enabled cell phone is required to use Bluetooth® wireless technology.
 - 6. Driver Assist Features – Forward Collision-Avoidance Assist (FCA) / Forward Collision Warning (FCW), Blind-Spot Collision Warning with Lane Change Assist, Blind-Spot Collision-Avoidance Assist-Rear (BCA-R), Rear Cross-Traffic Collision Warning (RCW), Lane Keeping Assist (LKA), Rear-Camera Display, Parking Distance Warning, Smart Cruise Control (SCC), Driver Attention Warning (DAW):** These features are not substitutes for safe driving, and may not detect all objects surrounding vehicle. Always drive safely and use caution.
 - 7. Electronic Stability Control (ESC) / Traction Control System (TCS)/Hill-start Assist Control (HAC):** No system, no matter how advanced, can compensate for all driver error and/or driving conditions. Always drive safely.
 - 8. Engine Start/Stop Button with Smart Key:** Always come to a complete stop before turning the engine on or off. However, if you have an emergency while the vehicle is in motion and must turn the engine off, you can turn the engine off to the ACC position by pressing the Start/Stop button for more than 3 seconds or 3 times in succession. If the vehicle is still moving, you can restart the engine by pressing the Start/Stop button with the shift lever in Neutral (N). With the engine off, hydraulic power assist for steering and braking will be disabled and the vehicle will be more difficult to control.
 - 9. Front Seat Headrest Adjustment:** Never attempt to adjust headrests when vehicle is in motion.
 - 10. Google Play™ Store** is a trademark of Google, Inc. ©2018 Google Inc. All rights reserved. Google and the Google Logo are registered trademarks of Google Inc.
 - 11. iPhone®/iPod®:** iPhone and iPod are registered trademarks of Apple Inc. Distracted driving can result in a loss of vehicle control. Never use a handheld device or vehicle system that takes your focus away from safe vehicle operation.
 - 12. Navigation:** Distracted driving can result in a loss of vehicle control. When operating a vehicle, never use a vehicle system that takes your focus away from safe vehicle operation. Navigation is for information purposes only, and Kia does not make any warranties about the accuracy of the information.
 - 13. Occupant Detection System (ODS):** Kia vehicles use a number of different ODS types that vary by model.
 - 14. Roadside Assist:** 24-hour Enhanced Roadside Assistance is a service plan provided by Kia Motors America, Inc. Certain limitations apply. Coverage details are available in the Kia Warranty and Consumer Information Manual. For access to Enhanced Roadside Assistance, a connected mobile phone via Bluetooth® within the cellular service coverage area is required.
 - 15. Seat adjustments:** Reclining the passenger seats can reduce the effectiveness of the safety restraint system and may lead to additional injury in an accident.
 - 16. Seat belts:** For maximum protection, always wear your seatbelt.
 - 17. Seat warmers:** Use extreme caution when using the seat warmers to avoid burns. Refer to the Owner's Manual for more information.
 - 18. SiriusXM®:** SiriusXM Satellite Radio, SiriusXM Traffic and SiriusXM Travel Link each require a subscription sold separately, or as a package, by SiriusXM Radio Inc. **If you decide to continue your service at the end of your trial subscription, the plan you choose will automatically renew and bill at then-current rates until you call 1-866-635-2349 to cancel. See SiriusXM Customer Agreement for complete terms at www.siriusxm.com.** Other fees and taxes will apply. All fees and programming are subject to change. Not all vehicles or devices are capable of receiving all services offered by SiriusXM. Data displays and individual product availability vary by vehicle hardware. Current information and features may not be available in all locations, or on all receivers. Weather Forecast, Current Conditions may not be available in all locations. Images above are for representative purposes only and are not real products. For actual features and images of real products, consult the vehicle manufacturer. SiriusXM is not responsible for any errors or inaccuracies in the data services or their use in the vehicle. Travel Link Stocks displays current price and daily delta of around 7,000 actively reported securities traded on the NYSE®, NASDAQ® and AMEX®. The service is delayed approximately 20 minutes. SiriusXM satellite service is available only to those at least 18 years of age in the 48 contiguous USA, DC, and Puerto Rico (with coverage limitations). SiriusXM Internet Radio service is available throughout our satellite service area in AK and HI. © 2018 SiriusXM Radio Inc. Sirius, XM and all related marks and logos are trademarks of SiriusXM Radio Inc.
 - 19. Steering-wheel-mounted controls:** Driving while distracted is dangerous and should be avoided. Remain attentive to driving and be cautious when using steering-wheel-mounted controls while driving.
 - 20. Sunvisors:** Sunvisor may not shield all direct light. Do not operate the vehicle if sunvisor is impairing your visibility.
 - 21. Tilt/Telescoping Steering Wheel:** Never attempt to adjust steering wheel position when vehicle is in motion.
 - 22. Tire Pressure Monitoring System (TPMS):** Even with Tire Pressure Monitoring System, check tire pressure on a regular basis.



KEY FEATURE WALKTHROUGH

- UVO eco / Android Auto™ / Apple CarPlay® Setup* – page 31
- UVO eServices Activation* – page 32

Walk customer through the registration/activation process for UVO eco.



- UVO eServices / UVO eco* – page 33

For further operational information, refer to the Car Multimedia System User's Manual.

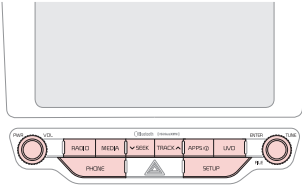

- UVO eServices with Premium Navigation / UVO eco with Navigation* – page 34

For further operational information, refer to the Car Multimedia System User's Manual.

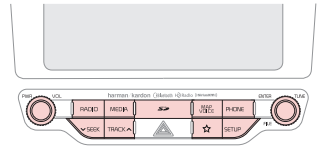

- Aux/USB/iPod® Port & Power Outlets – page 35

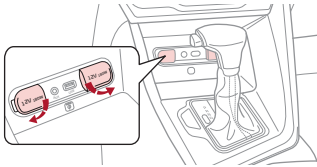

- Cruise Control – page 28

Demonstrate operation

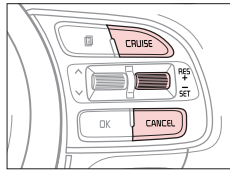

- Bluetooth® Wireless Technology – page 26

Demonstrate operation, and pair customer's phone.

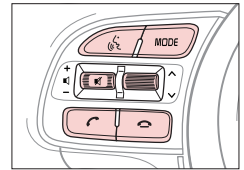

- Tire Pressure Monitoring System (TPMS) – page 5
- Trip Modes / Trip Computer – page 7
- Fuel Economy – page 8
- Sport/ECO Modes – page 10
- Engine Start/Stop Button – page 22
- Audio Controls – page 28
- Digital Clock – page 35
- Seat Warmers/Ventilated Seats* – page 39

- Smart Key – page 41
- Sunvisor – page 44
- Parking Distance Warning-Forward* – page 45
- Rear-Camera Display* – page 45
- Tire Mobility Kit – page 47
- Passenger Airbag Off Indicator – page 48

*IF EQUIPPED

DURING DELIVERY

- Explain first service process and schedule first service appointment
- Tour Parts & Service departments, introduce staff & explain value of Kia Parts and Service
- Review recommended maintenance schedule and maintenance requirements to validate warranty
- Review business hours & Customer 360° Care
- Review the Kia 10-year/100,000-mile warranty program
- Ensure 100% satisfaction with sales and delivery process and no problems with the vehicle
- Confirm time and best contact number for initial dealer follow-up

Sales Consultant: _____ Date: _____

Sales Manager: _____ Date: _____

Customer: _____ Date: _____



NIRO PLUG-IN HYBRID CUSTOMER DELIVERY CHECKLIST

Owner's Name: _____ VIN: _____ Mileage: _____

Dealership Name: _____ Sales Consultant: _____ Date: _____

BEFORE DELIVERY

- Confirm "Good Battery" with a Kia battery tester
- Verify all tire pressures are to spec (see driver's door label) LF _____ LR _____ RF _____ RR _____
- Verify proper operation of Remote Keyless Entry and Smart Key lock/unlock
- Ensure floor mats are snapped into place (if applicable)
- Verify vehicle is clean (interior and exterior), in good condition and free of chips and scratches
- Ensure all key documents are in the vehicle (Owner's Manual, Warranty and Consumer Information booklet, Tire Warranty booklet and Features & Functions Guide and any supplemental audio user's guides)

KEY FEATURE WALKTHROUGH

- Instrument Cluster / Hybrid / Plug-In Hybrid Displays – page 3

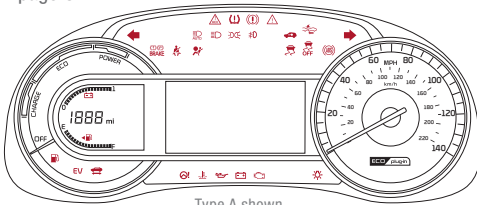

Type A shown

- Hybrid/Plug-In Hybrid Displays on the audio control unit – page 12

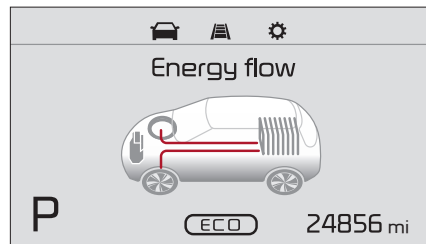

- Climate Control System* – page 36
Demo Defrost and Defog Windshield

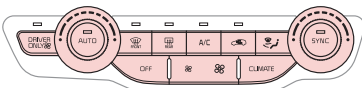

Type B shown

- Windshield/Rear Wipers & Washers – page 25
Windshield: Move lever Up/Down to change Wiper modes. Rotate lever to adjust Intermittent Wipe Speed.

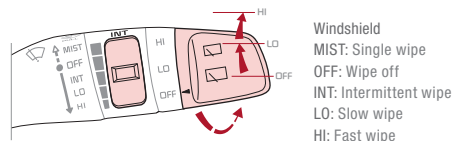

Pull to spray and wipe.

Windshield
 MIST: Single wipe
 OFF: Wipe off
 INT: Intermittent wipe
 LD: Slow wipe
 HI: Fast wipe



NIRO HYBRID / PLUG-IN HYBRID NORMAL MAINTENANCE SCHEDULE

P=Perform • R=Replace • I=Inspect^B

(up to 60,000 miles)^A

MAINTENANCE INTERVALS (MILES)

MAINTENANCE ITEMS	7,500	15,000	22,500	30,000	37,500	45,000	52,500	60,000
Add fuel additive ^C	P	P	P	P	P	P	P	P
Rotate tires	P	P	P	P	P	P	P	P
Engine oil and filter	R	R	R	R	R	R	R	R
Climate control air filter		R		R		R		R
Vacuum hose		I	I	I	I	I	I	I
Steering gear box, linkage & boots/lower arm ball joint, upper arm ball joint		I		I		I		I
Drive shafts and boots		I		I		I		I
Suspension mounting bolts		I		I		I		I
Air conditioner refrigerant		I		I		I		I
Exhaust pipe and muffler		I		I		I		I
Air cleaner filter	I	I	I	R	I	I	I	R
Engine clutch actuator fluid			R			R		
HSG belt ^D	I							
Brake fluid				I				I
Brake lines, hoses and line				I		I		I
Front brake discs/pads, calipers		I		I		I		I
Fuel tank air filter ^E				I				I
Parking brake				I				I
Engine clutch actuator hose and lines				I		I		I
Vapor hose and fuel filler cap				I				I
Rear brake discs/pads		I		I		I		I
Fuel cap, fuel lines, fuel hoses and connections				I				I
Dual clutch transmission fluid					I			I

QUICK TIP

Check your Maintenance Schedule or schedule an appointment with a dealer using your UVO eServices / UVO eco account by logging into your UVO eServices / UVO eco App or your account on MyUVO.com (See page 31 for setup information)

‡ If equipped.

A. See the Owner's Manual for complete maintenance schedule.

B. And, if necessary, adjust, correct, clean or replace.

C. If TOP TIER detergent gasoline is not available, one bottle of additive is recommended. Additives are available from your authorized Kia dealer along with information on how to use them. Do not mix other additives.

D. Inspect HSG belt for evidence of cuts, cracks, excessive wear or oil saturation and replace if necessary. If HSG belt noise occurred, readjust HSG belt tension before replace

E. Both the fuel filter & fuel tank air filter are generally considered to be maintenance free, depending on fuel quality being used. However, periodic inspection is recommended. If your vehicle is having issues like fuel flow restriction, power surging, loss of power, difficulty starting, etc., replace the fuel filter immediately and consult an authorized Kia dealer for service.

See your Owner's Manual for more details and complete maintenance information, including severe maintenance schedule. Warranty may be voided if maintenance schedule is not followed.