

NIRO EV

Features & Functions Guide



GETTING TO KNOW YOUR **NIRO EV**

Congratulations on Your New Kia Purchase!

Your new Kia vehicle has been designed, engineered and manufactured to provide you with years of comfortable and dependable driving. Kia is committed to quality, innovation, safety and — above all — your satisfaction.

Using This Guide

The information contained in this guide is a brief overview that will help you become familiar with the operation and features of your new Kia vehicle. The flipbook format facilitates information access, while the detailed illustrations help to ensure the instructions are easy to follow.

This **Features & Functions Guide**, and the specific operational and safety information it provides, is not a substitute for your Owner's Manual. In the interest of your safety and that of the vehicle's occupants, and to help you avoid risks that may result in death or serious injury, Kia reminds you to carefully read your Owner's Manual in order to fully familiarize yourself with the important information and safety warnings it contains.

While Kia endeavors to ensure that the information contained in this guide is accurate at the time of printing, Kia may change vehicle specifications without notice in advance or after the fact, and assumes no liability in connection with such changes.



Available on the App Store, the Kia AR Owner's Manual App uses AR (Augmented Reality) technology to provide tips and useful information about your vehicle.

To use the Kia AR Owner's Manual App:

- Simply scan the interior or engine (motor) room of your vehicle with your smartphone or tablet, select feature/component and view the video guide.
- If you are unable to scan the vehicle, use the AR Manual (without scan) menu, select feature/component and view the video guide.

www.kia.com

Consumer - Roadside Assistance^{†16}
1-800-333-4KIA (4542)

See Back Pages for Vehicle
Maintenance Schedule

*Always check the Owner's Manual for complete
operating information and safety warnings.*

†LEGAL DISCLAIMERS ON BACK INSIDE COVER

ESSENTIAL FEATURES

Air Conditioning / Climate Control	37
Android Auto™ / Apple CarPlay® Setup	31
Audio System – UVO link* Activation	32
Audio System – UVO link*	33
Audio System – UVO link with Navigation*	34
Bluetooth® Wireless Technology	26
Charging Your Electric Vehicle	15
Cruise Control	28
Digital Clock	35
Electric Vehicle (EV) Indicators	05
EV Mode Displays	13
Energy Consumption	06
Passenger Airbag Off Indicator	48
Sport/ECO/ECO+ Driving Modes	11
Tire Mobility Kit	47
Tire Pressure Monitoring System (TPMS)	06
USB/iPod® Port, Power Outlets & USB Charger	35
Windshield Wipers & Washers	25

Driving while distracted can result in a loss of vehicle control that may lead to an accident, severe personal injury and death. The driver's primary responsibility is in the safe and legal operation of a vehicle, and use of any handheld devices, other equipment or vehicle systems which take the driver's eyes, attention and focus away from the safe operation of a vehicle or that are not permissible by law should never be used during operation of the vehicle.

*IF EQUIPPED



VIDEOS & QR CODES	02
--	----

INSTRUMENT CLUSTER

Instrument Cluster Overview	03
Indicators & Warning Lights	04
Electric Vehicle (EV) Indicators	05
Energy Consumption	06
Tire Pressure Monitoring System (TPMS)	06
LCD Instrument Cluster Modes	07
Trip Modes / Trip Computer	07
Charge Warning Messages on LCD Display	08
User Settings	10
Service Interval Mode	10

ELECTRIC VEHICLE (EV) FEATURES

Drive Modes	11
Regenerative Braking with Paddle Shifters	12
EV Mode - UVO link with Navigation	13
Charging Your Electric Vehicle	15
Charging Connector Auto/Lock Mode	17
Scheduled Charging*	17

DRIVER'S PANEL

Blind-Spot Collision Warning (BCW) w/ LCA*	18
Rear Cross-Traffic Collision Warning (RCCW)*	18
Lane Keeping Assist (LKA)*	19
Forward Collision-Avoidance Assist (FCA) / Forward Collision Warning (FCW)*	20
Instrument Cluster Control	21
Electronic Stability Control (ESC)	21
Hill-Start Assist Control (HAC)	21
Reverse Parking Aid Function*	22
Power Button	22
Power Windows, Window Lock & Central Door Lock	23
Automatic Door Lock	23
Power/Heated Outside Mirrors*	23
Power Folding Outside Mirrors*	23

STEERING WHEEL CONTROLS

Headlights & High Beams	24
Turn Signals & Fog Lights*	24
Windshield/Rear Wipers & Washers	25
Bluetooth® Wireless Technology	26
Audio Controls	28
Standard Cruise Control	28
Smart Cruise Control (SCC) with Stop & Go*	29
Tilt/Telescoping Steering Wheel	30

AUDIO SYSTEM

Android Auto™ / Apple CarPlay® Setup	31
UVO link* Activation	32
UVO link*	33
UVO link with Premium Navigation*	34

CENTER PANEL

Digital Clock	35
USB Chargers*	35
USB/iPod® Port & Power Outlets*	35
Wireless Smartphone Charging System*	36
Automatic Climate Control	37
Rotary Dial Shifter Knob	38
Heated Steering Wheel Button*	38
Electronic Parking Brake*	39
Seat Warmers / Ventilated Seats*	40

SEATING

Driver Position Memory System*	40
Front Seat Headrest Adjustment	40
Power Adjustable Driver's Seat*	41
6-Way Manual Adjustable Driver's Seat*	41
Folding Rear Seats	42

OTHER KEY FEATURES

Hood Release Lever and Latch	42
Sunvisor	42
Smart Key*	43
Double-Turn Lock/Unlock All	43
Map/Room Lamps	44
Sunroof Operation	44
Parking Distance Warning-Forward and Reverse*	45
Rear-Camera Display*	45
Driver Attention Warning (DAW)*	46
Liftgate Release Button	47
Child-Protector Rear Door Lock	47
Tire Mobility Kit	47

SAFETY FEATURES

Occupant Detection System (ODS) / Passenger Airbag Off Indicator	48
Seat Belts	48
Seat Belt Retractor Locks	48

NORMAL MAINTENANCE SCHEDULE Back Cover

LEGAL DISCLAIMERS Inside Back Cover

Kia provides a number of video resources to assist you with becoming familiar with the features and functions found in your Kia vehicle. You can access these resources by snapping the QR Codes with your smartphone/tablet (mobile devices) or by visiting the following website: www.youtube.com/KiaFeatureVideos. Continue reading for a more in-depth look at QR Codes and for instructions on how to use them.

What are QR Codes?

A QR Code is a square, two-dimensional barcode that can be read by mobile devices loaded with an appropriate barcode or QR Code Reader App. The app reads the barcode image and then launches/uploads the specific information the code contains, such as URLs, text, photos, videos and so much more.

How to Use QR Codes

If you have a mobile device with a QR Code Reader App, you can snap the code with your phone and you'll be provided a video with additional information pertaining to the topic. For example, in the Fuel Cap section, if you would like additional information, just snap the code with your mobile device to view the selected Kia Features & Functions Video.

How to Snap a QR Code

1. With your mobile device, download a QR Code Reader App. With many devices, you can do this through an app store or marketplace
2. Open the QR Code Reader App on your mobile device
3. The app will utilize your device's camera. Center the code in the camera viewing area:
 - With some apps, as soon as the app recognizes the code, it will launch the corresponding video
 - With other apps, you will have to snap or take a picture of the code. The app will then launch the corresponding video
 - For operation specifics, refer to the instructions that come with the QR Code Reader App

QR CODE

Tire Pressure Monitoring System Video

To view a video on your mobile device, snap this QR Code or visit the listed website.



www.youtube.com/KiaFeatureVideos

REMINDER: When accessing videos on your mobile device, standard cellular data rates may apply.

QUICK TIPS

1. If you're having trouble scanning codes, check the following:
 - The code should be centered and focused in your mobile device's camera screen
 - Consider moving your device closer to or farther away from the code
 - The code should be well lit, without significant shadow
 - Avoid scanning from a significant angle
 - Confirm that the device's app supports 2D QR Code scanning
 - Try another QR Code Reader App; not all apps are created equal
2. After scanning, if a "connecting" message appears and then nothing happens or there's a "connection error" message, this typically indicates that your device is having trouble connecting to the Internet

Instrument Cluster Overview

- A** Power/Charge gauge
- B** Battery State of Charge (SOC) gauge
- C** Speedometer
- D** Warning and indicator lights
- E** LCD display
- F** Instant / Regenerative Mileage
- G** Distance to empty

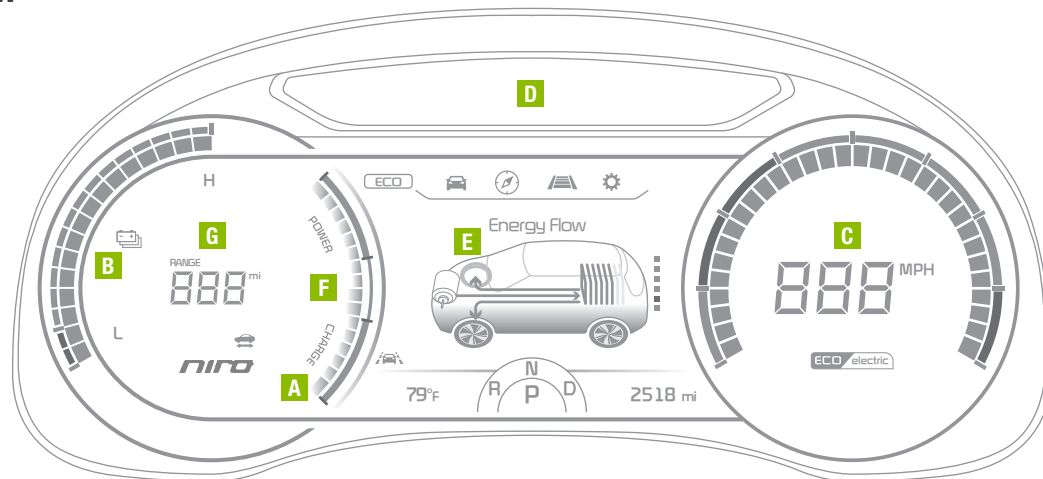

Your vehicle's instrument cluster & indicator light locations may differ from those in the illustrations. For more information on the instrument cluster, the LCD Warning Messages and the function of all indicator and warning lights, please refer to the Owner's Manual.





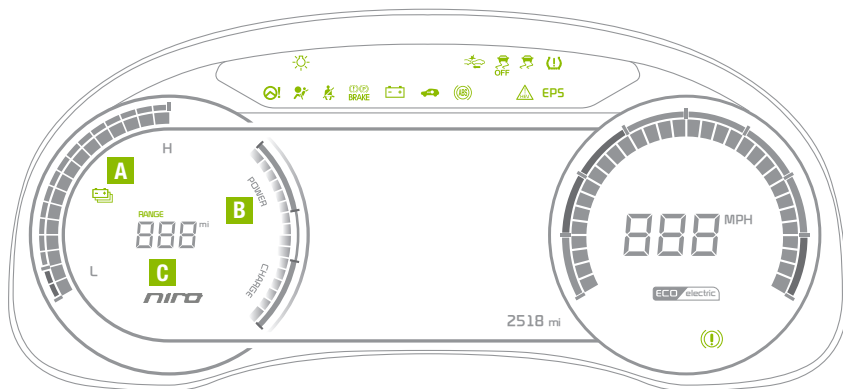





















This illustration is for demonstration purposes only. Some indicators and warning lights may not appear in illustration. On the vehicle, they may appear in the LCD.

Indicators & Warning Lights



Your vehicle's instrument cluster & indicator light locations may differ from those in the illustrations. For more information on the instrument cluster, the LCD Warning Messages and the function of all indicator and warning lights, please refer to the Owner's Manual.

This illustration is for demonstration purposes only. Some indicators and warning lights may not appear in illustration. On the vehicle, they may appear in the LCD.

-  High Beam Indicator
-  Light ON Indicator
-  Front Fog Light Indicator*
-  Master Warning Light
-  FCA / FCW Indicator*
-  Lane Keeping Assist (LKA) Indicator*
-  Electronic Brake Force (EBD) System Warning Indicator (Two separate indicators on Instrument Cluster lit at same time)
-  Immobilizer Indicator*
-  READY Indicator
-  ECO Mode Indicator
-  ECO+ Mode Indicator
-  SPORT Mode Indicator
-  EV Service Warning Light
-  EV Temperature Warning
-  Charging System Warning Indicator
-  Seat Belt Warning Indicator
-  Low Tire Pressure Light / Tire Pressure Monitoring System (TPMS) Malfunction Indicator*
-  Electronic Stability Control (ESC) Indicator / ESC Malfunction Indicator
-  Electronic Stability Control (ESC) OFF Indicator
-  Electronic Parking Brake (EPB) & Brake Fluid Warning Indicator
-  Electronic Power Steering (EPS) Warning Indicator
-  Airbag Warning Indicator
-  Anti-lock Braking System (ABS) Warning Indicator
-  CRUISE Cruise Indicator*
-  BRAKE Regenerative Brake Warning Indicator (Two separate indicators on Instrument Cluster lit at same time)
-  LED Headlamp Warning Indicator*
-  Charging Light Indicator
-  Power Down Warning Light
-  High Voltage Battery Level Warning Light
-  12V Battery
-  EPB Electric Parking Brake (EPB)

Electric Vehicle (EV) Indicators

A State of Charge (SOC) gauge

The State of Charge gauge displays the high-voltage battery charge status.

- L (low) position on the gauge indicates that the driving battery energy is low
- H (high) position on the gauge indicates that the driving battery is fully charged

B Power/Charge

Niro EV's Power/Charge gauge provides information on the energy consumption rate of the vehicle and the charge status of the regenerative brakes.

- **POWER** – Shows the energy consumption rate of the vehicle when driving uphill or accelerating. The more electric energy used, the higher the gauge level
- **CHARGE** – Shows the charging status of the battery when it is being charged by the regenerative brakes. The more electric energy charged, the lower the gauge level

C Distance to Empty

Distance to empty is the estimated distance the vehicle can be driven with the remaining high-voltage battery level. It is displayed differently according to the selected drive mode.



Ready indicator light – Illuminates when the vehicle is ready to drive. When the ready indicator light is OFF or blinking, a malfunction has occurred. Have an authorized Kia dealer address the concern as soon as possible.



EV Service warning light – Illuminates when there is a malfunction related to the electric vehicle control system. Have an authorized Kia dealer address the concern as soon as possible.



Power down warning light – Illuminates when the power is limited for the safety of the electric vehicle.



Charging indicator light – Shows the charging status of the high-voltage battery. When charging, the red indicator turns on. When charging is complete, the green indicator turns on.



High-voltage battery level warning light – Illuminates when the high-voltage battery charge level is insufficient.



Regenerative brake warning lights (when both indicators are lit) – Illuminates when the regenerative brake system is not functioning correctly.



Energy Consumption

There are several factors that contribute to your electric vehicle's energy consumption, including maintenance of your vehicle, driving style, environmental conditions, vehicle weight and vehicle aerodynamics.

Below are tips on how to help reduce energy consumption:

- Keep your vehicle in good condition with regular maintenance
- Don't "ride" the brake pedal
- Drive at a moderate speed, accelerating smoothly and at a moderate rate
- Keep tires inflated to the recommended pressure
- Travel lightly, without carrying unnecessary weight in your vehicles
- Ensure wheels are aligned correctly
- Avoid placing large or heavy items on roof racks
- Avoid hilly, winding or poorly maintained roads
- Use ECO or ECO+ Drive Modes in certain weather conditions (rain, snow, wind)

Tire Pressure Monitoring System (TPMS)^{t24}

 The TPMS indicator  functions as both Low Tire Pressure Light and TPMS Malfunction Indicator. The indicator  will illuminate if it detects one or more tires is significantly underinflated, the vehicle has a spare tire installed without TPMS or the outside temperature becomes significantly lower.

The LCD screen in the instrument cluster will display the Low Tire Pressure indicator **A** showing which tire(s) is underinflated. Inflate tire(s) to specifications using an accurate digital tire pressure gauge to turn off Low Tire Pressure Light . See front driver's door jamb for PSI specification.

When there is a problem with the TPMS, the TPMS Malfunction Indicator  will blink for approximately one minute then illuminate - see dealer for service.

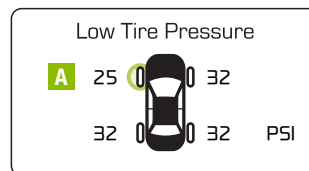

QUICK TIP

- Even with TPMS, tire pressure should be checked manually at least once a month. Only adjust tire pressure on "cold tires," i.e., tires that are not hot in temperature from direct sunlight or heat
- For proper maintenance and optimal fuel economy, maintain recommended tire inflation pressures and stay within the load limits and weight distribution recommended for your vehicle
- In winter or cold weather, the TPMS light may illuminate if the tire pressure was adjusted to the recommended tire inflation pressure during warm weather

REMINDERS:

- Check the recommended tire pressure label located on the left side of driver's door jamb, visible when the door is open
- Consult your dealer for service if Low Tire Pressure Light remains illuminated after inflating your tire(s)

QR CODE

Tire Pressure Monitoring System Video

To view a video on your mobile device, snap this QR Code or visit the listed website.

Refer to page 2 for more information.



www.youtube.com/KiaFeatureVideos

Personal electronic devices (such as laptops, wireless chargers, remote start systems, etc.) that have electronic noise may interfere with TPMS system, which may cause the Malfunction Warning Indicator (Check Engine Light) to illuminate.

LCD Instrument Cluster Modes

Press Mode button **A** to scroll through different LCD Instrument Cluster Modes.

 **Trip Computer Mode:** Displays driving information for consumption info, accumulated info, drive info, driving style and energy flow

 **Turn-by-Turn Mode*:** Displays the state of the navigation

 **LKA/Driver Attention Warning (DAW)/SCC* Mode:** Displays the state of the Lane Departure Warning (LDW), Driver Attention Warning (DAW) and TPMS

 **Master Warning Mode:** Informs and only appears when vehicle systems such as Forward Collision Assist (FCA), Blind-Spot Collision Warning (BCW), Smart Cruise Control (SCC), High Beam Assist (HBA) or others have malfunctioned

 **User Settings Mode:** Change settings for driver assistance, doors, lights, sound, convenience, service interval, other, reset

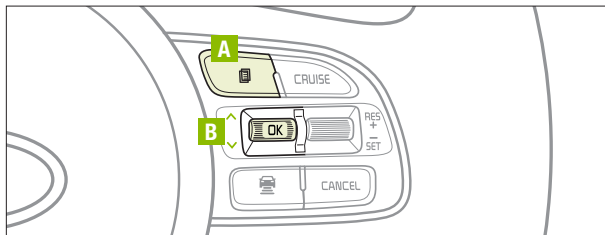

(Buttons located on Steering Wheel – Type A shown)

Your vehicle's steering wheel buttons may differ from those in the illustrations.

Driving while distracted is dangerous and should be avoided. Drivers should remain attentive to driving and always exercise caution when using the steering-wheel-mounted controls while driving.

Trip Modes / Trip Computer

The Trip Computer is a driver information system that displays information related to driving, such as Average and Instant accumulated info, drive info, driving style and energy flow. It appears on the display when the Engine Start/Stop button is in the ON position.

To cycle through the Trip modes, press the Mode button **A**.

When in the Trip Computer mode , press the Select/Reset (OK) button **B** to cycle through the screens. When displaying ACCUMULATED INFO or DRIVE INFO screens, press and hold the OK button **B** to reset to zero.

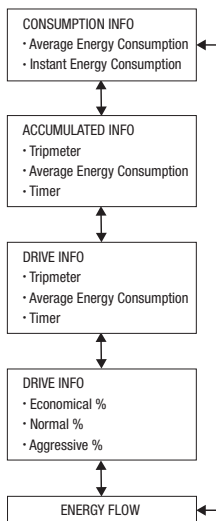

REMINDERS:

- Appearance of Trip Computer display may differ as equipped
- All stored driving information (except Odometer and Range) is reset if the battery is disconnected

Charge Warning Messages on LCD Display

Low EV Battery



Low Battery Warning <8% – When the high-voltage battery level reaches 8% or less, this warning message appears on the LCD and the warning indicator light on the instrument cluster illuminates. Charge the high-voltage battery immediately.

Charge immediately.
Power limited



Charge immediately. Power limited – When the high-voltage battery level reaches 3% or less, this warning message appears on the LCD, the warning indicator light on the instrument cluster illuminates and the power down warning light turns ON simultaneously.

The vehicle's power will be reduced to minimize the energy consumption of the high-voltage battery. Charge the high-voltage battery immediately.

Power limited



Power limited – This warning message appears when the vehicle's power is limited due to the following reasons:

- When the high-voltage battery is below a certain level, or voltage is decreasing
- When the temperature of the motor or high-voltage battery is too high or too low
- When there is a problem with the cooling system or a failure that may interrupt normal driving

Power limited
due to low EV battery
temperature.
Charge battery

Power limited due to low EV battery temperature. Charge battery – When the outside temperature is low and you turn the vehicle on or off, this warning message may appear on the LCD. If the battery level is low and the vehicle is parked outside for a long time, vehicle power may be limited. Charging battery before driving helps increase power.

EV Battery Overheated!
Stop Vehicle



EV Battery Overheated! Stop vehicle – When the high-voltage battery temperature is too high, this warning message will appear on the LCD. Stop the vehicle and turn off the Power button so that the battery temperature decreases.

Stop vehicle and
check power supply



Stop vehicle and check power supply – When there is a failure in the power supply system, this warning message appears on the LCD. Park the vehicle in a safe location and have it towed to the nearest Kia dealer for inspection.

REMINDERS:

- When these warning messages are displayed, do not accelerate or start the vehicle suddenly
- All stored driving information (except Odometer and Range) is reset if the battery is disconnected

These illustrations are for demonstration purposes only. Some messages may appear differently. See your Owner's Manual for more information.

Charge Warning Messages on LCD Display (Continued)

Unplug vehicle to start



Unplug vehicle to start – When starting the vehicle while the charging connector is still connected, this warning message will appear. Remove the charging connector and then start the vehicle.

Charging Door Open



Charging Door Open – When starting the vehicle while the charging door is still open, this warning message will appear. Close the charging door after charging is complete and then start the vehicle.

Charging Stopped.
Check the AC charger

Charging Stopped.
Check the DC charger

Charging Stopped. Check the AC/DC charger – When there is a problem with the external AC or DC charger, when the AC charger stopped charging or when the charging cable is damaged, this message will appear. Check whether there is a problem with the charger or cable. If no problem is found, see an authorized Kia dealer for further assistance.

Charging Stopped.
Check the cable connector

Charging Stopped. Check the cable connector – When the charging connector is not correctly connected to the charging inlet or the charging connector lock release button is pressed, this message will appear. If this occurs, separate the charging connector and re-connect it. Check whether there is any problem (external damage, foreign substances, etc.) with the charging connector and charging inlet. If the problem continues, see an authorized Kia dealer for assistance.

These illustrations are for demonstration purposes only. Some messages may appear differently. See your Owner's Manual for more information.

User Settings

To enter the User Settings mode in the LCD Instrument Cluster Modes, press the Mode button **A** when the vehicle is at a standstill and the Engine Start/Stop button is on and select User Settings .

You can navigate the selections on the display by pressing the OK button **B** up/down, and then selecting the item by pressing the OK button **B** again.

Driving Assistance*:

- Lane Safety
- Driver Attention Warning (DAW)*
- Leading Vehicle Distance
- Smart Cruise Control (SCC) Reaction
- Forward Collision-Avoidance Assist (FCA)*
- Forward Collision Warning (FCW)*
- Blind-Spot Collision Warning (BCW)
- Rear Cross-Traffic Collision Warning (RCCW)*

Door:

- Automatically Lock
- Automatically Unlock
- Two Press Unlock

Lights:

- Ambient Light Brightness
- Ambient Light Color
- Headlamp Delay

Sound:

- Parking Distance Warning-Forward* Volume

Convenience:

- Seat Easy Access*
- Utility Mode
- Welcome Mirror/Light System*
- Wireless Charging
- Wiper/Lights Display*
- Auto Rear Wiper
- Smart Regeneration
- Icy Road Warning

Service Interval:

- Enable Service Interval
- Adjust Interval
- Reset

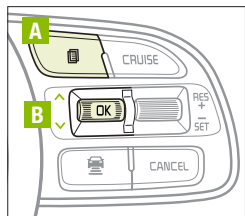

(Buttons located on Steering Wheel – Type B)

Other features:

- Aux. Battery Saver+
- Energy Consumption Reset
- Temperature Unit
- Tire Pressure Unit
- Instrument Cluster Layout

Reset

- Choosing reset will restore defaults for all User Settings menus

Service Interval Mode

To enter Service Interval mode, press the Mode button **A**, User Settings , then scroll to Service Interval Mode  and press the OK button **B**.

The system will display number of miles remaining until next service is due, as well as type of service.

When service is required, the following will be displayed:

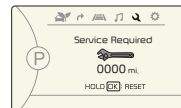

Service Required

To reset the Service Interval mode system, press and hold the OK button **B** for more than 1 second.



To turn Service In OFF, go to User Settings.

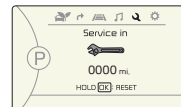

Service Interval Setting

To set the service interval when in User Settings mode:

- Press the OK button **B** up/down and scroll to Service Interval. Press the OK button **B** to enter
- Press the OK button **B** up/down and toggle to ON, then press the OK button **B** again. Then press the OK button **B** to scroll and select the desired miles or months for your next service
- Press the OK button **B** again

QR CODES

To view a video on your mobile device, snap these QR Codes or visit the listed website.

Refer to page 2 for more information.

LCD Display Video



LCD Display: Maintenance Video



www.youtube.com/KiaFeatureVideos

Drive Modes

Niro EV is equipped with four distinct and customizable driving modes. Press the Drive Mode button **A** to select the desired mode.

- **ECO+** – This super power-saving mode is designed to help maximize battery energy. Press and hold the Drive Mode button **A** to select the ECO+ mode
- **ECO** – This mode can help enhance efficiency by managing battery usage
- **NORMAL** – This mode balances drivability and efficiency
- **SPORT** – This mode provides enhanced acceleration and dynamic drivability

An indicator in the instrument cluster will illuminate to show which drive mode you have selected (no indicator will appear for the NORMAL mode).

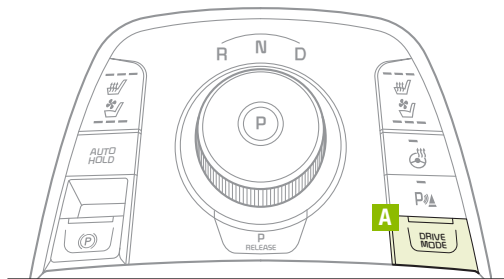

(Button located at right below Rotary Dial Shifter Knob)

Smart ECO pedal guide – When ECO mode is selected, the instrument cluster will show 3 efficiency zones to keep you informed of your power usage with accelerator pedal input.

- B** Variable ECO zone
- C** Variable power zone
- D** Regeneration/charge zone

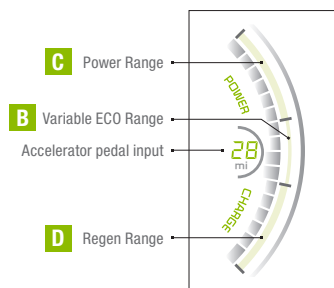

QUICK TIP

To help reduce energy consumption:

- Drive at a moderate speed, accelerating smoothly and at a moderate rate
- Keep tires inflated to the recommended pressure and wheels aligned properly

For more information on Driving Modes, refer to your Owner's Manual or contact your local dealership.

Regenerative Braking with Paddle Shifters

The regenerative braking system charges the battery when coasting or when you use the brakes to stop the vehicle. Use the paddle shifters to adjust the regenerative braking level from 0 to 3 during decelerating or braking. The level will be displayed on the instrument cluster **C**.

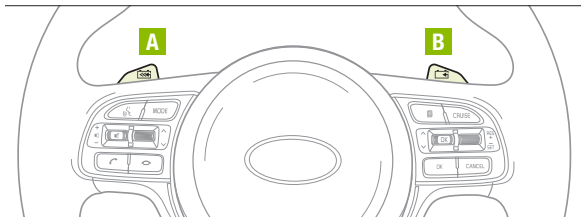

- Pull the left paddle shifter **A** to increase regenerative braking and deceleration
- Pull the right paddle shifter **B** to decrease regenerative braking and deceleration



The paddle shifters do not operate when:

- Both paddle shifters are pulled at the same time
- The vehicle is decelerating by depressing the brake pedal
- Cruise Control or Smart Cruise Control (SCC) is active

Brake and Hold System

The Brake and Hold System (one-pedal driving) increases the regenerative braking amount to above level 3 and enables you to come to a full stop by pulling down the left paddle.

- Pull and hold the left paddle shifter **A** while coasting
- When the vehicle speed is above 1.9 mph, release the left paddle shifter **A** for less than 0.5 seconds to return to the previously set level of regenerative braking
- When the vehicle speed is below 1.9 mph, the brake and hold system stops the vehicle even though the left paddle shifter is released
- While one-pedal driving is active, the driver can control the vehicle stopping position using the accelerator pedal

REMINDER: The driver's seat belt must be fastened to operate one-pedal driving.

Do not solely rely on one-pedal driving to stop the vehicle, as it may not be able to stop the vehicle depending on vehicle and road conditions. Pay attention to the road condition ahead and apply the brake if necessary.

Smart Regeneration System

This system automatically adjusts the regenerative braking level based on a vehicle being detected in front of the Niro EV.

- Activate Smart Regeneration in the User Settings mode. AUTO **D** will be displayed on the instrument cluster. AUTO regenerative brake adjusts regenerative braking based on the distance with the vehicle in front and its speed
- Pull and hold the right paddle shifter **B** for more than 1 second to turn on/off the automatic change of the regenerative braking

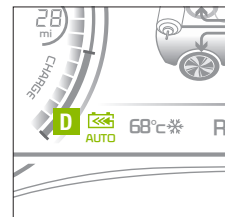

Smart Regeneration is a supplemental system for the driver's convenience. Do not solely rely on this system to stop the vehicle or avoid collisions. Always cautiously look ahead to prevent unexpected or sudden situations.

For more information on regenerative braking, one-pedal driving or the Smart Regeneration System, please refer to your Owner's Manual.

EV Mode - UVO link with Navigation

EV Mode on the UVO link with Navigation system screen allows you to navigate to a total of five menus that include information on available driving range, energy usage, energy information, ECO driving, charging and climate settings, and EV settings.

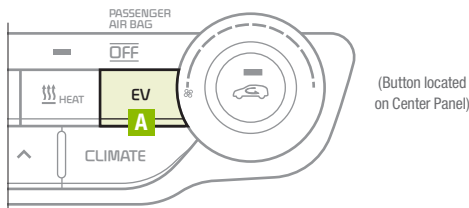

EV Button - Press the EV button **A** on the Climate Control panel to access the EV Mode screen or press the EV Mode button* on the touchscreen.

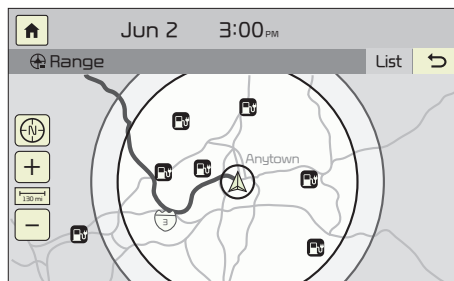

Available Range - Displays the available driving distance according to the vehicle's current location and charge amount. The estimated available driving distance is marked in red on the map.

The estimated range is based on a number of factors and assumes optimal driving conditions, efficient driving habits and a straight road. Actual range will vary with options, driving conditions, driving habits, vehicle maintenance, charging practice, battery age, weather, temperature and your vehicle's condition. Battery capacity will decrease with time and use. For more information on range, please see www.fueleconomy.gov.

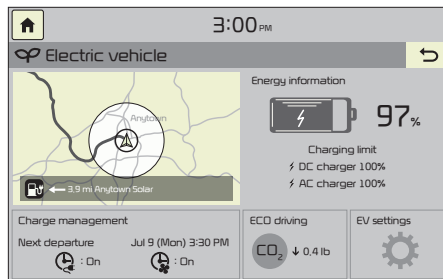

EV Mode menu - The EV Mode menu allows you to access five EV menus including Available Range, Energy information, ECO driving, Charge Management and EV settings.

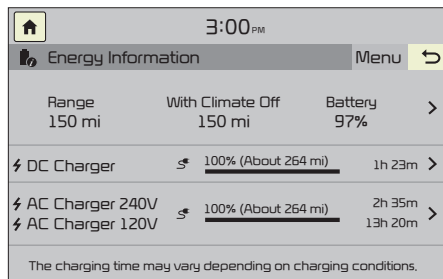

Energy Information – Displays battery charge information and electrical power consumption.

See Owner's Manual for more detailed information on screens.

These illustrations are for demonstration purposes only. Some items may appear different or vary in illustrations.

EV Mode – UVO link with Navigation (Continued)

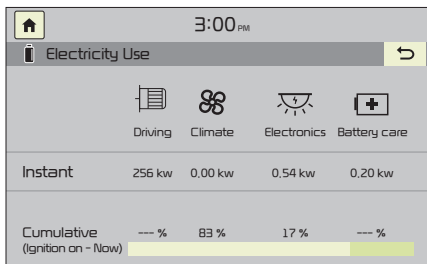

Electricity Use – Displays current energy consumption for each system of the vehicle.

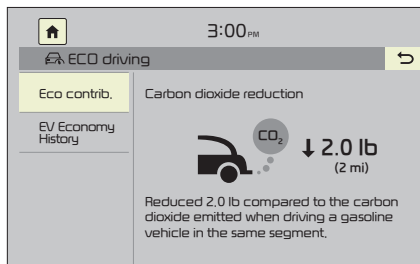

ECO Driving – Displays ECO level information and ECO driving history.

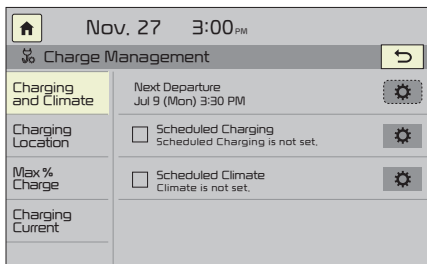

Charge Management – Allows you to select the time and date you wish to reserve for automatic charging and automatic climate control.

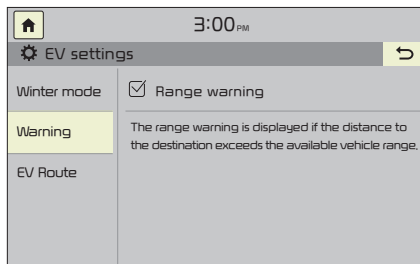

EV Settings – Allows the user to change the Winter mode, warning and EV route settings.

See Owner's Manual for more detailed information on screens.

These illustrations are for demonstration purposes only. Some items may appear different or vary in illustrations.

Charging Your Electric Vehicle

Level 1 Charging – “Trickle” Charge

A Level 1 or “trickle” charger is the most common type of charging system for an electric vehicle. This type of charger uses 120 volts/12 amps of household electricity and takes up to 60 hours for a full charge.

Trickle Charger Indicators:

A ICCB – In-Cable Control Box

B AC Plug

C Power – Indicates that the charger is plugged in and functioning

D Charge – Indicates that the vehicle is charging

E Fault – Indicates charge failure

F Charge Level – Indicates the level of charge – L (8A), M (10A), or H (12A)

REMINDER: Do not use an extension cord. Plug trickle charger directly into wall socket. Do not charge to a receptacle that is not a dedicated circuit, old, damaged, corroded or cracked.

Level 2 Charging – “Normal” Charge

A Level 2 or “normal” 240-volt/32-amp charger is the recommended charging system for your electric vehicle. This type of charger uses 240 volts of electricity and takes approximately 9.6 hours for a full charge. This charger may be able to be installed at your home or can be found at a public charging station.

REMINDER: Shape of charger and how to use the charger may be different for each manufacturer. Please see Owner’s Manual for more information.

Level 3 Charging* – “Quick” Charge (DC)

A Level 3 or “quick” DC charger is usually found at public charging stations. This type of DC charge may charge an electric vehicle in as little as 60 minutes to about an 80% charge.

For more information on Level 3 Charging, refer to the Owner’s Manual.

QUICK TIP

A Level 2 or “normal” 240-volt/32-amp charger is recommended for regular charging of the vehicle.

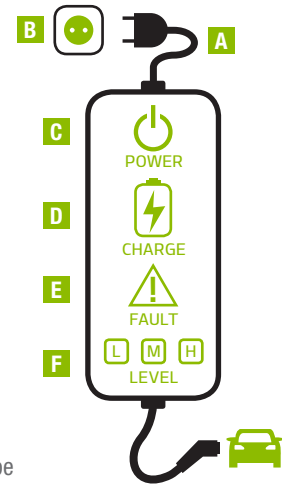

REMINDER: For more detail and/or subsequent steps in charging your vehicle, including safety precautions that should be taken, please see the Owner’s Manual.

Charging Your Electric Vehicle (Continued)

To charge the Niro EV using a normal/trickle charger:

1. Connect the ICCB **A** plug to a dedicated 120 volt/20 amp electrical outlet
2. Check if the power light (green) **B** on the ICCB turns on
3. Press the brake pedal and engage the parking brake
4. Turn off all switches, put the shift lever in P (Park), and turn off the vehicle
5. Press the charging symbol **C** on the charging door to open the charging door **F** at the front of the vehicle and remove the trickle/normal charging inlet cover **G** (the charging door can be opened when the vehicle is unlocked)
6. Hold the charging connector handle and connect it to the vehicle's trickle/normal charging inlet **H** by pushing the connector until you hear a clicking sound
7. Charging begins automatically (Ensure the charge indicator light **S** is illuminated on your instrument cluster, indicating the vehicle is charging, and ensure scheduled charging is not set)

Checking the Charging Status

The charging status can be checked by viewing the charging status indicator **I** on the dash panel. The lights will progressively become lit as the vehicle approaches a full charge. Ensure scheduled charging is not set.

REMINDER: For more detail and/or subsequent steps in charging your vehicle, including safety precautions that should be taken, please see the Owner's Manual.

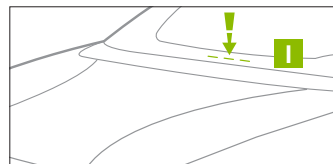
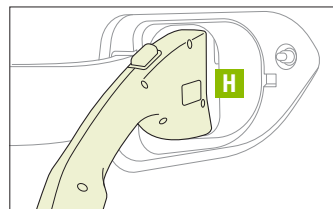
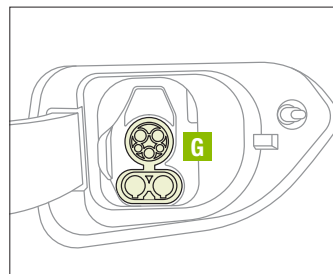
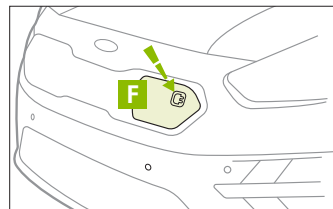

(Trickle / normal charge shown)

Charging Connector Auto/Lock Mode

The Charging Connector can be set to be locked or unlocked while in the charging inlet and charging. Press the AUTO  button **A** (LED lit) for the connector to lock while charging and unlock automatically when charging is complete.

When the AUTO  button **A** is not pressed (LED not lit), the mode will be set to LOCK. The connector will be locked when charging and remain locked until all doors are unlocked.

QUICK TIPS

- If in lock mode & the doors are unlocked, the charging connector unlocks, but if the charging cable is not disconnected within 10 seconds, the connector will be automatically locked again
- If the charging connector is unlocked but all the doors are locked again, immediately, the connector will be automatically locked again

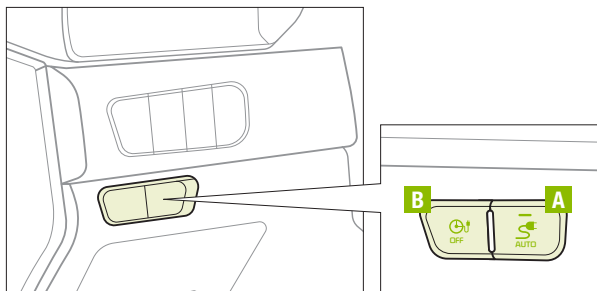

(Buttons are located left of the Steering Wheel)

Scheduled Charging*

Charging times can be set using the UVO link with Navigation.* You can also use the Scheduled Charging* App on your smartphone.

Charging with the UVO link smartphone app:

The Kia Access with UVO link smartphone app can help you find the nearest charging station, and also displays charging status and Scheduled Charging information. On your smartphone, go to an app store or marketplace to download the Kia Access with UVO link smartphone app.

REMINDER: When Scheduled Charging is set and the charger is plugged in, charging of the electric vehicle will not begin until the time and date set.

Deactivate Scheduled Charging - Depress the Deactivate Scheduled Charging button **B** to temporarily disable the scheduled charging feature when immediate charging is required.

QUICK TIP

When you press the Deactivate Scheduled Charging button the reserved charging setting will temporarily disable, and start immediate charging mode. If you need to completely deactivate the scheduled charge setting, change the setting from the audio control unit, or the smartphone Kia Access with UVO link app.

REMINDER: For more detail and/or subsequent steps in charging your vehicle, including safety precautions that should be taken, please see the Owner's Manual.

Blind-Spot Collision Warning (BCW) with Lane Change Assist (LCA)*†7

The BCW system uses radar sensors to help alert the driver if it detects an approaching vehicle in the driver's blind spot before changing lanes. The light on the BCW button **A** will illuminate when turned ON. The outside rearview mirror warning lights will also illuminate for 3 seconds.

The system will become active when the vehicle is traveling more than approximately 18 mph and will alert the driver if another vehicle is detected by the radar sensor.

Blind-Spot Collision Warning (BCW) / Lane Change Assist (LCA)

1st-stage alert: When another vehicle is detected within the BCW boundary **B**, or when a vehicle is detected within the LCA boundary **C**, a yellow indicator will illuminate on the outside rearview mirrors.

2nd-stage alert: When 1st-stage alert is on and the driver activates a turn signal, a flashing yellow indicator will illuminate on the outside rearview mirrors and the system will sound an alert.

Rear Cross-Traffic Collision Warning (RCCW)*†7

If the RCCW system sensors detect approaching vehicles from the left or right side **D**, the system will sound an audible alert, the warning indicators on the outside rearview mirror will illuminate, and a message will appear on the LCD screen, if the following conditions are met:

- When Rotary Dial Shifter Knob is in Reverse
- When the vehicle is moving slower than 6 mph
- When the vehicle moves in reverse from a parked position
- If the approaching vehicle speed is between 2.5-22 mph within sensing range

REMINDERS:

- The BCW system will not show a warning if the vehicle speed is only 6 mph above the surrounding vehicles
- If the BCW is turned ON/OFF and the ignition is cycled, the BCW system returns to ON/OFF
- The RCCW feature can be turned OFF/ON in User Settings

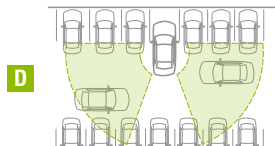
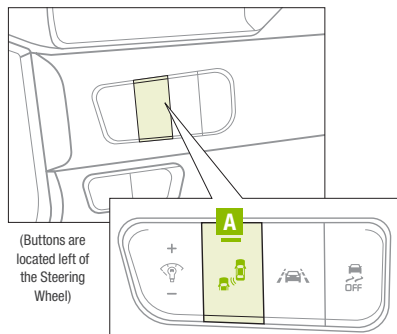

REMINDER: The above images are for illustration purposes only and may not reflect actual operation.

QR CODE

Blind Spot Collision Warning with Lane Change Assist Video

To view a video on your mobile device, snap this QR Code or visit the listed website.

Refer to page 2 for more information.



www.youtube.com/KiaFeatureVideos

The BCW and RCCW systems are supplemental systems. Do not solely rely on these systems and always drive safely.

For more information on the Blind-Spot Collision Warning, please refer to the Owner's Manual.

Lane Keeping Assist (LKA)*†7

With the Engine Start/Stop button in the ON position, press the LKA button **A** to turn system ON. The instrument cluster indicator  will initially illuminate white. It will remain white when the vehicle is traveling less than 40 mph or the system does not detect the lane markers. When the LKA system detects the lane markers and can assist the steering, the LKA icon will illuminate green.

If the LKA detects that you are moving outside of your lane, the system may give an audible warning and display a LDW (Lane Departure Warning) alert on the instrument cluster. If the vehicle continues to move outside of the lane, the LKA will apply a slight adjustment to the steering, trying to prevent the vehicle from moving outside its lane.

Standard LKA is the operating mode by default when the LKA button is depressed to ON. To switch between modes (Standard LKA, Active LKA and Lane Departure), go to User Settings in the Instrument Cluster.

All systems will operate under the following conditions:

- The vehicle exceeds approximately 40 mph
- The LKA system recognizes both sides of the lane markers the vehicle is traveling in
- The vehicle is between the lane markers

REMINDERS:

- LKA will not issue a warning if the turn signal or hazard signal is activated
- LKA will return to its previous setting on/off when the ignition is cycled

Lane Keeping Assist is not a substitute for safe driving, and may not always detect if the vehicle is moving outside of its lane. Always drive safely and use caution.

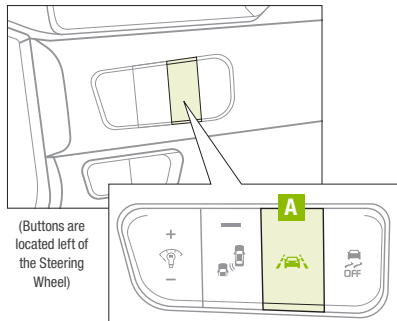

When the LKA sensor detects the lane traveled in, both lanes are illuminated

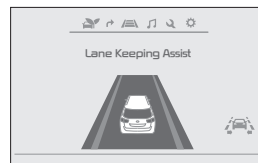

When the LKA sensor does not detect the lane traveled in the lanes are not illuminated



When the LKA sensor detects the vehicle moving outside of the lane being traveled in, a yellow indicator will illuminate either on the left or right lane (shown in both images above)



Your vehicle's instrument cluster & indicator light locations may differ from those in the illustrations. For more information on the instrument cluster, please refer to the Owner's Manual.

These illustrations are for demonstration purposes only. Actual indicators may vary in appearance.

QR CODE

Lane Keeping Assist Video

To view a video on your mobile device, snap this QR Code or visit the listed website.

Refer to page 2 for more information.



www.youtube.com/KiaFeatureVideos

Forward Collision-Avoidance Assist (FCA) / Forward Collision Warning (FCW)*†7

The FCA system is designed to help alert the driver, and, under certain conditions, apply emergency braking, when approaching a vehicle that is slowing down, braking or stopped. Initially, FCA provides Forward Collision Warning (FCW) when it detects a potential collision with a vehicle in front, emitting an audible warning and visual alert on the instrument cluster.

Adjust the alert settings (Early, Normal, Late) in the User Settings. To turn FCA/FCW off, go to User Settings again and turn it off.

If the collision risk increases and other conditions are met, Forward Collision-Avoidance Assist (FCA) is designed to automatically apply the brakes to reduce your speed, potentially helping to minimize the effects of a possible collision. FCA can be turned ON in the User Settings menu on the Instrument Cluster display.

FCA/FCW will become active when the:

- Engine Start/Stop button is ON
- Vehicle is traveling more than 5 mph
- Electronic Stability Control (ESC) is ON



REMINDERS:

- FCA will be activated by default when vehicle power is cycled on, even when previously set to off
- FCW will not operate when the vehicle is traveling faster than approximately 50 mph
- If FCA is operating and ESC (Electronic Stability Control) is turned off, the FCA system is automatically turned off
- When FCA is not operating, the FCA warning indicator will illuminate on the Instrument Cluster

Forward Collision-Avoidance Assist (FCA) / Forward Collision Warning (FCW) are not substitutes for safe and proper driving. Always drive safely and use caution. FCA / FCW may not always alert the driver when the vehicle is approaching another vehicle.*

QR CODE

Forward Collision-Avoidance Assist Video

To view a video on your mobile device, snap this QR Code or visit the listed website.



www.youtube.com/KiaFeatureVideos

Instrument Cluster Control

Press switch **A** up or down to adjust display brightness of the instrument panel illumination.



(Buttons are located left of the Steering Wheel)

Electronic Stability Control (ESC)^{†9}

The ESC system is designed to help stabilize the vehicle during certain cornering maneuvers. It is a good idea to keep ESC turned ON whenever possible.

Press ESC OFF button **B** to disable Traction Control in ESC (ESC OFF indicator will illuminate).

To turn both Traction Control and Stability Control off, press and hold ESC OFF button **B** (ESC OFF indicator will illuminate, and an alert sounds).

REMINDERS:

- ESC is active by default at vehicle startup
- The ESC Indicator Light  in the instrument cluster will illuminate whenever the ESC is in operation

For more information on Electronic Stability Control (ESC) and its specific features and operations, please refer to your Owner's Manual.

Hill-Start Assist Control (HAC)^{†9}

The HAC system is designed to help prevent the vehicle from rolling backward when accelerating from a stop while on a steep incline.

The HAC system automatically activates whether the ESC is OFF or ON but does NOT activate when the ESC has malfunctioned.

REMINDERS:

- The HAC system does not operate when the Rotary Dial Shifter Knob is in the P (Park) or the N (Neutral) position
- In the event of an HAC system malfunction, see an Authorized Kia Dealer for service

QUICK TIPS

- When HAC is active (e.g., accelerating from a stop on an incline), you may notice that the brakes will momentarily remain engaged after you depress the accelerator. This is normal HAC operation
- HAC provides a two-second delay before the vehicle may start rolling backward

HAC does not replace the need to apply brakes while the vehicle is stopped on an incline.

Reverse Parking Aid Function*

When the Rotary Dial Shifter Knob is moved into R (Reverse) and the vehicle is driven backwards, the outside rearview mirrors **A** will rotate downward to aid in reverse parking.

To turn ON the Reverse Parking Aid Function, depress either L or R mirror buttons **B**.

To turn OFF, depress the same buttons again.

The outside rearview mirrors will automatically return to their original positions when:

- The Engine Start/Stop button is in the OFF position
- The Rotary Dial Shifter Knob is moved to any position except R (Reverse)
- The L or R mirror buttons are not depressed

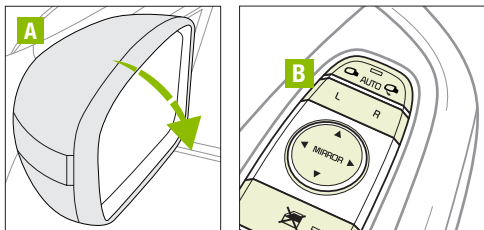

(Buttons panel located on Driver's Door)

REMEMBER: When the outside rearview mirror buttons are not depressed, the Reverse Parking Aid Function will not operate and the outside rearview mirrors will not rotate downward.

Power Button⁺¹⁵

To start the vehicle:

1. Depress the brake pedal
2. Press the POWER button while Rotary Dial Shifter Knob is in P (Park) or (N) Neutral

To turn the vehicle power OFF, press the POWER button.

To use the POWER button, you must have the Smart Key fob on your person.

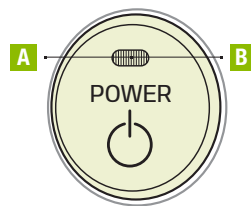

QUICK TIPS

To use electrical accessories:

ACC position

- When in the OFF position and without depressing the brake pedal, press the POWER button once (amber light **A**)

ON position

- When already in the ACC position (amber light **A**) and without depressing the brake pedal, press the POWER button again (red light **B**)
- When in the OFF position (not illuminated) and without depressing the brake pedal, press the POWER button twice (red light **B**)

Keeping the vehicle in ACC or ON position without turning the vehicle Power on may discharge the vehicle's battery.

REMEMINDERS:

- In an emergency situation while the vehicle is in motion, you are able to turn the vehicle off and to the ACC position by pressing the POWER button for more than 2 seconds or 3 times successively within 3 seconds
- If the Smart Key battery is weak or not working properly, hold the Smart Key fob up to the POWER button (Lock button side closest) and press to start vehicle
- Do not turn the vehicle off by pushing the POWER button while the vehicle is in motion. If the vehicle has been turned off the power brake and power steering system cannot operate

QR CODE

Kia Key Fob Video

To view a video on your mobile device, snap this QR code or visit the listed website.

Refer to page 2 for more information.



www.youtube.com/KiaFeatureVideos

Power Windows, Window Lock & Central Door Lock

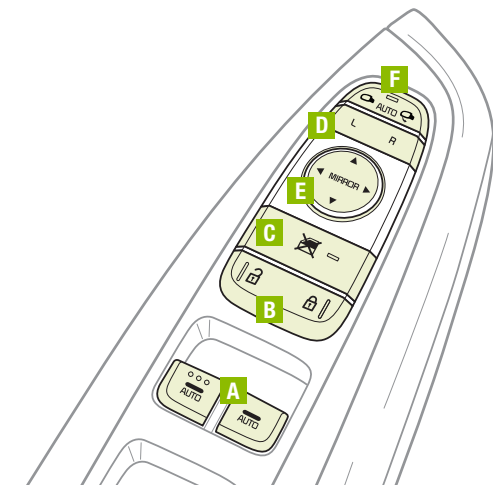

A Pull/Press to operate Driver's and Front Passenger's Windows Auto-Up/Down*

QUICK TIP

Press button again to stop Auto Up/Down function.

B Press to Unlock/Lock All Doors

C Press to disable Rear Passenger Windows

REMINDER: When pressed **C**, window controls for the Rear Passenger Windows are disabled.

Automatic Door Lock

Auto Door Lock will engage when the Rotary Dial Shifter Knob is moved into or out of the P (Park) position. Refer to the User Settings in the LCD Instrument Cluster modes on how to turn Auto Door Lock/Unlock ON/OFF.

Power/Heated Outside Mirrors*

Mirror heaters automatically turn ON/OFF at the same time the Rear Window Defroster is turned ON/OFF. Rear Window Defroster button* is located on climate control system panel.

Power Folding Outside Mirrors*

Press L or R buttons **D** (left or right) to select mirrors. Then press arrows **E** to adjust mirror position.

To fold and unfold both the outside rearview mirrors, press the folding mirror button **F** as pictured:

- Left – The mirrors will unfold.
- Right – The mirrors will fold.
- Center – The mirrors will fold/unfold automatically when doors are locked/unlocked with the Smart Key or a door handle button is pressed. Also, the mirrors will unfold when approaching the vehicle with the Smart Key fob in proximity.

QUICK TIP

To automatically fold mirrors when exiting vehicle, press the LOCK button once on the Smart Key.

REMINDER: To lock position of mirrors, toggle switch to the neutral (center) position.

Headlights & High Beams

To operate:

- Rotate lever to change the Headlight function
- Push lever to turn High Beams ON
- Pull lever to flash Headlights/High Beams



AUTO Light position – When the light switch is in the AUTO Light position, the tail lights and headlights will turn ON/OFF automatically depending on the amount of light outside the vehicle.

Daytime Running Lights (DRL)* – DRL may help others to see the front of your vehicle during the day. The lights will be on automatically when the ignition or POWER button* is ON and the headlight switch is in the AUTO position, unless one of the following occurs:

- Parking brake is applied
- Engine is turned off

REMINDER: The DRL system turns off when parking brake is applied.

Turn Signals & Fog Lights*

To operate:

- Turn Signals - Move lever Up/Down for Right/Left Turn Signal
- Fog Lights - Press switch **A** to turn Fog Lights ON/OFF

REMINDER: Headlights must be in the ON/AUTO position for Fog Light operation.

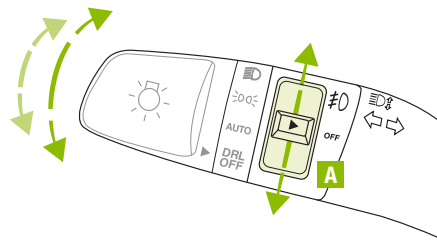

One-Touch Lane Change Signal is activated by moving the Turn Signal Lever slightly for less than 1 second and then releasing. The lane change signal will blink 3 times.

To change how many times (3/5/7 times) the Lane Change Signal blinks, go to User Settings Mode in the LCD Instrument Cluster modes.

Windshield/Rear Wipers & Washers

To operate Windshield Wipers and Washers:

- Move lever Up/Down to change front Wiper modes
- Press switch **A** Up (fast) / Down (slow) to adjust Intermittent Wipe Speed
- Pull lever to spray and wipe front windshield
- Push lever to spray and wipe rear glass

Windshield

- MIST:** Single wipe
- OFF:** Wiper off
- INT:** Intermittent wipe
- LO:** Slow wipe
- HI:** Fast wipe

Rear

- HI:** Continuous wipe
- LO:** Intermittent wipe
- OFF:** Wiper off

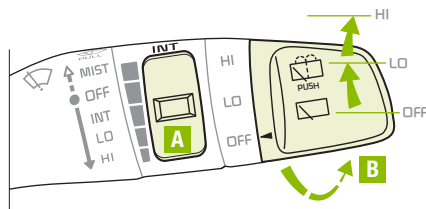

QUICK TIPS

- Pressing switch **B** up increases Intermittent wipe frequency and wipe speed. Pressing switch **B** down decreases frequency of wipes
- Set the wiper to OFF position when the wiper is not in use
- LO and HI sets rear wiper speed. Low intermittent wipe function on rear wipers

To operate Rear Wiper & Washer:

- Rotate Rear Wiper switch **B** LO - Intermittent / HI - Continuous to change Wiper modes
- Push lever to spray and wipe

Bluetooth® Wireless Technology†6,21

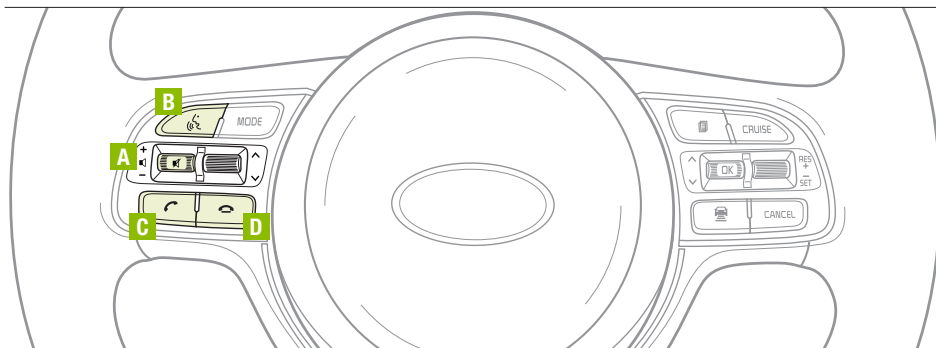

(Type B shown)

- A Volume button:** Press up/down to raise/lower speaker volume
Mute button: Push to mute the microphone during a call
- B Talk button:** Press to activate voice recognition
- C Receive/Place Call button:** Press to receive/place/answer calls.
In vehicles with navigation, if no phone is paired, press button to pair a phone
- D End Call button:** Press to end a call or cancel a function

QUICK TIPS

- Phone book transfer upload time varies by phone model and with number of phone book entries
- When using the voice command feature, wait for the system BEEP before speaking the command
- Because of differences in phone quality, service providers and Bluetooth® Wireless Technology chip programming, functionality may differ from one phone to another

Your vehicle's steering wheel buttons may differ from those in the illustrations. See your Owner's Manual for more details.

Driving while distracted is dangerous and should be avoided. Drivers should remain attentive to driving and always exercise caution when using the steering-wheel-mounted controls while driving.

For more information, if equipped, refer to the Car Multimedia System User's Manual. For Bluetooth® Wireless Technology FAQs, go to www.kia.com, Owners section, or call Consumer Information for Bluetooth® Technology at (800) 333-4KIA. Refer to your Owner's Manual for more specific Bluetooth® Wireless Technology phone pairing and operation instructions.

Bluetooth® Wireless Technology†6,21

Pairing a Phone

For instructions on how to pair a phone, refer to the Car Multimedia System User's Manual or your vehicle's Quick Start Guide.

QUICK TIP

During the pairing process, be sure to accept the connection requests on the phone for contacts download and to allow acceptance of all future Bluetooth® connection requests.

How to Place a Call

- Option 1: Press the Receive/Place Call button **C** (displays the phone screen with call history)
- Option 2: Press the Talk button **B**. Then say the command “Call {name}” or “Dial {number}” followed by contact name or number

QUICK TIP

When using the voice command feature, wait for the system BEEP before speaking the command.

Voice Recognition and Phone Contact Tips

To help optimize the Bluetooth® Wireless Technology Voice Recognition system, below are some tips and reminders. Improve the performance by making a few simple changes to your phone contacts:

- Use full names (first and last names) vs. short or single-syllable names (“John Smith” vs. “Dad,” “Smith Residence” vs. “Home”)
- Avoid using special characters, emojis or hyphenated names (@, &, #, /, -, *, +, etc.)
- Avoid using acronyms (“In Case of Emergency” vs. “ICE”) or words with all capital letters
- Spell words completely, no abbreviations (“Doctor Smith” vs. “Dr. Smith”)

The system may have difficulty understanding some accents or uncommon names. Below are other tips to optimize using the voice recognition.

QUICK TIPS

- When placing a call, speak in a natural, moderate tone, with clear pronunciation. The system may have trouble recognizing commands if you speak too softly or too loudly
- Always wait for the beep before speaking any commands
- Close windows and turn off A/C – Open windows, weather (wind/rain), or an A/C fan operating at higher speeds can interfere with Voice Recognition
- Press the talk button and say “Help” to get a list of available commands

QR CODE

Voice Recognition Tips Video

To view a video on your mobile device, snap this QR Code or visit the listed website.

Refer to page 2 for more information.



www.youtube.com/KiaFeatureVideos

Audio Controls^{†20}

Standard Cruise Control^{†21}

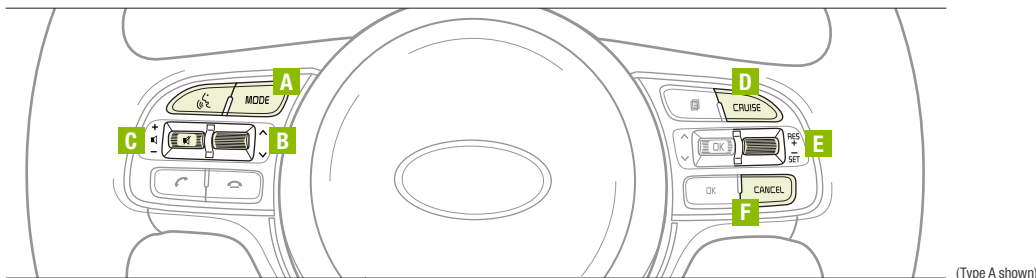

A Audio MODE button: Press to cycle through FM/AM/SiriusXM®/Media modes
Audio System ON/OFF: Press and hold to turn power on; Press to turn power off

B Seek/Presets button:
FM/AM/SiriusXM® Modes: Press up/down to advance through Preset Stations. Press and hold to auto seek
Media Mode: Press up/down to move Track Up/Down. Press & hold up/down to fast forward/rewind (except for *Bluetooth®* Audio)

C Volume button: Press up/down to raise/lower volume
Mute button: Press to mute/unmute all audio

D CRUISE Control ON/OFF button: Press to turn the Cruise Control ON/OFF

E Cruising Speed button:

- Press up to resume or increase Cruising Speed
- Press down to set or decrease Cruising Speed

F Cruise Control CANCEL button: To cancel Cruise Control setting, do one of the following:

- Press the brake pedal
- Press the CANCEL button

QUICK TIP

Pressing the Audio Mode button for more than 1 second will turn Audio Mode ON/OFF.

Driving while distracted is dangerous and should be avoided. Drivers should remain attentive to driving and always exercise caution when using the steering-wheel-mounted controls while driving. To help minimize driver distraction, some audio system functionalities have been modified while the vehicle is in Drive, Reverse or moved out of Park.

For further audio system operations, refer to pages 31-34.

Your vehicle's steering wheel buttons may differ from those in the illustrations. See your Owner's Manual for more details.

QUICK TIPS

- Cruise Control is designed to function above 20 mph
- The Cruise Control system will not activate until the brake pedal has been depressed at least once after ignition ON or engine start

REMINDER: Standard Cruise Control is a part of the Smart Cruise Control (SCC) system and can be set as the operating mode. To switch from SCC to Standard Cruise Control, press and hold the SCC button for two seconds (the SCC system must not be activated to change modes). Repeat to switch back to SCC mode.

Smart Cruise Control (SCC) with Stop & Go*†7,21

The Smart Cruise Control (SCC) system allows you to set the vehicle to maintain a constant speed and predetermined distance so long as it is not limited by traffic. When traffic is encountered, the vehicle may be slowed to help maintain the set distance from vehicles detected ahead without the driver depressing the brake pedal.

To set/adjust SCC speed:

- Push the CRUISE button **A** to turn system ON. The CRUISE indicator will illuminate on the instrument cluster
- Accelerate/decelerate to the desired speed
- Press button **B** down to set the speed. Press the RES+/SET- button **B** up/down to increase/decrease the set speed

To adjust the vehicle-to-vehicle distance setting **C:** Press the SCC button **D** on the steering wheel. The images on the LCD screen **E** and the Instrument Cluster **F** will change when scrolling through the settings. Each time the button is pressed, the vehicle-to-vehicle distance changes.

To cancel SCC operation: Press the CANCEL button **G** or press the brake pedal. The LCD screen will display a message that the SCC operation is canceled **H**.

To turn SCC system OFF: Press the CRUISE button **A**. The CRUISE indicator on the instrument cluster will turn OFF.

QUICK TIPS

- To change the Cruise Control mode from SCC to standard Cruise Control, press and hold button **B**. Repeat to switch modes again (The SCC system must not be activated to change modes)
- For the SCC system to operate, you must be traveling at a minimum speed of 20 mph, when no vehicle is detected in front
- When following a vehicle, the system is able to automatically adjust your cruise speed based on the vehicle detected in front

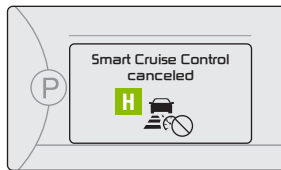
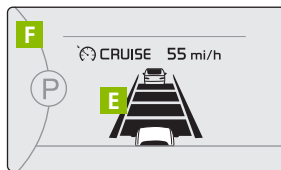

(Actual screen on vehicle may vary)

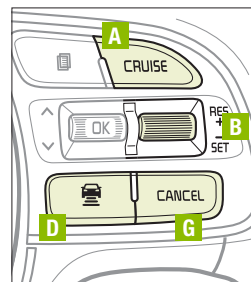

(Type B shown)

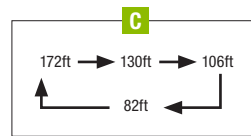

(Distances are approximate and vary depending on vehicle speed)

QR CODE

Smart Cruise Control with Stop & Go Video

To view a video on your mobile device, snap this QR Code or visit the listed website.

Refer to page 2 for more information.



www.youtube.com/KiaFeatureVideos

REMINDERS:

- In standard Cruise Control, the driver needs to manually assess the distance from other vehicles as the system will not apply brakes to slow down the vehicle
- SCC system is activated when ignition is turned on. Speed will need to be reset when ignition is cycled on
- The distance settings are approximations and may vary depending on speed and factory settings at the time. See owner's manual for more information
- The SCC is also canceled when the driver's door is opened, Rotary Dial Shifter Knob is changed out of D (Drive) and various other conditions. See owner's manual for other conditions
- If the SCC system is left on, it can be activated inadvertently. Keep the system off when not in use to avoid setting a speed which the driver is not aware of

The SCC system is a supplemental system and is not a substitute for safe driving. It is the responsibility of the driver to always check the speed and distance to the vehicle ahead.

Tilt/Telescoping Steering Wheel†23

To adjust the Steering Wheel, push the lock-release lever **A** down and adjust the desired angle **B** and distance **C**.

When finished, pull the lock-release lever **A** up to lock Steering Wheel in place.

QUICK TIP

It may be helpful to pull/push bottom of Steering Wheel towards/away from you to adjust desired distance.

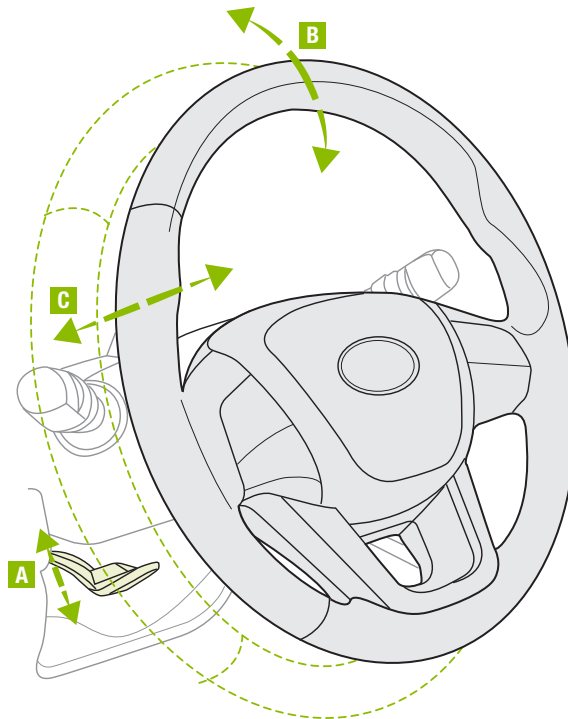

Android Auto™+3 / Apple CarPlay®+5 Setup*

Android Auto™*

Setting up Android Auto™:

1. From an Android Auto™ compatible device, download the Android Auto™ app from the Google Play™+11 Store
2. Open the Android Auto™ app and proceed with the onscreen instructions to complete setup on the mobile device

How to start Android Auto™:

1. Press the SETUP key on your audio control unit's control panel
2. Press the PHONE PROJECTION button , select Android Auto™ then select ENABLE ANDROID AUTO. Accept all terms, conditions and requests on the head unit and phone in order to use Android Auto™
3. Connect the Android™ device with the vehicle's USB port using the manufacturer's cable provided with your phone
4. From the vehicle's home screen, select the Android Auto™ button, where you'll see all the Android Auto™ supported apps

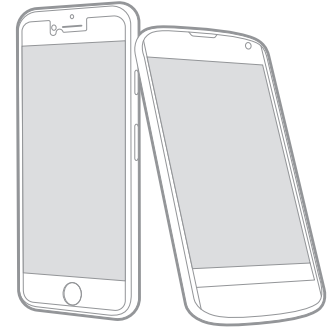

Apple CarPlay®*

Setting up and starting Apple CarPlay®:

1. Connect the Apple CarPlay® compatible iPhone® with the vehicle's USB port using the manufacturer's cable provided with your iPhone®
2. On the audio control unit's control panel, press the SETUP key
3. Press the PHONE PROJECTION button  on the screen and select Apple CarPlay®
4. Select ENABLE APPLE CARPLAY. Accept all terms, conditions and requests on the head unit and phone in order to use Apple CarPlay®
5. From the vehicle's home screen, select the Apple CarPlay® button, where you'll see all the Apple CarPlay® supported apps

REMINDERS:

- Android Auto™ compatibility requirements: Micro-USB cable that came with your phone, OS Android™ 5.0 or higher, compatible Android smartphone and data and wireless plan for applicable feature(s)
- Apple CarPlay® compatibility requirements: Apple Lightning® cable, latest iOS software, iPhone® 5 or later and data and wireless plan for applicable feature(s)
- It is recommended to always update your phone to the latest operating system release

Do not attempt to setup your mobile phone while operating your vehicle as this can result in a loss of vehicle control that may lead to an accident, severe bodily injury, and death.

For further UVO link operations, refer to the Car Multimedia System User's Manual. For other audio system information, refer to pages 32-34.

UVO link Activation*†1

1. Enter the activation screen on your vehicle's head unit
 - a. Press SETUP key
 - b. Press UVO icon
 - c. Press UVO Activation
2. Agree to Terms of Service and Privacy Policy and press SUBMIT
3. Enter smartphone number or email address to receive a verification code, then press SUBMIT

4a. Follow these steps if using your phone number to receive your verification code

- a. Check your phone for a SMS (text message)
- b. Open the link in your SMS

A page will open requesting that you create your account.

Note: If you already have a Kia Owners Portal account using the phone number as your login ID, you will need to provide your password prior to receiving the verification code.

- c. Enter your first name, last name, email, phone number and an account password, and click CREATE ACCOUNT

A page will open displaying your verification code.

- d. Enter the code in the head unit and press ACTIVATE
- e. Go back to the page with your verification code and press “I have entered my PIN”

A link will be provided to download the Kia Access with UVO link app from your app store. After installing the app, log in and enjoy.

For further UVO link operations, refer to the Car Multimedia System User's Manual. For further audio system operations, refer to pages 31-34.

4b. Follow these steps if using your email to receive your verification code

- a. Check your email. The email will be from reset@notifications.myuvo.com
- b. Open link inside email

A page will open requesting that you create your account

Note: If you already have a Kia Owners Portal account using the email as your login ID, you will need to provide your password prior to receiving the verification code.

- c. Enter your first name, last name, email, phone number and an account password, and click CREATE ACCOUNT

A page will open displaying your verification code.

- d. Enter the code in the head unit and press ACTIVATE
- e. Go back to the page with your verification code and press “I have entered my PIN”

A link will be provided to download the Kia Access with UVO link app from your app store. After installing the app, log in and enjoy.

Driving while distracted can result in a loss of vehicle control that may lead to an accident, severe bodily injury, and death. The driver's primary responsibility is in the safe and legal operation of a vehicle, and use of any handheld devices, other equipment, or vehicle systems which take the driver's eyes, attention and focus away from the safe operation of a vehicle or which are not permissible by law should never be used during operation of the vehicle.

UVO link*1 – FM/AM/SiriusXM®+20/Media (USB, iPod®, AUX, Bluetooth® Audio, My Music)

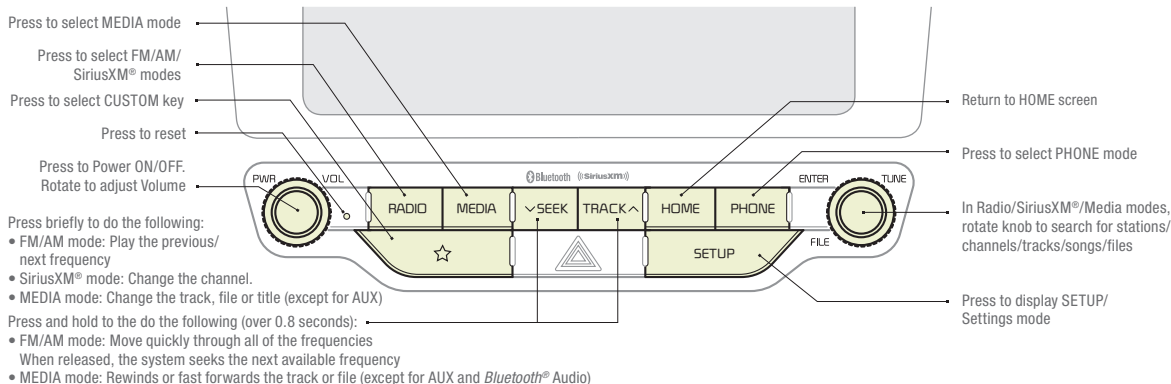

Sound Settings

To adjust the audio system sound settings:

1. Press the SETUP key on the audio control unit
2. Select the onscreen SOUND button, or SOUND SETTINGS
3. Select the menu item (Position, Volume, Tone, Priority, Advanced, Default)
4. Use the onscreen buttons to adjust settings. Press the return button to save settings

Radio Presets: You can listen to FM, AM and SiriusXM® radio and save frequently used stations

How to Save a Preset: Press and hold the desired slot. This saves the current station in the selected slot

SiriusXM® Smart Favorites: For the first ten favorite SiriusXM® channels, you may play live or repeat from the beginning of a song or a program segment. In Radio mode, choose SiriusXM®, then select any of the first six favorites. During song or program play, tap the Skip Backward icon to start from the beginning of the song or program. Tap the Play Live icon to return to the live broadcast

Custom Button ☆: A programmable key to provide quick access to one of several available system features

To program the Custom Button: Press the SETUP key, then press the Custom button ☆. Select one of the available features you would like the Custom button to open

ALWAYS CHECK THE OWNER'S MANUAL FOR COMPLETE OPERATING INFORMATION AND SAFETY WARNINGS.

QR CODE

UVO link Videos

To view a video on your mobile device, snap this QR Code or visit the listed website. Refer to page 2 for more information.



www.youtube.com/KiaFeatureVideos

QUICK TIPS

- Using Android Auto™ or Apple CarPlay® and a supported smartphone, the phone's Navigation App may be displayed on the head unit
- At any time, you can interrupt Command Feedback by pressing the TALK button
- Prolonged use of the audio system in ACC mode may drain the vehicle's 12V battery
- A warning screen may appear periodically to remind users that the audio system should be operated when the engine is running to prevent 12V battery discharge

REMINDER:

To help minimize driver distraction, some audio system functionalities have been restricted while the vehicle is in Drive, Reverse or moved out of Park.

Your audio system may differ from those in the illustrations. For further UVO link operations, refer to the Car Multimedia System User's Manual. For further audio system operations, refer to pages 31-34.

Driving while distracted is dangerous and should be avoided. Drivers should remain attentive to driving and always exercise caution when using the audio system controls while driving. To help minimize driver distraction, some audio system functionalities have been modified while the vehicle is in Drive, Reverse or moved out of Park.

*IF EQUIPPED

†LEGAL DISCLAIMERS ON BACK INSIDE COVER

UVO link with Navigation*†1,13

– FM/AM/SiriusXM®/Media (USB, iPod®, AUX, *Bluetooth*® Audio)

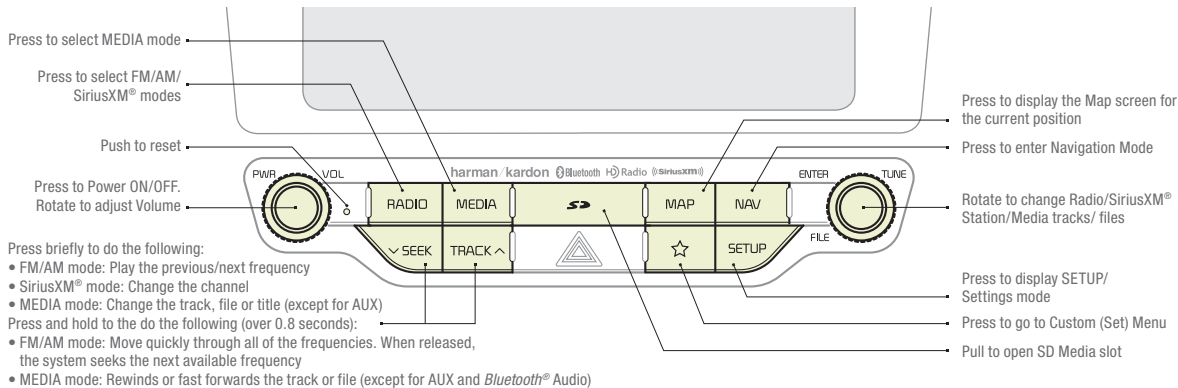

Sound Settings – To adjust the sound settings:

1. Press the SETUP key on the audio control unit. Select the onscreen SOUND button
3. Select the menu item (Position, Volume, Tone, Priority, Navigation Volume, Advanced, Default)
4. Use the onscreen buttons to adjust settings. Press the return button to save settings

Radio Presets: You can listen to FM, AM and SiriusXM® radio and save frequently used stations

How to Save a Preset: Press and hold the desired slot. This saves the current station in the selected slot

SiriusXM® Smart Favorites: For the first ten favorite SiriusXM® channels, you may play live or repeat from the beginning of a song or a program segment. In Radio mode, choose SiriusXM®, then select any of the first ten favorites. During song or program play, tap the Skip Backward icon to start from the beginning of the song or program. Tap the Play Live icon to return to the live broadcast.

Custom button : A programmable key to provide quick access to one of several available system features.

To Program the Custom Key: Press the SETUP key, then press the Custom button . Select one of the available features you would like the Custom button to open.

QUICK TIPS

- Using Android Auto™ or Apple CarPlay® and a supported smartphone, the phone's Navigation App may be displayed on the head unit
- At any time, you can interrupt Command Feedback by pressing the TALK button
- Prolonged use of the audio system in ACC mode may drain the vehicle's battery
- A warning screen may appear periodically to remind users that the audio system should be operated when the engine is running to prevent battery discharge

Your audio system may differ from those in the illustrations. For further UVO link operations, refer to the Car Multimedia System User's Manual. For further audio system operations, refer to pages 31-33.

QR CODE

UVO link with Navigation Videos

To view a video on your mobile device, snap this QR Code or visit the listed website. Refer to page 2 for more information.



www.youtube.com/KiaFeatureVideos

REMINDER: Driving while distracted is dangerous and should be avoided. Drivers should remain attentive to driving and always exercise caution when using the audio system controls while driving. To help minimize driver distraction, some audio system functionalities have been modified while the vehicle is in Drive, Reverse or moved out of Park.

Digital Clock

Press the SETUP key on the head unit. Then press the onscreen Clock icon to enter clock settings. Follow the onscreen options to adjust the clock settings.

QUICK TIPS

- Daylight Savings must be enabled or disabled in the Clock Settings screen
- To access manual date and time setting, turn GPS Time OFF in the Clock Settings (UVO link / UVO link with Navigation*)

USB Chargers*

The USB chargers **C** are located on the center panel and inside the Center Console. Devices can be recharged using a USB cable. The Power button needs to be in the ACC/ON/RUN/START position to operate the USB Chargers.

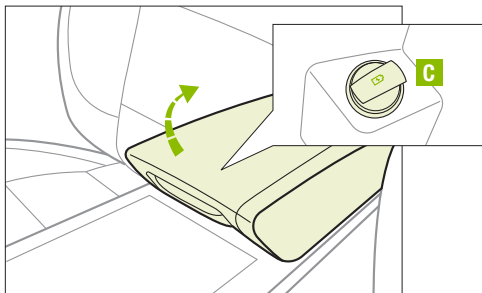

(Front of Center Console shown)

USB/iPod® Port & Power Outlets*

USB/iPod® Port **A**

Use the USB port to connect USB audio devices, smartphones and iPod® devices.

Power Outlets **B**

Use the power outlet for mobile phones and other devices designed to operate on a 12V (180W max) power outlet.

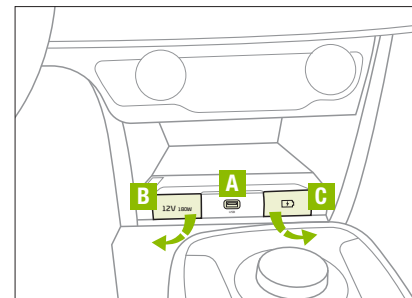

QUICK TIP

The power outlets are inactive when ignition is in the OFF position.

For more information on the USB/iPod® Port & Power Outlets, refer to the Owner's Manual.

REMINDERS:

- Using the power outlets (accessory plugs) for prolonged periods of time with the POWER button in the ACC position (Power OFF) may cause the 12V battery to discharge
- Only use cables made by your device manufacturer. Third party cables may damage your device

Wireless Smartphone Charging System*

1. Place a compatible smartphone on the center of the charging pad **A**
2. Indicator light **B** will change to amber once the wireless charging begins
3. Once charging is complete, the amber light will change to green

QUICK TIPS

- The smartphone must be a compatible phone with Qi function available
- Wireless charging must be enabled in user settings
- If wireless charging does not work, move smartphone around the pad until the charging indicator turns amber. Avoid placing other metal items in the bin while charging as to not impede the charging area
- For wireless charging to occur, all doors (excluding rear hatch) must be closed & the Smart Key Fob must be detected inside the vehicle and driver's seat belt on

REMINDERS:

- This vehicle is equipped with wireless charging technology which allows for a device to be charged using inductive charging, however, device compatibility varies. See your owner's manual for more detailed information and the back page for legal disclaimers
- Inductive charging systems are less efficient than conventional charging through cable. As a result, higher device operating temperatures may be experienced during use
- Charging Performance - Device position on the wireless charging system can affect charging performance. Other factors that may affect the charging rate includes foreign objects, such as coins or pens, and phone case thickness

Requires Qi enabled device or Qi enabled case

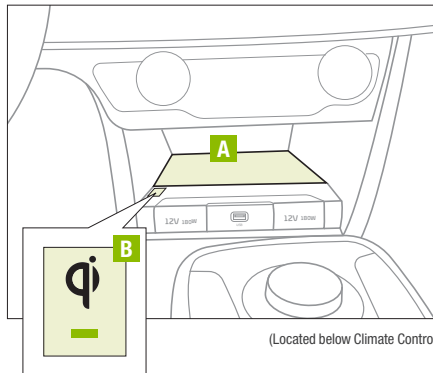

QR CODE

Wireless Charging Video

To view a video on your mobile device, snap this QR Code or visit the listed website.

Refer to page 2 for more information.



www.youtube.com/KiaFeatureVideos

Automatic Climate Control

- A** Driver Only Fan Control
- B** Temperature Control knob
- C** Automatic Climate Control button
- D** Front Windshield Defroster
- E** Rear Windshield Defroster
- F** Air Conditioning On/Off button
- G** Recirculated Air button
- H** Air Flow Mode Selection button
- I** Heater on/off button
- J** EV menu button
- K** CLIMATE information screen selection button
- L** Fan Speed Control knob
- M** System OFF button

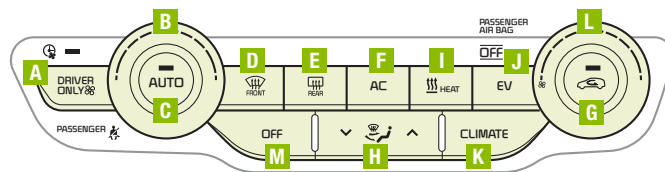

Your Automatic Climate Control system may differ from those in the illustration. See your Owner's Manual for more details.

Climate Control Auto Function

1. Press AUTO to select Full Auto Operation. The Auto setting automatically controls the airflow modes, fan speeds, air intake and air conditioning according to the temperature setting selected
2. Turn temperature control knob **A** to the desired temperature

QUICK TIPS

- Defrost mode  activates A/C and opens Fresh Air Vent to help dehumidify the air and improve defog performance
- During Auto Operation, the A/C indicator will NOT illuminate. The fan speed, air intake, air flow and air conditioning may automatically be engaged at any time to reach desired temperature and reduce humidity
- Keep inside glass as clean as possible to reduce window fogging

Driver Only Ventilation:

Driver Only Ventilation restricts air flow to the driver's side vents only. This can help driving range by limiting the power drawn from the battery. Press DRIVER ONLY button to enable air flow through the driver's side vents only.

REMINDERS:

- Pressing any button during AUTO operation will deactivate the AUTO function and switch to manual mode, except for Temperature Control
- When in AUTO mode, Air Flow mode and Fan Speed do not display on the Climate Control Display
- Cold or warm ambient air may flow in through vents if Recirculated Air button is not pressed ON (LED lit)

Air Flow Modes **H**:

To select Air Flow Modes, press the Mode selection buttons:

-  Face-Level
-  Bi-Level
-  Floor-Level
-  Floor/Defrost-Level

Defrost Outside Windshield:

1. Set **Temperature** to **Hot B**
2. Press the **Front Defrost** button  **D**

Defog Inside Windshield:

1. Set **Fan Speed** to desired position **L**
2. Set desired **Temperature B**
3. Press the **Front Defrost** button  **D**

Rotary Dial Shifter Knob

Rotate dial for the following:

P: Park - Press to place in Park

R: Reverse

N: Neutral

D: Drive

P Release: Park Release – Press brake pedal and press the P Release button **A** to release the Parking Brake and rotate dial to R, D or N.

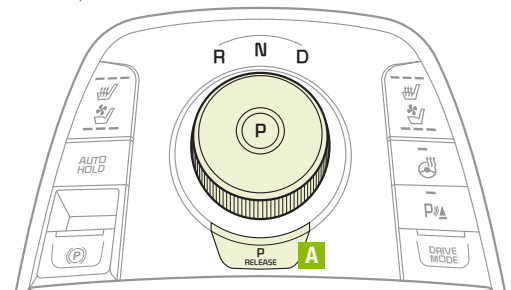

REMINDER: The vehicle is equipped with a shift-by-wire system and a shift-lock system that prevents you from shifting gears without depressing the brake pedal.

Heated Steering Wheel Button*

Press button **B** to turn ON/OFF the steering wheel heater, while the POWER button is in the ON or READY position.

The steering wheel heater will turn off automatically after 30 minutes, or when button is pressed again to deactivate. Steering wheel heater will also turn ON or OFF automatically depending on the steering wheel temperature.

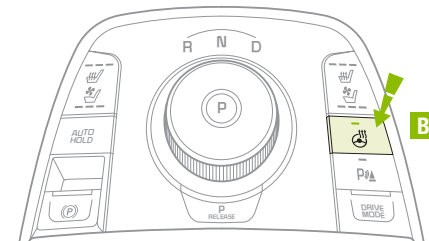

(Located to the right of Rotary Dial Shifter Knob)

QUICK TIP

If ignition is cycled, the Heated Steering Wheel turns OFF. Press button again to turn ON.

REMINDER: If the steering wheel becomes too warm, turn the system off. The heated steering wheel may cause burns even at low temperatures, especially if used for long periods of time.

Electronic Parking Brake (EPB)

The Electronic Parking Brake (EPB) system utilizes an electric motor to engage the parking brake.

Applying the Parking Brake

Pull up the EPB switch **A**. Ensure that the indicator light  is illuminated on the instrument cluster.

Releasing the Parking Brake

The EPB will automatically release when the shifter is placed in Reverse or Drive.

To release EPB manually, depress the brake pedal, then press the EPB switch **A**, with the ignition switch in the ON position. Ensure that the indicator light  is OFF.

REMINDERS:

- As a bulb check, the EPB malfunction indicator will illuminate for approximately 3 seconds when the ignition switch is turned ON
- If the warning light does not illuminate temporarily, or continues to remain lit, take your vehicle to an authorized Kia dealer and have the system checked
- The EPB should not be operated while the vehicle is moving
- A click or electric brake motor sound may be heard while operating or releasing the EPB, but these conditions are normal and indicate that the EPB is functioning properly

QUICK TIPS

- When leaving your keys with parking lot attendants or valet, make sure to inform them how to operate the EPB
- If parked on a steep incline/decline, pull up the EPB switch for more than 3 seconds for a firmer EPB application
- Pull up and hold EPB switch again to increase brake pressure if parked on a decline or incline

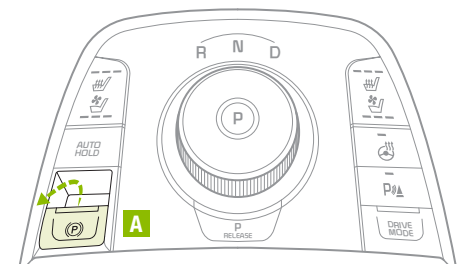

(Located below left of Rotary Dial Shifter Knob)

QR CODE

Electronic Parking Brake Video

To view a video on your mobile device, snap this QR Code or visit the listed website.

Refer to page 2 for more information.



www.youtube.com/KiaFeatureVideos

Seat Warmers / Ventilated Seats*†19 (Driver & Front Passenger)

Seat Warmers — Press top of the button once for high setting (3 amber LEDs lit), again for middle setting (2 LEDs lit), again for low setting (1 amber LED lit). Press again to turn OFF.

Ventilated Seats — Press bottom of button once for high setting (3 blue LEDs lit), again for middle setting (2 blue LEDs lit), again for low setting (1 blue LED lit). Press again to turn OFF.

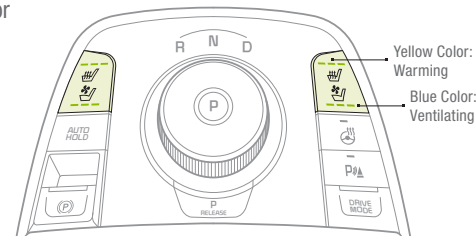

QUICK TIPS

- With the seat warmer switch in the ON position, the heating system in the seat turns OFF or ON automatically depending on the seat temperature
- System is OFF by default

QR CODES

Seat Warmers / Ventilated Seats Video

To view a video on your mobile device, snap this QR Code or visit the listed website.

Refer to page 2 for more information.



www.youtube.com/KiaFeatureVideos

REMINDERS:

- Use extreme caution when using the seat warmers to avoid burns. Refer to the Owner's Manual for more information
- You can also press and hold buttons to turn off the seat heater / ventilation

Driver Position Memory System*

To store a seating position into memory, first place the shifter into P (Park) while the ignition switch is ON. Then:

1. Adjust the driver's seat
2. Press the SET button **A** on the control panel. System will beep once
3. Press one of the memory buttons **B** within 5 seconds. The system will beep twice when memory has been stored
4. "Driver (1 or 2) set is memorized" will appear on the instrument cluster LCD screen



Do not attempt to operate the driver position memory system while the vehicle is moving. This could result in a loss of control of the vehicle.

Front Seat Headrest Adjustment†10

To raise headrest: Pull headrest up.

To lower headrest: Press lock **C**, then press the headrest down.

QUICK TIPS

- For easy adjustments, hold a headrest post with one hand while using the other hand to pull the headrest from underneath
- For more operational information, refer to the Owner's Manual

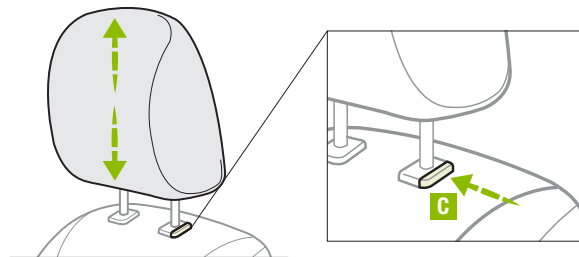

Do not operate the vehicle with the headrests removed. Headrests can provide critical neck and head support in an accident.

Power Adjustable Driver's Seat*†17

Move/Press controls to adjust Seat forward/backward, Seat Cushion tilt up/down, Seatback forward/backward or Lumbar forward/backward.

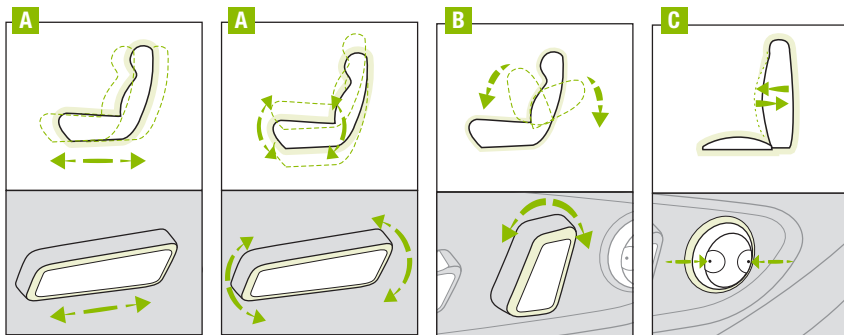
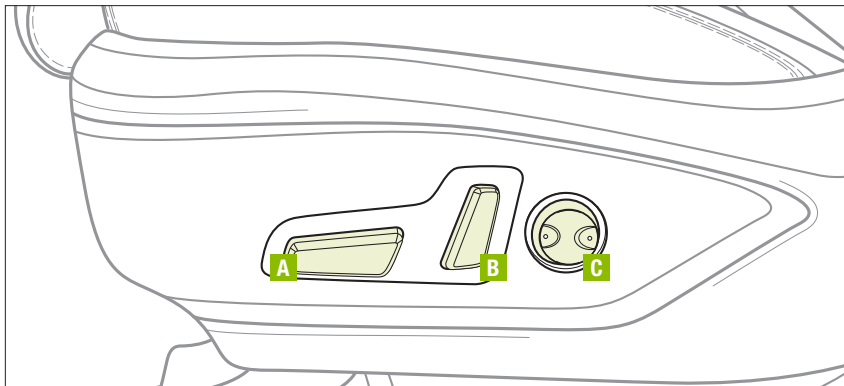

Seat

Seat Cushion

Seatback

Lumbar

REMINDER: Do not attempt to adjust the seat while the vehicle is moving. This could result in loss of control of the vehicle.

6-Way Manual Adjustable Driver's Seat*†17

Pull lever **D** to slide Seat forward/backward.

Pull/press lever **E** up/down one or more times to adjust Seat height.

Pull lever **F** to adjust Seatback recline.

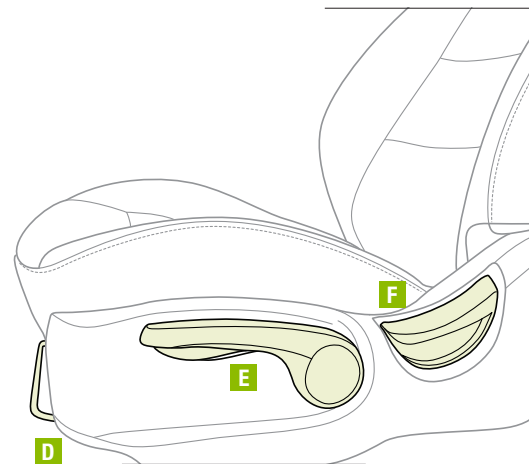

QUICK TIP

When adjusting seat forward or backwards, ensure seat clicks or locks into place before driving vehicle.

Do not attempt to adjust the seat while the vehicle is moving. This could result in loss of control of the vehicle.

Folding Rear Seats

To Fold:

1. Ensure the belt strap is out of way of the Seatback folding **A**. Insert the metal seat belt tab into the holder **B**.
2. Adjust the Front Seatback to the upright position and lower the rear headrest to the lowest position.
3. Pull on the Rear Seatback lock release lever **C**, then fold the seat toward the front.

To Unfold:

1. Pull the lock release lever **C** and lift the Seatback backward until it clicks firmly in place.
2. Return the rear seat belt to the proper position.

QUICK TIPS

- It may be necessary to adjust the front seatbacks to fully lower rear seats.
- Ensure seat is locked by pressing down on Seatback and ensuring red line is NOT visible on bottom of Folder Lever.

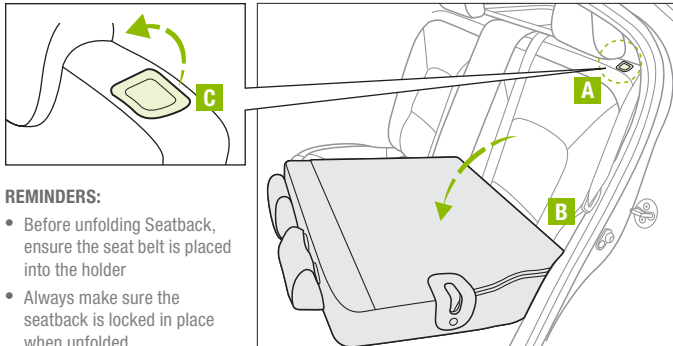

REMINDERS:

- Before unfolding Seatback, ensure the seat belt is placed into the holder.
- Always make sure the seatback is locked in place when unfolded.

For illustration purposes only. Actual vehicle might be slightly different.

Hood Release Lever and Latch

Opening the Hood:

1. Pull the Hood Release Lever **A** to unlatch the Hood.
2. In the front of the vehicle, lift the Hood slightly, pull the secondary Latch **B** inside of the Hood's center to the left and lift the Hood.

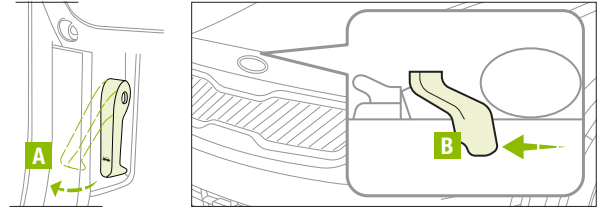

(Located on Driver side kick panel)

(Latch located inside hood)

Closing the Hood: Lower the Hood about halfway and then press down to securely lock in place.

Sunvisor†22

Use the Sunvisor to shield direct light through the front or side windows. Slide the Sunvisor out and adjust as needed.

REMINDERS:

- Sunvisor may not shield all direct light.
- Do not operate the vehicle if Sunvisor is impairing your visibility.
- Be aware of your seating position when adjusting or swinging Sunvisor around from the front or side windows.

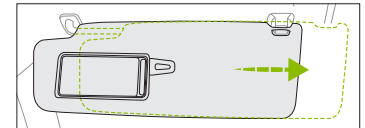

Smart Key*†15

Smart Key Fob:

- A** Press to lock All Doors
- B** Press to unlock Driver's Door. Press twice in 4 seconds to unlock All Doors
- C** Press and hold for more than 1 second to unlock Liftgate. Then lift the lid to manually open Liftgate

REMINDER: The Liftgate auto unlocks when the Smart Key fob is within close proximity of the vehicle Liftgate.

- D** Press and hold more than 1 second for Panic Alarm. To turn off Alarm, press any button
- E** Press to release Mechanical Key (on reverse side of fob)

Driver's Door Lock/Unlock button **F**:

- Press button once to unlock Driver's Door
- Press again within 4 seconds to unlock All Doors
- Press again to lock All Doors

Mechanical Key **G**:

- Use to unlock Driver's Door
- Use to enable/disable Child Safety Locks
- Use to unlatch rear center seatbelt lower anchor

QUICK TIPS

- If the Smart Key battery is weak or not working properly, hold the Smart Key fob up to the POWER button (Lock button side closest) and press to start vehicle
- The Smart Key's signal can be blocked by the normal operation of a cell phone or smartphone. To help prevent this, store each device separately

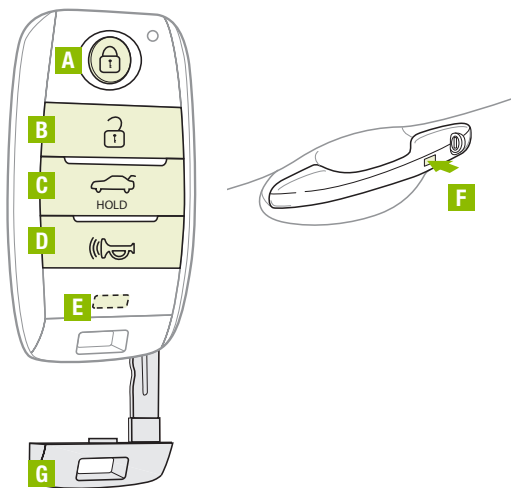

Double-Turn Lock/Unlock All

- Turn counterclockwise once to unlock Driver's Door
- Turn counterclockwise again within 4 seconds to unlock All Doors
- Turn clockwise once to lock All Doors

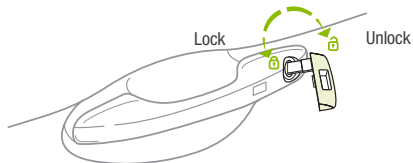

QR CODE

Kia Key Fob Video

To view a video on your mobile device, snap this QR Code or visit the listed website.

Refer to page 2 for more information.



www.youtube.com/KiaFeatureVideos

REMINDEES:

- Remote button configuration may vary depending on vehicle options
- One/two button turn logic can be changed in User Settings

Map/Room Lamps

Automatic turn off function*

The interior lights automatically turn off approximately 30 seconds after the POWER button is OFF.

Map Lamp/Room Lamp Operation

Push the lens **A** to turn the map lamp ON/OFF. This light produces a spot beam for convenient use as a map lamp or as a personal lamp for the driver or the front passenger.

Map/Room Lamp Button – Press button **B**, to turn the front and rear room lamps on and off.

Door Mode Button – Press button

C, to enable or disable Door Mode. In Door Mode the map and room lamps turn on when any door is opened. When all doors are locked or the ignition is on, the map and room lamp will turn off immediately.

Rear Room Lamps – Press the button **D** to turn the rear passenger lamp ON/OFF.

QUICK TIPS

- When doors are unlocked by the Smart Key*, the lamp turns ON for approximately 30 seconds
- If your vehicle is equipped with the theft alarm system, the interior lights automatically turn off approximately 3 seconds after the system is in armed stage
- Using interior lights for an extended period of time may cause 12V battery discharge

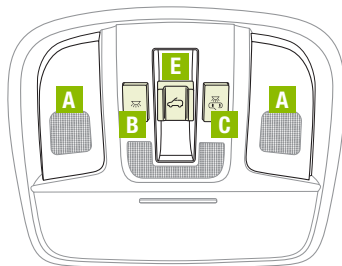

(Type B*)

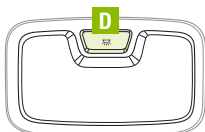

(Type C*)

Sunroof Operation*

The Sunroof and Sunshade operation is controlled through a multidirectional switch/lever, and the ignition needs to be in the ON position to operate the Sunroof/Sunshade.

Slide the Sunshade and Sunroof:

- Auto Open: Slide lever **E** backward to the farthest position and release
- Auto Close (Sunroof only): Slide the lever **E** forward to the farthest position and release

Slide the Sunroof (with Sunshade open):

- Open: Press the Sunroof lever **E** backward and press again forward/backward until you reach the desired detent position (manual slide feature)
- Close: Press the Sunroof lever **E** forward and press again forward/backward until you reach the desired detent position (manual slide feature)

Tilt the Sunroof:

- **Raise:** Push lever **E** upward
- **Lower:** Push lever **E** forward

QUICK TIPS

- To stop the Sunroof at any position, push or pull the Sunroof control lever in any direction
- Adjusting the sunroof past the first stop position (normal), in the fully opened position may cause wind buffeting noise

REMINDER: Sunshade needs to remain OPEN while Sunroof is open and vehicle is moving.

Do not adjust the sunroof or sunshade while driving. This could result in loss of control of the vehicle.

QR CODES

Sunroof Video

To view a video on your mobile device, snap this QR Code or visit the listed website. Refer to page 2 for more information.



www.youtube.com/KiaFeatureVideos

Parking Distance Warning-Forward and Reverse*

Reverse*⁺⁷The Parking Distance Warning-Forward and Reverse* is a supplemental system that is designed to assist the driver by chiming if any object is detected within the sensing area to the front and rear of the vehicle when moving forward or backing up.

The system is activated when the ignition is ON/READY and the vehicle is in R (Reverse). To deactivate the system, press the Parking Distance Warning-Forward* button

A (LED illuminated), when vehicle is in D (Drive) or R (Reverse).

To activate, press button **A** again (LED not illuminated).

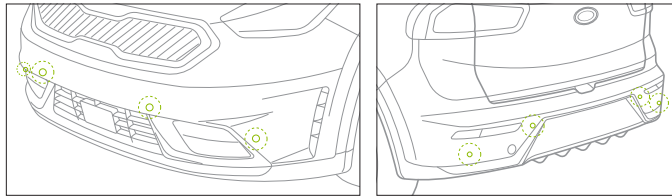
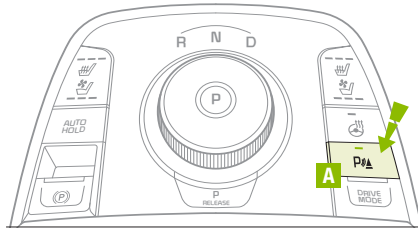

REMEMINDERS:

- If the vehicle is moving at speeds over 3 mph, the system may not activate correctly
- When more than two objects are sensed at the same time, the closest one will be recognized first
- The above images are for illustration purposes only. Operational details may vary

The Parking Distance Warning-Forward and Reverse system is not a substitute for proper and safe parking and backing-up procedures. Always drive safely and use caution when backing up. The Parking Distance Warning-Forward and Reverse system* may not detect every object in front of or behind the vehicle.*

Rear-Camera Display*⁺⁷

The Rear-Camera Display is a supplemental system that displays the view behind the vehicle through the audio system screens while the vehicle is in Reverse.

The Rear-Camera Display activates when the:

- POWER button is in the ON/READY position
- Rotary Dial Shifter Knob is in the R (Reverse) position

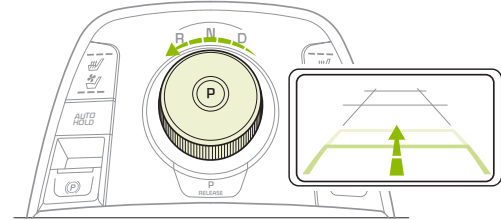

REMEMINDERS:

- The images shown are for illustration purposes only and may not reflect actual operation
- UVO link – While camera is active, only the audio controls on the Audio System can be operated
- UVO link with Navigation* – While camera is active, only the Audio System can be operated on the Steering Wheel and Audio Control Unit. All other features are disabled

The Rear-Camera Display is not a substitute for proper and safe backing-up procedures. The Rear-Camera Display may not display every object behind the vehicle. Always drive safely and use caution when backing up.

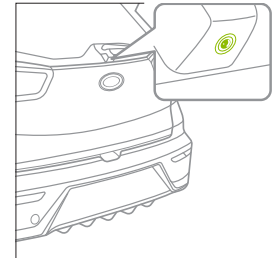

Driver Attention Warning (DAW)*†8

The DAW system is designed to alert the driver if it detects inattentive driving practices and, in certain situations, can alert the driver to take a break.

The DAW system is set to OFF by default. To turn the DAW system ON, turn the ignition on and then select User Settings in the LCD Display on the Instrument Cluster. Then go to Driving Assist and select Driver Attention Warning. Set the DAW system to Normal or High Sensitivity.

Driver Attention Warning (DAW) modes:

Off: The DAW system is deactivated **A**

Normal: The DAW system alerts the driver of his/her fatigue level or inattentive driving practices

High Sensitivity: The DAW system alerts the driver of his/her fatigue level or inattentive driving practices faster than Normal mode

If the DAW system is activated, the DAW system information will appear on the LCD Display **B** when you select the ASSIST mode .

A message, “Consider taking a break,” appears on the LCD display and a warning sounds to suggest the driver to take a break when the driver’s attention level is below one bar **C**.



(For illustration purposes only. Screen contents may vary)

REMINDERS:

- The setup of the DAW system will be maintained, as selected, when the ignition is cycled
- When activated, the DAW system does not display “Consider taking a break” message when the total trip driving time is less than 10 minutes
- The DAW system will enter a standby mode if the camera does not detect the lanes and/or the driving speed remains under 40 mph

Driver Attention Warning is not a substitute for safe driving and may not detect all instances of inattentive driving practices.

Failure to pay attention to travel conditions and vehicle operation could result in loss of vehicle control. Always drive safely and use caution.

Liftgate Release Button*

The button is located on the bottom of the Liftgate lid. With doors unlocked, press the Liftgate Release button **A** and pull the Liftgate up by the handle to open.

QUICK TIPS

- The Liftgate must be unlocked before it can be opened by the Liftgate Release Button
- The Liftgate unlocks automatically and then can be opened manually when the Smart Key* is within close proximity to the vehicle

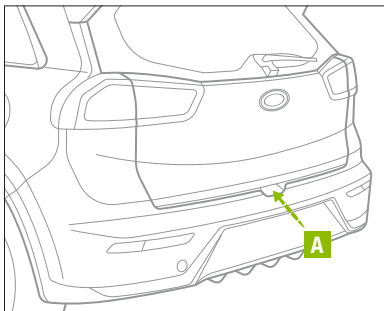

REMINDER: Pressing the Smart Key remote liftgate button only unlocks the liftgate. To open liftgate, also press the Liftgate Release button & pull the liftgate up by the handle to open.

Child-Protector Rear Door Lock

Locate these locks on the rear edge of the rear passenger doors. Turn the safety lock to the LOCK position to disable the inner door handles from opening the rear doors.

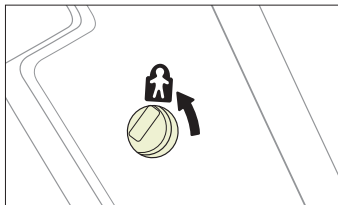

REMINDER: Child-Protector Rear Door Lock is located on rear passenger's door jamb.

Tire Mobility Kit

The Tire Mobility Kit may temporarily seal certain types of tire damage.

For operational information, please refer to the Owner's Manual.

B Sealant Bottle

C Compressor

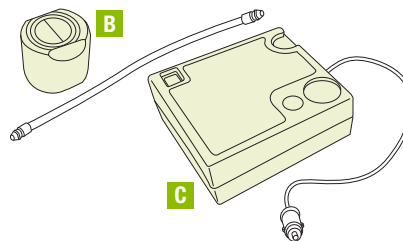

QUICK TIPS

- The Tire Mobility Kit is a temporary fix and is to be used for one tire only; the tire should be inspected as soon as possible
- The kit should only be used for sealing/inflating passenger car tires; do not use for inflating any other type of tires
- Some damaged tires cannot be sealed completely; do not use the kit if it appears a tire is damaged beyond repair

REMINDEES:

- The above images are for illustration purposes only and may not reflect actual operation
- After tire is properly sealed, drive cautiously and never exceed 50 mph or 120 miles on a tire that has been properly sealed with the Tire Mobility Kit
- Accessory spare tire kit is available for purchase

QR CODE

Tire Mobility Kit Video

To view a video on your mobile device, snap this QR Code or visit the listed website.

Refer to page 2 for more information.



www.youtube.com/KiaFeatureVideos

Occupant Detection System (ODS)^{†14} / Passenger Airbag Off Indicator^{†2,18}

ODS is designed to detect the presence and position of the front passenger and adjusts or turns off airbag deployment accordingly.

Depending on the situation and type of accident, the system may:

- Deploy airbag (Adult)
- Not deploy the airbag (Unoccupied)

If the system determines that the airbag should not be deployed, the “PASSENGER AIR BAG OFF” light will illuminate.



REMINDER: Do not allow an adult passenger to ride in the front seat when the Passenger Airbag Indicator is illuminated OFF because the airbag will not deploy in the event of a crash. The driver must instruct the passenger to reposition her/himself in the seat.

Seat Belts^{†18}

To properly fasten your safety belts:

1. Insert the belt tongue plate **A** into the buckle **B** until it clicks
2. Position the lap portion of the belt across your lap as **LOW ON THE HIPS** as possible **C**. Adjust the belt to a **SNUG FIT** by pulling up on the shoulder portion **D**

QUICK TIP

The Seat Belt warning chime operates for driver's seat only.

REMINDER: For maximum protection, always wear your Seat Belt.

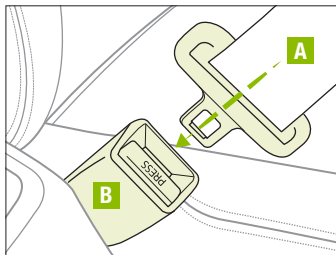

Seat Belt Retractor Locks

Retractor locks allow lap/shoulder seat belts to remain unlocked during normal vehicle operation for freedom of movement and increased comfort.

During a **STRONG STOP, SUDDEN TURN OR CERTAIN COLLISIONS**, seat belt retractors will automatically lock the belts to reduce the risk of injury.

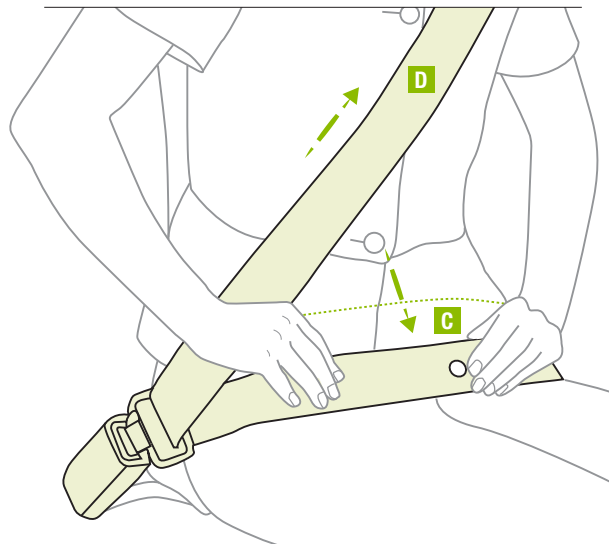

LEGAL DISCLAIMERS

Driving while distracted can result in a loss of vehicle control that may lead to an accident, severe personal injury and death. The driver's primary responsibility is in the safe and legal operation of a vehicle, and use of any handheld devices, other equipment or vehicle systems which take the driver's eyes, attention and focus away from the safe operation of a vehicle or that are not permissible by law should never be used during operation of the vehicle.

Safety Features: No system, no matter how advanced, can compensate for all driver error and/or driving conditions. Always drive safely.

- 1. UVO Link:** Purchase/lease of a new 2019 Kia Niro EV vehicle with UVO link includes a complimentary 1-year subscription starting from new vehicle retail sale/lease date as recorded by the dealer. After your complimentary 1-year UVO link subscription expires, continued access to UVO link will require a paid subscription at the then current subscription rate or your use of UVO link will immediately terminate. Use of UVO is subject to agreement to the UVO Privacy Policy (available at <https://www.myuvo.com/legal/privacy-policy.shtml>) and Terms of Service (available at <https://www.myuvo.com/legal/terms-of-service.shtml>). UVO link transferrable to subsequent owner during the original UVO link service term. Only use UVO link when safe to do so. The Kia Access with UVO link App is available from the App Store® or Google Play™ Store. Kia Motors America, Inc. reserves the right to change or discontinue UVO link at any time without prior notification or incurring any future obligation. Message and data rates may apply. Cellular and GPS coverage is required to use most features. UVO link features may vary by model, model year, and trim level. Features, specifications, and fees are subject to change. For more on details and limitations, visit <https://www.myuvo.com/> or your authorized Kia dealer. Google and logos are trademarks of Google, Inc. Apple Store is a service mark of Apple, Inc.
- 2. Airbags:** For maximum protection, always wear your seat belt.
- 3. Android Auto™:** Vehicle user interface is a product of Google and its terms and privacy statements apply. Requires the Android Auto app on Google Play and an Android compatible smartphone running Android™ 5.0 Lollipop or higher. Data plan rates apply. Android Auto is a trademark of Google LLC. Android™ is a registered trademark of Google, Inc. Distracted driving can result in a loss of vehicle control. Never use a handheld device or vehicle system that takes your focus away from safe vehicle operation.
- 4. Apple App Store:** App Store is a service mark of Apple, Inc.
- 5. Apple CarPlay®:** Apple CarPlay® a registered trademark of Apple Inc. Distracted driving can result in a loss of vehicle control. Never use a handheld device or vehicle system that takes your focus away from safe vehicle operation.
- 6. Bluetooth® Wireless Technology:** The Bluetooth® word mark and logos are registered trademarks owned by Bluetooth SIG Inc., and any use of such marks by Kia is pursuant to license. A Bluetooth® enabled cell phone is required to use Bluetooth® wireless technology.
- 7. Driver Assist Features – Forward Collision-Avoidance Assist (FCA) / Forward Collision Warning (FCW), Blind-Spot Collision Warning with Lane Change Assist, Rear Cross-Traffic Collision Warning (RCCW), Lane Keeping Assist (LKA), Rear-Camera Display, Parking Distance Warning - Forward and Reverse, Smart Cruise Control (SCC) with Stop & Go:** These features are not substitutes for safe driving, and may not detect all objects surrounding vehicle. Always drive safely and use caution.
- 8. Driver Attention Warning (DAW):** Driver Attention Warning is not a substitute for safe driving and may not detect all instances of driver fatigue or inattentive driving practices. Failure to pay attention to travel conditions and vehicle operation could result in loss of vehicle control. Always drive safely and use caution.
- 9. Electronic Stability Control (ESC) / Traction Control System (TCS)/Hill-start Assist Control (HAC):** No system, no matter how advanced, can compensate for all driver error and/or driving conditions. Always drive safely.
- 10. Front Seat Headrest Adjustment:** Never attempt to adjust headrests when vehicle is in motion.
- 11. Google Play™ Store** is a trademark of Google, Inc. ©2019 Google Inc. All rights reserved. Google and the Google Logo are registered trademarks of Google Inc.
- 12. iPhone®/iPod®:** iPhone and iPod are registered trademarks of Apple Inc. Distracted driving can result in a loss of vehicle control. Never use a handheld device or vehicle system that takes your focus away from safe vehicle operation.
- 13. Navigation:** Distracted driving can result in a loss of vehicle control. When operating a vehicle, never use a vehicle system that takes your focus away from safe vehicle operation. Navigation is for information purposes only, and Kia does not make any warranties about the accuracy of the information.
- 14. Occupant Detection System (ODS):** Kia vehicles use a number of different ODS types that vary by model.
- 15. Power Button with Smart Key:** Always come to a complete stop before turning the power on or off. However, if you have an emergency while the vehicle is in motion and must turn the power off, you can turn the power off to the ACC position by pressing the Power button for more than 3 seconds or 3 times in succession. If the vehicle is still moving, you can restart the power by pressing the Power button with the shift lever in Neutral (N). With the power off, hydraulic power assist for steering and braking will be disabled and the vehicle will be more difficult to control.
- 16. Roadside Assist:** 24-hour Enhanced Roadside Assistance is a service plan provided by Kia Motors America, Inc. Certain limitations apply. Coverage details are available in the Kia Warranty and Consumer Information Manual. For access to Enhanced Roadside Assistance, a connected mobile phone via Bluetooth® within the cellular service coverage area is required.
- 17. Seat adjustments:** Reclining the passenger seats can reduce the effectiveness of the safety restraint system and may lead to additional injury in an accident.
- 18. Seat belts:** For maximum protection, always wear your seatbelt.
- 19. Seat warmers:** Use extreme caution when using the seat warmers to avoid burns. Refer to the Owner's Manual for more information.
- 20. SiriusXM®:** SiriusXM Satellite Radio, SiriusXM Traffic and SiriusXM Travel Link each require a subscription sold separately, or as a package, by SiriusXM Radio Inc. **If you decide to continue your service at the end of your trial subscription, the plan you choose will automatically renew and bill at then-current rates until you call 1-866-635-2349 to cancel. See SiriusXM Customer Agreement for complete terms at www.siriusxm.com.** Other fees and taxes will apply. All fees and programming are subject to change. Not all vehicles or devices are capable of receiving all services offered by SiriusXM. Data displays and individual product availability vary by vehicle hardware. Current information and features may not be available in all locations, or on all receivers. Weather Forecast, Current Conditions may not be available in all locations. Images above are for representative purposes only and are not real products. For actual features and images of real products, consult the vehicle manufacturer. SiriusXM is not responsible for any errors or inaccuracies in the data services or their use in the vehicle. Travel Link Stocks displays current price and daily delta of around 7,000 actively reported securities traded on the NYSE®, NASDAQ® and AMEX®. The service is delayed approximately 20 minutes. SiriusXM satellite service is available only to those at least 18 years of age in the 48 contiguous USA, DC, and Puerto Rico (with coverage limitations). SiriusXM Internet Radio service is available throughout our satellite service area and in AK and HI. © 2019 SiriusXM Radio Inc. Sirius, XM and all related marks and logos are trademarks of SiriusXM Radio Inc.
- 21. Steering-wheel-mounted controls:** Driving while distracted is dangerous and should be avoided. Remain attentive to driving and be cautious when using steering-wheel-mounted controls while driving.
- 22. Sunvisors:** Sunvisor may not shield all direct light. Do not operate the vehicle if sunvisor is impairing your visibility.
- 23. Tilt/Telescoping Steering Wheel:** Never attempt to adjust steering wheel position when vehicle is in motion.
- 24. Tire Pressure Monitoring System (TPMS):** Even with Tire Pressure Monitoring System, check tire pressure on a regular basis.



KEY FEATURE WALKTHROUGH

Android Auto™ / Apple CarPlay® Setup* – page 31

UVO link Activation* – page 32

Walk customer through the registration/activation process for UVO link.



UVO link – page 33

For further operational information, refer to the Car Multimedia System User's Manual.

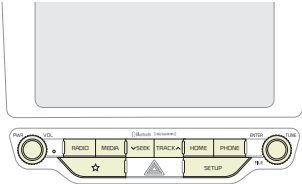

UVO link with Navigation* – page 34

For further operational information, refer to the Car Multimedia System User's Manual.

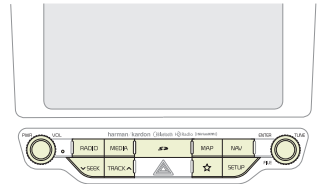

Aux/USB/iPod® Port & Power Outlets – page 35

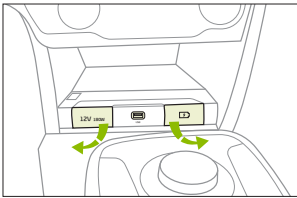

Cruise Control – page 28

Demonstrate operation

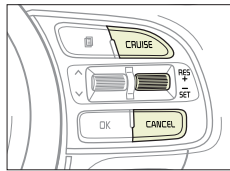

Bluetooth® Wireless Technology – page 26

Demonstrate operation, and pair customer's phone.

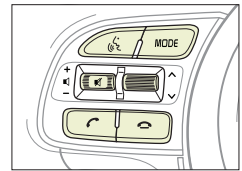

- Tire Pressure Monitoring System (TPMS) – page 6
- Trip Modes / Trip Computer – page 7
- Energy Economy – page 6
- Drive Modes – page 11
- Power Button – page 22
- Audio Controls – page 28
- Digital Clock – page 35
- Seat Warmers/Ventilated Seats* – page 40

- Sunvisor – page 42
- Smart Key – page 43
- Parking Distance Warning-Forward and Reverse* – page 45
- Rear-Camera Display* – page 45
- Tire Mobility Kit – page 47
- Passenger Airbag Off Indicator – page 48

*IF EQUIPPED

DURING DELIVERY

- Explain first service process and schedule first service appointment
- Tour Parts & Service departments, introduce staff & explain value of Kia Parts and Service
- Review recommended maintenance schedule and maintenance requirements to validate warranty
- Review business hours & Customer 360° Care
- Review the Kia 10-year/100,000-mile warranty program
- Ensure 100% satisfaction with sales and delivery process and no problems with the vehicle
- Confirm time and best contact number for initial dealer follow-up

Sales Consultant: _____ Date: _____

Sales Manager: _____ Date: _____

Customer: _____ Date: _____



NIRO EV CUSTOMER DELIVERY CHECKLIST

Owner's Name: _____ VIN: _____ Mileage: _____

Dealership Name: _____ Sales Consultant: _____ Date: _____

BEFORE DELIVERY

- Confirm "Good Battery" with a Kia battery tester
- Verify all tire pressures are to spec (see driver's door label) LF _____ LR _____ RF _____ RR _____
- Verify proper operation of Remote Keyless Entry and Smart Key lock/unlock
- Ensure floor mats are snapped into place (if applicable)
- Verify vehicle is clean (interior and exterior), in good condition and free of chips and scratches
- Ensure all key documents are in the vehicle (Owner's Manual, Warranty and Consumer Information booklet, Tire Warranty booklet and Features & Functions Guide and any supplemental audio user's guides)

KEY FEATURE WALKTHROUGH

- Instrument Cluster / EV Displays – page 3

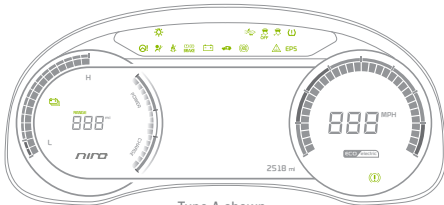

Type A shown

- EV Mode Displays* on the audio control unit – page 13

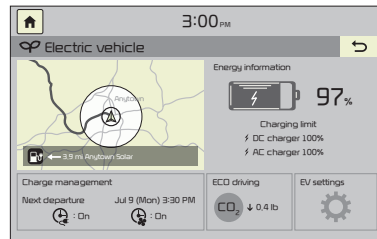

- Climate Control System* – page 37

Demo Defrost and Defog Windshield

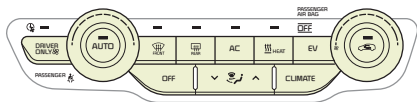

Type B shown

- Windshield/Rear Wipers & Washers – page 25

Windshield: Move lever Up/Down to change Wiper modes. Rotate lever to adjust Intermittent Wipe Speed.

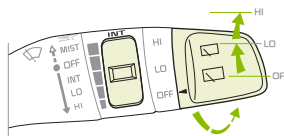

Windshield
 MIST: Single wipe
 OFF: Wipe off
 INT: Intermittent wipe
 LD: Slow wipe
 HI: Fast wipe

Pull to spray and wipe.

(up to 60,000 miles)^A

MAINTENANCE ITEMS	MAINTENANCE INTERVALS (MILES)							
	7,500	15,000	22,500	30,000	37,500	45,000	52,500	60,000
Rotate tires (every 6,500 miles)	P	P	P	P	P	P	P	P
Climate control air filter [‡]	I	I	I	R	I	I	I	R
12V battery condition	I	I	I	I	I	I	I	I
Steering gear rack, linkage & boots	I	I	I	I	I	I	I	I
Air conditioner refrigerant (compressor [‡])	I	I	I	I	I	I	I	I
Brake fluid	I	I	I	I	I	I	I	I
Brake lines, hoses and connections	I	I	I	I	I	I	I	I
Disc brakes and pads	I	I	I	I	I	I	I	I
Brake pedal	I	I	I	I	I	I	I	I
Drive shafts and boots		I		I		I		I
Suspension ball bolts		I		I		I		I
Reduction Gear Oil			I		I		I	

QUICK TIP

Check your Maintenance Schedule or schedule an appointment with a dealer using your UVO link account by logging into your Kia Access with UVO link App or your account on MyUVO.com (See page 32 for setup information)

[‡] If equipped.

A. See the Owner's Manual for complete maintenance schedule.

B. And, if necessary, adjust, correct, clean or replace.

See your Owner's Manual for more details and complete maintenance information, including severe maintenance schedule. Warranty may be voided if maintenance schedule is not followed.