



4C

2019

Alpine® Radio

TABLE OF CONTENTS

SECTION		PAGE
1	SAFETY GUIDELINES	3
2	GETTING STARTED	15
3	RADIO	21
4	RBDS	25
5	CD/MP3/WMA	27
6	SOUND SETTING	37
7	SETUP	69
8	BLUETOOTH HANDS FREE CALLING	79
9	ACCESSORIES	99
10	SIRIUSXM SATELLITE RADIO OPERATION — IF EQUIPPED	117
11	ADDITIONAL INFORMATION	135

SAFETY GUIDELINES

CONTENTS

- WARNINGS/CAUTIONS/PRECAUTIONS4
- CYBERSECURITY13

WARNINGS/CAUTIONS/PRECAUTIONS

WARNING!

Always drive safely with your hands on the steering wheel and obey all applicable laws. You have full responsibility and assume all risks related to the use of the features and applications in this vehicle. Only use the features and applications in this vehicle when it is safe to do so. Failure to do so may result in an accident involving in serious injury or death.

⚠ WARNING

This symbol means important instructions. Failure to heed them can result in serious injury or death.

Glance at screen only when safe to do so. If prolonged viewing of the screen is required, park in a safe location and set the parking brake

KEEP THE VOLUME AT A LEVEL WHERE YOU CAN STILL HEAR OUTSIDE NOISES WHILE DRIVING.

Excessive volume levels that obscure sounds such as emergency vehicle sirens or road warning signals (train crossings, etc.) can be dangerous and may result in an

accident. LISTENING AT LOUD VOLUME LEVELS IN A CAR MAY ALSO CAUSE HEARING DAMAGE.

DO NOT DISASSEMBLE OR ALTER.

Doing so may result in an accident, fire or electric shock.

USE ONLY IN CARS WITH A 12 VOLT NEGATIVE GROUND.

(Check with your dealer if you are not sure.) Failure to do so may result in fire, etc.

KEEP SMALL OBJECTS SUCH AS BATTERIES OUT OF THE REACH OF CHILDREN.

Swallowing them may result in serious injury. If swallowed, consult a physician immediately.

USE THE CORRECT AMPERE RATING WHEN REPLACING FUSES.

Failure to do so may result in fire or electric shock.

DO NOT BLOCK VENTS OR RADIATOR PANELS.

Doing so may cause heat to build up inside and may result in fire.

USE THIS PRODUCT FOR MOBILE 12 VOLT APPLICATIONS.

Use for other than its designed application may result in fire, electric shock or other injury.

DO NOT PLACE HANDS, FINGERS OR FOREIGN OBJECTS IN INSERTION SLOTS OR GAPS.

Doing so may result in personal injury or damage to the product.

CAUTION

This symbol means important instructions. Failure to heed them can result in injury or material property damage.

HALT USE IMMEDIATELY IF A PROBLEM APPEARS.

Failure to do so may cause personal injury or damage to the product. Return it to your authorized Alpine dealer or the nearest Alpine Service Center for repairing.

PRECAUTIONS

Product Cleaning

Use a soft dry cloth for periodic cleaning of the product. For more severe stains, please dampen the cloth with

water only. Anything else has the chance of dissolving the paint or damaging the plastic.

Temperature

Ensure the temperature inside the vehicle is between +140° F (+60° C) and +14° F (-10° C) before turning your unit on.

Moisture Condensation

You may notice the CD playback sound wavering due to condensation. If this happens, remove the disc from the player and wait about an hour for the moisture to evaporate.

Damaged Disc

Do not attempt to play cracked, warped, or damaged discs. Playing a bad disc could severely damage the playback mechanism.

Maintenance

If you have problems, do not attempt to repair the unit yourself. Return it to your Alpine dealer or the nearest Alpine Service Station for servicing.

Never Attempt the Following

Do not grip or pull out the disc while it is being pulled back into the player by the automatic reloading mechanism. Do not attempt to insert a disc into the unit when the unit power is off.

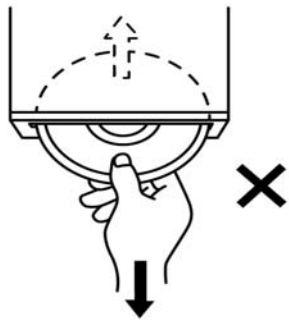

Inserting Discs

Your player accepts only one disc at a time for playback. Do not attempt to load more than one disc.

Ensure the label side is facing up when you insert the disc. "Error" will be displayed on your player if you insert a disc incorrectly. If "Error" continues to be displayed even though the disc has been inserted correctly, push the RESET switch with a pointed object such as a ballpoint pen.

Playing a disc while driving on a very bumpy road may result in skips, but this will not scratch the disc or damage the player.

New Discs

To prevent the CD from jamming, "Error" is displayed if discs with irregular surfaces are inserted or if discs are inserted incorrectly. When a new disc is ejected immediately after initial loading, use your finger to feel around the inside of the center hole and outside edge of the disc. If you feel any small bumps or irregularities, this could inhibit proper loading of the disc. To remove the bumps, rub the inside edge of the hole and outside edge of the disc with a ballpoint pen or other such instrument, then insert the disc again.

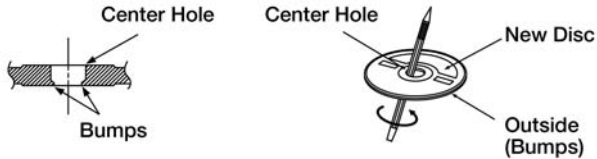

Irregular Shaped Discs

Be sure to use round discs only for this unit and never use any special shaped discs.

Use of anything but round discs may cause damage to the mechanism.

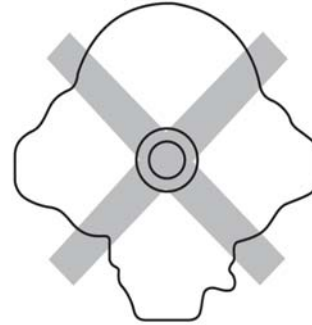

Installation Location

Ensure this unit will not be installed in a location subjected to:

- Direct sun and heat
- High humidity and water

8 SAFETY GUIDELINES

- Excessive dust
- Excessive vibrations

Correct Handling

Do not drop the disc while handling. Hold the disc so you will not leave fingerprints on the surface. Do not affix tape, paper, or gummed labels to the disc. Do not write on the disc.

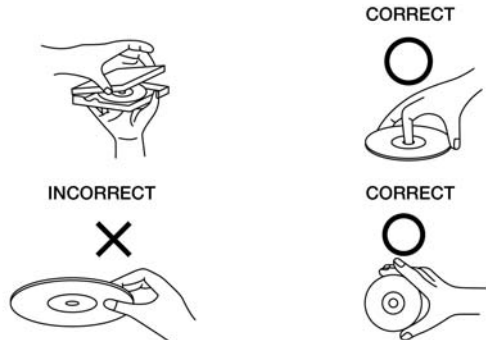

Disc Cleaning

Fingerprints, dust, or soil on the surface of the disc could cause the CD player to skip. For routine cleaning, wipe the playing surface with a clean, soft cloth from the center of the disc to the outer edge. If the surface is heavily soiled, dampen a clean, soft cloth in a solution of mild neutral detergent before cleaning the disc.



Disc Accessories

There are various accessories available on the market for protecting the disc surface and improving sound quality. However, most of them will influence the thickness and/or diameter of the disc. Using such accessories can cause the disc to be out of standard specifications and may create operational problems. We recommend not using these accessories on discs played in Alpine CD players.

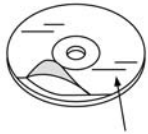

Transparent Sheet

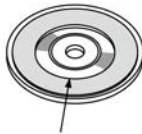

Disc Stabilizer

On handling Compact Discs (CD/CD-R/CD-RW)

- Do not touch the surface.
- Do not expose the disc to direct sunlight.
- Do not affix stickers or labels.
- Clean the disc when it is dusty.
- Make sure that there are no bumps around the disc.
- Do not use commercially available disc accessories.

Do not leave the disc in the car or the unit for a long time. Never expose the disc to direct sunlight. Heat and humidity may damage the CD and you may not be able to play it again.

To customers using CD-R/CD-RW

- If a CD-R/CD-RW cannot be played back, make sure the last recording session was closed (finalized).
- Finalize the CD-R/CD-RW if necessary, and attempt playback again.

About media that can be played

Use only compact discs with the label side showing the CD logo marks below.



If you use unspecified compact discs, correct performance cannot be guaranteed.

You can play CD-Rs (CD-Recordables)/CD-RWs (CD-ReWritables) which have been recorded only on audio devices.

You can also play CD-Rs/CD-RWs containing MP3/WMA/AAC formatted audio files.

- Some of the following CDs may not play on this unit: Flawed CDs, CDs with fingerprints, CDs exposed to extreme temperatures or sunlight (e.g., left in the car or this unit), CDs recorded under unstable conditions, CDs on which a recording failed or a re-recording was attempted, copy-protected CDs which do not conform to the audio CD industry standard.
- Use discs with MP3/WMA/AAC files written in a format compatible with this unit. For details, refer to “About MP3/WMA/AAC” on page 32.
- ROM data other than audio files contained in a disc will not produce sound when played back.

Protecting the USB connector

- Only a Flash Memory or iPod/iPhone can be connected to the USB port on this unit. Correct performance using other USB products cannot be guaranteed.
- If the USB connector is used, be sure to use a USB extension cable (supplied). A USB hub is not supported.

- Depending on the connected Flash Memory device, the unit may not function or some functions may not be performed.
- The audio file format that can be played back on the unit is MP3/WMA/AAC.
- Artist/song name, etc., can be displayed. Certain, special characters may not be correctly displayed.
- Fix the Flash Memory in a location where driver operation will not be hindered.
- Flash Memory may not function correctly at high or low temperature.
- Use only certified Flash Memory. Pay attention that even certified Flash Memory, may not function correctly depending on its type or state.

⚠ On Handling Flash Memory

CAUTION!

Alpine accepts no responsibility for lost data, etc., even if data, etc. is lost while using this product.

- To prevent malfunction or damage, note the following points. Read the Flash Memory Owner's Manual thoroughly. Do not touch the terminals by hand or metal. Do not subject Flash Memory to excessive shock. Do not bend, drop, disassemble, modify or soak in water.
- Avoid usage or storage in the following locations: Anywhere in the car exposed to direct sunlight or high temperatures. Anywhere the possibility of high humidity or corrosive substances are present.
- Flash Memory function is not guaranteed. Use Flash Memory according to the terms of agreement.
- Depending on the settings of the Flash Memory type, memory state or encoding software, the unit may not play back or display properly.
- A file that is copy-protected (copyright protection) cannot be played back.
- Flash Memory may take time to start playback. If there is a particular file other than audio in the Flash Memory, it may take considerable time before the file is played back or searched.
- The unit can play back "mp3", "wma" or "m4a" file extensions.

12 SAFETY GUIDELINES

- Do not add the above extensions to a file other than audio data. This non-audio data will not be recognized. The resulting playback may contain noise that can damage speakers and/or amplifiers.
- It is recommended to back up important data on a personal computer.

- Windows Media and the Windows logo are trademarks, or registered trademarks of Microsoft Corporation in the United States and/or other countries.
- iPhone, iPod, iPod classic, iPod nano, and iPod touch are trademarks of Apple Inc., registered in the U.S. and other countries.
- “Made for iPod,” and “Made for iPhone,” mean that an electronic accessory has been designed to connect specifically to iPod, or iPhone, respectively, and has been certified by the developer to meet Apple performance standards. Apple is not responsible for the operation of this device or its compliance with safety and regulatory standards. Please note that the use of this accessory with iPod, or iPhone may affect wireless performance.

- The Bluetooth word mark and logos are registered trademarks owned by the Bluetooth SIG, Inc. and any use of such marks by Alpine Electronics, Inc. is under license. Other trademarks and trade names are those of their respective owners.
- MPEG Layer-3 audio coding technology licensed from Fraunhofer IIS and Thomson. Supply of this product only conveys a license for private, non-commercial use and does not convey a license nor imply any right to use this product in any commercial (i.e. revenue-generation) real time broadcasting (terrestrial, satellite, cable and/or any other media), broadcasting/streaming via internet, intranets and/or other networks or in other electronic content distribution systems, such as pay-audio or audio-on-demand applications. An independent license for such use is required. For details, please visit <http://www.mp3licensing.com>
- HD Radio Technology manufactured under license from iBiquity Digital Corporation. U.S. and Foreign Patents. HD Radio and the HD, HD Radio, and “Arc” logos are proprietary trademarks of iBiquity Digital Corp.

- Pandora, the Pandora logo, and the Pandora trade dress are trademarks or registered trademarks of Pandora Media, Inc., used with permission. Pandora is currently available exclusively in the United States.
- Sirius, XM and all related marks and logos are trademarks of Sirius XM Radio Inc. All rights reserved.
- Android is a trademark of Google Inc.

CYBERSECURITY

Your vehicle may be a connected vehicle and may be equipped with both wired and wireless networks. These networks allow your vehicle to send and receive information. This information allows systems and features in your vehicle to function properly.

Your vehicle may be equipped with certain security features to reduce the risk of unauthorized and unlawful access to vehicle systems and wireless communications. Vehicle software technology continues to evolve over time and FCA US LLC, working with its suppliers, evaluates and takes appropriate steps as needed. Similar to a computer or other devices, your vehicle may require software updates to improve the usability and performance of your systems or to reduce the potential risk of unauthorized and unlawful access to your vehicle systems.

The risk of unauthorized and unlawful access to your vehicle systems may still exist, even if the most recent version of vehicle software (such as Uconnect software) is installed.

WARNING!

- It is not possible to know or to predict all of the possible outcomes if your vehicle's systems are breached. It may be possible that vehicle systems, including safety related systems, could be impaired or a loss of vehicle control could occur that may result in an accident involving serious injury or death.
- ONLY insert media (e.g., USB, SD card, or CD) into your vehicle if it came from a trusted source. Media of unknown origin could possibly contain malicious software, and if installed in your vehicle, it may increase the possibility for vehicle systems to be breached.
- As always, if you experience unusual vehicle behavior, take your vehicle to your nearest authorized dealer immediately.

NOTE:

- FCA or your dealer may contact you directly regarding software updates.
- To help further improve vehicle security and minimize the potential risk of a security breach, vehicle owners should:
 - Routinely check www.driveuconnect.com/support/software-update.html to learn about available Uconnect software updates.
 - Only connect and use trusted media devices (e.g. personal mobile phones, USBs, CDs).

Privacy of any wireless and wired communications cannot be assured. Third parties may unlawfully intercept information and private communications without your consent. For further information, refer to “Onboard Diagnostic System (OBD II) Cybersecurity” in “Getting To Know Your Instrument Panel” in your Owner’s Manual.

GETTING STARTED

CONTENTS

■ GETTING STARTED	16	□ Adjusting Volume	19
□ Turning Power On And Off	16	□ Setting The Dimmer Control	19
□ Source Selection	17	□ Setting The Time	20
□ Detaching And Attaching The Front Panel	17	□ Controllable With Remote Control	20
□ Initial System Start-Up	19		

GETTING STARTED

WARNING!

Always drive safely with your hands on the steering wheel and obey all applicable laws. You have full responsibility and assume all risks related to the use of the features and applications in this vehicle. Only use the features and applications in this vehicle when it is safe to do so. Failure to do so may result in an accident involving in serious injury or death.

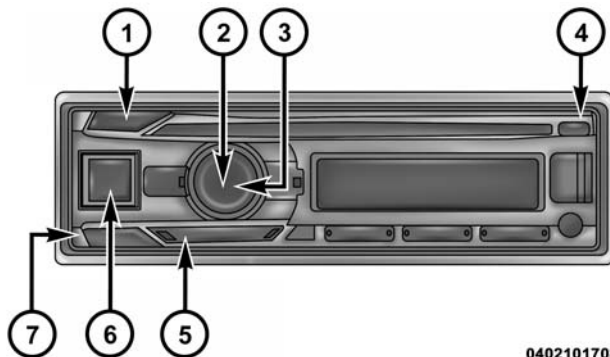

0402101708NA

- 1 — AUDIO/SETUP
 2 — Rotary Encoder
 3 — Q /ENTER Button
 4 — DIM

- 5 — BACK/POWER BUTTON
 6 — SOURCE
 7 — EJECT BUTTON

Turning Power On And Off

Press to turn on the unit.

NOTE:

- The unit can be turned on by pressing any other button except .

-  /SOURCE key blinks each time the unit is powered on.

Press and hold  for at least 2 seconds to turn off the unit.

NOTE:

- The first time power is turned on, the volume will start from level 12.

Source Selection

Push  /SOURCE to change the source.

HD Radio → SiriusXM*1 → Disc → USB/iPod*2 → BLUETOOTH Audio*3 → PANDORA*4 → Auxiliary*5 → HD Radio

*1 Displayed only when a SiriusXM Tuner is connected.

*2 Displayed only when the iPod/iPhone is connected.

*3 Displayed only when Bluetooth IN is set to ON, refer to “Setting The BLUETOOTH Connection (Bluetooth IN)” on page 84.

*4 Not displayed when Alpine APP is set to OFF, refer to “Setting The Communication Mode With A Smartphone (Alpine APP)” on page 77.

*5 Displayed only when the AUX IN is set to ON, refer to “Setting The AUX SETUP Mode” on page 72.

Detaching And Attaching The Front Panel

Detaching

1. Turn off the unit power.
2. Press  (OPEN) to open the front panel.

To close the front panel, press the left side until it locks.

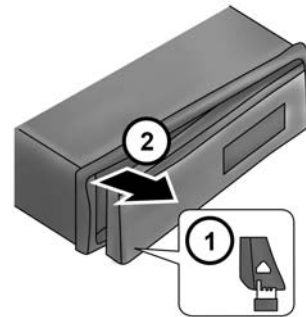

0402101709NA

- 1 — EJECT Button
- 2 — Pull Radio Outward

3. Grasp the front panel firmly, slide to the left (1), and then pull to remove (2).

NOTE:

- The front panel may become hot in normal usage (especially the connector terminals on the back of the front panel). This is not a malfunction.
- To protect the front panel, place it in the supplied carrying case.
- When detaching the front panel, do not apply excessive force as it may result in a malfunction.
- Do not leave the front panel open, or drive the car with the panel open as it may result in an accident or malfunction.

Attaching

1. Insert the right side of the front panel into the main unit. Align the groove on the front panel with the projections on the main unit (1).
2. Push the left side of the front panel until it locks firmly into the main unit (2).

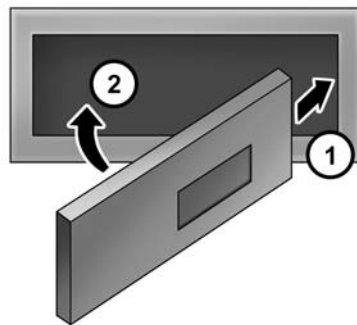

0101068314

NOTE:

- Before attaching the front panel, make sure that there is no dirt or dust on the connector terminals and no foreign objects between the front panel and the main unit.
- Attach the front panel carefully, holding the sides of the front panel to avoid pushing buttons by mistake.

Initial System Start-Up

NOTE: Be sure to press the RESET button when using the unit for the first time, after changing the car battery, or using the battery disconnect (anytime the vehicle loses power).

To reset the system, perform the following procedure:

1. Turn off the unit.
2. Press  (OPEN) to open the front panel, and then remove it.
3. Press RESET button (1) with a ballpoint pen or similar pointed object.

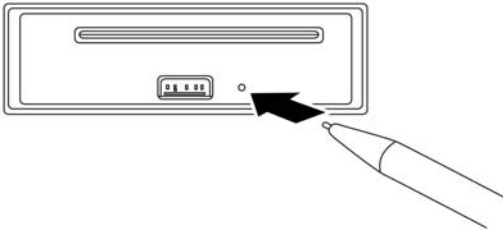

0402101710NA

Adjusting Volume

Turn the Rotary encoder until the desired sound level is obtained.

Setting The Dimmer Control

Press and hold DIM for at least two seconds to select the DIMMER mode.

DIMMER AUTO → DIMMER ON → DIMMER OFF → DIMMER AUTO

DIMMER AUTO Mode:

Decrease the illumination of the unit's buttons while the vehicle headlights are ON. The unit's backlighting will decrease with headlight usage.

DIMMER ON Mode:

Keep the illumination of the backlighting dimmed.

DIMMER OFF Mode:

Keep the illumination of the backlighting bright.

NOTE: The setting items are the same as DISPLAY setting in SETUP mode. For details, refer to "Dimmer Control".

Setting The Time

1. Press and hold AUDIO/SETUP for at least two seconds to activate the SETUP selection mode.
2. Turn the Rotary encoder to select the General mode, and then press **Q** /ENTER.
3. Turn the Rotary knob to select Clock Adjust, and then press **Q** /ENTER. The time indication will blink.
4. Turn the Rotary knob to adjust the hours while the time indication is blinking.
5. Press **Q** /ENTER.
6. Turn the Rotary knob to adjust the minutes while the time indication is blinking.
7. Press and hold AUDIO/SETUP for at least two seconds to return to normal mode.

NOTE:

- To synchronize the clock to another clock/watch or radio time announcement, press and hold **Q** /ENTER for at least two seconds after setting the "hour." Minutes will reset to 00. If the display shows over "30" minutes when you do this, the time will advance one hour.

- Pressing **↩** returns to the previous SETUP mode.
- If no operation is performed for 60 seconds, SETUP is canceled.

Controllable With Remote Control

This unit can be controlled with an optional Alpine remote control. For details, consult your Alpine dealer. Point the optional remote control transmitter at the remote-control sensor (1).

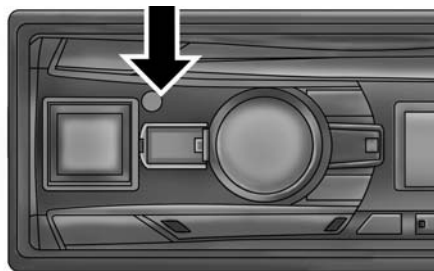

0402101711NA

Remote Control Sensor Connectable to Remote Control Interface Box

With an optional Alpine Steering Wheel Remote Control Interface Box, this unit is controllable from the vehicles steering wheel controls. For details, contact your Alpine dealer.

RADIO

CONTENTS

■ RADIO22	□ Presetting Stations Automatically24
□ Listening To Radio23	□ Tuning To Preset Stations24
□ Presetting Stations Manually23	□ Frequency Search Function24

RADIO

WARNING!

Always drive safely with your hands on the steering wheel and obey all applicable laws. You have full responsibility and assume all risks related to the use of the features and applications in this vehicle. Only use the features and applications in this vehicle when it is safe to do so. Failure to do so may result in an accident involving in serious injury or death.

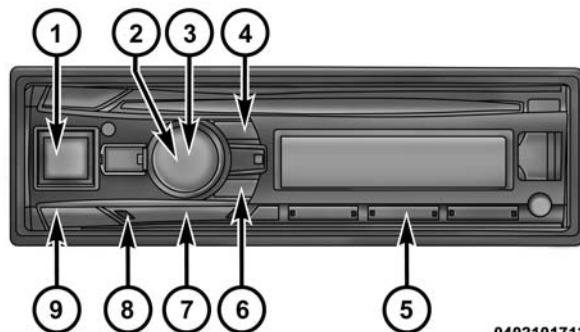

0402101712NA

- | | |
|----------------------------|------------------------|
| 1 — SOURCE | 6 — ⏮ Fast Rewind |
| 2 — Q /ENTER | 7 — Tune/A.ME |
| 3 — Rotary Encoder | 8 — Back Button |
| 4 — ⏭ Fast Forward | 9 — BAND Select Button |
| 5 — Preset Buttons (1 — 6) | |

Depending on the Listen Mode setting, this unit will tune to either the Digital or Analog signals.

Listening To Radio

1. Press  /SOURCE to select Radio mode.
2. Press BAND repeatedly until the desired radio band is displayed.
FM1 → FM2 → AM → FM1
3. Press TUNE/A.ME to select the tuning mode.
DX (Distance mode) → LOCAL (Local mode) →
MANUAL (Manual mode) → DX

NOTE:

- The initial mode is Distance mode.

Distance mode:

Both strong and weak stations will be automatically tuned in (Automatic Seek Tuning).



Local mode:

Only strong stations will be automatically tuned in (Automatic Seek Tuning).

Manual mode:

The frequency is manually tuned in steps (Manual tuning).

4. Press  or  to tune in the desired station.

Holding down  or  will change the frequency continuously.

Presetting Stations Manually

1. Select the radio band and tune in a desired radio station you wish to store in the preset memory.
2. Press and hold, for at least two seconds, any one of the preset buttons (1 through 6) into which you wish to store the station.

The display shows the band, preset number and station frequency memorized.

NOTE:

- A total of 18 stations can be stored in the preset memory (6 stations for each band; FM1, FM2 and AM).
- If you store a station in a preset memory which already has a station, the current station will be cleared and replaced with the new station.

Presetting Stations Automatically

1. Press BAND repeatedly until the desired radio band is displayed.
2. Press and hold TUNE/A.ME for at least two seconds.

The frequency on the display continues to change while the automatic memory is in progress. The tuner will automatically seek and store 6 strong stations in the selected band. They will be stored into preset buttons 1 to 6 in order of signal strength. When the automatic memory has been completed, the tuner goes to the station stored in preset location No.1.

NOTE:

- If no stations are stored, the tuner returns to the station you were listening to before the auto memory procedure began.

Tuning To Preset Stations

1. Press BAND repeatedly until the desired band is displayed.
2. Press any one of the station preset buttons (1 through 6) that has your desired radio station in memory.

The display shows the band, preset number and frequency of the station selected.

Frequency Search Function

You can search for a radio station by its frequency.

1. Press  /ENTER in Radio mode to activate the search mode.
2. Turn the Rotary encoder to select the desired frequency. *

* Operation is not required when Listen Mode is set to Analog.

3. Turn the Rotary knob to select the desired frequency.
4. Press  /ENTER to receive the selected frequency.

NOTE:

- Press  in the search mode to cancel. Or, the search mode will be canceled if no operation is performed for 60 seconds.

RBDS

CONTENTS

■ RBDS26	□ Displaying Radio Text26
□ PTY (Program Type) Tuning26		

RBDS

The RBDS (Radio Broadcast Data System) is a radio information system.

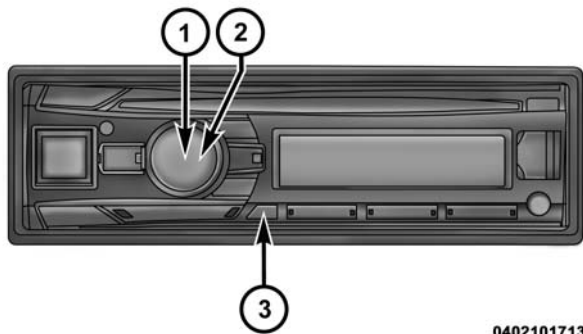

0402101713NA

1 — Q /ENTER

2 — Rotary Encoder

3 — VIEW Button

PTY (Program Type) Tuning

1. Press and hold ENTER/OPTION for at least two seconds while the unit is in Radio (FM receiving) mode.

2. Turn the Rotary encoder to select PTY SELECT, and then press Q /ENTER.
3. Turn the Rotary encoder to choose the desired program type while the PTY (program type) is being displayed.
4. Press Q /ENTER after selecting the program type to start searching for a station in the selected program type.

The chosen program type display blinks during searching and lights when a station is found.

If no PTY station is found, "NO PTY" will be displayed for five seconds.

Displaying Radio Text

Text messages from a radio station can be displayed.

Press  while receiving FM in the radio mode to select the Radio Text display.

The display will change every time the button is pressed.

CD/MP3/WMA

CONTENTS

■ CD/MP3/WMA.28	□ Folder/File Name Search (Concerning MP3/WMA)31
□ Playback.28	□ Search Position Memory32
□ Repeat And Random (M.I.X.) Play30	□ About MP3/WMA32
□ Searching For CD Text30		

CD/MP3/WMA

WARNING!

Always drive safely with your hands on the steering wheel and obey all applicable laws. You have full responsibility and assume all risks related to the use of the features and applications in this vehicle. Only use the features and applications in this vehicle when it is safe to do so. Failure to do so may result in an accident involving in serious injury or death.

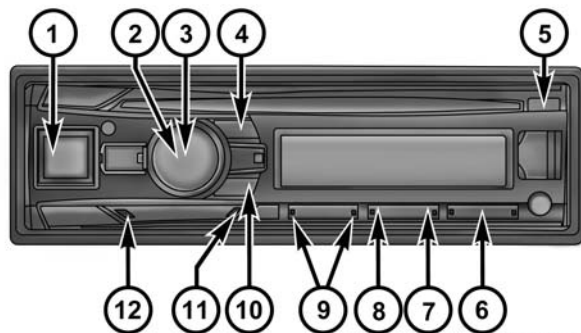

0402101714NA

- | | | |
|--------------------|--------------------|----------------------------|
| 1 — /SOURCE | 5 — EJECT Button | 9 — Forward/
Backwards |
| 2 — /ENTER | 6 — Shuffle | 10 — Fast Rewind |
| 3 — Rotary Encoder | 7 — Repeat | 11 — Play/Pause |
| 4 — Fast Forward | 8 — Preset Buttons | 12 — BACK |

Playback



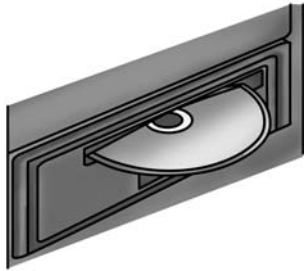





- Press (OPEN).
The front panel will open.
- Insert a disc with the label side facing up.
The disc will be pulled into the unit automatically.



0402101715NA



3. Close the front panel manually.

NOTE:

- When a disc is already inserted, press  /SOURCE to switch to the Disc mode.
4. While playing back MP3/WMA, press Rewind  or  Forward to select the desired folder.
- Pressing and holding Rewind  or  Forward will change folders continuously.
5. Press  or  to select the desired track (file).
- Pressing and holding  or  will fast backward/fast forward track continuously.

6. To pause playback, press .



Pressing  again will resume playback.

7. After pressing  (OPEN) to open the front panel, press  to eject the disc.

NOTE:

- Do not remove a CD during its eject cycle. Do not load more than one disc at a time. A malfunction may result from doing either.
- Three-inch (8 cm) CDs cannot be used.
- Any file protected by DRM (Digital Rights Management) copy protection, cannot be played back on this unit.
- The track display for MP3/WMA data playback is the file numbers recorded on the disc.
- The playback time may not be correctly displayed when a VBR (Variable Bit Rate) recorded file is played back.
- Press  VIEW to switch the display. For details, refer to “Displaying The Text” on page 59.

Repeat And Random (M.I.X.) Play

1. During playback, press  or  until the setting appears.

REPEAT ONE:

REPEAT FOLDER*:

Files in a folder are played back repeatedly.

MIX FOLDER*:

Files in a folder are played back randomly.



MIX ALL:

All files in the disc or Flash Memory are played back randomly.

* When MP3/WMA files are played back.

2. To cancel repeat or M.I.X play, select (OFF) with the above procedure.

NOTE:

-  indicator lights up during repeat play mode.
-  indicator lights up during random play mode.

Searching For CD Text

On discs utilizing CD Text, songs can be searched and played by using their recorded titles. For discs without CD Text, searches are made using the track numbers associated with each song.

1. Press  /ENTER during play.

This will set the search mode.

2. Turn the Rotary encoder to select the desired track, and then press  /ENTER.

This will play the selected track.



NOTE:

- Press  in the search mode to cancel. Or, the search mode is canceled if no operation is performed for 60 seconds.
- When CD Text Search is made during M.I.X. play, the M.I.X. play mode will be canceled.
- If any one of the preset buttons (1 through 6) is pressed in the search mode, a search can be made quickly by skipping to the specified location. For details, refer to "Direct Search Function" on page 107.



Folder/File Name Search (Concerning MP3/WMA)

Folder and file names may be searched and displayed during playback.

Folder Name Search Mode



1. During MP3/WMA playback, press  /ENTER to activate the search mode.
2. Turn the Rotary encoder to select Folder Name Search mode, and then press  /ENTER.
3. Turn the Rotary encoder to select the desired folder.
4. Press and hold  /ENTER for at least two seconds to play back the first file in the selected folder.

NOTE:

- If no operation is performed for 60 seconds, the search mode is canceled.
- Press  in the search mode to return to the previous mode.
- To search for files in the Folder Name Search mode, press  /ENTER. Files in the folder may be searched.

- When Folder Name Search is made during M.I.X. play, the M.I.X. play mode will be canceled.
- The root folder of a disc is displayed as “\ROOT”.
- If any one of the preset buttons (1 through 6) is pressed in the search mode, a search can be made quickly by skipping to the specified location. For details, refer to “Direct Search Function” on page 107.

File Name Search Mode

1. During MP3/WMA playback, press  /ENTER to activate the search mode.
2. Turn the Rotary encoder to select File Name Search mode, and then press  /ENTER.
3. Select the desired file by turning the Rotary encoder.
4. Press  /ENTER to play back the selected file.

NOTE:

- If no operation is performed for 60 seconds, the search mode is canceled.
- Press  in the search mode to return to the previous mode.

- When File Name Search is made during M.I.X. play, the M.I.X. play mode will be canceled.
- If any one of the preset buttons (1 through 6) is pressed in the search mode, a search can be made quickly by skipping to the specified location. For details, refer to "Direct Search Function" on page 107.

Search Position Memory

During playback, you can quickly return to the last-selected hierarchy level in the search mode.

Press \Rightarrow .

The hierarchy you selected last in the search mode is displayed.

About MP3/WMA

CAUTION!

Except for private use, duplicating audio data (including MP3/ WMA/AAC data) or distributing, transferring, or copying it, whether for free or for a fee, without permission of the copyright holder is strictly prohibited by the Copyright Act and by international treaty.

What is MP3?

MP3, whose official name is "MPEG Audio Layer 3," is a compression standard prescribed by the ISO, the International Standardization Organization and MPEG which is a joint activity institution of the IEC. MP3 files contain compressed audio data. MP3 encoding is capable of compressing audio data at extremely high ratios, reducing the size of music files to as much as one-tenth their original size. This is achieved while still maintaining near CD quality. The MP3 format realizes such high compression ratios by eliminating the sounds that are either inaudible to the human ear or masked by other sounds.

What is WMA?

WMA, or "Windows Media Audio," is compressed audio data. WMA is similar to MP3 audio data.

Method for creating MP3/WMA files

Audio data is compressed using software with MP3/WMA codecs. For details on creating MP3/WMA/AAC files, refer to the user's manual for that software. MP3/WMA/AAC files that are playable on this device have the file extensions "mp3"/"wma"/"m4a". Files with no extension cannot be played back (WMA ver. 7,

8 and 9 are supported). Protected files are not supported. Confirm that the software being used conforms to the acceptable formats listed above. It's possible that the format may be unplayable even though the extension is valid.

Supported playback sampling rates and bit rates

MP3	
Sampling rates:	48 kHz, 44.1 kHz, 32 kHz, 24 kHz, 22.05 kHz, 16 kHz, 12 kHz, 11.025 kHz, 8 kHz
Bit rates:	8 - 320 kbps
WMA	
Sampling rates:	48 kHz, 44.1 kHz, 32 kHz
Bit rates:	32 - 192 kbps

This device may not play back correctly depending on sampling rates. In the USB mode, the playback time may not be correctly displayed when a VBR (Variable Bit Rate) recorded file is played back.

ID3 tags/WMA tags

This device supports ID3 tag v1 and v2, and WMA/AAC tag. If tag data is in an MP3/WMA file, this device can display the title (track title), artist name, and album name ID3 tag/WMA/AAC tag data. This device can only display single-byte alphanumeric characters (up to 32 for ID3 tags and up to 32 for WMA tags) and the underscore. For non-supported characters, "No Support" is displayed or the character is displayed as space.

If information contains characters other than ID3 tag information, the audio file may not be played back.

The tag information may not be correctly displayed, depending on the contents.

Producing MP3/WMA Discs

MP3/WMA files are prepared, then written to a CD-R, CD-RW using CD-R writing software or stored to a Flash Memory. A disc can hold up to 509 files/folders (including Root Folders), and the maximum number of folders is 255.

Playback may not be performed if a disc exceeds the limitations described above.

Media supported

The media that this device can play back are CD-ROMs, CD-Rs, and CD-RWs.

This device also can play back Flash Memory media.

Corresponding File Systems

This device supports discs formatted with ISO9660 Level 1 or Level 2. Under the ISO9660 standard, there are some restrictions to remember. The maximum nested folder depth is 8 (including the root directory). The number of characters for a folder/file name is limited.

Valid characters for folder/file names are letters A-Z (all caps), numbers 0-9, and '_' (underscore).

This device also can play back discs in Joliet, Romeo, etc., and other standards that conform to ISO9660. However, sometimes the file names, folder names, etc., are not displayed correctly.

This device also supports FAT 12/16/32 for Flash Memory device.

Formats supported

This device supports CD-ROM XA, Mixed Mode CD, Enhanced CD (CD-Extra) and Multi-Session.

This device cannot correctly play back discs recorded with Track At Once or packet writing.

Order of files

Files are played back in the order that the writing software writes them to the disc. Therefore, the playback order may not be what is expected. Verify the writing order in the software's documentation. The playback order of the folders and files is as follows.

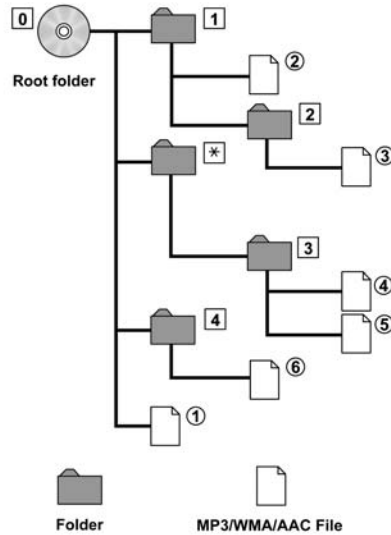

0501067418

* The folder No./ folder Name will not be displayed if no file is contained in the folder.

Terminology

Bit rate

This is the “sound” compression rate specified for encoding. The higher the bit rate, the higher the sound quality, but also the larger the files.

Sampling rate

This value shows how many times per second the data is sampled (recorded). For example, music CDs use a sampling rate of 44.1 kHz, so the sound is sampled (recorded) 44,100 times per second. The higher the sampling rate, the higher the sound quality, but also the larger the volume of data.

Encoding

Converting music CDs, WAVE (AIFF) files, and other sound files into the specified audio compression format.

Tag

Song information such as track titles, artist names, album names, etc., written into MP3/WMA files.

Root folder

The root folder (or root directory) is found at the top of the file system. The root folder contains all folders and files. It is created automatically for all burned discs.

SOUND SETTING

CONTENTS

■ SOUND SETTING	38	□ About “Text”	61
□ Adjusting Subwoofer Level/Bass Level/Treble Level/Balance (Between Left And Right)/Fader (Between Front And Rear)/Defeat.	38	□ Using The Front AUX Input Terminal	61
□ Audio Setup	39	□ Option Menu Setting	62
□ Bass Engine SQ Function	47	□ Applying TuneIt	64
□ About Time Correction	48	□ Adjusting The Sound Via Smartphone.	65
□ About The Crossover.	53	□ Facebook Notification Function.	65
■ OTHER FUNCTIONS.	59	□ Receiving Notification (Ready On Future Update)	66
□ Displaying The Text.	59	□ Displaying Notification List	67

SOUND SETTING

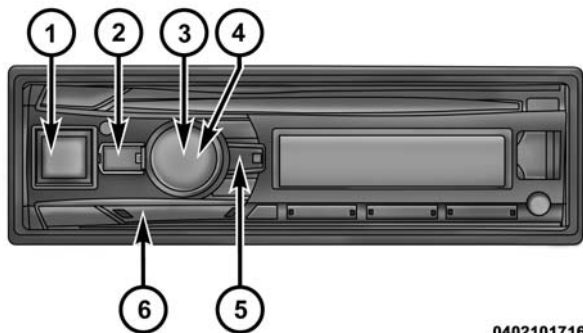

0402101716NA

- 1 — AUDIO/SETUP
2 — Bass
3 — Rotary Encoder

- 4 —  /Enter
5 — Phone Button
6 — BACK Button

Adjusting Subwoofer Level/Bass Level/Treble Level/Balance (Between Left And Right)/Fader (Between Front And Rear)/Defeat

1. Press AUDIO/Setup repeatedly to choose the desired mode. Each press changes the mode as follows:

SUBWOOFER*1/*2 → BASS LEVEL*2/*3 → TRE LEVEL*2/*3 → BALANCE → FADER*4 → DEFEAT → VOLUME → SUBWOOFER

*1 When the subwoofer mode is set to OFF, its level cannot be adjusted, refer to “Turning Subwoofer ON/OFF” within this section.

*2 Not displayed when BASS ENGINE SQ mode is selected. Refer to “Switching BASS ENGINE SQ mode” within this section.

*3 Adjustable only when DEFEAT is OFF.

*4 Not displayed when 2WAY/3WAY system mode is set to 3WAY.

Refer to “Switching the 2WAY/3WAY system mode” within this section.

Subwoofer Level	0 ~ 15
Bass Level	-7 ~ 7
Treble Level	-7 ~ 7
Balance	-15 (L) ~ 15 (R)
Fader	-15 (R) ~ 15 (F)
Defeat	ON/OFF
Volume	0 ~ 35

NOTE:

- If no operation is performed for five seconds after selecting the SubW LEVEL, BASS, TREBLE, BALANCE, FADER, DEFEAT or VOLUME mode, the unit automatically returns to normal mode.
2. Turn the Rotary encoder until the desired sound is obtained in each mode.



NOTE:

- By setting DEFEAT ON, previously adjusted level settings of BASS and TREBLE will return to the factory defaults.

Audio Setup

You can flexibly customize the unit to suit your own preference and usage. From the AUDIO SETUP menu, Audio Setting can be modified.

Use steps 1 to 5 to select the category you wish to modify. For details on how to change each setting, see the following sections below.

1. Press and hold AUDIO/SETUP for at least two seconds to activate the SETUP mode.
 2. Turn the Rotary Encoder to select Audio, and then press  /ENTER.
 3. Turn the Rotary Encoder to select the desired sound setting menu, and then press  /ENTER.
 EQ PRESETS*1/*2/*3 ↔ BASS ENGIN*4/*5 ↔
 PARAMETER*5/*6 ↔ 9BAND P-EQ*1/*3/*7 ↔
 SOURCE VOL ↔ X-OVER*1/*3 ↔ SUBWOOFER*8 ↔
 SUBW PHASE*9 ↔ SUBW SYS*3/*9 ↔ LENGTH*1 s
 TCR*1 ↔ POWER IC ↔ MX SETTING*1/*3 ↔ EQ
 PRESETS
- *1 Adjustment cannot be performed when DEFEAT is set to ON.
- *2 Any changes made to either EQ PRESETS or 9BAND P-EQ are reflected in the others' settings.
- *3 These items are not adjustable in BASS ENGINE SQ mode. If you want to adjust these items separately, follow the confirm message and select "YES" to exit BASS ENGINE SQ mode, then make the setting.
- *4 Not displayed when the Audio Setup mode is activated by pressing BASS.
- *5 Not displayed when 2WAY /3WAY system mode is set to 3WAY.

*6 Not displayed when BASS ENGINE is set to OFF.

*7 In step 3, after selecting a Band (BAND1 to BAND9) from 9BAND P-EQ adjustment mode. Turn the Rotary encoder to select the desired item, and then press ENTER to continue to step 4.

*8 This item is also related to BASS ENGINE SQ mode when you adjust sound settings via the TuneIt App on a Smartphone. Refer to "Adjusting the sound via the Smartphone".

*9 These functions are inoperable when SUBWOOFER is set to OFF.

4. Turn the Rotary Encoder to change the setting, and then press  /ENTER.
5. Press and hold AUDIO/SETUP for at least two seconds to return to normal mode.

NOTE:

- Pressing  returns to the previous Sound menu mode.
- Adjustment cannot be performed during a call.
- Pressing BACK returns to the previous Sound menu mode.

- You can access the Sound menu mode directly by pressing BASS when BASS ENGINE is set to OFF. Refer to "Setting BASS ENGINE SQ ON/ OFF" within this section.
- If no operation is performed for 60 seconds, sound menu mode is canceled.

Equalizer Presets (Factory's EQ)

Ten typical equalizer settings are preset at the factory for a variety of musical source material. User settings are created in the Parametric EQ mode.

User ↔ Flat (Initial setting) ↔ Pops ↔ Rock ↔ News ↔ Jazz&Blues ↔ Electrical Dance ↔ Hip Hop&Rap ↔ Easy Listening ↔ Country ↔ Classical

NOTE:

- The 9 - Band, Parametric EQ is used to create the Factory EQ settings.

Setting BASS ENGINE SQ On/Off

This function provides a short cut for BASS ENGINE SQ setting. EQ PRESETS, 9BAND P-EQ, etc., will no longer be adjustable when ON is set.

Setting item: BASS ENGINE

Setting contents:

OFF (Initial setting) / ON

OFF (*MANUAL SET mode*):

Adjust each audio effect setting separately.

ON (*BASS ENGINE SQ mode*):

Adjust BASS ENGINE SQ via a short cut.

NOTE: You can also set BASS ENGINE SQ ON/OFF directly by pressing and holding BASS. Refer to “Switching BASS ENGINE SQ mode” within this section.

Displaying the BASS ENGINE SQ PARAMETER

After setting BASS ENGINE to ON, you can display the current BASS ENGINE SQ Parameter type.

Setting item: PARAMETER

Displaying contents:

The name of the parameter currently selected is displayed. (INITIAL / TUNEIT A ~ TUNEIT E)

Adjusting The Parametric Equalizer Curve (Parametric EQ)

You can modify the Equalizer settings to create a response curve more appealing to your personal taste.

1. After selecting a BAND (BAND1 ~ BAND9) from the 9BAND P-EQ adjustment mode, turn the Rotary encoder to select the desired setting item, and then press **Q** /ENTER.

CENTER FRQ ↔ WIDTH (Q) ↔ LEVEL ↔ CENTER FRQ

2. Turn the Rotary Encoder to select the desired frequency within the selected band, then press **Q** /Enter.
3. Press BACK to return to the previous step.

Adjusting The Band**Setting contents:**

Band1/Band2/Band3/Band4/Band5/Band6/Band7/
Band8/Band9

Adjusting The Frequency (Freq.)

Adjustable frequency bands: 20 Hz to 20 kHz

Band 1	20 Hz ~ 100 Hz (63 Hz)
Band 2	63 Hz ~ 315 Hz (125 Hz)
Band 3	125 Hz ~ 500Hz (250 Hz)
Band 4	250 Hz ~ 1 kHz (500 Hz)
Band 5	500 Hz ~ 2 kHz (1 kHz)
Band 6	1 kHz ~ 4 kHz (2 kHz)
Band 7	7: 2 kHz ~ 7.2 kHz (4 kHz)
Band 8	5.8 kHz ~ 12 kHz (8 kHz)
Band 9	9 kHz ~ 20 kHz (16 kHz)

Setting The Bandwidth (Q)

Setting contents:

3.0 (Initial setting) / 4.0 / 5.0

Adjusting The Level

Setting contents:

-7 to +7 (Initial setting: 0)

NOTE:

- Band 2 and Band 8 are the same as the Bass and Treble controls. Their Level adjustment can also be controlled by pressing AUDIO and selecting Bass Level or Treble Level. Refer to “Adjusting Subwoofer Level/Bass Level/Treble Level/Balance (Between Left and Right)/Fader (Between Front and Rear)/Defeat” on page 38.
- Settings exceeding the frequency of adjacent bands are not available.
- While adjusting the Parametric EQ, you should consider the frequency response of the connected speakers.
- The 9-Band, Parametric EQ is used to customize the EQ PRESETS settings.

Setting The Source Volume Level

The output level of each source is individually adjustable. For example, if the Tuner level sounds lower than Disc, its output can be adjusted without affecting the other sources.

- **Setting item:** SOURCE VOL
- **Further setting items:** Tuner / SiriusXM / Disc / USB / iPod / BTAudio / Pandora / AUX

Setting contents:

-14 dB ~ +14 dB

Adjusting The Crossover Settings (X-Over)

Before performing the following procedures, refer to "About the Crossover" on page 53.

Setting item: X-OVER

1. After selecting X-Over from the Audio Setup mode, turn the Rotary Encoder to select the desired channel, then press **Q** /ENTER.

2WAY System

FRONT (HPF) ↔ REAR (HPF) ↔ SUBW LPF ↔ FRONT (HPF)

3WAY System

LOW (LPF) ↔ MID LOW (HPF) ↔ MID HIGH (LPF) ↔ HIGH (HPF) ↔ LOW

2. Turn the Rotary Encoder to select the desired frequency within the selected channel, then press **Q** /ENTER.
3. Repeat step 2 to adjust the Slope and Level within the selected channel.

Selecting The Cut-Off Frequency (Freq.)

2WAY System

20 / 25 / 31.5 / 40 / 50 / 63 / 80 (Initial setting) / 100 / 125 / 160 / 200 (Hz)

3WAY System

LOW/MID LOW:

20 / 25 / 31.5 / 40 / 50 / 63 / 80 / 100 / 125 / 160 / 200 / 250 / 315 / 400 / 500 (Initial setting) / 630 / 800 (Hz)

MID HIGH:

20 / 25 / 31.5 / 40 / 50 / 63 / 80 / 100 / 125 / 160 / 200 / 250 / 315 / 400 / 500 / 630 / 800 / 1 k / 1.2 k / 1.6 k / 2 k / 2.5 k / 3.2 k / 4 k / 5 k (Initial setting) / 6.3 k / 8 k / 10 k / 12.5 k / 16 k / 20 k (Hz)

HIGH:

1 k / 1.2 k / 1.6 k / 2 k / 2.5 k / 3.2 k / 4 k / 5 k (Initial setting) / 6.3 k / 8 k / 10 k / 12.5 k / 16 k / 20 k (Hz)

NOTE: The frequency of MID LOW should not be more than the frequency of MID HIGH.

Adjusting The Slope

2WAY System

FLAT / 6 / 12 / 18 / 24 (dB/oct.)

3WAY System

FLAT / 6 / 12 (dB/oct.)

NOTE: The Initial setting for 2WAY is FLAT. 3WAY is 12.

Adjusting the Level (LEVEL)

2WAY System/3WAY System

-12 to 0 (dB) (Initial setting: 0)

NOTE: The level setting results for MID LOW and MID HIGH in 3WAY system are linkage.

Repeat steps 1 to 2 to make adjustment to the other channels.

Turning Subwoofer ON/OFF

When the subwoofer is on, you can adjust the subwoofer output level (refer to “Adjusting Subwoofer Level/Bass Level/Treble Level/Balance (Between Left and Right)/Fader (Between Front and Rear)/Defeat” on page 38.

- **Setting item:** Subwoofer

Setting contents:

OFF/ON (Initial setting)

OFF: No subwoofer signal is output from the Subwoofer RCA Connector.

ON: The subwoofer signal is output from the Subwoofer RCA Connector.

Setting The Subwoofer Phase

The subwoofer output phase is toggled Subwoofer Normal (0°) or Subwoofer Reverse (180°). To adjust the level, turn the Rotary Encoder.

- **Setting item:** Subwoofer Phase

Setting contents:

NORMAL (Initial setting) / REVERSE

Setting The Subwoofer System

When the subwoofer is on, you can select either System 1 or System 2 for the desired subwoofer effect.

- **Setting item:** Subwoofer System

Setting contents:

System 1/ System 2 (Initial setting)

System 1:

Subwoofer level changes according to the main volume setting.

System 2:

Subwoofer level change is different from the main volume setting. For example, even at low volume settings, the subwoofer is still audible.

Setting The Time Correction Unit (TCR Parameter)

You can change the unit, (cm or inch) of time correction.

- **Setting item:** TCR Parameter

Setting contents:

cm (Initial setting) / inch

cm: Time correction value is in centimeters.

inch: Time correction value is in inches.

Adjusting The Time Correction (T.Correction)

Before performing the following procedures, refer to “About Time Correction” on page 48.

1. After selecting T.Correction from the Audio Setup mode, turn the Rotary Encoder to select a speaker to be adjusted, and then press  /ENTER.

F-L*1 ↔ F-R*2 ↔ R-L*3 ↔ R-R*4 ↔ SSW-L ↔ SW-R

*1 Front-L

*2 Front-R

*3 Rear-L

*4 Rear-R

2. Turn the Rotary Encoder to adjust the distance of the selected speaker, and then press  /ENTER.
0.0 cm to 336.6 cm (3.4 cm/step)
0.0 inch to 132.7 inch (1.3 inch/step)

NOTE:

- The total adjustment distance for all speakers should be less than 510 centimeters (201 inches).
3. Repeat steps 1 and 2 to set another speaker.
By setting these values to make its sound reach the listening position at the same time as the sound of other speakers.

External Device

Connecting to an External Amplifier (POWER IC)

When an external amplifier is connected, sound quality can be improved by stopping the power supply of the built-in amplifier.

Setting item: POWER IC

Setting contents:

OFF / ON (Initial setting)

OFF :

Use this mode when the line output of this unit is used to drive an external amplifier. In this setting, the head unit's internal amplifier is turned OFF and cannot drive speakers.

ON :

The speakers are driven by the built-in amplifier.

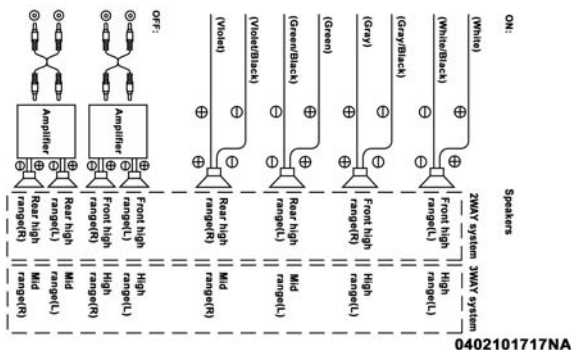

NOTE:

- For more details about 2WAY/3WAY system mode. Please refer to “Switching the 2WAY/3WAY system mode” and “About the 2WAY/ 3WAY system mode” within this section.
- No sound is produced by the system when the power output is set to OFF.

Setting The Media Xpander Mode (MX Setup)

MX (Media Xpander) makes vocals or instruments sound distinct regardless of the music source. The CD and iPod, etc. will be able to reproduce the music clearly even in cars with a lot of road noise.

- **Setting item:** MX Setup

1. Turn the Rotary Encoder to select the source to which you want to apply Media Xpander, and then press  /ENTER.

FM ↔ SIRIUS XM ↔ CD ↔ CMPM* ↔ USB ↔ IPOD
↔ BT AUDIO ↔ PANDORA ↔ AUX ↔ FM

* Be applied for MP3/WMA files in disc.

2. Turn the Rotary Encoder to select the Media Xpander level, and then press  /ENTER.

OFF ↔ Level 1 ↔ Level 2 ↔ Level 3

Bass Engine SQ Function

With the BASS ENGINE SQ function on this unit, several parameters affecting Bass performance are adjusted simultaneously. The Bass Level adjustment varies these parameters uniformly for optimum Bass effect at different levels.

Switching BASS ENGINE SQ mode

Press and hold BASS for at least two seconds to switch the sound mode.

BASS ENGINE SQ ↔ MANUAL SET (Initial setting)

BASS ENGINE SQ:

Adjust the relevant Bass parameters uniformly and automatically.

MANUAL SET:

Adjust each audio effect setting separately and manually.

NOTE:

- This operation can also be performed by selecting BASS ENGIN in Audio Setup mode. Refer to “Setting BASS ENGINE SQ ON/OFF” within this section.
- You can access the Sound menu mode directly by pressing BASS when BASS ENGIN is set to OFF.
- You can set this item via the TuneIt App on a Smartphone. Refer to “Adjusting the sound via the Smartphone”.
- If you switch the 2WAY/3WAY system (page 23) to 3WAY mode, you cannot adjust this item.

Adjusting BASS ENGINE SQ Level

With BASS ENGINE SQ ON, adjusting the Bass Level uniformly effects various sound parameters for optimum Bass effect.

1. Press BASS to display the BASS ENGINE SQ Level adjustment screen.

The unit's back lighting changes to white amber during this period.

2. Turn the Rotary encoder to select the desired level (+0 - +6).

The initial level is +3.

NOTE:

- Adjustable only when DEFEAT is OFF.
- Adjustable when 2WAY/3WAY system mode is set to 2WAY.
- The Bass parameters affected contain EQ PRESETS, 9 BAND EQ, SUBWOOFER (when set this item via TuneIt App), X-OVER, SUBW SYS and MX SETTING. These items are set automatically in BASS ENGINE SQ mode and cannot be adjusted separately.

- From Level 0 to Level 6, the effect of BASS ENGINE SQ Enhance increases level by level.

About Setup when the external power amplifier is connected.

In order to optimize the BASS ENGINE SQ, we recommend the following power amplifier setup.

After setting up, you can adjust the BASS ENGINE SQ Level according to the music.

1. Set gain of the power amplifier to "MIN".
2. Set the Crossover Mode Sector switch to "OFF".
3. Set the BASS ENGINE SQ of this unit to "ON", and the BASS ENGINE SQ Level to "+3".
4. Play a song of the genre you frequently listen to, and adjust gain of the power amplifier.

About Time Correction

The distance between the listener and the speakers in a car vary widely due to the complex speaker placement. This difference in the distances from the speakers to the listener creates a shift in the sounds image and frequency characteristics. This is caused by the time delay between the sound reaching the listener's right versus the left ear.

To correct this, this unit is able to delay the audio signal to the speakers closest to the listener. This effectively creates a perception of increased distance for those speakers. The listener can be placed at an equal distance between the left and right speakers for optimum staging.

Listening Position example as follows in this section:

Example 1: Front Left Seat

Adjust the time correction level of the front left speaker to a high value and the rear right to zero or a low value.

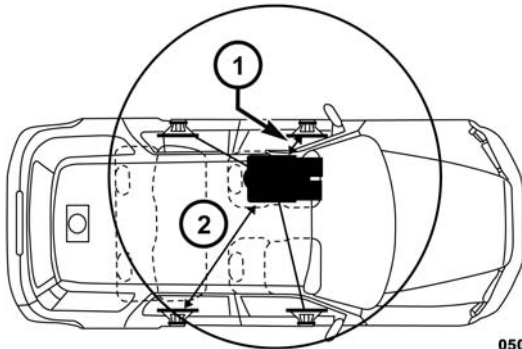

0501067415

1 — 0.5m
2 — 2.25m

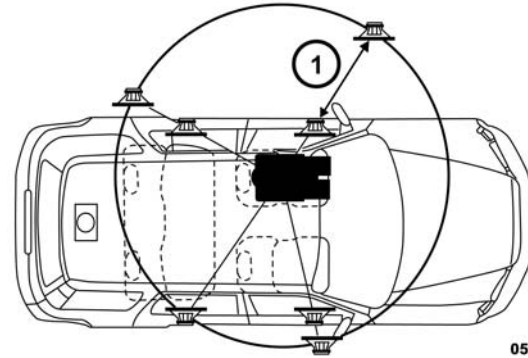

0501067416

6

1 — 5.1ms

The sound is not balanced because the distance between the listening position and the various speakers is different. The difference in distance between the front left speaker and the rear right speaker is 1.75 m (68-7/8"). Here we calculate the time correction value for the front left speaker in the diagram on the above.

Conditions:

Farthest Speaker - listening position : 2.25 m (88-9/16")

Front left speaker - listening position : 0.5 m (19-11/16")

50 SOUND SETTING

Calculation: $L = 2.25 \text{ m} - 0.5 \text{ m} = 1.75 \text{ m}$ (68-7/8")

Time correction = $1.75 \div 343^* \times 1000 = 5.1 \text{ (ms)}$

* Speed of sound: 343 m/s (765 mph) at 20°C

In other words, giving the front left speaker a time correction value of 5.1 ms makes it seem as if its distance from the listener is the same as the distance to the farthest speaker. Time correction eliminates the differences in the time required for the sound to reach the listening position. The time of the front left speaker is corrected by 5.1 ms so that its sound reaches the listening position at the same time as the sound of other speakers.

Example 2: All Seats

Adjust the time correction level of each speaker to almost the same level.

1. Sit in the listening position (driver's seat, etc.) and measure the distance (in meters) between your head and the various speakers.
2. Calculate the difference between the distance correction value to the farthest speaker and the other speakers.

$L = (\text{distance to farthest speaker}) - (\text{distance to other speakers})$

These values are the time correction values for the different speakers. Setting these values to make each sound reach the listening position at the same time as the sound of other speakers.

Time Correction Value List

Delay Number	Time Difference (ms)	Distance (cm)	Distance (inch)
0	0.0	0.0	0.0
1	0.1	3.4	1.3
2	0.2	6.8	2.7
3	0.3	10.2	4.0
4	0.4	13.6	5.4
5	0.5	17.0	6.7
6	0.6	20.4	8.0
7	0.7	23.8	9.4
8	0.8	27.2	10.7
9	0.9	30.6	12.1
10	1.0	34.0	13.4
11	1.1	37.4	14.7
12	1.2	40.8	16.1

Delay Number	Time Difference (ms)	Distance (cm)	Distance (inch)
13	1.3	44.2	17.4
14	1.4	47.6	18.8
15	1.5	51.0	20.1
16	1.6	54.4	21.4
17	1.7	57.8	22.8
18	1.8	61.2	24.1
19	1.9	64.6	25.5
20	2.0	68.0	26.8
21	2.1	71.4	28.1
22	2.2	74.8	29.5
23	2.3	78.2	30.8
24	2.4	81.6	32.2
25	2.5	85.0	33.5
26	2.6	88.4	34.8
27	2.7	91.8	36.2
28	2.8	95.2	37.5
29	2.9	98.6	38.9
30	3.0	102.0	40.2

Delay Number	Time Difference (ms)	Distance (cm)	Distance (inch)
31	3.1	105.4	41.5
32	3.2	108.8	42.9
33	3.3	112.2	44.2
34	3.4	115.6	45.6
35	3.5	119.0	46.9
36	3.6	122.4	48.2
37	3.7	125.8	49.6
38	3.8	129.2	50.9
39	3.9	132.6	52.3
40	4.0	136.0	53.6
41	4.1	139.4	54.9
42	4.2	142.8	56.3
43	4.3	146.2	57.6
44	4.4	149.6	59.0
45	4.5	153.0	60.3
46	4.6	156.4	61.6
47	4.7	159.8	63.0
48	4.8	163.2	64.3

Delay Number	Time Difference (ms)	Distance (cm)	Distance (inch)
49	4.9	166.6	65.7
50	5.0	170.0	67.0
51	5.1	173.4	68.3
52	5.2	176.8	69.7
53	5.3	180.2	71.0
54	5.4	183.6	72.4
55	5.5	187.0	73.7
56	5.6	190.4	75.0
57	5.7	193.8	76.4
58	5.8	197.2	77.7
59	5.9	200.6	79.1
60	6.0	204.0	80.4
61	6.1	207.4	81.7
62	6.2	210.8	83.1
63	6.3	214.2	84.4
64	6.4	217.6	85.8
65	6.5	221.0	87.1
66	6.6	224.4	88.4

Delay Number	Time Difference (ms)	Distance (cm)	Distance (inch)
67	6.7	227.8	89.8
68	6.8	231.2	91.1
69	6.9	234.6	92.5
70	7.0	238.0	93.8
71	7.1	241.4	95.1
72	7.2	244.8	96.5
73	7.3	248.2	97.8
74	7.4	251.6	99.2
75	7.5	255.0	100.5
76	7.6	258.4	101.8
77	7.7	261.8	103.2
78	7.8	265.2	104.5
79	7.9	268.6	105.9
80	8.0	272.0	107.2
81	8.1	275.4	108.5
82	8.2	278.8	109.9
83	8.3	282.2	111.2
84	8.4	285.6	112.6

Delay Number	Time Difference (ms)	Distance (cm)	Distance (inch)
85	8.5	289.0	113.9
86	8.6	292.4	115.2
87	8.7	295.8	116.6
88	8.8	299.2	117.9
89	8.9	302.6	119.3
90	9.0	306.0	120.6
91	9.1	309.4	121.9
92	9.2	312.8	123.3
93	9.3	316.2	124.6
94	9.4	319.6	126.0
95	9.5	323.0	127.3
96	9.6	326.4	128.6
97	9.7	329.8	130.0
98	9.8	333.2	131.3
99	9.9	336.6	132.7

About The Crossover

Crossover (X-Over):

This unit is equipped with an active crossover. The crossover limits the frequencies delivered to the outputs. Each channel is controlled independently. Thus, each speaker pair can be driven by the frequencies for which they have been optimally designed.

The crossover adjusts the HPF (high pass filter) or LPF (low pass filter) of each band, and also the slope (how fast the filter rolls off the highs or lows).

Adjustments should be made according to the reproduction characteristics of the speakers. Depending on the speakers, a passive network may not be necessary. If you are unsure about this point, consult your authorized Alpine dealer.

2WAY Mode

	Cut-off frequency (1/3 octave steps)		Slope		Level
	HPF	LPF	HPF	LPF	
Low range speaker	—	20 Hz - 200 Hz	—	Flat, 6, 12, 18, 24 dB/oct.	0 to -12 dB
Rear high range speaker	20 Hz - 200 Hz	—	Flat, 6, 12, 18, 24 dB/oct.	—	0 to -12 dB
Front high range speaker	20 Hz - 200 Hz	—	Flat, 6, 12, 18, 24 dB/oct.	—	0 to -12 dB

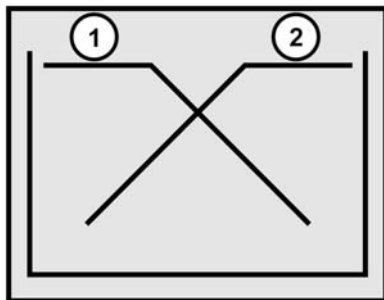

0501067429

- 1 — Low Range
2 — High Range
-

3WAY Mode

	Cut-off frequency (1/3 octave steps)		Slope		Level
	HPF	LPF	HPF	LPF	
Low range speaker	—	20 Hz - 800 Hz	—	Flat, 6, 12 dB/oct.	0 to -12 dB
Rear high range speaker	20 Hz - 800 Hz	20 Hz - 20 kHz	Flat, 6, 12 dB/oct.	Flat, 6, 12 dB/oct.	0 to -12 dB
Front high range speaker	1 Hz - 20 Hz	—	Flat, 6, 12 dB/oct.	—	0 to -12 dB

* Depending on the response characteristics of the speaker, care should be taken when setting the response slope of the high range speaker to FLAT in 3WAY mode, as speaker damage may result.

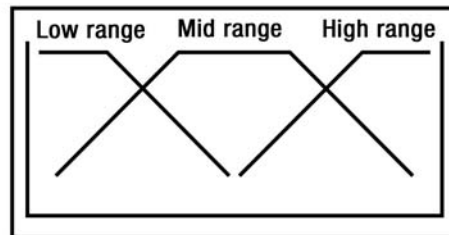

(Different from actual display)

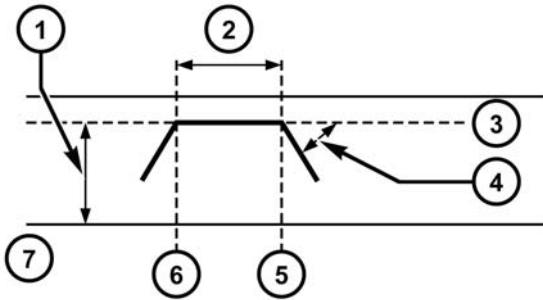

0501067430

- | | |
|-----------------------------------|---------------------------|
| 1 — Level Adjusting (0 to -12 dB) | 4 — Slope Adjusting |
| 2 — Output Frequency Range | 5 — LPF Cut-Off Frequency |
| 3 — Slope Flat | 6 — HPF Cut-Off Frequency |
| | 7 — 20 Hz |

NOTE:

- HPF (high pass filter): Cuts the lower frequencies and allows the higher frequencies to pass.
- LPF (low pass filter): Cuts the higher frequencies and allows the lower frequencies to pass.
- Slope: The level change (in dB) for a frequency change of one octave.

- The higher the slope value, the steeper the slope becomes.
- Adjust the slope to Flat to bypass the HP or LP filters.
- Do not use a tweeter without the HPF on or set to a low frequency, as it may cause damage to the speaker due to the low frequency content.
- You cannot adjust the crossover frequency higher than the HPF or lower than the LPF.
- Adjustment should be made according to the recommended crossover frequency of the connected speakers. Determine the recommended crossover frequency of the speakers. Adjusting to a frequency range outside that recommended may cause damage to the speakers. For the recommended crossover frequencies of Alpine speakers, refer to the respective Owner's Manual. We are not responsible for damage or malfunction of speakers caused by using the crossover outside the recommended value.

Switching The 2WAY/3WAY System Mode

1. Press the AUDIO/SETUP and the PHONE button at the same time.

NOTE: In this case, the device will be muted.

- Turn the Rotary encoder to select the desired system mode, and then press ENTER.

NOTE: When the system mode is changed, the setting items for X-OVER are displayed. Please follow the instructions of “Adjusting the Crossover Settings (X-OVER)”.

- After setting, turn the Rotary encoder to select DONE, and then press ENTER. “TURN ACC OFF AND ON” will be displayed.
- Switch the ignition key to ACC OFF.

Depending on the response characteristics of the speaker, care should be taken when you switch the 2WAY/3WAY system, as speaker damage may result.

- Switching the ignition key from ACC OFF to ON. The change is saved.

NOTE:

- If you skip the 4th and the 5th steps, the setting results will not be saved and unit will return to previous mode.
- While playing back music after the vehicle’s ignition is turned off (STAY ON mode), you cannot adjust the 2WAY/3WAY mode.

About The 2WAY/3WAY System Mode

The X-OVER for a 2WAY system (frequency range is divided between highs for front/rear and lows for the Subwoofer).

2WAY mode

The X-OVER for a 3WAY system whose frequency range is divided among the highs (Front), mids (Front), and lows (Subwoofer).

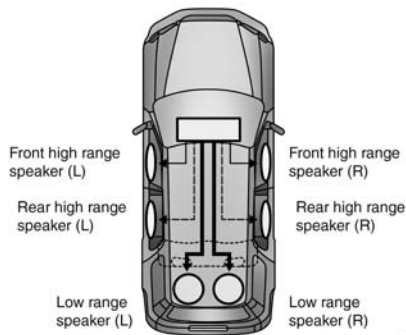

0402101719NA

3WAY mode

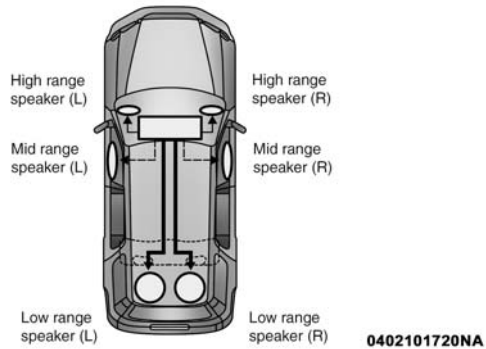

- Use the Sub-W output cord to connect the unit to the low range speaker.
- You cannot adjust the fader when set to 3WAY.

OTHER FUNCTIONS

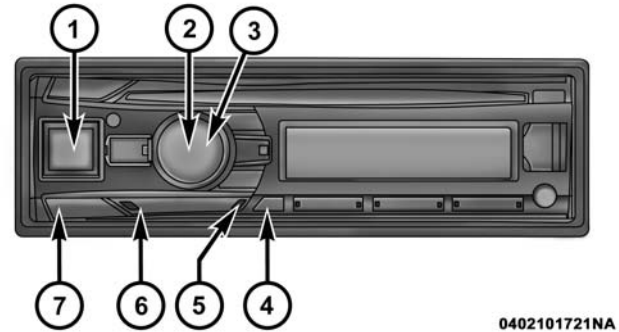

- 1 — SOURCE
- 2 — Rotary Encoder
- 3 — Q /ENTER
- 4 — VIEW

- 5 — Play/Pause
- 6 — BACK Button
- 7 — BAND Button

Displaying The Text

Text information, such as the disc name and the track name, will be displayed if playing a CD text compatible disc. It is also possible to display the folder name, the file name and the tag, etc. while playing MP3/WMA/AAC files.

Press  View.

The display will change every time the button is pressed.

NOTE:

- When the Text Scroll is set to Manual (refer to “Scroll Setting (Text Scroll)” on page 75), press and hold  View for at least two seconds, the current text will be scrolled one time (except Radio mode).

The display in Radio mode:

If there is PS (Program Service Name)

BAND/PS (Program Service Name) → ARTIST/SONG
→ PTY (Program Type)/PS (Program Service Name) →
RADIO TEXT → BAND/CLOCK → BAND/PS (Program
Service Name)

If there is no PS (Program Service Name)

BAND/FREQUENCY → ARTIST/SONG → PTY (Pro-
gram Type)/FREQUENCY → RADIO TEXT → BAND/
CLOCK → BAND/FREQUENCY

The display in CD mode:

TRACK NO./ELAPSED TIME → DISC TEXT*1/TRACK
TEXT*1 → TRACK NO./CLOCK → TRACK NO./
ELAPSED TIME

The display in MP3/WMA mode:

FOLDER NO./FILE NO./ELAPSED TIME → FOLDER
NAME*2/FILE NAME*2 → ARTIST NAME*3/SONG
NAME*3 → ALBUM NAME*3/SONG NAME*3 →
FOLDER NO./FILE NO./CLOCK → FOLDER NO./FILE
NO./ELAPSED TIME

The display in BLUETOOTH Audio mode:

BT AUDIO/ELAPSED TIME*4 → ARTIST NAME*3/
SONG NAME*3 → ALBUM NAME*3/SONG NAME*3
→ BT AUDIO/CLOCK → BT AUDIO/ELAPSED TIME

*1 Displayed during playback of a disc with CD text. If there is no Text (Disc Name or Track Name), “DISC TEXT”/ “TRACK TEXT” is displayed.

*2 Displayed during playback of MP3/WMA with folder/file information. If there is no folder/file information, “FOLDER”/“FILE” is displayed.

*3 ID3 tag/WMA tag If an MP3/WMA file contains ID3 tag/WMA tag information, the ID3 tag/WMA tag information is displayed (e.g., song name, artist name, and album name). All other tag data is ignored. If there is no tag information, “ARTIST”/“ALBUM”/“SONG” is displayed.

*4 Depending on the connected Smartphone, the elapsed time may not be displayed.

About “Text”

Text compatible CDs contain text information such as the disc name and track name. Such text information is referred to as “text”.

NOTE:

- Some characters may not be displayed correctly with this device, depending on the character type.
- If there is no TEXT information, the display is blank.
- The text or tag information may not be correctly displayed, depending on the contents.

Using The Front AUX Input Terminal

Connect a portable music player, etc. by simply connecting it to the input on the front panel. An optional adapter cable is required (standard RCA to 3.5ø mini-phono plug or 3.5ø to 3.5ø mini-phono plug).

Press SOURCE, and select the AUXILIARY mode to listen to the portable device.

CDE-164BT

Portable player, etc.

NOTE: This function is available only when AUX SETUP is set to ON. For details, refer to “Setting the AUX SETUP in “SETUP””.

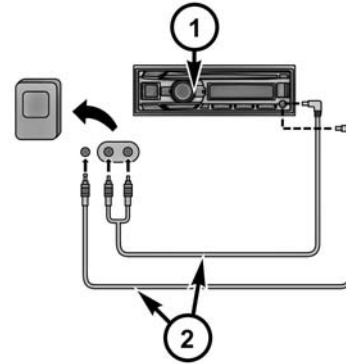

0402101722NA

- 1 — Main Unit
 2 — Optional Adapter Cable (RCA pin plugs [red, white] 3.5ø miniplugs) or (3.5ø miniplugs)



NOTE: This function is available only when AUX SETUP is set to ON. For details, refer to “Setting the AUX SETUP mode” in “SETUP”.

Option Menu Setting

You can quickly adjust the setting items relevant to the current SOURCE by using Option Menu.

1. Press and hold  /ENTER/OPTION for at least 2 seconds to activate the Option menu of the current source.

NOTE:

- The option menu varies depending on the source.
2. Turn the Rotary encoder to select the desired setting item, and then press  /ENTER.
 3. Turn the Rotary encoder to change the setting, and then press  /ENTER.

After the setting, the display will return to the current source automatically.

• Setting item:

HD Radio mode:

PTY SELECT*1 ↔ TUNER SET*2 ↔ SOURCE VOL*3
↔ MX SETTING*4 ↔ PTY SELECT

SiriusXM mode:

TUNE SCAN*5 ↔ ALERT MEMO*6 ↔ SXM SET*7 ↔
SOURCE VOL*3 ↔ MX SETTING*4 ↔ TUNE SCAN

DISC mode:

CD SET*8 ↔ SOURCE VOL*3 ↔ MX SETTING*4 ↔
CD SET

USB mode:

SOURCE VOL*3 ↔ MX SETTING*4 ↔ SOURCE VOL

iPod mode:

APP DIRECT*9 ↔ IPOD SET*10 ↔ SOURCE VOL*3 ↔
MX SETTING*4 ↔ APP DIRECT

AUX mode:

AUX SET*11 ↔ SOURCE VOL*3 ↔ MX SETTING*4 ↔
AUX SET

Pandora mode:

SOURCE VOL*3 ↔ MX SETTING*4 ↔ SOURCE VOL

BT Audio mode:

BT SET*12 ↔ SOURCE VOL*3 ↔ MX SETTING*4 ↔
BT SET

Phone mode (Non-calling mode):

PHONE SET*13 ↔ SOURCE VOL*14 ↔ PHONE SET

Phone mode (Calling mode):

MIC GAIN*15 ↔ CALL SOUND*15 ↔ SPK SWITCH*16 ↔ VOICE MUTE*17 ↔ CALL WAIT*18 ↔ END CALL*19 ↔ SOURCE VOL*14 ↔ MIC GAIN

*1 Refer to "PTY (Program Type) Tuning" in "RBDS".

*2 The setting items are the same as TUNER setting in SETUP mode. For details, refer to "Tuner Setting" in "Setup".

*3 You can individually emphasize or weaken the volume level of the current source to create your own tonal preference. The setting values in Option mode and in SETUP mode are linked. Refer to "Setting The Source Volume Level" in "Sound Setting".

*4 Refer to "Setting The Media Xpander Mode" in "Sound Setting".

*5 Displayed only when SiriusXM Tuner-SXV200 or later is connected. For details, refer to "TuneScan Function" in "SiriusXM Satellite Radio Operation-If Equipped".

*6 Refer to "Storing The Desired Artist And Song Alerts" in "SiriusXM Satellite Radio Operation-If Equipped".

*7 ALERTSETUP, GAME ALERT, P-LOCK, SIGNAL IND and TUNE START can be selected in this mode. For details about these settings, refer to "SiriusXM Setting" in "SiriusXM Satellite Radio Operation-If Equipped".

*8 PLAY MODE can be selected in this mode. For details, refer to "Playing MP3/WMA Data (PLAY MODE)" in "Setup".

*9 Refer to "Setting The iPod Control" in "Accessories".

*10 The setting items are the same as iPod setting in SETUP mode. For details, refer to "iPod/iPhone Search Mode Setting" in "Setup".

*11 AUX NAME can be selected in this mode. For details, refer to "Setting The AUX NAME Mode" in "Sound Setting".

*12 FW VERSION can be selected in this mode. You can see the current firmware version about Bluetooth by using this setting.

*13 CALL SOUND, CALLER ID, PB UPDATE, PB ORDER, SPEAKER SL and FW VERSION can be selected in this mode. For details about these settings, refer to "Bluetooth Setup" in "Sound Setting".

*14 The Hands free phone talk level, ring tone level and microphone gain level can be adjusted by using this setting. The setting values in Option mode and in SETUP mode are linked. Refer to “Adjusting The Volume (SOURCE VOL)” in “Bluetooth Hands Free Calling”.

*15 Refer to “Setting The Bluetooth Sound Quality” in “Bluetooth Hands Free Calling”.

*16 While calling, the call sound can be switched between the unit and Smartphone by using this setting. This operation can also be done by pressing BAND. Refer to “Call Switching Operation” in “Bluetooth Hands Free Calling”.

*17 While calling, and the Voice Mute is activated, the microphone input will mute instantly and “VOICE MUTE” will blink. This operation can also be done by pressing Play/Pause. Refer to “Muting The Microphone Input Quickly (Voice Mute)” in “Bluetooth Hands Free Calling”.

*18 If there is a waiting call, select this item to display the waiting person Name and number. Press  to switch the information between the current call and the person on hold.

NOTE:

- Press  to return to the previous mode.
- If no operation is performed for 60 seconds, the unit will return to normal mode automatically.

Applying TuneIt

This unit’s sound tuning is programmable from a connected Smartphone. It is also possible to download specific parameters for certain vehicles from Alpine’s TuneIt database stored in the Cloud. Using the TuneIt App, customized parameters can also be uploaded for others to share and rate.

Through this unit, it is also possible to receive and respond to information from Alpine’s Social Network Service (SNS) available through the connected Smartphone.

The installed TuneIt App should be launched on the Smartphone before connection to the head unit. TuneIt, is downloadable from Apple’s App Store; the Android user can download it from Google Play. For details, consult your Alpine dealer.

Before these operations, set Alpine APP to USB or BT depending on the connected Smartphone. For details, refer to “Setting the communication mode with a Smartphone (Alpine APP)” on page 77.

NOTE:

- The application program and the related specifications and data may be deleted or terminated without notice.
- Some functions of TuneIt may not be available when the Smartphone is not in service area or receives no signal.

Adjusting The Sound Via Smartphone

After setting the above procedure, the VOLUME indicator lights up, and then you can adjust the unit’s sound function on the Smartphone.

1. Make sure the unit is powered on.
2. Launch the TuneIt App on Smartphone. Adjust the unit’s sound accordingly on the Smartphone.

During sound setting, the VOLUME indicator may blink.

NOTE:

- Volume and sound parameter preset function cannot be adjusted via Smartphone.
- The setting cannot be done on both the Smartphone and this unit at the same time. While the sound function of this unit is set via the Smartphone, sound function settings on CDE-164BT will be displayed as “APP Connect”.
- When the unit is powered off or during a call, sound setting cannot be done via the Smartphone.
- This function may not be available depending on the paired Smartphone.
- Please obey all local traffic laws while using this function.

Facebook Notification Function

NOTE:

- Depending on the paired Smartphone, the following functions may not be available even though the TuneIt version is updated.

Receiving Notification (Ready On Future Update)

When the Smartphone connected to this unit receives notification from Facebook, it will BEEP and the SOURCE key blinks (depending on the TuneIt settings on the phone). At the same time, the user's name is shown in the display (20 characters maximum).

1. While receiving Notification from Facebook, press  /SOURCE button.

Notification Menu screen is displayed.

2. Turn the Rotary encoder to select the desired mode, and then press  /ENTER .

Like*1 ↔ Replay ↔ Next ↔ Previous ↔ TTS Volume*2 ↔ Like

*1 Not displayed only when the received Notification is Message type.

*2 It can also be set in SETUP section. For details, refer to "Setting the TTS (Text To Speech) volume" on page 78.

Like: The Smartphone feedbacks to Facebook with "Like", and meanwhile, the received Wall Posts or Comments is played back by TTS (Text To Speech).

Replay: To play back Notification by TTS (Text To Speech) again.

Next: To select the next Notification.

Previous: To select the previous Notification.



TTS Volume: To adjust the playback volume of TTS (Text To Speech).

NOTE:

- Press  to return to the previous mode.
- A new received Notification prompt will last for 30 seconds. If there is no operation within 30 seconds, the unit will return to normal mode.
- When this unit is powered off or during a call, Notification of Smartphone will not be prompted by this unit.
- In 3WAY mode, the TTS sound is output from all of speaker in car. In 2WAY mode, the TTS sound is only output from Front Left/Right speaker.

Displaying Notification List

You can view the received Notification from Facebook in the connected Smartphone via this unit.

1. Press and hold  /SOURCE for at least 2 seconds.
The received Notification will be displayed according to when it was posted.
2. Turn the Rotary encoder to select the desired Notification, and then press  /ENTER .
3. Then go to step 2 of “Receiving Notification”.

NOTE:

- When there is no Notification, “No Notification” will be displayed.
- The displayable amount of the Notification list depends on the connected Smartphone.
- If no operation is performed for 60 seconds, the unit will return to normal mode automatically.

SETUP

CONTENTS

■ SETUP70	□ Tuner Setting76
□ Setting70	□ iPod&USB Setting77
□ General Setting71	□ Application Setting (APP)77
□ Display Setting74		

SETUP

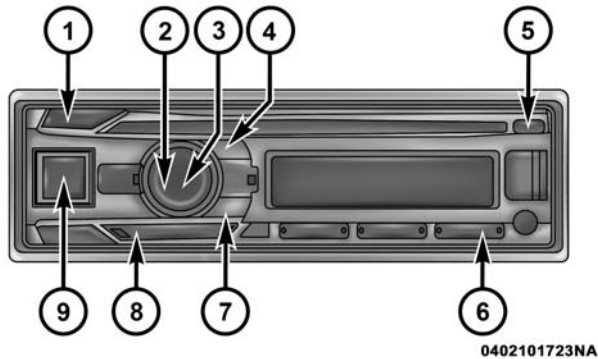

- 1 — AUDIO/SETUP
- 2 — Q /Enter
- 3 — Rotary Encoder
- 4 — Fast-Forward Buttons
- 5 — DIM. Button

- 6 — 6
- 7 — Fast-Rewind Buttons
- 8 — BACK Button
- 9 — SOURCE Button

Setting

You can flexibly customize the unit to suit your own preferences and usage. From the SETUP menu, General Setting, Display Setting, etc. can be modified.

Use steps 1 to 5 to select one of the SETUP modes to modify. See the applicable section below for details about the selected SETUP item.

1. Press and hold AUDIO/SETUP for at least two seconds to activate the SETUP mode.
2. Turn the Rotary encoder to select the desired item, and then press Q /ENTER.

Audio*1 ↔ General ↔ Display ↔ Tuner ↔ SiriusXM*2 ↔ iPod&USB ↔ Application ↔ Bluetooth*3 ↔ Audio

General:

CLOCK MODE ↔ CLOCK ADJ*4 ↔ PWR CLOCK ↔ AUX SETUP ↔ AUX NAME*5 ↔ INT MUTE ↔ PLAY MODE ↔ STAY ON ↔ DEMO MODE ↔ CLOCK MODE

Display:

ILLUMINATI ↔ DIMMER ↔ TEXTSCROLL ↔ SCROLLTYPE ↔ ILLUMINATI

Tuner:

TUNER FREQ ↔ FM SET ↔ TUNER FREQ

iPod:

IPOD LIST

Application:

ALPINE APP ↔ TTS VOLUME ↔ ALPINE APP



*1 Refer to “Sound Settings”

*2 Refer to “SiriusXM Setting”

*3 Refer to “BLUETOOTH SETUP”

*4 Refer to “Setting Time”

*5 Displayed only when AUX SETUP is ON.

3. Turn the Rotary encoder to select a setting item, and then press  /ENTER.
(e.g. Select AUX SETUP)
4. Turn the Rotary encoder to change the setting, and then press  /ENTER.
(e.g. Select ON or OFF)
5. Press and hold AUDIO/SETUP for at least two seconds to return to normal mode.

NOTE:

- Pressing  returns to the previous SETUP mode.
- If no operation is performed for 60 seconds, SETUP is canceled.

General Setting

General is selected on the setup main menu in step 2.

Setting The Clock Display (Clock Mode)

You can select the clock display type, 12-hour or 24-hour, depending on your preference.

- **Setting item:** Clock Mode

Setting contents:

12H (Initial setting) / 24H

Turning The Clock Display ON/OFF

Setting item: PWR CLOCK

Setting contents:

OFF / ON (Initial setting)

OFF: The clock isn't displayed when the power is off.

ON: The clock is displayed when the power is off.

Setting The AUX SETUP mode

You can input the audio of an external device, (such as a Portable audio player) to the AUX connector of this unit.

- **Setting item:** AUX SETUP

Setting contents:

OFF / ON (Initial setting)

OFF:

When set to OFF, AUX source cannot be selected.

ON:

Set to ON, when the portable device is connected. If  /SOURCE is pressed and AUX is selected, the sound of the portable device is input to the unit.

Setting The AUX NAME Mode

You can change the AUX NAME display in the SETUP mode.

- **Setting item:** AUX Name

Setting contents:

AUXILIARY (Initial setting) / TV / DVD / PORTABLE / GAME

Turning Mute Mode On/Off (INT MUTE)

If a device having the interrupt feature is connected, audio will be automatically muted whenever the interrupt signal is received from the device.

Make sure the Audio Interrupt In Lead (Pink/Black) is connected to the terminal where the voltage becomes 0 V (GND) when a sound from External Unit is input into AUX. Otherwise, this function may not operate.

Setting item: INT MUTE

Setting contents:

OFF AUX (Initial setting) / ON

OFF AUX: When the interrupt signal is received from device, the AUX source volume will be output from the unit.

ON: When the interrupt signal is received from device, no sound will be output.

Playing MP3/WMA Data (Play Mode)

This unit can play back CDs containing both CD and MP3/WMA data (created in Enhanced CD (CD Extra) format). However, in some situations, playback of an enhanced CD may be difficult. In this case, you can select

playback of a single session only, containing the CD data. When a disc contains both CD and MP3/WMA data, playback starts from the CD data portion of the disc.

- **Setting item:** Play Mode

Setting contents:

CD-DA / CDDA/MP3 (Initial setting)

CD-DA:

Only the CD data in Session 1 can be played back.

CDDA&MP3/WMA:

CD data, MP3/WMA/AAC files in mixed mode, and multi-session discs can be played back.

NOTE: Perform this setting before inserting a disc. If a disc has already been inserted, remove it.

Setting The Stay On Mode

You can set the delay in turning OFF the unit's power after the vehicle's ignition is turned off (ACC OFF). When you select a mode other than OFF, the music will be paused after you turn the ignition key off (ACC OFF). At the same time, the prompt "PRESS PRESET 6 TO STAY ON" will scroll once. Press 6 within 15 seconds to continue enjoying music for the selected period. If 6 is not

pressed, the unit will power off within 15 seconds. During this period, you can only receive a call by operating a paired Smartphone.

- **Setting item:** STAY ON

Setting contents:

OFF (Initial setting) / 5 MIN / 15 MIN / 30 MIN

NOTE:

- Note that there is a possibility that the battery may be drained if already weak, during this period.
- The setting result of STAY ON will be cleared if you switch the 2WAY/ 3WAY system mode.

Demonstration

This unit has a demonstration feature for the display.

- **Setting item:** Demo Mode

Setting contents:

ON (Initial setting) / STANDBY / OFF

ON: The unit starts the demonstration if there is no operation for 30 seconds.

STANDBY: Quit the demonstration mode. Note that if this unit is disconnected from the vehicle's battery, the next time you use this unit the DEMO mode will be ON.

OFF: Quit the demonstration mode completely.

Display Setting

Display is selected on the setup main menu in step 2.

Changing Lighting Color

You can change the lighting color of the unit's buttons.

Setting item: ILLUMINATI

Further setting items: KEY & DISP(Key & Display) / KEY (Key) / DISP* (Display)

Setting contents:

OPTION / CUSTOMIZE

OPTION: A total of 30 colors can be selected.

CUSTOMIZE: If there is no color you prefer in OPTION, you can customize the color as follows.

* You can change the lighting colour of keys and display simultaneously or respectively by selecting KEY or KEY/DISP.

1. After entering CUSTOMIZE, turn the Rotary encoder to select a color (RED, GREEN, BLUE) you want to adjust, and then press ENTER.
2. The adjusted color will blink, turn the Rotary encoder to select a value (0-60).
R is red, G is green and B is blue.
3. Press ENTER or BACK to finish the color setting.
4. Repeat steps 1 to 3 to set another color.

NOTE:

- In step 2, you can switch to another color setting mode by pressing SEEK UP or SEEK DOWN.
- The setting values in OPTION mode and CUSTOMIZE mode are linked, when the setting value in CUSTOMIZE is different from the one in OPTION, "USER" will be displayed in OPTION mode.
- During CUSTOMIZE setting, at least one setting value should be greater than 20.

Dimmer Control

Set the Dimmer control to Auto to decrease the illumination brightness of the unit with the head lights of the vehicle ON. This mode is useful if you feel the unit's backlighting is too bright at night.

- **Setting item:** Dimmer

Setting contents:

AUTO (Initial setting) / ON / OFF

NOTE: You can also adjust this item by pressing and holding DIM.

Scroll Setting (Text Scroll)

This CD player can scroll the disc and track names recorded on CD-TEXT discs, as well as text information of MP3/WMA/AAC files, folder names, tags, HD Radio broadcasts and SiriusXM.

- **Setting item:** TEXTSCROLL

Setting contents:

Manual (Initial setting) / Auto

Manual:

The display is scrolled when a disc is loaded or when a track is changed, etc.

Auto:

The current text information of CD, folder, tag, etc. is scrolled automatically.

NOTE:

- The unit scrolls CD text names, folder names, file names or tag display.

Scroll Type Setting

Choose the type you prefer from two scrolling methods.

- **Setting item:** SCROLLTYPE

Setting contents:

TYPE 1 / TYPE 2 (Initial setting)

TYPE 1:

The characters scroll from right to left, one character at a time, until the entire title has scrolled.

TYPE 2:

Words are built up from left to right, a single character at a time. When the display is full, it is cleared and the subsequent words are displayed the same way until all words of the title have been shown.

Tuner Setting

Tuner is selected on the setup main menu in step 2.

Setting The TUNER (FM) Frequency Step (TUNER FREQ)

During manual tuning, you can select the frequency step for FM analog radio station searching.

Setting item: TUNER FREQ

Setting contents:

200KHZ (Initial setting) / 100KHZ

Setting The TUNER (FM) Tone Quality

This unit can set your preferred tone quality for FM radio source.

- **Setting item:** FM Tuner Setup

Setting contents:

Hi-Fi / Normal (Initial setting) / Stable

Hi-Fi:



High-quality setting

Normal:

Standard setting

Stable:

Control noise

1. Press and hold AUDIO/SETUP for at least two seconds to activate the SETUP mode.
2. Turn the Rotary encoder to select Tuner Setting, and press  /ENTER.
3. Turn the Rotary encoder to select FM Tuner Setup, and press  /ENTER.
4. Turn the Rotary encoder to select either Hi-Fi, Normal (Initial setting) or Stable, and press  /ENTER.
5. Press and hold AUDIO/SETUP for at least two seconds to return to normal mode.

NOTE:

- Noise may be more noticeable when Hi-Fi is set, depending on the reception status. In this case, the Normal setting is recommended.

iPod&USB Setting

iPod&USB is selected on the setup main menu in step 2.

iPod/iPhone Search Mode Setting

The unit allows you to search for the iPod/iPhone using nine different search modes.

- **Setting item:** IPOD LIST
- **Further setting items:** PLAYLISTS / ARTISTS / ALBUMS / AUDIOBOOKS / PODCASTS / GENRES / COMPOSERS / SONGS / GENIUS MIX

Setting contents:

OFF / ON

NOTE:

- When the search mode is in Playlists/Artists/Albums/Podcasts/Genres/ Songs/Genius Mixes, the initial setting is On, and when the search mode is in Audiobooks/Composers, the initial setting is Off.
- For search mode details, refer to “Searching for a desired song” on page 97.

Application Setting (APP)

Application is selected on the setup main menu in step 2.

Setting The Communication Mode With A Smartphone (Alpine APP)

Set Alpine APP to USB when an iPhone is connected, or set to BT when an Android Smartphone is paired.

- **Setting item:** ALPINE APP

Setting contents:

USB (Initial setting) / BT / OFF

USB:

When an iPhone is connected to CDE-HD149BT's USB port, you can enjoy Pandora, program the unit's sound tuning parameters, or communicate with SNS.

BT:

Set this when an Android Smartphone is paired with this unit via BLUETOOTH technology. At this time, you can enjoy Pandora, program the unit's sound tuning parameters, or communicate with SNS.

OFF:

No Smartphone is connected.

NOTE:

- It takes a few seconds to validate this function.
- For this function to work properly, specific applications must be installed on your Smartphone before connection. Consult your Alpine dealer or the Alpine website for details.
- Only the iPhone and certain Android/BlackBerry Smartphones support this function.

Setting The TTS (Text To Speech) Volume

This function allows for readout of comments, etc., on a Smartphone, and outputs sound from the speaker of the unit.

- **Setting item:** TTS Volume

Setting contents:

0~35

NOTE:

- The initial volume level is 12.

BLUETOOTH HANDS FREE CALLING

CONTENTS

■ BLUETOOTH HANDS FREE CALLING80	□ Hands-Free Phone Control89
□ Setup Before Using81	□ Bluetooth Audio Operation96
□ Bluetooth Setup.83		

BLUETOOTH HANDS FREE CALLING

NOTE:

- Always drive safely with your hands on the steering wheel and obey all applicable laws. You have full responsibility and assume all risks related to the use of the features and applications in this vehicle. Only use the features and applications in this vehicle when it is safe to do so. Failure to do so may result in an accident involving in serious injury or death.
- Any voice commanded system should be used only in safe driving conditions following all applicable laws. Your attention should be focused on safely operating the vehicle. Failure to do so may result in a collision causing serious injury or death.

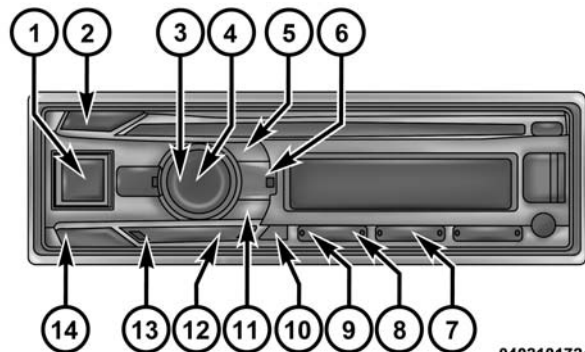

0402101724NA

- | | |
|------------------------------|----------------------|
| 1 — /SOURCE | 8 — Forward |
| 2 — AUDIO/SETUP | 9 — Rewind |
| 3 — /ENTER | 10 — View |
| 4 — Rotary Encoder | 11 — Fast Rewind |
| 5 — Fast Forward | 12 — Play/Pause |
| 6 — Phone/Voice CTRL. Button | 13 — BACK Button |
| 7 — Presets Buttons (1-6) | 14 — BAND/ABC SEARCH |

Setup Before Using

About BLUETOOTH

BLUETOOTH is a wireless technology allowing communication between a mobile device or personal computer over short distances. This enables a hands-free call or data transmission between BLUETOOTH compatible devices. BLUETOOTH transmission is available in the unlicensed 2.4 GHz spectrum if the distance between devices is within 10 meters. For details, refer to the BLUETOOTH Home page (<http://www.bluetooth.com>).

NOTE:

- Depending on the BLUETOOTH version, a BLUETOOTH compatible device may not be able to communicate with this unit.
- Proper function of this unit with all BLUETOOTH compatible devices is not guaranteed. For handling of the BT compatible device, consult your ALPINE dealer or ALPINE website.
- Depending on the surroundings, BLUETOOTH wireless connection may be unstable.
- When you place a call, or perform setup operations, be sure to stop your car in a safe place.

- Depending on the connected BLUETOOTH compatible device(s), the function may differ. Also refer to the Owner's Manual of the connected device(s).
- When you search for this unit using the BLUETOOTH compatible phone, the unit name is displayed as "Alpine CD Receiver".

Before Using BLUETOOTH Function

Before using the BLUETOOTH function, the following settings need to be made.

Set "Bluetooth IN" to ON when you want to use Hands-Free phone or Bluetooth Audio function. Refer to "Setting the BLUETOOTH Connection (Bluetooth IN)" on page 84.

NOTE:

- Before using BLUETOOTH function, it must be paired with this unit. Refer to "How to connect to a BLUETOOTH compatible device (Pairing)" within this section.

How To Connect To A Bluetooth Compatible Device (Pairing)

For details on the control from a BLUETOOTH compatible device, refer to the Owner's Manual of the BLUETOOTH compatible device.

Pairing a BLUETOOTH compatible device with SSP (Secure Simple Pairing)

1. Using your BLUETOOTH compatible device, select the "Alpine CD Receiver" for pairing.
2. Turn the Rotary encoder to change the head unit display from "Pairing NO" to "Pairing YES", and then press **Q** /ENTER.
If "Pairing NO" is selected, the connection will be canceled.
3. If the pairing was successful, "Connected" is displayed for a few seconds. The head unit then returns to its previous state.

Pairing a BLUETOOTH compatible device without SSP (Secure Simple Pairing)

1. Using your BLUETOOTH compatible device, select the "Alpine CD Receiver" for pairing.
2. Input the passcode ("0000") in a BLUETOOTH compatible device.

NOTE:

- The passcode is fixed as "0000".

3. If the pairing was successful, "Connected" is displayed for a few seconds. The head unit then returns to its previous state.

NOTE:

- If the connection is unsuccessful, "Failed" is displayed.
- After a successful pairing, the two devices should reconnect automatically whenever the vehicle's ignition is turned ON. If the auto connection fails, try to reconnect manually.
- Set "Visible Mode" to ON to enable this unit to be recognized by a BLUETOOTH compatible device, refer to "Setting the Visible Mode" within this section.
- You can also manually pair the BLUETOOTH devices from this unit.

Auto Pairing With A iPod/iPhone

When an iPod/iPhone is connected to the USB port, the unit will automatically pair with it.

1. Make sure USB PAIR is set to ON. Refer to "Setting the Auto Pairing with iPod/iPhone" within this section.
2. Connect an iPod/iPhone to this unit's USB port.

- Turn the Rotary encoder to select "PAIR YES", and then press ENTER. *

If "PAIR NO" is selected, the connection will be canceled.

* Depending on the iOS version, you may need to turn on the Bluetooth function manually on the iPod/iPhone side, then perform this step.

- If pairing is successful, "CONNECTED" is displayed for a few seconds. The head unit then returns to its previous state.

NOTE:

- If the device has been paired with this unit previously, it will not USB Pair automatically.
- If the connection is unsuccessful, "FAILED" is displayed.
- After a successful pairing, the device and this unit should connect automatically whenever the vehicle's ignition is turned ON. If the auto reconnect fails, try to connect manually.
- Set "VISIBLE M" to ON, so this unit is visible to other Bluetooth compatible devices. Refer to "Setting the Visible Mode" within this section.

Bluetooth Setup

The following steps one to five are common to the various BLUETOOTH functions. For details, refer to each individual function.

NOTE:

- Set "Bluetooth IN" to ON, and then perform BLUETOOTH SETUP operation. Refer to "Setting the BLUETOOTH Connection (Bluetooth IN)" on page 84.

- Press and hold AUDIO/SETUP for at least two seconds to activate the SETUP mode.
- Turn the Rotary encoder to select "Bluetooth", and then press  /ENTER.

The BLUETOOTH setup mode is activated.↔

- Turn the Rotary encoder to select the desired items and then press  /ENTER.

BLUETOOTH:

Bluetooth IN*1↔Paired Device*2↔Visible Mode*1/*2
 ↔Search Device*1/*2↔Call Sound*2↔Caller ID*2↔
 PB Update*1/*2 ↔ PB Order*2 ↔ Auto Answer*2 ↔
 Service Name*2 ↔ Speaker Select*2 ↔ FW Version*2
 ↔ FW Update*1/*2 ↔ Bluetooth IN

*1 The items are not displayed during a phone call.

*2 The items are not displayed if “Bluetooth IN” is set to OFF. Refer to “Setting the BLUETOOTH Connection (Bluetooth IN)” within this section.

4. Turn the Rotary encoder to change the settings.
5. Press and hold AUDIO/SETUP for at least two seconds.

The SETUP mode is canceled.

NOTE:

- Press  to return to the previous mode.
- If no operation is performed for 60 seconds, the unit will return to normal mode automatically.

Setting The BLUETOOTH Connection (Bluetooth IN)

With BLUETOOTH technology, you can place a hands-free call by a BLUETOOTH-equipped Smartphone.

Audio information of a BLUETOOTH compatible Smartphone, a portable audio player, etc., is controllable/playable wirelessly from this unit.

- **Setting item:** Bluetooth IN

Setting contents:

OFF / ON (Initial setting)



OFF:

Hands-Free Phone function and Bluetooth Audio function are not used.

ON:

Select when you want to pair your BLUETOOTH compatible phone with this unit or use Bluetooth Audio function.

NOTE:

- When Bluetooth IN is set to OFF, the indicators related to Hands-free phone ( battery quantity and  signal strength) will not be displayed.

Setting The Auto Pairing With iPod/iPhone

By setting this item to ON, the unit will auto pair when an iPod/iPhone is connected to this unit via the USB port.

Setting item: USB PAIR

Setting contents:

OFF / ON (Initial setting)

OFF: Turn off the auto pair function.

ON: Auto pair when an iPod/iPhone is connected to this unit via the USB port.

NOTE: USB Auto-Pairing cannot take place if either device has been paired previously. Make sure the device name of both has been deleted from each device.

Setting The BLUETOOTH Device









Select one of five connected BLUETOOTH compatible devices that you previously registered.

- **Setting item:** PAIRED DEV

1. Turn the Rotary encoder to select a Bluetooth compatible device you want to use (you want to change connection), and then press ENTER.
2. Turn the Rotary encoder to select "CONNECT" to connect the selected device.

The connected device is marked with "1". Select "DISCONNECT" to disconnect this device. Select "CLEAR" when you want to clear the device from the device list.

NOTE:

- If the connection is successfully changed, "Connected" is displayed for two seconds and the  indicator lights up, then the display returns to the SETUP screen.
- If a Smartphone is connected to this unit successfully, the  indicator lights up to show the battery charge of the connected Smartphone. The  indicator lights up when the battery charge is about 50%, the  indicator lights up when the battery charge is not enough, and it blinks as a low level warning. The  indicator goes out when the battery is drained. At this time, the BLUETOOTH function is unavailable due to the Smartphone powered off.
- Indicator  (Signal Strength) will display the current signal strength of your service provider. The  indicator goes out when the Smartphone is not in service area or receives no signal.
- Depending on the connected Smartphone, the  (battery charge), and  (signal strength) indicators may not be displayed.

- If all the five positions have been registered, you cannot register the 4th device. To register another device, you need to delete one of the devices from position 1 to 3 first.

Setting The Visible Mode

You can set whether this unit can be recognized or not from a BLUETOOTH compatible device. Normally set this to ON.

- **Setting item:** Visible M

OFF:

Disable recognition of this unit from the BLUETOOTH compatible device.

ON: (Initial Setting)

Enable recognition of this unit from the BLUETOOTH compatible device.

Setting The Bluetooth Sound Quality

You can flexibly customize the sound of a call to fit your own preferences.

- **Setting item:** Call Sound
- **Further setting items:** Source VOL/Type Set

Adjusting The Volume (SOURCE VOL)

You can emphasize or weaken the volume level of the Phone call, the ring tone and the microphone input to fit your own preferences.

- **Setting contents:**

Phone Talk:

-5 dB ~ +5 dB

Ring Tone:

-5 dB ~ +5 dB

MIC Gain:

-5 dB ~ +5 dB

NOTE: The initial setting of PHONE TALK / RING TONE / MIC GAIN is 0.

Sound Auto Setting (Type Set)

Depending on your calling environment, choose one of the settings below which gives the best sound quality.

Setting contents: TYPE1 (Initial setting) / TYPE2 / TYPE3 / TYPE4 / TYPE5

TYPE1:

Standard Mode (recommended)

TYPE2:

Enhances the noise reduction

TYPE3:

Enhances the echo-cancel

TYPE4:

Enhances both noise reduction and echo-cancel

TYPE5:

Weakens both noise reduction and echo-cancel

NOTE:

- The functions below are designed to improve the sound quality of the outgoing call.

Noise reduction: This function can reduce the road noise, but excessive enhancement may affect the sound quality of the call.

Echo-cancel: This function can reduce the echo, but excessive enhancement may affect the sound quality of the call.

Setting the Caller Information Display ON/OFF

You can choose whether to use these functions according to the following setting.

- **Setting item:** Caller ID

Setting contents:

OFF / ON (Initial setting)

If you want to keep the ID information of the caller from others, set this item to OFF. Depending on the stored ID information, while you are dialing a number or a call is dialing in, only telephone number will be displayed or telephone name will be displayed as “NO Name”; During a call, “NO Name” will be displayed.

Setting The Phone Book Update

You can update the phone book automatically or manually.

- **Setting item:** PB Update

Setting contents:

Auto / Manual

Setting The Phone Book Auto Update ON/OFF (Auto)

When you select ON in this step, whenever the vehicle’s ignition is turned ON or after the phone is reconnected with this unit, the phone book will be updated automatically.

- **Setting contents:**

Auto OFF / Auto ON (Initial setting)

NOTE:

- “Updating” will be displayed during the phone book update.

Setting The Phone Book Manual Update ON/OFF (Manual)

When you select YES in this step, the phone book will be updated immediately regardless if the Auto update function is on or off.

- **Setting contents:**

NO (Initial setting) / YES

NOTE:

- “Updating” will be displayed during the phone book update.

Changing The Phone Book List Order

The phone book is listed alphabetically by the first letter of First or Last Name.

Listing by First Name is the default but Last Name can be selected.

- **Setting item:** PB Order

Setting contents:

First Name (Initial setting) / Last Name

NOTE:

- “Waiting” will be displayed while the Phone book order is switching. You can cancel the “Waiting” screen to perform other operations by pressing \Rightarrow when the ordering is still in progress. The phone book is not accessible during this time. In addition, the ordering may affect the playback of Bluetooth Audio.

Selecting The Output Speaker

Choose the speaker in your vehicle from which you want to hear the call.

- **Setting item:** Speaker SL

Setting contents:

ALL (Initial setting) / F-L / F-R / F-LR

ALL:

The sound will come out from all of speakers in the vehicle.

F-L:

The sound will only come out from the front left speaker.

F-R:

The sound will only come out from the front right speaker.

F-LR:

The sound will only come out from the front left and front right speakers.

NOTE: In 3WAY mode, the call sound will come from all of the speakers in the car.

Displaying The Firmware Version

The current firmware version will be displayed.

- **Setting item:** FW Version

Updating The Firmware

Future BLUETOOTH firmware updates may become available for phone interoperability.

For detailed information and operation to update your BLUETOOTH firmware, please visit Alpine home page (<http://www.alpine-usa.com>).

- **Setting item:** FW Update

Setting contents:

NO (Initial setting) / YES

Hands-Free Phone Control

About The Hands-Free Phone

Hands-free calls are possible when using a HSP (Head Set Profile) and HFP (Hands-Free Profile) compatible Smartphone with this unit.

NOTE:

- Avoid performing a hands-free call in heavy traffic or on narrow or winding streets.
- Close the windows while calling to reduce background noise.
- If both calling parties are using hands-free devices, or the call is made in a noisy location, difficulty hearing the other person's voice is normal.
- Depending on telephone line conditions or certain mobile devices used, voices may sound unnatural.
- When using a microphone, speak as directly as you can into the microphone to pick up the best sound quality.

- Certain Smartphone features are dependent on the capabilities and settings of your service provider's network. Additionally, certain features may not be activated by your service provider, and/or the provider's network settings may limit the feature's functionality.
- Always contact your service provider about feature availability and functionality.
- All features, functionality, and other product specifications, as well as the information contained in the Owner's Manual are based upon the latest available information and are believed to be accurate at the time of printing.
- Alpine reserves the right to change or modify any information or specifications without notice or obligation.

Answering A Call

Incoming calls are announced by the received call ring tone and a displayed message (Phone).

Press  or press  /ENTER.

The call starts.

NOTE:

- While calling, the source sound on the unit is muted. After calling, playback will resume.

Hanging Up The Telephone

Press .

The call finishes.

NOTE:

- You can also hang up the call by pressing .

Calling

Call History is recorded for the last dialed/received/missed calls (20 records for each). There are various ways of making calls based on the "Calling". The following steps 1 to 5 are common to the various ways of making these calls. For details, refer to each individual category for making calls.

1. Press .

The outgoing method list is displayed.

2. Turn the Rotary encoder to select the outgoing mode.

Dialed:

Dialed history

Received:

Received history

Missed:

Missed incoming history

Phone Book:

Smartphone phone book

3. Press **Q** /ENTER

The outgoing mode is activated, and each mode list is displayed.

NOTE:

- It may take some time for the list to be displayed, and also directly after connection, the list may not be brought up to date.

4. Turn the Rotary encoder to select a name or a telephone number from the list.

NOTE:

- You can use Phone book alphabet search function to search a name or number from Phone Book. For details, refer to "Phone book Alphabet Search Function" on page 92

5. Press **Q** /ENTER.

The selected telephone number will be called.

If one name has several numbers registered in the telephone book, press **Q** /ENTER after selecting the name*, then turn the Rotary encoder to choose the desired number and press **Q** /ENTER, the telephone will be called.

* If the name cannot be recognized, "NO Name" will be displayed.

NOTE:

- Press **↵** to return to the previous mode.
- If no operation is performed for 60 seconds, the unit will return to normal mode automatically.

Redialing A Number In Outgoing History

Previously dialed telephone numbers (maximum number of call record is 20) are stored in dialed calls history. You can redial a number by searching from dialed calls history.

- **Setting item:** Dialed

Dialing A Number In Incoming History

Telephone numbers (maximum number of call record is 20) from received calls are stored in the Received List. You can redial these numbers by searching here.

- **Setting item:** Received

Dialing A Number In Incoming Missed Call History

Telephone numbers (maximum number of call record is 20) for received calls that are missed, are stored in the Missed List. You can redial these numbers by searching here.

- **Setting item:** Missed

Dialing a Number In The Phone Book

Up to 1,000 names (at most 3 telephone numbers for each name) are downloadable from a Smartphone. Dial a call by selecting a person from the phone book list.

- **Setting item:** Phone Book

NOTE:

- The order of the list display depends on the setting of "PB Order" (refer to "Changing the Phone book List Order" within this section).
- If the call history or phone book of the Smartphone is added or deleted while it is connected to the unit, the list displayed on the unit may not be brought up to date. If it is not updated, you cannot correctly place a call.

- You can display the information of a number stored in phone book by pressing  VIEW. Each press changes the display as Name → Telephone NO./Telephone label* → Name If the information cannot be obtained, "NO Name" or "NO Number" will display.

* The telephone label of a number depends on the number information stored in Phone book of the Smartphone, which includes 4-type icons-(Mobile), (Home), (Work), and (Other).

Phone Book Alphabet Search Function

You can select the first three letters to search for a desired name in phone book list by using the Phone book alphabet search function.

For example:

Searching a name "Michael James".

The following example explains how the search is performed.

Depending on the setting in PB Order (refer to "Changing the Phone book List Order" within this section), the phone book is listed in first name or last name order. Please search for the first name or last name according to the setting.

1. Press BAND/ABC Search while in the phone book list, the phone book alphabet search mode is activated.
 - The letter selection screen is displayed.
2. Turn the Rotary encoder to select the first letter (e.g. M), and then press ►.
3. Turn the Rotary encoder to select the second letter (e.g. I), and then press ►.
4. Turn the Rotary encoder to select the third letter (e.g. C), and then press 🔍 /ENTER.
5. Turn the Rotary encoder to select the desired name (e.g. Michael James), and then press 🔍 /ENTER to make the call.

NOTE:

- The Alphabet Search Function is only applicable to English alphabet characters.
- If the selected name has several numbers registered in phone book, you need to turn the Rotary encoder to select the desired number, and then press 🔍 /ENTER.
- Press ◀ in step 3 or 4 to delete the current entry and return to the previous step.

- You can search for a name by its first letter, first two letters or first three letters. Press 🔍 /ENTER after entering the desired number of letters. A list displays the names beginning with the entered letter(s).

Voice Control Operation

When a Smartphone equipped with voice recognition function is paired with this unit. The Smartphone can be controlled by Voice Control via this unit.

Press and hold VOICE CTRL. for at least two seconds to activate the Voice Recognition mode.

After the Voice Recognition mode is activated and "Speak" is displayed, you can make a phone call, play a song, etc., via this unit by inputting voice control commands*.

* Please refer to your Smartphone manual for other voice control commands.

NOTE:

- You can perform this operation only when a Voice Recognition compatible Smartphone is connected. If the Smartphone is not compatible with the Voice Recognition, "No Support" is displayed for two seconds.

- The Voice Recognition function performance depends on the recognition range of the Smartphone and mounting location of the microphone. Please pay attention when the microphone is mounted.
- Voice Recognition operation depends on the function of the Smartphone. For details, refer to the Owner's Manual of the Smartphone.
- If a called person that you say is not found, "No Call" is displayed for two seconds.
- Please obey all local traffic laws while using this function.

Call Waiting Function

If a second call is received during a current call, you can have the first caller wait momentarily while you take the second call. When you are finished with one call, you can switch to the other one.

If a second call is received during the current call (call1), the information of second caller (call2) is displayed instead of the current caller's name. Press 2, the call waiting mode is activated.

In this case, call 1 is on hold, while you take call 2.

NOTE:

- In the call waiting mode, press 1 or 2 to switch between the current call and the person on hold.
- In the call waiting mode, press and hold 1 or 2 for at least 2 seconds to hang up call1 or call2, and the other call will be answered automatically. (The action depends on the paired device.)
- In the call waiting mode, you can press  VIEW to change the display between the current call and the person on hold.

Preset A Number In The Phone Menu (Shortcut Dial)

Assign numbers that you dial frequently to presets for quick recall. You can assign up to six frequently called phone numbers to number presets.

Select a number you want to preset from the Phone Menu list (Phone Book, Dialed Call, etc.). Press and hold any one of the preset buttons (1 through 6) as the one that you wish to store the number for at least 2 seconds.

The phone number you selected is stored in presets.

NOTE:

- If the name has several numbers registered in the phone book, press **Q** /ENTER after selecting the name. Turn the Rotary encoder to choose the desired number. Press and hold any one of the preset buttons (1 through 6) for at least two seconds. The selected number is stored as a preset number.
- A total of 18 phone numbers can be stored in the preset memory (6 numbers for each Smartphone in the paired device list). If a Smartphone is deleted from the paired device list, the stored preset numbers of this Smartphone are deleted, even when it is paired again.
- If you store a phone number in a preset with a previously stored number, the current number will be cleared and replaced by the new one.

Dialing The Preset Number

1. Press any one of the preset buttons (1 through 6) that has had a number stored in the phone mode.
The information (name/number) stored in the preset station is displayed.
2. Press **Q** /ENTER or press **↙**.
The stored preset number is dialed directly.

Adjusting The Volume When Receiving A Call

While calling, you can adjust the volume.

Turn the Rotary encoder to adjust the volume.

NOTE:

- You may need to increase volume from your regular audio listening source level. However, increasing the volume excessively may result in feedback. Feedback is directly related to the volume. Turning down the volume as low as acceptable, will reduce it. Positioning the microphone in a direction away from the main car speakers (e.g. clipped on sun visor) may also reduce feedback at high volume.

Muting the Microphone Input Quickly (Voice Mute)

While calling, activating the Voice Mute function will instantly mute the microphone input. Your voice will not be heard by the caller.

While calling, press **▶/■** to mute the microphone input.

Press **▶/■** again will bring the microphone input back to its previous volume level.

Call Switching Operation

While making a call, this function allows you to initiate the transfer of the audio between the Smartphone and the speakers in the car.

While calling, press BAND or press and hold **▶/■** for at least two seconds to switch the call sound between the unit and Smartphone.

NOTE:

- Depending on the Smartphone, this operation may not be performed.

Bluetooth Audio Operation

Audio information of a BLUETOOTH compatible Smartphone, a portable player, etc., is controllable/playable wirelessly* from this unit.

* To play back audio, a Smartphone or a portable player conforming to A2DP (Advanced Audio Distribution Profile) and AVRCP (Audio/ Video Remote Control Profile) is required.

Not all functions work with all devices.

NOTE:

- Set “Bluetooth IN” to ON when you want to use Bluetooth Audio function. Refer to “Setting the BLUETOOTH Connection (Bluetooth IN)” on page 84.
- During a call, sound on the BLUETOOTH audio source is muted.
- If you operate the Hands-free phone (e.g. searching in the phonebook) while using the Bluetooth Audio function, BLUETOOTH Audio playback may be affected.

Recalling The Bluetooth Audio Mode

Press **◀** /SOURCE to select the BLUETOOTH Audio mode.

Selecting The Desired Song

1. Press **⏮**.
Returns the beginning of the song being played back.
2. Press **⏭**.
Forwards the next song.
Pressing and holding **⏮** or **⏭** will fast backward/ fast forward track continuously.

NOTE:

- The action depends on the paired device.

Pausing

Press **▶/⏸**.

Playback stops. Pressing **▶/⏸** again will resume playback.

Selecting The Desired Group (Folder)

Press **Rewind ◀** or **▶ Forward** to select the desired Group (Folder).

Pressing and holding **Rewind ◀** or **▶ Forward** will change folders continuously.

NOTE:

- This function may not be available depending on the paired device.

Searching For A Desired Song

Artist name, album name, etc., may be searched and displayed during playback or pause.

1. Press **🔍 /ENTER** to activate the search mode.

2. Turn the Rotary encoder to select the desired Group (Folder), and then press **🔍 /ENTER**.

3. Turn the Rotary encoder to select the desired album, folder, etc., within the selected Group (Folder), and then press **🔍 /ENTER**.

4. Repeat step 3 if necessary until the desired song is found.

NOTE:

- Search mode may differ depending on the connected device.
- The pause mode may be canceled after the search.
- This function may not be available depending on the paired device.

ACCESSORIES

CONTENTS

■ FLASH MEMORY — IF EQUIPPED	100	□ Random Play Shuffle (M.I.X.)	109
□ Connecting The Flash Memory (Optional)	100	□ Repeat Play	110
□ Playback	100	□ Displaying The Text	111
□ About MP3/WMA File Of Flash Memory.	101	■ PANDORA INTERNET RADIO —	
■ IPOD/IPHONE — IF EQUIPPED.	101	IF EQUIPPED.	111
□ Connecting An iPod/iPhone	102	□ Listening To Pandora	112
□ Setting The iPod Control	103	□ “Thumbs” Feedback	113
□ Playback	104	□ Searching For A Desired Station	113
□ Searching For A Desired Song	104	□ Shuffle	114
□ Direct Search Function	107	□ Bookmarking A Desired Song Or Artist	115
□ Select Playlist/Artist/Album/Genre/ Composer/Episode	108	□ Creating A New Station	115
□ Alphabet Search Function	108	□ Search Position Memory	116
□ Search Position Memory	109	□ Changing The Display	116

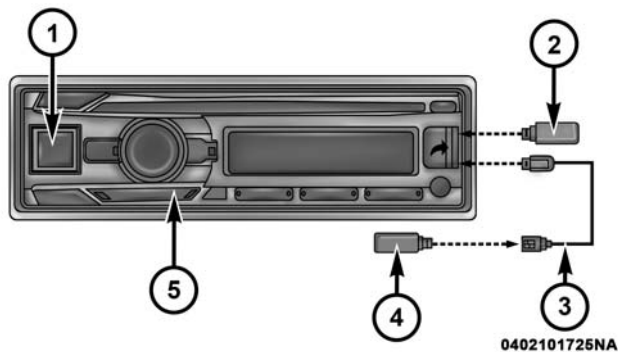
LASH MEMORY — IF EQUIPPED

1 — SOURCE

2 — USB Memory (Sold Separately)

3 — Cable (sold separately)

4 — USB Memory (sold separately)

5 — Play/Pause

Connecting The Flash Memory (Optional)

If a Flash Memory device is connected to the unit, MP3/WMA files can be played back.

Playback

1. Press SOURCE to select the USB mode.
2. To pause playback, press . Pressing again will resume playback.

NOTE:

- This unit plays back files in Flash Memory with the same controls and modes used for playback of CDs containing MP3/WMA. For details, refer to “CD/MP3/WMA”.
- The root folder is displayed as “\ROOT”.
- Before disconnecting Flash Memory, be sure to change to another source or set to pause.
- The playback time may not be correctly displayed when a VBR (Variable Bit Rate) recorded file is played back.

About MP3/WMA File Of Flash Memory

Playing Back MP3/WMA

MP3/WMA files are prepared, then stored to a Flash Memory Device. This unit can recognize at most 255 folders and 255 files per folder stored in Flash Memory. Playback may not be performed if a Flash Memory Device exceeds the limitations described above. Do not make a file's playback time more than 1 hour.

Media Supported

This device can play back files stored on Flash Memory devices designed for USB connection.

Corresponding File Systems

This device supports FAT 12/16/32 for Flash Memory devices.

IPOD/IPHONE — IF EQUIPPED

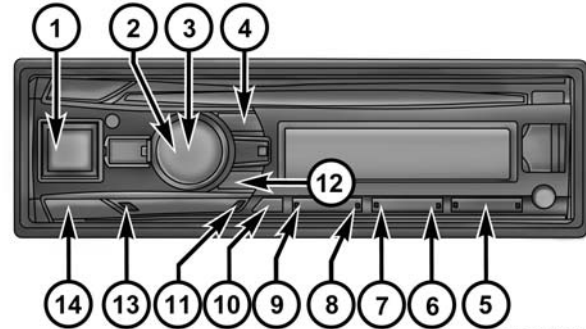

0402101726NA

- 1 — Return Source
- 2 — Enter
- 3 — Rotary Encoder
- 4 — Fast Forward
- 5 — Random
- 6 — Repeat
- 7 — Preset Buttons (1 through 6)

- 8 — Forward
- 9 — Rewind
- 10 — View
- 11 — Play/Pause
- 12 — Fast Rewind
- 13 — Back Button
- 14 — Band/ABC Source

Connecting An iPod/iPhone

An iPod/iPhone can be connected to this unit by using the Interface cable for iPod (included with iPod/iPhone). When this unit is connected by using the cable, the controls on the iPod are not functional.

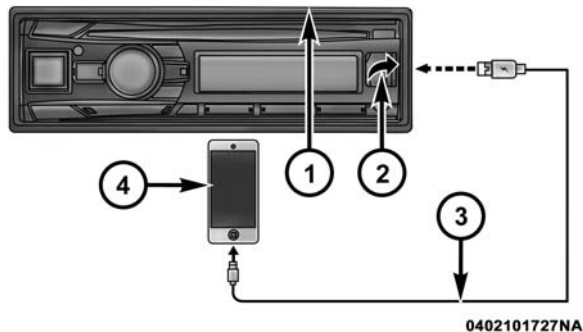

- 1 — Main Unit
- 2 — USB Connection Terminal
- 3 — Cord Included With iPod/iPhone
- 4 — iPod/iPhone (sold separately)

NOTE:

- Internet and telephone functions of the iPod touch or iPhone, etc., can also be used when connecting to this unit. However, using these functions will stop or pause the currently playing songs. At this time do not operate the unit to avoid a malfunction.
- An iPhone connected to this unit is usable as an iPod or a hands-free phone. The iPhone must be paired with the unit's Bluetooth to use the hands-free function.
- Do not leave an iPod/iPhone in a car, as its mechanism is sensitive to high temperature and humidity conditions, and damage may result.

About iPod/iPhone models usable with this unit

- The following devices have been certified following Made for iPod guidelines. Correct function of earlier versions cannot be guaranteed.

iPod nano (7th generation): Ver.1.0.2

iPod touch (5th generation): Ver.7.0.4

iPod touch (4th generation): Ver.6.1.5

iPod nano (6th generation): Ver.1.2

iPod touch (3rd generation): Ver.5.1.1

iPod nano (5th generation): Ver.1.0.2

iPod classic (160 GB) (Late 2009): Ver.2.0.4

iPod touch (2nd generation): Ver.4.2.1

iPod classic (120 GB): Ver.2.0.1

iPod touch (1st generation): Ver.3.1.3

iPod nano (3rd generation): Ver.1.1.3

iPod classic (80 GB, 160 GB): Ver.1.1.2

- The following devices have been certified following Made for iPhone guidelines. Correct function of earlier versions cannot be guaranteed.

iPhone 5s: Ver.7.1.1

iPhone 5c: Ver.7.1.1

iPhone 5: Ver.7.1.1

iPhone 4s: Ver.7.1.1

iPhone 4: Ver.7.1.1

iPhone 3GS: Ver.6.1.6

iPhone 3G: Ver.4.2.1

iPhone: Ver.3.1.3

- For clarity in identifying your model of iPod, please see Apple's own document "Identifying iPod models" at <http://support.apple.com/kb/HT1353>.
- This unit does not support video playback from iPod/iPhone, even using a video-compatible cable.

Setting The iPod Control

When an iPod/iPhone is connected, operate it from its own controls or from the head unit.

1. Press and hold  /ENTER/OPTION for at least 2 seconds in the iPod mode.

The Option menu for iPod mode is activated.

2. Turn the Rotary Encoder to select " **APP Direct**", and then press  /ENTER.

The iPod control mode will switch between iPod Mode and HU Mode.

HU Mode (HEAD UNIT):

Operate the iPod/iPhone via this unit.

iPod Mode:

Operate the iPod/iPhone using its own controls. When iPod is selected, some functions will not be operable via the head unit.

NOTE:

- During HU Mode, you can switch to iPod Mode directly by pressing **BAND**.
- Once the control mode is changed, this will set pause status, press **▶/||** to continue.
- Depending upon the iPod used, iPod control may not be selectable. Or, if iPod is selected, operation must still be from the head unit.

Playback

1. Press **☐** SOURCE to switch to the iPod mode.
2. Press **◀◀** or **▶▶** to select the desired song.
Pressing and holding **◀◀** or **▶▶** will fast backward/ fast forward the current song.
3. To pause playback, press **▶/||**.
Pressing **▶/||** again will resume playback.

NOTE:

- A song playing on the iPod/iPhone while it is connected to this unit will continue to play from where it was paused after disconnection.

- If you listen to an episode from a selected podcast or audiobook, the episode can be changed by pressing Forward **◀** or **▶** Rewind.
- An episode may have several chapters. The chapter can be changed by pressing **◀◀** or **▶▶**.

Searching For A Desired Song

An iPod/iPhone can contain hundreds of songs. This unit utilizes various methods to make searches for desired content as simple as possible.

Each music category has its own individual hierarchy as shown below. Choose a music category from the list below to narrow searches quickly.

Hierarchy 1	Hierarchy 2	Hierarchy 3	Hierarchy 4
Playlist	Song	—	—
Artist*	Album*	Song	—
Album*	Song	—	—
Song		—	—
Podcast	Episode	—	—
Genre*	Artist*	Album*	Song
Composer*	Album*	Song	—
Audiobook	—	—	—
Genius Mix list	—	—	—

For example:

Searching by Artist name.

The following example explains how an Artist search is performed.

Another search mode can be used for the same operation, although the hierarchy differs.

1. Press  /ENTER to activate the search selection mode.



2. Turn the Rotary encoder to select the Artist search mode, and then press  /ENTER.

Shuffle All*1 ↔ Playlist ↔ Artist ↔ Album
 ↔ Song ↔ Podcast ↔ Genre ↔ Composer ↔ Au-
 diobook ↔ Genius Mix*2/*3 ↔ Shuffle All*1



*1 Refer to “Random Play Shuffle (M.I.X.)” on page 109.

*2 Depending on the connected iPod/iPhone, Genius Mix function may not be supported.

*3 When an iPod/iPhone with Genius Mix list created by iTunes is connected to this unit, Genius Mix search mode can be used to search a Genius Mix list.

3. Turn the Rotary encoder to select the desired Artist, and then press  /ENTER.
4. Turn the Rotary encoder to select the desired Album, and then press  /ENTER.
5. Turn the Rotary encoder to select the desired Song, and then press  /ENTER.
The selected song is played back.

NOTE:

- This function is unavailable when iPod MODE is selected in “Setting the iPod Control” (refer to “Setting the iPod Control” within this section). And “iPod CONTROL” will be displayed.
- After pressing and holding  /ENTER for at least two seconds while in each hierarchy (except SONG, AUDIOBOOK and GENIUS MIX List hierarchy), all songs of the selected hierarchy are played back.
- Playback [ALL] is only applicable for those categories marked with “*”, press and hold ENTER for at least two seconds to play back all songs in the iPod/iPhone or selected search mode.
- If no operation is performed for 60 seconds, the search mode is canceled.
- In the search mode, pressing  will return to the previous mode.
- When search is made during M.I.X. play, the M.I.X. play mode will be canceled.
- When search is made during song downloading on iPhone, “UPDATING” will be displayed for a few second and the search mode will be canceled.
- “NO SONG” will be displayed if there are no songs in the selected playlist in the PLAYLIST search mode.
- “NO PODCAST” will be displayed if there is no podcast data in the iPod/iPhone in the PODCAST search mode.
- “NO AUDIOBOOK” will be displayed if there is no audiobook data in the iPod/iPhone in AUDIOBOOK search mode.
- “NO GENIUS” will be displayed if there is no genius mix list data in the GENIUS MIX search mode.
- If “iPod name” stored in the iPod/iPhone is selected in the Playlist search mode, and  /ENTER is pressed, you can search for all songs in the iPod/iPhone. Also, if you press and hold ENTER for at least two seconds, all songs in the iPod/iPhone are played back.

- Depending on the iPod/iPhone, podcast search is not supported.
- Press any of the preset buttons (1 through 6) during a search to skip over a calculated percentage of songs. For details, refer to “Direct Search Function” in this section.
- During search mode, a search can be made quickly by Alphabet search function to find the desired artist or song, etc. For details, refer to “Alphabet Search Function” within this section.

Direct Search Function

Direct search can be used to jump a fixed percentage of titles within the current search category (album, song, etc.).

In the search mode, press any one of the preset buttons (1 through 6) to quickly skip over a designated percent of your song content.

Song search example:

If there are 100 songs in your iPod/iPhone, they are divided into 6 groups using percentages (shown below). These groups are assigned to preset buttons 1 through 6.

Example 1:

Suppose the song you are searching for is located at around the middle (50%) of your library: press button 4 to jump to the 50th song and turn the Rotary Encoder to find the desired song.

Example 2:

Suppose the song you are searching for is located near the end (83%) of your library: press button 6 to jump to the 83rd song and turn the Rotary Encoder to find the desired song.

	All 100 songs (100%)					
	0%	17%	33%	50%	67%	83%
Preset buttons	1	2	3	4	5	6
Songs	1st song	17th song	33rd song	50th song	67th song	83rd song

NOTE:

- The Alphabet Search Function is only applicable to English alphabetic characters.
- While in Alphabet search mode, pressing t will return to the previous mode.
- If the PLAYLIST search mode is used to search for a song, the Alphabet search function is inactive in the song search hierarchy.
- This function is unavailable when GENIUS MIX is selected.

Select Playlist/Artist/Album/Genre/ Composer/ Episode

Playlist/Artist/Album/Genre/Composer/Episode can be easily changed. For example, if you listen to a song from a selected album, the previous or next album can be selected.

Press Rewind ◀ or ▶ Forward to change to the previous or next Playlist/ Artist/Album/Genre/ Composer/Episode.



NOTE:

- If the song search mode was used to select a song, this function is inactive.

- If an album is selected during an artist search, other albums by that artist are searchable.
- This function is inactive during shuffle (M.I.X.) playback.

Alphabet Search Function

Use the Alphabet Search Function to search for an album, song, etc., by its first letter. Select the first letter of the desired title (album, song, etc.), and the titles beginning with this letter are listed.

1. During search mode, press BAND/ABC SEARCH to activate Alphabet Search Function.
2. Turn the Rotary Encoder to select a desired letter (e.g. M), and then press  /ENTER.
A list which begins with the selected initial letter is searched.
3. Turn the Rotary encoder to select the desired item (which begins with initial letter "M"), and then press  /ENTER.

NOTE:

- The Alphabet Search Function is only applicable to English alphabetic characters.

- While in Alphabet Search Mode, pressing \leftarrow will return to the previous mode.
- If the Playlist search mode is used to search for a song, the Alphabet Search Function is inactive in the song search hierarchy.
- This function is unavailable when Genius Mix list is selected.

Search Position Memory

During iPod/iPhone playback, you can quickly return to the last-selected hierarchy level in the search mode.

Press \leftarrow .

The hierarchy you selected last in the search mode is displayed.

NOTE: This function is unavailable when iPod MODE is selected in “Setting the iPod Control” (refer to “Setting the iPod Control” within this section).

Random Play Shuffle (M.I.X.)

The Shuffle function of the iPod/iPhone is displayed as M.I.X. on this unit.

Shuffle Albums:

The songs on each album are played back in proper order. Upon completion of all the songs on the album, the next album is selected randomly. This continues until all albums have been played.

Shuffle Songs:

Song shuffle randomly plays back songs within a selected category (playlist, album, etc.). The songs within the category are played just once until all songs have been played.

1. Press \rightarrow .

The songs are played back in random sequence.

MIX ALBUM \rightarrow MIX SONG*2 \rightarrow (off) \rightarrow MIX OFF \rightarrow
MIX ALBUM

*1 Shuffle Albums.

*2 Shuffle Songs.



2. To cancel M.I.X. play, select (off) with the above procedure.

NOTE:

- If a song is selected in the album search mode before selecting M.I.X. play, the songs will not play back randomly even when Shuffle Albums is selected.

Shuffle All:

Shuffle All plays all songs in the iPod/iPhone randomly. Any one song does not play back again until all songs have been played back.

1. Press  /ENTER to activate the search selection mode.
2. Turn the Rotary Encoder to select Shuffle All, and then press  /ENTER.

To cancel M.I.X. play, press  to select OFF.

NOTE:

- If Shuffle All is selected, the selected songs being played back in the search mode are canceled.
- This function is unavailable when iPod MODE is selected in “Setting the iPod Control” (refer to “Setting the iPod Control” within this section) .

Repeat Play

Only Repeat One is available for the iPod/iPhone.

Repeat One:

A single song is repeatedly played back.

1. Press  .

The song is played back repeatedly.

REPEAT ONE* → REPEAT OFF → REPEAT ONE

* Repeat One.

2. To cancel repeat play, select (Repeat Off) with the above procedure.

NOTE:

- Depending on the connected iPod, track up/down may be not available during Repeat play.

Displaying The Text

You can display the tag information of a song in the iPod/iPhone.

Press  VIEW.

Each press changes the display.

NOTE:

- When the Text Scroll is set to Manual (refer to “Scroll Setting (Text Scroll)” on page 75), press and hold  VIEW for at least two seconds, the current text will be scrolled one time.

TRACK NO./ELAPSED TIME → ARTIST NAME*/
SONG TITLE* → ALBUM NAME*/SONG TITLE* →
TRACK NO./CLOCK → TRACK NO./ELAPSED TIME

* TAG information “ARTIST”/“ALBUM”/“SONG” is displayed if there is no tag information.





NOTE:

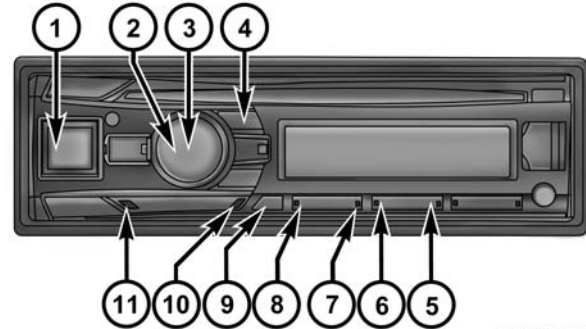



- The maximum number of characters for the head unit is 70 (70 byte).
- Some characters may not be correctly displayed.

PANDORA INTERNET RADIO — IF EQUIPPED



0402101728NA

- 1 —  Source
- 2 —  Enter
- 3 — Rotary Encoder
- 4 —  Fast Forward
- 5 —  New Station
- 6 —  Bookmark

- 7 —  Thumbs Up
- 8 —  Thumbs Down
- 9 —  View
- 10 —  Play/Pause
- 11 —  Return

Pandora internet radio is your own FREE personalized radio now available to stream music on your Smartphone (which runs Android OS or iOS).

Just start with the name of one of your favorite artists, songs or classical composers and Pandora will create a “station” that plays their music and more music like it.



The unit enables you to interact with your Pandora account by connecting a Smartphone that has the latest version of the Pandora application installed.

NOTE:

- Some Pandora application functions are not available when using this unit.
- Pandora is also controllable from an iPod touch with Wi-Fi connection.
- Pandora is available on iOS and Android OS with this unit.
- Before this operation, set ALPINE APP to USB or BT depending on the connected Smartphone. For details, refer to “Application Setting (APP)” in “Setup”.

Listening To Pandora

1. Connect a Smartphone with the latest version of Pandora installed.
2. Press  /SOURCE to switch to the Pandora mode.

3. To pause playback, press . Pressing  again will resume playback.



4. To skip to the next song, press .



NOTE:



- The operation to replay a previous song is not available.
- Pandora limits the number of skips allowed on their service. If you attempt to skip songs beyond the limit, “Skip Limit” is displayed.
- The unit remembers the source just before turning off the power. If Pandora is the last SOURCE to be played, it will appear as the SOURCE the next time the unit is power up even if the app is not launched on your Smartphone.
- Pandora audio could drop out in areas with poor phone coverage.
- The display content varies when ads are received.
- The playback time may not be correctly displayed.

“Thumbs” Feedback

You can personalize your stations with “Thumbs Up” or “Thumbs Down” feedback, which the system takes into account for future music selections.

During playback, press  or  for thumbs up or thumbs down.

 : The  icon appears in the display. Pandora will add similar music to your station.

 : The  icon is displayed. Pandora will ban that song from your station, and the current song is skipped. If the number of skips allowed has reached its limit, the current song continues to play back.

NOTE:

- In some situations, “Thumbs” feedback may not be available.

Searching For A Desired Station

You can display your station list and select stations directly from this unit.

Alphabet Search:

1. Press  /ENTER to activate the Search mode.

2. Turn the Rotary encoder to select “A-Z”, and then press  /ENTER.

The “A-Z” search mode is activated and the station names are listed alphabetically.

3. Turn the Rotary encoder to select the desired station, and then press  /ENTER.

Pandora will play that station.

Search by Date Added:

1. Press  /ENTER to activate the Search mode.



2. Turn the Rotary encoder to select “By Date”, and then press  /ENTER.

The “By Date” search mode is activated and the station names are listed by the date they were added to the account.

3. Turn the Rotary encoder to select the desired station, and then press  /ENTER.

Pandora will play that station.

Search by Genre:



1. Press  /ENTER to activate the Search mode.
The “GENRE” search mode is activated and all the genre types are listed.
2. Turn the Rotary encoder to select the desired genre type, and then press  /ENTER.
3. Turn the Rotary encoder to select the desired station, and then press  /ENTER.
Pandora will play that station.

NOTE:

- The shared station is marked with “H” in search list. The current station is marked with “K” in the search list. And then if the current station is a shared station, the station will be marked with “J”.
- If any one of the **preset buttons (1 through 6)** is pressed in the search mode, a search can be made quickly by skipping the specified number of channels. For details, refer to “Direct Search Function” on page 107.
- When the desired station can’t be found, turn to SHUFFLE mode to select station randomly.

Shuffle

Use Shuffle to create a playlist based on two or more of your Pandora stations. Edit your Shuffle station selections on the Pandora Compatible Application for iPhone when it is not connected to this unit.



1. Press  /ENTER to activate the Search mode.
2. Turn the Rotary encoder to select “A-Z” or “By Date”, and then press  /ENTER.
The “A-Z” or “By Date” search mode is activated and the station name is displayed.
3. Press  /ENTER while selecting “SHUFFLE”.

NOTE:

- The songs from the created stations are played back in random sequence.
- Select another station during search mode to cancel Shuffle.
- During search list mode, the Shuffle icon will be displayed when the current station belongs to SHUFFLE.

Bookmarking A Desired Song Or Artist

The currently playing track or artist can be bookmarked and saved to your Pandora account.



1. During playback, press  (Bookmarks).
The Pandora Bookmark screen is displayed.
2. Turn the Rotary encoder to select "Track (Bookmark)" or "Artist (Bookmark)", and then press  /ENTER.
The current track or artist is bookmarked. "Bookmark Track" or "Bookmark Artist" is displayed.

NOTE:

- Your bookmarks can be viewed on your "Profile" page at www.pandora.com.
- In some situations, bookmarks may not be available.
- When Bookmark operation is failed, Bookmark N/A will be displayed.

Creating A New Station

Based on currently playing track or artist, you can create a new station and save to your Pandora account.

1. During playback, press  (New Station).
The Pandora New Station screen is displayed.
2. Turn the Rotary encoder to select "Track" or "Artist", and then press  /ENTER.
A "New Track" or "New Artist" pop-up screen.
A New Station based on current track or artist is created.

NOTE:

- Your New Station can be viewed on your "Profile" page at www.pandora.com.
- In some situations, creating a new station function may not be available.

- If this operation fails, N/A will be displayed.
- When the Smartphone is not connected to this unit, you can create personalized Pandora stations using the Pandora Application on your Smartphone. You can also create stations on the web at www.pandora.com.

Search Position Memory

During playback, you can quickly return to the last-selected hierarchy level in the search mode.

Press .

The hierarchy you selected last in the search mode is displayed.

Changing The Display

Press  VIEW.

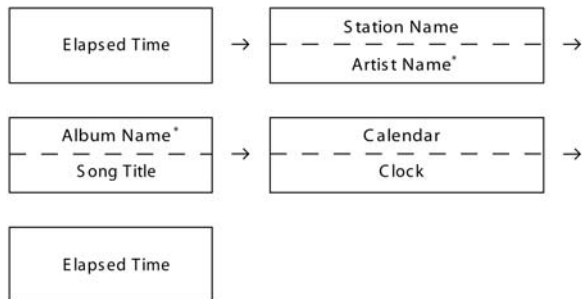

0501067446

* TAG information If there is no text information, nothing will be displayed.

NOTE:

- Some characters may not be correctly displayed.

SIRIUSXM SATELLITE RADIO OPERATION — IF EQUIPPED

CONTENTS

■ SIRIUSXM SATELLITE RADIO OPERATION — IF EQUIPPED.118	□ SmartFavorites Function.125
□ Receiving Channels With The SiriusXM Tuner119	□ TuneScan Function.125
□ SiriusXM Setting119	□ TuneStart Function.126
□ Managing Artist And Song Alerts120	□ Storing The Desired Artist And Song Alerts126
□ Setting The Favorite Sports Team Alerts.121	□ Receiving And Tuning To An Alert127
□ Setting The Parental Control121	□ Search Function.128
□ Confirming The Strength Of The SiriusXM Signal.123	□ Using Jump Memory And Jump Recall Function130
□ Setting TuneStart123	□ Replay Function130
□ Checking The SiriusXM Radio ID Number123	□ Parental Lock Function.131
□ Storing Channel Presets124	□ iTunes Radio Tagging.132
□ Tuning Channels Using Presets124	□ Changing The Display133

**SIRIUSXM SATELLITE RADIO OPERATION —
IF EQUIPPED**

SiriusXM Tuner operation:

WARNING!

Always drive safely with your hands on the steering wheel and obey all applicable laws. You have full responsibility and assume all risks related to the use of the features and applications in this vehicle. Only use the features and applications in this vehicle when it is safe to do so. Failure to do so may result in an accident involving in serious injury or death.

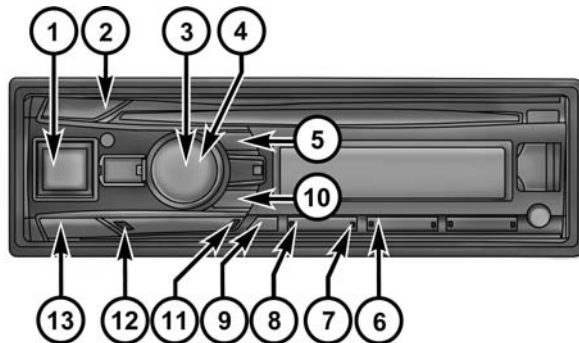

0402101729NA

- | | |
|----------------------------------|------------------|
| 1 — Source | 8 — Rewind |
| 2 — Setup Button | 9 — Tag |
| 3 — Enter | 10 — Replay |
| 4 — Rotary Encoder | 11 — Play/Pause |
| 5 — Fast Forward | 12 — Return |
| 6 — Preset Buttons (1 through 6) | 13 — Band Button |
| 7 — Forward | |

When a SiriusXM Tuner is connected to this unit, the following operations may be performed.

Receiving Channels With The SiriusXM Tuner

About SiriusXM Satellite Radio

Only SiriusXM brings you more of what you love to listen to, all in one place. Get over 140 channels, including commercial-free music plus the best sports, news, talk, comedy and entertainment. Welcome to the world of satellite radio. A SiriusXM Vehicle Tuner and Subscription are required. For more information, visit www.siriusxm.com.



To activate SiriusXM Canada service, go to <https://activate.siriusxm.ca> and click on “ACTIVATE RADIO” in the bottom left corner, or call 877-438-9677.

NOTE:

- The SiriusXM Satellite Radio controls on this unit are available only when a SiriusXM Tuner is connected.

1. Press  /Source to activate the Satellite Radio (SiriusXM) mode.

2. Press  or  to select the desired channel.

Holding down  or  will rapidly browse through the channels.

Alternatively, you can enter the number of the desired channel using the numeric keypad on an optional remote control.

SiriusXM Setting

The following steps one to five are common to the various SiriusXM functions. For details, refer to each individual function.

1. Press and hold AUDIO/SETUP for at least two seconds to activate the SETUP mode.

2. Turn the Rotary encoder to select “SiriusXM”, and then press  /Enter.

The SiriusXM setup mode is activated.

3. Turn the Rotary encoder to select the desired items and then press  /Enter.

SiriusXM:

Alert Setup ↔ Games Alert Setup ↔ Parental Lock ↔ Signal Indicator ↔ Alert Setup

4. Turn the Rotary encoder to change the settings.

5. Press and hold AUDIO/SETUP for at least two seconds.

The SETUP mode is canceled.

NOTE:

- Press  to return to the previous mode.

- If no operation is performed for 60 seconds, the unit will return to normal mode automatically.

Managing Artist And Song Alerts

The following operations can be performed to change the Alert settings. The Artist and Song Alerts feature allows you to mark Artists and Songs from the current channel and then the unit alerts you later when the marked Artists or Songs are playing on other channels.

- **Setting item:** Alert Setup

Setting contents:

Alert List / Alert / A S Alert / Delete All

Alert List

This menu option allows you to enable the Artist/Song alert for individual Artist/Songs (ON or OFF) or to delete individual stored Artist/Song alerts (Delete).

1. Turn the Rotary encoder to select Alert List, and then press **Q** / ENTER.
2. Turn the Rotary encoder and select a stored Artist or Song and press **Q** / ENTER.

3. Turn the Rotary encoder to select either Alert to enable (ON) or disable (OFF) the alert for the selected Artist/Song or turn the Rotary Encoder to select Delete to delete the selected Artist/Song from memory.

Alert

This menu option allows you to temporarily disable the Artist/Song Alerts for all Artists/Songs. When the Alerts are re-enabled, individual Artist/Song Alert disabled in the Alert List menu setting remain disabled.

Turn the Rotary encoder to select ON or OFF, and then press **Q** / ENTER.

If ON is set, the alert for all stored Artists/Songs is enabled.

If OFF is set, the alert for all stored Artists/Songs is disabled.

A S Alert

This menu option allows you to enable the alerts of all sources.

Turn the Rotary encoder to select ON or OFF, and then press **Q** / ENTER.

If ON is set, the alert of all source is enabled.

If OFF is set, only the alert of SiriusXM source is enabled.

Delete All

This operation will delete all alerts (artists, songs and team) stored in memory.



After selecting this item, turn the Rotary encoder to select YES, and then press  /ENTER.

Setting The Favorite Sports Team Alerts

This menu option allows you to select your favorite teams, organized by leagues, so that you will be alerted later when your favorite teams are playing on other channels.

- **Setting item:** GAME ALERT

After selecting Games Alert Setup, a sports league list will be displayed.

1. Turn the Rotary encoder to select the desired league, and then press  /ENTER.
2. Turn the Rotary encoder to select a team you want to store and press  /ENTER.

“TEAM SAVED” and “XXU(sed)/YYE(mpty)” are displayed.

XX is the total number of Artist/Song/GameAlert items stored in memory, and YY is the total number of memory slots still available for storage.

NOTE:

- Select “None” on the team list if you do not want to store in memory.

Setting The Parental Control

You can lock out channels with passcode protection. Channels that are locked cannot be accessed without entering the pass code. You can unlock a channel or change the pass code using this menu option.

- **Setting item:** P Lock

Setting contents:

Clear All / Locked CH/ Edit Code

How to input pass code?

1. After select Parental Lock, a pass code input screen will be displayed.
2. Input the pass code using the Rotary encoder.
The initial default four digit pass code is set to 0000.

The pass code is entered one digit at a time with the Rotary encoder. For example, by turning clockwise 2 steps, the number 1 is selected.

After entering the digit, it is displayed as * (asterisk).

3. Press **▶▶**, and then input the next digit of the pass code as described in step 2.

Press **◀◀** to delete the current entry return to the previous step.

4. Repeat steps 2 to 3 until the 4 digits of the pass code are entered, and then press **Q** / ENTER.

After the correct pass code is entered, the Clear All/Locked Channels/Edit Code items can be adjusted.

Clear All:

Unlock all locked channels.

Turn the Rotary encoder to select YES, and then press **Q** / ENTER.

Locked CH:

After selecting this item, turn the Rotary encoder to select a channel from channel list, press **Q** / ENTER to select to lock or unlock the channel. Locked channels cannot be tuned without entering the pass code.

The locked channel will be displayed with “L” before channel No.

Edit Code:

Change the pass code.

Input the old pass code as steps 1 to 4 in “How to input pass code?”.

After the old pass code is entered, the new pass code input screen will be displayed.

Input the new pass code as steps 1 to 4 in “How to input pass code?”.

A confirm screen will be displayed and the new passcode must be entered again for confirmation. When the passcode is changed successfully, the unit will display Code Saved.

1. Press and hold AUDIO/SETUP for at least two seconds to activate the SETUP mode.
2. Turn the Rotary encoder to select “SiriusXM”, and then press **Q** / ENTER.
The SiriusXM setup mode is activated.
3. Turn the Rotary encoder and select Parental Lock and press **Q** / ENTER.

4. Turn the Rotary encoder to select either Clear All, Locked Channels or Edit Code, and press  / ENTER.

NOTE:

- Keep a note of the numbers somewhere safe in case you should forget it.

Confirming The Strength Of The SiriusXM Signal

You can check the signal strength through this setting item.

- **Setting item:** Signal IND

Signal content

Setting IND

Setting Indicator:

This menu item displays the SiriusXM signal strength as Strong, Good, Weak or No Signal.

NOTE:

- If the Signal Indicator reports Weak or No Signal and your vehicle is parked outside with no obstructions to the southern sky, then your SiriusXM antenna may not be properly installed or may have become damaged.

Setting TuneStart

With the TuneStart feature turned ON, you will hear the beginning of the song when you tune to one of your Preset music channels from the current band of presets. It may take a minute or two for the feature to work after power up or after changing preset bands.

Setting item: TUNE START

Setting contents:

OFF / ON (Initial setting)

OFF: When set to OFF, TuneStart mode is unavailable.

ON: When ON, selecting a SmartFavorites or Preset Channel will automatically start the currently song from the beginning, depending on the channel content type. Pressing BACK will return to live satellite radio.

NOTE: Displayed only when SiriusXM Tuner-SXV200 or later is connected.

Checking The SiriusXM Radio ID Number

To subscribe to the SiriusXM Satellite Radio service, it is necessary to locate and identify the Radio ID of your SiriusXM Tuner. The Radio ID contains 8 characters and can be found on the bottom of your SiriusXM Tuner or

can be displayed on when selecting Channel 0 by following the steps below:

1. While in the Satellite Radio Mode, press ◀◀ or ▶▶ to select channel "0".

The unit displays "RADIO ID" and ID number at the same time.

NOTE:

- The Radio ID does not include the letters I, O, S or F.
2. To cancel the ID number display, select a channel other than "0".

Storing Channel Presets

1. Press BAND to select the desired band you want to store the preset in.

There are 3 Satellite Radio Preset bands.

Each press of BAND changes the band: SiriusXM1 → SiriusXM2 → SiriusXM3 → SiriusXM1

2. Tune to the desired channel, and then press and hold (for at least two seconds) one of the preset buttons (1 through 6) to store the channel.

The display then shows the stored Band and preset number (for example, SiriusXM1-3 is shown when preset 3 of BAND1 is selected).

3. Repeat the procedure to store up to 5 other channels onto the same band.

NOTE:

- A total of 18 channels can be stored in the preset memory, 6 Channels for each band (SiriusXM1, SiriusXM2 and SiriusXM3).
- If you store a new channel into a preset which already has a channel assigned, the current channel will be cleared and replaced with the new one.

Tuning Channels Using Presets

1. Press BAND to select the desired band of Presets you wish to access.
2. Press the preset buttons (1 through 6) that has your desired Satellite Radio channel stored in memory.

SmartFavorites Function

SmartFavorites allow you to rewind and replay any missed programming from your current Band of Preset channels. Miss a music, news, talk or sports segment? No Problem, because you can rewind and replay when you tune to one of your SmartFavorites channel and hear what you missed. Note that buffering starts five seconds after changing the band. It takes five seconds for SmartFavorites to start buffering the preset channels in the new band. TuneScan and TuneStart functions are enabled by the above-mentioned SmartFavorites functionality.

NOTE:

- Compatible with SXV200 or later tuner models.
- SmartFavorites channels are the same as Preset channels on this Owner's Manual.

TuneScan Function

If you've got more than one Favorites music channel, you've got a lot of choices every time you tune in. Instead of pushing every preset button and hearing the live song, you can simply use the TuneScan function to get a short preview of songs that you have missed on each of your SmartFavorites music channels. Find a song you like and press ENTER again to continue listening to that song. You

can even skip back if you think you missed the preview or if you are not interested in the current preview, skip forward.

1. Press and hold ENTER/OPTION for at least two seconds when you want to scan the preset music.

The Option mode is activated.

2. Turn the Rotary encoder to select TUNE SCAN, and then press ENTER.

The "T.S." indicator lights up during TuneScan mode. Press ENTER during scan playback, TuneScan mode will be canceled and the selected track will be played back normally, at the same time the "T.S." indicator disappears.

Press BACK during scan playback to cancel TuneScan mode. The tuner returns to the channel before TuneScan was initiated and "SCAN STOP" will be displayed.

NOTE:

- Compatible with SXV200 or later tuner models. TuneScan channels are comprised of SmartFavorites Channels and may take a few minutes after power On or Preset Band change to operate.

- If you use this function after changing the band within five seconds, “SCAN UNAVL” will be displayed.
- If no operation is performed during the scanning process, when scanning finishes, the next mode depends on the SiriusXM Tuner.
- The SiriusXM Tuner scans through the songs from the SmartFavorites channels on the current band only, scanning from oldest to newest.

TuneStart Function

With the TuneStart feature turned ON, you will hear the beginning of the song when you tune to one of your SmartFavorites channels. It may take a minute or two for the feature to work after power up or after changing preset bands. Information for turning TUNE START ON or OFF can be found in the SiriusXM Setting section.

NOTE:



- Preset stations that play other than music-type content will start playing the channel from the current live play point when selected.
- Compatible with SXV200 or later tuner models.

Storing The Desired Artist And Song Alerts

While listening to SiriusXM Satellite Radio, you can be alerted when your favorite songs or artists are playing on other channels. An interruption Alert will be displayed when a matching artist or song is found on another channel. For receiving interruption Alert information, refer to “Receiving and Tuning to an Alert” on page 127.

1. Press and hold  /ENTER/OPTION for at least two seconds when a Song or the song of an Artist you want to store is playing.

The Option mode is activated.



2. Turn the Rotary encoder to select Alert Memory, and then press  /ENTER.
3. Turn the Rotary encoder to choose Save Artist? or Save Song? (when available), and then press  /ENTER.

NOTE:

- If both the artist name and song title are not available to save, Artist/Song will be displayed.
4. The new alert was stored in memory.
An “Artist/Song Saved” pop-up screen is followed by an “X U(sed)/Y E(mpty)”.

X is the total number of song titles or artist names stored in memory, and Y is the total number of memory locations still available for storage.

NOTE:



- If you try to store when the memory is full, “Memory Full” is displayed followed by “Replace/Cancel”. If you want to replace an existing alert item, select “Replace” by turning Rotary encoder, and then press  /ENTER, the existing alert list stored in memory is displayed. Select one of the stored alerts using the Rotary encoder. To replace the selected alert, press  /ENTER and an “Artist/Song Saved” pop-up screen is followed by an “X U(sed)/Y E(mpty)”.
- You can manage the stored Alert memory setting on Setup mode, for details, refer to “Managing Artist and Song Alerts” on page 120.
- If no operation is performed for 60 seconds, the setting mode is canceled.

Receiving And Tuning To An Alert

Whenever a stored sports team, artist, or song is playing on another channel, an interruption Alert appears on the unit display. To tune to the game, artist or song identified by the alert, follow the steps below:

1. Turn the Rotary encoder to select the desired game, artist or song from the list of active alerts.
2. Press  /ENTER.

NOTE:

- If no operation is performed for five seconds, the unit returns to normal mode.
- Sports teams/Artist name and Song title which you have stored and which are currently playing will be displayed in a category called “My Music”/“My Games” in search mode. For details, refer to “Search Function” on page 128.
- When an artist or song alert occurs, you may press  to change the information as below.
Artist name*/Song name* → Channel number/
Channel name → Artist name/Song name
* Depending on the alert type, the display order for Artist name or Song name will be reversed.
- When a GameAlert occurs, you may press  to change the information as below.

Team name/League name → Channel number/
Channel name → Team name/League name

Search Function

You can search for SiriusXM programming content by Category or by Channel.

Searching by Channel

1. Turn the Rotary encoder to select All Channels after step 1, and then press  / ENTER.

All Channels will be displayed in a list.

2. Turn the Rotary encoder to select the desired channel, and then press  / ENTER to confirm.



NOTE:

- Press  VIEW, the information of the broadcasting channels will be displayed. You can choose the desired channel from the artist name list or song name list.

Each time you press  VIEW, the display changes as below.

Channel number/Channel name → Channel number/
Artist name → Channel number/Song name → Chan-
nel number/Channel name

Searching By Category

1. Enter SEARCH mode by pressing  /ENTER while in the SiriusXM mode.
2. Turn the Rotary encoder to select the desired Category, and then press  /ENTER.
3. Turn the Rotary encoder to select the desired Channel Name, and then press  /ENTER.

NOTE: During Category search, pressing the arrow buttons to select another Category.

Searching by My Music

1. Turn the Rotary encoder to select My Music* after step 1, and then press  / ENTER.



The artist names and song names that you have stored and are currently playing will be displayed in a list.

* Displayed only when the stored song or artist is broadcasting.

2. Turn the Rotary encoder to select the desired artist/song, and then press  / ENTER to confirm.

The channel of the selected artist/song being broadcast is received.

NOTE:

- Press  VIEW, the information of the broadcasting channels will be displayed. You can choose the desired channel from the artist name list or song name list. Each time you press  VIEW, the display changes as below. Artist name*/Song name* → Channel number/Channel name → Content Info → Artist name/Song name.

* Depending on the alert type, the display order for Artist name or Song name will be reversed.

Searching By My Games

1. Turn the Rotary encoder to select My Games* after step 1, and then press  / ENTER.



The sport teams that you have stored and the game is currently broadcasting will be displayed in a list.

* Displayed only when the game of stored team is broadcasting.

2. Turn the Rotary encoder to select the desired team, and then press  / ENTER to confirm.

The channel of the selected game being broadcast is received.

NOTE:

- Press , the information of the broadcasting channels will be displayed.
- Each time you press , the display changes as below. Team name/League name → channel number/channel name → Content Info → Team name/League name

Searching By Featured Favorites

Featured Favorites are groups of channels that are created by the SiriusXM Programming department allowing you to discover new channels. Featured Favorites channels are dynamic and can change often, allowing you to discover new channels.

1. Enter Search mode and turn the Rotary encoder to select FEATURED*. Press  /ENTER.

The Banks that SXM recommends will be displayed in a list, and the recommended Banks will be displayed with an "1" before the Bank name.

* Only displayed when connected with SiriusXM Tuner-SXV200 or later.

2. Turn the Rotary encoder to select the desired Bank, and then press  /ENTER.

- Turn the Rotary encoder to select the desired channel, and then press  /ENTER to confirm.

NOTE:

- Press , the information of the selected channels will be displayed. You can choose the desired channel from the artist name list or song name list.

Each time you press , the display changes as below. Channel Number → Channel Name → Artist Name → Song Name → Content Info → Channel Number

- When the selected Featured Favorites station is not broadcasting, the channel will tune to channel 000 automatically.
- Press BACK to return to the previous mode.
- If no operation is performed for 60 seconds, the unit will return to normal mode automatically.

Using Jump Memory And Jump Recall Function

- While in SiriusXM mode, select your favorite SiriusXM Channel.

- Press and hold  for at least two seconds.

The channel you selected is stored as the Jump Source.

- Press and hold BAND for at least two seconds to recall, and then tune to the saved Jump Source channel.

NOTE:

- Pressing and holding BAND again for at least two seconds will jump back to the previous mode or SiriusXM channel.
- During saved Jump Source channel playing, search function, channel up/down, etc. are not available.

Replay Function

In SiriusXM mode, you can pause, rewind and replay live SiriusXM Satellite Radio.

- While listening to a SiriusXM channel, press  to enter the Replay mode, which mutes the audio.

The display will show “  ” while in this mode.

2. Press **▶/||** again to resume playback of the stored audio from the point at which it was paused.

During playback, the SiriusXM Tuner will continue to store the channel audio until you exit the Replay mode.

During REPLAY playback:

- Fast rewind:
Press and hold **◀◀**.
- Fast forward:
Press and hold **▶▶**.
- Returning to the beginning of the current song: Press **◀◀**.
- Advancing to the beginning of the next song: Press **▶▶**.

3. Press **↵** to cancel the REPLAY mode.

The unit returns to live SiriusXM radio mode.

NOTE:

- Press **Ⓞ**, the information of the replaying channels will be displayed. You can choose the desired channel from the artist name list or song name list.

Each time you press **Ⓞ**, the displayed changes as below. Band/Channel Number/IR Time → Band/Channel Number/Channel Name → Artist Name*/Song Title* → Content info */Category Name* → Clock → Band/Channel Number/IR Time.

* If there is no text information, nothing will be displayed.

Parental Lock Function

This function can help restrict the listening of channels to children of appropriate age levels only. For information on setting the Parental Control passcode, refer to “Setting the Parental Control” on page 121. When a locked channel is selected, a “Channel Locked” pop-up screen is displayed.

Input the four digit passcode you set in, and then press **Q** /ENTER, refer to “Setting the Parental Control” on page 121.

Turn the Rotary encoder to select the number from 0-9, and then use **◀◀** or **▶▶** to adjust the digit. The initial number is 0000.

NOTE:

- If you input a wrong passcode, “Wrong Code” is displayed.

- After entering the correct passcode, you can access all locked channels without entering the passcode again until the unit is powered off and then back on.

iTunes Radio Tagging

iTunes Tagging lets you tag songs heard on SiriusXM channels. Use this unit in conjunction with an optional SiriusXM Tuner and a Tagging compatible iPod/iPhone to tag the music that you listen to. This tag information is automatically transferred to your iPod/iPhone. Later, when your iPod/iPhone is connected to iTunes, you can preview, buy and download your tagged songs. For details, refer to the Owner's Manual of the Tagging compatible iPod/iPhone.

The Tag indicator will light when a song playing on a SiriusXM channel has tag information available.

Press and hold  VIEW for at least two seconds to save its tag information.

During tagging, the **TAG** indicator blinks.

If no iPod/iPhone is connected, "Tag Count X" is displayed (X is the total amount of the tag information stored in this unit).

NOTE:

- During tagging, the iPod/iPhone takes priority to save the tag information. If no iPod/iPhone is connected, the tag information is saved to this unit.
- When the memory of iPod/iPhone is full, "iPod Full" and "Tag Count X" are displayed. The tag information will be stored to the unit.
- If the operation is failed, "Cannot Tag" is displayed.
- This unit can store up to 50 tagged songs. When the memory of the unit is full, "Tag Count50" and "Memory Full" are displayed.
- When an iPod that doesn't support the tagging function is connected, "Non-Tagging iPod" is displayed.
- When the iPod/iPhone is disconnected from the unit during tagging, its tag information will be stored in the unit.
- If there is stored tag information on the unit, when an iPod/iPhone supporting the tag function is connected, the stored tag information will be transferred to the iPod/iPhone automatically. When the iPod/iPhone

memory becomes full, “iPod Full” will be displayed, and any remaining tag information on the unit will not be transferred to the iPod/iPhone.

- If tag information already exists, “Already Tagged” will be displayed when you try to tag information again.

Changing The Display

Text information, such as the channel name, artist name/feature and song/program title, is available with each SiriusXM channel. The unit can display this text information as explained below.

In SiriusXM mode, press  VIEW.

Each time you press this button, the display changes as shown below.

Band/Channel Number/Channel Name* → Artist Name*/Song Title* → Content info.*/Category Name* → Clock → Band/Channel Number/Channel Name

* If there is no text information, nothing will be displayed.

ADDITIONAL INFORMATION

CONTENTS

■ IN CASE OF DIFFICULTY.	136	□ Flash Memory Messages.	139
□ Basic.	136	□ iPod Messages.	140
□ Radio	136	□ Bluetooth Mode.	141
□ CD.	137	□ SiriusXM Advisory Messages	141
□ MP3/WMA.	138	□ Pandora Mode Messages	143
□ Audio.	138	□ Specifications	145
□ iPod	138	□ About The Rules Of Bluetooth Electromagnetic Radiation Regulation	147
□ CD Player Messages.	138		

IN CASE OF DIFFICULTY

If you encounter a problem, turn the power off, then on again. If the unit is still not functioning normally, review the items in the following checklist. This guide will help you isolate the problem if the unit is at fault. Otherwise, make sure the rest of your system is properly connected or consult an authorized dealer.

Basic

No Function or Display.

- Vehicle's ignition is off.
 - If connected following instructions, the unit will not operate with the vehicle's ignition off.
- Improper power lead (Red) and battery lead (Yellow) connections.
 - Check power lead and battery lead connections.
- Blown fuse.
 - Check the fuse of the unit; replace with the proper value if necessary.
- Internal micro-computer malfunctioned due to interference noise etc.
 - Press the RESET switch with a ballpoint pen or other pointed article. For details, refer to "Initial System Start-Up" in "Getting Started".

Radio

Unable to receive stations.

- No antenna or open connection in cable.
 - Make sure the antenna is properly connected; replace the antenna or cable if necessary.

Unable to tune stations in the seek mode.

- You are in a weak signal area.
 - Make sure the tuner is in the DX mode.
- If the area you are in is a primary signal area, the antenna may not be grounded and connected properly.
 - Check your antenna connections; make sure the antenna is properly grounded at its mounting location.
- The antenna may not be the proper length.
 - Make sure the antenna is fully extended; if broken, replace the antenna with a new one.

Broadcast in noisy.

- The antenna is not the proper length.
 - Extend the antenna fully; replace it if it is broken.
- The antenna is poorly grounded.
 - Make sure the antenna is grounded properly at its mounting location.

CD**CD Player not functioning.**

- Out of operating temperature range +50°C (+120°F) for CD.
 - Allow the vehicle's interior (or trunk) temperature to cool.

CD playback sound is wavering.

- Moisture condensation in the CD Module.
 - Allow enough time for the condensation to evaporate (about 1 hour).

CD insertion not possible.

- A CD is already in the CD player.
 - Eject the CD and remove it.
- The CD is being improperly inserted.
 - Make sure the CD is being inserted following instructions in the CD Player Operation section.

Unable to fast forward or backward the CD.

- The CD has been damaged.
 - Eject the CD and discard it; using a damaged CD in your unit can cause damage to the mechanism.

CD playback sound skips due to vibration.

- Improper mounting of the unit.
 - Securely re-mount the unit.
- The disc is very dirty.
 - Clean the disc.
- The disc has scratches.
 - Change the disc.
- The pick-up lens is dirty.
 - Do not use a commercially available lens cleaner disc. Consult your nearest authorized dealer.

CD playback sound skips without vibration.

- The disc is dirty or scratched.
 - Clean the disc; damaged disc should be replaced.

Error displays (built-in CD player only).

- Mechanical error.
 - Press . After the error indication disappears, insert the disc again. If the above-mentioned solution does not solve the problem, consult your nearest authorized dealer.

CD-R/CD-RW playback not possible.

- Close session (finalization) has not been performed.
 - Perform finalization and attempt playback again.

MP3/WMA**MP3 or WMA is not played back.**

- Writing error occurred. The MP3/WMA format is not compatible.
 - Make sure the MP3/WMA has been written in a supported format. Refer to “About MP3/WMA” on page 32, then rewrite in the format supported by this device.

Audio**The sound is not output from the speakers.**

- There is no signal output from the internal amplifier.
 - Power IC is switched to “ON”.



iPod**iPod does not play and no sound is output.**

- The iPod has not been recognized.
 - Reset this unit and the iPod. Refer to “Initial System Start-Up” on page 19. To reset the iPod, refer to the Owner’s Manual of the iPod.



CD Player Messages**No Disc**

- No CD is inserted.
 - Insert a CD.
- Although a disc is inserted, “No Disc” is displayed and the unit does not start to play or eject the disc.
 - Remove the disc by following these steps:
 - Press the  button again for at least two seconds.
 - If the disc still does not eject, consult an authorized dealer.

Error

- Mechanism error.
 1. Press the  button and eject the CD.
 - If not ejecting, consult an authorized dealer.
 2. When the error indication remains after ejecting, press the  button again.
 - If the error indication still does not turn off after pressing the  button for a few times, consult your authorized dealer.

- When “Error” is displayed:

If the disc cannot be ejected by pressing , press the RESET switch (refer to “Initial System Start-Up” on page 19) and press  again. If the disc still cannot be ejected, consult your authorized dealer.

Protect

- A copy-protected WMA file was played back.
 - You can only play back non-copy-protected files.

Unsupported

- A sampling rate/bit rate not supported by the unit is used.
 - Use a sampling rate/bit rate that is supported by the unit.

No Support

- An AAC format disc is inserted.
 - Change to a disc of a supported format.
- Text information that is not recognizable by the unit is being used.
 - Change the text information to text that is supported by the unit.

Flash Memory Messages

Error

- Communication error or other error.
 - You can solve the problem by switching the source, turning ACC off/on, or turning power off/on.

Error-01

- Communication error.
 - You can solve the problem by switching the source, turning ACC off/on, or turning power off/on.

Error-04

- Abnormal current is run to the USB Flash Memory device.
 - You can solve the problem by turning ACC off/on, or turning power off/on.

No USB Device

- A Flash Memory is not connected.
 - Make sure the Flash Memory device is correctly connected.

No File

- No song (file) is stored in the Flash Memory.
 - Connect the Flash Memory device after storing songs (files).

Unsupported

- A sampling rate/bit rate not supported by the unit is used.
 - Use a sampling rate/bit rate that is supported by the unit.

Protect

- A copy-protected WMA file was played back.
 - You can only play back non-copy-protected files.

No Support

- Text information that is not recognizable by the unit is being used.
 - Change the text information to text that is supported by the unit.

Device Error

- An unsupported USB device is connected.
 - Change other Flash Memory.

iPod Messages**No Song**

- There are no songs in the iPod/iPhone.
 - Download songs to the iPod/iPhone and connect to this unit.

Error-01

- Communication error or boot error, etc.
 - You can solve the problem by reconnecting the iPod/iPhone or changing source.

Error-02

- The iPod/iPhone version is too low.
 - Update the iPod/iPhone version.

Error-03

- The iPod/iPhone is not verified.
 - You can solve the problem by reconnecting the iPod/iPhone.

Error-04

- Abnormal current is run to the iPod/iPhone.
 - You can solve the problem by reconnecting the iPod/iPhone, turning ACC off/on, or turning power off/on.

No USB Device

- The iPod/iPhone is not connected.
 - Make sure the iPod/iPhone is correctly connected and the cable is not bent excessively.

Updating

- The search mode is activated during song downloading.
 - No necessary operation.

Bluetooth Mode

No Unit

- The BLUETOOTH device is not connected.
 - Connect the BLUETOOTH device.

SiriusXM Advisory Messages

The following messages may be displayed while operating the unit in SiriusXM mode.

CHK Tuner

- The radio is having difficulty communicating with the SiriusXM Connect Vehicle Tuner. The tuner may be disconnected or damaged.

- Verify that the SiriusXM Connect Vehicle Tuner cable is securely connected to the radio.

CHK Antenna

- The radio has detected a fault with the SiriusXM antenna. The antenna cable may be either disconnected or damaged.
 - Verify that the antenna cable is connected to the SiriusXM Connect Vehicle Tuner.
 - Inspect the antenna cable for damage and kinks. Replace the antenna if the cable is damaged.

No Signal

- The SiriusXM Connect Vehicle Tuner is having difficulty receiving the SiriusXM satellite signal.
 - Verify that your vehicle is outdoors with a clear view of the sky.
 - Verify that the SiriusXM magnetic mount antenna is mounted on a metal surface on the outside the vehicle.
 - Move the SiriusXM antenna away from any obstructions.
 - Inspect the antenna cable for damage and kinks.

CH UNSUB

- The channel that you have requested is not included in your SiriusXM subscription package or the channel that you were listening to is no longer included in your SiriusXM subscription package.

NOTE:

- The unit will revert to the previous selected channel or to channel 1 automatically.
 - U.S. residents visit: www.siriusxm.com, Canadian residents visit: www.siriusxm.ca or call 866-635-2349 if you have questions about your subscription package or would like to subscribe to this channel.

CH UNAVAIL

- The channel that you have requested is not a valid SiriusXM channel or the channel that you were listening to is no longer available.

NOTE:

- The unit will revert to the previous channel or to channel 1 automatically.
 - U.S. residents visit: www.siriusxm.com, Canadian residents visit: www.siriusxm.ca for more information about the SiriusXM channel lineup.

SUBSCRIP Updated → Any Key To Continue

- The radio has detected a change in your SiriusXM subscription status.
 - Press any button to clear this message.

CH Locked → Lock Code?

- When a locked channel is selected, “CH LOCKED” is displayed, then press ENTER or turn Rotary encoder, “LOCK CODE?” will be displayed.

The channel that you have requested is locked by the radio Parental Control feature.

- See “Setting the Parental Control” for more information on the Parental Control feature and how to access locked channels.

NOTE:

- If wrong passcode is input, “CODE ERROR” will be displayed and the unit will revert to the previous selected channel.

Memory

- Buffer for Replay will full within 11 seconds.

MEM Full

- Buffer for Replay is full.

Pandora Mode Messages

No Pandora

- You have not created any personalized Pandora Stations.
 - When you are not driving, use the Pandora Compatible Application on the Smartphone to create your Pandora station(s).



Create A Station

- You have not created any personalized Pandora Stations.
 - When you are not driving, use the Pandora Compatible Application on the Smartphone to create your Pandora station(s).

Pandora APP Error

- The music cannot be played because the Pandora Compatible Application on the Smartphone requires the user's attention.
 - When you are not driving, please see the Pandora Compatible Application on the Smartphone.

No Service

- You switched CDE-HD149BT to Pandora mode by pressing  /SOURCE with a Smartphone connected, without launching or installing the Pandora Application.
 - Launch the Pandora Application on the Smartphone.
 - Select a source other than Pandora by pressing  /SOURCE.

Login To _____ Pandora

- The user didn't log in Pandora account of the Smartphone side.
 - Log in the Pandora account.

Station____List_Full

- The number of new stations reached the limit (100 stations).
 - Delete an existing station.

Update___PandoraAPP

- You switch CDE-W265BT/CDE-164BT to Pandora mode by pressing SOURCE with a Smartphone connected, with an old version Pandora Compatible Application.
 - Update the Pandora Compatible Application on the Smartphone.
 - Select a source other than Pandora by pressing SOURCE.

Limited___Connection

- A Smartphone in the airplane mode is connected the unit, so that the Pandora application has limited connectivity and is unable to be active.
 - Make sure the Smartphone is in a mode other than the airplane mode.
 - Wait for the Pandora application to auto-recover and resume playback.

No_Service_Available

- Attempt to launch the Pandora application on the Smartphone from restriction region.
 - Move the vehicle to a location with the Pandora license.

Station_____N/A

- The searched station is no longer available on Pandora servers.
 - Select another station to play.

Specifications

FM TUNER SECTION

Tuning Range	87.7~107.9 MHz
Mono Usable Sensitivity	9.3 dBf (0.8 μ V/75 ohms)
50 dB Quieting Sensitivity	13.5 dBf (1.3 μ V/75 ohms)
Alternate Channel Selectivity	80 dB
Signal-to-Noise Ratio	65 dB
Stereo Separation	35 dB
Capture Ratio	2.0 dB

AM TUNER SECTION

Tuning Range	530~1,710 kHz
Sensitivity (IEC Standard)	22.5 μ V/27 dB

CD PLAYER SECTION

Frequency Response	5~20,000 Hz (\pm 1 dB)
Wow & Flutter (% WRMS)	Below measurable limits
Total Harmonic Distortion	0.008% (at 1 kHz)

Dynamic Range	95 dB (at 1 kHz)
Signal-to-Noise Ratio	105 dB
Channel Separation	85 dB (at 1 kHz)

PICKUP

Wave length	795 nm
Laser power	CLASS I

USB SECTION

USB requirements	USB 1.1/2.0
Max. Power Consumption	Smartphone charge-capable
USB Class	Mass Storage
File System	FAT 12/16/32
MP3 Decoding	MPEG AUDIO Layer-3
WMA Decoding	Windows Media Audio
AAC Decoding	AAC-LC format “.m4a” file

BLUETOOTH SECTION

BLUETOOTH Specification	Bluetooth V2.1 + EDR
Output Power	+4 dBm Max. (Power class 2)
Profile	HFP (Hands-Free Profile) HSP (Head Set Profile) A2DP (Advanced Audio Distribution Profile) AVRCP (Audio/Video Remote Control Profile)

GENERAL

Power Requirement	14.4 V DC (11~16 V allowable)
Power Output	18 W RMS \times 4*

* Primary amplifier ratings per CEA-2006 Standard

- Power output: measured at 4 Ohms and \leq 1% THD+N
- S/N: 80 dBA (reference: 1 W into 4 Ohms)

Maximum Pre-Output Voltage	4V/10k ohms
Bass	\pm 9.1 dB at 100 Hz
Treble	\pm 9.1 dB at 10 kHz
Loudness	10 dB at 100 Hz
Weight	1.5 kg (3 lbs. 5 oz)

CHASSIS SIZE

Width	178 mm (7")
Height	50 mm (2")
Depth	161.5 mm (6-3/8")

NOSEPIECE SIZE

Width	168 mm (6-5/8")
Height	45 mm (1-3/4")
Depth	24 mm (1")

NOTE: Due to continuous product improvement, specifications and design are subject to change without notice.

About The Rules Of Bluetooth Electromagnetic Radiation Regulation

USA/Canada	<p>FCC CAUTION</p> <p>Changes or modifications not expressly approved by the party responsible for compliance could void the user's authority to operate the equipment.</p> <p>This device complies with Part 15 of FCC Rules and Industry Canada licence-exempt RSS standard(s). Operation is subject to the following two conditions: (1) this device may not cause interference, and (2) this device must accept any interference, including interference that may cause undesired operation of this device.</p> <p>Le présent appareil est conforme aux la partie 15 des règles de la FCC et CNR d'Industrie Canada applicables aux appareils radio exempts de licence. L'exploitation est autorisée aux deux conditions suivantes : (1) l'appareil ne doit pas produire de brouillage, et (2) l'utilisateur de l'appareil doit accepter tout brouillage radioélectrique subi, même si le brouillage est susceptible d'en compromettre le fonctionnement.</p>
USA/Canada	<p>This equipment complies with FCC/IC radiation exposure limits set forth for an uncontrolled environment and meets the FCC radio frequency (RF) Exposure Guidelines in Supplement C to OET65 and RSS-102 of the IC radio frequency (RF) Exposure rules. This equipment has very low levels of RF energy that it deemed to comply without maximum permissive exposure evaluation (MPE). But it is desirable that it should be installed and operated keeping the radiator at least 20cm or more away from person's body (excluding extremities: hands, wrists, feet and ankles).</p>

USA/Canada	Cet équipement est conforme aux limites d'exposition aux rayonnements énoncées pour un environnement non contrôlé et respecte les règles des radioélectriques (RF) de la FCC lignes directrices d'exposition dans le Supplément C à OET65 et d'exposition aux fréquences radioélectriques (RF) CNR-102 de l'IC. Cet équipement émet une énergie RF très faible qui est considérée conforme sans évaluation de l'exposition maximale autorisée. Cependant, cet équipement doit être installé et utilisé en gardant une distance de 20 cm ou plus entre le dispositif rayonnant et le corps (à l'exception des extrémités : mains, poignets, pieds et chevilles).
México	La operación de este equipo está sujeta a las siguientes dos condiciones: (1) es posible que este equipo o dispositivo no cause interferencia perjudicial y (2) este equipo o dispositivo debe aceptar cualquier interferencia, incluyendo la que pueda causar su operación no deseada.



4C

© 2018 FCA US LLC. All Rights Reserved.
ALFA ROMEO is a registered trademark of
FCA Group Marketing S.p.A., used with permission.
19ALP-526-AA • First Edition



Printed in U.S.A.