

# 2018 OWNER'S MANUAL



The Power to Surprise

## ***Kia, THE COMPANY***

---



Thank you for becoming the owner of a new Kia vehicle.

As a global car manufacturer focused on building high-quality vehicles with exceptional value, Kia Motors is dedicated to providing you with a customer service experience that exceeds your expectations.

All information contained in this Owner's Manual was accurate at the time of publication. However, Kia reserves the right to make changes at any time so that our policy of continual product improvement can be carried out.

This manual applies to all models of this vehicle and includes descriptions and explanations of optional as well as standard equipment. As a result, you may encounter material in this manual that is not applicable to your specific Kia vehicle.

***Drive safely and enjoy your Kia!***

---

## Foreword

Thank you for choosing a Kia vehicle.

When you require service, remember that your Kia dealer knows your vehicle best. Your dealer has factory-trained technicians, recommended special tools and genuine Kia replacement parts. It is dedicated to your complete customer satisfaction.

Because subsequent owners require this important information as well, this publication should remain with the vehicle if it is sold.

This manual will familiarize you with operational, maintenance and safety information about your new vehicle. It is supplemented by a Warranty and Consumer Information manual that provides important information on all warranties regarding your vehicle.

We urge you to read these publications carefully and follow the recommendations to help assure enjoyable and safe operation of your new vehicle.

Kia offers a great variety of options, components and features for its various models. Therefore, some of the equipment described in this manual, along with the various illustrations, may not be applicable to your particular vehicle.

The information and specifications provided in this manual were accurate at the time of printing. Kia reserves the right to discontinue or change specifications or design at any time without notice and without incurring any obligation. If you have questions, always check with your Kia dealer.

We assure you of our continuing interest in your motoring pleasure and satisfaction in your Kia vehicle.

© 2017 Kia MOTORS AMERICA, Inc.

All rights reserved. May not be reproduced or translated in whole or in part without the written consent of Kia Motors America, Inc.

Printed in Korea

## How To Use This Manual

We want to help you get the greatest possible driving pleasure from your vehicle. Your Owner's Manual can assist you in many ways. We strongly recommend that you read the entire manual. In order to minimize the chance of death or injury, you must read the WARNING and CAUTION sections in the manual.

Illustrations complement the words in this manual to best explain how to enjoy your vehicle. By reading your manual, you will learn about features, important safety information, and driving tips under various road conditions.

The general layout of the manual is provided in the Table of Contents. Use the index when looking for a specific area or subject; it has an alphabetical listing of all located in the back of this manual.

Sections: This manual has eight sections plus an index. Each section begins with a brief list of contents so you can tell at a glance if that section has the information you want.

You will find various types of safety instructions in this manual. These instructions were prepared to enhance your personal safety.

Carefully read and follow ALL procedures and recommendations provided in these instructions.

### **WARNING**

**A WARNING indicates a situation in which harm, serious bodily injury or death could result if the warning is ignored.**

### **CAUTION**

**A CAUTION indicates a situation in which damage to your vehicle could result if the caution is ignored.**

### **\* NOTICE**

**A NOTICE indicates interesting or helpful information is being provided.**



## Table of contents

### **Electric Vehicle Guide**

Review of Electric Vehicle / High voltage battery / Charge / Driving Electric Vehicle / Etc.

### **Introduction**

Vehicle data collection and event data recorders

### **Your vehicle at a glance**

Exterior overview / Interior overview / Instrument panel overview / Motor room compartment

### **Safety features of your vehicle**

Seats / Seat belts / Child restraint system / Air bag

### **Features of your vehicle**

Smart key / Door locks / Tailgate / Windows / Steering wheel / Mirrors / Instrument cluster / Lighting / Etc.

### **Driving your vehicle**

Before driving / POWER button / Active ECO system / Reduction gear / Brake system / Etc.

### **What to do in an emergency**

Road warning / Emergency while driving / Emergency starting / Vehicle overheat / TPMS / Flat tire / Towing / Etc.

### **Maintenance**

Motor room compartment / Maintenance service / Coolant / Brake fluid / Washer fluid / Lights bulbs / Etc.

### **Specifications, Consumer information and Reporting safety defects**

### **Index**

1

2

3

4

5

6

7

8

I



## Electric Vehicle Guide

✱ This is an electric vehicle guide to assist drivers with understanding their vehicle.

Refer to the following content for electric vehicle details and precautions

Review of Electric Vehicle .....	2
Main Components of Electric Vehicle .....	4
High voltage battery .....	5
EV Mode .....	7
■ Available Range .....	7
■ Near by stations .....	8
■ Energy Information .....	8
■ ECO Driving .....	9
■ Setting Charging Times .....	9
■ Setting Climate Times .....	11
■ EV Setting .....	11
Charge Types for Electric Vehicle .....	13
Charge Indicator Lamp for Electric Vehicle .....	15
Reserved Charging .....	16
Reserved Climate Control .....	18
Precautions for Charging Electric Vehicle .....	19
Charging Electric Vehicle (Normal Charge) .....	22
■ How to Connect Normal Charger .....	22
■ Unlock Charging Door in Emergency .....	25
■ Emergency Release of the Charging connector lock system .....	26
■ Checking Charging Status .....	26
■ How to Disconnect Normal Charger .....	27
Charging Electric Vehicle (Quick Charge) .....	28
■ How to Connect Quick Charger .....	28
■ Unlock Charging Door in Emergency .....	31
■ Checking Charging Status .....	31
■ How to Disconnect Quick Charger .....	33
Charging Electric Vehicle (Trickle Charge) .....	34
■ How to Connect Portable Charging Cable (ICCB: In-Cable Control Box) .....	34
■ Unlock Charging Door in Emergency .....	38
■ Emergency Release of the Charging connector lock system .....	39
■ Checking Charging Status .....	39
■ Charging Status Indicator Lamp for Portable Charging Cable .....	40
■ How to Disconnect Portable Charging Cable (ICCB: In-CableControl Box) .....	41
■ Precautions for Portable Charging Cable (ICCB: In-Cable Control Box) .....	43
Driving Electric Vehicle .....	44
■ How to Start the Vehicle .....	44
■ How to Stop the Vehicle .....	45
■ Pedestrian Warning System .....	46
■ Active ECO system .....	46
■ Range .....	47
■ Tips for Improving Distance to Empty .....	48
■ Motor Operation Gauge .....	48
■ State of charge (SOC) gauge for high voltage battery .....	49
■ Warning Message on LCD Display (related to charge) .....	50
■ Warning Lamp and Indicator Lamp (related to electric vehicle) .....	53
Safety Precautions for Electric Vehicle .....	56
■ Service Plug .....	59
Environmental Friendliness Mark .....	59

### Review of Electric Vehicle

An electric vehicle is driven using a battery and an electric motor. While general vehicles use an internal combustion engine and gasoline as fuel, electric vehicles use electrical energy that is stored inside the high voltage battery. As a result, electric vehicles are eco-friendly in that they do not require fuel and do not emit exhaust gases.

### Characteristics of Electric Vehicles

1. It is driven using the electrical energy that is stored inside the high voltage battery. This method prevents air pollution since fuel, like gasoline, is not required, negating the emission of exhaust gases.
2. A high performance motor is used in the vehicle as well. Compared to standard, internal combustion engine vehicles, engine noise and vibrations are much more minimal when driving.
3. When decelerating or driving downhill, regenerative braking is utilized to charge the high voltage battery. This minimizes energy loss and increases the distance to empty.
4. When the battery charge is not sufficient, normal charge, quick charge and trickle charge are available. (Refer to “Charge Types for Electric Vehicle” for details.)



#### Note

**What does regenerative braking do?**

It uses an electric motor when decelerating and braking and transforms kinetic energy to electrical energy in order to charge the high voltage battery. (Torque is applied in the opposite direction when decelerating to generate braking force and electric energy.)

### Battery Information

- The vehicle is composed of a high voltage battery that drives the motor and air-conditioner, and an auxiliary battery (12 V) that drives the lamps, wipers, and audio system.
- The auxiliary battery is automatically charged when the vehicle is in the ready (🔄) mode or the high voltage battery is being charged.

## Main Components of Electric Vehicle

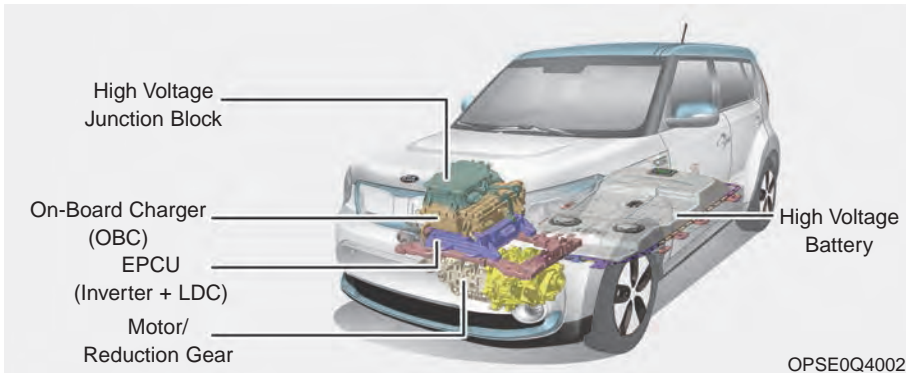

- **High voltage battery (lithium-ion polymer)** : Stores and supplies power necessary for the electric vehicle to operate (12 V auxiliary battery provides power to the vehicle features such as lights and wipers).

✧ OBC : On-Board Charger

✧ LDC : Low Voltage DC-DC Converter

- **High Voltage Junction Block:** Supplies power from the high voltage battery to the inverter, LDC, air-conditioner compressor, and PTC heater.
- **On-Board Charger (OBC):** External device (low speed) to charge the high voltage battery.
- **Inverter:** Transforms direct current into alternating current to supply power to the motor, and transforms alternating current into direct current to charge the high voltage battery.
- **LDC:** Transforms power from the high voltage battery to low voltage (12 V) to supply power to the vehicle (DC-DC).
- **Motor:** Uses electrical energy stored inside the high voltage battery to drive the vehicle (functions like an engine in a standard vehicle).
- **Reduction Gear :** Delivers rotational force of the motor to the tires at appropriate speeds and torque.

### High Voltage Battery (lithium-ion polymer)

**⚠ WARNING - Repair of  
high voltage components**

The high voltage battery in your system is very dangerous and can cause severe burns and electric shock. Never inspect, remove or disassemble any of the high voltage components in your vehicle. Kia recommends that all inspections and repairs be performed by an authorized and trained Kia dealer.



- The high voltage battery is used when using the air-conditioner / heater. This may reduce the distance to empty. Make sure to set moderate temperatures when using the air-conditioner/heater.
  - Natural degradation may occur with the high voltage battery depending on the number of years the vehicle is used. This may reduce the distance to empty.
  - When the charge capacity and distance to empty keep falling, we recommend that you contact an authorized Kia dealer for inspection and maintenance.
  - If the vehicle will not be in use for an extended period of time, charge the high voltage battery once every three months to prevent it from discharging. Also, if the charge amount is not enough to store the vehicle for an extended period of time, immediately charge to enough state of charge and store the vehicle.
- The charge amount of the high voltage battery may gradually decrease when the vehicle is not driving.
  - The battery capacity of the high voltage battery may decrease when the vehicle is stored in high/low temperatures.
  - Distance to empty may vary depending on the driving conditions, even if the charge amount is the same. The high voltage battery may expend more energy when driving at quick speed or uphill. These actions may reduce the distance to empty.

- Normal charge is recommended to keep the high voltage battery in optimal condition.  
If the high voltage battery charge amount is below 20%, you can keep the high voltage battery performance in optimal condition if you charge the high voltage battery to 100%. (Once a month or more is recommended.)
- If the vehicle is in a collision, we recommend that you contact an authorized Kia dealer to inspect whether the high voltage battery is still connected.



### **CAUTION - Damaging high voltage battery**

- ***Make sure to use a designated charger when charging the high voltage battery. Using different types of chargers may have a serious impact on vehicle durability.***
- ***Make sure that the high voltage battery charger gauge does not reach SOC 0% on cluster gauge. If the vehicle is kept at SOC 0% for a long period, it may damage the high voltage battery and the high voltage battery may have to be replaced depending on the level of degradation.***

## High Voltage Battery Warmer System

The high voltage battery warmer system prevents reduction of battery output when battery temperature is low. If the charging connector is connected, the warmer system automatically operate according to the battery temperature.

Charging time may shorten compare to vehicles without the high voltage battery warmer system. But, electricity charge may increase because of high voltage battery warmer system operation.

The high voltage battery warmer system operates when the charging connector is connected to the vehicle.

However, the high voltage warmer system may not operate when battery temperature drops below -31°F (-35°C)

## EV MODE

### EV Mode (if equipped)



If you select the "EV" menu at the AVN home screen or press the "EV" button on the left side of the air-conditioning button panel, you can enter EV mode.

\* Refer to the AVN manual for details.



The EV mode has a total of 6 menus including Available Range, Near by stations, Energy information, ECO driving, Set timings for Charging /Climate and EV settings.

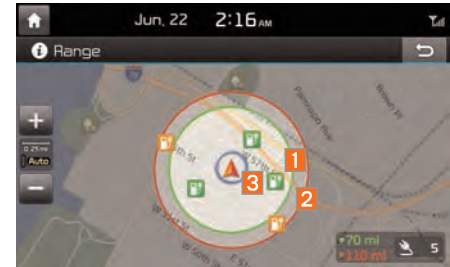

### Available Range

Name	Description
1 Green Circle	Reachable area
2 Red Circle	Risky area (depending on circumstances)
3 Grey Area	Unreachable area



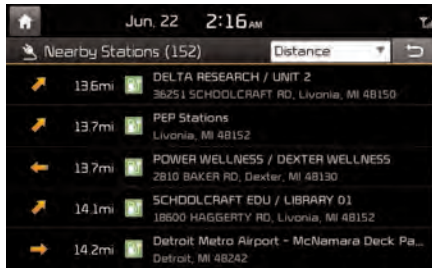

## ■ Near by stations

Stations around the current location is searched. Depending on the symbol color of the station, it is categorized as Reachable area, Risky area and Unreachable area.



## ■ Energy Information

You can check battery information and power consumption.

### ► Battery Information

You can check the available range, battery charge amount that can be used, and approximate expected charging time for each charge type.

More accurate time will be appeared while charging.



## ► Power Consumption

Power that is consumed by the drive system, climate and electrical components are displayed respectively.

You can check how far the vehicle can drive currently, and how much more the vehicle can drive if the climate is turned OFF.



## ■ ECO Driving

You can check ECO level information and ECO driving history.

### ▶ ECO Level

A total of 8 ECO levels and the average energy consumption are displayed depending on vehicle driving style.

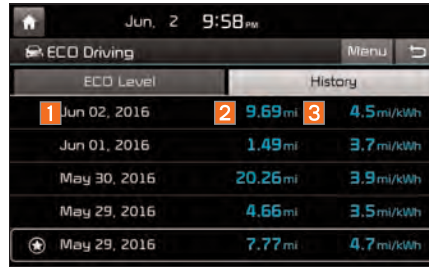

### ▶ Driving History

You can check the driving date **1**, driving distance **2**, and the average energy consumption **3** rating for previous 30 driving trips. The date with the highest ECO level is marked with a star shaped icon.

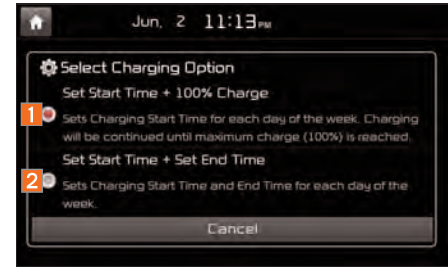

## ■ Set Charging Times

This is a feature that starts charging the battery on the date and time that is designated by the user. One reservation can be set between 2 options.

Name	Description
1 Set Start Time + Charging Ratio 100%	You can set start charging time and ratio is set 100 automatically by days of the week.
2 Set Start Time + Set End Time	You can set charging time from start to end by days of the week.

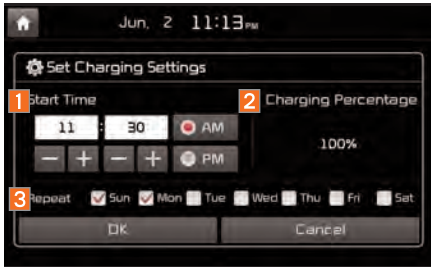

► **Set Start Time + Charging Ratio 100%**

Name	Description
1 Start charging time	Select the time that you wish to start charging the battery
2 Charging Ratio	100 %
3 Repeat Day of Week	Select the day of the week you wish to reserve for automatic charging.



► **Set Start Time + Set End Time**

Name	Description
1 Start charging time	Select the time that you wish to start charging the battery
2 End charging time	Select the time that you wish to end charging.
3 Repeat Day of Week	Select the day of the week you wish to reserve for automatic charging.



Setting is saved and setting information is displayed on the screen.

	Description
1	If you do not want to use the reserved setting, select OFF.

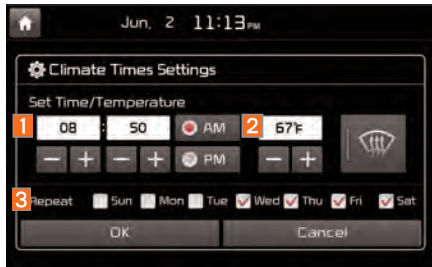

## ■ Set Climate Times

This is a feature that automatically starts climate control on the reserved day and time along with the temperature designated by the user. Two separate reservations can be set.

Name	Description
1 Vehicle Departure Time	Enter the anticipated departure time for the vehicle.
2 Set Temperature	Enter the temperature that you desire.
3 Repeat Day of Week	Select the day of the week you wish to reserve for automatic air conditioning.



	Description
1	When selecting the list again, change the setting.
2	If you do not want use the reserved setting, select OFF.

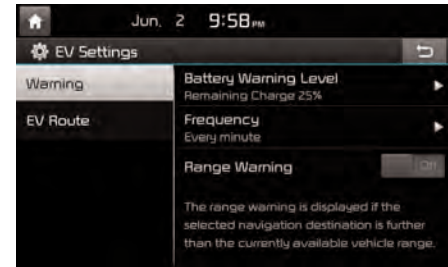

## ■ EV Setting

You can change the EV warning alarm.

### ▶ Warning Settings

- **Low battery warning** : You can select several battery levels at which to display an alarm message.
- **Frequency** : You can select the repetition interval to display the Low battery warning.

- **Destination Unreachable Warning** : If the destination set in the navigation cannot be reached with the remaining battery charge, a warning message is displayed.



### ► EV Route Settings

Displays the EV route on the map.

Non-drivable and drivable sections across start point, current position, waypoint and destination are separately marked.

### Charging Information

- **Normal Charge :**

We recommend using normal charging for usual charging of the vehicle.

(Refer to “Normal Charge.” in this chapter)

- **Quick Charge (if equipped) :**

You can charge at high speeds at public charging stations. Refer to the respective company's manual that is provided for each quick charger type.

Battery performance and durability can deteriorate if the quick charger is used constantly.

Use of quick charge should be minimized in order to help prolong high voltage battery life.

- **Trickle Charge :**

Trickle Charge can be used when Normal Charge or Quick Charge is not available by using household electricity.

### Charging Time Information

- **Normal Charge :**

Takes about 5-6 hours at room temperature (depending on charger ) for a full charge (208V : about 6 hours, 240V : about 5h 10min.) (Can be charged to 100%.)

- **Quick Charge (if equipped) :**

Takes about 33 minutes at room temperature to 80% of SOC. (50kw charger) (Can be charged directly to 94%)







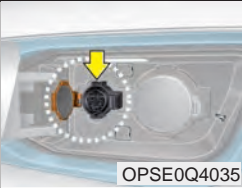

DC cable shorter than 10m.

- **Trickle Charge :**

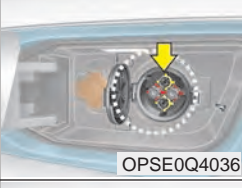
Takes about 33 hours at room temperature. (120V-12A : about 33 hours) (Can be charged to 100%.)

Depending on the condition and durability of the high voltage battery, charger specifications, and ambient temperature, the time required for charging the high voltage battery may vary.

## Charging Types

Category	Charging Inlet (Vehicle)	Charging Connector	Charging Outlet	How to Charge	Charging Time
Normal Charge	 OPSE0Q4035	 OPSE0Q4005	 OPSE0Q4057N	Use the normal charger that is installed in your home or public charging station	Approx. 5-6 hours (208V : Approx. 6 hours, 240V : about 5h 10min. room temperature) (Can be charged to 100%)
Quick Charge (if equipped)	 OPSE0Q4036	 OPSE0Q4006	 OPSE0Q4004	Use the quick charger at public charging station	Approx. 33min to 80% of SOC (50kw, room temperature) (Can be charged directly to 94%)
Trickle Charge	 OPSE0Q4035	 OPSE0Q4005	 OPSE0Q4007	Use household electricity	Approx. 33hours (120V-12A : Approx.33hours, room temperature) (Can be charged to 100%)

\* Shape of charger and how to use the charger may be different for each manufacturer.

\* Depending on the condition and durability of the high voltage battery, charger specifications, and ambient temperature, the time required for charging the high voltage battery may vary.

## Charging Status Information

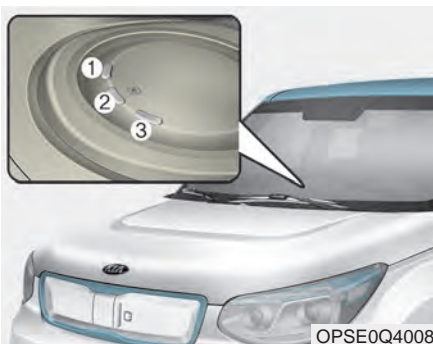

When charging the high voltage battery, the charge level can be checked from outside the vehicle.

### Normal charging and trickle charging

Operation of Charging Indicator Lamp			Details
(1)	(2)	(3)	
○ (OFF)	○ (OFF)	○ (OFF)	Not Charged
Blinking	○ (OFF)	○ (OFF)	0~33%
● (ON)	Blinking	○ (OFF)	Charging 34~66%
● (ON)	● (ON)	Blinking	67~99%
● (ON)	● (ON)	● (ON)	Charging complete (100%)(turns OFF in 3 seconds)
Blinking	Blinking	Blinking	Error while charging /If charging cables are connected when the vehicle is in the ready mode or the POWER button is in the ON position.
○ (OFF)	○ (OFF)	Blinking	Charging 12 V auxiliary battery or reserved air conditioner is operating
○ (OFF)	Blinking	○ (OFF)	Reserved charging is operating (turns OFF after 3 minutes)

### Quick charge

Operation of Charging Indicator Lamp			Details
(1)	(2)	(3)	
○ (OFF)	○ (OFF)	○ (OFF)	Not Charged
Blinking	○ (OFF)	○ (OFF)	0~33%
● (ON)	Blinking	○ (OFF)	Charging 34~66%
● (ON)	● (ON)	Blinking	67~94%
Blinking	Blinking	Blinking	Error while charging /If charging cables are connected when the vehicle is in the ready mode or the POWER button is in the ON position.



### Reserved Charging (if equipped)

- You can set-up a charging schedule for your vehicle through the UVO audio control unit, the UVO eco App, or by logging into MyUVO.com.

Refer to the AVN manual or the UVO manual for detailed information about setting reserved charging.

- Reserved charging can only be done when using a normal charger or the portable charging cable (ICCB: In-Cable Control Box).



- When reserved charging is set and the normal charger or the portable charging cable (ICCB: In-Cable Control Box) is connected for charging, the indicator lamp in the middle blinks (for 3 minutes) to indicate that reserved charging is set.

- When reserved charging is set, charging is not initiated immediately when the normal charger or portable charging cable (ICCB: In-Cable Control Box) is connected. When immediate charging is required, use the AVN to deactivate the reserved charge setting or press the Deactivate Reserved Charge button [  ].



To immediately charge the battery (not at reserved time only) first connect the charging cables. Then, the Deactivate Reserved Charge button [OFF] should be pressed within three minutes after the cable connection.

If the battery does not charge after the Deactivate Reserved Charge button [OFF] has been pressed, remove the charging cable and reconnect it.

After the Deactivate Reserved Charge button [OFF] has been pressed (pressed position), you can charge the battery at any given time.

To change the status to reserved charging, please press the Deactivate Reserved Charge button [OFF] again (not pressed position).

\* Refer to "Normal Charge, Trickle Charge" for details about connecting the normal charger and the portable charging cable (ICCB: In-Cable Control Box).

## Reserved Climate Control (if equipped)

- You can set reserved climate control using the AVN.

Refer to the AVN for detailed information about the reserved climate control setting.

- Reserved climate control can only be done when using the normal charger or portable charging cable (ICCB: In-Cable Control Box).
- If reserved climate control is set and the charging cable is connected, reserved climate control starts operating 30 minutes prior to the set time (departure time).

※ Refer to "Normal Charge, Trickle Charge" for details about connecting the normal charger and the portable charging cable (ICCB: In-Cable Control Box).



OPSE0Q4010N

- If you press the Set Reserved climate control button [🕒], the indicator lamp on the button blinks three times and the reserved climate control setting screen is displayed on the AVN.

Refer to the AVN manual for details about setting reserved climate control.

### ※ Lamp ON Conditions

- Blinks three times: When you press the set button and enter the AVN reserved climate control setting screen.
- ON: When reserved air conditioning is set.
- Blinking: Reserved climate control is operating (only operates when the charging cable is connected).

## Charging Precautions

### ■ Normal Charger



OPSE0Q4057N

### ■ Quick Charger



OPSE0Q4004

※ Shape of charger and how to use the charger may be different for each manufacturer.

**⚠ WARNING - Fires caused by dust or water**

Do not connect the charging cable connector plug to the vehicle if there is water or dust on the charging inlet.

Connecting while there is water or dust on the charging cable connector and plug may cause a fire or electric shock.

**⚠ WARNING - Interference with electronic medical devices**

When using medical electric devices such as an implantable cardiac pacemaker, make sure to ask the medical team and manufacturer whether charging your electric vehicle will impact the operation of the medical devices. In some instances, electromagnetic waves that are generated from the charger can seriously impact medical electric devices such as an implantable cardiac pacemaker.

### **⚠ WARNING - Touching the charging connector**

**Do not to touch the charging connector, charging plug, and the charging inlet when connecting the cable to the charger and the charging inlet on the vehicle. Doing so may result in electrocution.**

- Comply with the following in order to prevent electrical shock when charging:
  - Use a waterproof charger.
  - Make sure to not touch the charging connector and charging plug when your hand is wet. Do not stand in water or snow when connecting the charging cable.
  - Do not charge when there is lightning.
  - Do not charge when the charging connector and plug is wet.

### **⚠ WARNING - Charging cable**

- **Immediately stop charging when you find abnormal symptoms (smell, smoke).**
- **Replace the charging cable if the cable coating is damaged to prevent electrical shock.**
- **When connecting or removing the charging cable, make sure to hold the charging connector handle and charging plug. If you pull the cable itself (without using the handle), the internal wires may disconnect or get damaged. This may lead to electric shock or fire.**

**⚠ WARNING - Cooling fan**  
**Do not touch the cooling fan while vehicle is charging. When the vehicle is switched [OFF] while charging, the cooling fan inside the motor compartment may automatically operate.**

- Always keep the charging connector and charging plug in clean and dry condition. Be sure to keep the charging cable in a condition where there is no water or moisture.
- Make sure to use the designated charger for charging the electric vehicle. Using any other charger may cause failure.
- Before charging the battery, turn the vehicle [OFF].
- Be careful not to drop the charging connector. The charging connector can be damaged.

## Normal Charge

### ■ Normal Charger



OPSE0Q4057N

We recommend using normal charging for usual charging of the vehicle.



OPSE0Q4011

### ■ How to Connect Normal Charger

1. While the brake pedal is pressed, engage the parking brake.
2. Turn OFF all switches, place the shift lever in P (Park), and turn OFF the vehicle.

3. Press the charging door open switch [  ] to open the charging door. Charging door open switch can be operated only when vehicle is turned off.

4. If you cannot open the charging door due to freezing weather :

- 1) Remove any ice near the charging door.
- 2) Pull the emergency cable to open the charging door.

(When the charging door does not open, refer to “How to Unlock Charging Door in Emergencies.”)

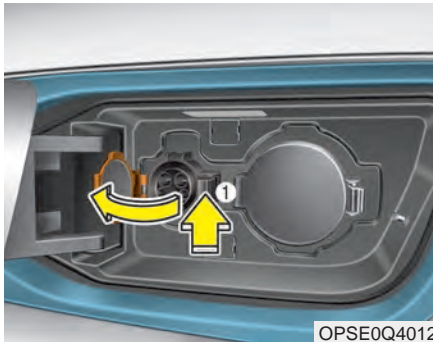

5. Open the charging door and press the normal charging inlet cover release tab (1) to open the normal charging inlet cover.

6. Before connecting the charging connector, make sure the door lock is released.

When the door is locked, the charging connector lock system will be triggered. And the charging connector will not be connected.

### **⚠ CAUTION - Charging Connector Door**

*To avoid damage to your vehicle, do not attempt to connect the charging connector to your vehicle without first opening the door to the charging connector.*

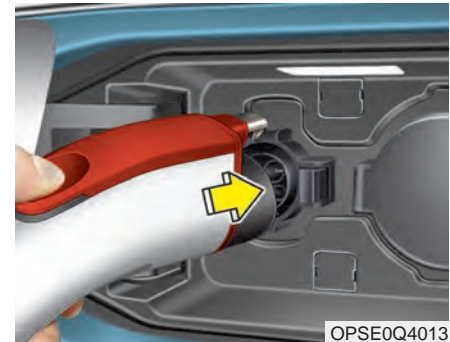

7. Remove any dust on the charging connector and charging inlet.
8. Hold the charging connector handle and connect it to the vehicle normal charging inlet. Push the connector until you hear a "clicking" sound.



## CHARGING ELECTRIC VEHICLE (NORMAL CHARGE)



9. Check if the charge indicator lamp of the high voltage battery in the instrument cluster is turned ON. Charging is not done when the charging indicator lamp is OFF.

When the charging connector is not connected properly, reconnect the charging cable to charge.

- You can start charging when the Power button is in the OFF position and the shift lever is in P (Park). After charging has started, you can use electrical components such as the radio by pressing the Power button to the ACC or ON position.
- If you move the shift lever from P (Park) to R (Rear), N (Neutral), D (Drive), charging stops immediately. If you want to start charging again, place the shift lever to P (Park) and press the Power button to the OFF position. Unplug and reconnect the charging cable to start charging again.



10. After charging has started, the estimated charging time is displayed on the instrument cluster for about 1 minute.

If you open the driver seat door while charging, the estimated charging time is also displayed on the instrument cluster for about 1 minute.

When reserved charging is set, the estimated charging time is displayed as "--" .

Depending on the condition and durability of the high voltage battery, charger specifications, and ambient temperature, the time required for charging the battery may vary.

11. You may prevent possible charging cable theft by taking the following steps. Lock the door after the charging cable is connected, by pressing the lock button on the smart key or on the central door lock switch.

When the door is locked, the charging connector will become locked and this will prevent possible theft.

So, after charging is complete, you must release the door lock in order to disconnect the charging connector.



### ■ Unlock Charging Door in Emergency

If the charging door does not open due to battery discharge and failure of the electric wires, open the hood and slightly pull the emergency cable as shown above. The charging door will then open.

## CHARGING ELECTRIC VEHICLE (NORMAL CHARGE)



### ■ Emergency Release of the Charging connector lock system

Use this function if the charging connector lock does not unlatch even after the door lock has been released. You can release the charging connector lock system by using the emergency release lever.

Open the hood, and then fully lift the charging connector emergency release cover after turning it. Then, pull on the emergency release lever to disconnect the charging connector.

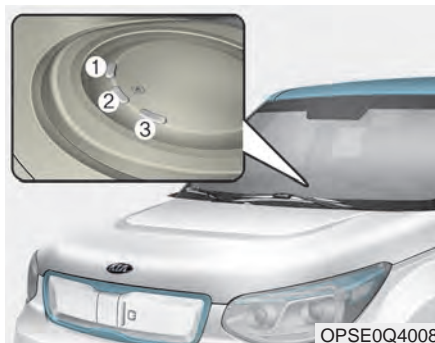

### ■ Checking Charging Status

When charging the high voltage battery, the charge level can be checked from outside the vehicle.

Operation of Charging Indicator Lamp			Details	
(1)	(2)	(3)		
○ (OFF)	○ (OFF)	○ (OFF)	Not Charged	
Blinking	○ (OFF)	○ (OFF)	Charging	
● (ON)	Blinking	○ (OFF)		0~33%
● (ON)	● (ON)	Blinking		34~66%
● (ON)	● (ON)	● (ON)	67~99%	
● (ON)	● (ON)	● (ON)	Charging complete (100%)(turns OFF in 3 seconds)	
Blinking	Blinking	Blinking	Error while charging /If charging cables are connected when the vehicle is in the ready mode or the POWER button is in the ON position.	
○ (OFF)	○ (OFF)	Blinking	Charging 12 V auxiliary battery or reserved air conditioner is operating	
○ (OFF)	Blinking	○ (OFF)	Reserved charging is operating (turns OFF after 3 minutes)	

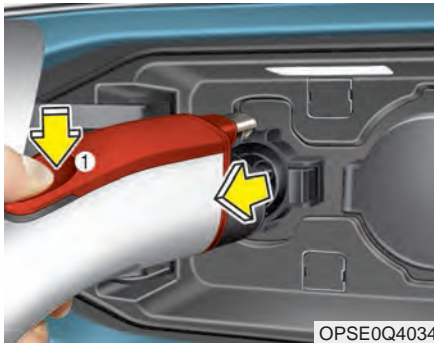

### ■ How to Disconnect Normal Charger

1. Before disconnecting the charging connector, make sure the door lock is released. When the door is locked, the charging connector lock system will be triggered. And the charging connector will not be disconnected.

#### ⚠ CAUTION

*In order to disconnect the charging connector, release the door lock to unlatch the charging connector lock system. If not, the charging connector and the vehicle's charging inlet may be damaged.*

2. Hold the charging connector handle and pull it while pressing the release button (1).

#### ⚠ CAUTION - Disconnecting charging plug

*When disconnecting the charging connector, do not try to disconnect it by force while not pressing the release button. This may damage the charging connector and vehicle charging inlet.*

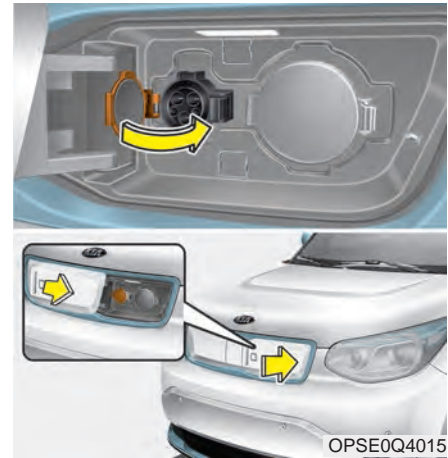

3. Make sure to completely close the normal charging inlet cover.
4. Make sure to completely close the charging door.

## CHARGING ELECTRIC VEHICLE (QUICK CHARGE)

### Quick Charge (if equipped)

#### ■ Quick Charger



OPSE0Q4004

You can charge at high speeds at public charging stations. Refer to the respective company's manual that is provided for each quick charger type.

Battery performance and durability can deteriorate if the quick charge is used constantly in hot weather conditions (heat wave, etc.)

Use of quick charge in hot weather condition should be minimized in order to help prolong high voltage battery life.

※ Shape of charger and how to use the charger may be different for each manufacturer.

※ If you use a quick charger when the vehicle is already fully charged, some quick chargers will send out an error message. When the vehicle is fully charged, do not charge the vehicle.



OPSE0Q4011

#### ■ How to Connect Quick Charger

1. While the brake pedal is pressed, engage the parking brake.
2. Turn OFF all switches, place the shift lever in P (Park), and turn OFF the vehicle.

## CHARGING ELECTRIC VEHICLE (QUICK CHARGE)

3. Press the charging door open switch [  ] to open the charging door. Charging door open switch can be operated only when vehicle is turned off.
4. If you cannot open the charging door due to freezing weather :
  - 1) Remove any ice near the charging door.
  - 2) Pull the emergency cable to open the charging door.(When the charging door does not open, refer to "How to Unlock Charging Door in Emergencies.")

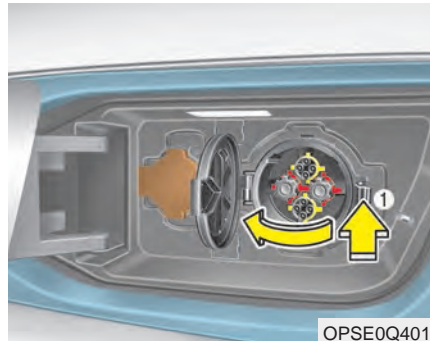

5. Open the charging door and press the quick charging inlet release tab (1) to open the quick charging inlet cover.

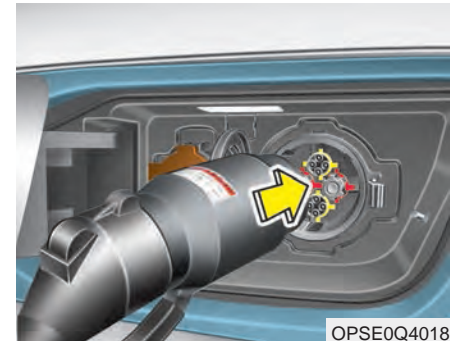

6. Remove any dust or foreign substances inside the charging connector and charging inlet.
7. Hold the charging connector handle and connect it to the vehicle quick charging inlet. Push the connector until you hear a "clicking" sound.

## CHARGING ELECTRIC VEHICLE (QUICK CHARGE)

- ❖ Refer to the manual for each type of quick charger for how to charge and remove the charger.
- ❖ The shape of the charging connector may vary depending on the manufacturer.



OPSE0Q4058L

8. Check if the charge indicator lamp of the high voltage battery in the instrument cluster is turned ON. Charging is not done when the charging indicator lamp is OFF. When the charging connector is not connected properly, reconnect the charging cable to charge it again.

- ❖ If you use a quick charger when the vehicle is already fully charged, some quick chargers will send out an error message. When the vehicle is fully charged, do not charge the vehicle.



※ During cold weather, quick charging may not be available to prevent high voltage battery degradation.

- You can start charging when the Power button is in the OFF position and the shift lever is in P (Park).

After charging has started, you can use electrical components such as the radio by pressing the Power button to ACC or ON position.

- If you move the shift lever from P (Park) to R (Reverse), N (Neutral), D (Drive), charging stops immediately. If you want to start charging again, place the shift lever to P (Park) and press the Power button to the OFF position. Unplug and reconnect the charging cable to start charging again.



### ■ Unlock Charging Door in Emergency

If the charging door does not open due to battery discharge and failure of the electric wires, open the hood and slightly pull the emergency cable as shown above. The charging door will then open.

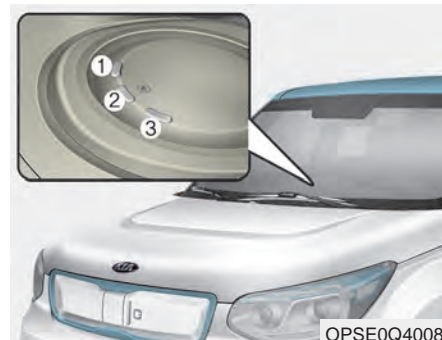

### ■ Checking Charging Status

When charging the high voltage battery, the charge level can be checked from outside the vehicle.



## CHARGING ELECTRIC VEHICLE (QUICK CHARGE)

Depending on the condition and durability of the high voltage battery, charger specifications, and ambient temperature, the time required for charging the battery may vary.

Operation of Charging Indicator Lamp			Details	
(1)	(2)	(3)		
○ (OFF)	○ (OFF)	○ (OFF)	Not Charged	
Blinking	○ (OFF)	○ (OFF)	Charging	
● (ON)	Blinking	○ (OFF)		0~33%
● (ON)	● (ON)	Blinking		34~66%
			67~94%	
Blinking	Blinking	Blinking	Error while charging /If charging cables are connected when the vehicle is in the ready mode or the POWER button is in the ON position.	

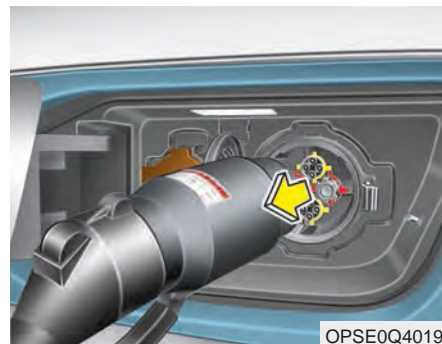

### How to Disconnect Quick Charger

1. Remove the charging connector when quick charging is completed, or after you stop charging using the quick charger. Refer to each respective quick charger manual for details about how to disconnect the charging connector.

**⚠ CAUTION - Disconnecting charging plug**

*When disconnecting the charging connector, do not try to disconnect it by force while not pressing the release button. This may damage the charging connector and vehicle charging inlet.*

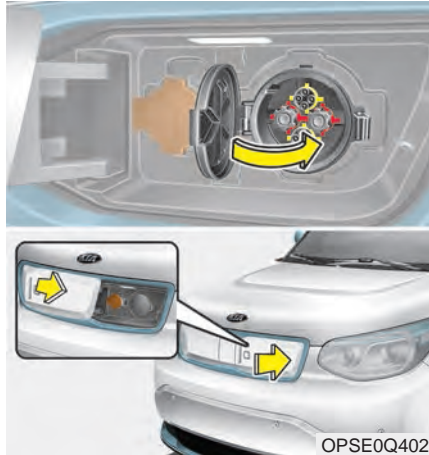

2. Make sure to completely close the quick charging inlet cover.
3. Make sure to completely close the charging door.

# CHARGING ELECTRIC VEHICLE (TRICKLE CHARGE)

## Trickle Charge

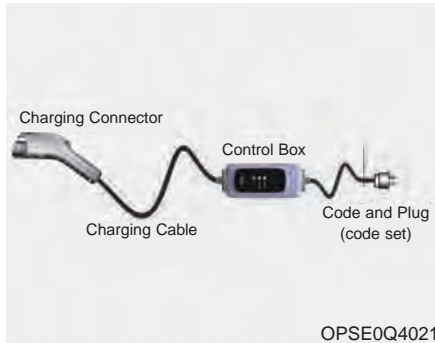

Trickle Charge can be used when Normal Charge or Quick Charge is not available by using household electricity.



### ■ How to Connect Portable Charging Cable (ICCB: In-Cable Control Box)

1. Connect the plug to a household electric outlet.



2. Check if every LED lamp on the control box is turned on for 0.5 seconds. Then, check if the power lamp (green) turns ON.

## CHARGING ELECTRIC VEHICLE (TRICKLE CHARGE)



3. While the brake pedal is pressed, engage the parking brake.
4. Turn OFF all switches, place the shift lever in P (Park), and turn OFF the vehicle.

5. Press the charging door open switch [  ] to open the charging door. Charging door open switch can be operated only when vehicle is turned off.
6. If you cannot open the charging door due to freezing weather :
  - 1) Remove any ice near the charging door.
  - 2) Pull the emergency cable to open the charging door.

(When the charging door does not open, refer to “How to Unlock Charging Door in Emergencies.”)

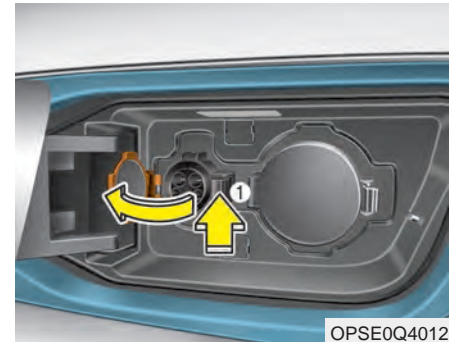

7. Open the charging door and press the normal charging inlet release tab (1) to open the normal charging inlet cover.
8. Before connecting the charging connector, make sure the door lock is released.

When the door is locked, the charging connector lock system will be triggered. And the charging connector will not be connected.

**⚠ CAUTION - Charging  
Connector Door**

*To avoid damage to your vehicle, do not attempt to connect the charging connector to your vehicle without first opening the door to the charging connector.*

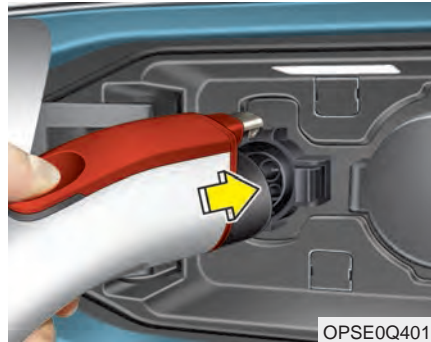

9. Open the protective cover of the charging connector and remove any dust on the charging connector and charging inlet.
10. Hold the charging connector handle and connect it to the vehicle normal charging inlet. Push the connector until you hear a "clicking" sound.



11. Charging starts automatically. Check if the power lamp and charging lamp (orange) are ON.

## CHARGING ELECTRIC VEHICLE (TRICKLE CHARGE)

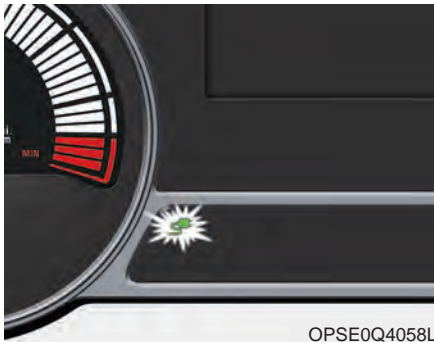

12. Check if the charge indicator lamp of the high voltage battery in the instrument cluster is turned ON. Charging is not done when the charging indicator lamp is OFF.

When the charging connector is not connected properly, reconnect the charging cable to charge it again.

- You can start charging when the Power button is in the OFF position and the shift lever is in P (Park).

After charging has started, you can use electrical components such as the radio by pressing the Power button to ACC or ON position.

- If you move the shift lever from P (Park) to R (Reverse), N (Neutral), D (Drive), charging stops immediately. If you want to start charging again, place the shift lever to P (Park) and press the Power button to the OFF position. Unplug and reconnect the charging cable to start charging again.



13. After charging has started, the estimated charging time is displayed on the instrument cluster for about 1 minute.

If you open the driver seat door while charging, the estimated charging time is also displayed on the instrument cluster for about 1 minute.

When reserved charging is set, the estimated charging time is displayed as "--" .

## CHARGING ELECTRIC VEHICLE (TRICKLE CHARGE)

Depending on the condition and durability of the high voltage battery, charger specifications, and ambient temperature, the time required for charging the battery may vary.

14. You may prevent possible charging cable theft by taking the following steps. Lock the door after the charging cable is connected, by pressing the lock button on the smart key or on the central door lock switch.

When the door is locked, the charging connector will become locked and this will prevent possible theft.

So, after charging is complete, you must release the door lock in order to disconnect the charging connector.



### ■ Unlock Charging Door in Emergency

If the charging door does not open due to battery discharge and failure of the electric wires, open the hood and slightly pull the emergency cable as shown above. The charging door will then open.

## CHARGING ELECTRIC VEHICLE (TRICKLE CHARGE)



### ■ Emergency Release of the Charging connector lock system

Use this function if the charging connector lock does not unlatch even after the door lock has been released. You can release the charging connector lock system by using the emergency release lever.

Open the hood, and then fully lift the charging connector emergency release cover after turning it. Then, pull on the emergency release lever to disconnect the charging connector.

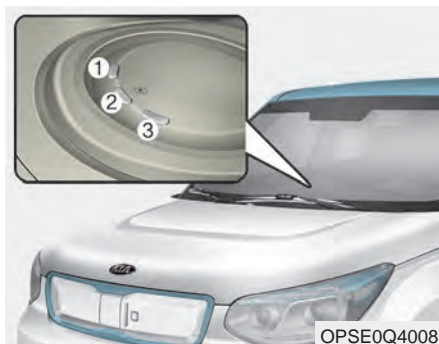

### ■ Checking Charging Status

When charging the high voltage battery, the charge level can be checked from outside the vehicle.





Operation of Charging Indicator Lamp			Details	
(1)	(2)	(3)		
○ (OFF)	○ (OFF)	○ (OFF)	Not Charged	
Blinking	○ (OFF)	○ (OFF)	Charging	
● (ON)	Blinking	○ (OFF)		0~33%
● (ON)	● (ON)	Blinking		34~66%
● (ON)	● (ON)	● (ON)	67~99%	
● (ON)	● (ON)	● (ON)	Charging complete (100%)(turns OFF in 3 seconds)	
Blinking	Blinking	Blinking	Error while charging /If charging cables are connected when the vehicle is in the ready mode or the POWER button is in the ON position.	
○ (OFF)	○ (OFF)	Blinking	Charging 12 V auxiliary battery or reserved air conditioner is operating	
○ (OFF)	Blinking	○ (OFF)	Reserved charging is operating (turns OFF after 3 minutes)	



# CHARGING ELECTRIC VEHICLE (TRICKLE CHARGE)

## ■ Charging Status Indicator Lamp for Portable Charging Cable

Category	Lamp ON	Lamp OFF	Blinking
LED Status	●	-	⦿

Charger Status		Control Box ON/OFF Status	Power	Charge	Fault	Status / Diagnosis / Countermeasure
Initial Preparation Mode		 OPSE0Q4045	●	●	●	When applying power to the initial ICCB wall
Charging Preparation Mode		 OPSE0Q4046	●	-	-	When ICCB charging connector is not connected to the vehicle, or connected but charging status is in Standby mode
Charging Mode		 OPSE0Q4048	●	●	-	Charging
Failure	Detects Leakage	 OPSE0Q4047	●	-	⦿	Stop charging immediately when a leak is detected on the ICCB output terminal (we recommend that you contact an authorized Kia dealer)
	ICCB Failure		●	-	●	When a failure is detected inside the ICCB (we recommend that you contact an authorized Kia dealer)

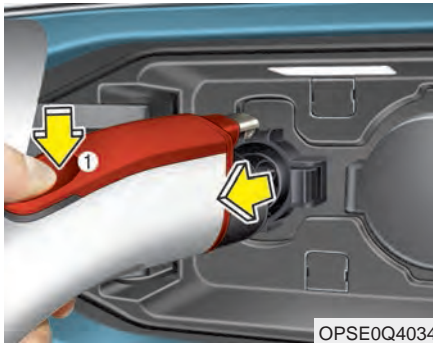

### ■ How to Disconnect Portable Charging Cable (ICCB: In-Cable Control Box)

1. Before disconnecting the charging connector, make sure the door lock is released.

When the door is locked, the charging connector lock system will be triggered. And the charging connector will not be disconnected.

#### ⚠ CAUTION

*In order to disconnect the charging connector, release the door lock to unlatch the charging connector lock system.*

*If not, the charging connector and the vehicle's charging inlet may be damaged.*

2. Hold the charging connector handle and pull it while pressing the release button (1).

#### ⚠ CAUTION - Disconnecting charging plug

*When disconnecting the charging connector, do not try to disconnect it by force while not pressing the release button. This may damage the charging connector and vehicle charging inlet.*

## CHARGING ELECTRIC VEHICLE (TRICKLE CHARGE)

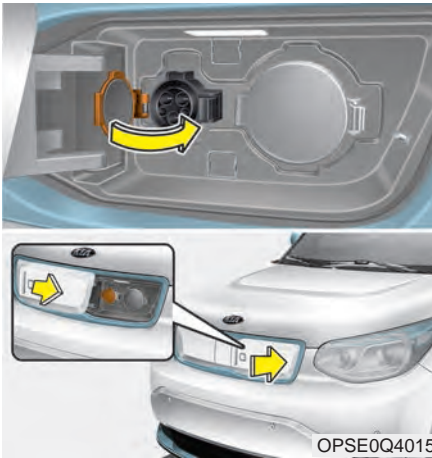

3. Make sure to completely close the normal charging inlet cover.
4. Make sure to completely close the charging door.



5. Disconnect the plug from the household electric outlet. Do not pull the cable when disconnecting the plug.
6. Close the protective cover for the charging connector so that foreign substances do not flow into the terminal.
7. Put the charging cable inside the cable compartment to protect it.

### ■ Precautions for Portable Charging Cable (ICCB: In-Cable Control Box)

- Use the portable charging cable that is certified by Kia Motors.
- Do not try to repair, disassemble, or adjust the portable charging cable.
- Do not use an extension cord or adapter.
- Stop using immediately when failure occurs.
- Do not touch the plug and charging connector with wet hands.
- Do not touch the terminal part of the normal charging connector and the normal charging inlet on the vehicle.
- Do not connect the charging connector to voltage that does not comply with regulations.
- Do not use the portable charging cable if it is worn out, exposed, or there exists any type of damage on the portable charging cable.
- If the ICCB case and normal charging connector is damaged, cracked, or the wires are exposed in any way, do not use the portable charging cable.
- Do not let kids operate or touch the portable charging cable.
- Keep the control box free of water.
- Keep the normal charging connector or plug terminal free of foreign substances.
- Do not step on the cable or cord. Do not pull the cable or cord and do not twist or bend it.
- Do not charge when there is lightning.
- Do not drop the control box or place a heavy object on the control box.
- Do not place an object that can generate high temperatures near the charger when charging.
- Charging with the worn out or damaged household electric outlet can result in a risk of electric shock. If you are in doubt to the household electric outlet condition, have it checked by licensed electrician and charge again.
- Stop using the portable charging cable immediately if the household electric outlet or any components is overheated or you notice burnt odors.



### How to Start the Vehicle

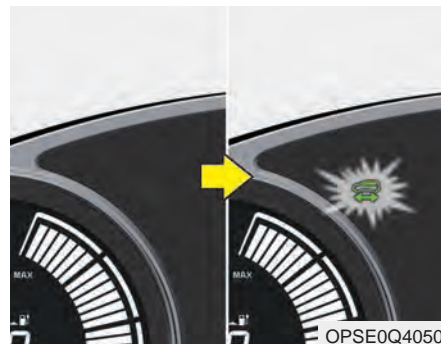

1. With the smart key, sit in the driver's seat.
2. Fasten the safety belt before starting the vehicle.
3. Make sure to engage the parking brake for your safety.
4. Turn OFF all electrical devices.

5. Make sure the accelerator and brake pedal have clearance with your right foot.
6. Make sure to press and hold the brake pedal.
7. While pressing the brake pedal, place the shift lever in P (Park).  
Vehicle only starts when the shift lever is placed in P (Park).
8. Press and hold the brake while pressing the POWER button.



9. When  (indicator lamp) is ON, you can drive the vehicle.  
When  (indicator lamp) is OFF, you cannot drive the vehicle. Start the vehicle again.
10. Press and hold the brake pedal and place the shift lever in the desired position.

## How to Stop the Vehicle

✱ For vehicles with Shift Lock, you have to press the POWER button to the ON position, press and hold the brake pedal, then press the unlock button on the shift lever while it is placed in P (Park) in order to move the shift lever to R (Reverse).

- While the charging cable is connected, you cannot use the shift lever for safety reasons.

11. Release the parking brake and slowly release the brake pedal. Check if the vehicle slowly moves forward, then press the accelerator pedal.



1. Hold down the brake pedal while the vehicle is parked.
2. While pressing the brake pedal, place the shift lever in P (Park).
3. While pressing the brake pedal, engage the parking brake.
4. While pressing the brake pedal, press the POWER button and stop the vehicle.

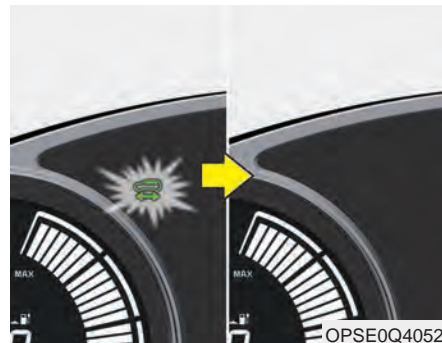

5. Check if  (indicator lamp) is turned OFF on the instrument cluster.

When  (indicator lamp) is ON and the shift lever is in a position other than P (Park), the driver can accidentally press the accelerator pedal, causing the vehicle to move unexpectedly.

### Pedestrian Warning System

The Pedestrian Warning System generates engine sound for pedestrians to hear vehicle sound because there is little sound while the Electric Vehicle (EV) is operating.

If the vehicle is moving at a slow speed, the Pedestrian Warning System will be operated.

- When the reduction gear is shifted to [R], the Pedestrian Warning System will be operated immediately.
- The vehicle generates little sound. Be aware of your driving environment and drive safely.
- After you park the vehicle or while you are waiting at a traffic light, check whether there are kids or obstacles around the vehicle.
- Check if there is something behind the vehicle when driving in reverse. Pedestrians may not hear the sound of the vehicle.

### Active ECO system



Active ECO helps improve energy efficiency by controlling certain motor and climate control system operating parameters. Energy efficiency depends on the driver's driving habit and road condition.

- When the Active ECO button is pressed the ECO indicator (green) will illuminate to show that the Active ECO is operating.

- When the Active ECO is activated, it will remain on until the Active ECO button is pressed again. Active ECO does not turn off when the vehicle is restarted. To turn off Active ECO, press the Active ECO button again.
- If Active ECO is turned off, the system will return to normal mode.

### Range



On average, a vehicle can drive about 111 miles (179 km) when the high voltage battery is 100% charged.

Under certain circumstances where the air conditioner/heater is ON, the distance to empty is impacted, resulting in a possible distance range from 75~162 mi. (120~260 km). When using the heater during cold weather or driving at high speed, the high voltage battery consumes a lot more electricity. This may reduce the distance to empty significantly.

After “---” has been displayed, the vehicle can drive an additional 2.5~6.0 mi. (4~9 km) (depending on driving speed, heater/air conditioner, weather, driving style, and other factors).

Distance to empty that is displayed on the instrument cluster after completing a recharge may vary significantly depending on previous operating patterns.

When previous driving patterns include high speed driving, resulting in the driving battery using more electricity than usual, the estimated distance to empty is reduced. When the high voltage battery uses a little electricity in ECO mode, the estimated distance to empty increases.

Distance to empty may depend on many factors such as the charge amount of the high voltage battery, weather, temperature, durability of the battery, geographical features, and driving style.

Natural degradation may occur with the high voltage battery depending on the number of years the vehicle is used. This may reduce the distance to empty.



### Tips for Improving Distance to Empty

- If you operate the air conditioner /heater too much, the driving battery uses too much electricity. This may reduce the distance to empty. Therefore, it is recommended that you set the cabin temperature to (73°F (23°C)) AUTO. This setting that has been certified by various assessment tests to maintain optimal energy consumption rates while keeping the temperature fresh.

Turn OFF the heater and air conditioner if you do not need them.

- Press and hold the accelerator pedal to maintain speed and drive economically.
- Gradually press and release the accelerator pedal when accelerating or decelerating.
- Always maintain specified tire pressures.
- Do not use unnecessary electrical components while driving.
- Do not load unnecessary items in the vehicle trunk.
- Do not mount parts that may increase air resistance.

### Motor Operation Gauge



It shows the energy consumption rate of the vehicle and the charge/discharge status of the regenerative brakes.

- **POWER** : It shows the energy consumption rate of the vehicle when driving uphill or accelerating. The more electric energy is used, the higher the gauge level.
- **ECO GUIDE** : It shows the energy consumption rate during normal driving condition.
- **CHARGE** : It shows the charging status of the battery when it is being charged by the regenerative brakes (decelerating or driving on a downhill road). The more electric energy is charged, the lower the gauge level.

### State of charge (SOC) gauge for high voltage battery



- It shows the charging status of the high voltage battery.  
[MIN] position on the indicator indicates that there is not enough energy in the high voltage battery.  
[MAX] position indicates that the driving battery is fully charged.
- When driving on highways or motorways, make sure to check in advance if the driving battery is charged enough.



When there are 3 gauge bars (near the "MIN" area) on the high voltage charge indicator, the warning lamp turns ON to alert you of the battery level.

When the warning lamp turns ON, the vehicle can drive an additional 14~28 miles (22~45 km) (depending on the driving speed, heater/air conditioner, weather, driving style, and other factors). Charging is required.

When there are 1-2 gauge bars left for the high voltage battery, the vehicle speed is limited and then eventually the vehicle will be turned OFF. Charge the vehicle immediately.

## Warning Message on LCD Display (related to charge)

### ■ Low Battery



OPSE044213L

When the high voltage battery level reaches below 20%, this warning message illuminates.

In this case, the warning lamp on the instrument cluster (🔋) turns ON simultaneously.

Charge the high voltage battery immediately.

### ■ Low Battery. Charge immediately



OPSE044214L

When the high voltage battery level reaches below 10%, this warning message illuminates .

In this case, the warning lamp on the instrument cluster (🔋) turns ON simultaneously and the distance to empty gauge will be displayed as "---".

Charge the high voltage battery immediately.

### ■ Charge immediately. Power limited



OPSE044215L

When the high voltage battery level reaches below 7%, this warning message illuminates.

In this case, the warning lamp on the instrument cluster (🔋) and the power down warning lamp (⚡) turn ON simultaneously and the distance to empty gauge will be displayed as "---".

The vehicle's power will be reduced to minimize the energy consumption of the high voltage battery. Charge the battery immediately.

### ■ Power limited



In the following cases, this warning message illuminates when the vehicle's power is limited for the safety.

- When the high voltage battery is below a certain level, or voltage is decreasing.
- When the temperature of the motor or high voltage battery is too high or too low.
- When there is a problem with the cooling system or a failure that may interrupt normal driving.

- When this warning messages is displayed, do not accelerate or start the vehicle suddenly.
- Charge the battery immediately when the high voltage battery level is not enough.

### ■ Unplug vehicle to start



When the vehicle is started while the charging connector is connected, this warning message illuminates.

Remove the charging connector and start the vehicle.

## ■ Charging Door Open



When the vehicle is started while the charging door is opened, this warning message illuminates. Make sure to close the charging door after charging is complete.

## ■ Charger Error!



This message is displayed when the charging failed by external normal charger error.

You should change and charge with the other external charger immediately.

## ■ Quick Charger Error!



This message is displayed when the charging failed by external quick charger error.

You should change and charge with the other external charger immediately.

### Warning Lamp and Indicator Lamp (related to electric vehicle)

#### ■ Ready indicator light



This warning light illuminates :

When the vehicle is ready to drive.

- ON: Normal driving is available.
- OFF: Normal driving is not available, or a failure has occurred.
- Blinking: Emergency driving.

When ready indicator light is OFF or blinking, there is a failure. In this case, have your vehicle inspected by an authorized Kia dealer

#### ■ Service Warning Light



This warning light illuminates :

- Once you set the POWER Button to the ON position.
- It illuminates for approximately 3 seconds
- There is a failure with a sensor, actuator, or the electric compressor for the air conditioner related to the electric vehicle control system. When the warning light turns ON while driving, or does not turn OFF after vehicle has started, have your vehicle inspected by an authorized Kia dealer.

#### ■ Power Down Warning Light



This warning light illuminates :

- when the power is limited for the safety of the electric vehicle.
- When the high voltage battery level is below a certain threshold, the voltage is decreasing, the temperature of the motor or driving battery is too high or too low, there is a failure in the cooling system, or a failure that is disrupting normal driving.

## ■ Charging Indicator Light

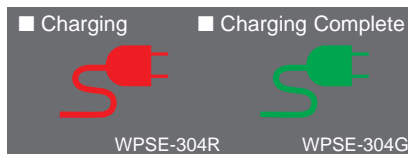

This warning light illuminates :

This indicator light shows the charging status of the high voltage battery. When it is charging, the red light turns ON. When charging is complete, the green light turns ON.

## ■ High voltage battery level warning light



This warning light illuminates :

- When the high voltage battery level is not enough. When the warning light turns ON, Charge the battery immediately

## ■ Regenerative Brake Warning Light



This warning light illuminates :

- The regenerative brake does not operate and the brake does not perform well. This causes the brake warning lamp (red) and regenerative brake warning lamp (yellow) to turn ON simultaneously. In this case, drive safely and have your vehicle inspected by an authorized Kia dealer.

In this case, operation of the brake pedal may be more difficult than normal and the braking distance can increase.

■ **ECOMINDER®**  
indicator  
Active ECO system



This indicator light illuminates:

- The Active ECO system always remembers the previous status before the vehicle was turned off.
- When the Active ECO button is pressed the ECOMINDER® indicator (green) will illuminate to show that the Active ECO is operating.  
To turn off the Active ECO system, press the button again.

For more details, refer to "Active ECO system" in the chapter 5 or "Electric Vehicle Guide".



### Responding to Vehicle Accidents in your Electric Vehicle

When a vehicle accident occurs, move the vehicle to a safe place, turn OFF the vehicle and remove the auxiliary battery (12 V) terminal to prevent high voltage electricity from flowing. Remove the auxiliary battery (12 V) terminal and turn it OFF.

#### **⚠ WARNING - Exposed Wires & Electrical Components**

**Do not touch electric wires that may become exposed from inside or outside the vehicle, high voltage electric wires (orange), connectors and all electric components and devices. Doing so may result in electric shock and lead to injuries.**

#### **⚠ WARNING - Damaged battery**

**Do not touch harmful gas and electrolytes which may leak if the high voltage battery is damaged in an accident.**

When you suspect leakage of inflammable gas and other harmful gases, open the windows and evacuate to a safe place. If any leaked fluid comes in contact with your eyes or skin, immediately clean the affected area thoroughly with tap water or saline solution and have doctors inspect it as soon as possible.

#### **⚠ WARNING - Vehicle fires**



- If a small scale fire occurs, use a fire extinguisher (ABC, BC) that is meant for electrical fires.

If it is impossible to extinguish the fire in the early stage, remain a safe distance from the vehicle and immediately call 911. Also, advise them that an electric vehicle is involved.

(Continued)

## SAFETY PRECAUTIONS FOR ELECTRIC VEHICLE

### (Continued)

If the fire spreads to the high voltage battery, large amount of water is needed to put out the fire.

Using small amount of water or fire extinguishers not meant for electrical fires could cause serious injury or death from electrical shocks.

- When a vehicle fire occurs due to the battery, there is a risk of a second fire. Contact the fire department when towing the vehicle.

### **⚠ WARNING**

If you cannot put out the fire immediately, the high voltage battery may explode. Evacuate to a safe place and do not let other people approach the site. Contact the fire department and notify them of an electric vehicle fire.

If the vehicle is flooded with water, immediately turn OFF the vehicle and evacuate to a safe place. Contact the fire department or an authorized Kia dealer.

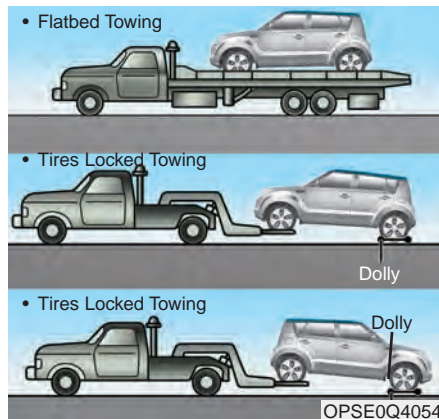

If towing is required, lift all four wheels off the ground and tow the vehicle. If you must tow the vehicle using only two wheels, lift the front wheels off the ground and tow the vehicle.

### CAUTION



OPSE0Q4037

*If you tow the vehicle while the front wheels are touching the ground, the vehicle motor may generate electricity and the motor components may be damaged or a fire may occur.*

## Other Precautions for Electric Vehicle

- When you paint or apply heat treatment to the vehicle as a result of an accident, the performance of the high voltage battery can be reduced.

If heat treatment is required, we recommend that you contact an authorized Kia dealer.

### WARNING - Damaging Battery

**When you clean the motor compartment, do not use high pressure water to wash. This may cause an electric shock due to a discharge in high voltage electricity.**

### CAUTION - Non-genuine parts

***Do not use, remodel, or install non-genuine parts.***

***This may damage the electric power system.***

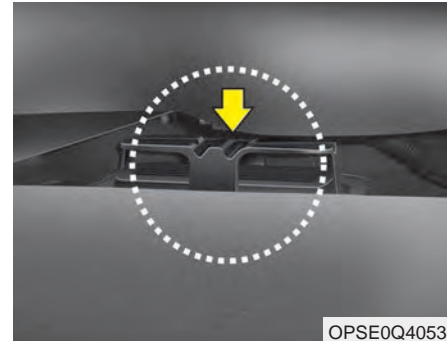

OPSE0Q4053

- An air inlet is installed under the front seat for cooling the driving battery. Do not block the air inlet with a foreign substance.

## Service Plug



**⚠ WARNING - Service plug**  
Do not touch the service plug installed at the rear seat footrest. The service plug is designed to block high voltage electricity when repairing the vehicle. If you are careless when handling the service plug, an electric shock may occur.

## Environmental Friendliness Mark

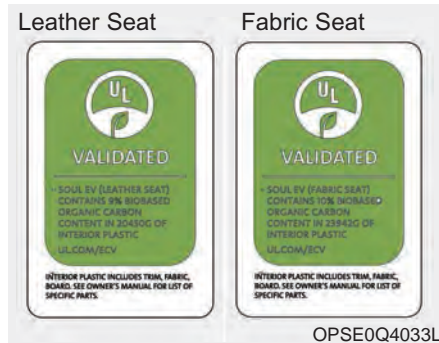

Kia Motors 'Soul Electric Vehicle' uses eco-friendly bioplastics, fiber, and board for the interior materials and has passed close inspection and validation. The plastic is validated 20,450g biomaterial where 9% is plant derived carbon (14C). (Leather Seat)

The plastic is validated 23,942g biomaterial where 10% is plant derived carbon (14C). (Fabric Seat). The plastic is validated 19,890g biomaterial where 9% is plant derived carbon (14C). (Sun-roof, Leather Seat)

The plastic is validated 23,382g biomaterial where 10% is plant derived carbon (14C). (Sun-roof, Fabric Seat). It has been awarded the UL Bio environmental friendliness mark for the first time in vehicle industry.

The 'Soul Electric Vehicle' not only uses eco-friendly interior materials, but it also does not emit exhaust gases, using regenerative biomass to prevent the generation of carbon dioxide (a major cause of global warming). This also helps curb the depletion of oil resources.

## List of Parts with Environmental Friendliness Mark

	NO.	NO.
Bio Materials Part	1	SKIN-C/PAD MAIN
	2	SKIN - DR TRIM UPR
	3	NON WOVEN - HEADLINER
	4	THREAD - FLOOR CARPET
	5	THREAD - FLOOR MAT
	6	FLOOR CONSOLE - MAIN, REAR
		FLOOR CONSOLE - UPPER
	7	PILLAR TRIM - FRONT
		PILLAR TRIM - REAR
		PILLAR TRIM - CENTER LWR
	8	DOOR SCUFF - FRONT
		DOOR SCUFF - REAR
	9	DOOR TRIM - FRONT LWR, REAR MAIN
	10	COWL SIDE TRIM
	11	SKIN-SUNVISOR
12	COVERING SHELF	
13	REAR TRANVERS TRIM	
14	LUGG SIDE TRIM	
15	SEAT FABRIC	

# Introduction

**Vehicle Data Collection and  
Event Data Recorders ..... 1-2**

## VEHICLE DATA COLLECTION AND EVENT DATA RECORDERS

This vehicle is equipped with an event data recorder (EDR). The main purpose of an EDR is to record, in certain crash or near crash-like situations, such as an air bag deployment or hitting a road obstacle, data that will assist in understanding how a vehicle's systems performed. The EDR is designed to record data related to vehicle dynamics and safety systems for a short period of time, typically 30 seconds or less. The EDR in this vehicle is designed to record such data as:

- \* How various systems in your vehicle were operating;
- \* Whether or not the driver and passenger safety belts were buckled/ fastened;
- \* How far (if at all) the driver was depressing the accelerator and/or brake pedal; and,
- \* How fast the vehicle was traveling.

These data can help provide a better understanding of the circumstances in which crashes and injuries occur. NOTE: EDR data are recorded by your vehicle only if a non-trivial crash situation occurs; no data are recorded by the EDR under normal driving conditions and no personal data (e.g., name, gender, age, and crash location) are recorded. However, other parties, such as law enforcement, could combine the EDR data with the type of personally identifying data routinely acquired during a crash investigation.

To read data recorded by an EDR, special equipment is required, and access to the vehicle or the EDR is needed. In addition to the vehicle manufacturer, other parties, such as law enforcement, that have the special equipment, can read the information if they have access to the vehicle or the EDR.

Your rights with respect to the information discussed above may vary from state to state. In some states, such information is considered private, is exclusively owned by the owner of the motor vehicle, and is not retrievable or usable by another person or entity.

## Your vehicle at a glance

<b>Exterior overview</b> .....	<b>2-2</b>
<b>Interior overview</b> .....	<b>2-4</b>
<b>Instrument panel overview</b> .....	<b>2-5</b>
<b>Motor room compartment</b> .....	<b>2-6</b>



## EXTERIOR OVERVIEW

■ Front view

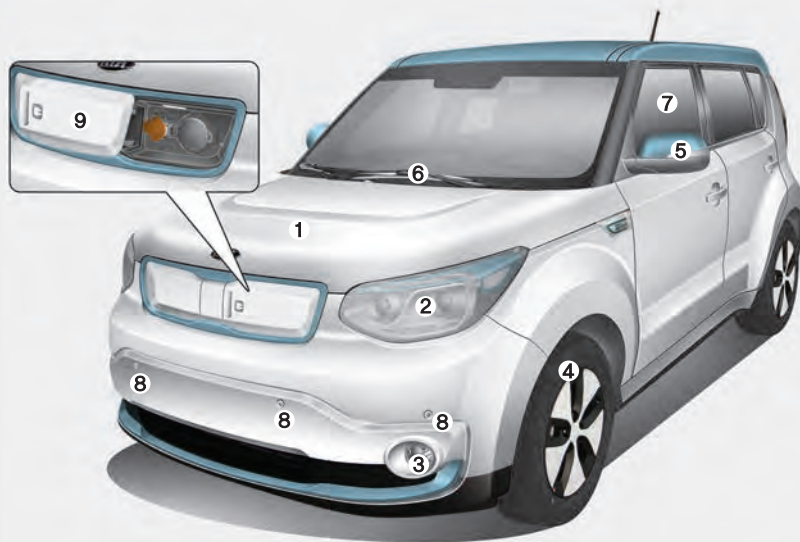

- 1. Hood .....4-22
- 2. Head lamp .....4-83, 7-64
- 3. Fog lamp .....4-86, 7-67
- 4. Wheel and tire .....7-36
- 5. Outside rearview mirror .....4-37
- 6. Front windshield wiper blades.....4-87, 7-29
- 7. Windows .....4-17
- 8. Parking assist system.....4-76
- 9. Charging door .....EV Guide-22, 25

\* The actual shape may differ from the illustration.

OPSE014001

■ Rear view

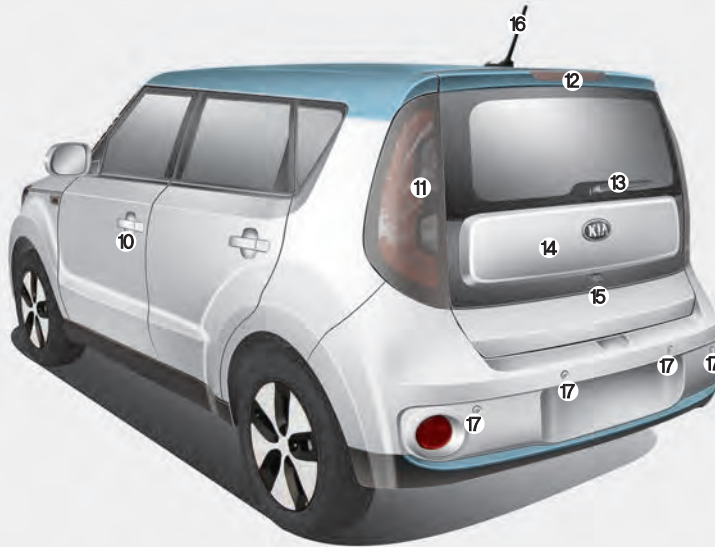

10. Door locks .....	4-11
11. Rear combination lamp.....	7-68
12. High mounted stop lamp .....	7-70
13. Rear window wiper blade .....	4-87, 7-31
14. Tailgate.....	4-15
15. Rear camera display.....	4-80
16. Antenna .....	4-128
17. Parking assist system.....	4-76

\* The actual shape may differ from the illustration.

OPSE014002

## INTERIOR OVERVIEW

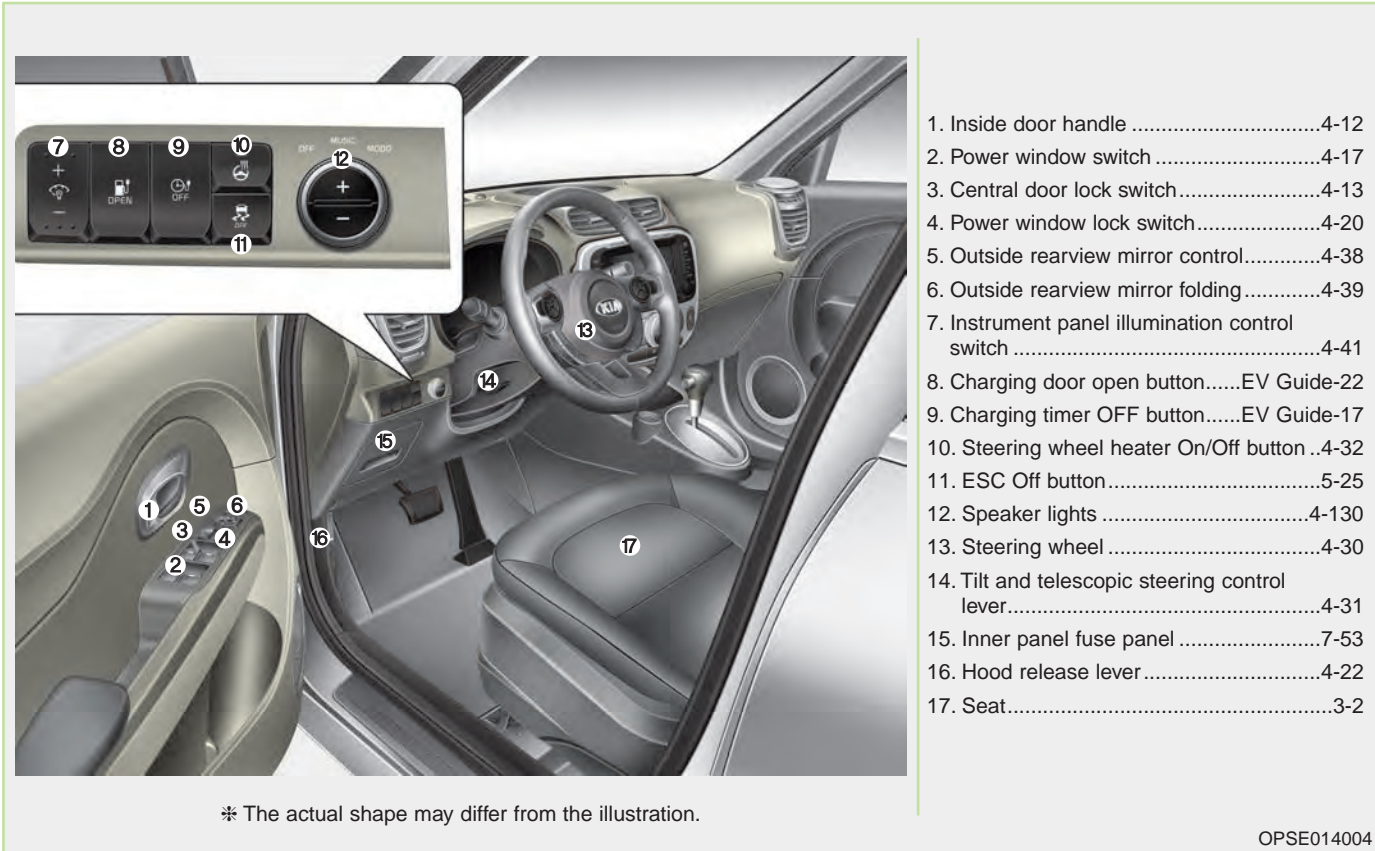

OPSE014004

## INSTRUMENT PANEL OVERVIEW

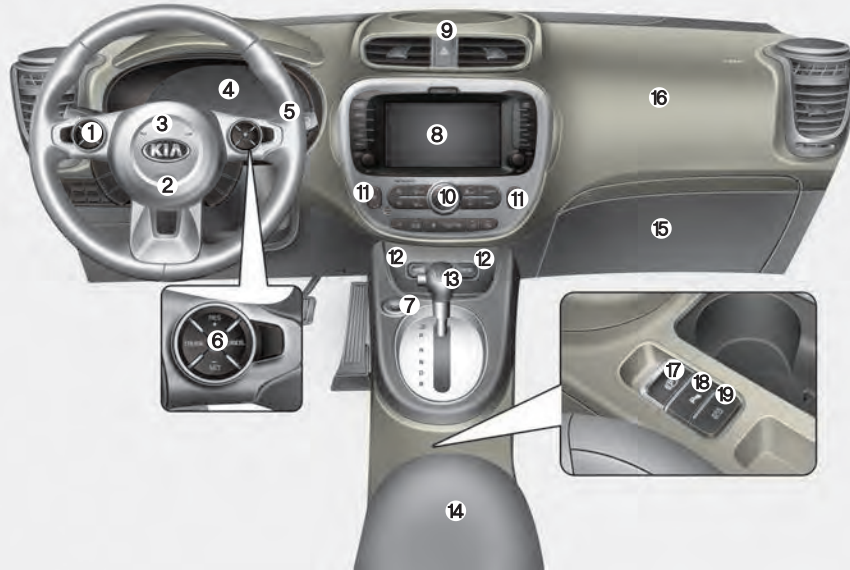

- 1. Audio remote control buttons.....4-144
- 2. Driver's front air bag .....3-46
- 3. Horn .....4-32
- 4. Instrument cluster .....4-40
- 5. Wiper and washer control lever .....4-87
- 6. Cruise control button .....5-33
- 7. POWER button .....5-5
- 8. AVN(Audio/Video/Navigation)
- 9. Hazard warning flasher.....6-2
- 10. Climate control system .....4-94
- 11. Front seat warmer /  
Seat air ventilation.....4-119, 4-121
- 12. Power outlet .....4-123
- 13. Shift Lever.....5-11
- 14. Center console storage box.....4-116
- 15. Glove box.....4-116
- 16. Passenger's front air bag.....3-46
- 17. Electronic parking brake .....5-18
- 18. Parking assist system button.....4-76
- 19. Active ECO button .....5-10

\* The actual shape may differ from the illustration.

OPSE014003N

## MOTOR ROOM COMPARTMENT



- 1. Coolant reservoir .....7-21
- 2. Brake fluid reservoir .....7-24
- 3. Fuse box.....7-51
- 4. Positive battery terminal .....7-33
- 5. Negative battery terminal .....7-33
- 6. Radiator cap .....7-23
- 7. Windshield washer fluid reservoir .....7-26

\* The actual motor compartment in the vehicle may differ from the illustration.

OPSE015005

# Safety features of your vehicle

Seats . . . . .	3-2
• Front seat adjustment . . . . .	3-5
• Seatback pocket . . . . .	3-9
• Rear seat adjustment . . . . .	3-9
Seat belts . . . . .	3-13
• Seat belt restraint system . . . . .	3-13
• Pre-tensioner seat belt . . . . .	3-20
• Seat belt precautions . . . . .	3-22
• Care of seat belts . . . . .	3-25
Child restraint system . . . . .	3-26
• Using a child restraint system . . . . .	3-27
• Tether anchor system . . . . .	3-31
• Lower anchor system . . . . .	3-32
Air bag -	
advanced supplemental restraint system . . . . .	3-34
• How does the air bag system operate . . . . .	3-35
• Do not installing a child restraint on a front passenger's seat . . . . .	3-37
• Air bag warning light . . . . .	3-37
• SRS components and functions . . . . .	3-38
• Occupant Detection System (ODS) . . . . .	3-41
• Driver's and passenger's front air bag . . . . .	3-46
• Side air bag . . . . .	3-49
• Curtain air bag . . . . .	3-51

• Inflation and non-inflation conditions of the air bag .	3-52
• SRS Care . . . . .	3-57
• Adding equipment to or modifying your air bag-equipped vehicle. . . . .	3-58
• Air bag warning label . . . . .	3-58

## SEATS

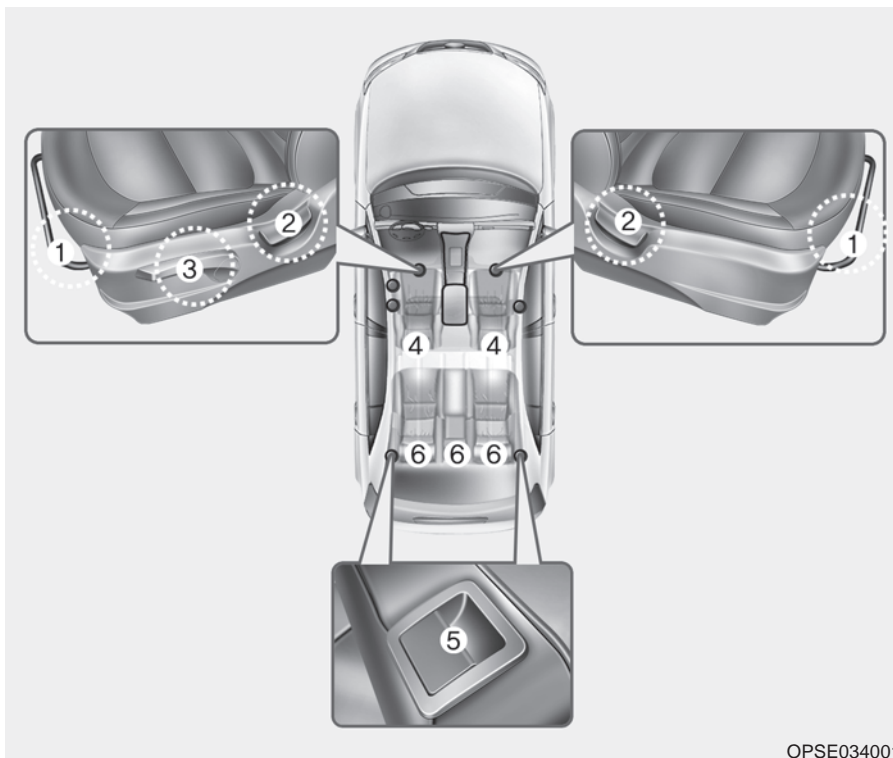

### Front seat

- (1) Forward and backward
- (2) Seatback angle
- (3) Seat cushion height (Driver's seat)
- (4) Headrest

### Rear seat

- (5) Seatback folding
- (6) Headrest

OPSE034001

**⚠ WARNING - Loose objects**

Do not place anything in the driver's foot well or under the front seats. Loose objects in the driver's foot area could interfere with the operation of the foot pedals.

**⚠ WARNING - Uprighting seat**

Do not press the release lever on a manual seatback without holding and controlling the seatback. The seatback will spring upright possibly impacting you or other passengers.

**⚠ WARNING - Driver responsibility for passengers**



The driver must advise the passenger to keep the seatback in an upright position whenever the vehicle is in motion. If a seat is reclined during an accident, the occupant's hips may slide under the lap portion of the seat belt, applying great force to the unprotected abdomen.

**⚠ WARNING - Seat cushion**

Occupants should never sit on aftermarket seat cushions or sitting cushions. The passenger's hips may slide under the lap portion of the seat belt during an accident or a sudden stop.

**⚠ WARNING - Driver's seat**

- Never attempt to adjust the seat while the vehicle is moving. This could result in loss of control of your vehicle.
- Do not allow anything to interfere with the normal position of the seatback and seatback adjustment.
- Sit as far back as possible from the steering wheel while still maintaining comfortable control of your vehicle. A distance of at least 10" from your chest to the steering wheel is recommended. Failure to do so can result in airbag inflation injuries to the driver.



**⚠ WARNING - Rear seatbacks**

Always lock the rear seatback before driving. Failure to do so could result in passengers or objects being thrown forward injuring vehicle occupants.

**⚠ WARNING - Luggage and Cargo**

Do not stack pile or stack luggage or cargo higher than the seatback in the cargo area. In an accident the cargo could strike and injure a passenger. If objects are large, heavy or must be piled, they must be secured in the cargo area.

**⚠ WARNING - Unexpected Seat Movement**

After adjusting a manual seat, always check that it is locked by shifting your weight to the front and back. Sudden or unexpected movement of the driver's seat could cause you to lose control of the vehicle.

**⚠ WARNING - Seat adjustment**

- Do not adjust the seat while wearing seat belts. Moving the seat forward will cause strong pressure on the abdomen.
- Do not place your hand near the seat bottom or seat track while adjusting the seat. Your hand could get caught in the seat mechanism.

**⚠ WARNING - Small Objects**

Use extreme caution when picking small objects trapped under the seats or between the seat and the center console. Your hands might be cut or injured by the sharp edges of the seats mechanism.

**⚠ WARNING - Cargo Area**

Do not allow passengers to ride in the cargo area under any circumstance. The cargo area is solely for the purpose of transporting luggage or cargo.

### Feature of Seat Leather

- Leather is made from the outer skin of an animal, which goes through a special process to be available for use. Since it is a natural substance, each part differs in thickness or density. Wrinkles may appear as a natural result of stretching and shrinking depending on the temperature and humidity.
- The seat is made of stretchable fabric to improve comfort.
- The parts contacting the body are curved and the side supporting area is high which provides driving comfort and stability.
- Wrinkles may appear naturally from usage. It is not a fault of the product.

### CAUTION

- **Belts with metallic accessories, zippers or keys inside the back pocket may damage the seat fabric.**
- **Make sure not to wet the seat. It may change the nature of natural leather.**
- **Jeans or clothes which could bleach may contaminate the surface of the seat covering fabric.**

### \* NOTICE

Wrinkles or abrasions which appear naturally from usage are not covered by warranty.

### Front seat adjustment

#### Forward and backward

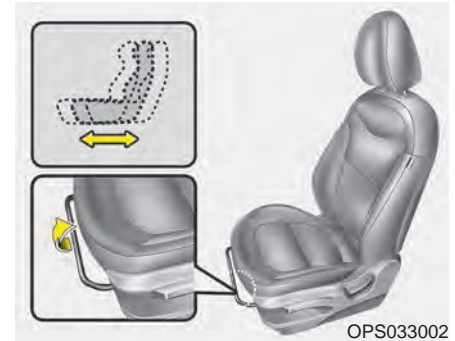

To move the seat forward or backward:

1. Pull the seat slide adjustment lever up and hold it.
2. Slide the seat to the position you desire.
3. Release the lever and make sure the seat is locked in place.

Adjust the seat before driving, and make sure the seat is locked securely by trying to move forward and backward without using the lever. If the seat moves, it is not locked properly.

### Seatback angle

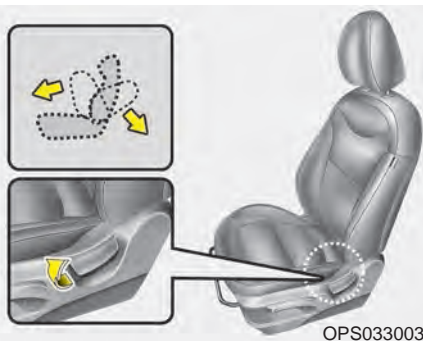

To recline the seatback:

1. Lean forward slightly and lift up the seatback recline lever.
2. Carefully lean back on the seat and adjust the seatback of the seat to the position you desire.
3. Release the lever and make sure the seatback is locked in place. (The lever **MUST** return to its original position for the seatback to lock.)

### Seat height (for driver's seat)

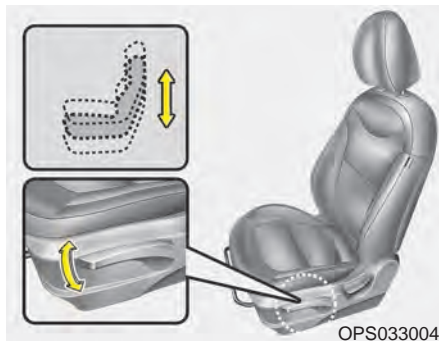

To change the height of the seat, push the lever upwards or downwards.

- To lower the seat cushion, push the lever down several times.
- To raise the seat cushion, pull the lever up several times.

### Headrest (for front seat)

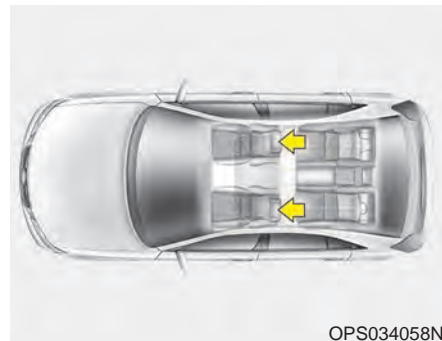

The driver's and front passenger's seats are equipped with a headrest for the occupant's safety and comfort. The headrest not only provides comfort for the driver and front passenger, but also helps protect the head and neck in the event of a rear collision.

For maximum effectiveness in case of an accident, the headrest should be adjusted so the middle of the headrest is at the same height of the center of gravity of an occupant's head. Generally, the center of gravity of most people's head is similar with the height of the top of their eyes. Also, adjust the headrest as close to your head as possible. For this reason, the use of a cushion that holds the body away from the seatback is not recommended.



#### Forward and rearward adjustment

The headrest may be adjusted forward to 4 different positions by pulling the headrest forward to the desired detent. To adjust the headrest to its furthest rearward position, pull it fully forward to the farthest position and release it. Adjust the headrest so that it properly supports the head and neck.

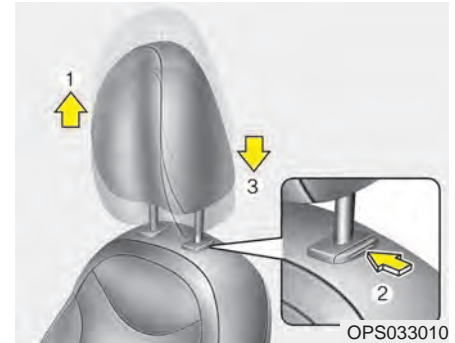

#### Adjusting the height up and down

To raise the headrest, pull it up to the desired position (1). To lower the headrest, push and hold the release button (2) on the headrest support and lower the headrest to the desired position (3).

#### **⚠ WARNING - Headrest removal/adjustment**

- Do not operate the vehicle with the headrests removed. Headrests can provide critical neck and head support in a crash.
- Do not adjust the headrest height while the vehicle is in motion. Driver may lose control of the vehicle.

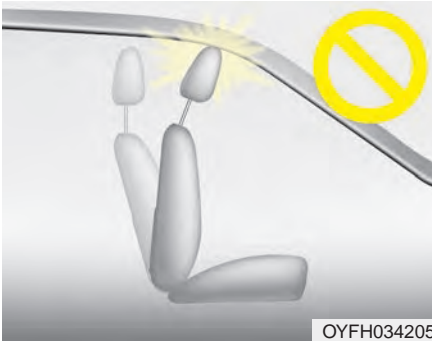

**\* NOTICE**

If you recline the seatback towards the front with the headrest and seat cushion raised, the headrest may come in contact with the sunvisor or other parts of the vehicle.

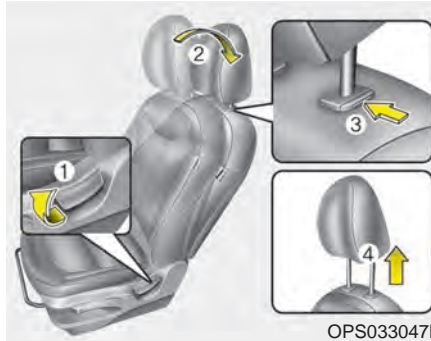

**Removal and installation**

To remove the headrest:

1. Recline the seatback (2) with the recline lever (1).
2. Raise headrest as far as it can go.
3. Press the headrest release button (3) while pulling the headrest up (4).

**⚠ WARNING**

**NEVER allow anyone to ride in a seat with the headrest removed.**

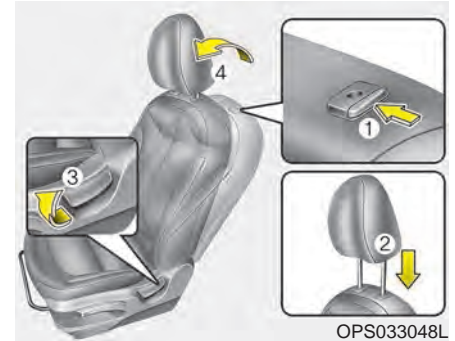

To reinstall the headrest :

1. Put the headrest poles (2) into the holes while pressing the release button (1).
2. Recline the seatback (4) with the recline lever (3).
3. Adjust the headrest to the appropriate height.

**⚠ WARNING - Headrest Reinstallation**

To reduce the risk of injury to the head or neck, always make sure the headrest is locked into position and adjusted properly after reinstalling.

## Seatback pocket

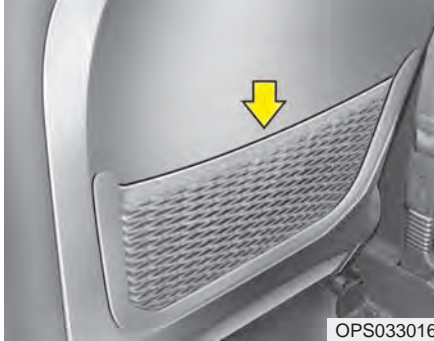

The seatback pocket is provided on the back of the front passenger's seatbacks.

### **⚠ WARNING - Seatback pockets**

Do not put heavy or sharp objects in the seatback pocket. An occupant could contact such objects in a crash. Heavy objects in the front passenger seatback could also interfere with the airbag sensing system.

## Rear seat adjustment

### *Folding the rear seat*

The rear seatbacks can be folded to facilitate carrying long items or to increase the luggage capacity of the vehicle.

### **⚠ WARNING - Folded down seatback**

**Never allow passengers sit on top of the folded down seatback while the vehicle is moving. This is not a proper seating position and no seat belts are available for use.**

**This could result in serious injury or death in case of an accident or sudden stop.**

### **⚠ WARNING - Objects**

**Objects carried on the folded down seatback should not extend higher than the top of the front seatbacks. This could allow cargo to slide forward and cause injury or damage during sudden stops.**

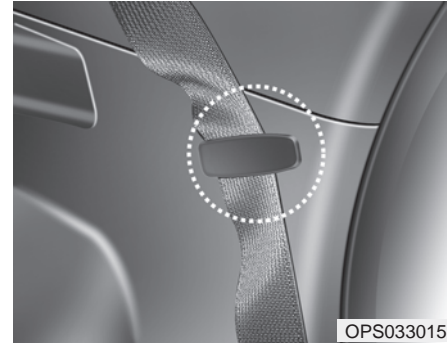

### **To fold down the rear seatback**

1. Insert the rear seat belt webbing in the guide to prevent the seat belt from being damaged.
2. Set the front seatback to the upright position and if necessary, slide the front seat forward.
3. Lower the rear headrests to the lowest position.

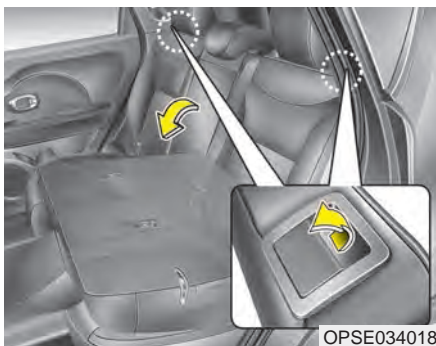

4. Pull on the seatback folding lever, then fold the seat toward the front of the vehicle. When you return the seatback to its upright position, always be sure it has locked into position by pushing on the top of the seatback.
5. To use the rear seat, lift and pull the seatback backward by pulling on the folding lever.  
Pull the seatback firmly until it clicks into place.  
Make sure the seatback is locked in place.
6. Return the rear seat belt to the proper position.

### **⚠ WARNING - Cargo**

**Do not place heavy objects in the rear seats, since they cannot be properly secured and may hit vehicle occupants in a frontal collision.**

Make sure the vehicle is off, the reduction gear is in P (Park) position, and the parking brake is securely applied whenever loading or unloading cargo. Failure to take these steps may allow the vehicle to move if the shift lever is inadvertently moved to another position.

### **Headrest**

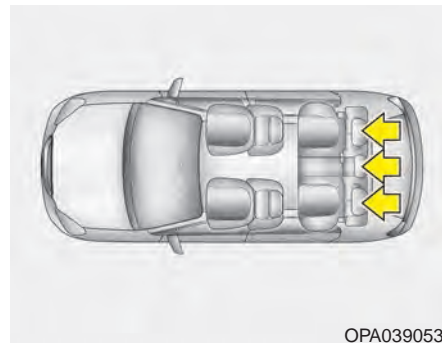

The rear seat(s) is equipped with headrests in all the seating positions for the occupant's safety and comfort. The headrest not only provides comfort for passengers, but also helps protect the head and neck in the event of a collision.



For maximum effectiveness in case of an accident, the headrest should be adjusted so the middle of the headrest is at the same height as the center of gravity of an occupant's head.

Generally, the center of gravity of most people's head is similar with the height of the top of their eyes.

Also adjust the headrest as close to your head as possible. For this reason, the use of a cushion that holds the body away from the seatback is not recommended.

### Adjusting the height up and down

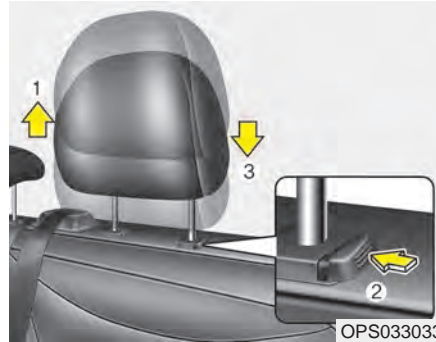

To raise the headrest :

1. Pull it up to the desired position (1).

To lower the headrest :

1. Push and hold the release button (2) on the headrest support
2. Lower the headrest to the desired position (3).

### Removal and installation

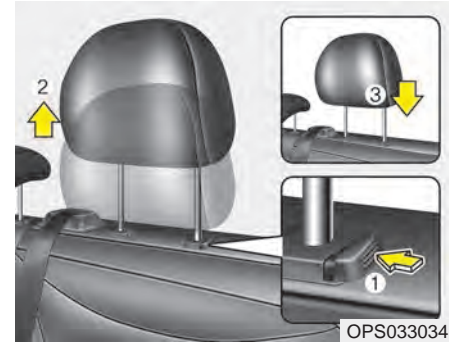

To remove the headrest :

1. Raise it as far as it can go then press the release button (1) while pulling the headrest up (2).

To reinstall the headrest :

1. Put the headrest poles (3) into the holes while pressing the release button (1).
2. Adjust it to the appropriate height.

### **⚠ WARNING - Headrest removal/adjustment**

- Do not operate the vehicle with the headrests removed. Headrests can provide critical neck and head support in a crash.
- Do not adjust the headrest height while the vehicle is in motion. Driver may lose control of the vehicle.



**⚠ WARNING - Headrest installation**

After installing the headrest, make sure that it is installed in the right direction.

A headrest installed reversely could increase whiplash injury during rear impact.

*Armrest (if equipped)*

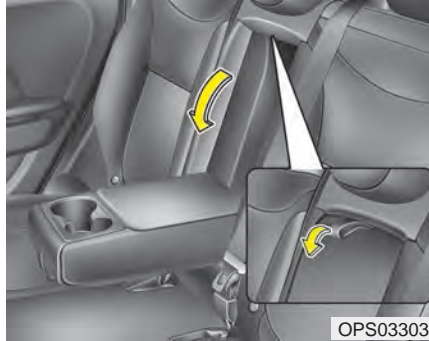

To use the armrest, pull it forward from the seatback.

## SEAT BELTS

### Seat belt restraint system

- For maximum restraint system protection, the seat belts must always be used whenever the vehicle is moving. A properly positioned shoulder belt should be positioned midway over your shoulder across your collarbone.
- Never allow children to ride in the front passenger seat. See child restraint system section for further discussion.

#### **WARNING - Shoulder Belt**

- **Never wear the shoulder belt under your arm or behind your back. An improperly positioned shoulder belt cannot protect the occupant in a crash.**
- **Always wear both the shoulder portion and lap portion of the lap/shoulder belt.**

#### **WARNING - Damaged seat belt**

**Replace the entire seat belt assembly if any part of the webbing or hardware is damaged as you can no longer be sure that a damaged seat belt will provide protection in a crash.**

Seat belts are designed to bear upon the bony structure of the body, and should be worn low across the front of the pelvis or the pelvis, chest and shoulders, as applicable; wearing the lap section of the belt across the abdominal area must be avoided.

Seat belts should be adjusted as firmly as possible, consistent with comfort, to provide the protection for which they have been designed.

A slack belt will greatly reduce the protection afforded to the wearer.

Care should be taken to avoid contamination of the webbing with polishes, oils and chemicals, and particularly battery acid. Cleaning may safely be carried out using mild soap and water. The belt should be replaced if webbing becomes frayed, contaminated or damaged.

- No modifications or additions should be made by the user which will either prevent the seat belt adjusting devices from operating to remove slack, or prevent the seat belt assembly from being adjusted to remove slack.

- When you fasten the seat belt, be careful not to latch the seat belt in buckles of other seat. It's very dangerous and you may not be protected by the seat belt properly.
- Do not unfasten the seat belt and do not fasten and unfasten the seat belt repeatedly while driving. This could result in loss of control, and an accident causing death, serious injury, or property damage.
- When fastening the seat belt, make sure that the seat belt does not pass over objects that are hard or can break easily.

**⚠ WARNING - Seat belt buckle**  
**Do not allow foreign material (gum, crumbs, coins, etc.) to obstruct the seat belt buckle. This may prevent the seat belt from fastening securely.**

**Seat belt warning**



OAM032161L

**Driver's seat belt warning (1)**

The driver's seat belt warning light and chime will activate pursuant to the following table when the POWER button is in "ON" position.

Conditions		Warning Pattern	
Seat Belt	Vehicle Speed	Light-Blink	Chime-Sound
Unbuckled		6 seconds	
Buckled		6 seconds	None
Buckled → Unbuckled	Below 3 mph (5 km/h)	6 seconds	None
	3 mph~6 mph	6 seconds	
	Above 6 mph (10 km/h)	6 sec. on / 24 sec. off (11 times)	
Unbuckled	Above 6 mph (10 km/h) ↓	6 seconds *1 ↓	
	Below 3 mph (5 km/h)	Stop *2	

\*1 Warning pattern repeats 11 times with an interval of 24 seconds. If the driver's seat belt is buckled, the light will stop within 6 seconds and chime will stop immediately.

\*2 The light will stop within 6 seconds and chime will stop immediately.

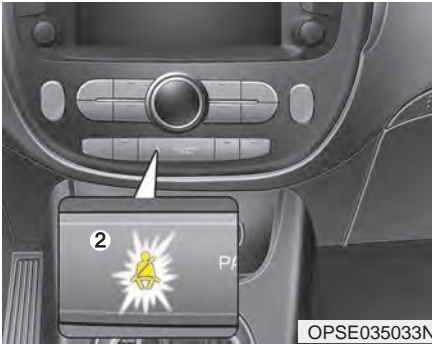

### Front passenger's seat belt warning (2)

The front passenger's seat belt warning light will activate to the following table when the POWER button is in "ON" position.

Conditions		Warning Pattern
Seat Belt	Vehicle Speed	Light-Blink
Unbuckled		6 seconds
Unbuckled	Above 6mph (10 km/h)	Continuously
Buckled		6 seconds
Buckled →	Above 6mph (10 km/h)	Continuously *1
Unbuckled	Below 6mph (10 km/h)	None

\*1 The seat belt warning light will go off if the vehicle speed decreases below 3 mph (5 km/h). If the vehicle speed increases above 3 mph (5 km/h), the warning light will blink again.

Riding in an improper position adversely affects the front passenger's seat belt warning system. It is important for the driver to instruct the passenger as to the proper seating instructions as contained in this manual.

- You can find the front passenger's seat belt warning light on the center fascia panel.
- Although the front passenger seat is not occupied, the seat belt warning light will blink for 6 seconds.
- The seat belt warning light can blink when a briefcase or purse is placed on the front passenger seat.

### **Seat belt - Driver's 3-point system with emergency locking retractor**

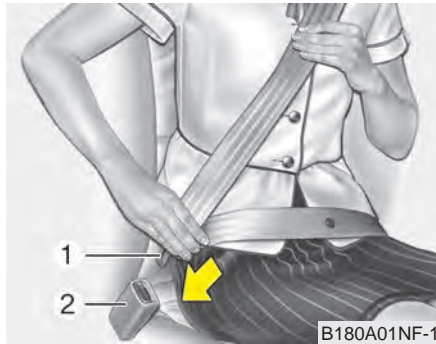

#### **To fasten your seat belt:**

To fasten your seat belt, pull it out of the retractor and insert the metal tab (1) into the buckle (2). There will be an audible "click" when the tab locks into the buckle.

The seat belt automatically adjusts to the proper length only after the lap belt portion is adjusted manually so that it fits snugly around your hips. If you lean forward in a slow, easy motion, the belt will extend and let you move around. If there is a sudden stop or impact, however, the belt will lock into position. It will also lock if you try to lean forward too quickly.

If you are not able to pull out the seat belt from the retractor, firmly pull the belt out and release it. Then you will be able to pull the belt out smoothly.

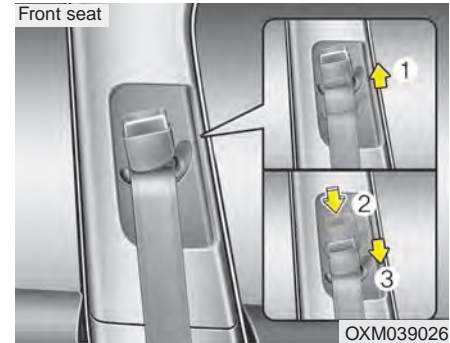

#### **Height adjustment**

You can adjust the height of the shoulder belt anchor to one of the 3 positions for maximum comfort and safety.

The height of the adjusting seat belt should not be too close to your neck. The shoulder portion should be adjusted so that it lies across your chest and midway over your shoulder near the door and not your neck.

To adjust the height of the seat belt anchor, lower or raise the height adjuster into an appropriate position.

To raise the height adjuster, pull it up (1). To lower it, push it down (3) while pressing the height adjuster button (2).

Release the button to lock the anchor into position. Try sliding the height adjuster to make sure that it has locked into position.

Improperly positioned seat belts can cause serious injuries in an accident.

**⚠ WARNING - Shoulder belt positioning**

**Never position the shoulder belt across your neck or face.**

**⚠ WARNING - Seat belt replacement**

**Replace your seat belts after being in an accident. Failure to replace seat belts after an accident could leave you with damaged seat belts that will not provide protection in the event of another collision.**

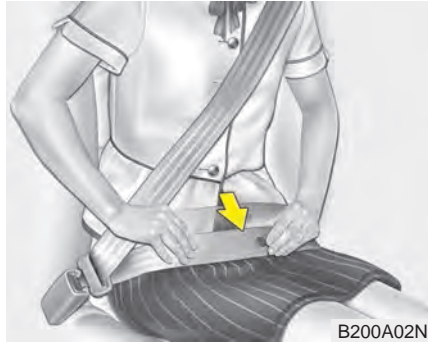

You should place the lap belt portion as low as possible and snugly across your hips, not on your waist. If the lap belt is located too high on your waist, it may increase the chance of injury in the event of a collision. Both arms should not be under or over the belt. Rather, one should be over and the other under, as shown in the illustration.

Never wear the seat belt under the arm that is near the door.

***Seat belts - Front passenger and rear seat 3-point system with combination locking retractor***

**To fasten your seat belt:**

Combination retractor type seat belts are installed in the rear seat positions to help accommodate the installation of child restraint systems. Although a combination retractor is also installed in the front passenger seat position, it is strongly recommended that children always be seated in the rear seat. NEVER place any infant restraint system in the front seat of the vehicle.

This type of seat belt combines the features of both an emergency locking retractor seat belt and an automatic locking retractor seat belt. To fasten your seat belt, pull it out of the retractor and insert the metal tab into the buckle. There will be an audible "click" when the tab locks into the buckle. When not securing a child restraint, the seat belt operates in the same way as the driver's seat belt (Emergency Locking Retractor Type).

It automatically adjusts to the proper length only after the lap belt portion of the seat belt is adjusted manually so that it fits snugly around your hips. When the seat belt is fully extended from the retractor to allow the installation of a child restraint system, the seat belt operation changes to allow the belt to retract, but not to extend (Automatic Locking Retractor Type). Refer to “Using a child restraint system” in this section.

### \* NOTICE

Although the combination retractor provides the same level of protection for seated passengers in either emergency or automatic locking modes, have the seated passengers use the emergency locking feature for improved convenience. The automatic locking function is intended to facilitate child restraint installation. To convert from the automatic locking feature to the emergency locking operation mode, allow the unbuckled seat belt to fully retract.

Do NOT fold down the left portion of the rear seat back when the rear center seat belt is buckled. ALWAYS UNBUCKLE the rear center seat belt before folding down the left portion of the rear seat back. If the rear center seat belt is buckled when the left portion of the rear seat back is folded down, distortion and damage to the top portion of the seat back and seat belt garnish may result, causing the seat back to lock into the folded down position.

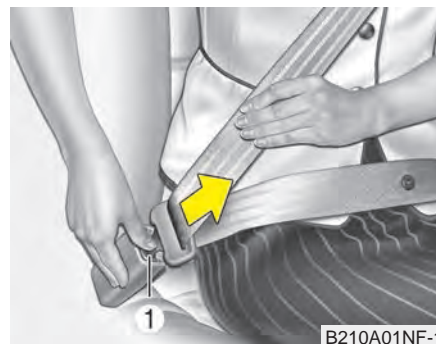

#### To release the seat belt:

The seat belt is released by pressing the release button (1) on the locking buckle. When it is released, the belt should automatically draw back into the retractor.

If this does not happen, check the belt to be sure it is not twisted, then try again.

### Stowing the rear seat belt

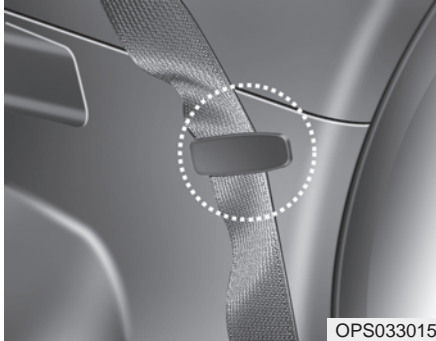

Routing the seat belt webbing through the rear seat belt guides will help keep the belts from being trapped behind or under the seats. After inserting the seat belt, tighten the belt webbing by pulling it up.

**⚠ CAUTION - Seat belt guide**  
*Remove the seat belt from the guides before using. If you pull on the seat belt when it is stored in the guides, it may damage the guides and/or belt webbing.*

### 3 Point rear center belt

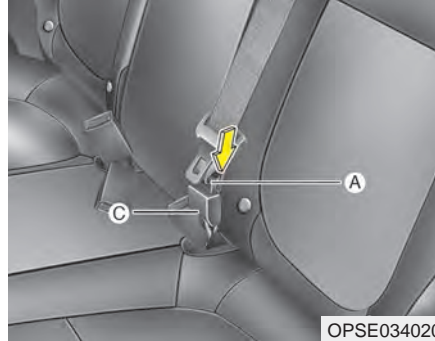

#### To fasten the rear center belt

1. Insert the mini tongue (A) into the open end of the anchor connector (C) until an audible “click” is heard, indicating the latch is locked. Make sure the belt is not twisted.

#### **⚠ WARNING - Rear center seat belt**

**Do not separate mini tongue and mini buckle even if there is not an occupant.**

**If it is separated, It may hit the rear seat occupants in a collision or sudden stops.**

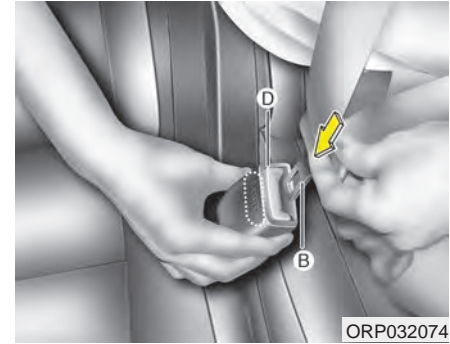

2. Pull the tongue plate (B) and insert the tongue plate (B) into the open end of the buckle (D) until an audible “click” is heard, indicating the latch is locked. Make sure the belt is not twisted.

When using the rear center seat belt, the buckle with the “CENTER” mark must be used.



There will be an audible “click” when the tab locks in the buckle. The seat belt automatically adjusts to the proper length only after the lap belt is adjusted manually so that it fits snugly around your hips, if you lean forward in a slow, easy motion, the belt will extend and let you move around. If there is a sudden stop or impact, the belt will lock into position. It will also lock if you try to lean forward too quickly.

When using the rear seat center belt, you must lock all tongue plates and buckles.

### *To unfasten the rear center belt*

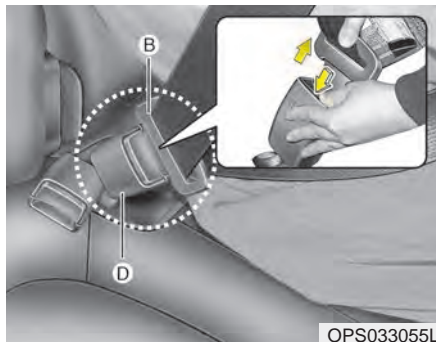

Press the release button on the buckle (D) and remove the tongue plate (B) from the buckle (D).

### **Pre-tensioner seat belt**



Your vehicle is equipped with driver's and front passenger's pre-tensioner seat belts (retractor pretensioner and EFD (Emergency Fastening Device)). The pre-tensioner seat belts may be activated, when a frontal collision is severe enough, together with the air bags.

When the vehicle stops suddenly, or if the occupant tries to lean forward too quickly, the seat belt retractor may lock into position. In certain frontal collisions, the pre-tensioner will activate and pull the seat belt into tighter contact against the occupant's body.

(1) Retractor Pretensioner

The purpose of the retractor pretensioner is to make sure that the shoulder belts fit in tightly against the occupant's upper body in certain frontal collisions.

(2) EFD (Emergency Fastening Device)

The purpose of the EFD is to make sure that the pelvic belts fit in tightly against the occupant's lower body in certain frontal collisions.

If the system senses excessive tension on the driver or passenger's seat belt when the pre-tensioner system activates, the load limiter inside the retractor pretensioner will release some of the pressure on the affected seat belt.

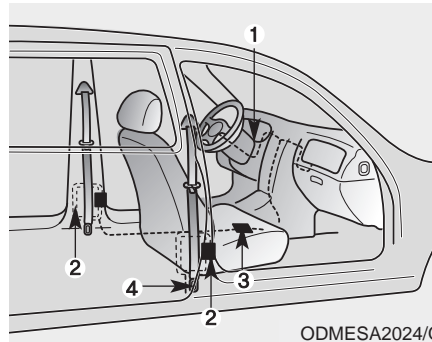

The seat belt pre-tensioner system consists mainly of the following components. Their locations are shown in the illustration:

- (1) SRS air bag warning light
- (2) Retractor pre-tensioner assembly
- (3) SRS control module
- (4) Emergency fastening device (EFD)

- Both the driver's and front passenger's seat belt pre-tensioner system may be activated not only in certain frontal collision but also in certain side collision or rollover, if the vehicle is equipped with a side or curtain air bag.
- Because the sensor that activates the SRS air bag is connected with the pre-tensioner seat belt, the SRS air bag warning light  on the instrument panel will illuminate for approximately 6 seconds after the POWER button has been turned to the ON position, and then it should turn off.

If the pre-tensioner seat belt system are not working properly, this warning light will illuminate even if there is no malfunction of the SRS air bag. If the SRS air bag warning light does not illuminate when the POWER button is turned ON, or if it remains illuminated after illuminating for approximately 6 seconds, or if it illuminates while the vehicle is being driven, have an authorized Kia dealer inspect the pre-tensioner seat belt and SRS air bag system as soon as possible.

 **WARNING - Hot pre-tensioner**

**Do not touch the pre-tensioner seat belt assemblies for several minutes after they have been activated. When the pre-tensioner seat belt mechanism fires during a collision the pre-tensioner becomes hot and can burn you.**

Pre-tensioners are designed to operate only one time. After activation, pre-tensioner seat belts must be replaced. If the pre-tensioner must be replaced, contact an authorized Kia dealer.

### **Seat belt precautions**

#### *Infant or small child*

All 50 states have child restraint laws. You should be aware of the specific requirements in your state. Child and/or infant seats must be properly placed and installed in the rear seat. For more information about the use of these restraints, refer to “Child restraint system” in this section.

**\* NOTICE**

Small children are best protected from injury in an accident when properly restrained in the rear seat by a child restraint system that meets the requirements of the Federal Motor Vehicle Safety Standards. Before buying any child restraint system, make sure that it has a label certifying that it meets Federal Motor Vehicle Safety Standard 213. The restraint must be appropriate for your child's height and weight. Check the label on the child restraint for this information. Refer to "Child restraint system" in this section.

***Larger children***

Children who are too large for child restraint systems should always occupy the rear seat and use the available lap/shoulder belts. The lap portion should be fastened and snugged on the hips and as low as possible. Check if the belt fits periodically. A child's squirming could put the belt out of position. Children are given the most safety in the event of an accident when they are restrained by a proper restraint system in the rear seat. If a larger child (over age 12) must be seated in the front seat, the child should be securely restrained by the available lap/shoulder belt and the seat should be placed in the rearmost position. Children age 12 and under should be restrained securely in the rear seat. NEVER place a child age 12 and under in the front seat. NEVER place a rear facing child seat in the front seat of a vehicle.

If the shoulder belt portion slightly touches the child's neck or face, try placing the child closer to the center of the vehicle. If the shoulder belt still touches their face or neck they need to be returned to a child restraint system.

** WARNING - Small children**

**Do not allow small children to ride in the vehicle without an appropriate child restraint system. If the shoulder belt comes in contact with your child's neck or face your child is too small to ride in the vehicle. In a crash the seat belt will inflict injury to your child's neck, throat and face.**

### ***Restraint of pregnant women***

Pregnant women should wear lap/shoulder belt assemblies whenever possible according to specific recommendations by their doctors. The lap portion of the belt should be worn AS SECURELY AND LOW AS POSSIBLE.

**⚠ WARNING - Pregnant women**

**Pregnant women must never place the lap portion of the seat belt above or on the abdomen where the fetus is located. The force of the seat belt during a collision will crush the fetus.**

### ***Injured person***

A seat belt should be used when an injured person is being transported. When this is necessary, you should consult a physician for recommendations.

### ***One person per belt***

Two people (including children) should never attempt to use a single seat belt. This could increase the severity of injuries in case of an accident.

### ***Do not lie down***

To reduce the chance of injuries in the event of an accident and to achieve maximum effectiveness of the restraint system, all passengers should be sitting up and the front and rear seats should be in an upright position when the vehicle is moving. A seat belt cannot provide proper protection if the person is lying down in the rear seat or if the front and rear seats are in a reclined position.

## Care of seat belts

Seat belt systems should never be disassembled or modified. In addition, care should be taken to assure that seat belts and belt hardware are not damaged by seat hinges, doors or other abuse.

### **WARNING - Pinched seat belt**

- **Make sure that the webbing and/or buckle does not get caught or pinched in the rear seat when returning the rear seatback to its upright position. A caught or pinched webbing/buckle may become damaged and could fail during a collision or sudden stop.**
- **Seatbelts can become hot in a vehicle that has been closed up in sunny weather. They could burn infants and children.**

## *Periodic inspection*

All seat belts should be inspected periodically for wear or damage of any kind. Any damaged parts should be replaced as soon as possible.

## *Keep belts clean and dry*

Seat belts should be kept clean and dry. If belts become dirty, they can be cleaned by using a mild soap solution and warm water. Bleach, dye, strong detergents or abrasives should not be used because they may damage and weaken the fabric.

## *When to replace seat belts*

The entire in-use seat belt assembly or assemblies should be replaced if the vehicle has been involved in an accident. This should be done even if no damage is visible. Additional questions concerning seat belt operation should be directed to an authorized Kia dealer.

## CHILD RESTRAINT SYSTEM

Children riding in the vehicle should sit in the rear seat and must always be properly restrained to minimize the risk of injury in an accident, sudden stop or sudden maneuver. According to accident statistics, children are safer when properly restrained in the rear seats than in the front seat. Larger children not in a child restraint should use one of the seat belts provided.

You should be aware of the specific requirements in your country. Child and/or infant safety seats must be properly placed and installed in the rear seat. You must use a commercially available child restraint system that meets the requirements of the Federal Motor Vehicle Safety Standards (FMVSS).

Child restraint systems are designed to be secured in vehicle seats by the lap belt portion of a lap/shoulder belt, or by a tether anchor and/or LATCH anchors.

Children could be injured or killed in a crash if their restraints are not properly secured. For small children and babies, a child seat or infant seat must be used. Before buying a particular child restraint system, make sure it fits your vehicle seat and seat belts, and fits your child.

Follow all the instructions provided by the manufacturer when installing the child restraint system.

 **WARNING - Restraint location**

**Never install a child or infant seat on the front passenger's seat. A child riding in the front passenger seat can be forcefully struck by an inflating airbag.**

 **WARNING - Hot child restraint**

**A child restraint system can become very hot if it is left in a closed vehicle on a sunny day. Be sure to check the seat cover, buckles and latches before placing a child in the restraint system.**

When the child restraint system is not in use, store it in the luggage area or fasten it with a seat belt so that it will not be thrown forward in case of a sudden stop or an accident.

## Using a child restraint system

Rearward-facing child restraint system

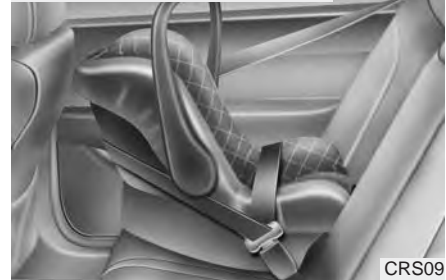

CRS09

Forward-facing child restraint system



OTQ037038

For small children and babies, the use of a child seat or infant seat is required. The child seat or infant seat should be of appropriate size for the child and should be installed in accordance with the manufacturer's instructions.

### **⚠ WARNING - Holding children**

Never hold a child in your arms or lap when riding in a vehicle. The violent forces created during a crash will tear the child from your arms and throw the child against the car's interior. Always use a child restraint system which is appropriate for your child's height and weight.

### **⚠ WARNING - Unattended Children**

Never leave children unattended in a vehicle. The car can heat up very quickly, resulting in injuries to the child in the vehicle.

### **⚠ WARNING - Seat belt use**

Do not use one seat belt for two occupants at the same time. This will eliminate any safety benefit provided by the seat belt to the occupants.

After an accident, have an authorized Kia dealer check the child restraint system, seat belt, tether anchor and lower anchor.



For safety reasons, we recommend that the child restraint system be used in the rear seats.

Never place a rear-facing child restraint in the front passenger seat, because of the danger an inflating passenger-side air bag could impact the rear-facing child restraint and kill the child.

Since all passenger seat belts move freely under normal conditions and only lock under extreme or emergency conditions (emergency lock mode), you must manually change these seat belts to the auto lock mode to secure a child restraint.

If the seat belt does not operate as described in this section, have the system checked immediately by your authorized Kia dealer.

### **⚠ WARNING - Child seat installation**

- **Always follow the instructions provided by the child restraint system manufacturer. Child restraint system manufacturers know their products best.**
- **Failure to observe this manual's instructions regarding child restraint system and the instructions provided with the child restraint system could result in the improper installation of the child restraint system which may reduce the protection to your child in a crash or a sudden stop.**

### **\* NOTICE**

**If the vehicle headrest prevents proper installation of a child seat (as described in the child seat system manual), the headrest of the respective seating position shall be readjusted or entirely removed.**

### ***Placing a passenger seat belt into the auto lock mode***

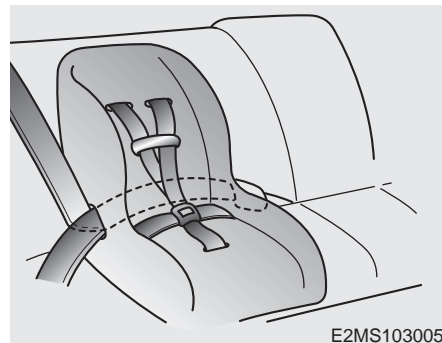

The auto lock mode will help prevent the normal movement of the child in the vehicle from causing the seat belt to loosen and compromise the child restraint system. To secure a child restraint system, use the following procedure.

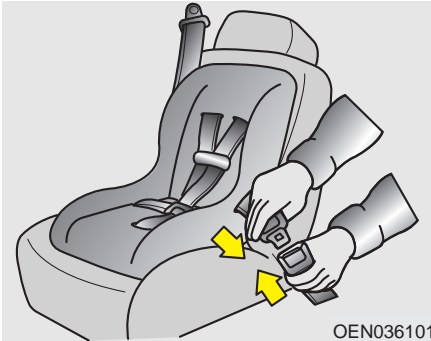

If the vehicle headrest prevents proper installation of a child seat (as described in the child seat system manual), the headrest of the respective seating position shall be readjusted or entirely removed.

To install a child restraint system on the outboard or center rear seats, do the following:

1. Place the child restraint system in the seat and route the lap/shoulder belt around or through the restraint, following the restraint manufacturer's instructions. Be sure the seat belt webbing is not twisted.
2. Fasten the lap/shoulder belt latch into the buckle. Listen for the distinct "click" sound.

*Position the release button so that it is easy to access in case of an emergency.*

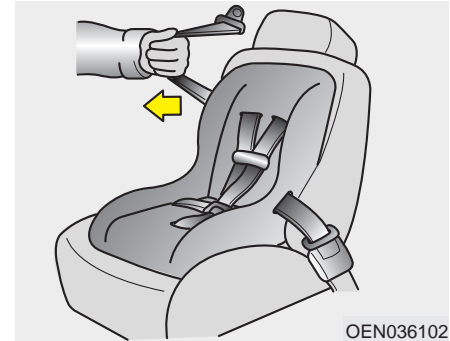

3. Pull the shoulder portion of the seat belt all the way out. When the shoulder portion of the seat belt is fully extended, it will shift the retractor to the "Auto Lock" (child restraint) mode.



4. Slowly allow the shoulder portion of the seat belt to retract and listen for an audible “clicking” or “ratcheting” sound. This indicates that the retractor is in the “Auto Lock” mode. If no distinct sound is heard, repeat steps 3 and 4.

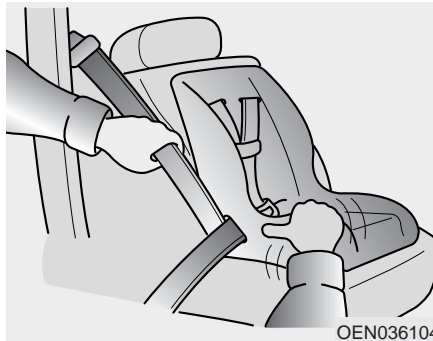

5. Remove as much slack from the belt as possible by pushing down on the child restraint system while feeding the shoulder belt back into the retractor.
6. Push and pull on the child restraint system to confirm that the seat belt is holding it firmly in place. If it is not, release the seat belt and repeat steps 2 through 6.
7. Double check that the retractor is in the “Auto Lock” mode by attempting to pull more of the seat belt out of the retractor. If you cannot, the retractor is in the “Auto Lock” mode.

The lap/shoulder belt automatically returns to the “emergency lock mode” whenever the belt is allowed to retract fully. Therefore, the preceding seven steps must be followed each time a child restraint is installed.

To remove the child restraint, press the release button on the buckle and then pull the lap/shoulder belt out of the restraint and allow the seat belt to retract fully.

**⚠ WARNING - Auto lock mode**

**Set the retractor to Automatic Lock mode when installing any child restraint system. If the retractor is not in the Automatic Locking mode, the child restraint can move when your vehicle turns or stops suddenly.**

**When the seat belt is allowed to retract to its fully stowed position, the retractor will automatically switch from the “Auto Lock” mode to the emergency lock mode for normal adult usage.**

**Securing a child restraint seat with tether anchor system**

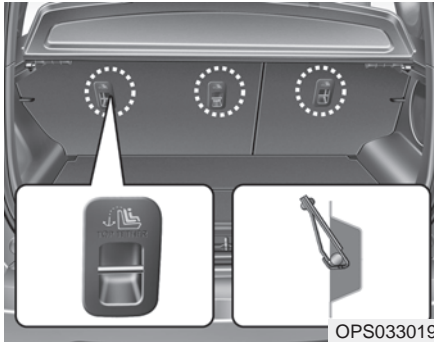

Child restraint hook holders are located on the back of the rear seatbacks.



This symbol indicates the position of the tether anchor.

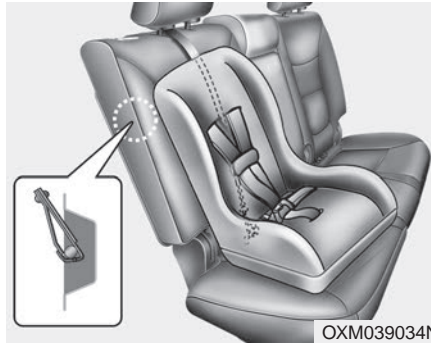

1. Route the child restraint seat strap over the seatback.

For vehicles with adjustable headrests, route the tether strap under the headrest and between the headrest posts, otherwise route the tether strap over the top of the seatback. In case of interference between the child restraint seat and the headrest remove the particular head restraint for better fitment of the child restraint seat.

2. Connect the tether strap hook to the appropriate child restraint hook holder and tighten to secure the child restraint seat.

**⚠ WARNING - Tether strap**  
 Never mount more than one child restraint to a single tether or to a single lower anchorage point. The increased load caused by multiple seats may cause the tethers or anchorage points to break.

Check that the child restraint system is secure by pushing and pulling it in different directions. Incorrectly fitted child restraints may swing, twist, tip or separate causing death or serious injury.

### **Securing a child restraint seat with child seat lower anchor system**

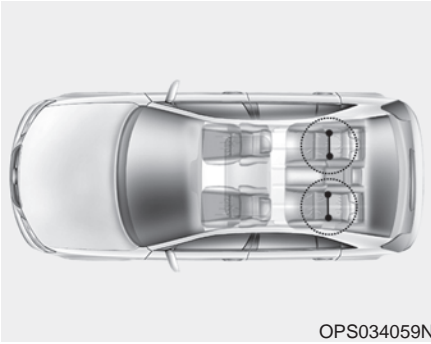

Some child seat manufacturers make child restraint seats that are labeled as LATCH or LATCH-compatible child restraint seats. LATCH stands for "Lower Anchors and Tethers for Children". These seats include two rigid or webbing mounted attachments that connect to two LATCH anchors at specific seating positions in your vehicle. This type of child restraint seat eliminates the need to use seat belts to attach the child seat in the rear seats.

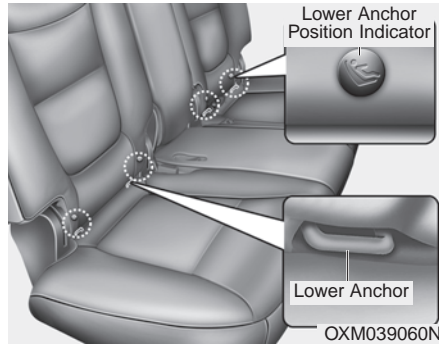

Child restraint symbols are located on the left and right 2nd row seat backs to indicate the position of the lower anchors for child restraints.

### **⚠ WARNING - Unused rear seatbelts**

**Always fasten the seatbelts behind the child restraint seat when they are not used to secure the child seat. Failure to do so may result in child strangulation.**

Install the child restraint seat fully rearward against the seatback with the seatback reclined two positions from the most upright latched position.

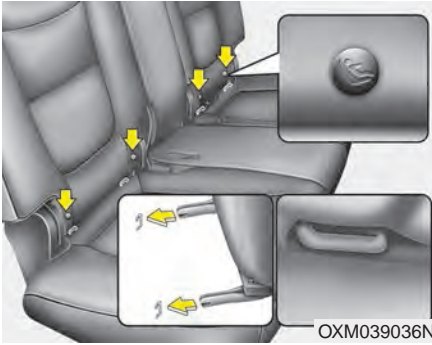

LATCH anchors have been provided in your vehicle. The LATCH anchors are located in the left and right outboard rear seating positions. Their locations are shown in the illustration. There is no LATCH anchor provided for the center rear seating position.

The LATCH anchors are located between the seatback and the seat cushion of the 2nd row seat left and right outboard seating positions.

Follow the child seat manufacturer's instructions to properly install child restraint seats with LATCH or LATCH-compatible attachments.

Once you have installed the LATCH child restraint, assure that the seat is properly attached to the LATCH and tether anchors.

Also, test the child restraint seat before you place the child in it. Tilt the seat from side to side. Also try to tug the seat forward. Check to see if the anchors hold the seat in place.

**⚠ WARNING - LATCH lower anchors**

**Never attempt to attach a LATCH equipped seat in the center seating position. LATCH lower anchors are only to be used with the left and right rear outboard seating positions. You may damage the anchors or the anchors may fail and break in a collision.**

**\* NOTICE**

The recommended weight for the LATCH system is under 65 lb (30 kg).

How to calculate the child restraint weight :

$$\text{Child restraint weight} = 65 \text{ lb (30 kg)} - \text{Child weight}$$

## AIR BAG - ADVANCED SUPPLEMENTAL RESTRAINT SYSTEM

- (1) Driver's front air bag
- (2) Passenger's front air bag
- (3) Side air bag
- (4) Curtain air bag

Even in vehicles with air bags, you and your passengers must always wear the safety belts provided in order to minimize the risk and severity of injury in the event of a collision or rollover.

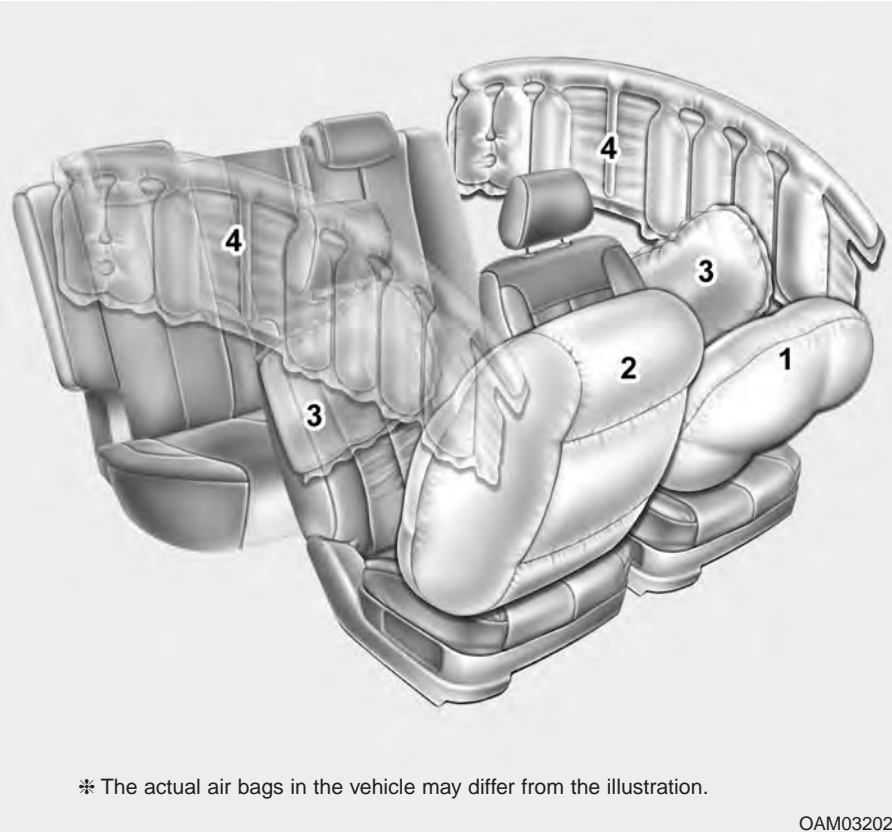

\* The actual air bags in the vehicle may differ from the illustration.

OAM032026

## How does the air bag system operate

- Air bags are activated (able to inflate if necessary) only when the POWER button is turned to the ON or the vehicle is in the ready (🔄) mode.
- The appropriate air bags inflate instantly in the event of a serious frontal collision or side collision in order to help protect the occupants from serious physical injury.
- There is no single speed at which the air bags will inflate.

Generally, air bags are designed to inflate based upon the severity of a collision and its direction. These two factors determine whether the sensors produce an electronic deployment/ inflation signal.

- Air bag deployment depends on a number of factors including vehicle speed, angles of impact and the density and stiffness of the vehicles or objects which your vehicle hits in the collision. The determining factors are not limited to those mentioned above.

- The front air bags will completely inflate and deflate in an instant.

It is virtually impossible for you to see the air bags inflate during an accident.

It is much more likely that you will simply see the deflated air bags hanging out of their storage compartments after the collision.

- In addition to inflating in serious side collisions, side and/or curtain air bags will inflate if the sensing system detects a rollover.
- When a rollover is detected, curtain air bags will remain inflated longer to help provide protection from ejection, especially when used in conjunction with the seat belts.

- In order to help provide protection, the air bags must inflate rapidly. The speed of the air bag inflation is a consequence of extremely short time in which to inflate the air bag between the occupant and the vehicle structures before the occupant impacts those structures. This speed of inflation reduces the risk of serious or life-threatening injuries and is thus a necessary part of the air bag design.

However, air bag inflation can also cause injuries which can include facial abrasions, bruises and broken bones because the inflation speed also causes the air bags to expand with a great deal of force.

- **There are even circumstances under which contact with the steering wheel or passenger air bag can cause fatal injuries, especially if the occupant is positioned excessively close to the steering wheel or passenger air bag.**



**⚠ WARNING - Airbag inflation**

**Sit as far back as possible from the steering wheel while still maintaining comfortable control of your vehicle. A distance of at least 10" from your chest to the steering wheel is recommended. Failure to do so can result in airbag inflation injuries to the driver.**

***Noise and smoke***

When inflated, the air bags make a loud noise and leave smoke and powder in the air inside the vehicle. This is normal and is a result of the ignition of the air bag inflator. After the air bag inflates, you may feel substantial discomfort in breathing due to the contact of your chest with both the seat belt and the air bag, as well as from breathing the smoke and powder. **Open your doors and/or windows as soon as possible after impact in order to reduce discomfort and prevent prolonged exposure to the smoke and powder.**

Though smoke and powder are non-toxic, it may cause irritation to the skin (eyes, nose and throat, etc). If this is the case, wash and rinse with cold water immediately and consult a doctor if the symptom persists.

**⚠ WARNING - Hot components**

**Do not touch the air bag storage area's internal components immediately after airbag inflation. The air bag related parts in the steering wheel, instrument panel and the roof rails above the front and rear doors are very hot. Hot components can result in burn injuries.**

**Do not install or place any accessories near air bag deployment areas, such as the instrument panel, windows, pillars, and roof rails.**

**Do not install a child restraint on the front passenger's seat.**



Never place a rear-facing child restraint in the front passenger's seat. If the air bag deploys, it would impact the rear-facing child restraint, causing serious or fatal injury.

In addition, do not place front-facing child restraints in the front passenger's seat either. If the front passenger air bag inflates, it could cause serious or fatal injuries to the child.

**⚠ WARNING - Air bag deployment**

When children are seated in the rear outboard seats of a vehicle equipped with side and/or curtain air bags, install the child restraint system as far away from the door side as possible. Inflation of the side and/or curtain air bags could impact the child.

**Air bag warning light**



The purpose of air bag warning light in your instrument panel is to alert you of a potential problem with your air bag system, which could include your side and/or curtain air bags used for rollover protection.

When the POWER button is turned ON, the warning light should illuminate for approximately 6 seconds, then go off. Have the system checked by an authorized Kia dealership if:

- The light does not turn on briefly when you turn the POWER button ON.
- The light stays on after illuminating for approximately 6 seconds.
- The light comes on while the vehicle is in motion.
- The light blinks when the POWER button is in ON position.

### SRS components and functions

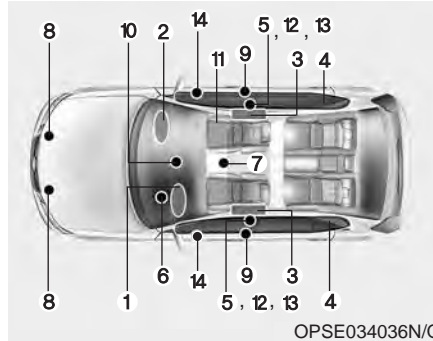

The SRS consists of the following components:

1. Driver's front air bag module
2. Passenger's front air bag module
3. Side air bag modules
4. Curtain air bag modules
5. Retractor pre-tensioner assemblies
6. Air bag warning light
7. SRS control module (SRSCM)/ Rollover sensor
8. Front impact sensors
9. Side impact sensors

10. PASSENGER "AIR BAG OFF" indicator (Front passenger's seat only)
11. Occupant detection system (Front passenger's seat only)
12. Driver's and front passenger's seat belt buckle sensors
13. Emergency fastening device (EFD)
14. Side pressure impact sensor

The SRSCM continually monitors all SRS components while the POWER button is ON to determine if a crash impact is severe enough to require air bag deployment or pre-tensioner seat belt deployment.



W7-147

If the air bag warning light illuminated for more than, 6 seconds after the POWER button is turned on, or of it illuminates during vehicle operation, an SRS component may not be functioning properly and you should have your vehicle checked by an authorized Kia dealer.

If any of the following conditions occurs, this indicates a malfunction in the air bag system. Have an authorized Kia dealer inspect the air bag system as soon as possible.

- The light does not turn on briefly when you turn the POWER button ON.
- The light stays on after illuminating for approximately 6 seconds.
- The light comes on while the vehicle is in motion.
- The light blinks when the POWER button is in ON position.

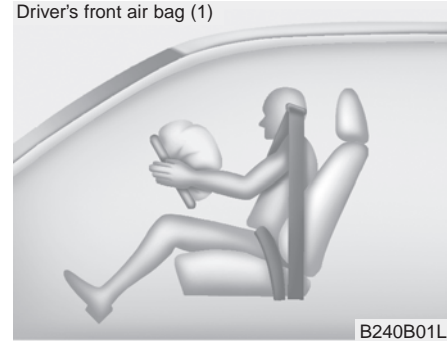

Driver's front air bag (1)

B240B01L

The front air bag modules are located both in the center of the steering wheel and in the front passenger's panel above the glove box. When the SRSCM detects a sufficiently severe impact to the front of the vehicle, it will automatically deploy the front air bags.

Driver's front air bag (2)

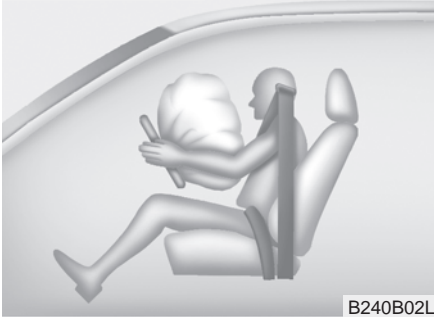

Upon deployment, tear seams molded directly into the pad covers will separate under pressure from the expansion of the air bags. Further opening of the covers then allows full inflation of the air bags.

Driver's front air bag (3)



A fully inflated air bag, in combination with a properly worn seat belt, slows the driver's or the passenger's forward motion, reducing the risk of head and chest injury.

After complete inflation, the air bag immediately starts deflating, enabling the driver to maintain forward visibility and the ability to steer or operate other controls.

Passenger's front air bag



**⚠ WARNING - Air bag obstructions**

**Do not install or place any accessories on the steering wheel, instrument panel, or on the front passenger's panel above the glove box in a vehicle. Such objects may become dangerous projectiles if the air bag deploys.**

**⚠ WARNING - Flying objects**  
Do not place any objects (an umbrella, bag, etc.) between the front door and the front seat. Such objects may become dangerous projectiles if the side airbag inflates.

- If an air bag deploys, there may be a loud noise followed by a fine dust released in the vehicle. These conditions are normal and are not hazardous - the air bags are packed in this fine powder. The dust generated during air bag deployment may cause skin or eye irritation as well as aggravate asthma for some persons. Always wash all exposed skin areas thoroughly with cold water and a mild soap after an accident in which the air bags were deployed.

- The SRS can function only when the POWER button is in the ON position. If the SRS air bag warning light does not illuminate, or continuously remains on after illuminating for about 6 seconds when the POWER button is turned to the ON position, or after the vehicle is in the ready (🚗) mode, comes on while driving, the SRS is not working properly. If this occurs, have your vehicle immediately inspected by an authorized Kia dealer.

### \* NOTICE

**Before you replace a fuse or disconnect a battery terminal, turn the vehicle off. Never remove or replace the air bag related fuse(s) when the POWER button is in the ON position. Failure to heed this warning will cause the SRS air bag warning light to illuminate.**

## Occupant Detection System (ODS)



Your vehicle is equipped with an occupant detection system in the front passenger's seat.

The occupant detection system is designed to detect the presence of a properly-seated front passenger and determine if the passenger's front air bag should be enabled (may inflate) or not. Only the front passenger front air bag is controlled by the Occupant Detection System.

Do not put anything in front of the passenger air bag **OFF** indicator.

### ***Main components of the occupant detection system***

- A detection device located within the front passenger seat cushion.
- An electronic system which determines whether the passenger air bag systems should be activated or deactivated.
- A indicator light located on the instrument panel which illuminates the words PASSENGER AIR BAG “OFF” indicating the front passenger air bag system is deactivated.
- The instrument panel air bag warning light is interconnected with the occupant detection system.

If the front passenger seat is occupied by a person that the system determines to be of appropriate size, and he/she sits properly (sitting upright with the seatback in an upright position, centered on the seat cushion with their seat belt on, legs comfortably extended and their feet on the floor), the PASSENGER AIR BAG “OFF” indicator will turn off and the front passenger's air bag will be able to inflate, if necessary, in frontal crashes.

You will find the PASSENGER AIR BAG “OFF” indicator on the center facia panel. This system detects the conditions 1~4 in the following table and activates or deactivates the front passenger air bag based on these conditions.

Always be sure that you and all vehicle occupants are seated and restrained properly (sitting upright with the seat in an upright position, centered on the seat cushion, with the person's legs comfortably extended, feet on the floor, and wearing the safety belt properly) for the most effective protection by the air bag and the safety belt.

- The ODS (Occupant Detection System) may not function properly if the passenger takes actions which can defeat the detection system. These include:
  - (1) Failing to sit in an upright position.
  - (2) Leaning against the door or center console.
  - (3) Sitting towards the sides or the front of the seat.
  - (4) Putting legs on the dashboard or resting them on other locations which reduce the passenger weight on the front seat.
  - (5) Improperly wearing the safety belt.
  - (6) Reclining the seat back.
  - (7) Wearing a thick cloth like ski wear or hip protection wear.
  - (8) Put on the seat an additional thick cushion.

**Condition and operation in the front passenger occupant detection system**

Condition detected by the occupant detection system	Indicator/Warning light		Devices
	"PASSENGER AIR BAG OFF" indicator light	SRS warning light	Front passenger air bag
1. Adult or child*1	Off	Off	Activated
2. Child restraint system*2	On	Off	Deactivated
3. Unoccupied	On	Off	Deactivated
4. There is a malfunction in the system	Off	On	Activated

\*1 : The ODS system uses a field to evaluate a person's size to determine whether the air bag should deploy. It is possible for a child to be detected and activate the ODS, thus allowing the air bag to deploy. To maximize safety, do not allow children to ride in the front passenger seat.

\*2 : Never install a child restraint system on the front passenger seat.

**\* NOTICE**

Do not modify or replace the front passenger seat. Don't place anything on or attach anything such as a blanket, front seat cover or after market seat heater to the front passenger seat. This can adversely affect the occupant detection system.

**⚠ WARNING - ODS System**  
 Riding in an improper position adversely affects the Occupant Detection System and may result in the deactivation of the front passenger airbag. It is important for the driver to instruct the passenger as to the proper seating instructions as contained in this manual.

(Continued)



(Continued)



- Never put a heavy load or an active electronic device on the front passenger seat or seatback pocket.



- Never sit with hips shifted towards the front of the seat.



- Never place feet on the dashboard.



- Never place feet on the front passenger seatback.



- Never excessively recline the front passenger seatback.



- Never lean on the door or center console.
- Never sit on one side of the front passenger seat.

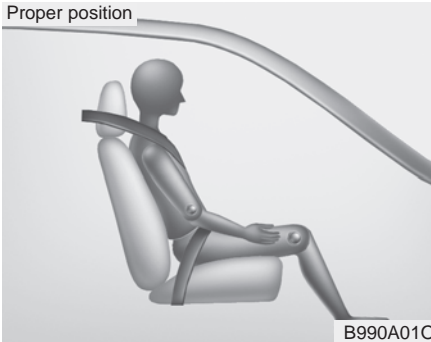

When an adult is seated in the front passenger seat, if the PASSENGER AIR BAG “OFF” indicator is on, turn the vehicle off and ask the passenger to sit properly (sitting upright with the seat back in an upright position, centered on the seat cushion with their seat belt on, legs comfortably extended and their feet on the floor). Restart the vehicle and have the person remain in that position. This will allow the system to detect the person and to enable the passenger air bag.

If the PASSENGER AIR BAG “OFF” indicator is still on, ask the passenger to move to the rear seat.

**⚠ WARNING - “AIR BAG OFF” light**

**Do not allow an adult passenger to ride in the front seat when the PASSENGER AIR BAG “OFF” indicator is illuminated, because the air bag will not deploy in the event of a crash. The driver must instruct the passenger to reposition himself in the seat. Failure to properly position yourself may lead to air bag deactivation resulting in air bag non-deployment in a collision. If the PASSENGER AIR BAG “OFF” indicator remains illuminated after the passenger repositions themselves properly and the car is restarted, it is recommended that passenger move to the rear seat because the passenger’s front air bag will not deploy.**

**\* NOTICE**

The PASSENGER AIR BAG “OFF” indicator illuminates for about 4 seconds after the POWER button is turned to the ON position or after the vehicle is in the ready (🔄) mode. If the front passenger seat is occupied, the occupant detection sensor will then classify the front passenger after several more seconds.

Any child age 12 and under should ride in the rear seat. Children too large for child restraints should use the available lap/shoulder belts. No matter what type of crash, children of all ages are safer when restrained in the rear seat.

If the occupant detection system is not working properly, the SRS air bag warning light on the instrument panel will illuminate because the passenger's front air bag is connected with the occupant detection system. If there is a malfunction of the occupant detection system, the PASSENGER AIR BAG "OFF" indicator will not illuminate and the passenger's front air bag will inflate in frontal impact crashes even if there is no occupant in the front passenger's seat

### Driver's and passenger's front air bag

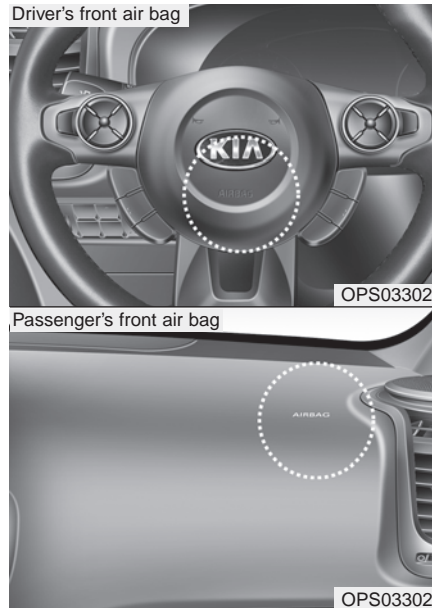

Your vehicle is equipped with an Advanced Supplemental Restraint (Air Bag) System and lap/shoulder belts at both the driver and passenger seating position.

The indication of the system's presence are the letters "AIR BAG" embossed on the air bag pad cover on the steering wheel and the passenger's side front panel pad above the glove box.

The SRS consists of air bags installed under the pad covers in the center of the steering wheel and the passenger's side front panel above the glove box.

The purpose of the SRS is to provide the vehicle's driver and/or the front passenger with additional protection than that offered by the seat belt system alone in case of a frontal impact of sufficient severity. The SRS uses sensors to gather information about the driver's and front passenger's seat belt usage and impact severity.

The seat belt buckle sensors determine if the driver and front passenger's seat belts are fastened.

**⚠ WARNING - Replacement/ modifications**

The front passenger seat, dashboard or door should not be replaced except by an authorized Kia dealer using original Kia parts designed for this vehicle and model. Any other such replacement or modification could adversely affect the operation of the occupant detection system and your advanced air bags.

**⚠ CAUTION - Seat Track Sensor**

*Do not place any objects underneath the front seats as they could damage the seat track position sensor or interfere with the occupant detection system.*

These sensors provide the ability to control the SRS deployment based on whether or not the seat belts are fastened, and how severe the impact is.

The advanced SRS offers the ability to control the air bag inflation with two levels. A first stage level is provided for moderate-severity impacts. A second stage level is provided for more severe impacts.

The passenger's front air bag is designed to help reduce the injury of children sitting close to the instrument panel in low speed collisions. However, children are safer if they are restrained in the rear seat.

According to the impact severity and seat belt usage, the SRSCM (SRS Control Module) controls the air bag inflation. Failure to properly wear seat belts can increase the risk or severity of injury in an accident.

Additionally, your vehicle is equipped with an occupant detection system in the front passenger's seat. The occupant detection system detects the presence of a passenger in the front passenger's seat and will turn off the front passenger's air bag under certain conditions. For more detail, see "Occupant detection system" in this section.

**⚠ WARNING - Modification**

**Modification to the seat structure can cause the air bag to deploy at a different level than should be provided.**

Manufacturers are required by government regulations to provide a contact point concerning modifications to the vehicle for persons with disabilities, which modifications may affect the vehicle's advanced air bag system. That contact is Kia's toll-free Customer Assistance center at 1-800-333-4Kia. However, Kia does not endorse nor will it support any changes to any part or structure of the vehicle that could affect the advanced air bag system, including the occupant detection system.

### **⚠ WARNING - Replacement /Modifications**

**The front passenger seat, dashboard or door should not be replaced except by an authorized Kia dealer using original Kia parts designed for this vehicle and model. Any other such replacement or modification could adversely affect the operation of the occupant detection system and your advanced air bags.**

Advanced air bags are combined with pre-tensioner seat belts to help provide enhanced occupant protection in frontal crashes. Front air bags are not intended to deploy in collisions in which sufficient protection can be provided by the pre-tensioner seat belt.

**⚠ WARNING - SRS Wiring**  
**Do not tamper with or disconnect SRS wiring or other components of the SRS system. Doing so could result in injury, due to accidental deployment of the air bags or by rendering the SRS inoperative.**

Front air bags are not intended to deploy in side-impact, rear-impact or rollover crashes. However, when frontal deployment threshold is satisfied at side-impact, front air bags may deploy. In addition, front air bags will not deploy in frontal crashes below the deployment threshold.



OEP036096N



OVQ036018N



1VQA2091

**⚠ WARNING - No attaching objects**

No objects (such as crash pad cover, cellular phone holder, cup holder, perfume or stickers) should be placed over or near the air bag modules on the steering wheel, instrument panel, windshield glass, and the front passenger's panel above the glove box. Such objects could cause harm if the vehicle is in a crash severe enough to cause the air bags to deploy. Do not place any objects over the air bag or between the air bag and yourself.

**Side air bag**

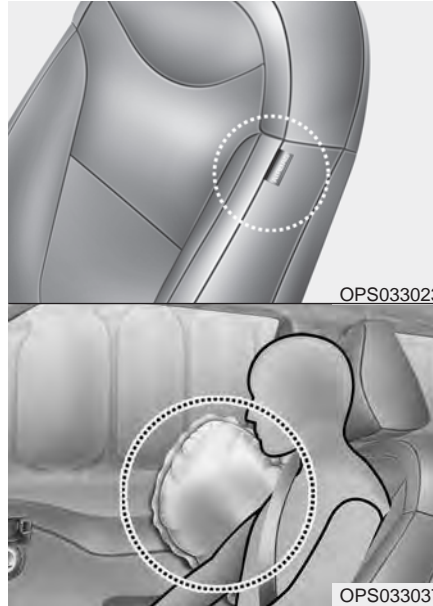

\* The actual air bags in the vehicle may differ from the illustration.

Your vehicle is equipped with a side air bag in each front seat. The purpose of the air bag is to provide the vehicle's driver and/or the front passenger with additional protection than that offered by the seat belt alone.

- The side air bags are designed to deploy during certain side-impact collisions, depending on the crash severity, angle, speed and point of impact.
- The side and/or curtain air bags do not only deploy on the side of the impact but also on the opposite side.
- The side and/or curtain air bags on both sides of the vehicle will deploy if a rollover or possible rollover is detected.
- The side air bags are not designed to deploy in all side impact or rollover situations.

**⚠ WARNING - Unexpected deployment**

**Avoid impact to the side impact airbag sensor when the POWER button is ON to prevent unexpected deployment of the side impact air bag.**

- The side air bag is supplemental to the driver's and the passenger's seat belt systems and is not a substitute for them. Therefore your seat belts must be worn at all times while the vehicle is in operation.
- For best protection from the side air bag system and to avoid being injured by the deploying side air bag, both front seat occupants should sit in an upright position with the seat belt properly fastened. The driver's hands should be placed on the steering wheel at the 9:00 and 3:00 positions. The passenger's arms and hands should be placed on their laps.

**⚠ WARNING - Deployment**

**Do not install any accessories including seat covers, on the side or near the side impact air bag as this may affect the deployment of the side air bags.**

- If seat or seat cover is damaged, have the vehicle checked and repaired by an authorized Kia dealer. Inform the dealer that your vehicle is equipped with side air bags and an occupant detection system.

**⚠ WARNING - Flying objects**

**Do not place any objects (an umbrella, bag, etc.) between the front door and the front seat. Such objects may become dangerous projectiles if the side airbag inflates.**

**⚠ WARNING - No attaching objects**

- **Do not place any objects over the air bag or between the air bag and yourself. Also, do not attach any objects around the area the air bag inflates such as the door, side door glass, front and rear pillar.**
- **Do not place any objects between the door and the seat. They may become dangerous projectiles if the side air bag inflates.**
- **Do not install any accessories on the side or near the side air bags.**



## Curtain air bag

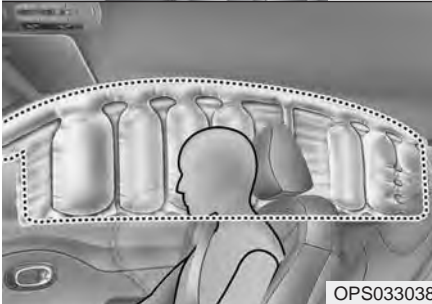
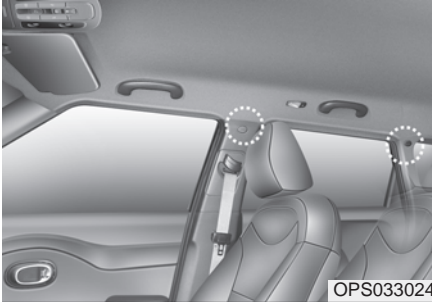

\* The actual air bags in the vehicle may differ from the illustration.

Curtain air bags are located along both sides of the roof rails above the front and rear doors.

They are designed to help protect occupants in certain side impacts and to help prevent them from ejecting out of the vehicle as a result of a rollover, especially when the seatbelts are also in use. The curtain air bags are designed to deploy during certain side impact collisions, depending on the crash severity, angle, speed and point of impact. The side and/or curtain air bags do not only deploy on the side of the impact but also on the opposite side. Also, the curtain air bags on both sides of the vehicle will deploy in certain rollover situations. The curtain air bags are not designed to deploy in all side impact or rollover situations. Do not allow the passengers to lean their heads or bodies against the doors, put their arms on the doors, stretch their arms out of the window or place objects between the doors and passengers when they are seated on seats equipped with side impact and/or curtain air bags.

### \* NOTICE

Never try to open or repair any components of the side and curtain air bag system. This should only be done by an authorized Kia dealer.

### **⚠ WARNING - No attaching objects**

- Do not place any objects over the air bag. Also, do not attach any objects around the area the air bag inflates such as the door, side door glass, front and rear pillar, roof side rail.
- Do not hang hard or breakable objects on the clothes hanger.



**Why didn't my air bag go off in a collision? (Inflation and non-inflation conditions of the air bag)**

There are many types of accidents in which the air bag would not be expected to provide additional protection.

These include rear impacts, second or third collisions in multiple impact accidents, as well as low speed impacts.

*Air bag collision sensors*

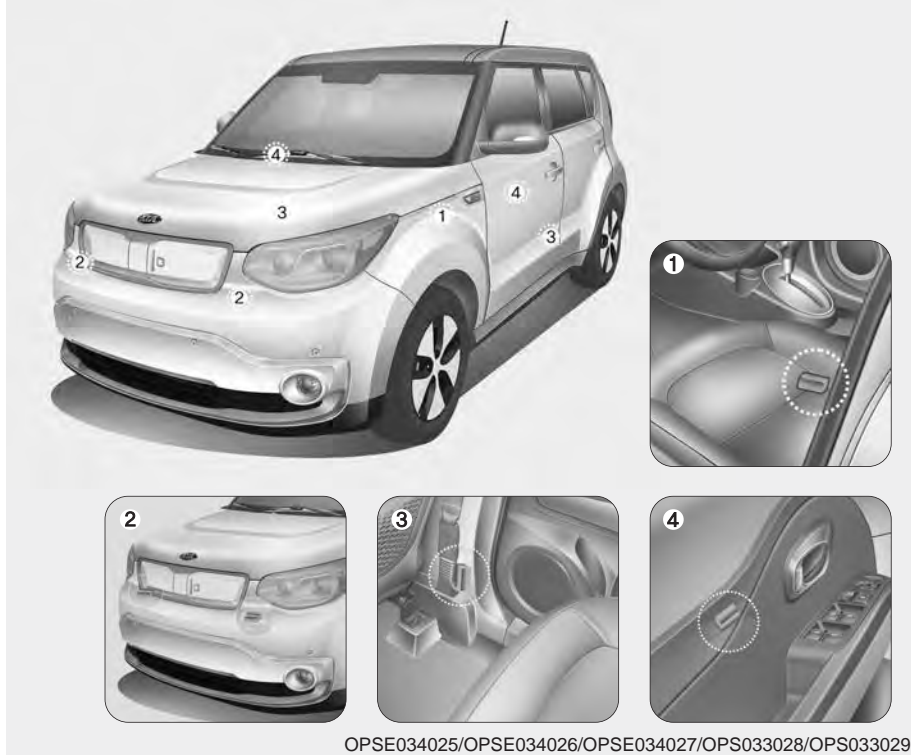

- (1) SRS control module/Rollover sensor
- (2) Front impact sensor

- (3) Side impact sensor
- (4) Side pressure sensor

**⚠ WARNING - Air bag sensors**

- Do not hit or allow any objects to impact the locations where air bags or sensors are installed.

This may cause unexpected air bag deployment, which could result in serious personal injury or death.

- If the installation location or angle of the sensors is altered in any way, the air bags may deploy when they should not or they may not deploy when they should.

Therefore, do not try to perform maintenance on or around the air bag sensors. Have the vehicle checked and repaired by an authorized Kia dealer.

- Problems may arise if the sensor installation angles are changed due to the deformation of the front bumper, front end module, body or front doors and/or B pillar where side collision sensors are installed. Have the vehicle checked and repaired by an authorized Kia dealer.
- Installing bumper guards (or side step or running board) or replacing a bumper (or front door module) with non-genuine parts may adversely affect your vehicle's collision and air bag deployment performance.

**Air bag inflation conditions**



**Front air bags**

Front air bags are designed to inflate in a frontal collision depending on the intensity, speed or angles of impact of the front collision.

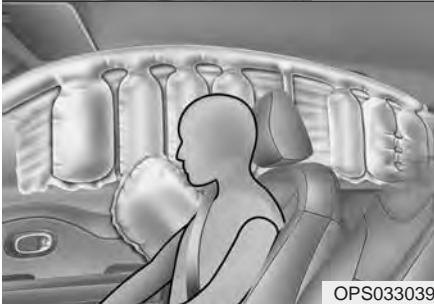

※ The actual air bags in the vehicle may differ from the illustration.

### Side and/or curtain air bags

Side air bags (side and/or curtain air bags) are designed to inflate when an impact is detected by side collision sensors depending on the strength, speed or angles of impact resulting from a side impact collision.

Also, the side and curtain air bags are designed to inflate when a rollover is detected by a rollover sensor.

Although the front air bags (driver's and front passenger's air bags) are designed to inflate in frontal collisions, they also may inflate in other types of collisions if the front impact sensors detect a sufficient frontal force in another type of impact. Side and curtain air bags are designed to inflate in certain side impact collisions. They may inflate in other type of collisions where a side force is detected by the sensors. Side air bag and/or curtain air bags may also inflate where rollover sensors indicate the possibility of a rollover occurring (even if none actually occurs) or in other situations, including when the vehicle is tilted while being towed. Even where side and/or curtain air bags would not provide impact protection in a rollover, however, they will deploy to prevent ejection of occupants, especially those who are restrained with seat belts.

If the vehicle chassis is impacted by bumps or objects on unimproved roads, the air bags may deploy. Drive carefully on unimproved roads or on surfaces not designed for vehicle traffic to prevent unintended air bag deployment.

**Air bag non-inflation conditions**



- In certain low-speed collisions the air bags may not deploy. The air bags are designed not to deploy in such cases because they may not provide benefits beyond the protection of the seat belts in such collisions.



- Air bags are not designed to inflate in rear collisions, because occupants are moved backward by the force of the impact. In this case, inflated air bags would not be able to provide any additional benefit.



- Front air bags may not inflate in side impact collisions, because occupants move to the direction of the collision, and thus in side impacts, frontal air bag deployment would not provide additional occupant protection.

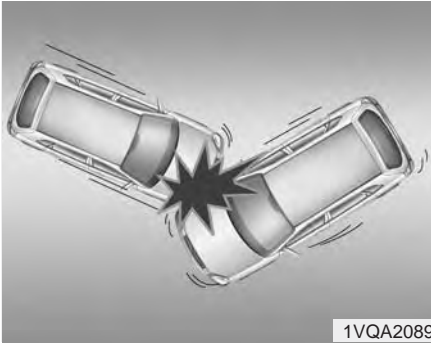

- In an angled collision, the force of impact may direct the occupants in a direction where the air bags would not be able to provide any additional benefit, and thus the sensors may not deploy any air bags.

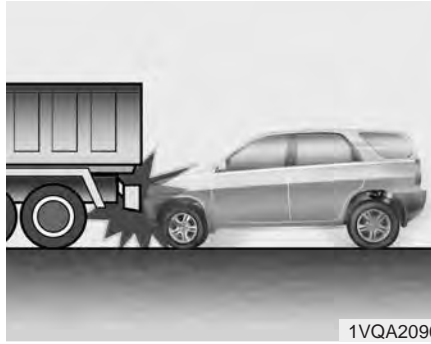

- Just before impact, drivers often brake heavily. Such heavy braking lowers the front portion of the vehicle causing it to “ride” under a vehicle with a higher ground clearance. Air bags may not inflate in this “under-ride” situation because deceleration forces that are detected by sensors may be significantly reduced by such “under-ride” collisions.

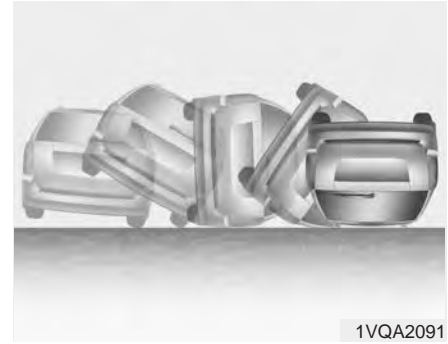

- Front air bags may not inflate in rollover accidents because front airbag deployment would not provide additional occupant protection.

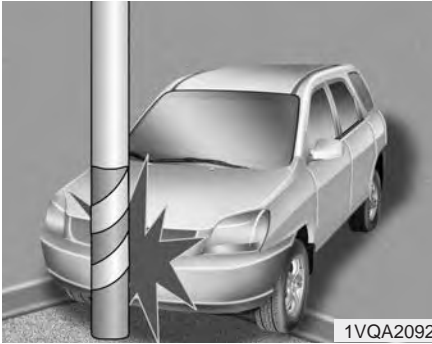

1VQA2092

- Air bags may not inflate if the vehicle collides with objects such as utility poles or trees, where the point of impact is concentrated to one area and the full force of the impact is not delivered to the sensors.

### SRS Care

The SRS is virtually maintenance-free and so there are no parts you can safely service by yourself. If the SRS air bag warning light does not illuminate, or continuously remains on, have your vehicle immediately inspected by an authorized Kia dealer.

Any work on the SRS system, such as removing, installing, repairing, or any work on the steering wheel, the front passenger's panel, front seats and roof rails must be performed by an authorized Kia dealer. Improper handling of the SRS system may result in serious personal injury.

- For cleaning the air bag pad covers, use only a soft, dry cloth or one which has been moistened with plain water. Solvents or cleaners could adversely affect the air bag covers and proper deployment of the system.
- If components of the air bag system must be discarded, or if the vehicle must be scrapped, certain safety precautions must be observed. An authorized Kia dealer knows these precautions and can give you the necessary information. Failure to follow these precautions and procedures could increase the risk of personal injury.

**⚠ WARNING - Tampering with SRS**

Do not tamper with or disconnect SRS wiring, or other components of the SRS system. Doing so could result in the accidental inflation of the air bags or by rendering the SRS inoperative.

**⚠ WARNING - Towing Vehicle**

Always have the ignition off when your vehicle is being towed. The side air bags may inflate if the vehicle is tilted such as when being towed because of the rollover sensors in the vehicle.

**Adding equipment to or modifying your air bag-equipped vehicle**

If you modify your vehicle by changing your vehicle's frame, bumper system, front end or side sheet metal or ride height, this may affect the operation of your vehicle's air bag system.

**Air bag warning label**



OAM039041



OPS033030

Air bag warning labels, some required by the U.S. National Highway Traffic Safety Administration (NHTSA), are attached to the sunvisor to alert the driver and passengers of potential risks of the air bag system.

# Features of your vehicle

<b>Smart key</b> .....	4-4	<b>Panoramic sunroof</b> .....	4-24
• Record your key number .....	4-4	• Sunroof open warning.....	4-25
• Smart key function .....	4-4	• Sliding the sunroof .....	4-25
• Loss of the smart key .....	4-7	• Tilting the sunroof.....	4-26
• Smart key precautions .....	4-7	• Sunshade .....	4-27
• Smart key immobilizer system.....	4-8	• Closing the sunroof .....	4-28
• Battery replacement .....	4-9	• Resetting the sunroof .....	4-29
<b>Door locks</b> .....	4-10	<b>Steering wheel</b> .....	4-30
• Operating door locks from outside the vehicle ....	4-10	• Electric power steering (EPS) .....	4-30
• Operating door locks from inside the vehicle.....	4-11	• Tilt and telescopic steering .....	4-31
• Impact sensing door unlock system.....	4-13	• Heated steering wheel.....	4-32
• Auto door lock/unlock feature .....	4-13	• Horn .....	4-32
• Speed sensing door lock system.....	4-13	• FLEX STEER .....	4-33
• Child-protector rear door lock .....	4-13	<b>Mirrors</b> .....	4-35
<b>Tailgate</b> .....	4-14	• Inside rearview mirror .....	4-35
• Opening the tailgate .....	4-14	• Outside rearview mirror.....	4-37
• Closing the tailgate .....	4-15	<b>Instrument cluster</b> .....	4-40
• Emergency tailgate safety release .....	4-15	• Instrument Cluster Control .....	4-41
<b>Windows</b> .....	4-17	• LCD Display Control .....	4-41
• Power windows .....	4-18	• Gauges .....	4-42
<b>Hood</b> .....	4-22	• Reduction gear shift indicator .....	4-45
• Opening the hood .....	4-22	<b>LCD Display</b> .....	4-46
• Closing the hood .....	4-22	• LCD Modes .....	4-46
		• EV information mode .....	4-47



- A/V Mode . . . . . 4-48
- Service Mode . . . . . 4-48
- User Settings Mode . . . . . 4-49
- Warning Messages . . . . . 4-52
- Trip computer** . . . . . 4-61
  - Overview . . . . . 4-61
  - Energy consumption . . . . . 4-61
  - Trip A/B . . . . . 4-62
  - Range . . . . . 4-64
- Warning and indicator lights** . . . . . 4-65
  - Warning lights . . . . . 4-65
  - Indicator Lights . . . . . 4-72
- Parking assist system** . . . . . 4-76
  - Operation of the parking assist system . . . . . 4-76
  - Non-operational conditions of parking assist system . . . . . 4-78
  - Self-diagnosis . . . . . 4-79
- Rear camera display** . . . . . 4-80
- Lighting** . . . . . 4-81
  - Headlamp escort . . . . . 4-81
  - Battery saver function . . . . . 4-81
  - Daytime running light . . . . . 4-81
  - Abnormal lamp operation . . . . . 4-82
  - Abnormal lamp operation due to stabilization of electric control system . . . . . 4-82
- Lighting control . . . . . 4-82
- High beam operation . . . . . 4-84
- Turn signals and lane change signals . . . . . 4-85
- Front fog light . . . . . 4-86
- Wipers and washers** . . . . . 4-87
  - Windshield wiper/washer . . . . . 4-87
  - Rear window wiper/washer . . . . . 4-87
  - Windshield wipers . . . . . 4-87
  - Windshield washers . . . . . 4-88
  - Rear window wiper and washer switch . . . . . 4-89
- Interior light** . . . . . 4-90
  - Interior lamp AUTO cut . . . . . 4-90
  - Map lamp . . . . . 4-90
  - Room lamp . . . . . 4-91
  - Luggage room lamp . . . . . 4-92
  - Glove box lamp . . . . . 4-92
  - Vanity mirror lamp . . . . . 4-92
- Defroster** . . . . . 4-93
  - Rear window defroster . . . . . 4-93
- Automatic climate control system** . . . . . 4-94
  - Automatic heating and air conditioning . . . . . 4-95
  - Manual heating and air conditioning . . . . . 4-96
  - Automatic Ventilation . . . . . 4-106
  - System operation . . . . . 4-107
  - Climate control air filter . . . . . 4-109

- Checking the amount of air conditioner refrigerant and compressor lubricant . . . . . 4-109
- Air Conditioning refrigerant label . . . . . 4-110
- Windshield defrosting and defogging . . . . . 4-111**
  - Automatic climate control system . . . . . 4-111
  - Defogging logic . . . . . 4-113
- Clean air . . . . . 4-114**
- Auto defogging system . . . . . 4-115**
- Storage compartment . . . . . 4-116**
  - Center console storage . . . . . 4-116
  - Glove box . . . . . 4-116
  - Sunglass holder . . . . . 4-117
  - Luggage box . . . . . 4-117
- Interior features . . . . . 4-118**
  - Cup holder . . . . . 4-118
  - Sunvisor . . . . . 4-119
  - Seat warmer . . . . . 4-119
  - Seat air ventilation . . . . . 4-121
  - Rear seat warmer . . . . . 4-122
  - Power outlet . . . . . 4-123
  - Clothes hanger . . . . . 4-124
  - Floor mat anchor(s) . . . . . 4-124
  - Luggage net holder . . . . . 4-125
  - Cargo area cover . . . . . 4-126

- Audio system . . . . . 4-128**
  - Antenna . . . . . 4-128
  - AUX, USB and iPod® port . . . . . 4-129
  - Speaker lights . . . . . 4-130
  - How vehicle audio works . . . . . 4-131
  - Using the USB device . . . . . 4-135
  - Using iPod® device . . . . . 4-136
  - *Bluetooth*® Wireless Technology . . . . . 4-137
  - Audio . . . . . 4-141

## SMART KEY

### Record your key number



The key code number is stamped on the key code tag attached to the key set. Should you lose your keys, this number will enable an authorized Kia dealer to duplicate the keys easily. Remove the key code tag and store it in a safe place. Also, record the key code number and keep it in a safe and handy place, but not in the vehicle.

**⚠ WARNING - Smart key**  
**Never leave the smart key in your vehicle with unsupervised children. Leaving children unattended in a vehicle with a smart key is dangerous. Children copy adults and they could press the start button. The key would enable children to operate power windows or other controls, or even make the vehicle move, which could result in serious bodily injury or death. result in serious bodily injury or death.**

### Smart key function



OXMA043316

To remove the mechanical key, press and hold the release button(1) and remove the mechanical key (2).

To reinstall the mechanical key, put the key into the hole and push it until a click sound is heard.

With a smart key, you can lock or unlock a door (and Tailgate) and start the vehicle.

Refer to the following for more details.

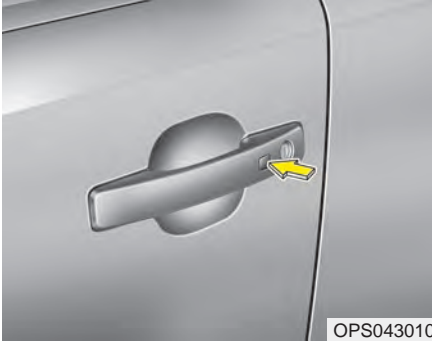
**Door Lock**

OPS043010

**Using the door handle button**

1. Carry the smart key.
2. Close all doors, hood and tailgate.
3. Press the button of the outside door handle.
4. The hazard warning lights will blink and the chime will sound once.
5. Make sure that doors are locked by pulling the outside door handle.

The button will only operate when the smart key is within 28~40 in. (0.7~1m) from the outside door handle.

Even though you press the outside door handle button, the doors will not lock and the chime will sound for 3 seconds if any of following occur:

- The smart key is in the vehicle.
- The POWER button is in ON position.
- Any door except the tailgate is open.



OXMA043316/Q

**Using the button on the smart key**

- 1 Close all doors, hood and tailgate.
2. Press the lock button(1).
3. The hazard warning lights will blink and the chime will sound once.
4. Make sure that doors are locked by pulling the outside door handle.

### **Unlocking**

#### **Using the door handle button**

1. Carry the smart key.
  2. Press the button of the driver's outside door handle.
  3. The driver's door will unlock. The hazard warning lights will blink and the chime will sound two times.
  4. Press the button twice within 4 seconds and all doors and the tailgate will unlock and the hazard warning lights will blink and the chime will sound two times.
- The button will only operate when the smart key is within 28~40 in. (0.7~1m) from the outside door handle.
  - When the smart key is recognized in the area of 28~40 in. (0.7~1m) from the front outside door handle, other people can also open the doors.
  - After unlocking the driver's door or all doors, the door(s) will lock automatically unless the door is opened.

#### **Using the button on the smart key**

1. Press the unlock button(2) of the smart key.
2. The driver's door will unlock. The hazard warning lights will blink and the chime will sound two times.
3. Press the unlock button(2) twice within 4 seconds and all doors and the tailgate will unlock. The hazard warning lights will blink and the chime will sound two times.

### **\* NOTICE**

**After pressing the button, the doors will lock automatically unless any door is opened within 30 seconds.**

### **\* NOTICE**

**You can activate or deactivate the Two Turn Unlock function. Refer to "User settings" in this chapter.**

### **Tailgate unlocking**

#### **Using the tailgate handle button**

1. Carry the smart key.
2. Press the tailgate handle button.
3. When all doors are locked, the hazard warning lights will blink two times.  
Once the tailgate is opened and then closed, the tailgate will lock automatically.

If you are within 28~40 in. (0.7~1 m) from the outside tailgate handle, with your smart key in possession, the tailgate will unlock and open when you press the tailgate handle switch.

#### **Using the button on the smart key**

1. Press the tailgate unlock button(3) for more than 1 second.
2. When all doors are locked, the hazard warning lights will blink two times.

### **Panic**

1. Press the panic button(4) for more than 1 second.
2. The horn sounds and hazard warning light flash for about 30 seconds.

### **Start-up**

You can start the vehicle without inserting the key. For detailed information refer to the “POWER button” in chapter 5.

### **Loss of the smart key**

A maximum of 2 smart keys can be registered to a single vehicle.

If you happen to lose your smart key, you will not be able to start the vehicle. You should immediately take the vehicle and remaining key to your authorized Kia dealer(tow the vehicle, if necessary) to protect it from potential theft.

### **Smart key precautions**

- The smart key will not work if any of the following occur:
  - The smart key is close to a radio transmitter such as a radio station or an airport which can interfere with normal operation of the smart key.
  - The smart key is near a mobile two way radio system or a cellular phone.
  - Another vehicle's smart key is being operated close to your vehicle.
- When the smart key does not work correctly, open and close the door with the mechanical key and contact an authorized Kia dealer.

- If the smart key is in close proximity to your cell phone or smart phone, the signal from the smart key could be blocked by normal operation of your cell phone or smart phone. This is especially important when the phone is active such as making a call, receiving calls, text messaging, and/or sending/receiving emails. Avoid placing the smart key and your cell phone or smart phone in the same pants or jacket pocket and maintain adequate distance between the two devices.

#### **CAUTION**

***Keep the smart key away from water or any liquid as it can become damaged and not function properly.***

#### **\* NOTICE**

**If the smart key is inoperative due to exposure to water or liquids, it will not be covered by your manufacturer's vehicle warranty.**

### Smart key immobilizer system

Your vehicle is equipped with an electronic immobilizer system to reduce the risk of unauthorized vehicle use.

Your immobilizer system is comprised of a small transponder in the smart key and electronic devices inside the vehicle.

With the immobilizer system, whenever you turn the POWER button to the ON position by pressing the button while carrying the smart key, it checks and determines and verifies if the smart key is valid or not.

If the key is determined to be valid, the vehicle will start.

If the key is determined to be invalid, the vehicle will not start.

#### ***To deactivate the immobilizer system:***

Turn the POWER button to the ON position by pressing the button while carrying the smart key.

#### ***To activate the immobilizer system:***

Turn the POWER button to the OFF position. The immobilizer system activates automatically. Without a valid smart key for your vehicle, the vehicle will not start.

In order to prevent theft of your vehicle, do not leave spare keys anywhere in your vehicle. Your Immobilizer password is a customer unique password and should be kept confidential. Do not leave this number anywhere in your vehicle.

#### **\* NOTICE**

When starting the vehicle, do not use the key with other immobilizer keys around. Otherwise the vehicle may not start or may stop soon after it starts. Keep each key separate in order to avoid a starting malfunction.

Do not put metal accessories near the smart key.

The vehicle may not start because the metal accessories may interrupt the transponder signal from transmitting normally.

#### **\* NOTICE**

If you need additional keys or lose your keys, contact an authorized Kia dealer.

#### **CAUTION - Immobilizer damage**

***Do not expose your immobilizer system to moisture, static electricity and rough handling. This may damage your immobilizer.***

#### **CAUTION - Immobilizer alterations**

***Do not change, alter or adjust the immobilizer system because it could cause the immobilizer system to malfunction.***

### This device complies with Part 15 of the FCC rules.

Operation is subject to the following two conditions:

1. This device may not cause harmful interference, and
2. This device must accept any interference received, including interference that may cause undesired operation.

### \* NOTICE

Changes or modifications not expressly approved by the party responsible for compliance could void the user's authority to operate the equipment. If the keyless entry system is inoperative due to changes or modifications not expressly approved by the party responsible for compliance, it will not be covered by your manufacturer's vehicle warranty.

### Battery replacement

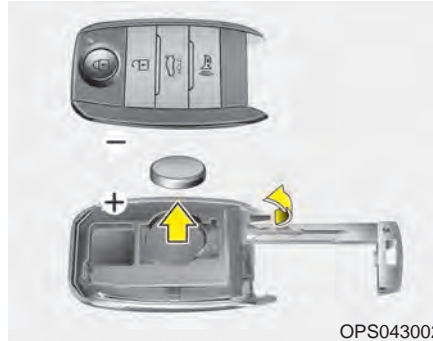

A smart key battery should last for several years, but if the smart key is not working properly, try replacing the battery with a new one. If you are unsure how to use your smart key or replace the battery, contact an authorized Kia dealer.

1. Remove the mechanical key.
2. Pry open the rear cover.
3. Replace the battery with a new battery (CR2032). When replacing the battery, make sure the battery position.

4. Install the battery in the reverse order of removal.

- The smart key is designed to give you years of trouble-free use, however it can malfunction if exposed to moisture or static electricity. If you are unsure how to use or replace the battery, contact an authorized Kia dealer.
- Using the wrong battery can cause the smart key to malfunction. Be sure to use the correct battery.
- To avoid damaging the smart key, don't drop it, get it wet, or expose it to heat or sunlight.
-  An inappropriately disposed battery can be harmful to the environment and human health. Dispose the battery according to your local law(s) or regulation.

### CAUTION - Smart key damage

***Do not drop, get wet or expose the smart key to heat or sunlight, or it will be damaged.***



## DOOR LOCKS

### Operating door locks from outside the vehicle

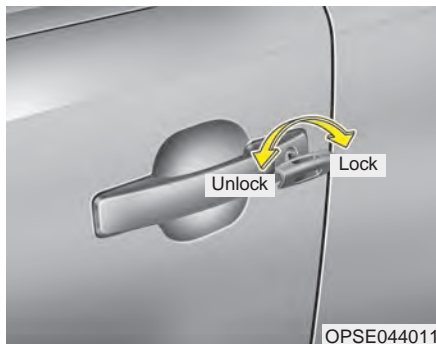

- Turn the key clockwise to lock and counterclockwise to unlock.
- If you lock the driver's door with a key - only the driver's door will lock.
- From the driver's door
  - turn the key to the left once to unlock the driver's door.
- Doors can also be locked and unlocked with the smart key.

- Once the doors are unlocked, they may be opened by pulling the door handle.
- When closing the door, push the door by hand. Make sure the doors are closed securely.

### \* NOTICE

- In cold and wet climates, door lock and door mechanisms may not work properly due to freezing conditions.
- If the door is locked/unlocked multiple times in rapid succession with either the vehicle key or door lock switch, the system may stop operating temporarily in order to protect the circuit and prevent damage to system components.

### **⚠ WARNING**

**Be careful that someone's body and hands are not trapped when closing the door.**



- To lock a door without the key, push the inside door lock button (1) or central door lock switch (2) to the "Lock" position and close the door (3).
- If you lock the door with the central door lock switch (2), all vehicle doors will lock automatically.

### \* NOTICE

Always carry the smart key after the vehicle is turned off, engage the parking brake, close all windows and lock all doors when leaving your vehicle unattended.

**⚠ WARNING**

If people must spend a longer time in the vehicle while it is very hot or cold outside, there is risk of injuries or danger to life. Do not lock the vehicle from the outside when there are people in it.

**⚠ CAUTION**

Do not open and close the door repeatedly if unnecessary or with excessive force. Such action can damage the vehicle door.

**Operating door locks from inside the vehicle**

*With the door lock button*

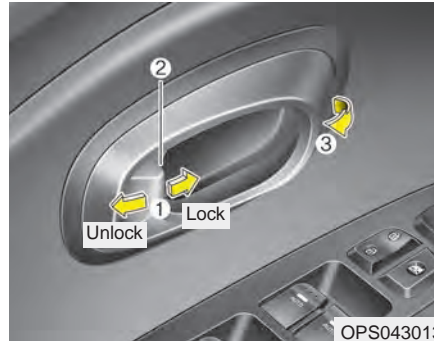

- To unlock a door, push the door lock button (1) to the “Unlock” position. The red mark (2) on the button will be visible.
- To lock a door, push the door lock button (1) to the “Lock” position. If the door is locked properly, the red mark (2) on the door lock button will not be visible.
- To open a door, pull the door handle (3) outward.

- If the inner door handle of the driver’s (or front passenger’s) door is pulled when the driver door lock button is in the lock position, the button will unlock and the door will open.
- Front doors cannot be locked if the smart key is in the vehicle and any front door is opened.

If a power door lock ever fails to function while you are in the vehicle, try one or more of the following techniques to exit:

- Operate the door unlock feature repeatedly (both electronic and manual) while simultaneously pulling on the door handle.
- Operate the other door locks and handles, front and rear.
- Lower a front window and use the key to unlock the door from outside.
- Move to the cargo area and open the tailgate.

**⚠ WARNING**

Do not pull the inner door handle of driver’s (or passenger’s) door while the vehicle is moving.

## With central door lock switch

Driver's door

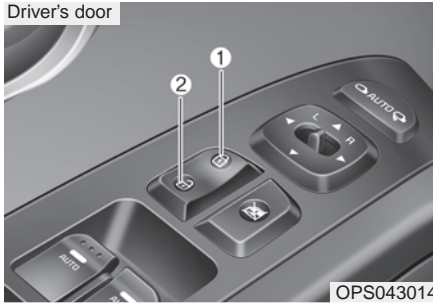

Passenger's door

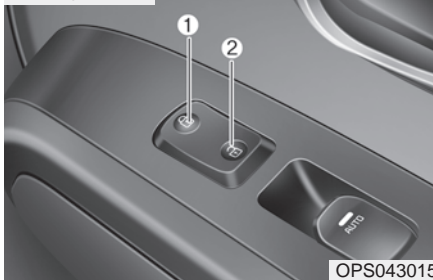

Operate by pressing the central door lock switch.

- When pressing the front portion (1) of the switch, all vehicle doors will lock.

- When pressing the rear portion (2) of the switch, all vehicle doors will unlock.
- If the vehicle is in the ready (🚗) mode and any front door is opened, the doors will not lock even though the front portion (1) of the central door lock switch is pressed.

### **⚠️ WARNING - Doors**

- The doors should always be fully closed and locked while the vehicle is in motion to prevent accidental opening of the door.
- Be careful when opening doors and watch for vehicles, motorcycles, bicycles or pedestrians approaching the vehicle in the path of the door. Opening a door when something is approaching can cause injury.

### **⚠️ WARNING - Unattended children/animals**

Never leave children or animals unattended in your vehicle. An enclosed vehicle can become extremely hot, causing death or severe injury to unattended children or animals who cannot escape the vehicle.

### **⚠️ WARNING - Unlocked vehicles**

Leaving your vehicle unlocked can invite theft or possible harm to you or others from someone hiding in your vehicle while you are gone. Always remove the ignition key, engage the parking brake, close all windows and lock all doors when leaving your vehicle unattended.

### Impact sensing door unlock system

In the event of air bag deployment resulting from a vehicle impact, all doors will automatically unlock.

### Auto door lock/unlock feature

You can activate or deactivate the auto door lock/unlock features in the vehicle. Refer to "User settings" in this chapter.

### Speed sensing door lock system

All doors will be automatically locked after the vehicle speed exceeds 9.3 mph (15 km/h).

### Child-protector rear door lock

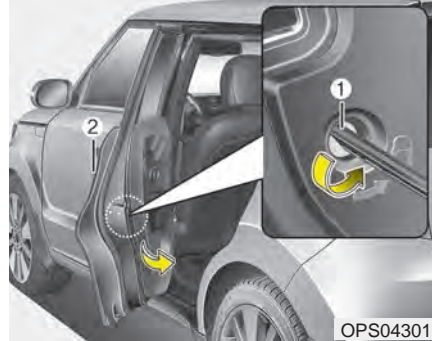

The child safety lock is provided to help prevent children from accidentally opening the rear doors from inside the vehicle. The rear door safety locks should be used whenever children are in the vehicle.

1. Open the rear door.
2. Push the child safety lock located on the rear edge of the door to the lock (🔒) position. When the child safety lock is in the lock position, the rear door will not open even when the inner door handle is pulled.

3. Close the rear door.

To open the rear door, pull the outside door handle.

Even though the doors may be unlocked, the rear door will not open by pulling the inner door handle (1) until the rear door child safety lock is unlocked.

### **⚠️ WARNING - Rear door locks**

**Use the rear door safety locks whenever children are in the vehicle. If a child accidentally opens the rear doors while the vehicle is motion, he can fall out.**

## TAILGATE

### Opening the tailgate



- The tailgate is locked or unlocked when all doors are locked or unlocked with the key, smart key or central door lock switch.
- If unlocked, the tailgate can be opened by pressing the handle switch and then pulling the handle up.
- Only the tailgate is unlocked if the tailgate unlock button on the smart key is pressed. Once the tailgate is opened and then closed, the tailgate is locked automatically.

### **⚠ WARNING - Exhaust fumes**

The tailgate lid should always be kept completely closed while the vehicle is in motion. If it is left open or ajar, exhaust gases may enter the car and serious illness or death may result.

### **\* NOTICE**

In cold and wet climates, door lock and door mechanisms may not work properly due to freezing conditions.

The tailgate swings upward. Make sure no objects or people are near the rear of the vehicle when opening the tailgate.

### **⚠ CAUTION - Tailgate lift**

*Make certain that you close the tailgate before driving your vehicle. Possible damage may occur to the tailgate lift cylinders and attached hardware if the tailgate is not closed prior to driving.*

## Closing the tailgate



To close the tailgate, lower and push down the tailgate firmly. Make sure that the tailgate is securely latched.

Make sure your hands, feet and other parts of your body are safely out of the way before closing the tailgate.

### **⚠ WARNING - Rear cargo area**

Occupants should never ride in the rear cargo area where no restraints are available. Occupants should always be properly restrained.

### **⚠ WARNING**

Make sure there are no people or objects around the trunk before opening or closing the power trunk. Wait until the trunk is open fully and stopped before loading or unloading cargo from the vehicle.

## Emergency tailgate safety release



Your vehicle is equipped with an emergency tailgate safety release lever located on the bottom of the tailgate. When someone is inadvertently locked in the cargo area, the tailgate can be opened by pushing the release lever and pushing open the tailgate.

### **WARNING**

- No one should be allowed to occupy the cargo area of the vehicle at any time. The cargo area is a very dangerous location in the event of a crash.
- Use the release lever for emergencies only. Use with extreme caution, especially while the vehicle is in motion.



## WINDOWS

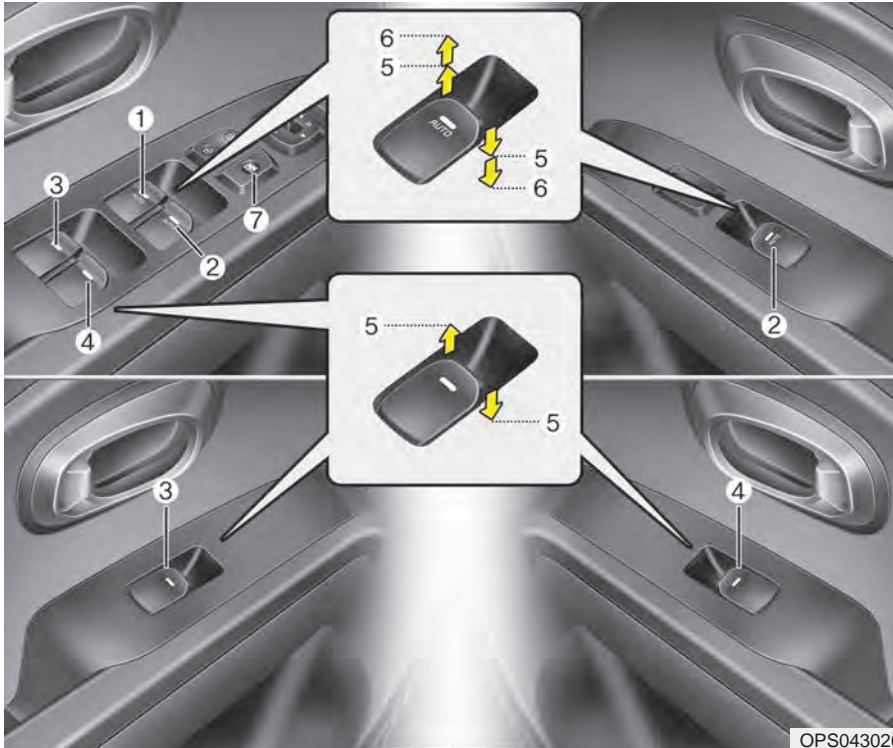

- (1) Driver's door power window switch
- (2) Front passenger's door power window switch
- (3) Rear door (left) power window switch
- (4) Rear door (right) power window switch
- (5) Window opening and closing
- (6) Automatic power window up/down
- (7) Power window lock switch

In cold and wet climates, power windows may not work properly due to freezing conditions.

OPS043020



### Power windows

The POWER button must be in the ON position for power windows to operate.

Each door has a power window switch that controls the door's window. The driver has a power window lock button which can block the operation of the rear passenger windows. The power windows can be operated for approximately 30 seconds after the vehicle turned off or turned to the ACC position. However, if the front doors are opened, the power windows cannot be operated even within the 30 second period.

If the window cannot be close because it is blocked by objects, remove the objects and close the window.

### \* NOTICE

While driving with the rear windows down or with the sunroof (if equipped) in an open (or partially open) position, your vehicle may demonstrate a wind buffeting or pulsation noise. This noise is a normal occurrence and can be reduced or eliminated by taking the following actions. If the noise occurs with one or both of the rear windows down, partially lower both front windows approximately one inch. If you experience the noise with the sunroof open, slightly reduce the size of the sunroof opening.

### ⚠ CAUTION

***Do not install any accessories in the vehicle that extend into the open window area. Such objects will impact the proper function of the Automatic reversal "jam protection" feature described on page 4-19 of this manual.***

### Window opening and closing



The driver's door has a master power window switch that controls all the windows in the vehicle.

To open or close a window, press down or pull up the front portion of the corresponding switch to the first detent position (5).

### Auto up/down window (for driver's window)



Pressing or pulling up the power window switch momentarily to the second detent position (6) completely lowers or raises the window even when the switch is released. To stop the window at the desired position while the window is in operation, pull up or press down and release the switch.

If the power window does not operate normally, the automatic power window system must be reset as follows:

1. Turn the POWER button to the ON position.
2. Close the driver's window and continue pulling up the driver's power window switch for at least 1 second after the window is completely closed.

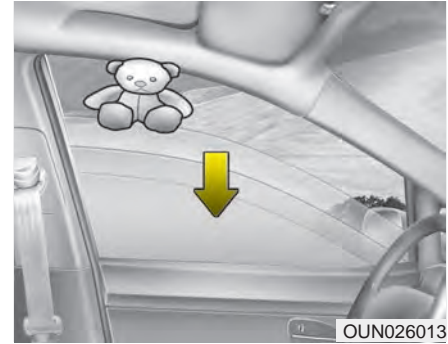

### Automatic reversal

If the upward movement of the window is blocked by an object or part of the body, the window will detect the resistance and will stop upward movement. The window will then lower approximately 11.8 in. (30 cm) to allow the object to be cleared.

The distance may vary based on the size or position of the window. If the window detects the resistance while the power window switch is pulled up continuously, the window will stop upward movement then lower approximately 1 in. (2.5 cm).

And if the power window switch is pulled up continuously again within 5 seconds after the window is lowered by the automatic window reversal feature, the automatic window reversal will not operate.

The automatic reverse feature for the driver's window is only active when the "auto up" feature is used by fully pulling up the switch. The automatic reverse feature will not operate if the window is raised using the halfway position on the power window switch.

### **⚠ WARNING**

**Always check for obstructions before raising any window to avoid injuries or vehicle damage. If an object less than 4 mm (0.16 in.) in diameter is caught between the window glass and the upper window channel, the automatic reverse window may not detect the resistance and will not stop and reverse direction.**

### **⚠ WARNING**

**The automatic reverse feature doesn't activate while resetting power window system. Make sure body parts or other objects are safely out of the way before closing the windows to avoid injuries.**

### ***Power window lock button***



- The driver can disable the power window switches on the passenger doors by pressing the power window lock button located on the driver's door to the LOCK position (pressed).

- **When the power window lock switch is pressed :**

- The driver's master control can operate all the power windows.
- The front passenger's control can operate the front passenger's power window.
- The rear passenger's control cannot operate the rear passenger's power window.

 **CAUTION - Opening / closing Window**

*To prevent possible damage to the power window system, do not open or close two windows or more at the same time. This will also ensure the longevity of the fuse.*

Always double check to make sure all arms, hands, head and other obstructions are safely out of the way before closing a window.

 **WARNING - Power windows**

- **Do not allow children to play with the power windows. Keep the power window lock switch (on the driver's door) in the LOCK (pressed) position.**
- **Do not extend a face or arms outside through the window opening while driving.**

## HOOD

### Opening the hood

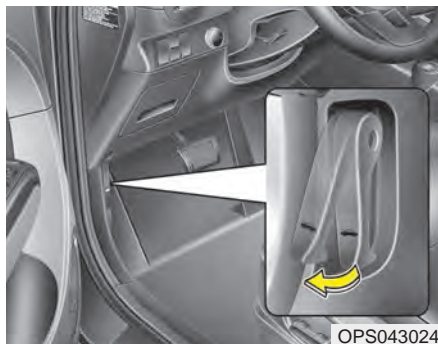

1. Pull the release lever to unlatch the hood. The hood should pop open slightly.

Open the hood after turning off the vehicle on a flat surface, shifting the shift lever to the P (Park) position and setting the parking brake.

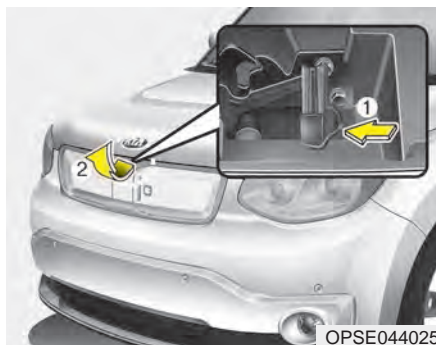

2. Go to the front of the vehicle, raise the hood slightly, pull the secondary latch (1) inside of the hood center and lift the hood (2).

3. Raise the hood. It will completely rise by itself after it has been raised about halfway.

### Closing the hood

1. Before closing the hood, check the following:

- All filler caps in engine compartment must be correctly installed.
- Gloves, rags or any other combustible material must be removed from the engine compartment.

2. Return the support rod to its clip to prevent it from rattling.

3. Lower the hood until it is about 30 cm above the closed position and let it drop. Make sure that it locks into place.

4. Check that the hood has engaged properly. If the hood can be raised slightly, it is not properly engaged.

Open it again and close it with a little more force.

### **⚠ WARNING**

**Before closing the hood, ensure that all obstructions are removed from the hood opening. Closing the hood with an obstruction present in the hood opening may result in severe personal injury.**

**⚠ WARNING - Fire risk**

Do not leave gloves, rags or any other combustible material in the motor compartment. Doing so may cause a heat-induced fire.

**⚠ WARNING - Unsecured hood**

Always double check to be sure that the hood is firmly latched before driving away. If it is not latched, the hood could fly open while the vehicle is being driven, causing a total loss of visibility, which might result in an accident.

## PANORAMIC SUNROOF (IF EQUIPPED)



The sunroof can be operated for approximately 30 seconds after the ignition key is removed or turned to the ACC or LOCK position. However, if the front doors are opened, the sunroof cannot be opened even within the 30 seconds period.

### \* NOTICE

- In cold and wet climates, the sunroof may not work properly due to freezing conditions.
- After a vehicle is washed or in a rainstorm be sure to wipe off any water that is on the sunroof before operating it.



**CAUTION - Sunroof control**  
*Do not continue to pull or push the sunroof glass control lever after the sunroof is fully opened, closed, or tilted. Damage to the motor or system components could occur.*



**WARNING - Roof cargo**  
Do not operate the sun roof while using the roof rack to transport cargo. This may cause the cargo to come loose and distract the driver.



**WARNING**  
Never adjust the sunroof or sunshade while driving. This could result in loss of control and an accident that may cause death, serious injury, or property damage.



**WARNING**  
In order to prevent accidental operation of the sunroof, especially by a child, do not let a child operate the sunroof.



**CAUTION**  
*Do not sit on the top of the vehicle. It may cause vehicle damage.*

### Sunroof open warning (if equipped)



If the driver removes the ignition key (smart key: turns off the engine) when the sunroof is not fully closed, the warning chime will sound for a few seconds and a message will appear on the LCD display or warning indicator will illuminate.

Close the sunroof securely when leaving your vehicle.

### Sliding the sunroof



#### *When the sunshade is closed*

Pull the sunroof control lever backward to the 2nd detent position, the sunshade and sunroof glass will slide all the way open. To stop the sunroof movement at any point, push the sunroof control lever momentarily.

#### *When the sunshade is opened*

Pull the sunroof control lever backward to the 1st or 2nd detent position, the sunroof glass will slide all the way open. To stop the sunroof movement at any point, pull or push the sunroof control lever momentarily.

\* The front part of the sunroof glass can only be opened and closed.



### **Automatic reversal**

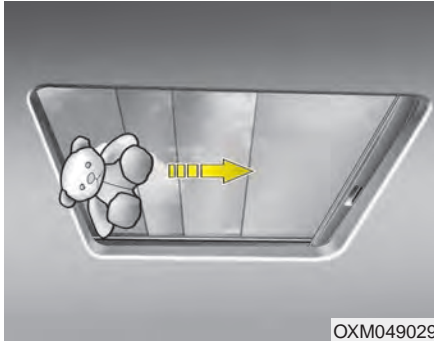

If an object or part of the body is detected while the sunroof glass or sunshade is closing automatically, it will reverse the direction, and then stop.

The auto reverse function does not work if a tiny obstacle is between the sliding glass or sunshade and the sunroof sash. You should always check that all passengers and objects are away from the sunroof before closing it.

### **Tilting the sunroof**



### **When the sunshade is closed**

Push the sunroof control lever upward, the sunshade will slide halfway open then the sunroof glass will tilt.

To stop the sunroof movement at any point, push the sunroof control lever momentarily.

### **When the sunshade is closed**

Push the sunroof control lever upward, the sunroof glass will tilt.

To stop the sunroof movement at any point, push the sunroof control lever momentarily.

Do not extend the face, neck, arms or body outside the sunroof while driving.

**⚠ WARNING - Sunroof Operation**

When closing the sunroof, make sure there are no body parts in the movement range of the sliding roof. Parts of the body could become trapped or crushed.



**CAUTION - Sunroof motor damage**

*If you try to open the sunroof when the temperature is below freezing or when the sunroof is covered with snow or ice, the glass or the motor could be damaged.*



**CAUTION**

*To prevent damage to the sunroof, periodically remove any dirt that may accumulate on the guide rail.*

## Sunshade



**To open the sunshade**

Pull the sunroof control lever backward to the 1st detent position.

### ***To close the sunshade when the sunroof glass is closed***

Push the sunroof control lever forward or pull it down to the 1st detent position.

To stop the sliding at any point, press the sunshade control switch momentarily.

### **\* NOTICE**

Wrinkles formed on the sunshade as material characteristic are normal.



### **CAUTION - Automatic sunroof shade**

- ***Do not pull or push the sunshade by hand as such action may damage the sunshade or cause it to malfunction.***
- ***Close the sunroof when driving in dusty environments. Dust may cause a malfunction of the vehicle system.***

### **Closing the sunroof**

#### ***To close the sunroof glass with the sunshade***

Push the sunroof control lever forward or downward to the 2nd detent position. The sunroof glass and sunshade will close automatically.

To stop the sunroof movement at any point, push the sunroof control lever momentarily.

#### ***To close the sunroof glass only***

Push the sunroof control lever forward or downward to the 1st detent position. The sunroof glass will close automatically.

To stop the sunroof movement at any point, push the sunroof control lever momentarily.

## Resetting the sunroof

Whenever the vehicle battery is disconnected or discharged, you must reset your sunroof system as follows:

- 1.Start the engine.
- 2.Close the sunshade and sunroof completely if opened.
- 3.Release the sunroof control lever.
- 4.Push the sunroof control lever forward in the direction of close (about 10 seconds) until the sunshade slightly moves. Then, release the lever.

- 5.Push the sunroof glass control lever forward in the direction of close, until the sunroof operates as follows again:

Sunshade open → Glass tilt open  
→ Glass slide open → Glass slide close  
→ Sunshade close

Then, release the lever.

When this is complete, the sunroof system is reset.

### \* NOTICE

**If you do not reset the sunroof, it may not work properly.**

### \* NOTICE

**If the sunroof is not reset when the vehicle battery is disconnected or discharged, or related fuse is blown, the sunroof may operate improperly.**

## STEERING WHEEL

### Electric power steering (EPS)

The power steering uses a motor to assist you in steering the vehicle. If the vehicle is in not the ready (🚗) mode or if the power steering system becomes inoperative, the vehicle may still be steered, but it will require increased steering effort.

The motor driven power steering is controlled by a power steering control unit which senses the steering wheel torque and vehicle speed to command the motor.

The steering becomes heavier as the vehicle's speed increases and becomes lighter as the vehicle's speed decreases for optimum steering control.

Should you notice any change in the effort required to steer during normal vehicle operation, have the power steering checked by an authorized Kia dealer.

- If the Electric Power Steering System does not operate normally, the warning light will illuminate on the instrument cluster. The steering wheel may require increased steering effort. Take your vehicle to an authorized Kia dealer and have the vehicle checked as soon as possible.
- When you operate the steering wheel in low temperature, noise may occur. If temperature rises, the noise will likely disappear. This is a normal condition.
- When the vehicle is stationary, when the steering wheel is turned all the way to the left or right continuously, the steering wheel becomes harder to turn. The power assist is limited to protect the motor from overheating.

As time passes, the steering wheel return to its normal condition.

### \* NOTICE

The following symptoms may occur during normal vehicle operation:

- The EPS warning light does not illuminate.
- The steering gets heavy immediately after turning the POWER button on. This happens as the system performs the EPS system diagnostics. When the diagnostics are completed, the steering wheel will return to its normal condition.
- A click noise may be heard from the EPS relay after the POWER button is turned to the ON or OFF position.
- A motor noise may be heard when the vehicle is at a stop or at a low driving speed.
- If the Electric Power Steering System does not operate normally, the warning light will illuminate on the instrument cluster. The steering wheel may become difficult to control or operate abnormally. Take your vehicle to an authorized Kia dealer and have the vehicle checked as soon as possible.

(Continued)

(Continued)

- When you operate the steering wheel in low temperature, abnormal noise may occur. If temperature rises, the noise will likely disappear. This is a normal condition.
- When the charging system warning light comes on due to the low voltage (When the alternator or battery) does not operate normally or it malfunctions), the steering wheel may require increased steering effort.

### Tilt and telescopic steering

Tilt and telescopic steering allows you to adjust the steering wheel before you drive. You can also raise it to give your legs more room when you exit and enter the vehicle.

The steering wheel should be positioned so that it is comfortable for you to drive, while permitting you to see the instrument panel warning lights and gauges.

**⚠ WARNING - Steering wheel adjustment**

**Never adjust the angle and height of the steering wheel while driving. You may lose steering control.**

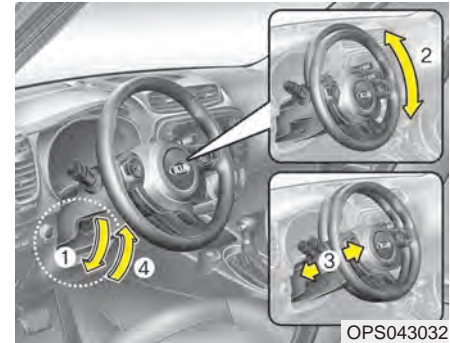

To change the steering wheel angle, pull down the lock-release lever (1), adjust the steering wheel to the desired angle (2) and height (3, if equipped) then pull up the lock-release lever to lock (4) the steering wheel in place. Be sure to adjust the steering wheel to the desired position before driving.

## Heated steering wheel

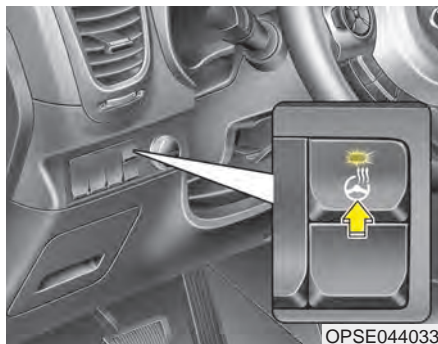

With the POWER button in the ON position, pressing the heated steering wheel button warms the steering wheel. The indicator on the button will illuminate.

To turn the heated steering wheel off, press the button once again. The indicator on the button will turn off.

## \* NOTICE

The heated steering wheel will turn off automatically approximately 30 minutes after the heated steering wheel is turned on.

### ⚠ CAUTION

- ***Do not install any grip to operate the steering wheel. This causes damage to the heated steering wheel system.***
- ***When cleaning the heated steering wheel, do not use an organic solvent such as paint thinner, benzene, alcohol and gasoline. Doing so may damage the surface of the steering wheel.***
- ***If the surface of steering wheel is damaged by sharp object, damage to the heated steering wheel components could occur.***

## Horn



To sound the horn, press the horn symbols on your steering wheel. Check the horn regularly to be sure it operates properly.

## \* NOTICE

To sound the horn, press the area indicated by the horn symbol on your steering wheel (see illustration). The horn will operate only when this area is pressed.

## FLEX STEER



The FLEX STEER controls steering effort based upon as driver's preference or road condition.

You can select the desired steering mode by pressing the FLEX STEER button.

When the steering mode button is pressed, the selected steering mode will appear on the instrument cluster.

If the steering mode button is pressed within 4 seconds, the steering mode will change as shown above.

If the steering wheel mode button is not pressed for about 4 seconds, the LCD display will change to the previous screen.

## *Normal mode*



The normal mode offers medium steering effort.



### *Sport mode*



The steering wheel becomes heavier. The sport mode is usually used when driving on the highway.

### *Comfort mode*



The steering wheel becomes lighter. The comfort mode is usually used when driving in the city or when parking the vehicle.

- For your safety, if you press the steering mode button while operating the steering wheel, but the steering effort will not change immediately. After operating the steering wheel, the steering effort will change automatically to the selected mode.
- Use caution when changing the steering mode while driving.
- When the electronic power steering is not operating properly, the flex steering wheel will not work.

## MIRRORS

### Inside rearview mirror

Adjust the rearview mirror so that the center view through the rear window is seen. Make this adjustment before you start driving.

Do not place objects in the rear seat or cargo area which would interfere with your vision through the rear window.

#### **⚠ WARNING - Mirror adjustment**

**Do not adjust the rearview mirror while the vehicle is moving. This could result in loss of control.**

#### **⚠ WARNING**

**Do not modify the inside mirror and don't install a wide mirror. It could result in injury, during an accident or deployment of the air bag.**

### *Day/night rearview mirror (if equipped)*

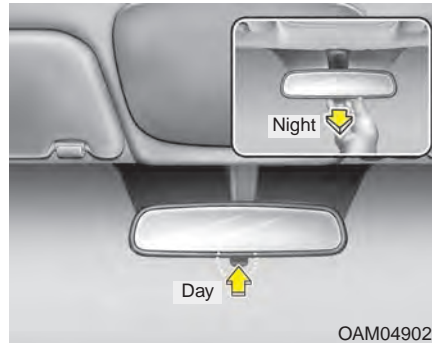

Make this adjustment before you start driving and while the day/night lever is in the day position.

Pull the day/night lever toward you to reduce the glare from the headlights of the vehicles behind you during night driving.

*Remember that you lose some rearview clarity in the night position.*

### *Electric chromic mirror (ECM) (if equipped)*

The electric rearview mirror automatically controls the glare from the headlights of the vehicles behind you in nighttime or low light driving conditions. The sensor mounted in the mirror senses the light level around the vehicle, and automatically controls the headlight glare from the vehicles behind you.

When the vehicle is in the ready (🚗) mode the glare is automatically controlled by the sensor mounted in the rearview mirror.

Whenever the shift lever is shifted into reverse (R), the mirror will automatically go to the brightest setting in order to improve the drivers view behind the vehicle.

**⚠ CAUTION - Cleaning mirror**

*When cleaning the mirror, use a paper towel or similar material dampened with glass cleaner. Do not spray glass cleaner directly on the mirror. It may cause the liquid cleaner to enter the mirror housing.*

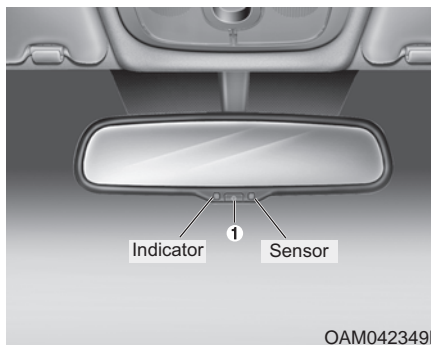

**To operate the electric rearview mirror:**

- The mirror defaults to the ON position whenever the POWER button is turned on.
- Press the ON/OFF button (1) to turn the automatic dimming function off. The mirror indicator light will turn off.

Press the ON/OFF button (1) to turn the automatic dimming function on. The mirror indicator light will illuminate.

**UVO center (if equipped)**



- **i** button

Press the **i** button to request inquiries, consultation, Diagnostic service, etc. Press the **i** button to finish the call.

- **UVO** button

Press this button for navigation-related services. Press this button to finish the call.

-  button

In case of an emergency, requests for help to the UVO center.

The call is connected to the UVO emergency rescue center.

Repressing the button will end the call.

For more details, refer to the Navigation Manual.

### Outside rearview mirror

Be sure to adjust the mirror angles before driving.

Your vehicle is equipped with both left-hand and right-hand outside rearview mirrors. The mirrors can be adjusted remotely with the remote switch. The mirror heads can be folded back to prevent damage during an automatic vehicle wash or when passing through a narrow street.

The right outside rearview mirror is convex. Objects seen in the mirror are closer than they appear.

Use your interior rearview mirror or direct observation to determine the actual distance of following vehicles when changing lanes.

#### **CAUTION - Rearview mirror**

*Do not scrape ice off the mirror face; this may damage the surface of the glass. If ice should restrict the movement of the mirror, do not force the mirror for adjustment. To remove ice, use a deicer spray, or a sponge or soft cloth with very warm water.*

If the mirror is jammed with ice, do not adjust the mirror by force. Use an approved spray de-icer (not radiator antifreeze) to release the frozen mechanism or move the vehicle to a warm place and allow the ice to melt.

#### **WARNING - Mirror adjustment**

**Do not adjust or fold the outside rearview mirrors while the vehicle is moving. This could result in loss of control.**

### Remote control



#### Electric type

The electric remote control mirror switch allows you to adjust the position of the left and right outside rearview mirrors. To adjust the position of either mirror the POWER button should be in the ACC or ON position. Move the switch (1) to R or L to select the right side mirror or the left side mirror, then press a corresponding point on the mirror adjustment control to position the selected mirror up, down, left or right.

After the adjustment, put the switch into the neutral (center) position to prevent inadvertent adjustment.



#### **CAUTION - Outside mirror**

- *The mirrors stop moving when they reach the maximum adjusting angles, but the motor continues to operate while the switch is pressed.*

*Do not press the switch longer than necessary, the motor may be damaged.*

- *Do not attempt to adjust the outside rearview mirror by hand. Doing so may damage the parts.*

### Folding the outside rearview mirror

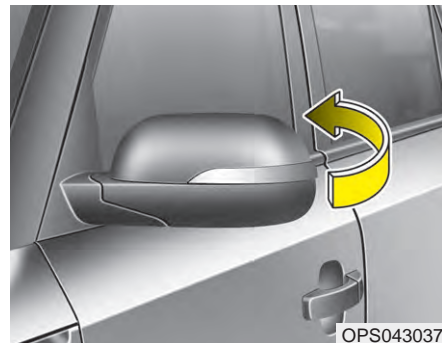

#### Manual type

To fold the outside rearview mirror, grasp the housing of the mirror and then fold it toward the rear of the vehicle.

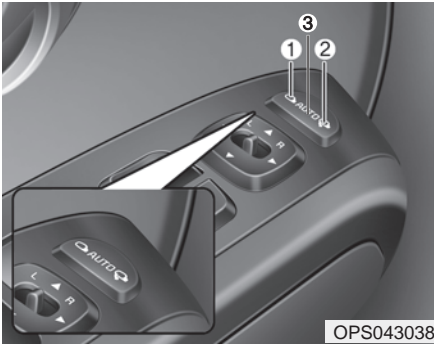

OPS043038

### Electric type

The outside rearview mirror can be folded or unfolded by pressing the switch as below.

**Left (1) :** The mirror will unfold.

**Right (2) :** The mirror will fold.

**Center (AUTO, 3) :**

The mirror will fold or unfold automatically as follows:

- Without smart key system
  - The mirror will fold or unfold when the door is locked or unlocked by the transmitter.

- With smart key system
  - The mirror will fold or unfold when the door is locked or unlocked by the smart key.
  - The mirror will fold or unfold when the door is locked or unlocked by the button on the outside door handle.
  - The mirror will unfold when you approach the vehicle (all doors closed and locked) with a smart key in possession.

### **CAUTION - Electric type outside rearview mirror**

*The electric type outside rearview mirror operates even though the POWER button is in the OFF position. However, to prevent unnecessary battery discharge, do not adjust the mirrors longer than necessary while the vehicle is in not the ready (🚗) mode. In case it is an electric type outside rearview mirror, don't fold it by hand. It could cause motor failure.*

### Outside mirror defroster

■ Type A



OPSE045309N

■ Type B



OPS043125

The outside mirror defroster will operate at the same time you turn on the rear window defroster.

## INSTRUMENT CLUSTER



1. Motor operation gauge
2. Speedometer
3. Range meter
4. Warning and indicator lights
5. State of charge gauge
6. LCD display

\* The actual cluster in the vehicle may differ from the illustration.  
For more details, refer to the "Gauges" in this chapter.

## Instrument Cluster Control

### Adjusting Instrument Cluster Illumination

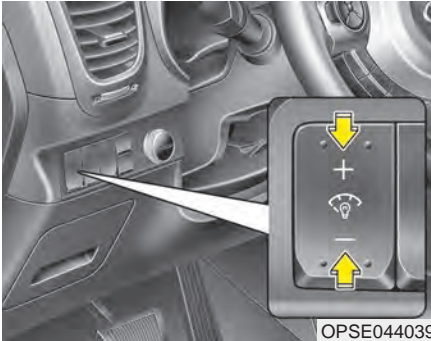

The brightness of the instrument panel illumination is changed by pressing the illumination control button ("+" or "-") when the POWER button is ON, or the tail lights are turned on.



- If you hold the illumination control button ("+" or "-"), the brightness will be changed continuously.
- If the brightness reaches to the maximum or minimum level, an alarm will sound.

## LCD Display Control



The LCD display modes can be changed by using the control buttons on the steering wheel.

- (1) : MODE button for changing modes or SELECT button for setting the selected item
- (2) : MOVE button for changing items or RESET button for resetting the selected item

\* For the LCD modes, refer to "LCD Display" in this chapter.



## Gauges

### Speedometer



The speedometer indicates the speed of the vehicle and is calibrated in miles per hour (mph) or kilometers per hour (km/h).

### Motor operation gauge



It shows the energy consumption rate of the vehicle and the charge/discharge status of the regenerative brakes.

- **POWER** : It shows the energy consumption rate of the vehicle when driving uphill or accelerating. The more electric energy is used, the higher the gauge level.
- **ECO GUIDE** : It shows the energy consumption rate during normal driving condition.

- **CHARGE** : It shows the charging status of the battery when it is being charged by the regenerative brakes (decelerating or driving on a downhill road). The more electric energy is charged, the lower the gauge level.

### State of charge (SOC) gauge for high voltage battery



It shows the charging status of the high voltage battery.

"MIN" position on the indicator indicates that there is not enough energy in the high voltage battery. "MAX" position indicates that the driving battery is fully charged.

When driving on highways or motorways, make sure to check in advance if the driving battery is charged enough.



When there are 4 gauge bars (near the "MIN" area) on the high voltage charge indicator, the warning lamp turns ON to alert you of the battery level.

When the warning lamp turns ON, the vehicle can drive an additional 12.4~24.8 miles (20~40 km) (depending on the driving speed, heater/air conditioner, weather, driving style, and other factors). Charging is required.

When there are 1-2 gauge bars left for the high voltage battery, the vehicle speed is limited and then eventually the vehicle will be turned OFF. Charge the vehicle immediately.

### Odometer



The odometer indicates the total distance that the vehicle has been driven and should be used to determine when periodic maintenance should be performed.

- Odometer range : 0 ~ 999999 miles or kilometers.

### Outside Temperature Gauge



This gauge indicates the current outside air temperatures by 1°F (1°C).

- Temperature range : -40°F ~ 140°F  
(-40°C ~ 60°C)

The outside temperature on the display may not change immediately like a general thermometer to prevent the driver from being inattentive.

The temperature unit can be changed by using the "User Settings" mode of the LCD display

\* For more details, refer to "LCD Display" in this chapter.

## Reduction gear shift indicator

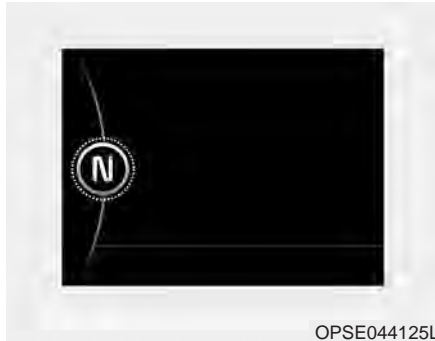







This indicator displays which reduction gear shift lever is selected.

- Park :P
- Reverse : R
- Neutral : N
- Drive :D
- Regenerate brake : B

✧ For the detailed explanation of each shift range, refer to "Reduction Gear" in chapter 5.

## LCD DISPLAY

### LCD Modes

Modes	Symbol	Explanation
EV information		This mode displays EV system energy flow and ECO level. For more details, refer to "EV information mode" in this chapter.
Trip Computer		This mode displays driving information like the tripmeter, energy consumption, and so on. For more details, refer to "Trip Computer" in this chapter.
A/V		This mode displays the state of the A/V system.
Service		This mode informs of service interval (mileage or days) and warning messages related to TPMS and so on.
Master warning		
User Settings		On this mode, you can change settings of the doors, lamps, and so on.

\* For controlling the LCD modes, refer to "LCD Display Control" in this chapter.

## EV information mode

EV information mode shows EV energy flow and ECO level.

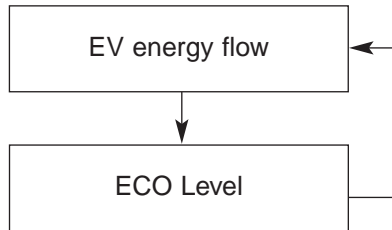

To change the EV information mode, press the ▾ (MOVE) button

## EV energy flow



EV energy flow notifies the drivers of energy flow in operating modes. Following modes show drivers the current operating condition.

- EV Propulsion :  
Energy flows from high voltage battery to wheel when the vehicle is driven by motor
- Regeneration :  
Energy flows from wheel to high voltage battery when you release the accelerator pedal or press the brake pedal.

## ECO Level



When the vehicle is started, the ECO Level display will indicate level. If you drive economically, the ECO Level will increase. However, if you do not drive economically, the ECO Level will decrease.

## A/V Mode



This mode displays the state of the A/V system.

## Service Mode

### Service Interval



### Service interval

It calculates and displays when you need a scheduled maintenance service (mileage or days).

If the remaining mileage or time reaches 900 mi. (1,500 km) or 30 days, "Service Interval" message is displayed for several seconds each time you set the POWER button to the ON position.



### Service required

If you do not have your vehicle serviced according to the already inputted service interval, "Service required" message is displayed for several seconds each time you set the POWER button to the ON position (The mileage and time changes to "---").

To reset the service interval to the mileage and days you inputted before:

- Press the RESET button ▽ for more than 1 second.



OTF044192L

### Service interval OFF

If the service interval is not set, "Service interval OFF" message is displayed on the LCD display.

### \* NOTICE

If any of the following conditions occurs, the mileage and days may be incorrect.

- The battery cable is disconnected.
- The fuse switch is turned off.
- The battery is discharged.

### Master Warning Mode



- This warning light informs the driver the following situations
  - TPMS
  - Service reminder

The Master Warning Light illuminates when more than one of the above warning situations occur. At this time, the LCD Modes Icon will change from (N) to (▲).

If the warning situation is solved, the LCD Modes Icon will be changed back to its previous icon (N).

### User Settings Mode

#### Description



OPSE044212L

On this mode, you can change setting of the doors, lamps, and so on.

### **▲ WARNING**

**Do not adjust the User Setting while driving. You may lose your steering control and cause severe personal injury or accidents.**



### **Door**

#### **Auto Lock**

- Off:  
The auto door lock operation will be deactivated.
- Enable on speed:  
All doors will be automatically locked when the vehicle speed exceeds 9.3mph (15km/h).
- Enable on shift:  
All doors will be automatically locked if the reduction gear shift lever is shifted from the P (Park) position to the R (Reverse), N (Neutral), or D (Drive) position.

#### **Auto Unlock**

- Off:  
The auto door unlock operation will be canceled.
- Vehicle off:  
All doors will be automatically unlocked when the POWER button is set to the OFF position.
- On shift P:  
All doors will be automatically unlocked if the reduction gear shift lever is shifted to the P (Park) position.
- Driver Door Unlock:  
All doors will be automatically unlocked if the driver's door is unlocked.

#### **Two Press Unlock**

- Off:  
The two press unlock function will be deactivated. Therefore, all doors will unlock if the door is unlocked.
- On:  
The driver's door will unlock if the door is unlocked. When the door is unlocked again within 4 seconds, all doors will unlock.

#### **Horn Feedback**

- Off:  
The Horn feedback operation will be deactivated.
- On:  
After locking the door by pressing the lock button on the transmitter, if you press the lock button again within 4 seconds, the warning sound will operate once to indicate that all doors are locked.

### **Lamp**

#### **One Touch Turn Lamp (if equipped)**

If this item is checked, the lane change signals will blink 3, 5 or 7 times when the turn signal lever is moved slightly.

#### **Head Lamp Delay (if equipped)**

If this item is checked, the headlamp delay function will be activated.

### **Settings**

#### **Language**

Choose the language you prefer within the LCD.

#### **Temperature Unit**

Convert the temperature unit from °C to °F or from °F to °C.

#### **Welcome Sound (if equipped)**

If this item is checked, the welcome sound function will be activated.

### **Energy Consumption Auto Reset**

#### **• Auto Reset :**

The average energy consumption will reset automatically when charge the high voltage battery more than 10%

#### **• Manual Reset:**

The average energy consumption will not reset automatically when charge the high voltage battery more than 10%

### Service Interval



On this mode, you can activate the service interval function with mileage (mi. or km) and period (months).

### Warning Messages

#### Low Battery



When the high voltage battery level reaches below 20%, this warning message illuminates.

In this case, the warning lamp on the instrument cluster (🚨) turns ON simultaneously.

Charge the high voltage battery immediately.

#### Low Battery. Charge immediately



When the high voltage battery level reaches below 10%, this warning message illuminates .

In this case, the warning lamp on the instrument cluster (🚨) turns ON simultaneously and the distance to empty gauge will be displayed as "---".

Charge the high voltage battery immediately.

**Charge immediately. Power limited**

When the high voltage battery level reaches below 7%, this warning message illuminates.

In this case, the warning lamp on the instrument cluster (🔋) and the power down warning lamp (⚡) turn ON simultaneously and the distance to empty gauge will be displayed as "---".

The vehicle's power will be reduced to minimize the energy consumption of the high voltage battery. Charge the battery immediately.

**Power limited**

In the following cases, this warning message illuminates when the vehicle's power is limited for the safety.

- When the high voltage battery is below a certain level, or voltage is decreasing.
- When the temperature of the motor or high voltage battery is too high or too low.
- When there is a problem with the cooling system or a failure that may interrupt normal driving.

When this warning message is displayed, do not accelerate or start the vehicle suddenly.

Charge the battery immediately when the high voltage battery level is not enough.

### *Unplug vehicle to start*



When the vehicle is started while the charging connector is connected, this warning message illuminates.

Remove the charging connector and start the vehicle.

### *Charging door open*



When the vehicle is started while the charging door is opened, this warning message illuminates. Make sure to close the charging door after charging is complete.

### *Check electric vehicle system*



This warning message illuminates when a failure related to EV control system occurs.

Refrain from driving when the warning message is displayed. In this case, have your vehicle inspected by an authorized Kia dealer.

**Low Battery Temp. Power limited**

This warning message illuminates to protect battery and electric vehicle system when the high voltage battery temperature is too low.

If this warning message is still illuminated even after the ambient temperature has increased, have your vehicle inspected by an authorized Kia dealer.

**Battery Overheated! Stop vehicle**

This warning message illuminates to protect battery and electric vehicle system when the high voltage battery temperature is too high.

Turn off the POWER button and stop the vehicle so that the battery temperature decreases.

If this warning message is still illuminated even after you have stopped the vehicle for a certain time, refrain from driving and have your vehicle inspected by an authorized Kia dealer.

**Stop vehicle and check power supply**

This warning message illuminates when a failure occurs in the power supply system. In this case, park the vehicle in a safe location and tow your vehicle to the nearest authorized Kia dealer and have the vehicle inspected.

### *Check brakes*



This warning message illuminates when the brake performance is low or the regenerative brake does not work properly due to a failure in the brake system. In this case, it may take longer for the brake pedal to operate and the braking distance may become longer. Refrain from driving when the warning message is displayed. In this case, have your vehicle inspected by an authorized Kia dealer as soon as possible.

### *Stop vehicle and check brakes*



This warning message illuminates when a failure occurs in the brake system. In this case, park the vehicle in a safe location and tow your vehicle to the nearest authorized Kia dealer and have the vehicle inspected.

### *Shift to P position*



- This warning message illuminates if you try to turn off the vehicle without the shift lever in P (Park) position.
- At this time, the POWER button turns to the ACC position (If you press the POWER button once more, it will turn to the ON position).

**Low Key Battery**

OPSE044142L

- This warning message illuminates if the battery of the smart key is discharged when the POWER button changes to the OFF position.

**Press brake pedal to start vehicle**

OPSE044152L

- This warning message illuminates if the POWER button changes to the ACC position twice by pressing the button repeatedly without depressing the brake pedal.
- It means that you should depress the brake pedal to start the vehicle.

**Key not in vehicle**

OPSE044138L

- This warning message illuminates if the smart key is not in the vehicle while the door is opened or closed with the POWER button in the ACC position or the vehicle is in the ready (⚡) mode.
- It means that you should always have the smart key with you.



*Key not detected*



- This warning message illuminates if the smart key is not detected when you press the POWER button.

*Press POWER button again*



- This warning message illuminates if you can not operate the POWER button when there is a problem with the POWER button system.
- It means that you could start the engine by pressing the POWER button once more.
- If the warning illuminates each time you press the POWER button, have your vehicle inspected by an authorized Kia dealer.

*Press POWER button with key*



- This warning message illuminates if you press the POWER button while the warning message “Key not detected” is illuminating.
- At this time, the immobilizer indicator light blinks.

**Check BRAKE SWITCH fuse**

- This warning message illuminates if the brake switch fuse is disconnected.
- It means that you should replace the fuse with a new one. If that is not possible, you can start the engine by pressing the POWER button for 10 seconds in the ACC position.

**Door Open**

- It means that any door is open.

**Tailgate Open**

- It means that the tailgate is open.

### Turn on FUSE SWITCH



- This warning message illuminates if the fuse switch on the fuse box is OFF.
- It means that you should turn the fuse switch on.

For more details, refer to “Fuses” in chapter 7.

### Charger Error!



- This message is displayed when the charging failed by external normal charger error.
- You should change and charge with the other external charger immediately.

### Quick Charger Error!



- This message is displayed when the charging failed by external quick charger error.
- You should change and charge with the other external charger immediately.

## TRIP COMPUTER

### Overview

#### Description

The trip computer is a microcomputer-controlled driver information system that displays information related to driving.

#### \* NOTICE

Some driving information stored in the trip computer (for example Average Vehicle Speed) resets if the battery is disconnected.

### Trip Modes

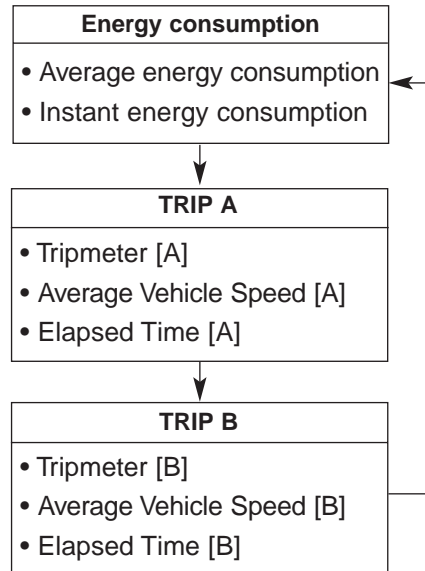

To change the trip mode, press the MOVE button ▾.

### Energy consumption



#### Average energy consumption (1)

- The average energy consumption is calculated by the total driving distance and the high voltage battery consumption since the last average energy consumption reset.
  - Average energy consumption range : 0.0 ~ 99.9 miles/kwh
- The average energy consumption can be reset both manually and automatically.

### Manual reset

To clear the average energy consumption manually, press the  $\nabla$  button (MOVE) on the steering wheel for more than 1 second when the average energy consumption is displayed.

### Automatic reset

To make the average energy consumption be reset automatically whenever recharging, select the "Auto Reset" mode in User Settings menu of the LCD display (Refer to "LCD Display").

Under "Auto Reset" mode, the average energy consumption will be cleared to zero (---) when the driving distance exceeds 0.19 mile (300m) after recharging more than 10%.

### Instant energy consumption (2)

- This mode displays the instant energy consumption during the last few seconds when the vehicle speed is more than 10 km/h (6.2 MPH).
  - Instant energy consumption range : 0.0 ~ 8miles/kwh

### Trip A/B



### Tripmeter (1)

- The tripmeter is the total driving distance since the last tripmeter reset.
  - Distance range: 0.0 ~ 999.9 mi. or km
- To reset the tripmeter, press the RESET ( $\nabla$ ) button on the steering wheel for more than 1 second when the tripmeter is displayed.

**Average Vehicle Speed (2)**

- The average vehicle speed is calculated by the total driving distance and driving time since the last average vehicle speed reset.
  - Speed range: 160 MPH or 200 km/h
- To reset the average vehicle speed, press the RESET (▽) button on the steering wheel for more than 1 second when the average vehicle speed is displayed.

**\* NOTICE**

- The average vehicle speed is not displayed if the driving distance is less than 0.03 miles (50 meters) or the driving time is less than 10 seconds since the POWER button is turned to ON.
- Even if the vehicle is not in motion, the average vehicle speed keeps going while the vehicle is in the ready (⊞) mode.

**Elapsed Time (3)**

- The elapsed time is the total driving time since the last elapsed time reset.
  - Time range (hh:mm): 00:00 ~ 99:59
- To reset the elapsed time, press the RESET (▽) button on the steering wheel for more than 1 second when the elapsed time is displayed.

**\* NOTICE**

Even if the vehicle is not in motion, the elapsed time keeps going while the vehicle is in the ready (⊞) mode.

**One time driving information mode**

This display shows trip distance (1), battery level(2), charging time status (3, if equipped) and climate time status (4, if equipped).

This information is displayed for a few seconds when you turn off the vehicle and then goes off automatically. The information provided is calculated according to each trip.

If the estimated distance is below 9.3 mi.(15km), and a recharging message will appear (5).

To set the charging time and/or climate time, refer to a separately supplied navigation manual for detailed information.

### Range



On average, a vehicle can drive about 111miles (179km) when the high voltage battery is 100% charged.

Under certain circumstances where the air conditioner/heater is ON, the distance to empty is impacted, resulting in a possible distance range from 75~162mi. (120~260km). When using the heater during cold weather or driving at high speed, the high voltage battery consumes a lot more electricity. This may reduce the distance to empty significantly.

After “---” has been displayed, the vehicle can drive an additional 2.5~6.0 mi. (4~9 km) (depending on driving speed, heater/air conditioner, weather, driving style, and other factors).

Distance to empty that is displayed on the instrument cluster after completing a recharge may vary significantly depending on previous operating patterns.

When previous driving patterns include high speed driving, resulting in the driving battery using more electricity than usual, the estimated distance to empty is reduced. When the high voltage battery uses a little electricity in ECO mode, the estimated distance to empty increases.

Distance to empty may depend on many factors such as the charge amount of the high voltage battery, weather, temperature, durability of the battery, geographical features, and driving style.

Natural degradation may occur with the high voltage battery depending on the number of years the vehicle is used. This may reduce the distance to empty.

## WARNING AND INDICATOR LIGHTS

### Warning lights

#### \* NOTICE - Warning lights

Make sure that all warning lights are OFF after starting the vehicle. If any light is still ON, this indicates a situation that needs attention.

#### *Service warning light*



#### **This warning light illuminates :**

- Once you set the POWER button to the ON position.
  - It illuminates for approximately 3 seconds
- There is a failure with a sensor, actuator, or the electric compressor for the air conditioner related to the electric vehicle control system. When the warning light turns ON while driving, or does not turn OFF after vehicle has started, have your vehicle inspected by an authorized Kia dealer.

#### *Power down warning light*



#### **This warning light illuminates :**

- When the power is limited for the safety of the electric vehicle.
  - When the high voltage battery level is below a certain threshold, the voltage is decreasing, the temperature of the motor or driving battery is too high or too low, there is a failure in the cooling system, or a failure that is disrupting normal driving.



### *High voltage battery level warning light*



#### **This warning light illuminates :**

- When the high voltage battery level is not enough.  
When the warning light turns ON, Charge the battery immediately.

### *Regenerative brake warning light*



#### **This warning light illuminates :**

- The regenerative brake does not operate and the brake does not perform well. This causes the brake warning lamp (red) and regenerative brake warning lamp (yellow) to turn ON simultaneously. In this case, drive safely and have your vehicle inspected by an authorized Kia dealer.  
In this case, operation of the brake pedal may be more difficult than normal and the braking distance can increase.

### *Air bag Warning Light*



#### **This warning light illuminates:**

- Once you set the POWER button to the ON position.
  - It illuminates for approximately 6 seconds and then goes off.
- When there is a malfunction with the SRS.  
In this case, have your vehicle inspected by an authorized Kia dealer.

### Seat Belt Warning Light



This warning light informs the driver that the seat belt is not fastened. For more details, refer to the “Seat Belts” in chapter 3.

### Parking Brake & Brake Fluid Warning Light



#### **This warning light illuminates:**

- Once you set the POWER button to the ON position.
  - It illuminates for approximately 3 seconds
  - It remains on if the parking brake is applied.
- When the parking brake is applied.
- When the brake fluid level in the reservoir is low.
  - If the warning light illuminates with the parking brake released, it indicates the brake fluid level in reservoir is low.

#### **If the brake fluid level in the reservoir is low:**

1. Drive carefully to the nearest safe location and stop your vehicle.
2. Turn the vehicle off, check the brake fluid level immediately and add fluid as required (For more details, refer to “Brake Fluid” in chapter 7).

Then check all brake components for fluid leaks. If any leaks in the brake system is still found, the warning light remains on, or the brakes do not operate properly, do not drive the vehicle.

In this case, have your vehicle towed to an authorized Kia dealer and inspected.

### Dual-diagonal braking system

Your vehicle is equipped with dual-diagonal braking systems. This means you still have braking on two wheels even if one of the dual systems should fail.

With only one of the dual systems working, more than normal pedal travel and greater pedal pressure are required to stop the vehicle.

Also, the vehicle will not stop in as short a distance with only a portion of the brake system working.

If the brakes fail while you are driving, shift to B position for additional engine braking and stop the vehicle as soon as it is safe to do so.

**⚠ WARNING - Parking Brake & Brake Fluid Warning Light**

**Driving the vehicle with a warning light ON is dangerous. If the Parking Brake & Brake Fluid Warning Light illuminates with the parking brake released, it indicates that the brake fluid level is low.**

**In this case, have your vehicle inspected by an authorized Kia dealer.**

### Anti-lock Brake System (ABS) Warning Light



#### This warning light illuminates:

- Once you set the POWER button to the ON position.
  - It illuminates for approximately 3 seconds and then goes off.
- When there is a malfunction with the ABS (The normal braking system will still be operational without the assistance of the anti-lock brake system).

In this case, have your vehicle inspected by an authorized Kia dealer.

**Electronic  
Brake force  
Distribution  
(EBD) System  
Warning Light**



**These two warning lights illuminate at the same time while driving:**

- When the ABS and regular brake system may not work normally.  
In this case, have your vehicle inspected by an authorized Kia dealer.

**▲ WARNING - Electronic  
Brake force Distribution  
(EBD) System Warning Light**

**When both ABS, Parking Brake, and Brake Fluid Warning Lights are on, the brake system will not work normally and you may experience an unexpected and dangerous situation during sudden braking thereby increasing the risk of a crash or injury.**

**In this case, avoid high speed driving and abrupt braking. Have your vehicle inspected by an authorized Kia dealer as soon as possible.**

**\* NOTICE - Electronic Brake  
force Distribution (EBD)  
System Warning Light**

**When the ABS Warning Light is on or both ABS and Parking Brake & Brake Fluid Warning Lights are on, the speedometer, odometer, or trip-meter may not work. Also, the EPS Warning Light may illuminate and the steering effort may increase or decrease.**

**In this case, have your vehicle inspected by an authorized Kia dealer as soon as possible.**

### **Electronic Power Steering (EPS) Warning Light**



#### **This warning light illuminates:**

- Once you set the POWER button to the ON position.
  - It remains on until the vehicle is in the ready (  ) mode.
- When there is a malfunction with the EPS.

In this case, have your vehicle inspected by an authorized Kia dealer.

### **Charging System Warning Light (for 12-volt battery)**



#### **This warning light illuminates:**

- When the 12-volt battery level is low or a failure occurs on the charging system such as LDC.
- If the warning light turns on while driving, move the vehicle to a safe location, turn off and turn on the vehicle again, and check if the warning light turns off. If the warning light remains on, In this case, have your vehicle inspected by an authorized Kia dealer.
- Even if the warning lamp turns off, have your vehicle inspected by an authorized Kia dealer.

If you drive the vehicle while the warning light is on, vehicle speed may be limited and the 12-volt battery may be discharged.

※ LDC : Low voltage DC-DC Converter.

### **Low Tire Pressure Warning Light**



#### **This warning light illuminates:**

- Once you set the POWER button to the ON position.
  - It illuminates for approximately 3 seconds and then goes off.
- When one or more of your tires are significantly underinflated.

For more details, refer to “Tire Pressure Monitoring System (TPMS)” in chapter 6.

This warning light remains on after blinking for approximately 60 seconds or repeats blinking and off at the intervals of approximately 3 seconds:

- When there is a malfunction with the TPMS.

In this case, have your vehicle inspected by an authorized Kia dealer as soon as possible.

For more details, refer to “Tire Pressure Monitoring System (TPMS)” in chapter 6.

**⚠ WARNING**  
- Low tire pressure

- **Significantly low tire pressure makes the vehicle unstable and can contribute to loss of vehicle control and increased braking distances.**
- **Continued driving or low pressure tires will cause the tires to overheat and fail.**

- The TPMS cannot alert you to severe and sudden tire damage caused by external factors.
- If you notice any vehicle instability, immediately take your foot off the accelerator pedal, apply the brakes gradually with light force, and slowly move to a safe position off the road.

***Door Ajar Warning Light***



**This warning light illuminates:**  
When a door is not closed securely.

***Tailgate Open Warning Light***



**This warning light illuminates:**  
When the tailgate is not closed securely.

### Indicator Lights

#### *Ready indicator light*



**This warning light illuminates :**

When the vehicle is ready to drive.

- ON: Normal driving is available.
- OFF: Normal driving is not available, or a failure has occurred.
- Blinking: Emergency driving.

When ready indicator light is OFF or blinking, there is a failure. In this case, have your vehicle inspected by an authorized Kia dealer.

#### *Charging indicator light*



**This warning light illuminates :**

This indicator light shows the charging status of the high voltage battery.

When it is charging, the red light turns ON. When charging is complete, the green light turns ON.

#### *Electronic Stability Control (ESC) Indicator Light*



**This indicator light illuminates:**

- Once you set the POWER button to the ON position.
  - It illuminates for approximately 3 seconds and then goes off.
- When there is a malfunction with the ESC system.

In this case, have your vehicle inspected by an authorized Kia dealer.

**This indicator light blinks:**

While the ESC is operating.

For more details, refer to “Electronic Stability Control (ESC)” in chapter 5.

### **Electronic Stability Control (ESC) OFF Indicator Light**



#### **This indicator light illuminates:**

- Once you set POWER button to the ON position.
  - It illuminates for approximately 3 seconds and then goes off.
- When you deactivate the ESC system by pressing the ESC OFF button.

For more details, refer to “Electronic Stability Control (ESC)” in chapter 5.

### **ECOMINDER® indicator Active ECO system**

**ECO**

#### **This indicator light illuminates:**

- The active ECO system always remembers the previous status before the vehicle was turned off.
- When the Active ECO button is pressed the ECOMINDER® indicator (green) will illuminate to show that the Active ECO is operating.
  - To turn off the Active ECO system, press the button again.

For more details, refer to "Active ECO system" in the chapter 5 or "Electric Vehicle Guide".

### **Immobilizer Indicator Light**



#### **This indicator light illuminates for up to 30 seconds:**

- When the vehicle detects the smart key in the vehicle properly while the POWER button is ACC or ON.
  - At this time, you can start the vehicle.
  - The indicator light goes off after the vehicle is in the ready (🚗) mode.

#### **This indicator light blinks for a few seconds:**

- When the smart key is not in the vehicle.
  - At this time, you can not start the vehicle.



### **This indicator light illuminates for 2 seconds and goes off:**

- When the vehicle can not detect the smart key which is in the vehicle while the POWER button is ON. In this case, have your vehicle inspected by an authorized Kia dealer.

### **This indicator light blinks:**

- When the battery of the smart key is weak.
  - At this time, you can not start the vehicle. However, you can start the vehicle if you press the POWER button with the smart key. (For more details, refer to “Starting the vehicle” in chapter 5).
- When there is a malfunction with the immobilizer system. In this case, have your vehicle inspected by an authorized Kia dealer.

### **Turn Signal Indicator Light**



### **This indicator light blinks:**

- When you turn the turn signal light on.

If any of the following occurs, there may be a malfunction with the turn signal system. In this case, have your vehicle inspected by an authorized Kia dealer.

- The indicator light does not blink but illuminates.
- The indicator light blinks more rapidly.
- The indicator light does not illuminate at all.

### **High Beam Indicator Light**



### **This indicator light illuminates:**

- When the headlights are on and in the high beam position
- When the turn signal lever is pulled into the Flash-to-Pass position.

### **Light ON Indicator Light**



### **This indicator light illuminates:**

- When the tail lights or headlights are on.

**Front Fog Indicator Light (if equipped)****This indicator light illuminates:**

- When the front fog lights are on.

**Cruise Indicator Light****This indicator light illuminates:**

- When the cruise control system is enabled.

For more details, refer to “Cruise Control System” in chapter 5.

**Cruise SET Indicator Light****This indicator light illuminates:**

- When the cruise control speed is set.

For more details, refer to “Cruise Control System” in chapter 5.

## PARKING ASSIST SYSTEM (IF EQUIPPED)

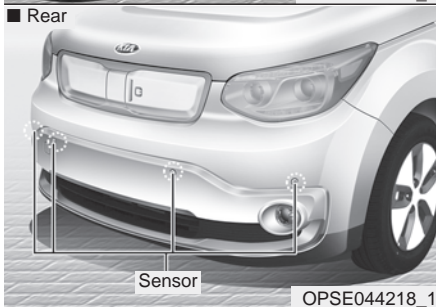
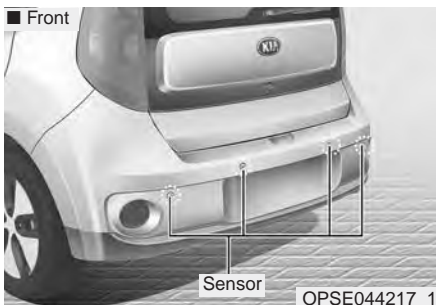

The Parking Assist System is not a substitute for proper and safe parking and backing-up procedures. Always drive safely and use caution when parking. The Parking Assist System may not detect every object behind or in front of the vehicle.

The parking assist system assists the driver during movement of the vehicle by chiming if any object is sensed within the distance of 39 in (100 cm) in front or 47in(120cm) behind the vehicle.

This system is a supplemental system and it is not intended to nor does it replace the need for extreme care and attention of the driver.

The sensing range and objects detectable by the sensors are limited. When the vehicle moving, pay attention to your surroundings.

### **⚠ WARNING - Parking Assist Warning**

**Never rely solely on the parking assist system when parking the vehicle. Always perform a visual inspection to make sure the vehicle is clear of all obstructions before moving the vehicle in any direction. Stop immediately if you are aware of a child anywhere near your vehicle. Some objects may not be detected by the sensors, due to the object's size or material.**

## Operation of the parking assist system

### Operating condition









- This system activates when the parking assist button is pressed with the POWER button ON.
- The parking assist button turns on automatically and activates the parking assist system when you shift the gear to the R (Reverse) position.

- The sensing distance while backing up is approximately 47 in. (120 cm) when you are driving less than 6.2 mph (10 km/h).
- The sensing distance while moving forward is approximately 39 in. (100 cm) when you are driving less than 6.2 mph (10 km/h).
- When more than two objects are sensed at the same time, the closest one will be recognized first.

**\* NOTICE**

The system may not detect and object if the distance from the object is already less than approximately 10 in. (25 cm) when the system is turned ON.

**Types of warning sound and indicator**

Distance from object		Warning indicator		Warning sound
		When driving forward	When driving rearward	
39 in. ~ 24 in. (100cm~60cm)	Front		-	Buzzer beeps intermittently
47 in. ~ 24 in. (120cm~60cm)	Rear	-		Buzzer beeps intermittently
24 in. ~ 12 in. (60cm~30cm)	Front			Buzzer beeps intermittently
	Rear	-		Buzzer beeps intermittently
12 in. (30cm)	Front			Buzzer sounds continuously
	Rear	-		Buzzer sounds continuously

**\* NOTICE**

The indicator may differ from the illustration as objects or sensors status. If the indicator blinks, the system should be checked by an authorized Kia dealer.

### **Non-operational conditions of parking assist system**

#### ***Parking assist system may not operate normally when:***

1. Moisture is frozen to the sensor. (It will operate normally when moisture melts.)
2. Sensor is covered with foreign matter, such as snow or water, or the sensor cover is blocked. (It will operate normally when the material is removed or the sensor is no longer blocked.)
3. Sensor is stained with foreign matter such as snow or water. (Sensing range will return to normal when removed.)
4. The parking assist button is off.

#### ***There is a possibility of parking assist system malfunction when:***

1. Driving on uneven road surfaces such as unpaved roads, gravel, bumps, or gradient.
2. Objects generating excessive noise such as vehicle horns, loud motorcycle engines, or truck air brakes can interfere with the sensor.
3. Heavy rain or water spray.
4. Wireless transmitters or mobile phones present near the sensor.
5. Sensor is covered with snow.

#### ***Detecting range may decrease when:***

1. Outside air temperature is extremely hot or cold.
2. Undetectable objects smaller than 39 in (1 m) and narrower than 5.5 in (14 cm) in diameter.

#### ***The following objects may not be recognized by the sensor:***

1. Sharp or slim objects such as ropes, chains or small poles.
2. Objects, which tend to absorb sensor frequency such as clothes, spongy material or snow.

#### **\* NOTICE**

1. **The warning may not sound sequentially depending on the speed and shapes of the objects detected.**
2. **The parking assist system may malfunction if the vehicle bumper height or sensor installation has been modified. Any non-factory installed equipment or accessories may also interfere with the sensor performance.**
3. **Sensor may not recognize objects less than 12 in (30 cm) from the sensor, or it may sense an incorrect distance. Use with caution.**

**(Continued)**

(Continued)

4. When the sensor is frozen or stained with snow or water, the sensor may be inoperative until the stains are removed using a soft cloth.
5. Do not push, scratch or strike the sensor with any hard objects that could damage the surface of the sensor. Sensor damage could occur.

### **\* NOTICE**

This system can only sense objects within the range and location of the sensors, it can not detect objects in other areas where sensors are not installed. Also, small or slim objects, or objects located between sensors may not be detected.

Always visually check in front and behind the vehicle when driving. Be sure to inform any drivers in the vehicle that may be unfamiliar with the system regarding the system's capabilities and limitations.

### **Self-diagnosis**

If you don't hear an audible warning sound or if the buzzer sounds intermittently when shifting the shift lever into the R (Reverse) position, this may indicate a malfunction in the parking assist system. If this occurs, have the system checked by an authorized Kia dealer.

Your new vehicle warranty does not cover any accidents or damage to the vehicle or injuries to its occupants related to a parking assist system. Always drive safely and cautiously.

## REAR CAMERA DISPLAY

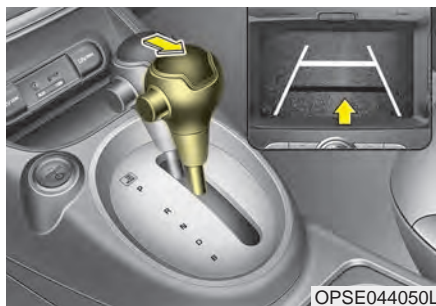

The rear camera display will activate when the back-up light is ON with the POWER button ON and the shift lever in the R (Reverse) position.

This system is a supplemental system that helps the driver by displaying objects behind the vehicle when backing up.

Always keep the camera lens clean. If lens is covered with foreign matter, the camera may not operate normally.

The rear camera display is not a safety device. It only serves to assist the driver in identifying objects directly behind the middle of the vehicle. The camera does NOT cover the complete area behind the vehicle. While the camera's display is generally accurate, objects can be much closer than they appear in the display screen and can be distorted in both size and proportion.

### **⚠ WARNING - Backing up using camera**

**Never rely solely on the rear camera display when backing. You must always use methods of viewing the area behind you including looking over both shoulders as well as continuously checking all three rear view mirrors. Due to the difficulty of ensuring that the area behind you remains clear, always back slowly and stop immediately if you even suspect that a person, and especially a child, might be behind you.**

## LIGHTING

### Headlamp escort (if equipped)

If you turn the POWER button to the ACC or OFF position with the headlights ON, the headlights remain on for about 5 minutes. However, if the driver's door is opened and closed, the headlights are turned off after 15 seconds.

The headlights can be turned off by pressing the lock button on the smart key twice or turning the light switch to the OFF or Auto position. However, if you turn the light switch to the Auto position when it is dark outside, the headlights will not be turned off immediately.

### Battery saver function

- The purpose of this feature is to prevent the battery from being discharged. The system automatically turns off the parking lights when the driver turns the vehicle off and opens the driver-side door (in that order).
- With this feature, the parking lights will turn off automatically if the driver parks on the side of the road at night.

If necessary, to keep the lights on when the vehicle is turned off, perform the following:

- 1) Open the driver-side door.
- 2) Turn the parking lights OFF and ON again using the light switch on the steering column.

### Daytime running light (if equipped)

The Daytime Running Lights (DRL) can make it easier for others to see the front of your vehicle during the day. DRL can be helpful in many different driving conditions, and it is especially helpful after dawn and before sunset.

The DRL system turns OFF when:

1. The headlight switch is ON.
2. The engine is OFF.
3. The front fog light is ON.
4. Engaging the Parking Brake



### Abnormal lamp operation

If there is a problem with the electric communication system in the vehicle, the position light and fog light will not turn on even though, the parking light and front fog light switch is turned to the ON position. However, when the headlight switch is turned to the ON position, the position light and fog light will turn on.

### Abnormal lamp operation due to stabilization of electric control system

Blinking may occur on a normally operating lamp. This symptom occurs due to stabilization of the electric control system. There is no problem with the vehicle if the lamp turns back on after blinking.

However, if the lamp turns off after blinking or the symptom above occurs repeatedly, there may be a failure in the electric control system. If this is the case, contact an authorized Kia dealer and have the system checked.

### Lighting control



The light switch has a Headlight and a Parking light position.

To operate the lights, turn the knob at the end of the control lever to one of the following positions:

- (1) OFF position
- (2) Parking light position
- (3) Headlight position
- (4) Auto light position (if equipped)

**Parking light position (☀️)**

When the light switch is in the parking light position (1st position), the tail, license and instrument panel lights will turn ON.

**Headlight position (☀️)**

When the light switch is in the headlight position (2nd position), the head, tail, license and instrument panel lights will turn ON.

The POWER button must be in the ON position to turn on the headlights.

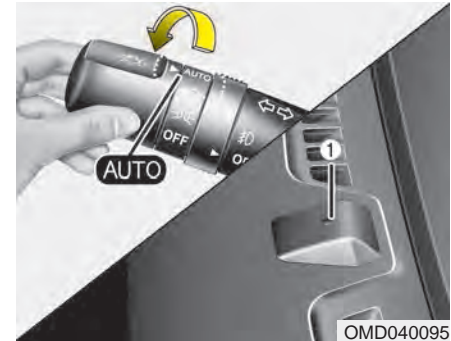
**Auto light position**

When the light switch is in the AUTO light position, the taillights and headlights will be turned ON or OFF automatically depending on the amount of light outside the vehicle.

- Never place anything over sensor (1) located on the instrument panel. This will ensure better auto-light system control.
- Don't clean the sensor using a window cleaner. The cleaner may leave a light film which could interfere with sensor operation.
- If your vehicle has window tint or other types of metallic coating on the front windshield, the Auto light system may not work properly.

### High beam operation



To turn on the high beam headlights, push the lever away from you. Pull it back for low beams.

The high beam indicator will light when the headlight high beams are switched on.

To prevent the battery from being discharged, do not leave the lights on for a prolonged time while the vehicle is not in the ready (🚗) mode.



To flash the headlights, pull the lever towards you. It will return to the normal (low beam) position when released. The headlight switch does not need to be on to use this flashing feature.

**⚠ WARNING - High beams**  
**Do not use high beam when there are other vehicles. Using high beam could obstruct the other driver's vision.**

## Turn signals and lane change signals

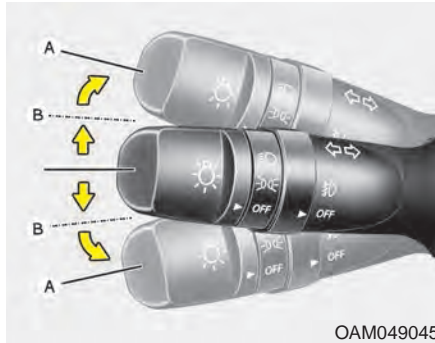

The POWER button must be on for the turn signals to function. To turn on the turn signals, move the lever up or down (A). The green arrow indicators on the instrument panel indicate which turn signal is operating. They will self-cancel after a turn is completed. If the indicator continues to flash after a turn, manually return the lever to the OFF position.

To signal a lane change, move the turn signal lever slightly and hold it in position (B). The lever will return to the OFF position when released.

If an indicator stays on and does not flash or if it flashes abnormally, one of the turn signal bulbs may be burned out and will require replacement.

If an indicator flash is abnormally quick or slow, a bulb may be burned out or have a poor electrical connection in the circuit.

### *One-touch lane change function (if equipped)*

To activate an one-touch lane change function, move the turn signal lever slightly and then release it. The lane change signals will blink 3, 5 or 7 times.

You can choose one-touch lane change blinking function in "One touch turn lamp" of "User setting". Refer to "User setting" in chapter 4.

### **\* NOTICE**

**If an indicator flash is abnormally quick or slow, the bulb may be burned out or have a poor electrical connection in the circuit.**

### Front fog light (if equipped)



Fog lights are used to provide improved visibility when visibility is poor due to fog, rain or snow, etc. The fog lights will turn on when the fog light switch (1) is turned to the on position after the headlight is turned on.

To turn off the fog lights, turn the fog light switch (1) to the OFF position.

When in operation, the fog lights consume large amounts of vehicle electrical power. Only use the fog lights when visibility is poor.

## WIPERS AND WASHERS

### Windshield wiper/washer

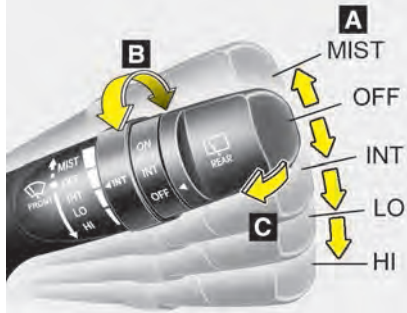

#### A : Wiper speed control

- MIST – Single wipe
- OFF – Off
- INT – Intermittent wipe
- LO – Low wiper speed
- HI – High wiper speed

#### B : Intermittent wipe time adjustment

#### C : Wash with brief wipes (front)

### Rear window wiper/washer

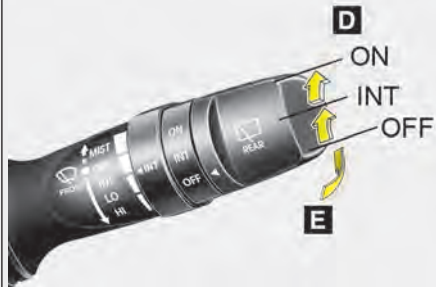

OAM049100N/OAM049048N

#### D : Rear wiper/washer control

- ON – Continuous wipe
- INT – Intermittent wipe (if equipped)
- OFF – Off

#### E : Wash with brief wipes (rear)

### Windshield wipers

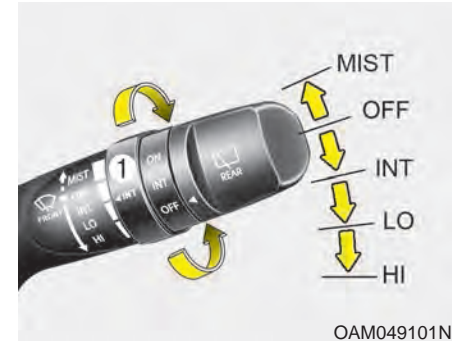

OAM049101N

Operates as follows when the POWER button is turned ON.

**MIST** : For a single wiping cycle, push the lever upward and release it with the lever in the OFF position. The wipers will operate continuously if the lever is pushed upward and held.

**OFF** : Wiper is not in operation

**INT** : Wiper operates intermittently at the same wiping intervals. Use this mode in light rain or mist. To vary the speed setting, turn the speed control knob (1).

LO : Normal wiper speed

HI : Fast wiper speed

### \* NOTICE

If there is heavy accumulation of snow or ice on the windshield, defrost the windshield for about 10 minutes, or until the snow and/or ice is removed before using the windshield wipers to ensure proper operation.

### Windshield washers



In the OFF position, pull the lever gently toward you to spray washer fluid on the windshield and to run the wipers 1-3 cycles.

Use this function when the windshield is dirty.

The spray and wiper operation will continue until you release the lever.

If the washer does not work, check the washer fluid level. If the fluid level is not sufficient, you will need to add appropriate non-abrasive windshield washer fluid to the washer reservoir.

The reservoir filler neck is located in the front of the motor compartment on the passenger side.

**⚠ CAUTION - Washer pump**  
*To prevent possible damage to the washer pump, do not operate the washer when the fluid reservoir is empty.*

**⚠ WARNING - Obscured visibility**  
**Do not use the washer in freezing temperatures without first warming the windshield with the defrosters; the washer solution could freeze on the windshield and obscure your vision.**

**⚠ CAUTION - Wipers & windshields**

- *To prevent possible damage to the wipers or windshield, do not operate the wipers when the windshield is dry.*
- *To prevent damage to the wiper blades, do not use gasoline, kerosene, paint thinner, or other solvents on or near them.*
- *To prevent damage to the wiper arms and other components, do not attempt to move the wipers manually.*

**Rear window wiper and washer switch**

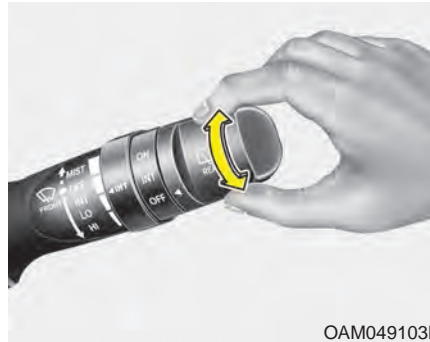

The rear window wiper switch is located at the end of the wiper and washer switch lever. Turn the switch to the desired position to operate the rear wiper and washer.

ON - Normal wiper operation

INT - Intermittent wiper operation  
(if equipped)

OFF - Wiper is not in operation



Push the lever away from you to spray rear washer fluid and to run the rear wipers 1~3 cycles. The spray and wiper operation will continue until you release the lever.



## INTERIOR LIGHT

Do not use the interior lights for extended periods when the vehicle is not in the ready (🚗) mode.

It may cause battery discharge.

**⚠ WARNING - Interior light**  
Do not use the interior lights when driving in the dark. The glare from the interior lights may obstruct your view and cause an accident.

### Interior lamp AUTO cut

- When all entrances are closed, if you lock the vehicle by using the smart key, all interior lamp will be off after a few seconds.
- If you do not operate anything in the vehicle after turning off the POWER button, the lights will turn off after 20 minutes.

### Map lamp



Press the lens (1) or button (1) to turn the map lamp on or off.

### • ROOM (2) :

- The map lamp and room lamp stays on at all times.
- To turn off the ROOM mode, press the ROOM button (2) once again (not pressed.)

- DOOR (3) :

- The map lamp and room lamp comes on when a door is opened. The lamps go out after approximately 30 seconds.
- The map lamp and room lamp comes on for approximately 30 seconds when doors are unlocked with a smart key as long as the doors are not opened.
- The map lamp and room lamp will stay on for approximately 20 minutes if a door is opened with the POWER button in the ACC or LOCK/OFF position.
- The map lamp and room lamp will stay on continuously if the door is opened with the POWER button in the ON position.
- The map lamp and room lamp will go out immediately if the POWER button is changed to the ON position or all doors are locked.
- To turn off the DOOR mode, press the DOOR button (3) once again (not pressed).

- **\* NOTICE**

- **When the lamp is turned on by pressing the lens (1), the lamp does not turn off even if the DOOR mode or ROOM mode is not selected (not pressed).**
- **If the ROOM button and DOOR button are pressed at the same time, the map lamp and room lamp will stay on at all times (ROOM mode will be selected).**

## Room lamp

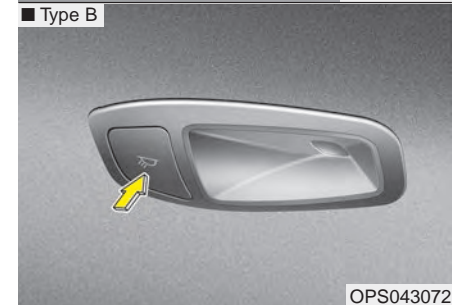

Press the button to turn the light on or off.

If the front map lamp turns on by the front map lamp switch, the room lamp will turn on.

## Luggage room lamp

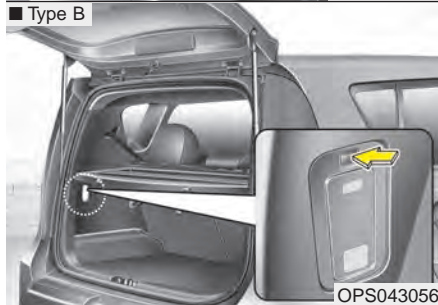
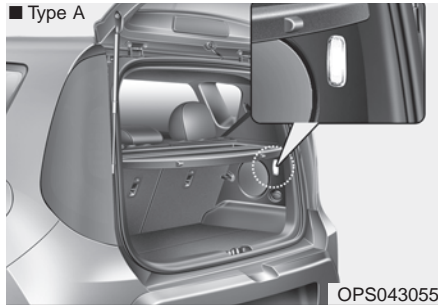

The luggage room lamp comes on when the tailgate is opened.

The lamp comes on as long as the tailgate is open. To prevent unnecessary charging system drain, close the tailgate securely after using the luggage room.

## Glove box lamp

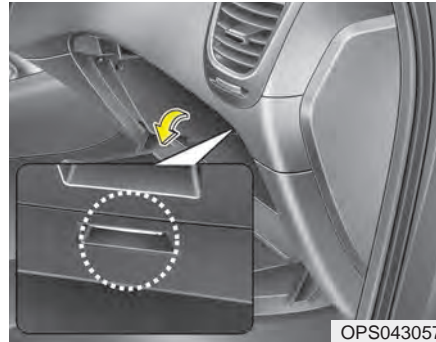

The glove box lamp comes on when the glove box is opened.

To prevent unnecessary charging system drain, close the glove box securely after using the glove box.

## Vanity mirror lamp



Pull the sunvisor downward and you can turn the vanity mirror lamp ON or OFF by pushing the button.

- ☺ : To turn the lamp ON.
- ○ : To turn the lamp OFF.

To prevent unnecessary charging system drain, turn off the lamp by pushing the O button after using the lamp.

## DEFROSTER

### ⚠ CAUTION - Conductors

*To prevent damage to the conductors bonded to the inside surface of the rear window, never use sharp instruments or window cleaners containing abrasives to clean the window.*

### \* NOTICE

If you want to defrost and defog the front windshield, refer to “Windshield defrosting and defogging” in this section.

### Rear window defroster

#### ■ Type A



#### ■ Type B

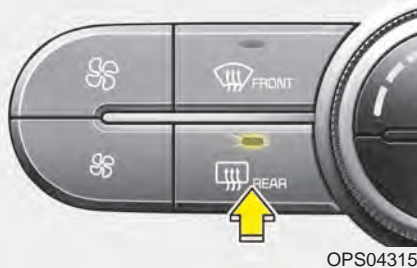

The defroster heats the window to remove frost, fog and thin ice from the rear window, while the vehicle is in the ready (🚗) mode.

To activate the rear window defroster, press the rear window defroster button located in the center facia switch panel.

The indicator on the rear window defroster button illuminates when the defroster is ON.

If there is heavy accumulation of snow on the rear window, brush it off before operating the rear defroster.

The rear window defroster automatically turns off after approximately 20 minutes or when the POWER button is turned off. To turn off the defroster, press the rear window defroster button again.

### *Outside rearview mirror defroster*

If your vehicle is equipped with the outside rearview mirror defrosters, they will operate at the same time you turn on the rear window defroster.

## AUTOMATIC CLIMATE CONTROL SYSTEM

### ■ Type A



1. Fan speed control button
2. Front windshield defroster button
3. Rear windshield defroster button
4. Temperature control knob/button
5. AUTO (automatic control) button
6. OFF button
7. HEAT button
8. Air conditioning button
9. Climate control information screen selection button
10. Mode selection button
11. Driver Only button
12. Air intake control button
13. Climate control timer
14. Climate control display

### ■ Type B



OPSE045310N/OPSE044162N

## Automatic heating and air conditioning

### ■ Type A



### ■ Type B



1. Push the AUTO button. It is indicated by AUTO on the display. The modes, fan speeds, air intake, air conditioning and heater will be controlled automatically by temperature setting.

### ■ Type A

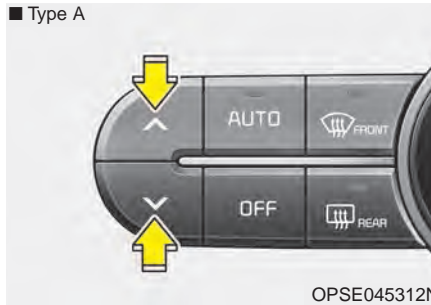

### ■ Type B

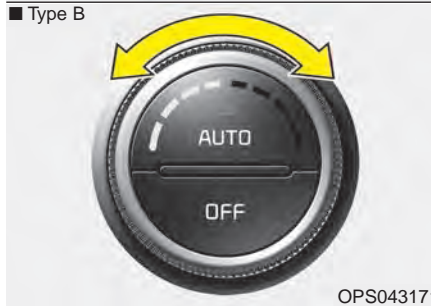

2. Push the temperature control button to set the desired temperature. (Type A)

Turn the temperature control knob to set the desired temperature. (Type B)

## \* NOTICE

• To turn the automatic operation off, select any button or switch of the following:

- Mode selection button
  - Air conditioning (A/C) button
  - Heater (HEAT) button
  - DRIVER ONLY button
  - Front windshield defroster button (Press the button one more time to deselect the front windshield defroster function. The 'AUTO' sign will illuminate on the information display once again.)
  - Air intake control button
  - Fan speed control switch
- The selected function will be controlled manually while other functions operate automatically.

• Regardless of the temperature setting, when using automatic operation, the air conditioning system can automatically turn on to decrease the humidity inside the vehicle, even if the temperature is set to warm.

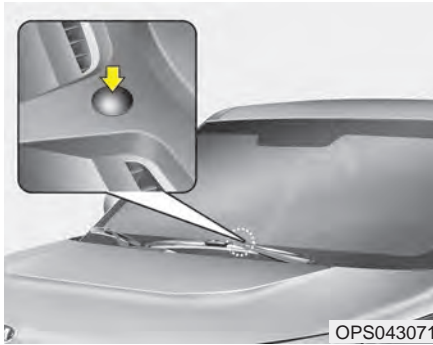

Never place anything over the sensor located on the instrument panel to ensure better control of the heating and cooling system.

### **Manual heating and air conditioning**

The heating and cooling system can be controlled manually by pushing buttons other than the AUTO button. In this case, the system works sequentially according to the order of buttons selected.

When pressing any button (or turning any knob) except AUTO button while automatic operation, the functions not selected will be controlled automatically.

1. Start the vehicle.
2. Set the mode to the desired position.
3. Set the temperature control to the desired position.
4. Set the air intake control to the outside (fresh) air position.
5. Set the fan speed control to the desired speed.
6. If air conditioning is desired, turn the air conditioning system on.
7. If heater is desired, press the HEAT button.

Press the AUTO button in order to convert to full automatic control of the system.



**Mode selection**

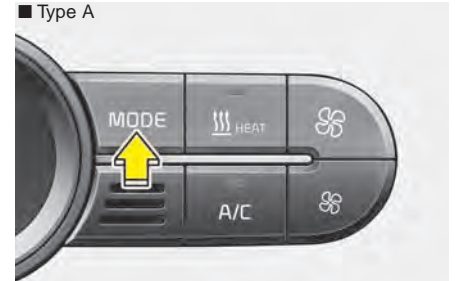

OPSE045313N

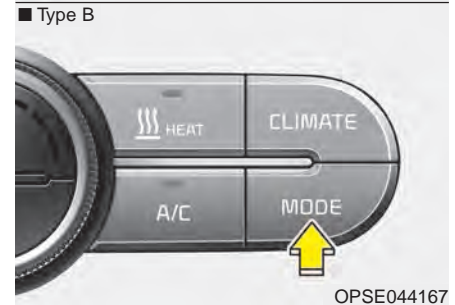

OPSE044167

The mode selection button controls the direction of the air flow through the ventilation system.

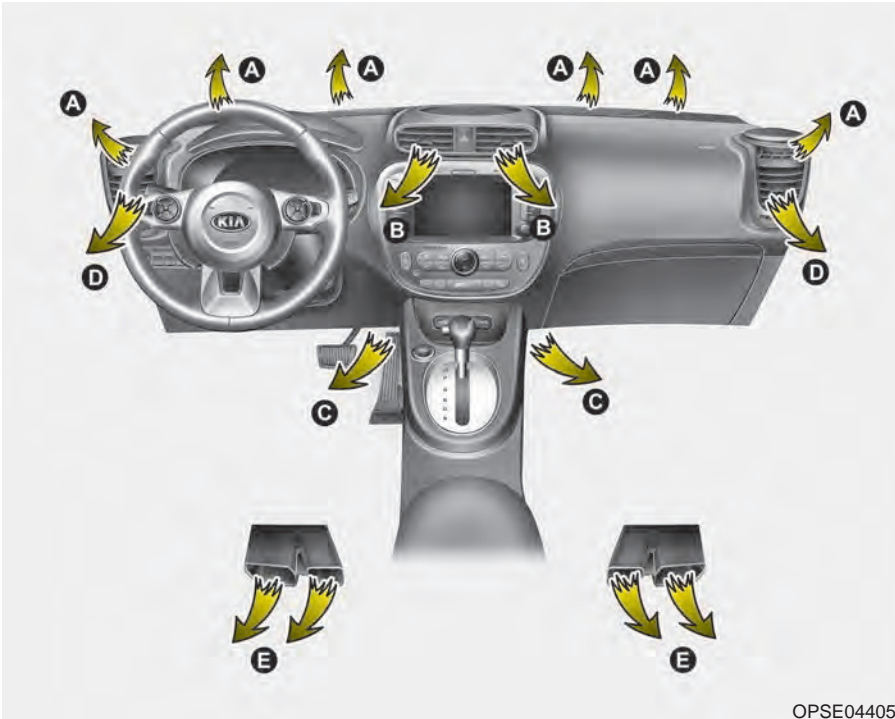

OPSE044058



The air flow outlet port is converted as follows:



 **Vent mode (B, D)**

Air flow is directed toward the upper body and face. Additionally, each outlet can be controlled to direct the air discharged from the outlet.

 **Floor mode (C, E, A, D)**

Most of the air flow is directed to the floor, with a small amount of the air being directed to the windshield and side window defroster.

 **Vent-Floor mode (B, D, C, E)**

Air flow is discharged towards the face and floor.

 **Floor/Defrost mode (A, C, E, D)**

Most of the air flow is directed to the floor and the windshield with a small amount directed to the side window defrosters.

■ Type A



OPSE045314N

■ Type B



OPS043169

**Defrost mode (A, D)**

Most of the air flow is directed to the windshield with a small amount of air directed to the side window defrosters.

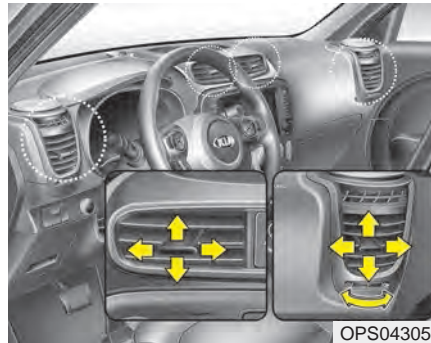

OPS043059

**Instrument panel vents**

The outlet port can be opened or closed separately using the thumbwheel.

Also, you can adjust the direction of air delivered from these vents using the vent control lever as shown.

**Temperature control**

■ Type A

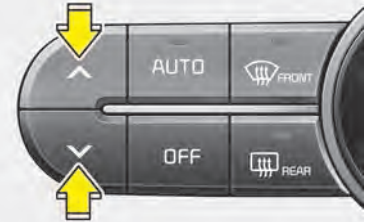

OPSE045312N

■ Type B



OPS043171

• **Type A**

The temperature will increase to the maximum (90°F(32°C)) by pushing the button (∧).

The temperature will decrease to the minimum (62°F(17°C)) by pushing the button (V).

When pushing the button, the temperature will increase or decrease by 0.5°C/1°F. When set to the lowest temperature setting, the air conditioning will operate continuously.

### • Type B

The temperature will increase to the maximum (90°F(32°C)) by turning the knob to the right extremely.

The temperature will decrease to the minimum (62°F(17°C)) by turning the knob to the left extremely.

When turning the knob, the temperature will increase or decrease by 0.5°C/1°F. When set to the lowest temperature setting, the air conditioning will operate continuously.

### Temperature scale conversion

If the battery has been discharged or disconnected, the temperature mode display will reset to Centigrade.

This is normal condition. You can switch the temperature scale as follows;

While pressing the AUTO button, press the OFF button for 3 seconds or more. The temperature scale will change from Centigrade to Fahrenheit, or from Fahrenheit to Centigrade.

The temperature unit (from °C to °F or from °F to °C) can be changed by using the “User Settings” mode of the LCD display.

\* You change the temperature unit, the temperature unit on the instrument cluster is changed as well.

### Air intake control

■ Type A



OPSE045315N

■ Type B



OPSE044173N

This is used to select outside (fresh) air position or recirculated air position. To change the air intake control position, push the control button.

### Recirculated air position



The indicator light on the button illuminates when the recirculated air position is selected.

With the recirculated air position selected, air from passenger compartment will be drawn through the heating system and heated or cooled according to the function selected.

- \* According to the outside temperature if the recirculation air position is on for a long time, the air intake position will automatically change to the outside (fresh) air position to ventilate the inside air.

### Outside (fresh) air position



The indicator light on the button does not illuminate when the outside (fresh) air position is selected.

With the outside (fresh) air position selected, air enters the vehicle from outside and is heated or cooled according to the function selected.

#### **⚠ WARNING - Recirculated air**

**Continuous use of the climate control system in the recirculated air position can cause drowsiness or sleepiness, and loss of vehicle control. Set the air intake control to the outside (fresh) air position as much as possible while driving.**

#### **⚠ WARNING - Reduced visibility**

**Continued climate control system operation in the recirculated air position may allow humidity to increase inside vehicle which may fog the glass and obscure visibility.**

**⚠ WARNING - Sleeping with AC On**  
Do not sleep in a vehicle with the air conditioning or heating system on as this may cause serious harm or death due to a drop in the oxygen level and/or body temperature.

It should be noted that prolonged operation of the heating in recirculated air position will cause fogging of the windshield and side windows and the air within the passenger compartment will become stale.

In addition, prolonged use of the air conditioning with the recirculated air position selected, will result in excessively dry air in the passenger compartment.

### Fan speed control

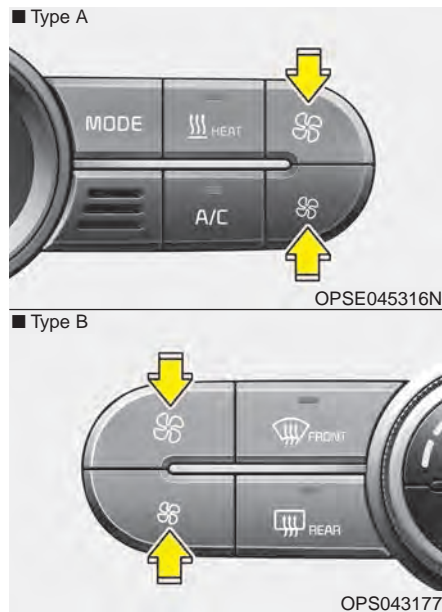

To change the fan speed, press the button (⌘) for higher speed, or push the button (⌘) for lower speed. To turn the fan speed control off, press the OFF button and select outside (fresh) air position.

The fan speed can be set to the desired speed by pressing the fan speed control button.

**Air conditioning**

■ Type A



OPSE045317N

■ Type B



OPSE044175

Push the A/C button to turn the air conditioning system on (indicator light will illuminate).

Push the button again to turn the air conditioning system off.

- Air conditioner/Heater uses energy from the battery. If you use the heater or air conditioner for too long, distance to empty can be reduced due to too much power consumption. Turn off the heater and air conditioner if you do not need them.

**HEAT Button**

■ Type A



OPSE045318N

■ Type B

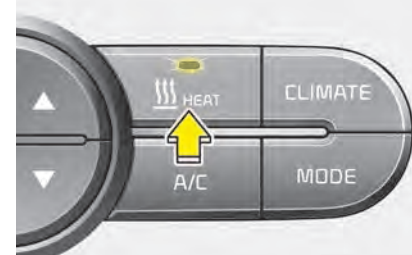

OPSE044253L

Push the HEAT button to turn the heater on (indicator light will illuminate). Push the button again to turn the heater off.

- Air conditioner/Heater uses energy from the battery. If you use the heater or air conditioner for too long, distance to empty can be reduced due to too much power consumption. Turn off the heater and air conditioner if you do not need them.

### Driver Only Button

#### ■ Type A





OPSE045319N

#### ■ Type B



OPSE044254L

If you press the driver seat air conditioning button and the indicator lamp inside the button turns on, cool air blows only in the driver's seat. If you use it when there is no passenger on the front passenger seat, you can increase the distance to empty.

If you select the driver seat air conditioning in the front windshield defrost mode (  ,  ) air comes out from both left and right sides on the front windshield.

**Reserved Climate Control Button  
(if equipped)**



If you press the reserved climate control button (⌚), the indicator lamp inside the button blinks three times and the settings for reserved climate control is displayed on AVN.

For details on how to set reserved climate control, refer to the AVN manual that is provided separately.

When reserved climate control is set and the charging cable is connected, the climate control begins operating 30 minutes before the set time (departure time).

The indicator lamp lighting conditions

1. Blinking three times:  
When you press the reserved climate control button and enter the corresponding settings screen on AVN
2. Remaining turned on:  
When reserved climate control is set
3. Blinking continuously:  
When the climate control is operating (operates only when the charging cable is connected)

**Blower OFF**

■ Type A



■ Type B



Push the OFF button to turn off the blower. However you can still operate the mode and air intake buttons as long as the POWER button is in the position ON.



## Climate information screen selection (if equipped)

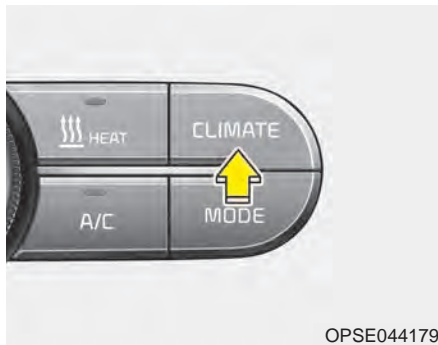

Press the climate information screen selection button to view climate information in full screen mode.

## Automatic Ventilation

When operating the heater and air conditioner with the ventilation mode on at low temperature for more than 30 minutes, the ventilation mode is automatically switched to the outside air mode for the ventilation of the passenger compartment.

### How to cancel or reset the Automatic Ventilation

To cancel or reset the Automatic Ventilation, Press the recirculated air position button more than five times within 3 seconds after selecting Face Level mode and pressing the A/C button while the heater or A/C is on.

When the automatic ventilation is canceled, the recirculated air position indicator blinks 3 times every 0.5 seconds and wind direction, air volume, recirculated/ outside air positions and air conditioner are automatically controlled.

When the automatic ventilation system is set, the recirculated air position button blinks 6 times every 0.25 seconds and wind direction, air volume, recirculated/ outside air positions and air conditioner are controlled automatically.



If the battery is discharged or disconnected, the automatic ventilation function will be reset. In such cases, the function should be adjusted accordingly.

## System operation

### Ventilation

1. Set the mode to the  position.
2. Set the air intake control to the outside (fresh) air position.
3. Set the temperature control to the desired position.
4. Set the fan speed control to the desired speed.

### Heating

1. Set the mode to the  position.
2. Set the air intake control to the outside (fresh) air position.
3. Set the temperature control to the desired position.
4. Set the fan speed control to the desired speed.
5. If dehumidified heating is desired, turn the air conditioning system on.
  - If the windshield fogs up, set the mode to the  or  position.

### Operation Tips

- To keep dust or unpleasant fumes from entering the vehicle through the ventilation system, temporarily set the air intake control to the recirculated air position. Be sure to return the control to the fresh air position when the irritation has passed to keep fresh air in the vehicle. This will help keep the driver alert and comfortable.
- Air for the heating/cooling system is drawn in through the grilles just ahead of the windshield. Care should be taken that these are not blocked by leaves, snow, ice or other obstructions.
- To prevent interior fog on the windshield, set the air intake control to the fresh air position and fan speed to the desired position, turn on the air conditioning system, and adjust the temperature control to desired temperature.

### Air conditioning

All Kia Air Conditioning Systems are filled with R-134a refrigerant.

1. Start the vehicle. Press the air conditioning button.
  2. Set the mode to the  position.
  3. Set the air intake control to the outside air or recirculated air position.
  4. Adjust the fan speed control and temperature control to maintain maximum comfort.
- When maximum cooling is desired, set the temperature control to the extreme left position, set the mode control to the MAX A/C position, then set the fan speed control to the highest speed.

### **CAUTION - Excessive A/C**

- *When using the air conditioning system, monitor the coolant closely while driving up hills or in heavy traffic when outside temperatures are high. Air conditioning system operation may cause overheating. Continue to use the blower fan but turn the air conditioning system off if the engine coolant temperature gauge indicates overheating.*
- *When opening the windows in humid weather air conditioning may create water droplets inside the vehicle. Since excessive water droplets may cause damage to electrical equipment, air conditioning should only be used with the windows closed.*

### **Air conditioning system operation tips**

- If the vehicle has been parked in direct sunlight during hot weather, open the windows for a short time to let the hot air inside the vehicle escape.
- To help reduce moisture inside of the windows on rainy or humid days, decrease the humidity inside the vehicle by operating the air conditioning system.
- During air conditioning system operation, you may occasionally notice a slight change in vehicle speed as the air conditioning compressor cycles. This is a normal system operation characteristic.
- Use the air conditioning system every month only for a few minutes to ensure maximum system performance.
- When using the air conditioning system, you may notice clear water dripping (or even puddling) on the ground under the passenger side of the vehicle. This is a normal system operation characteristic.
- Operating the air conditioning system in the recirculated air position provides maximum cooling, however, continual operation in this mode may cause the air inside the vehicle to become stale.
- During cooling operation, you may occasionally notice a misty air flow because of rapid cooling and humid air intake. This is a normal system operation characteristic.

## Climate control air filter (if equipped)

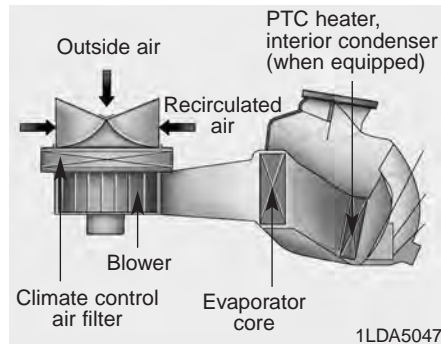

The climate control air filter installed behind the glove box filters the dust or other pollutants that come into the vehicle from the outside through the heating and air conditioning system. If dust or other pollutants accumulate in the filter over a period of time, the air flow from the air vents may decrease, resulting in moisture accumulation on the inside of the windshield even when the outside (fresh) air position is selected. If this happens, have the climate control air filter replaced by an authorized Kia dealer.

## \* NOTICE

- Replace the filter every 15,000 miles or once a year. **If the vehicle is being driven in severe conditions such as dusty or rough roads, more frequent air conditioner filter inspections and changes are required.**
- **When the air flow rate suddenly decreases, the system should be checked at an authorized Kia dealer.**

## Checking the amount of air conditioner refrigerant and compressor lubricant

When the amount of refrigerant is low, the performance of the air conditioning is reduced. Overfilling also has a negative impact on the air conditioning system.

(Heater performance as well as air conditioner performance can be deteriorated on the vehicle that is equipped with a heat pump.)

Therefore, if abnormal operation is found, have the system inspected by an authorized Kia dealer.

**⚠ WARNING**

The air conditioning system for the Electric Vehicle (EV) should be serviced by an authorized Kia dealer. The Electric Vehicle (EV) air conditioning system is connected to the high voltage system and requires special fluids, tools and service procedures. Improperly servicing the Electric Vehicle (EV) air conditioning system could result in electrical shock, serious injury, or even death.

**⚠ WARNING**

The oil and refrigerant in your vehicle's air conditioning system is under very high pressure. If proper service procedures are not followed an explosion may result. To reduce the risk of serious injury or death, the air conditioning system in your vehicle should only be serviced by trained and certified technicians.

**⚠ CAUTION - AC Repair**

*It is important that the correct type and amount of oil and refrigerant is used, otherwise damage to the vehicle and injury may occur. To prevent damage, the air conditioning system in your vehicle should only be serviced by trained and certified technicians.*

**Air Conditioning refrigerant label**

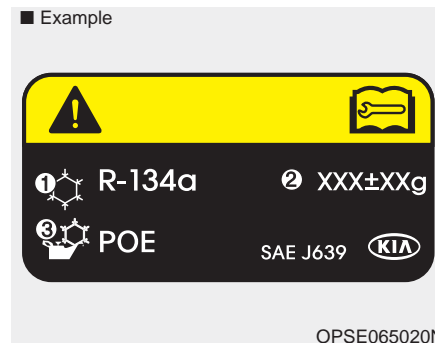

\* The actual Air Conditioning refrigerant label in the vehicle may differ from the illustration.



Each symbols and specification on air conditioning refrigerant label means as below ;

- 1. Classification of refrigerant
- 2. Amount of refrigerant
- 3. Classification of Compressor lubricant

Refer to chapter 8 for more detail location of air conditioning refrigerant label.

## WINDSHIELD DEFROSTING AND DEFOGGING

### **⚠ WARNING - Windshield heating**

Do not use the  or  position during cooling operation in extremely humid weather. The difference between the temperature of the outside air and that of the windshield could cause the outer surface of the windshield to fog up, causing loss of visibility. In this case, set the mode selection knob or button to the  position and fan speed control knob or button to the lower speed.

- For maximum defrosting, set the temperature control to the extreme right/hot position and the fan speed control to the highest speed.
- If warm air to the floor is desired while defrosting or defogging, set the mode to the floor-defrost position.
- Before driving, clear all snow and ice from the windshield, rear window, outside rear view mirrors, and all side windows.
- Clear all snow and ice from the hood and air inlet in the cowl grille to improve heater and defroster efficiency and to reduce the probability of fogging up inside of the windshield.

### Automatic climate control system

#### *To defog inside windshield*

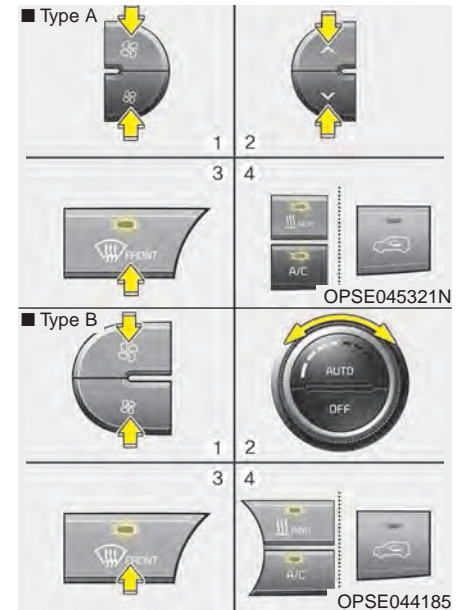

1. Set the fan speed to the desired position.
2. Select desired temperature.

3. Press the defrost button (  ).
4. The air-conditioning and heater will be turned on according to the detected ambient temperature, outside (fresh) air position and higher fan speed will be selected automatically.

If the air-conditioning and heater, outside (fresh) air position and higher fan speed are not selected automatically, adjust the corresponding button or knob manually.

If the  position is selected, with a low fan speed, a higher fan speed may be automatically selected.

### To defrost outside windshield

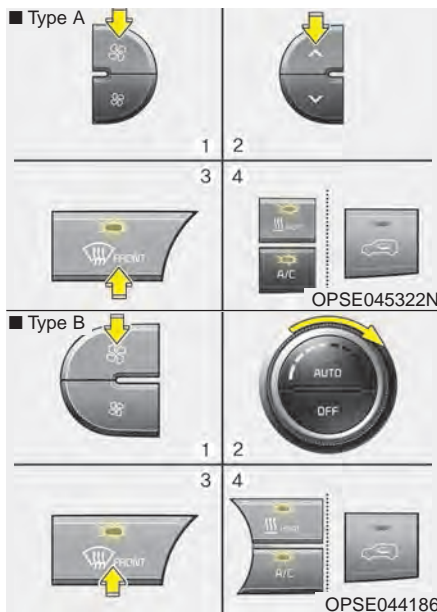



1. Set fan speed to the highest position.
2. Set temperature to the Maximum (90°F(32°C)).



3. Press the defrost button (  ).
4. The air-conditioning and heater will be turned on according to the detected ambient temperature and outside (fresh) air position will be selected automatically.

If the  position is selected, with a low fan speed, a higher fan speed may be automatically selected.

## Defogging logic

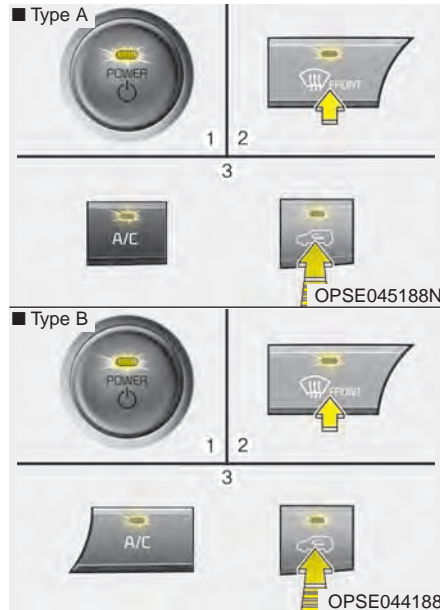
To reduce the possibility of fogging up the inside of the windshield, the air intake or air-conditioning and heater are controlled automatically according to certain conditions such as  or  position. To cancel or return to the defogging logic, do the following.



1. Turn the POWER button to the ON position.
2. Press the defrost button (.
3. While pressing the air conditioning button (A/C), press the air intake control button () at least 5 times within 3 seconds.

The indicator on the air intake button blinks 3 times with 0.5 seconds of interval. It indicates that the defogging logic is canceled or returned to the programmed status.

If the battery has been discharged or disconnected, it will be reset to the defog logic status.



## CLEAN AIR



When the POWER button is in the ON position, the clean air function turns on automatically.

Also, the clean air function turns off automatically, when the POWER button turns to the OFF position.

## AUTO DEFOGGING SYSTEM

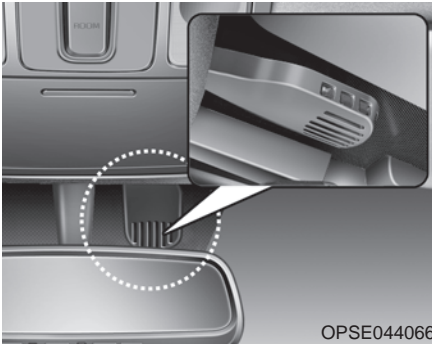

OPSE044066

Auto defogging reduces the possibility of fogging up the inside of the windshield by automatically sensing the moisture of inside the windshield.

The auto defogging system operates when the AUTO mode is on.



This indicator illuminates when the auto defogging system senses the moisture of inside the windshield and operates.

If more moisture is in the vehicle, higher steps operate as follow.

- Step 1 : Outside air position
- Step 2 : Operating the air conditioning
- Step 3 : Blowing air flow toward the windshield
- Step 4 : Increasing air flow toward the windshield

If your vehicle is equipped with the auto defogging system, it is automatically activated when the conditions are met. However, if you would like to cancel the auto defogging system, press the front defroster button more than 3 seconds. To use the system, repeat the above procedure again.

- When cancelled : The indicator in the front defroster button will blink 3 times (interval of 1 seconds) to notify you that the system is cancelled.
- When activated : The indicator in the front defroster button will blink 6 times (interval of 0.5 seconds) to notify you that the system is set.

If the battery has been disconnected or discharged, it resets to the auto defogging status.

### \* NOTICE

If the A/C off is manually selected while the auto defogging system is on, the auto defogging indicator will blink 3 times to give notice that the A/C off can not be selected.

## STORAGE COMPARTMENT

These compartments can be used to store small items.

- To avoid possible theft, do not leave valuables in the storage compartment.
- Always keep the storage compartment covers closed while driving. Do not attempt to place so many items in the storage compartment that the storage compartment cover cannot close securely.

**⚠ WARNING - Flammable materials**

**Do not store, propane cylinders or other flammable/explosive materials in the vehicle. These items may catch fire and/or explode if the vehicle is exposed to hot temperatures for extended periods.**

### Center console storage

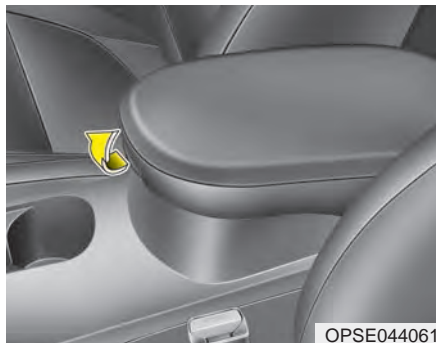

These compartments can be used to store small items required by the driver or front passenger.

To open the center console storage, pull up the lever.

### Glove box

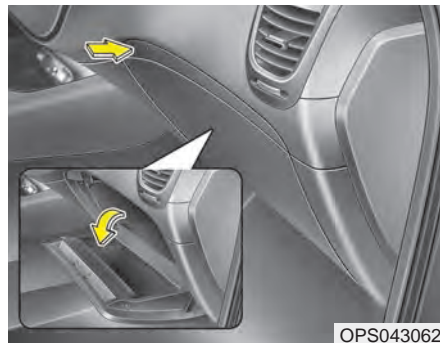

To open the glove box, push the button and the glove box will automatically open. Close the glove box after use.

Always keep the glove box closed while the vehicle is in operation.

**⚠ WARNING - Glove box**

**To reduce the risk of injury in an accident or sudden stop, always keep the glove box door closed while driving.**

## Sunglass holder

### ■ Type A

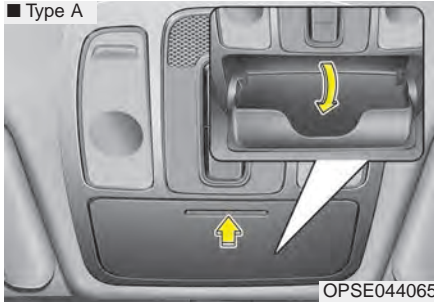

### ■ Type B

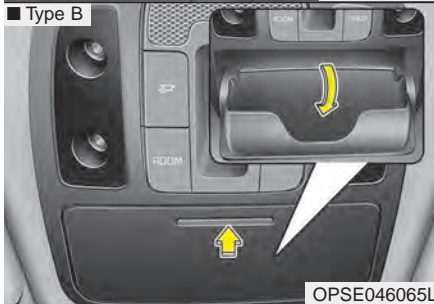

To open the sunglass holder, press the cover and the holder will slowly open. Place your sunglasses with the lenses facing out.

To close the sunglass holder, push it up.

Do not place other items in the sunglass holder.

### **⚠ WARNING - Sunglass holder**

- Do not keep objects except sunglasses inside the sunglass holder. Such objects can be thrown from the holder in the event of a sudden stop or an accident, possibly injuring the passengers in the vehicle.
- Do not open the sunglass holder while the vehicle is moving. The rear view mirror of the vehicle can be blocked by an opened sunglass holder.

## Luggage box

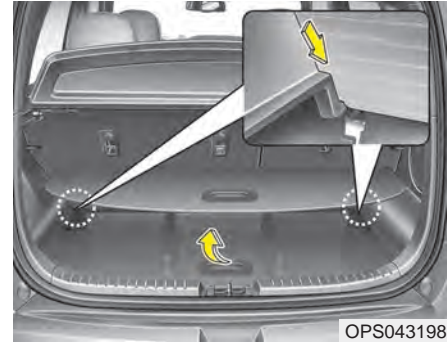

You can place a first aid kit, a reflector triangle, tools, etc. in the box for easy access.

## INTERIOR FEATURES

### Cup holder

#### **⚠ WARNING - Hot liquids**

Do not place uncovered cups with hot liquid in the cup holder while the vehicle is in motion. If the hot liquid spills, you burn yourself. Such a burn to the driver could lead to loss of control of the vehicle.

#### **⚠ CAUTION**

- *Keep your drinks sealed while driving to prevent spilling your drink. If liquid spills, it may get into the vehicle's electrical/electronic system and damage electrical/electronic parts.*
- *When cleaning spilled liquids, do not use heat to dry the cup holders. This may damage the cup holder.*



Cups or small beverage cans may be placed in the cup holders.

### Rear (if equipped)

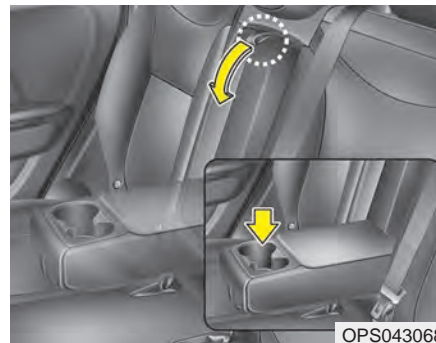

To use the cup holder, folding the center seat or pull down the armrest.

## Sunvisor

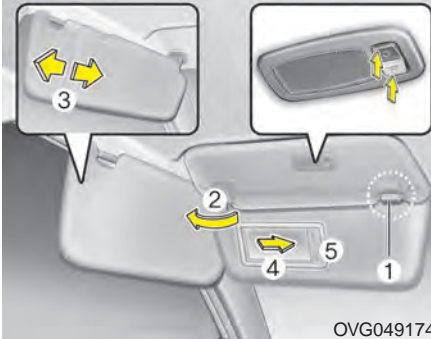

Use the sunvisor to shield direct light through the front or side windows.

To use the sunvisor, pull it downward.

To use the sunvisor for the side window, pull it downward, unsnap it from the bracket (1) and swing it to the side (2).

Adjust the sunvisor extension forward or backward (3).

To use the vanity mirror, pull down the visor and slide the mirror cover (4).

To use the vanity mirror lamp, switch it on. (if equipped)

The ticket holder (5, if equipped) is provided for holding a tollgate ticket.



## CAUTION - Vanity mirror lamp

*If you use the vanity mirror lamp, turn off the lamp before return the sunvisor to its original position. It could result in battery discharge and possible sunvisor damage.*

## Seat warmer (if equipped)



The seat warmer is provided to warm the front seats during cold weather. With the POWER button in the ON position, push either of the switches to warm the driver's seat or the front passenger's seat.

During mild weather or under conditions where the operation of the seat warmer is not needed, keep the switches in the "OFF" position.

- Each time you press the switch, the temperature setting of the seat will change as follows :

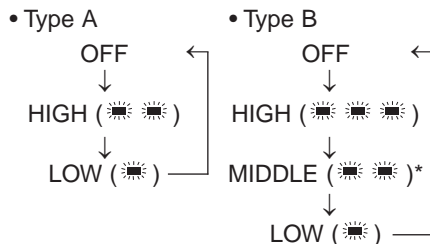

- The seat warmer defaults to the OFF position whenever the POWER button is turned on.
- When pressing the switch for more than 1.5 seconds with the seat warmer operating, the seat warmer will turn OFF.

### \* NOTICE

With the seat warmer switch in the ON position, the heating system in the seat turns off or on automatically depending on the seat temperature.

### ⚠️ CAUTION - Seat damage

- *When cleaning the seats, do not use an organic solvent such as paint thinner, benzene, alcohol and gasoline. Doing so may damage the surface of the heater or seats.*
- *To prevent overheating the seat warmer, do not place anything on the seats that insulates against heat, such as blankets, cushions or seat covers while the seat warmer is in operation.*
- *Do not place heavy or sharp objects on seats equipped with seat warmers. Damage to the seat warming components could occur.*

**\* NOTICE**

Be careful not to spill liquid such as water or beverages on the seat. If you spill some liquid, wipe the seat with a dry towel. Before using the seat warmer, dry the seat completely.

**⚠ WARNING - Seat heater burns**

The seat warmer may cause burns, even at low temperatures, if used over a long period of time. Never allow passengers who may not be able to take care of themselves to be exposed to the risk of seat heater burns. These include:

1. Infants, children, elderly or disabled persons, or hospital outpatients
2. Persons with sensitive skin or those that burn easily
3. Fatigued individuals
4. Intoxicated individuals
5. Individuals taking medication that can cause drowsiness or sleepiness (sleeping pills, cold tablets, etc.)

**Seat air ventilation (if equipped)**

The temperature setting of the seat changes according to the switch position.



- If you want to cool your seat cushion, press the switch (blue color).
- Each time you press the button, the airflow will change as follows:

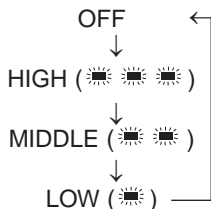

- When pressing the switch for more than 1.5 seconds with the seat air ventilation operating, the seat air ventilation will turn OFF.
- The seat air ventilation defaults to the OFF position whenever the POWER button is turned on.

### Rear seat warmer (if equipped)

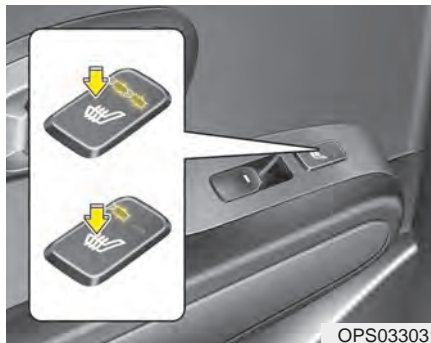

The seat warmer is provided to warm the rear outboard seats during cold weather. With the POWER button in the ON position, push either of the switches to warm rear seats.

During mild weather or under conditions where the operation of the seat warmer is not needed, keep the switches in the "OFF" position.



- When pressing the switch for more than 1.5 seconds with the seat warmer operating, the seat warmer will turn OFF.
- The seat warmer defaults to the OFF position whenever the POWER button is turned on.

### \* NOTICE

With the seat warmer switch in the ON position, the heating system in the seat turns off or on automatically depending on the seat temperature.

## Power outlet (if equipped)

### ■ Front (Type A)

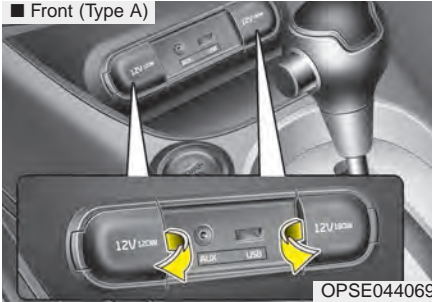

### ■ Rear (if equipped)

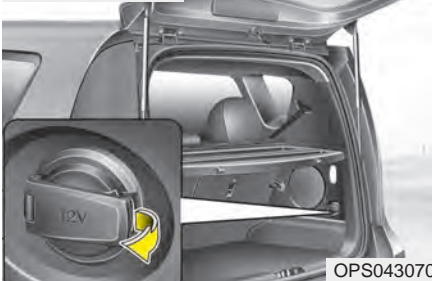

The power outlet is designed to provide power for mobile telephones or other devices designed to operate with vehicle electrical systems.

The devices should draw less than 10 amps with the vehicle is in the ready (🚗) mode.

- Use the power outlet only when the vehicle is in the ready (🚗) mode and remove the accessory plug after use. Using the accessory plug for prolonged periods of time with the vehicle is not in the ready (🚗) mode could cause the battery to discharge.
- Only use 12V electric accessories which are less than 10A(Driver's side) or 15A(Passenger's side) in electric capacity.
- Adjust the air-conditioner or heater to the lowest operating level when using the power outlet.
- Close the cover when not in use.
- Some electronic devices can cause electronic interference when plugged into a vehicle's power outlet. These devices may cause excessive audio static and malfunctions in other electronic systems or devices used in your vehicle.

## **⚠ WARNING - Electric shock**

**Do not put a finger or a foreign element (pin, etc.) into a power outlet and do not touch with a wet hand. You may get an electric shock.**

### Clothes hanger

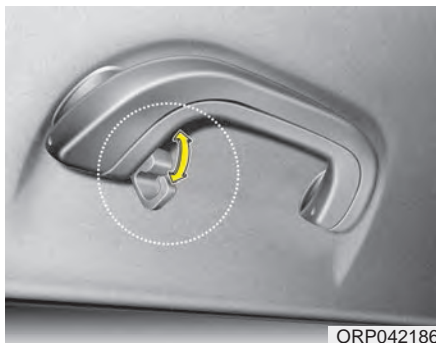

To use the hanger, pull down the upper portion of hanger.

Be careful when opening and closing the doors. Clothes, etc. may get caught between the door gap.

**⚠ CAUTION - Hanging clothing**

*Do not hang heavy clothes, since those may damage the hook.*

### Floor mat anchor(s)

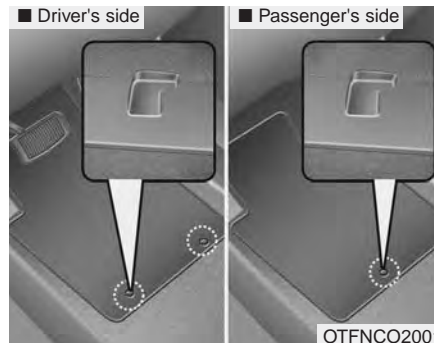

When using a floor mat on the floor carpet, make sure it attaches to the floor mat anchor(s) in your vehicle. This keeps the floor mat from sliding forward.

**⚠ WARNING - After market floor mat**

**Do not install aftermarket floor mats that are not capable of being securely attached to the vehicle's floor mat anchors. Unsecured floor mats can interfere with pedal operation.**

The following must be observed when installing ANY floormat to the vehicle.

- Ensure that the floormats are securely attached to the vehicle's floormat anchor(s) before driving the vehicle.
- Do not use ANY floormat that cannot be firmly attached to the vehicle's floormat anchors.
- Do not stack floormats on top of one another (e.g. all-weather rubber mat on top of a carpeted floormat). Only a single floormat should be installed in each position.

**IMPORTANT** - Your vehicle was manufactured with driver's side floormat anchors that are designed to securely hold the floormat in place. To avoid any interference with pedal operation, Kia recommends that only the Kia floormat designed for use in your vehicle be installed.

### Luggage net holder (if equipped)



To keep items from shifting in the cargo area, you can use the holders located in the cargo area to attach the luggage net.

If necessary, contact your authorized Kia dealer to obtain a luggage net.

To prevent damage to the goods or the vehicle, care should be taken when carrying fragile or bulky objects in the luggage compartment.

### **⚠ WARNING - Luggage net**

- Always keep your face and body out of the luggage net recoil path and avoid using the luggage net when the straps have visible signs of wear or damage. The luggage net can snap and cause injuries.
- All cargo should be evenly distributed, properly secured and never piled higher than the seatback.

### Cargo area cover (if equipped)



Use the cargo area cover to hide items stored in the cargo area.

### Removal and installation



#### To remove the cargo area cover:

1. Fold the cargo area cover up in half.

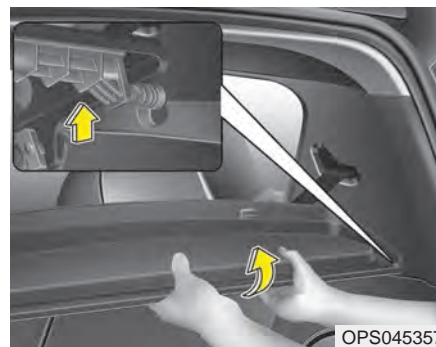

2. Firmly hold the folded part of the cover and lift it up.

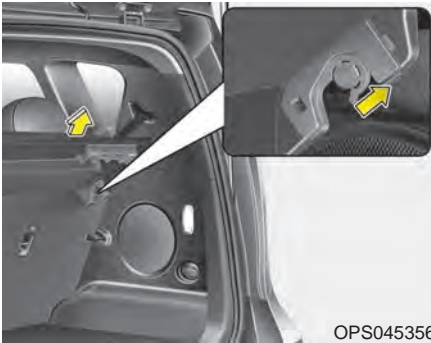

3. While lifting the cover up, hold the area near the front slots. Then, pull up the cover at approximately 45° angle.

### **⚠ WARNING**

Do not permit the fold cover to block the rear view. Put the folded cover in the appropriate position.

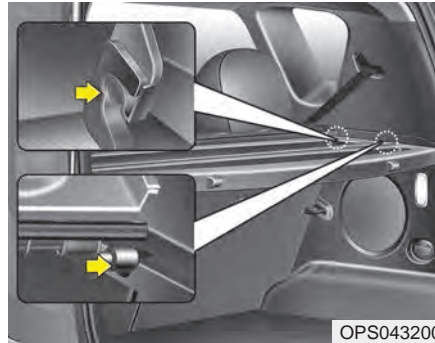

### **To install the cargo area cover:**

To use the cargo area cover, insert the 4 edges into the slots.

### **⚠ WARNING - Objects**

- Do not place objects on the cargo area cover. Such objects may be thrown about inside the vehicle and possibly injure vehicle occupants during an accident or when braking.
- All cargo should be evenly distributed, properly secured and never piled higher than the seatback.

### **⚠ CAUTION - Luggage**

*Since the cargo area cover may be damaged or malformed, do not apply excessive force to the cover or do not put the heavy loads on it.*

## AUDIO SYSTEM

If you install aftermarket HID head lamps, your vehicle's audio and electronic devices may malfunction.

### Antenna

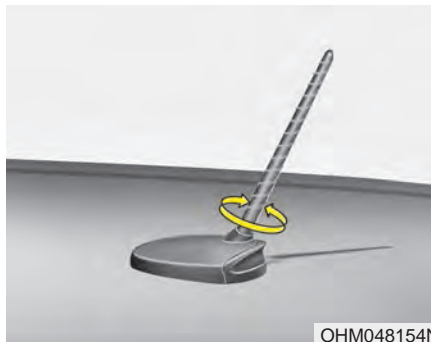

Your vehicle uses a roof antenna to receive AM or/and FM broadcast signals.

This antenna pole is removable. To remove the roof antenna pole, turn it counterclockwise. To install the roof antenna pole, turn it clockwise.



### **CAUTION - Antenna**

*Before entering a place with a low height clearance or a car wash, remove the antenna pole by rotating it counterclockwise. If not, the antenna may be damaged.*

- When reinstalling your roof antenna pole, it is important that it is fully tightened to ensure proper reception.
- When cargo is loaded on the roof rack, do not place the cargo near the antenna pole to ensure proper reception.

### AUX, USB and iPod®\* port



If your vehicle has an AUX and/or USB(universal serial bus) port or iPod® port, you can use an AUX port to connect audio devices and an USB port to plug in an USB and also an iPod® port to plug in an iPod®.

When using a portable audio device connected to the power outlet, noise may occur during playback. If this happens, use the power source of the portable audio device.

\* iPod® is a registered trademark of Apple Inc.



### Speaker lights (if equipped)

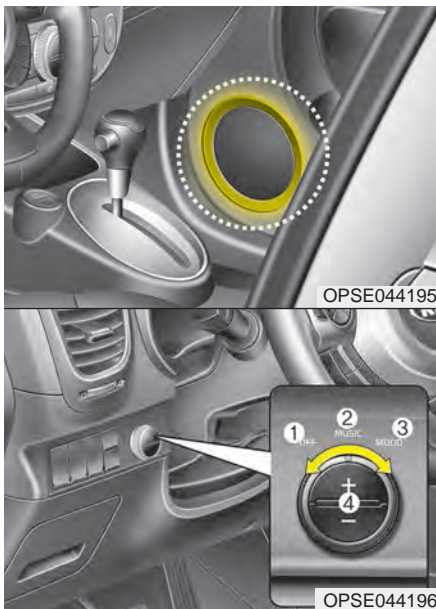

The speaker lights that lights around the front speaker is adjusted by turning the knob as follows.

1. OFF : The light turns off.
2. MUSIC :  
The red light blinks according to the sound of the audio.  
If the audio is not turned on, the light does not turn on.
3. MOOD :  
The light color changes automatically at regular interval.
4. +/- :  
When the lights are on, push the illumination button to adjust the light intensity.  
If low lighting grade is selected, the intensity of light may be weak or may not illuminate according to the audio volume or selected condition.

The lighting around the front speaker may not illuminate when the sound of the audio is low.

Do not use the lights for extended periods when engine is not running. It may cause battery discharge.

### \* NOTICE

When the doors are opened, the lighting system will not operate..

## How vehicle audio works

### FM reception

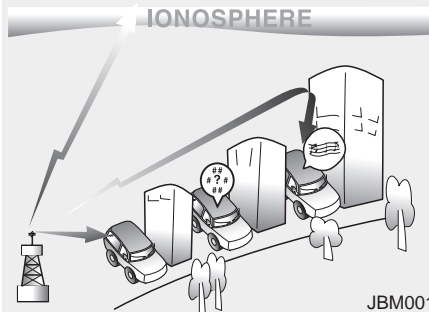

AM and FM radio signals are broadcast from transmitter towers located around your city. They are intercepted by the radio antenna on your vehicle. This signal is then processed by the radio and sent to your vehicle speakers.

However, in some cases the signal coming to your vehicle may not be strong and clear.

This can be due to factors, such as the distance from the radio station, closeness of other strong radio stations or the presence of buildings, bridges or other large obstructions in the area.

### AM reception

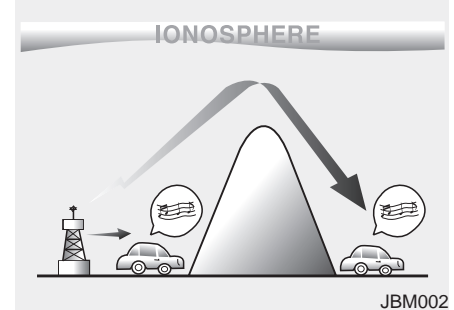

AM broadcasts can be received at greater distances than FM broadcasts. This is because AM radio waves are transmitted at low frequencies. These long distance, low frequency radio waves can follow the curvature of the earth rather than travelling straight. In addition, they curve around obstructions resulting in better signal coverage.

## FM radio station

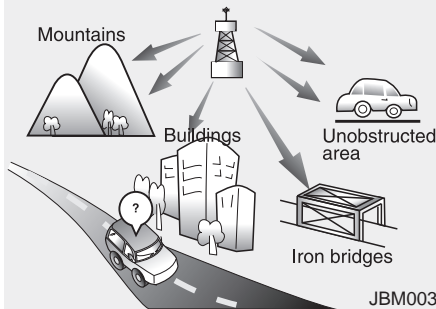

FM broadcasts are transmitted at high frequencies and do not bend to follow the earth's surface. Because of this, FM broadcasts generally begin to fade within short distances from the station. Also, FM signals are easily affected by buildings, mountains, and obstructions. This can lead to undesirable or unpleasant listening conditions which might lead you to believe a problem exists with your radio. The following conditions are normal and do not indicate radio trouble:

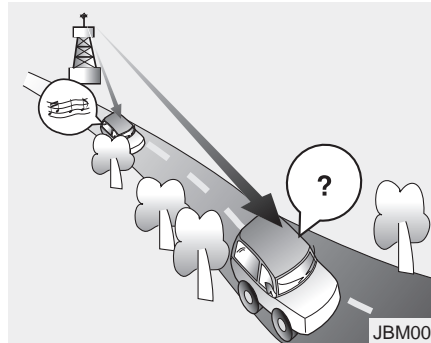

- **Fading** - As your vehicle moves away from the radio station, the signal will weaken and sound will begin to fade. When this occurs, we suggest that you select another stronger station.
- **Flutter/Static** - Weak FM signals or large obstructions between the transmitter and your radio can disturb the signal causing static or fluttering noises to occur. Reducing the treble level may lessen this effect until the disturbance clears.

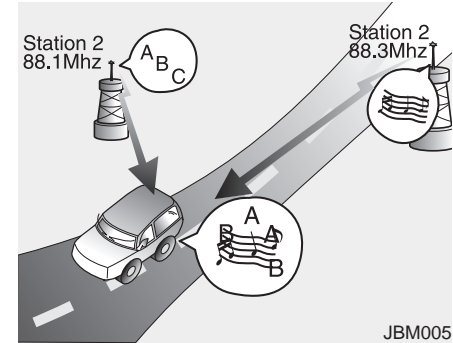

- **Station Swapping** - As an FM signal weakens, another more powerful signal near the same frequency may begin to play. This is because your radio is designed to lock onto the clearest signal. If this occurs, select another station with a stronger signal.
- **Multi-Path Cancellation** - Radio signals being received from several directions can cause distortion or fluttering. This can be caused by a direct and reflected signal from the same station, or by signals from two stations with close frequencies. If this occurs, select another station until the condition has passed.

### ***Using a cellular phone or a two-way radio***

When a cellular phone is used inside the vehicle, noise may be produced from the audio system. This does not mean that something is wrong with the audio equipment. In such a case, try to operate mobile devices as far from the audio equipment as possible.

When using a communication system such as a cellular phone or a radio set inside the vehicle, a separate external antenna must be fitted. When a cellular phone or a radio set is used with an internal antenna alone, it may interfere with the vehicle's electrical system and adversely affect safe operation of the vehicle.

#### **WARNING - Cell phone use**

**Do not use a cellular phone while driving. Stop at a safe location to use a cellular phone.**

#### **WARNING - Driver Distraction**

- **Do not stare at the screen while driving. Staring at the screen for prolonged periods of time could lead to traffic accidents.**
- **Using the phone while driving may lead to a lack of attention of traffic conditions and increase the likelihood of accidents. Use the phone feature after parking the vehicle.**

#### **WARNING - Audio System**

**Do not disassemble, assemble, or modify the audio system. Such acts could result in fire or electric shock.**

#### **WARNING - Antenna**

**Do not touch the antenna during thunder or lightning as such acts may lead to lightning induced electric shock.**

#### **CAUTION**

***Refrain from use if the screen is blank or no sound can be heard as these signs may indicate product malfunction.***

### **WARNING - Distracted Driving**

Driving while distracted can result in a loss of vehicle control that may lead to an accident, severe personal injury, and death. The driver's primary responsibility is in the safe and legal operation of a vehicle, and use of any handheld devices, other equipment, or vehicle systems which take the driver's eyes, attention and focus away from the safe operation of a vehicle or which are not permissible by law should never be used during operation of the vehicle.

- Adjust the volume to levels that allow the driver to hear sounds from outside of the vehicle. Driving in a state where external sounds cannot be heard may lead to accidents.

- Pay attention to the volume setting when turning the device on. A sudden output of extreme volume upon turning the device on could lead to hearing impairment. (Adjust the volume to a suitable levels before turning off the device.)
- Turn on the car ignition before using the audio system. Do not operate the audio system for long periods of time with the ignition turned off as such operations may lead to battery discharge.
- In case of product malfunction, please contact your place of purchase or After Service center.
- Placing the audio system within an electromagnetic environment may result in noise interference.

### **CAUTION - LCD Monitor**

***Do not subject the device to severe shock or impact. Direct pressure onto the front side of the monitor may cause damage to the LCD or touch screen.***

### **CAUTION**

- ***When cleaning the device, make sure to turn off the audio system and use a dry and smooth cloth.***
- ***Never use tough materials, chemical cloths, or solvents (alcohol, benzene, thinners, etc.) as such materials may damage the device panel or cause color/quality deterioration.***
- ***Prevent caustic solutions such as perfume and cosmetic oil from contacting the dashboard because they may cause damage or discoloration.***

## USING THE USB DEVICE

- To use an external USB device, make sure the device is not connected when starting up the vehicle. Connect the device after starting up.
- If you start the engine when the USB device is connected, it may damage the USB device. (USB flashdrives are very sensitive to electric shock.)
- If the engine is started up or turned off while the external USB device is connected, the external USB device may not work.
- The System may not play unauthenticated MP3 or WMA files.
  - 1) It can only play MP3 files with the compression rate between 8Kbps ~ 320Kbps.
  - 2) It can only play WMA music files with the compression rate between 8Kbps ~ 320Kbps.
- Take precautions for static electricity when connecting or disconnecting the external USB device.

(Continued)

(Continued)

- An encrypted MP3 PLAYER is not recognizable.
- Depending on the condition of the external USB device, the connected external USB device can be unrecognizable.
- When the formatted byte/sector setting of external USB device is not either 512BYTE or 2048BYTE, then the device will not be recognized.
- Use only a USB device formatted to FAT 12/16/32.
- USB devices without USB I/F authentication may not be recognizable.
- Make sure the USB connection terminal does not come in contact with the human body or other objects.
- If you repeatedly connect or disconnect the USB device in a short period of time, it may break the device.

(Continued)

(Continued)

- You may hear a strange noise when connecting or disconnecting a USB device.
- If you disconnect the external USB device during playback in USB mode, the external USB device can be damaged or may malfunction. Therefore, disconnect the external USB device when the audio is turned off or in another mode. (e.g, Radio)
- Depending on the type and capacity of the external USB device or the type of the files stored in the device, there is a difference in the time for recognizing the device.
- Do not use the USB device for purposes other than playing music files.
- Playing videos through the USB is not supported.
- Use of USB accessories such as rechargers or heaters using USB I/F may lower performance or cause trouble.

(Continued)

(Continued)

- If you use devices such as a USB hub purchased separately, the vehicle's audio system may not recognize the USB device. In that case, connect the USB device directly to the multimedia terminal of the vehicle.
- If the USB device is divided by logical drives, only the music files on the highest-priority drive are recognized by car audio.
- Devices such as MP3 Player/Cellular phone/Digital camera can be unrecognizable by standard USB I/F can be unrecognizable.
- Charging through the USB may not be supported in some mobile devices.
- USB HDD or USB types liable to connection failures due to vehicle vibrations are not supported. (i-stick type)
- Some non-standard USB devices (METAL COVER TYPE USB) can be unrecognizable.

(Continued)

(Continued)

- Some USB flash memory readers (such as CF, SD, micro SD, etc.) or external-HDD type devices can be unrecognizable.
- Music files protected by DRM (DIGITAL RIGHTS MANAGEMENT) are not recognizable.
- The data in the USB memory may be lost while using this audio. Always back up important data on a personal storage device.
- Please avoid using USB memory products which can be used as key chains or cellular phone accessories as they could cause damage to the USB jack. Please make certain only to use plug type connector products.



## USING iPod® DEVICE

iPhone® is a registered trademark of Apple inc.

- Some iPod® models may not support communication protocol and files may not properly play.  
Supported iPod® models:
  - iPhone® 3GS/4
  - iPod® touch 1st~4th generation
  - iPod® nano 1st~6th generation
  - iPod® classic
- The order of search or playback of songs in the iPod® can be different from the order searched in the audio system.
- If the iPod® is disabled due to its own malfunction, reset the iPod®. (Reset: Refer to iPod® manual)
- An iPod® may not operate normally on low battery.

(Continued)

(Continued)

- Some iPod® devices, such as the iPhone®, can be connected through the *Bluetooth®* Wireless Technology interface. The device must have audio *Bluetooth®* Wireless Technology capability (such as for stereo headphone *Bluetooth®* Wireless Technology ). The device can play, but it will not be controlled by the audio system.
- To use iPod® features within the audio, use the cable provided upon purchasing an iPod® device.
- Skipping or improper operation may occur depending on the characteristics of your iPod®/iPhone® device.
- If your iPhone® is connected to both the *Bluetooth®* Wireless Technology and USB, only support iPod® mode because the sound may not be properly played in *Bluetooth®* Audio Streaming. To use *Bluetooth®* Audio Streaming, disconnect iPod® cable with iPhone®.

(Continued)

(Continued)

- When connecting iPod® with the iPod® Power Cable, insert the connector to the multimedia socket completely. If not inserted completely, communications between iPod® and audio may be interrupted.
- When adjusting the sound effects of the iPod® and the audio system, the sound effects of both devices will overlap and might reduce or distort the quality of the sound.
- Deactivate (turn off) the equalizer function of an iPod® when adjusting the audio system's volume, and turn off the equalizer of the audio system when using the equalizer of an iPod®.
- When not using iPod® with car audio, detach the iPod® cable from iPod®. Otherwise, iPod® may remain in accessory mode, and may not work properly.
- Beside support 1M cable when purchasing iPod®/iPhone® products, Long Cable cannot be recognized.

## ***Bluetooth®* Wireless Technology (if equipped)**

### ***Bluetooth®* Wireless Technology**

The *Bluetooth®* word mark and logos are registered trademarks owned by Bluetooth SIG, Inc. and any use of such marks by Kia is under license.

A *Bluetooth®* enabled call phone is required to use *Bluetooth®* wireless technology.

### **⚠ WARNING**

**Driving while distracted can result in a loss of vehicle control that may lead to an accident, severe personal injury, and death. The driver's primary responsibility is in the safe and legal operation of a vehicle, and use of any handheld devices, other equipment, or vehicle systems which take the driver's eyes, attention and focus away from the safe operation of a vehicle or which are not permissible by law should never be used during operation of the vehicle.**



### Before Using the *Bluetooth*<sup>®</sup> Wireless Technology Handsfree

#### *What is Bluetooth*<sup>®</sup> ?

- *Bluetooth*<sup>®</sup> refers to a short-distance wireless networking technology which uses a 2.4GHz ~ 2.48GHz frequency to connect various devices within a certain distance.
- Supported within PCs, external devices, *Bluetooth*<sup>®</sup> phones, PDAs, various electronic devices, and automotive environments, *Bluetooth*<sup>®</sup> allows data to be transmitted at high speeds without having to use a connector cable.
- *Bluetooth*<sup>®</sup> Handsfree refers to a device which allows the user to conveniently make phone calls with *Bluetooth*<sup>®</sup> mobile phones through the audio system.
- *Bluetooth*<sup>®</sup> Handsfree may not be supported in some mobile phones. To learn more about mobile device compatibility, visit <http://www.kia.com/us/en/content/owners/bluetooth>

### Precautions for Safe Driving

- *Bluetooth*<sup>®</sup> Handsfree is a feature that enables drivers to practice safe driving. Connecting the head unit with a *Bluetooth*<sup>®</sup> phone allows the user to conveniently make and receive calls and use contacts. Before using *Bluetooth*<sup>®</sup>, carefully read the contents of this user's manual.
- Excessive use or operations while driving may lead to negligent driving practices and result in accidents. Refrain from excessive operations while driving.
- Viewing the screen for prolonged periods of time is dangerous and may lead to accidents. When driving, view the screen only for short periods of time.

### When connecting a *Bluetooth*<sup>®</sup> Phone

- Before connecting the head unit with the mobile phone, check to see that the mobile phone supports *Bluetooth*<sup>®</sup> features.
- Even if the phone supports *Bluetooth*<sup>®</sup>, the phone will not be found during device searches if the phone has been set to hidden state or the *Bluetooth*<sup>®</sup> power is turned off. Disable the hidden state or turn on the *Bluetooth*<sup>®</sup> power prior to searching/connecting with the Head unit.
- If you do not want automatic connection with your *Bluetooth*<sup>®</sup> device, turn off the *Bluetooth*<sup>®</sup> feature within your mobile phone.
- The Handsfree call volume and quality may differ depending on the mobile phone.

- Park the vehicle when connecting the head unit with the mobile phone.
- Bluetooth® connection may become intermittently disconnected in some mobile phones. Follow these steps to try again.
  1. Within the mobile phone, turn the Bluetooth® function off/on and try again.
  2. Turn the mobile phone power Off/On and try again.
  3. Reboot the audio system and try again.
  4. Delete all paired devices, pair and try again.
- Handsfree call quality and volume may differ depending on the model of your mobile phone.

---

### **iPod®**

iPod® is a registered trademark of Apple Inc.

---

### ***Bluetooth®* Wireless Technology**

A compatible *Bluetooth®* Wireless Technology-enabled cell phone is required to use *Bluetooth®* Wireless Technology.

The Bluetooth® word mark and logos are registered trademarks owned by Bluetooth SIG, Inc. and any use of such marks by Kia is under license.

Other trademarks and trade names are those of their respective owners.

A Bluetooth® enabled cell phone is required to use *Bluetooth®* Wireless Technology.

*Bluetooth®* Wireless Technology phone compatibility can be checked by visiting <http://www.kia.com>.

---

### **Pandora®**

Pandora, the Pandora logo, and the Pandora trade dress are trademarks or registered trademarks of Pandora Media, Inc. Used with permission. Pandora is only available in certain countries.

Please visit <http://www.pandora.com/legal> for more information.



## AUDIO (With Touch Screen)

■ Type B



(With *Bluetooth*® Wireless Technology)

E4H4G0000EU

## Feature of Your Audio

### Head unit



\* The actual image in the vehicle may differ from the illustration.

#### (1) LCD screen

- Tap the screen to select a button.

#### (2) RADIO

- Start FM, AM and SiriusXM.

#### (3) MEDIA

- Select USB(iPod®), *Bluetooth*® Wireless Technology(BT) Audio, AUX, My Music or Pandora.
- Display the media menu when two or more media are connected or when the **[MEDIA]** button is pressed in media mode.

#### (4) PHONE

- Start *Bluetooth*® Wireless Technology Phone mode.

#### (5) POWER/VOL knob

- Turn to adjust the volume.
- Press to turn the device on or off.

#### (6) SEEK/TRACK

- Search for frequencies in radio mode.
- Change the current song in media mode.

**(10) TUNE knob**

- Turn to navigate through the stations/songs list.
- Press to select an item.

**(11) RESET**

- Shutdown and restart the system.

**(7) DISP**

- Turn the display on or off.

**(8) CLOCK**

- Display the time/date/day.

**(9) SETUP**

- Access Display, Sound, Date/Time, Bluetooth, System, Screen Saver and Display Off settings.

## Steering wheel remote control



※ The actual image in the vehicle may differ from the illustration.

### (1) **MODE**

- Press the button to change the mode in the following order: Radio → Media.

### (2) **VOLUME**

- Press to adjust the volume.

### (3) **UP/DOWN**

- Press the button in radio mode to search Presets.
- Press and hold the button in radio mode to search frequencies.

- Press the button in media mode to change the current song.
- Press and hold the button in media mode to quick search through songs.

### (4) **VOICE**

- Pressing the button
  - If Siri is not active: Starts Siri.
  - If Siri is active: Re-starts Siri.
- Pressing and holding the button: Siri is deactivated.

### (5) **CALL**

- Pressing the button
  - If not in *Bluetooth*<sup>®</sup> Wireless Technology Handsfree mode or receiving a phone call.  
First press: Display Dial Number screen.  
Second press: Automatically display the most recently Dialed call number.  
Third press: Dial the phone number entered.
  - Press in the Incoming Call notification screen to accept the phone call.

- Press in *Bluetooth*<sup>®</sup> Wireless Technology Handsfree mode to switch to the waiting call.
- Pressing and holding the button (over 1.0 seconds)
  - If not in *Bluetooth*<sup>®</sup> Wireless Technology Handsfree mode or receiving a phone call, the most recently Dialed Call number is dialed.
  - Press in *Bluetooth*<sup>®</sup> Wireless Technology Handsfree mode to transfer the call to your cell phone.
  - Press in cell phone mode to switch to *Bluetooth*<sup>®</sup> Wireless Technology Handsfree mode.

### (6) **END**

- Press in *Bluetooth*<sup>®</sup> Wireless Technology Handsfree mode to end the phone call.
- Press in the incoming call screen to reject the call.

**⚠ WARNING****- Audio System Safety Warnings**

- Do not use a cellular phone while driving. Stop at a safe location to use a cellular phone.
- Do not stare at the screen while driving. Staring at the screen for prolonged periods of time could lead to traffic accidents.
- Do not disassemble, assemble, or modify the audio system. Such acts could result in accidents, fire, or electric shock.
- Using the phone while driving may lead to a lack of attention of traffic conditions and increase the likelihood of accidents. Use the phone feature after parking the vehicle.

(Continued)

**(Continued)**

- Exercise caution not to spill water or introduce foreign objects into the device. Such acts could lead to smoke, fire, or product malfunction.
- Please refrain from use if the screen is blank or no sound can be heard as these signs may indicate product malfunction. Continued use in such conditions could lead to accidents (fires, electric shock) or product malfunctions.
- Do not touch the antenna during thunder or lightening as such acts may lead to lightning induced electric shock.
- Do not stop or park in parking-restricted areas to operate the product. Such acts could lead to traffic accidents.

- Driving while distracted can result in a loss of vehicle control that may lead to an accident, severe personal injury, and death. The driver's primary responsibility is in the safe and legal operation of a vehicle, and use of any handheld devices, other equipment, or vehicle systems which take the driver's eyes, attention and focus away from the safe operation of a vehicle or which are not permissible by law should never be used during operation of the vehicle.



 **CAUTION**











- *Do not subject the device to severe shock or impact. Direct pressure onto the front side of the monitor may cause damage to the LCD or touch screen.*
- *When cleaning the device, make sure to turn off the device and use a dry and smooth cloth. Never use tough materials, chemical cloths, or solvents (alcohol, benzene, thinners, etc.) as such materials may damage the device panel or cause color/quality deterioration.*
- *Do not place beverages close to the audio system. Spilling beverages may lead to system malfunction.*
- *Placing the audio system within an electromagnetic environment may result in noise interference.*

**\* NOTICE**

- Turn on the car ignition before using this device. Do not operate the audio system for long periods of time with the ignition turned off as such operations may lead to battery discharge.
- In case of product malfunction, please contact your place of purchase or After Service center.

**Information on status icons**

Icons showing audio status are shown in the upper-right corner of the screen.

Icon		Description
	Mute	Mute engaged
	Battery	Remaining battery life of a connected Bluetooth® device
	Handsfree + Audio streaming connection	Bluetooth® Handsfree call and audio streaming available
	Handsfree connection	Bluetooth® Handsfree call available
	Bluetooth® audio streaming	Bluetooth® audio streaming available
	Downloading contacts	Downloading contacts through Bluetooth® wireless communications
	Downloading call history	Downloading call history through Bluetooth® wireless communications
	Line busy	Phone call in progress
	Mute mic	Mic muted during a call (caller cannot hear your voice)
	Phone signal strength	Display the phone signal strength for a cell phone connected by Bluetooth®

## Radio

You can listen to FM, AM and SiriusXM radio.



### (1) Band

Switch between FM, AM and SiriusXM.

### (2) Presets

Change the preset number on the main screen.

### (3) List

Display all available stations.

### (4) Menu

Navigate to the menu screen.

### (5) Presets 1~40

Save or listen to favorite stations.

### Switching between FM, AM and SiriusXM

- Press the **[RADIO]** button on the audio system to switch between FM, AM and SiriusXM.
- Press the **[Band]** on the screen to switch between FM, AM and SiriusXM.

### Searching frequencies

Searching frequencies by pressing the **[SEEK/TRACK]** button on the product.

### < Presets >

By pressing [**< Presets >**], the buttons for Presets 1~40 displayed on the screen can be changed.

### Presets 1~40

Press the button to listen to a preset. Press and hold the button number to save the current station.

### List

A list of all available stations is displayed. Press the desired station.

Favorite stations can be saved to **[Presets]** by pressing the **[+]**.

### Menu

Press the **[Menu]**, and select the desired function.

- **Presets:** Save up to 40 frequently used stations.

To listen to a preset, press the desired station.

Press and hold the desired slot from 1 through 40. This saves the current station in the selected slot.

If the slot is empty, simply pressing saves the station to the slot.

- **Scan:** All stations available in the current location of the vehicle are played for five seconds each.
- **Information:** View detailed station information.
- **Sound Settings:** Audio sound settings can be changed.
- **Station Info:** Set whether to receive station information.

**\* NOTICE - SiriusXM® Satellite Radio information**

- **Satellite Radio channels:**  
Enjoy SiriusXM Satellite Radio with a 3-month trial subscription to the Sirius Select package. You'll get over variable channels, including commercial-free music, plus all your favorite sports, exclusive talk, entertainment, and a selection of premium programming. For more information and a complete list of SiriusXM channels, visit [siriusxm.com](http://siriusxm.com) in the United States, [siriusxm.ca](http://siriusxm.ca) in Canada, or call SiriusXM at 1-888-539-7474.
- **Satellite Radio reception factors:**  
To receive the satellite signal, your vehicle has been equipped with a satellite radio antenna located on the roof of your vehicle. The vehicle roof provides the best location for an unobstructed, open view of the sky, a requirement of a satellite radio system. Like AM/FM, there are several factors that can affect satellite radio reception performance:

(Continued)

(Continued)

- **Antenna obstructions:** For optimal reception performance, keep the antenna clear of snow and ice build-up and keep luggage and other material as far away from the antenna as possible.
- **SiriusXM Satellite Radio service:** SiriusXM is a subscription-based satellite radio service that broadcasts music, sports, news and entertainment programming to radio receivers, which are available for installation in motor vehicles or factory installed, as well as for the home, portable and wireless devices, and through an Internet connection on a personal computer. Vehicles that are equipped with a factory installed SiriusXM Satellite Radio system include:
  - **Hardware and an introductory trial subscription term,** which begins on the date of sale or lease of the vehicle.
  - **For a small upgrade fee, access to SiriusXM music channels, and other select channels over the Internet using any computer connected to the Internet (U.S. customers only).**

(Continued)

(Continued)

- **SiriusXM services require a subscription sold separately, or as a package, by Sirius XM Radio Inc.** If you decide to continue service after your trial, the subscription plan you choose will automatically renew thereafter and you will be charged according to your chosen payment method at then-current rates. Fees and taxes apply. To cancel you must call SiriusXM at 1-866-635-2349. See SiriusXM Customer Agreement for complete terms at [www.siriusxm.com](http://www.siriusxm.com). SiriusXM U.S. satellite and data services are available only in the 48 contiguous states, DC and Puerto Rico (with coverage limitations). SiriusXM satellite service is also available in Canada; see [www.siriusxm.ca](http://www.siriusxm.ca). All fees and programming subject to change. Sirius, XM and all related marks and logos are trademarks of Sirius XM Radio Inc.

## SiriusXM



### (1) Band

Switch between FM, AM and SiriusXM.

### (2) Presets

Change the preset number on the main screen.

### (3) List

Display all channels.

### (4) Menu

Navigate to the menu screen.

### (5) Presets 1~40

Save or listen to favorite channels.

### (6) Play Live

Switches to the live broadcast mode.

### (7) Skip Backward

Repeats the previously broadcasted program.

- Holding for less than 0.8 seconds: Moves to the previous segment.
- Holding for over 1.0 seconds: Moves to the previous 5 seconds.

### (8) Play/Pause

Pauses/plays the current broadcasted program.

### (9) Skip Forward

Moves to the next segment.

## Switching between FM, AM and SiriusXM

- Press the **[RADIO]** button on the audio system to switch between FM, AM and SiriusXM.
- Press the **[Band]** on the screen to switch between FM, AM and SiriusXM.

## Searching channels

Press the **[SEEK/TRACK]** button to search channels.

## < Presets >

By pressing [**< Presets >**], the buttons for Presets 1~40 displayed on the screen can be changed.

## Presets 1~40

Press the button to listen to a preset. Press and hold the button number to save the current channel.

## List

A list of all channels is displayed. Press the desired channel.

Favorite channels can be saved to [Presets] by pressing the [+].

## Menu

Press the [Menu], and select the desired function.

- Presets: Save up to 40 frequently used channels.

To listen to a preset, press the desired channel.

Press and hold the desired slot from 1 through 40. This saves the current channel in the selected slot.

If the slot is empty, simply pressing saves the channel to the slot.

- Categories: Channels can be searched by category.
- Direct Tune: The desired channel can be selected by entering numbers.
- Sound Settings: Audio sound settings can be changed.

- Tag Song: Tag the current song information.

When an Apple device (iPhone®, iPod®) is connected, tagged song information is sent automatically to the connected device.

## \* NOTICE

**Up to 50 songs can be tagged.**

- Scan: All channels available in the vehicle's current location are played for ten seconds each.
- Program Schedule: View the program schedule.
- Featured Favorites: The Featured Favorites feature allows SiriusXM™ to broadcast additional presets.
  - Example 1: During holidays, "Holiday Music" might include all SiriusXM™ channels that are playing holiday music for easy access by users.

Multiple sets of Featured Favorites data can be broadcast by SiriusXM™ and can change from time to time.

- Information: View detailed channel information.

- Category Lock: Search or scan channels in the current category only.

**Media**

**MP3**

**Supported audio formats**

Compressed audio formats	MPEG1 Audio Layer3
	MPEG2 Audio Layer3
	MPEG2.5 Audio Layer3
	Windows Media Audio Ver 7.X & 8.X

**\* NOTICE**

File formats other than the formats above may not be recognized or playable. Information such as file-name may not be displayed.

**Range of supported compressed file types**

**1. Bitrate range (Kbps)**

BIT RATE(kbps)	MPEG1	MPEG2	MPEG2.5	WMA
		Layer3		
	32	8	8	48
	40	16	16	64
	48	24	24	80
	56	32	32	96
	64	40	40	128
	80	48	48	160
	96	56	56	192
	112	64	64	
	128	80	80	
	160	96	96	
	192	112	112	
	224	128	128	
	256	144	144	
	320	160	160	

**2. Sampling frequency (Hz)**

MPEG1	MPEG2	MPEG2.5	WMA
44100	22050	11025	32000
48000	24000	12000	44100
32000	16000	8000	48000

- The sound quality of MP3/WMA compressed files may vary depending on the bitrate. (A higher bitrate can have better sound quality.)
- The product only recognizes files with the MP3 or WMA extension. Files without one of these extensions are not recognized.

**3. Number of recognizable folders and files**

- Folders: 2,000 for USB
- Files: 6,000 for USB
- No recognition limit for folder hierarchies

#### 4. Character display range (Unicode)

- Filenames: Up to 64 English characters (64 Korean characters)
- Folder names: Up to 32 English characters (32 Korean characters)

#### **Languages supported (Unicode support)**

- Korean: 2,604 characters
- English: 94 characters
- Common Chinese characters: 4,888 characters
- Special symbols: 986 characters

#### **\* NOTICE**

**Japanese/Simplified Chinese characters are not supported.**



**\* NOTICE - Using the USB Devices**

- Starting the vehicle while a USB device is connected can damage the device. Please disconnect USB devices before starting the vehicle.
- Starting the vehicle or stopping the engine while an external USB device is connected can result in failure of the external USB device to operate.
- Be cautious of static electricity when connecting/disconnecting external USB devices.
- An encrypted MP3 player is not recognized when connected as an external device.
- External USB devices may not be recognized, depending on the state of the external USB device.
- Only products with byte/sectors formatted at 4 KB or lower are recognized.
- Only USB devices in FAT12/16/32 format are recognized; NTFS and ExFAT file systems are not recognized.
- Some USB devices are not recognized due to compatibility issues.

(Continued)

(Continued)

- Do not touch the USB connections.
- Connecting and disconnecting USB devices rapidly over a short period of time can cause equipment failure.
- Abnormal sounds may be audible when the USB device is disconnected.
- Turn the audio off before connecting or disconnecting external USB devices.
- Recognition may take longer depending on the type, capacity or file format of the external USB device. This is not a product malfunction.
- Use of USB devices for purposes other than playing music files is prohibited.
- Image display and video playback are not supported.
- Use of USB accessories, including charge and heat though the USB I/F, can lead to reduced product performance or malfunctions. Do not use USB devices or accessories for these purposes.

(Continued)

(Continued)

- Use of aftermarket USB hubs and extension cables can result in the vehicle's audio system failing to recognize your USB device. Connect the USB device directly to the multimedia port of your vehicle.
- When using high-capacity USB devices with logical drive divisions, only files saved on the highest level logical drive can be played. If applications are loaded on a USB drive, file playback may fail.
- Some MP3 players, cell phones, digital cameras, etc. (USB devices that are not recognized as mobile storage) may not operate normally when connected.
- USB charging may not be supported by some mobile devices.
- Operation is guaranteed only for standard (Metal Cover Type) USB Memory drives.
- Operation of HDD, CF, SD and memory stick devices is not guaranteed.

(Continued)

(Continued)

- **DRM (Digital Rights Management) files cannot be played.**
- **SD-type USB memory, CF-type USB memory, and other USB memory devices that require adapters for connection are not supported.**
- **Proper operation of USB HDDs or USB drives with connectors that loosen due to vehicle vibrations is not guaranteed. (iStick, etc.)**
- **USB products that are used as key chains or cell phone accessories may damage the USB jack and affect proper file playback. Please refrain from use. Use only products with plug connectors, as shown in the following illustration.**
- **When MP3 devices or cell phones are connected simultaneously through AUX, BT Audio and USB modes, a popping noise or malfunction may occur.**



## USB



### (1) Repeat

Enable/disable repeat.

### (2) Shuffle

Enable/disable shuffle play.

### (3) List

View a list of all songs.

### (4) Menu

Navigate to the menu screen.

### (5) Album Image

View song info.

### (6) Pause

Pause or play music.

### (7) Playback progress

Press to skip to the desired location.

## Playback

- Press the **[MEDIA]** button, and select **[USB]**.
- Connect a USB drive to the USB port to automatically play files on the USB drive.

## Changing songs

- Press the **[SEEK/TRACK]** button to play the previous or next song.
- Press and hold the **[SEEK/TRACK]** button to rewind or fast forward the currently playing song.
- Search songs by turning **TUNE** knob, and press the knob to play.







## Selecting songs from a list

Press the **[List]** to see a list of songs available for play.

Select and play the desired song.

## Repeat play

Press the **[Repeat]** to enable or disable 'Repeat all', 'Repeat current song', 'Repeat folder' or 'Repeat category'.



-  Repeat all: All songs in the playlist are repeated.
-  Repeat current song: The currently playing song is repeated.
-  Repeat folder: All songs in the current folder are repeated.
-  Repeat category: Repeat all songs in the current category.

## \* NOTICE

The repeat folder function is available only when songs are playing from the [File] category under [List].

### Shuffle play

Press the [Shuffle] to enable/disable 'Shuffle', 'Shuffle folder' or 'Shuffle category' play.

-  Shuffle: Songs are played in random order.
-  Shuffle folder: Songs within the current folder are played in random order.
-  Shuffle category: Songs within the current category are played in random order.

### Menu

Press the [Menu], and select the desired function.

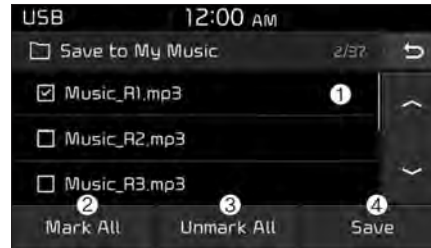

- Save to My Music: Songs on your USB device can be saved to My Music.

- (1) File: Select a file to save.
- (2) Mark All: Select all files.
- (3) Unmark All: Deselect all files.
- (4) Save: Save the selected files.
  - Select the files you want to save, and press the [Save]. This saves the selected files to My Music.
  - If Siri is activated, phone calls are received or made while saving, saving will be canceled.
  - Up to 6,000 files can be saved.

- The currently playing file on the USB device cannot be changed while saving.
- My Music cannot be used while saving.
- Up to 700 MB can be saved.
- Information: Detailed information on the currently playing song is displayed.
- Sound Settings: Audio sound settings can be changed.

**\* NOTICE - Using the iPod®  
Devices**

- To use the audio system's iPod® control function, use the dedicated cable provided with your iPod®.
- Connecting the iPod® to the vehicle during play may result in a loud noise that lasts about one to two seconds. Connect the iPod® to the vehicle after stopping or pausing play.
- Connect the iPod® with the vehicle in the ACC ON state to begin charging.
- When connecting the iPod® cable, be sure to fully push the cable into the port.
- When EQ effects are enabled simultaneously on external devices, such as iPod®s and the audio system, the EQ effects may overlap, causing sound quality deterioration or distortion. Deactivate the EQ function for all external devices, if possible.
- Noise may occur when your iPod® or the AUX port is connected. Disconnect and store separately when not in use.

(Continued)

(Continued)

- There may be noise if the audio system is used with an iPod® or AUX external device connected to the power jack. In these cases, disconnect the iPod® or external device from the power jack.
- Play may be interrupted, or device malfunctions may occur depending on the characteristics of your iPod®/iPhone®.
- Play may fail if your iPhone® is connected through both *Bluetooth*® Wireless Technology and USB. In this case, select Dock connector or *Bluetooth*® Wireless Technology on your iPhone® to change the sound output settings.
- If your software version does not support the communication protocol or your iPod® is not recognized due to device failure, anomalies or defects, iPod® mode cannot be used.
- iPod® nano (5th generation) devices may not be recognized if the battery is low. Charge sufficiently before use.

(Continued)

(Continued)

- The search and song play order in the iPod® device may be different from the search order in the audio system.
- If the iPod® has failed due to an internal defect, please reset the iPod® (consult your iPod® manual).
- Depending on the software version, the iPod® may fail to sync with the system. If the media is removed or disconnected before recognition, the previous mode may not be restored (iPad® cannot be charged).
- Cables other than the 1-meter cable provided with iPod®/iPhone® products may not be recognized.
- When other music apps are used on your iPod®, the system sync function may fail due to malfunction of the iPod® application.

**iPod®****(1) Repeat**

Enable/disable repeat.

**(2) Shuffle**

Enable/disable shuffle play.

**(3) List**

View a list of all songs.

**(4) Menu**

Navigate to the menu screen.

**(5) Album Image**

View song info.

**(6) Pause**

Pause or play music.

**(7) Playback progress**

Press to skip to the desired location.

**Playback**

- Connect your iPod® to the audio USB port, press the **[MEDIA]** button, and select [iPod].

**Changing songs**

- Press the **[SEEK/TRACK]** button to play the previous or next song.
- Press and hold the **[SEEK/TRACK]** button to rewind or fast forward the currently playing song.
- Search songs by turning the **TUNE** knob, and press the knob to play.



**Selecting songs from a list**

Press the [List] to see a list of songs available for play.

Select and play the desired song.

**Repeat play**

Press the [Repeat] to enable or disable 'Repeat category', 'Repeat current song'.

-  Repeat category: Repeat all songs in the current category.
-  Repeat current song: The currently playing song is repeated.

**Shuffle play**

Press the [Shuffle] to enable/disable 'Shuffle category' play.

-  Shuffle category: Songs within the current category are played in random order.

**Menu**

Press the [Menu], and select the desired function.

- Information: Detailed info on the currently playing song is displayed.
- Sound Settings: Audio sound settings can be changed.



### **When other music programs are running**

When songs saved on your iPod® are playing through a separate music app, the following screen is displayed.

- (1) Play/Pause: Pause or play music.
- (2) Play iPod Files: Play music saved on your iPod®.
- (3) Album Image: View playback info.

### **\* NOTICE**

**Operation cannot be carried out correctly due to iPod® application malfunction.**

### **Playing iPod files**

- Select [Play iPod Files] to play songs saved on your iPod®.

If there are no songs saved on your iPod®, the [Play iPod Files] is disabled.

**\* NOTICE - Using *Bluetooth*<sup>®</sup> Wireless Technology Audio**

- *Bluetooth*<sup>®</sup> Wireless Technology Audio mode can only be used if a *Bluetooth*<sup>®</sup> Wireless Technology-enabled phone is connected. Only devices that support *Bluetooth*<sup>®</sup> Wireless Technology audio can be used.
- If the *Bluetooth*<sup>®</sup> Wireless Technology-enabled phone is disconnected during play, the music stops.
- When the TRACK UP/DOWN buttons are used during *Bluetooth*<sup>®</sup> Wireless Technology audio streaming, a popping noise or sound interruptions may occur, depending on the cell phone device.
- Depending on the cell phone model, the audio streaming function may not be supported.

(Continued)

(Continued)

- If a phone call is made or received when music is playing in *Bluetooth*<sup>®</sup> Wireless Technology Audio mode, the call may mix with the music.
- When returning to *Bluetooth*<sup>®</sup> Wireless Technology Audio mode after ending a call, play might not resume automatically for some cell phone models.

**Precautions for Safe Driving**

- *Bluetooth*<sup>®</sup> Wireless Technology Handsfree is a feature that enables drivers to practice safe driving. Connecting the car audio system with a *Bluetooth*<sup>®</sup> Wireless Technology phone allows the user to conveniently make calls, receive calls, and manage the phone book. Before using the *Bluetooth*<sup>®</sup> Wireless Technology, carefully read the contents of this user's manual.
- Excessive use or operations while driving may lead to negligent driving practices and be the cause of accidents.
- Do not operate the device excessively while driving.
- Viewing the screen for prolonged periods of time is dangerous and may lead to accidents.
- When driving, view the screen only for short periods of time.



## Bluetooth® Wireless Technology (BT) Audio



### (1) Repeat

Enable/disable repeat.

### (2) Shuffle

Enable/disable shuffle play.

### (3) Menu

Navigate to the menu screen.

### (4) Play/Pause

Pause or play music.

## \* NOTICE

- Some cell phone models may not support particular functions.
- **Bluetooth®** Wireless Technology audio volume is synced with cell phone media volume.

### Playback

- Press the [**MEDIA**] button, and select [BT Audio].

### Changing songs

- Press the [**SEEK/TRACK**] button to play the previous or next song.

## \* NOTICE

Some cell phones may not support this function.

### Repeat play

Press the [Repeat] to enable or disable 'Repeat all', 'Repeat current song' or 'Repeat category'.

- Repeat all: All songs in the playlist are repeated.
- Repeat current song: The currently playing song is repeated.
- Repeat category: Repeat all songs in the current category.

## \* NOTICE

The repeat play function is engaged, depending on the operation of the connected **Bluetooth®** Wireless Technology device.

### Shuffle play

Press the [Shuffle] to enable/disable 'Shuffle', 'Shuffle category' play.

- Shuffle: Songs are played in random order.
- Shuffle category: Songs within the current category are played in random order.

## \* NOTICE

The shuffle function is engaged, depending on the operation of the connected **Bluetooth®** Wireless Technology device.

## Menu

Press the [Menu], and select the desired function.

- Connections: The currently connected *Bluetooth®* Wireless Technology device can be changed.
- Information: Detailed information on the currently playing song is displayed.
- Sound Settings: Audio sound settings can be changed.

## AUX

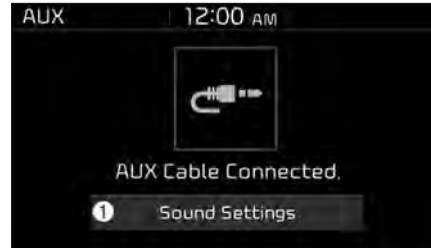

### Running AUX

- Press the **[MEDIA]** button, and select [AUX].
  - Connect the external device connection jack to the AUX terminal to run AUX.
- (1) Sound Settings: Audio sound settings can be changed.

## My Music



### (1) Repeat

Enable/disable repeat.

### (2) Shuffle

Enable/disable shuffle play.

### (3) List

View a list of all songs.

### (4) Menu

Navigate to the menu screen.

### (5) Album Image

View song info.

### (6) Pause

Pause or play music.

### (7) Playback progress

Press to skip to the desired location.

### Playback

Press the **[MEDIA]** button, and select [My Music].

- My Music cannot be selected if it does not contain music.
- Check the content of your USB drive before saving music to My Music.

### Changing songs

Press the **[SEEK/TRACK]** button to play the previous or next song.

- Press and hold the **[SEEK/TRACK]** button to rewind or fast forward the currently playing song.
- Search songs by turning the **TUNE** knob and press the knob to play.



### Selecting songs from a list

Press the [List] to see a list of songs available for play.

- Select and play the desired song.

### Repeat play

Press the [Repeat] to enable or disable 'Repeat all', 'Repeat current song' or 'Repeat category'.

- Repeat all: All songs in the playlist are repeated.
- Repeat current song: The currently playing song is repeated.
- Repeat category: Repeat all songs in the current category.

### Shuffle play

Press the [Shuffle] to enable/disable 'Shuffle', 'Shuffle category' play.

- Shuffle: Songs are played in random order.
- Shuffle category: Songs within the current category are played in random order.

### Menu

Press the [Menu], and select the desired function.

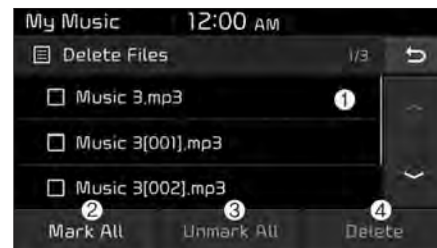

- Delete Files: You can delete files from My Music.

- (1) File: Select saved file.
- (2) Mark All: Select all Files.
- (3) Unmark All: Deselect all files.
- (4) Delete: Delete the selected file(s).

- Select the file to delete, then press the [Delete] to delete it.
- If Siri is activated, phone calls are received or made during delete, delete will be canceled.
- Add to Playlist: Frequently played songs can be paired in a [Playlist].
  - Songs can be played from the [Playlist].
- Information: Detailed info on the currently playing song is displayed.
- Sound Settings: Audio sound settings can be changed.

### **Delete from Playlist**

When a song in the playlist is playing, press the [Menu] and select [Delete from Playlist].

Select the song to delete, then press [Delete].

## Pandora



### (1) Thumbs Down

If you don't like the song that is currently playing, press this button to skip to the next song and to minimize the number of songs from similar genres.

### \* NOTICE

Pandora® limits the number of times that you can skip to the next song.

### (2) Thumbs Up

If you like the song that is currently playing, press this button. Pandora® will play more songs from the same genre.

### \* NOTICE

The settings of this function cannot be reset.

### (3) Skip

Skip to the next song.

### \* NOTICE

Pandora® limits the number of times that you can skip to the next song.

### (4) Stations

Display the station list.

### (5) Menu

Navigate to the menu screen.

### (6) Album Image

View song info.

### (7) Pause

Pause or play music.

### (8) Shared Station

Indicate that the station is already shared.

### \* NOTICE

Thumbs Up/Down is not available for shared stations.

### Playback

Press the [MEDIA] button, and select [Pandora].

### \* NOTICE

- Pandora®: Connect a smartphone to listen to Pandora® Radio
- Apple devices must be connected via USB cable and Android devices must be connected via Bluetooth® Wireless Technology in order to run Pandora®.

## Menu

Press the [Menu] and select the desired function.

- **Bookmark:** Add the song that is currently playing to your bookmarks list.

## \* NOTICE

- **You can view your bookmarked songs on your online Pandora® profile. Go to [pandora.com](http://pandora.com), then go to [Your profile] above the player. That will bring up a page with your stations and bookmarked songs.**
- **The settings of this function cannot be reset.**
- **Quit:** Exit Pandora® mode and return to previous audio mode.
- **Information:** Detailed info on the currently playing song is displayed.
- **Sound Settings:** Audio sound settings can be changed.

## Phone

### \* **NOTICE - Using *Bluetooth*<sup>®</sup> Wireless Technology Phone**

- *Bluetooth*<sup>®</sup> Wireless Technology is a near-field wireless networking technology that uses the 2.4 GHz frequency to connect various devices within a certain distance wirelessly.
- The technology is used in PCs, peripherals, *Bluetooth*<sup>®</sup> Wireless Technology phones, tablet PCs, household appliances and automobiles. Devices supporting *Bluetooth*<sup>®</sup> Wireless Technology can exchange data at high speeds without physical cable connections.
- *Bluetooth*<sup>®</sup> Wireless Technology Handsfree devices enable convenient access to phone functions through cell phones equipped with *Bluetooth*<sup>®</sup> Wireless Technology.

(Continued)

(Continued)

- Some *Bluetooth*<sup>®</sup> Wireless Technology devices may not be supported by the *Bluetooth*<sup>®</sup> Wireless Technology Handsfree function.
- When *Bluetooth*<sup>®</sup> Wireless Technology is connected and calls are attempted through a connected cell phone from outside the vehicle, the call is connected through the *Bluetooth*<sup>®</sup> Wireless Technology Handsfree function of the vehicle.
- Please be sure to disconnect the *Bluetooth*<sup>®</sup> Wireless Technology Handsfree function through your *Bluetooth*<sup>®</sup> Wireless Technology device or the audio screen.
- The *Bluetooth*<sup>®</sup> Wireless Technology Handsfree function helps drivers to drive safely. By connecting a *Bluetooth*<sup>®</sup> Wireless Technology-enabled phone to the vehicle's audio system, phone calls can be made and received through the audio system and contacts can be managed. Consult the user manual before use.

(Continued)

(Continued)

- Excessive manipulation of controls while driving, making it difficult to pay attention to the road ahead, can lead to accidents. Do not operate the device excessively while driving.
- Looking at the screen for a prolonged time increases the risk of accidents. Keep time spent looking at the screen to a minimum.

### Precautions when connecting *Bluetooth*<sup>®</sup> Wireless Technology devices

- The vehicle supports the following *Bluetooth*<sup>®</sup> Wireless Technology functions. Some *Bluetooth*<sup>®</sup> Wireless Technology devices may not support some functions.
  - 1) *Bluetooth*<sup>®</sup> Wireless Technology Handsfree phone calls
  - 2) Operations during a call (Private, Switch, Out Vol. controls)
  - 3) Download call history saved to the *Bluetooth*<sup>®</sup> Wireless Technology device
  - 4) Download contacts saved to the *Bluetooth*<sup>®</sup> Wireless Technology device
  - 5) Automatic contacts/call history download when *Bluetooth*<sup>®</sup> Wireless Technology is connected
  - 6) Automatic *Bluetooth*<sup>®</sup> Wireless Technology device connection when the vehicle is started
  - 7) *Bluetooth*<sup>®</sup> Wireless Technology audio streaming playback
- Before connecting the audio system to your device, make sure your device supports *Bluetooth*<sup>®</sup> Wireless Technology.
- Even if your device supports *Bluetooth*<sup>®</sup> Wireless Technology, a *Bluetooth*<sup>®</sup> Wireless Technology connection cannot be established if the device's *Bluetooth*<sup>®</sup> Wireless Technology function is switched off. Search and connect with the *Bluetooth*<sup>®</sup> Wireless Technology function enabled.
- Pair or connect *Bluetooth*<sup>®</sup> Wireless Technology devices to the audio system with the vehicle at a standstill.
- If a *Bluetooth*<sup>®</sup> Wireless Technology connection is lost due to abnormal conditions while a *Bluetooth*<sup>®</sup> Wireless Technology device is connected (communication range exceeded, device power OFF, communication errors, etc.), the disconnected *Bluetooth*<sup>®</sup> Wireless Technology device is searched for and automatically reconnected.
- If you want to disable the *Bluetooth*<sup>®</sup> Wireless Technology device auto-connect function, turn the *Bluetooth*<sup>®</sup> Wireless Technology function OFF on your device. Consult the user manuals for individual devices to see whether *Bluetooth*<sup>®</sup> Wireless Technology is supported.
- Handsfree call quality and volume may vary depending on the type of *Bluetooth*<sup>®</sup> Wireless Technology device.
- Some *Bluetooth*<sup>®</sup> Wireless Technology devices are subject to intermittent *Bluetooth*<sup>®</sup> Wireless Technology connection failures. In this case, use the following method.
  - 1) Turn the *Bluetooth*<sup>®</sup> Wireless Technology function off on your *Bluetooth*<sup>®</sup> Wireless Technology device → Turn it on and try again.
  - 2) Delete the paired device from both the audio system and *Bluetooth*<sup>®</sup> Wireless Technology device, then pair again.
  - 3) Power down your *Bluetooth*<sup>®</sup> Wireless Technology device → Turn it on and try again.
  - 4) Completely remove the battery from your *Bluetooth*<sup>®</sup> Wireless Technology device; reinsert it, reboot, and attempt connection.
  - 5) Restart the vehicle and reattempt connection.



### Pairing a Bluetooth® Wireless Technology device

#### Information on pairing Bluetooth® Wireless Technology devices

- Pairing refers to the process of pairing Bluetooth® Wireless Technology cell phones or devices with the system prior to connection. This is a necessary procedure for Bluetooth® Wireless Technology connection and usage.
- Up to five devices can be paired.

#### Pairing the first Bluetooth® Wireless Technology device

Select the **[PHONE]** button on the audio system or the **[CALL]** button on the steering wheel remote control → Search for the vehicle from the Bluetooth® Wireless Technology device, and pair → Enter the passkey on the Bluetooth® Wireless Technology device or approve passkey → Bluetooth® Wireless Technology pairing completed.

1. When the **[PHONE]** button on the audio or the **[CALL]** button on the steering wheel remote control is pressed, the following screen is displayed. Devices can now be paired.



- (1) Vehicle Name: Searched name in Bluetooth® Wireless Technology device.

#### \* NOTICE

The vehicle name in the image above is an example. Refer to your device for the actual name of your device.

2. Search for available Bluetooth® Wireless Technology devices in the Bluetooth® Wireless Technology menu of your Bluetooth® Wireless Technology device (cell phone, etc.).

3. Confirm that the vehicle name in your Bluetooth® Wireless Technology device matches the vehicle name shown on the audio screen, then select it.

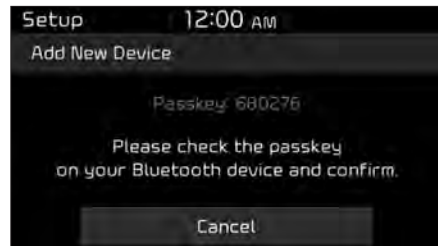

4. For devices that require passkey confirmation, the following screen is shown on the audio system. A 6-digit passkey input screen is shown in the Bluetooth® Wireless Technology device.
  - After confirming that the 6-digit passkey on the audio screen and the Bluetooth® Wireless Technology device are identical, press [OK] in your Bluetooth® Wireless Technology device.

**\* NOTICE**

- For device that require passkey entry, enter the passkey '0000' in your *Bluetooth*<sup>®</sup> Wireless Technology device.
- The 6-digit passkey in the image above is an example. Refer to your vehicle for the actual passkey.

**Pairing a second *Bluetooth*<sup>®</sup> Wireless Technology device**

Press the **[SETUP]** button on the audio system → Select **[Bluetooth]** → Select **[Connections]** → Select **[Add New]**.



- The pairing procedure from this point is identical to [Pairing the first Bluetooth device].

**\* NOTICE**

- *Bluetooth*<sup>®</sup> Wireless Technology standby mode lasts for three minutes. If a device is not paired within three minutes, pairing is canceled. Start over from the beginning.
- For most *Bluetooth*<sup>®</sup> Wireless Technology devices, a connection is established automatically after pairing. Some devices, however, require separate confirmation when connecting after pairing. Be sure to check your *Bluetooth*<sup>®</sup> Wireless Technology device after pairing to confirm that it has connected.

**Connecting *Bluetooth*<sup>®</sup> Wireless Technology devices****If there are no connected devices**

Select the **[PHONE]** button on the audio system or the **[CALL]** button in the steering wheel remote control → List of paired *Bluetooth*<sup>®</sup> Wireless Technology devices → Select the desired *Bluetooth*<sup>®</sup> Wireless Technology device from the list → Connect *Bluetooth*<sup>®</sup> Wireless Technology.



### If there are connected devices

Select the **[PHONE]** button on the audio system → Select [Settings] → Select [Connections] → Select *Bluetooth*® Wireless Technology device to connect → Select [Connect] → Connect *Bluetooth*® Wireless Technology.

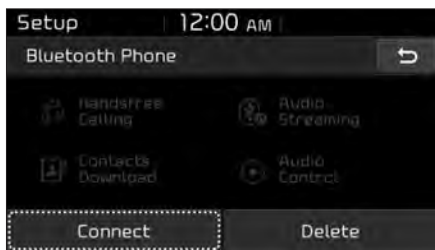

### \* NOTICE

- Only one *Bluetooth*® Wireless Technology device can be connected at a time.
- When a *Bluetooth*® Wireless Technology device is connected, other devices cannot be paired.

### Accepting/rejecting phone calls

Receiving phone calls with *Bluetooth*® Wireless Technology connected.



- (1) Caller name: If the caller number is in your contacts, the corresponding name is displayed.
- (2) Incoming phone number: Incoming phone number is displayed.
- (3) Accept: Accept call.
- (4) Reject: Reject call.

### \* NOTICE

- When the incoming call screen is displayed, audio mode and the settings screen cannot be shown. Only call volume control is supported.
- Some *Bluetooth*® Wireless Technology devices may not support the call reject function.
- Some *Bluetooth*® Wireless Technology devices may not support the phone number display function.

### Operation during calls

Incoming call with *Bluetooth*<sup>®</sup> Wireless Technology connected → Select [Accept].



- (1) Call duration: Call duration display.
- (2) Caller name: If the caller number is in your contacts, the corresponding name is displayed.
- (3) Incoming phone number: Incoming phone number is displayed.
- (4) Keypad: Number keypad for Automatic Response Service input is displayed.
- (5) Private: Call is transferred to a cell phone.
- (6) Outgoing Volume: Adjust outgoing voice volume.
- (7) End: End call.

### \* NOTICE

- Some *Bluetooth*<sup>®</sup> Wireless Technology devices may not support the Private function.
- The outgoing voice volume may vary depending on the type of *Bluetooth*<sup>®</sup> Wireless Technology device. If the outgoing voice volume is too high or low, adjust the Out Vol.

### Favorites

Select the [PHONE] button on the audio system → Select [Favorites] → Favorites list displayed.



- (1) Favorites list: A list of paired favorites is displayed.  
Connect a call when selected.

- (2) Add to Favorites: Add a downloaded phone number to favorites.
- (3) Delete: Delete a saved favorites.

### \* NOTICE

- Up to 20 favorites can be paired for each paired *Bluetooth*<sup>®</sup> Wireless Technology device.
- Favorites can be accessed when the *Bluetooth*<sup>®</sup> Wireless Technology device they were paired from is connected.
- The audio system does not download favorites from *Bluetooth*<sup>®</sup> Wireless Technology devices. Favorites must be newly saved before use.
- To add to favorites, contacts must be downloaded first.
- Saved favorites are not updated even if the contacts of the connected *Bluetooth*<sup>®</sup> Wireless Technology device are changed. In this case, favorites need to be deleted and added again.

### Call history

Select the **[PHONE]** button on the audio system → Select [Call history] → Call history is displayed.



- (1) Call history: Display the downloaded call history list.  
Connect a call when selected.
- (2) Sort by: Sort by all calls, dialed calls, received calls or missed calls.
- (3) Download: Download call history from connected *Bluetooth*® Wireless Technology devices.

### \* NOTICE

- Up to 50 dialed, received and missed calls are saved.
- When the latest call history is received, the existing call history is deleted.

### Contacts

Select the **[PHONE]** button on the audio system → Select [Contacts] → Select letter (ABC) → Contacts displayed.



- (1) Contacts: Display downloaded contacts.  
Connect a call when selected.
- (2) Download: Download contacts from connected *Bluetooth*® Wireless Technology devices.

### \* NOTICE

- Only supported contacts format can be downloaded and displayed from the *Bluetooth*® Wireless Technology device, contacts from some applications will not be included.
- Up to 2,000 contacts can be saved.
- In some cases, additional confirmation from your *Bluetooth*® Wireless Technology device is necessary when downloading contacts. If downloading of contacts unsuccessful, consult your *Bluetooth*® Wireless Technology device's settings or the audio screen to approve the download.
- Contacts without phone numbers are not displayed.

**Dial**

Select the **[PHONE]** button on the audio → Select [Dial].



- (1) Phone number entry window: The phone number entered using the keypad is displayed.
- (2) Clear
  - Press to delete individual digits.
  - Press and hold to delete the entire phone number.
- (3) Keypad: Enter phone number.
- (4) *Bluetooth*<sup>®</sup> Wireless Technology phone name
  - The name of the connected *Bluetooth*<sup>®</sup> Wireless Technology device is displayed.
  - Contacts matching the keypad number/letter input are displayed.

**(5) Call**

- Enter and select a phone number to call.
- Select without entering a phone number to see the most recent dialed call.

**Connections**

Select the **[PHONE]** button on the audio → Select [Connections].

- For connections setting, refer to Setup → Select [Bluetooth] → Select [Connections] page.

**Setup**

Select the **[PHONE]** button on the audio → Select [Settings].

- For phone Setup, refer to Setup page → Select [Bluetooth].

### Siri

#### \* NOTICE - Using Siri

- Android device is not supported to use Siri.
- If you want to use Siri, you have to connect your iOS device to multi-media system through *Bluetooth*® Wireless Technology. (Please check whether your iOS device supports Siri and turning Siri On)
- If the iOS version is changed, the functions and response may be different according to the iOS device and the latest version.
- Siri automatically stops in the following events.
  - 1) Outgoing and incoming phone calls.
  - 2) Media (USB, etc.) is connected. (Siri mode is maintained when iPod®s are connected)
  - 3) Rear camera is activated (option).
  - 4) Vehicle is started or engine is turned off.

(Continued)

(Continued)

- 5) Screen transition buttons, such as RADIO or MEDIA, are selected.
  - 6) When a pop-up message is displayed on the screen due to accidental execution of Siri.
- The microphone is located above the driver's seat. To ensure proper Siri, state your voice while maintaining proper driving posture.

#### Starting Siri

Press the [VOICE] button on the steering wheel remote control to start Siri and see the screen.



(1) Speak: Re-start Siri.

(2) Exit: End Siri.

#### \* NOTICE

- Functions and feedbacks from voice commands via Siri are executed in the iOS device.
- The Audio system only supports “Phone” related functions, other functions will be performed in your iOS device.

## Setup



Access Display, Sound, Date/Time, Bluetooth, System, Screen Saver and Display Off settings.

Select the **[SETUP]** button on the audio system.

### Display

Select the **[SETUP]** button on the audio system → Select [Display].

- Mode: Audio screen brightness can be adjusted to the time of day.
- Illumination: The brightness of the audio screen can be changed.

### Sound

Select the **[SETUP]** button on the audio system → Select [Sound].

- Position: Sound balance and panning can be adjusted.
- Tone: Sound tone color can be adjusted.
- Speed Dependent Volume: Automatically adjust volume based on vehicle speed.
- Beep: Select whether to play a sound when the screen is touched.

### Date/Time

Select the **[SETUP]** button on the audio system → Select [Date/Time].

- Set Time: Set the time displayed on the audio screen.
- Time Format: Choose between 12-hour and 24-hour time formats.
- Set Date: Set the date displayed on the audio screen.

### **⚠ WARNING - Date/Time Setting Distraction**

**Adjusting the date/time setting while driving can result in a loss of vehicle control that may lead to an accident, severe personal injury, and death.**

### Bluetooth

Select the **[SETUP]** button on the audio system → Select [Bluetooth].

- Connections: Control pairing, deletion, connection and disconnection of *Bluetooth*® Wireless Technology devices.
- Auto Connection Priority: Set the connection priority of *Bluetooth*® Wireless Technology devices when the vehicle is started.
- Download Contacts: Contacts can be downloaded from connected *Bluetooth*® Wireless Technology devices.
- Bluetooth Voice Prompts: Play or mute voice prompts for *Bluetooth*® Wireless Technology device pairing, connection and errors.



### \* NOTICE

- When paired devices are deleted, the call history and contacts of the device saved to the audio system are deleted.
- For *Bluetooth*® Wireless Technology connections with low connection priority, some time may be required for the connection to be established.
- Contacts can be downloaded only from the currently connected *Bluetooth*® Wireless Technology device.  
If no *Bluetooth*® Wireless Technology device is connected, the download contacts button is disabled.

### System

- Select the **[SETUP]** button on the audio system → Select [System].
- Memory Information: View My Music memory usage.
  - Language: Change the user language.
  - Default: Reset the audio system.
  - System Information: At the System Information screen, Software version information, updates are available.
    - System Update: At the System Information screen, insert the USB memory with the latest file downloaded, and then select the [Update] to begin updating. The system will then reboot automatically.

### \* NOTICE

- The system resets to the default values, and all saved data and settings are lost.
- This product needs supplemented software updates and additional functions, which collectively may take some time to complete, depending on the amount of data.
- If the Power is disconnected or the USB is removed during an update, the data might be damaged. Please wait until the update is complete while engine is on.

### ***Screen Saver***

Set the information displayed when the audio system is switched off or the screen is turned off.

Select the **[SETUP]** button on the audio system → Select [Screen Saver].

- Analog: An analog clock is displayed.
- Digital: A digital clock is displayed.
- None: No information is displayed.

### ***Display Off***

To prevent glare, the screen can be turned off with the audio system in operation.

Select the **[SETUP]** button on the audio system → Select [Display Off].

## Declaration of Conformity

### FCC

This equipment has been tested and found to comply with the limits for a Class B digital device, pursuant to part 15 of the FCC Rules. These limits are designed to provide reasonable protection against harmful interference in a residential installation.

This equipment generates, uses and can radiate radio frequency energy and, if not installed and used in accordance with the instructions, may cause harmful interference to radio communications. However, there is no guarantee that interference will not occur in a particular installation. If this equipment does cause harmful interference to radio or television reception, which can be determined by turning the equipment off and on, the user is encouraged to try to correct the interference by one or more of the following measures:

- Reorient or relocate the receiving antenna.
- Increase the separation between the equipment and receiver.
- Connect the equipment into an outlet on a circuit different from that to which the receiver is connected.
- Consult the dealer or an experienced radio/TV technician for help.

Caution: Any changes or modifications to this device not explicitly approved by manufacturer could void your authority to operate this equipment.

This device complies with part 15 of the FCC Rules. Operation is subject to the following two conditions:

(1) This device may not cause harmful interference, and (2) this device must accept any interference received, including interference that may cause undesired operation.

This equipment complies with FCC radiation exposure limits set forth for an uncontrolled environment.

This equipment should be installed and operated with minimum 20cm between the and your body. This transmitter must not be collocated or operating in conjunction with any other antenna or transmitter unless authorized to do so by the FCC.

# Driving your vehicle

<b>Before driving</b> . . . . .	5-3	<b>Cruise control system</b> . . . . .	5-33
• Before entering vehicle . . . . .	5-3	• Cruise control switch . . . . .	5-34
• Necessary inspections . . . . .	5-3	• To set cruise control speed . . . . .	5-34
• Before starting . . . . .	5-3	• To increase cruise control set speed . . . . .	5-35
<b>POWER button</b> . . . . .	5-5	• To decrease the cruising speed . . . . .	5-35
• Illuminated POWER button . . . . .	5-5	• To temporarily accelerate with the cruise control on . . . . .	5-35
• POWER button position . . . . .	5-5	• To cancel cruise control . . . . .	5-36
• Starting the vehicle . . . . .	5-7	• To resume cruising speed at more than approximately 20 mph (30 km/h) . . . . .	5-36
• Pedestrian Warning System . . . . .	5-9	• To turn cruise control off . . . . .	5-37
• Turning off the Vehicle . . . . .	5-9	<b>Economical operation</b> . . . . .	5-38
<b>Active ECO operation</b> . . . . .	5-10	<b>Special driving conditions</b> . . . . .	5-40
<b>Reduction gear</b> . . . . .	5-11	• Hazardous driving conditions . . . . .	5-40
• Reduction gear operation . . . . .	5-12	• Reducing the risk of a rollover . . . . .	5-40
• Good driving practices . . . . .	5-16	• Rocking the vehicle . . . . .	5-41
<b>Brake system</b> . . . . .	5-17	• Smooth cornering . . . . .	5-42
• Power brakes . . . . .	5-17	• Driving at night . . . . .	5-42
• Electronic parking brake (EPB) . . . . .	5-19	• Driving in the rain . . . . .	5-43
• Anti-lock brake system (ABS) . . . . .	5-23	• Driving in flooded areas . . . . .	5-43
• Electronic stability control (ESC) . . . . .	5-25	• Driving off-road . . . . .	5-44
• Vehicle stability management (VSM) . . . . .	5-29	• Highway driving . . . . .	5-44
• Hill-start assist control (HAC) . . . . .	5-30		
• Good braking practices . . . . .	5-31		

<b>Winter driving</b> .....	5-45
• Snowy or icy conditions .....	5-45
• Use high quality ethylene glycol coolant.....	5-47
• Check battery and cables .....	5-47
• To keep locks from freezing .....	5-47
• Use approved window washer anti-freeze in system.....	5-47
• Don't let your parking brake freeze .....	5-47
• Don't let ice and snow accumulate underneath ...	5-48
• Carry emergency equipment .....	5-48
<b>Trailer Towing</b> .....	5-48
<b>Vehicle load limit</b> .....	5-49
• Tire and loading information label .....	5-49
• Certification label .....	5-52
<b>Vehicle weight glossary</b> .....	5-54
• Base curb weight .....	5-54
• Vehicle curb weight .....	5-54
• Cargo weight .....	5-54
• GAW (Gross axle weight) .....	5-54
• GAWR (Gross axle weight rating).....	5-54
• GVW (Gross vehicle weight) .....	5-54
• GVWR (Gross vehicle weight rating) .....	5-54

## BEFORE DRIVING

### Before entering vehicle

- Be sure that all windows, outside mirror(s), and outside lights are clean.
- Check the condition of the tires.
- Check under the vehicle for any sign of leaks.
- Be sure there are no obstacles behind you if you intend to back up.

### Necessary inspections

Fluid levels, such as coolant, brake fluid, and washer fluid should be checked on a regular basis, at the exact interval depending on the fluid. Further details are provided in chapter 7, "Maintenance".

 **WARNING - Distracted driving**

**Focus on the road while driving. The driver's primary responsibility is in the safe and legal operation of the vehicle. Use of any handled devices, other equipment or vehicle systems that distract the drive should not be used during vehicle operation.**

### Before starting

- Close and lock all doors.
- Position the seat so that all controls are easily reached.
- Buckle your seat belt.
- Adjust the inside and outside rearview mirrors.
- Be sure that all lights work.
- Check all gauges.
- Check the operation of warning lights when the POWER button is turned to the ON position.
- Release the parking brake and make sure the brake warning light goes out.

For safe operation, be sure you are familiar with your vehicle and its equipment.

**⚠ WARNING - Check surroundings**

Always check the surrounding areas near your vehicle for people, especially children, before putting a vehicle into D (Drive) or R (Reverse).

**⚠ WARNING - Loose objects**

Securely store items in your vehicle. When you make a sudden stop or turn the steering wheel rapidly, loose objects may drop on the floor and it could interfere with the operation of the foot pedals, possibly causing an accident.

**⚠ WARNING - Driving while intoxicated**

Do not drive while intoxicated. Drinking and driving is dangerous. Even a small amount of alcohol will affect your reflexes, perceptions and judgment.

Driving while under the influence of drugs is as dangerous as or more dangerous than driving drunk.



## POWER BUTTON

### Illuminated POWER button



Whenever the front door is opened, the POWER button will illuminate for your convenience. The light will go off after about 30 seconds when the door is closed.

When all entrances are closed, if you lock the vehicle by using the smart key, the light will go off immediately.

### POWER button position

#### OFF

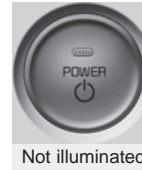

To turn off the vehicle, press the POWER button with the shift lever in the P (Park) position. When you press the POWER button without the shift lever in the P (Park) position, the POWER button will not change to the OFF position but to the ACC position.

In an emergency situation while the vehicle is in motion, you are able to turn the vehicle off and to the ACC position by pressing the POWER button for more than 2 seconds or 3 times successively within 3 seconds. If the vehicle is still moving, you can restart the vehicle without depressing the brake pedal by pressing the POWER button with the shift lever in the N (Neutral) position.

#### ACC (Accessory)



Press the POWER button while it is in the OFF position without depressing the brake pedal.

If the POWER button is in the ACC position for more than 1 hour, the POWER button is turned off automatically to prevent battery discharge.

## ON



Press the POWER button while it is in the ACC position without depressing the brake pedal.

The warning lights can be checked before the vehicle is started. Do not leave the POWER button in the ON position for a long time, otherwise the battery may discharge.

## START/RUN

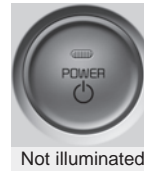

To start the vehicle, depress the brake pedal and press the POWER button with the shift lever in the P (Park) position.

If you press the POWER button without depressing the brake pedal, the vehicle will not start and the POWER button changes as follow:

OFF → ACC → ON → OFF or ACC

### \* NOTICE

If you leave the POWER button in the ACC or ON position for a long time, the battery will discharge.

### **⚠ WARNING - Starting vehicle**

Never press the POWER button while the vehicle is in motion except in an emergency. If the vehicle stops while the vehicle is in motion, this would result in loss of directional control and braking function, which could cause an accident.

### **⚠ WARNING - Leaving the Vehicle**

To avoid unexpected or sudden vehicle movement, never leave your vehicle if the transmission is not locked in the P (Park) position and the parking brake is fully engaged. Before leaving the driver's seat, always make sure the shift lever is engaged in P (Park), set the parking brake fully and shut the engine off.

## Starting the vehicle

1. Carry the smart key or leave it inside the vehicle.
  2. Make sure the parking brake is firmly applied
  3. Place the transaxle shift lever in P (Park). Depress the brake pedal fully.
  4. Press the POWER button until the ready "" indicator light in the cluster is turned on.
- Even if the smart key is in the vehicle, if it is far away from you, the vehicle may not start.
  - When the POWER button is in the ACC position or above, if any door is opened, the system checks for the smart key. If the smart key is not in the vehicle, a message "key is not in the vehicle" will appear on the LCD display. And if all doors are closed, the chime will sound for 5 seconds. The indicator or warning will turn off while the vehicle is moving. Always have the smart key with you.

### CAUTION

*If the vehicle stalls while the vehicle is in motion, do not attempt to move the shift lever to the P (Park) position. If the traffic and road conditions permit, you may put the shift lever in the N (Neutral) position while the vehicle is still moving and press the POWER button in an attempt to restart the vehicle.*

### WARNING - Proper footwear

**Always wear appropriate shoes when operating your vehicle. Unsuitable shoes (high heels, ski boots, sandals, etc.) may interfere with your ability to use the brake and accelerator pedals.**

**⚠ WARNING - Unintended vehicle movement**

Never leave the smart key in the vehicle with children or vehicle occupants who are unfamiliar with the vehicle operation. Pushing the POWER button while the smart key is in the vehicle may result in unintended vehicle movement.



- If the battery is weak or the smart key does not work correctly, you can start the vehicle by pressing the POWER button with the smart key.

The side with the lock button should contact the POWER button directly.

When you press the POWER button directly with the smart key, the smart key should contact the POWER button at a right angle.

- When the stop lamp fuse is blown, you can't start the vehicle normally. Replace the fuse with a new one. If it is not possible, you can start the vehicle by pressing the POWER button for 10 seconds while it is in the ACC position. The vehicle can start with depressing the brake pedal.

Do not press the POWER button for more than 10 seconds except when the stop lamp fuse is blown.

## Pedestrian Warning System

The Pedestrian Warning System generates engine sound for pedestrians to hear vehicle sound because there is little sound while the Electric Vehicle (EV) is operating.

If the vehicle is moving low speed, the Pedestrian Warning System will operated.

- When the reduction gear is shifted to [R], the Pedestrian Warning System will be operated immediately.

## Turing off the Vehicle



1. Depress the brake pedal fully.
2. Place the shift lever in the P (Park).
3. Apply the parking brake firmly.
4. Press the POWER button to turn the vehicle off.
5. Make sure the "⚡ (ready)" indicator lights on the instrument cluster are turned off.

## \* NOTICE

If the "⚡ (ready)" indicator light on the instrument cluster is still on, be careful that the vehicle is not turned off and can move when you place the shift lever in any position except P (Park).

## ACTIVE ECO SYSTEM

### Active ECO operation





Active ECO helps improve energy efficiency by controlling certain motor and climate control system operating parameters. Energy efficiency depends on the driver's driving habit and road condition.

- When the Active ECO is activated, it will remain on until the Active ECO button is pressed again. Active ECO does not turn off when the vehicle is restarted. To turn off Active ECO, press the Active ECO button again.
  - If Active ECO is turned off, the system will return to normal mode.
- When the Active ECO button is pressed the ECO indicator (green) will illuminate to show that the Active ECO is operating.

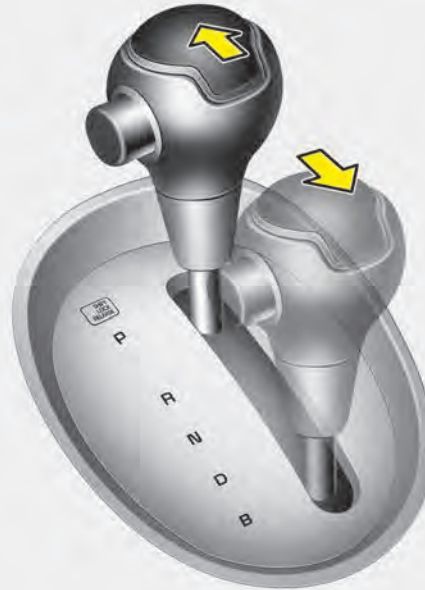
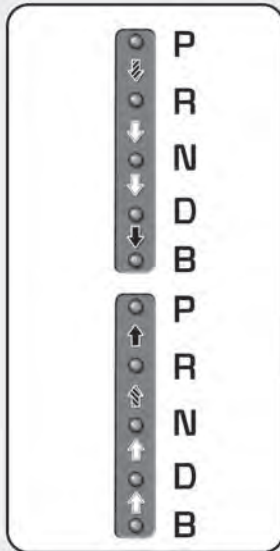
## REDUCTION GEAR



-  Depress the brake pedal and the lock release button when shifting.
-  Press the lock release button when shifting.
-  The shift lever can be shifted freely.

OPSE057007L

## Reduction gear operation

### **WARNING** - Leaving the vehicle

Before leaving the driver's seat, always make sure the shift lever is in the P (Park) position; then set the parking brake fully and shut the vehicle off. Do not use the P position in place of the parking brake. Always make sure the shift lever is latched in the P position and set the parking brake fully. Unexpected and sudden vehicle movement can occur if these precautions are not followed.



### **CAUTION** - Reduction gear

*To avoid damage to your reduction gear, do not accelerate the vehicle in R (Reverse) or any forward gear position with the brakes on. The reduction gear may be damaged if you shift into P (Park) while the vehicle is in motion.*

When stopped on an incline, do not hold the vehicle with the motor power. Use the service brake or the parking brake.

## *Transaxle ranges*

The indicator in the instrument cluster displays the shift lever position when the POWER button is in the ON position.

### **P (Park)**

Always come to a complete stop before shifting into P (Park). This position locks the gear and prevents the drive wheels from rotating.

Shifting into P (Park) while the vehicle is in motion will cause the drive wheels to lock which will cause you to lose control of the vehicle.



**R (Reverse)**

Use this position to drive the vehicle backward.

 **CAUTION - Shifting**

*Always come to a complete stop before shifting into or out of R (Reverse); you may damage the gear if you shift into R (Reverse) while the vehicle is in motion, except when “Rocking the vehicle” explained in this section.*

**N (Neutral)**

The wheels and gear are not engaged. The vehicle will roll freely even on the slightest incline unless the parking brake or service brakes are applied.

**D (Drive)**

This is the normal forward driving position. The gear will automatically shift providing the best energy economy and power.

**\* NOTICE**

Always come to a complete stop before shifting into D (Drive).

**B (Regenerative brake): maximum regenerative braking mode**

Use it when you desire to use regenerative braking.

It is useful when you drive on a long downhill on a highway, mountain trails, or a slope.

\* If you use regenerative braking, you can achieve the same effect as engine brake of a combustion engine.

## - Parking in N (Neutral) gear

Follow below steps when parking and you want the vehicle to move when pushed.

1. After stopping your vehicle, depress the brake pedal and move the shift lever to [P] with the POWER button in [ON] or while vehicle is in the ready (🚗) mode.
2. If the parking brake is applied, release the parking brake.

\* For EPB (Electronic Parking Brake) equipped vehicles, depress the brake pedal and press the EPB (Electronic Parking Brake) switch, while the POWER button is in [ON] or vehicle is in the ready (🚗) mode to release the parking brake.



3. Push the EPB (Electronic Parking Brake) switch while depressing the brake pedal, and turn the POWER button [OFF].

\* If the POWER button is moved to 'OFF' when the shift lever is in 'P', the parking brake will apply automatically. For 'N' gear parking, if the POWER button is turned 'OFF' while pressing the EPB (Electronic Parking Brake) switch, the parking brake will not lock.

\* For smart key equipped vehicles, the POWER button can be moved to [OFF] only when the shift lever is in [P].

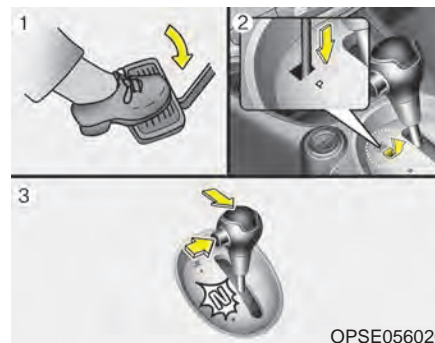

4. To unlock the transaxle shift lock system, remove the [SHIFT LOCK RELEASE] cap with care. Insert a screwdriver into the shift-lock override access hole and press down. While depressing the screwdriver, you can move the shift lever to [N] (Neutral) gear.

5. After depressing the brake pedal and pushing the shift lever button, move the shift lever to 'N'. Then, the vehicle will move when pushed.

**⚠ WARNING**

- With the exception of parking in neutral gear, always park the vehicle in [P] (Park) for safety and apply the parking brake.
- Before parking in [N] (Neutral) gear, make sure the parking ground is level and flat. Do not park in [N] gear on any slopes or gradients.  
If parked and left in [N], the vehicle may move and cause serious damage or injury.

**\* NOTICE**

After the POWER button has been turned off, the EPB (Electronic Parking Brake) cannot be released.

**Shift lock system**

For your safety, the reduction gear has a shift lock system which prevents shifting the gear from P (Park) or N (Neutral) into R (Reverse) unless the brake pedal is depressed.

To shift the gear from P (Park) or N (Neutral) into R (Reverse) or from D (Drive) into R (Reverse) :

1. Depress and hold the brake pedal.
2. Start the vehicle or turn the POWER button to the ON position.
3. Move the shift lever.

You can change the gearshift from N or D to R, only when the break is in ON and vehicle speed is less than 7 Km/h

If the brake pedal is repeatedly depressed and released with the shift lever in the P (Park) position, a chattering noise near the shift lever may be heard. This is a normal condition.

**⚠ WARNING - Shifting from park**

**Always fully depress the brake pedal before and while shifting out of the P (Park) position into another position to avoid inadvertent motion of the vehicle which could injure persons in or around the vehicle.**

Shiftlock function will activate when the gear is changed from N to R.

Before changing the gear from N to R, the driver must step on the brake after the vehicle has come to a full stop. Then, while pressing down on the brake pedal, press onto the lock release button.

\*This function is to prevent any reduction gear damage which may occur if the driver locks the gear while the vehicle is in motion.

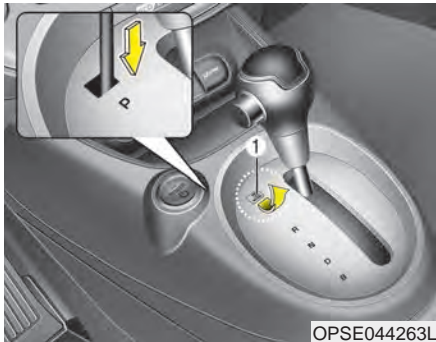

### Shift-lock override

If the shift lever cannot be moved from the P (Park) position into R (Reverse) position with the brake pedal depressed, continue depressing the brake, then do the following:

1. Carefully remove the cap covering the shift-lock access hole (1).
  2. Insert a screwdriver into the access hole and press down on the screwdriver.
  3. Move the shift lever.
  4. Have your vehicle inspected by an authorized Kia dealer immediately.
- While the charging cable is connected, you cannot use the shift lever for safety reasons.

### Good driving practices

- Never move the gear shift lever from P (Park) to any other position with the accelerator pedal depressed.
- Never move the gear shift lever into P (Park) when the vehicle is in motion.
- Slow down before shifting to a lower gear. Otherwise, the lower gear may not be engaged.
- Always use the parking brake. Do not depend on placing the shift lever in P (Park) to keep the vehicle from moving.
- Optimum vehicle performance and economy is obtained by smoothly depressing and releasing the accelerator pedal.

### *Moving up a steep grade from a standing start*

To move up a steep grade from a standing start, depress the brake pedal, shift the shift lever to D (Drive). Select the appropriate gear depending on load weight and steepness of the grade, and release the parking brake. Depress the accelerator gradually while releasing the service brakes.

## BRAKE SYSTEM

### Power brakes

Your vehicle's brake system is power-assisted by the electric hydraulic pump.

In the event the brakes lose power because of a brake control system malfunction, unstable power supply or some other reason, you can still stop your vehicle by applying greater force to the brake pedal than you normally would. The stopping distance, however will be longer. Please have the system checked as soon as possible.

If the brake pedal does not return to its normal position when released, there may be a malfunction in the brake system. Take your vehicle to an authorized Kia dealer and have the system checked.

#### **WARNING**

**Do not turn off the vehicle while going down a hill. The brake booster may not work sufficiently and the braking distance may be longer.**

#### **CAUTION**

**Do not depress the brake pedal continuously without *READY* (⬅️) status. The battery may be discharged.**

#### **CAUTION - Brake Pedal**

**Do not drive with your foot resting on the brake pedal. This will create abnormally high brake temperatures which can cause excessive brake lining and pad wear.**

#### **WARNING - Steep hill braking**

**Avoid continuous application of the brakes when descending a long or steep hill by shifting to a lower gear. Continuous brake application will cause the brakes to overheat and could result in a temporary loss of braking performance.**

Wet brakes may impair the vehicle's ability to safely slow down; the vehicle may also pull to one side when the brakes are applied. Applying the brakes lightly will indicate whether they have been affected in this way. Always test your brakes in this fashion after driving through deep water. To dry the brakes, apply them lightly while maintaining a safe forward speed until brake performance returns to normal.

### *In the event of brake failure*

If service brakes fail to operate while the vehicle is in motion, you can make an emergency stop with the parking brake. The stopping distance, however, will be much greater than normal.

**⚠ WARNING - Parking brake**  
Applying the parking brake while the vehicle is moving at normal speeds can cause a sudden loss of control of the vehicle. If you must use the parking brake to stop the vehicle, use great caution in applying the brake.

### *Disc brakes wear indicator*

When your brake pads are worn and new pads are required, you will hear a high-pitched warning sound from your front brakes or rear brakes. You may hear this sound come and go or it may occur whenever you depress the brake pedal.

Please remember that some driving conditions or climates may cause a brake squeal when you first apply (or lightly apply) the brakes. This is normal and does not indicate a problem with your brakes.

Always replace the front or rear brake pads as pairs.

**⚠ WARNING - Brake wear**  
Do not ignore high pitched whining sounds from your brakes. If you ignore this audible warning, you will eventually lose braking performance, which could lead to a serious accident.

## Electronic parking brake (EPB)

### Applying the parking brake



### To apply the EPB (electronic parking brake):

1. Depress the brake pedal.
2. Pull up the EPB switch.

Make sure the warning light  comes on.

- After parking the vehicle, if the ignition button is turned OFF when the transmission shift lever is in Park, the electronic parking brake will lock automatically.

For neutral parking and prevention of freezing in winter, press down on the electronic parking brake switch and turn the ignition button OFF. Then, the brake will not lock automatically.

- During wintry season, the electronic parking brake may freeze. Avoid gradients when parking the vehicle and park on safe and level ground. When the EPB has to be used, block the wheel to prevent unintended movement.

### \* NOTICE

A click or electric brake motor whine sound may be heard while operating or releasing the EPB, but these conditions are normal and indicate that the EPB is functioning properly.

### WARNING

**Always shift your vehicle to the Park gear prior to exiting your vehicle. Failure to shift to Park could result in your vehicle rolling away unoccupied and causing an accident.**

### Releasing the parking brake



To release the EPB (electronic parking brake), press the EPB switch in the following condition:

- Have the POWER button in the ON position.
- Depress the brake pedal.

Make sure the brake warning light  goes off.

To release EPB (electronic parking brake) automatically:

- Shift lever in P (Park)

With the vehicle is in the ready (🚗) mode depress the brake pedal and shift out of P (Park) to R (Reverse) or D (Drive).

- Shift lever in N (Neutral)

With the vehicle is in the ready (🚗) mode depress the brake pedal and shift out of N (Neutral) to R (Reverse) or D (Drive).

1. The vehicle is in the ready (🚗) mode.
2. Fasten the driver's seat belt.
3. Close the driver's door, tailgate.
4. Depress the accelerator pedal while the shift lever is in R(Rear) with trunk closed, D (Drive).

Make sure the brake warning light  goes off.

### \* NOTICE

- You can engage the EPB even though the POWER button is in the OFF position, but you cannot release it.
- Depress the brake pedal and release the parking brake manually with the EPB switch when you drive downhill or when backing up the vehicle.

**Do not follow the above procedure when driving on a flat level ground. The vehicle may suddenly move forward.**

### CAUTION

***Do not drive your vehicle with the EPB applied. It may cause excessive brake pad and brake rotor wear.***

### \* NOTICE

If the parking brake warning light  is still on even though the EPB has been released, have the system checked by an authorized Kia dealer.

**EPB (electronic parking brake) may be automatically applied when:**

- Requested by other systems



**System warning**

- If you try to drive off depressing the accelerator pedal with the EPB applied, but the EPB doesn't release automatically, a warning will sound and a message will appear.
- If the driver's seat belt is not fastened and any door, the tailgate is opened, a warning will sound and a message will appear.
- If there is a problem with the vehicle, a warning may sound and a message may appear.

If the above situation occurs, depress the brake pedal and release EPB by pressing the EPB switch.

**⚠ WARNING - Parking Brake Use**

- **Never allow a passenger to touch the parking brake. If the parking brake is released unintentionally, serious injury may occur.**
- **All vehicles should always have the parking brake fully engaged when parked to avoid inadvertent movement of the car which can injure occupants or pedestrians.**

- A click or electric brake motor whine sound may be heard while operating or releasing the EPB, but these conditions are normal and indicate that the EPB is functioning properly.
- When leaving your keys with a parking lot attendant or valet, make sure to inform him/her how to operate the EPB.
- When you automatically release EPB by depressing the accelerator pedal, depress it slowly.

### EPB malfunction indicator





This warning light illuminates if the POWER button is changed to the ON position and goes off in approximately 3 seconds if the system is operation normally.

If the EPB malfunction indicator remains on, comes on while driving, or does not come on when the POWER button is changed to the ON position, this indicates that the EPB may have malfunctioned.

If this occurs, have your vehicle checked by an authorized Kia dealer as soon as possible.

The EPB malfunction indicator may illuminate when the ESC indicator comes on to indicate that the ESC is not working properly, but it does not indicate a malfunction of the EPB.

- The EPB warning light may illuminate if the EPB switch operates abnormally. Shut the vehicle power off and turn it on again after a few minutes. The warning light will go off and the EPB switch will operate normally. However, if the EPB warning light is still on, have the system checked by an authorized Kia dealer.
- If the parking brake warning light  does not illuminate or blinks even though the EPB switch was pulled up, the EPB is not applied.
- If the brake warning light  is blinking while the [EPB] warning light is on, press the electronic parking brake (EPB) switch once to release the parking brake and turn off the vehicle.  
Turn on the vehicle again and pull the EPB switch to engage the parking brake. Check if the [EPB] warning light turns off. If the [EPB] warning lamp remains on, contact an authorized Kia dealer and have the system checked.

### **Emergency braking**

If there is a problem with the brake pedal while driving, emergency braking is possible by pulling up and holding the EPB switch. Braking is possible only while you are holding the EPB switch.

#### **⚠ WARNING**

**Do not operate the electronic parking brake while the vehicle is moving except in an emergency situation. Applying the electronic parking brake while the vehicle is moving at normal speeds can cause a sudden loss of control of the vehicle. If you must use the electronic parking brake to stop the vehicle, use great caution in applying the brake.**

#### **\* NOTICE**

During emergency braking by the EPB, the parking brake warning light will illuminate to indicate that the system is operating.

If you notice a continuous noise or burning smell when the EPB is used for emergency braking, have your vehicle checked by an authorized Kia dealer.

#### ***When the EPB (electronic parking brake) is not released***

If the EPB does not release normally, take your vehicle to an authorized Kia dealer by loading the vehicle on a flatbed tow truck and have the system checked.

### **Anti-lock brake system (ABS)**

ABS (or ESC) will not prevent accidents due to improper or dangerous driving maneuvers. Even though vehicle control is improved during emergency braking, always maintain a safe distance between you and objects ahead. Vehicle speeds should always be reduced during extreme road conditions. The vehicle should be driven at reduced speeds in the following circumstances:

- When driving on rough, gravel or snow-covered roads
- When driving with tire chains installed
- When driving on roads where the road surface is pitted or has different surface heights.

Driving in these conditions increase the stopping distance for your vehicle.

The ABS continuously senses the speed of the wheels. If the wheels are going to lock, the ABS system repeatedly modulates the hydraulic brake pressure to the wheels.

When you apply your brakes under conditions which may lock the wheels, you may hear a “tik-tik” sound from the brakes, or feel a corresponding sensation in the brake pedal. This is normal and it means your ABS is active.

In order to obtain the maximum benefit from your ABS in an emergency situation, do not attempt to modulate your brake pressure and do not try to pump your brakes. Press your brake pedal as hard as possible or as hard as the situation allows the ABS to control the force being delivered to the brakes.

### \* NOTICE

**A click sound may be heard in the motor compartment when the vehicle begins to move after the vehicle is started. These conditions are normal and indicate that the anti-lock brake system is functioning properly.**

- Even with the anti-lock brake system, your vehicle still requires sufficient stopping distance. Always maintain a safe distance from the vehicle in front of you.
- Always slow down when cornering. The anti-lock brake system cannot prevent accidents resulting from excessive speeds.
- On loose or uneven road surfaces, operation of the anti-lock brake system may result in a longer stopping distance than for vehicles equipped with a conventional brake system.



W-78

The ABS warning light will stay on for approximately 3 seconds after the POWER button is ON. During that time, the ABS will go through self-diagnosis and the light will go off if everything is normal. If the light stays on, you may have a problem with your ABS. Contact an authorized Kia dealer as soon as possible.

- When you drive on a road having poor traction, such as an icy road, and have operated your brakes continuously, the ABS will be active continuously and the ABS warning light may illuminate. Pull your vehicle over to a safe place and turn off the POWER button.
- Restart the vehicle. If the ABS warning light goes off, then your ABS system is normal. Otherwise, you may have a problem with the ABS. Contact an authorized Kia dealer as soon as possible.

### \* NOTICE

When you jump start your vehicle because of a drained battery, the ABS warning light may turn on. This happens because of low battery voltage. It does not mean your ABS has malfunctioned.

- Do not pump your brakes!
- Have the battery recharged before driving the vehicle.

### Electronic stability control (ESC)

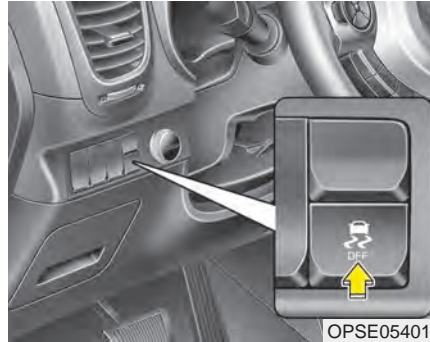

The Electronic Stability control (ESC) system is designed to stabilize the vehicle during cornering maneuvers. ESC checks where you are steering and where the vehicle is actually going. ESC applies the brakes on individual wheels to stabilize the vehicle.

Electronic stability control (ESC) will not prevent accidents. Excessive speed in turns, abrupt maneuvers and hydroplaning on wet surfaces can still result in serious accidents. Only a safe and attentive driver can prevent accidents by avoiding maneuvers that cause the vehicle to lose traction. Even with ESC installed, always follow all the normal precautions for driving - including driving at safe speeds for the conditions.

The Electronic Stability Control (ESC) system is an electronic system designed to help the driver maintain vehicle control under adverse conditions. It is not a substitute for safe driving practices. Factors including speed, road conditions and driver steering input can all affect whether ESC will be effective in preventing a loss of control. It is still your responsibility to drive and corner at reasonable speeds and to leave a sufficient margin of safety.

When you apply your brakes under conditions which may lock the wheels, you may hear a “tik-tik” sound from the brakes, or feel a corresponding sensation in the brake pedal. This is normal and it means your ESC is active.

**\* NOTICE**

A click sound may be heard in the motor compartment when the vehicle begins to move after the vehicle is started. These conditions are normal and indicate that the Electronic Stability Control System is functioning properly.

**\* NOTICE**

For maximum protection, always wear your seat belt. No system, no matter how advanced, can compensate for all driver error and/or driving conditions. Always drive responsibly.

**ESC operation**

**ESC ON condition**



- When the POWER button is turned ON, ESC and ESC OFF indicator lights illuminate for approximately 3 seconds, then ESC is turned on.
- Press the ESC OFF button for at least half a second after turning the ignition ON to turn ESC off. (ESC OFF indicator will illuminate). To turn the ESC on, press the ESC ON button (ESC ON indicator light will go off).
- When starting the vehicle, you may hear a slight ticking sound. This is the ESC performing an automatic system self-check and does not indicate a problem.

**When operating**



- When the ESC is in operation, the ESC indicator light blinks.
- When the Electronic Stability Control is operating properly, you can feel a slight pulsation in the vehicle. This is only the effect of brake control and indicates nothing unusual.

**⚠ WARNING**

**Electronic stability control (ESC) will not prevent accidents. Excessive speed in turns, abrupt maneuvers and hydroplaning on wet surfaces can still result in serious accidents. Only a safe and attentive driver can prevent accidents by avoiding maneuvers that cause the vehicle to lose traction. Even with ESC installed, always follow all the normal precautions for driving - including driving at safe speeds for the conditions.**

**ESC operation off****ESC OFF state**



This car has 2 kinds of ESC off states.

If the POWER button is turned off when ESC is off, ESC remains off. Upon restarting the vehicle, the ESC will automatically turn on again.



OPSE054013L



**• ESC off state 1**

To cancel ESC operation, press the ESC OFF button (ESC OFF ) shortly (ESC OFF indicator light (ESC OFF ) illuminates). At this state, the vehicle control function does not operate. It means the traction control function does not operate. Brake control function only operates.



OPSE054014L

**• ESC off state 2**

To cancel ESC operation, press the ESC OFF button (ESC OFF ) for more than 3 seconds. ESC OFF indicator light (ESC OFF ) illuminates and ESC OFF warning chime will sound. At this state, the vehicle control function and brake control function do not operate. It means the car stability control function does not operate any more.

## Indicator light

### ■ ESC indicator light



### ■ ESC OFF indicator light



When POWER button is turned to ON, the indicator light illuminates, then goes off if the ESC system is operating normally.

The ESC indicator light blinks whenever ESC is operating or illuminates when ESC fails to operate.

The ESC OFF indicator light comes on when the ESC is turned off with the button.

## CAUTION

*Driving with varying tire or wheel sizes may cause the ESC system to malfunction. When replacing tires, make sure they are the same size as your original tires.*

## WARNING - Electronic stability control

**Drive carefully even though your vehicle has Electronic Stability Control. It can only assist you in maintaining control under certain circumstances.**

## ESC OFF usage

### When driving

- ESC should be turned on for daily driving whenever possible.
- To turn ESC off while driving, press the ESC OFF button while driving on a flat road surface.

## WARNING - Operating ESC

**Never press the ESC OFF button while ESC is operating (ESC indicator light blinks).**

**If ESC is turned off while ESC is operating, the vehicle may slip out of control.**



**\* NOTICE**

- When operating the vehicle on a dynamometer, ensure that the ESC is turned off (ESC OFF light illuminated). If the ESC is left on, it may prevent the vehicle speed from increasing, and result in false diagnosis.
- Turning the ESC off does not affect ABS or brake system operation.

**Vehicle stability management (VSM)**

This system provides further enhancements to vehicle stability and steering responses when a vehicle is driving on a slippery road or a vehicle detects changes in coefficient of friction between right wheels and left wheels when braking.

***VSM operation***

When the VSM is in operation, ESC indicator light (  ) blinks.

When the vehicle stability management is operating properly, you can feel a slight pulsation in the vehicle and/or abnormal steering responses (EPS). This is only the effect of brake and EPS control and indicates nothing unusual.

**The VSM does not operate when:**

- Driving on bank road such as gradient or incline
- Driving in reverse
- ESC OFF indicator light (  ) remains on the instrument cluster
- EPS indicator light remains on the instrument cluster

***VSM operation off***

If you press the ESC OFF button to turn off the ESC, the VSM will also cancel and the ESC OFF indicator light (  ) illuminates.

To turn on the VSM, press the button again. The ESC OFF indicator light goes out.

### ***Malfunction indicator***

The VSM can be deactivated even if you don't cancel the VSM operation by pressing the ESC OFF button. It indicates that a malfunction has been detected somewhere in the Electric Power Steering system or VSM system. If the ESC indicator light (  ) or EPS warning light remains on, take your vehicle to an authorized Kia dealer and have the system checked.

### **\* NOTICE**

- The VSM is designed to function above approximately 13 mph (22 km/h) on curves.
- The VSM is designed to function above approximately 6 mph (10 km/h) when a vehicle is braking on a split-mu road. The split-mu road is made of surfaces which have different friction forces.

- The Vehicle Stability Management system is not a substitute for safe driving practices but a supplementary function only. It is the responsibility of the driver to always check the speed and the distance to the vehicle ahead. Always hold the steering wheel firmly while driving.
- Your vehicle is designed to activate according to the driver's intention, even with installed VSM. Always follow all the normal precautions for driving at safe speeds for the conditions – including driving in clement weather and on a slippery road.

### **Hill-start assist control (HAC)**

A vehicle has the tendency to roll back on a steep hill when it starts to go after stopping. The Hill-start Assist Control (HAC) prevents the vehicle from rolling back by applying the brakes automatically for about 2 seconds. The brakes are released when the accelerator pedal is depressed or after about 2 seconds.

The HAC is activated only for about 2 seconds, so when the vehicle is starting off always depress the accelerator pedal.

**⚠ WARNING - Maintaining Brake Pressure on Incline**

**HAC does not replace the need to apply brakes while stopped on an incline. While stopped, make sure you maintain brake pressure sufficient to prevent your vehicle from rolling backward and causing an accident. Don't release the brake pedal until you are ready to accelerate forward.**

**Good braking practices**

- Check to be sure the parking brake is not engaged and the parking brake indicator light is out before driving away.
- Driving through water may get the brakes wet. They can also get wet when the vehicle is washed. Wet brakes can be dangerous! Your vehicle will not stop as quickly if the brakes are wet. Wet brakes may cause the vehicle to pull to one side.

To dry the brakes, apply the brakes lightly until the braking action returns to normal, taking care to keep the vehicle under control at all times. If the braking action does not return to normal, stop as soon as it is safe to do so and call an authorized Kia dealer for assistance.

- Don't coast down hills with the vehicle out of gear. This is extremely hazardous. Keep the vehicle in gear at all times, use the brakes to slow down, then shift to a lower gear so that regenerative braking will help you maintain a safe speed.
- Don't "ride" the brake pedal. Resting your foot on the brake pedal while driving can be dangerous because the brakes might overheat and lose their effectiveness. It also increases the wear of the brake components.
- If a tire goes flat while you are driving, apply the brakes gently and keep the vehicle pointed straight ahead while you slow down. When you are moving slowly enough for it to be safe to do so, pull off the road and stop in a safe place.

- If your vehicle is equipped with an automatic transaxle, don't let your vehicle creep forward. To avoid creeping forward, keep your foot firmly on the brake pedal when the vehicle is stopped.
- Be cautious when parking on a hill. Firmly engage the parking brake and place the shift lever in P (automatic transaxle) or in first or reverse gear (manual transaxle). If your vehicle is facing downhill, turn the front wheels into the curb to help keep the vehicle from rolling. If your vehicle is facing uphill, turn the front wheels away from the curb to help keep the vehicle from rolling. If there is no curb or if it is required by other conditions to keep the vehicle from rolling, block the wheels.
- Under some conditions your parking brake can freeze in the engaged position. This is most likely to happen when there is an accumulation of snow or ice around or near the rear brakes or if the brakes are wet. If there is a risk that the parking brake may freeze, apply it only temporarily while you put the shift lever in P (automatic transaxle) or in first or reverse gear (manual transaxle) and block the rear wheels so the vehicle cannot roll. Then release the parking brake.
- Do not hold the vehicle on the upgrade with the accelerator pedal. This can cause the transaxle to overheat. Always use the brake pedal or parking brake.

## CRUISE CONTROL SYSTEM (IF EQUIPPED)



1. Cruise indicator
2. Cruise set indicator

The cruise control system allows you to program the vehicle to maintain a constant speed without pressing the accelerator pedal.

This system is designed to function above approximately 20 mph (30 km/h).

- If the cruise control is left on (CRUISE indicator light in the instrument cluster illuminated), the cruise control can be switched on accidentally. Keep the cruise control system off (CRUISE indicator light OFF) when the cruise control is not in use, to avoid inadvertently setting a speed.
- Use the cruise control system only when traveling on open highways in good weather.
- Do not use the cruise control driving in heavy or varying traffic, or on slippery (rainy, icy or snow-covered) or winding roads or over 6% up-hill or down-hill roads.

### **⚠ WARNING - Misuse of Cruise Control**

**Do not use cruise control if the traffic situation does not allow you to drive safely at a constant speed and with sufficient distance to the vehicle in front.**

### **\* NOTICE**

- During normal cruise control operation, when the SET switch is activated or reactivated after applying the brakes, the cruise control will energize after approximately 3 seconds. The delay is normal.
- To activate cruise control, depress the brake pedal at least once after turning the POWER button to the ON position or starting the vehicle. This is to check if the brake switch which is important part to cancel cruise control is in normal condition.

### Cruise control switch



- CRUISE : Turns cruise control system on or off.
- CANCEL: Cancels cruise control operation.
- RES+: Resumes or increases cruise control speed.
- SET-: Sets or decreases cruise control speed.

### To set cruise control speed:



1. Press the CRUISE button on the steering wheel to turn the system on. The CRUISE indicator light in the instrument cluster will illuminate.
2. Accelerate to the desired speed, which must be more than 20 mph (30 km/h).



3. Push the SET - switch, and release it at the desired speed. The SET indicator light in the instrument cluster will illuminate. Release the accelerator pedal at the same time. The desired speed will automatically be maintained.

*On a steep grade, the vehicle may slow down or speed up slightly while going uphill or downhill.*

### To increase cruise control set speed:



Follow either of these procedures:

- Push the RES + switch and hold it. Your vehicle will accelerate. Release the lever at the speed you want.
- Push the RES + switch and release it immediately.

The cruising speed will increase by 1 mph (or 2km/h) each time you move the lever up (to RES+) in this manner.

### To decrease the cruising speed:



Follow either of these procedures:

- Push the SET - switch and hold it. Your vehicle will gradually slow down. Release the lever at the speed you want to maintain.
- Push the SET - switch and release it immediately.

The cruising speed will decrease by 1 mph (2 km/h) each time you move the lever down (to SET-) in this manner.

### To temporarily accelerate with the cruise control on:

If you want to speed up temporarily when the cruise control is on, depress the accelerator pedal. Increased speed will not interfere with cruise control operation or change the set speed.

To return to the set speed, take your foot off the accelerator.

### To cancel cruise control, do one of the following:



- Press the brake pedal.
- Shift into N (Neutral).
- Push the CANCEL switch located on the steering wheel.
- Decrease the vehicle speed lower than the memory speed by approximately 12mph (20km/h).
- Decrease the vehicle speed to less than approximately 15 mph (25 km/h).
- Pull up the EPB (Electronic parking brake) switch.

*Each of these actions will cancel cruise control operation (the SET indicator light in the instrument cluster will go off), but it will not turn the system off. If you wish to resume cruise control operation, push the RES + switch located on your steering wheel. You will return to your previously preset speed.*

### To resume cruising speed at more than approximately 20 mph (30 km/h):



If any method other than the CRUISE button was used to cancel cruising speed and the system is still activated, the most recent set speed will automatically resume when the RES+ switch is pushed.

It will not resume, however, if the vehicle speed has dropped below approximately 20 mph (30 km/h).



To turn cruise control off, do one of the following:



- Press the CRUISE button (the CRUISE indicator light in the instrument cluster will go off).
- Turn the vehicle off.

*Both of these actions cancel cruise control operation. If you want to resume cruise control operation, repeat the steps provided in "To set cruise control speed" on the previous page.*

### ECONOMICAL OPERATION

Your vehicle's energy economy depends mainly on your style of driving, where you drive and when you drive.

Each of these factors affects how many miles (kilometers) you can get from a capacity (kwh) of battery. To operate your vehicle as economically as possible, use the following driving suggestions to help save money in both energy and repairs:

- Drive smoothly. Accelerate at a moderate rate. Don't make "jack-rabbit" starts or full-throttle shifts and maintain a steady cruising speed. Don't race between stop-lights. Try to adjust your speed to the traffic so you don't have to change speeds unnecessarily. Avoid heavy traffic whenever possible. Always maintain a safe distance from other vehicles so you can avoid unnecessary braking. This also reduces brake wear.
- Drive at a moderate speed. The faster you drive, the more energy your vehicle uses. Driving at a moderate speed, especially on the highway, is one of the most effective ways to reduce energy consumption.
- Don't "ride" the brake or clutch pedal. This can increase energy consumption and also increase wear on these components. In addition, driving with your foot resting on the brake pedal may cause the brakes to overheat, which reduces their effectiveness and may lead to more serious consequences.
- Take care of your tires. Keep them inflated to the recommended pressure. Incorrect inflation, either too much or too little, results in unnecessary tire wear. Check the tire pressures at least once a month.
- Be sure that the wheels are aligned correctly. Improper alignment can result from hitting curbs or driving too fast over irregular surfaces. Poor alignment causes faster tire wear and may also result in other problems as well as greater energy consumption.
- Keep your vehicle in good condition. For better energy economy and reduced maintenance costs, maintain your vehicle in accordance with the maintenance schedule in section 7. If you drive your vehicle in severe conditions, more frequent maintenance is required (see section 7 for details).
- Keep your vehicle clean. For maximum service, your vehicle should be kept clean and free of corrosive materials. It is especially important that mud, dirt, ice, etc. not be allowed to accumulate on the underside of the vehicle. This extra weight can result in increased energy consumption and also contribute to corrosion.

- Travel lightly. Don't carry unnecessary weight in your vehicle. Weight reduces energy economy.
- Open windows at high speeds can reduce energy economy.
- Energy economy is less in crosswinds and headwinds. To help offset some of this loss, slow down when driving in these conditions.

Keeping a vehicle in good operating condition is important both for economy and safety. Therefore, have an authorized Kia dealer perform scheduled inspections and maintenance.

**⚠ WARNING****- Vehicle off during motion**

**Never turn the POWER button off to coast down hills or anytime the vehicle is in motion. The power steering and power brakes will not function properly without the vehicle is in the ready (🔄) mode. In addition, turning off the POWER button while driving could engage the steering wheel lock resulting in loss of vehicle steering. Keep the vehicle is in the ready (🔄) mode and gear lever in B(Braking) position for engine braking effect.**

## SPECIAL DRIVING CONDITIONS

### Hazardous driving conditions

When hazardous driving conditions are encountered such as water, snow, ice, mud, sand, or similar hazards, follow these suggestions:

- Drive cautiously and allow extra distance for braking.
- Avoid sudden braking or steering.
- When braking with non-ABS brakes pump the brake pedal with a light up-and-down motion until the vehicle is stopped.

Do not pump the brake pedal on a vehicle equipped with ABS.

- If stalled in snow, mud, or sand, use second gear. Accelerate slowly to avoid spinning the drive wheels.
- Use sand, rock salt, or other non-slip material under the drive wheels to provide traction when stalled in ice, snow, or mud.

**⚠ WARNING - Downshifting**  
**Do not downshift with an automatic transaxle while driving on slippery surfaces. The sudden change in tire speed could cause the tires to skid and result in an accident.**

### Reducing the risk of a rollover

This multi-purpose passenger vehicle is defined as a Crossover Utility Vehicle (CUV). Utility vehicles have a significantly higher rollover rate than other types of vehicles. CUV's have higher ground clearance and a narrower track to make them capable of performing in a wide variety of off-road applications. Specific design characteristics give them a higher center of gravity than ordinary vehicles. An advantage of the higher ground clearance is a better view of the road, which allows you to anticipate problems. They are not designed for cornering at the same speeds as conventional passenger vehicles, any more than low-slung sports vehicles are designed to perform satisfactorily in off-road conditions. Due to this risk, driver and passengers are strongly recommended to buckle their seat belts. In a rollover crash, an unbelted person is significantly more likely to die than a person wearing a seat belt. There are steps that a driver can make to reduce the risk of a rollover.

If at all possible, avoid sharp turns or abrupt maneuvers, do not load your roof rack with heavy cargo, and never modify your vehicle in any way.

**⚠ WARNING - Replacement tires**

**Always use the size and type of tires recommended in the tire section of the manual. Installation of variant tires can affect the safety and performance of your vehicle.**

### Rocking the vehicle

If it is necessary to rock the vehicle to free it from snow, sand, or mud, first turn the steering wheel right and left to clear the area around your front wheels. Then, shift back and forth between R (Reverse) and any forward gear. Do not race the vehicle, and spin the wheels as little as possible. If you are still stuck after a few tries, have the vehicle pulled out by a tow vehicle to avoid overheating and possible damage to the gear.

**⚠ WARNING  
- Sudden vehicle movement**

**Do not attempt to rock the vehicle if people or objects are nearby. The vehicle may suddenly move forward or backwards as it becomes unstuck.**

**⚠ CAUTION - Vehicle rocking**  
*Prolonged rocking may cause overheating, gear damage or failure, and tire damage.*

**⚠ CAUTION - Spinning tires**  
*Do not spin the wheels, especially at speeds more than 35 mph (56 km/h). Spinning the wheels at high speeds when the vehicle is stationary could cause a tire to overheat which could result in tire damage that may injure bystanders.*

The ESC system should be turned OFF prior to rocking the vehicle.

### Smooth cornering



Avoid braking or gear changing in corners, especially when roads are wet. Ideally, corners should always be taken under gentle acceleration. If you follow these suggestions, tire wear will be held to a minimum.

### Driving at night



Because night driving presents more hazards than driving in the daylight, here are some important tips to remember:

- Slow down and keep more distance between you and other vehicles, as it may be more difficult to see at night, especially in areas where there may not be any street lights.

- Adjust your mirrors to reduce the glare from other driver's headlights.
- Keep your headlights clean and properly aimed. (On vehicles not equipped with the automatic headlight aiming feature.) Dirty or improperly aimed headlights will make it much more difficult to see at night.
- Avoid staring directly at the headlights of oncoming vehicles. You could be temporarily blinded, and it will take several seconds for your eyes to readjust to the darkness.

## Driving in the rain



1VQA3003

Rain and wet roads can make driving dangerous, especially if you're not prepared for the slick pavement. Here are a few things to consider when driving in the rain:

- A heavy rainfall will make it harder to see and will increase the distance needed to stop your vehicle, so slow down.
- Keep your windshield wiping equipment in good shape. Replace your windshield wiper blades when they show signs of streaking or missing areas on the windshield.
- If your tires are not in good condition, making a quick stop on wet pavement can cause a skid and possibly lead to an accident. Be sure your tires are in good shape.
- Turn on your headlights to make it easier for others to see you.
- Driving too fast through large puddles can affect your brakes. If you must go through puddles, try to drive through them slowly.
- If you believe you may have gotten your brakes wet, apply them lightly while driving until normal braking operation returns.

## Driving in flooded areas

Avoid driving through flooded areas unless you are sure the water is no higher than the bottom of the wheel hub. Drive through any water slowly. Allow adequate stopping distance because brake performance may be affected.

After driving through water, dry the brakes by gently applying them several times while the vehicle is moving slowly.

### Driving off-road

Drive carefully off-road because your vehicle may be damaged by rocks or roots of trees. Become familiar with the off-road conditions where you are going to drive before you begin driving.

### Highway driving

#### *Tires*

Adjust the tire inflation pressures to specification. Low tire inflation pressures will result in overheating and possible failure of the tires.

Avoid using worn or damaged tires which may result in reduced traction or tire failure.

Never exceed the maximum tire inflation pressure shown on the tires.

 **WARNING - Under/over inflated tires**

**Always check the tires for proper inflation before driving. Underinflated or overinflated tires can cause poor handling, loss of vehicle control, and sudden tire failure leading to accidents, injuries, and even death. For proper tire pressures, refer to "Tires and wheels" in section 8.**

 **WARNING - Tire tread**

**Always check the tire tread before driving your vehicle. Worn-out tires can result in loss of vehicle control. Worn-out tires should be replaced as soon as possible. For further information and tread limits, refer to "Tires and wheels" in section 7.**



## WINTER DRIVING



Severe weather conditions in the winter result in greater wear and other problems. To minimize the problems of winter driving, you should follow these suggestions:

### Snowy or icy conditions

To drive your vehicle in deep snow, it may be necessary to use snow tires or to install tire chains on your tires. If snow tires are needed, it is necessary to select tires equivalent in size and type of the original equipment tires. Failure to do so may adversely affect the safety and handling of your vehicle. Furthermore, speeding, rapid acceleration, sudden brake applications, and sharp turns are potentially very hazardous practices.

During deceleration, use regenerative braking to the fullest extent. Sudden brake applications on snowy or icy roads may cause skids to occur. You need to keep sufficient distance between the vehicle in operation in front of your vehicle. Also, apply the brake gently. It should be noted that installing tire chains on the tire will provide a greater driving force, but will not prevent side skids.

### \* NOTICE

**Tire chains are not legal in all states. Check state laws before fitting tire chains.**

### Snow tires

If you mount snow tires on your vehicle, make sure they are radial tires of the same size and load range as the original tires. Mount snow tires on all four wheels to balance your vehicle's handling in all weather conditions. Keep in mind that the traction provided by snow tires on dry roads may not be as high as your vehicle's original equipment tires. You should drive cautiously even when the roads are clear. Check with the tire dealer for maximum speed recommendations.

*Do not install studded tires without first checking local, state and municipal regulations for possible restrictions against their use.*

### **⚠ WARNING - Snow tire size**

**Snow tires should be equivalent in size and type to the vehicle's standard tires. Otherwise, the safety and handling of your vehicle may be adversely affected.**

### Tire chains



Since the sidewalls of radial tires are thinner, they can be damaged by mounting some types of snow chains on them. Therefore, the use of snow tires is recommended instead of snow chains. Do not mount tire chains on vehicles equipped with aluminum wheels; snow chains may cause damage to the wheels. If snow chains must be used, use wire-type chains with a thickness of less than 0.59 in (15 mm). Damage to your vehicle caused by improper snow chain use is not covered by your vehicle manufacturer's warranty.

When using tire chains, install them on the front tires only.

#### **CAUTION - Snow chains**

***Make sure the snow chains are the correct size and type for your tires. Incorrect snow chains can cause damage to the vehicle body and suspension and may not be covered by your vehicle manufacturer warranty.***

#### **Chain installation**

When installing chains, follow the manufacturer's instructions and mount them as tightly as you can. Drive slowly with chains installed. If you hear the chains contacting the body or chassis, stop and tighten them. If they still make contact, slow down until it stops. Remove the chains as soon as you begin driving on cleared roads.

When mounting snow chains, park the vehicle on level ground away from traffic. Turn on the vehicle Hazard Warning flashers and place a triangular emergency warning device behind the vehicle if available. Always place the vehicle in P (Park), apply the parking brake and turn off the vehicle before installing snow chains.

- The use of chains may adversely affect vehicle handling.
- Do not exceed 20 mph (30 km/h) or the chain manufacturer's recommended speed limit, whichever is lower.
- Drive carefully and avoid bumps, holes, sharp turns, and other road hazards, which may cause the vehicle to bounce.
- Avoid sharp turns or locked-wheel braking.

**⚠ CAUTION - Snow chains**

- *Chains that are the wrong size or improperly installed can damage your vehicle's brake lines, suspension, body and wheels.*
- *Stop driving and retighten the chains any time you hear them hitting the vehicle.*

**Use high quality ethylene glycol coolant**

Your vehicle is delivered with high quality ethylene glycol coolant in the cooling system. It is the only type of coolant that should be used because it helps prevent corrosion in the cooling system, lubricates the water pump and prevents freezing. Be sure to replace or replenish your coolant in accordance with the maintenance schedule in section 7. Before winter, have your coolant tested to assure that its freezing point is sufficient for the temperatures anticipated during the winter.

**Check battery and cables**

Winter puts additional burdens on the battery system. Visually inspect the battery and cables as described in section 7. The level of charge in your battery can be checked by an authorized Kia dealer or a service station.

**To keep locks from freezing**

To keep the locks from freezing, squirt an approved de-icer fluid or glycerine into the key opening. If a lock is covered with ice, squirt it with an approved de-icing fluid to remove the ice. If the lock is frozen internally, you may be able to thaw it out by using a heated key. Handle the heated key with care to avoid injury.

**Use approved window washer anti-freeze in system**

To keep the water in the window washer system from freezing, add an approved window washer anti-freeze solution in accordance with instructions on the container. Window washer anti-freeze is available from an authorized Kia dealer and most auto parts outlets. Do not use coolant or other types of anti-freeze as these may damage the paint finish.

**Don't let your parking brake freeze**

Under some conditions your parking brake can freeze in the engaged position. This is most likely to happen when there is an accumulation of snow or ice around or near the rear brakes or if the brakes are wet. If there is a risk the parking brake may freeze, apply it only temporarily while you put the gear shift lever in P (Park, automatic transaxle) or in first or reverse gear (manual transaxle) and block the rear wheels so the vehicle cannot roll. Then release the parking brake.

### **Don't let ice and snow accumulate underneath**

Under some conditions, snow and ice can build up under the fenders and interfere with the steering. When driving in severe winter conditions where this may happen, you should periodically check underneath the vehicle to be sure the movement of the front wheels and the steering components are not obstructed.

### **Carry emergency equipment**

Depending on the severity of the weather, you should carry appropriate emergency equipment. Some of the items you may want to carry include tow straps or chains, flashlight, emergency flares, sand, shovel, jumper cables, window scraper, gloves, ground cloth, coveralls, blanket, etc.

## **TRAILER TOWING**

**We do not recommend using this vehicle for trailer towing.**

## VEHICLE LOAD LIMIT

### Tire and loading information label



The label contains the following information:

TIRE AND LOADING INFORMATION RENSEIGNEMENTS SUR LES PNEUS ET LE CHARGEMENT			
SEATING CAPACITY NOMBRE DE PLACES		TOTAL 5	FRONT 2 AVANT 2
			REAR 3 ARRIERE 3
The combined weight of occupants and cargo should never exceed 375 kg or 827 lbs. Le poids total des occupants et du chargement ne doit jamais dépasser 375 kg or 827 lbs.			
TIRE PNEU	SIZE DIMENSIONS	COLD TIRE PRESSURE PRESSION DES PNEUS A FROID	SEE OWNER'S MANUAL FOR ADDITIONAL INFORMATION  VOIR LE MANUEL DE L'USAGER POUR PLUS DE RENSEIGNEMENTS
FRONT AVANT	205/60R16	230kPa, 33psi	
REAR ARRIERE	205/60R16	230kPa, 33psi	
SPARE DE SECOURS	NONE AUCUN		

OPS053105N

The label located on the driver's door sill gives the original tire size, cold tire pressures recommended for your vehicle, the number of people that can be in your vehicle and vehicle capacity weight.

### Vehicle capacity weight:

827 lbs. (375 kg)

Vehicle capacity weight is the maximum combined weight of occupants and cargo. If your vehicle is equipped with a trailer, the combined weight includes the tongue load.

### Seating capacity:

Total - 5 persons  
(Front seat : 2 persons,  
Rear seat : 3 persons)

Seating capacity is the maximum number of occupants including a driver, your vehicle may carry.

However, the seating capacity may be reduced based upon the weight of all of the occupants, and the weight of the cargo being carried or towed.

Do not overload the vehicle as there is a limit to the total weight, or load limit including occupants and cargo, the vehicle can carry.

### Towing capacity:

**We do not recommend using this vehicle for trailer towing.**

### ***Cargo capacity:***

The cargo capacity of your vehicle will increase or decrease depending on the weight and the number of occupants and the tongue load, if your vehicle is equipped with a trailer.

### ***Steps for determining correct load limit***

1. Locate the statement "The combined weight of occupants and cargo should never exceed XXX kg or XXX lbs." on your vehicle's placard.
2. Determine the combined weight of the driver and passengers that will be riding in your vehicle.
3. Subtract the combined weight of the driver and passengers from XXX kg or XXX lbs.
4. The resulting figure equals the available amount of cargo and luggage load capacity. For example, if the "XXX" amount equals 1400 lbs. and there will be five 150 lbs. passengers in your vehicle, the amount of available cargo and luggage load capacity is 650 lbs.  
(1400-750 (5 x 150) = 650 lbs.)
5. Determine the combined weight of luggage and cargo being loaded on the vehicle. That weight may not safely exceed the available cargo and luggage load capacity calculated in Step 4.
6. If your vehicle will be towing a trailer, load from your trailer will be transferred to your vehicle. Consult this manual to determine how this reduces the available cargo and luggage load capacity of your vehicle.

**Example 1**



C190F01JM

Item	Description	Total
A	Vehicle Capacity Weight	1400 lbs (635 kg)
B	Subtract Occupant Weight 150 lbs (68 kg) × 2	300 lbs (136 kg)
C	Available Cargo and Luggage weight	1100 lbs (499 kg)

**Example 2**

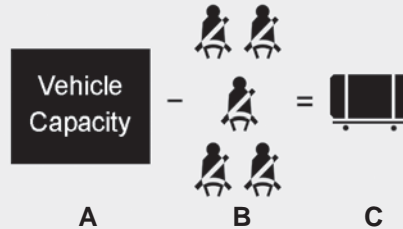

C190F02JM

Item	Description	Total
A	Vehicle Capacity Weight	1400 lbs (635 kg)
B	Subtract Occupant Weight 150 lbs (68 kg) × 5	750 lbs (340 kg)
C	Available Cargo and Luggage weight	650 lbs (295 kg)

**Example 3**

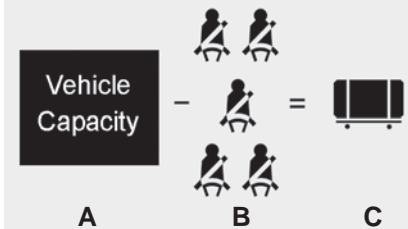

C190F03JM

Item	Description	Total
A	Vehicle Capacity Weight	1400 lbs (635 kg)
B	Subtract Occupant Weight 172 lbs (78 kg) × 5	860 lbs (390 kg)
C	Available Cargo and Luggage weight	540 lbs (245 kg)

Refer to your vehicle's tire and loading information label for specific information about your vehicle's capacity weight and seating positions. The combined weight of the driver, passengers and cargo should never exceed your vehicle's capacity weight.

### Certification label



OEN056020

The certification label is located on the driver's door sill at the center pillar.

This label shows the maximum allowable weight of the fully loaded vehicle. This is called the GVWR (Gross Vehicle Weight Rating). The GVWR includes the weight of the vehicle, all occupants, fuel and cargo.

This label also tells you the maximum weight that can be supported by the front and rear axles, called Gross Axle Weight Rating (GAWR).

To find out the actual loads on your front and rear axles, you need to go to a weigh station and weigh your vehicle. Your dealer can help you with this. Be sure to spread out your load equally on both sides of the centerline.

**⚠ WARNING - Over loading**  
**Never exceed the GVWR for your vehicle, the GAWR for either the front or rear axle and vehicle capacity weight. Exceeding these ratings can affect your vehicle's handling and braking ability.**

The label will help you decide how much cargo and installed equipment your vehicle can carry.

If you carry items inside your vehicle - like suitcases, tools, packages, or anything else - they are moving as fast as the vehicle. If you have to stop or turn quickly, or if there is a crash, the items will keep going and can cause an injury if they strike the driver or a passenger.



**⚠ WARNING - Over loading**

Do not overload your vehicle. Overloading your vehicle can cause heat buildup in your vehicle's tires and possible tire failure, increased stopping distances and poor vehicle handling all of which may result in a crash.

**⚠ WARNING - Loose cargo**

Do not travel with unsecured blunt objects in the passenger compartment of your vehicle (e.g. suit cases or unsecured child seats). These items may strike occupant during a sudden stop or crash.

**\* NOTICE**

Overloading your vehicle may cause damage. Repairs would not be covered by your warranty. Do not overload your vehicle.

## VEHICLE WEIGHT GLOSSARY

This section will guide you in the proper loading of your vehicle and/or trailer, to keep your loaded vehicle weight within its design rating capability, with or without a trailer. Properly loading your vehicle will provide maximum return of the vehicle design performance. Before loading your vehicle, familiarize yourself with the following terms for determining your vehicle's weight ratings, with or without a trailer, from the vehicle's specifications and the certification label:

### **Base curb weight**

This is the weight of the vehicle including all standard equipment. It does not include passengers, cargo, or optional equipment.

### **Vehicle curb weight**

This is the weight of your new vehicle when you picked it up from your dealer plus any aftermarket equipment.

### **Cargo weight**

This figure includes all weight added to the Base Curb Weight, including cargo and optional equipment.

### **GAW (Gross axle weight)**

This is the total weight placed on each axle (front and rear) - including vehicle curb weight and all payload.

### **GAWR (Gross axle weight rating)**

This is the maximum allowable weight that can be carried by a single axle (front or rear). These numbers are shown on the certification label. The total load on each axle must never exceed its GAWR.

### **GVW (Gross vehicle weight)**

This is the Base Curb Weight plus actual Cargo Weight plus passengers.

### **GVWR (Gross vehicle weight rating)**

This is the maximum allowable weight of the fully loaded vehicle (including all options, equipment, passengers and cargo). The GVWR is shown on the certification label located on the driver's door sill.

# What to do in an emergency

Road warning . . . . .	6-2
• Hazard warning flasher . . . . .	6-2
In case of an emergency while driving . . . . .	6-3
• If the vehicle stalls at a crossroad or crossing . . . . .	6-3
• If you have a flat tire while driving . . . . .	6-3
• If vehicle stalls while driving . . . . .	6-3
If the vehicle will not start. . . . .	6-4
• If vehicle doesn't turn over or turns over slowly . . . . .	6-4
Emergency starting . . . . .	6-5
• Jump starting . . . . .	6-5
• Push-starting . . . . .	6-7
If the vehicle overheats . . . . .	6-8
Tire Pressure Monitoring System (TPMS) . . . . .	6-9
• Low tire pressure indicator . . . . .	6-10
• TPMS malfunction indicator . . . . .	6-11
• Changing a tire with TPMS . . . . .	6-12
If you have a flat tire (with Tire Mobility Kit) . . . . .	6-14
• Introduction . . . . .	6-14
• Components of the Tire Mobility Kit . . . . .	6-16
• Using the Tire Mobility Kit . . . . .	6-17
• Distributing the sealant. . . . .	6-18
• Technical Data . . . . .	6-19

Towing . . . . .	6-20
• Towing service . . . . .	6-20
• Removable towing hook (front) . . . . .	6-21
• Emergency towing . . . . .	6-22

## ROAD WARNING

### Hazard warning flasher



The hazard warning flasher serves as a warning to other drivers to exercise extreme caution when approaching, overtaking, or passing your vehicle.

It should be used whenever emergency repairs are being made or when the vehicle is stopped near the edge of a roadway.

Depress the flasher switch with the ignition switch in any position. The flasher switch is located in the center console switch panel. All turn signal lights will flash simultaneously.

- The hazard warning flasher operates whether your vehicle is running or not.
- The turn signals do not work when the hazard flasher is on.
- Care must be taken when using the hazard warning flasher while the vehicle is being towed.

## IN CASE OF AN EMERGENCY WHILE DRIVING

### **If the vehicle stalls at a cross-road or crossing**

If the vehicle stalls at a crossroad or crossing, set the shift lever in the N (Neutral) position and then push the vehicle to a safe place.

### **If you have a flat tire while driving**

If a tire goes flat while you are driving:

1. Take your foot off the accelerator pedal and let the vehicle slow down while driving straight ahead. Do not apply the brakes immediately or attempt to pull off the road as this may cause a loss of control. When the vehicle has slowed to such a speed that it is safe to do so, brake carefully and pull off the road. Drive off the road as far as possible and park on a firm level ground. If you are on a divided highway, do not park in the median area between the two traffic lanes.

2. When the vehicle is stopped, turn on your emergency hazard flashers, set the parking brake and put the transaxle in P.
3. Have all passengers get out of the vehicle. Be sure they all get out on the side of the vehicle that is away from traffic.
4. When changing a flat tire, follow the instruction provided later in this section.

### **If the vehicle stalls while driving**

1. Reduce your speed gradually, keeping a straight line. Move cautiously off the road to a safe place.
2. Turn on your emergency flashers.
3. Try to start the vehicle again. If your vehicle will not start, contact an authorized Kia dealer or seek other qualified assistance.

## IF THE VEHICLE WILL NOT START

### If vehicle doesn't turn over or turns over slowly

1. Be sure the shift lever is in N (Neutral) or P (Park) and the emergency brake is set.
2. Check the battery connections to be sure they are clean and tight.
3. Check the starter connections to be sure they are securely tightened.
4. Do not push or pull the vehicle to start it. See instructions for "Jump starting".

 **WARNING - Push/pull start**

**Do not push or pull the vehicle to start it. Push or pull starting may cause the catalytic converter to overload and create a fire hazard.**

## EMERGENCY STARTING

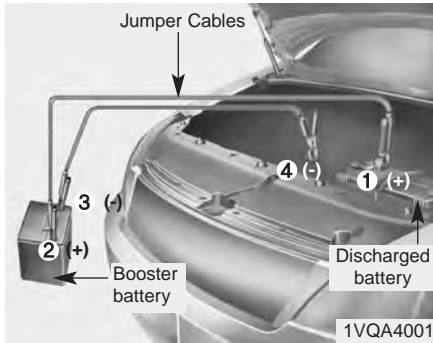

Connect cables in numerical order and disconnect in reverse order.

### Jump starting

Jump starting can be dangerous if done incorrectly. Therefore, to avoid harm to yourself or damage to your vehicle or battery, follow these jump starting procedures. If in doubt, we strongly recommend that you have a competent technician or towing service jump start your vehicle.

#### **CAUTION - 12 volt battery**

*Use only a 12-volt jumper system. You can damage a 12-volt starting motor, ignition system, and other electrical parts beyond repair by use of a 24-volt power supply (either two 12-volt batteries in series or a 24-volt motor generator set).*

#### **WARNING - Battery**

**Never attempt to check the electrolyte level of the battery as this may cause the battery to rupture or explode causing serious injury.**

#### **WARNING - Frozen batteries**

**Do not attempt to jump start the vehicle if the discharged battery is frozen or if the electrolyte level is low as the battery may rupture or explode.**

**⚠ WARNING - Battery**

Keep all flames or sparks away from the battery. The battery produces hydrogen gas which will explode if exposed to flame or sparks.

**⚠ WARNING - Sulfuric acid risk**

When jump starting your vehicle be careful not to get acid on yourself, your clothing or on the vehicle. Automobile batteries contain sulfuric acid. This is poisonous and highly corrosive.

***Jump starting procedure***

1. Make sure the booster battery is 12-volt and that its negative terminal is grounded.
2. If the booster battery is in another vehicle, do not allow the vehicles to come in contact.
3. Turn off all unnecessary electrical loads.
4. Connect the jumper cables in the exact sequence shown in the illustration. First connect one end of a jumper cable to the positive terminal of the discharged battery (1), then connect the other end to the positive terminal of the booster battery (2).

Proceed to connect one end of the other jumper cable to the negative terminal of the booster battery (3), then the other end to a solid, stationary, metallic point away from the battery (4). Do not connect it to or near any part that moves when the vehicle is started.

Do not allow the jumper cables to contact anything except the correct battery terminals or the correct ground. Do not lean over the battery when making connections.

**⚠ WARNING - Battery cables**

Do not connect the jumper cable from the negative terminal of the booster battery to the negative terminal of the discharged battery.

This can cause the discharged battery to overheat and crack, releasing battery acid.

**\* NOTICE**

Make sure to connect one end of the jumper cable to the negative terminal of the booster battery, and the other end to a metallic point, far away from the battery.



5. Start the vehicle with the booster battery and the auxiliary battery begins to charge when EV ready light glows, then start the vehicle with the discharged battery. If the first starting attempt is not successful, wait a few minutes before making another attempt in order to allow the discharged battery to recharge.

*If the cause of your battery discharging is not apparent, you should have your vehicle checked by an authorized Kia dealer.*

### **Push-starting**

Your reduction gear equipped vehicle should not be push-started.

 **WARNING - Tow starting vehicle**

**Never tow a vehicle to start it because the sudden surge forward when the engine starts could cause a collision with the towing vehicle.**

## IF THE VEHICLE OVERHEATS

1. Pull off the road and stop as soon as it is safe to do so.
2. Place the shift lever in P and set the parking brake. If the air conditioning is on, turn it off.
3. If coolant is running out under the vehicle or steam is coming out from underneath the hood, stop the vehicle. Do not open the hood until the coolant has stopped running or the steaming has stopped. If there is no visible loss of coolant and no steam, leave the vehicle running and check to be sure cooling fan is operating. If the fan is not running, turn the vehicle off.
4. Check for coolant leaking from the radiator, hoses or under the vehicle. (If the air conditioning had been in use, it is normal for cold water to be draining from it when you stop).

 **WARNING - Radiator cap**  
**Do not remove the radiator cap when the radiator is hot. This may result in coolant being blown out of the opening and cause serious burns.**

5. If you cannot find the cause of the overheating, wait until the radiator temperature has returned to normal. Then, if coolant has been lost, carefully add coolant to the reservoir to bring the fluid level in the reservoir up to the halfway mark.
6. Proceed with caution, keeping alert for further signs of overheating. If overheating happens again, call an authorized Kia dealer for assistance.

Serious loss of coolant indicates there is a leak in the cooling system and this should be checked as soon as possible by an authorized Kia dealer.

## TIRE PRESSURE MONITORING SYSTEM (TPMS)



- (1) Low tire pressure telltale / TPMS malfunction indicator

Each tire, including the spare (if provided), should be checked monthly when cold and inflated to the inflation pressure recommended by the vehicle manufacturer on the vehicle placard or tire inflation pressure label. (If your vehicle has tires of a different size than the size indicated on the vehicle placard or tire inflation pressure label, you should determine the proper tire inflation pressure for those tires.)

As an added safety feature, your vehicle has been equipped with a tire pressure monitoring system (TPMS) that illuminates a low tire pressure telltale when one or more of your tires is significantly under-inflated. Accordingly, when the low tire pressure telltale illuminates, you should stop and check your tires as soon as possible, and inflate them to the proper pressure. Driving on a significantly under-inflated tire causes the tire to overheat and can lead to tire failure. Under-inflation also reduces fuel efficiency and tire tread life, and may affect the vehicle's handling and stopping ability.

Please note that the TPMS is not a substitute for proper tire maintenance, and it is the driver's responsibility to maintain correct tire pressure, even if under-inflation has not reached the level to trigger illumination of the TPMS low tire pressure telltale.

Your vehicle has also been equipped with a TPMS malfunction indicator to indicate when the system is not operating properly. The TPMS malfunction indicator is combined with the low tire pressure telltale. When the system detects a malfunction, the telltale will flash for approximately one minute and then remain continuously illuminated. This sequence will continue upon subsequent vehicle start-ups as long as the malfunction exists. When the malfunction indicator is illuminated, the system may not be able to detect or signal low tire pressure as intended. TPMS malfunctions may occur for a variety of reasons, including the installation of replacement or alternate tires or wheels on the vehicle that prevent the TPMS from functioning properly.

Always check the TPMS malfunction telltale after replacing one or more tires or wheels on your vehicle to ensure that the replacement or alternate tires and wheels allow the TPMS to continue to function properly.

### \* NOTICE

**If the TPMS, Low Tire Pressure indicator do not illuminate for 3 seconds when the ignition switch is turned to the ON position or vehicle is running, or if they remain illuminated after coming on for approximately 3 seconds, take your vehicle to your nearest authorized Kia dealer and have the system checked.**



### **Low tire pressure telltale**

When the tire pressure monitoring system warning indicators are illuminated, one or more of your tires is significantly under-inflated.

If the telltale illuminates, immediately reduce your speed, avoid hard cornering and anticipate increased stopping distances. You should stop and check your tires as soon as possible. Inflate the tires to the proper pressure as indicated on the vehicle's placard or tire inflation pressure label located on the driver's side center pillar outer panel. If you cannot reach a service station or if the tire cannot hold the newly added air, replace the low pressure tire with the spare tire.

Then the Low Tire Pressure telltale may flash for approximately one minute and then remain continuously illuminated after restarting and about 10 minutes of continuous driving at speed above 15.5 mph (25 km/h) before you have the low pressure tire repaired and replaced on the vehicle.

- In winter or cold weather, the low tire pressure telltale may be illuminated if the tire pressure was adjusted to the recommended tire inflation pressure in warm weather. It does not mean your TPMS is malfunctioning because the decreased temperature leads to a proportional lowering of tire pressure.
- When you drive your vehicle from a warm area to a cold area or from a cold area to a warm area, or the outside temperature is greatly higher or lower, you should check the tire inflation pressure and adjust the tires to the recommended tire inflation pressure.

**\* NOTICE**

When filling tires with more air, conditions to turn off the low tire pressure telltale may not be met. This is because a tire inflator has a margin of error in performance. The low tire pressure telltale will be turned off if the tire pressure is above the recommended tire inflation pressure.

**⚠ WARNING - Low pressure damage**

Do not drive on low pressure tires. Significantly low tire pressure can cause the tires to overheat and fail making the vehicle unstable resulting in increased braking distances and a loss of vehicle control.

***TPMS (Tire Pressure Monitoring System) malfunction indicator***

The TPMS malfunction indicator will illuminate after it blinks for approximately one minute when there is a problem with the Tire Pressure Monitoring System. Have the system checked by an authorized Kia dealer as soon as possible to determine the cause of the problem.

- The TPMS malfunction indicator may blink for approximately 1 minute and then remain continuously illuminated if the vehicle is moving around electric power supply cables or radios transmitters such as at police stations, government and public offices, broadcasting stations, military installations, airports, or transmitting towers, etc. This can interfere with normal operation of the Tire Pressure Monitoring System (TPMS).
- The TPMS malfunction indicator may blink for approximately 1 minute and then remain continuously illuminated if snow chains are used or some separate electronic devices such as notebook computer, mobile charger, remote starter or navigation etc., are used in the vehicle. This can interfere with normal operation of the Tire Pressure Monitoring System (TPMS).

### Changing a tire with TPMS

If you have a flat tire, the Low Tire Pressure telltale will come on. Have the flat tire repaired by an authorized Kia dealer as soon as possible or replace the flat tire with the spare tire.



#### **CAUTION - Repair Agents**

***Never use a puncture-repairing agent not approved by Kia to repair and/or inflate a low pressure tire. The tire sealant not approved by Kia may damage the tire pressure sensor.***

Each wheel is equipped with a tire pressure sensor mounted inside the tire behind the valve stem. You must use TPMS specific wheels. It is recommended that you always have your tires serviced by an authorized Kia dealer.

Even if you replace the low pressure tire with the spare tire, the Low Tire Pressure telltale will remain on until the low pressure tire is repaired and placed on the vehicle.

After you replace the low pressure tire with the spare tire, the TPMS malfunction indicator may illuminate after a few minutes because the TPMS sensor mounted on the spare wheel is not initiated.

Once the low pressure tire is reinflated to the recommended pressure and installed on the vehicle or the TPMS sensor mounted on the replaced spare wheel is initiated by an authorized Kia dealer, the TPMS malfunction indicator and the low tire pressure telltale will extinguish within a few minutes of driving.

If the indicator is not extinguished after a few minutes of driving, please visit an authorized Kia dealer.

If an original mounted tire is replaced with the spare tire, the TPMS sensor on the replaced spare wheel should be initiated and the TPMS sensor on the original mounted wheel should be deactivated. If the TPMS sensor on the original mounted wheel located in the spare tire carrier still activates, the tire pressure monitoring system may not operate properly. Have the tire with TPMS serviced or replaced by an authorized Kia dealer.

You may not be able to identify a low tire by simply looking at it. Always use a good quality tire pressure gauge to measure the tire's inflation pressure. Please note that a tire that is hot (from being driven) will have a higher pressure measurement than a tire that is cold (from sitting stationary for at least 3 hours and driven less than 1 mile (1.6 km) during that 3 hour period).

Allow the tire to cool before measuring the inflation pressure. Always be sure the tire is cold before inflating to the recommended pressure.

Do not use any tire sealant if your vehicle is equipped with a Tire Pressure Monitoring System. The liquid sealant can damage the tire pressure sensors.

- The TPMS cannot alert you to severe and sudden tire damage caused by external factors such as nails or road debris.
- If you feel any vehicle instability, immediately take your foot off the accelerator, apply the brakes gradually and with light force, and slowly move to a safe position off the road.

#### **\* NOTICE - Protecting TPMS**

**Tampering with, modifying, or disabling the Tire Pressure Monitoring System (TPMS) components may interfere with the system's ability to warn the driver of low tire pressure conditions and/or TPMS malfunctions. Tampering with, modifying, or disabling the Tire Pressure Monitoring System (TPMS) components may void the warranty for that portion of the vehicle.**

#### **This device complies with Part 15 of the FCC rules.**

Operation is subject to the following two conditions:

1. This device may not cause harmful interference, and
2. This device must accept any interference received, including interference that may cause undesired operation.

## IF YOU HAVE A FLAT TIRE (TIRE MOBILITY KIT)

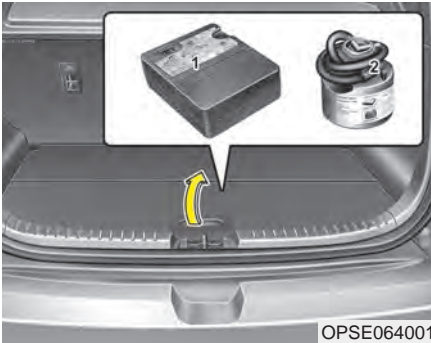

When two or more tires are flat, do not use the tire mobility kit because the supported one sealant of Tire Mobility Kit is only used for one flat tire.

**⚠ WARNING - Tire wall**  
**Do not use the Tire Mobility Kit to repair punctures in the tire walls. This can result in an accident due to tire failure.**

For safe operation, carefully read and follow the instructions in this manual before use.

- (1) Compressor
- (2) Sealant bottle

The Tire Mobility Kit is a temporary fix to the tire and the tire should be inspected by an authorized Kia dealer as soon as possible.

## Introduction



With the Tire Mobility Kit you stay mobile even after experiencing a tire puncture.

The system of compressor and sealing compound effectively and comfortably seals most punctures in a passenger car tire caused by nails or similar objects and reinflates the tire.

After you ensured that the tire is properly sealed you can drive cautiously on the tire (distance up to 200 km (120 miles)) at a max. speed of (80 km/h) in order to reach a service station or tire dealer for the tire replacement.



It is possible that some tires, especially with larger punctures or damage to the sidewall, cannot be sealed completely.

Air pressure loss in the tire may adversely affect tire performance.

For this reason, you should avoid abrupt steering or other driving maneuvers, especially if the vehicle is heavily loaded or if a trailer is in use.

The Tire Mobility Kit is not designed or intended as a permanent tire repair method and is to be used for one tire only.

This instruction shows you step by step how to temporarily seal the puncture simply and reliably.

Read the section "Notes on the safe use of the Tire Mobility Kit".

### **Notes on the suggested use of the Tire Mobility Kit**

- Park your car at the side of the road so that you can work with the Tire Mobility Kit away from moving traffic.
- To be sure your vehicle will not move, even when you're on fairly level ground, always set your parking brake.
- Only use the Tire Mobility Kit for sealing/inflation passenger car tires. Only punctured areas located within the tread region of the tire can be sealed using the tire mobility kit.
- Do not use on motorcycles, bicycles or any other type of tires.
- When the tire and wheel are damaged, do not use Tire Mobility Kit for your safety.
- Use of the Tire Mobility Kit may not be effective for tire damage larger than approximately 0.24 in (6 mm).  
Please contact the nearest Kia dealership if the tire cannot be made roadworthy with the Tire Mobility Kit.

- Do not use the Tire Mobility Kit if a tire is severely damaged by driving run flat or with insufficient air pressure.
- Do not remove any foreign objects such as nails or screws that have penetrated the tire.
- Provided the car is outdoors, leave the vehicle running. Otherwise operating the compressor may eventually drain the car battery.
- Never leave the Tire Mobility Kit unattended while it is being used.
- Do not leave the compressor running for more than 10 min. at a time or it may overheat.
- Do not use the Tire Mobility Kit if the ambient temperature is below -22°F (-30°C).
- Before using the TMK, read the precautionary advice printed on the sealant bottle!

## Components of the Tire Mobility Kit

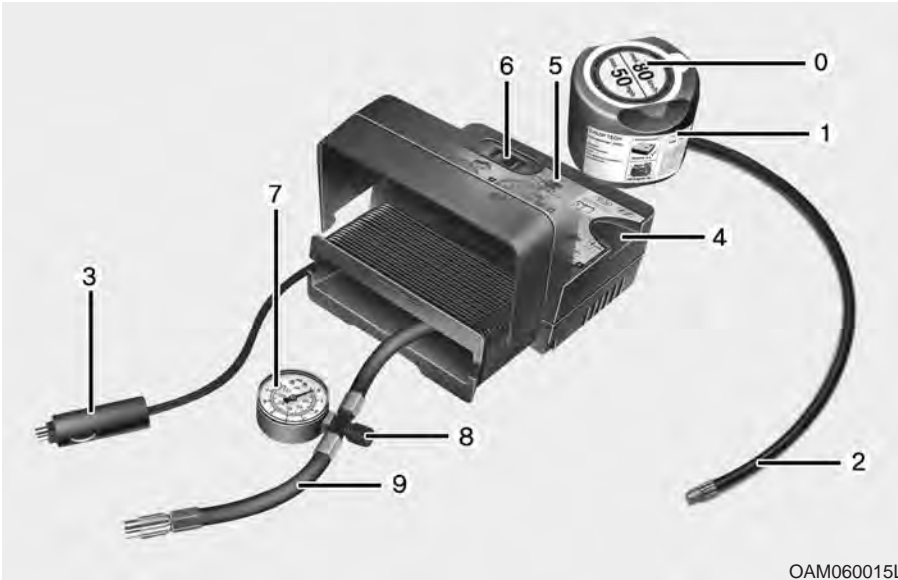

OAM060015L

0. Speed restriction label
1. Sealant bottle and label with speed restriction
2. Filling hose from sealant bottle to wheel
3. Connectors and cable for the power outlet direct connection
4. Holder for the sealant bottle
5. Compressor
6. On/off switch
7. Pressure gauge for displaying the tire inflation pressure
8. Screw cap for reducing tire inflation pressure
9. Hose to connect compressor and sealant bottle or compressor and wheel

9. Hose to connect compressor and sealant bottle or compressor and wheel

Connectors, cable and connection hose are stored in the compressor housing.

**⚠ WARNING - Expired sealant**

Do not use the Tire sealant after the sealant has expired (i.e. pasted the expiration date on the sealant container). This can increase the risk of tire failure.

**⚠ WARNING - Sealant**

- Keep out of reach of children.
- Avoid contact with eyes.
- Do not swallow.

Strictly follow the specified sequence, otherwise the sealant may escape under high pressure.

## Using the Tire Mobility Kit

1. Detach the speed restriction label (0) from the sealant bottle (1), and place it in a highly visible place inside the vehicle such as on the steering wheel to remind the driver not to drive too fast.
2. Screw connection hose (9) onto the connector of the sealant bottle.
3. Ensure that screw cap (8) is closed.
4. Unscrew the valve cap from the valve of the defective wheel and screw filling hose (2) of the sealant bottle onto the valve.
5. Insert the sealant bottle into the housing (4) of the compressor so that the bottle is upright.



6. Ensure that the compressor is switched off, position 0.

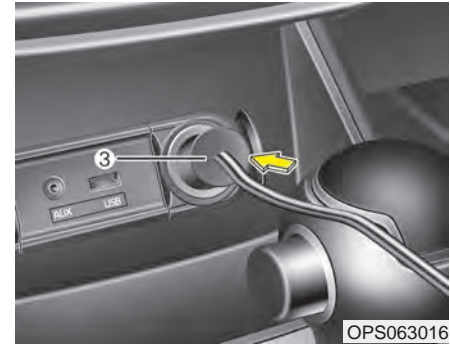

7. Plug the compressor power cord into the front passenger side power outlet (180W) of the vehicle. Only use the front passenger side power outlet when connecting the power cord.

### \* NOTICE

If a foreign object is seen that has punctured the tire, do not remove it before using Tire Mobility Kit.

8. With the vehicle start/stop button position on or ignition switch position on, switch on the compressor and let it run for approximately 5~7 minutes to fill the sealant up to proper pressure. (refer to the Tire and Wheels, chapter 8). The inflation pressure of the tire after filling is unimportant and will be checked/corrected later.

Be careful not to overinflate the tire and stay away from the tire when filling it.

**⚠ WARNING - Tire pressure**  
Do not attempt to drive your vehicle if the tire pressure is below 29 PSI(200kpa). This could result in an accident due to sudden tire failure.

9. Switch off the compressor.  
10. Detach the hoses from the sealant bottle connector and from the tire valve.

Return the Tire Mobility Kit to its storage location in the vehicle.

**⚠ WARNING - Carbon monoxide**

Do not leave your vehicle running in a poorly ventilated area for extended periods of time. Carbon monoxide poisoning and suffocation can occur.

### Distributing the sealant

11. Immediately drive approximately 4~6miles (7~10km or, about 10min) to evenly distribute the sealant in the tire.

Do not exceed a speed of 50 mph (80 km/h). If possible, do not fall below a speed of 12 mph (20 km/h).

While driving, if you experience any unusual vibration, ride disturbance or noise, reduce your speed and drive with caution until you can safely pull off of the side of the road.

Call for road side service or towing.

When you use the Tire Mobility Kit, the tire pressure sensors and wheel may be stained by sealant. Therefore, remove the tire pressure sensors and wheel stained by sealant and we recommend that inspect at an authorized Kia dealer.

### Checking the tire inflation pressure

1. After driving approximately 4 ~6miles (7~10km or about 10min), stop at a safety location.
2. Connect connection hose (9) of the compressor directly to the tire valve.
3. Plug the compressor power cord into the vehicle power outlet.
4. Adjust the tire inflation pressure to the recommended tire inflation.

With the ignition switched on, proceed as follows.

- **To increase the inflation pressure** : Switch on the compressor, position I. To check the current inflation pressure setting, briefly switch off the compressor.

### \* NOTICE

The pressure gauge may show higher than actual reading when the compressor is running. To get an accurate tire pressure, the compressor needs to be turned off.

- **To reduce the inflation pressure**: Loosen the screw cap (8) on the compressor hose.



### CAUTION - Tire pressure sensor

*When you use the Tire Mobility Kit including sealant not approved by Kia, the tire pressure sensors may be damaged by sealant. The sealant on the tire pressure sensor and wheel should be removed when you replace the tire with a new one and inspect the tire pressure sensors in authorized dealer.*

### Technical Data

System voltage: DC 12 V

Working voltage: DC 10 - 15 V

Amperage rating: max. 15 A

Suitable for use at temperatures:

-22 ~ +158°F (-30 ~ +70°C)

Max. working pressure:

87 psi (6 bar)

Size

Compressor: 6.7 x 5.9 x 2.4 in.

(170 x 150 x 60 mm)

Sealant bottle: 3.03 x 3.4 ø in.

(77 x 85 ø mm)

Compressor weight:

1.77 lbs (0.8 kg)

Sealant volume:

12.2 cu. in. (200 ml)

## TOWING

### Towing service

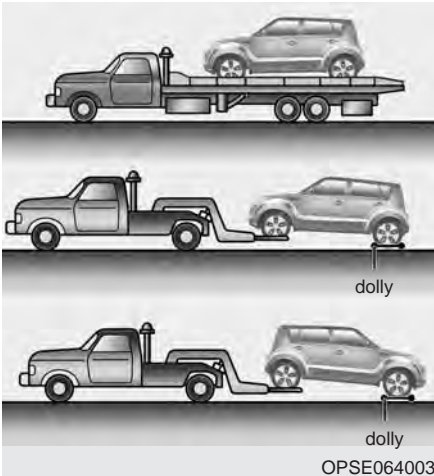

If emergency towing is necessary, we recommend having it done by an authorized Kia dealer or a commercial tow-truck service. Proper lifting and towing procedures are necessary to prevent damage to the vehicle. The use of wheel dollies or flatbed is recommended.

For trailer towing guidelines information, refer to “Trailer towing” in chapter 5.

If towing is required, lift all four wheels off the ground and tow the vehicle. If you must tow the vehicle using only two wheels, lift the front wheels off the ground and tow the vehicle.

**⚠ WARNING - Side and curtain air bag**

If your vehicle is equipped with side and curtain air bags, set the ignition switch to LOCK or ACC position when the vehicle is being towed. The side and curtain air bag may deploy when the ignition is ON and the rollover sensor detects the situation as a rollover.



**⚠ CAUTION - Towing**

- Do not tow the vehicle backwards with the front wheels on the ground as this may cause damage to the vehicle.
- Do not tow with sling-type equipment. Use wheel lift or flatbed equipment.

**⚠ WARNING - Towing EV**

Never tow the vehicle with the front wheels on the ground (forward or backward), as this may cause damage to the motor or a vehicle fire.

When towing your vehicle in an emergency without wheel dollies :

1. Set the ignition switch in the ACC position.
2. Place the transaxle shift lever in N (Neutral).
3. Release the parking brake.

**⚠ CAUTION - Towing gear position**

*Failure to place the shift lever in N (Neutral) may cause internal damage to the transaxle.*

**⚠ WARNING - Towing EV**

- If you tow the vehicle while the front wheels are touching the ground, the vehicle motor may generate electricity and the motor components may be damaged or a fire may occur.
- When a vehicle fire occurs due to the battery, there is a risk of a second fire. Contact the fire department when towing the vehicle.

**Removable towing hook**

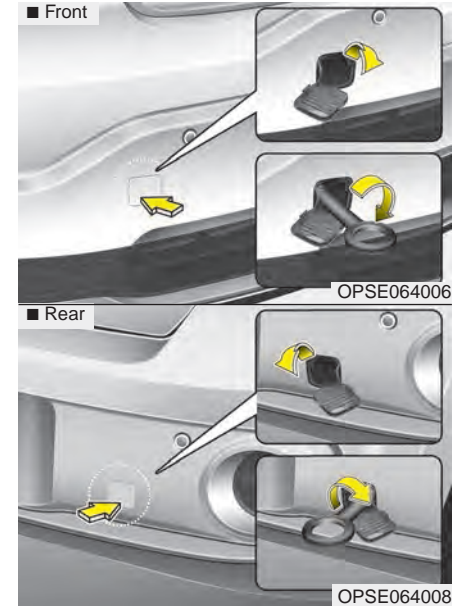

1. Remove the towing hook from the tool case.
2. Remove the hole cover pressing the lower part of the cover on the front bumper.

3. Install the towing hook by turning it clockwise into the hole until it is fully secured.
4. Remove the towing hook and install the cover after use.

### Emergency towing

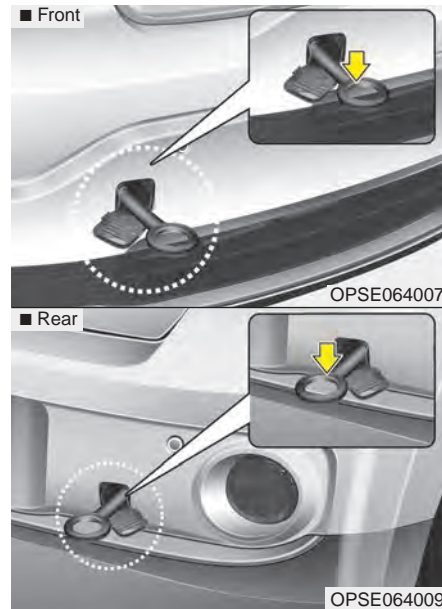

**If towing is necessary, we recommend you to have it done by an authorized Kia dealer or a commercial tow truck service.**

If towing service is not available in an emergency, your vehicle may be temporarily towed using a cable or chain secured to the emergency towing hook under the front (or rear) of the vehicle. Use extreme caution when towing the vehicle. A driver must be in the vehicle to steer it and operate the brakes.

Towing in this manner may be done only on hard-surfaced roads for a short distance and at low speeds. Also, the wheels, axles, power train, steering and brakes must all be in good condition.

- Do not use the tow hooks to pull a vehicle out of mud, sand or other conditions from which the vehicle cannot be driven out under its own power.
- Avoid towing a vehicle heavier than the vehicle doing the towing.
- The drivers of both vehicles should communicate with each other frequently.



- Attach a towing strap to the tow hook.
- Using a portion of the vehicle other than the tow hooks for towing may damage the body of your vehicle.
- Only use a cable or chain specifically intended for use in towing vehicles. Securely fasten the cable or chain to the towing hook provided.
- Before emergency towing, check that the hook is not broken or damaged.
- Fasten the towing cable or chain securely to the hook.
- Do not jerk the hook. Apply it steadily and with even force.
- To avoid damaging the hook, do not pull from the side or at a vertical angle. Always pull straight ahead.

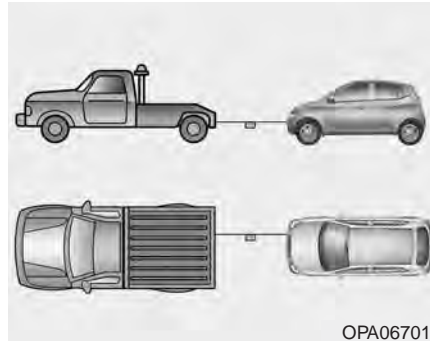

- Use a towing strap less than 16 feet (5 m) long. Attach a white or red cloth (about 12 inches (30 cm) wide) in the middle of the strap for easy visibility.
- Drive carefully so that the towing strap is not loose during towing.

### ***Emergency towing precautions***

- Turn the ignition switch to ACC so the steering wheel isn't locked.
- Place the shift lever in N (Neutral).
- Release the parking brake.
- Press the brake pedal with more force than usual since you will have reduced brake performance.
- More steering effort will be required because the power steering system will be disabled.
- If you are driving down a long hill, the brakes may overheat and brake performance will be reduced. Stop often and let the brakes cool off.

 **CAUTION**

*To avoid serious damage to the reduction gear, limit the vehicle speed to 10 mph (15 km/h) and drive less than 1 mile (1.5 km) when towing.*

**\* NOTICE**

Before towing, check the reduction gear for fluid leaks under your vehicle. If the reduction gear fluid is leaking, a flatbed equipment or towing dolly must be used.

# Maintenance

<b>Motor room compartment</b> .....	7-3	<b>Tires and wheels</b> .....	7-36
<b>Maintenance services</b> .....	7-3	• Tire care.....	7-36
• Owner's responsibility.....	7-3	• Recommended cold tire inflation pressures.....	7-36
• Owner maintenance precautions.....	7-4	• Checking tire inflation pressure.....	7-37
<b>Owner maintenance</b> .....	7-5	• Tire rotation.....	7-38
• Owner maintenance schedule.....	7-5	• Wheel alignment and tire balance.....	7-39
<b>Scheduled maintenance service</b> .....	7-7	• Tire replacement.....	7-40
<b>Explanation of scheduled maintenance items</b> ...	7-19	• Wheel replacement.....	7-40
<b>Coolant</b> .....	7-21	• Tire traction.....	7-41
• Checking the coolant level.....	7-21	• Tire maintenance.....	7-41
• Changing the coolant.....	7-23	• Tire sidewall labeling.....	7-41
<b>Brake fluid</b> .....	7-24	<b>Fuses</b> .....	7-51
• Checking the brake fluid level.....	7-24	• Fuse/relay panel description.....	7-56
<b>Washer fluid</b> .....	7-26	<b>Light bulbs</b> .....	7-63
• Checking the washer fluid level.....	7-26	• Front light replacement.....	7-64
<b>Climate control air filter</b> .....	7-27	• Side repeater light bulb replacement.....	7-68
• Filter inspection.....	7-27	• Rear combination light bulb replacement.....	7-68
• Filter replacement.....	7-27	• High mounted stop light bulb replacement.....	7-70
<b>Wiper blades</b> .....	7-29	• License plate light bulb replacement.....	7-71
• Blade inspection.....	7-29	• Interior light bulb replacement.....	7-72
• Blade replacement.....	7-29	<b>Appearance care</b> .....	7-73
<b>Battery</b> .....	7-33	• Exterior care.....	7-73
• For best battery service.....	7-33	• Interior care.....	7-78
• Battery recharging.....	7-34	<b>California perchlorate notice</b> .....	7-80
• Reset items.....	7-35		

## MOTOR ROOM COMPARTMENT



1. Coolant reservoir
2. Brake fluid reservoir
3. Fuse box
4. Positive battery terminal
5. Negative battery terminal
6. Radiator cap
7. Windshield washer fluid reservoir

\* The actual motor compartment in the vehicle may differ from the illustration.

OPSE075001

## MAINTENANCE SERVICES

You should exercise the utmost care to prevent damage to your vehicle and injury to yourself whenever performing any maintenance or inspection procedures.

Should you have any doubts concerning the inspection or servicing of your vehicle, we strongly recommend that you have an authorized Kia dealer perform this work.

An authorized Kia dealer has factory trained technicians and genuine Kia parts to service your vehicle properly. For expert advice and quality service, see an authorized Kia dealer.

Inadequate, incomplete or insufficient servicing may result in operational problems with your vehicle that could lead to vehicle damage, an accident, or personal injury.

### Owner's responsibility

#### \* NOTICE

**Maintenance Service and Record Retention are the owner's responsibility.**

You should retain documents that show proper maintenance has been performed on your vehicle in accordance with the scheduled maintenance service charts shown on the following pages. You need this information to establish your compliance with the servicing and maintenance requirements of your vehicle warranties.

Detailed warranty information is provided in your Warranty & Consumer Information manual.

Repairs and adjustments required as a result of improper maintenance or a lack of required maintenance are not covered.

We recommend you have your vehicle maintained and repaired by an authorized Kia dealer. An authorized Kia dealer meets Kia's high service quality standards and receives technical support from Kia in order to provide you with a high level of service satisfaction.

#### \* NOTICE - NHTSA Safety Corrosion Alert

**The National Highway Traffic Safety Administration (NHTSA) has issued a general warning to all vehicle owners of all brands regarding the risks associated with vehicle underbody corrosion. From your initial purchase, take the following steps to prevent unsafe corrosion damage to your vehicle:**

**(Continued)**

(Continued)

- Wash the undercarriage of your vehicle regularly during the winter and whenever your vehicle has been exposed to such salts or chemicals.
- Do a thorough washing of the undercarriage at the end of the winter.
- Use professional service technicians or governmental inspection stations to annually inspect for corrosion.
- Immediately seek an inspection of your vehicle if you become visually aware of corrosion flaking or scaling or if you become aware of a change in vehicle performance, such as soft or spongy brakes, fluids leaking, impairment of directional control, suspension noises or rattling metal straps. NHTSA further advises that after a vehicle is 7 years old, it is essential that you take these indicated maintenance steps to ensure that you protect yourself from unsafe corrosion conditions.

### Owner maintenance precautions

Improper or incomplete service may result in problems. This section gives instructions only for the maintenance items that are easy to perform.

As explained earlier in this section, several procedures can be done only by an authorized Kia dealer with special tools.

### \* NOTICE

Improper owner maintenance during the warranty period may affect warranty coverage. For details, read the separate Warranty & Consumer Information manual provided with the vehicle. If you're unsure about any servicing or maintenance procedure, have it done by an authorized Kia dealer.

### **WARNING** - Maintenance work

Do not wear jewelry or loose clothing while working under the hood of your vehicle with ready (🔌) mode. These can become entangled in moving parts, if you must run the vehicle in the ready (🔌) mode while working under the hood, make certain that you remove all jewelry (especially rings, bracelets, watches, and necklaces) and all neckties, scarves, and similar loose clothing before getting near cooling fans.

## OWNER MAINTENANCE

The following lists are vehicle checks and inspections that should be performed by the owner or an authorized Kia dealer at the frequencies indicated to help ensure safe, dependable operation of your vehicle.

Any adverse conditions should be brought to the attention of your dealer as soon as possible.

These Owner Maintenance Checks are generally not covered by warranties and you may be charged for labor, parts and lubricants used.

### Owner maintenance schedule

#### *When you stop for fuel:*

- Check the coolant level in the coolant reservoir.
- Check the windshield washer fluid level.
- Look for low or under-inflated tires. Check if the front of the radiator and condenser are clean and not blocked with leaves, dirt or insects etc. If any of the above parts are extremely dirty or you are not sure of their condition, take your vehicle to an authorized Kia dealer.

#### *While operating your vehicle:*

- Check for vibrations in the steering wheel. Notice any increased steering effort or looseness in the steering wheel, or change in its straight-ahead position.
- Notice if your vehicle constantly turns slightly or “pulls” to one side when traveling on smooth, level road.
- When stopping, listen and check for unusual sounds, pulling to one side, increased brake pedal travel or “hard-to-push” brake pedal.
- If any slipping or changes in the operation of your transaxle occurs, check the transaxle fluid level.
- Check the reduction gear P (Park) function.
- Check the parking brake.
- Check for fluid leaks under your vehicle (water dripping from the air conditioning system during or after use is normal).

### ***At least monthly:***

- Check the coolant level in the coolant reservoir.
- Check the operation of all exterior lights, including the stoplights, turn signals and hazard warning flashers.
- Check the inflation pressures of all tires including the spare.

### ***At least twice a year (i.e., every Spring and Fall):***

- Check the radiator, heater and air conditioning hoses for leaks or damage.
- Check the windshield washer spray and wiper operation. Clean the wiper blades with clean cloth dampened with washer fluid.
- Check the headlight alignment.
- Check the muffler, exhaust pipes, shields and clamps.
- Check the lap/shoulder belts for wear and function.
- Check for worn tires and loose wheel lug nuts.

### ***At least once a year:***

- Clean the body and door drain holes.
- Lubricate the door hinges and checks, and hood hinges.
- Lubricate the door and hood locks and latches.
- Lubricate the door rubber weatherstrips.
- Check the air conditioning system.
- Inspect and lubricate the reduction gear linkage and controls.
- Clean the battery and terminals.
- Check the brake fluid level.



## SCHEDULED MAINTENANCE SERVICE

Follow the Normal Maintenance Schedule if the vehicle is usually operated where none of the following conditions apply. If any of the following conditions apply, follow the Maintenance Under Severe Usage Conditions.

- Repeated driving short distance of less than 5 miles (8 km) in normal temperature or less than 10 miles (16 km) in freezing temperature
- Extensive engine idling or low speed driving for long distances
- Driving on rough, dusty, muddy, unpaved, graveled or salt-spread roads
- Driving in areas using salt or other corrosive materials or in very cold weather
- Driving in heavy dust condition
- Driving in heavy traffic area
- Driving on uphill, downhill, or mountain road repeatedly
- Towing a trailer or using a camper, or roof rack
- Driving as a patrol car, taxi, other commercial use of vehicle towing
- Driving over 106 mile/h(170 km/h)
- Frequently driving in stop-and-go condition

*If your vehicle is operated under the above conditions, you should inspect, replace or refill more frequently than the following Normal Maintenance Schedule. After 120 months or 150,000 miles continue to follow the prescribed maintenance intervals.*

### **NORMAL MAINTENANCE SCHEDULE**

The following maintenance services must be performed to ensure good emission control and performance. Keep receipts for all vehicle emission services to protect your warranty. Where both mileage and time are shown, the frequency of service is determined by whichever occurs first.

\*1 : When adding coolant, use only deionized water or soft water for your vehicle and never mix hard water in the coolant filled at the factory. An improper coolant mixture can result in serious malfunction or motor compartment damage.

**NORMAL MAINTENANCE SCHEDULE (CONT.)****7,500 miles (12,000 km) or 6 months**

- Inspect air conditioning compressor, air conditioner refrigerant and performance (if equipped)
- Inspect cooling system \*<sup>1</sup>
- Inspect 12V battery condition
- Inspect brake lines, hoses and connections
- Inspect brake fluid
- Inspect disc brakes and pads
- Inspect suspension ball joints & mounting bolts
- Inspect steering gear rack, linkage and boots
- Inspect brake pedal
- Rotate tires - including tire pressure and tread wear (Every 3,750 miles (6,000 km) or 6 months)
- Replace climate control air filter (if equipped)

\* Inspect : Inspect and if necessary, adjust, correct, clean or replace.

**15,000 miles (24,000 km) or 12 months**

- Inspect air conditioning compressor, air conditioner refrigerant and performance (if equipped)
- Inspect cooling system \*<sup>1</sup>
- Inspect 12V battery condition
- Inspect brake lines, hoses and connections
- Inspect brake fluid
- Inspect disc brakes and pads
- Inspect suspension ball joints & mounting bolts
- Inspect steering gear rack, linkage and boots
- Inspect brake pedal
- Inspect drive shafts and boots
- Rotate tires - including tire pressure and tread wear (Every 3,750 miles (6,000 km) or 6 months)
- Replace climate control air filter (if equipped)

\* Inspect : Inspect and if necessary, adjust, correct, clean or replace.

## NORMAL MAINTENANCE SCHEDULE (CONT.)

### 22,500 miles (36,000 km) or 18 months

- Rotate tires - including tire pressure and tread wear (Every 3,750 miles (6,000 km) or 6 months)

### 30,000 miles (48,000 km) or 24 months

- Inspect air conditioning compressor, air conditioner refrigerant and performance (if equipped)
- Inspect cooling system \*<sup>1</sup>
- Inspect 12V battery condition
- Inspect brake lines, hoses and connections
- Inspect brake fluid
- Inspect disc brakes and pads
- Inspect suspension ball joints & mounting bolts
- Inspect steering gear rack, linkage and boots
- Inspect brake pedal
- Inspect drive shafts and boots
- Rotate tires - including tire pressure and tread wear (Every 3,750 miles (6,000 km) or 6 months)
- Replace climate control air filter (if equipped)

\* Inspect : Inspect and if necessary, adjust, correct, clean or replace.

## NORMAL MAINTENANCE SCHEDULE (CONT.)

### 37,500 miles (60,000 km) or 30 months

- Inspect reduction gear oil
- Rotate tires - including tire pressure and tread wear  
(Every 3,750 miles (6,000 km) or 6 months)

\* Inspect : Inspect and if necessary, adjust, correct, clean or replace.

### 45,000 miles (72,000 km) or 36 months

- Inspect air conditioning compressor, air conditioner refrigerant and performance (if equipped)
- Inspect cooling system \*<sup>1</sup>
- Inspect 12V battery condition
- Inspect brake lines, hoses and connections
- Inspect brake fluid
- Inspect disc brakes and pads
- Inspect suspension ball joints & mounting bolts
- Inspect steering gear rack, linkage and boots
- Inspect brake pedal
- Inspect drive shafts and boots
- Rotate tires - including tire pressure and tread wear  
(Every 3,750 miles (6,000 km) or 6 months)
- Replace climate control air filter (if equipped)

\* Inspect : Inspect and if necessary, adjust, correct, clean or replace.

## NORMAL MAINTENANCE SCHEDULE (CONT.)

### 52,500 miles (84,000 km) or 42 months

- Rotate tires - including tire pressure and tread wear (Every 3,750 miles (6,000 km) or 6 months)

### 60,000 miles (96,000 km) or 48 months

- Inspect air conditioning compressor, air conditioner refrigerant and performance (if equipped)
- Inspect cooling system \*<sup>1</sup>
- Inspect 12V battery condition
- Inspect brake lines, hoses and connections
- Inspect brake fluid
- Inspect disc brakes and pads
- Inspect suspension ball joints & mounting bolts
- Inspect steering gear rack, linkage and boots
- Inspect brake pedal
- Inspect drive shafts and boots
- Rotate tires - including tire pressure and tread wear (Every 3,750 miles (6,000 km) or 6 months)
- Replace climate control air filter (if equipped)

\* Inspect : Inspect and if necessary, adjust, correct, clean or replace.

**NORMAL MAINTENANCE SCHEDULE (CONT.)****67,500 miles (108,000 km) or 54 months**

- Rotate tires - including tire pressure and tread wear  
(Every 3,750 miles (6,000 km) or 6 months)

**75,000 miles (120,000 km) or 60 months**

- Inspect air conditioning compressor, air conditioner refrigerant and performance (if equipped)
- Inspect cooling system \*<sup>1</sup>
- Inspect 12V battery condition
- Inspect brake lines, hoses and connections
- Inspect brake fluid
- Inspect disc brakes and pads
- Inspect suspension ball joints & mounting bolts
- Inspect steering gear rack, linkage and boots
- Inspect brake pedal
- Inspect drive shafts and boots
- Inspect reduction gear oil
- Rotate tires - including tire pressure and tread wear  
(Every 3,750 miles (6,000 km) or 6 months)
- Replace climate control air filter (if equipped)

\* Inspect : Inspect and if necessary, adjust, correct, clean or replace.

## NORMAL MAINTENANCE SCHEDULE (CONT.)

### 82,500 miles (132,000 km) or 66 months

- Rotate tires - including tire pressure and tread wear (Every 3,750 miles (6,000 km) or 6 months)

### 90,000 miles (144,000 km) or 72 months

- Inspect air conditioning compressor, air conditioner refrigerant and performance (if equipped)
- Inspect cooling system \*<sup>1</sup>
- Inspect 12V battery condition
- Inspect brake lines, hoses and connections
- Inspect brake fluid
- Inspect disc brakes and pads
- Inspect suspension ball joints & mounting bolts
- Inspect steering gear rack, linkage and boots
- Inspect brake pedal
- Inspect drive shafts and boots
- Rotate tires - including tire pressure and tread wear (Every 3,750 miles (6,000 km) or 6 months)
- Replace climate control air filter (if equipped)

\* Inspect : Inspect and if necessary, adjust, correct, clean or replace.



**NORMAL MAINTENANCE SCHEDULE (CONT.)****97,500 miles (156,000 km) or 78 months**

- Rotate tires - including tire pressure and tread wear (Every 3,750 miles (6,000 km) or 6 months)

**105,000 miles (168,000 km) or 84 months**

- Inspect air conditioning compressor, air conditioner refrigerant and performance (if equipped)
- Inspect cooling system \*<sup>1</sup>
- Inspect 12V battery condition
- Inspect brake lines, hoses and connections
- Inspect brake fluid
- Inspect disc brakes and pads
- Inspect suspension ball joints & mounting bolts
- Inspect steering gear rack, linkage and boots
- Inspect brake pedal
- Inspect drive shafts and boots
- Rotate tires - including tire pressure and tread wear (Every 3,750 miles (6,000 km) or 6 months)
- Replace climate control air filter (if equipped)

\* Inspect : Inspect and if necessary, adjust, correct, clean or replace.

## NORMAL MAINTENANCE SCHEDULE (CONT.)

### 112,500 miles (180,000 km) or 90 months

- Rotate tires - including tire pressure and tread wear (Every 3,750 miles (6,000 km) or 6 months)
- Inspect reduction gear oil

\* Inspect : Inspect and if necessary, adjust, correct, clean or replace.

### 120,000 miles (192,000 km) or 96 months

- Inspect air conditioning compressor, air conditioner refrigerant and performance (if equipped)
- Inspect cooling system \*<sup>1</sup>
- Inspect 12V battery condition
- Inspect brake lines, hoses and connections
- Inspect brake fluid
- Inspect disc brakes and pads
- Inspect suspension ball joints & mounting bolts
- Inspect steering gear rack, linkage and boots
- Inspect brake pedal
- Inspect drive shafts and boots
- Rotate tires - including tire pressure and tread wear (Every 3,750 miles (6,000 km) or 6 months)
- Replace climate control air filter (if equipped)
- Replace coolant (First at 120,000 miles (192,000 km) then after every 30,000 miles (48,000km))

\* Inspect : Inspect and if necessary, adjust, correct, clean or replace.

## MAINTENANCE UNDER SEVERE USAGE CONDITIONS

The following items must be serviced more frequently on cars mainly used under severe driving conditions. Refer to the chart below for the appropriate maintenance intervals.

R : Replace    I : Inspect and if necessary, adjust, correct, clean or replace

Maintenance item	Maintenance operation	Maintenance intervals	Driving condition
Reduction gear oil	R	Every 75,000 miles (120,000 km)	C, D, E, G, H, I, K
Drive shaft and boots	I	Inspect more frequently depending on the condition	C, D, E, F, G, H, I, J, K
Climate control air filter (if equipped)	I	Inspect more frequently depending on the condition	C, D, E, F, G
Disc brakes and pads	I	Inspect more frequently depending on the condition	C, D, E, G, H

Maintenance item	Maintenance operation	Maintenance intervals	Driving condition
Steering gear rack, linkage and boots	I	Inspect more frequently depending on the condition	C, D, E, F, G, H, I, K
Front suspension ball joints	R	Replace more frequently depending on the condition	C, E, G

### SEVERE DRIVING CONDITIONS

A : Repeatedly driving short distance of less than 8 km (5 miles) in normal temperature or less than 16 km (10 miles) in freezing temperature.

B : Extensive low speed driving for long distances.

C : Driving on rough, dusty, muddy, unpaved, graveled or salt-spread roads.

D : Driving in areas using salt or other corrosive materials or in very cold weather

E : Driving in heavy dust condition

F : Driving in heavy traffic area

G : Driving on uphill, downhill, or mountain roads.

H : Towing a trailer or using a camper on roof rack.

I : Driving for patrol car, taxi, commercial car or vehicle towing.

J : Driving in very cold weather.

K : Driving over 170 km/h (106 mile/h).

L : Frequently driving in stop-and-go conditions.

## EXPLANATION OF SCHEDULED MAINTENANCE ITEMS

### Cooling system

Check the cooling system components, such as the radiator, coolant reservoir, hoses and connections, coolant 3way valve, chiller for leakage and damage. Replace any damaged parts.

### Coolant

The coolant should be changed at the intervals specified in the maintenance schedule.

### Brake hoses and lines

Visually check for proper installation, chafing, cracks, deterioration and any leakage. Replace any deteriorated or damaged parts immediately.

### \* NOTICE - NHTSA Safety Corrosion Alert

NHTSA has warned all vehicle owners of all brands that they must maintain their vehicles in a manner which will prevent brake hose and brake line failures due to corrosion when such vehicles are exposed to winter road salt and related chemicals. While serious corrosion conditions typically only manifest themselves as safety issues after 7 years of vehicle use, the corrosion process starts immediately and thus underbody cleaning maintenance must commence from your vehicle's first exposure to road salts and chemicals. NHTSA urges vehicle owners to take the following steps to prevent corrosion:

(Continued)

(Continued)

1. Wash the undercarriage of your vehicle regularly throughout the winter and do a thorough washing in the spring to remove road salt and other de-icing chemicals.
2. Monitor the brake system for signs of corrosion by having regular professional inspections and watching for signs of problems, including loss of brake fluid, unusual leaks and soft or spongy feel in the brake pedal.
3. Replace the entire brake pipe assembly if you find severe corrosion that causes scaling or flaking of brake components.

### **Brake fluid**

Check the brake fluid level in the brake fluid reservoir. The level should be between “MIN” and “MAX” marks on the side of the reservoir. Use only hydraulic brake fluid conforming to DOT 3 or DOT 4 specification.

### **Brake discs, pads, calipers and rotors**

Check the pads for excessive wear, discs for run out and wear, and calipers for fluid leakage.

### **Suspension mounting bolts**

Check the suspension connections for looseness or damage. Retighten to the specified torque.

### **Steering gear box, linkage & boots/lower arm ball joint**

With the vehicle stopped and off, check for excessive free-play in the steering wheel.

Check the linkage for bends or damage. Check the dust boots and ball joints for deterioration, cracks, or damage. Replace any damaged parts.

### **Drive shafts and boots**

Check the drive shafts, boots and clamps for cracks, deterioration, or damage. Replace any damaged parts and, if necessary, repack the grease.

### **Air conditioning refrigerant**

Check the air conditioning lines and connections for leakage and damage.

## COOLANT

The high-pressure cooling system has a reservoir filled with year round antifreeze coolant. The reservoir is filled at the factory.

Check the antifreeze protection and coolant level at least once a year, at the beginning of the winter season, and before traveling to a colder climate.

 **CAUTION - Radiator /Inverter cap**

*Never attempt to remove the radiator or inverter cap while the motor is operating or hot. Doing so might lead to cooling system and motor damage.*

### Checking the coolant level

 **WARNING**



**Removing radiator cap**

**Never attempt to remove the radiator cap while the motor compartment is operating or hot. Doing so might lead to cooling system damage and could result in serious personal injury from escaping hot coolant or steam.**

Turn the vehicle off and wait until it cools down. Use extreme care when removing the radiator cap. Wrap a thick towel around it, and turn it counterclockwise slowly to the first stop. Step back while the pressure is released from the cooling system.

When you are sure all the pressure has been released, press down on the cap, using a thick towel, and continue turning counterclockwise to remove it.

**⚠ WARNING - Cooling fan**



Use caution when working near the blade of the cooling fan. The electric motor (cooling fan) is controlled by coolant temperature, refrigerant pressure and vehicle speed. It may sometimes operate even when the vehicle is not running.

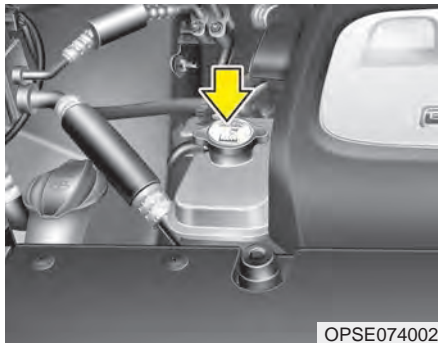

Check the condition and connections of all cooling system hoses and heater hoses. Replace any swollen or deteriorated hoses.

The coolant level should be filled between F and L marks on the side of the coolant reservoir when the motor room is cool.

If the coolant level is low, add enough specified coolant to provide protection against freezing and corrosion. Bring the level to F, but do not overfill. If frequent additions are required, see an authorized Kia dealer for a cooling system inspection.

***Recommended coolant***

- When adding coolant, use only deionized water or soft water for your vehicle and never mix hard water in the coolant filled at the factory. An improper coolant mixture can result in serious malfunction or damage.
- DO NOT USE alcohol or methanol coolant or mix them with the specified coolant.
- Do not use a solution that contains more than 60% antifreeze or less than 35% antifreeze, which would reduce the effectiveness of the solution.
- The cooling circuit of a vehicle equipped with a heat pump system may freeze in extremely low temperature when the concentration of the antifreezing liquid is below 45%.



For mixture percentage, refer to the following table.

Ambient Temperature	Mixture Percentage (volume)	
	Antifreeze	Water
5°F (-15°C)	35	65
-13°F (-25°C)	40	60
-31°F (-35°C)	50	50
-49°F (-45°C)	60	40

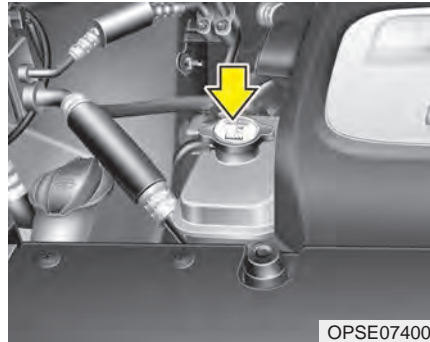

## Changing the coolant

Have the coolant changed by an authorized Kia dealer according to the Maintenance Schedule at the beginning of this chapter.

Put a thick cloth around the radiator cap before refilling the coolant in order to prevent the coolant from overflowing into motor compartment.



### WARNING



#### Radiator cap

Do not remove the radiator cap when the motor compartment and radiator are hot. Scalding hot coolant and steam may blow out under pressure which may result in serious injury.

## BRAKE FLUID



### Checking the brake fluid level

Check the fluid level in the reservoir periodically. The fluid level should be between MAX and MIN marks on the side of the reservoir.

Before removing the reservoir cap and adding brake fluid, clean the area around the reservoir cap thoroughly to prevent brake fluid contamination.



### **CAUTION - Proper fluid**

***Only use brake fluid in brake system. Small amounts of improper fluids can cause damage to the brake system.***

If the level is low, add fluid to the MAX level. The level will fall with accumulated mileage. This is a normal condition associated with the wear of the brake linings. If the fluid level is excessively low, have the brake system checked by an authorized Kia dealer.

*Use only the specified brake fluid. (Refer to "Recommended lubricants and capacities" in chapter 8.)*

*Never mix different types of fluid.*

In the event the brake system requires frequent additions of fluid, the vehicle should be inspected by an authorized Kia dealer.

When changing and adding brake fluid, handle it carefully. Do not let it come in contact with your eyes. If brake fluid should come in contact with your eyes, immediately flush them with a large quantity of fresh tap water. Have your eyes examined by a doctor as soon as possible.

**CAUTION - Brake fluid**

*Do not allow brake fluid to contact the vehicle's body paint, as paint damage will result.*

Brake fluid, which has been exposed to open air for an extended time should never be used as its quality cannot be guaranteed. It should be disposed of properly.

## WASHER FLUID

### Checking the washer fluid level

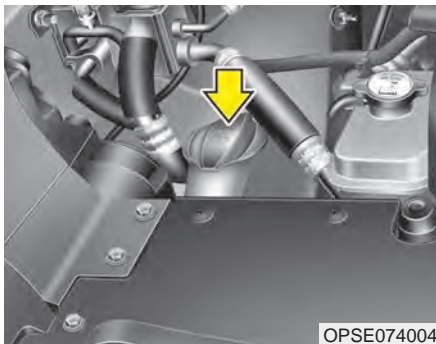

The reservoir is translucent so that you can check the level with a quick visual inspection.

Check the fluid level in the washer fluid reservoir and add fluid if necessary. Plain water may be used if washer fluid is not available. However, use washer solvent with antifreeze characteristics in cold climates to prevent freezing.

#### **⚠ WARNING - Flammable Fluid**

Do not allow the washer fluid to come in contact with open flames or sparks. The windshield washer fluid reservoir is flammable under certain circumstances. This can result in a fire.

#### **⚠ WARNING - Coolant**

- Do not use radiator coolant or antifreeze in the washer fluid reservoir.
- Radiator coolant can severely obscure visibility when sprayed on the windshield and may cause loss of vehicle control.

#### **⚠ WARNING - Windshield fluid**

Do not drink the windshield washer fluid. The windshield washer fluid is poisonous to humans and animals.

## CLIMATE CONTROL AIR FILTER

### Filter inspection & replacement

The climate control air filter should be replaced according to the maintenance schedule. If the vehicle is operated in severely air-polluted cities or on dusty rough roads for a long period, it should be inspected more frequently and replaced earlier. When you replace the climate control air filter, replace it performing the following procedure, and be careful to avoid damaging other components.

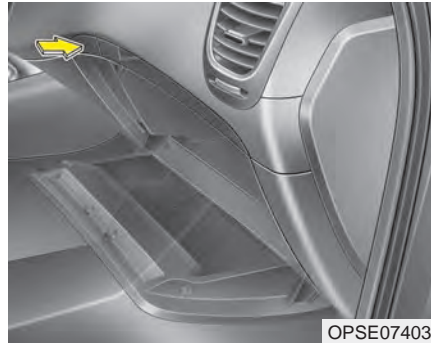

1. Open the glove box.



2. With the glove box open, remove the Air filter cover.

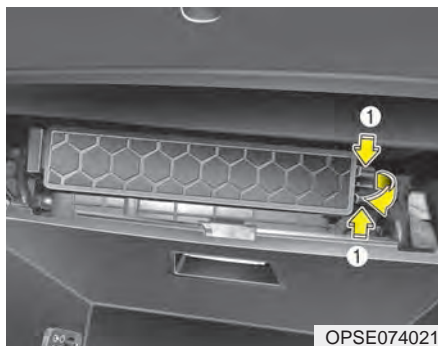

3. Remove the climate control air filter case by pulling out both sides of the cover.

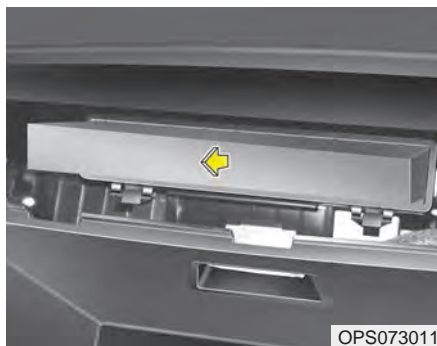

4. Replace the climate control air filter.  
5. Reassembly in the reverse order of disassembly.

When replacing the climate control air filter install it properly. Otherwise, the system may produce noise and the effectiveness of the filter may be reduced.

## WIPER BLADES

### Blade inspection

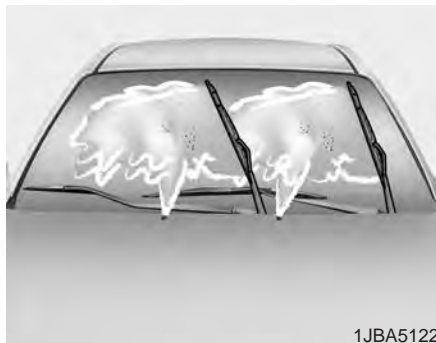

Commercial hot waxes applied by automatic vehicle washes have been known to make the windshield difficult to clean.

Contamination of either the windshield or the wiper blades with foreign matter can reduce the effectiveness of the windshield wipers. Common sources of contamination are insects, tree sap, and hot wax treatments used by some commercial vehicle washes. If the blades are not wiping properly, clean both the window and the blades with a good cleaner or mild detergent, and rinse thoroughly with clean water.



### **CAUTION - Wiper blades**

***To prevent damage to the wiper blades, do not use gasoline, kerosene, paint thinner, or other solvents on or near them.***

### Blade replacement

When the wipers no longer clean adequately, the blades may be worn or cracked, and require replacement.

To prevent damage to the wiper arms or other components, do not attempt to move the wipers manually.

The use of a non-specified wiper blade could result in wiper malfunction and failure.

### Front windshield wiper blade

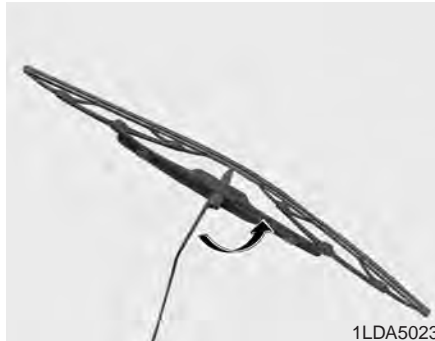

#### Type A

1. Raise the wiper arm and turn the wiper blade assembly to expose the plastic locking clip.

**⚠ CAUTION - Wiper arms**  
*Do not allow the wiper arm to fall against the windshield, since it may chip or crack the windshield.*

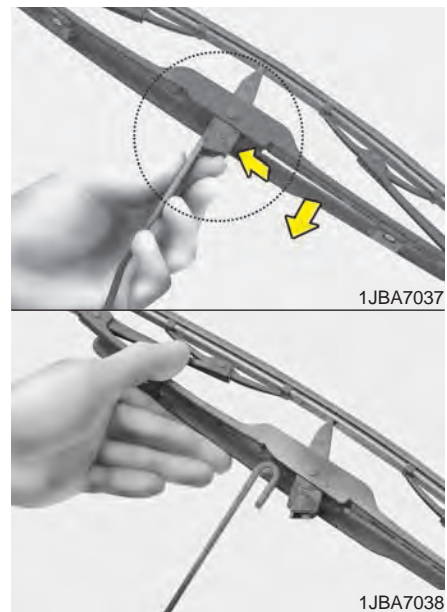

2. Compress the clip and slide the blade assembly downward.
3. Lift it off the arm.
4. Install the blade assembly in the reverse order of removal.



#### Type B

1. Raise the wiper arm.



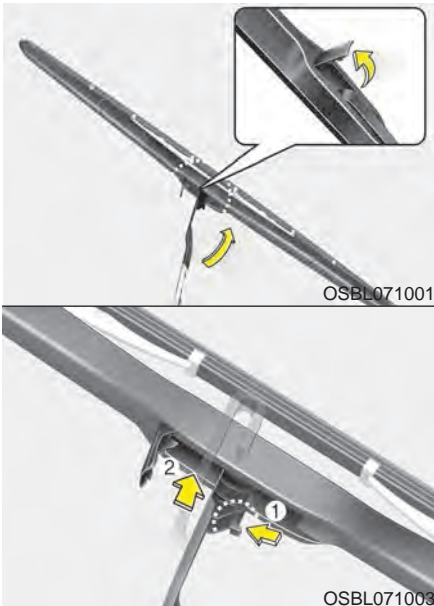

2. Turn the wiper blade clip. Then lift up the blade clip.
3. Push the clip (1) and push up the wiper arm (2).



4. Push down the wiper arm (3) and install the new blade assembly in the reverse order of removal.
5. Return the wiper arm on the windshield.

### Rear window wiper blade

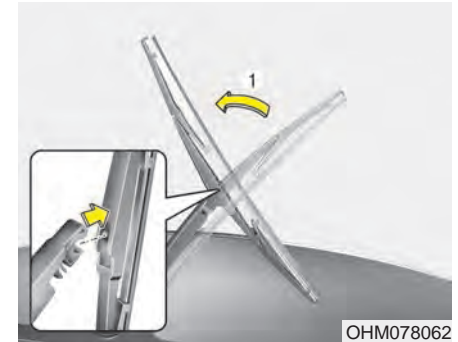

1. Raise the wiper arm and pull out the wiper blade assembly.

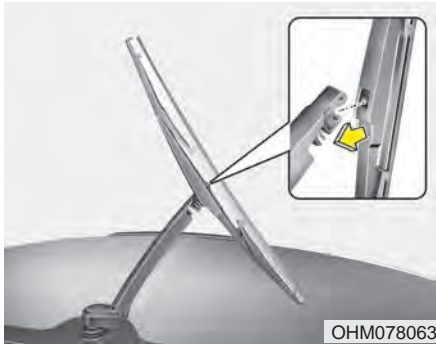

2. Install the new blade assembly by inserting the center part into the slot in the wiper arm until it clicks into place.
3. Make sure the blade assembly is installed firmly by trying to pull it slightly.

To prevent damage to the wiper arms or other components, have an authorized Kia dealer replace the wiper blade.

## BATTERY

### For best battery service

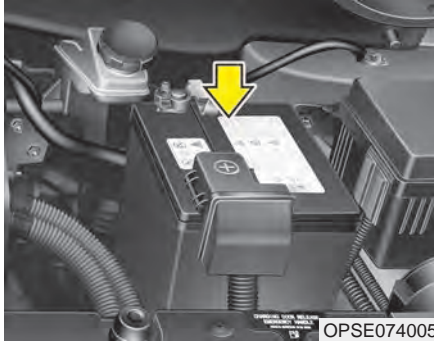

- Keep the battery securely mounted.
- Keep the battery top clean and dry.
- Keep the terminals and connections clean, tight, and coated with petroleum jelly or terminal grease.
- Rinse any spilled electrolyte from the battery immediately with a solution of water and baking soda.
- If the vehicle is not going to be used for an extended time, disconnect the battery cables.

### **⚠ WARNING - Risk of explosion**



Keep lit cigarettes and all other flames or sparks away from the battery.



The battery contains hydrogen -- a highly combustible gas which will explode if it comes in contact with a flame or spark.



Keep batteries out of the reach of children because batteries contain highly corrosive **SULFURIC ACID** and electrolytes. Do not allow battery acid to contact your skin, eyes, clothing or paint finish.



Wear eye protection when charging or working near a battery. Always provide ventilation when working in an enclosed space.



Always read the following instructions carefully when handling a battery.



If any electrolyte gets into your eyes, flush your eyes with clean water for at least 15 minutes and get immediate medical attention.

If electrolyte gets on your skin, thoroughly wash the contacted area. If you feel pain or burning sensation, get medical attention immediately.



An inappropriately disposed battery can be harmful to the environment and human health. Dispose the battery according to your local law(s) or regulation.

Never attempt to recharge the battery when the battery cables are connected.

**⚠ WARNING - Risk of electrocution**

Never touch the electrical ignition system while the vehicle is running. This system works with high voltage which can "zap" you.

**⚠ CALIFORNIA PROPOSITION 65 WARNING**

Battery posts, terminals, and related accessories contain lead and lead compounds, chemicals known to the State of California to cause cancer, birth defects and reproductive harm. Batteries also contain other chemicals known to the State of California to cause cancer. Wash hands after handling.

**\* NOTICE**

If you connect unauthorized electronic devices to the battery, the battery may be discharged. Never use unauthorized devices.

**⚠ WARNING - Recharging battery**

Never attempt to recharge the battery when the battery cables are connected.

**Battery recharging**

Your vehicle has a maintenance-free, calcium-based battery.

- If the battery becomes discharged in a short time (because, for example, the headlights or interior lights were left on while the vehicle was not in use), recharge it by slow charging (trickle) for 10 hours.
- If the battery gradually discharges because of high electric load while the vehicle is being used, recharge it at 20-30A for two hours.

When recharging the battery, observe the following precautions:

- The battery must be removed from the vehicle and placed in an area with good ventilation.
- Do not allow cigarettes, sparks, or flame near the battery.
- Watch the battery during charging, and stop or reduce the charging rate if the battery cells begin gassing (boiling) violently or if the temperature of the electrolyte of any cell exceeds 120°F (49°C).
- Wear eye protection when checking the battery during charging.
- Disconnect the battery charger in the following order.

1. Turn off the battery charger main switch.
  2. Unhook the negative clamp from the negative battery terminal.
  3. Unhook the positive clamp from the positive battery terminal.
- Before performing maintenance or recharging the battery, turn off all accessories and stop the vehicle.
  - The negative battery cable must be removed first and installed last when the battery is disconnected.

### **Reset items**

Items should be reset after the battery has been discharged or the battery has been disconnected.

- Auto up/down window (See chapter 4)
- Trip computer (See chapter 4)
- Climate control system (See chapter 4)
- Audio (See chapter 4)

## TIRES AND WHEELS

### Tire care

For proper maintenance, safety, and maximum fuel economy, you must always maintain recommended tire inflation pressures and stay within the load limits and weight distribution recommended for your vehicle.

### Recommended cold tire inflation pressures

All tire pressures should be checked when the tires are cold. "Cold Tires" means the vehicle has not been driven for at least three hours or driven less than one mile (1.6 km).

Recommended pressures must be maintained for the best ride, vehicle handling, and minimum tire wear.

For recommended inflation pressure, refer to "Tire and wheels" in chapter 8.



All specifications (sizes and pressures) can be found on a label attached to the driver's side center pillar.

### **⚠ WARNING - Tire under inflation**

**Inflate your tire consistent with the instructions provided in this manual. Severe under inflation can lead to severe heat build-up, causing blowouts, tread separation and other tire failures that can result in the loss of vehicle control. This risk is much higher on hot days and when driving for long periods at high speeds.**

- Underinflation also results in excessive wear, poor handling and reduced fuel economy. Wheel deformation also is possible. Keep your tire pressures at the proper levels. If a tire frequently needs refilling, have it checked by an authorized Kia dealer.
- Overinflation produces a harsh ride, excessive wear at the center of the tire tread, and a greater possibility of damage from road hazards.
- Warm tires normally exceed recommended cold tire pressures by 4 to 6 psi (28 to 41 kPa). Do not release air from warm tires to adjust the pressure or the tires will be underinflated.
- Be sure to reinstall the tire inflation valve caps. Without the valve cap, dirt or moisture could get into the valve core and cause air leakage. If a valve cap is missing, install a new one as soon as possible.

Always observe the following:

- Check tire pressure when the tires are cold. (After vehicle has been parked for at least three hours or hasn't been driven more than one mile (1.6 km) since startup.)
- Never overload your vehicle. Be careful not to overload a vehicle luggage rack if your vehicle is equipped with one.

**⚠ WARNING - Tire Inflation**  
**Overinflation or underinflation can reduce tire life, adversely affect vehicle handling, and lead to sudden tire failure. This could result in loss of vehicle control and potential injury.**

## Checking tire inflation pressure

Check your tires once a month or more.

### *How to check*

Use a good quality gauge to check tire pressure. You cannot tell if your tires are properly inflated simply by looking at them. Radial tires may look properly inflated even when they're underinflated.

Check the tire's inflation pressure when the tires are cold. - "Cold" means your vehicle has been sitting for at least three hours or driven no more than 1 mile (1.6 km).

Remove the valve cap from the tire valve stem. Press the tire gauge firmly onto the valve to get a pressure measurement. If the cold tire inflation pressure matches the recommended pressure on the tire and loading information label, no further adjustment is necessary. If the pressure is low, add air until you reach the recommended amount.

If you overfill the tire, release air by pushing on the metal stem in the center of the tire valve. Recheck the tire pressure with the tire gauge. Be sure to put the valve caps back on the valve stems. They help prevent leaks by keeping out dirt and moisture.

- Inspect your tires frequently for proper inflation as well as wear and damage. Always use a tire pressure gauge.
- Tires with too much or too little pressure wear unevenly causing poor handling, loss of vehicle control, and sudden tire failure leading to accidents, injuries, and even death. The recommended cold tire pressure for your vehicle can be found in this manual and on the tire label located on the driver's side center pillar.

### **Tire rotation**

To equalize tread wear, it is recommended that the tires be rotated every 7,500 miles (12,000 km) or sooner if irregular wear develops.

During rotation, check the tires for correct balance.

When rotating tires, check for uneven wear and damage. Abnormal wear is usually caused by incorrect tire pressure, improper wheel alignment, out-of-balance wheels, severe braking or severe cornering. Look for bumps or bulges in the tread or side of tire. Replace the tire if you find either of these conditions. Replace the tire if fabric or cord is visible. After rotation, be sure to bring the front and rear tire pressures to specification and check lug nut tightness.

Refer to "Tire and wheels" in chapter 8.



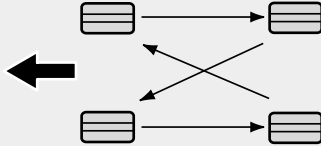

S2BLA790A

*Disc brake pads should be inspected for wear whenever tires are rotated.*

Rotate radial tires that have an asymmetric tread pattern only from front to rear and not from right to left.

**⚠ WARNING - Mixing tires**  
**Do not mix bias ply and radial ply tires under any circumstances. This may cause unusual handling characteristics.**

### **Wheel alignment and tire balance**

The wheels on your vehicle were aligned and balanced carefully at the factory to give you the longest tire life and best overall performance.

In most cases, you will not need to have your wheels aligned again. However, if you notice unusual tire wear or your vehicle pulling one way or the other, the alignment may need to be reset.

If you notice your vehicle vibrating when driving on a smooth road, your wheels may need to be rebalanced.

**⚠ CAUTION - Wheel weight**  
***Improper wheel weights can damage your vehicle's aluminum wheels. Use only approved wheel weights.***

## Tire replacement



If the tire is worn evenly, a tread wear indicator will appear as a solid band across the tread. This shows there is less than 1/16 inch (1.6 mm) of tread left on the tire. Replace the tire when this happens.

Do not wait for the band to appear across the entire tread before replacing the tire.

The ABS works by comparing the speed of the wheels. The tire size affects wheel speed. When replacing tires, all 4 tires must use the same size originally supplied with the vehicle. Using tires of a different size can cause the ABS (Anti-lock Brake System) and ESC (Electronic Stability Control) to work irregularly.

### \* NOTICE

**We recommend that when replacing tires, use the same originally supplied with the vehicles. If not, that affects driving performance.**

## Wheel replacement

When replacing the metal wheels for any reason, make sure the new wheels are equivalent to the original factory units in diameter, rim width and offset.

A wheel that is not the correct size may adversely affect wheel and bearing life, braking and stopping abilities, handling characteristics, ground clearance, body-to-tire clearance, snow chain clearance, speedometer and odometer calibration, headlight aim and bumper height.

### CAUTION - Wheels

***Wheels that do not meet Kia specifications may fit poorly and result in damage to the vehicle or unusual handling and poor vehicle control.***

## Tire traction

Tire traction can be reduced if you drive on worn tires, tires that are improperly inflated or on slippery road surfaces. Tires should be replaced when tread wear indicators appear. Slow down whenever there is rain, snow or ice on the road to reduce the possibility of losing control of the vehicle.

## Tire maintenance

In addition to proper inflation, correct wheel alignment helps to decrease tire wear. If you find a tire is worn unevenly, have your dealer check the wheel alignment.

When you have new tires installed, make sure they are balanced. This will increase vehicle ride comfort and tire life. Additionally, a tire should always be rebalanced if it is removed from the wheel.

## Tire sidewall labeling

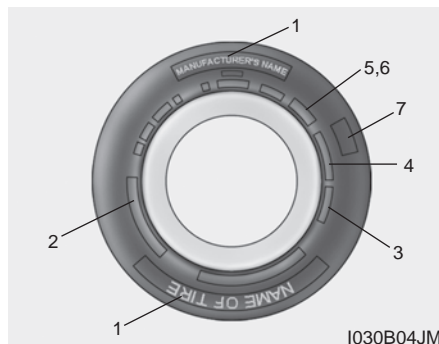

This information identifies and describes the fundamental characteristics of the tire and also provides the tire identification number (TIN) for safety standard certification. The TIN can be used to identify the tire in case of a recall.

### 1. *Manufacturer or brand name*

Manufacturer or Brand name is shown.

### 2. *Tire size designation*

A tire's sidewall is marked with a tire size designation. You will need this information when selecting replacement tires for your vehicle. The following explains what the letters and numbers in the tire size designation mean.

Example tire size designation:

(These numbers are provided as an example only; your tire size designation could vary depending on your vehicle.)

**P235/65R17 108T**

P - Applicable vehicle type (tires marked with the prefix “P” are intended for use on passenger vehicles or light trucks; however, not all tires have this marking).

235 - Tire width in millimeters.

65 - Aspect ratio. The tire's section height as a percentage of its width.

R - Tire construction code (Radial).

17 - Rim diameter in inches.

108 - Load Index, a numerical code associated with the maximum load the tire can carry.

T - Speed Rating Symbol. See the speed rating chart in this section for additional information.

### Wheel size designation

Wheels are also marked with important information that you need if you ever have to replace one. The following explains what the letters and numbers in the wheel size designation mean.

Example wheel size designation:

#### **7.0JX17**

7.0 - Rim width in inches.

J - Rim contour designation.

17 - Rim diameter in inches.

### Tire speed ratings

The chart below lists many of the different speed ratings currently being used for passenger vehicle tires. The speed rating is part of the tire size designation on the sidewall of the tire. This symbol corresponds to that tire's designed maximum safe operating speed.

Speed Rating Symbol	Maximum Speed
S	112 mph (180 km/h)
T	118 mph (190 km/h)
H	130 mph (210 km/h)
V	149 mph (240 km/h)
Z	Above 149 mph (240 km/h)

### 3. Checking tire life (TIN : Tire Identification Number)

Any tires that are over 6 years old, based on the manufacturing date, should be replaced by new ones. You can find the manufacturing date on the tire sidewall (possibly on the inside of the wheel), displaying the DOT Code. The DOT Code is a series of numbers on a tire consisting of numbers and English letters. The manufacturing date is designated by the last four digits (characters) of the DOT code.

#### **DOT : XXXX XXXX OOOO**

The front part of the DOT means a plant code number, tire size and tread pattern and the last four numbers indicate week and year manufactured.

For example:

DOT XXXX XXXX 1617 represents that the tire was produced in the 16th week of 2017.

#### **⚠ WARNING - Tire age**

**Replace tires within the recommended time frame. Failure to replace tires as recommended can result in sudden tire failure, which could lead to a loss of control and an accident.**

### 4. Tire ply composition and material

The number of layers or plies of rubber-coated fabric in the tire. Tire manufacturers also must indicate the materials in the tire, which include steel, nylon, polyester, and others. The letter "R" means radial ply construction; the letter "D" means diagonal or bias ply construction; and the letter "B" means belted-bias ply construction.

### 5. Maximum permissible inflation pressure

This number is the greatest amount of air pressure that should be put in the tire. Do not exceed the maximum permissible inflation pressure. Refer to the Tire and Loading Information label for recommended inflation pressure.

### **6. Maximum load rating**

This number indicates the maximum load in kilograms and pounds that can be carried by the tire. When replacing the tires on the vehicle, always use a tire that has the same load rating as the factory installed tire.

### **7. Uniform tire quality grading**

Quality grades can be found where applicable on the tire sidewall between tread shoulder and maximum section width.

For example:

TREADWEAR 200

TRACTION AA

TEMPERATURE A

Tires degrade over time, even when they are not being used. Regardless of the remaining tread, we recommend that tires be replaced after approximately six (6) years of normal service. Heat caused by hot climates or frequent high loading conditions can accelerate the aging process.

### **Tread wear**

The tread wear grade is a comparative rating based on the wear rate of the tire when tested under controlled conditions on a specified government test course. For example, a tire graded 150 would wear one-and-a-half times ( $1\frac{1}{2}$ ) as well on the government course as a tire graded 100.

The relative performance of tires depends upon the actual conditions of their use, however, and may depart significantly from the norm due to variations in driving habits, service practices and differences in road characteristics and climate.

These grades are molded on the side-walls of passenger vehicle tires. The tires available as standard or optional equipment on your vehicle may vary with respect to grade.

### **Traction - AA, A, B & C**

The traction grades, from highest to lowest, are AA, A, B and C. Those grades represent the tire's ability to stop on wet pavement as measured under controlled conditions on specified government test surfaces of asphalt and concrete. A tire marked C may have poor traction performance.

The traction grade assigned to this tire is based on straight-ahead braking traction tests, and does not include acceleration, cornering, hydroplaning, or peak traction characteristics.

### Temperature -A, B & C

The temperature grades are A (the highest), B and C representing the tire's resistance to the generation of heat and its ability to dissipate heat when tested under controlled conditions on a specified indoor laboratory test wheel.

Sustained high temperature can cause the material of the tire to degenerate and reduce tire life, and excessive temperature can lead to sudden tire failure. The grade C corresponds to a level of performance which all passenger vehicle tires must meet under the Federal Motor Vehicle Safety Standard No. 109. Grades B and A represent higher levels of performance on the laboratory test wheel than the minimum required by law.

### Tire terminology and definitions

**Air Pressure:** The amount of air inside the tire pressing outward on the tire. Air pressure is expressed in pounds per square inch (psi) or kilopascal (kPa).

**Accessory Weight:** This means the combined weight of optional accessories. Some examples of optional accessories are, automatic transaxle, power seats, and air conditioning.

**Aspect Ratio:** The relationship of a tire's height to its width.

**Belt:** A rubber coated layer of cords that is located between the plies and the tread. Cords may be made from steel or other reinforcing materials.

**Bead:** The tire bead contains steel wires wrapped by steel cords that hold the tire onto the rim.

**Bias Ply Tire:** A pneumatic tire in which the plies are laid at alternate angles less than 90 degrees to the centerline of the tread.

**Cold Tire Pressure:** The amount of air pressure in a tire, measured in pounds per square inch (psi) or kilopascals (kPa) before a tire has built up heat from driving.

**Curb Weight:** This means the weight of a motor vehicle with standard and optional equipment including the maximum capacity of fuel, oil and coolant, but without passengers and cargo.

**DOT Markings:** A code molded into the sidewall of a tire signifying that the tire is in compliance with the U.S. Department of Transportation motor vehicle safety standards. The DOT code includes the Tire Identification Number (TIN), an alphanumeric designator which can also identify the tire manufacturer, production plant, brand and date of production.

**GVWR:** Gross Vehicle Weight Rating

**GAWR FRT:** Gross Axle Weight Rating for the Front Axle.

**GAWR RR:** Gross Axle Weight Rating for the Rear axle.

**Intended Outboard Sidewall:** The side of an asymmetrical tire, that must always face outward when mounted on a vehicle.

**Kilopascal (kPa):** The metric unit for air pressure.

**Light truck (LT) tire:** A tire designated by its manufacturer as primarily intended for use on lightweight trucks or multipurpose passenger vehicles.

**Load ratings:** The maximum load that a tire is rated to carry for a given inflation pressure.

**Load Index:** An assigned number ranging from 1 to 279 that corresponds to the load carrying capacity of a tire.

**Maximum Inflation Pressure:** The maximum air pressure to which a cold tire may be inflated. The maximum air pressure is molded onto the sidewall.

**Maximum Load Rating:** The load rating for a tire at the maximum permissible inflation pressure for that tire.

**Maximum Loaded Vehicle Weight:** The sum of curb weight; accessory weight; vehicle capacity weight; and production options weight.

**Normal Occupant Weight:** The number of occupants a vehicle is designed to seat multiplied by 150 pounds (68 kg).

**Occupant Distribution:** Designated seating positions.

**Outward Facing Sidewall:** The side of a asymmetrical tire that has a particular side that faces outward when mounted on a vehicle. The outward facing sidewall bears white lettering or bears manufacturer, brand, and/or model name molding that is higher or deeper than the same moldings on the inner facing sidewall.

**Passenger (P-Metric) Tire:** A tire used on passenger cars and some light duty trucks and multipurpose vehicles.

**Ply:** A layer of rubber-coated parallel cords.

**Pneumatic tire:** A mechanical device made of rubber, chemicals, fabric and steel or other materials, that, when mounted on an automotive wheel, provides the traction and contains the gas or fluid that sustains the load.

**Production options weight:** The combined weight of installed regular production options weighing over 5 lb.(2.3 kg) in excess of the standard items which they replace, not previously considered in curb weight or accessory weight, including heavy duty brakes, ride levelers, roof rack, heavy duty battery, and special trim.

**Recommended Inflation Pressure:** Vehicle manufacturer's recommended tire inflation pressure and shown on the tire placard.

**Radial Ply Tire:** A pneumatic tire in which the ply cords that extend to the beads are laid at 90 degrees to the centerline of the tread.

**Rim:** A metal support for a tire and upon which the tire beads are seated.



**Sidewall:** The portion of a tire between the tread and the bead.

**Speed Rating:** An alphanumeric code assigned to a tire indicating the maximum speed at which a tire can operate.

**Traction:** The friction between the tire and the road surface. The amount of grip provided.

**Tread:** The portion of a tire that comes into contact with the road.

**Treadwear Indicators:** Narrow bands, sometimes called "wear bars," that show across the tread of a tire when only 2/32 inch of tread remains.

**UTQGS:** Uniform Tire Quality Grading Standards, a tire information system that provides consumers with ratings for a tire's traction, temperature and treadwear. Ratings are determined by tire manufacturers using government testing procedures. The ratings are molded into the sidewall of the tire.

**Vehicle Capacity Weight:** The number of designated seating positions multiplied by 150 lbs. (68 kg) plus the rated cargo and luggage load.

**Vehicle Maximum Load on the Tire:** Load on an individual tire due to curb and accessory weight plus maximum occupant and cargo weight.

**Vehicle Normal Load on the Tire:** Load on an individual tire that is determined by distributing to each axle its share of the curb weight, accessory weight, and normal occupant weight and driving by 2.

**Vehicle Placard:** A label permanently attached to a vehicle showing the original equipment tire size and recommended inflation pressure.

## All season tires

Kia specifies all season tires on some models to provide good performance for use all year round, including snowy and icy road conditions. All season tires are identified by ALL SEASON and/or M+S (Mud and Snow) on the tire sidewall. Snow tires have better snow traction than all season tires and may be more appropriate in some areas.

## Summer tires

Kia specifies summer tires on some models to provide superior performance on dry roads. Summer tire performance is substantially reduced in snow and ice. Summer tires do not have the tire traction rating M+S (Mud and Snow) on the tire side wall. If you plan to operate your vehicle in snowy or icy conditions, Kia recommends the use of snow tires or all season tires on all four wheels.

### **Snow tires**

If you equip your vehicle with snow tires, they should be the same size and have the same load capacity as the original tires. Snow tires should be installed on all four wheels; otherwise, poor handling may result.

Snow tires should carry 4 psi (28 kPa) more air pressure than the pressure recommended for the standard tires on the tire label on the driver's side of the center pillar, or up to the maximum pressure shown on the tire sidewall, whichever is less.

Do not drive faster than 75 mph (120 km/h) when your vehicle is equipped with snow tires.

### **Tire chains**

Tire chains, if necessary, should be installed on the front wheels.

Be sure that the chains are installed in accordance with the manufacturer's instructions.

To minimize tire and chain wear, do not continue to use tire chains when they are no longer needed.

- When driving on roads covered with snow or ice, drive at less than 20 mph (30 km/h).
- Use the SAE "S" class or wire chains.
- If you hear noise caused by chains contacting the body, retighten the chain to avoid contact with the vehicle body.
- To prevent body damage, retighten the chains after driving 0.3~0.6 miles (0.5~1.0 km).
- Do not use tire chains on vehicles equipped with aluminum wheels. In unavoidable circumstance, use a wire type chain.
- Use wire chains less than 0.59 inches (15 mm) to prevent damage to the chain's connection.

### **Radial-ply tires**

Radial-ply tires provide improved tread life, road hazard resistance and smoother high speed ride. The radial-ply tires used on this vehicle are of belted construction, and are selected to complement the ride and handling characteristics of your vehicle. Radial-ply tires have the same load carrying capacity, as bias-ply or bias belted tires of the same size, and use the same recommended inflation pressure. Mixing of radial-ply tires with bias-ply or bias belted tires is not recommended. Any combinations of radial-ply and bias-ply or bias belted tires when used on the same vehicle will seriously deteriorate vehicle handling. The best rule to follow is: Identical radial-ply tires should always be used as a set of four.

Longer wearing tires can be more susceptible to irregular tread wear. It is very important to follow the tire rotation interval shown in this section to achieve the tread life potential of these tires. Cuts and punctures in radial-ply tires are repairable only in the tread area, because of sidewall flexing. Consult your tire dealer for radial-ply tire repairs.

### **Low aspect ratio tire (if equipped)**

Low aspect ratio tires, whose aspect ratio is lower than 50, are provided for sporty looks.

Because the low aspect ratio tires are optimized for handling and braking, it may be more uncomfortable to ride in and there is more noise compare with normal tires.

### **CAUTION**

***Because the sidewall of the low aspect ratio tire is shorter than the normal, the wheel and tire of the low aspect ratio tire is easier to be damaged. So, follow the instructions below.***

- ***When driving on a rough road or off road, drive cautiously because tires and wheels may be damaged. And after driving, inspect tires and wheels.***
- ***When passing over a pothole, speed bump, manhole, or curb stone, drive slowly so that the tires and wheels are not damaged.***
- ***If the tire is impacted, we recommend that you inspect the tire condition or contact an authorized Kia dealer.***
- ***To prevent damage to the tire, inspect the tire condition and pressure every 1,900 miles (3,000 km).***

- It is not easy to recognize the tire damage with your own eyes. But if there is the slightest hint of tire damage, even though you cannot see the tire damage with your own eyes, have the tire checked or replaced because the tire damage may cause air leakage from the tire.
- If the tire is damaged by driving on a rough road, off road, pothole, manhole, or curb stone, it will not be covered by the warranty.
- You can find out the tire information on the tire sidewall.

## FUSES

### ■ Micro mini type

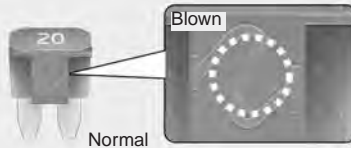

### ■ Cartridge type

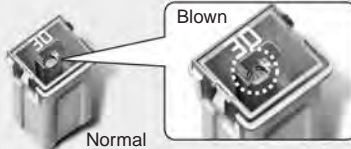

### ■ Multi fuse

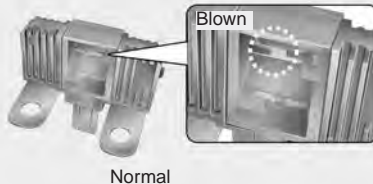

OPS073054

A vehicle's electrical system is protected from electrical overload damage by fuses.

This vehicle has 3 (or 4) fuse panels, one located in the driver's side panel bolster, the other in the motor compartment near the battery.

If any of your vehicle's lights, accessories, or controls do not work, check the appropriate circuit fuse. If a fuse has blown, the element inside the fuse will melt.

If the electrical system does not work, first check the driver's side fuse panel.

Always replace a blown fuse with one of the same rating.

If the replacement fuse blows, this indicates an electrical problem. Avoid using the system involved and immediately consult an authorized Kia dealer.

*Three kinds of fuses are used: micro mini type for lower amperage rating, cartridge type, and multi fuse for higher amperage ratings.*

### **⚠ WARNING - Fuse replacement**

- **Never replace a fuse with anything but another fuse of the same rating.**
  - **A higher capacity fuse could cause damage and possibly a fire.**
  - **Never install a wire or aluminum foil instead of the proper fuse - even as a temporary repair. It may cause extensive wiring damage and a possible fire.**
- Replace the fuse with the ignition "OFF", switch off of all electrical devices and then separation (-) terminal from the battery in a safe place.
  - Do not arbitrarily modify or add-on electric wiring of the vehicle.

 **CAUTION - Fuse Replacement**

*Do not use a screwdriver or any other metal object to remove fuses because it may cause a short circuit and damage the system.*

 **CAUTION - Fuse Replacement**

*Do not input any other objects except fuses or relays into fuse/relay terminals such as a driver or wiring. It may cause contact failure and system malfunction.*

**\* NOTICE**

The actual fuse/relay panel label may differ depending on equipment/options.

 **WARNING - Fuse fire**

Do not remove fuses, relays and terminals fastened with bolts or nuts. The fuses, relays and terminals may be fastened incompletely, and it may cause a possible fire. If fuses, relays and terminals fastened with bolts or nuts are blown, we recommend that you consult with an authorized Kia dealer.

 **WARNING - Electrical Fire**

- Always ensure replacements fuses and relays are securely fastened when installed. Failure to do so can result in a vehicle fire.
- We recommend that you do not remove fuses, relays and terminals that are fastened with bolts or nuts. If they are not completely re-installed, such looseness may cause electrical arcing and a possible fire. If fuses, relays and terminals fastened with bolts or nuts need replacement, consult with an authorized Kia dealer.

## Inner panel fuse replacement

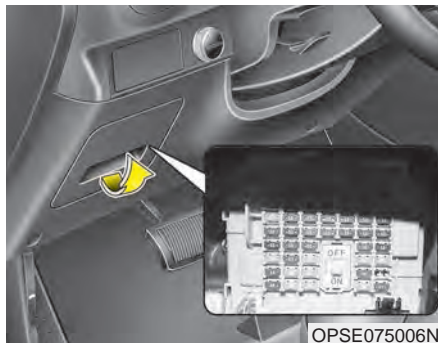

1. Turn the ignition switch and all other switches off.
2. Open the fuse panel cover.

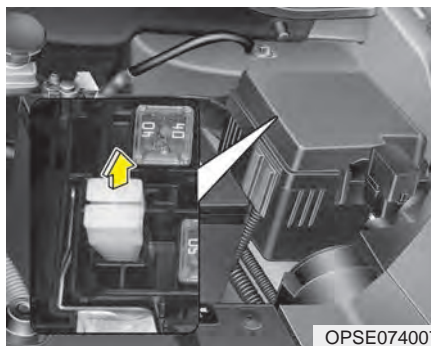

3. Pull the suspected fuse straight out. Use the fuse puller provided on the motor compartment fuse panel cover.
4. Check the removed fuse; replace it if it is blown.

*Spare fuses are provided in the motor compartment fuse panel.*

5. Push in a new fuse of the same rating, and make sure it fits tightly in the clips.

If it fits loosely, consult an authorized Kia dealer.

*If you do not have a spare, use a fuse of the same rating from a circuit you may not need for operating the vehicle, such as the power outlet fuse.*

If the headlights or other electrical components do not work and the fuses are OK, check the fuse panel in the motor compartment. If a fuse is blown, it must be replaced.

### Fuse switch

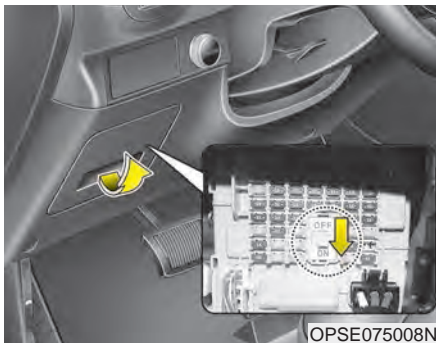

Always, put the fuse switch at the ON position.

If you move the switch to the OFF position, some items such as audio and digital clock must be reset and transmitter (or smart key) may not work properly.

### \* NOTICE

If you need to park your vehicle for prolonged periods more than 1 month, move the transportation fuse switch to the OFF position to prevent the battery being discharged.

### Motor compartment fuse replacement

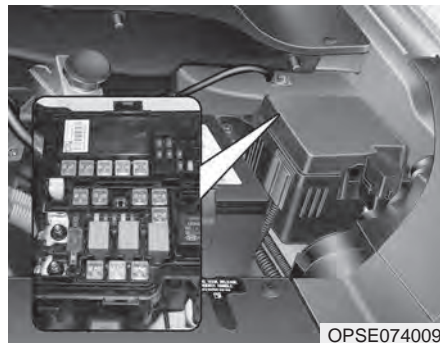

1. Turn the ignition switch and all other switches off.
2. Remove the fuse panel cover by pressing the tab and pulling the cover up.
3. Check the removed fuse; replace it if it is blown. To remove or insert the fuse, use the fuse puller in the motor compartment fuse panel.
4. Push in a new fuse of the same rating, and make sure it fits tightly in the clips. If it fits loosely, consult an authorized Kia dealer.



**⚠ CAUTION - Fuse panel covers**

*After checking the fuse panel in the motor compartment, securely install the fuse panel cover with using cover locking sound. If not, electrical failures may occur from water contact.*

**Multi fuse**

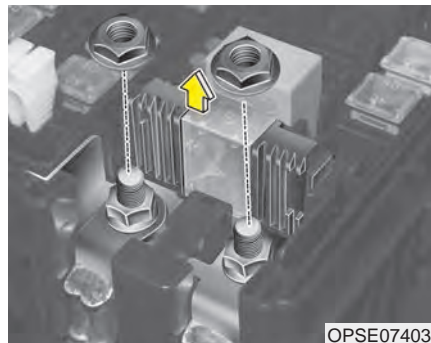

If the multi fuse is blown, it must be removed as follows:

1. Turn off the vehicle.
2. Disconnect the negative battery cable.
3. Remove the nuts shown in the picture above.
4. Replace the fuse with a new one of the same rating.
5. Reinstall in the reverse order of removal.

**\* NOTICE**

If the multi fuse is blown, consult an authorized Kia dealer.

### Fuse/relay panel description

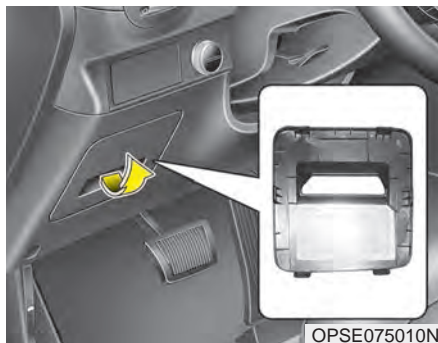

Inside the fuse/relay panel covers, you can find the fuse/relay label describing fuse/relay name and capacity.

### \* NOTICE

Not all fuse panel descriptions in this manual may be applicable to your vehicle. It is accurate at the time of printing. When you inspect the fuse panel in your vehicle, refer to the fuse panel label.

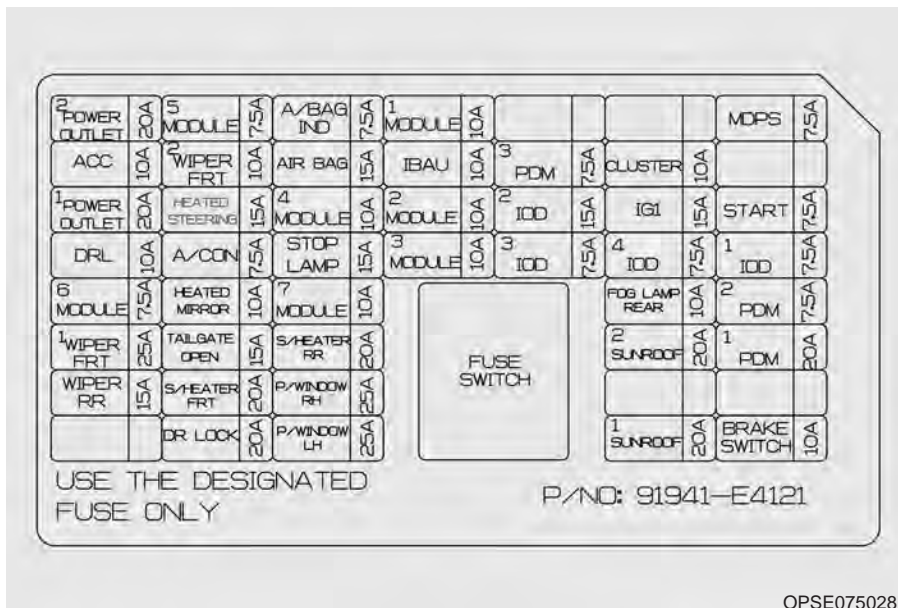

**Instrument panel (Driver's side fuse panel)**

<b>Fuse Name</b>	<b>Fuse rating</b>	<b>Circuit Protected</b>
POWER OUTLET 2	20A	Front Power Outlet
ACC	10A	BCM, Mood Lamp Module, A/V & Navigation Head Unit, Smart Key Control Module, Power Outside Mirror Switch, E/R Junction Block (Power Outlet Relay)
POWER OUTLET 1	20A	Rear Power Outlet
DRL	10A	BCM
MODULE 6	7.5A	Front Seat Warmer Module, Driver Air Ventilation Seat Control Module
WIPER FRT 1	25A	E/R Junction Block (Front Wiper Low Relay)
WIPER RR	15A	Rear Wiper Motor, Multifunction Switch
MODULE 5	7.5A	BCM, Smart Key Control Module
WIPER FRT 2	10A	BCM, Multifunction Switch, PCB Block (Front Wiper High Relay)
HEATED STEERING	15A	Clock Spring (Steering Wheel Heated)
A/CON	7.5A	A/C Control Module, Heater Assembly (Cluster Ionizer)
HEATED MIRROR	10A	A/C Control Module, Driver/Passenger Power Outside Mirror, Rear Defogger
TAIL GATE OPEN	15A	Tail Gate Open Relay
S/HEATER FRT	20A	Front Seat Warmer Module, Driver Air Ventilation Seat Control Module
DR LOCK	20A	Door Lock Relay, Door Unlock Relay, Two Turn Unlock Relay
A/BAG IND	7.5A	Instrument Cluster
AIR BAG	15A	SRS Control Module
MODULE 4	10A	Electro Chromic Mirror, Front Seat Warmer Module, Driver Air Ventilation Seat Control Module
STOP LAMP	15A	Stop Signal Electronic Module
MODULE 7	10A	Sport Mode Switch, ICM Relay Box
S/HEATER RR	20A	Rear Seat Warmer Module
P/WINDOW RH	25A	Power Window RH Relay
P/WINDOW LH	25A	Power Window LH Relay, Driver Safety Power Window Module

## Maintenance

Fuse Name	Fuse rating	Circuit Protected
MODULE 1	10A	BCM
IBAU	10A	Integrated Brake Actuation Unit
MODULE 2	10A	Tire Pressure Monitoring Module, Crash Pad Switch, Center Fascia Switch, Electronic Parking Brake Module, Stop Lamp Switch, Rear Parking Assist Sensor RH/LH (IN/OUT), Front Parking Assit Sensor LH/RH (OUT/IN)
MODULE 3	10A	ATM Lever Indicator, Multipurpose Check Connector, PCB Block (IG3 #4 Relay)
PDM 3	7.5A	Smart Key Control Module
IOD 2	15A	A/V & Navigation Head Unit
IOD 3	7.5A	ICM Relay Box (Outside Mirror Folding Relay, Outside Mirror Unfolding Relay)
CLUSTER	10A	Instrument Cluster
IG1	15A	EPCU
IOD 4	7.5A	Instrument Cluster, Tire Pressure Monitoring Module, Data Link Connector, Multipurpose Check Connector, A/C Control Module, BCM
FOG LAMP REAR	10A	Rear Fog Lamp Control Block
SUNROOF 2	20A	SUNROOF_MOTOR (POWER)
SUNROOF 1	20A	SUNROOF_MOTOR (POWER)
MDPS	7.5A	MDPS Unit
START	7.5A	Transaxle Range Switch
IOD 1	7.5A	Overhead Console Lamp, Vanity Lamp LH/RH, Room Lamp, Glove Box Lamp, Luggage Lamp
PDM 2	7.5A	Smart Key Control Module
PDM 1	20A	Smart Key Control Module
BRAKE SWITCH	10A	Smart Key Control Module, Stop Lamp Switch

**Motor compartment fuse panel**

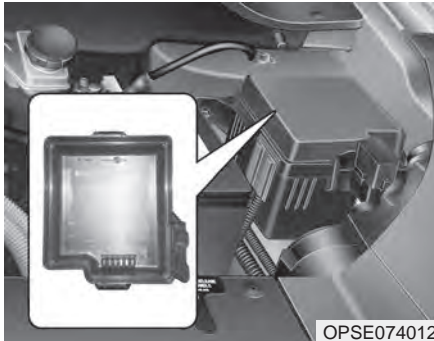

OPSE074012

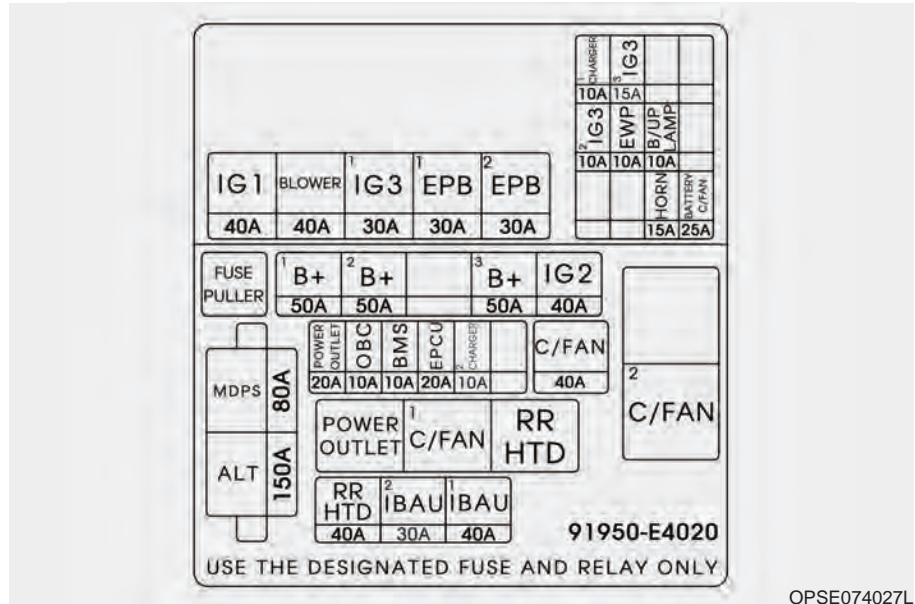

OPSE074027L

## Maintenance

Fuse Name	Fuse rating	Circuit Protected
MDPS	80A	MDPS Unit
ALT	150A	Alternator
B+1	50A	Smart Junction Block (Fuse - (S/HEATER FRT, TAIL GATE OPEN, DR LOCK, P/WINDOW LH, P/WINDOW RH, MODULE 7))
B+2	50A	Smart Junction Block (Fuse - (STOP LAMP) Arisu-LT2)
B+3	50A	Smart Junction Block (Fuse - (PDM 1, PDM 2, BRAKE SWITCH, Leak Current Autocut Device) IPS1, Arisu-LT1)
IG2	40A	PCB Block (Button Start (IG2) Relay)
POWER OUTLET	20A	Power Outlet Relay
OBC	10A	OBC Unit, Rear Heated Relay
BMS	10A	BMS Control Module
EPCU	20A	EPCU
CHARGER 2	10A	Normal Charge Port Lmap
C/FAN	40A	COOLING FAN 1 Relay, COOLING FAN 2 Relay
RR HTD	40A	Rear Heated Relay
IBAU 2	30A	Integrated Brake Actuation Unit
IBAU 1	40A	Integrated Brake Actuation Unit

Fuse Name	Fuse rating	Circuit Protected
IG1	40A	Button Start (ACC) Relay, Button Start (IG1) Relay
BLOWER	40A	Blower Relay
IG3 1	30A	IG3 #1/#2/#3/#4/#5 Relay
EPB 1	30A	Electronic Parking Brake Module
EPB 2	30A	Electronic Parking Brake Module
IG3 2	10A	Blower Relay, A/C Control Module, A/C Compressor, E/R Junction Block (Cooling Fan 1/2 Relay), Heater Assembly (PTC Heater)
CHARGER 1	10A	OBC Unit, BMS Control Module
EWP	10A	Electronic Water Pump
IG3 3	15A	EPCU, Transaxle Range Switch, A/V & Navigation Head Unit, Instrument Cluster
HORN	15A	Horn Relay
B/UP LAMP	10A	Transaxle Range Switch, EPCU
BATTERY C/FAN	25A	Battery C/FAN Relay

No.	Relay Name	Type
E41	Power Outlet Relay	PLUG MICRO
E42	C/FAN 1 Relay	PLUG MICRO
E43	RR HTD Relay	PLUG MICRO
E44	C/FAN 2 Relay	PLUG MINI

**Motor compartment fuse panel  
(Battery terminal cover)**

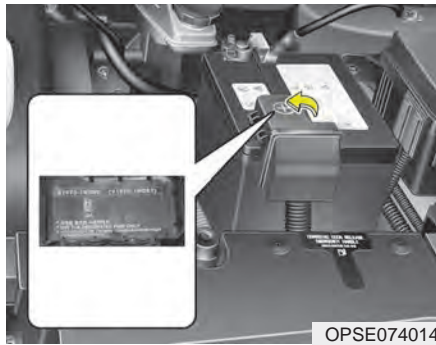

**\* NOTICE**

The actual fuse/relay panel label may differ depending on equipment/options.

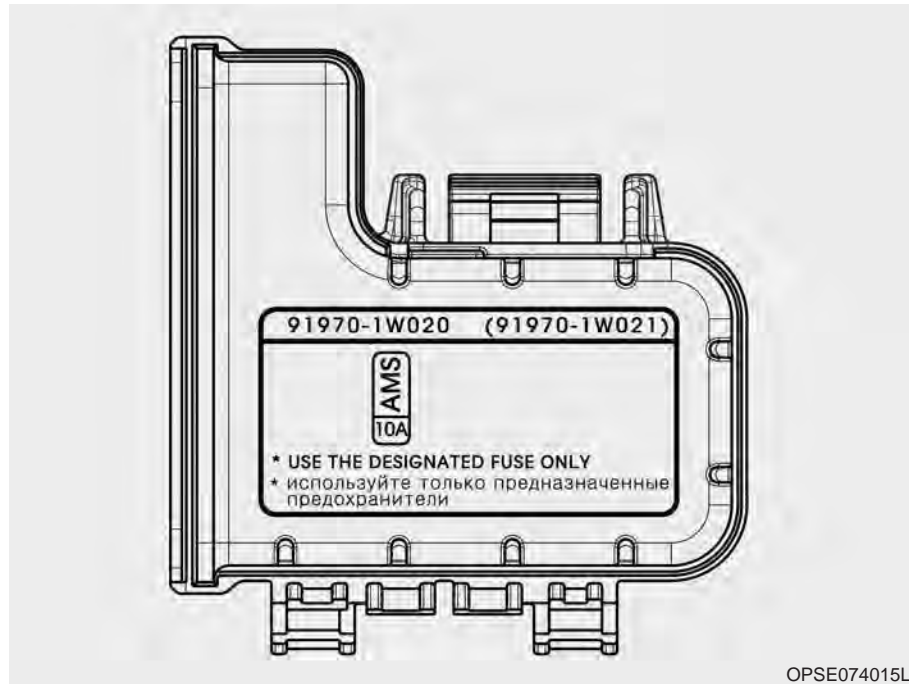



## LIGHT BULBS

### **WARNING - Lights**

Prior to working on the light, firmly apply the parking brake, ensure that the ignition switch is turned to the LOCK position and turn off the lights to avoid sudden movement of the vehicle and burning your fingers or receiving an electric shock.

*Use only the bulbs of the specified wattage.*



### **CAUTION - Light replacement**

*Be sure to replace the burned-out bulb with one of the same wattage rating. Otherwise, it may cause damage to the fuse or electric wiring system.*

- If you don't have necessary tools, the correct bulbs and the expertise, consult an authorized Kia dealer. In many cases, it is difficult to replace vehicle light bulbs because other parts of the vehicle must be removed before you can get to the bulb. This is especially true if you have to remove the headlight assembly to get to the bulb(s).

Removing/installing the headlight assembly can result in damage to the vehicle.

- Do not install additional bulb or LED. If you install that, the lamp may not be operated properly and fuse box or electric wiring system may have problem.

## Front light replacement

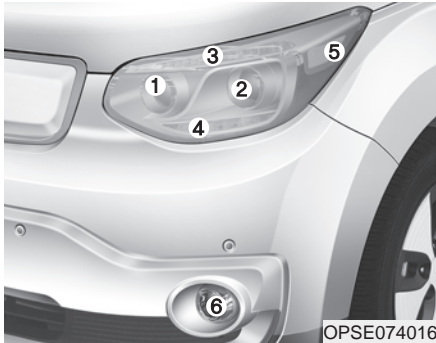

- (1) Headlight (High)
- (2) Headlight (Low)
- (3) Front position light/  
Daytime running light  
(if equipped)
- (4) Front turn signal
- (5) Front side marker light
- (6) Front fog light (if equipped)

If the headlight aiming adjustment is necessary after the headlight assembly is reinstalled, consult an authorized Kia dealer.

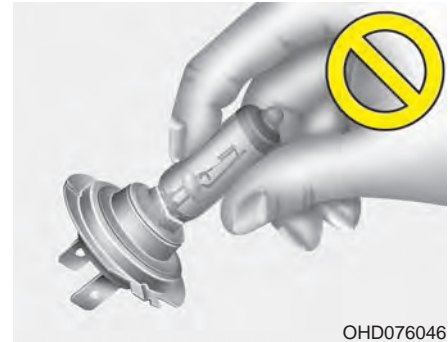

**⚠ WARNING - Halogen bulbs**

**Handle halogen bulbs with care.**

- **Halogen bulbs contain pressurized gas that will produce flying pieces of glass if broken.**

- Always handle them carefully, and avoid scratches and abrasions. If the bulbs are lit, avoid contact with liquids. Never touch the glass with bare hands. Residual oil may cause the bulb to overheat and burst when lit. A bulb should be operated only when installed in a headlight.
  - If a bulb becomes damaged or cracked, replace it immediately and carefully dispose of it.
  - Wear eye protection when changing a bulb. Allow the bulb to cool down before handling it.
1. Turn off the vehicle and open the hood.
  2. Disconnect the power connector from the back of the headlight assembly.

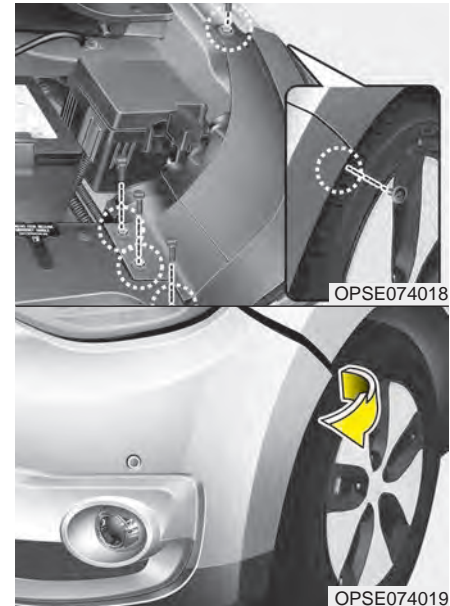

3. Disconnect the negative battery cable.
4. Loosen the retaining bolts.

5. Pull out the end of the front bumper.

If you can reach the bulb without removing the headlight assembly, you do not need to do step 4,5 and 6.

6. Remove the headlight assembly from the body of the vehicle.

### ***Headlight bulb (High, Low)***

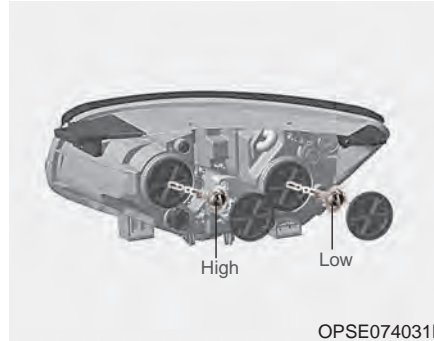

Follow the steps 1 to 6 from the previous page.

7. Remove the headlight bulb cover by turning it counterclockwise.
8. Disconnect the headlight bulb socket-connector.
9. Unsnap the headlight bulb retaining wire by depressing the end and pushing it upward.
10. Remove the bulb from the headlight assembly.

11. Install a new headlight bulb and snap the headlight bulb retaining wire into position by aligning the wire with the groove on the bulb.
12. Connect the headlight bulb socket connector.
13. Install the headlight bulb cover by turning it clockwise.
14. Connect the power connector to the back of the headlight assembly.
15. Reinstall the headlight assembly to the body of the vehicle.

**Front turn signal / position light / DRL**

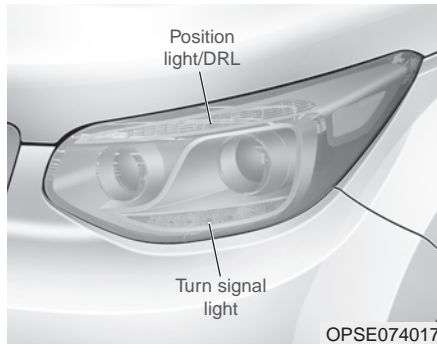

**LED type**

If the light bulb is not operating, have the vehicle checked by an authorized Kia dealer.

**Front side marker**

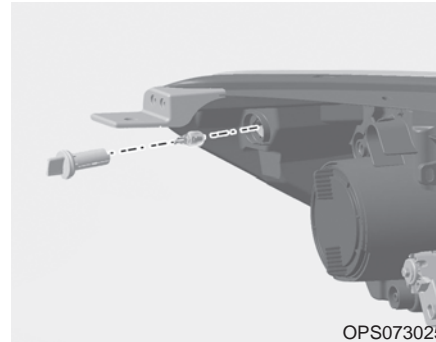

Follow the steps 1 to 6 from the previous page.

7. Remove the socket from the assembly by turning the socket counterclockwise until the tabs on the socket align with the slots on the assembly.
8. Pull the bulb out of the socket.
9. Insert a new bulb into the socket.
10. Install the socket into the assembly by aligning the tabs on the socket with the slots on the assembly and turning the socket clockwise.

**Front fog lamp bulbs (if equipped)**

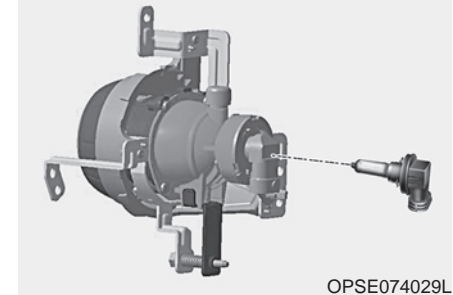

1. Remove the front bumper under cover.
2. Reach your hand into the back of the front bumper.

3. Disconnect the power connector from the socket.
4. Remove the bulb-socket from the housing by turning the socket counter clockwise until the tabs on the socket align with the slots on the housing.
5. Install the new bulb-socket into the housing by aligning the tabs on the socket with the slots in the housing. Push the socket into the housing and turn the socket clockwise.
6. Connect the power connector to the socket.
7. Reinstall the front bumper under cover.

### \* NOTICE

If the headlight aiming adjustment is necessary after the headlight assembly is reinstalled, consult an authorized Kia dealer.

### Side repeater light bulb replacement (if equipped)

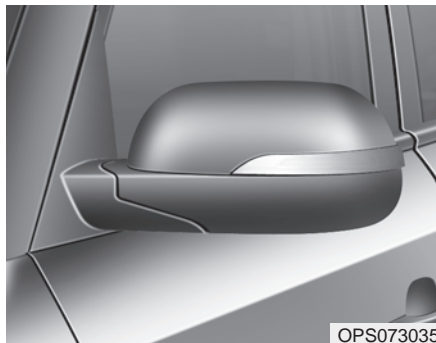

If the light bulb is not operating, have the vehicle checked by an authorized Kia dealer.

### Rear combination light bulb replacement

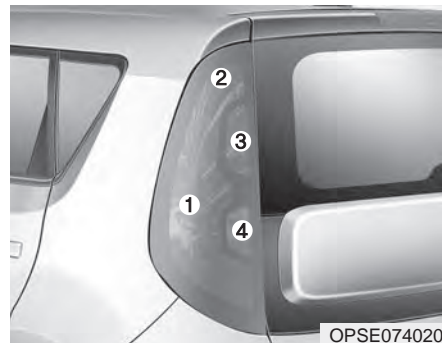

- (1) Tail and stop light/  
Side marker light (LED)
- (2) Tail and side marker light(LED)
- (3) Rear turn signal light
- (4) Back-up light

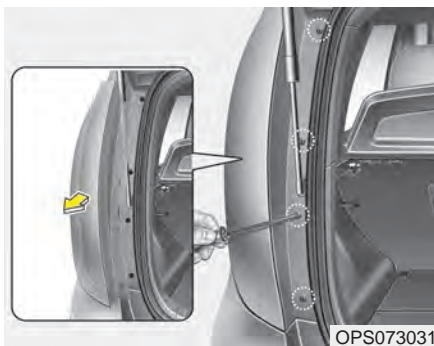

1. Open the tailgate.
2. Loosen the light assembly retaining screws with a philips head screwdriver.
3. Remove the rear combination light assembly from the body of the vehicle.

### *Turn signal light*

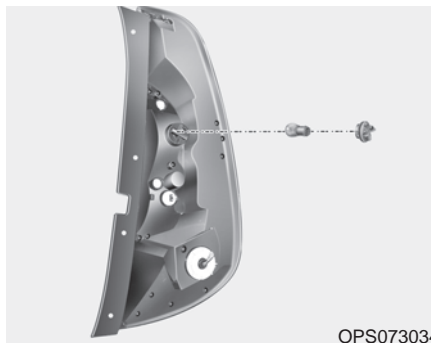

4. Remove the socket from the assembly by turning the socket counterclockwise until the tabs on the socket align with the slots on the assembly.
5. Remove the bulb from the socket by pressing it in and rotating it counterclockwise until the tabs on the bulb align with the slots in the socket.

6. Insert a new bulb by inserting it into the socket and rotating it until it locks into place.
7. Install the socket in the assembly by aligning the tabs on the socket with the slots in the assembly and turning the socket clockwise.
8. Reinstall the light assembly to the body of the vehicle.

### Back-up light

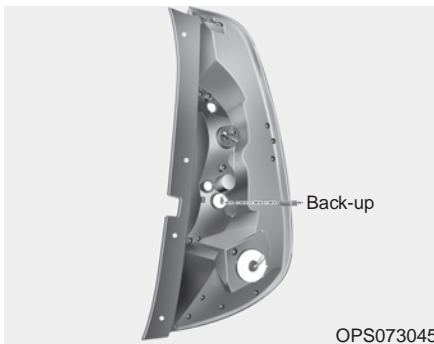

Follow the steps 1 to 3 from the previous page.

4. Remove the socket from the assembly by turning the socket counterclockwise until the tabs on the socket align with the slots on the assembly.
5. Pull the bulb out of the socket.
6. Insert a new bulb into the socket.
7. Install the socket into the assembly by aligning the tabs on the socket with the slots on the assembly and turning the socket clockwise.

8. Reinstall the light assembly to the body of the vehicle.

### Tail, stop light and side marker light (LED type)

If the light does not operate, have the system be checked by an authorized Kia dealer.

### High mounted stop light replacement

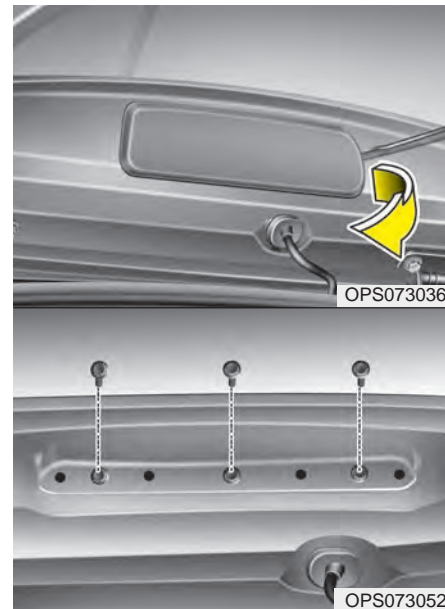

1. Open the tailgate.
2. Remove the cover.
3. Loosen the retaining bolts.



### LED type

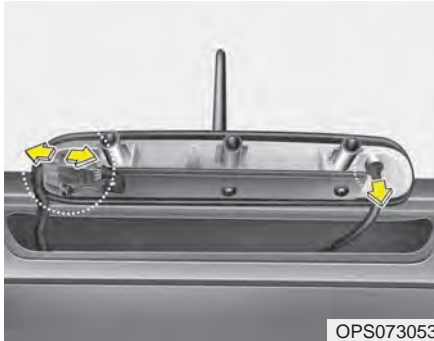

4. Pull out the module from the high mounted stop light assembly by pulling both clips.
5. Replace the LED with new one.
6. Reinstall in the reverse order.

### License plate light bulb replacement

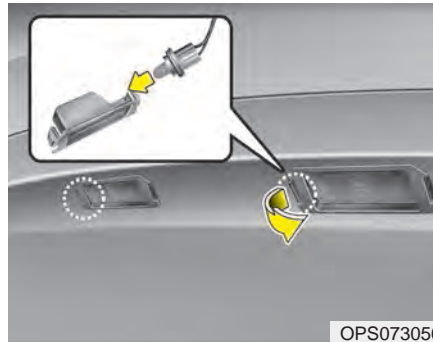

1. Remove the lens by pressing the tabs.
2. Remove the socket from the lens.
3. Remove the bulb by turning it counter clockwise.
4. Install a new bulb in the socket and install the socket to the lens.
5. Reinstall the lens securely.

Map lamp



Room lamp



Glove box lamp



Luggage lamp



Vanity mirror lamp



OPS073041/OPS073042/OPS073043/  
OPS073044/OXM079041

## Interior light bulb replacement

1. Using a flat-blade screwdriver, gently pry the lens from the interior light housing.
2. Remove the bulb by pulling it straight out.

### **⚠ WARNING - Interior lights**

**Prior to working on the Interior Lights, ensure that the "OFF" button is depressed to avoid burning your fingers or receiving an electric shock.**

3. Install a new bulb in the socket.
4. Align the lens tabs with the interior light housing notches and snap the lens into place.

### **⚠ CAUTION**

***Be careful not to dirty or damage the lens, lens tab, and plastic housings.***

## APPEARANCE CARE

### Exterior care

#### *Exterior general caution*

It is very important to follow the label directions when using any chemical cleaner or polish. Read all warning and caution statements that appear on the label.

#### *Finish maintenance*

##### **Washing**

To help protect your vehicle's finish from rust and deterioration, wash it thoroughly and frequently at least once a month with lukewarm or cold water.

If you use your vehicle for off-road driving, you should wash it after each off-road trip. Pay special attention to the removal of any accumulation of salt, dirt, mud, and other foreign materials. Make sure the drain holes in the lower edges of the doors and rocker panels are kept clear and clean.

Insects, tar, tree sap, bird droppings, industrial pollution and similar deposits can damage your vehicle's finish if not removed immediately.

Even prompt washing with plain water may not completely remove all these deposits. A mild soap, safe for use on painted surfaces, may be used.

After washing, rinse the vehicle thoroughly with lukewarm or cold water. Do not allow soap to dry on the finish.

After washing the vehicle, test the brakes while driving slowly to see if they have been affected by water. If braking performance is impaired, dry the brakes by applying them lightly while maintaining a slow forward speed.

### CAUTION

- ***Do not use strong soap, chemical detergents or hot water, and do not wash the vehicle in direct sunlight or when the body of the vehicle is warm.***
- ***Be careful when washing the side windows of your vehicle. Especially, with high-pressure water. Water may leak through the windows and wet the interior.***
- ***To prevent damage to the plastic parts and lamps, do not clean with chemical solvents or strong detergents.***

### High-pressure washing

- When using high-pressure washers, make sure to maintain sufficient distance from the vehicle.

Insufficient clearance or excessive pressure can lead to component damage or water penetration.

- Do not spray the camera, sensors or its surrounding area directly with a high pressure washer. Shock applied from high pressure water may cause the device to not operate normally.
- Do not bring the nozzle tip close to boots (rubber or plastic covers) or connectors as they may be damaged if they come into contact with high pressure water.

#### **⚠ WARNING**

After washing the vehicle, test the brakes while driving slowly to see if they have been affected by water. If braking performance is impaired, dry the brakes by applying them lightly while maintaining a slow forward speed.

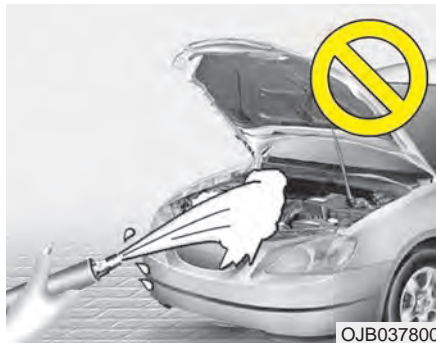

#### **CAUTION - Wetting motor compartment**

- *Water washing in the motor-compartment including high pressure water washing may cause the failure of electrical circuits located in the motor compartment.*
- *Never allow water or other liquids to come in contact with electrical/electronic components inside the vehicle as this may damage them.*

### Waxing

Wax the vehicle when water will no longer bead on the paint.

Always wash and dry the vehicle before waxing. Use a good quality liquid or paste wax, and follow the manufacturer's instructions. Wax all metal trim to protect it and to maintain its luster.

Removing oil, tar, and similar materials with a spot remover will usually strip the wax from the finish. Be sure to re-wax these areas even if the rest of the vehicle does not yet need waxing.

**⚠ CAUTION - Drying vehicle**

- *Wiping dust or dirt off the body with a dry cloth will scratch the finish.*
- *Do not use steel wool, abrasive cleaners, acid detergents or strong detergents containing high alkaline or caustic agents on chrome-plated or anodized aluminum parts. This may result in damage to the protective coating and cause discoloration or paint deterioration.*

**Finish damage repair**

Deep scratches or stone chips in the painted surface must be repaired promptly. Exposed metal will quickly rust and may develop into a major repair expense.

**\* NOTICE**

If your vehicle is damaged and requires any metal repair or replacement, be sure the body shop applies anti-corrosion materials to the parts repaired or replaced.

**Bright-metal maintenance**

- To remove road tar and insects, use a tar remover, not a scraper or other sharp object.
- To protect the surfaces of bright-metal parts from corrosion, apply a coating of wax or chrome preservative and rub to a high luster.
- During winter weather or in coastal areas, cover the bright metal parts with a heavier coating of wax or preservative. If necessary, coat the parts with non-corrosive petroleum jelly or other protective compound.

**Underbody maintenance**

Road salt and other corrosive chemicals are used in cold weather states to melt snow and prevent ice accumulation. If these chemicals are not regularly removed, they will corrode the vehicle underbody and over time damage fuel lines, the fuel tank retention system, the vehicle suspension, the exhaust system, and even the body frame. The National Highway Traffic Safety Administration has warned all vehicle owners of all brands of the need to take the following steps:

- Wash the undercarriage of your vehicle regularly during the winter and whenever your vehicle has been exposed to such salts or chemicals.
- Do a thorough washing of the undercarriage at the end of the winter.
- Use professional service technicians or governmental inspection stations to annually inspect for corrosion.
- Immediately seek an inspection of your vehicle if you become visually aware of corrosion flaking or scaling or if you become aware of a change in vehicle performance, such as soft or spongy brakes, fluids leaking, impairment of directional control, suspension noises or rattling metal straps.

### ***Aluminum wheel maintenance***

The aluminum wheels are coated with a clear protective finish.

- Do not use any abrasive cleaner, polishing compound, solvent, or wire brushes on aluminum wheels. They may scratch or damage the finish.
- Clean the wheel when it has cooled.
- Use only a mild soap or neutral detergent, and rinse thoroughly with water. Also, be sure to clean the wheels after driving on salted roads. This helps prevent corrosion.
- Avoid washing the wheels with highspeed vehicle wash brushes.
- Do not use any alkaline or acid detergents. It may damage and corrode the aluminum wheels coated with a clear protective finish.

### ***Corrosion protection***

#### **Protecting your vehicle from corrosion**

By using the most advanced design and construction practices to combat corrosion, we produce vehicles of the highest quality. However, this is only part of the job. To achieve the long-term corrosion resistance your vehicle can deliver, the owner's cooperation and assistance is also required.

#### **Common causes of corrosion**

The most common causes of corrosion on your vehicle are:

- Road salt, dirt and moisture that is allowed to accumulate underneath the vehicle.
- Removal of paint or protective coatings by stones, gravel, abrasion or minor scrapes and dents which leave unprotected metal exposed to corrosion.

### **High-corrosion areas**

If you live in an area where your vehicle is regularly exposed to corrosive materials, corrosion protection is particularly important. Some of the common causes of accelerated corrosion are road salts, dust control chemicals, ocean air and industrial pollution.

#### **Moisture breeds corrosion**

Moisture creates the conditions in which corrosion is most likely to occur. For example, corrosion is accelerated by high humidity, particularly when temperatures are just above freezing. In such conditions, the corrosive material is kept in contact with the vehicle's surface by moisture that evaporates slowly.

Mud is particularly corrosive because it dries slowly and holds moisture in contact with the vehicle. Although the mud appears to be dry, it can still retain the moisture and promote corrosion.

High temperatures can also accelerate corrosion of parts that are not properly ventilated so the moisture can be dispersed. For all these reasons, it is particularly important to keep your vehicle clean and free of mud or accumulations of other materials. This applies not only to the visible surfaces but particularly to the underside of the vehicle.

### **To help prevent corrosion**

You can help prevent corrosion from beginning by observing the following:

### **Keep your vehicle clean**

The best way to prevent corrosion is to keep your vehicle clean and free of corrosive materials. Attention to the underside of the vehicle is particularly important.

- If you live in a high-corrosion area — where road salts are used, near the ocean, areas with industrial pollution, acid rain, etc.—, you should take extra care to prevent corrosion. In winter, hose off the underside of your vehicle at least once a month and be sure to clean the underside thoroughly when winter is over.
- When cleaning underneath the vehicle, give particular attention to the components under the fenders and other areas that are hidden from view. Do a thorough job; just dampening the accumulated mud rather than washing it away will accelerate corrosion rather than prevent it. Water under high pressure and steam are particularly effective in removing accumulated mud and corrosive materials.

- When cleaning lower door panels, rocker panels and frame members, be sure that drain holes are kept open so that moisture can escape and not be trapped inside to accelerate corrosion.

### **Keep your garage dry**

Don't park your vehicle in a damp, poorly ventilated garage. This creates a favorable environment for corrosion. This is particularly true if you wash your vehicle in the garage or drive it into the garage when it is still wet or covered with snow, ice or mud. Even a heated garage can contribute to corrosion unless it is well ventilated so moisture is dispersed.

### Keep paint and trim in good condition

Scratches or chips in the finish should be covered with "touch-up" paint as soon as possible to reduce the possibility of corrosion. If bare metal is showing through, the attention of a qualified body and paint shop is recommended.

**Bird droppings :** Bird droppings are highly corrosive and may damage painted surfaces in just a few hours. Always remove bird droppings as soon as possible.

### Don't neglect the interior

Moisture can collect under the floor mats and carpeting and cause corrosion. Check under the mats periodically to be sure the carpeting is dry. Use particular care if you carry fertilizers, cleaning materials or chemicals in the vehicle.

These should be carried only in proper containers and any spills or leaks should be cleaned up, flushed with clean water and thoroughly dried.

### Interior care

#### *Interior general precautions*

Prevent chemicals such as perfume, cosmetic oil, sun cream, hand cleaner, and air freshener from contacting the interior parts because they may cause damage or discoloration. If they do contact the interior parts, wipe them off immediately. If necessary, use a vinyl cleaner, see product instructions for correct usage.



#### **CAUTION - Electrical components**

***Never allow water or other liquids to come in contact with electrical/electronic components inside the vehicle as this may damage them.***



#### **CAUTION - Leather**

***When cleaning leather products (steering wheel, seats etc.), use neutral detergents or low alcohol content solutions. If you use high alcohol content solutions or acid/alkaline detergents, the color of the leather may fade or the surface may get stripped off.***



### ***Taking care of leather seats***

- Vacuum the seat periodically to remove dust and sand on the seat. It will prevent abrasion or damage of the leather and maintain its quality.
- Wipe the natural leather seat cover often with dry or soft cloth.
- Sufficient use of a leather protective may prevent abrasion of the cover and helps maintain the color. Be sure to read the instructions and consult a specialist when using leather coating or protective agents.
- Leather with bright colors(beige, cream beige) is easily contaminated and clear in appearance. Clean the seats frequently.
- Avoid wiping with wet cloth. It may cause the surface to crack.

### ***Cleaning the leather seats***

- Remove all contaminations instantly. Refer to instructions below for removal of each contaminant.
- Cosmetic products(sunscreen, foundation, etc.)
  - Apply cleansing cream on a cloth and wipe the contaminated point. Wipe off the cream with a wet cloth and remove water with a dry cloth.
- Beverages(coffee, soft drink, etc.)
  - Apply a small amount of neutral detergent and wipe until contaminations do not smear.
- Oil
  - Remove oil instantly with absorbable cloth and wipe with stain remover for natural leather only.
- Chewing gum
  - Harden the gum with ice and remove gradually.

### ***Fabric seat cover (If equipped)***

Please clean the fabric seats regularly with a vacuum cleaner in consideration of fabric material characteristics. If they are heavily soiled with beverage stains, etc., use a suitable interior cleaner. To prevent damage to seat covers, wipe off the seat covers down to the seams with a large wiping motion and moderate pressure using a soft sponge or microfiber cloth.

Velcro closures on clothing or sharp objects may cause snagging or scratches on the surface of the seats.

Make sure not to rub such objects against the surface.

### *Cleaning the upholstery and interior trim*

#### **Vinyl**

Remove dust and loose dirt from vinyl with a whisk broom or vacuum cleaner. Clean vinyl surfaces with a vinyl cleaner.

#### **Fabric**

Remove dust and loose dirt from fabric with a whisk broom or vacuum cleaner. Clean with a mild soap solution recommended for upholstery or carpets. Remove fresh spots immediately with a fabric spot cleaner. If fresh spots do not receive immediate attention, the fabric can be stained and its color can be affected. Also, its fire-resistant properties can be reduced if the material is not properly maintained.

Using anything but recommended cleaners and procedures may affect the fabric's appearance and fire-resistant properties.

### *Cleaning the lap/shoulder belt webbing*

Clean the belt webbing with any mild soap solution recommended for cleaning upholstery or carpet. Follow the instructions provided with the soap. Do not bleach or re-dye the webbing because this may weaken it.

### *Cleaning the interior window glass*

If the interior glass surfaces of the vehicle become fogged (that is, covered with an oily, greasy or waxy film), they should be cleaned with a glass cleaner. Follow the directions on the glass cleaner container.



#### **CAUTION - Rear window**

***Do not scrape or scratch the inside of the rear window. This may result in damage of the rear window defroster grid.***

## **CALIFORNIA PERCHLORATE NOTICE**

Perchlorate Material-special handling may apply, See [www.dtsc.ca.gov/hazardouswaste/perchlorate](http://www.dtsc.ca.gov/hazardouswaste/perchlorate).

Notice to California Vehicle Dismantlers: Perchlorate containing materials, such as air bag inflators, seatbelt pretensioners and keyless remote entry batteries, must be disposed of according to Title 22 California Code of Regulations Section 67384.10 (a).

# Specifications, Consumer information and Reporting safety defects

Dimensions .....	8-2
Power electric specifications .....	8-2
Gross vehicle weight .....	8-3
Luggage volume .....	8-3
Air conditioning system.....	8-3
Bulb wattage .....	8-4
Tires and wheels.....	8-5
Recommended lubricants and capacities.....	8-6
Vehicle identification number (VIN) .....	8-7
Vehicle certification label.....	8-7
Motor number .....	8-8
Tire specification and pressure label .....	8-8
Air conditioner compressor label.....	8-8
Refrigerant label.....	8-9

## DIMENSIONS

Item	in (mm)	
Overall length	162.9 (4,140)	
Overall width	70.9 (1,800)	
Overall height	62.9 (1,600)	
Front tread	205/60R16	62.1 ( 1,576)
Rear tread	205/60R16	62.4 ( 1,585)
Wheelbase	101.2 ( 2,570)	

## POWER ELECTRIC SPECIFICATIONS

MOTOR		Max. Output (KW)	81.4
		Max. Torque (Nm)	285
EPCU	INVERTER	Input Voltage	250~430
	LDC	Max. Output (KW)	1.7
CHARGER (OBC)		Max. Output (KW)	6.6

## GROSS VEHICLE WEIGHT

Item	
Gross vehicle weight lbs. (kg)	4,321 ( 1,960)

## LUGGAGE VOLUME

Item	
Luggage volume (SAE) l (cu ft)	532 (18.79)*1 / 1402 (49.51)*2

\*1 Back seat upright with luggage under tray

\*2 Back seat folded with luggage under tray

## AIR CONDITIONING SYSTEM

Item	Weight of volume		Classification
	A/CON (STD)	HEATPUMP (OPT)	
Refrigerant	550±25g	900±25g	R-134a
Compressor lubricant	180±10g		POE (RB100EV)

We recommend that you contact an authorized Kia dealer for more details.

## BULB WATTAGE

Light Bulb		Wattage	Bulb type
Front	Headlamps (High)	55	H7LL
	Headlamps (Low)	55	H7LL
	Front turn signal lamps	LED	LED
	Front position lamps	LED	LED
	Front fog lamps*	55	9006
	Front day time running lamps*	LED	LED
	Front side marker	5	W5W
	Side Repeater lamps (Outside Mirror)*	LED	LED
Rear	Rear tail, stop lamps and side marker	LED	LED
	Rear tail lamps and side marker	LED	LED
	Rear turn signal lamps	27	PY27W
	Back-up lamps	16	W16W
	High mounted stop lamps	LED	LED
	License plate lamps	5	W5W
Interior	Map lamps	8 (LED*)	FESTOON (LED*)
	Room lamps	8 (LED*)	FESTOON (LED*)
	Personal lamps*	LED*	LED*
	Vanity mirror lamps	5	FESTOON
	Glove box lamps	5	FESTOON
	Luggage lamp	8 (LED*)	FESTOON (LED*)

\*: If equipped

## TIRES AND WHEELS

Item	Tire size	Wheel size	Load Capacity		Speed capacity		Inflation pressure psi (kPa)				Wheel lug nut torque lb•ft, N•m (kg•m)
			LI *1	Kg	SS *2	Km/h	Normal load		Maximum load		
							Front	Rear	Front	Rear	
Full size tire	205/60R16	6.5Jx16	92	630	H	210	33 (230)				79~97, 107~127 (11~13)

\*1 : Load Index

\*2 : Speed Symbol

### CAUTION

*When replacing tires, use the same size originally supplied with the vehicle.  
Using tires of a different size can damage the related parts or make it work irregularly.*

### \* NOTICE

- We recommend that when replacing tires, use the same originally supplied with the vehicles. If not, that affects driving performance.
- When driving in high altitude grades, it is natural for the atmospheric pressure to decrease. Therefore, please check the tire pressure and add more air when necessary. Additionally required tire air pressure per km above sea level: 1.5psi/km

## RECOMMENDED LUBRICANTS AND CAPACITIES

To help achieve proper performance, durability, use only lubricants of the proper quality for your vehicle. These lubricants and fluids are recommended for use in your vehicle.

Lubricant	Volume	Classification
Reduction gear oil	1.4±0.1 US qt. (1.3±0.1l)	"70W, API GL-4, TGO-9 (MS517-14) or other brands meeting the GL-4 specification approved by Kia Motors Corp."
Coolant	5.39 US qt. (5.1l)	Mixture of antifreeze and water (Ethylene glycol base coolant for aluminum radiator)
Brake fluid		FMVSS116 DOT-3 or DOT-4



## VEHICLE IDENTIFICATION NUMBER (VIN)

■ Frame number

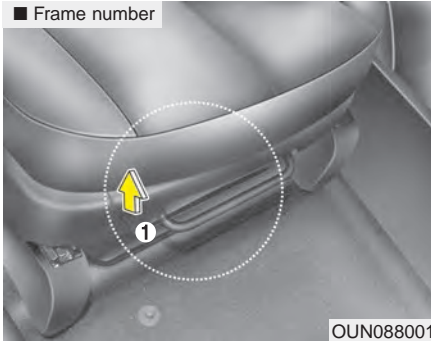

The vehicle identification number (VIN) is the number used in registering your vehicle and in all legal matters pertaining to its ownership, etc. The number is punched on the floor under the front passenger seat. To check the number, remove the cover (1).

■ VIN label (if equipped)

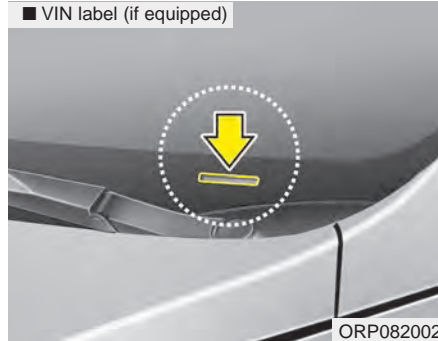

The VIN is also on a plate attached to the top of the dashboard. The number on the plate can easily be seen through the windshield from outside.

## VEHICLE CERTIFICATION LABEL



The vehicle certification label attached on the driver's side center pillar gives the vehicle identification number (VIN).

## TIRE SPECIFICATION AND PRESSURE LABEL

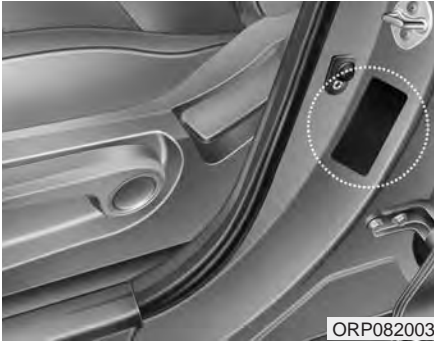

The tires supplied on your new vehicle are chosen to provide the best performance for normal driving.

The tire label located on the driver's side center pillar gives the tire pressures recommended for your vehicle.

## MOTOR NUMBER

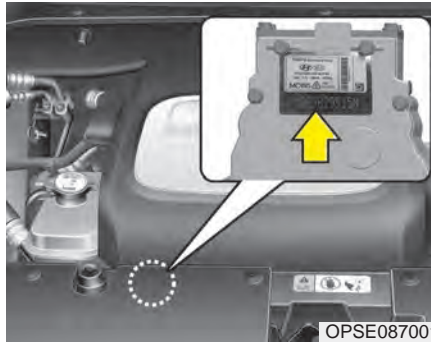

The motor number is stamped on the motor compartment as shown in the drawing.

## AIR CONDITIONER COMPRESSOR LABEL

■ Type A

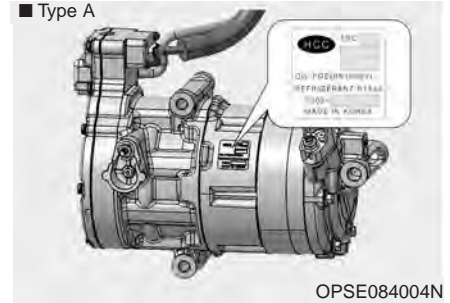

■ Type B

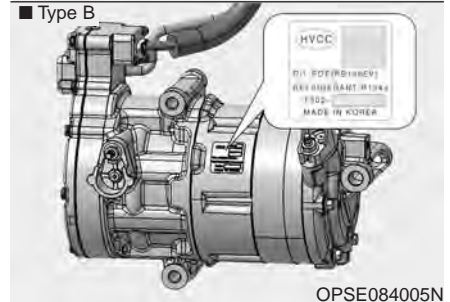

A compressor label informs you the type of compressor your vehicle is equipped with such as model, supplier part number, production number, refrigerant and refrigerant oil.

## REFRIGERANT LABEL



The refrigerant label is located on the underside of the hood.

## **CONSUMER ASSISTANCE (U.S. ONLY)**

Roadside Assistance is provided on all new current model year Kia Vehicles from the date the vehicle is delivered to the first retail buyer or otherwise put into use (in-service date), whichever is earlier, for a period of 60 months or 60,000 miles, whichever is earlier, subject to the terms, conditions and exclusions set forth in the Kia Warranty and Consumer Information Manual applicable to your model year vehicle.

KMA reserves the right to limit or deny services or other benefits to any owner or driver when, in KMA's judgment, the claims and/or service requests are excessive in frequency or type of occurrence.

### **Toll free consumer assistance**

Kia's toll-free Consumer Assistance hot line is staffed from 5:00 AM to 6:00 PM PST, Monday through Friday and is accessible by dialing 1-800-333-4Kia (4542).

For more information regarding assistance available, please refer to your Kia Warranty & Consumer Information Manual.

### **Emergency roadside assistance**

Kia's toll free Roadside Assistance hot line is staffed 24 hours a day, 365 days a year and is accessible by dialing 1-800-333-4Kia (4542).

Please note that you must provide your Vehicle Identification Number (VIN) to verify coverage at the time of your call. The VIN can be found on the dash of your vehicle on the driver's side, on the door jamb of the driver's door, your vehicle's registration or proof of insurance card.

Kia utilizes a network of over 30,000 roadside assistance providers. Should you accidentally, require a battery jump, or need help changing a tire, a Kia Roadside Assistance Representative will dispatch someone to, change a flat tire with your inflated spare, or arrange a battery jump to allow you to proceed to your destination. We have access to a network of over 10,000 locksmiths to help you should you become locked out of your Kia.

In the event that mechanical difficulty renders your vehicle undriveable due to a warranty-related concern, Kia's Roadside Assistance Representative will arrange to transport your vehicle to the nearest Kia dealer or to an alternative service location.

Your vehicle must be accessible to our dispatch transport vehicle, as determined by our driver, to receive this service.

**\* NOTICE**

**Roadside Assistance benefits are not available for any Kia vehicle that has ever been or should be issued a “salvage” title or similar “branded” title under any state’s law or has been declared a “total loss” or equivalent by a financial institution or insurance company.**

**Trip interruption**

Trip interruption expense benefits are provided in the event that a warranty-related disablement occurs more than 150 miles from your home, and the repairs require more than 24 hours to complete. Reasonable reimbursement is included for meals, lodging, or rental vehicle expenses. Trip interruption coverage is limited to \$100 per day subject to a three day maximum limit per incident. You must contact the Kia Roadside Assistance Center to obtain pre-authorization of expenses. Once the Kia Roadside Assistance Center gives authorization for trip interruption benefits, they will assist you in making the necessary arrangements. Insurance deductibles, expenses, and claims paid by your insurance company or other providers are not eligible for reimbursement.

Fleet vehicles are excluded from reimbursement under Kia’s Trip Interruption Policy.

### **Registering your vehicle in a foreign country**

If you plan to register your vehicle in a foreign country, you should confirm that it conforms to the regulations in that country. Even if you successfully register the vehicle in a foreign country, you may experience the following problems and should therefore consider the possibility of having to deal with them:

1. The fuel specified for your vehicle may be unavailable.
2. We must, therefore, clearly state that when you leave the country in which you purchased your Kia new and register it in another country, vehicles like yours may not be marketed in the new country of registration, parts, servicing techniques and tools necessary to maintain and repair your vehicle may be unavailable.

Even if vehicles like yours are sold there, mechanical specifications required by the government may vary enough from the country of purchase to cause additional problems.

3. There may not be an Authorized Kia Dealer in the area in which you plan to register your vehicle. You may additionally experience difficulty in obtaining services in a foreign country for any number of reasons.

Further, we cannot assume any responsibility for problems that result from unsatisfactory service or lack of service outside of the United States.

## **ELECTRICAL EQUIPMENT (U.S. ONLY)**

The electrical system of your vehicle is designed to perform under all reasonably expected operating conditions. However, before any additional electrical equipment is installed in your vehicle, consult an Authorized Kia Dealer, in order to ensure that you do not void your warranty.

Certain electrical equipment, or the way in which it is installed, may adversely affect the operation of your vehicle, including such systems as the engine control system, the audio system and the electrical charging system and thus potentially void all or part of your warranty.

We assume no responsibility for any expense you may incur or for any malfunction of your vehicle or any of its components or systems that may result from the installation of additional electrical equipment that is not supplied, or recommended for installation by, Kia.

### **Installation of a mobile two-way radio system**

If a mobile two-way radio system is installed improperly, or if an excessively powerful type of system is used, other electronic systems may be adversely affected. To avoid damage to your vehicle, consult an Authorized Kia Dealer concerning the proper equipment and installation.

Kia motor vehicles are designed and manufactured to meet or exceed all applicable safety standards.

For your safety, however, we strongly urge you to read and follow all directions in this Owner's Manual, particularly the information under the headings "NOTICE", "CAUTION" and "WARNING".

If, after reading this manual, you have any questions regarding the operation of your vehicle, safety issues and defects please contact your Kia's toll-free Consumer Assistance hot line as below:

National Consumer Affairs Manager  
Kia Motors America, Inc.  
P.O. Box 52410  
Irvine, CA 92619-2410  
1-800-333-4Kia (4542)

## **REPORTING SAFETY DEFECTS (U.S. ONLY)**

If you believe that your vehicle has a defect which could cause a crash or could cause injury or death, you should immediately inform the National Highway Traffic Safety Administration (NHTSA) in addition to notifying Kia Motors America, Inc.

If NHTSA receives similar complaints, it may open an investigation, and if it finds that a safety defect exists in a group of vehicles, it may order a recall and remedy campaign. However, NHTSA cannot become involved in individual problems between you, your dealer, or Kia Motors America, Inc.

To contact NHTSA, you may call the Vehicle Safety Hotline toll-free at 1-888-327-4236 (TTY: 1-800-424-9153); go to <http://www.safercar.gov>; download the SaferCar mobile application; or write to: Administrator, NHTSA, 1200 New Jersey Ave., SE., West Building, Washington, DC 20590. You can also obtain other information about motor vehicle safety from <http://www.safercar.gov>.

## **ONLINE FACTORY AUTHORIZED MANUALS (U.S. ONLY)**

The following publications are available on [www.KiaTechinfo.com](http://www.KiaTechinfo.com).

### **Service manual:**

This manual covers maintenance and recommended procedures for repair to engine and chassis components. It is written for the Journeyman mechanic, but is simple enough for most mechanically inclined owners to understand.

### **Electrical troubleshooting manual:**

This manual complements the Service Manual by providing indepth troubleshooting information for each electrical circuit in your vehicle.

### **Owner's manual:**

This manual describes the overall features and operating procedures for the vehicle.





**A**

A/V Mode . . . . . 4-48

Abnormal lamp operation . . . . . 4-82

ACTIVE ECO SYSTEM . . . . . 5-10

Air bag warning label . . . . . 3-58

Air bag warning light . . . . . 3-37

Air bags . . . . . 3-34

    Air bag warning label . . . . . 3-58

    Air bag warning light . . . . . 3-37

    Curtain air bag . . . . . 3-51

    Driver's and passenger's front air bag . . . . . 3-46

    Inflation and non-inflation conditions . . . . . 3-52

    Occupant Detection System (ODS) . . . . . 3-41

    Operation . . . . . 3-35

    Side air bag . . . . . 3-49

    SRS Care . . . . . 3-57

    SRS components and functions . . . . . 3-38

Air conditioner compressor label . . . . . 8-8

Airconditioning system

    Automatic climate control system . . . . . 4-94

Antenna . . . . . 4-128

Anti-lock brake system (ABS) . . . . . 5-23

Appearance care . . . . . 7-73

    Exterior care . . . . . 7-73

    Interior care . . . . . 7-78

Audio system . . . . . 4-128

    Antenna . . . . . 4-128

    Audio . . . . . 4-141

    AUX, USB and iPod® port . . . . . 4-129

    Bluetooth® Wireless Technology . . . . . 4-137

    How vehicle audio works . . . . . 4-131

    Speaker lights . . . . . 4-130

    Using iPod® device . . . . . 4-136

    Using the USB device . . . . . 4-135

    Speaker lights . . . . . 4-130

Auto defogging system . . . . . 4-115

Auto door lock/unlock feature . . . . . 4-13

Auto light position . . . . . 4-83

Automatic climate control system . . . . . 4-94

    Air conditioning . . . . . 4-103

    Automatic heating and air conditioning . . . . . 4-95

    Automatic Ventilation . . . . . 4-106

    Climate control air filter . . . . . 109

    Manual heating and air conditioning . . . . . 4-96

    System operation . . . . . 4-107

AUX, USB and iPod® port . . . . . 4-129

**B**

Battery . . . . . 7-33

Battery replacement (smart key) . . . . . 4-9

Battery saver function . . . . . 4-81

Before driving . . . . . 5-3

Bonnet see the hood . . . . . 4-22

Brake system . . . . .	5-17
Anti-lock brake system (ABS) . . . . .	5-23
Electronic parking brake (EPB) . . . . .	5-19
Electronic stability control (ESC) . . . . .	5-25
Hill-start assist control (HAC) . . . . .	5-30
Power brakes . . . . .	5-17
Vehicle stability management (VSM) . . . . .	5-29
Brakes fluid . . . . .	7-24
Bulb replacement . . . . .	7-63
Bulb wattage . . . . .	8-4

## C

Camera see the Rear camera display . . . . .	4-80
Capacities (Lubricants) . . . . .	8-6
Care	
Care of seat belts . . . . .	3-25
Exterior care . . . . .	7-73
Interior care . . . . .	7-78
Tire care . . . . .	7-36
Care of seat belts . . . . .	3-25
Cargo area cover . . . . .	4-126
Center console storage . . . . .	4-116
Central door lock switch . . . . .	4-13
Chains - Tire . . . . .	5-46
Checking tire inflation pressure . . . . .	7-37

Child restraint system . . . . .	3-26
Lower anchor system . . . . .	3-32
Seat belt . . . . .	3-27
Tether anchor system . . . . .	3-31
Child-protector rear door lock . . . . .	4-13
Clean air . . . . .	4-114
Climate control air filter . . . . .	7-27
Clothes hanger . . . . .	4-124
Combined instrument, see instrument cluster . . . . .	4-40
Coolant . . . . .	7-21
Cooling fluid, see engine coolant . . . . .	7-21
Cruise control system . . . . .	5-33
To set cruise control speed . . . . .	5-34
Cup holder . . . . .	4-118
Curtain air bag . . . . .	3-50

## D

Dashboard illumination, see instrument panel illumination . . . . .	4-41
Dashboard, see instrument cluster . . . . .	4-40
Day/night rearview mirror . . . . .	4-35
Daytime running light . . . . .	4-81
Defogging (Windscreen) . . . . .	4-111
Defogging (Windshield) . . . . .	4-111
Defogging logic . . . . .	4-114

Defroster . . . . .	4-93
Outside mirror defroster . . . . .	4-93
Rear window defroster . . . . .	4-93
Dimensions . . . . .	8-2
Display illumination, see instrument panel illumination . . . . .	4-41
Displays, see instrument cluster . . . . .	4-40
Door locks . . . . .	4-10
Auto door lock/unlock feature . . . . .	4-13
Central door lock switch . . . . .	4-13
Child-protector rear door lock . . . . .	4-13
from inside the vehicle . . . . .	4-11
from outside the vehicle . . . . .	4-10
Impact sensing door unlock system . . . . .	4-13
Speed sensing door lock system . . . . .	4-13
Driver's and passenger's front air bag . . . . .	3-46
Driving at night . . . . .	5-42
Driving in flooded areas . . . . .	5-43
Driving in the rain . . . . .	5-43
Driving off-road . . . . .	5-44

## E

Economical operation . . . . .	5-38
Electric chromic mirror (ECM) . . . . .	4-35
Electronic parking brake (EPB) . . . . .	5-19
Electric power steering . . . . .	4-30
Electronic stability control (ESC) . . . . .	5-25

Emergency starting . . . . .	6-5
Jump starting . . . . .	6-5
Emergency tailgate safety release . . . . .	4-15
Emergency while driving . . . . .	6-3
Energy consumption . . . . .	4-61
EV information mode . . . . .	4-47
Explanation of scheduled maintenance items . . . . .	7-19
Exterior care . . . . .	7-73
Exterior overview . . . . .	2-2

## F

Flat tire . . . . .	6-14
Tire Mobility Kit . . . . .	6-14
FLEX Steer . . . . .	4-33
Floor mat anchor(s) . . . . .	4-124
Fluid	
Brakes fluid . . . . .	7-24
Washer fluid . . . . .	7-26
Fog light (Front) . . . . .	4-86
Front seat adjustment . . . . .	3-5
Fuse switch . . . . .	7-53
Fuses . . . . .	7-51
Fuse switch . . . . .	7-53
Fuse/relay panel description . . . . .	7-56
Instrument panel fuse . . . . .	7-52
Multi fuse . . . . .	7-55

**G**

Gauges . . . . .	4-42
Glove box . . . . .	4-116
Glove box lamp. . . . .	4-92
Gross vehicle weight. . . . .	8-3

**H**

Hazard warning flasher. . . . .	6-2
Hazardous driving conditions. . . . .	5-40
Headlamp escort . . . . .	4-81
Headlight bulb replacement . . . . .	7-66
Headlight position. . . . .	4-83
Headrest(front) . . . . .	3-6
Heated steering wheel. . . . .	4-32
Heater	
Automatic climate control system . . . . .	4-94
High - beam operation . . . . .	4-84
High adjustment. . . . .	3-16
Highway driving . . . . .	5-43
Hill-start assist control (HAC) . . . . .	5-30
Hood . . . . .	4-22
Horn . . . . .	4-32

**I**

Immobilizer system . . . . .	4-8
Impact sensing door unlock system . . . . .	4-13
Indicator Lights. . . . .	4-72
Inside rearview mirror . . . . .	4-35
Instrument cluster . . . . .	4-40
A/V Mode. . . . .	4-48
Energy consumption. . . . .	4-61
EV information mode. . . . .	4-47
Gauges . . . . .	4-42
Indicator Lights . . . . .	4-72
Instrument panel illumination . . . . .	4-41
LCD Display . . . . .	4-46
LCD Display Control. . . . .	4-41
LCD Modes . . . . .	4-46
One time driving information mode . . . . .	4-63
Range . . . . .	4-64
Service Mode . . . . .	4-48
Trip A/B . . . . .	4-62
Trip computer. . . . .	4-61
User settings mode . . . . .	4-49
Warning and Indicator lights . . . . .	4-65
Warning lights . . . . .	4-65
Warning Messages . . . . .	4-52
Instrument panel fuse . . . . .	7-52
Instrument panel overview . . . . .	2-5
Interior care. . . . .	7-78

Interior features . . . . .	4-118
Cargo area cover . . . . .	4-126
Clothes hanger . . . . .	4-124
Cup holder . . . . .	4-118
Floor mat anchor(s) . . . . .	4-124
Luggage net (holder) . . . . .	4-125
Power outlet . . . . .	4-123
Rear seat warmer . . . . .	4-122
Seat air ventilation . . . . .	4-121
Seat warmer . . . . .	4-119
Sunvisor . . . . .	4-119
Interior lamp auto cut . . . . .	4-90
Interior light . . . . .	4-90
Glove box lamp . . . . .	4-92
Interior lamp auto cut . . . . .	4-90
Luggage room lamp . . . . .	4-92
Map lamp . . . . .	4-90
Room lamp . . . . .	4-91
Vanity mirror lamp . . . . .	4-92
Interior overview . . . . .	2-4

## J

Jump starting . . . . .	6-5
-------------------------	-----

## L

Label	
Air bag warning label . . . . .	3-57
Air conditioner compressor label . . . . .	8-8
Tire sidewall labeling . . . . .	7-41
Tire specification and pressure label . . . . .	8-8
Lane change signals . . . . .	4-85
Lap/shoulder belt . . . . .	3-15
LCD Display . . . . .	4-46
LCD Modes . . . . .	4-46
Light bulbs . . . . .	7-63
Lighting . . . . .	4-81
Abnormal lamp operation . . . . .	4-82
Battery saver function . . . . .	4-81
Daytime running light . . . . .	4-81
Front fog light . . . . .	4-86
Headlamp escort . . . . .	4-81
High - beam operation . . . . .	4-84
Lane change signals . . . . .	4-85
Lighting control . . . . .	4-82
Turn signals . . . . .	4-85
Lighting control . . . . .	4-82
Auto light position . . . . .	4-83
Headlight position . . . . .	4-83
Parking light position . . . . .	4-83
Loss of the smart key . . . . .	4-7
Lower anchor system . . . . .	3-32

Lubricants and capacities . . . . .	8-6
Luggage box . . . . .	4-117
Luggage net (holder) . . . . .	4-125
Luggage room lamp . . . . .	4-92
Luggage volume . . . . .	8-3

## M

### Maintenance

Explanation of scheduled maintenance items . . . . .	7-19
Maintenance services . . . . .	7-3
Owner maintenance . . . . .	7-5
Scheduled maintenance service . . . . .	7-7
Tire maintenance . . . . .	7-41
Maintenance schedule . . . . .	7-7
Maintenance services . . . . .	7-3
Map lamp . . . . .	4-90
Mirrors . . . . .	4-35
Mirrors	
Day/night rearview mirror . . . . .	4-35
Electric chromic mirror (ECM) . . . . .	4-35
Inside rearview mirror . . . . .	4-35
Outside mirror defroster . . . . .	4-39
Outside rearview mirror . . . . .	4-37
Outside rearview mirror folding . . . . .	4-38
Motor number . . . . .	8-8
Motor operation gauge . . . . .	4-42
Motor room compartment . . . . .	2-6

Multi fuse . . . . .	7-55
----------------------	------

## O

Occupant Detection System (ODS) . . . . .	3-41
Odometer . . . . .	4-38
ODS see the Occupant Detection System . . . . .	3-41
One time driving information mode . . . . .	4-63
Outside mirror defroster . . . . .	4-39
Outside rearview mirror . . . . .	4-37
Outside rearview mirror folding . . . . .	4-38
Outside Temperature Gauge . . . . .	4-44
Overheats . . . . .	6-8
Owner maintenance . . . . .	7-5

## P

Panoramic sunroof . . . . .	4-24
Parking assist system . . . . .	4-76
Non-operational conditions . . . . .	4-78
Operation . . . . .	4-76
Parking light position . . . . .	4-83
Pedestrian Warning System . . . . .	5-9
Power brakes . . . . .	5-17
POWER button . . . . .	5-5
Illuminated POWER button . . . . .	5-5
Pedestrian Warning System . . . . .	5-9
POWER button position . . . . .	5-5

Starting the vehicle . . . . .	5-7
Turing off the Vehicle . . . . .	5-9
POWER button illumination . . . . .	5-5
POWER button position . . . . .	5-5
Power electric specifications . . . . .	8-2
Power outlet . . . . .	4-123
Power window lock button . . . . .	4-20
Pre-tensioner seat belt . . . . .	3-20

**R**

Range . . . . .	4-64
Rear camera display . . . . .	4-80
Rear seat adjustment . . . . .	3-8
Rear seat warmer . . . . .	4-122
Recommended cold tire inflation pressures . . . . .	7-36
Recommended lubricants and capacities . . . . .	8-6
Record your key number . . . . .	4-4
Reducing the risk of a rollover . . . . .	5-39
Reduction gear . . . . .	5-11
Shift-lock override . . . . .	5-14
Transaxle ranges . . . . .	5-12
Reduction gear shift indicator . . . . .	4-45
Replacement light bulb . . . . .	7-63
Road warning . . . . .	6-2
Rocking the vehicle . . . . .	5-41
Room lamp . . . . .	4-91
Rotation (Tire) . . . . .	7-38

**S**

Scheduled maintenance service . . . . .	7-7
Seat air ventilation . . . . .	4-121
Seat belt warning . . . . .	3-13
Seat belts . . . . .	3-13
Care of seat belts . . . . .	3-25
Pre-tensioner seat belt . . . . .	3-20
Seat belt precautions . . . . .	3-22
Seat belt restraint system . . . . .	3-13
Seat warmer . . . . .	4-119
Seatback pocket . . . . .	3-8
Seats . . . . .	3-2
Front seat adjustment . . . . .	3-5
Headrest(front) . . . . .	3-6
Rear seat adjustment . . . . .	3-9
Seatback pocket . . . . .	3-9
Service Mode . . . . .	4-48
Shift-lock override - Reduction gear . . . . .	5-14
Side air bag . . . . .	3-49
Smart Key . . . . .	4-4
Battery replacement . . . . .	4-9
Loss of the smart key . . . . .	4-7
Record your key number . . . . .	4-4
Smart key function . . . . .	4-4
Smart key immobilizer system . . . . .	4-8
Smart key precautions . . . . .	4-7
Smart key function . . . . .	4-4





Tire maintenance . . . . .	7-41
Tire replacement . . . . .	7-40
Tire rotation . . . . .	7-38
Tire sidewall labeling . . . . .	7-41
Tire traction . . . . .	7-41
Wheel alignment and tire balance . . . . .	7-39
Wheel replacement . . . . .	7-40
Towing . . . . .	6-20
Emergency towing . . . . .	6-22
Removable towing hook . . . . .	6-21
Trailer Towing . . . . .	5-48
Trip A/B . . . . .	4-62
Trip computer . . . . .	4-61
Tuning off the Vehicle . . . . .	5-9
Turn signals . . . . .	4-85

## U

User settings mode . . . . .	4-49
------------------------------	------

## V

Vanity mirror lamp . . . . .	4-92
Vehicle identification number (VIN) . . . . .	8-7
Vehicle load limit . . . . .	5-49
Vehicle overheats . . . . .	6-8
Vehicle stability management (VSM) . . . . .	5-29
Vehicle weight . . . . .	5-54

Vehicle will not start . . . . .	6-4
----------------------------------	-----

## W

Warning and Indicator lights . . . . .	4-65
Warning lights . . . . .	4-65
Warning Messages . . . . .	4-52
Washer fluid . . . . .	7-26
Wheel alignment and tire balance . . . . .	7-39
Wheel replacement . . . . .	7-40
Windows . . . . .	4-17
Power window lock button . . . . .	4-20
Windscreen defrosting and defogging . . . . .	4-111
Windscreen washers (front) . . . . .	4-87
Windscreen washers (rear) . . . . .	4-87
Windscreen wipers (front) . . . . .	4-87
Windscreen wipers (rear) . . . . .	4-87
Windshield defrosting and defogging . . . . .	4-111
Windshield washers (front) . . . . .	4-87
Windshield washers (rear) . . . . .	4-87
Windshield wipers (front) . . . . .	4-87
Windshield wipers (rear) . . . . .	4-87
Winter driving . . . . .	5-44
Snow tires . . . . .	5-44
Tire chains . . . . .	5-45
Wiper blades . . . . .	7-29

Wipers and washers . . . . . 4-87  
    Windscreen washers (front) . . . . . 4-87  
    Windscreen washers (rear) . . . . . 4-87  
    Windscreen wipers (front) . . . . . 4-87  
    Windscreen wipers (rear) . . . . . 4-87  
    Windshield washers (front) . . . . . 4-87  
    Windshield washers (rear) . . . . . 4-87  
    Windshield wipers (front) . . . . . 4-87  
    Windshield wipers (rear) . . . . . 4-87

**ETC**

3 Point rear center belt . . . . . 3-19

