

SOUL ev

Features & Functions Guide



Delivery First
The priority that delivers more

GETTING TO KNOW YOUR **SOUL EV**

Congratulations on Your New Kia Purchase!

Your new Kia vehicle has been designed, engineered and manufactured to provide you with years of comfortable and dependable driving. Kia is committed to quality, innovation, safety and — above all — your satisfaction.

Using This Guide

The information contained in this guide is a brief overview that will help you become familiar with the operation and features of your new Kia vehicle. The flipbook format facilitates information access, while the detailed illustrations help to ensure the instructions are easy to follow.

This **Features & Functions Guide**, and the specific operational and safety information it provides, is not a substitute for your Owner's Manual. In the interest of your safety and that of your family, and to help you avoid risks that may result in death or serious injury, Kia reminds you to carefully read your Owner's Manual in order to fully familiarize yourself with the important information it contains.

While the information contained in this guide is accurate at the time of printing, Kia may change vehicle specifications without notice in advance or after the fact, and assumes no liability in connection with such changes.



Available on the App Store, the Kia AR Owner's Manual App uses AR (Augmented Reality) technology to provide tips and useful information about your vehicle.

To use the Kia AR Owner's Manual App:

- Simply scan the interior or engine (motor) room of your vehicle with your smart phone or tablet, select feature/component and view the video guide.
- If you are unable to scan the vehicle, use the AR Manual (without scan) menu, select feature/component and view the video guide.

www.kia.com

Consumer - Roadside Assistance
1-800-333-4KIA (4542)

See Back Pages for Vehicle
Maintenance Schedule

Always check the Owner's Manual for complete operating information and safety warnings.

ESSENTIAL FEATURES

Air Conditioning / Climate Control	27
Audio Systems - UVO EV Services / Android Auto™ / Apple CarPlay® Setup*	25
Audio Systems - UVO EV Services / Premium Navigation*	26
Audio Systems - Standard Audio System*	24
Aux/USB/iPod® Port & Power Outlets	28
Bluetooth® Wireless Technology	22
Charging your Electric Vehicle	10
Cruise Control	21
Digital Clock	28
Active ECO System	09
Folding Rear Seatback	34
Passenger Airbag Off Indicator	41
Tire Mobility Kit	39
Tire Pressure Monitoring System (TPMS)	06
Windshield/Rear Wipers & Washers	19

Driving while distracted can result in a loss of vehicle control that may lead to an accident, severe personal injury and death. The driver's primary responsibility is in the safe and legal operation of a vehicle, and use of any handheld devices, other equipment or vehicle systems which take the driver's eyes, attention and focus away from the safe operation of a vehicle or that are not permissible by law should never be used during operation of the vehicle.



VIDEOS & QR CODES	02
--	----

INSTRUMENT CLUSTER

Instrument Cluster Overview	03
Indicators & Warning Lights	04
Electric Vehicle (EV) Indicators	05
Energy Consumption	06
Tire Pressure Monitoring System (TPMS)	06
LCD Instrument Cluster Modes	07
Trip Computer / Tripmeter	07
User Settings Mode	08
Service Mode	08

ELECTRIC VEHICLE (EV) FEATURES

Active ECO System	09
Charging Your Electric Vehicle	10
EV Information Modes - Instrument Cluster	13
EV System Information - UVO EV Services/ Premium Navigation*	14

DRIVER'S PANEL

Instrument Panel Dimmer	16
Electronic Stability Control (ESC)	16
Heated Steering Wheel Button	16
Hill-Start Assist Control (HAC)	16
Power Windows, Window Lock & Central Door Lock	17
Automatic Door Lock/Unlock	17
Heated Outside Mirrors*	17
Power Folding Outside Mirrors*	17

STEERING WHEEL CONTROLS

Tilt/Telescoping Steering Wheel	18
Headlights & High Beams	18
Turn Signals & Fog Lights*	18
Windshield Wipers & Washers	19
Rear Wiper & Washer	19
FlexSteer™ Steering Wheel Mode	20
Audio Controls	21
Cruise Control	21
Bluetooth® Wireless Technology	22

AUDIO SYSTEMS

Standard Audio System*	24
UVO EV Services / Android Auto™ / Apple CarPlay® Setup*	25
UVO EV Services with Premium Navigation*	26

CENTER PANEL

Automatic Climate Control	27
Driver Only Ventilation	28
Reserved Climate Control*	28
Digital Clock	28
Aux/USB/iPod® Port & Power Outlets	28
Power Button	29
Electronic Parking Brake (EPB)	30
Automatic Gear Shift with Regenerative Brake Mode	31
Seat Warmers / Ventilated Seats*	32

SEATING

6-Way Adjustable Driver's Seat	33
Front Seat Headrest Adjustment	33
Folding Rear Seatback	34

OTHER KEY FEATURES

Smart Key	35
Double-Turn Lock/Unlock All	35
Panoramic Sunroof Operation*	36
Map/Room Lamps	37
Sunvisor	37
Pedestrian Warning System	37
Rear-Camera Display	38
Parking Assist System*	38
Hood Release Lever and Latch	39
Tire Mobility Kit	39
High-Voltage Areas	40
Air Inlet	40
Tailgate Release Button	40
Child-Protector Rear Door Locks	40

SAFETY FEATURES

Seat Belts	41
Seat Belt Retractor Locks	41
Occupant Detection System (ODS) / Passenger Airbag Off Indicator	41

NORMAL MAINTENANCE SCHEDULE 42

LEGAL DISCLAIMERS (See Back Inside Cover Page)

Kia provides a number of video resources at your disposal to assist you with becoming familiar with the features and functions found in your Kia vehicle. You can access these resources by snapping the QR Codes with your smartphone/tablet (mobile devices) or by visiting the following website: www.youtube.com/KiaFeatureVideos. Continue reading for a more in-depth look at QR Codes and for instructions on how to use them.

What are QR Codes?

A QR Code is a square, 2-dimensional barcode that can be read by mobile devices loaded with an appropriate barcode or QR Code Reader App. The app reads the barcode image and then launches/uploads the specific information the code contains, such as URLs, text, photos, videos and so much more.

How to use QR Codes

If you have a mobile device with a QR Code Reader App, you can snap the code with your phone and you'll be provided a video with additional information pertaining to the topic. For example, in the Instrument Cluster Overview section, if you would like additional information, just snap the code with your mobile device to view the selected Kia Features & Functions Video.

How to snap a QR Code

1. With your mobile device, download a QR Code Reader App. With many devices, you can do this through an app store or marketplace
2. Open the QR Code Reader App on your mobile device
3. The app will utilize your device's camera. Center the code in the camera viewing area:
 - With some apps, as soon as the app recognizes the code, it will launch the corresponding video
 - With other apps, you will have to snap or take a picture of the code. The app will then launch the corresponding video
 - For operation specifics, refer to the instructions that come with the QR Code Reader App

QR CODE

EV Overview Video

To view a video on your mobile device, snap this QR Code or visit the listed website.



www.youtube.com/KiaFeatureVideos

REMINDER: When accessing videos on your mobile device, standard cellular data rates may apply.

QUICK TIPS

1. If you're having trouble scanning codes, check the following:
 - The code should be centered and focused in your mobile device's camera screen
 - Consider moving your device closer to or farther away from the code
 - The code should be well lit, without significant shadow
 - Avoid scanning from a significant angle
 - Confirm that the device's app supports 2D QR Code scanning
 - Try another QR Code Reader App; not all apps are created equal
2. After scanning, if a "connecting" message appears and then nothing happens or there's a "connection error" message, this typically indicates that your device is having trouble connecting to the Internet
3. When accessing videos on your mobile device, standard cellular data rates will apply

Instrument Cluster Overview

A Motor Operation Gauge

B Range Meter

C Turn Signal Indicators

D State-of-Charge Gauge

E Indicators & Warnings Lights

F Gear Shift Position

G Trip Computer / Trip Meter

H Odometer

I Speedometer

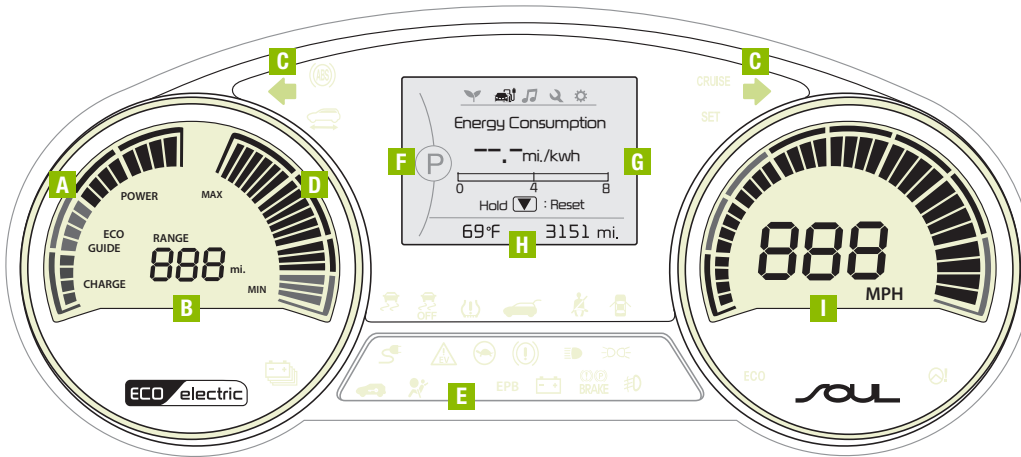

QR CODE

EV Overview Video

To view a video on your mobile device, snap this QR Code or visit the listed website.



www.youtube.com/KiaFeatureVideos

Your vehicle's instrument cluster & indicator light locations may differ from those in the illustrations. For more information on the instrument cluster, the LCD Warning Messages and the function of all indicator and warning lights, please refer to the Owner's Manual.

Indicators & Warning Lights

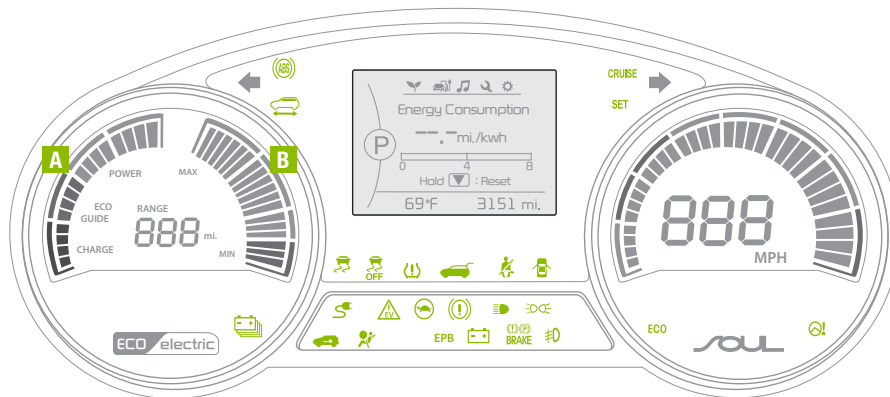

- | | | | | | |
|--|--|--|--|--|---|
| | Ready Indicator Light | | Electronic Stability Control (ESC) OFF Indicator | | Airbag Warning Light |
| | Service Warning Light | | Low Tire Pressure Light / Tire Pressure Monitoring System (TPMS) Malfunction Indicator | | Electric Parking Brake (EPB) |
| | Charging Indicator Light | | TPMS Malfunction Indicator | | Parking Brake & Brake Fluid Warning Light |
| | Power Down Warning Light | | Tailgate Open Warning Light | | Electronic Brake Force Distribution (EBD) System Warning Light (Two separate indicators on Instrument Cluster lit at same time) |
| | High-Voltage Battery Level Warning Light | | Seat Belt Warning Light | | Front Fog Light Indicator* |
| | Anti-lock Braking System (ABS) Warning Light | | Door Ajar Warning Light | | ECOMINDER® indicator (Active ECO system) |
| | Cruise ON/OFF Indicator | | Regenerative Brake Warning Light (red/yellow) (Two separate indicators on Instrument Cluster lit at same time) | | Electronic Power Steering Warning Light |
| | Cruise SET Indicator | | High Beam Indicator | | |
| | Electronic Stability Control (ESC) Indicator | | Light ON Indicator | | |
| | Immobilizer Indicator Light* | | | | |

QR CODE

EV Cluster Overview Video

To view a video on your mobile device, snap this QR Code or visit the listed website.



www.youtube.com/KiaFeatureVideos

Your vehicle's instrument cluster & indicator light locations may differ from those in the illustrations. For more information on the instrument cluster, the LCD Warning Messages and the function of all indicator and warning lights, please refer to the Owner's Manual.

Electric Vehicle (EV) Indicators

A Motor operation gauge

Soul EV's motor operation gauge provides information on the energy consumption rate of the vehicle and the charge status of the regenerative brakes.

- **CHARGE** – Shows the charging status of the battery when it is being charged by the regenerative brakes. The more electric energy charged, the lower the gauge level
- **ECO GUIDE** – Shows the energy consumption rate during normal driving conditions
- **POWER** – Shows the energy consumption rate of the vehicle when driving uphill or accelerating. The more electric energy used, the higher the gauge level

B State of Charge gauge (SOC)

The State of Charge gauge displays the high-voltage battery charge status.

- MIN position on the gauge indicates that the driving battery energy is low
- MAX position on the gauge indicates that the driving battery is fully charged



Ready indicator light – Illuminates when the vehicle is ready to drive. When the ready indicator light is OFF or blinking, a malfunction has occurred. Have an authorized Kia dealer address the concern as soon as possible.



ECOMINDER® indicator – Indicates that the Active ECO System is operational. This indicator light is always illuminated unless the Active ECO System is turned OFF.



Service warning light – Illuminates when there is a malfunction related to the electric vehicle control system. Have an authorized Kia dealer address the concern as soon as possible.



Power down warning light – Illuminates when the power is limited for the safety of the electric vehicle.



Charging indicator light – Shows the charging status of the high-voltage battery. When charging, the red indicator turns on. When charging is complete, the green indicator turns on.



High-voltage battery level warning light – Illuminates when the high-voltage battery charge level is insufficient.



Regenerative brake warning lights (when both indicators are lit) – Illuminates when the regenerative brake system is not functioning correctly.

Energy Consumption

There are several factors that contribute to your electric vehicle's energy consumption, including maintenance of your vehicle, driving style, environmental conditions, vehicle weight and vehicle aerodynamics.

Below are tips on how to help reduce energy consumption:

- Keep your vehicle in good condition with regular maintenance
- Don't "ride" the brake pedal
- Drive at a moderate speed, accelerating smoothly and at a moderate rate
- Keep tires inflated to the recommended pressure
- Travel lightly, without carrying unnecessary weight in your vehicles
- Ensure wheels are aligned correctly
- Avoid placing large or heavy items on roof racks
- Avoid hilly, winding or poorly maintained roads

REMINDER: Do not turn the vehicle off by pushing the POWER button while the vehicle is in motion. If the vehicle has been turned off the power brake and power steering system cannot operate.

Tire Pressure Monitoring System (TPMS)



The indicator  functions as both Low Tire Pressure Light and TPMS Malfunction Indicator.

The TPMS indicator illuminates if one or more tires is significantly underinflated, the vehicle has a spare tire installed without TPMS or the outside temperature becomes significantly lower.

Inflate tire(s) to specifications using an accurate digital tire pressure gauge to turn off Low Tire Pressure Light . See front driver's door jamb for PSI specification.

When there is a problem with the TPMS, the TPMS Malfunction Indicator  will blink for approximately one minute and then illuminate - see dealer for service.

REMINDER: Consult your dealer for service if Low Tire Pressure Light remains illuminated after inflating your tire(s).

QUICK TIPS

- Even with TPMS, tire pressure should be checked manually at least once a month. Only adjust Tire Pressure on "cold tires"
- For proper maintenance and optimal fuel economy, maintain recommended tire inflation pressures and stay within the load limits and weight distribution recommended for your vehicle
- In winter or cold weather, the TPMS light may illuminate if the tire pressure was adjusted to the recommended tire inflation pressure during warm weather

QR CODE

Tire Pressure Monitoring System Video

To view a video on your mobile device, snap this QR Code or visit the listed website.

Refer to page 2 for more information.



www.youtube.com/KiaFeatureVideos

LCD Instrument Cluster Modes

To cycle through the LCD Instrument Cluster modes, press the Mode/Select button **A**

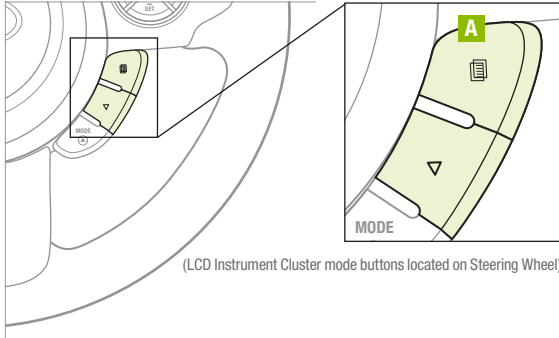

EV Information: Displays EV System energy flow and ECO level



Trip Computer Mode: Displays driving information for tripmeter, energy consumption, etc.



A/V Mode: Displays the state of the A/V System



Master Warning / Service Modes: Informs on upcoming service intervals, and warning messages related to TPMS and others



User Settings Mode: Change settings of the doors, lamps and other features

Trip Computer / Tripmeter

The Trip Computer is a driver information system that displays information related to driving — such as Average and Instant Energy Consumption, Tripmeter, Average Vehicle Speed and Driving Time — on the display when the ignition switch is in the ON position.

To cycle through the LCD Instrument Cluster modes, press the Mode/Select button **B**.

When in the Trip Computer mode , press the Move/Reset button **C** to cycle through the screens. When displaying Trip A or Trip B screens, press and hold the Move/Reset button **C** to reset the Tripmeter to zero.

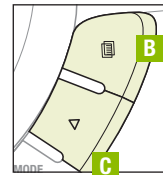

(Buttons located on Steering Wheel)

REMINDERS:

- Appearance of Tripmeter display may differ as equipped
- All stored driving information (except Odometer and Range) is reset if the battery is disconnected

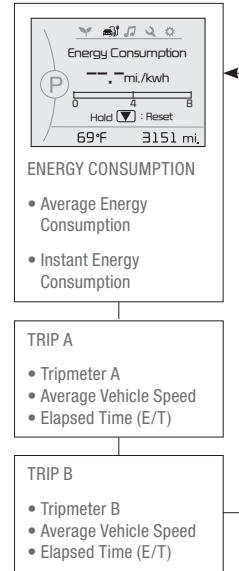

User Settings Mode

To enter the User Settings mode in the LCD Instrument Cluster Modes, press the Mode/Select button **A** when the vehicle is at a standstill and with the POWER button in the ON position and select User Settings .

You can navigate the selections on the display by pressing the Move/Reset button **B**, and then selecting the item by pressing the Mode/Select button **A**.

Door:

- Auto Door Lock
- Auto Door Unlock
- Two Press Unlock
- Horn Feedback

Lights:

- One-Touch Turn Lamp*
- Headlamp Delay*

Settings:

- Language
- Temperature Unit
- Welcome Sound*
- Energy Consumption Auto Reset

Service Interval:

- ON/OFF
- Set mileage/months

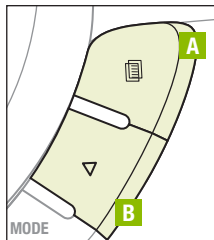

(Buttons located on Steering Wheel)

Service Mode

To enter Service Mode, press the Mode/Select button **A**, scroll to Service Mode  by pressing Move/Reset button **B**. Then press the Mode/Select button **A** to enter. System will display number of miles remaining until next service is due, and type of service.

When service is required, the following will be displayed: **Service Required**.

To reset the Service Mode system, press and hold the Move/Reset button **B** for more than 1 second.

To turn **Service In** mode OFF, go to User Settings in the LCD Instrument Cluster Modes.

Service Interval Setting

To set the service interval when in User Settings mode:

- Press the Move/Reset button **B** and scroll to Service Interval. Press the Mode/Select button **A** to enter
- Press the Move/Reset button **B** and toggle to ON, then press the Mode/Select button **A**. Then press the Move/Reset button **B** to scroll and select the desired miles or months for your next service
- Press the Mode/Select button **A** to enter

(Instrument Cluster LCD Screens)

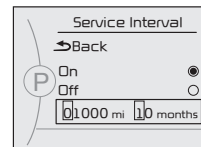
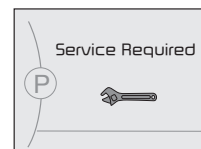
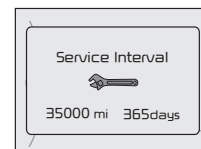

Active ECO System

Soul EV is equipped with an ECO feature that improves energy efficiency and helps extend battery life. The Active ECO System helps reduce energy consumption by controlling several vehicle components. When activated, it optimizes drivetrain operations to help improve energy economy.

Active ECO System ON results in reduced torque, higher energy efficiency, and enhanced regenerative braking.

Active ECO System OFF results in more torque, lower energy efficiency, and reduced regenerative braking.

The Active ECO System is activated by pressing the ACTIVE ECO button **A** (LED illuminated) and can be deactivated by pressing the button again (LED not illuminated). The green ECO indicator light **B** in the instrument cluster will illuminate, indicating that ECO is operating.

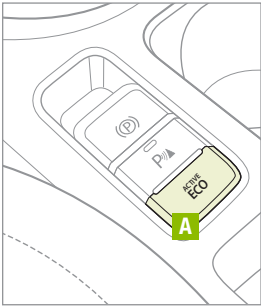

(Button located below Gear Shift)

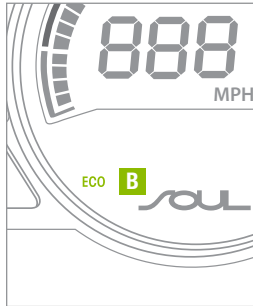

(Shown in Instrument Cluster)

Regenerative Brake Mode “B” – Move the gear shift to the “B” position **C** to enter the maximum regenerative braking drive mode. This mode helps to minimize energy loss and increase the distance to empty.

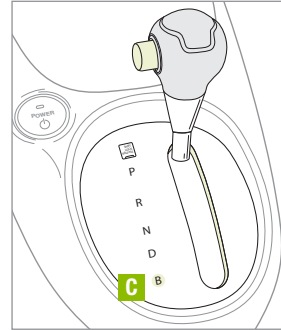

QR CODE

EV Active ECO Video

To view a video on your mobile device, snap this QR Code or visit the listed website.

Refer to page 2 for more information.



www.youtube.com/KiaFeatureVideos

QUICK TIPS

To help reduce energy consumption:

- Drive at a moderate speed, accelerating smoothly and at a moderate rate
- Keep tires inflated to the recommended pressure and wheels aligned properly
- Be sure the wheels are properly aligned

REMINDER: When Active ECO is activated and the Power button is cycled, the Active ECO system remains ON.

For more information on the Active ECO System, refer to your Owner's Manual or contact your local dealership.

Charging Your Electric Vehicle

Level 1 Charging – “Trickle” Charge

A Level 1 or “trickle” charger is the most common type of charging system for an electric vehicle. This type of charger uses 110 volts of household electricity and takes up to 24 hours for a full charge.

Trickle Charger Indicators:

A ICCB – In-Cable Control Box

C Charge – Indicates that the vehicle is charging.

B Power – Indicates that the charger is plugged in and functioning.

D Fault – Indicates charge failure.

REMINDER: Do not use an extension cord. Plug Trickle charger directly into wall socket.

Level 2 Charging – “Normal” Charge

A Level 2 or “normal” charger is the recommended charging system for your Soul EV. This type of charger uses 240 volts of electricity and takes approximately 4-5 hours for a full charge (Based on Kia Motors Corporation testing with SAE J1772 charger performed at 6.6kW). This charger can be installed at your home or found at a public charging station.

REMINDER: Shape of charger and how to use the charger may be different for each manufacturer. Please see Owner’s Manual for more information.

Level 3 Charging - “Quick” Charge

A Level 3 or “Quick” charger are usually found at public charging stations. This type of charge may charge an electric vehicle in as little as 43 minutes to about an 83% charge.

For more information on Level 3 Charging, refer to the Owner’s Manual

QUICK TIP

A Level 2 or “normal” 240-volt charger is recommended for regular charging of the vehicle.

REMINDER: For more detail and/or subsequent steps in charging your vehicle, please see the Owner’s Manual.

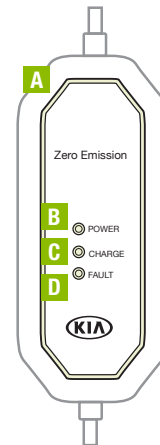

(Control box on charging cable)

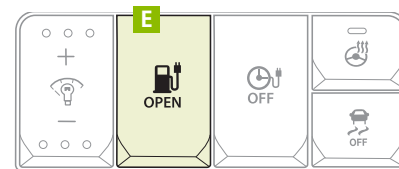

(Buttons located left of steering column)

Charging Your Electric Vehicle (Continued)

To charge the Soul EV using a normal/trickle charger:

1. Connect the ICCB **A** plug to an electrical outlet
2. Check if the power light (green) **B** on the ICCB turns on
3. Press the brake pedal and engage the parking brake
4. Turn off all switches, put the shift lever in P (Park), and turn off the vehicle
5. Release the charging door by pressing the charging door open button **E** located to the left of the steering column
6. Open the charging door **F** at the front of the vehicle and press the trickle charging inlet release tab to open the inlet cover **G**
7. Open the protective cover **G** of the trickle charger's charging connector
8. Hold the charging connector handle and connect it to the vehicle's trickle charging inlet **H** by pushing the connector until you hear a "clicking" sound
9. Charging begins automatically (Ensure the charge indicator light **I** is illuminated on your instrument cluster, indicating the vehicle is charging)

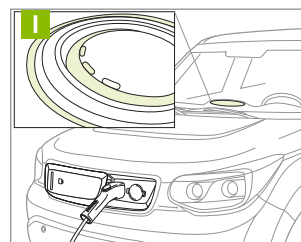
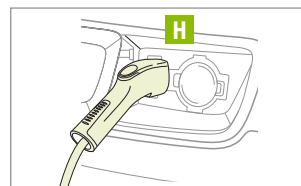
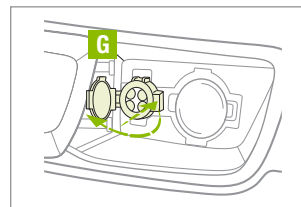
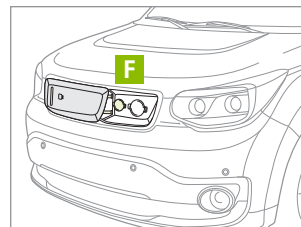

(Normal/trickle charge shown)

QR CODE

EV Charging, Charging Station Search Video

To view a video on your mobile device, snap this QR Code or visit the listed website.

Refer to page 2 for more information.



www.youtube.com/KiaFeatureVideos

Checking the Charging Status

The charging status can be checked by viewing the charging status indicator **I** on the dash panel. The lights will progressively become lit as the vehicle approaches a full charge.

REMINDER: For more detail and/or subsequent steps in charging your vehicle, please see the Owner's Manual.

Charging Your Electric Vehicle (Continued)

Reserved Charging* - Charging times can be set using the UVO EV Services with Premium Navigation* settings when in EV Mode. You can also use the Reserved Charging* App on your smartphone.

Reserved Charging* with the UVO Eco* App:

The UVO Eco* App can help you find the nearest charging station, displays charging-status information and the lists the Reserved Charging* schedule. On your Smartphone, go to an app store or marketplace to download the UVO Eco* App.

REMINDER: When Reserved Charging* is set and the charger is plugged in, charging of the electric vehicle will not begin until the time and date set.

For more information on UVO Eco and using the app refer to the Car Multimedia System User's Manual.*

Deactivate reserved charging - Depress the Deactivate Reserved Charging button* **A** to disable the reserved charging feature when immediate charging is required.

QUICK TIP

When you press the Deactivate Reserved Charge button* for immediate charging, the reserved charge setting is not completely deactivated. If you need to completely deactivate the reserved charge setting, use the UVO EV Services with Premium Navigation* to finalize the deactivation.

REMINDER: For more detail and/or subsequent steps in charging your vehicle, please see the Owner's Manual.

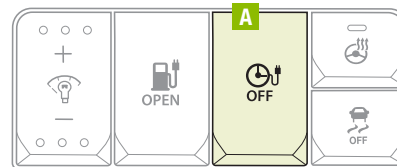

(Buttons located left of steering column)

EV Information Modes – Instrument Cluster

To access the EV Information Mode screen, use the control buttons located on the steering wheel. Press the Mode/Select button **A** to enter.

You can navigate the selections on the screen by pressing the following buttons:

- Use the Mode/Select button **A** for changing modes and setting a selected item
- Use the Move button **B** for changing items

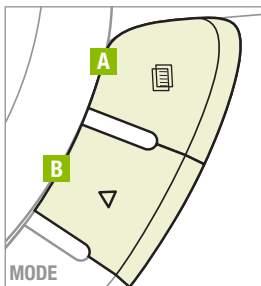

(Buttons located on Steering Wheel)

Soul EV's instrument cluster LCD displays the following EV system screens to inform the driver of the current energy flow and ECO level.

The EV Energy Flow screen notifies the driver of the EV system's energy flow in operating modes.

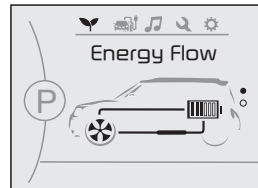

EV Propulsion – Energy flows from high-voltage battery to the wheel when the accelerator pedal is released or the vehicle is driven by motor

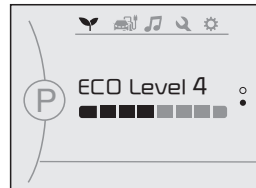

Regenerative Braking – Energy flows from wheel to high-voltage battery when the accelerator pedal is released or the brake pedal is pressed.

The ECO Level screen displays the current ECO driving level. If you drive economically, the ECO level will increase. If you do not drive economically, the ECO level will decrease.

EV System Information - UVO EV Services with Premium Navigation*

EV mode on the UVO EV Services with Premium Navigation* screen allows you to navigate to a total of six menus that include available driving range, nearby charging stations, energy usage, ECO driving, charging and climate settings, and EV settings.

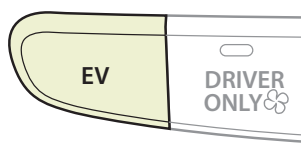

(Button located on Center Panel)

EV button - Press the EV button to access the EV mode screen or press the EV Mode button* on the touchscreen.

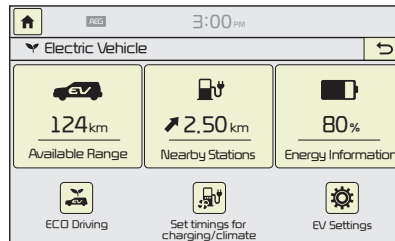

EV mode menu - The EV mode menu allows you to access six EV menus.

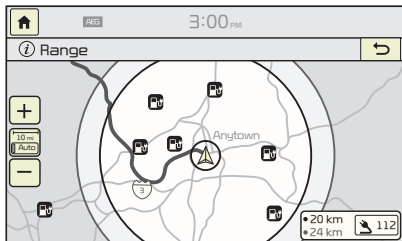

Available range - Displays the available driving distance according to the vehicle's current location and charge amount. Reachable areas are displayed within a green circle. Risky areas are displayed within a red circle. Unreachable areas are displayed in a gray shaded area.

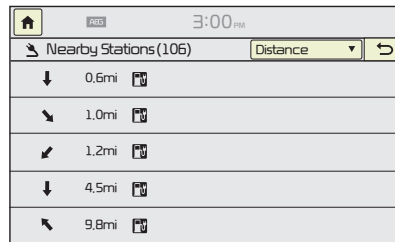

Nearby stations - Displays charging stations near the vehicle's current location. The station locations are categorized as reachable, risky or unreachable areas.

EV System Information - UVO EV Services with Premium Navigation*

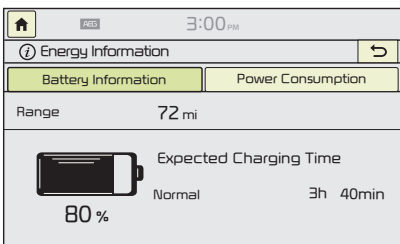

Energy information - Displays battery charge information and electrical power consumption.

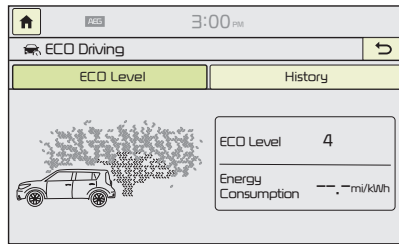

ECO driving - Displays ECO level information and ECO driving history.

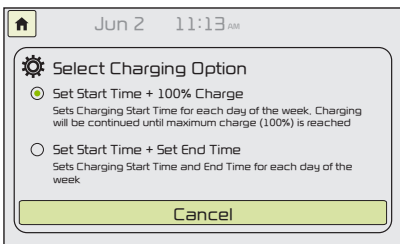

Set timings for charging/climate - Allows you to select the time and date you wish to reserve for automatic charging and automatic climate control.

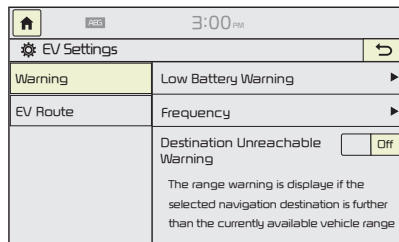

EV Settings - Allows the user to change the EV warning alarm settings.

QR CODE

EV Energy Information AVN Screen Video

To view a video on your mobile device, snap this QR Code or visit the listed website.

Refer to page 2 for more information.



www.youtube.com/KiaFeatureVideos

Instrument Panel Dimmer

With parking lights / headlights ON, press button **A** + or – to adjust display brightness of the instrument panel illumination.

REMEMINDERS:

- Door Mood Lamp is a fixed brightness and cannot be adjusted (not to be confused with Advanced Mood Lighting Speaker)
- The Instrument Panel Dimmer does not adjust brightness on the UVO EV Services with Premium Navigation* screen; use UVO EV Services with Premium Navigation* settings menu to adjust brightness on the screen.

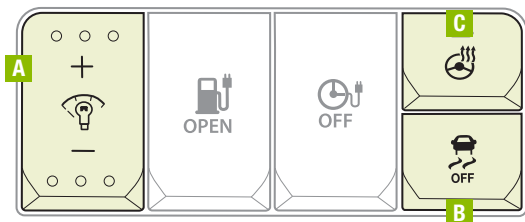

(Buttons located left of steering column)

Electronic Stability Control (ESC)

The ESC system is designed to help stabilize the vehicle during cornering maneuvers. It is a good idea to keep the ESC turned ON for daily driving whenever possible.

Press ESC button **B** to turn ESC OFF/ON.

REMEMINDERS:

- ESC is turned ON by default at vehicle start-up. If vehicle power is cycled, ESC will turn ON again
- The ESC Indicator Light in the instrument cluster will be lit momentarily whenever the ESC is active

Heated Steering Wheel Button

Press button **C** to turn ON/OFF steering wheel heater, while the Engine Start/Stop Button is in the ON position. Steering wheel heater will turn off automatically in 30 minutes, or when button is pressed again to deactivate.

QUICK TIP

If ignition is turned OFF, then ON again, within 30 minutes of steering wheel heater being turned on, system will automatically be set ON again.

Hill-Start Assist Control (HAC)

HAC helps prevent the vehicle from rolling backward when accelerating from a stop while on a steep incline. The HAC automatically activates whether the ESC is OFF or ON but does NOT activate when the ESC has malfunctioned.

REMEMINDER: The HAC does not operate when the gear shift is in the P (Park) or the N (Neutral) position.

QUICK TIPS

- HAC provides a 2-second delay before the vehicle may start rolling backwards
- When HAC is active (e.g., accelerating from a stop on an incline), you may notice that the brakes will momentarily remain engaged after you depress the accelerator

Power Windows, Window Lock & Central Door Lock

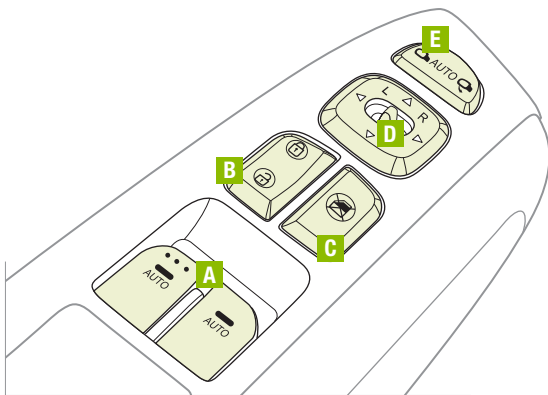

A Pull/Press to operate Driver's and Front Passenger's window Auto Up/Down

B Press to Unlock/Lock All Doors

C Press to disable Rear Passenger Windows

REMINDER: When button **C** is pressed, window controls for the Rear Passenger Windows are disabled.

Button configuration may vary depending on vehicle model.

Automatic Door Lock/Unlock

Auto Door Lock/Unlock will engage when the gear shift is moved in to or out of the P (Park) position. Refer to the User Settings in the LCD Instrument Cluster modes on how to turn Auto Door Lock/Unlock ON/OFF.

Heated Outside Mirrors*

Mirror heaters automatically turn ON/OFF at the same time the Rear Window Defroster is turned ON/OFF. Rear Window Defroster button* is located on climate control system panel.

Power Folding Outside Mirrors*

Toggle switch **D** left or right to select mirror. Then press arrows to adjust mirror position.

Toggle button **E** left/right to unfold/fold the outside rearview mirrors.

Toggle button **E** to center to automatically fold/unfold mirrors when:

- The Smart Key Lock/Unlock buttons are pressed
- The door outside handle button is pressed

REMINDEES:

- To automatically fold mirrors when exiting vehicle, press the LOCK button on the Smart Key
- To lock position of mirrors, toggle switch to the neutral (center) position

QUICK TIP

The mirrors will automatically unfold when the Smart Key* is within close proximity to the vehicle.

Tilt/Telescoping Steering Wheel

To adjust the Steering Wheel, push down the lock-release lever **A** and adjust the desired angle **B** and then the distance **C**.

When finished, pull up the lock-release lever **A** to lock Steering Wheel in place.

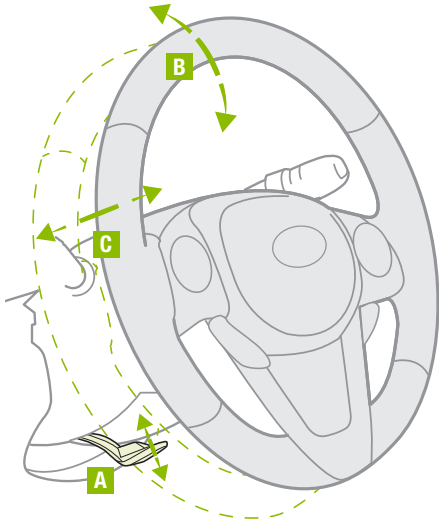

QUICK TIP

It may be helpful to pull/push bottom of Steering Wheel towards/ away from you to adjust desired distance.

Headlights & High Beams

To operate:

- Rotate lever to change the Headlight function
- Push lever to turn High Beams ON
- Pull lever to flash Headlights / High Beams

AUTO Light function — When the light switch is in the AUTO Light position, the tail lights and headlights will turn ON/OFF automatically, depending on the amount of light outside the vehicle.

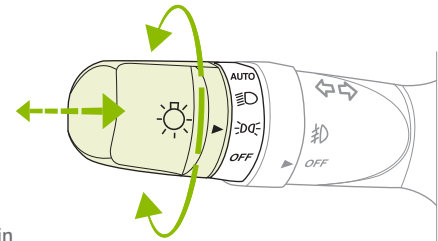

AUTO	Automatic Headlights position
☰	Parking light position
☰☑	Headlight position
OFF	OFF position

Turn Signals & Fog Lights*

To operate:

- Turn Signals - Move lever Up/Down for Right/Left Turn Signal
- Fog Lights - Rotate lever ring to turn Fog Lights ON/OFF

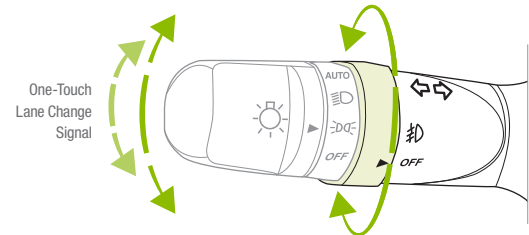

One-Touch Lane Change Signal is activated by moving the Turn Signal Lever slightly for less than 1 second and then releasing. The lane change signal will blink 3 times.

To change how many times (3/5/7) the Lane Change Signal blinks, go to User Settings Mode* in the LCD Instrument Cluster modes (Type B cluster).

For more information on the User Settings Mode, please refer to your Owner's Manual.

Windshield Wipers & Washers

To operate:

- Move lever Up/Down to change Wiper modes
- Rotate INT Switch to adjust Intermittent Wipe Speed
- Pull to spray and wipe

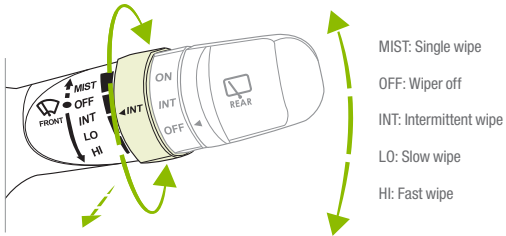

QUICK TIPS

- Rotating Int Switch up increases Intermittent wipe frequency and wipe speed. Rotating Int Switch down decreases frequency of wipes.
- Set the wiper to OFF position when the wiper is not in use

Rear Wiper & Washer

To operate:

- Rotate Rear Wiper switch to change Wiper modes
- Push to spray and wipe
- Push lever for brief wipe

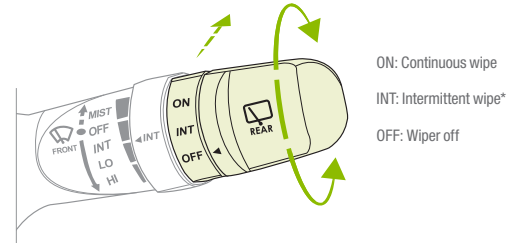

QUICK TIP

On Rear Wipers, intermittent wipe function is not adjustable.

FlexSteer™ Steering Wheel Mode

Select the desired steering mode by toggling through the steering modes.

- Press FlexSteer™ Steering Wheel Mode button **A** to display the steering mode on the LCD screen
- Then press the button **A** again within 4 seconds to switch modes

Your vehicle's steering wheel buttons may differ from those in the illustrations. See your Owner's Manual for more details.

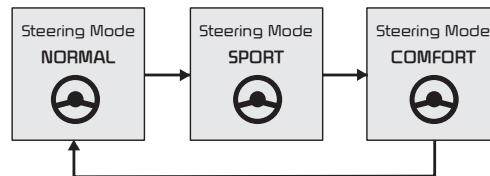
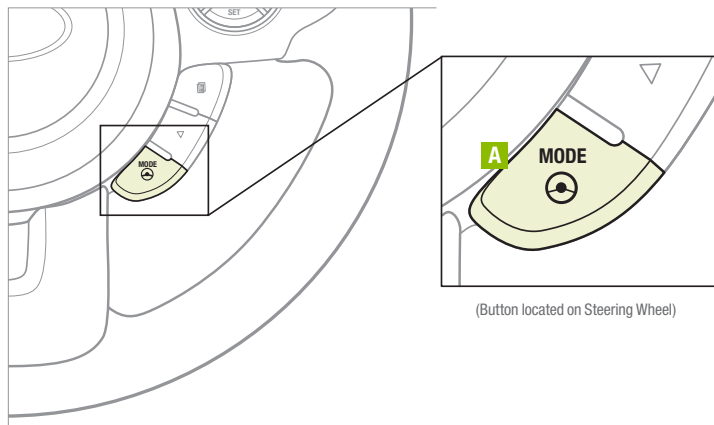

QR CODE

FlexSteer™ Steering Wheel Mode Video

To view a video on your mobile device, snap this QR Code or visit the listed website.

Refer to page 2 for more information.



www.youtube.com/KiaFeatureVideos

Audio Controls

Cruise Control

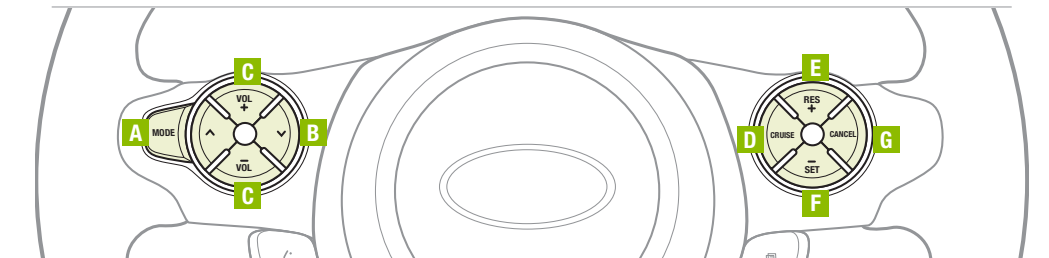

A Audio MODE button: Press to cycle through FM/AM/SiriusXM®/Media (USB, iPod®, Aux, BT Audio, My Music)

B Seek/Preset buttons

Radio Mode: Press to advance through Preset Stations. Press and hold to Auto Seek

Media Mode: Press to move track up/down. Press & hold to forward/rewind

C Volume buttons: Press **VOL+** to raise volume or **VOL-** to lower volume

QUICK TIPS

- Mute audio - To mute the audio system, hold the **VOL-** button **C**
- Pressing the Audio Mode button for more than 1 second will turn Audio Mode ON/OFF.

Your vehicle's steering wheel buttons may differ from those in the illustrations. See your Owner's Manual for more details

Driving while distracted is dangerous and should be avoided. Drivers should remain attentive to driving and always exercise caution when using the steering-wheel-mounted controls while driving

For further audio system operations, refer to page 24.

D CRUISE Control On/Off button: Press to turn the Cruise Control ON/OFF

E Resume Cruising Speed buttons: Press **RES+** to resume or increase Cruising Speed

F Set Cruising Speed button: Press **RES-** to set or decrease Cruising Speed

G Cruise Control CANCEL button: To cancel Cruise Control, do one of the following:

- Press the brake pedal
- Press the CANCEL button

QUICK TIPS

- Cruise Control is designed to function above 25 mph.
- The Cruise Control system will not activate until the brake pedal has been depressed at least once after ignition ON or engine starting

Bluetooth® Wireless Technology

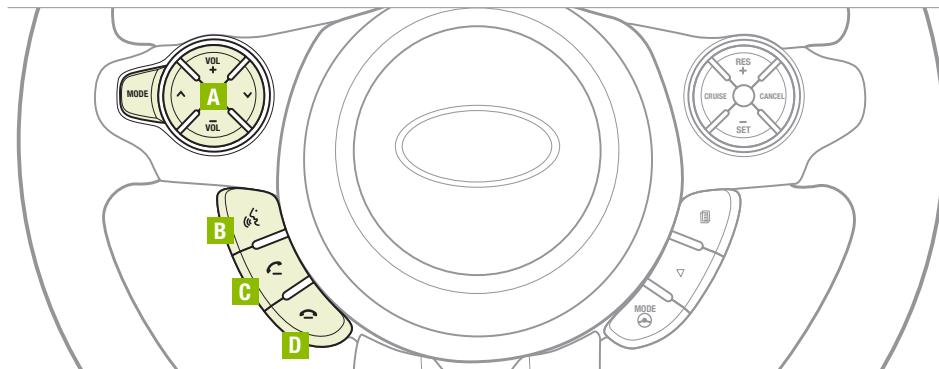

A Volume buttons: Press **VOL +** to raise volume or **VOL -** to lower speaker volume

B Talk button: Press to activate voice recognition / bring up menus / place calls

QUICK TIPS

- Mute audio or a call - To mute the audio system or a call, hold the **VOL -** button **A**
- When using the voice command feature, wait for the system BEEP before speaking the command.

C Receive/Place Call button: Press to receive/place/transfer calls.

D End Call button: Press to end a call or cancel a function

REMINDERS:

- Microphone is located in the overhead console
- Your vehicle's steering wheel buttons may differ from those in the illustrations. See your Owner's Manual for more details

QUICK TIPS

- Phonebook transfer upload time varies by phone model and with number of phonebook entries
- Because of differences in phone quality, service providers and **Bluetooth®** Wireless Technology chip programming, functionality may differ from one phone to another

Driving while distracted is dangerous and should be avoided. Drivers should remain attentive to driving and always exercise caution when using the steering-wheel-mounted controls while driving.

*For more information, if equipped, refer to the Car Multimedia System User's Manual or the Owner's Manual. For Bluetooth® Wireless Technology FAQs, go to www.kia.com, Owners section, or call Consumer Information for Bluetooth® Technology at (800) 333-4KIA. Refer to your Owner's Manual for more specific **Bluetooth®** Wireless Technology phone pairing and operation instructions.*

Bluetooth® Wireless Technology (Continued) Pairing a Phone

For instructions on how to pair a phone, refer to the audio system's user's guide or your vehicle's Quick Start Guide.

QUICK TIP

During the pairing process, be sure to accept the connection requests on the phone for phonebook download and to allow acceptance of all future **Bluetooth®** connection requests.

How to Place a Call

When using the voice command feature, wait for the system BEEP before speaking the command.

There are two options for placing a call:

Standard Audio System*

- Option 1: Press the Receive/Place Call button **C** (system will prompt you through call process)
- Option 2: Press the Talk button **B** (system will BEEP to indicate it is ready for call placement). Then say the command "Call {name}" or "Dial {number}"

UVO EV Services with Premium Navigation*

- Option 1: Press the Receive/Place Call button **C** (displays the phone screen with number keypad or call history)
- Option 2: Press the Talk button **B**. Then say the command "Call {name}" or "Dial {number}"

Voice Recognition and Phone Contact Tips

To help optimize the **Bluetooth®** Wireless Technology Voice Recognition system, below are some tips and reminders. Improve the performance by making a few simple changes to your phone contacts:

- Use full names (first and last names) vs. short or single-syllable names ("John Smith" vs. "Dad," "Smith Residence" vs. "Home")
- Avoid using special characters, emoji's or hyphenated names (@, &, #, /, -, *, +, etc.)
- Avoid using acronyms ("In Case of Emergency" vs. "ICE") or words with all capital letters
- Spell words completely, no abbreviations ("Doctor Smith" vs. "Dr. Smith")

The system may have difficulty understanding some accents or uncommon names. Below are other tips to optimize using the voice recognition.

QUICK TIPS

- When placing a call, speak in a natural, moderate tone, with clear pronunciation. The system may have trouble recognizing commands if you speak too soft or too loud
- Always wait for the beep before speaking any commands
- Close windows and sunroof and turn off A/C - Open windows, sunroof, weather (wind/rain), or an A/C fan operating at higher speeds can interfere with Voice Recognition
- Press the talk button and say "Help" to get a list of available commands

QR CODE

Voice Recognition Tips Video

To view a video on your mobile device, snap this QR Code or visit the listed website.

Refer to page 2 for more information.



www.youtube.com/KiaFeatureVideos

Standard Audio System*

FM/AM/SiriusXM®/Media (USB, iPod®, Aux, *Bluetooth*® Audio, My Music)

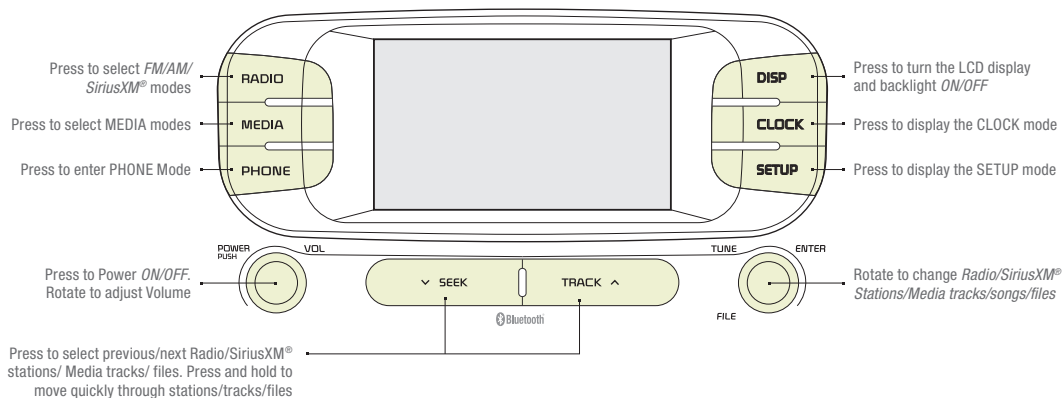

QR CODE

Standard Audio System Videos

To view a video on your mobile device, snap this QR Code or visit the listed website.

Refer to page 2 for more information.



www.youtube.com/KiaFeatureVideos

Audio System Set-up Options

Press the SETUP button, then use the TUNE knob to cycle through the available settings for each equipped audio option. Press the TUNE knob to adjust the audio option selected. Audio options may include the following:

- Display settings - Mode, Illumination
- Sound settings - Position, Tone, Speed Dependent Volume, Beep
- *Bluetooth*® settings: Connections, Auto Connection Priority, Download Contacts, *Bluetooth*® Voice Prompts
- Date/Time settings - Set Time, Time Format, Set Date
- System settings - Memory Information, Language, Default, System Information

To adjust the Sound settings (bass, middle, treble, fader, balance) – When in the SETUP menu, select Sound and then Sound Setting. Adjust the settings by pressing the onscreen arrows and then return to exit.

Your vehicle's audio system may differ from that in the illustration. See your Owner's Manual for more details.

For further audio system operations, refer to pages 25-26.

UVO EV Services / Android Auto™ / Apple CarPlay® Setup*

UVO EV Services Registration/Activation – To use UVO EV Services:

1. Go to your vehicle and from your vehicle's audio control unit, select the UVO menu.
2. Then select the UVO settings menu and press the Activate button to register your vehicle.
3. After completing the in-vehicle registration, on your smartphone go to the app store or marketplace to download the free Kia UVO eco app.

Android Auto™*

Setting up Android Auto™:

1. From an Android Auto™ compatible device, download the Android Auto™ app from the Google Play™ Store.
2. Open the Android Auto™ app and proceed with the on-screen instructions to complete setup on the mobile device.

How to start Android Auto™:

1. Press the SETUP key on your audio control unit's control panel.
2. Press the PHONE PROJECTION button  or CONNECTIVITY button, select Android Auto™ then select ENABLE ANDROID AUTO. Accept all terms, conditions and requests on the head unit and phone in order to use Android Auto™.
3. Connect the Android™ device with the vehicle's USB port using the manufacturer's cable provided with your phone.
4. From the vehicle's home screen, select the Android Auto™ button, where you'll see all the Android Auto™ supported apps.

For further UVO EV Services System operations, refer to the Car Multimedia System User's Manual. For other audio system information, refer to pages 24-26.

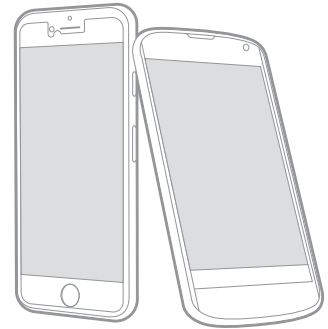

Apple CarPlay®*

Setting up and starting Apple CarPlay®:

1. Connect the Apple CarPlay® compatible iPhone with the vehicle's USB port using the manufacture's cable provided with your iPhone.
2. On the audio control unit's control panel, press the SETUP key.
3. Press the PHONE PROJECTION button  or CONNECTIVITY button on the screen and select Apple CarPlay®.
4. Select ENABLE APPLE CARPLAY. Accept all terms, conditions and requests on the head unit and phone in order to use Apple CarPlay®.
5. From the vehicle's home screen, select the Apple CarPlay® button, where you'll see all the Apple CarPlay® supported apps

REMINDERS:

- Android Auto compatibility requirements: Micro-USB cable that came with your phone, OS Android™ 5.0 or higher, compatible Android smartphone and data and wireless plan for applicable feature(s).
- Apple CarPlay compatibility requirements: Apple Lightning® cable, latest iOS software, iPhone 5 or later and data and wireless plan for applicable feature(s)
- It is recommended to always update your phone to the latest operating system release

UVO EV Services with Premium Navigation*

FM/AM/SiriusXM®/Media (USB, iPod®, Aux, Bluetooth® Audio, My Music)

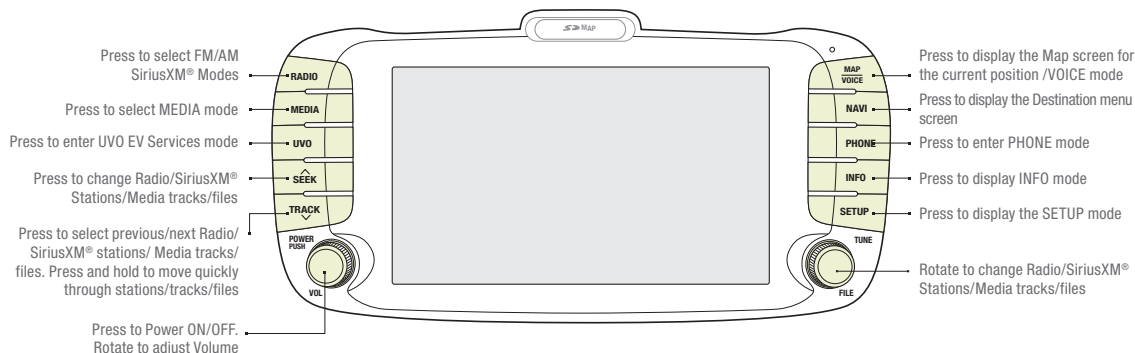

Sound Settings:

To adjust the audio control unit's sound settings:

1. Press the SETUP key on the audio control unit or the on-screen MENU button, when in MEDIA mode.
2. Select the on-screen SOUND button, or SOUND SETTINGS
3. Select the menu item (Position, Tone, Priority, Advanced)
4. Use the onscreen buttons to adjust settings
5. Press the return button \Rightarrow to save settings

Your vehicle's audio system may differ from that in the illustration. For further operational information and using the app, refer to the Car Multimedia System User's Manual. For other audio system information, refer to pages 24-25.

QUICK TIPS

- Navigation may be available when connected to Android Auto™ or Apple CarPlay® supported smartphones
- At any time, you can interrupt Command Feedback by pressing the TALK button
- When using the voice command feature, wait for the system BEEP before speaking the command
- Prolonged use of the audio control unit in ACC mode may drain the vehicle's battery.
- A warning screen may appear periodically to remind users that the audio control unit should be operated with the engine running to prevent battery discharge

REMINDER: The registered MyUVO.com account is activated for five years with no charges. When it expires, go to MyUVO.com and register for the plan of your choice

Automatic Climate Control

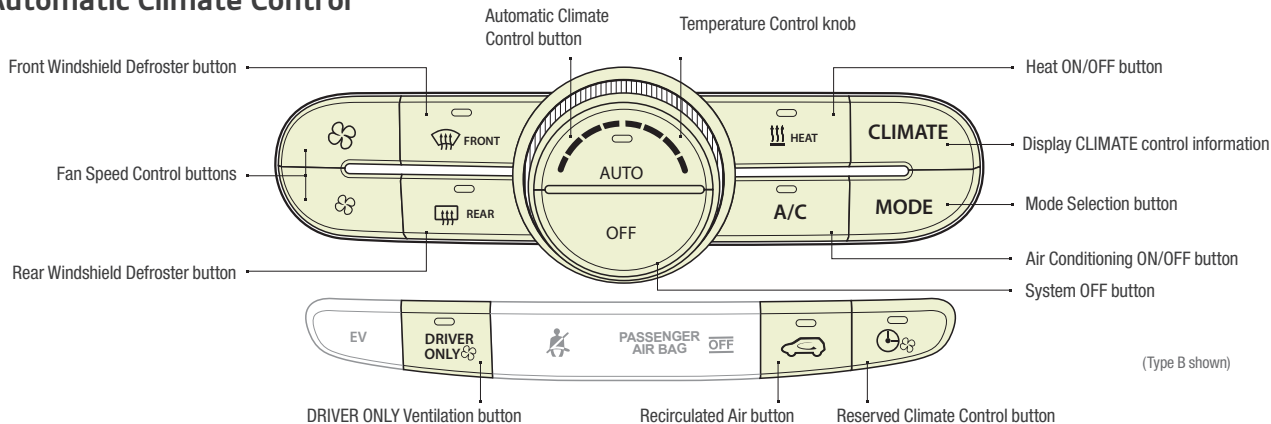

Air Flow Modes

To select Air Flow Modes, press the Mode selection buttons:

-  Face-Level
-  Bi-Level
-  Floor-Level
-  Floor/Defrost-Level

Climate Control Auto Function:

1. Press **AUTO** to select Full Auto Operation - The Auto setting automatically controls the airflow modes, fan speeds, air intake and air conditioning according to the temperature setting selected

Defrost Outside Windshield:

1. Set **Fan Speed** to the highest position
2. Set **Temperature** to **Hot**
3. Press the **Defrost button** 

Defog Inside Windshield:

1. Set desired fan **Fan Speed**
2. Set desired **Temperature**
3. Press the **Defog button** 

QUICK TIPS

- Keep inside glass as clean as possible to reduce window fogging
- Defrost  Mode activates A/C and opens Fresh Air Vent
- During Auto Operation, the A/C indicator will NOT illuminate. The fan speed, air intake, air flow and air conditioning may automatically engage at any time to reach desired temperature and reduce humidity

REMINDERS:

- Pressing any button during AUTO operation will deactivate the AUTO function and switch to manual mode, except for Temperature Control
- Warm air may flow in through vents if Recirculated Air button is not pressed ON (LED lit)
- When in AUTO mode, Air Flow Mode and Fan Speed do not display on the Climate Control Display

Your Automatic Climate Control system may differ from those in the illustrations. See your Owner's Manual for more details.

Driver Only Ventilation

Driver Only Ventilation restricts air flow to the driver's side vents only. This helps to optimize driving range by limiting the power drawn from the battery.

Press DRIVER ONLY button **A** to enable air flow through the driver's side vents only.



(Buttons located on Center Panel)

Digital Clock

Standard Audio System* Clock Setup:

1. Press the SETUP button
2. Rotate knob to select Clock mode, then press to enter
3. Rotate knob to adjust Hour, then press to enter
4. Rotate knob to adjust Minute, then press to enter

UVO EV Services with Premium Navigation* Clock Setup:

Press the SETUP key, then the CLOCK button to display the Clock setting screen. Then use the on-screen buttons to navigate through setup.

QUICK TIP

Daylight Savings must be enabled or disabled in the Clock Settings screen. To access manual date and time setting, turn GPS Time OFF in the Clock Settings (UVO EV Services with Premium Navigation*)

Reserved Climate Control*

Reserved Climate Control* is designed to pre-cool or heat the vehicle's interior to the preferred temperature while the vehicle is plugged into a charger.

When Reserved Climate Control* is set and the charging cable is connected, climate control begins operating 30 minutes before the set departure time.

Press the Reserved Climate Control* button **B** to display the settings for appointed ventilation on the UVO EV Services with Premium Navigation*.

The Reserved Climate Control* can also be set using the UVO Eco App.

For more information, refer to the Owner's Manual or the Car Multimedia System User's Manual.

Aux/USB/iPod® Port & Power Outlets

Aux/USB/iPod® Port **C**

Use the Aux port to connect audio devices and the USB port to connect USB audio devices, smartphones and iPod® devices.

If equipped, additional power outlets are located inside the center console.

Power Outlets **D**

Use the power outlets for mobile phones and other devices designed to operate on a 12V (180W max) power outlet.

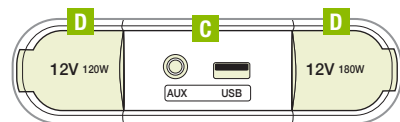

(Located on lower part of Center Panel)

REMINDERS:

- For the Tire Mobility Kit, only use the **12V/15A/180W** Power Outlet, located on the right side of the outlet/aux. port area.
- Using the power outlets (accessory plugs) for prolonged periods of time with the POWER button in the ACC position (Power OFF) may cause the battery to discharge
- Use manufacturer cables only that came with your device. Third party cables may cause damage to device

QR CODES

EV A/C and Driver Only Ventilation Video

To view a video on your mobile device, snap this QR Code or visit the listed website.

Refer to page 2 for more information.



www.youtube.com/KiaFeatureVideos

QUICK TIP

The power outlets are inactive when ignition is in the OFF position.

For more information on the Aux/USB/iPod® Port & Power Outlets, refer to the Owner's Manual.

*IF EQUIPPED

Power Button

To start the vehicle:

1. Turn off all electrical devices
2. Depress the brake pedal
3. Press the POWER button while gear shift is in P (Park)

When Ready Indicator Light  is ON (located in the top left corner of the LCD screen of the Instrument Cluster), the vehicle can be driven.

To turn the power off, press the POWER button again, and ensure the gear shift is in (P) Park.

To use the POWER button, you must have the Smart Key fob on your person or inside the vehicle.

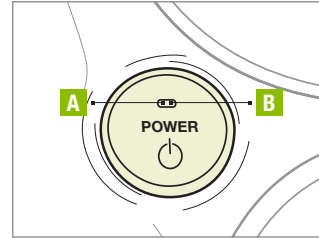

QUICK TIPS

To use electrical accessories:

Accessory position

- When in the OFF position (no light) and without depressing the brake pedal, press the POWER button once (Amber light **A**)

On position

- When already in the ACC position (Amber light **A**) and without depressing the brake pedal, press the POWER button again (Reddish-orange light **B**)
- When in the OFF position (no light) and without depressing the brake pedal, press the POWER button twice (Reddish-orange light **B**)

Keeping the vehicle in ACC or the ON position without driving may discharge the vehicle's battery.

REMINDERS:

- When the Ready Indicator Light is illuminated, the vehicle can be operated
- Do not operate the vehicle if the Ready Indicator Light is not illuminated
- In an emergency situation while the vehicle is in motion, you are able to turn the vehicle off by pressing the Power button for more than 2 seconds or 3 times within 3 seconds
- If Smart Key fob battery is dead, with the lock button facing the POWER button, hold the fob up against the POWER button and press

For more info and detail steps on how to start the vehicle, please refer to the Owner's Manual.

ALWAYS CHECK THE OWNER'S MANUAL FOR COMPLETE OPERATING INFORMATION AND SAFETY WARNINGS.

QR CODE

EV Power Button and Smart Key Video

To view a video on your mobile device, snap this QR Code or visit the listed website.

Refer to page 2 for more information.



www.youtube.com/KiaFeatureVideos

Electronic Parking Brake (EPB)

The Electronic Parking Brake (EPB) system utilizes an electric motor to engage the parking brake.

Applying the Parking Brake

Depress the brake pedal and pull up the EPB switch **A**. Ensure that the indicator light  is illuminated on the instrument cluster.

Releasing the Parking Brake

The EPB will automatically release when the shifter is placed in Reverse or Drive.

To release EPB manually, depress the brake pedal, then press the EPB switch **A**, with the ignition switch in the ON position. Ensure that the indicator light  is OFF.

REMINDERS:

- EPB will not release unless the hood, liftgate and all doors are closed and seat belts are fastened
- As a bulb check, the EPB malfunction indicator will illuminate for approximately 3 seconds when the ignition switch is turned ON
- If the warning light does not illuminate temporarily, or continues to remain lit, take your vehicle to an authorized Kia dealer and have the system checked
- The EPB should not be operated while the vehicle is moving
- A click or electric brake motor sound may be heard while operating or releasing the EPB, but these conditions are normal and indicate that the EPB is functioning properly

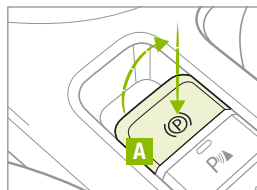

(Located below Gear Shift)

QR CODE

Electronic Parking Brake Video

To view a video on your mobile device, snap this QR Code or visit the listed website.

Refer to page 2 for more information.



www.youtube.com/KiaFeatureVideos

QUICK TIPS

- When leaving your keys with parking lot attendants or valet, make sure to inform them how to operate the EPB
- If parked on a steep incline/decline, pull up the EPB switch for more than 3 seconds for a firmer EPB application
- Pull up and hold EPB switch again to increase brake pressure if parked on a decline or incline

Automatic Gear Shift with Regenerative Brake Mode

- P:** Park
- R:** Reverse
- N:** Neutral
- D:** Drive
- B:** Regenerative Brake Mode

Regenerative Brake Mode “B” – Move the gear shift to the “B” position **A** to enter the maximum regenerative braking drive mode. This mode helps to minimize energy loss and increase the distance to empty.

For more information on Regenerative Brake Mode, refer to the Owner’s Manual.

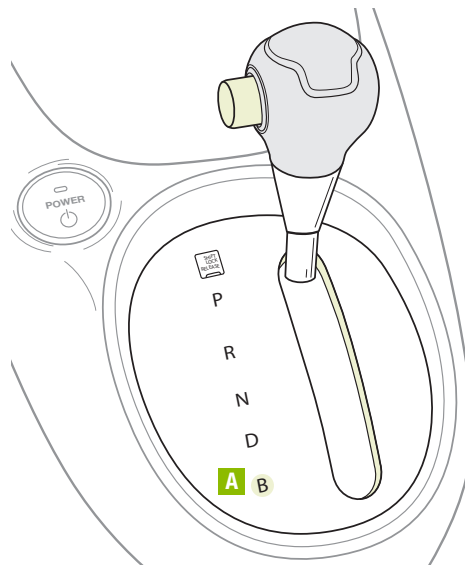

QR CODE

EV Regenerative Braking Video

To view a video on your mobile device, snap this QR Code or visit the listed website.

Refer to page 2 for more information.



www.youtube.com/KiaFeatureVideos

Seat Warmers / Ventilated Seats*

Seat Warmers – Press top of button once for high setting (3 LEDs lit). Press button twice for medium setting (2 LEDs lit). Press a third time for low setting (1 LED lit) and again to turn OFF.

Ventilated Seats – Press bottom of button once for high setting (3 LEDs lit). Press twice for medium setting (2 LEDs lit). Press a third time for low setting (1 LED lit) and again to turn OFF.

Seat Warmers*

Press button once for high setting (2 LEDs lit). Press button twice for low setting (1 LED lit). Press again to turn OFF.

QUICK TIPS

- System turns OFF when ignition is cycled. To turn system ON, press the seat warmer switch
- With the seat warmer switch in the ON position, the heating system in the seat turns off or on automatically depending on the seat temperature

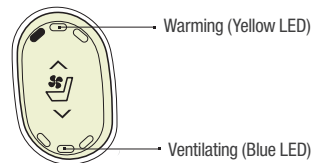

(Buttons located on Center Panel)



(Buttons located on Center Panel)

QR CODE

Heated and Ventilated Seats Video

To view a video on your mobile device, snap this QR Code or visit the listed website.

Refer to page 2 for more information.



www.youtube.com/KiaFeatureVideos

6-Way Adjustable Driver's Seat

Pull lever **A** to slide Seat forward/backward

Pull/press lever **B** up/down one or more times to adjust Seat height.

Pull lever **C** to adjust Seatback Recline

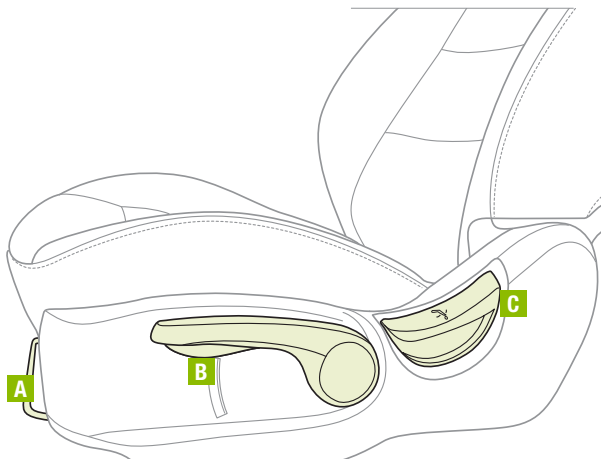

QUICK TIP

When adjusting seat forward or backwards, ensure seat clicks or locks into place before driving the vehicle.

Front Seat Headrest Adjustment

To adjust headrest forward*: Pull headrest forward to one of several positions.

To adjust headrest back*: Pull headrest completely forward, then release.

To raise headrest: Pull headrest up.

To lower headrest: Press lock, then press the headrest down.

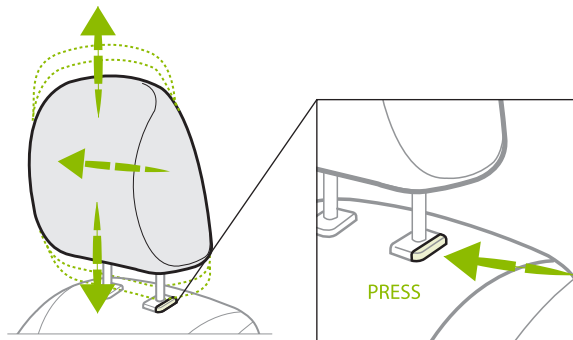

QUICK TIP

For easy adjustments, hold a headrest post with one hand while using the other hand to pull the headrest from underneath.

Folding Rear Seatback

To Fold:

1. Adjust the Front Seatback in the upright position and/or slide the Front Seat forward
2. Insert the rear seat belt strap into the clip located on the side panel next to the Seatback
3. Lower the Rear Headrests to the lowest position
4. Pull on the Rear Seatback folding lever **A**, then fold the seat towards the front

REMINDER: Always make sure the seat back is locked in place (clicks) when unfolded.

To Unfold:

1. Lift and pull the Seatback backward by pulling on the folding lever **A**. Pull the Seatback firmly until it clicks and is locked into place
2. Return the rear seat belt to the proper position

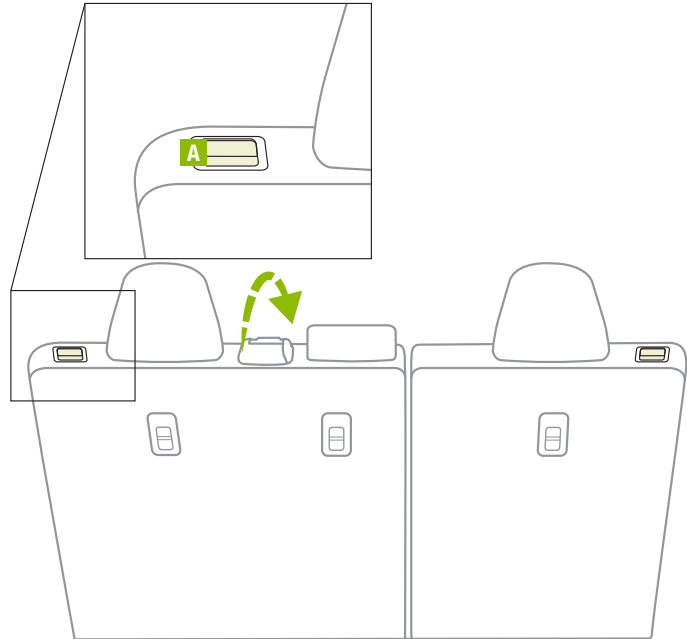

Smart Key

- A** Press to lock All Doors
- B** Press to unlock Driver's Door. Press twice in 4 seconds to unlock All Doors
- C** Press and hold to unlock Liftgate. Then lift lid by the handle to manually open Trunk

REMINDER: The Liftgate unlocks when the Smart Key fob is within close proximity of the vehicle.

- D** Press and hold more than 1 second for Panic Alarm. To turn off Alarm, press any button
- E** Press to release Mechanical Key (Button located on back of Smart Key)

Driver's Door Lock/Unlock button **F**:

- Press button once to unlock driver's door
- Press again within 4 seconds to unlock all doors
- Press again to lock all doors

Mechanical Key **G**:

- Use to unlock driver's door
- Use to turn Child-Protector Rear Door Locks

For more information on the Mechanical Key, please refer to your Owner's Manual.

Double-Turn Lock/Unlock All

- Turn counterclockwise once to unlock Driver's Door
- Turn counterclockwise again within 4 seconds to unlock All Doors
- Turn clockwise once to Lock All Doors

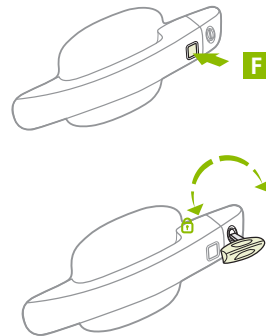

QR CODE

EV Power Button and Smart Key Video

To view a video on your mobile device, snap this QR Code or visit the listed website.

Refer to page 2 for more information.



www.youtube.com/KiaFeatureVideos

QUICK TIP

The Smart Key's signal can be blocked by the normal operation of a cell or smart phone. To help prevent this, store each device separately.

REMINDER: Remote button configuration may vary depending on vehicle options.

Panoramic Sunroof Operation*

The sunroof and sunshade operation is controlled through a multi-directional switch/lever **A**.
The ignition needs to be in the ON position to operate the Sunroof and Sunshade.

Slide the Sunshade and Sunroof:

- Auto Open: Slide lever **A** backward to the farthest position and release
- Auto Close: Slide the lever **A** forward to the farthest position and release

Slide the Sunshade:

- Auto Open: Slide the lever **A** partially backward to the first detent position
- Auto Close: Slide the lever **A** forward to the farthest position

Slide the Sunroof (with Sunshade open):

- Open: Slide the lever **A** backward and release
- Auto Close: Slide the lever **A** forward to the first detent position or pull the lever downward

Tilt the Sunroof:

- Raise: Push lever **A** upward
- Lower: Pull lever **A** downward
- Auto Close Sunroof and Sunshade: Slide the lever **A** forward to the farthest position

REMINDERS:

- Sunshade needs to remain OPEN while sunroof is open and vehicle is moving
- Sunshade cannot slide when it is in the tilt position or tilt while in an open or slide position

QUICK TIP

To stop the Sunroof/Sunshade at any position, push or pull the sunroof control lever **A** in any direction.

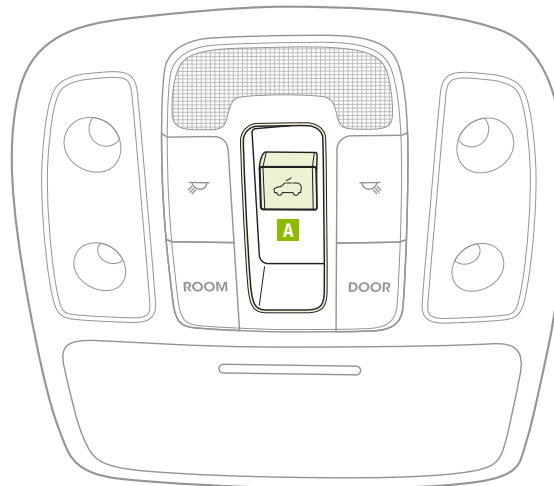

Sunroof Open Warning*

If the Sunroof is not fully closed, the warning will chime and display on the LCD screen* when:

- The ignition is turned off (Smart Key*)
- The ignition key is removed
- The driver's door is opened

Map/Room Lamps

Push the lens **A** to turn the Map Lamp ON/OFF. This light produces a spot beam for convenient use as a map lamp or personal lamp for the driver or front passenger.

When the DOOR button **B** is pressed, the Map Lamp turns ON when any door is opened.

When the ROOM button **C** is pressed, the Map and Room Lamps turn ON.

Room Lamp

When the Room Lamp button **D** is pressed, the lamp turns ON.

Automatic turn off function*

The interior lights automatically turn off approximately 30 seconds after the Engine System Start/Stop button* is OFF.

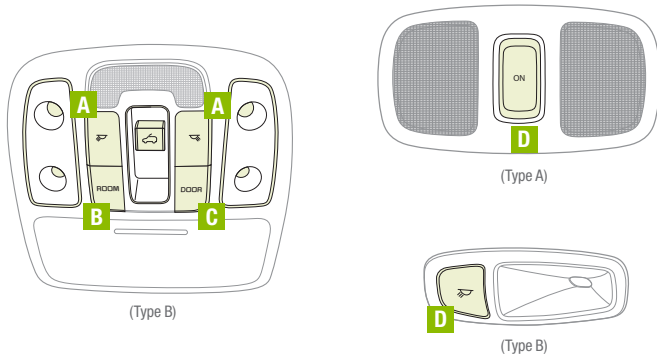

QUICK TIPS

- When doors are unlocked by the Smart Key*, the lamp turns ON for approximately 30 seconds
- If your vehicle is equipped with the theft alarm system, the interior lights automatically turn off approximately 3 seconds after the system is in armed stage
- Using interior lights for an extended period of time may cause battery discharge

Sunvisor

Use the Sunvisor to shield direct light through the front or side windows. Slide the Sunvisor out and adjust as needed.

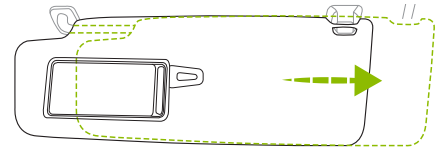

REMINDERS:

- Sunvisor may not shield all direct light
- Do not operate the vehicle if Sunvisor is impairing your visibility
- The Sunvisor may impair visibility if not adjusted properly
- Be aware of seating position when adjusting or swinging Sunvisor around to or from the front or side windows.

Pedestrian Warning System

The Pedestrian Warning System generates engine sound for pedestrians to hear the vehicle since an Electric Vehicle (EV) has no sound when operating.

The Pedestrian Warning System will operate when:

- The EV vehicle is moving at a low speed
- The gear shift is moved to the (R) Reverse position

Rear-Camera Display

The Rear-Camera Display system is not a safety device. It is a supplemental system that displays the view behind the vehicle through the UVO EV Services with Premium Navigation* system screen while the vehicle is in Reverse.

The Rear-Camera Display activates when the:

- Power Start/Stop* button is in the ON position (Red Light) or in READY mode.
- Gear Shift Lever is in the R (Reverse) position

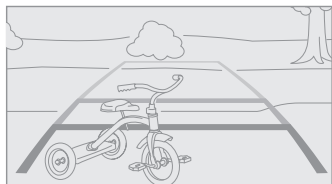

(Rear-Camera Display)

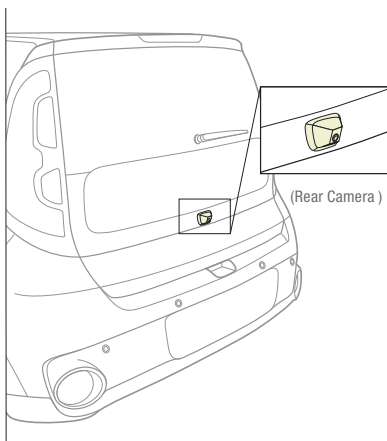

(Rear Camera)

REMINDER: While camera is active, only the volume controls on the Audio System can be operated.

The Rear-Camera Display is not a substitute for proper and safe backing-up procedures. The Rear-Camera Display may not display every object behind the vehicle. Always drive safely and use caution when backing up.

Parking Assist System*

The Parking Assist System* is not a safety device. The Parking Assist System* is a supplemental system that assists the driver by chiming if any object is detected within the sensing areas to the rear and side of the vehicle when backing up.

The Parking Assist system* activates with the POWER button ON and the Parking Assist button **A** pressed (LED illuminated).

When Parking Assist button is OFF and the Gear Shift is placed into R (Reverse), the Parking Assist button turns ON automatically and the system activates.

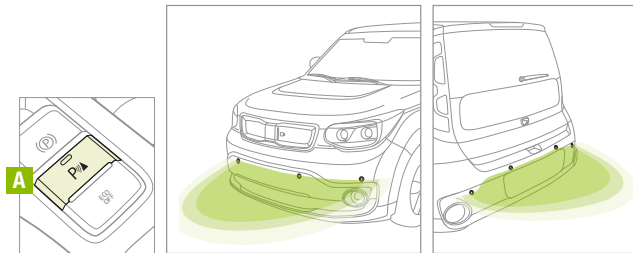

(Located under gear shift)

(Front and rear sensor location shown)

REMINDERS:

- If the vehicle is moving at speeds over 3 mph, the system may not activate correctly
- When more than two objects are sensed at the same time, the closest one will be recognized first
- The above images are for illustration purposes only and may not reflect actual operation

The Parking Assist System is not a substitute for proper and safe parking and backing-up procedures. Always drive safely and use caution when parking and backing up. The Parking Assist System* may not detect every object around the vehicle*

Hood Release Lever and Latch

Opening the Hood:

1. Located on the bottom left of the driver's panel, pull the Hood Release Lever **A** to unlatch the Hood
2. In the front of the vehicle, lift the Hood slightly, push the secondary Latch **B** up inside of the Hood's center and lift the Hood

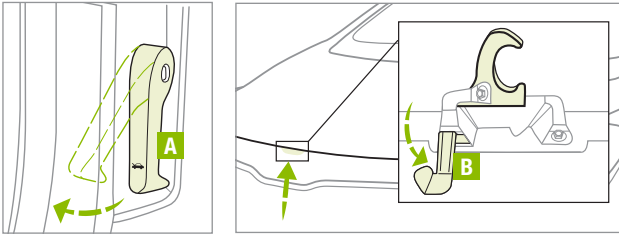

Closing the Hood:

Lower the Hood by pressing the front center of the Hood. Then, press down to securely lock in place.

REMINDER: While lowering and closing, keep hands away from under the Hood

Tire Mobility Kit

The Tire Mobility Kit may temporarily seal certain types of tire damage.

For operational information, please refer to section 6 of your Owner's Manual.

C Sealant Bottle

D Compressor

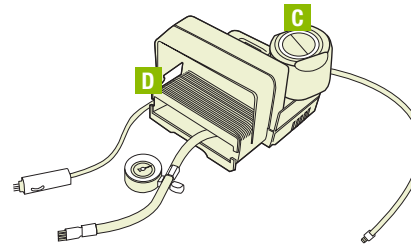

QUICK TIPS

- The Tire Mobility Kit is a temporary fix and is to be used for one tire only; the tire should be inspected as soon as possible
- The kit should only be used for sealing/ inflating passenger car tires; do not use for inflating any other type of tires
- Some damaged tires cannot be sealed completely; do not use the kit if a tire is damaged beyond repair

QR CODE

Tire Mobility Kit Video

To view a video on your mobile device, snap this QR Code or visit the listed website.

Refer to page 2 for more information.



www.youtube.com/KiaFeatureVideos

REMINDERS:

- The Tire Mobility Kit requires the use of the 12V/15A/180W Power Outlet, which is located on the right side of the outlet/aux port area
- After tire is properly sealed, drive cautiously at no more than a total distance speed of 50 mph for no longer than a maximum distance of up to 120 miles

High-Voltage Areas

High-voltage areas are marked with an orange color with warning labels attached.

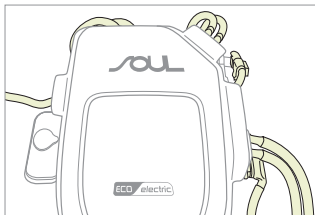

REMINDER: Never touch the high voltage components marked in orange on the vehicle.

Air Inlet

The air inlets **A**, located underneath both front seats, are used to cool the driving battery. For safety reasons, these air inlets should never be blocked. Doing so may cause the battery to overheat.

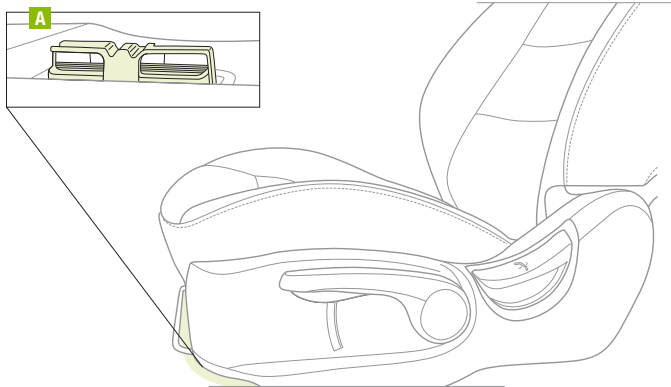

Tailgate Release Button

Button is located underneath the Tailgate lid. With Tailgate unlocked, press the Tailgate Release button **B** and pull the Tailgate lid up by the handle to open.

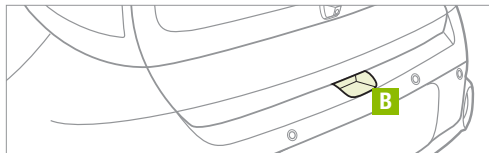

QUICK TIPS

- The Tailgate must be unlocked before it can be opened by the Tailgate Release Button
- The Tailgate unlocks automatically and then can be opened manually when the Smart Key* is within close proximity to the vehicle

Child-Protector Rear Door Locks

Located on the edge of the rear passenger doors, adjust switch **C** to the LOCK position to disable the inner door handles from opening the rear passenger doors.

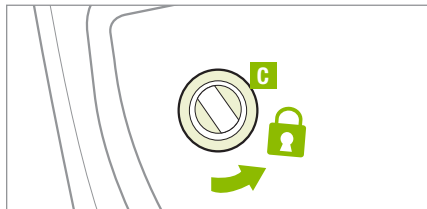

REMINDER: Child-Protector Rear Door Lock is located on rear passenger's door jamb.

Seat Belts

To properly fasten your seat belts:

1. Insert the belt tongue plate **A** into the buckle **B** until it clicks
2. Position the lap portion of the belt across your lap as LOW ON THE HIPS as possible **C**. Adjust the belt to a SNUG FIT by pulling up on the shoulder portion **D**

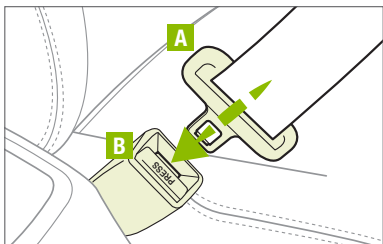

Seat Belt Retractor Locks

- Retractor locks allow lap/shoulder seat belts to remain unlocked during normal vehicle operation for freedom of movement and increased comfort
- During a STRONG STOP, SUDDEN TURN OR CERTAIN COLLISIONS, seat belt retractors will automatically lock the belts to reduce the risk of injury

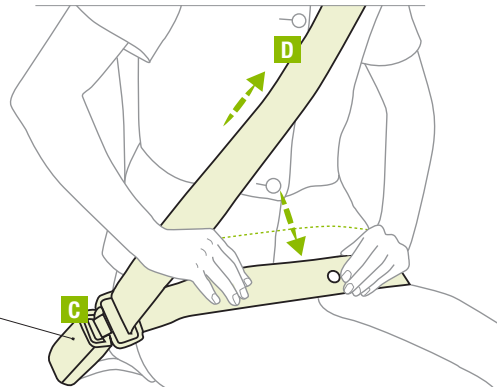

QUICK TIP

The Seat Belt warning chime operates for driver's seat only.

Occupant Detection System (ODS) / PASSENGER AIRBAG OFF Indicator

ODS detects the presence and position of the front passenger and adjusts or turns off airbag deployment accordingly.

Depending on the situation and type of accident, the system may:

- Deploy airbag (Adult)
- Not deploy the airbag (Unoccupied)

If the system determines that the airbag should not be deployed, the "PASSENGER AIRBAG OFF" light will illuminate.

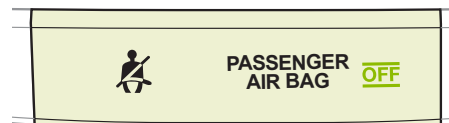

Normal Maintenance Schedule

When your vehicle requires service, remember that your dealer knows your vehicle best. Your dealer has factory-trained technicians, recommended special tools, genuine Kia replacement parts and is dedicated to your complete satisfaction. For expert advice and quality service, see your authorized Kia dealer.

3,750 miles

PERFORM

- Rotate tires - including check tire pressure and tread wear

7,500 miles

PERFORM

- Rotate tires - including check tire pressure and tread wear

REPLACE

- Climate control air filter**

INSPECT*

- Air conditioning compressor, air conditioner refrigerant and performance **
- Cooling system¹
- 12V battery condition
- Brake lines, hoses and connections
- Brake fluid
- Disc brakes and pads
- Suspension ball joints & mounting bolts
- Steering gear rack, linkage and boots
- Brake pedal
- Drive shaft and boots

*Inspect and, if necessary, adjust, correct, clean, or replace ** If equipped

1. When adding coolant, use only deionized water or soft water for your vehicle and never mix hard water in the coolant filled at the factory. An improper coolant mixture can result in serious malfunction or motor compartment damage.

11,250 miles

PERFORM

- Rotate tires - including check tire pressure and tread wear

15,000 miles

PERFORM

- Rotate tires - including check tire pressure and tread wear

REPLACE

- Climate control air filter**

INSPECT*

- Air conditioning compressor, air conditioner refrigerant and performance**
- Cooling system¹
- 12V battery condition
- Brake lines, hoses and connections
- Brake fluid
- Disc brakes and pads
- Suspension ball joints & mounting bolts
- Steering gear rack, linkage and boots
- Brake pedal
- Drive shaft and boots

*Inspect and, if necessary, adjust, correct, clean, or replace **If equipped

1. When adding coolant, use only deionized water or soft water for your vehicle and never mix hard water in the coolant filled at the factory. An improper coolant mixture can result in serious malfunction or motor compartment damage.

QUICK TIP

Check your Maintenance Schedule or schedule an appointment with a dealer using your UVO EV Services account by logging into your UVO Eco App or your account on MyUVO.com (Vehicles equipped with UVO EV Services only - See page 25 for setup).

Normal Maintenance Schedule (Continued)

18,750 miles

PERFORM

- Rotate tires - including check tire pressure and tread wear

22,500 miles

PERFORM

- Rotate tires - including check tire pressure and tread wear

26,250 miles

PERFORM

- Rotate tires - including check tire pressure and tread wear

30,000 miles

PERFORM

- Rotate tires - including check tire pressure and tread wear

REPLACE

- Climate control air filter**

INSPECT*

- Air conditioning compressor, air conditioner refrigerant and performance**
- Cooling system¹
- 12V battery condition
- Brake lines, hoses and connections
- Brake fluid
- Disc brakes and pads
- Suspension ball joints & mounting bolts
- Steering gear rack, linkage and boots
- Brake pedal
- Drive shaft and boots

*Inspect and, if necessary, adjust, correct, clean, or replace **If equipped

1. When adding coolant, use only deionized water or soft water for your vehicle and never mix hard water in the coolant filled at the factory. An improper coolant mixture can result in serious malfunction or motor compartment damage.

33,750 miles

PERFORM

- Rotate tires - including check tire pressure and tread wear

Normal Maintenance Schedule (Continued)

37,500 miles

PERFORM

- Rotate tires - including check tire pressure and tread wear

INSPECT*

- Reduction gear oil

*Inspect and, if necessary, adjust, correct, clean, or replace

41,250 miles

PERFORM

- Rotate tires - including check tire pressure and tread wear

45,000 miles

PERFORM

- Rotate tires - including check tire pressure and tread wear

REPLACE

- Climate control air filter**

INSPECT*

- Air conditioning compressor, air conditioner refrigerant and performance**
- Cooling system¹
- 12V battery condition
- Brake lines, hoses and connections
- Brake fluid
- Disc brakes and pads
- Suspension ball joints & mounting bolts
- Steering gear rack, linkage and boots
- Brake pedal
- Drive shaft and boots

*Inspect and, if necessary, adjust, correct, clean, or replace **If equipped

1. When adding coolant, use only deionized water or soft water for your vehicle and never mix hard water in the coolant filled at the factory. An improper coolant mixture can result in serious malfunction or motor compartment damage.

48,750 miles

PERFORM

- Rotate tires - including check tire pressure and tread wear

Normal Maintenance Schedule (Continued)

52,500 miles

PERFORM

- Rotate tires - including check tire pressure and tread wear

56,250 miles

PERFORM

- Rotate tires - including check tire pressure and tread wear

60,000 miles

PERFORM

- Rotate tires - including check tire pressure and tread wear

REPLACE

- Climate control air filter**

INSPECT*

- Air conditioning compressor, air conditioner refrigerant and performance**
- Cooling system¹
- 12V battery condition
- Brake lines, hoses and connections
- Brake fluid
- Disc brakes and pads
- Suspension ball joints & mounting bolts
- Steering gear rack, linkage and boots
- Brake pedal
- Drive shaft and boots

*Inspect and, if necessary, adjust, correct, clean, or replace **If equipped

1. When adding coolant, use only deionized water or soft water for your vehicle and never mix hard water in the coolant filled at the factory. An improper coolant mixture can result in serious malfunction or motor compartment damage.

NOTES

Driving while distracted is dangerous and should be avoided. Drivers should remain attentive to driving and always exercise caution when using the steering-wheel-mounted controls while driving.

Driving while distracted can result in a loss of vehicle control that may lead to an accident, severe personal injury and death. The driver's primary responsibility is in the safe and legal operation of a vehicle, and use of any handheld devices, other equipment or vehicle systems which take the driver's eyes, attention and focus away from the safe operation of a vehicle or that are not permissible by law should never be used during operation of the vehicle.

Safety Features: No system, no matter how advanced, can compensate for all driver error and/or driving conditions. Always drive responsibly.

Airbags: For maximum protection, always wear your seat belt.

Android Auto™: Android Auto is a trademark of Google, Inc. Android™ is a registered trademark of Google, Inc. Distracted driving can result in a loss of vehicle control. Never use a handheld device or vehicle system that takes your focus away from safe vehicle operation. Navigation is for information purposes only, and Kia does not make any warranties about the accuracy of the information.

Apple CarPlay®: Apple CarPlay® a registered trademark of Apple Inc. Distracted driving can result in a loss of vehicle control. Never use a handheld device or vehicle system that takes your focus away from safe vehicle operation. Navigation is for information purposes only, and Kia does not make any warranties about the accuracy of the information.

Apps: All information contained herein was based upon the latest available information at the time of appstore registration. Descriptions are believed to be correct, and Kia makes every effort to ensure accuracy, however, accuracy cannot be guaranteed. From time to time, Kia may need to update or make changes to the vehicle features and other vehicle information reported in this app. Kia, by the publication and dissemination of this material, does not create any warranties, either express or implied, to any Kia products. Contact your local Kia dealer for the most current information.

Bluetooth® Wireless Technology: The Bluetooth® word mark and logos are registered trademarks owned by Bluetooth SIG Inc., and any use of such marks by Kia is pursuant to license. A Bluetooth® enabled cell phone is required to use Bluetooth® wireless technology.

Electronic Stability Control (ESC)/ Traction Control System (TCS)/Hill-start Assist Control (HAC): No system, no matter how advanced, can compensate for all driver error and/or driving conditions. Always drive responsibly.

Engine Start/Stop Button with Smart Key: Always come to a complete stop before turning the engine on or off. However, if you have an emergency while the vehicle is in motion and must turn the engine off, you can turn the engine off to the ACC position by pressing the Start/Stop button for more than 3 seconds or 3 times in succession. If the vehicle is still moving, you can restart the engine by pressing the Start/Stop button with the shift lever in Neutral (N). With the engine off, hydraulic power assist for steering and braking will be disabled and the vehicle will be more difficult to control.

Front Seat Headrest Adjustment: Never attempt to adjust headrests when vehicle is in motion.

Google Play™ Store is a trademark of Google, Inc. © 2012 Google Inc. All rights reserved. Google and the Google Logo are registered trademarks of Google Inc.

iPod®/iPhone® are registered trademarks of Apple Inc. iPod® mobile digital device sold separately, and connectivity requires the Kia accessory cable.

Navigation: Distracted driving can result in a loss of vehicle control. When operating a vehicle, never use a vehicle system that takes your focus away from safe vehicle operation. Navigation is for information purposes only, and Kia does not make any warranties about the accuracy of the information.

Occupant Detection System (ODS): Kia vehicles use a number of different ODS types that vary by model.

Roadside Assist: 24-hour Enhanced Roadside Assistance is a service plan provided by Kia Motors America, Inc. Certain limitations apply. Coverage details are available in the Kia Warranty and Consumer Information Manual. For access to Enhanced Roadside Assistance, a connected mobile phone via Bluetooth® within the cellular service coverage area is required.

Seat adjustments: Reclining the passenger seats can reduce the effectiveness of the safety restraint system and may lead to additional injury in an accident.

Seat belts: For maximum protection, always wear your seatbelt.

Seat warmers: Use extreme caution when using the seat warmers to avoid burns. Refer to the Owner's Manual for more information.

SiriusXM®: SiriusXM Satellite Radio, SiriusXM Traffic and SiriusXM Travel Link each require a subscription sold separately, or as a package, by SiriusXM Radio Inc. **If you decide to continue your service at the end of your trial subscription, the plan you choose will automatically renew and bill at then-current rates until you call 1-866-635-2349 to cancel. See SiriusXM Customer Agreement for complete terms at www.siriusxm.com.** Other fees and taxes will apply. All fees and programming are subject to change. Not all vehicles or devices are capable of receiving all services offered by SiriusXM. Data displays and individual product availability vary by vehicle hardware. Current information and features may not be available in all locations, or on all receivers. Weather Forecast, Current Conditions may not be available in all locations. Images above are for representative purposes only and are not real products. For actual features and images of real products, consult the vehicle manufacturer. SiriusXM is not responsible for any errors or inaccuracies in the data services or their use in the vehicle. Travel Link Stocks displays current price and daily delta of around 7,000 actively reported securities traded on the NYSE®, NASDAQ® and AMEX®. The service is delayed approximately 20 minutes. SiriusXM satellite service is available only to those at least 18 years of age in the 48 contiguous USA, DC, and Puerto Rico (with coverage limitations). SiriusXM Internet Radio service is available throughout our satellite service area and in AK and HI. © 2017 SiriusXM Radio Inc. Sirius, XM and all related marks and logos are trademarks of SiriusXM Radio Inc.

Steering-wheel-mounted controls: Driving while distracted is dangerous and should be avoided. Remain attentive to driving and be cautious when using steering-wheel-mounted controls while driving.

Sunvisors: Sunvisor may not shield all direct light. Do not operate the vehicle if sunvisor is impairing your visibility.

Tilt/Telescoping Steering Wheel: Never attempt to adjust steering wheel position when vehicle is in motion.

Tire Pressure Monitoring System (TPMS): Even with Tire Pressure Monitoring System, check tire pressure on a regular basis.

UVO EV Services: Distracted driving can result in a loss of vehicle control. Never use a handheld device or vehicle system that takes your focus away from safe vehicle operation.

UVO Eco app: App uses your smartphone data service. Normal cellular service rates will apply.

UVO EV Services with Premium Navigation: Distracted driving can result in a loss of vehicle control. Never use a handheld device or vehicle system that takes your focus away from safe vehicle operation. Navigation is for information purposes only, and Kia does not make any warranties about the accuracy of the information.



KEY FEATURE WALKTHROUGH

Demonstrate the following with the customer:

- UVO EV Services / Android Auto™ / Apple CarPlay® Setup* – page 25

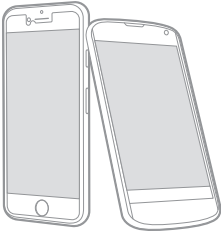

- Standard Audio System – page 24
For further operational information, refer to the Owner's Manual.

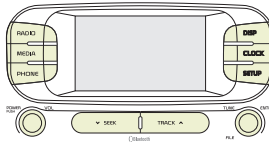

- UVO EV Services with Premium Navigation* – page 26
For further operational information, refer to the Car Multimedia System User's Manual.



- Charging Your Electric Vehicle – page 10

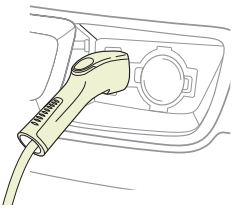

- Cruise Control – page 21
Demonstrate operation

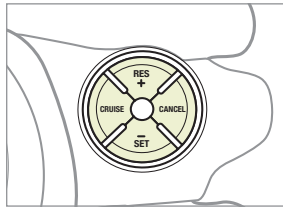

- Bluetooth® Wireless Technology – page 22
Demonstrate operation

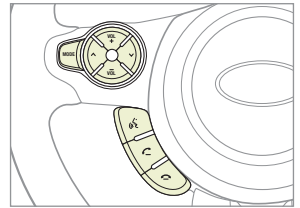

- Digital Clock – page 28
- Active ECO System – page 9
- Power Button – page 29
- Folding Rear Seatback – page 34
- Passenger Airbag Off Indicator – page 41
- Rear-Camera Display – page 38

- Seat Warmers / Ventilated Seats* – page 32
- Smart Key – page 35
- Tire Mobility Kit – page 39
- Tire Pressure Monitoring System (TPMS) – page 6
- Aux/USB/iPod® Port and Power Ports – page 28

*IF EQUIPPED

DURING DELIVERY

- Explain first service process and schedule first service appointment
- Tour Parts & Service departments, introduce staff & explain value of Kia Parts and Service
- Review recommended maintenance schedule and maintenance requirements to validate warranty
- Review business hours & Customer 360° Care
- Review the Kia 10-year/100,000-mile warranty program
- Ensure 100% satisfaction with sales and delivery process and no problems with the vehicle
- Confirm time and best contact number for initial dealer follow-up

Sales Consultant: _____ Date: _____

Sales Manager: _____ Date: _____

Customer: _____ Date: _____



SOUL EV CUSTOMER DELIVERY CHECKLIST

Owner's Name: _____ VIN: _____ Mileage: _____

Dealership Name: _____ Sales Consultant: _____ Date: _____

BEFORE DELIVERY

- Verify all tire pressures are to spec (see driver's door label) LF _____ LR _____ RF _____ RR _____
- Verify proper operation of Smart Key lock/unlock
- Ensure floor mats are snapped into place (if applicable)
- Verify vehicle is clean (interior and exterior), in good condition and free of chips and scratches
- Ensure all key documents are in the vehicle (Owner's Manual, Warranty and Consumer Information booklet, Tire Warranty booklet and Features & Functions Guide and Car Multimedia System User's Manual.)

KEY FEATURE WALKTHROUGH

- Air Conditioning / Climate Control – page 27
Demonstrate Air Flow Modes, Defog and Defrosting Windshield

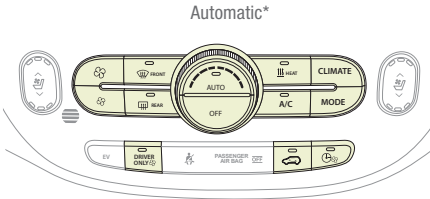

- Driver Only Ventilation/Reserved Climate Control* – page 28



- Windshield/Rear Wipers & Washers – page 19

Rotate level to adjust Intermittent Wipe Speed.

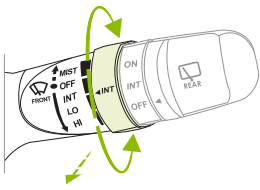

Pull to spray and wipe.

- MIST: Single wipe
- OFF: Wiper off
- INT: Intermittent wipe
- LO: Slow wipe
- HI: Fast wipe

Move lever Up/Down to change Wiper modes.

Push to spray and wipe.

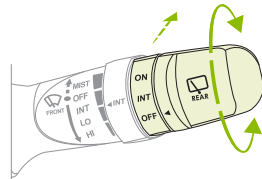

- ON: Normal wipe
- INT: Intermittent wipe
- OFF: Wiper Off



© 2017 Kia Motors America, Inc. All rights reserved.

Part Number: UE180-PS-004

Consumer - Roadside Assistance: 1-800-333-4KIA (4542)