

2018 OWNER'S MANUAL

SEDONA



The Power to Surprise

Kia, THE COMPANY



Thank you for becoming the owner of a new Kia vehicle.

As a global car manufacturer focused on building high-quality vehicles with exceptional value, Kia Motors is dedicated to providing you with a customer service experience that exceeds your expectations.

All information contained in this Owner's Manual was accurate at the time of publication. However, Kia reserves the right to make changes at any time so that our policy of continual product improvement can be carried out.

This manual applies to all models of this vehicle and includes descriptions and explanations of optional as well as standard equipment. As a result, you may encounter material in this manual that is not applicable to your specific Kia vehicle.

Drive safely and enjoy your Kia!

Thank you for choosing a Kia vehicle.

When you require service, remember that your Kia dealer knows your vehicle best. Your dealer has factory-trained technicians, recommended special tools and genuine Kia replacement parts. It is dedicated to your complete customer satisfaction.

Because subsequent owners require this important information as well, this publication should remain with the vehicle if it is sold.

This manual will familiarize you with operational, maintenance and safety information about your new vehicle. It is supplemented by a Warranty and Consumer Information manual that provides important information on all warranties regarding your vehicle.

We urge you to read these publications carefully and follow the recommendations to help assure enjoyable and safe operation of your new vehicle.

Kia offers a great variety of options, components and features for its various models. Therefore, some of the equipment described in this manual, along with the various illustrations, may not be applicable to your particular vehicle.

The information and specifications provided in this manual were accurate at the time of printing. Kia reserves the right to discontinue or change specifications or design at any time without notice and without incurring any obligation. If you have questions, always check with your Kia dealer.

We assure you of our continuing interest in your motoring pleasure and satisfaction in your Kia vehicle.

© 2017 Kia MOTORS AMERICA, Inc.

All rights reserved. May not be reproduced or translated in whole or in part without the written consent of Kia Motors America, Inc.

Printed in Korea

TABLE OF CONTENTS

Introduction

1

Your vehicle at a glance

2

Safety features of your vehicle

3

Features of your vehicle

4

Driving your vehicle

5

What to do in an emergency

6

Maintenance

7

Specifications & Consumer information

8

Index

I

Introduction

- How to use this manual 1-2**
- Fuel requirements 1-2**
 - Gasoline containing alcohol and methanol 1-3
 - Do not use methanol 1-4
 - Fuel Additives 1-5
 - Operation in foreign countries 1-5
- Vehicle handling instructions 1-6**
- Vehicle break-in process 1-6**
- Vehicle data collection and event data recorders . 1-7**

HOW TO USE THIS MANUAL

We want to help you get the greatest possible driving pleasure from your vehicle. Your Owner's Manual can assist you in many ways. We strongly recommend that you read the entire manual. In order to minimize the chance of death or injury, you must read the WARNING and CAUTION sections in the manual.

Illustrations complement the words in this manual to best explain how to enjoy your vehicle. By reading your manual, you will learn about features, important safety information, and driving tips under various road conditions.

The general layout of the manual is provided in the Table of Contents. Use the index when looking for a specific area or subject; it has an alphabetical listing of all information in your manual.

Sections: This manual has eight sections plus an index. Each section begins with a brief list of contents so you can tell at a glance if that section has the information you want.

You will find various WARNINGS, CAUTIONS, and NOTICES in this manual. These WARNINGS were prepared to enhance your personal safety. You should carefully read and follow ALL procedures and recommendations provided in these WARNINGS, CAUTIONS and NOTICES.

WARNING

A WARNING indicates a situation in which harm, serious bodily injury or death could result if the warning is ignored.

CAUTION

A CAUTION indicates a situation in which damage to your vehicle could result if the caution is ignored.

*** NOTICE**

A NOTICE indicates interesting or helpful information is being provided.

FUEL REQUIREMENTS

Your new vehicle is designed to use only unleaded fuel having a pump octane number ((R+M)/2) of 87 (Research Octane Number 91) or higher. (Do not use methanol blended fuels.)

Your new vehicle is designed to obtain maximum performance with UNLEADED FUEL, as well as minimize exhaust emissions and spark plug fouling.

Never add any fuel system cleaning agents to the fuel tank other than what has been specified. (Consult an authorized Kia dealer for details.)

- Tighten the cap until it clicks one time, otherwise the Check Engine  light will illuminate.

⚠ WARNING - Refueling

- Do not "top off" after the nozzle automatically shuts off. Attempts to force more fuel into the tank can cause fuel overflow onto you and the ground causing a risk of fire.
- Always check that the fuel cap is installed securely to prevent fuel spillage, especially in the event of an accident.

Gasoline containing alcohol and methanol

Gasohol, a mixture of gasoline and ethanol (also known as grain alcohol), and gasoline or gasohol containing methanol (also known as wood alcohol) are being marketed along with or instead of leaded or unleaded gasoline.

Pursuant to EPA regulations, ethanol may be used in your vehicle.

Do not use gasohol containing more than 15 percent ethanol, and do not use gasoline or gasohol containing any methanol. Ethanol provides less energy than gasoline and it attracts water, and it is thus likely to reduce your fuel efficiency and could lower your MPG results.

Methanol may cause drivability problems and damage to the fuel system, engine control system and emission control system.

Discontinue using gasohol of any kind if drivability problems occur.

Vehicle damage or drivability problems may not be covered by the manufacturer's warranty if they result from the use of:

1. Gasoline or gasohol containing methanol.
2. Leaded fuel or leaded gasohol.
3. Gasohol containing more than 15% ethanol.

"E85" fuel is an alternative fuel comprised of 85 percent ethanol and 15 percent gasoline, and is manufactured exclusively for use in Flexible Fuel Vehicles. "E85" is not compatible with your vehicle. Use of "E85" may result in poor engine performance and damage to your vehicle's engine and fuel system. Kia recommends that customers do not use fuel with an ethanol content exceeding 15 percent.

*** NOTICE**

Your New Vehicle Limited Warranty does not cover damage to the fuel system or any performance problems caused by the use of "E85" fuel.

*** NOTICE**

Never use gasohol which contains methanol. Discontinue use of any gasohol product which impairs drivability.

Other fuels

Using fuels that contain Silicone (Si), MMT (Manganese, Mn), Ferrocene (Fe), and Other metallic additives, may cause vehicle and engine damage or cause misfiring, poor acceleration, engine stalling, catalyst melting, clogging, abnormal corrosion, life cycle reduction, etc.

Also, the Malfunction Indicator Lamp (MIL) may illuminate.

*** NOTICE**

Damage to the fuel system or performance problem caused by the use of these fuels may not be covered by your New Vehicle Limited Warranty.

Gasoline containing MMT

Some gasoline contains harmful manganese-based fuel additives Such as MMT (Methylcyclopentadienyl Manganese Tricarbonyl).

Kia does not recommend the use of gasoline containing MMT. This type of fuel can reduce vehicle performance and affect your emission control system. The malfunction indicator lamp on the cluster may come on.

Do not use methanol

Fuels containing methanol (wood alcohol) should not be used in your vehicle. This type of fuel can reduce vehicle performance and damage components of the fuel system, engine control system and emission control system.

*** NOTICE**

Your New Vehicle Limited Warranty may not cover damage to the fuel system and any performance problems that are caused by the use of fuels containing methanol.

Fuel Additives

Kia recommends that you use good quality gasolines treated with detergent additives such as TOP TIER Detergent Gasoline, which help prevent deposit formation in the engine. These gasolines will help the engine run cleaner and enhance performance of the Emission Control System. For more information on TOP TIER Detergent Gasoline, please go to the website (www.toptiergas.com)

For customers who do not use TOP TIER Detergent Gasoline regularly, and have problems starting or the engine does not run smoothly, additives that you can buy separately may be added to the gasoline.

If TOP TIER Detergent Gasoline is not available, one bottle of additive should be added to the fuel tank at every 7,500 miles (12,000 km) or every engine oil change is recommended. Additives are available from your authorized Kia dealer along with information on how to use them. Do not mix other additives.

Operation in foreign countries

If you are going to drive your vehicle in another country, be sure to:

- Observe all regulations regarding registration and insurance.
- Determine that acceptable fuel is available.

VEHICLE HANDLING INSTRUCTIONS

As with other vehicles of this type, failure to operate this vehicle correctly may result in loss of control, an accident or vehicle rollover.

Specific design characteristics (higher ground clearance, track, etc.) give this vehicle a higher center of gravity than other types of vehicles. In other words they are not designed for cornering at the same speeds as conventional 2-wheel drive vehicles. Avoid sharp turns or abrupt maneuvers. Again, failure to operate this vehicle correctly may result in loss of control, an accident or vehicle rollover. **Be sure to read the “Reducing the risk of a rollover” driving guidelines, in section 5 of this manual.**

VEHICLE BREAK-IN PROCESS

No special break-in period is needed. By following a few simple precautions for the first 600 miles (1,000 km) you may add to the performance, economy and life of your vehicle.

- Do not race the engine.
- While driving, keep your engine speed (rpm, or revolutions per minute) between 2,000 rpm and 4,000 rpm.
- Do not maintain a single speed for long periods of time, either fast or slow. Varying engine speed is needed to properly break-in the engine.
- Avoid hard stops, except in emergencies, to allow the brakes to seat properly.
- Don't tow a trailer during the first 1,200 miles (2,000 km) of operation.

VEHICLE DATA COLLECTION AND EVENT DATA RECORDERS

This vehicle is equipped with an event data recorder (EDR). The main purpose of an EDR is to record, in certain crash or near crash-like situations, such as an air bag deployment or hitting a road obstacle, data that will assist in understanding how a vehicle's systems performed. The EDR is designed to record data related to vehicle dynamics and safety systems for a short period of time, typically 30 seconds or less. The EDR in this vehicle is designed to record such data as:

- How various systems in your vehicle were operating;
- Whether or not the driver and passenger safety belts were buckled/fastened;
- How far (if at all) the driver was depressing the accelerator and/or brake pedal; and,
- How fast the vehicle was traveling.

These data can help provide a better understanding of the circumstances in which crashes and injuries occur. NOTE: EDR data are recorded by your vehicle only if a non-trivial crash situation occurs; no data are recorded by the EDR under normal driving conditions and no personal data (e.g., name, gender, age, and crash location) are recorded. However, other parties, such as law enforcement, could combine the EDR data with the type of personally identifying data routinely acquired during a crash investigation.

To read data recorded by an EDR, special equipment is required, and access to the vehicle or the EDR is needed. In addition to the vehicle manufacturer, other parties, such as law enforcement, that have the special equipment, can read the information if they have access to the vehicle or the EDR.

Your vehicle at a glance

Exterior overview 2-2
Interior overview 2-4
Instrument panel overview 2-5
Engine compartment 2-6

EXTERIOR OVERVIEW

■ Front view

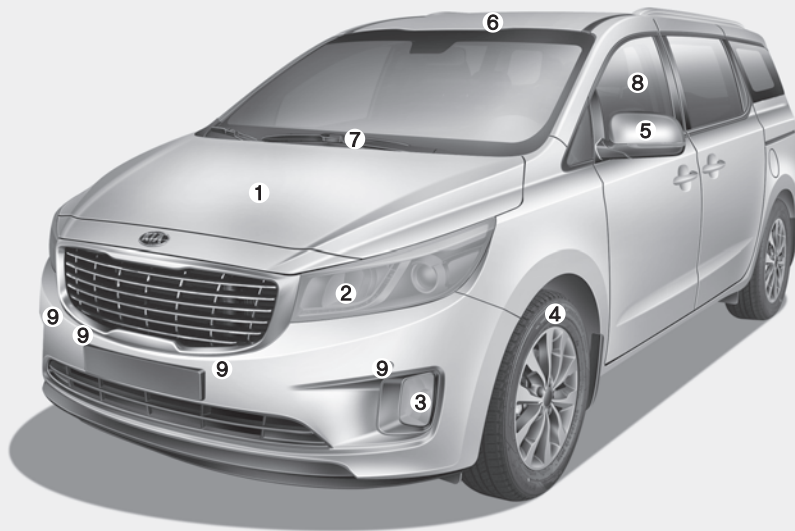

- 1. Hood4-55
- 2. Head lamp.....4-131, 7-77
- 3. Fog lamp4-137, 7-77
- 4. Wheel and tire7-51, 8-4
- 5. Outside rearview mirror4-76
- 6. Sunroof4-61
- 7. Front windshield wiper blades....4-139, 7-45
- 8. Windows4-50
- 9. Parking assist system4-125

* The actual shape may differ from the illustration.

OYP014001K

■ Rear view

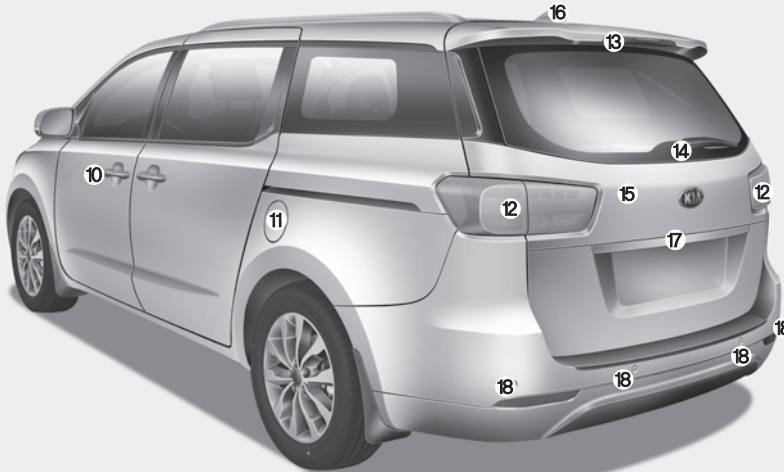

- 10. Door locks4-24
- 11. Fuel filler lid4-57
- 12. Rear combination lamp7-82
- 13. High mounted stop lamp7-85
- 14. Rear window wiper blade.....4-140, 7-47
- 15. Liftgate (Tailgate)4-30, 4-41
- 16. Antenna4-203
- 17. Rearview camera4-129
- 18. Parking assist system4-121, 4-125

* The actual shape may differ from the illustration.

INTERIOR OVERVIEW

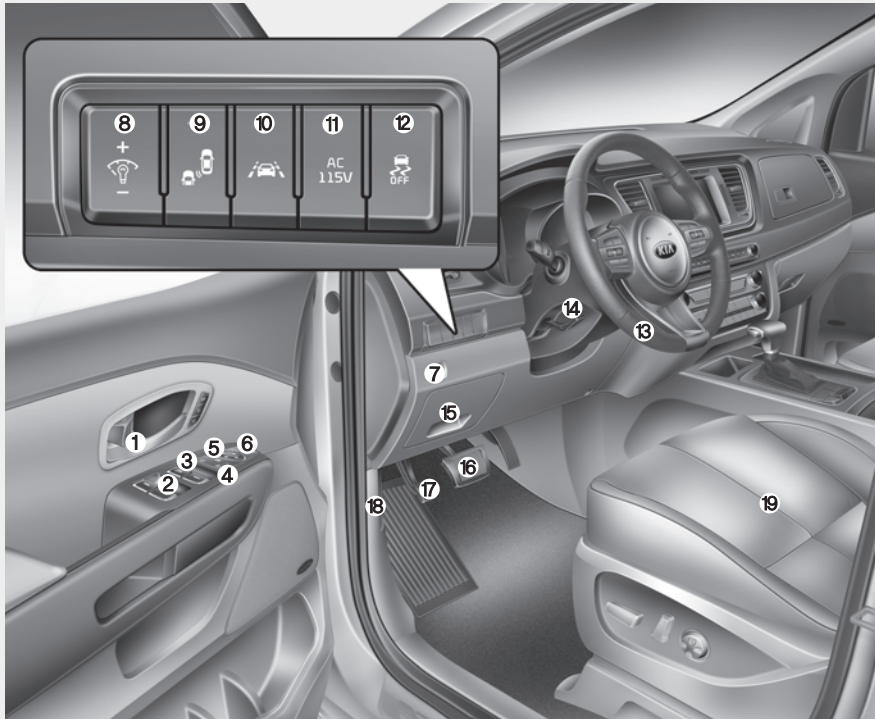

1. Inside door handle	4-26
2. Power window switch.....	4-50
3. Central door lock switch	4-27
4. Power window and rear sunroof lock button.....	4-54
5. Outside rearview mirror control	4-77
6. Outside rearview mirror folding switch	4-78
7. Fuel filler lid open switch	4-57
8. Instrument panel illumination control switch	4-82
9. BSD ON/OFF button	5-70
10. LDWS ON/OFF button	5-77
11. AC inverter button.....	4-195
12. ESC OFF button	5-25
13. Steering wheel.....	4-66
14. Tilt and telescopic steering control lever	4-68
15. Inner panel fuse panel.....	7-67
16. Brake pedal.....	5-19
17. Parking brake pedal.....	5-21
18. Hood release lever.....	4-55
19. Seat.....	3-2

* The actual interior in the vehicle may differ from the illustration

INSTRUMENT PANEL OVERVIEW

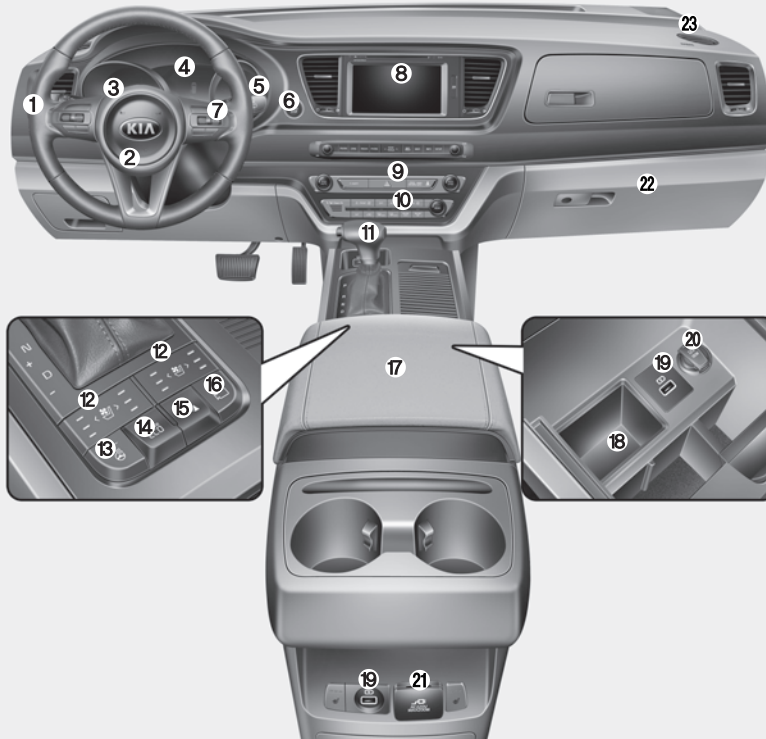

- 1. Audio remote control buttons4-211
- 2. Driver's front air bag3-74
- 3. Horn.....4-69
- 4. Instrument cluster.....4-81
- 5. Wiper and washer control lever4-138
- 6. Ignition switch5-6
Engine start/stop button5-9
- 7. Cruise control button 5-45
Smart cruise control button5-49
- 8. Audio4-208
- 9. Hazard warning flasher6-2
- 10. Climate control system.....4-146, 4-163
- 11. Shift lever.....5-13
- 12. Seat warmer4-192
Seat cooler4-193
- 13. Steering wheel warmer
ON/OFF Button4-68
- 14. Active ECO button5-66
Drive mode button5-67
- 15. Parking assist system
ON/OFF button.....4-125
- 16. Surround View Monitoring System
ON/OFF button.....4-130
- 17. Center console storage box4-189
- 18. Sunglasses holder.....4-190
- 19. USB charger.....4-197
- 20. Power outlet.....4-194
- 21. AC inverter4-195
- 22. Glove box4-190
- 23. Passenger's front air bag3-74

* The actual instrument panel in the vehicle may differ from the illustration

ENGINE COMPARTMENT

■ Gasoline Engine (Lambda 3.3L)

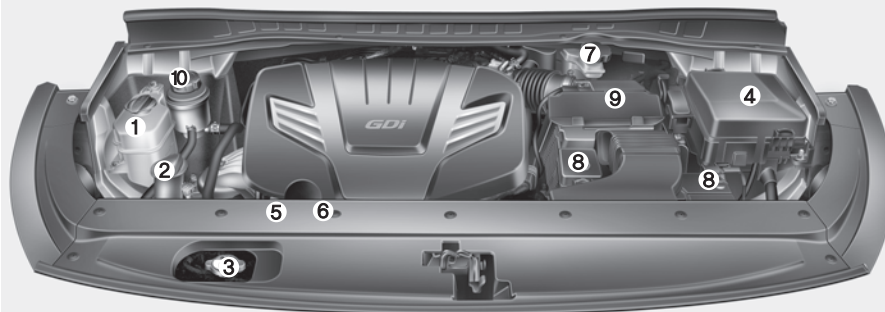

- 1. Engine coolant reservoir7-35
- 2. Windshield washer fluid reservoir7-39
- 3. Radiator cap7-36
- 4. Fuse box7-68
- 5. Engine oil filler cap7-32
- 6. Engine oil dipstick7-32
- 7. Brake fluid reservoir7-37
- 8. Battery terminal7-48
- 9. Air cleaner7-40
- 10. Power steering fluid(if equipped)7-38

※ The actual engine compartment in the vehicle may differ from the illustration.

OYP074061N

Safety features of your vehicle

Seats	3-2
• Front seat adjustment - manual	3-6
• Front seat adjustment - power	3-8
• Driver position memory system (for power seat)	3-10
• Headrest (for front seat)	3-12
• Seatback pocket	3-15
• Rear seat adjustment	3-16
• Headrest (for rear seat)	3-31
Seat belts	3-35
• Seat belt restraint system	3-35
• Pre-tensioner seat belt	3-46
• Seat belt precautions	3-48
• Care of seat belts	3-51
Child restraint system	3-52
• Using a child restraint system	3-53
• Tether anchor system	3-57
• Lower anchor system	3-58

Air bag	
- advanced supplemental restraint system	3-60
• How does the air bag system operate	3-61
• Air bag warning light	3-63
• SRS components and functions	3-64
• Occupant Detection System(ODS)	3-67
• Driver's and passenger's front air bag	3-74
• Side air bag	3-77
• Curtain air bag	3-79
• SRS Care	3-86
• Air bag warning label	3-87

SEATS

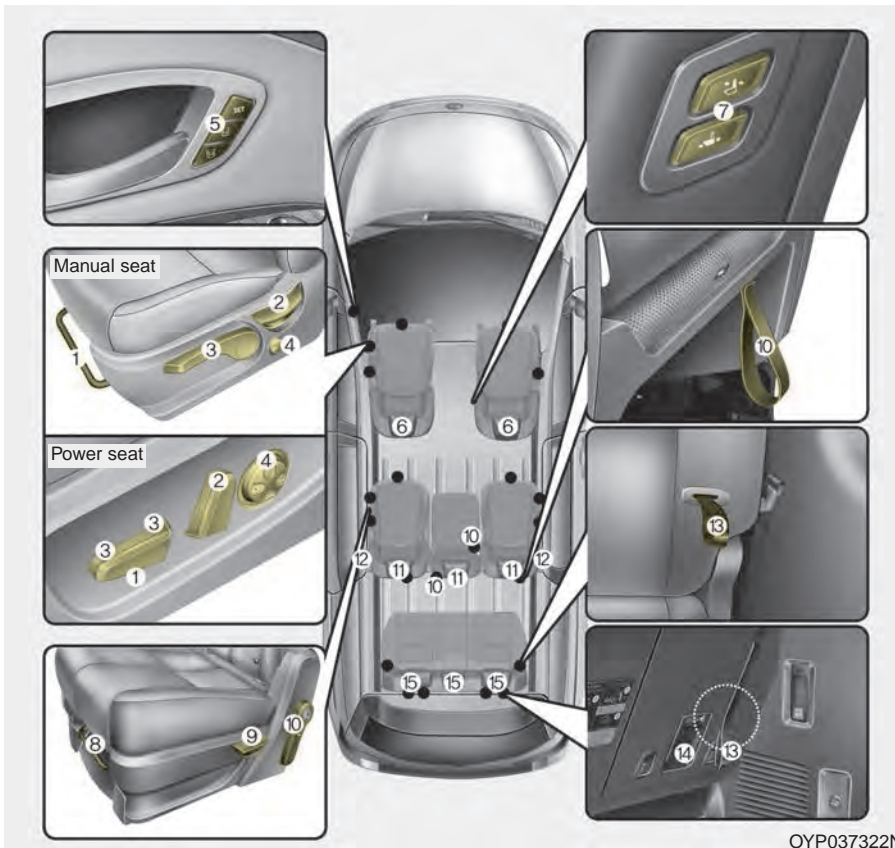

OYP037322N

Front seat

- (1) Forward and backward
- (2) Seatback angle
- (3) Seat cushion height
- (4) Lumbar support (Driver's seat)
- (5) Driver position memory
- (6) Headrest
- (7) Walk-in switch

2nd / 3rd row seat

- (8) Forward and backward
- (9) Seatback angle and folding
- (10) Walk-in
- (11) Headrest
- (12) Armrest
- (13) Seatback angle and folding
- (14) Seat sinking
- (15) Headrest

■ For SXL package

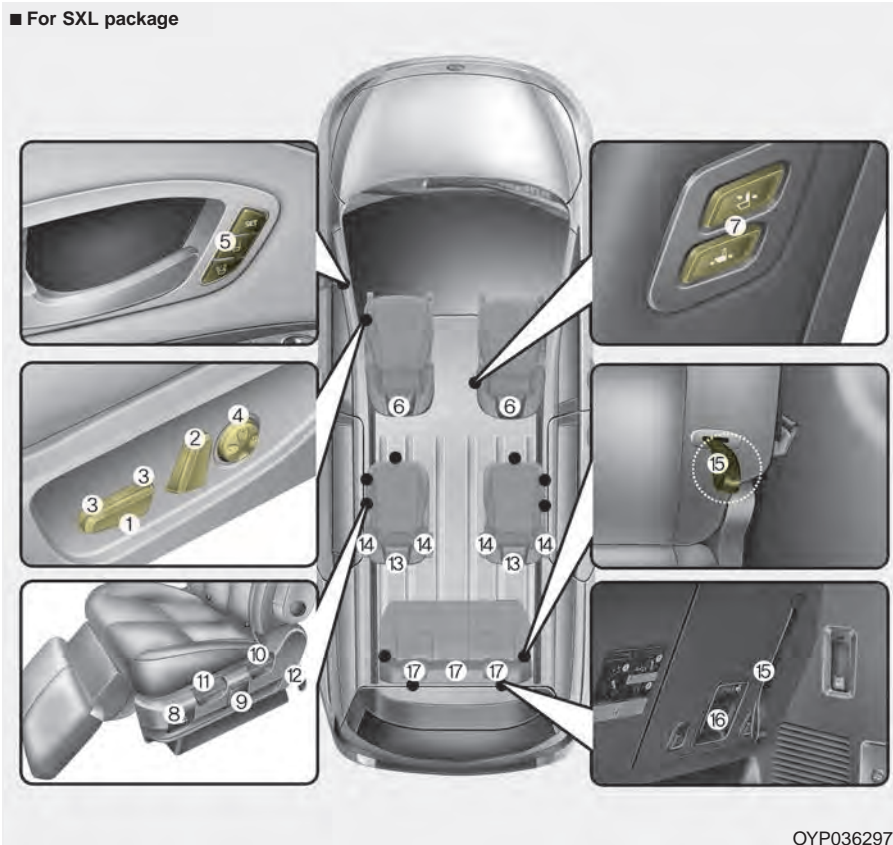

OYP036297N

Front seat

- (1) Forward and backward
- (2) Seatback angle
- (3) Seat cushion height
- (4) Lumbar support (Driver's seat)
- (5) Driver position memory
- (6) Headrest
- (7) Walk-in switch

2nd / 3rd row seat

- (8) Forward and backward
- (9) Left and right
- (10) Seatback angle and folding
- (11) Leg support
- (12) Walk-in
- (13) Headrest
- (14) Armrest
- (15) Seatback angle and folding
- (16) Seat sinking
- (17) Headrest

⚠ WARNING - Loose objects

Do not place anything in the driver's foot well or under the front seats. Loose objects in the driver's foot area could interfere with the operation of the foot pedals.

⚠ WARNING - Uprighting seat

Do not press the release lever on a manual seatback without holding and controlling the seatback. The seatback will spring upright possibly impacting you or other passengers.

⚠ WARNING - Driver responsibility for passengers



The driver must advise the passenger to keep the seatback in an upright position whenever the vehicle is in motion. If a seat is reclined during an accident, the occupant's hips may slide under the lap portion of the seat belt, applying great force to the unprotected abdomen.

⚠ WARNING - Seat cushion

Occupants should never sit on aftermarket seat cushions or sitting cushions.

The passenger's hips may slide under the lap portion of the seat belt during an accident or a sudden stop.

⚠ WARNING - Driver's seat

- Never attempt to adjust the seat while the vehicle is moving. This could result in loss of control of your vehicle.
- Do not allow anything to interfere with the normal position of the seatback and seatback adjustment.
- Sit as far back as possible from the steering wheel while still maintaining comfortable control of the your vehicle. A distance of at least 10" from your chest to the steering wheel is recommended. Failure to do so can result in air bag inflation injuries to the driver.

⚠ WARNING - Rear seatbacks

Always lock the rear seatback before driving. Failure to do so could result in passengers or objects being thrown forward injuring vehicle occupants.

⚠ WARNING - Luggage and Cargo

Do not stack pile or stack luggage or cargo higher than the seatback in the cargo area. In an accident the cargo could strike and injury a passenger. If objects are large, heavy or must be piled, they must be secured in the cargo area.

⚠ WARNING - Cargo Area

Do not allow passengers to ride in the cargo area under any circumstance. The cargo area is solely for the purpose of transporting luggage or cargo.

⚠ WARNING - Unexpected Seat Movement

After adjusting a manual seat, always check that it is locked by shifting your weight to the front and back. Sudden or unexpected movement of the driver's seat could cause you to lose control of the vehicle.

⚠ WARNING - Seat adjustment

- Do not adjust the seat while wearing seat belts. Moving the seat forward will cause strong pressure on the abdomen.
- Do not place your hand near the seat bottom or seat track while adjusting the seat. Your hand could get caught in the seat mechanism.

⚠ WARNING - Small Objects

Use extreme caution when picking small objects trapped under the seats or between the seat and the center console. Your hands might be cut or injured by the sharp edges of the seats mechanism.

Feature of Seat Leather

- Leather is made from the outer skin of an animal, which goes through a special process to be available for use. Since it is a natural substance, each part differs in thickness or density.

Wrinkles may appear as a natural result of stretching and shrinking depending on the temperature and humidity.

- The seat is made of stretchable fabric to improve comfort.
- The parts contacting the body are curved and the side supporting area is high which provides driving comfort and stability.
- Wrinkles may appear naturally from usage. It is not a fault of the product.

CAUTION

- **Wrinkles or abrasions which appear naturally from usage are not covered by warranty.**
- **Belts with metallic accessories, zippers or keys inside the back pocket may damage the seat fabric.**
- **Make sure not to wet the seat. It may change the nature of natural leather.**
- **Jeans or clothes which could bleach may contaminate the surface of the seat covering fabric.**

Front seat adjustment - manual Forward and backward

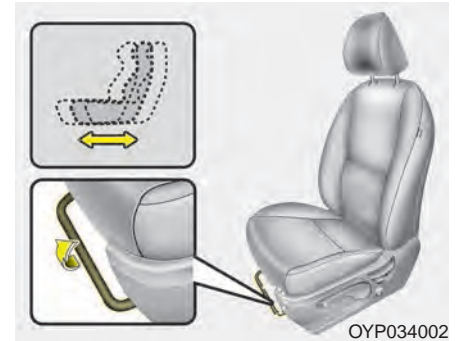

To move the seat forward or backward:

1. Pull the seat slide adjustment lever up and hold it.
2. Slide the seat to the position you desire.
3. Release the lever and make sure the seat is locked in place.

Adjust the seat before driving, and make sure the seat is locked securely by trying to move forward and backward without using the lever. If the seat moves, it is not locked properly.

Seatback angle

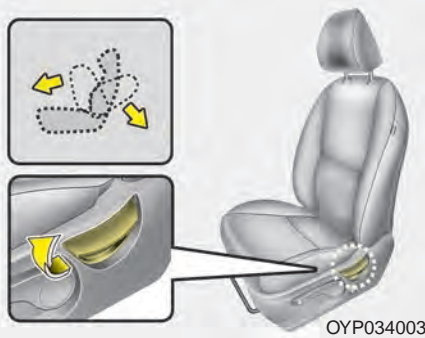

To recline the seatback:

1. Lean forward slightly and lift up the seatback recline lever.
2. Carefully lean back on the seat and adjust the seatback of the seat to the position you desire.
3. Release the lever and make sure the seatback is locked in place. (The lever **MUST** return to its original position for the seatback to lock.)

Seat height (for driver's seat)

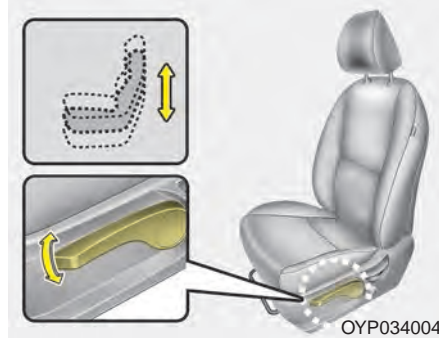

To change the height of the seat, push the lever upwards or downwards.

- To lower the seat cushion, push the lever down several times.
- To raise the seat cushion, pull the lever up several times.

Lumbar support (if equipped)

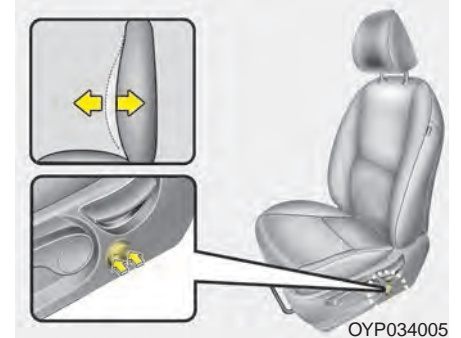

The lumbar support can be adjusted by pressing the lumbar support switch on the side of the seat.

1. Press the front portion of the switch to increase support, or the rear portion of the switch, to decrease support.
2. Release the switch once it reaches the desired position.

Front seat adjustment - power (if equipped)

The front seat can be adjusted by using the control switches located on the outside of the seat cushion. Before driving, adjust the seat to the proper position so you can easily control the steering wheel, pedals and switches on the instrument panel.

 **WARNING - Unattended children**

Do not leave children unattended in the vehicle. Children might operate features of the vehicle that could injure them.

 **CAUTION - Power seat adjustments**

The power seating controls function by electronic motor. Excessive operation may cause damage to the electrical equipment.

 **CAUTION - Power Seating**

Do not operate two or more power seat control switches at the same time. Doing so may damage the power seat motor or electrical components.

When in operation, the power seat consumes a large amount of electrical power. To prevent unnecessary charging system drain, don't adjust the power seat longer than necessary while the engine is not running.

Forward and backward

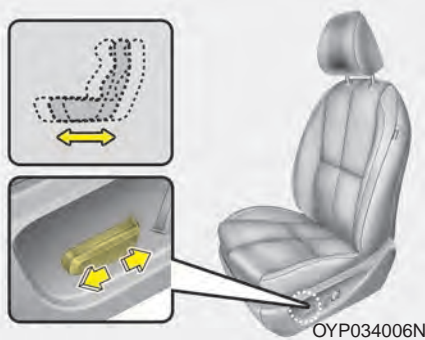

Push the control switch forward or backward to move the seat to the desired position. Release the switch once the seat reaches the desired position.

Seatback angle

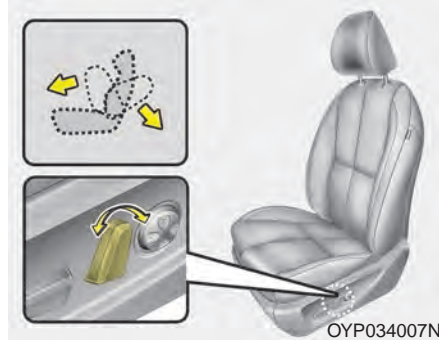

Push the control switch forward or backward to move the seatback to the desired angle. Release the switch once the seat reaches the desired position.

Seat height (if equipped)

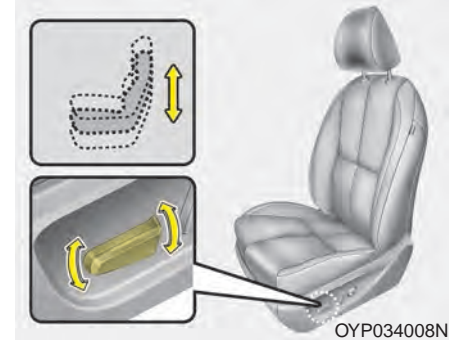

Pull the front portion of the control switch up to raise or press down to lower the front part of the seat cushion. Pull the rear portion of the control switch up to raise or press down to lower the rear part of the seat cushion. Release the switch once the seat reaches the desired position.

Walk-in Seat (for front passenger seat, if equipped)



The switch is located on the left side of the front passenger's seatback.

To adjust the position of front passenger's seat ;

Press the control switch forward (1) or rearward (2) to move the seat to the desired position.

Press the control switch forward (3) or rearward (4) to move the seatback to the desired angle.

Do not use these switches while the front passenger seat is occupied.

Lumbar support (for driver's seat)

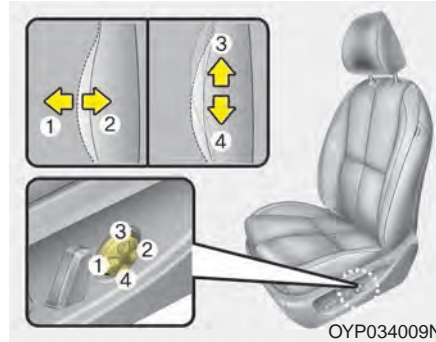

The lumbar support can be adjusted by pressing the lumbar support switch on the side of the drivers seat. Press the front portion of the switch (1) to increase support, or the rear portion of the switch (2) to decrease support.

Move the support position up and down by pressing the switch (3) or (4).

Driver position memory system (if equipped, for power seat)

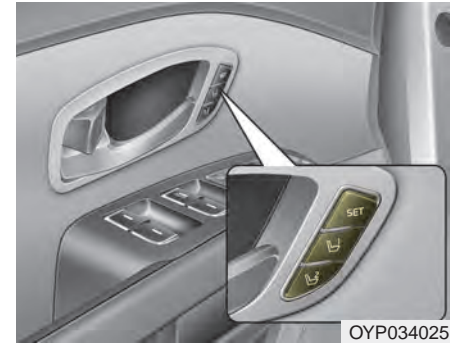

A driver position memory system is provided to store and recall the driver seat and outside rearview mirror position with a simple button operation. By saving the desired position into the system memory, different drivers can reposition the driver seat based upon their driving preference. If the battery is disconnected, the desired seat position memory will need to be re-saved.

⚠ WARNING

Never attempt to operate the driver position memory system while the vehicle is moving.

This could result in loss of control, and an accident causing death, serious injury.

Storing positions into memory using the buttons on the door**Storing driver's seat positions**

1. Shift the shift lever into P while the engine start/stop button is ON or ignition switch ON.
2. Adjust the driver's seat and outside rearview mirror comfortable for the driver.
3. Press SET button on the control panel. The system will beep once.
4. Press one of the memory buttons (1 or 2) within 5 seconds after pressing the SET button. The system will beep twice when memory has been successfully stored.

*** NOTICE**

When recalling an adjustment memory button while sitting in the vehicle, you can be surprised by the setting chosen if the memory has been adjusted by someone else. If that occurs, immediately push the seat position control knob in the direction of the desired position to stop further undesired movement.

Recalling positions from memory

1. Shift the shift lever into P while the engine start/stop button is ON or ignition switch ON.
2. To recall the position in the memory, press the desired memory button (1 or 2). The system will beep once, then the driver's seat will automatically adjust to the stored position.

Adjusting the control switch for the driver's seat while the system is recalling the stored position will cause the movement to stop and move in the direction that the control switch is moved.

Easy access function (if equipped)

The system will move the driver's seat automatically as follows:

- Without smart key system
 - It will move the driver's seat rearward when the ignition key is removed.
 - It will move the driver's seat forward when the ignition key is inserted.
- With smart key system
 - It will move the driver's seat rearward when the engine start/stop button is changed to the OFF position.
 - It will move the driver's seat forward when the engine start/stop button is changed to the ACC or START position.

You can activate or deactivate this feature. Refer to "User settings" in chapter 4.

Headrest (for front seat)

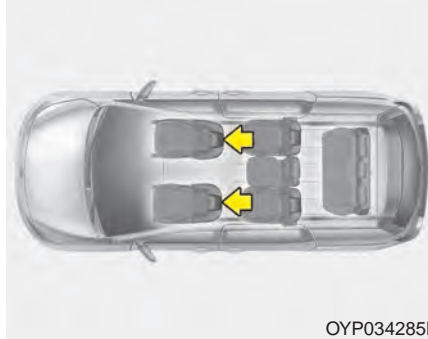

The driver's and front passenger's seats are equipped with a headrest for the occupant's safety and comfort.

The headrest not only provides comfort for the driver and front passenger, but also helps protect the head and neck in the event of a rear collision.

For maximum effectiveness in case of an accident, the headrest should be adjusted so the middle of the headrest is at the same height of the center of gravity of an occupant's head. Generally, the center of gravity of most people's head is similar with the height of the top of their eyes. Also, adjust the headrest as close to your head as possible. For this reason, the use of a cushion that holds the body away from the seatback is not recommended.

⚠ WARNING - Headrest removal/adjustment

- Do not operate the vehicle with the headrests removed. Headrests can provide critical neck and head support in a crash.
- Do not adjust the headrest height while the vehicle is in motion. Driver may lose control of the vehicle.

Adjusting the height up and down

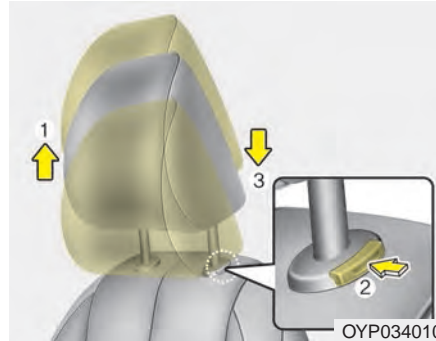

To raise the headrest, pull it up to the desired position (1). To lower the headrest, push and hold the release button (2) on the headrest support and lower the headrest to the desired position (3).

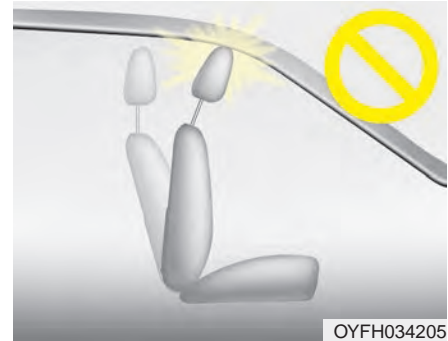

*** NOTICE**

If you recline the seatback towards the front with the headrest and seat cushion raised, the headrest may come in contact with the sunvisor or other parts of the vehicle.

Removal and reinstallation

■ Type A

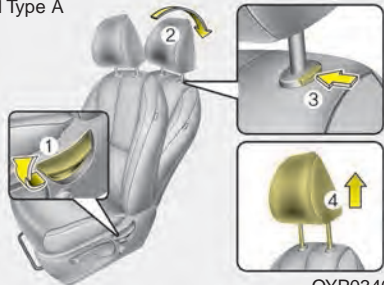

■ Type B

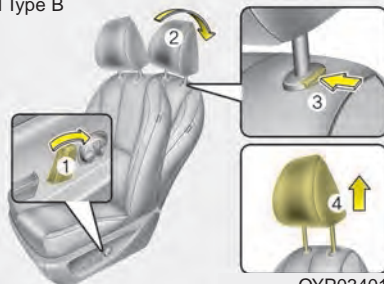

To remove the headrest:

1. Recline the seatback (2) with the recline lever or switch (1).
2. Raise headrest as far as it can go.

3. Press the headrest release button (3) while pulling the headrest up (4).

⚠ WARNING
NEVER allow anyone to ride in a seat with the headrest removed.

■ Type A

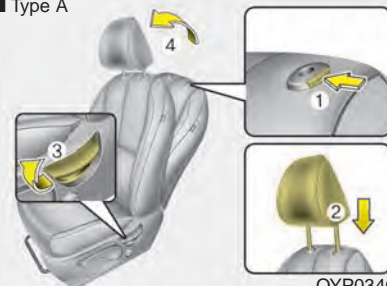

■ Type B

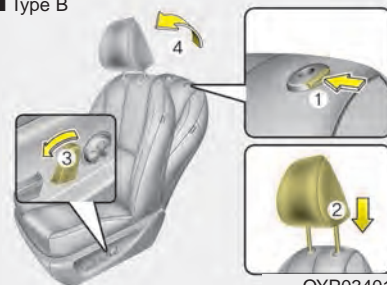

To reinstall the headrest :

1. Put the headrest poles (2) into the holes while pressing the release button (1).
2. Recline the seatback (4) with the recline lever or switch (3).

3. Adjust the headrest to the appropriate height.

⚠ WARNING - Headrest Reinstallation

To reduce the risk of injury to the head or neck, always make sure the headrest is locked into position and adjusted properly after reinstalling.

Seatback pocket

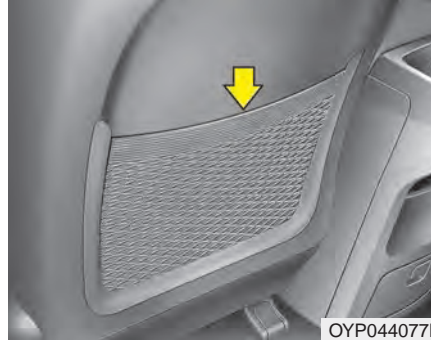

The seatback pocket is provided on the back of the front passenger's and driver's seatbacks.

⚠ WARNING - Seatback pockets

Do not put heavy or sharp objects in the seatback pockets. In an accident they could come loose from the pocket and injure vehicle occupants.

Rear seat adjustment

Forward and backward (2nd row seat)

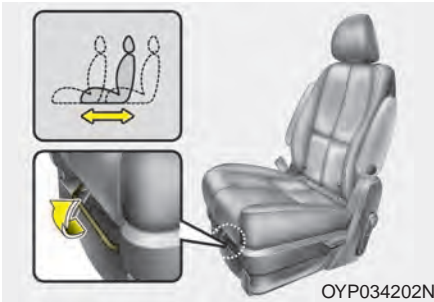

■ for SXL package



To move the seat forward or backward:

1. Pull the seat slide adjustment lever up and hold it.

2. Slide the seat to the position you desire.
3. Release the lever and make sure the seat is locked in place.

Adjust the seat before driving, and make sure the seat is locked securely by trying to move forward and backward without using the lever. If the seat moves, it is not locked properly.

* 7-seater SXL Seat

To move the seat inward, first turn the left/right control lever, and then move the seat to the farthest back position.

Left and Right (2nd row seat, SXL package)

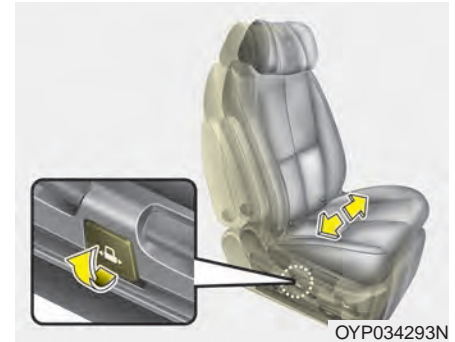

To move the seat left side or right side:

1. Pull the seat slide adjustment lever up and hold it.
2. Slide the seat to the position you desire.
3. Release the lever and make sure the seat is locked in place.

Adjust the seat before driving, and make sure the seat is locked securely by trying to move left side and right side without using the lever. If the seat moves, it is not locked properly.

Seatback angle

■ 2nd row seat



■ 2nd row center seat (if equipped)



■ 2nd row seat for SXL package



■ 3rd row seat

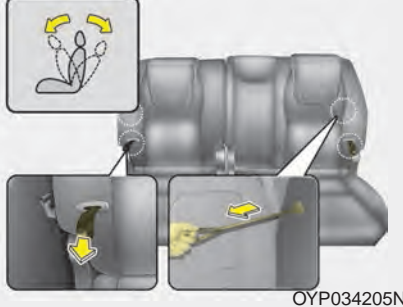

To recline the seatback:

1. Pull up the seatback recline lever (for 2nd row outboard seat) or strap (for 2nd row center or 3rd row seat).
2. Hold the lever or strap and adjust the seatback of the seat to the position you desire.
3. Release the lever or strap and make sure the seatback is locked in place. (The lever **MUST** return to its original position for the seatback to lock.)

Walk-in seat (2nd row seat)



- To get in or out of the 3rd row seat,
1. Lift the armrest up and lower the head rest to the lowest position (if necessary).
 2. Pull up the walk-in lever (1) or pull the walk-in strap (2) on the 2nd row seat to allow passenger to exit 3rd row seat.

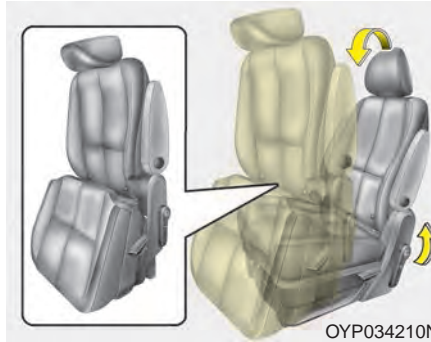

3. At this time, 2nd row seat position will be changed to stand up position, and the head rest will be folded automatically.

After getting in or out, push the 2nd row seat to the original position until it clicks into place and check the head rest position (unfolded position).

Make sure that the seat is locked in place.

**Walk-in seat
(2nd row seat for SXL package)**

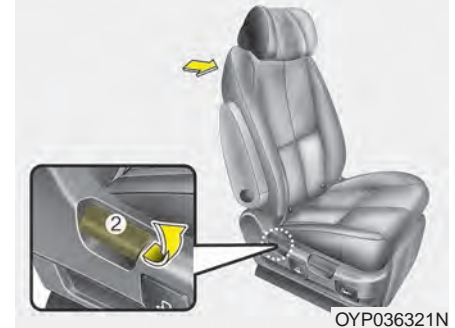
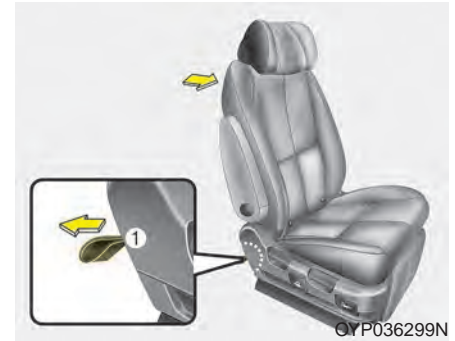

To get in or out of the 3rd row seat,

1. Lift the armrest up , lower the headrests to the lowest position and slide the seat inside. (if necessary).
2. Pull the walk-in strap (1) or recline lever (2) on the 2nd row seat when the passenger gets in or out of the 3rd row seat.
3. Push the 2nd row seat to forward.

After getting out, push the 2nd row seat to the original position until it clicks into place.

Make sure that the seat is locked in place. In the walk-in position, the front and back sliding function is not fixed.

⚠ WARNING

Never attempt to adjust the 2nd row seat while the vehicle is moving or the seat is occupied as the seat may suddenly move and cause the passenger on the seat to be injured.

**Leg support
(2nd row seat for SXL package)**

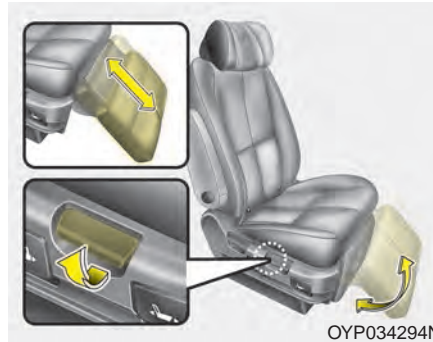

To use the leg support :

1. Pull the leg support lever up and hold it.
2. Adjust the angle and length of the leg support while holding the leg support. When using the leg rest, move the seat to the inner position, and then toward the back. If the seat is not moved far back, it may come in contact with the first row seat.
3. Release the lever and make sure the leg support is locked in place.

Folding the rear seat

The rear seatbacks can be folded to facilitate carrying long items or to increase the luggage capacity of the vehicle.

⚠ WARNING - Folded down seatback

Never allow passengers sit on top of the folded down seatback while the vehicle is moving. This is not a proper seating position and no seat belts are available for use.

This could result in serious injury or death in case of an accident or sudden stop.

⚠ WARNING - Objects

Objects carried on the folded down seatback should not extend higher than the top of the front seatbacks. This could allow cargo to slide forward and cause injury or damage during sudden stops.

■ 2nd row center seat (for 8 passenger vehicle)



OYP034267N

■ 3rd row seat

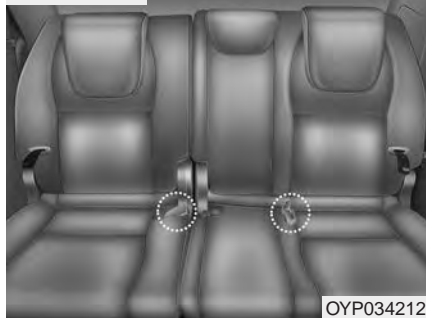

OYP034212N

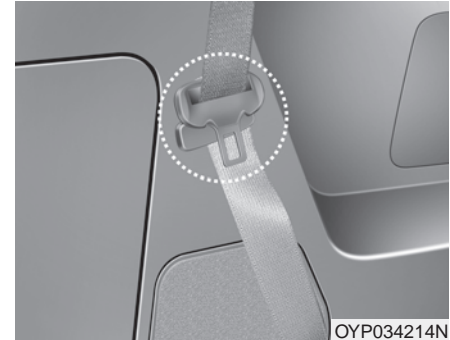

OYP034214N

To fold down the rear seatback

1. Insert the rear seat belt buckle in the pocket between the rear seatback and cushion, and insert the rear seat belt webbing in the guide to prevent the seat belt from being damaged.
2. Set the front seatback to the upright position and if necessary, slide the front seat forward.
3. Lower the rear headrests to the lowest position.

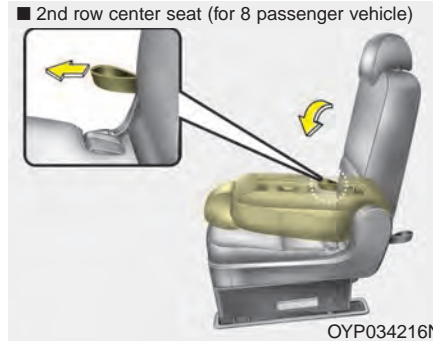
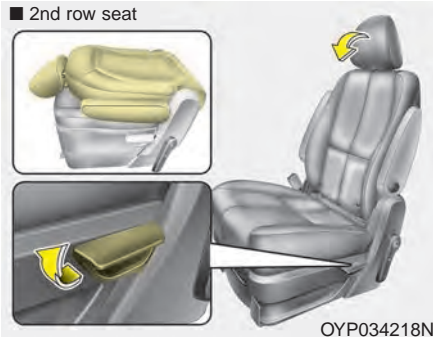

6. Return the rear seat belt to the proper position.

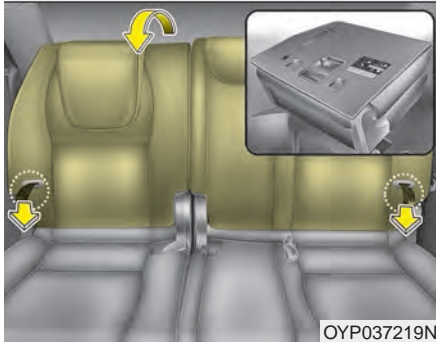

4. Pull on the seatback folding lever or strap, then fold the seat toward the front of the vehicle. When you return the seatback to its upright position, always be sure it has locked into position by pushing on the top of the seatback.
5. To use the rear seat, lift and pull the seatback backward by pulling on the folding lever or strap. Pull the seatback firmly until it clicks into place. Make sure the seatback is locked in place.

Removing the tumble seat (for 8 passenger vehicle)

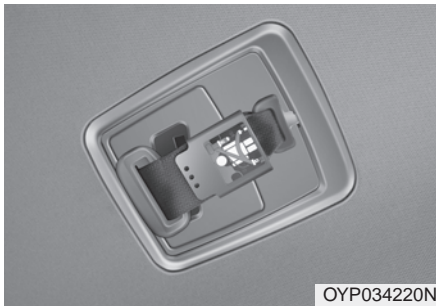

1. Insert the seat belt in the belt assembly cover.
2. Insert the seat belt buckle in the seat cushion pocket.

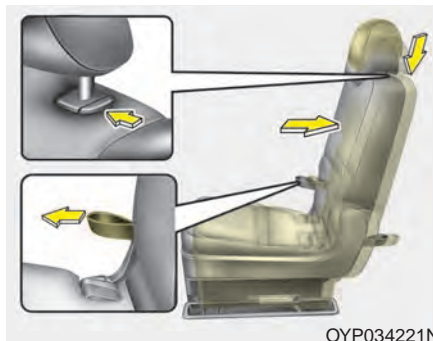

3. Lower the headrest to the lowest position.
4. Slide the seat to the farthest rearward.
5. Fold the seat back by pull up the recline strap.

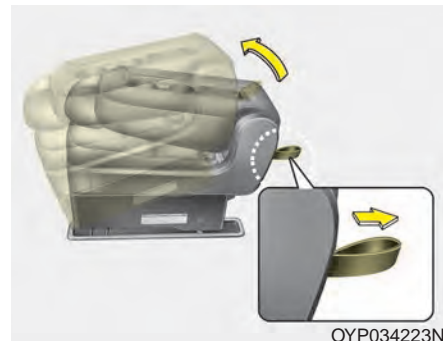

6. Pull the removal strap and lift the rear portion of the seat cushion.

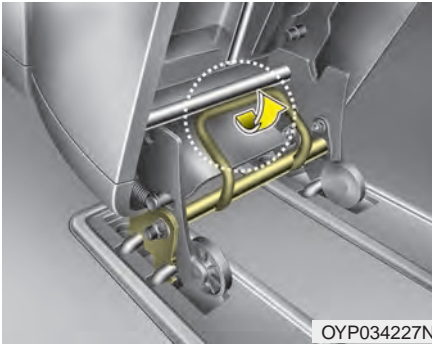

7. Pull up the catch release lever under the front of the seat cushion while reclining the folded seat rearward slightly to release the front catches from the anchors.
8. Remove the entire seat from the floor.

**Installing the tumble seat
(for 8 passenger vehicle)**

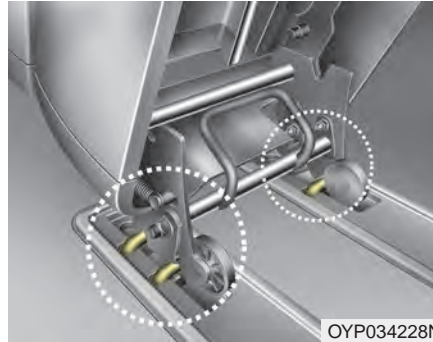

1. Put the front anchor strikers along the front anchors on the floor.
2. Insert two front anchor strikers into the front anchors.

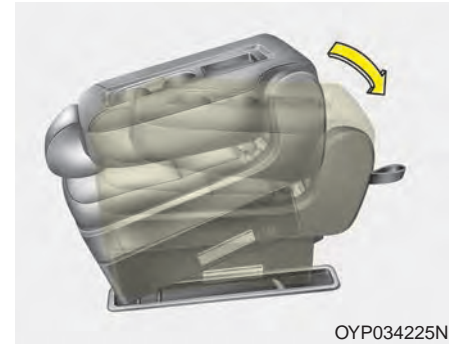

3. Lift the rear portion of the seat cushion then push down firmly to lock the catches into the rear anchors until an audible “click” is heard.

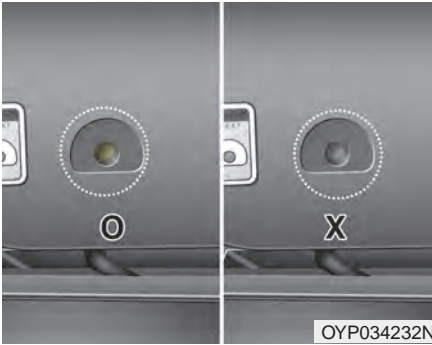

4. Make sure the green mark on the rear seat cushion frame is visible and the catches are locked in position by moving the seat forward and backward or lifting the front portion of the seat. If the green mark is invisible and the seat moves, it is not locked properly.

5. Pull up the seatback recline strap.

6. Lift and push the seatback backward firmly until it clicks into place.

Make sure the seatback is locked in place.

7. Return the seat belt to the proper position.

⚠ WARNING - Installing or removing the tumble seat



Do not install or remove the tumble (2nd row center) seat, if there are occupants in the 3rd row seats, as this may injure occupants.

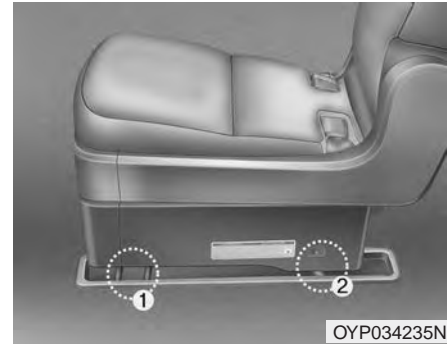

If the rear catches of the seat are locked into the rear anchors (2) while the front catches are not locked into the front anchors (1), do the followings to release the rear catches from the rear anchors.

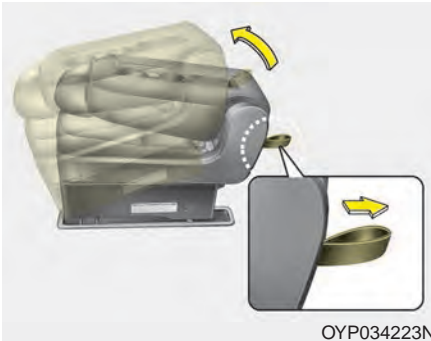

Pull the removal strap and lift the rear portion of the seat cushion. Then the rear catches will be released. Remove the seat while lifting up the rear portion of seat cushion and then reinstalling the tumble seat.

**Stowing the rear seat
- 3rd row seat**



The rear seat can be folded and stowed in the luggage compartment to provide additional cargo space.

To stow the rear seat:

1. Lower the headrest to the lowest position. To stow easily, adjust the seatback to upright position. (if necessary)

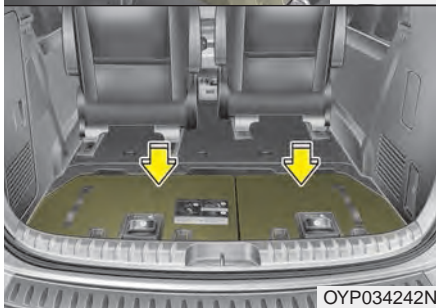

2. Pull up the seat by using the stowing lever.
3. Stow the seat by pushing down firmly.

Make sure there is no body or object around the seat and be careful not to injure your hands or body under the seat or in the moving parts when stowing or reinstalling the seat.

⚠ CAUTION - To stow 3rd row seat



Do not stow the 3rd row seat when the seat back is folded down. It may damage the 3rd seat mechanism.

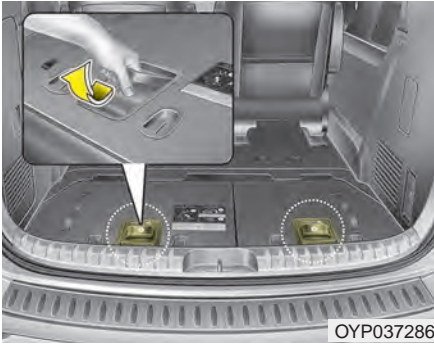

To use the rear seat:

1. Lift the seat by pulling up the stowing lever.

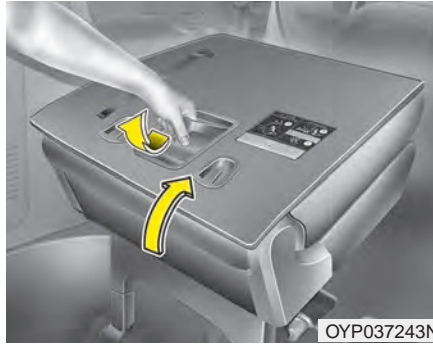

2. Release the lever and push the seat forward firmly until it clicks into place to insert the catches into the anchors.

*** NOTICE**

Do not push down the upper part of the seatback when pushing the seat forward. Doing so can prevent the catches from being locked in position.



3. Make sure the catches are locked in position by moving the seat forward and backward or lifting the front portion of the seat. If the seat moves, it is not locked properly.



4. Pull out and hold the folding strap.
5. Hold the seat back when you adjust the seat back angle until it clicks into place and then release the folding strap.

Make sure the seatback is locked in place.

6. Return the rear seat belt to the proper position.

⚠ WARNING - Cargo

Do not place heavy objects in the rear seats, since they cannot be properly secured and may hit vehicle occupants in a frontal collision.

When you fold the rear (2nd and/or 3rd row) seatback, insert the buckle in the pocket between the rear seatback and cushion. Doing so can prevent the buckle from being damaged by the rear seatback.

When returning the rear (2nd and/or 3rd row) seatbacks to the upright position, remember to return the rear shoulder belts to their proper position. Routing the seat belt webbing through the rear seat belt guides will help keep the belts from being trapped behind or under the seats.

Make sure the engine is off, the automatic transaxle is in P (Park) and the parking brake is securely applied whenever loading or unloading cargo. Failure to take these steps may allow the vehicle to move if the shift lever is inadvertently moved to another position.

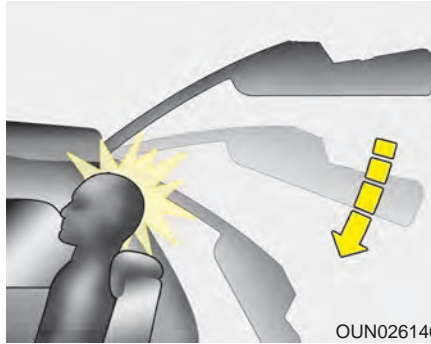

⚠ WARNING - 3rd row seat
3rd row occupants should always remain in the center of the seat cushion so the occupants head is protected by the headrest.
If not, the liftgate (tailgate) may hit the occupant's head, which could cause injury.

Armrest (2nd row seat)

■ Type A



OYP034254N

■ Type B (for SXL package)



OYP034300N/Q

The 2nd row seats have the armrest located on the side of seatback.

Type A

To use the armrest, swing down the armrest to the lowest position.

Type B

To use the armrest, press the release button (1) on the armrest and adjust the angle to the desired position. And then release the button (1).

Seatback pocket (for SXL package)

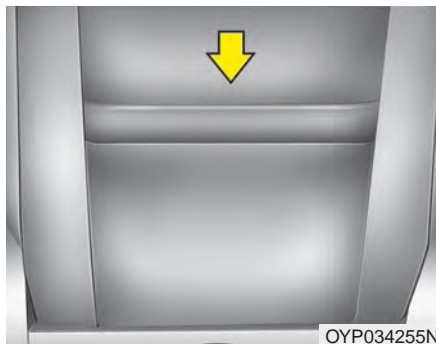

The seatback pocket is provided on the back of the 2nd row outboard seatbacks.

⚠ WARNING - Seatback pockets

Do not put heavy or sharp objects in the seatback pockets. In an accident they could come loose from the pocket and injure vehicle occupants.

Headrest (for rear seat)

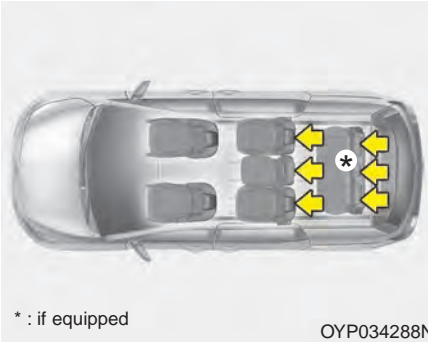

The rear seat(s) is equipped with headrests in all the seating positions for the occupant's safety and comfort. The headrest not only provides comfort for passengers, but also helps protect the head and neck in the event of a collision.

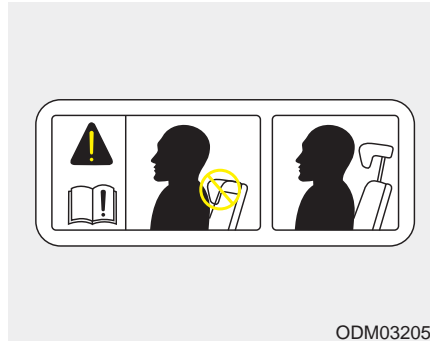

For maximum effectiveness in case of an accident, the headrest should be adjusted so the middle of the headrest is at the same height as the center of gravity of an occupant's head.

Generally, the center of gravity of most people's head is similar with the height of the top of their eyes.

Also adjust the headrest as close to your head as possible. For this reason, the use of a cushion that holds the body away from the seatback is not recommended.

Adjusting the height up and down

■ 2nd row outboard

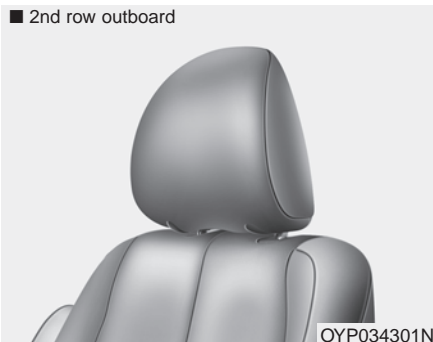

■ 2nd row center (if equipped)



■ 2nd row for SXL package



■ 3rd row

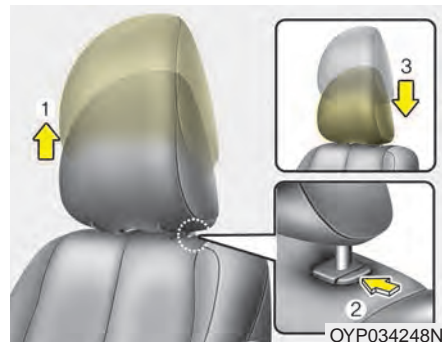
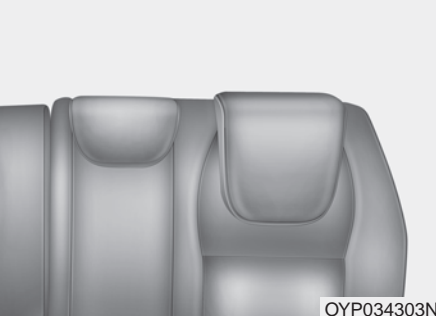

To raise the headrest :

1. Pull it up to the desired position (1).

To lower the headrest :

1. Push and hold the release button (2) on the headrest support
2. Lower the headrest to the desired position (3).

Removal and reinstallation

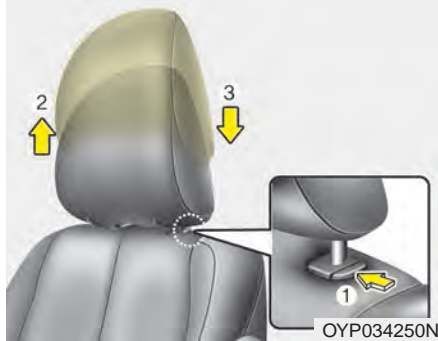

To remove the headrest :

1. Raise it as far as it can go then press the release button (1) while pulling the headrest up (2).

To reinstall the headrest :

1. Put the headrest poles (3) into the holes while pressing the release button (1).
2. Adjust it to the appropriate height.

After installing the headrest, make sure that it is installed in the right direction.

A headrest installed reversely could increase whiplash injury during rear impact.



CAUTION - Auto-folding headrest

Do not remove the headrest in vehicles equipped with the second row auto-folding function. The cable may become dislocated or damaged when the headrest is removed, and may lead to auto-folding function failure.

2nd row outboard headrest

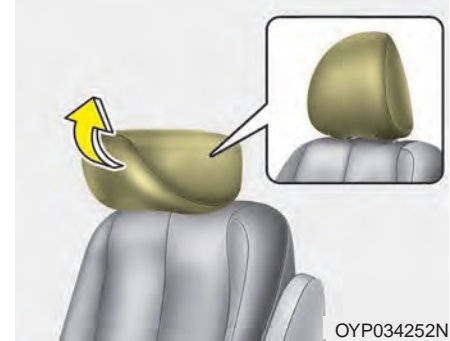

The headrest will fold down automatically when the seat is in the walk in position.

Always be sure the headrest has locked into position after you return the seatback.

Forward and backward adjustment (2nd row seat for SXL package)

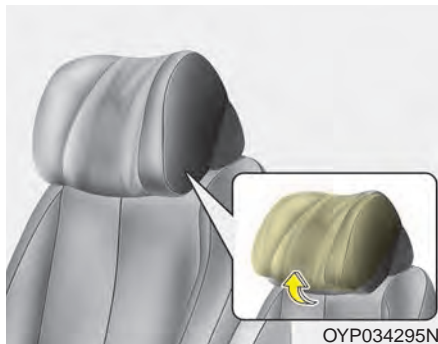

The headrest may be adjusted forward or backward by pulling the lower part of the headrest forward or backward to the desired detent in the direction of the arrow. Adjust the headrest so that it properly supports the head and neck.

Wing-out (2nd row seat for SXL package)

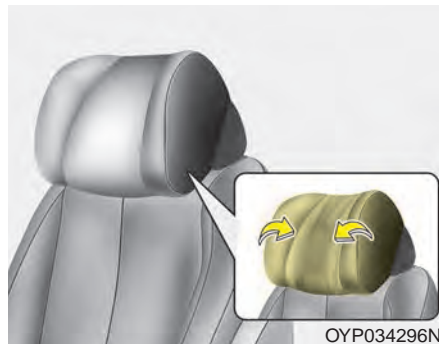

For rear outboard passenger's comfort, the ends of the headrest can be adjusted inward.

SEAT BELTS

Seat belt restraint system

- For maximum restraint system protection, the seat belts must always be used whenever the vehicle is moving. A properly positioned shoulder belt should be positioned midway over your shoulder across your collarbone.
- Never allow children to ride in the front passenger seat. See child restraint system section for further discussion.

WARNING - Twisted seat belt

Make sure your seat belt is not twisted when worn. A twisted seat belt may not properly protect you in an accident and could even cut into your body.

WARNING - Shoulder Belt

- **Never wear the shoulder belt under your arm or behind your back. An improperly positioned shoulder belt cannot protect the occupant in a crash.**
- **Always wear both the shoulder portion and lap portion of the lap/shoulder belt.**

WARNING - Damaged seat belt

Replace the entire seat belt assembly if any part of the webbing or hardware is damaged as you can no longer be sure that a damaged seat belt will provide protection in a crash.

Seat belts are designed to bear upon the bony structure of the body, and should be worn low across the front of the pelvis, chest and shoulders, as applicable; wearing the lap section of the belt across the abdominal area must be avoided.

Seat belts should be adjusted as firmly as possible, consistent with comfort, to provide the protection for which they have been designed.

A slack belt will greatly reduce the protection afforded to the wearer.

Care should be taken to avoid contamination of the webbing with polishes, oils and chemicals, and particularly battery acid. Cleaning may safely be carried out using mild soap and water. The belt should be replaced if webbing becomes frayed, contaminated or damaged.

- No modifications or additions should be made by the user which will either prevent the seat belt adjusting devices from operating to remove slack, or prevent the seat belt assembly from being adjusted to remove slack.
- When you fasten the seat belt, be careful not to latch the seat belt in buckles of other seat. It's very dangerous and you may not be protected by the seat belt properly.
- Do not unfasten the seat belt and do not fasten and unfasten the seat belt repeatedly while driving. This could result in loss of control, and an accident causing death, serious injury, or property damage.
- When fastening the seat belt, make sure that the seat belt does not pass over objects that are hard or can break easily.

⚠ WARNING - Seat belt buckle

Do not allow foreign material (gum, crumbs, coins, etc.) to obstruct the seat belt buckle. This may prevent the seat belt from fastening securely.

Seat belt warning (for driver's seat)



The driver's seat belt warning light and chime will activate pursuant to the following table when the ignition switch is in "ON" position.

Conditions		Warning Pattern	
Seat Belt	Vehicle Speed	Light-Blink	Chime-Sound
Unbuckled		6 seconds	
Buckled		6 seconds	None
Buckled → Unbuckled	Below 3 mph (5 km/h)	6 seconds	None
	3 mph~6 mph	6 seconds	
	Above 6 mph (10 km/h)	6 sec. on / 24 sec. off (11 times)	
Unbuckled	Above 6 mph (10 km/h)	6 seconds *1	
	↓ Below 3 mph (5 km/h)	↓ Stop *2	

*1 Warning pattern repeats 11 times with an interval of 24 seconds. If the driver's seat belt is buckled, the light will stop within 6 seconds and chime will stop immediately.

*2 The light will stop within 6 seconds and chime will stop immediately.

Seat belt warning (for front passenger's seat)

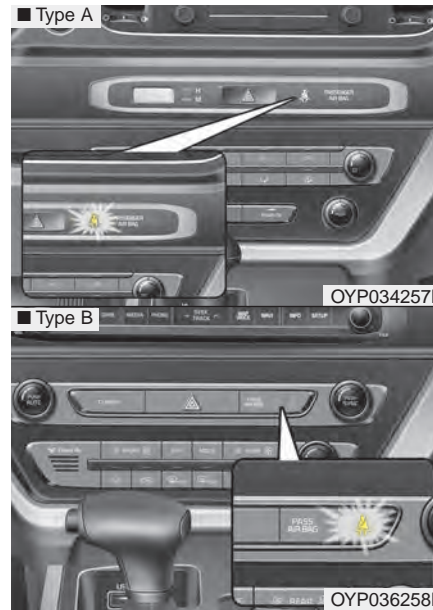

The front passenger's seat belt warning light will activate to the following table when the ignition switch is in "ON" position.

Conditions		Warning Pattern
Seat Belt	Vehicle Speed	Light-Blink
Unbuckled		6 seconds
Unbuckled	Above 10 km/h (6mph)	Continuously
Buckled		6 seconds
Buckled → Unbuckled	Above 10 km/h (6mph)	Continuously *1
	Below 10 km/h (6mph)	None

*1 The seat belt warning light will go off if the vehicle speed decreases below 5 km/h (3 mph). If the vehicle speed increases above 5 km/h (3 mph), the warning light will blink again.

- You can find the front passenger's seat belt warning light on the center fascia panel.
- Although the front passenger seat is not occupied, the seat belt warning light will blink for 6 seconds.
- The seat belt warning light can blink when a briefcase or purse is placed on the front passenger seat.

Riding in an improper position adversely affects the front passenger's seat belt warning system. It is important for the driver to instruct the passenger as to the proper seating instructions as contained in this manual.

Seat belt - Driver's 3-point system with emergency locking retractor

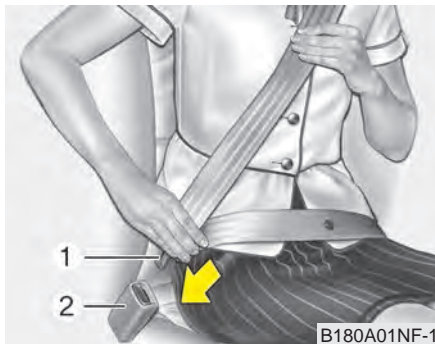

To fasten your seat belt:

To fasten your seat belt, pull it out of the retractor and insert the metal tab (1) into the buckle (2). There will be an audible "click" when the tab locks into the buckle.

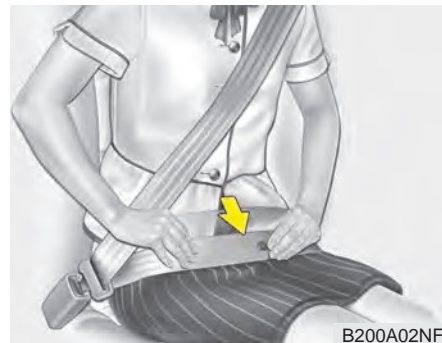

The seat belt automatically adjusts to the proper length only after the lap belt portion is adjusted manually so that it fits snugly around your hips. If you lean forward in a slow, easy motion, the belt will extend and let you move around. If there is a sudden stop or impact, however, the belt will lock into position. It will also lock if you try to lean forward too quickly.

*** NOTICE**

If you are not able to pull out the seat belt from the retractor, firmly pull the belt out and release it. Then you will be able to pull the belt out smoothly.

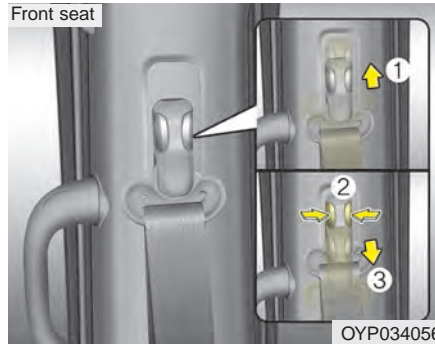
**Height adjustment**

You can adjust the height of the shoulder belt anchor to one of the 3 positions for maximum comfort and safety.

The height of the adjusting seat belt should not be too close to your neck. The shoulder portion should be adjusted so that it lies across your chest and midway over your shoulder near the door and not your neck.

To adjust the height of the seat belt anchor, lower or raise the height adjuster into an appropriate position.

To raise the height adjuster, pull it up (1). To lower it, push it down (3) while pressing the height adjuster button (2).

Release the button to lock the anchor into position. Try sliding the height adjuster to make sure that it has locked into position.

⚠ WARNING - Shoulder belt positioning

Never position the shoulder belt across your neck or face.

⚠ WARNING - Seat belt replacement

Replace your seat belts after being in an accident. Failure to replace seat belts after an accident could leave you with damaged seat belts that will not provide protection in the event of another collision.

Seat belts - Front passenger and rear seat 3-point system with combination locking retractor

To fasten your seat belt:

Combination retractor type seat belts are installed in the rear seat positions to help accommodate the installation of child restraint systems. Although a combination retractor is also installed in the front passenger seat position, it is strongly recommended that children always be seated in the rear seat. NEVER place any infant restraint system in the front seat of the vehicle.

This type of seat belt combines the features of both an emergency locking retractor seat belt and an automatic locking retractor seat belt. To fasten your seat belt, pull it out of the retractor and insert the metal tab into the buckle. There will be an audible "click" when the tab locks into the buckle. When not securing a child restraint, the seat belt operates in the same way as the driver's seat belt (Emergency Locking Retractor Type).

It automatically adjusts to the proper length only after the lap belt portion of the seat belt is adjusted manually so that it fits snugly around your hips.

When the seat belt is fully extended from the retractor to allow the installation of a child restraint system, the seat belt operation changes to allow the belt to retract, but not to extend (Automatic Locking Retractor Type). Refer to "Using a child restraint system" in this section.

*** NOTICE**

Although the combination retractor provides the same level of protection for seated passengers in either emergency or automatic locking modes, have the seated passengers use the emergency locking feature for improved convenience. The automatic locking function is intended to facilitate child restraint installation. To convert from the automatic locking feature to the emergency locking operation mode, allow the unbuckled seat belt to fully retract.

**CAUTION**

Do NOT fold down the left portion of the rear seat back when the rear center seat belt is buckled. ALWAYS UNBUCKLE the rear center seat belt before folding down the left portion of the rear seat back. If the rear center seat belt is buckled when the left portion of the rear seat back is folded down, distortion and damage to the top portion of the seat back and seat belt garnish may result, causing the seat back to lock into the folded down position.

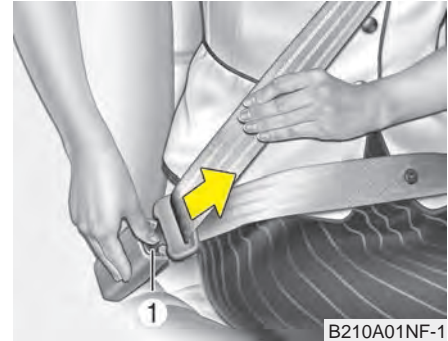
**To release the seat belt:**

The seat belt is released by pressing the release button (1) on the locking buckle. When it is released, the belt should automatically draw back into the retractor.

If this does not happen, check the belt to be sure it is not twisted, then try again.

3 Point rear center belt (for 2nd and/ 3rd center seat, if equipped)

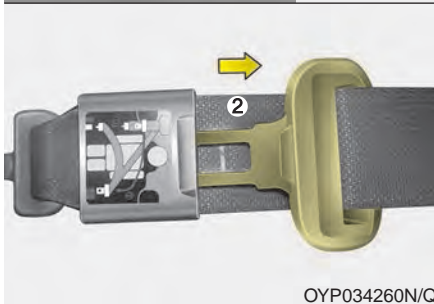
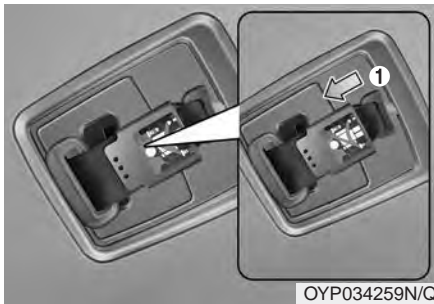

To fasten the rear center belt

1. Pull out the mini tongue from hole on the belt assembly cover (1) and then slowly pull the seat belt out from the retractor.

2. Pull out the tongue plate from the holder on the seat belt (2).

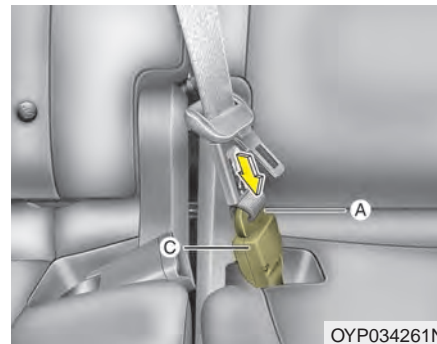

3. Insert the mini tongue (A) into the open end of the anchor connector (C) until an audible “click” is heard, indicating the latch is locked. Make sure the belt is not twisted.

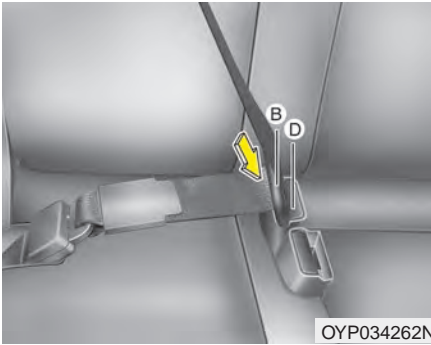

4. Pull the tongue plate (B) and insert the tongue plate (B) into the open end of the buckle (D) until an audible “click” is heard, indicating the latch is locked. Make sure the belt is not twisted.

When using the rear center seat belt, the buckle with the “CENTER” mark must be used.

There will be an audible “click” when the tab locks in the buckle. The seat belt automatically adjusts to the proper length only after the lap belt is adjusted manually so that it fits snugly around your hips, if you lean forward in a slow, easy motion, the belt will extend and let you move around. If there is a sudden stop or impact, the belt will lock into position. It will also lock if you try to lean forward too quickly.

⚠ WARNING

When using the rear seat center belt, you must lock all tongue plates and buckles. If any tongue plate or buckle is not locked, it will increase the chance of injury in the event of collision.

To unfasten the rear center belt

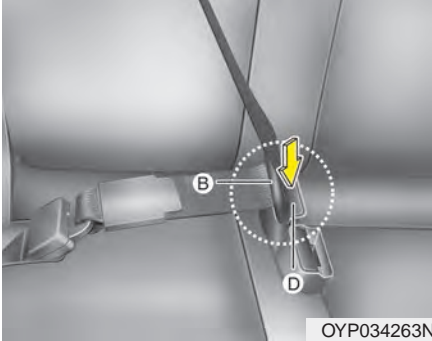

1. Press the release button on the buckle (D) and remove the tongue plate (B) from the buckle (D).

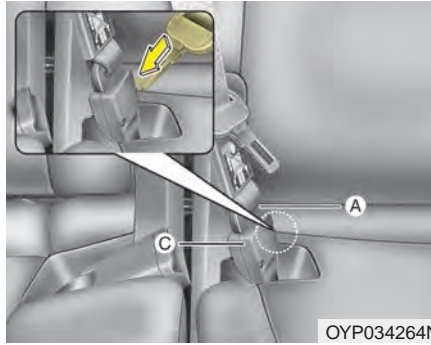

2. To retract the rear center seatbelt, insert the tongue plate or similar small rigid device into the web release hole (C). Pull up on the seat belt web (A) and allow the webbing to retract automatically.

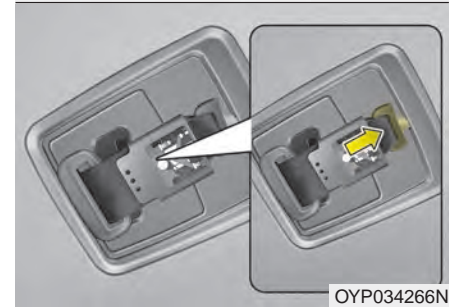
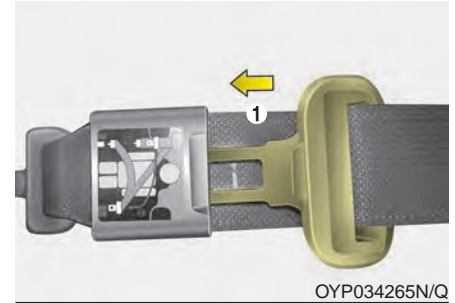

3. Insert the tongue plate into the holder (1) in seat belt and then insert the mini tongue into the hole on the belt assembly cover.

Stowing the rear seat belt

- 2nd row seat (for 2nd row center seat, if equipped)



- 3rd row

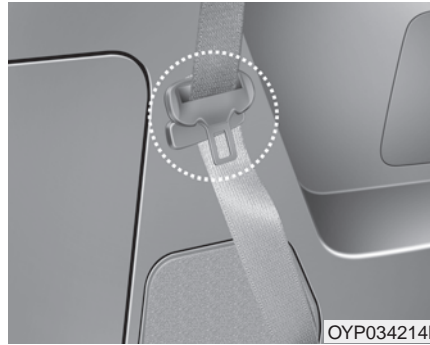
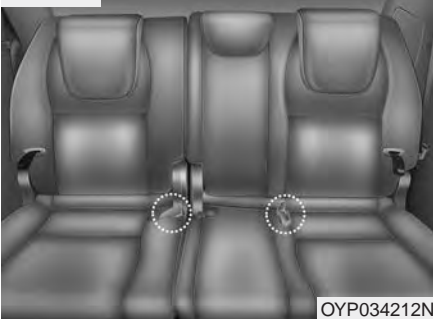

The rear seat belt buckles can be stowed in the pocket between the rear seatback and cushion when not in use.

Routing the seat belt webbing through the rear seat belt guides will help keep the belts from being trapped behind or under the seats.

After inserting the seat belt, tighten the belt webbing by pulling it up.

CAUTION

Remove the seat belt from the guides before using. If you pull on the seat belt when it is stored in the guides, it may damage the guides and/or belt webbing.

Pre-tensioner seat belt



Your vehicle is equipped with driver's and front passenger's pre-tensioner seat belts (retractor pretensioner and EFD (Emergency Fastening Device)). The pre-tensioner seat belts may be activated, when a frontal collision is severe enough, together with the air bags.

When the vehicle stops suddenly, or if the occupant tries to lean forward too quickly, the seat belt retractor may lock into position. In certain frontal collisions, the pre-tensioner will activate and pull the seat belt into tighter contact against the occupant's body.

(1) Retractor Pretensioner

The purpose of the retractor pretensioner is to make sure that the shoulder belts fit in tightly against the occupant's upper body in certain frontal collisions.

(2) EFD (Emergency Fastening Device)

The purpose of the EFD is to make sure that the pelvic belts fit in tightly against the occupant's lower body in certain frontal collisions.

If the system senses excessive tension on the driver or passenger's seat belt when the pre-tensioner system activates, the load limiter inside the retractor pretensioner will release some of the pressure on the affected seat belt.

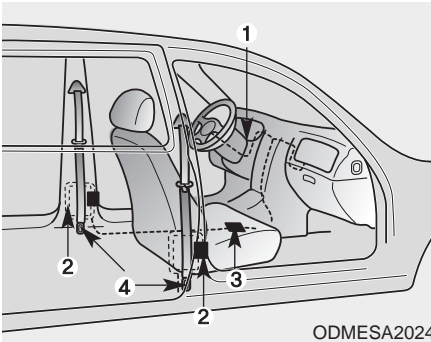

ODMESA2024

The seat belt pre-tensioner system consists mainly of the following components. Their locations are shown in the illustration:

- (1) SRS air bag warning light
- (2) Retractor pre-tensioner assembly
- (3) SRS control module
- (4) Emergency fastening device (EFD)

⚠ WARNING - Skin Irritation
 Wash all exposed skin areas thoroughly after an accident in which the pre-tensioner seat belts were activated. The fine dust from the pre-tensioner activation may cause skin irritation and should not be breathed for prolonged periods.

* NOTICE

- Both the driver's and front passenger's seat belt pre-tensioner system may be activated not only in certain frontal collision but also in certain side collision or rollover, if the vehicle is equipped with a side or curtain air bag.
- Because the sensor that activates the SRS air bag is connected with the pre-tensioner seat belt, the SRS air bag warning light  on the instrument panel will illuminate for approximately 6 seconds after the ignition switch has been turned to the ON position, and then it should turn off.

If the pre-tensioner seat belt system are not working properly, this warning light will illuminate even if there is no malfunction of the SRS air bag. If the SRS air bag warning light does not illuminate when the ignition switch is turned ON, or if it remains illuminated after illuminating for approximately 6 seconds, or if it illuminates while the vehicle is being driven, have an authorized Kia dealer inspect the pre-tensioner seat belt and SRS air bag system as soon as possible.

 **WARNING - Hot pre-tensioner**

Do not touch the pre-tensioner seat belt assemblies for several minutes after they have been activated. When the pre-tensioner seat belt mechanism fires during a collision the pre-tensioner becomes hot and can burn you.

Pre-tensioners are designed to operate only one time. After activation, pre-tensioner seat belts must be replaced. If the pre-tensioner must be replaced, contact an authorized Kia dealer.

Seat belt precautions

Infant or small child

All 50 states have child restraint laws. You should be aware of the specific requirements in your state. Child and/or infant seats must be properly placed and installed in the rear seat. For more information about the use of these restraints, refer to “Child restraint system” in this section.

*** NOTICE**

Small children are best protected from injury in an accident when properly restrained in the rear seat by a child restraint system that meets the requirements of the Federal Motor Vehicle Safety Standards. Before buying any child restraint system, make sure that it has a label certifying that it meets Federal Motor Vehicle Safety Standard 213. The restraint must be appropriate for your child's height and weight. Check the label on the child restraint for this information. Refer to "Child restraint system" in this section.

Larger children

Children who are too large for child restraint systems should always occupy the rear seat and use the available lap/shoulder belts. The lap portion should be fastened and snugged on the hips and as low as possible. Check if the belt fits periodically. A child's squirming could put the belt out of position. Children are given the most safety in the event of an accident when they are restrained by a proper restraint system in the rear seat. If a larger child (over age 12) must be seated in the front seat, the child should be securely restrained by the available lap/shoulder belt and the seat should be placed in the rearmost position. Children age 12 and under should be restrained securely in the rear seat. NEVER place a child age 12 and under in the front seat. NEVER place a rear facing child seat in the front seat of a vehicle.

If the shoulder belt portion slightly touches the child's neck or face, try placing the child closer to the center of the vehicle. If the shoulder belt still touches their face or neck they need to be returned to a child restraint system.

⚠ WARNING - Small children
Do not allow small children to ride in the vehicle without an appropriate child restraint system. If the shoulder belt comes in contact with your child's neck or face your child is too small to ride in the vehicle. In a crash the seat belt will inflict injury to your child's neck, throat and face.

Restraint of pregnant women

Pregnant women should wear lap/shoulder belt assemblies whenever possible according to specific recommendations by their doctors. The lap portion of the belt should be worn AS SECURELY AND LOW AS POSSIBLE.

⚠ WARNING - Pregnant women

Pregnant women must never place the lap portion of the seat belt above or on the abdomen where the fetus is located. The force of the seat belt during a collision will crush the fetus.

Injured person

A seat belt should be used when an injured person is being transported. When this is necessary, you should consult a physician for recommendations.

One person per belt

Two people (including children) should never attempt to use a single seat belt. This could increase the severity of injuries in case of an accident.

Do not lie down

To reduce the chance of injuries in the event of an accident and to achieve maximum effectiveness of the restraint system, all passengers should be sitting up and the front and rear seats should be in an upright position when the vehicle is moving. A seat belt cannot provide proper protection if the person is lying down in the rear seat or if the front and rear seats are in a reclined position.

Care of seat belts

Seat belt systems should never be disassembled or modified. In addition, care should be taken to assure that seat belts and belt hardware are not damaged by seat hinges, doors or other abuse.

 **WARNING - Pinched seat belt**

Make sure that the webbing and/or buckle does not get caught or pinched in the rear seat when returning the rear seatback to its upright position. A caught or pinched webbing/buckle may become damaged and could fail during a collision or sudden stop.

Periodic inspection

All seat belts should be inspected periodically for wear or damage of any kind. Any damaged parts should be replaced as soon as possible.

Keep belts clean and dry

Seat belts should be kept clean and dry. If belts become dirty, they can be cleaned by using a mild soap solution and warm water. Bleach, dye, strong detergents or abrasives should not be used because they may damage and weaken the fabric.

When to replace seat belts

The entire in-use seat belt assembly or assemblies should be replaced if the vehicle has been involved in an accident. This should be done even if no damage is visible. Additional questions concerning seat belt operation should be directed to an authorized Kia dealer.

CHILD RESTRAINT SYSTEM

Children riding in the vehicle should sit in the rear seat and must always be properly restrained to minimize the risk of injury in an accident, sudden stop or sudden maneuver. According to accident statistics, children are safer when properly restrained in the rear seats than in the front seat. Larger children not in a child restraint should use one of the seat belts provided.

You should be aware of the specific requirements in your country. Child and/or infant safety seats must be properly placed and installed in the rear seat. You must use a commercially available child restraint system that meets the requirements of the Federal Motor Vehicle Safety Standards (FMVSS).

Child restraint systems are designed to be secured in vehicle seats by the lap belt portion of a lap/shoulder belt, or by a tether anchor and/or LATCH anchors (if equipped).

Children could be injured or killed in a crash if their restraints are not properly secured. For small children and babies, a child seat or infant seat must be used. Before buying a particular child restraint system, make sure it fits your vehicle seat and seat belts, and fits your child.

Follow all the instructions provided by the manufacturer when installing the child restraint system.

WARNING - Restraint location

Never install a child or infant seat on the front passenger's seat. A child riding in the front passenger seat can be forcefully struck by an inflating airbag.

WARNING - Hot child restraint

A child restraint system can become very hot if it is left in a closed vehicle on a sunny day. Be sure to check the seat cover, buckles and latches before placing a child in the restraint system.

When the child restraint system is not in use, store it in the luggage area or fasten it with a seat belt so that it will not be thrown forward in case of a sudden stop or an accident.

Using a child restraint system

Rearward-facing child restraint system

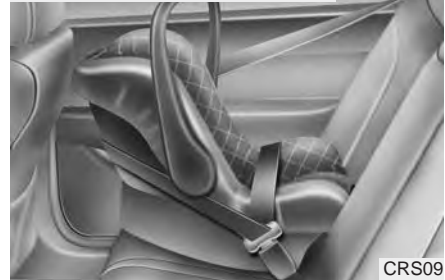

CRS09

Forward-facing child restraint system



OUN026150

For small children and babies, the use of a child seat or infant seat is required. The child seat or infant seat should be of appropriate size for the child and should be installed in accordance with the manufacturer's instructions.

⚠ WARNING - Holding children

Never hold a child in your arms or lap when riding in a vehicle. The violent forces created during a crash will tear the child from your arms and throw the child against the car's interior. Always use a child restraint system which is appropriate for your child's height and weight.

⚠ WARNING - Unattended Children

Never leave children unattended in a vehicle. The car can heat up very quickly, resulting in injuries to the child in the vehicle.

⚠ WARNING - Seat belt use

Do not use one seat belt for two occupants at the same time. This will eliminate any safety benefit provided by the seat belt to the occupants.

For safety reasons, we recommend that the child restraint system be used in the rear seats.

Never place a rear-facing child restraint in the front passenger seat, because of the danger an inflating passenger-side air bag could impact the rear-facing child restraint and kill the child.

Since all passenger seat belts move freely under normal conditions and only lock under extreme or emergency conditions (emergency lock mode), you must manually change these seat belts to the auto lock mode to secure a child restraint.

If the seat belt does not operate as described in this section, have the system checked immediately by your authorized Kia dealer.

Placing a passenger seat belt into the auto lock mode

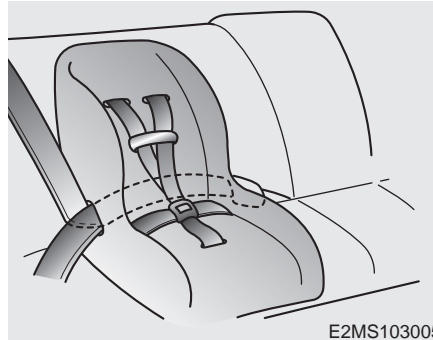

The auto lock mode will help prevent the normal movement of the child in the vehicle from causing the seat belt to loosen and compromise the child restraint system. To secure a child restraint system, use the following procedure.

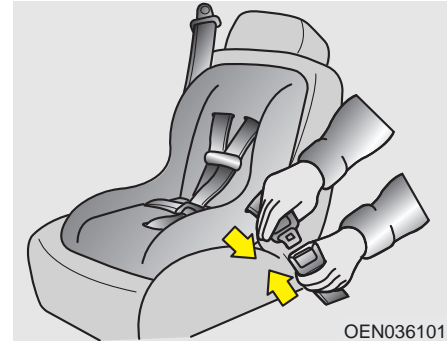

To install a child restraint system on the outboard or center rear seats, do the following:

1. Place the child restraint system in the seat and route the lap/shoulder belt around or through the restraint, following the restraint manufacturer's instructions. Be sure the seat belt webbing is not twisted.
2. Fasten the lap/shoulder belt latch into the buckle. Listen for the distinct "click" sound.

Position the release button so that it is easy to access in case of an emergency.

If the vehicle headrest prevents proper installation of a child seat (as described in the child seat system manual), the headrest of the respective seating position shall be readjusted or entirely removed.

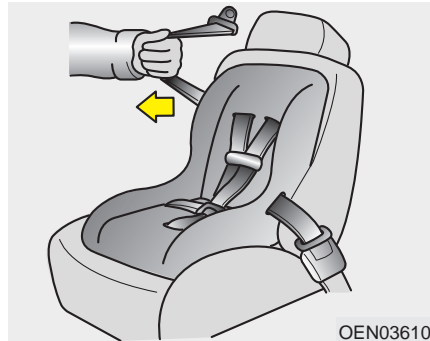

3. Pull the shoulder portion of the seat belt all the way out. When the shoulder portion of the seat belt is fully extended, it will shift the retractor to the “Auto Lock” (child restraint) mode.

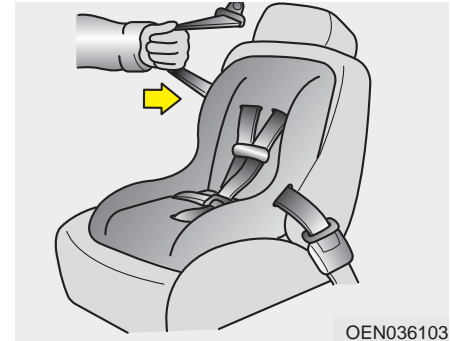

4. Slowly allow the shoulder portion of the seat belt to retract and listen for an audible “clicking” or “ratcheting” sound. This indicates that the retractor is in the “Auto Lock” mode. If no distinct sound is heard, repeat steps 3 and 4.

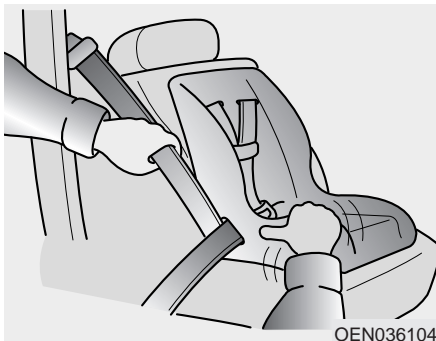

5. Remove as much slack from the belt as possible by pushing down on the child restraint system while feeding the shoulder belt back into the retractor.
6. Push and pull on the child restraint system to confirm that the seat belt is holding it firmly in place. If it is not, release the seat belt and repeat steps 2 through 6.
7. Double check that the retractor is in the “Auto Lock” mode by attempting to pull more of the seat belt out of the retractor. If you cannot, the retractor is in the “Auto Lock” mode.

The lap/shoulder belt automatically returns to the “emergency lock mode” whenever the belt is allowed to retract fully. Therefore, the preceding seven steps must be followed each time a child restraint is installed.

To remove the child restraint, press the release button on the buckle and then pull the lap/shoulder belt out of the restraint and allow the seat belt to retract fully.

⚠ WARNING - Auto lock mode

Set the retractor to Automatic Lock mode when installing any child restraint system. If the retractor is not in the Automatic Locking mode, the child restraint can move when your vehicle turns or stops suddenly.

When the seat belt is allowed to retract to its fully stowed position, the retractor will automatically switch from the “Auto Lock” mode to the emergency lock mode for normal adult usage.

Securing a child restraint seat with tether anchor system

■ 2nd row outboard seat



■ 3rd row seat

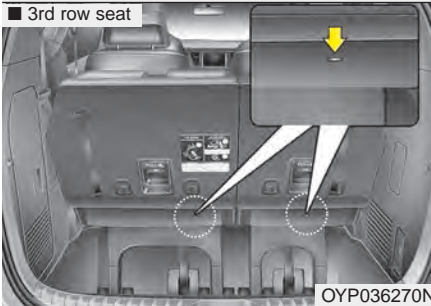

Child restraint hook holders are located on the back of the rear cushions.



1. Route the child restraint seat strap over the seatback.

For vehicles with adjustable headrests, route the tether strap under the headrest and between the headrest posts, otherwise route the tether strap over the top of the seatback. In case of interference between the child restraint seat and the headrest remove the particular head restraint for better fitment of the child restraint seat.

2. Connect the tether strap hook to the appropriate child restraint hook holder and tighten to secure the child restraint seat.

⚠ WARNING - Tether strap
Never mount more than one child restraint to a single tether or to a single lower anchorage point. The increased load caused by multiple seats may cause the tethers or anchorage points to break.

Check that the child restraint system is secure by pushing and pulling it in different directions. Incorrectly fitted child restraints may swing, twist, tip or separate causing death or serious injury.

Securing a child restraint seat with child seat lower anchor system

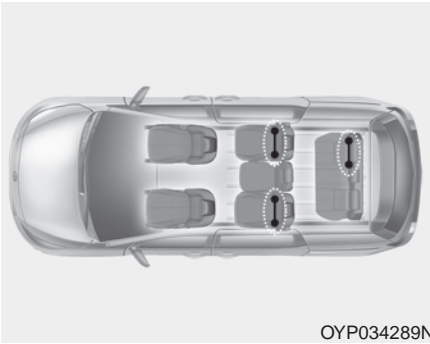

Some child seat manufacturers make child restraint seats that are labeled as LATCH or LATCH-compatible child restraint seats. LATCH stands for "Lower Anchors and Tethers for Children". These seats include two rigid or webbing mounted attachments that connect to two LATCH anchors at specific seating positions in your vehicle. This type of child restraint seat eliminates the need to use seat belts to attach the child seat in the rear seats.

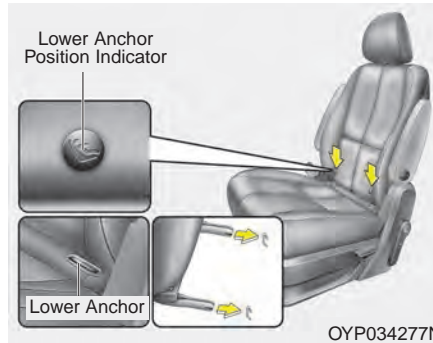

Child restraint symbols are located on the 2nd row outboard seat backs and 3rd row right seat back to indicate the position of the lower anchors for child restraints.

⚠ WARNING - Unused rear seatbelts

Always fasten the seatbelts behind the child restraint seat when they are not used to secure the child seat. Failure to do so may result in child strangulation.

Install the child restraint seat fully rearward against the seatback with the seatback reclined two positions from the most upright latched position.

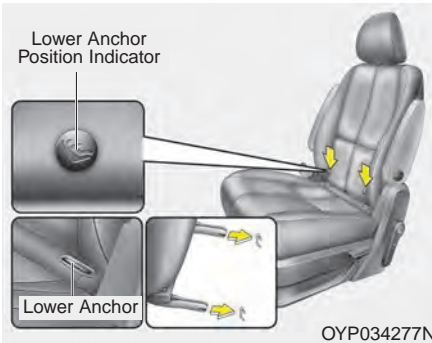

LATCH anchors have been provided in your vehicle. The LATCH anchors are located in the left and right outboard rear seating positions. Their locations are shown in the illustration. There is no LATCH anchor provided for the center rear seating position.

The LATCH anchors are located between the seatback and the seat cushion of the 2nd row seat left and right outboard seating positions.

Follow the child seat manufacturer's instructions to properly install child restraint seats with LATCH or LATCH-compatible attachments.

Once you have installed the LATCH child restraint, assure that the seat is properly attached to the LATCH and tether anchors.

Also, test the child restraint seat before you place the child in it. Tilt the seat from side to side. Also try to tug the seat forward. Check to see if the anchors hold the seat in place.

⚠ WARNING - LATCH lower anchors

Never attempt to attach a LATCH equipped seat in the center seating position. LATCH lower anchors are only to be used with the left and right rear outboard seating positions. You may damage the anchors or the anchors may fail and break in a collision.

*** NOTICE**

The recommended weight for the LATCH system is under 65 lb (30 kg).

How to calculate the child restraint weight :

**Child restraint weight =
65 lb (30 kg) - Child weight**

AIR BAG - ADVANCED SUPPLEMENTAL RESTRAINT SYSTEM

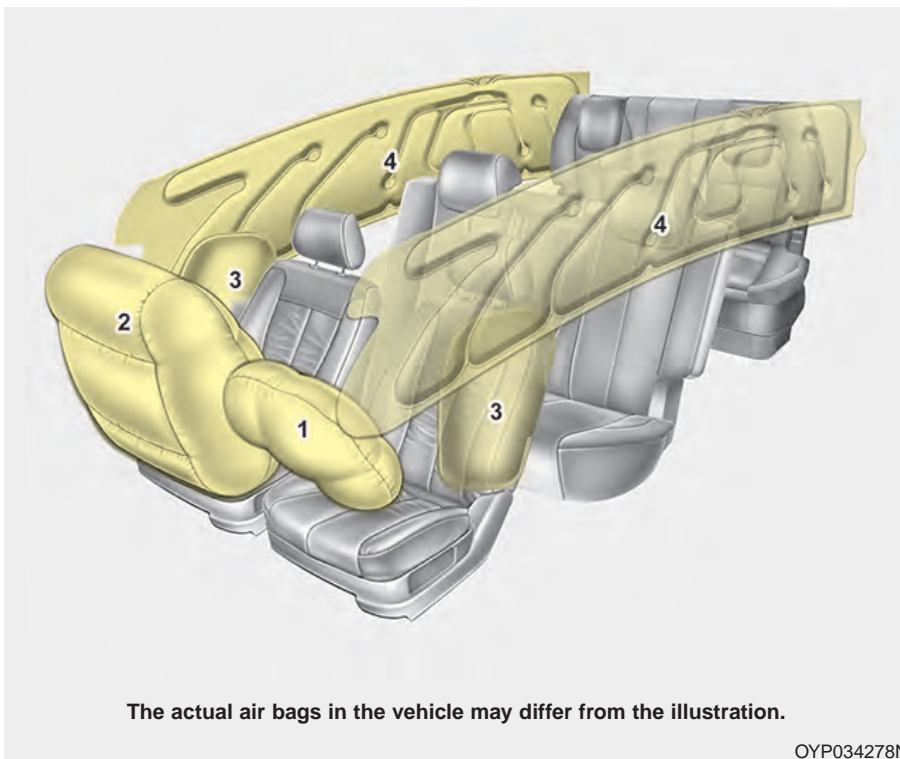

- (1) Driver's front air bag
- (2) Passenger's front air bag
- (3) Side air bag
- (4) Curtain air bag

Even in vehicles with air bags, you and your passengers must always wear the safety belts provided in order to minimize the risk and severity of injury in the event of a collision or rollover.

The actual air bags in the vehicle may differ from the illustration.

OYP034278N

How does the air bag system operate

- Air bags are activated (able to inflate if necessary) only when the ignition switch is turned to the ON or START position.
- The appropriate air bags inflate instantly in the event of a serious frontal collision or side collision in order to help protect the occupants from serious physical injury.
- There is no single speed at which the air bags will inflate.

Generally, air bags are designed to inflate based upon the severity of a collision and its direction. These two factors determine whether the sensors produce an electronic deployment/ inflation signal.

- Air bag deployment depends on a number of factors including vehicle speed, angles of impact and the density and stiffness of the vehicles or objects which your vehicle hits in the collision. The determining factors are not limited to those mentioned above.

- The front air bags will completely inflate and deflate in an instant.

It is virtually impossible for you to see the air bags inflate during an accident.

It is much more likely that you will simply see the deflated air bags hanging out of their storage compartments after the collision.

- In addition to inflating in serious side collisions, side and/or curtain air bags will inflate if the sensing system detects a rollover.
- When a rollover is detected, side and/or curtain air bags will remain inflated longer to help provide protection from ejection, especially when used in conjunction with the seat belts.

- In order to help provide protection, the air bags must inflate rapidly. The speed of the air bag inflation is a consequence of extremely short time in which to inflate the air bag between the occupant and the vehicle structures before the occupant impacts those structures. This speed of inflation reduces the risk of serious or life-threatening injuries and is thus a necessary part of the air bag design.

However, air bag inflation can also cause injuries which can include facial abrasions, bruises and broken bones because the inflation speed also causes the air bags to expand with a great deal of force.

- **There are even circumstances under which contact with the steering wheel or passenger air bag can cause fatal injuries, especially if the occupant is positioned excessively close to the steering wheel or passenger air bag.**

⚠ WARNING - Airbag inflation

Sit as far back as possible from the steering wheel while still maintaining comfortable control of your vehicle. A distance of at least 10" from your chest to the steering wheel is recommended. Failure to do so can result in airbag inflation injuries to the driver.

Noise and smoke

When inflated, the air bags make a loud noise and leave smoke and powder in the air inside the vehicle. This is normal and is a result of the ignition of the air bag inflator. After the air bag inflates, you may feel substantial discomfort in breathing due to the contact of your chest with both the seat belt and the air bag, as well as from breathing the smoke and powder. **Open your doors and/or windows as soon as possible after impact in order to reduce discomfort and prevent prolonged exposure to the smoke and powder.**

Though smoke and powder are non-toxic, it may cause irritation to the skin (eyes, nose and throat, etc). If this is the case, wash and rinse with cold water immediately and consult a doctor if the symptom persists.

⚠ WARNING - Hot components

Do not touch the air bag storage area's internal components immediately after airbag inflation. The air bag related parts in the steering wheel, instrument panel and the roof rails above the front and rear doors are very hot. Hot components can result in burn injuries.

Do not install a child restraint on the front passenger's seat.



Never place a rear-facing child restraint in the front passenger's seat. If the air bag deploys, it would impact the rear-facing child restraint, causing serious or fatal injury.

In addition, do not place front-facing child restraints in the front passenger's seat either. If the front passenger air bag inflates, it could cause serious or fatal injuries to the child.

⚠ WARNING - Air bag deployment

When children are seated in the rear outboard seats of a vehicle equipped with side and/or curtain air bags, install the child restraint system as far away from the door side as possible. Inflation of the side and/or curtain air bags could impact the child.

Air bag warning light



The purpose of air bag warning light in your instrument panel is to alert you of a potential problem with your air bag system, which could include your side and/or curtain air bags used for rollover protection.

SRS components and functions

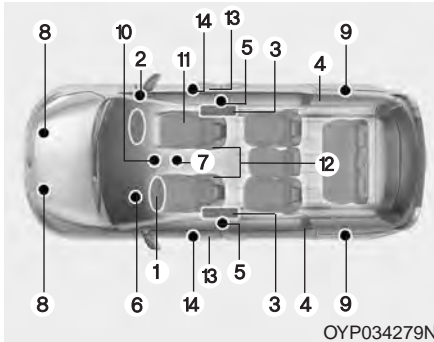

The SRS consists of the following components:

- (1) Driver's front air bag module
- (2) Passenger's front air bag module
- (3) Side air bag modules
- (4) Curtain air bag modules
- (5) Retractor pre-tensioner assemblies
- (6) Air bag warning light
- (7) SRS control module (SRSCM)/ Rollover sensor
- (8) Front impact sensors
- (9) Side impact sensors

- (10) PASSENGER "AIR BAG OFF" indicator (Front passenger's seat only)
- (11) Occupant detection system (Front passenger's seat only)
- (12) Driver's and front passenger's seat belt buckle sensors
- (13) Emergency fastening device (EFD)
- (14) Side pressure sensor

The SRSCM continually monitors all SRS components while the ignition switch is ON to determine if a crash impact is severe enough to require air bag deployment or pre-tensioner seat belt deployment.



W7-147

If the air bag warning light illuminated for more than, 6 seconds after the ignition is turned on, or of it illuminates during vehicle operation, an SRS component may not be functioning properly and you should have your vehicle checked by an authorized Kia dealer.

If any of the following conditions occurs, this indicates a malfunction in the air bag system. Have an authorized Kia dealer inspect the air bag system as soon as possible.

- The light does not turn on briefly when you turn the ignition ON.
- The light stays on after illuminating for approximately 6 seconds.
- The light comes on while the vehicle is in motion.
- The light blinks when the ignition switch is in ON position.

Driver's front air bag (1)

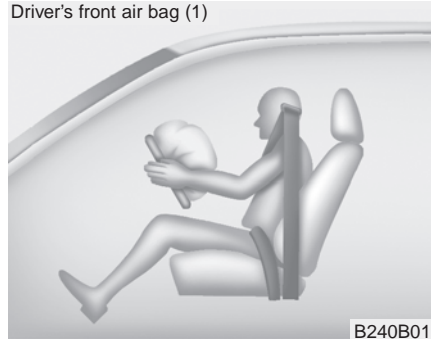

B240B01L

Driver's front air bag (2)

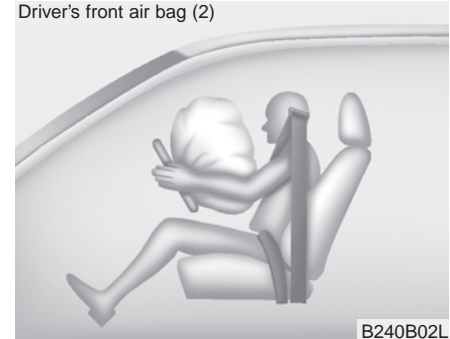

B240B02L

The front air bag modules are located both in the center of the steering wheel and in the front passenger's panel above the glove box. When the SRSCM detects a sufficiently severe impact to the front of the vehicle, it will automatically deploy the front air bags.

Upon deployment, tear seams molded directly into the pad covers will separate under pressure from the expansion of the air bags. Further opening of the covers then allows full inflation of the air bags.

Driver's front air bag (3)



A fully inflated air bag, in combination with a properly worn seat belt, slows the driver's or the passenger's forward motion, reducing the risk of head and chest injury.

After complete inflation, the air bag immediately starts deflating, enabling the driver to maintain forward visibility and the ability to steer or operate other controls.

Passenger's front air bag

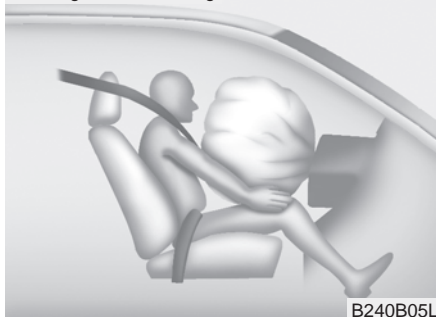

⚠ WARNING - Air bag obstructions

Do not install or place any accessories on the steering wheel, instrument panel, or on the front passenger's panel above the glove box in a vehicle. Such objects may become dangerous projectiles if the air bag deploys.

⚠ WARNING - Flying objects

Do not place any objects (an umbrella, bag, etc.) between the front door and the front seat. Such objects may become dangerous projectiles if the side airbag inflates.

- If an air bag deploys, there may be a loud noise followed by a fine dust released in the vehicle. These conditions are normal and are not hazardous - the air bags are packed in this fine powder. The dust generated during air bag deployment may cause skin or eye irritation as well as aggravate asthma for some persons. Always wash all exposed skin areas thoroughly with cold water and a mild soap after an accident in which the air bags were deployed.
- The SRS can function only when the ignition switch is in the ON position. If the SRS air bag warning light does not illuminate, or continuously remains on after illuminating for about 6 seconds when the ignition switch is turned to the ON position, or after the engine is started, comes on while driving, the SRS is not working properly. If this occurs, have your vehicle immediately inspected by an authorized Kia dealer.

*** NOTICE**

Before you replace a fuse or disconnect a battery terminal, turn the ignition switch to the LOCK position and remove the ignition switch. Never remove or replace the air bag related fuse(s) when the ignition switch is in the ON position. Failure to heed this warning will cause the SRS air bag warning light to illuminate.

Occupant Detection System(ODS)

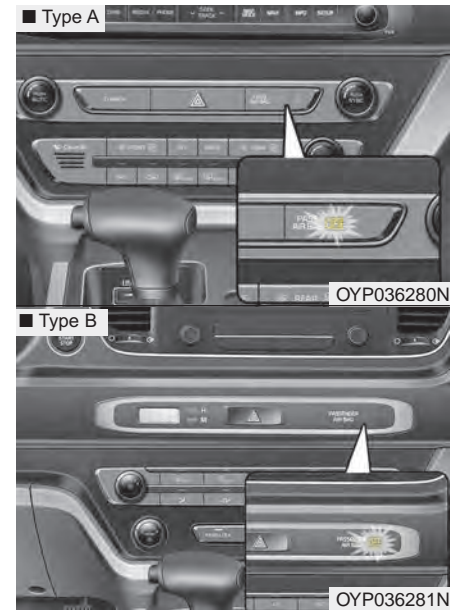

Your vehicle is equipped with an occupant detection system in the front passenger's seat.

The occupant detection system is designed to detect the presence of a properly-seated front passenger and determine if the passenger's front air bag should be enabled (may inflate) or not. Only the front passenger front air bag is controlled by the Occupant Detection System.

Do not put anything in front of the passenger air bag  indicator.

Main components of the occupant detection system

- A detection device located within the front passenger seat cushion.
- An electronic system which determines whether the passenger air bag systems should be activated or deactivated.
- A indicator light located on the instrument panel which illuminates the words PASSENGER AIR BAG "OFF" indicating the front passenger air bag system is deactivated.
- The instrument panel air bag warning light is interconnected with the occupant detection system.

If the front passenger seat is occupied by a person that the system determines to be of appropriate size, and he/she sits properly (sitting upright with the seatback in an upright position, centered on the seat cushion with their seat belt on, legs comfortably extended and their feet on the floor), the PASSENGER AIR BAG "OFF" indicator will turn off and the front passenger's air bag will be able to inflate, if necessary, in frontal crashes.

You will find the PASSENGER AIR BAG "OFF" indicator on the center facia panel. This system detects the conditions 1~4 in the following table and activates or deactivates the front passenger air bag based on these conditions.

Always be sure that you and all vehicle occupants are seated and restrained properly (sitting upright with the seat in an upright position, centered on the seat cushion, with the person's legs comfortably extended, feet on the floor, and wearing the safety belt properly) for the most effective protection by the air bag and the safety belt.

- The ODS (Occupant Detection System) may not function properly if the passenger takes actions which can defeat the detection system. These include:
 - (1) Failing to sit in an upright position.
 - (2) Leaning against the door or center console.
 - (3) Sitting towards the sides or the front of the seat.
 - (4) Putting legs on the dashboard or resting them on other locations which reduce the passenger weight on the front seat.
 - (5) Improperly wearing the safety belt.
 - (6) Reclining the seat back.

Condition and operation in the front passenger occupant detection system

Condition detected by the occupant detection system	Indicator/Warning light		Devices
	"PASSENGER AIR BAG OFF" indicator light	SRS warning light	Front passenger air bag
1. Adult or child*1	Off	Off	Activated
2. Child restraint system*2	On	Off	Deactivated
3. Unoccupied	On	Off	Deactivated
4. There is a malfunction in the system	Off	On	Activated

*1 : The ODS system uses a field to evaluate a person's size to determine whether the air bag should deploy. It is possible for a child to be detected and activate the ODS, thus allowing the air bag to deploy. To maximize safety, do not allow children to ride in the front passenger seat.

*2 : Never install a child restraint system on the front passenger seat.

*** NOTICE**

Do not modify or replace the front passenger seat. Don't place anything on or attach anything such as a blanket, front seat cover or after market seat heater to the front passenger seat. This can adversely affect the occupant detection system.

 WARNING - ODS System

Riding in an improper position adversely affects the Occupant Detection System and may result in the deactivation of the front passenger airbag. It is important for the driver to instruct the passenger as to the proper seating instructions as contained in this manual.

(Continued)

(Continued)



- Never put a heavy load or an active electronic device on the front passenger seat or seatback pocket.



- Never sit with hips shifted towards the front of the seat.



- Never place feet on the dashboard.



- Never place feet on the front passenger seatback.



- Never excessively recline the front passenger seatback.



- Never lean on the door or center console.
- Never sit on one side of the front passenger seat.

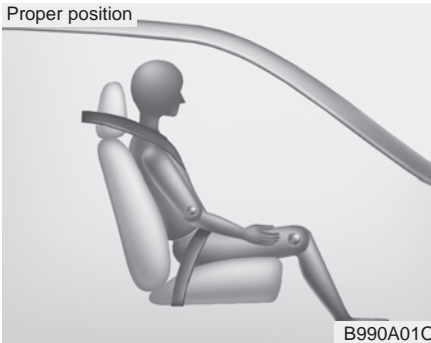

When an adult is seated in the front passenger seat, if the PASSENGER AIR BAG “OFF” indicator is on, turn the ignition switch to the LOCK position and ask the passenger to sit properly (sitting upright with the seat back in an upright position, centered on the seat cushion with their seat belt on, legs comfortably extended and their feet on the floor). Restart the engine and have the person remain in that position.

This will allow the system to detect the person and to enable the passenger air bag.

If the PASSENGER AIR BAG “OFF” indicator is still on, ask the passenger to move to the rear seat.

⚠ WARNING - “AIR BAG OFF” light

Do not allow an adult passenger to ride in the front seat when the PASSENGER AIR BAG “OFF” indicator is illuminated, because the air bag will not deploy in the event of a crash. The driver must instruct the passenger to reposition himself in the seat. Failure to properly position yourself may lead to air bag deactivation resulting in air bag non-deployment in a collision. If the PASSENGER AIR BAG “OFF” indicator remains illuminated after the passenger repositions themselves properly and the car is restarted, it is recommended that passenger move to the rear seat because the passenger's front air bag will not deploy.

*** NOTICE**

The PASSENGER AIR BAG “OFF” indicator illuminates for about 4 seconds after the ignition switch is turned to the ON position or after the engine is started. If the front passenger seat is occupied, the occupant detection sensor will then classify the front passenger after several more seconds.

- Even though your vehicle is equipped with the occupant detection system, never install a child restraint system in the front passenger's seat. A deploying air bag can forcefully strike a child resulting in serious injuries or death. Any child age 12 and under should ride in the rear seat. Children too large for child restraints should use the available lap/shoulder belts. No matter what type of crash, children of all ages are safer when restrained in the rear seat.
- If the PASSENGER AIR BAG “OFF” indicator is illuminated when the front passenger's seat is occupied by an adult and he/she sits properly (sitting upright with the seatback in an upright position, centered on the seat cushion with their seat belt on, legs comfortably extended and their feet on the floor), have that person sit in the rear seat.

Any child age 12 and under should ride in the rear seat. Children too large for child restraints should use the available lap/shoulder belts. No matter what type of crash, children of all ages are safer when restrained in the rear seat.

*** NOTICE**

The front passenger seat, dashboard or door should not be replaced except by an authorized Kia dealer using original Kia parts designed for this vehicle and model. Any other such replacement or modification could adversely affect the operation of the occupant detection system and your advanced air bags.

If the occupant detection system is not working properly, the SRS air bag warning light on the instrument panel will illuminate because the passenger's front air bag is connected with the occupant detection system. If there is a malfunction of the occupant detection system, the PASSENGER AIR BAG "OFF" indicator will not illuminate and the passenger's front air bag will inflate in frontal impact crashes even if there is no occupant in the front passenger's seat

Driver's and passenger's front air bag

■ Driver's front air bag

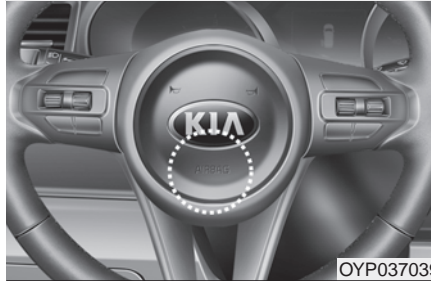

■ Passenger's front air bag



The indication of the system's presence are the letters "AIR BAG" located on the air bag pad cover on the steering wheel and the passenger's side front panel pad above the glove box.

Your vehicle is equipped with an Advanced Supplemental Restraint (Air Bag) System and lap/shoulder belts at both the driver and passenger seating position.

The SRS consists of air bags installed under the pad covers in the center of the steering wheel and the passenger's side front panel above the glove box.

The purpose of the SRS is to provide the vehicle's driver and/or the front passenger with additional protection than that offered by the seat belt system alone in case of a frontal impact of sufficient severity. The SRS uses sensors to gather information about the driver's and front passenger's seat belt usage and impact severity.

The seat belt buckle sensors determine if the driver and front passenger's seat belts are fastened.

These sensors provide the ability to control the SRS deployment based on whether or not the seat belts are fastened, and how severe the impact is.

The advanced SRS offers the ability to control the air bag inflation with two levels. A first stage level is provided for moderate-severity impacts. A second stage level is provided for more severe impacts.

The passenger's front air bag is designed to help reduce the injury of children sitting close to the instrument panel in low speed collisions. However, children are safer if they are restrained in the rear seat.

According to the impact severity and seat belt usage, the SRSCM (SRS Control Module) controls the air bag inflation. Failure to properly wear seat belts can increase the risk or severity of injury in an accident.

Additionally, your vehicle is equipped with an occupant detection system in the front passenger's seat. The occupant detection system detects the presence of a passenger in the front passenger's seat and will turn off the front passenger's air bag under certain conditions. For more detail, see "Occupant detection system" in this chapter.

⚠ WARNING

Modification to the seat structure can cause the air bag to deploy at a different level than should be provided.

Manufacturers are required by government regulations to provide a contact point concerning modifications to the vehicle for persons with disabilities, which modifications may affect the vehicle's advanced air bag system. That contact is Kia's toll-free Customer Assistance center at 1-800-333-4Kia. However, Kia does not endorse nor will it support any changes to any part or structure of the vehicle that could affect the advanced air bag system, including the occupant detection system.

*** NOTICE**

The front passenger seat, dashboard or door should not be replaced except by an authorized Kia dealer using original Kia parts designed for this vehicle and model. Any other such replacement or modification could adversely affect the operation of the occupant detection system and your advanced air bags.

Advanced air bags are combined with pre-tensioner seat belts to help provide enhanced occupant protection in frontal crashes. Front air bags are not intended to deploy in collisions in which sufficient protection can be provided by the pre-tensioner seat belt.

Front air bags are not intended to deploy in side-impact, rear-impact or rollover crashes. However, when frontal deployment threshold is satisfied at side-impact, front air bags may deploy. In addition, front air bags will not deploy in frontal crashes below the deployment threshold.

Side air bag

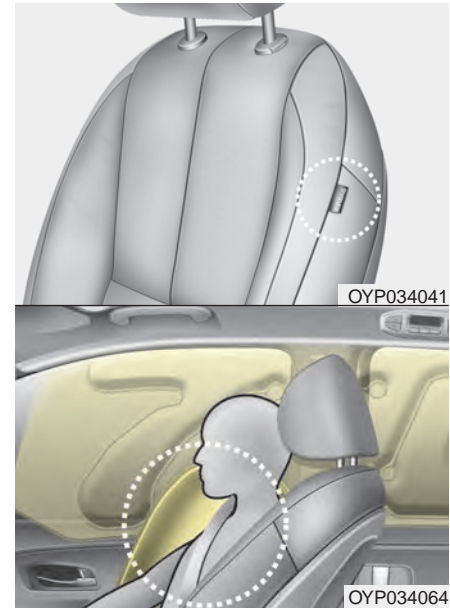

Your vehicle is equipped with a side air bag in each front seat. The purpose of the air bag is to provide the vehicle's driver and/or the front passenger with additional protection than that offered by the seat belt alone.

⚠ WARNING - SRS Wiring

Do not tamper with or disconnect SRS wiring or other components of the SRS system. Doing so could result in injury, due to accidental deployment of the air bags or by rendering the SRS inoperative.

⚠ WARNING - No attaching objects

No objects (such as crash pad cover, cellular phone holder, cup holder, perfume or stickers) should be placed over or near the air bag modules on the steering wheel, instrument panel, windshield glass, and the front passenger's panel above the glove box. Such objects could cause harm if the vehicle is in a crash severe enough to cause the air bags to deploy. Do not place any objects over the air bag or between the air bag and yourself.

- The side air bags are designed to deploy during certain side-impact collisions, depending on the crash severity, angle, speed and point of impact. However, when side deployment threshold is satisfied at front-impact, side air bags may deploy.
- The side air bags may deploy on the side of the impact or on both side.
- The side and/or curtain air bags on both sides of the vehicle will deploy if a rollover or possible rollover is detected.
- The side air bags are not designed to deploy in all side impact or rollover situations.

 **WARNING - Unexpected deployment**

Avoid impact to the side impact airbag sensor when the ignition switch is ON to prevent unexpected deployment of the side air bag.

- The side air bag is supplemental to the driver's and the passenger's seat belt systems and is not a substitute for them. Therefore your seat belts must be worn at all times while the vehicle is in operation.
- For best protection from the side air bag system and to avoid being injured by the deploying side air bag, both front seat occupants should sit in an upright position with the seat belt properly fastened. The driver's hands should be placed on the steering wheel at the 9:00 and 3:00 positions. The passenger's arms and hands should be placed on their laps.

⚠ WARNING - Deployment

Do not install any accessories including seat covers, on the side or near the side air bag as this may affect the deployment of the side air bags.

- If seat or seat cover is damaged, have the vehicle checked and repaired by an authorized Kia dealer. Inform the dealer that your vehicle is equipped with side air bags and an occupant detection system.

⚠ WARNING - Flying objects

Do not place any objects (an umbrella, bag, etc.) between the front door and the front seat. Such objects may become dangerous projectiles if the side airbag inflates.

⚠ WARNING - No attaching objects

- Do not place any objects over the air bag or between the air bag and yourself. Also, do not attach any objects around the area the air bag inflates such as the door, side door glass, front and rear pillar.
- Do not place any objects between the door and the seat. They may become dangerous projectiles if the side air bag inflates.
- Do not install any accessories on the side or near the side air bags.

Curtain air bag

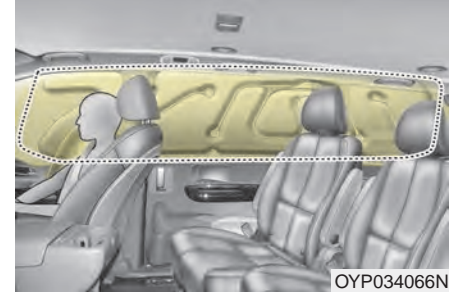

Curtain air bags are located along both sides of the roof rails above the front and rear doors.

They are designed to help protect occupants in certain side impacts and to help prevent them from ejecting out of the vehicle as a result of a rollover, especially when the seatbelts are also in use.

- The curtain air bags are designed to deploy during certain side impact collisions, depending on the crash severity, angle, speed and point of impact. However, when side deployment threshold is satisfied at front-impact, curtain air bags may deploy.
- The curtain air bags may deploy on the side of the impact or on both side.
- Also, the curtain air bags on both sides of the vehicle will deploy in certain rollover situations.
- The curtain air bags are not designed to deploy in all side impact or rollover situations.

Do not allow the passengers to lean their heads or bodies against the doors, put their arms on the doors, stretch their arms out of the window or place objects between the doors and passengers when they are seated on seats equipped with side impact and/or curtain air bags.

* NOTICE

Never try to open or repair any components of the side and curtain air bag system. This should only be done by an authorized Kia dealer.

 **WARNING - No attaching objects**

- Do not place any objects over the air bag. Also, do not attach any objects around the area the air bag inflates such as the door, side door glass, front and rear pillar, roof side rail.
- Do not hang hard or breakable objects on the clothes hanger.

Why didn't my air bag go off in a collision? (Inflation and non-inflation conditions of the air bag)

There are many types of accidents in which the air bag would not be expected to provide additional protection.

These include rear impacts, second or third collisions in multiple impact accidents, as well as low speed impacts.

Air bag collision sensors

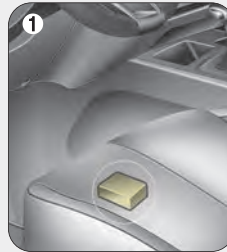

OYP034042/OYP036043/OYP034044/OYP034045/OYP034046

- (1) SRS control module/
Rollover sensor
- (2) Front impact sensor

- (3) Side impact sensor
- (4) Side pressure sensor

⚠ WARNING - Air bag sensors

- **Do not hit or allow any objects to impact the locations where air bags or sensors are installed.**

This may cause unexpected air bag deployment, which could result in serious personal injury or death.

- **If the installation location or angle of the sensors is altered in any way, the air bags may deploy when they should not or they may not deploy when they should.**

Therefore, do not try to perform maintenance on or around the air bag sensors. Have the vehicle checked and repaired by an authorized Kia dealer.

Problems may arise if the sensor installation angles are changed due to the deformation of the front bumper, front end module, body or front doors and/or B pillar where side collision sensors are installed. Have the vehicle checked and repaired by an authorized Kia dealer.

Installing bumper guards (or side step or running board) or replacing a bumper (or front door module) with non-genuine parts may adversely affect your vehicle's collision and air bag deployment performance.

Air bag inflation conditions



Front air bags

Front air bags are designed to inflate in a frontal collision depending on the intensity, speed or angles of impact of the front collision.

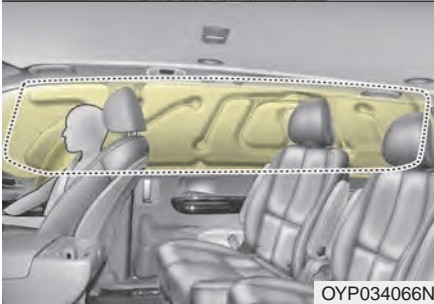

Side and/or curtain air bags

Side and/or curtain air bags are designed to inflate when an impact is detected by side collision sensors depending on the strength, speed or angles of impact resulting from a side impact collision.

Also, the side and curtain air bags are designed to inflate when a rollover is detected by a rollover sensor.

Although the front air bags (driver's and front passenger's air bags) are designed to inflate in frontal collisions, they also may inflate in other types of collisions if the front impact sensors detect a sufficient frontal force in another type of impact. Side and curtain air bags are designed to inflate in certain side impact collisions. They may inflate in other type of collisions where a side force is detected by the sensors. Side air bag and/or curtain air bags may also inflate where rollover sensors indicate the possibility of a rollover occurring (even if none actually occurs) or in other situations, including when the vehicle is tilted while being towed. Even where side and/or curtain air bags would not provide impact protection in a rollover, however, they will deploy to prevent ejection of occupants, especially those who are restrained with seat belts.

If the vehicle chassis is impacted by bumps or objects on unimproved roads, the air bags may deploy. Drive carefully on unimproved roads or on surfaces not designed for vehicle traffic to prevent unintended air bag deployment.

Air bag non-inflation conditions



- In certain low-speed collisions the air bags may not deploy. The air bags are designed not to deploy in such cases because they may not provide benefits beyond the protection of the seat belts in such collisions.

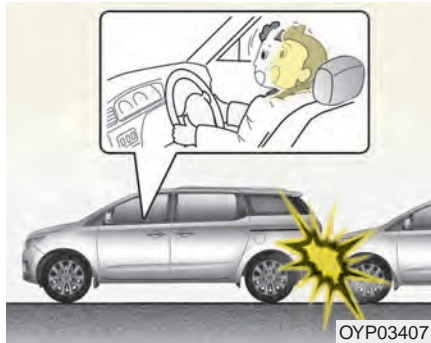

- Air bags are not designed to inflate in rear collisions, because occupants are moved backward by the force of the impact. In this case, inflated air bags would not be able to provide any additional benefit.

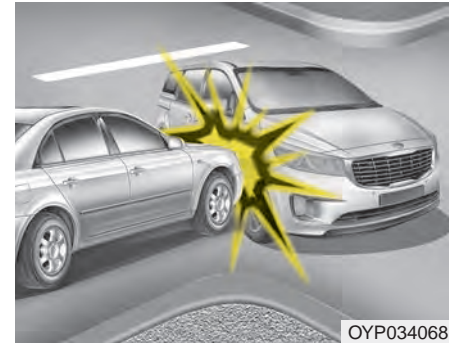

- Front air bags may not inflate in side impact collisions, because occupants move to the direction of the collision, and thus in side impacts, frontal air bag deployment would not provide additional occupant protection.

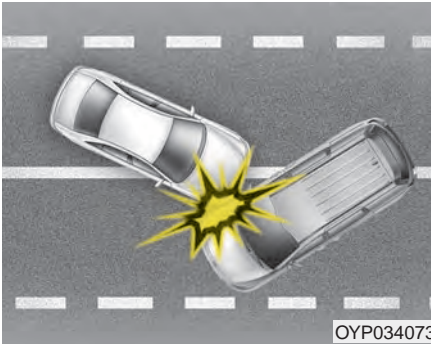

- In an angled collision, the force of impact may direct the occupants in a direction where the air bags would not be able to provide any additional benefit, and thus the sensors may not deploy any air bags.

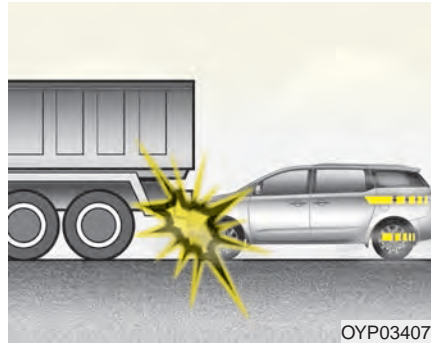

- Just before impact, drivers often brake heavily. Such heavy braking lowers the front portion of the vehicle causing it to “ride” under a vehicle with a higher ground clearance. Air bags may not inflate in this “under-ride” situation because deceleration forces that are detected by sensors may be significantly reduced by such “under-ride” collisions.

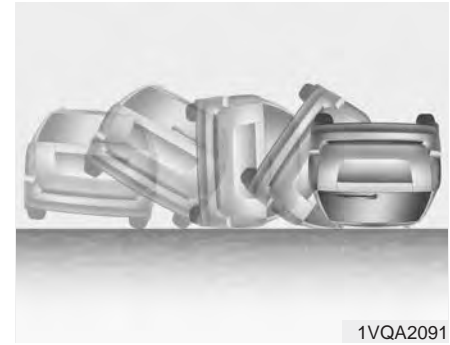

- Front air bags may not inflate in all rollover accidents where the SRSCM indicates that the front air bag deployment would not provide additional occupant protection.

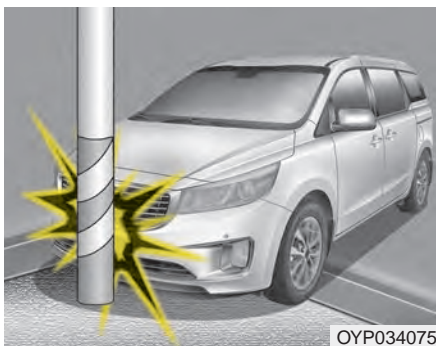

- Air bags may not inflate if the vehicle collides with objects such as utility poles or trees, where the point of impact is concentrated to one area and the full force of the impact is not delivered to the sensors.

SRS Care

The SRS is virtually maintenance-free and so there are no parts you can safely service by yourself. If the SRS air bag warning light does not illuminate, or continuously remains on, have your vehicle immediately inspected by an authorized Kia dealer.

Any work on the SRS system, such as removing, installing, repairing, or any work on the steering wheel, the front passenger's panel, front seats and roof rails must be performed by an authorized Kia dealer. Improper handling of the SRS system may result in serious personal injury.

For cleaning the air bag pad covers, use only a soft, dry cloth or one which has been moistened with plain water. Solvents or cleaners could adversely affect the air bag covers and proper deployment of the system.

If components of the air bag system must be discarded, or if the vehicle must be scrapped, certain safety precautions must be observed. An authorized Kia dealer knows these precautions and can give you the necessary information. Failure to follow these precautions and procedures could increase the risk of personal injury.

⚠ WARNING - Tampering with SRS

Do not tamper with or disconnect SRS wiring, or other components of the SRS system. Doing so could result in the accidental inflation of the air bags or by rendering the SRS inoperative.

⚠ WARNING - Towing Vehicle

Always have the ignition off when your vehicle is being towed. The side air bags may inflate if the vehicle is tilted such as when being towed because of the rollover sensors in the vehicle.

Adding equipment to or modifying your air bag-equipped vehicle

If you modify your vehicle by changing your vehicle's frame, bumper system, front end or side sheet metal or ride height, this may affect the operation of your vehicle's air bag system.

Air bag warning label

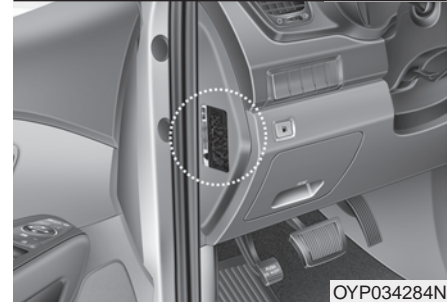

Air bag warning labels, some required by the U.S. National Highway Traffic Safety Administration (NHTSA), are attached to the sunvisor to alert the driver and passengers of potential risks of the air bag system.

Features of your vehicle

Folding key	4-5
• Record your key number	4-5
• Key operations	4-5
• Transmitter precautions	4-9
• Battery replacement	4-10
• Immobilizer system	4-11
Smart key	4-13
• Record your key number	4-13
• Smart key function	4-13
• Loss of the smart key	4-17
• Smart key precautions	4-18
• Battery replacement	4-19
• Smart key immobilizer system	4-20
Theft-alarm system	4-21
• Armed stage	4-21
• Theft-alarm stage	4-22
• Disarmed stage	4-22
Door locks	4-24
• Operating door locks from outside the vehicle	4-24
• Operating door locks from inside the vehicle	4-26
• Impact sensing door unlock system	4-29
• Automatic door lock system	4-29
• Child-protector rear door lock	4-29

Liftgate (tailgate) (for manual liftgate (tailgate))	4-30
• Opening the liftgate (tailgate)	4-30
• Closing the liftgate (tailgate)	4-31
• Emergency liftgate (tailgate) safety release	4-32
Power sliding door and power liftgate (tailgate)	4-33
• Automatic stop and reversal	4-35
• How to reset the power sliding door and power liftgate (tailgate)	4-36
• Power door ON/OFF button	4-37
• Power sliding door operation	4-38
• Power liftgate (tailgate) operation	4-41
• Power liftgate (tailgate) non-opening conditions	4-43
• Power liftgate (tailgate) opening height user setting	4-44
• Emergency liftgate (tailgate) safety release	4-45
• Smart Liftgate (Tailgate)	4-45
Windows	4-50
• Power windows	4-51
Hood	4-55
• Opening the hood	4-55
• Hood open warning	4-56
• Closing the hood	4-56
Fuel filler lid	4-57
• Opening the fuel filler lid	4-57
• Closing the fuel filler lid	4-57
• Emergency fuel filler lid release	4-60

Sunroof	4-61	• User Settings Mode	4-91
• Sliding the sunroof	4-62	• Turn By Turn Mode	4-95
• Tilting the sunroof (for front sunroof)	4-63	• SCC/LDWS Mode	4-95
• Sunshade	4-64	• A/V Mode	4-95
• Resetting the sunroof	4-64	• Warning Messages	4-96
• Rear sunroof lock	4-65	Trip computer	4-102
• Sunroof open warning	4-65	• Overview	4-102
steering wheel	4-66	• Trip A/B	4-103
• Power steering	4-66	• Fuel Economy	4-104
• Electric power steering	4-66	• Digital speedometer	4-106
• Tilt and telescopic steering	4-67	• One time driving information mode	4-106
• Heated steering wheel	4-68	Warning and indicator lights	4-107
• Horn	4-69	• Warning lights	4-107
Mirrors	4-70	• Indicator Lights	4-115
• Inside rearview mirror	4-70	Rear parking assist system	4-121
• Outside rearview mirror	4-76	• Operation of the rear parking assist system	4-121
Instrument cluster	4-81	• Non-operational conditions of rear parking assist system	4-122
• Instrument Cluster Control	4-82	• Rear parking assist system precautions	4-123
• LCD Display Control	4-82	• Self-diagnosis	4-124
• Gauges	4-83	Parking assist system	4-125
• Transaxle Shift Indicator	4-87	• Operation of the parking assist system	4-125
LCD Display	4-88	• Non-operational conditions of parking assist system	4-127
• LCD Modes	4-88	• Self-diagnosis	4-128
• Service Mode	4-89		

Rearview camera	4-129
Surround view monitoring system (SVM).....	4-130
Lighting	4-131
• Battery saver function.....	4-131
• Headlight escort function	4-131
• Lighting control.....	4-131
• High beam operation.....	4-133
• Turn signals and lane change signals	4-136
• Front fog light	4-137
Wipers and washers	4-138
• Windshield wipers	4-138
• Front windshield washers.....	4-139
• Rear window wiper and washer switch.....	4-140
Interior lights	4-141
• Automatic turn off function.....	4-141
• Room lamp.....	4-141
• Map lamp	4-142
• Luggage lamp.....	4-143
• Vanity mirror lamp	4-143
• Portable lamp usage	4-143
• Battery replacement	4-144
Defroster	4-145
• Rear window defroster	4-145

Manual climate control system	4-146
• Heating and air conditioning	4-147
• Rear climate control	4-154
• System operation	4-157
• Climate control air filter.....	4-160
• Air Conditioning refrigerant label	4-161
• Checking the amount of air conditioner refrigerant and compressor lubricant.....	4-161
Automatic climate control system	4-163
• Automatic heating and air conditioning	4-164
• Manual heating and air conditioning	4-165
• Outside thermometer	4-169
• Rear climate control	4-174
• From the front seat	4-174
• From the rear seat.....	4-174
• System operation	4-177
• Climate control air filter.....	4-179
• Checking the amount of air conditioner refrigerant and compressor lubricant.....	4-180
• Air Conditioning refrigerant label	4-181
Windshield defrosting and defogging	4-182
• Manual climate control system	4-182
• Automatic climate control system	4-183
• Defogging logic.....	4-184

Clean air	4-187
Storage compartments	4-188
• Center console storage	4-189
• Glove box	4-190
• Sunglass holder	4-190
Interior features	4-191
• Cup holder	4-191
• Bottle holder	4-192
• Seat warmer	4-192
• Air ventilation seat	4-193
• Sunvisor	4-194
• Power outlet	4-194
• AC inverter	4-195
• USB charger	4-197
• Clock	4-198
• Coat hook	4-198
• Floor mat anchor (s)	4-199
• Side curtain	4-199
Exterior features	4-201
• Roof rack	4-201
Audio system	4-203
• Antenna	4-203
• AUX, USB port	4-203
• How vehicle audio works	4-204

Audio	4-208
• Feature of Your Audio	4-209
• Radio	4-215
• SiriusXM	4-216
• Media	4-218
• Phone	4-234
• Siri	4-243
• Setup	4-244
• Declaration of Conformity	4-246

FOLDING KEY

Record your key number



The key code number is stamped on the key code tag attached to the key set. Should you lose your keys, this number will enable an authorized Kia dealer to duplicate the keys easily. Remove the key code tag and store it in a safe place. Also, record the key code number and keep it in a safe place. (not in the vehicle)

Key operations

■ Type A

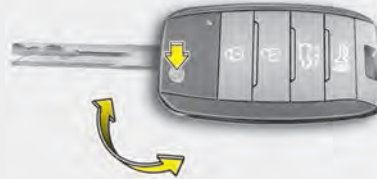

OXMA043331

■ Type B



OYP044168N

- To unfold the key, press the release button then the key will unfold automatically. To fold the key, fold the key manually while pressing the release button.

CAUTION

Do not fold the key without pressing the release button. This may damage the key.

- Used to start the engine.
- Used to lock and unlock the doors.
- Used to lock and unlock the glove box.

⚠ WARNING - Aftermarket key

Use only Kia original parts for the ignition key in your vehicle. If an aftermarket key is used, the ignition switch may not return to ON after START. If this happens, the starter will continue to operate causing damage to the starter motor and possible fire due to excessive current in the wiring.

⚠ WARNING - Ignition key (smart key)

Never leave the keys in your vehicle with unsupervised children. Leaving children unattended in a vehicle with a manual ignition key or a smart key is dangerous. Children copy adults and they could place the key in the ignition switch or press the start button. The key would enable children to operate power windows or other controls, or even make the vehicle move, which could result in serious bodily injury or death.

Door Lock (1)

■ Type A

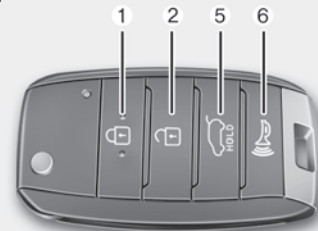

OYP044169K

■ Type B

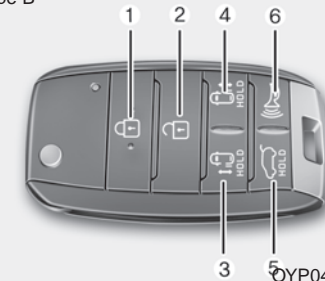

OYP044170N

1. Close all doors, engine hood and liftgate (tailgate).
2. Press the lock button(1).
3. All doors and liftgate (tailgate) will lock. The hazard warning lights will blink once.
4. If the lock button is pressed once more within 4 seconds, the hazard warning lights will blink and the horn will sound once.
5. Make sure that doors are locked by checking the door lock button inside or pulling the outside door handle.

Door Unlock (2)

1. Press the unlock button(2).
2. The driver's door will unlock. The hazard warning lights will blink two times.
3. Press the unlock button(2) twice within 4 seconds and all doors and liftgate (tailgate) will unlock. The hazard warning lights will blink two times.

*** NOTICE**

You can activate or deactivate the Two Turn Unlock function. Refer to "User settings" in this chapter.

Left power sliding door opening or closing (if equipped) (3)

When the power door ON/OFF button is ON (not depressed):

The left sliding door is opened or closed automatically if the button is pressed and held.

When the left sliding door is closed and more than one door is locked, and the button is pressed for more than one second all doors will be unlocked.

Right power sliding door opening or closing (if equipped) (4)

When the power door ON/OFF button is ON (not depressed) :

The right sliding door is opened or closed automatically if the button is pressed and held.

When the right sliding door is closed and more than one door is locked, and the button is pressed for more than one second all doors will be unlocked.

For detailed information refer to the "Power sliding door and power liftgate (tailgate)" in this chapter.

The power doors can be operated when the engine is not running. However, the power doors consume large amounts of vehicle electric power. To prevent the battery from being discharged, do not operate them consecutively.

Liftgate (Tailgate) unlock (5)

The liftgate (tailgate) is unlocked if the button is pressed for more than 1 second.

Also, once the liftgate (tailgate) is opened and then closed, the liftgate (tailgate) will be locked automatically.

- For Power Liftgate (Tailgate) Only:

The Power Liftgate (Tailgate) will open if the button is pressed for more than 1 second. Also, once the liftgate (tailgate) is opened and then closed, the liftgate (tailgate) will be locked again automatically.

If the power liftgate (tailgate) is switched 'Off' using the button in the overhead console, the liftgate (tailgate) unlock button will operate to unlock the liftgate (tailgate) as described above.

For detailed information refer to the "Power sliding door and power liftgate (tailgate)" in this chapter.

Panic (6)

The horn sounds and hazard warning lights flash for about 27 seconds if this button is pressed for more than 0.5 second. To stop the horn and lights, press any button on the transmitter.

Transmitter precautions

- The transmitter will not work if any of following occur:
 - The ignition key is in the ignition switch.
 - You exceed the operating distance limit (about 30 feet [10 m]).
 - The battery in the transmitter is weak.
 - Other vehicles or objects may be blocking the signal.
 - The weather is extremely cold.
 - The transmitter is close to a radio transmitter such as a radio substation or an airport which can interfere with normal operation of the transmitter.
- When the transmitter does not work correctly, open and close the door with the ignition key. If you have a problem with the transmitter, contact an authorized Kia dealer.
- If the transmitter is in close proximity to your mobile phone, the signal could be blocked by your mobile phones normal operational signals. This is especially important when the phone is active such as making and receiving calls, text messaging, and/or sending/receiving emails. Avoid placing the transmitter and your mobile phone in the same pants or jacket pocket and always try to maintain an adequate distance between the two devices.

CAUTION

Keep the transmitter away from water or any liquid as it can become damaged and not function properly.

* NOTICE

If the keyless entry system is inoperative due to exposure to water or liquids, it will not be covered by your manufacturer's vehicle warranty.

Battery replacement



The transmitter uses a 3 volt lithium battery which will normally last for several years. When replacement is necessary, use the following procedure.

1. Insert a slim tool into the slot and gently pry open the transmitter center cover.
2. Replace the battery with a new battery (CR2032). When replacing the battery, make sure the battery is positioned battery.
3. Install the battery in the reverse order of removal.

For replacement transmitters, see an authorized Kia dealer for transmitter reprogramming.

- The transmitter is designed to give you years of trouble-free use, however it can malfunction if exposed to moisture or static electricity. If you are unsure how to use your transmitter or replace the battery, contact an authorized Kia dealer.
- Using the wrong battery can cause the transmitter to malfunction. Be sure to use the correct battery.
- To avoid damaging the transmitter, don't drop it, get it wet, or expose it to heat or sunlight.
-  An inappropriately disposed battery can be harmful to the environment and may cause human health. Dispose the battery according to your local law(s) or regulation.

CAUTION - Transmitter damage

Do not drop, wet or expose the keyless entry system transmitter to heat or sunlight.

Immobilizer system (if equipped)

Your vehicle is equipped with an electronic engine immobilizer system to reduce the risk of unauthorized vehicle use.

Your immobilizer system is comprised of a small transponder in the ignition key and electronic devices inside the vehicle.

With the immobilizer system, whenever you insert your ignition key into the ignition switch and turn it to ON, it checks and determines and verifies if the ignition key is valid.

If the key is determined to be valid, the engine will start.

If the key is determined to be invalid, the engine will not start.

To activate the immobilizer system:

Turn the ignition key to the OFF position. The immobilizer system activates automatically. Without a valid ignition key for your vehicle, the engine will not start.

To deactivate the immobilizer system:

Insert the ignition key into the key cylinder and turn it to the ON position.

In order to prevent theft of your vehicle, do not leave spare keys anywhere in your vehicle. Your Immobilizer password is a customer unique password and should be kept confidential. Do not leave this number anywhere in your vehicle.

*** NOTICE**

When starting the engine, do not use the key with other immobilizer keys around. Otherwise the engine may not start or may stop soon after it starts. Keep each key separate in order to avoid a starting malfunction.

Do not put metal accessories near the ignition switch.

Metal accessories may interrupt the transponder signal and may prevent the engine from being started.

* NOTICE

If you need additional keys or lose your keys, contact an authorized Kia dealer.



CAUTION - Immobilizer damage

Do not expose your immobilizer system to moisture, static electricity and rough handling. This may damage your immobilizer.



CAUTION - Immobilizer alterations

Do not change, alter or adjust the immobilizer system because it could cause the immobilizer system to malfunction.

This device complies with Part 15 of the FCC rules.

Operation is subject to the following two conditions:

1. This device may not cause harmful interference, and
2. This device must accept any interference received, including interference that may cause undesired operation.

* NOTICE

Changes or modifications not expressly approved by the party responsible for compliance could void the user's authority to operate the equipment. If the keyless entry system is inoperative due to changes or modifications not approved by the party responsible for compliance, it will not be covered by your manufacturer's vehicle warranty.

SMART KEY

Record your key number



The key code number is stamped on the bar code tag attached to the key set. Should you lose your keys, this number will enable an authorized Kia dealer to duplicate the keys easily. Remove the bar code tag and store it in a safe place. Also, record the code number and keep it in a safe and handy place, but not in the vehicle.

Smart key function



OYP044002K

To remove the mechanical key, press and hold the release button(1) and remove the mechanical key (2).

To reinstall the mechanical key, put the key into the hole and push it until a click sound is heard.

With a smart key, you can lock or unlock a door (and Liftgate (Tailgate)) and start the engine.

Refer to the following for more details.

⚠ WARNING - Ignition key (smart key)

Never leave the keys in your vehicle with unsupervised children. Leaving children unattended in a vehicle with a manual ignition key or a smart key is dangerous. Children copy adults and they could place the key in the ignition switch or press the start button. The key would enable children to operate power windows or other controls, or even make the vehicle move, which could result in serious bodily injury or death. result in serious bodily injury or death.

Door Lock

■ Type A

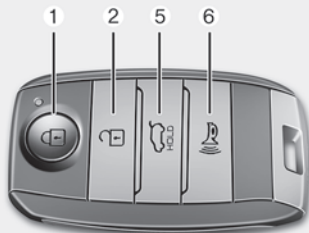

OYP044025K

■ Type B

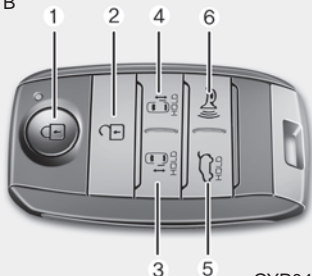

OYP044003K

Using the door handle button

1. Carry the smart key.
2. Close all doors, engine hood and liftgate (tailgate).
3. Press the button of the outside door handle.
4. The hazard warning lights will blink and the chime will sound once.
5. Make sure that doors are locked by pulling the outside door handle.

* NOTICE

- The button will only operate when the smart key is within 28~40in. (0.7~1m) from the outside door handle.
- Even though you press the outside door handle button, the doors will not lock and the chime will sound for 3 seconds if any of following occur:
 - The smart key is in the vehicle.
 - The engine start/stop button is in ACC or ON position.
 - Any door except the liftgate (tailgate) is open.

Using the button on the smart key

- 1 Close all doors, engine hood and liftgate (tailgate).
2. Press the lock button(1).
3. The hazard warning lights will blink and the chime will sound once.
4. Make sure that doors are locked by pulling the outside door handle.

Unlocking**Using the door handle button**

1. Carry the smart key.
2. Press the button of the driver's outside door handle.
3. The driver's door will unlock. The hazard warning lights will blink and the chime will sound two times.
4. Press the button twice within 4 seconds and all doors and the liftgate (tailgate) will unlock and the hazard warning lights will blink and the chime will sound two times.

*** NOTICE**

- **The button will only operate when the smart key is within 28~40in. (0.7~1m) from the outside door handle.**
- **When the smart key is recognized in the area of 28~40in. (0.7~1m) from the front outside door handle, other people can also open the doors.**
- **After unlocking the driver's door or all doors, the door(s) will lock automatically unless the door is opened.**

Using the button on the smart key

1. Press the unlock button(2) of the smart key.
2. The driver's door will unlock. The hazard warning lights will blink and the chime will sound two times.
3. Press the unlock button(2) twice within 4 seconds and all doors and the liftgate (tailgate) will unlock. The hazard warning lights will blink and the chime will sound two times.

* NOTICE

After pressing the button, the doors will lock automatically unless any door is opened within 30 seconds.

* NOTICE

You can activate or deactivate the Two Turn Unlock function. Refer to "User settings" in this chapter.

Left or Right power sliding door opening or closing (if equipped)

This function will be operated when the power door ON/OFF button is ON (not depressed).

Using the power sliding door handle

1. Carry the smart key.
2. Pull the power sliding door handle once.
3. The power sliding door will be opened or closed automatically. At this time, the hazard warning lights will blink and the chime will sound two times.

Using the button on the smart key

1. Press and hold the power sliding door open (or close) button (3), (4) more than 1 second.

For detailed information refer to the "Power sliding door and power liftgate (tailgate)" in this chapter.

Liftgate (Tailgate) unlocking

Using the liftgate (tailgate) handle button

1. Carry the smart key.
2. Press the liftgate (tailgate) handle button.
3. When all doors are locked, the hazard warning lights will blink two times.

Once the liftgate (tailgate) is opened and then closed, the liftgate (tailgate) will lock automatically.

* NOTICE

The button will only operate when the smart key is within 28~40in. (0.7~1m) from the liftgate (tailgate) handle.

Using the button on the smart key

1. Press the liftgate (tailgate) unlock button (5) for more than 1 second.
2. When all doors are locked, the hazard warning lights will blink two times.

- For Power Liftgate (Tailgate) Only:

The Power Liftgate (Tailgate) will open if the button is pressed for more than 1 second. Also, once the liftgate (tailgate) is opened and then closed, the liftgate (tailgate) will be locked again automatically.

If the power liftgate (tailgate) is switched 'Off' using the button in the overhead console, the liftgate (tailgate) unlock button will operate to unlock the liftgate (tailgate) as described above.

For detailed information refer to the "Power sliding door and power liftgate (tailgate)" in this chapter.

Panic

1. Press the panic button (6) for more than 1 second.
2. The horn sounds and hazard warning light flash for about 27 seconds.

*** NOTICE**

To stop the horn and lights, press any button on the smart key.

Start-up

You can start the engine without inserting the key. For detailed information refer to the "Engine start/stop button" in chapter 5.

Loss of the smart key

A maximum of 2 smart keys can be registered to a single vehicle.

If you happen to lose your smart key, you will not be able to start the engine. You should immediately take the vehicle and remaining key to your authorized Kia dealer (tow the vehicle, if necessary) to protect it from potential theft.

Smart key precautions

- The smart key will not work if any of the following occur:
 - The smart key is close to a radio transmitter such as a radio station or an airport which can interfere with normal operation of the smart key.
 - The smart key is near a mobile two way radio system or a cellular phone.
 - Another vehicle's smart key is being operated close to your vehicle.
- When the smart key does not work correctly, open and close the door with the mechanical key and contact an authorized Kia dealer.
- If the smart key is in close proximity to your cell phone or smart phone, the signal from the smart key could be blocked by normal operation of your cell phone or smart phone. This is especially important when the phone is active such as making a call, receiving calls, text messaging, and/or sending/receiving emails. Avoid placing the smart key and your cell phone or smart phone in the same pants or jacket pocket and maintain adequate distance between the two devices.



CAUTION - Transmitter

Keep the transmitter away from water or any liquid as it can become damaged and not function properly.

*** NOTICE**

If the keyless entry system is inoperative due to exposure to water or liquids, it will not be covered by your manufacturer's vehicle warranty.

Battery replacement

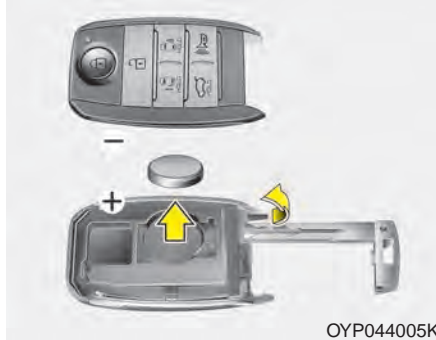

A smart key battery should last for several years, but if the smart key is not working properly, try replacing the battery with a new one. If you are unsure how to use your smart key or replace the battery, contact an authorized Kia dealer.

1. Remove the mechanical key.
2. Pry open the rear cover.
3. Replace the battery with a new battery (CR2032). When replacing the battery, make sure the battery position.

4. Install the battery in the reverse order of removal.

- The smart key is designed to give you years of trouble-free use, however it can malfunction if exposed to moisture or static electricity. If you are unsure how to use or replace the battery, contact an authorized Kia dealer.
- Using the wrong battery can cause the smart key to malfunction. Be sure to use the correct battery.
- To avoid damaging the smart key, don't drop it, get it wet, or expose it to heat or sunlight.
-  An inappropriately disposed battery can be harmful to the environment and human health. Dispose the battery according to your local law(s) or regulation.

CAUTION - Smart key damage

Do not drop, get wet or expose the smart key to heat or sunlight, or it will be damaged.

Smart key immobilizer system

Your vehicle is equipped with an electronic engine immobilizer system to reduce the risk of unauthorized vehicle use.

Your immobilizer system is comprised of a small transponder in the smart key and electronic devices inside the vehicle.

With the immobilizer system, whenever you turn the engine start/stop button to the ON position by pressing the button while carrying the smart key, it checks and determines and verifies if the smart key is valid or not.

If the key is determined to be valid, the engine will start.

If the key is determined to be invalid, the engine will not start.

To deactivate the immobilizer system:

Turn the engine start/stop button to the ON position by pressing the button while carrying the smart key.

To activate the immobilizer system:

Turn the engine start/stop button to the OFF position. The immobilizer system activates automatically. Without a valid smart key for your vehicle, the engine will not start.

*** NOTICE**

When starting the engine, do not use the key with other immobilizer keys around. Otherwise the engine may not start or may stop soon after it starts. Keep each key separate in order to avoid a starting malfunction.

*** NOTICE**

If you need additional keys or lose your keys, contact an authorized Kia dealer.

This device complies with Part 15 of the FCC rules.

Operation is subject to the following two conditions:

1. This device may not cause harmful interference, and
2. This device must accept any interference received, including interference that may cause undesired operation.

THEFT-ALARM SYSTEM

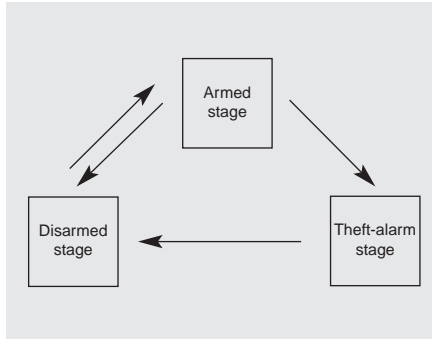

This system is designed to provide protection from unauthorized entry into the vehicle. This system is operated in three stages: the first is the "Armed" stage, the second is the "Theft-alarm" stage, and the third is the "Disarmed" stage. If triggered, the system provides an audible alarm with blinking of the hazard warning lights.

Armed stage

Park the vehicle and stop the engine. Arm the system as described below.

1. Remove the ignition key from the ignition switch and exit the vehicle.
2. Make sure that all doors (and liftgate (tailgate)) and engine hood are closed and latched.
3. Lock the doors using the transmitter of the keyless entry system (or smart key) or ignition key.

After completion of the steps above, the hazard warning lights will blink (for smart key, the chime also sounds) once to indicate that the system is armed.

If any door (or liftgate (tailgate)) or engine hood remains open, the hazard warning lights and the chime will not operate and the theft-alarm will not arm. If all doors (and liftgate (tailgate)) and engine hood are closed after the lock button is pressed, the hazard warning lights blink once.

The system can also be armed by locking the doors with the key from the front doors; however, the hazard warning lights will not blink using this method.

* NOTICE

The theft-alarm system can be deactivated by an authorized Kia dealer. If you want this feature, consult an authorized Kia dealer.

Do not arm the system until all passengers have left the vehicle. If the system is armed while a passenger(s) remains in the vehicle, the alarm may be activated when the remaining passenger(s) leave the vehicle. If any door (or liftgate (tailgate)) or engine hood is opened within 30 seconds after the system enters the armed stage, the system is disarmed to prevent an unnecessary alarm.

Theft-alarm stage

The alarm will be activated if any of the following occurs while the system is armed.

- A front or rear door is opened without using the ignition key or transmitter (or smart key).
- The liftgate (tailgate) is opened without using the transmitter (or smart key).
- The engine hood is opened.

The horn will sound and the hazard warning lights will blink continuously for approximately 27 seconds, and repeat the horn 3 times unless the system is disarmed. To turn off the system, unlock the doors with the ignition key or transmitter (or smart key).

Disarmed stage

The system will be disarmed when

- The doors (and liftgate (tailgate)) are unlocked with the transmitter (or smart key) or the ignition key.
- Pull the power sliding door out handle while the power door ON/OFF button is ON (not depressed).

After depressing the unlock button, the hazard warning lights will blink and the chime will sound twice (in smart key) to indicate that the system is disarmed.

After depressing the unlock button, if any door (or liftgate (tailgate)) is not opened within 30 seconds, the system will be rearmed.

*** NOTICE**

- Avoid trying to start the engine while the alarm is activated. The vehicle starting motor is disabled during the theft-alarm stage.
 - If the system is not disarmed with the transmitter, insert the key into the ignition switch, turn the ignition switch to the ON position and wait for 30 seconds. Then the system will be disarmed.
 - If the system is not disarmed with the smart key, press the engine start/stop button with smart key. The side with the lock button should contact the engine start/stop button directly.
- If you lose your keys, consult your authorized Kia dealer.

**CAUTION - Adjusting alarm system**

Do not change, alter or adjust the theft-alarm system because it could cause the theft-alarm system to malfunction and should only be serviced by an authorized Kia dealer.

*** NOTICE**

Malfunctions caused by improper alterations, adjustments or modifications to the theft-alarm system are not covered by your vehicle manufacturer warranty.

DOOR LOCKS

Operating door locks from outside the vehicle

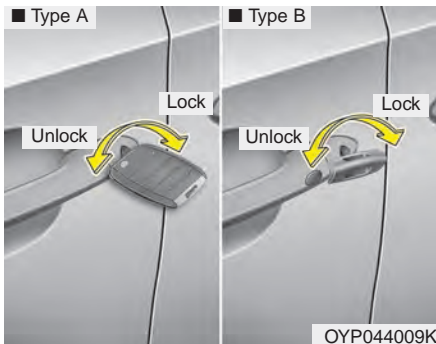

- Turn the key clockwise to lock and counterclockwise to unlock.
- If you lock the driver's door with a key, all vehicle doors will lock automatically.
- From the driver's door, turn the key to the right once to unlock the door and once more within 4 seconds to unlock all doors.

- Doors can also be locked and unlocked with the transmitter.
- Once the doors are unlocked, they may be opened by pulling the door handle.
- When closing the door, push the door by hand. Make sure the doors are closed securely.

* NOTICE

- In cold and wet climates, door lock and door mechanisms may not work properly due to freezing conditions.
- If the door is locked/unlocked multiple times in rapid succession with either the vehicle key or door lock switch, the system may stop operating temporarily in order to protect the circuit and prevent damage to system components.

⚠ WARNING

- If you don't close the door securely, the door may open again.
- Be careful that someone's body and hands are not trapped when closing the door.

⚠ WARNING

If people must spend a longer time in the vehicle while it is very hot or cold outside, there is risk of injuries or danger to life. Do not lock the vehicle from the outside when there are people in it.

⚠ CAUTION

Do not frequently repeat opening and closing of doors, or apply excessive force to a door while the door closer is operating.



- Once the doors are unlocked, it may be opened by pulling the door handle and sliding the door towards the rear of the vehicle. (for manual sliding doors)
- Once the doors are unlocked, it may be opened by pulling the door handle once. And then the sliding door will be opened. (for power sliding doors)

⚠ WARNING - Partially opened sliding door

When opening the rear sliding doors, make sure the doors are fully opened and locked in position. If the sliding doors are only partially opened and not locked in position, the rear sliding doors may move unintentionally causing injuries.

⚠ CAUTION

The left sliding door cannot be opened when the fuel filler lid is open. However, if the fuel filler lid is opened after the door is opened slightly, the left sliding door can be slid rearward. Close the left sliding door to prevent possible damage to the door or the fuel filler lid.

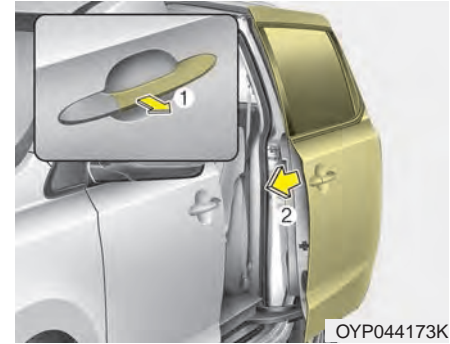

- When the door is fully open, the door will lock into an open position. To close the door, pull out the door handle (1) and sliding the door (2) towards the front of vehicle. (for manual sliding doors)
- When the door is fully open, the door will lock into an open position. To close the door, pull out the door handle (1) once. And then the sliding door will be closed. (for power sliding doors)

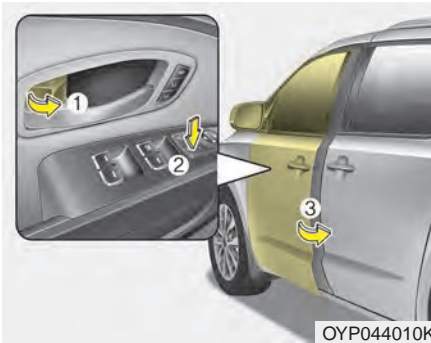

- To lock a door without the key, push the inside door lock button (1) or central door lock switch (2) to the “Lock” position when the ignition switch is OFF position and close the door (3).
- If you lock the door with the central door lock switch (2), all vehicle doors will lock automatically.

*** NOTICE**

Always remove the ignition key, engage the parking brake, close all windows and lock all doors when leaving your vehicle unattended.

Operating door locks from inside the vehicle

With the door lock button

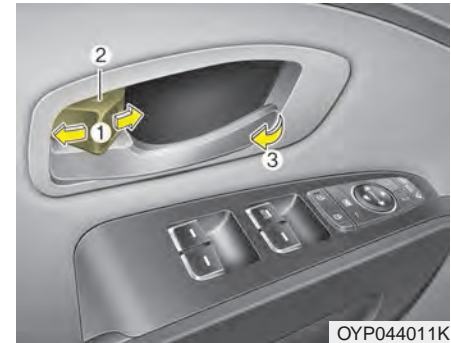

- To unlock a door, push the door lock button (1) to the “Unlock” position. The red mark (2) on the button will be visible.
- To lock a door, push the door lock button (1) to the “Lock” position. If the door is locked properly, the red mark (2) on the door lock button will not be visible.

- To open a door, pull the door handle (3) outward. (for front door)
- To open a door, pull the door handle rearward (for sliding door)
- If the inner door handle of the driver's (or front passenger's) door is pulled when the door lock button is in the lock position, the button will unlock and the door will open. (if equipped)
- Front doors cannot be locked if the ignition key is in the ignition switch and any front door is opened.

If a power door lock ever fails to function while you are in the vehicle, try one or more of the following techniques to exit:

- Operate the door unlock feature repeatedly (both electronic and manual) while simultaneously pulling on the door handle.
- Operate the other door locks and handles, front and rear.
- Lower a front window and use the key to unlock the door from outside.
- Move to the cargo area and open the liftgate (tailgate).

⚠ WARNING

Do not pull the inner door handle of driver's(or passenger's) door while the vehicle is moving.

With central door lock switch

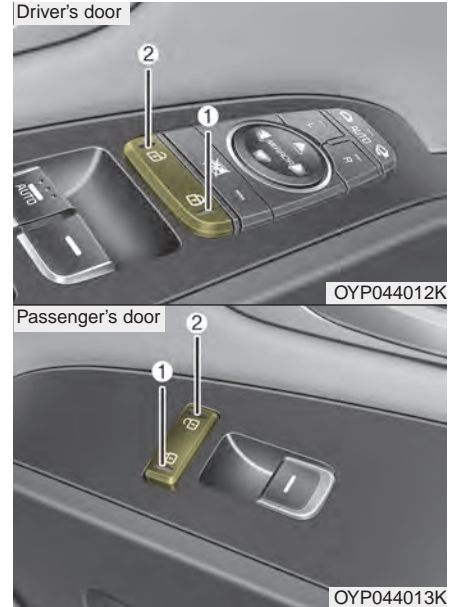

Operate by pressing the central door lock switch.

- When pressing the right portion (1) of the switch, all vehicle doors will lock.

- When pressing the left portion (2) of the switch, all vehicle doors will unlock.
- If the key is in the ignition switch (or if the smart key is in the vehicle) and any front door is opened, the doors will not lock even though the front portion (1) of the central door lock switch is pressed.

⚠ WARNING - Doors

- The doors should always be fully closed and locked while the vehicle is in motion to prevent accidental opening of the door.
- Be careful when opening doors and watch for vehicles, motorcycles, bicycles or pedestrians approaching the vehicle in the path of the door. Opening a door when something is approaching can cause damage or injury.

⚠ WARNING - Unattended children/animals

Never leave children or animals unattended in your vehicle. An enclosed vehicle can become extremely hot, causing death or severe injury to unattended children or animals who cannot escape the vehicle

⚠ WARNING - Unlocked vehicles

Leaving your vehicle unlocked can invite theft or possible harm to you or others from someone hiding in your vehicle while you are gone. Always remove the ignition key, engage the parking brake, close all windows and lock all doors when leaving your vehicle unattended.

⚠ CAUTION - Sliding door hinge

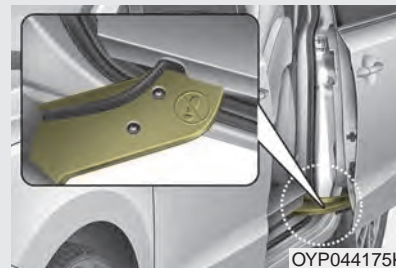

When getting in and out of the sliding door, do not step on the sliding door hinge or drop or put heavy objects on the hinge. The door may not open or close normally by damaging the door hinge or wire part.

Impact sensing door unlock system

In the event of air bag deployment resulting from a vehicle impact, all doors will automatically unlock.

Automatic door lock system

All doors will be automatically locked if the automatic transaxle shift lever is shifted from the P (Park) position to the R (Reverse), N (Neutral), or D (Drive) position.

Child-protector rear door lock



The child safety lock is provided to help prevent children from accidentally opening the rear doors from inside the vehicle. The rear door safety locks should be used whenever children are in the vehicle.

1. Open the rear door.
2. Push the child safety lock located on the front edge of the door to the lock (🔒) position. When the child safety lock is in the lock position, the rear door will not open even when the inner door handle is pulled.

3. Close the rear door.

To open the rear door, pull the outside door handle.

Even though the doors may be unlocked, the rear door will not open by pulling the inner door handle (1) until the rear door child safety lock is unlocked.

⚠️ WARNING - Rear door locks

Use the rear door safety locks whenever children are in the vehicle.

If a child accidentally opens the rear doors while the vehicle is motion, he can fall out.

LIFTGATE (TAILGATE) (for manual liftgate (tailgate))

Opening the liftgate (tailgate)

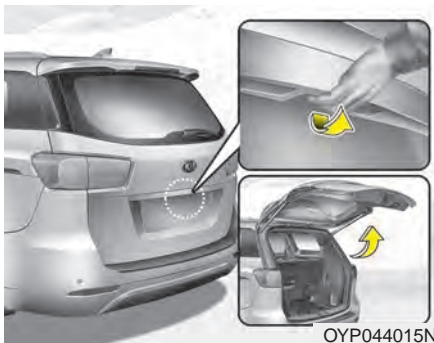

- Only the liftgate (tailgate) is unlocked if the liftgate (tailgate) unlock button on the smart key is pressed (if equipped). Once the liftgate (tailgate) is opened and then closed, the liftgate (tailgate) is locked automatically.
- The liftgate (tailgate) swings upward. Make sure no objects or people are near the rear of the vehicle when opening the liftgate (tailgate).
- The liftgate (tailgate) is locked or unlocked when all doors are locked or unlocked with the key, transmitter (or smart key) or central door lock switch.
 - If unlocked, the liftgate (tailgate) can be opened by pressing the handle switch and then pulling the handle up.

* NOTICE

In cold and wet climates, door lock and door mechanisms may not work properly due to freezing conditions.



CAUTION

- Liftgate (Tailgate) lift

Make certain that you close the liftgate (tailgate) before driving your vehicle. Possible damage may occur to the liftgate (tailgate) lift cylinders and attached hardware if the liftgate (tailgate) is not closed prior to driving.

Closing the liftgate (tailgate)



To close the liftgate (tailgate), lower and push down the liftgate (tailgate) firmly. Make sure that the liftgate (tailgate) is securely latched.

Make sure your hands, feet and other parts of your body are safely out of the way before closing the liftgate (tailgate).

⚠ WARNING - Exhaust fumes

Driving with the liftgate (tailgate) open is not advisable. Dangerous exhaust fumes can enter the passenger compartment and harm vehicle occupants. If you must drive with the liftgate (tailgate) opened, keep the air vents and all windows open so that additional outside air can enter.

⚠ WARNING - Rear cargo area

Occupants should never ride in the rear cargo area where no restraints are available. Occupants should always be properly restrained.

Power liftgate (tailgate) (if equipped)

Detailed information for the power liftgate (tailgate) is described in the following "Power sliding door and power liftgate (tailgate)" section.

Emergency liftgate (tailgate) safety release

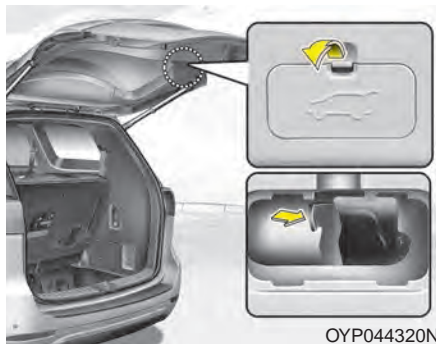

Your vehicle is equipped with an emergency liftgate (tailgate) safety release lever located on the bottom of the liftgate (tailgate). When someone is inadvertently locked in the cargo area, the liftgate (tailgate) can be opened by pushing the release lever and pushing open the liftgate (tailgate).

⚠ WARNING - Safety release lever use

Unless there is an emergency which requires otherwise, do not use the release lever for the liftgate (tailgate) while the vehicle is in motion. Opening the liftgate (tailgate) while the vehicle is in motion can increase the risk of an occupant falling out of the vehicle and being seriously injured.

POWER SLIDING DOOR AND POWER LIFTGATE (TAILGATE) (IF EQUIPPED)

On the overhead console



OYP044017K

On the center pillar trim

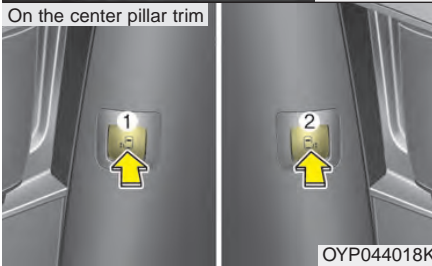

OYP044018K

On the liftgate (tailgate)

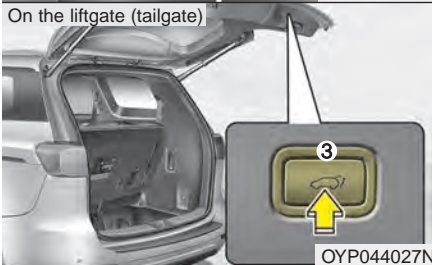

OYP044027N

- (1) Left power sliding door control button
 - (2) Right power sliding door control button
 - (3) Power liftgate (tailgate) control button*
 - (4) Power door ON/OFF button
- *: if equipped

The power sliding doors and power liftgate (tailgate) can be opened and closed automatically with the folding key or smart key, the main control buttons on the overhead console or the sub control buttons on the center pillar trim and the liftgate (tailgate).

When the power door ON/OFF button is OFF (depressed), the power sliding door and power liftgate (tailgate) can be opened and closed manually by pulling the door handles from inside or outside vehicle.

⚠ WARNING - Unattended children/pets

Never leave children or animals unattended in your vehicle. Children or animals might operate the power sliding door or power liftgate (tailgate) that could result in injury to themselves or others or damage to the vehicle.

*** NOTICE**

If the power sliding door is open approximately 6 hours, the ECU will enter Sleep mode to conserve battery power and the door might not close automatically. Close the door or liftgate (tailgate) manually and then operate the door with the power operating system.

*** NOTICE**

In cold and wet climates, power sliding doors and liftgate (tailgate) may not work properly due to freezing conditions.

*** NOTICE**

When the sliding doors are opened manually (power OFF), more effort will be required to open and close than on non-power sliding doors.

*** NOTICE**

- The power sliding door and power liftgate (tailgate) can be operated when the engine is not running. However the power operation consumes large amounts of vehicle electric power. To prevent the battery from being discharged, do not operate them excessively.
- To prevent the battery from being discharged, do not leave the power sliding door and power liftgate (tailgate) at open position for a long time.
- When jacking up the vehicle to change a tire or repair the vehicle, do not operate the power sliding door or power liftgate (tailgate). This could cause the power sliding door or power liftgate (tailgate) to operate improperly.

⚠ CAUTION - Operating sliding door/tailgate

Do not apply excessive force while operating the power sliding door or power liftgate (tailgate). This could cause damage to the power sliding door or power liftgate (tailgate).

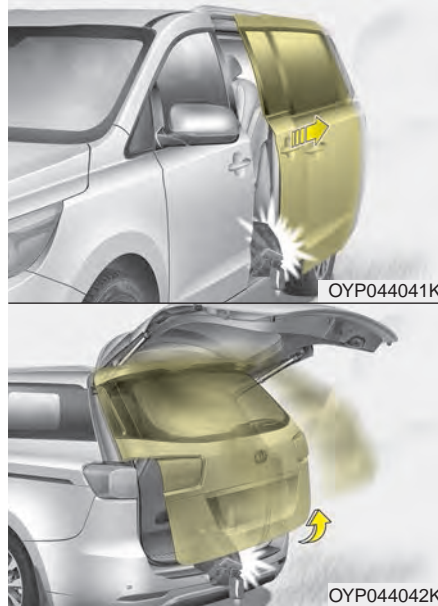

Automatic stop and reversal

If the power opening or closing is blocked by an object or part of the body, the power sliding door and power liftgate (tailgate) will detect the resistance, chime 3 times, and then either stop or move to the full open position.

However, if the resistance is weak such as an object that is thin or soft, or the door is near latched position, the automatic stop and reversal may not detect the resistance and closing operation will continue. Also, if the power sliding door or power liftgate (tailgate) is forced by strong impact, the automatic stop and reversal may operate.

If the automatic stop and reversal feature operates continuously more than twice during one opening or closing operation, the power sliding door or power liftgate (tailgate) may stop at that position. At this time, close the doors manually and operate the door automatically again.

How to reset the power sliding door and power liftgate (tailgate)

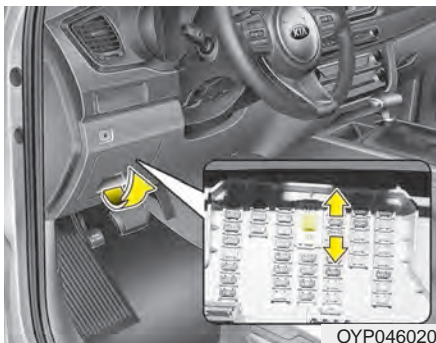

If the battery has been discharged or disconnected, the related fuse has been replaced or disconnected, and the power sliding door or power liftgate (tailgate) doesn't work properly, the power sliding door and power liftgate (tailgate) must be reset as follows:

For power sliding door

1. Put the shift lever in the P (Park).
2. Close the fuel filler lid.
3. Change the position of fuse switch to OFF on the driver's side fuse panel and change the position of fuse switch to ON after 1 minute.
4. Close the sliding door manually.
5. Open the sliding door completely using the transmitter or main control button on the overhead console.
6. Close the sliding door completely using the transmitter or main control button on the overhead console.

For the left/right power sliding doors and power liftgate (tailgate), follow above steps to reset.

If the power sliding door or power liftgate (tailgate) doesn't work properly after above procedure, have the system checked by an authorized Kia dealer.

For power liftgate (tailgate)

1. Put the shift lever in P (Park).
2. Press the liftgate (tailgate) handle switch and liftgate (tailgate) close button at the same time for more than 3 seconds. (the chime will sound).
3. Close the liftgate (tailgate) manually.
4. Open the liftgate (tailgate) using the liftgate (tailgate) handle switch and allow it to fully open.
5. After fully opening, the liftgate (tailgate) will complete initialization and lights will flash twice indicating reset complete.

If the power liftgate (tailgate) does not work properly after the above procedure, have the system checked by an authorized Kia dealer.

Power door ON/OFF button



- When the power door ON/OFF button is ON (not depressed), the power sliding door and power liftgate (tailgate) can be controlled with the sub control buttons on the center pillar trim or liftgate (tailgate). Also, the doors can be opened and closed automatically by pulling the inside or outside door handles.

- When the power door ON/OFF button is OFF (depressed), the power sliding door and power liftgate (tailgate) can not be controlled with the sub control buttons or door handles.

Also, the doors can be opened and closed manually by pulling the inside or outside door handles.

* NOTICE

Do not allow children to play with the power sliding door or power liftgate (tailgate). Keep the power door ON/OFF button in the OFF (depressed) position when not in use.

* NOTICE

Close the sliding door and liftgate (tailgate), and keep the power door ON/OFF button in the OFF (depressed) position before washing the vehicle in an automatic car wash.

* NOTICE

When the sliding doors and power liftgate (tailgate) are opened manually (power OFF), more effort will be required to open and close than on non-power sliding doors and non-power liftgate (tailgate).

Power sliding door operation



- Push the corresponding main control button on the overhead console to open or close the power sliding door.

However, the power sliding door will not open with the main control button when all power sliding doors and power tailgate are locked and closed.

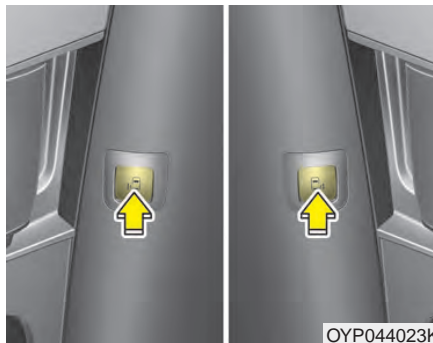

- When the power door ON/OFF button is ON (not depressed), do as follows to open or close the power sliding doors:
 - Push the corresponding sub control button on the center pillar trim.
 - Pull the door handle from inside or outside vehicle.
 - If the sub control button is pushed while the door is locked or child safety lock is engaged, the chime sounds once, and the power sliding door will not open.

- If the door handle is pulled from inside or outside while the door is locked or child safety lock is engaged, the power sliding door will not open. However, the power sliding door can be opened by pulling the outside door handle while the door is unlocked and child safety lock is engaged.

- When the power door ON/OFF button is OFF (depressed), the power sliding door can not be controlled with the sub control buttons or door handles, and if the sub control button is pushed, chime sounds once. However, the doors can be opened and closed manually by pulling the door handles from inside or outside vehicle.
- On a steep grade, the power sliding door will slide faster when closing. And the drive unit motor may operate additionally for a moment after the door is closed. This is a normal operation to ensure door closing, not a malfunction.

⚠ WARNING - Rear door locks

Use the rear door safety locks whenever children are in the vehicle. If a child accidentally opens the rear doors while the vehicle is motion, he can fall out.

When the rear passenger operates the power sliding door, make sure there are no people or objects around the door, and have all occupants get in or out of the vehicle after the door is open fully and stopped. Let the rear passengers get in or out of the vehicle after the door is open fully. Sudden closing could cause a serious injury. Close the door by pulling the door handle after the door is open fully. Do not pull the door handle while rear passengers are getting in or out. The door could suddenly close by itself and cause a serious injury. It takes about 5 seconds for the power sliding door to close and latch completely.

⚠ WARNING - Power sliding door

Do not begin to accelerate before the door closes and latches completely. If the door is not completely closed while the vehicle is moving, the door can open and passengers can fall out of the vehicle.

- The left power sliding door cannot be opened while the fuel filler lid is open fully. If the main or sub control button is pushed, the chime sounds once. Also, if the fuel filler lid open button is pushed while the left power sliding door is opening, the chime sounds 3 times.

*** NOTICE**

If the fuel filler lid is opened when the left sliding door is not closed completely, the door may be opened. Close the left sliding door before refueling to prevent possible damage to the door or the fuel filler lid.

- If the power sliding door is not closed and latched completely after power closing operation, the chime sounds 3 times. Open and close the door again.
- If the power sliding door is operated while the door is in partially opened position (less than 12 in./300 mm), the door is automatically opened fully.
- If the power sliding door is operated while the door is in half-opened position (more than 12 in./300 mm), the door is automatically closed completely.
- If the power sliding door is operated again while the door is closing, the door is automatically opened fully.
- If the power sliding door is operated again while the door is opening, the door is automatically closed completely. However, If the power sliding door is operated again when the door is in partially opened position (less than 12 in./300 mm), the door is opened continuously.
- The half-opened power sliding door is automatically opened or closed fully by pushing the door forward or backward without pulling the door handle while the power door ON/OFF button is in ON (not depressed). However, when the door is in partially opened position (less than 12 in./300 mm), the door is not closed automatically.

Power sliding door non-opening conditions

The power sliding door is not automatically opened, but closed under the following conditions. If the main or sub control button is pushed for power opening operation, the chime sounds once.

When the ignition switch is in the ON position,

1. Vehicle is moving above 3 mph (5 km/h).
2. The gearshift lever is not in P (Park) for automatic transaxle.

Power liftgate (tailgate) operation (if equipped)

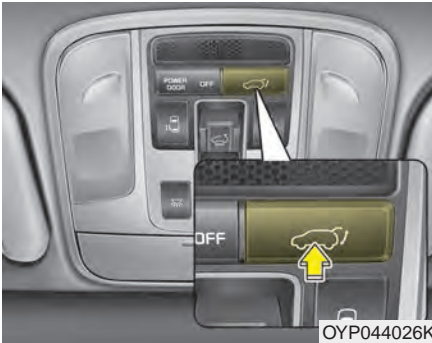

- Push the power liftgate (tailgate) main control button for approximately 1 second on the overhead console to open or close the power liftgate (tailgate). However, the power liftgate (tailgate) will not open with the main control button when all power sliding doors and power liftgate (tailgate) are locked and closed. But the power liftgate (tailgate) will be opened with the folding key (or smart key).

- When the power liftgate (tailgate) is operated with the main or sub control button or transmitter, the chime sounds and hazard warning lights flash 2 times.



- When the power door ON/OFF button is ON (not depressed), do as follows to open or close the power liftgate (tailgate):
 - Pushing the sub control button on the bottom of the liftgate (tailgate) will close the power liftgate (tailgate) automatically.
 - Pressing and pulling up the liftgate (tailgate) handle slightly will open the power liftgate (tailgate) automatically when the liftgate (tailgate) is unlocked.

- When the power door ON/OFF button is OFF (depressed), the power liftgate (tailgate) can not be controlled with the sub control buttons or liftgate (tailgate) handle.

However, the liftgate (tailgate) may be opened manually by pulling the exterior handle and lifting the liftgate (tailgate) upward. The liftgate (tailgate) may be manually closed by pushing the liftgate (tailgate) downward.

- Do not drive the vehicle until the power liftgate (tailgate) completely closed.

The power liftgate (tailgate) may not close completely if the vehicle is started during automatic closing.

* NOTICE

The button on the liftgate (tailgate) will not illuminated and operated when the power door On/OFF button is OFF (depressed).

* NOTICE

If the power liftgate (tailgate) does not operate normally, first check the following condition before using the power liftgate (tailgate).

- Make sure the shift lever is in Park
- Make sure the Power Liftgate (Tailgate) Off switch is not pressed.

If any of the power liftgate (tailgate) buttons are pressed while the power liftgate (tailgate) is in operation, the power liftgate (tailgate) will stop. If any button is pressed again the power liftgate (tailgate) will reverse direction.

- Even though the Power door ON/OFF button is in the OFF (depressed) position, if the liftgate (tailgate) is manually closed to the secondary latch position, the liftgate (tailgate) will be electrically moved to the fully latched position. Make sure that face, arms, hands, and other obstructions are safely out of the way before operating the liftgate (tailgate).
- The chime will sound and the hazard warning flasher will blink 10 times if you drive with the liftgate (tailgate) closed but not fully secured. Stop your vehicle immediately at a safe place to check if your liftgate (tailgate) is securely locked.
- Make sure there are no people or objects around the liftgate (tailgate) before operating the power liftgate (tailgate). Wait until the liftgate (tailgate) is open fully and stopped before loading or unloading cargo or passengers from the vehicle.

- Make sure the liftgate (tailgate) is closed firmly before driving. If the liftgate (tailgate) is open, you will draw dangerous exhaust fumes into your vehicle which can cause serious injury or death to vehicle occupants.
- If the power liftgate (tailgate) is not closed and latched completely after power closing operation, the chime will sound and hazard warning lights will blink 10 times. Stop the driving immediately and close the liftgate (tailgate) securely at the safe place.
- If the power liftgate (tailgate) is operated while the liftgate (tailgate) is in the partially opened position (more than 9degrees), the liftgate (tailgate) will stop the operation. If you operate the power liftgate (tailgate) again, the power liftgate (tailgate) will be operate in the opposite direction.
- If the power liftgate (tailgate) is operated while the liftgate (tailgate) is in the partially closed position (less than degrees), the liftgate (tailgate) will open fully.
- If the power liftgate (tailgate) is operated while the liftgate (tailgate) is in the partially opened position (less than 9degrees), the liftgate (tailgate) will stop at approximately 9degree open position.

Power liftgate (tailgate) non-opening conditions

The power liftgate (tailgate) will not open automatically, but will close under the following conditions.

When the ignition switch is in the ON position,

1. Vehicle is moving above 2 mph (3 km/h).
2. The gearshift lever is not in P (Park) for automatic transaxle.

The chime will sound continuously if you drive over 2mph (3km/h) with the liftgate (tailgate) opened. Stop your vehicle at a safe place as soon as possible to check if your liftgate (tailgate) is opened.

Power liftgate (tailgate) opening height user setting



The driver may set the height of a fully opened liftgate (tailgate) by following the below instruction.

1. Confirm the position of the power door ON/OFF button is ON (not depressed).
2. Position the liftgate (tailgate) manually or via automatic operation to the height you prefer.

⚠ WARNING

Make sure that there are no people or objects in the path of the power liftgate (tailgate) (or smart liftgate (tailgate)) prior to use. Serious injury, damage to the vehicle or damage to surrounding objects may result if contact with the power liftgate (tailgate) (or smart liftgate (tailgate)) occurs.

3. Press the liftgate (tailgate) close button for more than 3 seconds.
4. You will hear the system beep twice indicating height has been set up.

The liftgate (tailgate) will open to the height the driver has set up.

Emergency liftgate (tailgate) safety release

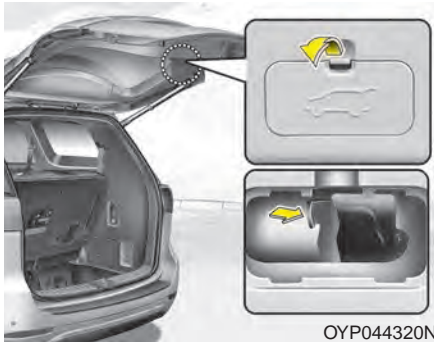

Your vehicle is equipped with an emergency liftgate (tailgate) safety release lever located on the bottom of the liftgate (tailgate). When someone is inadvertently locked in the cargo area, the liftgate (tailgate) can be opened by pushing the release lever and pushing open the liftgate (tailgate).

Smart Liftgate (Tailgate) (if equipped)



On a vehicle equipped with a smart key, the liftgate (tailgate) can be opened using the Smart Liftgate (Tailgate) system.

If the power door ON/OFF button is in the OFF (depressed) position, the smart liftgate (tailgate) will not operate.

How to use the Smart Liftgate (Tailgate)

The liftgate (tailgate) can be opened with no-touch activation satisfying all the conditions below.

- After 15 seconds when all doors are closed and locked
- Positioned in the detecting area for more than 3 seconds.

* NOTICE

- The Smart Liftgate (Tailgate) does not operate when:
 - The smart key is detected within 15 seconds after the doors are closed and locked, and is continuously detected.
 - The smart key is detected within 15 seconds after the doors are closed and locked, and within 60 inches (1.5 m) from the front door handles. (for vehicles equipped with Welcome Light)
 - A door is not locked or closed.
 - The smart key is in the vehicle.

1. Setting

To activate the Smart Liftgate (Tailgate), go to User Settings Mode and select Smart Liftgate (Tailgate) on the LCD display.

For more information, refer to the "LCD Display" section in this chapter.

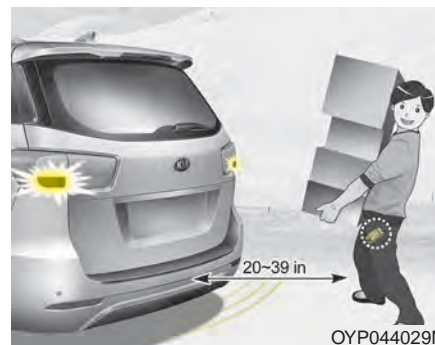

2. Detect and Alert

If you are positioned in the detecting area (20~40 inches (50 ~100 cm) behind the vehicle) carrying a smart key, the hazard warning lights will blink and chime will sound for about 3 seconds to alert you the smart key has been detected and the liftgate (tailgate) will open.

*** NOTICE**

Do not approach the detecting area if you do not want the liftgate (tailgate) to open. If you have unintentionally entered the detecting area and the hazard warning lights and chime starts to operate, leave the detecting area with the smart key. The liftgate (tailgate) will stay closed.

**3. Automatic opening**

The hazard warning lights will blink and chime will sound 2 times and then the liftgate (tailgate) will open.

Make sure you close the liftgate (tailgate) before driving your vehicle.

Make sure there are no people or objects around the liftgate (tailgate) before opening or closing the liftgate (tailgate). Make sure objects in the liftgate (tailgate) do not come out when opening the liftgate (tailgate) on a slope. It may cause serious injury. Make sure to deactivate the Smart Liftgate (Tailgate) when washing your vehicle. Otherwise, the liftgate (tailgate) may open inadvertently. The key should be kept out of reach of children. Children may inadvertently open the Smart Liftgate (Tailgate) while playing around the rear area of the vehicle.

CAUTION

- Liftgate (Tailgate) lift

Make certain that you close the liftgate (tailgate) before driving your vehicle. Possible damage may occur to the liftgate (tailgate) lift cylinders and attached hardware if the liftgate (tailgate) is not closed prior to driving.

How to deactivate the Smart Liftgate (Tailgate) function using the smart key



- 1. Door lock
- 2. Door unlock
- 3. Liftgate (Tailgate) open
- 4. Panic
- 5. Right side power sliding door open / close
- 6. Left side power sliding door open / close

If you press any button of the smart key during the Detect and Alert stage, the Smart Liftgate (Tailgate) function will be deactivated.

Make sure to be aware of how to deactivate the Smart Liftgate (Tailgate) function for emergency situations.

*** NOTICE**

- If you press the door unlock button (2), the Smart Liftgate (Tailgate) function will be deactivated temporarily. But, if you do not open any door for 30 seconds, the smart liftgate (tailgate) function will be activated again.
- If you press the liftgate (tailgate) open button (3) for more than 1 second, the liftgate (tailgate) opens.
- If you press the door lock button (1) or liftgate (tailgate) open button (3) when the Smart Liftgate (Tailgate) function is not in the Detect and Alert stage, the smart liftgate (tailgate) function will not be deactivated.
- In case you have deactivated the Smart Liftgate (Tailgate) function by pressing the smart key button and opened a door, the smart liftgate (tailgate) function can be activated again by closing and locking all doors.

Detecting area

- The Smart Liftgate (Tailgate) operates with a welcome alert if the smart key is detected within 20~40 inches (50~100 cm) from the liftgate (tailgate).
- The alert stops at once if the smart key is positioned outside the detecting area during the Detect and Alert stage.

*** NOTICE**

- The Smart Liftgate (Tailgate) function will not work if any of the following occurs:
 - The smart key is close to a radio transmitter such as a radio station or an airport which can interfere with normal operation of the transmitter.
 - The smart key is near a mobile two way radio system or a cellular phone.
 - Another vehicle's smart key is being operated close to your vehicle.
- The detecting range may decrease or increase when :
 - One side of the tire is raised to replace a tire or to inspect the vehicle.
 - The vehicle is parked on a slope or unpaved road, etc.

WINDOWS

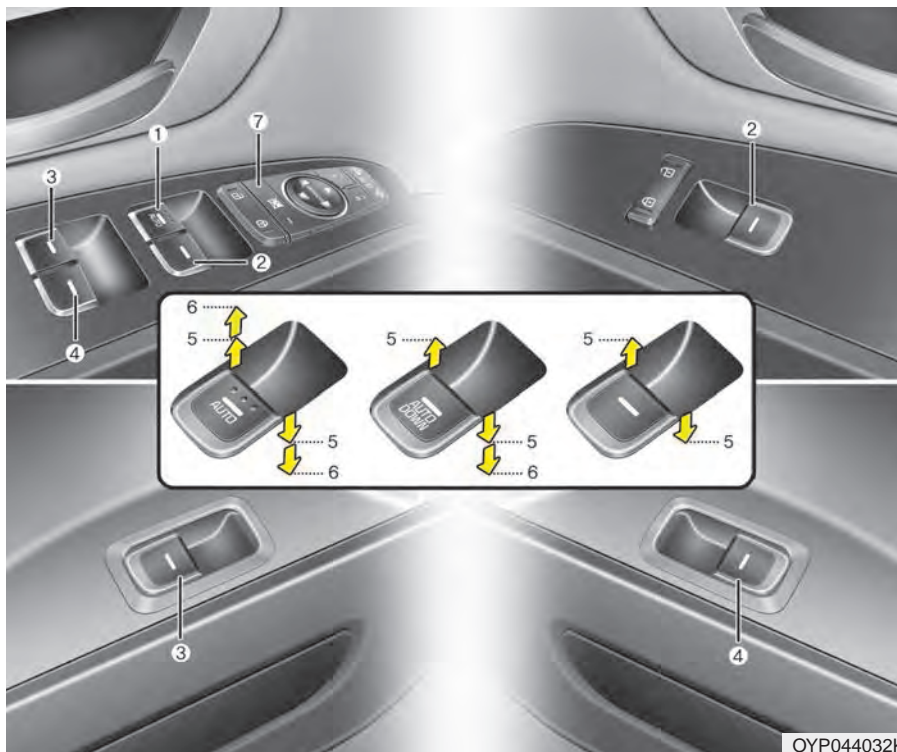

- (1) Driver's door power window switch
- (2) Front passenger's door power window switch
- (3) Rear door (left) power window switch
- (4) Rear door (right) power window switch
- (5) Window opening and closing
- (6) Automatic power window up/down* (Driver's and Passenger's window)
- (7) Power window and rear sunroof* lock switch

* if equipped

In cold and wet climates, power windows may not work properly due to freezing conditions.

OYP044032K

Power windows

The ignition switch must be in the ON position for power windows to operate. Each door has a power window switch that controls the door's window. The driver has a power window lock button which can block the operation of passenger windows. The power windows can be operated for approximately 30 seconds after the ignition key is removed or turned to the ACC or LOCK (or OFF) position. However, if the front doors are opened, the power windows cannot be operated even within the 30 second period.

If the window cannot be close because it is blocked by objects, remove the objects and close the window.

* NOTICE

While driving with the rear windows down or with the sunroof (if equipped) in an open (or partially open) position, your vehicle may demonstrate a wind buffeting or pulsation noise. This noise is a normal occurrence and can be reduced or eliminated by taking the following actions. If the noise occurs with one or both of the rear windows down, partially lower both front windows approximately one inch. If you experience the noise with the sunroof open, slightly reduce the size of the sunroof opening.

⚠ WARNING

Do not install any accessories in the area of windows. It may impact jam protection.

Window opening and closing



OYP044035K

The driver's door has a master power window switch that controls all the windows in the vehicle.

To open or close a window, press down or pull up the front portion of the corresponding switch to the first detent position (5).

Auto down window (if equipped)



Pressing the power window switch momentarily to the second detent position (6) completely lowers the driver's window even when the switch is released. To stop the window at the desired position while the window is in operation, momentarily pull the switch in the direction opposite of the window's movement.

Auto up/down window (if equipped)



Pressing or pulling up the power window switch momentarily to the second detent position (6) completely lowers or raises the window even when the switch is released. To stop the window at the desired position while the window is in operation, pull up or press down and release the switch.

If the power window does not operate normally, the automatic power window system must be reset as follows:

1. Turn the ignition switch to the ON position.
2. Close the driver's and passenger's window and continue pulling up the driver's power window switch for at least 1 second after the window is completely closed.

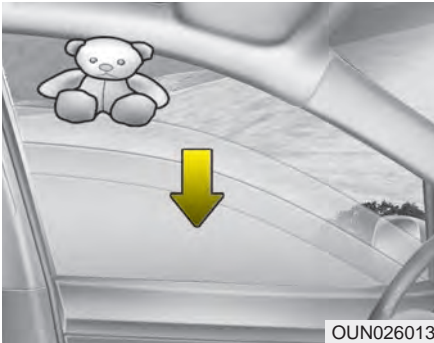

Automatic reversal (for Auto up/down window)

If the upward movement of the window is blocked by an object or part of the body, the window will detect the resistance and will stop upward movement. The window will then lower approximately 11.8 in. (30 cm) to allow the object to be cleared.

The distance may vary based on the size or position of the window. If the window detects the resistance while the power window switch is pulled up continuously, the window will stop upward movement then lower approximately 1 in. (2.5 cm).

And if the power window switch is pulled up continuously again within 5 seconds after the window is lowered by the automatic window reversal feature, the automatic window reversal will not operate.

The automatic reverse feature for the driver's window is only active when the "auto up" feature is used by fully pulling up the switch. The automatic reverse feature will not operate if the window is raised using the halfway position on the power window switch.

⚠ WARNING

Always check for obstructions before raising any window to avoid injuries or vehicle damage. If an object less than 0.16 in. (4 mm) in diameter is caught between the window glass and the upper window channel, the automatic reverse window may not detect the resistance and will not stop and reverse direction.

⚠ WARNING

The automatic reverse feature doesn't activate while resetting power window system. Make sure body parts or other objects are safely out of the way before closing the windows to avoid injuries or vehicle damage.

Power window and rear sunroof* lock button



- The driver can disable the power window switches on a rear passenger door and the rear sunroof switch on a rear passenger room lamp by depressing the power window and rear sunroof lock switch on the driver's door to LOCK (pressed).

* : if equipped

When the power window and rear sunroof lock switch is pressed:

- The driver's master control can operate all the power windows.
- The front passenger's control can operate the front passenger's power window.
- The rear passenger's control cannot operate the rear passenger's power window.
- The rear sunroof control cannot operate the rear sunroof. **But The front master sunroof control can operate both front and rear sunroofs (if equipped).**

CAUTION - Opening/closing Window

To prevent possible damage to the power window system, do not open or close two windows or more at the same time. This will also ensure the longevity of the fuse.

Always double check to make sure all arms, hands, head and other obstructions are safely out of the way before closing a window.

WARNING - Power windows

- Do not allow children to play with the power windows. Keep the power window lock button (on the driver's door) in the LOCK (pressed) position.
- Do not extend a face or arms outside through the window opening while driving.

HOOD

Opening the hood

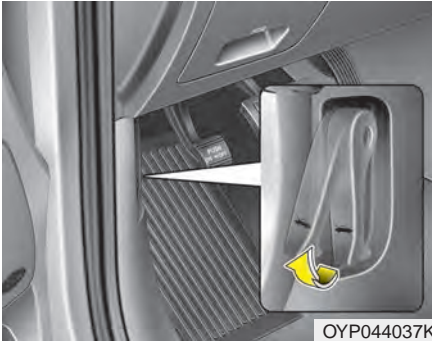

1. Pull the release lever to unlatch the hood. The hood should pop open slightly.

Open the hood after turning off the engine on a flat surface, shifting the shift lever to the P (Park) position and setting the parking brake.

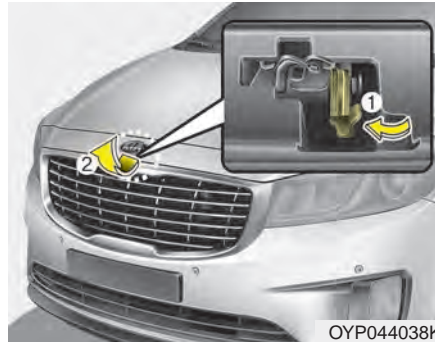

2. Go to the front of the vehicle, raise the hood slightly, pull up the secondary latch (1) inside of the hood center and lift the hood (2).



3. Pull out the support rod.

4. Hold the hood opened with the support rod.

* NOTICE - Hot parts

Grab the support rod in the area wrapped in rubber. The plastic will help prevent you from being burned by hot metal when the engine is hot.

Hood open warning (if equipped)



The warning message will appear on the LCD display when hood is open.

The warning chime will operate when the vehicle is being driven at or above 2 mph (3 km/h) with the hood open.

Closing the hood

1. Before closing the hood, check the following:
 - All filler caps in the engine compartment must be correctly installed.
 - Gloves, rags or any other combustible material must be removed from the engine compartment.
2. Return the support rod to its clip to prevent it from rattling.
3. Lower the hood until it is about 1 ft. (30 cm) above the closed position and let it drop. Make sure that it locks into place.

CAUTION - Hood obstruction

Before closing the hood, ensure that all obstructions are removed from the hood opening. Closing the hood with an obstruction present in the hood opening may result in property damage.

WARNING - Fire risk

Do not leave gloves, rags or any other combustible material in the engine compartment. Doing so may cause a heat-induced fire.

WARNING - Unsecured engine hood

Always double check to be sure that the hood is firmly latched before driving away. If it is not latched, the hood could fly open while the vehicle is being driven, causing a total loss of visibility, which might result in an accident.

The support rod must be inserted completely into the hole whenever you inspect the engine compartment. This will prevent the hood from falling and possibly injuring you.

FUEL FILLER LID

Opening the fuel filler lid

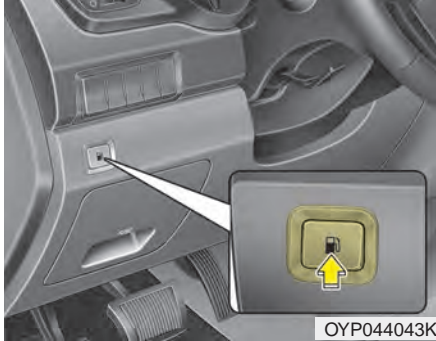

The fuel filler lid must be opened from inside the vehicle by pulling up the fuel filler lid opener.

If the fuel filler lid does not open because ice has formed around it, tap lightly or push on the lid to break the ice and release the lid. Do not pry on the lid. If necessary, spray around the lid with an approved de-icer fluid (do not use radiator anti-freeze) or move the vehicle to a warm place and allow the ice to melt.

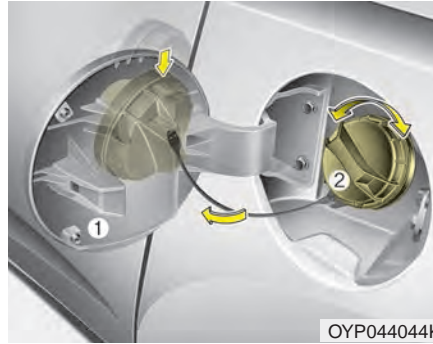

1. Stop the engine.
2. To open the fuel filler lid, push the fuel filler lid opener button.
3. Pull open the fuel filler lid (1).
4. To remove the cap, turn the fuel filler cap (2) counterclockwise.
5. Refuel as needed.

Closing the fuel filler lid

1. To install the cap, turn it clockwise until it “clicks” once. This indicates that the cap is securely tightened.
2. Close the fuel filler lid and push it in lightly making sure that it is securely closed.

* NOTICE

There may be an intermittent noise near the refueling hole while the engine is idling if the fuel cap is not closed securely. This occurs normally with the OBD system.

* NOTICE

When refueling fully at an up hill, the fuel gauge may not point to the F position.

It is not a malfunction. If you move your vehicle to a level ground, the fuel gauge will move to the full position.

⚠ WARNING - Refueling

Always remove the fuel cap carefully and slowly. If the cap is venting fuel or if you hear a hissing sound, wait until the condition stops before completely removing the cap. If pressurized fuel sprays out, it can cover your clothes or skin and subject you to the risk of fire and burns.

Always check that the fuel cap is installed securely to prevent fuel spillage in the event of an accident.

*** NOTICE**

Tighten the cap until it clicks once, otherwise the fuel cap open warning indicator  light will illuminate

⚠ WARNING - Fire/explosion risk

Read and follow all warnings posted at the gas station facility. Failure to follow all warnings will result in severe personal injury, severe burns or death due to fire or explosion.

⚠ WARNING - Static electricity

- Before touching the fuel nozzle, you should eliminate potentially dangerous static electricity discharge by touching another metal part of the vehicle, a safe distance away from the fuel filler neck, nozzle, or other gas source.
- Do not get back into a vehicle once you have begun refueling since you can generate static electricity by touching, rubbing or sliding against any item or fabric (polyester, satin, nylon, etc.) capable of producing static electricity. Static electricity discharge can ignite fuel vapors resulting in rapid burning. If you must reenter the vehicle, you should once again eliminate potentially dangerous static electricity discharge by touching a metal part of the vehicle, away from the fuel filler neck, nozzle or other gasoline source.

⚠ WARNING - Portable fuel container

When using an approved portable fuel container, be sure to place the container on the ground prior to refueling. Static electricity discharge from the container can ignite fuel vapors causing a fire. Once refueling has begun, contact with the vehicle should be maintained until the filling is complete. Use only approved portable plastic fuel containers designed to carry and store gasoline.

⚠ WARNING - Cell phone fires

Do not use cellular phones while refueling. Electric current and/or electronic interference from cellular phones can potentially ignite fuel vapors causing a fire.

⚠ WARNING - Smoking

DO NOT use matches or a lighter and **DO NOT SMOKE** or leave a lit cigarette in your vehicle while at a gas station especially during refueling. Automotive fuel is highly flammable and can, when ignited, result in fire.

⚠ WARNING - Refueling & Vehicle fires

When refueling, always shut the engine off. Sparks produced by electrical components related to the engine can ignite fuel vapors causing a fire. Once refueling is complete, check to make sure the filler cap and filler door are securely closed, before starting the engine.

Make sure to refuel your vehicle according to the “Fuel requirements” suggested in chapter 1.

If the fuel filler cap requires replacement, use only a genuine Kia cap or the equivalent specified for your vehicle. An incorrect fuel filler cap can result in a serious malfunction of the fuel system or emission control system.

⚠ CAUTION - Exterior paint

Do not spill fuel on the exterior surfaces of the vehicle. Any type of fuel spilled on painted surfaces may damage the paint.

Emergency fuel filler lid release

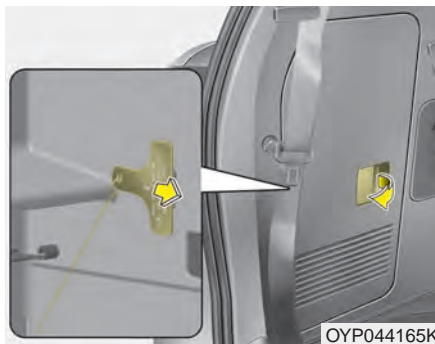

If the fuel filler lid does not open using the remote fuel filler lid release, you can open it manually by pulling the handle outward slightly.

⚠ CAUTION

Do not pull the handle excessively, otherwise the luggage area trim or release handle may be damaged.

SUNROOF (IF EQUIPPED)

■ Front



■ Rear

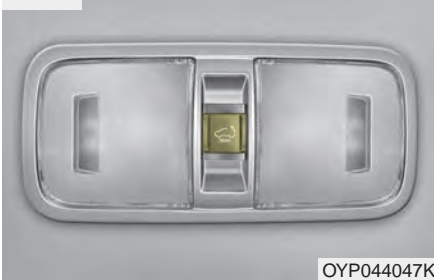

If your vehicle is equipped with a sunroof, you can slide or tilt your sunroof with the sunroof control lever located on the overhead console.

The sunroof can only be opened, closed, or tilted when the ignition switch is in the ON position.

The sunroof can be operated for approximately 30 seconds after the ignition key is removed or turned to the ACC or LOCK (or OFF) position. However, if the front door is opened, the sunroof cannot be operated even within the 30 second period.



CAUTION - Sunroof motor damage

To prevent damage to the sunroof, periodically remove any dirt that may accumulate on the guide rail.

In cold and wet climates, the sunroof may not work properly due to freezing conditions. After the vehicle is washed or in a rainstorm, be sure to wipe off any water that is on the sunroof before operating it.



CAUTION - Sunroof control lever

Do not continue to press the sunroof control lever after the sunroof is fully opened, closed, or tilted. Damage to the motor or system components could occur.



WARNING

Never adjust the sunroof or sunshade while driving. This could result in loss of control and an accident that may cause death, serious injury, or property damage.



WARNING

- In order to prevent accidental operation of the sunroof, especially by a child, do not let a child operate the sunroof.
- Do not sit on the top of the vehicle. It may cause vehicle damage.

⚠ WARNING - Roof cargo
Do not operate the sun roof while using the roof rack to transport cargo. This may cause the cargo to come loose and distract the driver.

Sliding the sunroof

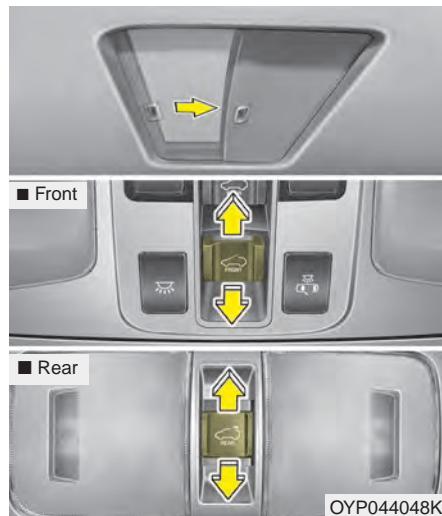

To open the sunroof, pull the sunroof control lever backward.

To close the sunroof, push the sunroof control lever forward.

To open the sunroof automatically:

Pull the sunroof control lever backward to the second detent position and then release it.

The sunroof will open as below:

- Front sunroof : sunroof will slide all the way open.
- Rear sunroof : sunroof will not open fully.

To open the sun roof fully, pull the sunroof control lever again.

To stop the sunroof sliding at any point, pull or push the sunroof control lever momentarily.

To close the sunroof automatically:

Pull the sunroof control lever backward to the second detent position and then release it. The sunroof will slide all the way open.

To stop the sunroof sliding at any point, pull or push the sunroof control lever momentarily.

While driving with the sunroof in an open (or partially open position), your vehicle may demonstrate a wind buffeting or pulsation noise. This noise is a normal occurrence and can be reduced or eliminated by taking the following actions. If you experience the noise with the sunroof open, slightly reduce the size of the sunroof opening.

Automatic reversal

OBK049018

If an object or part of the body is detected while the sunroof is closing automatically, it will reverse direction, and then stop.

The auto reverse function does not work if a tiny obstacle is between the sliding glass and the sunroof sash. You should always check that all passengers and objects are away from the sunroof before closing it.

Tilting the sunroof (for front sunroof)

OYP044049K

To open the sunroof, push the sunroof control lever upward until the sunroof moves to the desired position.

To close the sunroof, push the sunroof lever forward or pull downward until the sunroof moves to the desired position.

Do not extend the face, neck, arms or body outside the sunroof while driving. Care should be taken that no objects stick out through the sunroof. In a sudden stop, pertinent parts may be damaged.

With the sunroof open for an extended period of time, dirt may accumulate on the guide rails causing noise during opening and closing. Periodically remove dirt using a clean cloth.

⚠ WARNING - Sunroof

Do not extend the face, neck, arms or body outside through the sunroof opening while driving or operating the sunroof.

⚠ CAUTION - Sunroof motor damage

If you try to open the sunroof when the temperature is below freezing or when the sunroof is covered with snow or ice, the glass or the motor could be damaged.

Sunshade



When opening the sunroof, the sunshade will also open. Once the sunroof is closed, the sunshade can be manually closed.

Resetting the sunroof

Whenever the vehicle battery is disconnected or discharged, you must reset your sunroof system as follows:

1. Turn the ignition switch to the ON position.
2. Close the sunshade and sunroof completely if opened.
3. Release the sunroof control lever.
4. Push the sunroof control lever forward in the direction of close (about 10~15 seconds) until the sunroof moves a little. Then, release the lever.

5. Push the sunroof control lever forward in the direction of close, until the sunroof operates as follows again:

The sunroof glass slide open →
The sunroof glass slide close

Then, release the lever.

When this is complete, the sunroof system has been reset.

CAUTION

If the sunroof is not reset when the vehicle battery is disconnected or discharged, or related fuse is blown, the sunroof may operate improperly.

Rear sunroof lock

When the power window lock switch is pressed, the rear sunroof control cannot operate the rear sunroof. But The front master sunroof control can operate both front and rear sunroofs (if equipped).

Sunroof open warning (if equipped)

■ for B, C type cluster



OYP044155K

If the driver removes the ignition key (smart key: turns off the engine) when the sunroof is not fully closed, the warning chime will sound for a few seconds and a message will appear on the LCD display or warning indicator  will illuminate.

Close the sunroof securely when leaving your vehicle.

STEERING WHEEL

Power steering (if equipped)

Power steering uses energy from the engine to assist you in steering the vehicle. If the engine is off or if the power steering system becomes inoperative, the vehicle may still be steered, but it will require increased steering effort.

Should you notice any change in the effort required to steer during normal vehicle operation, have the power steering checked by an authorized Kia dealer.



CAUTION - Power steering pump

Never hold the steering wheel to the extreme right or left for more than 5 seconds with the engine running. Holding the steering wheel for more than 5 seconds in either position may cause damage to the power steering pump.

If the power steering drive belt breaks or if the power steering pump malfunctions, the steering effort will greatly increase.

* NOTICE

- **If the vehicle is parked for extended periods outside in cold weather (below 14°F/-10°C), the power steering may require increased effort when the engine is first started. This is caused by increased fluid viscosity due to the cold weather and does not indicate a malfunction.**

When this happens, increase the engine RPM by depressing the accelerator until the RPM reaches 1,500 rpm then release or let the engine idle for two or three minutes to warm up the fluid.

Electric power steering (if equipped)

Power steering uses the motor to assist you in steering the vehicle. If the engine is off or if the power steering system becomes inoperative, the vehicle may still be steered, but it will require increased steering effort.

The motor driven power steering is controlled by the power steering control unit which senses the steering wheel torque and vehicle speed to command the motor.

The steering wheel becomes heavier as the vehicle's speed increases and becomes lighter as the vehicle's speed decreases for better control of the steering wheel.

Should you notice any change in the effort required to steer during normal vehicle operation, have the power steering checked by an authorized Kia dealer.

*** NOTICE**

The following symptoms may occur during normal vehicle operation:

- The steering effort is high immediately after turning the ignition switch on. This happens as the system performs the EPS system diagnostics. When the diagnostics is completed, the steering wheel will return to its normal condition.
- A click noise may be heard from the EPS relay after the ignition switch is turned to the ON or LOCK position.
- Motor noise may be heard when the vehicle is at a stop or at a low driving speed.
- The steering effort increases if the steering wheel is rotated continuously when the vehicle is not in motion. However, after a few minutes, it will return to its normal conditions.
- When you operate the steering wheel in low temperature, abnormal noise could occur. If temperature rises, the noise will disappear. This is a normal condition.

If the Electric Power Steering System does not operate normally, the warning light will illuminate on the instrument cluster. The steering wheel may become difficult to control or operate abnormally. Take your vehicle to an authorized Kia dealer and have the vehicle checked as soon as possible.

Tilt and telescopic steering

Tilt and telescopic steering allows you to adjust the steering wheel before you drive. You can also raise it to give your legs more room when you exit and enter the vehicle.

The steering wheel should be positioned so that it is comfortable for you to drive, while permitting you to see the instrument panel warning lights and gauges.

 **WARNING**

Never adjust the angle of the steering wheel while driving. You may lose steering control and cause severe personal injury, death or accidents.

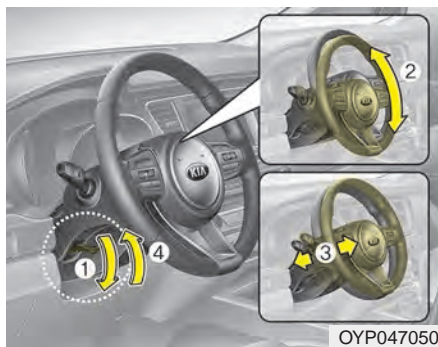

To change the steering wheel angle, pull down the lock-release lever (1), adjust the steering wheel to the desired angle (2) and height (3) then pull up the lock-release lever (4) to lock the steering wheel in place. Be sure to adjust the steering wheel to the desired position before driving.

Heated steering wheel (if equipped)

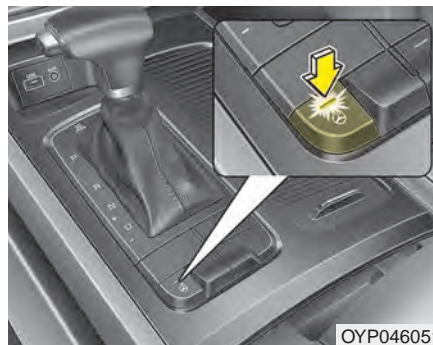

With the ignition switch in the ON position, pressing the heated steering wheel button warms the steering wheel. The indicator on the button will illuminate and notify you on the LCD display. (if equipped)

To turn the heated steering wheel off, press the button once again. The indicator on the button will turn off and notify you on the LCD display. (if equipped)

The heated steering wheel will turn off automatically approximately 30 minutes after the heated steering wheel is turned on.

If you turn off the engine within 30 minutes while the heated steering wheel is ON, the heated steering wheel will turn on automatically when you set the ignition switch in the ON position.

CAUTION

Do not install any grip or accessory to operate the steering wheel. This causes damage to the heated steering wheel system.

Horn



OYP047052

To sound the horn, press the horn symbols on your steering wheel. Check the horn regularly to be sure it operates properly.

* NOTICE

To sound the horn, press the area indicated by the horn symbol on your steering wheel (see illustration). The horn will operate only when this area is pressed.

MIRRORS

Inside rearview mirror

Adjust the rearview mirror so that the center view through the rear window is seen. Make this adjustment before you start driving.

Do not place objects in the rear seat or cargo area which would interfere with your vision through the rear window.

⚠ WARNING - Mirror adjustment

Do not adjust the rearview mirror while the vehicle is moving. This could result in loss of control.

⚠ WARNING

Do not modify the inside mirror and don't install a wide mirror. It could result in injury, during an accident or deployment of the air bag.

Day/night rearview mirror (if equipped)

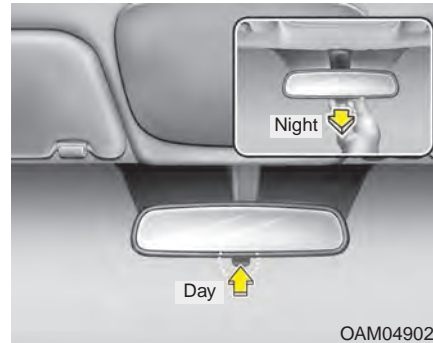

Make this adjustment before you start driving and while the day/night lever is in the day position.

Pull the day/night lever toward you to reduce the glare from the headlights of the vehicles behind you during night driving.

Remember that you lose some rearview clarity in the night position.

Electrochromic mirror with HomeLink system (if equipped)



To operate the electric rearview mirror

Press the I button (1) to turn the automatic-dimming function on. The mirror indicator light will illuminate.

Press the O button (2) to turn the automatic-dimming function off. The mirror indicator light will turn off.

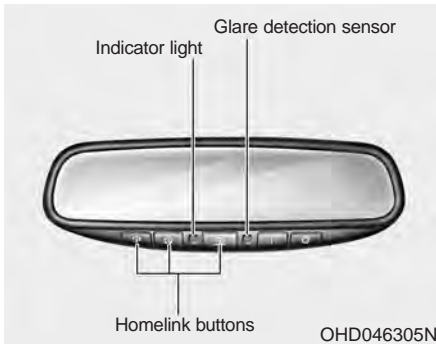

HomeLink® Wireless Control System

Your new mirror comes with an integrated HomeLink Universal Transceiver, which allows you to program the mirror to activate your garage door(s), estate gate, home lighting, etc. The mirror actually learns the codes from your various existing transmitters.

Retain the original transmitter for future programming procedures (i.e., new vehicle purchase). It is also suggested that upon the sale of the vehicle, the programmed HomeLink buttons be erased for security purposes (follow step 1 in the “Programming” portion of this text).

Programming

Your vehicle may require the ignition switch to be turned to the ACC position for programming and/or operation of HomeLink. It is also recommended that a new battery be replaced in the hand-held transmitter of the device being programmed to HomeLink for quicker training and accurate transmission of the radio-frequency.

Follow these steps to train your HomeLink mirror:



1. When programming the buttons for the first time, press and hold the left and center buttons (🏠, 🏠) simultaneously until the indicator light begins to flash after approximately 20 seconds. (This procedure erases the factory-set default codes. Do not perform this step when programming the additional HomeLink buttons.)

*** NOTICE**

For non rolling code garage door openers, follow steps 2 - 3.

For rolling code garage door openers, follow steps 2 - 6.

For Canadian Programming, please follow the Canadian Programming section.

For help with determining whether your garage door opener is non-rolling code or rolling code, please refer to the garage door openers owner's manual or contact HomeLink customer service at 1-800-355-3515.

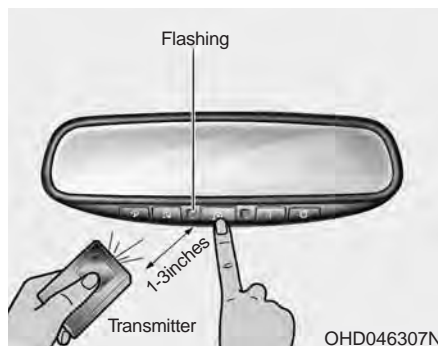

2. Press and hold the button on the HomeLink system you wish to train and the button on the transmitter while the transmitter is approximately 2-8 cm (1 to 3 inches) away from the mirror. Do not release the buttons until step 3 has been completed.
3. The HomeLink indicator light will flash, first slowly and then rapidly. When the indicator light flashes rapidly, both buttons may be released. (The rapid flashing light indicates successful programming of the new frequency signal.)

*** NOTICE**

Some gate and garage door openers may require you to replace step #3 with the “cycling” procedure noted in the “Canadian Programming” section of this document.

Rolling code programming

To train a garage door opener (or other rolling code equipped devices) with the rolling code feature, follow these instructions after completing the “Programming” portion of this text. (A second person may make the following training procedures quicker & easier.)

4. Locate the “learn” or “smart” button on the device’s motor head unit. Exact location and color of the button may vary by product brand. If there is difficulty locating the “learn” or “smart” button, reference the device’s owner’s manual or contact HomeLink at 1-800-355-3515 or on the internet at www.homelink.com.
5. Press and release the “learn” or “smart” button on the device’s motor head unit. You have 30 seconds to complete step number 6.

6. Return to the vehicle and firmly press and release the programmed HomeLink button up to three times. The rolling code equipped device should now recognize the HomeLink signal and activate when the HomeLink button is pressed. The remaining two buttons may now be programmed if this has not previously been done. Refer to the “Programming” portion of this text.

Operating HomeLink

To operate, simply press the programmed HomeLink button. Activation will now occur for the trained product (garage door, security system, entry door lock, estate gate, or home or office lighting). For convenience, the hand-held transmitter of the device may also be used at any time. The HomeLink Wireless Controls System (once programmed) or the original hand-held transmitter may be used to activate the device (e.g. garage door, entry door lock, etc.). In the event that there are still programming difficulties, contact HomeLink at 1-800-355-3515 or on the internet at www.homelink.com.

Erasing programmed HomeLink buttons

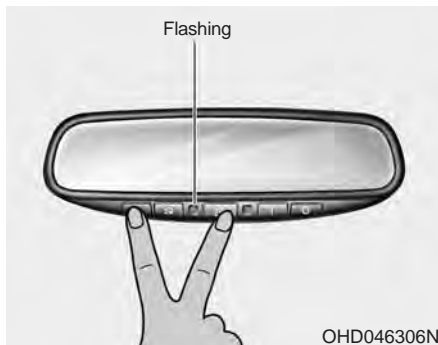

To erase the three programmed buttons (individual buttons cannot be erased):

- Press and hold the left and center buttons simultaneously, until the indicator light begins to flash (approximately 20 seconds). Release both buttons. Do not hold for longer than 30 seconds.

HomeLink is now in the train (or learning) mode and can be programmed at any time.

Reprogramming a single HomeLink button

To program a device to HomeLink using a HomeLink button previously trained, follow these steps:

1. Press and hold the desired HomeLink button. Do NOT release until step 4 has been completed.
2. When the indicator light begins to flash slowly (after 20 seconds), position the hand-held transmitter 2-8 cm (1 to 3 inches) away from the HomeLink surface.
3. Press and hold the hand-held transmitter button (or press and "cycle" - as described in "Canadian Programming").
4. The HomeLink indicator light will flash, first slowly and then rapidly. When the indicator light begins to flash rapidly, release both buttons.

The previous device has now been erased and the new device can be activated by pushing the HomeLink button that has just been programmed. This procedure will not affect any other programmed HomeLink buttons.

Canadian Programming Garage & gate openers

During programming, your hand-held transmitter may automatically stop transmitting. Continue to press and hold the HomeLink button (note steps 2 through 4 in the “Programming” portion of this text) while you press and re-press (“cycle”) your handheld transmitter every two seconds until the frequency signal has been learned. The indicator light will flash slowly and then rapidly after several seconds upon successful training.

Accessories

If you would like additional information on the HomeLink Wireless Control System, HomeLink compatible products, or to purchase other accessories such as the HomeLink® Lighting Package, please contact HomeLink at 1-800-355-3515 or on the internet at www.homelink.com.

**FCC ID: NZLZTVHL3
IC: 4112A-ZTVHL3**

This device complies with part 15 of the FCC Rules.

Operation is subject to the following two conditions:

1. This device may not cause harmful interference, and
2. This device must accept any interference received, including interference that may cause undesired operation.

The transceiver has been tested and complies with FCC and Industry Canada rules. Changes or modifications not expressly approved by the party responsible for compliance could void the user's authority to operate the device.

Conversation mirror

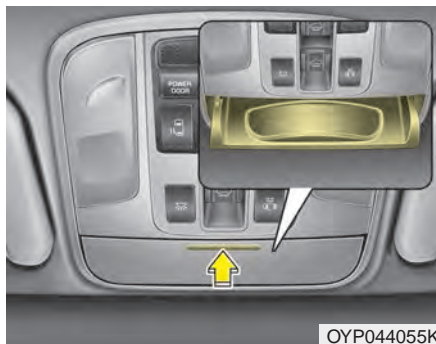

The mirror is a convenient feature to help the front passenger talk with rear passengers without turning the head or body rearward.

To use the mirror, push the cover and open it.

Close the cover after use.

Outside rearview mirror

Be sure to adjust the mirror angles before driving.

Your vehicle is equipped with both left-hand and right-hand outside rearview mirrors. The mirrors can be adjusted remotely with the remote switch. The mirror heads can be folded back to prevent damage during an automatic vehicle wash or when passing through a narrow street.

The right outside rearview mirror is convex. Objects seen in the mirror are closer than they appear.

Use your interior rearview mirror or direct observation to determine the actual distance of following vehicles when changing lanes.

CAUTION - Rearview mirror

Do not scrape ice off the mirror face; this may damage the surface of the glass. If ice should restrict the movement of the mirror, do not force the mirror for adjustment. To remove ice, use a deicer spray, or a sponge or soft cloth with very warm water.

If the mirror is jammed with ice, do not adjust the mirror by force. Use an approved spray de-icer (not radiator antifreeze) to release the frozen mechanism or move the vehicle to a warm place and allow the ice to melt.

⚠ WARNING - Mirror adjustment

Do not adjust or fold the outside rearview mirrors while the vehicle is moving. This could result in loss of control.

Adjusting outside rearview mirror



Adjusting the rearview mirrors:

Press either the L (driver's side) or R (passenger's side) button (1) to select the rearview mirror you would like to adjust when the ignition switch is ACC or ON position.

Use the mirror adjustment control (2) to position the selected mirror up, down, left or right.

After adjustment, press the L or R button (1) again to prevent inadvertent adjustment.

⚠ CAUTION - Outside mirror

- *The mirrors stop moving when they reach the maximum adjusting angles, but the motor continues to operate while the switch is pressed.*

Do not press the switch longer than necessary, the motor may be damaged.

- *Do not attempt to adjust the outside rearview mirror by hand. Doing so may damage the parts.*

Reverse parking aid function (if equipped)

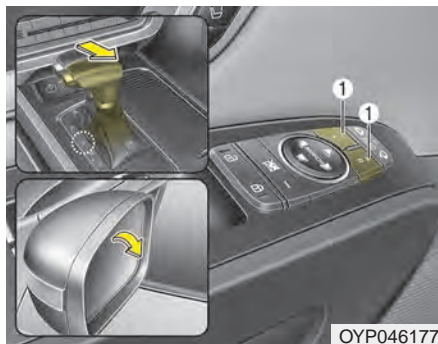

While the vehicle is moving rearward, the outside rearview mirror(s) will move downward to aid reverse parking. According to the position of the outside rearview mirror switch (1), the outside rearview mirror(s) will operate as follows:

L/R : When the remote control outside rearview mirror switch is selected to the L (left) or R (right) position, both outside rearview mirrors will move downward.

Neutral : When neither switch is selected, the outside rearview mirrors will not operate.

The outside rearview mirrors will automatically revert to their original positions under the following conditions:

1. The ignition switch is in the OFF position.
2. Shift lever is moved to any position except R (Reverse).
3. Remote control outside rearview mirror switch is placed in the middle.

Folding the outside rearview mirror



Electric type

The outside rearview mirror can be folded or unfolded by pressing the switch when the ignition switch is ACC or ON position as below.

Left (1) : The mirror will unfold.

Right (2) : The mirror will fold.

Center (AUTO, 3) :

The mirror will fold or unfold automatically as follows:

- The mirror will fold or unfold when the door is locked or unlocked by the folding key or smart key.
- The mirror will fold or unfold when the door is locked or unlocked by the button on the outside door handle.
- The mirror will unfold when you approach the vehicle (all doors closed and locked) with a smart key in possession.

**CAUTION - Electric type outside rearview mirror**

The electric type outside rearview mirror operates even though the engine start/stop button is in the OFF position. However, to prevent unnecessary battery discharge, do not adjust the mirrors longer than necessary while the engine is not running.

In case it is an electric type outside rearview mirror, don't fold it by hand. It could cause motor failure.

**Manual type**

To fold the outside rearview mirror, grasp the housing of the mirror and then fold it toward the rear of the vehicle.

Blind zone mirror (if equipped)

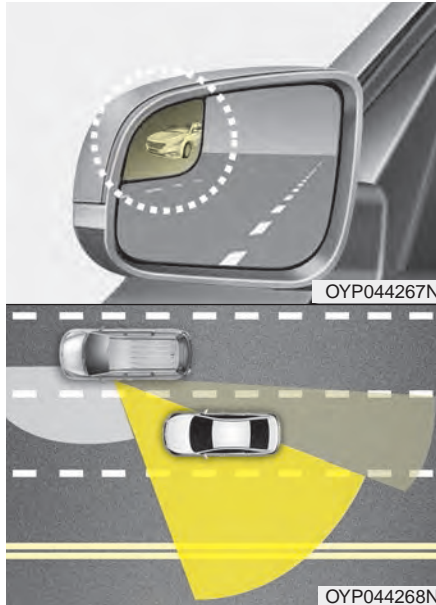

The Blind Zone Mirror (BZM) is a supplemental mirror that reduces the driver's blind zone by showing the rear side area of the vehicle. The blind zone mirror is equipped on the left-hand outside rearview mirror.

⚠ WARNING

- Always check the road condition while driving for unexpected situations even though the vehicle is equipped with a blind zone mirror.
- The blind zone mirror is a device made for convenience. Do not solely rely on the mirror but always pay attention to traffic around you.

⚠ CAUTION

Do not clean the mirror with harsh abrasives, fuel or other petroleum based cleaning products.

INSTRUMENT CLUSTER

■ Type A



1. Tachometer
2. Speedometer
3. Engine coolant temperature gauge
4. Fuel gauge
5. LCD display
6. Warning and indicator lights

■ Type B



- ※ The actual cluster in the vehicle may differ from the illustration.
For more details, refer to the "Gauges" in this chapter.

■ Type C



OYP046308N/OYP046101N/OYP046100N

Instrument Cluster Control

Adjusting Instrument Cluster Illumination

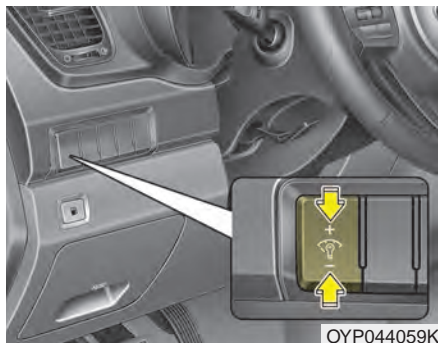

OYP044059K

The brightness of the instrument panel illumination is changed by pressing the illumination control button ("+" or "-") when the ignition switch or Engine Start/Stop button is ON, or the tale lights are turned on.



OYP044300N

OYP044157N

- If you hold the illumination control button ("+" or "-"), the brightness will be changed continuously.
- If the brightness reaches to the maximum or minimum level, an alarm will sound.

LCD Display Control

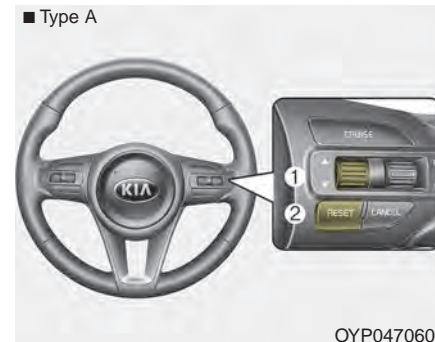

OYP047060N

The LCD display modes can be changed by using the control buttons on the steering wheel.

[Type A]

- (1) ▲ / ▼ : TRIP scroll switch for changing trip modes
- (2) RESET : RESET button for resetting items

■ Type B, C



OYP047060

[Type B, C]

- (1) : MODE button for changing modes
- (2) / / OK : SELECT scroll switch for setting the selected item and RESET scroll switch for resetting items
- (3) : RETURN button for move the previous mode or item (if equipped)

* For the LCD modes, refer to “LCD Display” in this chapter.

Gauges

Speedometer



OYP046102N

The speedometer indicates the speed of the vehicle and is calibrated in miles per hour (mph) and/or kilometers per hour (km/h).

Tachometer



OYP044103N

The tachometer indicates the approximate number of engine revolutions per minute (rpm).

Use the tachometer to select the correct shift points and to prevent lugging and/or over-revving the engine.

⚠ CAUTION - Red zone

Do not operate the engine within the tachometer's RED ZONE. This may cause severe engine damage.

Engine Coolant Temperature Gauge

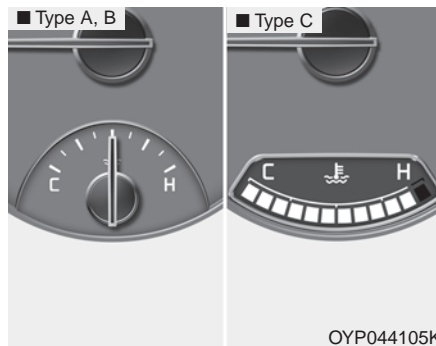

This gauge indicates the temperature of the engine coolant when the ignition switch or Engine Start/Stop button is ON.

If the gauge pointer moves beyond the normal range area toward the “H” position, it indicates overheating that may damage the engine.

Do not continue driving with an overheated engine. If your vehicle overheats, refer to “If the Engine Overheats” in chapter 6.

⚠ WARNING - Hot radiator

Never remove the radiator cap when the engine is hot. The engine coolant is under pressure and could severely burn. Wait until the engine is cool before adding coolant to the reservoir.

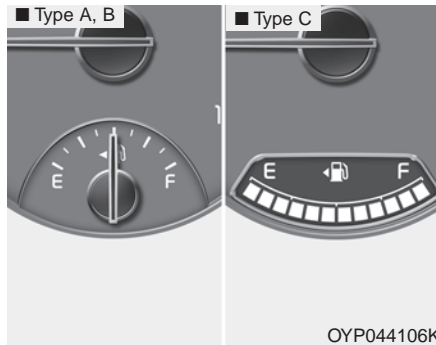
Fuel Gauge

This gauge indicates the approximate amount of fuel remaining in the fuel tank.

*** NOTICE**

- The fuel tank capacity is given in chapter 8.
- The fuel gauge is supplemented by a low fuel warning light, which will illuminate when the fuel tank is nearly empty.
- On inclines or curves, the fuel gauge pointer may fluctuate or the low fuel warning light may come on earlier than usual due to the movement of fuel in the tank.

⚠ WARNING - Fuel gauge
 Stop and obtain additional fuel as soon as possible after the warning light comes on or when the gauge indicator comes close to the E level. Running out of fuel can expose vehicle occupants to danger.

⚠ CAUTION - Low fuel
 Avoid driving with an extremely low fuel level. Running out of fuel could cause the engine to misfire damaging the catalytic converter.

*** NOTICE**

Fuel display may not be accurate if you are filling in sloping places.

Odometer

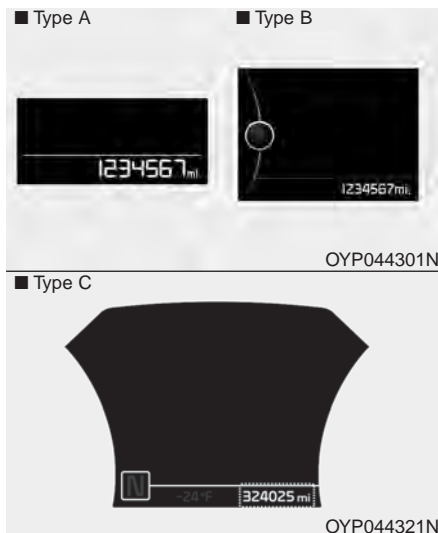

The odometer indicates the total distance that the vehicle has been driven and should be used to determine when periodic maintenance should be performed.

- Odometer range : 0 ~ 999999 miles or 0 ~ 159999 kilometers.

Outside Temperature Gauge

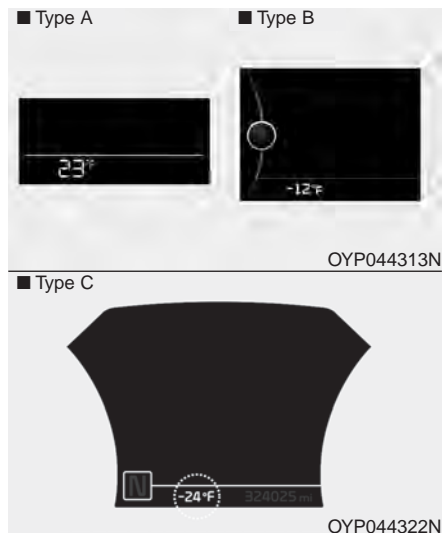

This gauge indicates the current outside air temperatures by 1°F (1°C).

- Temperature range : -40°F ~ 140°F (-40°C ~ 60°C)

The outside temperature on the display may not change immediately like a general thermometer to prevent the driver from being inattentive.

To change the temperature unit (from °C to °F or from °F to °C)

- Type A Cluster

Change the trip mode to RANGE mode with TRIP scroll switch and then press the RESET button more than 5 seconds

- Type B, C Cluster

The temperature unit can be changed by using the "User Settings" mode of the LCD display.

* For more details, refer to "LCD Display" in this chapter.

Transaxle Shift Indicator

Automatic Transaxle Shift Indicator

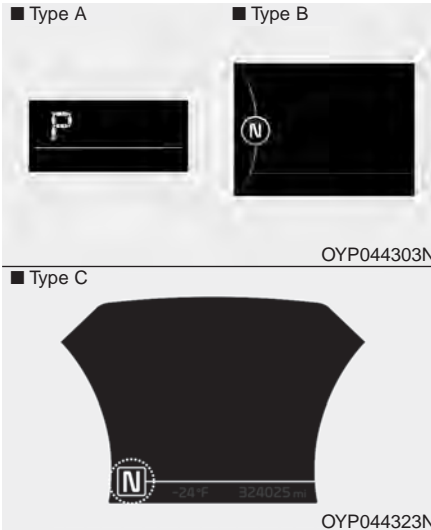









- Park : P
- Reverse : R
- Neutral : N
- Drive : D
- Sports Mode : 1, 2, 3, 4, 5, 6

This indicator displays which automatic transaxle shift lever is selected.

LCD DISPLAY (IF EQUIPPED)

LCD Modes (for type B/C cluster)

Modes	Symbol	Explanation
Trip Computer		This mode displays driving information like the tripmeter, fuel economy, and so on. For more details, refer to "Trip Computer" in this chapter.
Turn By Turn (if equipped)		This mode displays the state of the navigation.
SCC/LDWS (if equipped)		This mode displays the state of the Smart Cruise Control system (SCC) and Lane Departure Warning System (LDWS). For more details, refer to "Smart Cruise Control system (SCC)" or "Lane Departure Warning System (LDWS)" in chapter 5.
A/V (if equipped)		This mode displays the state of the A/V system.
Information		This mode informs of service interval (mileage or days).
		This mode informs of warning messages related to washer fluid or malfunction of Blind Spot Detection system (BSD) and so on.
		When the any door is not closed securely, this symbol illuminated. (for Type C cluster)
User Settings		On this mode, you can change settings of the doors, lamps and so on.

* For controlling the LCD modes, refer to "LCD Display Control" in this chapter.

Service Mode

Service Interval

■ Type A



OYP044304N

■ Type B, C

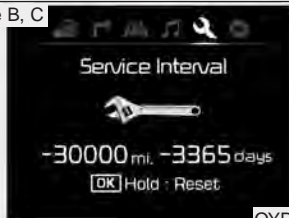

OYP044314N

Service in

It calculates and displays when you need a scheduled maintenance service (mileage or days).

If the remaining mileage or time reaches 900 mi. (1,500 km) or 30 days.

- For type A cluster

Service symbol (🔧) will blink and the chime will sound for several seconds each time you set the ignition switch or Engine Start/Stop Button to the ON position.

- For Type B and C cluster

Service interval message is displayed for several seconds each time you set the ignition switch or Engine Start/Stop Button to the ON position.

■ Type A



OYP044305N

■ Type B, C



OYP044119N

Service required

If you do not have your vehicle serviced according to the already inputted service interval.

- For type A cluster

Service symbol (🔧) will blink and the chime will sound for several seconds each time

you set the ignition switch or Engine Start/Stop Button to the ON position.

- For Type B and C cluster

“Service required” message is displayed for several seconds each time you set the ignition switch or Engine Start/Stop Button to the ON position.

To reset the service interval to the mileage and days you inputted before:

- For Type A cluster

Consult your authorized Kia dealer.

- For Type B and C cluster

Press the RESET button (OK) for more than 1 second.



Service interval OFF

If the service interval is not set

- For type A cluster

Service symbol (🔧) will not blink and the chime will not sound each time you set the ignition switch or Engine Start/Stop Button to the ON position.

If you want to activate Service interval function, consult your authorized Kia dealer.

- For Type B and C cluster

"Service interval OFF" message is displayed on the LCD display.

If you want to activate Service interval function, set the service interval in the User setting mode.

For more details, refer to "User setting mode" in this chapter.

* NOTICE

If any of the following conditions occurs, the mileage and days may be incorrect.

- The battery cable is disconnected.
- The fuse switch is turned off.
- The battery is discharged.

Master Warning Mode

- This warning light informs the driver the following situations
 - Low washer fluid (if equipped)
 - Blind Spot Detection (BSD) malfunction (if equipped)
 - Lane Departure warning system (LDWS) malfunction (if equipped)
 - Smart cruise control system (SCC) malfunction (if equipped)
 - Service reminder (if equipped)

The Master Warning Light illuminates when more than one of the above warning situations occur. At this time, the LCD Modes Icon will change from (🚗) to (⚠️).

If the warning situation is solved, the master warning light will be turned off and the LCD Modes Icon will be changed back to its previous icon (🚗). (ex : refill the washer fluid)

User Settings Mode (for type B/C cluster)**Description**

On this mode, you can change setting of the doors, lights, and so on.

⚠️ WARNING

Do not adjust the User Setting while driving. You may lose your steering control and cause severe personal injury or accidents.

Driving Assist**Smart Cruise Control Response (if equipped)**

Choose the sensitivity of the smart cruise control.

Autonomous Emergency Braking (if equipped)

If this item is checked, Autonomous Emergency Braking function will be activated.

Rear Cross Traffic Alert (if equipped)

If this item is checked, rear cross traffic alert function will be activated.

Door / Liftgate (Tailgate)

Automatically unlock

- **Disable:**
The auto door unlock operation will be canceled.
- **On Key out:**
All doors will be automatically unlocked when the ignition key is removed from ignition switch or Engine Start/Stop Button is set to the OFF position.
- **On shift to P:**
All doors will be automatically unlocked if the automatic transaxle shift lever is shifted to the P (Park) position.

Two Press Unlock

- **Off:**
The two press unlock function will be deactivated. Therefore, all doors will unlock if the door is unlocked.
- **On:**
The driver's door will unlock if the door is unlocked. When the door is unlocked again within 4 seconds, all doors will unlock.

Horn Feedback

- **Off:**
The Horn feedback operation will be deactivated.
- **On:**
After locking the door by pressing the lock button on the transmitter, if you press the lock button again within 4 seconds, the warning sound will operate once to indicate that all doors are locked.

Smart liftgate (tailgate) (if equipped)

If this item is checked, the smart liftgate (tailgate) function will be activated.

Lights

One touch turn signal

If this item is checked, the lane change signals will blink 3, 5 or 7 times when the turn signal lever is moved slightly.

Head Lamp Delay (if equipped)

If this item is checked, the headlamp delay function will be activated.

Welcome Light (if equipped)

If this item is checked, the welcome light function of the pocket lamp will be activated.

Sound

Park assist system vol. (if equipped)

Adjust the Park Assist System volume. (Level 1~3).

Blind spot detection Sound (if equipped)

If this item is checked, the blind spot detection sound function will be activated.

Welcome sound (if equipped)

If this item is checked, the welcome sound function will be activated.

Seat / Steering

Seat easy access (if equipped)

If this item is checked, the driver's seat will automatically move forward or rearward for the driver to enter or exit the vehicle comfortably.

Steering Position

If this item is checked, the warning function regarding the steering wheel alignment will be activated.

Service interval

On this mode, you can activate the service interval function with mileage (mi. or km) and period (months).

- Off : The service interval function will be deactivated.
- On : You can set the service interval (mileage and months).

Other features

Fuel economy auto reset

- Off :

The average fuel economy will not reset automatically whenever refueling.

- On (Auto Reset) :

The average fuel economy will reset automatically when refueling.

For more details, refer to "Trip A/B" in this chapter.

Auto rear wiper (reverse)

If this item is checked, the rear wiper will automatically activated when the front wiper is in ON position and shift lever is in R (reverse) position.

Fuel Economy Unit

Choose the fuel economy unit. (US gallon, UK gallon)

Temperature Unit

Convert the temperature unit from °C to °F or from °F to °C.

Language

Choose the language you prefer within the LCD.

Turn By Turn Mode (if equipped)



This mode displays the state of the navigation.

SCC/LDWS Mode (if equipped)



This mode displays the state of the Smart Cruise Control (SCC) and Lane Departure Warning System (LDWS).

For more information, refer to "Smart Cruise Control (SCC)" and "Lane Departure Warning System (LDWS)" in chapter 5.

A/V Mode (if equipped)



This mode displays the state of the A/V system.

Warning Messages (for Type B and C cluster)

*Shift to P position
(for smart key system)*



- This warning message illuminates if you try to turn off the engine without the shift lever in P (Park) position.
- At this time, the Engine Start/Stop Button turns to the ACC position (If you press the Engine Start/Stop Button once more, it will turn to the ON position).

Low Key Battery (for smart key system)



- This warning message illuminates if the battery of the smart key is discharged when the Engine Start/Stop Button changes to the OFF position.

Press start button while turn steering (for smart key system)



- This warning message illuminates if the steering wheel does not unlock normally when the Engine Start/Stop Button is pressed.
- It means that you should press the Engine Start/Stop Button while turning the steering wheel right and left.

**Press brake pedal to start engine
(for smart key system)**



- This warning message illuminates if the Engine Start/Stop Button changes to the ACC position twice by pressing the button repeatedly without depressing the brake pedal.
- It means that you should depress the brake pedal to start the engine.

**Key not in vehicle
(for smart key system)**



- This warning message illuminates if the smart key is not in the vehicle when you press the Engine Start/Stop Button.
- It means that you should always have the smart key with you.

**Key not detected
(for smart key system)**



- This warning message illuminates if the smart key is not detected when you press the Engine Start/Stop Button.

Press start button again (for smart key system)



- This warning message illuminates if you can not operate the Engine Start/Stop Button when there is a problem with the Engine Start/Stop Button system.
- It means that you could start the engine by pressing the Engine Start/ Stop Button once more.
- If the warning illuminates each time you press the Engine Start/Stop Button, have your vehicle inspected by an authorized Kia dealer.

Press start button with key (for smart key system)



- This warning message illuminates if you press the Engine Start/Stop Button while the warning message "Key not detected" is illuminating.
- At this time, the immobilizer indicator light blinks.

Check fuse BRAKE SWITCH (for smart key system)



- This warning message illuminates if the brake switch fuse is disconnected.
- It means that you should replace the fuse with a new one. If that is not possible, you can start the engine by pressing the Engine Start/Stop Button for 10 seconds in the ACC position.

**Shift to P or N to start engine
(for smart key system)**



- This warning message illuminates if you try to start the engine with the shift lever not in the P (Park) or N (Neutral) position.

**Door / Hood / Liftgate (Tailgate)
Open**



- It means that any door, hood, or liftgate (tailgate) is open.

Sunroof Open (if equipped)



- The warning message illuminates if you turn off the engine and then open the driver's door when the sunroof is open.

*** NOTICE**

You can start the engine with the shift lever in the N (Neutral) position. But, for your safety, we recommend that you start the engine with the shift lever in the P (Park) position.

Align steering wheel (if equipped)



OYP044141N

- This warning message illuminates if you start the engine when the steering wheel is turned to more than 90 degrees to the left or right.
- It means that you should turn the steering wheel and make the angle of the steering wheel be less than 30 degrees.

Low Washer Fluid (if equipped)



OYP044139N

- This warning message illuminates on the service reminder mode if the washer fluid level in the reservoir is nearly empty.
- It means that you should refill the washer fluid.

Turn on FUSE SWITCH (if equipped)

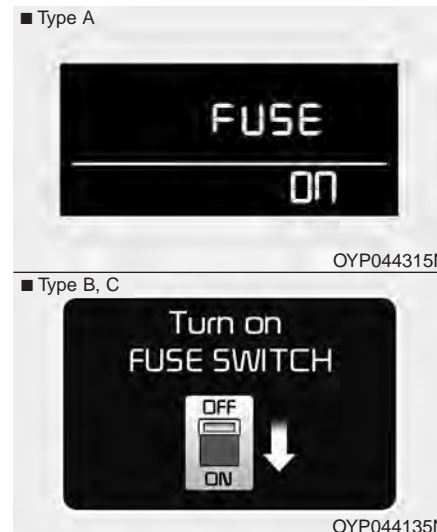

■ Type A



OYP044315N

■ Type B, C



OYP044135N

- This warning message illuminates if the fuse switch on the fuse box is OFF.
- It means that you should turn the fuse switch on.

For more details, refer to “Fuses” in chapter 7.

Low Fuel



This warning message illuminates if the fuel tank is nearly empty.

- When the low fuel level warning light is illuminates.
- When the trip computer displays "--- mile (or km)" as range.

Add fuel as soon as possible.

Check high beam assist system (if equipped)



This warning message illuminates if there is a malfunction (burned-out bulb or circuit malfunction) with the headlamp. In this case, have your vehicle inspected by an authorized Kia dealer.

Check AEB system (if equipped)



- This warning message illuminates if there is a malfunction with the Autonomous Emergency Braking (AEB) system. In this case, have your vehicle be inspected by an authorized Kia dealer.

For more details, refer to "Autonomous Emergency Braking (AEB) system" in chapter 5.

TRIP COMPUTER

Overview

Description

The trip computer is a microcomputer-controlled driver information system that displays information related to driving.

* NOTICE

Some driving information stored in the trip computer (for example Average Vehicle Speed) resets if the battery is disconnected.

Trip Modes (for Type A cluster)

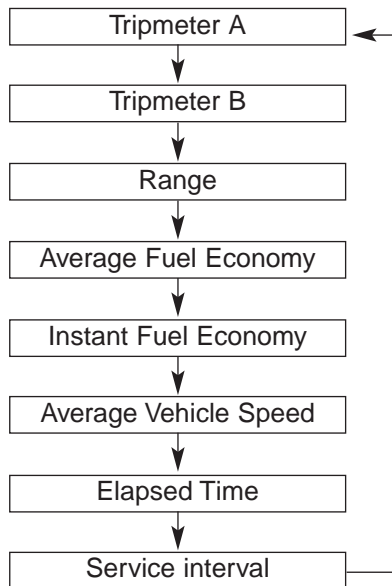

To change the trip mode, scroll the TRIP scroll switch (▲/▼).

Trip Modes (for Type B and C cluster)

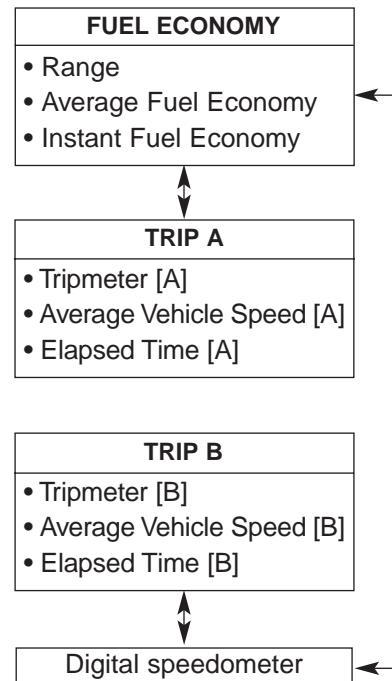

To change the trip mode, scroll the TRIP scroll switch (▲/▼/OK) in the trip computer mode.

Trip A/B

■ Type A



OYP044306N

■ Type B, C



OYP044147N

Tripmeter (1)

- The tripmeter is the total driving distance since the last tripmeter reset.
 - Distance range: 0.0 ~ 9999.9 mi. or km

To reset the tripmeter,

- Type A cluster
Press the RESET button
- Type B and C cluster

Press the SELECT scroll switch (OK) on the steering wheel for more than 1 second when the tripmeter is displayed.

Average Vehicle Speed (2)

- The average vehicle speed is calculated by the total driving distance and driving time since the last average vehicle speed reset.

- Speed range: 0 ~ 999 MPH or km/h

To reset the average vehicle speed,

- Type A cluster
Press the RESET button
- Type B and C cluster

Press the SELECT scroll switch (OK) on the steering wheel for more than 1 second when the average vehicle speed is displayed.

* NOTICE

- The average vehicle speed is not displayed if the driving distance is less than 0.03 miles (50 meters) or the driving time is less than 10 seconds since the ignition switch or Engine Start/Stop button is turned to ON.
- Even if the vehicle is not in motion, the average vehicle speed keeps going while the engine is running.

Elapsed Time (3)

- The elapsed time is the total driving time since the last elapsed time reset.

- Time range (hh:mm): 00:00 ~ 99:59

To reset elapsed time,

- Type A cluster

Press the RESET button

- Type B and C cluster

Press the SELECT scroll switch (OK) on the steering wheel for more than 1 second when the elapsed time is displayed.

* NOTICE

Even if the vehicle is not in motion, the elapsed time keeps going while the engine is running.

Fuel Economy

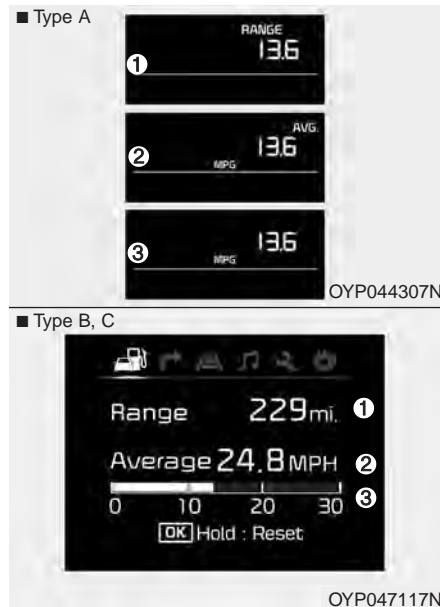

Range (1)

- The range is the estimated distance the vehicle can be driven with the remaining fuel.

- Distance range : 1 ~ 9,999 mi or
1 ~ 9,999 km.

- If the estimated distance is below 1mi. (1km), the trip computer will display "---" as range.
- If the vehicle is not on level ground or the battery power has been interrupted, the range function may not operate correctly.
- The range may differ from the actual driving distance as it is an estimate of the available driving distance.
- The trip computer may not register additional fuel if less than 6 liters (1.6 gallons) of fuel are added to the vehicle.
- The fuel economy and range may vary significantly based on driving conditions, driving habits, and condition of the vehicle.

Average Fuel Economy (2)

- The average fuel economy is calculated by the total driving distance and fuel consumption since the last average fuel economy reset.
 - Fuel economy range: 0.0 ~ 99.9 MPG or L/100km
- The average fuel economy can be reset both manually and automatically.

Manual reset

To reset average fuel economy manually,

- Type A cluster
Press the RESET button
- Type B and C cluster
Press the SELECT scroll switch (OK) on the steering wheel for more than 1 second when the average fuel economy is displayed.

Automatic reset

To make the average fuel economy be reset automatically whenever refueling, select the "Auto Reset" mode in User Setting menu of the LCD display (Refer to "LCD Display").

Under "Auto Reset" mode, the average fuel economy will be cleared to zero (---) when the vehicle speed exceeds 1 km/h after refueling more than 1.6 gallons (6 liters).

*** NOTICE**

The average fuel economy is not displayed for more accurate calculation if the vehicle does not drive more than 10 seconds or 0.03 miles (50 meters) since the ignition switch or Engine Start/Stop button is turned to ON.

Instant Fuel Economy (3)

- This mode displays the instant fuel economy during the last few seconds when the vehicle speed is more than 6.2 MPH (10 km/h).
 - Fuel economy range: 0 ~ 50 MPG or 0 ~ 30 L/100km

Digital speedometer

■ Type B, C



This mode displays the current speed of the vehicle.

One time driving information mode

■ Type B, C



This display shows trip distance (1), average fuel economy (2) and the vehicle can be driven with the remaining fuel (3).

This information is displayed for a few seconds when you turn off the engine and then goes off automatically. The information provided is calculated according to each trip.

If the estimated distance is below 1mi. (1km), the range (3) will display as "----" and a refuel message will appear (4).

WARNING AND INDICATOR LIGHTS

Warning lights

* NOTICE - Warning lights

Make sure that all warning lights are OFF after starting the engine. If any light is still ON, this indicates a situation that needs attention.

Air bag Warning Light



This warning light illuminates:

- Once you set the ignition switch or Engine Start/Stop Button to the ON position.
 - It illuminates for approximately 6 seconds and then goes off.
- When there is a malfunction with the SRS.

In this case, have your vehicle inspected by an authorized Kia dealer.

Seat Belt Warning Light



This warning light informs the driver that the seat belt is not fastened.

For more details, refer to the “Seat Belts” in chapter 3.

Parking Brake & Brake Fluid Warning Light



This warning light illuminates :

- Once you set the ignition switch or Engine Start/Stop Button to the ON position.
 - It illuminates for approximately 3 seconds.
 - It remains on if the parking brake is applied.
- When the parking brake is applied.
- When the brake fluid level in the reservoir is low.
 - If the warning light illuminates with the parking brake released, it indicates the brake fluid level in reservoir is low.

If the brake fluid level in the reservoir is low:

1. Drive carefully to the nearest safe location and stop your vehicle.
2. With the engine stopped, check the brake fluid level immediately and add fluid as required (For more details, refer to “Brake Fluid” in chapter 7).

Then check all brake components for fluid leaks. If any leaks in the brake system is still found, the warning light remains on, or the brakes do not operate properly, do not drive the vehicle.

In this case, have your vehicle towed to an authorized Kia dealer and inspected.

Dual-diagonal braking system

Your vehicle is equipped with dual-diagonal braking systems. This means you still have braking on two wheels even if one of the dual systems should fail.

With only one of the dual systems working, more than normal pedal travel and greater pedal pressure are required to stop the vehicle.

Also, the vehicle will not stop in as short a distance with only a portion of the brake system working.

If the brakes fail while you are driving, shift to a lower gear for additional engine braking and stop the vehicle as soon as it is safe to do so.

⚠ WARNING - Parking Brake & Brake Fluid Warning Light

Driving the vehicle with a warning light ON is dangerous. If the Parking Brake & Brake Fluid Warning Light illuminates with the parking brake released, it indicates that the brake fluid level is low.

In this case, have your vehicle inspected by an authorized Kia dealer.

Anti-lock Brake System (ABS) Warning Light



This warning light illuminates:

- Once you set the ignition switch or Engine Start/Stop Button to the ON position.
 - It illuminates for approximately 3 seconds and then goes off.
- When there is a malfunction with the ABS (The normal braking system will still be operational without the assistance of the anti-lock brake system).

In this case, have your vehicle inspected by an authorized Kia dealer.

Electronic Brake force Distribution (EBD) System Warning Light



These two warning lights illuminate at the same time while driving:

- When the ABS and regular brake system may not work normally. In this case, have your vehicle inspected by an authorized Kia dealer.

⚠ WARNING - Electronic Brake force Distribution (EBD) System Warning Light

When both ABS and Parking Brake & Brake Fluid Warning Lights are on, the brake system will not work normally and you may experience an unexpected and dangerous situation during sudden braking.

In this case, avoid high speed driving and abrupt braking.

Have your vehicle inspected by an authorized Kia dealer as soon as possible.

*** NOTICE - Electronic Brake force Distribution (EBD) System Warning Light**

When the ABS Warning Light is on or both ABS and Parking Brake & Brake Fluid Warning Lights are on, the speedometer, odometer, or trip-meter may not work. Also, the EPS Warning Light may illuminate and the steering effort may increase or decrease.

In this case, have your vehicle inspected by an authorized Kia dealer as soon as possible.

Electronic Power Steering (EPS) Warning Light (if equipped)



This warning light illuminates:

- Once you set the ignition switch or Engine Start/Stop Button to the ON position.
 - It remains on until the engine is started.
- When there is a malfunction with the EPS.

In this case, have your vehicle inspected by an authorized Kia dealer.

Malfunction Indicator Lamp (MIL)



This warning light illuminates:

- Once you set the ignition switch or Engine Start/Stop Button to the ON position.
 - It remains on until the engine is started.
- When there is a malfunction with the emission control system.

In this case, have your vehicle inspected by an authorized Kia dealer.



CAUTION - Malfunction Indicator Lamp (MIL)

Driving with the Malfunction Indicator Lamp (MIL) on may cause damage to the emission control systems which could affect drivability and/or fuel economy.



CAUTION - Catalytic converter

If the Malfunction Indicator Lamp (MIL) illuminates, potential catalytic converter damage is possible which could result in loss of engine power.

In this case, have your vehicle inspected by an authorized Kia dealer as soon as possible.

Charging System Warning Light



This warning light illuminates:

- Once you set the ignition switch or Engine Start/Stop Button to the ON position.
 - It remains on until the engine is started.
- When there is a malfunction with either the alternator or electrical charging system.

If there is a malfunction with either the alternator or electrical charging system:

1. Drive carefully to the nearest safe location and stop your vehicle.
2. Turn the engine off and check the alternator drive belt for looseness or breakage.

If the belt is adjusted properly, there may be a problem in the electrical charging system.

In this case, have your vehicle inspected by an authorized Kia dealer as soon as possible.

Engine Oil Pressure Warning Light



This warning light illuminates:

- Once you set the ignition switch or Engine Start/Stop Button to the ON position.
 - It remains on until the engine is started.
- When the engine oil pressure is low.

If the engine oil pressure is low:

1. Drive carefully to the nearest safe location and stop your vehicle.
2. Turn the engine off and check the engine oil level (For more details, refer to “Engine Oil” in section 7). If the level is low, add oil as required.

If the warning light remains on after adding oil or if oil is not available, have your vehicle inspected by an authorized Kia dealer as soon as possible.

 **CAUTION - Engine damage**

If the engine is not stopped immediately after the engine oil pressure warning light is illuminated and stays on while the engine is running, serious engine damage may result.

Low Tire Pressure Warning Light



This warning light illuminates:

- Once you set the ignition switch or Engine Start/Stop Button to the ON position.
 - It illuminates for approximately 3 seconds and then goes off.
- When one or more of your tires are significantly underinflated.

For more details, refer to “Tire Pressure Monitoring System (TPMS)” in chapter 6.

This warning light remains on after blinking for approximately 60 seconds or repeats blinking and off at the intervals of approximately 3 seconds:

- When there is a malfunction with the TPMS.

In this case, have your vehicle inspected by an authorized Kia dealer as soon as possible.

For more details, refer to “Tire Pressure Monitoring System (TPMS)” in chapter 6.

⚠ WARNING - Low tire pressure

Do not drive on low pressure tires. Significantly low tire pressure can cause the tires to overheat and fail making the vehicle unstable resulting in increased braking distances and a loss of vehicle control.

- The TPMS cannot alert you to severe and sudden tire damage caused by external factors.
- If you notice any vehicle instability, immediately take your foot off the accelerator pedal, apply the brakes gradually with light force, and slowly move to a safe position off the road.

Low Fuel Level Warning Light



This warning light illuminates:
When the fuel tank is nearly empty.

If the fuel tank is nearly empty:
Add fuel as soon as possible.

⚠ CAUTION - Low Fuel Level

Driving with the Low Fuel Level warning light on or with the fuel level below “0 or E” can cause the engine to misfire and damage the catalytic converter (if equipped).

Door Ajar Warning Light (if equipped)



This warning light illuminates:
When a door is not closed securely.

Liftgate (Tailgate) Open Warning Light (if equipped)



This warning light illuminates:
When the liftgate (tailgate) is not closed securely.

Sunroof Open Warning Light (if equipped)



This warning light illuminates:
When the sunroof is not closed securely.

Autonomous Emergency Braking (AEB) Warning light (if equipped)



This warning light illuminates :

- When the AEB system is turned off.
- When the radar sensor or cover is blocked with dirt or snow. Check the sensor and cover and clean them by using a soft cloth.
- When there is a malfunction with AEB.
In this case, have your vehicle inspected by an authorized Kia dealer.

Master Warning light (if equipped)



- This warning light informs the driver of the following situations
 - Low washer fluid (if equipped)
 - Blind Spot Detection (BSD) malfunction (if equipped)
 - Lane Departure warning system (LDWS) malfunction (if equipped)
 - Smart cruise control system (SCC) malfunction (if equipped)
 - High beam assist system (HBA) malfunction (if equipped)
 - Service required

The Master Warning Light illuminates when more than one of the above warning situations occur. At this time, the LCD Modes Icon will change from (👉) to (⚠️).

If the warning situation is solved, the master warning light will be turned off and the LCD Modes Icon will be changed back to its previous icon (👉). (ex : refill the washer fluid)

Washer Fluid Warning Light (if equipped)



This warning light illuminates:

- When the washer fluid level in the reservoir is nearly empty.
In this case, you should refill the washer fluid.

Indicator Lights

Electronic Stability Control (ESC) Indicator Light



This indicator light illuminates:

- Once you set the ignition switch or Engine Start/Stop Button to the ON position.
 - It illuminates for approximately 3 seconds and then goes off.
- When there is a malfunction with the ESC system.
In this case, have your vehicle inspected by an authorized Kia dealer.

This indicator light blinks:

While the ESC is operating.

For more details, refer to “Electronic Stability Control (ESC)” in chapter 5.

Electronic Stability Control (ESC) OFF Indicator Light



This indicator light illuminates:

- Once you set the ignition switch or Engine Start/Stop Button to the ON position.
 - It illuminates for approximately 3 seconds and then goes off.
- When you deactivate the ESC system by pressing the ESC OFF button.

For more details, refer to “Electronic Stability Control (ESC)” in chapter 5.

ECO Mode indicator Light



Active ECO system

This indicator light illuminates:

When the Active ECO button is pressed the ECO Mode indicator (green) will illuminate to show that the Active ECO is operating.

For more detailed information, refer to "Active ECO" or "Drive mode" in chapter 5.

COMFORT Mode Indicator Light (if equipped)

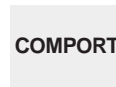

This indicator light illuminates:

- When you select “COMFORT” mode as drive mode.
- * For more details, refer to “Drive Mode” in chapter 5.

Immobilizer Indicator Light (Without Smart Key) (if equipped)



This indicator light illuminates:

- When the vehicle detects the immobilizer in your key properly while the ignition switch is ON.
 - At this time, you can start the engine.
 - The indicator light goes off after starting the engine.

This indicator light blinks:

- When there is a malfunction with the immobilizer system.
In this case, have your vehicle inspected by an authorized Kia dealer.

Immobilizer Indicator Light (With Smart Key) (if equipped)



This indicator light illuminates for up to 30 seconds:

- When the vehicle detects the smart key in the vehicle properly while the Engine Start/Stop Button is ACC or ON.
 - At this time, you can start the engine.
 - The indicator light goes off after starting the engine.

This indicator light blinks for a few seconds:

- When the smart key is not in the vehicle.
 - At this time, you can not start the engine.

This indicator light illuminates for 2 seconds and goes off:

- When the vehicle can not detect the smart key which is in the vehicle while the Engine Start/Stop Button is ON.
In this case, have your vehicle inspected by an authorized Kia dealer.

This indicator light blinks:

- When the battery of the smart key is weak.
 - At this time, you can not start the engine. However, you can start the engine if you press the Engine Start/Stop Button with the smart key. (For more details, refer to “Starting the Engine” in section 5).
- When there is a malfunction with the immobilizer system.

In this case, have your vehicle inspected by an authorized Kia dealer.

Turn Signal Indicator Light



This indicator light blinks:

- When you turn the turn signal light on.

If any of the following occurs, there may be a malfunction with the turn signal system. In this case, have your vehicle inspected by an authorized Kia dealer.

- The indicator light does not blink but illuminates.
- The indicator light blinks more rapidly.
- The indicator light does not illuminate at all.

High Beam Indicator Light



This indicator light illuminates:

- When the headlights are on and in the high beam position
- When the turn signal lever is pulled into the Flash-to-Pass position.

**High beam assist
Indicator Light
(if equipped)**



This indicator light illuminates :

- When the high-Beam is on with the light switch in the AUTO light position.
- If your vehicle detects oncoming or preceding vehicles, the High beam assist system will switch the high beam to low beam automatically.

For more details, refer to "High beam assist" in this chapter.

Light ON Indicator Light



This indicator light illuminates:

- When the tail lights or headlights are on.

**Front Fog Indicator
Light (if equipped)**



This indicator light illuminates:

- When the front fog lights are on.

**Cruise Indicator Light
(if equipped)**

CRUISE

This indicator light illuminates:

- When the cruise control system is enabled.

For more details, refer to "Cruise Control System" in chapter 5.

**Cruise SET Indicator
Light (if equipped)**

SET

This indicator light illuminates:

- When the cruise control speed is set.

For more details, refer to "Cruise Control System" in chapter 5.

KEY OUT Indicator Light (if equipped)

KEY OUT

When the ENGINE START/STOP button is in the ACC or ON position, if any door is open, the system checks for the smart key. If the smart key is not in the vehicle, the indicator will blink, and if all doors are closed, the chime will also sound for about 5 seconds. The indicator will go off while the vehicle is moving.

Adaptive Front Lighting System (AFLS) Warning Light (if equipped)

AFLS

This warning light blinks:

- Once you set the Engine Start/Stop Button to the ON position.
 - It illuminates for approximately 3 seconds and then goes off.
- When there is a malfunction with the AFLS.

If there is a malfunction with the AFLS:

1. Drive carefully to the nearest safe location and stop your vehicle.
2. Turn the engine off and restart the engine. If the warning light remains on, have your vehicle inspected by an authorized Kia dealer.

Icy Road Warning Light (if equipped)



This warning light is to warn the driver the road may be icy.

When the following conditions occur, the warning light (including Outside Temperature Gauge) blinks 5 times and then illuminates, and also warning chime sounds once.

- The temperature on the Outside Temperature Gauge is below approximately 40°F (4°C).

*** NOTICE**

If the icy road warning light appears while driving, you should drive more attentively and safely refrain from over-speeding, rapid acceleration, sudden braking or sharp turning, etc.

REAR PARKING ASSIST SYSTEM (IF EQUIPPED)



The rear parking assist system assists the driver during backward movement of the vehicle by chiming if any object is sensed within a distance of 47 in. (120 cm) behind the vehicle.

This system is a supplemental system and it is not intended to nor does it replace the need for extreme care and attention of the driver. The sensing range and objects detectable by the back sensors are limited. Whenever backing-up, pay as much attention to what is behind you as you would in a vehicle without a rear parking assist system.

⚠ WARNING - Rear parking assist system

Never rely solely on the rear parking assist system. Always perform a visual inspection to make sure the vehicle is clear of all obstructions before moving the vehicle in any direction. Stop immediately if you are aware of a child anywhere near your vehicle. Some objects may not be detected by the sensors, due to the object's size or material.

Operation of the rear parking assist system

Operating condition

- This system will activate when the indicator on the rear parking assist OFF button is not illuminated. If you desire to deactivate the rear parking assist system, press the rear parking assist OFF button again. (The indicator on the button will illuminate.) To turn the system on, press the button again. (The indicator on the button will go off.) If the vehicle is moving at a speed over 3 mph (5 km/h), the system may not be activated correctly.

- This system will activate when backing up with the ignition switch ON.

If the vehicle is moving at a speed over 3 mph (5 km/h), the system may not be activated correctly.

- The sensing distance while the back-up warning system is in operation is approximately 47 in. (120 cm) at the rear bumper center area, 23.5 in. (60 cm) at the rear bumper both side area.
- When more than two objects are sensed at the same time, the closest one will be recognized first.

Types of warning sound

- When an object is 47 in. to 24 in. (120 cm to 61 cm) from the rear bumper: Buzzer beeps intermittently.
- When an object is 24 in. to 12 in. (60 cm to 31 cm) from the rear bumper: Buzzer beeps more frequently.
- When an object is within 12 in. (30 cm) of the rear bumper: Buzzer sounds continuously.

Non-operational conditions of rear parking assist system

The rear parking assist system may not operate properly when:

1. Moisture is frozen to the sensor. (It will operate normally when the moisture has been cleared.)
2. The sensor is covered with foreign matter, such as snow or water, or the sensor cover is blocked. (It will operate normally when the material is removed or the sensor is no longer blocked.)
3. Driving on uneven road surfaces (unpaved roads, gravel, bumps, gradient).
4. Objects generating excessive noise (vehicle horns, loud motorcycle engines, or truck air brakes) are within range of the sensor.
5. Heavy rain or water spray exists.
6. Wireless transmitters or mobile phones are within range of the sensor.
7. The sensor is covered with snow.
8. Trailer towing

The detecting range may decrease when:

1. The sensor is stained with foreign matter such as snow or water. (The sensing range will return to normal when removed.)
2. Outside air temperature is extremely hot or cold.

The following objects may not be recognized by the sensor:

1. Sharp or slim objects such as ropes, chains or small poles.
2. Objects which tend to absorb the sensor frequency such as clothes, spongy material or snow.
3. Undetectable objects smaller than 40 in. (1 m) in height and narrower than 6 in. (14 cm) in diameter.

Rear parking assist system precautions

- The rear parking assist system may not sound consistently depending on the speed and shapes of the objects detected.
- The rear parking assist system may malfunction if the vehicle bumper height or sensor installation has been modified or damaged. Any non-factory installed equipment or accessories may also interfere with the sensor performance.
- The sensor may not recognize objects less than 15 in. (40 cm) from the sensor, or it may sense an incorrect distance. Use caution.
- When the sensor is frozen or SOILED with snow, dirt, or water, the sensor may be inoperative until the MATERIAL IS removed using a soft cloth.
- Do not push, scratch or strike the sensor. Sensor damage could occur.

*** NOTICE**

This system can only sense objects within the range and location of the sensors. It cannot detect objects in other areas where sensors are not installed. Also, small or slim objects, such as poles or objects located between sensors may not be detected by the sensors.

Always visually check behind the vehicle when backing up.

Be sure to inform any drivers of the vehicle that may be unfamiliar with the system regarding the systems capabilities and limitations.

Self-diagnosis

If you don't hear an audible warning sound or if the buzzer sounds intermittently when shifting the gear to the R (Reverse) position, this may indicate a malfunction in the rear parking assist system. If this occurs, have your vehicle checked by an authorized Kia dealer as soon as possible.

*** NOTICE**

Your new vehicle warranty does not cover any accidents or damage to the vehicle or injuries to its occupants due to a rear parking assist system malfunction. Always drive safely and cautiously.

PARKING ASSIST SYSTEM

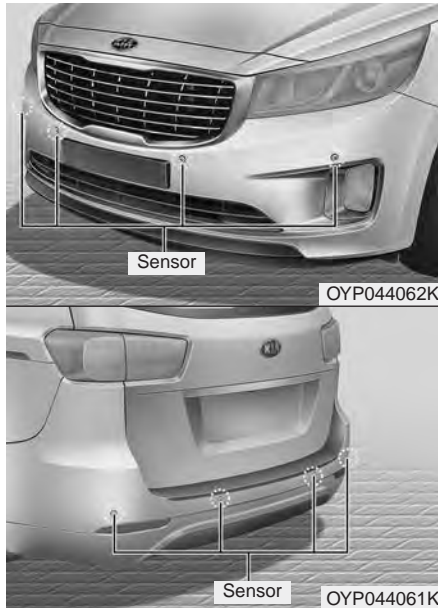

The Parking Assist System is not a substitute for proper and safe parking and backing-up procedures. Always drive safely and use caution when parking. The Parking Assist System may not detect every object behind or in front of the vehicle.

The parking assist system assists the driver during movement of the vehicle by chiming if any object is sensed within the distance of 39 in (100 cm) in front or behind the vehicle.

This system is a supplemental system and it is not intended to nor does it replace the need for extreme care and attention of the driver.

The sensing range and objects detectable by the sensors are limited. When the vehicle moving, pay attention to your surroundings.

⚠ WARNING - Parking assist system

Never rely solely on the parking assist system. Always perform a visual inspection to make sure the vehicle is clear of all obstructions before moving the vehicle in any direction. Stop immediately if you are aware of a child anywhere near your vehicle. Some objects may not be detected by the sensors, due to the object's size or material.

Operation of the parking assist system

Operating condition

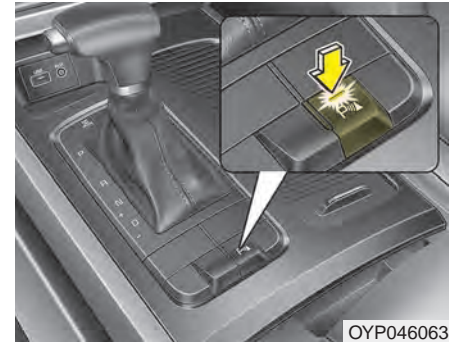







- This system activates when the parking assist button is pressed with the Engine Start/Stop Button ON.
- The parking assist button turns on automatically and activates the parking assist system when you shift the gear to the R (Reverse) position.

- The sensing distance while backing up is approximately 39 in. (100 cm) when you are driving less than 6.2 mph (10 km/h).
- The sensing distance while moving forward is approximately 39 in. (100 cm) when you are driving less than 6.2 mph (10 km/h).
- When more than two objects are sensed at the same time, the closest one will be recognized first.

*** NOTICE**

The system may not detect and object if the distance from the object is already less than approximately 10 in. (25 cm) when the system is turned ON.

Types of warning sound and indicator

Distance from object		Warning indicator		Warning sound
		When driving forward	When driving rearward	
39 in. ~ 24 in. (100cm, ~ 61cm)	Front		-	Buzzer beeps intermittently
47 in. ~ 24in. (120cm, ~ 61cm)	Rear	-		Buzzer beeps intermittently
24 in. ~ 12 in. (60cm ~ 31cm)	Front			Buzzer beeps frequently
	Rear	-		Buzzer beeps frequently
12 in. (30cm)	Front			Buzzer sounds continuously
	Rear	-		Buzzer sounds continuously

*** NOTICE**

The indicator may differ from the illustration as objects or sensors status. If the indicator blinks, the system should be checked by an authorized Kia dealer.

Non-operational conditions of parking assist system

Parking assist system may not operate normally when:

1. Moisture is frozen to the sensor. (It will operate normally when moisture melts.)
2. Sensor is covered with foreign matter, such as snow or water, or the sensor cover is blocked. (It will operate normally when the material is removed or the sensor is no longer blocked.)
3. Sensor is stained with foreign matter such as snow or water. (Sensing range will return to normal when removed.)
4. The parking assist button is off.

There is a possibility of parking assist system malfunction when:

1. Driving on uneven road surfaces such as unpaved roads, gravel, bumps, or gradient.
2. Objects generating excessive noise such as vehicle horns, loud motorcycle engines, or truck air brakes can interfere with the sensor.
3. Heavy rain or water spray.
4. Wireless transmitters or mobile phones present near the sensor.
5. Sensor is covered with snow.

Detecting range may decrease when:

1. Outside air temperature is extremely hot or cold.
2. Undetectable objects smaller than 39 in (1 m) and narrower than 5.5 in (14 cm) in diameter.

The following objects may not be recognized by the sensor:

1. Sharp or slim objects such as ropes, chains or small poles.
2. Objects, which tend to absorb sensor frequency such as clothes, spongy material or snow.

*** NOTICE**

1. The warning may not sound sequentially depending on the speed and shapes of the objects detected.
2. The parking assist system may malfunction if the vehicle bumper height or sensor installation has been modified. Any non-factory installed equipment or accessories may also interfere with the sensor performance.
3. Sensor may not recognize objects less than 12 in (30 cm) from the sensor, or it may sense an incorrect distance. Use with caution.

(Continued)

(Continued)

4. When the sensor is frozen or stained with snow or water, the sensor may be inoperative until the stains are removed using a soft cloth.
5. Do not push, scratch or strike the sensor with any hard objects that could damage the surface of the sensor. Sensor damage could occur.

*** NOTICE**

This system can only sense objects within the range and location of the sensors, it can not detect objects in other areas where sensors are not installed. Also, small or slim objects, or objects located between sensors may not be detected.

Always visually check in front and behind the vehicle when driving.

Be sure to inform any drivers in the vehicle that may be unfamiliar with the system regarding the system's capabilities and limitations.

Self-diagnosis

If you don't hear an audible warning sound or if the buzzer sounds intermittently when shifting the shift lever into the R (Reverse) position, this may indicate a malfunction in the parking assist system. If this occurs, have the system checked by an authorized Kia dealer.

Your new vehicle warranty does not cover any accidents or damage to the vehicle or injuries to its occupants related to a parking assist system. Always drive safely and cautiously.

REARVIEW CAMERA (IF EQUIPPED)

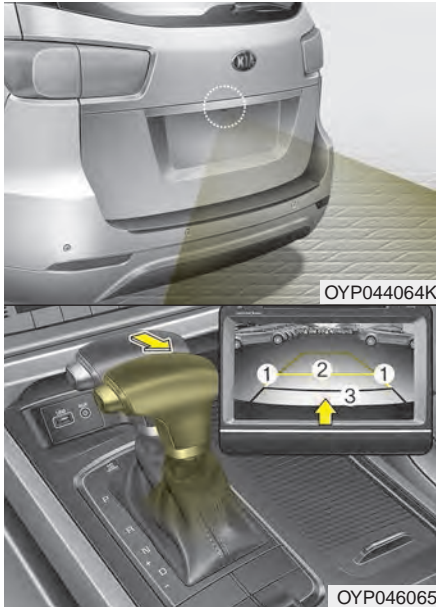

The rearview camera will activate with the ignition switch ON and the shift lever in the R (Reverse) position.

This system is a supplemental system that shows behind the vehicle through the rearview display mirror while backing up unless equipped with a navigation system, then will display on the screen.

The rearview camera may be turned off by pressing the ON/OFF button when the rearview camera is activated.

To turn the camera on again, press the ON/OFF button again when the ignition switch is on and the shift lever in R (Reverse). Also, the camera will turn on automatically whenever the ignition switch is turned off and on again.

- This system is a supplementary function only. It is the responsibility of the driver to always check the inside/outside rearview mirrors and the area behind the vehicle before and while backing up because there is a dead zone that can't be seen by the camera.
- Always keep the camera lens clean. If lens is covered with foreign matter, the camera may not operate normally.

⚠ WARNING - Backing up & using camera

Never rely solely on the rear view camera when backing up. You must always view the areas behind you including looking over both shoulders as well as continuously checking all three rear view mirrors. Due to the difficulty of ensuring that the areas behind you remains clear, always back up slowly and stop immediately if you even suspect that a person, and especially a child, might be behind you.

SURROUND VIEW MONITORING SYSTEM (SVM) (IF EQUIPPED)

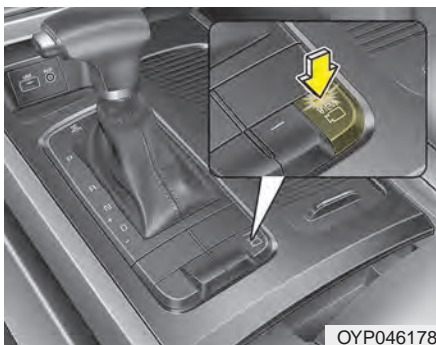

The Surround View Monitoring System (SVM) is not a substitute for proper and safe parking procedures. The Surround View Monitoring System (SVM) may not detect every object surrounding the vehicle. Always drive safely and use caution when parking.

The Surround View Monitoring System (SVM) can assist in parking by allowing the driver to see around the vehicle. Push the button into the [ON] position to operate the system.

To cancel the system, push the button again.

Operating conditions

- When the Engine Start/Stop Button is ON position
- When the transaxle is on D, N or R
- When the vehicle speed is not over 12.4 mph (20 km/h)
- When the vehicle speed is over 12.4 mph (20 km/h), the SVM system is turned off. If the vehicle speed is not over 12.4 mph (20 km/h) after turning off the SVM by over speed, the SVM is not turned on. To operate again, push the button.
- When the vehicle moves backwards, regardless of On/Off of button and vehicle speed, the SVM is operated.
- When the trunk and driver/passenger door are opened and the outside mirror is folded, the warning is illuminated in SVM system.
- If the SVM system is not operating normally, the system should be checked by an authorized Kia dealer.
- When the vehicle moves over 6.2 mph (10 km/h) forward after moving backward, the SVM screen will be turned off.

⚠ WARNING

This system is a supplementary function only. It is the responsibility of the driver to always check the area around the vehicle before and while moving.

LIGHTING

Battery saver function

- The purpose of this feature is to prevent the battery from being discharged if the lights are left in the ON position. The system automatically shuts off the parking lights 30 seconds after the ignition key is removed and the driver's door is opened and closed.
- With this feature, the parking lights will turn off automatically if the driver parks on the side of the road at night and opens the driver's side door.

If necessary, to keep the parking lights on when the ignition key is removed, perform the following:

- 1) Open the driver-side door.
- 2) Turn the parking lights OFF and ON again using the light switch on the steering column.

Headlight escort function

If you turn the ignition switch to the ACC or OFF position with the headlights ON, the headlights remain on for about 5 minutes. However, if the driver's door is opened and closed, the headlights are turned off after 15 seconds.

The headlights can be turned off by pressing the lock button on the transmitter (or smart key) twice or turning the light switch to the OFF position.

If the driver gets out of the vehicle through other doors (except driver's door), the battery saver function does not operate and the headlight escort function does not turn off automatically. Therefore, It causes the battery to be discharged. In this case, make sure to turn off the lamp before getting out of the vehicle.

Lighting control

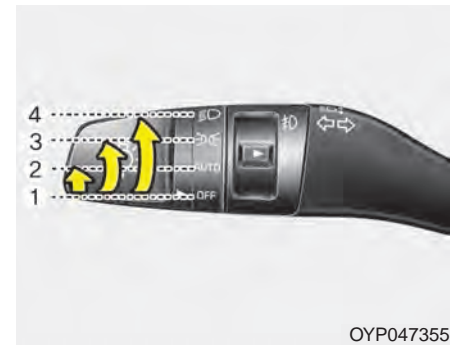

The light switch has a Headlight and a Parking light position.

To operate the lights, turn the knob at the end of the control lever to one of the following positions:

- (1) OFF position
- (2) Auto light position (if equipped)
- (3) Position & Tail light
- (4) Headlight position

Position & Tail light (㉔)



When the light switch is in the parking light position, the tail, license and instrument panel lights will turn ON.

Headlight position (㉕)



When the light switch is in the headlight position, the head, tail, license lights will turn ON.

*** NOTICE**

The ignition switch must be in the ON position to turn on the headlights.

Auto light position (if equipped)

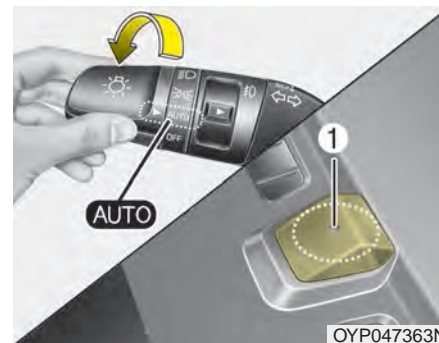

When the light switch is in the AUTO light position, the taillights and headlights will turn ON or OFF automatically depending on the amount of light outside the vehicle.

When the light switch is positioned at an auto light position, at first, the wiper will turn on and then, after 5 seconds the head lamp will turn on automatically.

If the head lamp has been turned on due to this function of the vehicle, the head lamp will turn off 60 seconds after the wiper has been turned off.

Headlights On with Wipers (Available With Auto lights Only)

- When the light switch is in the AUTO light position, the headlights will turn ON automatically the next 5 seconds with wiper is ON.

If this feature allows headlights to turn On, the headlights will be turned off on the next 60 seconds with wiper is off.

- Never place anything over the sensor (1) located on the instrument panel. This will ensure better auto-light system control.
- Don't clean the sensor using a window cleaner. The cleaner may leave a light film which could interfere with sensor operation.
- If your vehicle has window tint or other types of metallic coating on the front windshield, the Auto light system may not work properly.

High beam operation

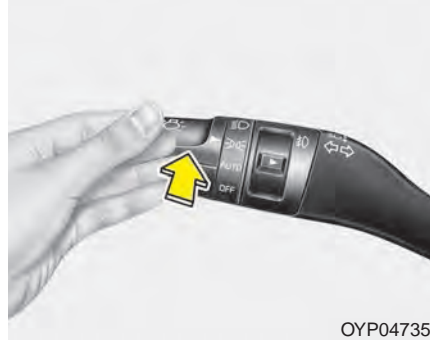

To turn on the high beam headlights, push the lever away from you. Pull it back for low beams.

The high beam indicator will light when the headlight high beams are switched on.

To prevent the battery from being discharged, do not leave the lights on for a prolonged time while the engine is not running.

⚠ WARNING - High beams
Do not use high beam when there are other vehicles. Using high beam could obstruct the other driver's vision.



OYP047358

To flash the headlights, pull the lever towards you. It will return to the normal (low beam) position when released. The headlight switch does not need to be on to use this flashing feature.

High Beam Assist (if equipped)

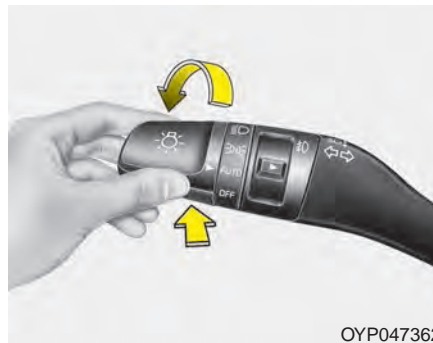

OYP047362

The High Beam Assist is a system that automatically adjusts the headlamp range (switches between high beam and low beam) according to the brightness of other vehicles and road conditions.

Operating condition

1. Place the light switch in the AUTO position.
2. Turn on the high beam by pushing the lever away from you.

The High Beam Assist () indicator will illuminate.

3. The High Beam Assist will turn on when vehicle speed is above 24.8mph (45km/h).

- If the lever is pushed away when the High Beam Assist is operating, the High Beam Assist will turn off and the high beam will be on continuously. The High Beam Assist () indicator will turn off.
- If the lever is pulled towards you when the High Beam Assist is operating, the High Beam Assist will turn off.

4. If the light switch is placed to the headlamp position, the High Beam Assist will turn off and the low beam will be on continuously.

The high beam switches to low beam in the below conditions.

- When the High Beam Assist is off.
- When the light switch is not in the AUTO position.
- When the headlamp is detected from the on-coming vehicle.
- When the tail lamp is detected from the front vehicle.
- When the surrounding is bright enough high beam is not needed.
- When streetlights or other lights are detected.
- When vehicle speed is below 21.7mph (35km/h).

The system may not operate normally in the below conditions.

- When the light from the on-coming or front vehicle is not detected because of lamp damage, hidden from sight, etc.
- When the lamp of the on-coming or front vehicle is covered with dust, snow or water.
- When the light from the on-coming or front vehicle is not detected because of exhaust fume, smoke, fog, snow, etc.
- When the front window is covered with foreign matters such as ice, dust, fog, or is damaged.
- When there is a similar shape lamp with the front vehicle's lamps.
- When it is hard to see because of fog, heavy rain or snow.
- When the headlamp is not repaired or replaced at an authorized dealer.

- When headlamp aiming is not properly adjusted.
- When driving on a narrow curved road or rough road.
- When driving downhill or uphill.
- When only part of the vehicle in front is visible on a crossroad or curved road.
- When there is a traffic light, reflecting sign, flash sign or mirror.
- When the road conditions are bad such as being wet or covered with snow.
- When the front vehicle's headlamps are off but the fog lamps on.
- When a vehicle suddenly appears from a curve.
- When the vehicle is tilted from a flat tire or being towed.
- When the LDWS (Lane Departure Warning System) warning light illuminates. (if equipped)

- Do not place any accessories, stickers or tint the windshield.
- Have the windshield glass replaced from an authorized dealer.
- Do not remove or impact related parts of the High Beam system.
- Be careful that water doesn't get into the High Beam unit.
- Do not place objects on the dashboard that reflects light such as mirrors, white paper, etc. The system may malfunction if sunlight is reflected.
- At times, the High Beam system may not work properly, always check the road conditions for your safety. When the system does not operate normally, manually change between the high beam and low beam.

Turn signals and lane change signals

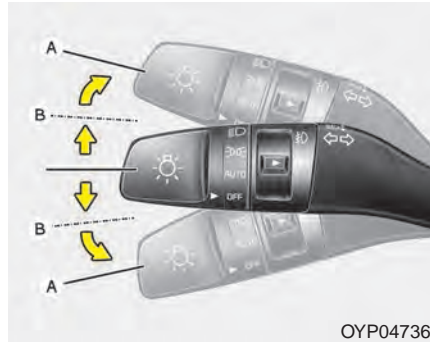

The ignition switch must be on for the turn signals to function. To turn on the turn signals, move the lever up or down (A). The green arrow indicators on the instrument panel indicate which turn signal is operating. They will self-cancel after a turn is completed. If the indicator continues to flash after a turn, manually return the lever to the OFF position.

To signal a lane change, move the turn signal lever slightly and hold it in position (B). The lever will return to the OFF position when released.

If an indicator stays on and does not flash or if it flashes abnormally, one of the turn signal bulbs may be burned out and will require replacement.

* NOTICE

If an indicator flash is abnormally quick or slow, a bulb may be burned out or have a poor electrical connection in the circuit.

Front fog light (if equipped)

OYP047361

Fog lights are used to provide improved visibility when visibility is poor due to fog, rain or snow, etc. The fog lights will turn on when the fog light switch (1) is turned to the on position after the headlight is turned on.

To turn off the fog lights, turn the fog light switch (1) to the OFF position.

When in operation, the fog lights consume large amounts of vehicle electrical power. Only use the fog lights when visibility is poor.

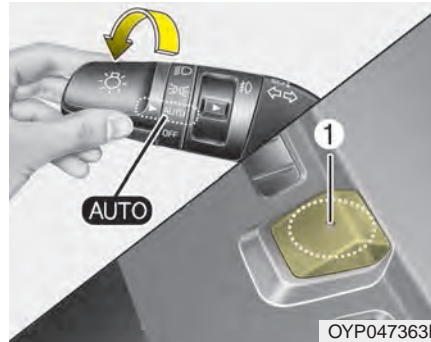
AFLS (Adaptive Front Lighting System) (if equipped)

OYP047363N

Adaptive front lighting system uses the steering angle and vehicle speed, to keep your field of vision wide by swiveling and leveling the headlamp.

Change the switch to the AUTO position when the engine is running. The adaptive front lighting system will operate when the headlamp is ON. To turn off the AFLS, change the switch to other positions. After turning the AFLS off, headlamp swiveling no longer occurs, but leveling operates continuously.

If the AFLS malfunction indicator comes on, the AFLS is not working properly. Drive to the nearest safe location and restart the engine. If the indicator continuously remains on, we recommend that the system be checked by an authorized Kia dealer.

WIPERS AND WASHERS

Windshield wiper/washer

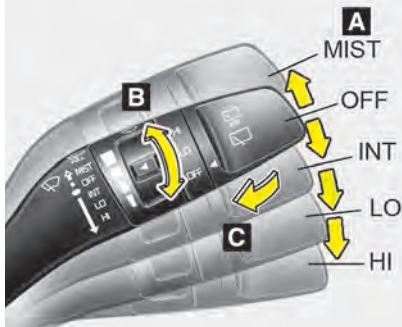

A : Wiper speed control (front)

- MIST – Single wipe
- OFF – Off
- INT – Intermittent wipe
- LO – Low wiper speed
- HI – High wiper speed

B : Intermittent control wipe time adjustment

C : Wash with brief wipes (front)*

Rear window wiper/washer

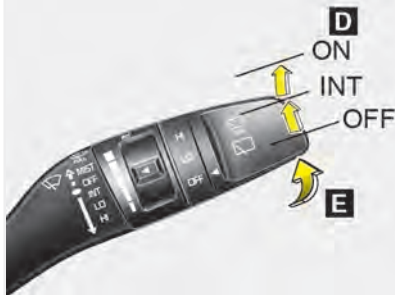

OYP044181K OYP044182N

D : Rear wiper/washer control*

- HI – Continuous wipe
- LO – Intermittent wipe*
- OFF – Off

E : Wash with brief wipes (rear)*

* if equipped

Windshield wipers

Operates as follows when the ignition switch is turned ON.

MIST : For a single wiping cycle, move the lever to this (MIST/√) position and release it. The wipers will operate continuously if the lever is held in this position.

OFF : Wiper is not in operation

INT : Wiper operates intermittently at the same wiping intervals. Use this mode in light rain or mist. To vary the speed setting, turn the speed control knob.

LO : Normal wiper speed

HI : Fast wiper speed

* NOTICE

If there is heavy accumulation of snow or ice on the windshield, defrost the windshield for about 10 minutes, or until the snow and/or ice is removed before using the windshield wipers to ensure proper operation.

Front windshield washers

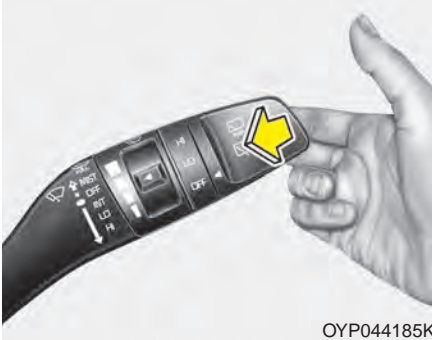

OYP044185K

In the OFF position, pull the lever gently toward you to spray washer fluid on the windshield and to run the wipers 1-3 cycles.

Use this function when the windshield is dirty.

The spray and wiper operation will continue until you release the lever.

If the washer does not work, check the washer fluid level. If the fluid level is not sufficient, you will need to add appropriate non-abrasive windshield washer fluid to the washer reservoir.

The reservoir filler neck is located in the front of the engine compartment on the passenger side.

⚠ CAUTION - Washer pump
To prevent possible damage to the washer pump, do not operate the washer when the fluid reservoir is empty.

⚠ WARNING - Obscured visibility
Do not use the washer in freezing temperatures without first warming the windshield with the defrosters; the washer solution could freeze on the windshield and obscure your vision.

⚠ CAUTION - Wipers & windshields

- *To prevent possible damage to the wipers or windshield, do not operate the wipers when the windshield is dry.*
- *To prevent damage to the wiper blades, do not use gasoline, kerosene, paint thinner, or other solvents on or near them.*
- *To prevent damage to the wiper arms and other components, do not attempt to move the wipers manually.*

Rear window wiper and washer switch

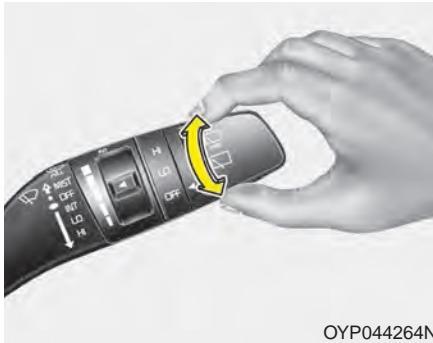

OYP044264N

The rear window wiper and washer switch is located at the end of the wiper and washer switch lever. Turn the switch to the desired position to operate the rear wiper and washer.

- HI : Continuous wipe
- LO : Intermittent wipe
- OFF : OFF

The rear window wiper is switched on automatically when the ignition is in OFF and the gear is shifted to R (Reverse) while the wiper is in motion.

The automatic rear wiper function can be turned on or off in 'User setting mode' on the cluster display.



OYP044186N

Push the lever away from you to spray rear washer fluid and to run the rear wipers 1~3 cycles. The spray and wiper operation will continue until you release the lever

INTERIOR LIGHTS

Do not use the interior lights for extended periods when the engine is not running.

It may cause battery discharge.

⚠ WARNING - Interior lights
Do not use the interior lights when driving in the dark. Accidents could happen because the view may be obscured by interior lights.

Automatic turn off function (if equipped)

The interior lights automatically turn off approximately 20 minutes after the ignition switch is turned off, if the lights are in the ON position.

If your vehicle is equipped with the theft alarm system, the interior lights automatically turn off approximately 3 seconds after the system in armed stage.

Room lamp

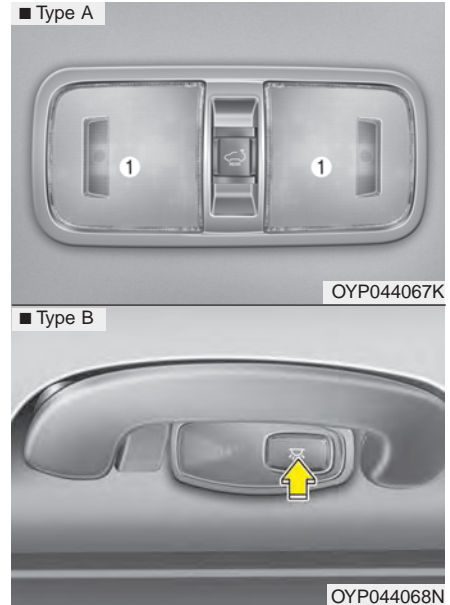







Press the button(1) or lens(1) to turn the light on or off.

If the front map lamp turns on by the front map lamp switch, the room lamp will turn on.

Map lamp



Press the lens (1) to turn the map lamp on or off

-  (2) : The light comes on when any door (or liftgate (tailgate)) is opened regardless of the ignition switch position. When doors are unlocked by the transmitter (or smart key) or the key is removed from the ignition switch, the light comes on for approximately 30 seconds as long as any door is not opened. The light goes out gradually after approximately 30 seconds if the door is closed.
 -  (3) : The light stays on at all times.
- * NOTICE**
- The  mode and  mode can not be selected at the same time.
 - When the lamp is turned on by pressing the lens (1), the lamp does not turn off even if the  mode or  mode is not selected (not pressed).

However, if the ignition switch is ON or all doors are locked, the light will turn off immediately. If a door is opened with the ignition switch in the ACC or LOCK position, the light stays on for about 20 minutes. However, if a door is opened with the ignition switch in the ON position, the light stays on continuously.

Luggage lamp (if equipped)

■ Type A

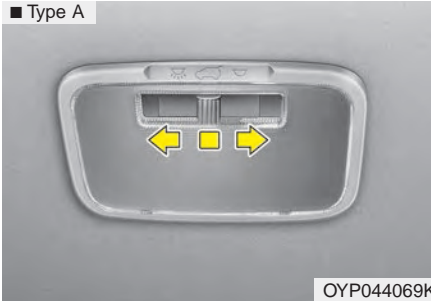

OYP044069K

■ Type B

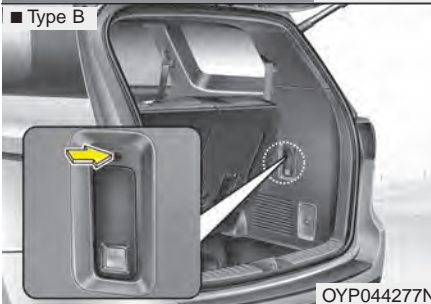

OYP044277N

- **DOOR** : The light comes on when the liftgate (tailgate) is opened.
- **OFF** : The light stays off at all times.
- **ON** : The light stays on at all times.

Vanity mirror lamp (if equipped)



OHG040128

Opening the lid of the vanity mirror will automatically turn on the mirror light.

Portable lamp usage (if equipped)

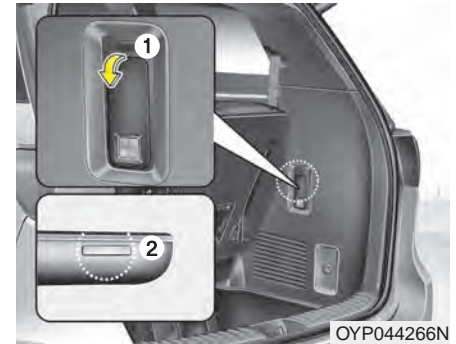

OYP044266N

1. In-vehicle lamp, if necessary, after separation can be used as a portable.
 2. Press push button (1).
 3. Pull out the lamp holder.
 4. Press the power switch (2).
- * If the portable lamp does not turn on, it means the portable lamp needs to be charged. Insert the lamp holder and then charge it again. The charge mode will be activated if the ignition switch (or engine start/stop button) is on position or engine is running.

1. Remove the batteries when not in use for a long time.
2. Use the specified battery.
3. You can use the regular batteries (Disposable batteries) but do not use the Non-rechargeable battery in charge mode. It may damage the vehicle.
4. Do not place the lamp with water or moist places and liquid compounds. These can cause internal leakage of a battery.
5. When replacing the batteries, check the direction and insert. It will not be charged if installed reversely.
6. Do not mix the rechargeable batteries. It may not be charged normally.
7. Do not place the lamp or batteries near fire or heat. It can cause internal leakage of a battery.
8. Do not apply electrical shock with portable charging terminals of the lamp. It can cause internal leakage of a battery or damage the portable lamp.
9. If the portable lamp does not turn on anymore after charged, replace the rechargeable batteries.

Battery replacement

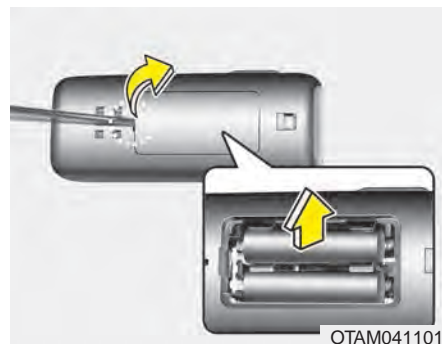

When replacement is necessary, use the following procedure.

1. Insert a slim tool into the slot and gently try open the battery cover.
2. Replace the batteries with new rechargeable batteries (AAA size). When replacing the batteries, make sure the position of batteries.
3. Close the cover carefully.

DEFROSTER

CAUTION - Conductors

To prevent damage to the conductors bonded to the inside surface of the rear window, never use sharp instruments or window cleaners containing abrasives to clean the window.

If you want to defrost and defog the front windshield, refer to “Windshield defrosting and defogging” in this section.

Rear window defroster

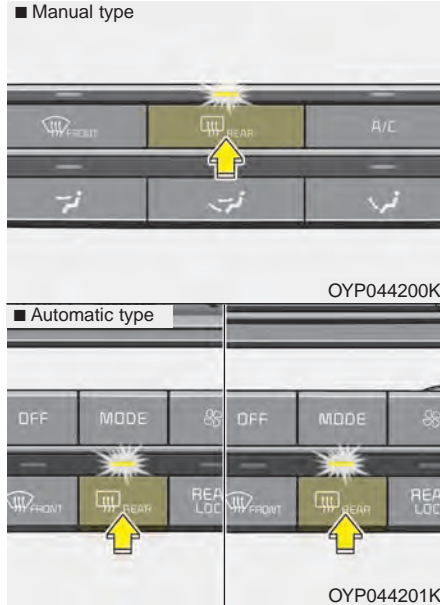

The defroster heats the window to remove frost, fog and thin ice from the rear window, while the engine is running.

To activate the rear window defroster, press the rear window defroster button located in the center fascia switch panel. The indicator on the rear window defroster button illuminates when the defroster is ON.

If there is heavy accumulation of snow on the rear window, brush it off before operating the rear defroster.

The rear window defroster automatically turns off after approximately 20 minutes or when the ignition switch is turned off. To turn off the defroster, press the rear window defroster button again.

Outside rearview mirror defroster (if equipped)

If your vehicle is equipped with the outside rearview mirror defrosters, they will operate at the same time you turn on the rear window defroster.

Wiper deicer (if equipped)

If your vehicle is equipped with the wiper deicer, it will operate at the same time you turn on the rear window defroster.

MANUAL CLIMATE CONTROL SYSTEM (IF EQUIPPED)

■ Front





1. Front fan speed control knob
2. Front window defroster button
3. Rear window defroster button
4. Air conditioning button
5. Air intake control button
6. Front temperature control knob

7. Front mode selection button
8. Rear fan speed control knob
9. Rear temperature control knob
10. Rear control lock button
11. Rear control on button

* if equipped

Heating and air conditioning

1. Start the engine.
2. Set the mode to the desired position.
For improving the effectiveness of heating and cooling;
 - Heating: 
 - Cooling: 
3. Set the temperature control to the desired position.
4. Set the air intake control to the outside (fresh) air position (if equipped).
5. Set the fan speed control to the desired speed.
6. If air conditioning is desired, turn the air conditioning system (if equipped) on.

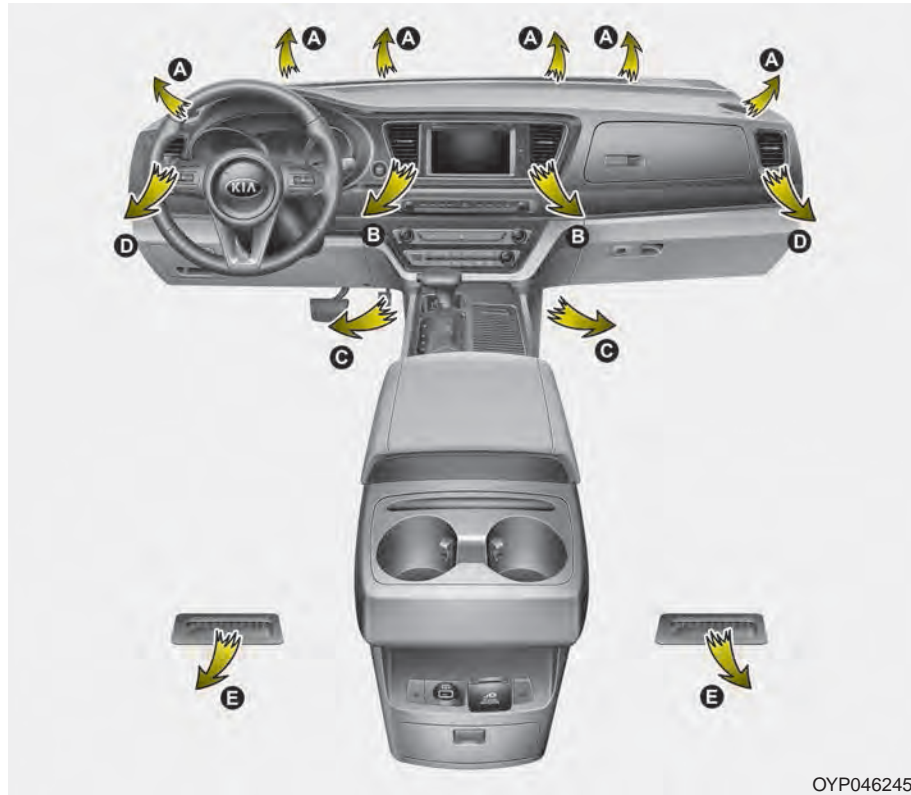

Mode selection

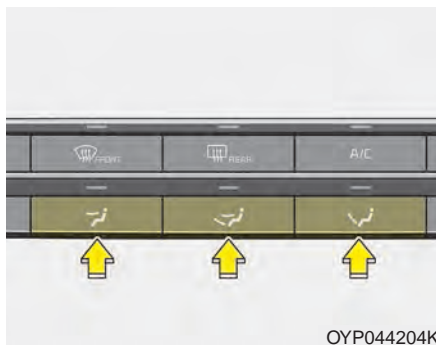

The mode selection button controls the direction of the air flow through the ventilation system.

Air can be directed to the floor, dashboard outlets, or windshield. Six symbols are used to represent MAX A/C, Face, Bi-Level, Floor, Floor-Defrost and Defrost air position.

The MAX A/C mode is used to cool the inside of the vehicle faster.



Face-Level (B, D)

Air flow is directed toward the upper body and face. Additionally, each outlet can be controlled to direct the air discharged from the outlet.



Floor-Level (A, C, D, E)

Most of the air flow is directed to the floor, with a small amount of the air being directed to the windshield and side window defrosters.



Bi-Level (A, B, C, D, E)

Air flow is directed towards the face and the floor.



Floor/Defrost-Level (A, C, D, E)

Most of the air flow is directed to the floor and the windshield with a small amount directed to the side window defrosters.

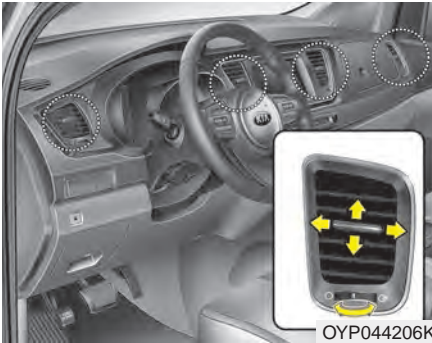

OYP044206K

Instrument panel vents

The outlet vents can be opened or closed separately using the thumbwheel (if equipped).

Also, you can adjust the direction of air delivery from these vents using the vent control lever as shown.

Temperature control



OYP044207K

The temperature control knob allows you to control the temperature of the air flowing from the ventilation system. To change the air temperature in the passenger compartment, turn the knob to the right position for warm and hot air or left position for cooler air.

Air intake control



OYP044208K

The air intake control is used to select the outside (fresh) air position or recirculated air position.

To change the air intake control position, press the control button.

Recirculated air position



With the recirculated air position selected, air from the passenger compartment will be drawn through the heating system and heated or cooled according to the function selected.

Outside (fresh) air position



With the outside (fresh) air position selected, air enters the vehicle from outside and is heated or cooled according to the function selected.

Prolonged operation of the heater in the recirculated air position (without air conditioning selected) may cause fogging of the windshield and side windows and the air within the passenger compartment may become stale.

In addition, prolonged use of the air conditioning with the recirculated air position selected will result in excessively dry air in the passenger compartment.

Sunroof Inside Air Recirculation (if equipped)

When the heater or air conditioning system is on with the sunroof opened, the outside (fresh) air position will be automatically selected. At this time, if you press the recirculated air position button, the recirculated air position will be selected but will change back to the outside (fresh) air position after 3 minutes.

When the sunroof is closed, the air intake position will return to the original position that was selected.

Fan speed control



The ignition switch must be in the ON position for fan operation.

The fan speed control knob allows you to control the fan speed of the air flowing from the ventilation system. To change the fan speed, turn the knob to the right for higher speed or left for lower speed.

⚠ WARNING - Reduced visibility

Continued use of the climate control system in the recirculated air position may allow humidity to increase inside the vehicle which may fog the glass and obscure visibility.

⚠ WARNING - Sleeping with AC on

Do not sleep in a vehicle with the air conditioning or heating system on as this may cause serious harm or death due to a drop in the oxygen level and/or body temperature.

⚠ WARNING - Recirculated air

Continued use of the climate control system in the recirculated air position can cause drowsiness or sleepiness, and loss of vehicle control. Set the air intake control to the outside (fresh) air position as much as possible while driving.

Air conditioning

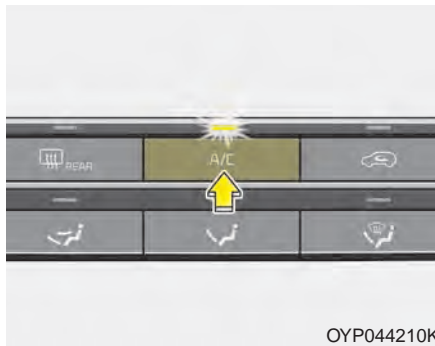

Press the A/C button to turn the air conditioning system on (indicator light will illuminate). Press the button again to turn the air conditioning system off.

■ Rear



1. Rear air conditioning OFF button
2. Rear fan speed control button

3. Rear mode selection button
4. Rear temperature control button

OYP044212K

Rear climate control (if equipped)

To turn on the rear climate control system;

From the front seat

1. Set the rear climate control selection (REAR ON) button in the front climate control panel to the ON position.
2. Set the rear fan speed control knob in the front climate control panel to the desired position.
3. Set the rear temperature control knob in the front climate control panel to the desired position.

From the rear seat

1. Set the rear climate control selection (REAR ON) button in the front climate control panel to the ON position.
2. Set the rear climate control selection (REAR LOCK) button in the front climate control panel to the OFF position.
3. Set the rear fan speed control button on the rear climate control panel to the desired position.
4. Set the rear temperature control button on the rear climate control panel to the desired position.
5. Select the desired rear mode button on the rear climate control panel.
6. To turn off the rear air conditioning system, press the off button in the rear climate control panel.

Rear fan speed control**From front seat**

Set the rear climate control selection (REAR ON) button in the front climate control panel to the ON position and turn the rear fan speed control (REAR) knob in the front climate control panel to the desired position. To change the rear fan speed, turn the knob to the right for higher speed or left for lower speed.

**From rear seat**

Set the rear climate control selection (REAR ON) button in the front climate control panel to the ON position and set the rear climate control selection (REAR LOCK) button in the front climate control panel to the OFF position and press the rear fan speed control button on the rear control panel to the desired position.

To turn off the rear air conditioning system press the off button in the rear climate control panel.

Rear temperature control**From front seat**

Set the rear climate control selection (REAR ON) button in the front climate control panel to the ON position and turn the rear temperature control (REAR TEMP) knob in the front climate control panel to the desired position.

To change the rear air temperature, turn the knob to the right position for warm and hot air or left position for cooler air.

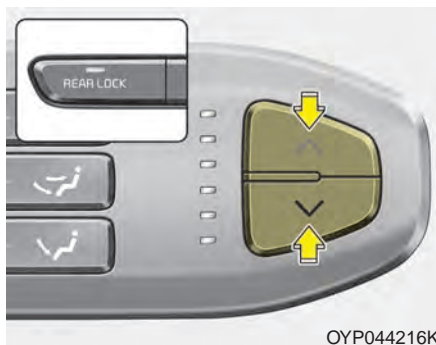





From rear seat

Set the rear climate control selection (REAR ON) button in the front climate control panel to the ON position and set the rear climate control selection (REAR LOCK) button in the front climate control panel to the OFF position.

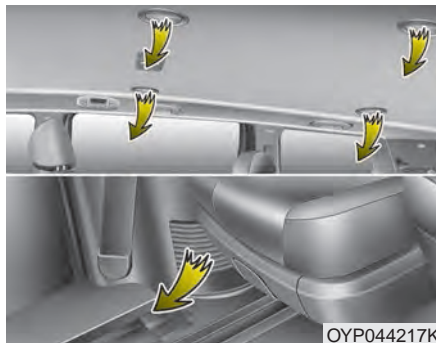
To change the rear air temperature, press the button (∧) for warmer air or press the button (∨) for cooler air.



Rear mode selection (if equipped)



- Front climate control is MAX A/C,  :
Rear air blows from the upper vents on the rear ceiling.
- Front climate control is  :
Rear air blows from the upper vents on the rear ceiling and the lower vents on the right rear trim together.
- Front climate control is  ,  :
Rear air blows from the lower vents on the right rear trim.



When the rear climate control selection (REAR ON) button in the front climate control panel is in the ON position and set the rear climate control selection (REAR LOCK) button in the front climate control panel to the OFF position and the rear mode is selected by pushing the rear mode selection button on the rear control panel as follows:

-  : Rear air blows from the upper vents on the rear ceiling.
-  : Rear air blows from the upper vents on the rear ceiling and the lower vents on the right rear trim together.
-  : Rear air blows from the lower vents on the right rear trim.

Rear vents (if equipped)

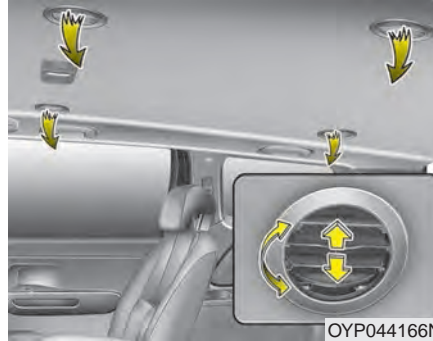

The vent can be adjusted by rotating the blade.

* NOTICE



If all the vents are closed, it may cause some noise. Always open 2 vents or more.

System operation

Ventilation

1. Set the mode to the  position.
2. Set the air intake control to the outside (fresh) air position.
3. Set the temperature control to the desired position.
4. Set the fan speed control to the desired speed.

Heating

1. Set the mode to the  position.
 2. Set the air intake control to the outside (fresh) air position.
 3. Set the temperature control to the desired position.
 4. Set the fan speed control to the desired speed.
 5. If dehumidified heating is desired, turn the air conditioning system (if equipped) on.
- If the windshield fogs up, set the mode to the  or  position.

Operation Tips

- To keep dust or unpleasant fumes from entering the vehicle through the ventilation system, temporarily set the air intake control to the recirculated air position. Be sure to return the control to the fresh air position when the irritation has passed to keep fresh air in the vehicle. This will help keep the driver alert and comfortable.
- Air for the heating/cooling system is drawn in through the grilles just ahead of the windshield. Care should be taken that these are not blocked by leaves, snow, ice or other obstructions.
- To prevent interior fog on the windshield, set the air intake control to the fresh air position and fan speed to the desired position, turn on the air conditioning system, and adjust the temperature control to desired temperature.

Air conditioning

Kia Air Conditioning Systems are filled with refrigerant*.

1. Start the engine. Push the air conditioning button.
2. Set the mode to the  position.
3. Set the air intake control to the outside air or recirculated air position.
4. Adjust the fan speed control and temperature control to maintain maximum comfort.

- The refrigerant system should only be serviced by trained and certified technicians to insure proper and safe operation.
- The refrigerant system should be serviced in a well-ventilated place.
- The air conditioning evaporator (cooling coil) shall never be repaired or replaced with one removed from a used or salvaged vehicle and new replacement MAC evaporators shall be certified (and labeled) as meeting SAE Standard J2842.

**CAUTION - Excessive AC**

- *When using the air conditioning system, monitor the temperature gauge closely while driving up hills or in heavy traffic when outside temperatures are high. Air conditioning system operation may cause engine overheating. Continue to use the blower fan but turn the air conditioning system off if the temperature gauge indicates engine overheating.*
- *When opening the windows in humid weather air conditioning may create water droplets inside the vehicle. Since excessive water droplets may cause damage to electrical equipment, air conditioning should only be used with the windows closed.*

Air conditioning system operation tips

- If the vehicle has been parked in direct sunlight during hot weather, open the windows for a short time to let the hot air inside the vehicle escape.
- To help reduce moisture inside of the windows on rainy or humid days, decrease the humidity inside the vehicle by operating the air conditioning system.
- During air conditioning system operation, you may occasionally notice a slight change in engine speed as the air conditioning compressor cycles. This is a normal system operation characteristic.
- Use the air conditioning system every month only for a few minutes to ensure maximum system performance.

- When using the air conditioning system, you may notice clear water dripping (or even puddling) on the ground under the passenger side of the vehicle. This is a normal system operation characteristic.
- Operating the air conditioning system in the recirculated air position provides maximum cooling, however, continual operation in this mode may cause the air inside the vehicle to become stale.
- During cooling operation, you may occasionally notice a misty air flow because of rapid cooling and humid air intake. This is a normal system operation characteristic.

Climate control air filter (if equipped)

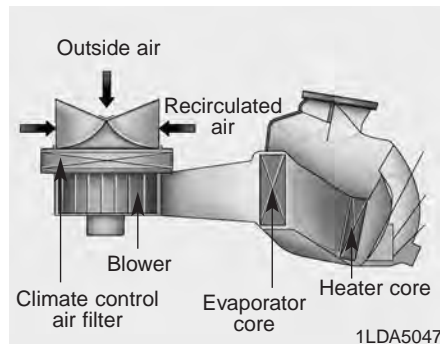

The climate control air filter installed behind the glove box filters the dust or other pollutants that come into the vehicle from the outside through the heating and air conditioning system. If dust or other pollutants accumulate in the filter over a period of time, the air flow from the air vents may decrease, resulting in moisture accumulation on the inside of the windshield even when the outside (fresh) air position is selected. If this happens, we recommend that the climate control air filter be replaced by an authorized Kia dealer.

* NOTICE

- Replace the filter according to the Maintenance Schedule. If the vehicle is being driven in severe conditions such as dusty or rough roads, more frequent climate control air filter inspections and changes are required.
- When the air flow rate suddenly decreases, we recommend that the system should be checked at an authorized Kia dealer.

Air Conditioning refrigerant label

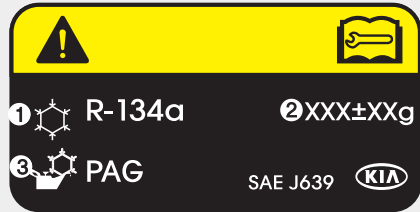

OXM063009

* The actual Air Conditioning refrigerant label in the vehicle may differ from the illustration.

Each symbols and specification on air conditioning refrigerant label means as below ;

1. Classification of refrigerant
2. Amount of refrigerant
3. Classification of Compressor lubricant

You can find out which air conditioning refrigerant is applied your vehicle at the label inside of the engine room.

Refer to section 8 for more detail location of air conditioning refrigerant label.

Checking the amount of air conditioner refrigerant and compressor lubricant

When the amount of refrigerant is low, the performance of the air conditioning is reduced. Overfilling also has a negative influence on the air conditioning system.

Therefore, if abnormal operation is found, have the system inspected by an authorized Kia dealer.

⚠ WARNING - AC Repair

The oil and refrigerant in your vehicle's air conditioning system is under very high pressure. If proper service procedures are not followed an explosion may result. To reduce the risk of serious injury or death, the air conditioning system in your vehicle should only be serviced by trained and certified technicians.

⚠ CAUTION - AC Repair

It is important that the correct type and amount of oil and refrigerant is used, otherwise damage to the vehicle may occur. To prevent damage, the air conditioning system in your vehicle should only be serviced by trained and certified technicians.

AUTOMATIC CLIMATE CONTROL SYSTEM (IF EQUIPPED)

■ Type A



1. Driver's temperature control knob
2. AUTO(automatic control) button
3. A/C display
4. Passenger's temperature control knob
5. SYNC temperature control selection button
6. Front fan speed control button
7. Front blower off button
8. Front mode selection button
9. Rear fan speed control button
10. A/C on button
11. Air intake control button
12. Front windshield defroster button
13. Rear window defroster button
14. Rear control lock button
15. Rear control on button
16. Rear temperature control knob
17. Climate information screen selection button

■ Type B



OYP047220L/OYP047366N

Automatic heating and air conditioning



1. Press the AUTO button. The modes, fan speeds, air intake and air-conditioning will be controlled automatically by setting the temperature.

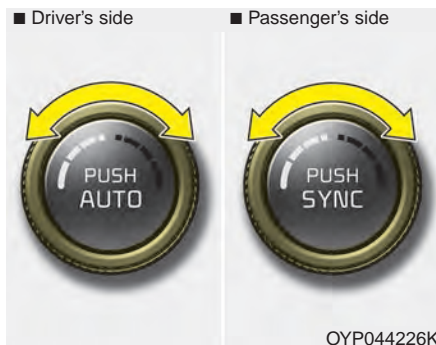

2. Turn the temperature control knob to the desired temperature.

* NOTICE

- To turn the automatic operation off, select any button or switch of the following:
 - Mode selection button
 - Air conditioning button
 - Front windshield defroster button (Press the button one more time to deselect the front windshield defroster function. The AUTO sign will illuminate on the information display once again.)
 - Air intake control button
 - Fan speed control switchThe selected function will be controlled manually while other functions operate automatically.
- For your convenience and to improve the effectiveness of the climate control, use the AUTO button and set the temperature to 73°F (23°C).

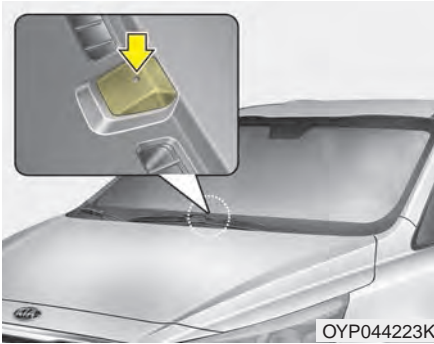

* NOTICE

Never place anything over the sensor located on the instrument panel to ensure better control of the heating and cooling system.

Manual heating and air conditioning

The heating and cooling system can be controlled manually by pressing buttons or turning knob(s) other than the AUTO button. In this case, the system works sequentially according to the order of buttons or knob(s) selected.

1. Start the engine.
2. Set the mode to the desired position.

For improving the effectiveness of heating and cooling;

- Heating:
- Cooling:

3. Set the temperature control to the desired position.
4. Set the air intake control to the outside (fresh) air position.
5. Set the fan speed control to the desired speed.
6. If air conditioning is desired, turn the air conditioning system on.

Press the AUTO button in order to convert to full automatic control of the system.

Mode selection

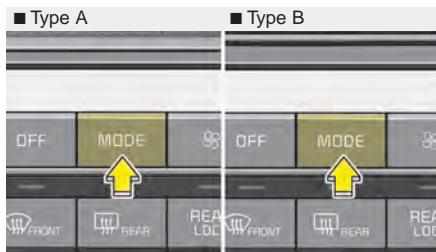

OYP044224K

The mode selection button controls the direction of the air flow through the ventilation system.

The air flow outlet port is converted as follows:



Refer to the illustration in the "Manual climate control system".



Face-Level

Air flow is directed toward the upper body and face. Additionally, each outlet can be controlled to direct the air discharged from the outlet.



Bi-Level

Air flow is directed towards the face and the floor.



Floor-Level

Most of the air flow is directed to the floor, with a small amount of the air being directed to the windshield and side window defrosters.



Floor/Defrost-Level

Most of the air flow is directed to the floor and the windshield with a small amount directed to the side window defrosters.

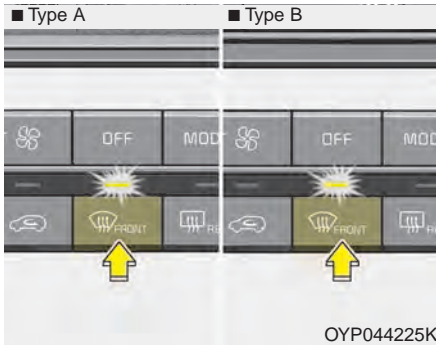

Defrost-Level

Most of the air flow is directed to the windshield with a small amount of air directed to the side window defrosters.



Instrument panel vents

The outlet vents can be opened or closed separately using the thumb-wheel (if equipped).

Also, you can adjust the direction of air delivery from these vents using the vent control lever as shown.

Temperature control

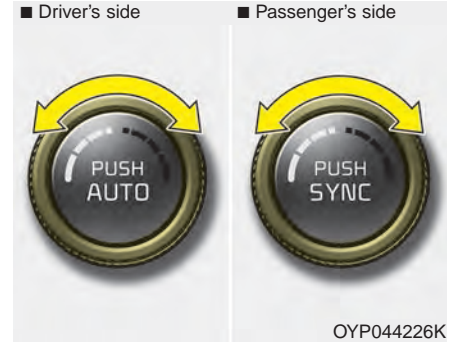

The temperature will increase to the maximum (HI) by turning the knob to the extreme right.

The temperature will decrease to the minimum (Lo) by turning the knob to the extreme left.

When turning the knob, the temperature will increase or decrease by 1°F/0.5°C. When set to the lowest temperature setting, the air conditioning will operate continuously.



Adjusting the driver and passenger side temperature equally

1. Press the SYNC button to activate SYNC mode. The passenger side temperature will be set to the same temperature as the driver side.
2. Operate the driver side temperature control knob. The driver and passenger side temperature will be adjusted equally.

Adjusting the driver and passenger side temperature individually

1. Press the SYNC button again to operate the driver and passenger side temperature individually. Also, if the passenger side temperature control knob is operated, it will individually.
2. Operate the left temperature control to adjust the driver side temperature. Operate the right side temperature control to adjust the passenger side temperature.

When the driver side temperature is set to the highest (HI) or lowest (Lo) temperature setting, the SYNC mode is deactivated for maximum heating or cooling.

Temperature conversion

You can switch the temperature mode from Centigrade to Fahrenheit as follows:

While pressing the OFF button, press the AUTO button for 3 seconds or more.

The display will change from Centigrade to Fahrenheit, or from Fahrenheit to Centigrade.

If the battery has been discharged or disconnected, the temperature mode display will reset to Fahrenheit.

Outside thermometer



OYP044311N



OYP044310N



OYP044309N

The current outside temperature is displayed in 1°F (1°C) increments. The temperature range is between -40°F ~ 140°F (-40°C ~ 60°C).

- The outside temperature on the display may not change immediately like a general thermometer to prevent the driver from being inattentive.

Air intake control

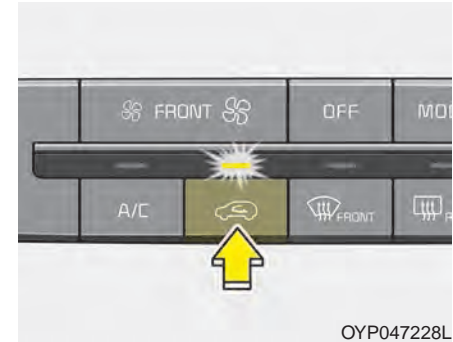

OYP047228L

This is used to select the outside (fresh) air position or recirculated air position.

To change the air intake control position, push the control button.

Recirculated air position



With the recirculated air position selected, air from the passenger compartment will be drawn through the heating system and heated or cooled according to the function selected.

Outside (fresh) air position



With the outside (fresh) air position selected, air enters the vehicle from outside and is heated or cooled according to the function selected.

Prolonged operation of the heater in the recirculated air position (without air conditioning selected) may cause fogging of the windshield and side windows and the air within the passenger compartment may become stale.

In addition, prolonged use of the air conditioning with the recirculated air position selected will result in excessively dry air in the passenger compartment.

Sunroof Inside Air Recirculation (if equipped)

When the heater or air conditioning system is on with the sunroof opened, the outside (fresh) air position will be automatically selected. At this time, if you press the recirculated air position button, the recirculated air position will be selected but will change back to the outside (fresh) air position after 3 minutes.

When the sunroof is closed, the air intake position will return to the original position that was selected.

⚠ WARNING - Reduced visibility

Continued use of the climate control system in the recirculated air position may allow humidity to increase inside the vehicle which may fog the glass and obscure visibility.

⚠ WARNING - Sleeping with AC on

Do not sleep in a vehicle with the air conditioning or heating system on as this may cause serious harm or death due to a drop in the oxygen level and/or body temperature.

⚠ WARNING - Recirculated air

Continued use of the climate control system in the recirculated air position can cause drowsiness or sleepiness, and loss of vehicle control. Set the air intake control to the outside (fresh) air position as much as possible while driving.

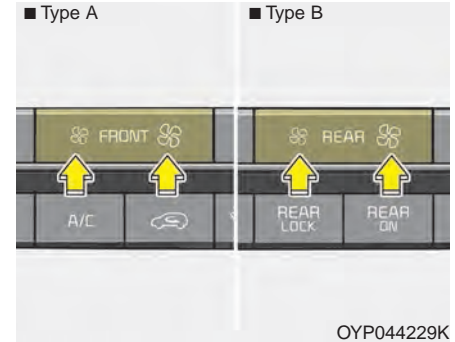
Fan speed control

The fan speed can be set to the desired speed by operating the fan speed control button.

To change the fan speed, press (♣) the button for higher speed, or push (♣) the button for lower speed. To turn the fan speed control off, press the front blower OFF button.

Air conditioning

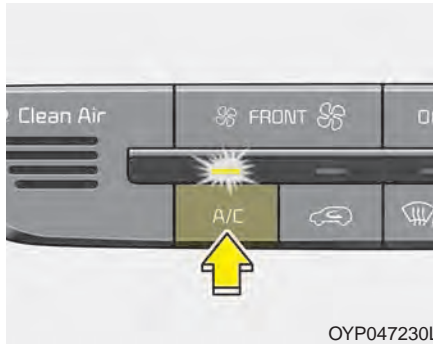

Press the A/C button to turn the air conditioning system on (indicator light will illuminate).

Press the button again to turn the air conditioning system off.

OFF mode

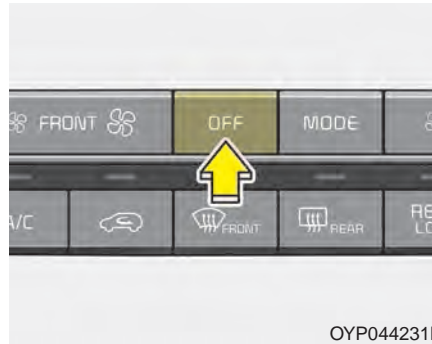

Press the front blower OFF button to turn off the front air climate control system. However, you can still operate the mode and air intake buttons as long as the ignition switch is in the ON position.

Climate information screen selection (for Type B)



Press the climate information screen selection button to display climate information on the screen.

■ Rear



1. Rear temperature control button
2. Rear AUTO button
3. Rear mode selection button

4. Rear air conditioning OFF button
5. Rear fan speed control button

OYP044234K

Rear climate control (if equipped)

To turn on the rear climate control system;

From the front seat

1. Set the rear climate control selection (REAR ON) button in the front climate control panel to the ON position.
2. Set the rear fan speed control button in the front climate control panel to the desired position.
3. Set the rear temperature control knob in the front climate control panel to the desired position. (if equipped)

From the rear seat

1. Set the rear climate control selection (REAR ON) button in the front climate control panel to the ON position.
2. Set the rear climate control selection (REAR LOCK) button in the front climate control panel to the OFF position.
3. Set the rear fan speed control button on the rear climate control panel to the desired position.
4. Set the rear temperature control button on the rear climate control panel to the desired position.
5. Select the desired rear mode button on the rear climate control panel. (if equipped)
6. To turn off the rear air conditioning system press the off button in the rear climate control panel.

Rear fan speed control

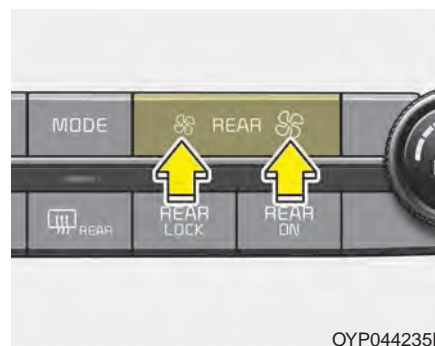

From front seat

Set the rear climate control selection (REAR ON) button to the ON position and press the rear fan speed control button in the front climate control panel to the desired position. To change the fan speed, press (♣) the button for higher speed, or press the (♣) the button for lower speed. To turn the fan speed control off, press the REAR ON button.

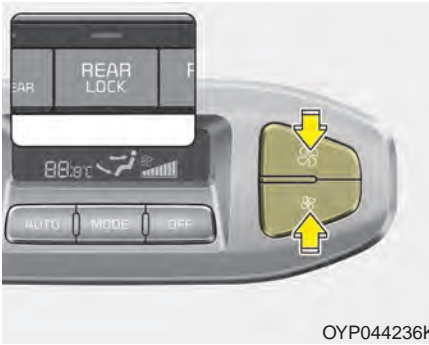

From rear seat (if equipped)

Set the rear climate control selection (REAR ON) button in the front climate control panel to the ON position and set the rear climate control selection (REAR LOCK) button in the front climate control panel to the OFF position and press the rear fan speed control button on the rear control panel to the desired position.

To change the fan speed, press (♣) the button for higher speed, or press the (♣) the button for lower speed. To turn the fan speed control off, press the rear blower OFF button.

Rear temperature control



From front seat

Set the rear climate control selection (REAR ON) button to the ON position and press the rear fan speed control button in the front climate control panel to the desired position. To change the rear air temperature, turn the knob to the right position for warm and hot air or left position for cooler air.







From rear seat

Set the rear climate control selection (REAR ON) button in the front climate control panel to the ON position and set the rear climate control selection (REAR LOCK) button in the front climate control panel to the OFF position and press the rear fan speed control button on the rear control panel to the desired position.

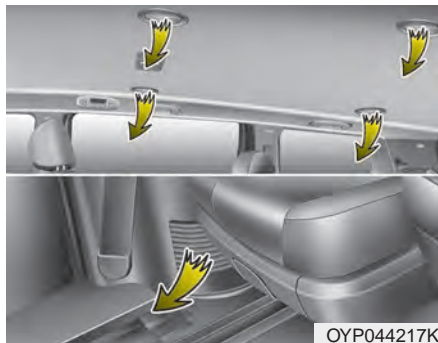
To change the rear air temperature, press the button (^) for warmer air or press the button (v) for cooler air.



Rear mode selection (if equipped)



- Front climate control is  : Rear air blows from the upper vents on the rear ceiling.
- Front climate control is  : Rear air blows from the upper vents on the rear ceiling and the lower vents on the right rear trim together.
- Front climate control is  ,  : Rear air blows from the lower vents on the right rear trim together.



When the rear climate control selection (REAR ON) button in the front climate control panel is in the ON position and set the rear climate control selection (REAR LOCK) button in the front climate control panel to the OFF position and the rear mode is selected by pushing the rear mode selection button on the rear control panel as follows:

-  : Rear air blows from the upper vents on the rear ceiling.
-  : Rear air blows from the upper vents on the rear ceiling and the lower vents on the right rear trim together.
-  : Rear air blows from the lower vents on the right rear trim.

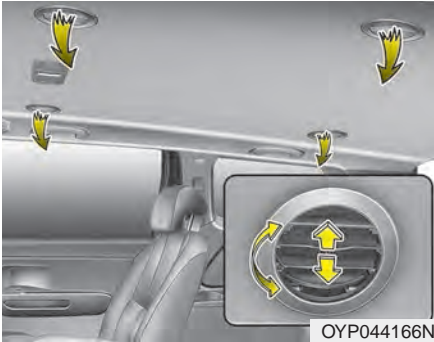
Rear vents

The vent can be adjusted by rotating the blade.



*** NOTICE**

If all the vents are closed, it may cause some noise. Always open 2 vents or more.

System operation**Ventilation**

1. Set the mode to the  position.
2. Set the air intake control to the outside (fresh) air position.
3. Set the temperature control to the desired position.
4. Set the fan speed control to the desired speed.

Heating

1. Set the mode to the  position.
 2. Set the air intake control to the outside (fresh) air position.
 3. Set the temperature control to the desired position.
 4. Set the fan speed control to the desired speed.
 5. If dehumidified heating is desired, turn the air conditioning system (if equipped) on.
- If the windshield fogs up, set the mode to the  or  position.

Operation Tips

- To keep dust or unpleasant fumes from entering the vehicle through the ventilation system, temporarily set the air intake control to the recirculated air position. Be sure to return the control to the fresh air position when the irritation has passed to keep fresh air in the vehicle. This will help keep the driver alert and comfortable.
- Air for the heating/cooling system is drawn in through the grilles just ahead of the windshield. Care should be taken that these are not blocked by leaves, snow, ice or other obstructions.
- To prevent interior fog on the windshield, set the air intake control to the fresh air position and fan speed to the desired position, turn on the air conditioning system, and adjust the temperature control to desired temperature.

Air conditioning (if equipped)

Air Conditioning System in this vehicle is filled with R-134a refrigerant.

1. Start the engine. Press the air conditioning button.
 2. Set the mode to the  position.
 3. Set the air intake control to the outside air or recirculated air position.
 4. Adjust the fan speed control and temperature control to maintain maximum comfort.
- When maximum cooling is desired, set the temperature control to the extreme left position, set the mode control to the MAX A/C position, then set the fan speed control to the highest speed.

 **CAUTION - Excessive A/C**
When using the air conditioning system, monitor the engine coolant closely while driving up hills or in heavy traffic when outside temperatures are high. Air conditioning system operation may cause engine overheating and potential engine damage. Continue to use the blower fan but turn the air conditioning system off if the engine coolant temperature gauge indicates engine overheating.

Air conditioning system operation tips

- If the vehicle has been parked in direct sunlight during hot weather, open the windows for a short time to let the hot air inside the vehicle escape.
- To help reduce moisture inside of the windows on rainy or humid days, decrease the humidity inside the vehicle by operating the air conditioning system.
- During air conditioning system operation, you may occasionally notice a slight change in engine speed as the air conditioning compressor cycles. This is a normal system operation characteristic.
- Use the air conditioning system every month only for a few minutes to ensure maximum system performance.

- When using the air conditioning system, you may notice clear water dripping (or even puddling) on the ground under the passenger side of the vehicle. This is a normal system operation characteristic.
- Operating the air conditioning system in the recirculated air position provides maximum cooling, however, continual operation in this mode may cause the air inside the vehicle to become stale.
- During cooling operation, you may occasionally notice a misty air flow because of rapid cooling and humid air intake. This is a normal system operation characteristic.

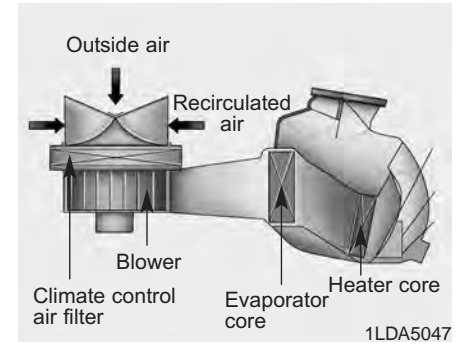
Climate control air filter (if equipped)

The climate control air filter installed behind the glove box filters the dust or other pollutants that come into the vehicle from the outside through the heating and air conditioning system. If dust or other pollutants accumulate in the filter over a period of time, the air flow from the air vents may decrease, resulting in moisture accumulation on the inside of the windshield even when the outside (fresh) air position is selected. If this happens, have the climate control air filter replaced by an authorized Kia dealer.

*** NOTICE**

- Replace the filter every 15,000 miles or once a year. If the vehicle is being driven in severe conditions such as dusty or rough roads, more frequent air conditioner filter inspections and changes are required.
- When the air flow rate suddenly decreases, the system should be checked at an authorized Kia dealer.

Checking the amount of air conditioner refrigerant and compressor lubricant

When the amount of refrigerant is low, the performance of the air conditioning is reduced. Overfilling also has a negative impact on the air conditioning system.

Therefore, if abnormal operation is found, have the system inspected by an authorized Kia dealer.

 **WARNING - AC Repair**
The oil and refrigerant in your vehicle's air conditioning system is under very high pressure. If proper service procedures are not followed an explosion may result. To reduce the risk of serious injury or death, the air conditioning system in your vehicle should only be serviced by trained and certified technicians.

 **CAUTION - AC Repair**
It is important that the correct type and amount of oil and refrigerant is used, otherwise damage to the vehicle may occur. To prevent damage, the air conditioning system in your vehicle should only be serviced by trained and certified technicians.

Air Conditioning refrigerant label

■ Example

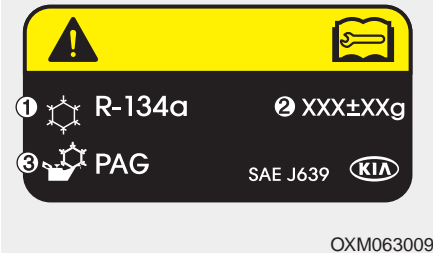

* The actual Air Conditioning refrigerant label in the vehicle may differ from the illustration.



Each symbols and specification on air conditioning refrigerant label means as below ;

1. Classification of refrigerant
2. Amount of refrigerant
3. Classification of Compressor Lubricant

Refer to chapter 8 for more detail location of air conditioning refrigerant label.

WINDSHIELD DEFROSTING AND DEFOGGING

⚠ WARNING - Windshield heating



Do not use the  or  position during cooling operation in extremely humid weather. The difference between the temperature of the outside air and the windshield could cause the outer surface of the windshield to fog up, causing loss of visibility. In this case, set the mode selection to the  position and fan speed control to the lower speed.

- For maximum defrosting, set the temperature control to the extreme right/hot position and the fan speed control to the highest speed.
- If warm air to the floor is desired while defrosting or defogging, set the mode to the floor-defrost position.
- Before driving, clear all snow and ice from the windshield, rear window, outside rear view mirrors, and all side windows.
- Clear all snow and ice from the hood and air inlet in the cowl grill to improve heater and defroster efficiency and to reduce the probability of fogging up the inside of the windshield.

Manual climate control system

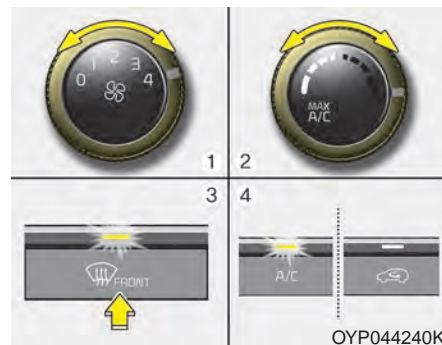
To defog inside windshield



1. Set the fan speed to the desired position.
2. Select desired temperature.
3. Select the  or  position.
4. The outside (fresh) air and air conditioning will be selected automatically.

If the air conditioning and/or outside (fresh) air position are not selected automatically, press the corresponding button manually.

To defrost outside windshield

1. Set the fan speed to the highest position.
2. Set the temperature to the extreme hot position.
3. Select the position.
4. The outside (fresh) air and air conditioning will be selected automatically.

If the air conditioning is not selected automatically press the corresponding button manually.

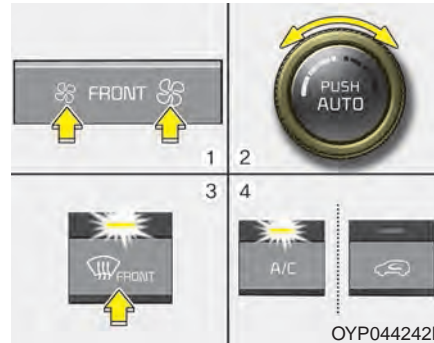
Automatic climate control system**To defog inside windshield**

1. Set the fan speed to the desired position.
2. Select desired temperature.
3. Press the defroster button ().
4. The outside (fresh) air position will be selected automatically and the air conditioning will turn on according to the detected ambient temperature.

If the air conditioning and outside (fresh) air position are not selected automatically, adjust the corresponding button manually. If the position is selected, lower fan speed is adjusted to a higher fan speed.

To defrost outside windshield

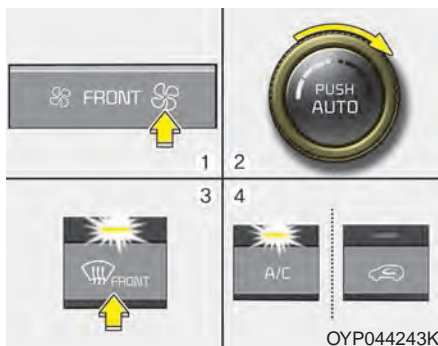

1. Set the fan speed to the highest position.
2. Set the temperature to the extreme hot (HI) position.
3. Press the defroster button (❄️).
4. The outside (fresh) air position will be selected automatically and the air conditioning will turn on according to the detected ambient temperature.

Defogging logic

To reduce the possibility of fogging up the inside of the windshield, the air intake or air conditioning is controlled automatically according to certain conditions such as 🧑‍🦺 or 🧑‍🦺. To cancel or return to the defogging logic, do the following.

Manual climate control system

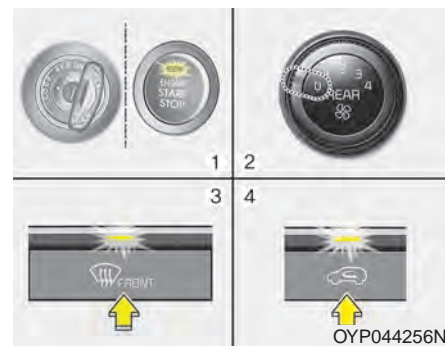

1. Turn the ignition switch to the ON position.
2. Turn the fan speed control knob to the OFF (0) position.
3. Turn the mode selection knob to the defrost position (❄️).
4. Push the air intake control button (🚗) at least 5 times within 3 seconds.

If the battery has been discharged or disconnected, it resets to the defog logic status.

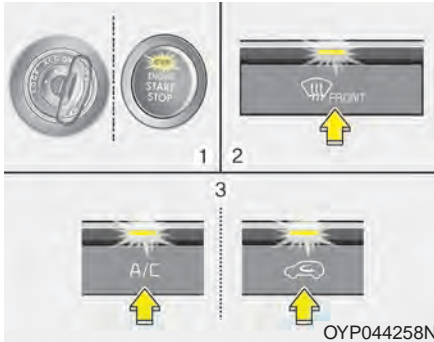
Automatic climate control system

1. Turn the ignition switch to the ON position.
2. Select the defroster position pressing the defroster button (with a windshield icon).
3. While pressing the air conditioning button (A/C), press the air intake control button at least 5 times within 3 seconds.

The recirculation indicator blinks 3 times with 0.5 second of interval. It indicates that the defogging logic is canceled or returned to the programmed status.

If the battery has been discharged or disconnected, it resets to the defog logic status.

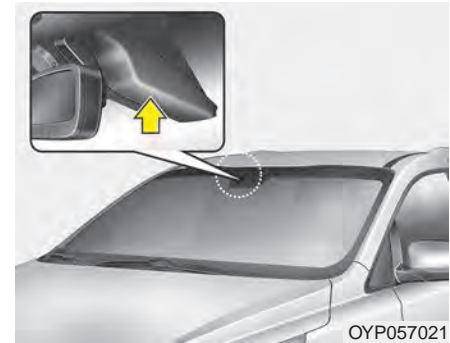
Auto defogging system (if equipped)

Auto defogging reduces the probability of fogging up the inside of the windshield by automatically sensing the moisture of inside the windshield. The auto defogging system operates when the heater or air conditioning is on.



This indicator illuminates when the auto defogging system senses the moisture of inside the windshield and operates.

If more moisture is in the vehicle, higher steps operate as follow. For example if auto defogging does not defog inside the windshield at step 1 Outside air position, it tries to defog again at step 2 Blowing air toward the windshield.

Step 1 : Outside air position

Step 2 : Blowing air toward the windshield

Step 3 : Increasing air flow toward the windshield

Step 4 : Operating the air conditioning

Step 5 : Maximizing the air conditioning

To cancel or reset the Auto Defogging System

Press the front windshield defroster button for 3 seconds when the ignition switch is in the ON position.

When the ADS system is canceled, [ADS OFF] symbol will blink 3 times per 1 sec and the position [ADS OFF] will be displayed on the climate control information screen. (A TYPE)

When the ADS system is canceled, Indicator on the button will blink 3 times per 0.5 sec. (B TYPE)

When the ADS system is reset, [ADS OFF] symbol will blink 6 times per 0.5sec and the position [ADS OFF] will be disappeared on the climate control information screen. (A TYPE)

When the ADS system is reset, Indicator on the button will blink 6 times per 0.25 sec. (B TYPE)

* NOTICE

If the A/C off or recirculated air position is manually selected while the auto defogging system is on, the auto defogging indicator will blink 3 times to give notice that manual operation is canceled.

Do not remove the sensor cover located on the upper end of the passenger side windshield glass. Damage to the system parts could occur and may not be covered by your vehicle warranty.

CLEAN AIR (IF EQUIPPED)



When the ignition switch is in the ON position, the clean air function turns on automatically.

Also, the clean air function turns off automatically, when the ignition switch turns to the OFF position.

STORAGE COMPARTMENTS

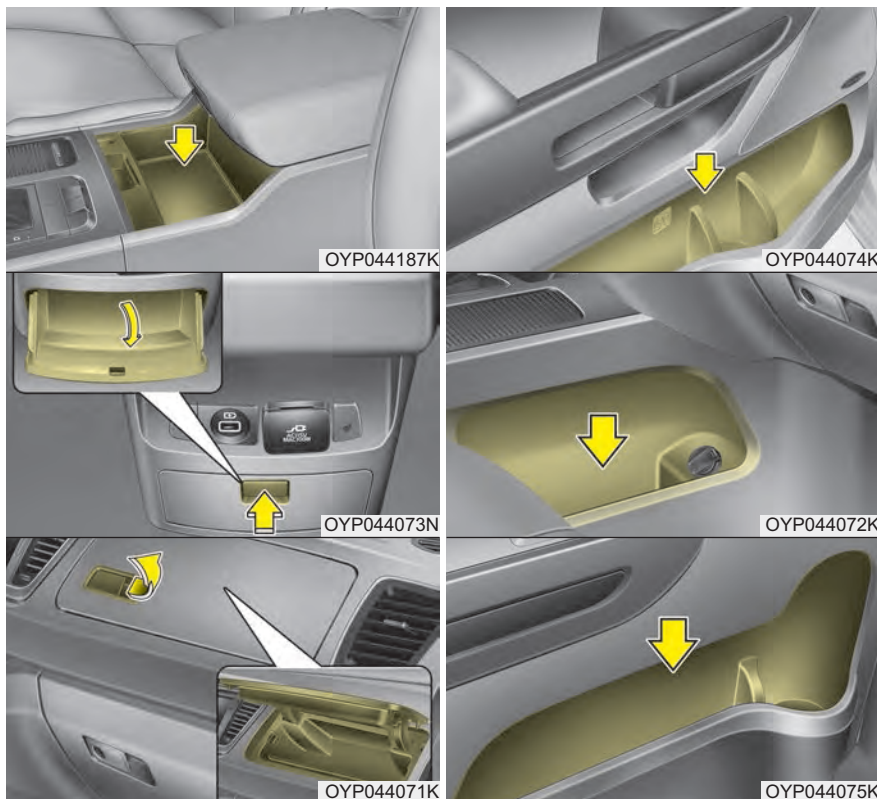

These compartments can be used to store small items required by the driver or passengers.

- To avoid possible theft, do not leave valuables in the storage compartment.
- Always keep the storage compartment covers closed while driving. Do not attempt to place so many items in the storage compartment that the storage compartment cover can not close securely.

⚠ WARNING - Flammable materials

Do not store, propane cylinders or other flammable/explosive materials in the vehicle. These items may catch fire and/or explode if the vehicle is exposed to hot temperatures for extended periods.

Center console storage

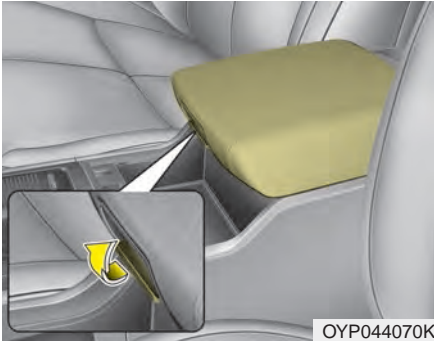

To open the center console storage, pull up the lever.

Center console sliding tray removal procedure

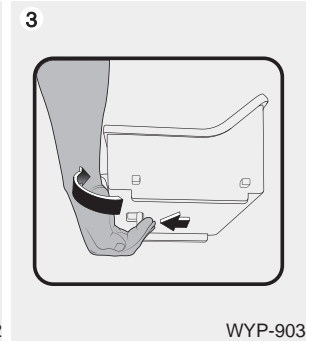

- ① Pull down the knob to slide the sliding tray.
- ② Check the lever located on the floor of the sliding tray and pull on the lever securely.
- ③ While pulling on the lever, remove the sliding tray.

Glove box

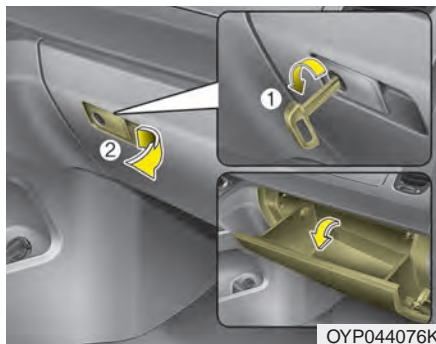

The glove box can be locked and unlocked with a master key. (if equipped)

To open the glove box, pull the handle and the glove box will automatically open. Close the glove box after use.

⚠ WARNING
To reduce the risk of injury in an accident or sudden stop, always keep the glove box door closed while driving.

*** NOTICE**
If the temperature control knob is in the warm or hot position, warm or hot air will flow into the glove box.

Sunglass holder

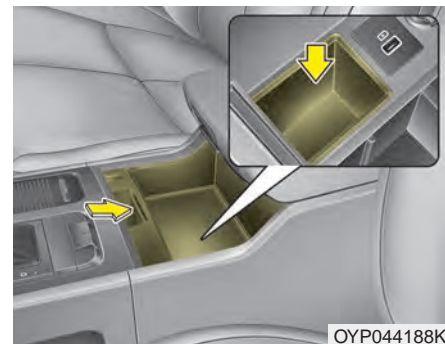

To open the sunglasses holder, move the sliding storage to backward.

INTERIOR FEATURES

Cup holder

⚠ WARNING - Hot liquids

Do not place uncovered cups with hot liquid in the cup holder while the vehicle is in motion. If the hot liquid spills, you may burn yourself. Such a burn to the driver could lead to loss of control of the vehicle.

* NOTICE

- Keep your drinks sealed while driving to prevent spilling your drink. If liquid spills, it may get into the vehicle's electrical/electronic system and damage electrical/electronic parts.
- When cleaning spilled liquids, do not dry the cup holder at high temperature. This may damage the cup holder.

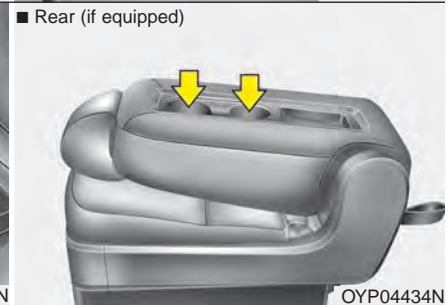
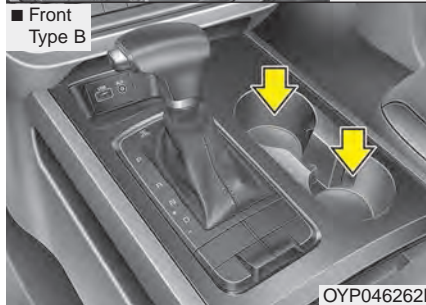
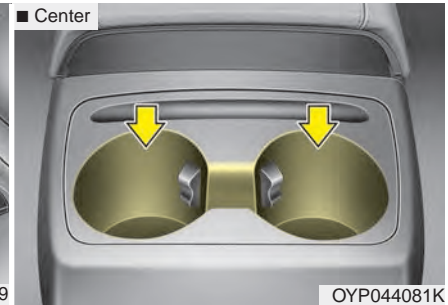
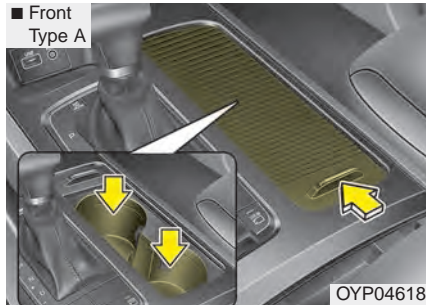

Cups or small beverage cans may be placed in the cup holders.

Bottle holder

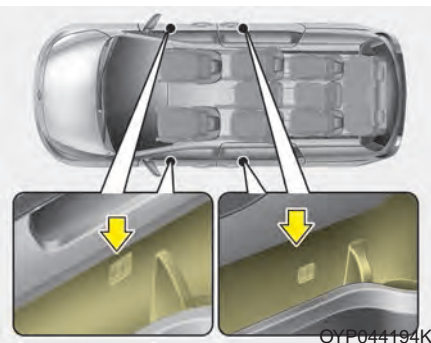

Bottles may be placed in the holder.

* NOTICE

Only bottles should be placed in the holder as it is written in the vehicle "BOTTLE ONLY".

Seat warmer (if equipped)

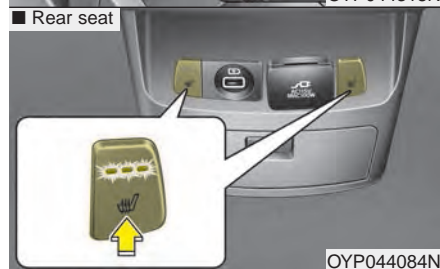
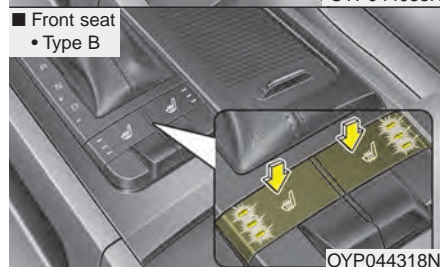
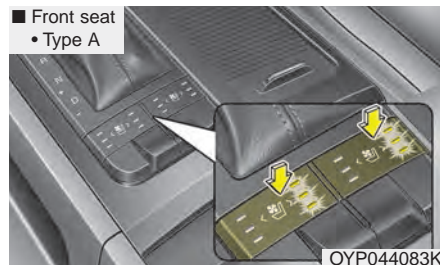

The seat warmer is provided to warm the front seats during cold weather. With the ignition switch in the ON position, push either of the switches to warm the driver's seat or the front passenger's seat.

During mild weather or under conditions where the operation of the seat warmer is not needed, keep the switches in the "OFF" position.

- Each time you press the switch, the temperature setting of the seat will change as follows :

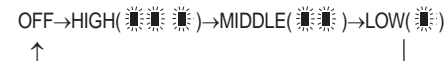

- The seat warmer defaults to the OFF position whenever the ignition switch is turned on.

* NOTICE

With the seat warmer switch in the ON position, the heating system in the seat turns off or on automatically depending on the seat temperature.

⚠ WARNING - Seat heater burns

The seat warmer may cause burns, even at low temperatures, if used over a long period of time. Never allow passengers who may not be able to take care of themselves to be exposed to the risk of seat heater burns. These include:

1. Infants, children, elderly or disabled persons, or hospital outpatients
2. Persons with sensitive skin or those that burn easily
3. Fatigued individuals
4. Intoxicated individuals
5. Individuals taking medication that can cause drowsiness or sleepiness (sleeping pills, cold tablets, etc.)

Air ventilation seat (if equipped)

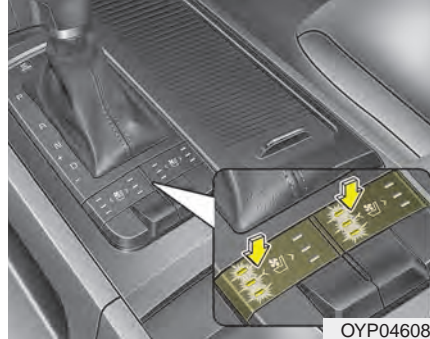

The temperature setting of the seat changes according to the switch position.

- If you want to cool your seat cushion, press the switch (blue color).
- Each time you press the button, the airflow will change as follows:

OFF → HIGH (☀☀☀☀) → MIDDLE (☀☀☀) → LOW (☀☀)
 ↑

- The seat warmer (with air ventilation) defaults to the OFF position whenever the ignition switch is turned on.

⚠ CAUTION - Seat damage

- *When cleaning the seats, do not use an organic solvent such as paint thinner, benzene, alcohol and gasoline. Doing so may damage the air ventilation seat.*
- *Do not place heavy or sharp objects on the seat. Those things may damage the air ventilation seat.*
- *Be careful not to spill liquid such as water or beverages on the seat. If you spill some liquid, wipe the seat with a dry towel. Before using the air ventilation seat, dry the seat completely.*

*** NOTICE**

For best seat cooling results, use with air-conditioning.

Sunvisor

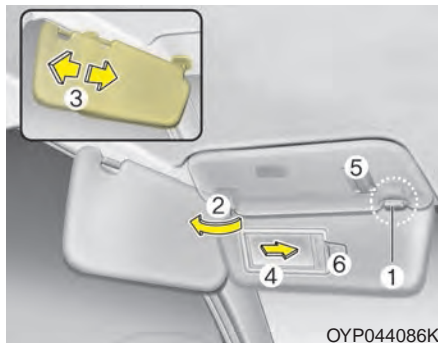

OYP044086K

Use the sunvisor to shield direct light through the front or side windows.

To use the sunvisor, pull it downward.

To use the sunvisor for the side window, pull it downward, unsnap it from the bracket (1) and swing it to the side (2).

Adjust the sunvisor extension forward or backward (3). (if equipped)

To use the vanity mirror, pull down the visor and slide the mirror cover (4).

The ticket holder (5) is provided for holding a tollgate ticket. (if equipped)

* The actual sunvisor lamp in the vehicle may differ from the illustration.

CAUTION - Vanity mirror lamp

If you use the vanity mirror lamp, turn off the lamp before returning the sunvisor to its original position, otherwise it could result in battery discharge and possible sunvisor damage.

Power outlet

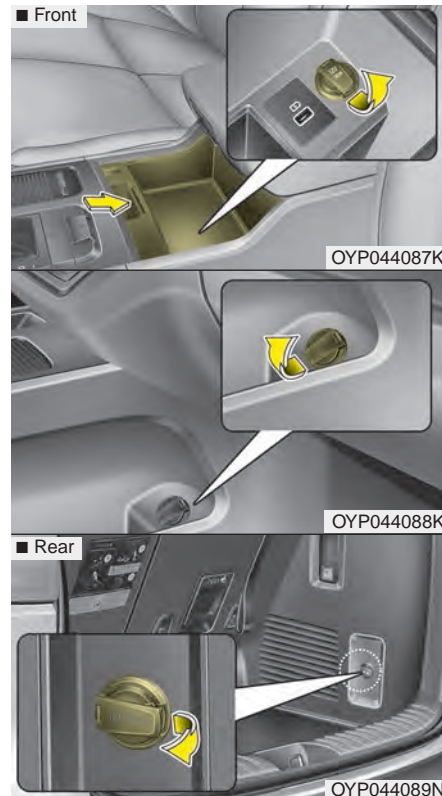

OYP044087K

OYP044088K

OYP044089N

The power outlet is designed to provide power for mobile telephones or other devices designed to operate with vehicle electrical systems. The devices should draw less than 10 amps with the engine running.

- Use the power outlet only when the engine is running and remove the accessory plug after use. Using the accessory plug for prolonged periods of time with the engine off could cause the battery to discharge.
- Only use 12V electric accessories which are less than 10A in electric capacity.
- Adjust the air-conditioner or heater to the lowest operating level when using the power outlet.
- Close the cover when not in use.
- Some electronic devices can cause electronic interference when plugged into a vehicle's power outlet. These devices may cause excessive audio static and malfunctions in other electronic systems or devices used in your vehicle.

⚠ WARNING - Electric shock
Do not put a finger or a foreign element (pen, etc.) into a power outlet and do not touch with a wet hand. You may get an electric shock.

AC inverter (if equipped)

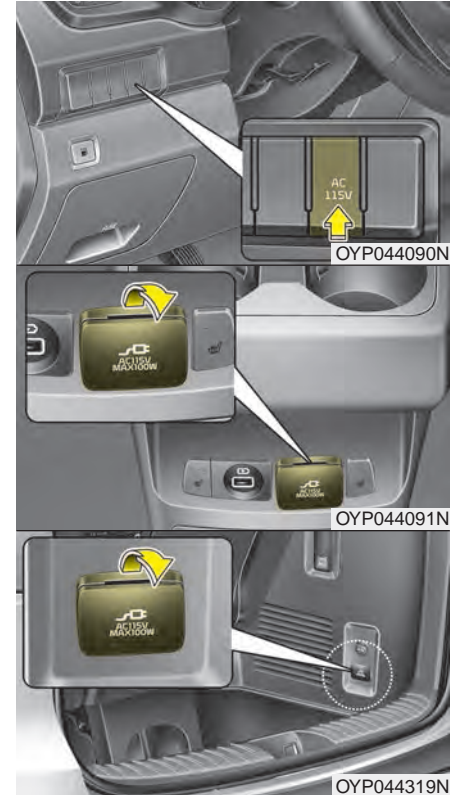

The AC inverter supplies 115V/100W electric power to operate electric accessories or equipments.

If you wish to use the AC inverter, press the AC inverter button while the engine is running. The light on the AC inverter button will illuminate.

If you press the AC inverter button again, the AC inverter will be deactivated and the light on the AC inverter button will turn off.

* NOTICE

When turning on the AC inverter, the indicator on the AC inverter button illuminates late while the system conducts a self-check.

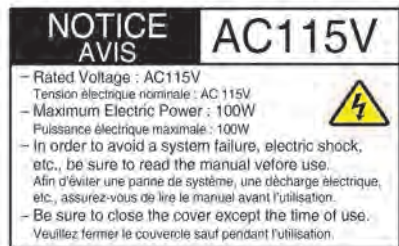

OYP074067N

* NOTICE

- **Rated voltage : AC 115V**
- **Maximum electric power : 100W**
- **In order to avoid an electrical system failure, electric shock, etc., be sure to read owner's manual before use.**
- **Be sure to close the cover except the time of use.**

- To prevent the battery from being discharged, do not use the AC inverter while the engine is not running.
- When not using the AC inverter, make sure to turn off the AC inverter (the indicator on the button does not illuminate) and close the AC inverter cover.
- After using an electric accessory or equipment, pull the plug out. Leaving the accessory or equipment plugged in for a long time may cause battery discharge.
- Do not use an electric accessory or equipment the power consumption of which is greater than 100W (115V).

- While the power consumption of some electrical devices/appliances may be within the AC inverter's electric power range, it may malfunction in below cases.
 - If the device/appliance requires high electric power for initial start up
 - If the device/appliance processes precise/very accurate data
 - If the device/appliance requires very stable supply of electricity

⚠ CAUTION - Electric accessory devices

- **Do not use broken electric accessories which may damage the AC inverter and electrical systems of the vehicle.**
- **Do not use two or more electric accessories at the same time. It may cause damage to the electrical systems of the vehicle.**

USB charger (if equipped)

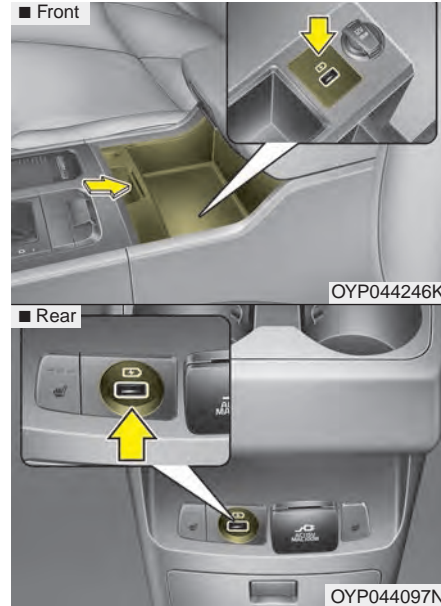

The USB charger is designed to recharge batteries of small size electrical devices using a USB cable. The electrical devices can be recharged when the Engine Start/Stop button is in ACC/ON/START position.

The battery charging state may be monitored on the electrical device. Disconnect the USB cable from the USB port after use.

- Some devices are not supported for fast charging but will be charged with normal speed.
- Use the USB charger when the engine is running to prevent battery discharge.
- Only devices that fits the USB port can be used.
- The USB charger can be used only for battery charging purposes.
- Battery chargers cannot be charged.

Clock (if equipped)



Hour (1)

Pressing the H button will advance the time displayed by one hour.

Minute (2)

Pressing the M button will advance the time displayed by one minute.

To change the 24 hour format to the 12 hours format (if equipped), while pressing the “H” button, press the “M” button for 3 seconds or more. For example, if the “H” and “M” buttons are pressed for more than 3 seconds while the time is 22:15, the display will change to 10:15.

Coat hook (if equipped)

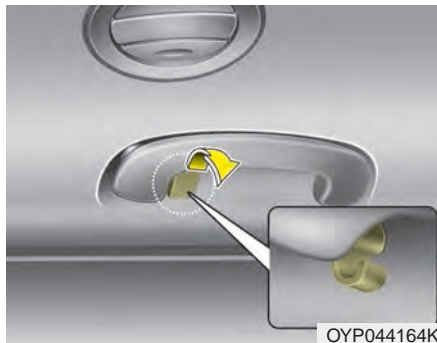

* This actual feature may differ from the illustration.

To use the coat hook, pull down the upper portion of hanger.

⚠ CAUTION - Hanging clothing

Do not hang heavy clothes, since those may damage the hook.

⚠ WARNING

Do not hang other objects such as hangers or hard objects except clothes. Also, do not put heavy, sharp or breakable objects in the clothe pockets. In an accident or when the curtain air bag is inflated, it may cause vehicle damage or personal injury.

Floor mat anchor (s) (if equipped)

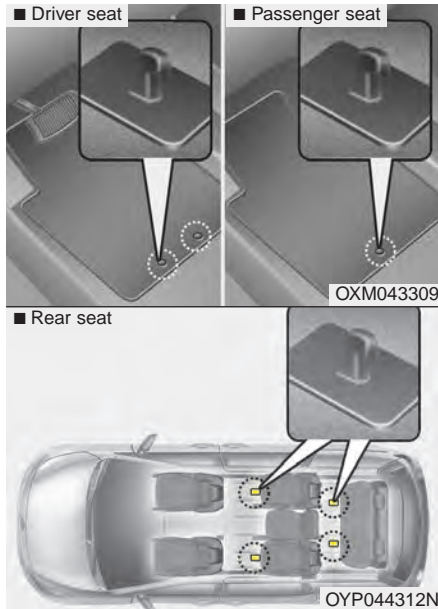

When using a floor mat on the front floor carpet, make sure it attaches to the floor mat anchor(s) in your vehicle. This keeps the floor mat from sliding forward.

The following must be observed when installing ANY floor mat to the vehicle.

- Ensure that the floor mats are securely attached to the vehicle's floor mat anchor(s) before driving the vehicle.
- Do not use ANY floor mat that cannot be firmly attached to the vehicle's floor mat anchors.
- Do not stack floor mats on top of one another (e.g. all-weather rubber mat on top of a carpeted floor mat). Only a single floor mat should be installed in each position.

IMPORTANT – Your vehicle was manufactured with driver's side floor mat anchors that are designed to securely hold the floor mat in place. To avoid any interference with pedal operation, Kia recommends that only the Kia floor mat designed for use in your vehicle be installed.

Side curtain (if equipped)

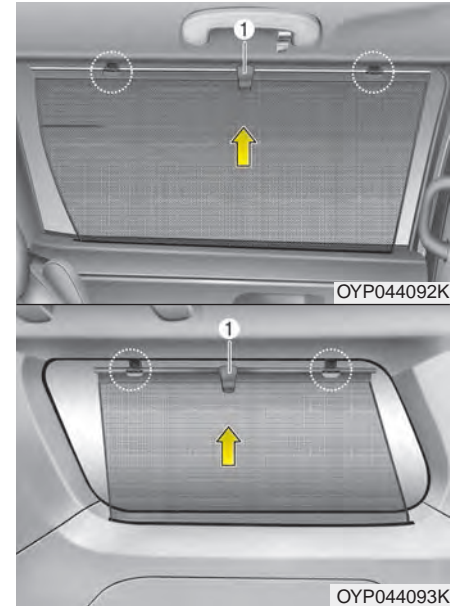

To use the side curtain:

1. Lift the curtain by the handle (1).
2. Hang the curtain on the hooks on both sides of the handle.

To avoid injury or damage to the side curtain and door moldings, lower side curtain by the handle all the way back to the stowed position. Do not release handle after disengaging from the hooks on the door.

EXTERIOR FEATURES

Roof rack (if equipped)



If the vehicle has a roof rack, you can load cargo on top of your vehicle.

* NOTICE

If the vehicle is equipped with a sunroof, be sure not to position cargo onto the roof rack in such a way that it could interfere with sunroof operation.

* NOTICE

- When carrying large objects on the roof rack, make sure they do not exceed the overall roof length or width.
- When you are carrying cargo on the roof rack, do not operate the sunroof (if equipped).

- The following specification is the maximum weight that can be loaded onto the roof rack. Distribute the load as evenly as possible on the roof rack and secure the load firmly.

ROOF RACK	220 lbs. (100 kg) EVENLY DISTRIBUTED
-----------	---

Loading cargo or luggage in excess of the specified weight limit on the roof rack may damage your vehicle.

⚠ WARNING - Driving with roof load

Always drive slow and turn corners carefully when carrying items on the roof rack. The vehicle center of gravity will be higher when items are loaded onto the roof rack.

- Always drive slowly and turn corners carefully when carrying items on the roof rack. Severe wind updrafts, caused by passing vehicles or natural causes, can cause sudden upward pressure on items loaded on the roof rack. This is especially true when carrying large, flat items such as wood panels or mattresses. This could cause the items to fall off the roof rack and cause damage to your vehicle or others around you.
- To prevent damage or loss of cargo while driving, check frequently before or while driving to make sure the items on the roof rack are securely fastened.

AUDIO SYSTEM

* NOTICE

If you install an after market HID head lamp, your vehicle's audio and electronic device may malfunction.

Antenna



The shark fin antenna will receive the AM, FM broadcast signals and transmit data.

AUX, USB port

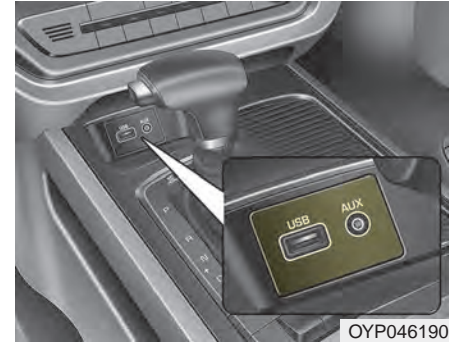

If your vehicle has an AUX and/or USB(universal serial bus) port, you can use an AUX port to connect audio devices and an USB and also an iPod®.

* NOTICE

When using a portable audio device connected to the power outlet, noise may occur during playback. If this happens, use the power source of the portable audio device.

⚠ WARNING - Distracted driving

Driving while distracted can result in a loss of vehicle control that may lead to an accident, severe personal injury, and death. The driver's primary responsibility is in the safe and legal operation of a vehicle, and use of any handheld devices, other equipment, or vehicle systems which take the driver's eyes, attention and focus away from the safe operation of a vehicle or which are not permissible by law should never be used during operation of the vehicle.

How vehicle audio works

FM reception

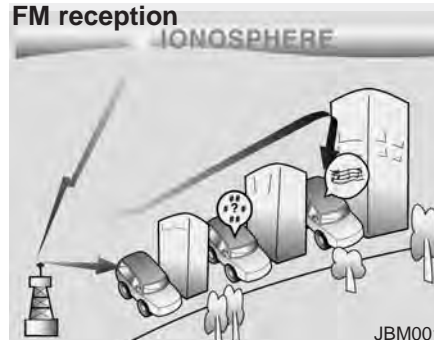

AM and FM radio signals are broadcast from transmitter towers located around your city. They are intercepted by the radio antenna on your vehicle. This signal is then processed by the radio and sent to your vehicle speakers.

However, in some cases the signal coming to your vehicle may not be strong and clear.

This can be due to factors, such as the distance from the radio station, closeness of other strong radio stations or the presence of buildings, bridges or other large obstructions in the area.

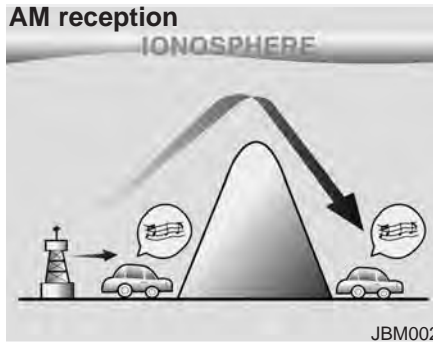

AM broadcasts can be received at greater distances than FM broadcasts. This is because AM radio waves are transmitted at low frequencies. These long distance, low frequency radio waves can follow the curvature of the earth rather than travelling straight. In addition, they curve around obstructions resulting in better signal coverage.



FM broadcasts are transmitted at high frequencies and do not bend to follow the earth's surface. Because of this, FM broadcasts generally begin to fade within short distances from the station. Also, FM signals are easily affected by buildings, mountains, and obstructions. This can lead to undesirable or unpleasant listening conditions which might lead you to believe a problem exists with your radio. The following conditions are normal and do not indicate radio trouble:

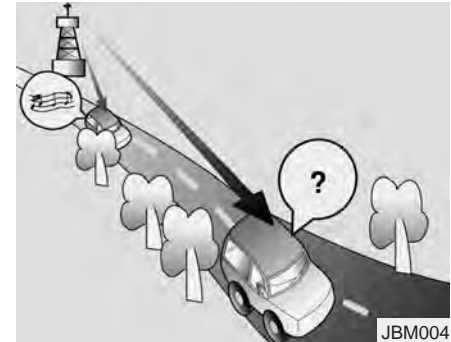

- **Fading** - As your vehicle moves away from the radio station, the signal will weaken and sound will begin to fade. When this occurs, we suggest that you select another stronger station.
- **Flutter/Static** - Weak FM signals or large obstructions between the transmitter and your radio can disturb the signal causing static or fluttering noises to occur. Reducing the treble level may lessen this effect until the disturbance clears.

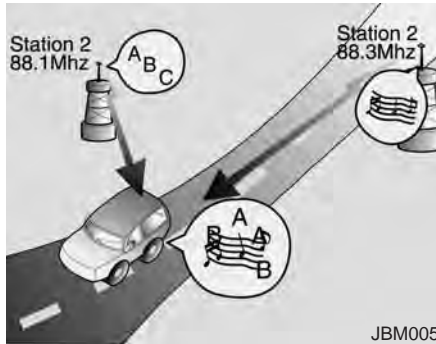

- **Station Swapping** - As an FM signal weakens, another more powerful signal near the same frequency may begin to play. This is because your radio is designed to lock onto the clearest signal. If this occurs, select another station with a stronger signal.
- **Multi-Path Cancellation** - Radio signals being received from several directions can cause distortion or fluttering. This can be caused by a direct and reflected signal from the same station, or by signals from two stations with close frequencies. If this occurs, select another station until the condition has passed.

Using a cellular phone or a two-way radio

When a cellular phone is used inside the vehicle, noise may be produced from the audio system. This does not mean that something is wrong with the audio equipment. In such a case, try to operate mobile devices as far from the audio equipment as possible.

When using a communication system such as a cellular phone or a radio set inside the vehicle, a separate external antenna must be fitted. When a cellular phone or a radio set is used with an internal antenna alone, it may interfere with the vehicle's electrical system and adversely affect safe operation of the vehicle.

⚠ WARNING - Antenna
Do not touch the antenna during thunder or lightning as such acts may lead to lightning induced electric shock.

iPod®

iPod® is a registered trademark of Apple Inc.

***Bluetooth®* Wireless Technology**

A compatible *Bluetooth®* Wireless Technology-enabled cell phone is required to use *Bluetooth®* Wireless Technology.

The Bluetooth® word mark and logos are registered trademarks owned by Bluetooth® SIG, Inc. and any use of such marks by Kia is under license.

Other trademarks and trade names are those of their respective owners.

A Bluetooth® enabled cell phone is required to use *Bluetooth®* Wireless Technology.

Pandora®

Pandora, the Pandora logo, and the Pandora trade dress are trademarks or registered trademarks of Pandora Media, Inc. Used with permission. Pandora is only available in certain countries.

Please visit <http://www.pandora.com/legal> for more information.



AUDIO (With Touch Screen)



(With *Bluetooth*[®] Wireless Technology)

A9H4G0000EU

Feature of Your Audio

Head unit



* The actual features in the vehicle may differ from the illustration.

(1) LCD screen

- Tap the screen to select a button.

(2) RADIO

- Start FM, AM and SiriusXM.

(3) MEDIA

- Select USB(iPod®), *Bluetooth*® Wireless Technology(BT) Audio, AUX, My Music or Pandora.
- Display the media menu when two or more media are connected or when the **[MEDIA]** button is pressed in media mode.

(4) PHONE

- Start *Bluetooth*® Wireless Technology Phone mode.

(5) POWER/VOL knob

- Turn to adjust the volume.
- Press to turn the device on or off.

(6) SEEK/TRACK

- Search for frequencies in radio mode.
- Change the current song in media mode.



(7) **RESET**

- Shutdown and restart the system.

(8) **DISP**

- Turn the display on or off.

(9) **MUTE**

- When the button is pressed, stops sound and  icon is displayed on LCD.

(10) **SETUP**

- Display, Sound, Bluetooth, System and Display Off settings.

(11) **TUNE** knob

- Turn to navigate through the stations/songs list.
- Press to select an item.

Steering wheel remote control

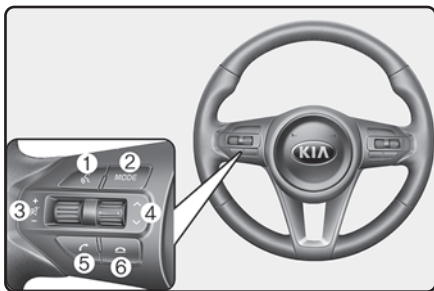

* The actual features in the vehicle may differ from the illustration.

(1) VOICE

- Pressing the button
 - If Siri is not active: Starts Siri.
 - If Siri is active: Re-starts Siri.
- Pressing and holding the button: Siri is deactivated.

(2) MODE

- Press the button to change the mode in the following order: Radio
→ Media.

(3) VOLUME

- Press to adjust the volume.

(4) UP/DOWN

- Press the button in radio mode to search Presets.
- Press and hold the button in radio mode to search frequencies.
- Press the button in media mode to change the current song.
- Press and hold the button in media mode to quick search through songs.

(5) CALL

- Pressing the button
 - If not in *Bluetooth*[®] Wireless Technology Handsfree mode or receiving a phone call
First press: Display Dial Number screen.
Second press: Automatically display the most recently Dialed call number.
Third press: Dial the phone number entered.

- Press in the Incoming Call notification screen to accept the phone call.
- Press in *Bluetooth*[®] Wireless Technology Handsfree mode to switch to the waiting call.
- Pressing and holding the button
 - If not in *Bluetooth*[®] Wireless Technology Handsfree mode or receiving a phone call, the most recently Dialed Call number is dialed.
 - Press in *Bluetooth*[®] Wireless Technology Handsfree mode to transfer the call to your cell phone.
 - Press in cell phone mode to switch to *Bluetooth*[®] Wireless Technology Handsfree mode.

(6) END

- Press in *Bluetooth*[®] Wireless Technology Handsfree mode to end the phone call.
- Press in the incoming call screen to reject the call.

⚠ WARNING

- Audio System Safety Warnings

- Do not stare at the screen while driving. Staring at the screen for prolonged periods of time could lead to traffic accidents.
- Do not disassemble, assemble, or modify the audio system. Such acts could result in accidents, fire, or electric shock.
- Using the phone while driving may lead to a lack of attention of traffic conditions and increase the likelihood of accidents. Use the phone feature after parking the vehicle.
- Exercise caution not to spill water or introduce foreign objects into the device. Such acts could lead to smoke, fire, or product malfunction.

(Continued)

(Continued)

- Please refrain from use if the screen is blank or no sound can be heard as these signs may indicate product malfunction. Continued use in such conditions could lead to accidents (fires, electric shock) or product malfunctions.
- Do not touch the antenna during thunder or lightening as such acts may lead to lightning induced electric shock.
- Do not stop or park in parking-restricted areas to operate the product. Such acts could lead to traffic accidents.

⚠ WARNING - Distracted Driving

Driving while distracted can result in a loss of vehicle control that may lead to an accident, severe personal injury, and death. The driver's primary responsibility is in the safe and legal operation of a vehicle, and use of any handheld devices, other equipment, or vehicle systems which take the driver's eyes, attention and focus away from the safe operation of a vehicle or which are not permissible by law should never be used during operation of the vehicle.

*** NOTICE**

- If you want to change the position of device installation, please inquire with your place of purchase or service maintenance center. Technical expertise is required to install or disassemble the device.
- Turn on the car ignition before using this device. Do not operate the audio system for long periods of time with the ignition turned off as such operations may lead to battery discharge.

**CAUTION**











- *Do not subject the device to severe shock or impact. Direct pressure onto the front side of the monitor may cause damage to the LCD or touch screen.*
- *When cleaning the device, make sure to turn off the device and use a dry and smooth cloth. Never use tough materials, chemical cloths, or solvents (alcohol, benzene, thinners, etc.) as such materials may damage the device panel or cause color/quality deterioration*
- *Do not place beverages close to the audio system. Spilling beverages may lead to system malfunction.*
- *Placing the audio system within an electromagnetic environment may result in noise interference.*

*** NOTICE**

In case of product malfunction, please contact your dealer or vehicle service center.

Information on status icons

Icons showing audio status are shown in the upper-right corner of the screen.

Icon	Description
	Mute Mute engaged
	Battery Remaining battery life of a connected <i>Bluetooth</i> ® Wireless Technology device
	Handsfree + Audio streaming connection <i>Bluetooth</i> ® Wireless Technology Handsfree call and audio streaming available
	Handsfree connection <i>Bluetooth</i> ® Wireless Technology Handsfree call available
	<i>Bluetooth</i> ® Wireless Technology audio streaming <i>Bluetooth</i> ® Wireless Technology audio streaming available
	Downloading contacts Downloading contacts through <i>Bluetooth</i> ® Wireless Technology wireless communications
	Downloading call history Downloading call history through <i>Bluetooth</i> ® Wireless Technology wireless communications
	Line busy Phone call in progress
	Mute mic Mic muted during a call (caller cannot hear your voice)
	Phone signal strength Display the phone signal strength for a cell phone connected by <i>Bluetooth</i> ® Wireless Technology

Radio

You can listen to FM, AM and SiriusXM radio.



(1) Band

Switch between FM, AM and SiriusXM.

(2) Presets

Change the preset number on the main screen.

(3) List

Display all available stations.

(4) Menu

Navigate to the menu screen.

(5) Presets 1~40

Save or listen to favorite stations.

Switching between FM, AM and SiriusXM

- Press the **[RADIO]** button on the audio system to switch between FM, AM and SiriusXM.
- Press the **[Band]** on the screen to switch between FM, AM and SiriusXM.

Searching frequencies

Searching frequencies by pressing the **[SEEK/TRACK]** button on the product.

< Presets >

By pressing [**< Presets >**], the buttons for Presets 1~40 displayed on the screen can be changed.

Presets 1~40

Press the button to listen to a preset.
Press and hold the button number to save the current station.

List

A list of all available stations is displayed. Press the desired station.

Favorite stations can be saved to **[Presets]** by pressing the **[+]**.

Menu

- **Presets:** Save up to 40 frequently used stations.

To listen to a preset, press the desired station.

Press and hold the desired slot from 1 through 40. This saves the current station in the selected slot.

If the slot is empty, simply pressing saves the station to the slot.

- **Scan:** All stations available in the current location of the vehicle are played for five seconds each.
- **Information:** View detailed station information.
- **Sound Settings:** Audio sound settings can be changed.
- **Station Info:** Set whether to receive station information.

SiriusXM



(1) Band

Switch between FM, AM and SiriusXM.

(2) Presets

Change the preset number on the main screen.

(3) List

Display all channels.

(4) Menu

Navigate to the menu screen.

(5) Presets 1~40

Save or listen to favorite channels.

(6) Play Live

Switches to the live broadcast mode.

(7) Skip Backward

Repeats the previously broadcasted program.

- Holding for less than 0.8 seconds: Moves to the previous segment
- Holding for more than 0.8 seconds: Moves to the previous 5 seconds.

(8) Play/Pause

Pauses/plays the current broadcasting program.

(9) Skip Forward

Moves to the next segment.

Switching between FM, AM and SiriusXM

- Press the **[RADIO]** button on the audio system to switch between FM, AM, and SiriusXM.
- Press the **[Band]** on the screen to switch between FM, AM, and SiriusXM.

Searching channels

Press the **[SEEK/TRACK]** button to search channels.

< Presets >

By pressing [**< Presets >**], the buttons for Presets 1~40 displayed on the screen can be changed.

Presets 1~40

Press the button to listen to a preset. Press and hold the button number to save the current channel.

List

A list of all channels is displayed. Press the desired channel.

Favorite channels can be saved to [Presets] by pressing the [+].

Menu

- Presets: Save up to 40 frequently used channels.

To listen to a preset, press the desired channel.

Press and hold the desired slot from 1 through 40. This saves the current channel in the selected slot.

If the slot is empty, simply pressing saves the channel to the slot.

- Categories: Channels can be searched by category.
- Direct Tune: The desired channel can be selected by entering numbers.
- Sound Settings: Audio sound settings can be changed.

- Tag Song: Tag the current song information.

When an Apple device (iPhone®, iPod®) is connected, tagged song information is sent automatically to the connected device.

* NOTICE

Up to 50 songs can be tagged.

- Scan: All channels available in the vehicle's current location are played for ten seconds each.
- Program Schedule: View the program schedule.
- Featured Favorites: The Featured Favorites feature allows SiriusXM™ to broadcast additional presets.
 - Example 1: During holidays, "Holiday Music" might include all SiriusXM™ channels that are playing holiday music for easy access by users.

Multiple sets of Featured Favorites data can be broadcast by SiriusXM™ and can change from time to time.

- Information: View detailed channel information.
- Category Lock: Search or scan channels in the current category only.

Media

MP3

Supported audio formats

Compressed audio formats	MPEG1 Audio Layer3
	MPEG2 Audio Layer3
	MPEG2.5 Audio Layer3
	Windows Media Audio Ver 7.X & 8.X

*** NOTICE**

File formats other than the formats above may not be recognized or playable. Information such as filename may not be displayed.

Range of supported compressed file types

1. Bitrate range (Kbps)

BIT RATE(kbps)	MPEG1	MPEG2	MPEG2.5	WMA
	Layer3			High Range
	32	8	8	48
	40	16	16	64
	48	24	24	80
	56	32	32	96
	64	40	40	128
	80	48	48	160
	96	56	56	192
	112	64	64	
128	80	80		
160	96	96		
192	112	112		
224	128	128		
256	144	144		
320	160	160		

2. Sampling frequency (Hz)

MPEG1	MPEG2	MPEG2.5	WMA
44100	22050	11025	32000
48000	24000	12000	44100
32000	16000	8000	48000

- The sound quality of MP3/WMA compressed files may vary depending on the bitrate. (A higher bitrate can have better sound quality.)
- The product only recognizes files with the MP3 or WMA extension. Files without one of these extensions are not recognized.

3. Number of recognizable folders and files

- Folders: 2,000 for USB
- Files: 6,000 for USB
- No recognition limit for folder hierarchies

4. Character display range (Unicode)

- Filenames: Up to 64 English characters. (64 Korean characters)
- Filenames: Up to 32 English characters. (32 Korean characters)

Languages supported (Unicode support)

- Korean: 2,604 characters
- English: 94 characters
- Common Chinese characters: 4,888 characters
- Special symbols: 986 characters

*** NOTICE**

Japanese/Simplified Chinese characters are not supported.

*** NOTICE - Using the USB Devices**

- Starting the vehicle while a USB device is connected can damage the device. Please disconnect USB devices before starting the vehicle.
- Starting the vehicle or stopping the engine while an external USB device is connected can result in failure of the external USB device to operate.
- Be cautious of static electricity when connecting/disconnecting external USB devices.
- An encrypted MP3 player is not recognized when connected as an external device.
- External USB devices may not be recognized, depending on the state of the external USB device.
- Only products with byte/sectors formatted at 4 KB or lower are recognized.
- Only USB devices in FAT12/16/32 format are recognized; NTFS and ExFAT file systems are not recognized.
- Some USB devices are not recognized due to compatibility issues.

(Continued)

(Continued)

- Do not touch the USB connections.
- Connecting and disconnecting USB devices rapidly over a short period of time can cause equipment failure.
- Abnormal sounds may be audible when the USB device is disconnected.
- Turn the audio off before connecting or disconnecting external USB devices.
- Recognition may take longer depending on the type, capacity or file format of the external USB device. This is not a product malfunction.
- Use of USB devices for purposes other than playing music files is prohibited.
- Image display and video playback are not supported.
- Use of USB accessories, including charge and heat though the USB I/F, can lead to reduced product performance or malfunctions. Do not use USB devices or accessories for these purposes.

(Continued)

(Continued)

- Use of aftermarket USB hubs and extension cables can result in the vehicle's audio system failing to recognize your USB device. Connect the USB device directly to the multimedia port of your vehicle.
- When using high-capacity USB devices with logical drive divisions, only files saved on the highest level logical drive can be played. If applications are loaded on a USB drive, file playback may fail.
- Some MP3 players, cell phones, digital cameras, etc. (USB devices that are not recognized as mobile storage) may not operate normally when connected.
- USB charging may not be supported by some mobile devices.
- Operation is guaranteed only for standard (Metal Cover Type) USB Memory drives.
- Operation of HDD, CF, SD and memory stick devices is not guaranteed.

(Continued)

(Continued)

- **DRM (Digital Rights Management) files cannot be played.**
- **SD-type USB memory, CF-type USB memory, and other USB memory devices that require adapters for connection are not supported.**
- **Proper operation of USB HDDs or USB drives with connectors that loosen due to vehicle vibrations is not guaranteed. (iStick, etc.)**
- **USB products that are used as key chains or cell phone accessories may damage the USB jack and affect proper file playback. Please refrain from use. Use only products with plug connectors, as shown in the following illustration.**
- **When MP3 devices or cell phones are connected simultaneously through AUX, BT Audio and USB modes, a popping noise or malfunction may occur.**



USB



(1) Repeat

Enable/disable repeat.

(2) Shuffle

Enable/disable shuffle play.

(3) List

View a list of all songs.

(4) Menu

Navigate to the menu screen.

(5) Album Image

View song info.

(6) Pause

Pause or play music.

(7) Playback progress

Press to skip to the desired location.

Playback

- Press the **[MEDIA]** button, and select **[USB]**.
- Connect a USB drive to the USB port to automatically play files on the USB drive.

Changing songs

- Press the **[SEEK/TRACK]** button to play the previous or next song.
- Press and hold the **[SEEK/TRACK]** button to rewind or fast forward the currently playing song.
- Search songs by turning **TUNE** knob, and press the knob to play.



Selecting songs from a list

Press the **[List]** to see a list of songs available for play.

Select and play the desired song.

Repeat play

Press the **[Repeat]** to enable or disable 'Repeat all', 'Repeat current song', 'Repeat folder' or 'Repeat category'.



- Repeat all: Repeat all songs.
- Repeat current song: The currently playing song is repeated.
- Repeat folder: All songs in the current folder are repeated.
- Repeat category: Repeat all songs in the current category.

* NOTICE

The repeat folder function is available only when songs are playing from the [File] category under [List].

Shuffle play

Press the [Shuffle] to enable/disable 'Shuffle', 'Shuffle folder' or 'Shuffle category' play.

-  Shuffle: Songs are played in random order.
-  Shuffle folder: Songs within the current folder are played in random order.
-  Shuffle category: Songs within the current category are played in random order.

Menu

Press the [Menu], and select the desired function.

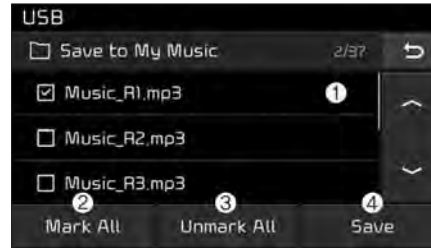

- Save to My Music: Songs on your USB device can be saved to My Music.

(1) File: Select a file to save.

(2) Mark All: Select all files.

(3) Unmark All: Deselect all files.

(4) Save: Save the selected files.

- Select the files you want to save, and press the [Save]. This saves the selected files to My Music.
- If Siri is activated, phone calls are received or made while saving, saving will be canceled.
- Up to 6,000 files can be saved.

- The currently playing file on the USB device cannot be changed while saving.
- My Music cannot be used while saving.
- Up to 700 MB can be saved.
- Information: Detailed information on the currently playing song is displayed.
- Scan: All songs are played for 10 seconds each.
- Sound Settings: Audio sound settings can be changed.

*** NOTICE - Using the iPod®
Devices**

- To use the audio system's iPod® control function, use the dedicated cable provided with your iPod®.
- Connecting the iPod® to the vehicle during play may result in a loud noise that lasts about one to two seconds. Connect the iPod® to the vehicle after stopping or pausing play.
- Connect the iPod® with the vehicle in the ACC ON state to begin charging.
- When connecting the iPod® cable, be sure to fully push the cable into the port.
- When EQ effects are enabled simultaneously on external devices, such as iPod®s and the audio system, the EQ effects may overlap, causing sound quality deterioration or distortion. Deactivate the EQ function for all external devices, if possible.
- Noise may occur when your iPod® or the AUX port is connected. Disconnect and store separately when not in use.

(Continued)

(Continued)

- There may be noise if the audio system is used with an iPod® or AUX external device connected to the power jack. In these cases, disconnect the iPod® or external device from the power jack.
- Play may be interrupted, or device malfunctions may occur depending on the characteristics of your iPod®/iPhone®.
- Play may fail if your iPhone® is connected through both *Bluetooth*® Wireless Technology and USB. In this case, select Dock connector or *Bluetooth*® Wireless Technology on your iPhone® to change the sound output settings.
- If your software version does not support the communication protocol or your iPod® is not recognized due to device failure, anomalies or defects, iPod® mode cannot be used.
- iPod® nano (5th generation) devices may not be recognized if the battery is low. Charge sufficiently before use.

(Continued)

(Continued)

- The search and song play order in the iPod® device may be different from the search order in the audio system.
- If the iPod® has failed due to an internal defect, please reset the iPod® (consult your iPod® manual).
- Depending on the software version, the iPod® may fail to sync with the system. If the media is removed or disconnected before recognition, the previous mode may not be restored. (iPad® cannot be charged)
- Cables other than the 1-meter cable provided with iPod®/iPhone® products may not be recognized.
- When other music apps are used on your iPod®, the system sync function may fail due to malfunction of the iPod® application.

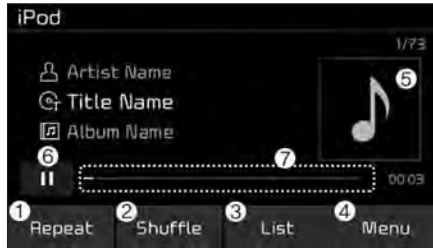
iPod®**(1) Repeat**

Enable/disable repeat.

(2) Shuffle

Enable/disable shuffle play.

(3) List

View a list of all songs.

(4) Menu

Navigate to the menu screen.

(5) Album Image

View song info.

(6) Pause

Pause or play music.

(7) Playback progress

Press to skip to the desired location.

Playback

- Connect your iPod® to the audio USB port, press the **[MEDIA]** button, and select [iPod].

Changing songs

- Press the **[SEEK/TRACK]** button to play the previous or next song.
- Press and hold the **[SEEK/TRACK]** button to rewind or fast forward the currently playing song.
- Search songs by turning the **TUNE** knob, and press the knob to play.



Selecting songs from a list

Press the [List] to see a list of songs available for play.

Select and play the desired song.

Repeat play

Press the [Repeat] to enable or disable 'Repeat category', 'Repeat current song.'

-  Repeat category: Repeat all songs in the current category.
-  Repeat current song: The currently playing song is repeated.

Shuffle play

Press the [Shuffle] to enable/disable 'Shuffle category' play.

-  Shuffle category: Songs within the current category are played in random order.

Menu

Press the [Menu], and select the desired function.

- Information: Detailed info on the currently playing song is displayed.
- Sound Settings: Audio sound settings can be changed.



When other music programs are running

When songs saved on your iPod® are playing through a separate music app, the following screen is displayed.

- (1) Play/Pause: Pause or play music.
- (2) Play iPod Files: Play music saved on your iPod®.
- (3) Album Image: View playback info.

*** NOTICE**

Operation cannot be carried out correctly due to iPod® application malfunction.

Playing iPod files

- Select [Play iPod Files] to play songs saved on your iPod®.

If there are no songs saved on your iPod®, the [Play iPod Files] is disabled.

*** NOTICE - Using *Bluetooth*[®] Wireless Technology Audio**

- *Bluetooth*[®] Wireless Technology Audio mode can only be used if a *Bluetooth*[®] Wireless Technology-enabled phone is connected. Only devices that support *Bluetooth*[®] Wireless Technology audio can be used.
- If the *Bluetooth*[®] Wireless Technology-enabled phone is disconnected during play, the music stops.
- When the TRACK UP/DOWN buttons are used during *Bluetooth*[®] Wireless Technology audio streaming, a popping noise or sound interruptions may occur, depending on the cell phone device.
- Depending on the cell phone model, the audio streaming function may not be supported.
- If a phone call is made or received when music is playing in *Bluetooth*[®] Wireless Technology Audio mode, the call may mix with the music.

(Continued)

(Continued)

- When returning to *Bluetooth*[®] Wireless Technology Audio mode after ending a call, play might not resume automatically for some cell phone models.

 **CAUTION**

- *Bluetooth*[®] Wireless Technology Handsfree is a feature that enables drivers to practice safe driving. Connecting the car audio system with a *Bluetooth*[®] Wireless Technology phone allows the user to conveniently make calls, receive calls, and manage the phone book. Before using the *Bluetooth*[®] Wireless Technology, carefully read the contents of this user's manual.
- Excessive use or operations while driving may lead to negligent driving practices and be the cause of accidents.
- Do not operate the device excessively while driving.
- Viewing the screen for prolonged periods of time is dangerous and may lead to accidents.
- When driving, view the screen only for short periods of time.

Bluetooth® Wireless Technology (BT) Audio



(1) Repeat

Enable/disable repeat.

(2) Shuffle

Enable/disable shuffle play.

(3) Menu

Navigate to the menu screen.

(4) Play/Pause

Pause or play music.

* NOTICE

- Some cell phone models may not support particular functions.
- *Bluetooth®* Wireless Technology audio volume is synced with cell phone media volume.

Playback

- Press the [MEDIA] button, and select [BT Audio].

Changing songs

- Press the [SEEK/TRACK] button to play the previous or next song.

* NOTICE

Some cell phones may not support this function.

Repeat play

Press the [Repeat] to enable or disable 'Repeat all', 'Repeat current song'.

- Repeat all: All songs in the playlist are repeated.
- Repeat current song: The currently playing song is repeated.

* NOTICE

The repeat play function is engaged, depending on the operation of the connected *Bluetooth®* Wireless Technology device.

Shuffle play

Press the [Shuffle] to enable/disable 'Shuffle' play.

- Shuffle: Songs are played in random order.

* NOTICE

The shuffle function is engaged, depending on the operation of the connected *Bluetooth®* Wireless Technology device.

Menu

Press the [Menu], and select the desired function.

- Connections: The currently connected *Bluetooth®* Wireless Technology device can be changed.
- Information: Detailed information on the currently playing song is displayed.
- Sound Settings: Audio sound settings can be changed.

AUX

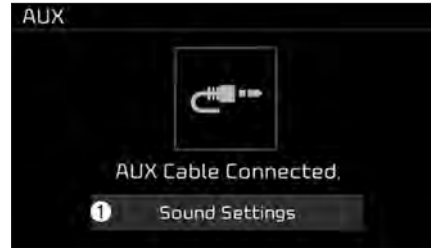

Running AUX

- Press the **[MEDIA]** button, and select [AUX].
 - Connect the external device connection jack to the AUX terminal to run AUX.
- (1) Sound Settings: Audio sound settings can be changed.

My Music



(1) Repeat

Enable/disable repeat.

(2) Shuffle

Enable/disable shuffle play.

(3) List

View a list of all songs.

(4) Menu

Navigate to the menu screen.

(5) Album Image

View song info.

(6) Pause

Pause or play music.

(7) Playback progress

Press to skip to the desired location.

Playback

Press the **[MEDIA]** button, and select **[My Music]**.

- My Music cannot be selected if it does not contain music.
- Check the content of your USB drive before saving music to My Music.

Changing songs

Press the **[SEEK/TRACK]** button to play the previous or next song.

- Press and hold the **[SEEK/TRACK]** button to rewind or fast forward the currently playing song.
- Search songs by turning the **TUNE** knob and press the knob to play.



Selecting songs from a list

Press the **[List]** to see a list of songs available for play.

- Select and play the desired song.

Repeat play

Press the **[Repeat]** to enable or disable 'Repeat all', 'Repeat current song' or 'Repeat category'.

- Repeat all: Repeat all songs.
- Repeat current song: The currently playing song is repeated.
- Repeat category: Repeat all songs in the current category.

Shuffle play

Press the **[Shuffle]** to enable/disable 'Shuffle', 'Shuffle category' play.

- Shuffle: Songs are played in random order.
- Shuffle category: Songs within the current category are played in random order.

Menu

Press the **[Menu]**, and select the desired function.



- Delete Files: You can delete files from My Music.

(1) File: Select saved file.

(2) Mark All: Select all Files.

(3) Unmark All: Deselect all files.

(4) Delete: Delete the selected file(s).

- Select the file to delete, then press the [Delete] to delete it.
- If Siri is activated, phone calls are received or made during delete, delete will be canceled.
- Add to Playlist: Frequently played songs can be paired in a [Playlist].
 - Songs can be played from the [Playlist].
- Information: Detailed info on the currently playing song is displayed.
- Sound Settings: Audio sound settings can be changed.
- Scan: All songs are played for 10 seconds each.

Delete from Playlist

When a song in the playlist is playing, press the [Menu] and select [Delete from Playlist].

Select the song to delete, then press [Delete].

Pandora



(1) Thumbs Down

If you don't like the song that is currently playing, press this button to skip to the next song and to minimize the number of songs from similar genres.

* NOTICE

Pandora® limits the number of times that you can skip to the next song.

(2) Thumbs Up

If you like the song that is currently playing, press this button. Pandora® will play more songs from the same genre.

* NOTICE

The settings of this function cannot be reset.

(3) Skip

Skip to the next song.

* NOTICE

Pandora® limits the number of times that you can skip to the next song.

(4) Stations

Display the station list.

(5) Menu

Navigate to the menu screen.

(6) Album Image

View song info.

(7) Pause

Pause or play music.

(8) Shared Station

Indicate that the station is already shared.

* NOTICE

Thumbs Up/Down is not available for shared stations.

Playback

Press the **[MEDIA]** button, and select [Pandora].

* NOTICE

- **Pandora®: Connect a smartphone to listen to Pandora® Radio**
- **Apple devices must be connected via USB cable and Android devices must be connected via Bluetooth® Wireless Technology in order to run Pandora®.**

Menu

Press the [Menu] and select the desired function.

- **Bookmark:** Add the song that is currently playing to your bookmarks list.

* NOTICE

- **You can view your bookmarked songs on your online Pandora® profile. Go to pandora.com, then go to [Your profile] above the player. That will bring up a page with your stations and bookmarked songs.**
- **The settings of this function cannot be reset.**

- **Quit:** Exit Pandora® mode and return to previous audio mode.
- **Information:** Detailed info on the currently playing song is displayed.
- **Sound Settings:** Audio sound settings can be changed.

Phone

* NOTICE - Using

Bluetooth[®] Wireless Technology Phone

- *Bluetooth*[®] Wireless Technology is a near-field wireless networking technology that uses the 2.4 GHz frequency to connect various devices within a certain distance wirelessly.
- The technology is used in PCs, peripherals, *Bluetooth*[®] Wireless Technology phones, tablet PCs, household appliances and automobiles. Devices supporting *Bluetooth*[®] Wireless Technology can exchange data at high speeds without physical cable connections.
- *Bluetooth*[®] Wireless Technology Handsfree devices enable convenient access to phone functions through cell phones equipped with *Bluetooth*[®] Wireless Technology.

(Continued)

(Continued)

- Some *Bluetooth*[®] Wireless Technology devices may not be supported by the *Bluetooth*[®] Wireless Technology Handsfree function.
- When *Bluetooth*[®] Wireless Technology is connected and calls are attempted through a connected cell phone from outside the vehicle, the call is connected through the *Bluetooth*[®] Wireless Technology Handsfree function of the vehicle.
- Please be sure to disconnect the *Bluetooth*[®] Wireless Technology Handsfree function through your *Bluetooth*[®] Wireless Technology device or the audio screen.
- The *Bluetooth*[®] Wireless Technology Handsfree function helps drivers to drive safely. By connecting a *Bluetooth*[®] Wireless Technology-enabled phone to the vehicle's audio system, phone calls can be made and received through the audio system and contacts can be managed. Consult the user manual before use.

(Continued)

(Continued)

- Excessive manipulation of controls while driving, making it difficult to pay attention to the road ahead, can lead to accidents. Do not operate the device excessively while driving.
- Looking at the screen for a prolonged time increases the risk of accidents. Keep time spent looking at the screen to a minimum.

Precautions when connecting *Bluetooth*[®] Wireless Technology devices

- The vehicle supports the following *Bluetooth*[®] Wireless Technology functions. Some *Bluetooth*[®] Wireless Technology devices may not support some functions.
 - 1) *Bluetooth*[®] Wireless Technology Handsfree phone calls
 - 2) Operations during a call (Private, Switch, Out Vol. controls)
 - 3) Download call history saved to the *Bluetooth*[®] Wireless Technology device
 - 4) Download contacts saved to the *Bluetooth*[®] Wireless Technology device
 - 5) Automatic contacts/call history download when *Bluetooth*[®] Wireless Technology is connected
 - 6) Automatic *Bluetooth*[®] Wireless Technology device connection when the vehicle is started
 - 7) *Bluetooth*[®] Wireless Technology audio streaming playback
- Before connecting the audio system to your device, make sure your device supports *Bluetooth*[®] Wireless Technology.
- Even if your device supports *Bluetooth*[®] Wireless Technology, a *Bluetooth*[®] Wireless Technology connection cannot be established if the device's *Bluetooth*[®] Wireless Technology function is switched off. Search and connect with the *Bluetooth*[®] Wireless Technology function enabled.
- Pair or connect *Bluetooth*[®] Wireless Technology devices to the audio system with the vehicle at a standstill.
- If a *Bluetooth*[®] Wireless Technology connection is lost due to abnormal conditions while a *Bluetooth*[®] Wireless Technology device is connected (communication range exceeded, device power OFF, communication errors, etc.), the disconnected *Bluetooth*[®] Wireless Technology device is searched for and automatically reconnected.
- If you want to disable the *Bluetooth*[®] Wireless Technology device auto-connect function, turn the *Bluetooth*[®] Wireless Technology function OFF on your device. Consult the user manuals for individual devices to see whether *Bluetooth*[®] Wireless Technology is supported.
- Handsfree call quality and volume may vary depending on the type of *Bluetooth*[®] Wireless Technology device.
- Some *Bluetooth*[®] Wireless Technology devices are subject to intermittent *Bluetooth*[®] Wireless Technology connection failures. In this case, use the following method.
 - 1) Turn the *Bluetooth*[®] Wireless Technology function off on your *Bluetooth*[®] Wireless Technology device → Turn it on and try again.
 - 2) Delete the paired device from both the audio system and *Bluetooth*[®] Wireless Technology device, then pair again.

- 3) Power down your *Bluetooth®* Wireless Technology device → Turn it on and try again.
- 4) Completely remove the battery from your *Bluetooth®* Wireless Technology device; reinsert it, reboot, and attempt connection.
- 5) Restart the vehicle and reattempt connection.

Pairing a Bluetooth® Wireless Technology device

Information on pairing *Bluetooth®* Wireless Technology devices

- Pairing refers to the process of pairing *Bluetooth®* Wireless Technology cell phones or devices with the system prior to connection. This is a necessary procedure for *Bluetooth®* Wireless Technology connection and usage.
- Up to five devices can be paired.
- Pairing *Bluetooth®* Wireless Technology device is not allowed while vehicle is moving.

Pairing the first *Bluetooth®* Wireless Technology device

Select the **[PHONE]** button on the audio system or the **[CALL]** button on the steering wheel remote control → Search for the vehicle from the *Bluetooth®* Wireless Technology device, and pair → Enter the passkey on the *Bluetooth®* Wireless Technology device or approve passkey → *Bluetooth®* Wireless Technology pairing completed.

1. When the **[PHONE]** button on the audio or the **[CALL]** button on the steering wheel remote control is pressed, the following screen is displayed. Devices can now be paired.

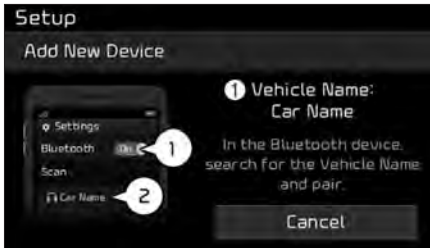

(1) Vehicle Name: Searched name in *Bluetooth*® Wireless Technology device.

* NOTICE

The vehicle name in the image above is an example. Refer to your device for the actual name of your device.

2. Search for available *Bluetooth*® Wireless Technology devices in the *Bluetooth*® Wireless Technology menu of your *Bluetooth*® Wireless Technology device. (cell phone, etc.)
3. Confirm that the vehicle name in your *Bluetooth*® Wireless Technology device matches the vehicle name shown on the audio screen, then select it.

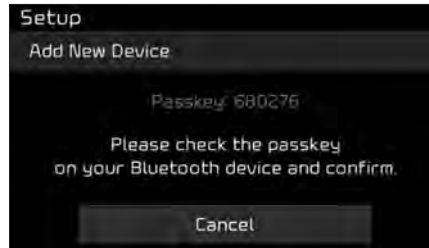

4. For devices that require passkey confirmation, the following screen is shown on the audio system. A 6-digit passkey input screen is shown in the *Bluetooth*® Wireless Technology device.

- After confirming that the 6-digit passkey on the audio screen and the *Bluetooth*® Wireless Technology device are identical, press [OK] in your *Bluetooth*® Wireless Technology device.

* NOTICE

The 6-digit passkey in the image above is an example. Refer to your vehicle for the actual passkey.

Pairing a second *Bluetooth*® Wireless Technology device

Press the [SETUP] button on the audio system → Select [Settings] → Select [Connections] → Select [Add New].



- The pairing procedure from this point is identical to [Pairing the first Bluetooth device].

*** NOTICE**

- *Bluetooth*[®] Wireless Technology standby mode lasts for three minutes. If a device is not paired within three minutes, pairing is canceled. Start over from the beginning.
- For most *Bluetooth*[®] Wireless Technology devices, a connection is established automatically after pairing. Some devices, however, require separate confirmation when connecting after pairing. Be sure to check your *Bluetooth*[®] Wireless Technology device after pairing to confirm that it has connected.

Connecting *Bluetooth*[®] Wireless Technology devices

If there are no connected devices

Select the **[PHONE]** button on the audio system or the **[CALL]** button in the steering wheel remote control → List of paired *Bluetooth*[®] Wireless Technology devices → Select the desired *Bluetooth*[®] Wireless Technology device from the list → Connect *Bluetooth*[®] Wireless Technology.

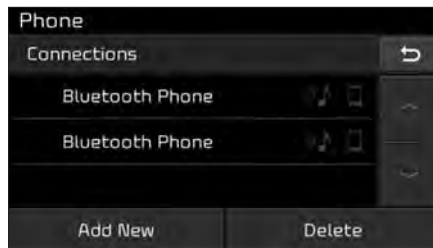

If there are connected devices

Select the **[SETUP]** button on the audio system → Select **[Bluetooth]** → Select **[Connections]** → Select *Bluetooth*[®] Wireless Technology device to connect → Select **[Connect]** → Connect *Bluetooth*[®] Wireless Technology.

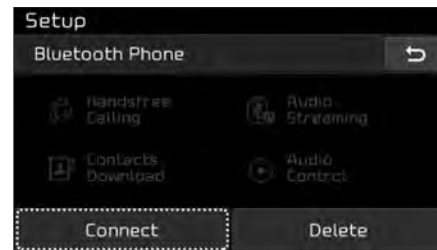

*** NOTICE**

- Only one *Bluetooth*[®] Wireless Technology device can be connected at a time.
- When a *Bluetooth*[®] Wireless Technology device is connected, other devices cannot be paired.

Accepting/rejecting phone calls

Receiving phone calls with *Bluetooth*® Wireless Technology connected.



- (1) Caller name: If the caller number is in your contacts, the corresponding name is displayed.
- (2) Incoming phone number: Incoming phone number is displayed.
- (3) Accept: Accept call.
- (4) Reject: Reject call.

* NOTICE

- When the incoming call screen is displayed, audio mode and the settings screen cannot be shown. Only call volume control is supported.
- Some *Bluetooth*® Wireless Technology devices may not support the call reject function.
- Some *Bluetooth*® Wireless Technology devices may not support the phone number display function.

Operation during calls

Incoming call with *Bluetooth*® Wireless Technology connected → Select [Accept].



- (1) Call duration: Call duration display.
- (2) Caller name: If the caller number is in your contacts, the corresponding name is displayed.
- (3) Incoming phone number: Incoming phone number is displayed.
- (4) Keypad: Number keypad for Automatic Response Service input is displayed.
- (5) Private: Call is transferred to a cell phone.
- (6) Outgoing Volume: Adjust outgoing voice volume.
- (7) End: End call.

* NOTICE

- Some *Bluetooth*[®] Wireless Technology devices may not support the Private function.
- The outgoing voice volume may vary depending on the type of *Bluetooth*[®] Wireless Technology device. If the outgoing voice volume is too high or low, adjust the Out Vol.

Favorites

Select the **[PHONE]** button on the audio system → Select [Favorites] → Favorites list displayed.



- (1) Favorites list: A list of paired favorites is displayed.
Connect a call when selected.
- (2) Add to Favorites: Add a downloaded phone number to favorites.
- (3) Delete: Delete a saved favorites.

* NOTICE

- Up to 20 favorites can be paired for each paired *Bluetooth*[®] Wireless Technology device.
- Favorites can be accessed when the *Bluetooth*[®] Wireless Technology device they were paired from is connected.
- The audio system does not download favorites from *Bluetooth*[®] Wireless Technology devices. Favorites must be newly saved before use.
- To add to favorites, contacts must be downloaded first.
- Saved favorites are not updated even if the contacts of the connected *Bluetooth*[®] Wireless Technology device are changed. In this case, favorites need to be deleted and added again.

Call history

Select the **[PHONE]** button on the audio system → Select [Call history] → Call history is displayed.



- (1) Call history: Display the downloaded call history list.
Connect a call when selected.
- (2) Sort by: Sort by all calls, dialed calls, received calls or missed calls.
- (3) Download: Download call history from connected *Bluetooth*® Wireless Technology devices.

* NOTICE

- Up to 50 dialed, received and missed calls are saved.
- When the latest call history is received, the existing call history is deleted.

Contacts

Select the **[PHONE]** button on the audio system → Select [Contacts] → Select letter (ABC) → Contacts displayed.



- (1) Contacts: Display downloaded contacts.
Connect a call when selected.
- (2) Download: Download contacts from connected *Bluetooth*® Wireless Technology devices.

* NOTICE

- Up to 2,000 contacts can be saved.
- In some cases, additional confirmation from your *Bluetooth*[®] Wireless Technology device is necessary when downloading contacts. If downloading of contacts unsuccessful, consult your *Bluetooth*[®] Wireless Technology device's settings or the audio screen to approve the download.
- Contacts without phone numbers are not displayed.

Dial

Select the **[PHONE]** button on the audio → Select [Dial].



- (1) Phone number entry window: The phone number entered using the keypad is displayed.
- (2) Clear
 - Press to delete individual digits.
 - Press and hold to delete the entire phone number.
- (3) Keypad: Enter phone number.
- (4) *Bluetooth*[®] Wireless Technology phone name
 - The name of the connected *Bluetooth*[®] Wireless Technology device is displayed.
 - Contacts matching the keypad number/letter input are displayed.

(5) Call

- Enter and select a phone number to call.
- Select without entering a phone number to see the most recent dialed call.

Setup

Select the **[PHONE]** button on the audio → Select [Settings].

- For phone Setup, refer to Setup page → Select [Bluetooth].

Siri

* NOTICE - Using Siri

- If you want to use Siri, you have to connect your iOS device to multimedia system through *Bluetooth*® Wireless Technology. (Please check whether your iOS device supports Siri and turning Siri On)
- If the iOS version is changed, the functions and response may be different according to the iOS device and the latest version.
- Siri automatically stops in the following events.
 - 1) Outgoing and incoming phone calls.
 - 2) Media (USB, etc.) is connected. (Siri mode is maintained when iPod®s are connected)
 - 3) Rear camera is activated (option).
 - 4) Vehicle is started or engine is turned off.
 - 5) Screen transition buttons, such as RADIO or MEDIA, are selected.

(Continued)

(Continued)

- 6) When a pop-up message is displayed on the screen due to accidental execution of Siri.
- The microphone is located above the driver's seat. To ensure proper Siri, state your voice while maintaining proper driving posture.

Starting Siri

Press the **[VOICE]** button on the steering wheel remote control to start Siri and see the screen.



(1) Speak: Re-start Siri.

(2) Exit: End Siri.

* NOTICE

- Functions and feedbacks from voice commands via Siri are executed in the iOS device.
- The Audio system only supports “Phone” related functions, other functions will be performed in your iOS device.

Setup

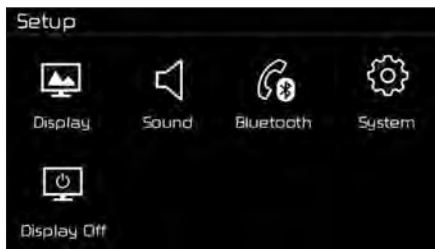

Access Display, Sound, Bluetooth, System and Display Off settings.

Select the **[SETUP]** button on the audio system.

Display

Select the **[SETUP]** button on the audio system → Select [Display].

- Mode: Audio screen brightness can be adjusted to the time of day.
- Illumination: The brightness of the audio screen can be changed.

Sound

Select the **[SETUP]** button on the audio system → Select [Sound].

- Position: Sound balance and panning can be adjusted.
- Tone: Sound tone color can be adjusted.
- Speed Dependent Volume: Automatically adjust volume based on vehicle speed.
- Beep: Select whether to play a sound when the screen is touched.

Bluetooth

Select the **[SETUP]** button on the audio system → Select [Bluetooth].

- Connections: Control pairing, deletion, connection and disconnection of *Bluetooth*® Wireless Technology devices.
- Auto Connection Priority: Set the connection priority of *Bluetooth*® Wireless Technology devices when the vehicle is started.
- Download Contacts: Contacts can be downloaded from connected *Bluetooth*® Wireless Technology devices.
- Bluetooth Voice Prompts: Play or mute voice prompts for *Bluetooth*® Wireless Technology device pairing, connection and errors.

*** NOTICE**

- When paired devices are deleted, the call history and contacts of the device saved to the audio system are deleted.
- For *Bluetooth*® Wireless Technology connections with low connection priority, some time may be required for the connection to be established.
- Contacts can be downloaded only from the currently connected *Bluetooth*® Wireless Technology device.
If no *Bluetooth*® Wireless Technology device is connected, the download contacts button is disabled.
- If the language setting is Korean, *Bluetooth*® Wireless Technology voice prompts are not supported.

System

Select the **[SETUP]** button on the audio system → Select [System].

- Memory Information: View My Music memory usage.
- Language: Change the user language.
- Default: Reset the audio system.
- System Information: At the System Information screen, Software version information, updates are available.
 - System Update: At the System Information screen, insert the USB memory with the latest file downloaded, and then select the [Update] to begin updating. The system will then reboot automatically.

*** NOTICE**

- The system resets to the default values, and all saved data and settings are lost.
- This product needs supplemented software updates and additional functions, which collectively may take some time to complete, depending on the amount of data.
- If the Power is disconnected or the USB is removed during an update, the data might be damaged. Please wait until the update is complete while engine is on.

Display Off

To prevent glare, the screen can be turned off with the audio system in operation.

Select the **[SETUP]** button on the audio system → Select [Display Off].

Declaration of Conformity

FCC

This equipment has been tested and found to comply with the limits for a Class B digital device, pursuant to part 15 of the FCC Rules. These limits are designed to provide reasonable protection against harmful interference in a residential installation.

This equipment generates, uses and can radiate radio frequency energy and, if not installed and used in accordance with the instructions, may cause harmful interference to radio communications. However, there is no guarantee that interference will not occur in a particular installation. If this equipment does cause harmful interference to radio or television reception, which can be determined by turning the equipment off and on, the user is encouraged to try to correct the interference by one or more of the following measures:

- Reorient or relocate the receiving antenna.
- Increase the separation between the equipment and receiver.
- Connect the equipment into an outlet on a circuit different from that to which the receiver is connected.
- Consult the dealer or an experienced radio/TV technician for help.

Caution: Any changes or modifications to this device not explicitly approved by manufacturer could void your authority to operate this equipment.

This device complies with part 15 of the FCC Rules. Operation is subject to the following two conditions:

(1) This device may not cause harmful interference, and (2) this device must accept any interference received, including interference that may cause undesired operation.

This equipment complies with FCC radiation exposure limits set forth for an uncontrolled environment.

This equipment should be installed and operated with minimum 20cm between the radiator and your body. This transmitter must not be collocated or operating in conjunction with any other antenna or transmitter unless authorized to do so by the FCC.

Driving your vehicle

Before driving	5-4	• AEB Warning Message and System Control	5-35
• Before entering vehicle	5-4	• AEB Front Radar Sensor	5-38
• Necessary inspections	5-4	• System Malfunction.	5-39
• Before starting	5-4	• Limitations of the System.	5-40
key positions	5-6	Cruise Control system	5-45
• Illuminated ignition switch	5-6	• To set cruise control speed	5-45
• Ignition switch position.	5-6	• To increase cruise control set speed.	5-46
• Starting the engine	5-7	• To decrease the cruising speed.	5-46
Engine START/STOP button	5-9	• To temporarily accelerate with the cruise control on	5-47
• Illuminated Engine START/STOP button	5-9	• To cancel cruise control	5-47
• Engine START/STOP button position.	5-9	• To resume cruising speed at more than approximately 20 mph (30 km/h)	5-48
• Starting the engine with a smart key	5-11	• To turn cruise control off	5-48
Automatic transaxle	5-13	Smart cruise control system (SCC)	5-49
• Automatic transaxle operation.	5-13	• Speed setting (SCC).	5-50
• Good driving practices	5-18	• Vehicle to vehicle distance setting (SCC)	5-55
Brake system	5-19	• To adjust the sensitivity of Smart Cruise Control	5-59
• Power brakes	5-19	• To convert to cruise control mode	5-59
• Parking brake – Foot type	5-21	• Limitations of the system	5-60
• Anti-lock brake system (ABS)	5-22	Active ECO system	5-66
• Electronic stability control (ESC)	5-25	• Active ECO operation.	5-66
• Vehicle stability management (VSM)	5-29	• When Active ECO is activated.	5-66
• Hill-start assist control (HAC)	5-30	• Limitation of Active ECO operation	5-66
• Good braking practices.	5-31		
Autonomous emergency braking (AEB)	5-33		
• System Setting and Activation	5-33		

Drive mode integrated control system	5-67
• DRIVE mode	5-67
Blind spot detection system (BSD)	5-69
• BSD (Blind Spot Detection) / LCA (Lane Change Assist)	5-70
• RCTA (Rear Cross Traffic Alert)	5-73
• Non-operating condition	5-75
Lane departure warning system (LDWS)	5-77
• Warning indicator	5-79
• The LDWS does not operate when:	5-79
Economical operation	5-81
Special driving conditions	5-83
• Hazardous driving conditions	5-83
• Reducing the risk of a rollover	5-83
• Rocking the vehicle	5-84
• Smooth cornering	5-85
• Driving at night	5-85
• Driving in the rain	5-86
• Driving in flooded areas	5-87
• Driving off-road	5-87
• Highway driving	5-87
Winter driving	5-89
• Snowy or icy conditions	5-89
• Use high quality ethylene glycol coolant	5-91
• Check battery and cables	5-92

• Change to "winter weight" oil if necessary	5-92
• Check spark plugs and ignition system	5-92
• To keep locks from freezing	5-92
• Use approved window washer anti-freeze in system	5-92
• Don't let your parking brake freeze	5-93
• Don't let ice and snow accumulate underneath	5-93
• Carry emergency equipment	5-93
Trailer Towing	5-94
• Hitches	5-95
• Safety chains	5-95
• Trailer brakes	5-96
• Driving with a trailer	5-96
• Maintenance when trailer towing	5-100
• If you do decide to pull a trailer	5-100
Vehicle load limit	5-103
• Tire and loading information label	5-103
• Certification label	5-107
Vehicle weight glossary	5-109
• Base curb weight	5-109
• Vehicle curb weight	5-109
• Cargo weight	5-109
• GAW (Gross axle weight)	5-109
• GAWR (Gross axle weight rating)	5-109
• GVW (Gross vehicle weight)	5-109
• GVWR (Gross vehicle weight rating)	5-109

Be sure the exhaust system does not leak.

The exhaust system should be checked whenever the vehicle is raised to change the oil or for any other purpose. If you hear a change in the sound of the exhaust or if you drive over something that strikes the underneath side of the vehicle, have the exhaust system checked as soon as possible by an authorized Kia dealer.

⚠ WARNING - Engine exhaust

Do not inhale exhaust fumes or leave your engine running in a enclosed area for a prolonged time. Exhaust fumes contain carbon monoxide, a colorless, odorless gas that can cause unconsciousness and death by asphyxiation.

⚠ WARNING - Open liftgate (tailgate)

Do not drive with the liftgate (tailgate) open. Poisonous exhaust gases can enter the passenger compartment. If you must drive with the liftgate (tailgate) open proceed as follows:

1. Close all windows.
2. Open side vents.
3. Set the air intake control at "Fresh", the air flow control at "Floor" or "Face" and the fan at the highest speed.

⚠ WARNING - California PROPOSITION 65

Engine exhaust and a wide variety of automobile components and parts, including components found in the interior furnishings in a vehicle, contain or emit chemicals known to the State of California to cause cancer and birth defects and reproductive harm. In addition, certain fluids contained in vehicles and certain products of component wear contain or emit chemicals known to the State of California to cause cancer and birth defects or other reproductive harm.

BEFORE DRIVING

Before entering vehicle

- Be sure that all windows, outside mirror(s), and outside lights are clean.
- Check the condition of the tires.
- Check under the vehicle for any sign of leaks.
- Be sure there are no obstacles behind you if you intend to back up.

Necessary inspections

Fluid levels, such as engine oil, engine coolant, brake fluid, and washer fluid should be checked on a regular basis, at the exact interval depending on the fluid. Further details are provided in chapter 7, "Maintenance".

 **WARNING - Distracted driving**

Focus on the road while driving. The driver's primary responsibility is in the safe and legal operation of the vehicle. Use of any handled devices, other equipment or vehicle systems that distract the drive should not be used during vehicle operation.

Before starting

- Close and lock all doors.
- Position the seat so that all controls are easily reached.
- Buckle your seat belt.
- Adjust the inside and outside rearview mirrors.
- Be sure that all lights work.
- Check all gauges.
- Check the operation of warning lights when the ignition switch is turned to the ON position.
- Release the parking brake and make sure the brake warning light goes out.

For safe operation, be sure you are familiar with your vehicle and its equipment.

⚠ WARNING - Fire risk

When you intend to park or stop the vehicle with the engine on, be careful not to depress the accelerator pedal for a long period of time. It may overheat the engine or exhaust system and cause fire.

⚠ WARNING - Check surroundings

Always check the surrounding areas near your vehicle for people, especially children, before putting a vehicle into D (Drive) or R (Reverse).

⚠ WARNING - Loose objects

Securely store items in your vehicle. When you make a sudden stop or turn the steering wheel rapidly, loose objects may drop on the floor and it could interfere with the operation of the foot pedals, possibly causing an accident.

⚠ WARNING - Driving while intoxicated

Do not drive while intoxicated. Drinking and driving is dangerous. Even a small amount of alcohol will affect your reflexes, perceptions and judgment.

Driving while under the influence of drugs is as dangerous as or more dangerous than driving drunk.

KEY POSITIONS (IF EQUIPPED)

Illuminated ignition switch



Whenever a front door is opened, the ignition switch will illuminate for your convenience, provided the ignition switch is not in the ON position. The light will go off immediately when the ignition switch is turned on. It will also go off after about 30 seconds when the door is closed.

Ignition switch position

LOCK



The steering wheel locks to protect against theft (if equipped). The ignition key can be removed only in the LOCK position.

ACC (Accessory)

The steering wheel is unlocked and electrical accessories are operative.

If difficulty is experienced turning the ignition switch to the ACC position, turn the key while turning the steering wheel right and left to release the tension.

ON

The warning lights can be checked before the engine is started. This is the normal running position after the engine is started.

Do not leave the ignition switch ON if the engine is not running to prevent battery discharge.

START

Turn the ignition switch to the START position to start the engine. The engine will crank until you release the key; then it returns to the ON position. The brake warning light can be checked in this position.

The anti-theft steering column lock (if equipped) is not a substitute for the parking brake. Before leaving the driver's seat, always make sure the shift lever is engaged in P (Park) for automatic transaxle, set the parking brake fully and shut the engine off. Unexpected and sudden vehicle movement may occur if these precautions are not taken.

 **WARNING - Ignition switch**

Never turn the ignition switch to LOCK or ACC while the vehicle is moving. This would result in loss of directional control and braking function, which could cause an accident.

Starting the engine **WARNING - Proper footwear**

Always wear appropriate shoes when operating your vehicle. Unsuitable shoes (high heels, ski boots, sandals, etc.) may interfere with your ability to use the brake and accelerator pedal.

1. Make sure the parking brake is applied.
2. Place the transaxle shift lever in P (Park). Depress the brake pedal fully.
You can also start the engine when the shift lever is in the N (Neutral) position.

3. Turn the ignition switch to START and hold it there until the engine starts (a maximum of 10 seconds), then release the key.

*It should be started **without depressing the accelerator.***

4. Do not wait for the engine to warm up while the vehicle remains stationary.

Start driving at moderate engine speeds. (Steep accelerating and decelerating should be avoided.)

 **WARNING - Steering wheel**

Never reach for any controls through the steering wheel while the vehicle is in motion. The presence of your hand or arm in this area could cause a loss of vehicle control.

If the engine stalls while you are in motion, do not attempt to move the shift lever to the P (Park) position. If traffic and road conditions permit, you may put the shift lever in the N (Neutral) position while the vehicle is still moving and turn the ignition switch to the START position in an attempt to restart the engine.



CAUTION - Starter

Do not engage the starter for more than 10 seconds. If the engine stalls or fails to start, wait 5 to 10 seconds before re-engaging the starter. Improper use of the starter may damage it.

ENGINE START/STOP BUTTON (IF EQUIPPED)

Illuminated ENGINE START/STOP button



Whenever the front door is opened, the ENGINE START/STOP button will illuminate for your convenience. The light will go off after about 30 seconds when the door is closed.

When all entrances are closed, if you lock the vehicle by using the transmitter or the smart key, the light will go off immediately.

ENGINE START/STOP button position

OFF



To turn off the engine (START/RUN position) or vehicle power (ON position), press the ENGINE START/STOP button with the shift lever in the P (Park) position. When you press the ENGINE START/STOP button without the shift lever in the P (Park) position, the ENGINE START/STOP button will not change to the OFF position but to the ACC position.

In an emergency situation while the vehicle is in motion, you are able to turn the engine off and to the ACC position by pressing the ENGINE START/STOP button for more than 2 seconds or 3 times successively within 3 seconds. If the vehicle is still moving, you can restart the engine without depressing the brake pedal by pressing the ENGINE START/STOP button with the shift lever in the N (Neutral) position.

ACC(Accessory)



Amber

Press the ENGINE START/STOP button while it is in the OFF position without depressing the brake pedal.

If the ENGINE START/STOP button is in the ACC position for more than 1 hour, the button is turned off automatically to prevent battery discharge.

ON



Redish orange

Press the ENGINE START/STOP button while it is in the ACC position without depressing the brake pedal.

The warning lights can be checked before the engine is started. Do not leave the ENGINE START/STOP button in the ON position for a long time. The battery may discharge, because the engine is not running.

START/RUN



Not illuminated

To start the engine, depress the brake pedal and press the ENGINE START/ STOP button with the shift lever in the P (Park) or the N (Neutral) position. For your safety, start the engine with the shift lever in the P (Park) position.

If you press the ENGINE START/STOP button without depressing the brake pedal for automatic transaxle vehicles, the engine will not start and the ENGINE START/STOP button changes as follows:

OFF → ACC → ON → OFF or ACC

*** NOTICE**

If you leave the **ENGINE START/STOP** button in the **ACC** or **ON** position for a long time, the battery will discharge.

 **WARNING - Starting vehicle**

Never press the ENGINE START/STOP button while the vehicle is in motion except in an emergency. This would result in loss of directional control and braking function, which could cause an accident.

Starting the engine with a smart key

1. Carry the smart key or leave it inside the vehicle.
2. Make sure the parking brake is firmly applied
3. Place the transaxle shift lever in P (Park). Depress the brake pedal fully.

You can also start the engine when the shift lever is in the N (Neutral) position.

4. Press the **ENGINE START/STOP** button while depressing the brake pedal.

It should be started without depressing the accelerator.

5. Do not wait for the engine to warm up while the vehicle remains stationary.

Start driving at moderate engine speeds. (Steep accelerating and decelerating should be avoided.)

- Even if the smart key is in the vehicle, if it is far away from you, the engine may not start.
- When the **ENGINE START/STOP** button is in the **ACC** position or above, if any door is opened, the system checks for the smart key. If the smart key is not in the vehicle, a message "key is not in the vehicle" will appear on the LCD display. And if all doors are closed, the chime will sound for 5 seconds. The indicator or warning will turn off while the vehicle is moving. Always have the smart key with you.

⚠ WARNING - Unintended vehicle movement

Never leave the smart key in the vehicle with children or vehicle occupants who are unfamiliar with the vehicle operation. Pushing the ENGINE START/STOP button while the smart key is in the vehicle may result in unintended engine activation and/or unintended vehicle movement.



- If the battery is weak or the smart key does not work correctly, you can start the engine by pressing the engine start/stop button with the smart key.

The side with the lock button should contact the engine start/stop button directly.

When you press the engine start/stop button directly with the smart key, the smart key should contact the button at a right angle.

- When the stop lamp fuse is blown, you can't start the engine normally. Replace the fuse with a new one. If it is not possible, you can start the engine by pressing the ENGINE START/STOP button for 10 seconds while it is in the ACC position. The engine can start without depressing the brake pedal. But for your safety always depress the brake pedal before starting the engine.

Do not press the ENGINE START/STOP button for more than 10 seconds except when the stop lamp fuse is blown.

AUTOMATIC TRANSAXLE

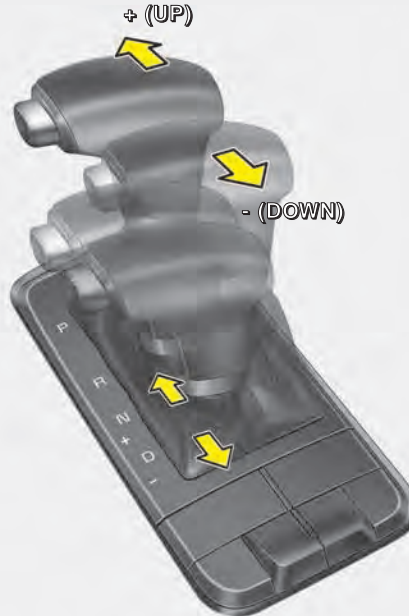
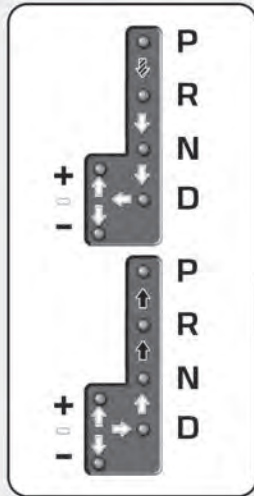

Automatic transaxle operation

The automatic transaxle has 6 forward speeds and one reverse speed. The individual speeds are selected automatically, depending on the position of the shift lever.

* NOTICE

The first few shifts on a new vehicle, if the battery has been disconnected, may be somewhat abrupt. This is a normal condition, and the shifting sequence will adjust after shifts are cycled a few times by the TCM (Transaxle Control Module) or PCM (Powertrain Control Module).

 Depress the brake pedal and the lock release button when shifting.
(If the shift lock system is not equipped, it is not necessary to depress the brake pedal. However, it is recommended to depress the brake pedal to avoid inadvertent movement of the vehicle.)

 Press the lock release button when shifting.

 The shift lever can be shifted freely.

OYP056006

For smooth operation, depress the brake pedal and the lock release button when shifting from N (Neutral) to a forward or reverse gear.

 **WARNING - Automatic transaxle**

Before leaving the driver's seat, always make sure the shift lever is in the P (Park) position; then set the parking brake fully and shut the engine off. Do not use the P position in place of the parking brake. Always make sure the shift lever is latched in the P position and set the parking brake fully. Unexpected and sudden vehicle movement can occur if these precautions are not followed.



CAUTION - Transaxle

To avoid damage to your transaxle, do not accelerate the engine in R (Reverse) or any forward gear position with the brakes on. The transaxle may be damaged if you shift into P (Park) while the vehicle is in motion.

When stopped on an incline, do not hold the vehicle with the engine power. Use the service brake or the parking brake.

Transaxle ranges

The indicator in the instrument cluster displays the shift lever position when the ignition switch is in the ON position.

P (Park)

Always come to a complete stop before shifting into P (Park). This position locks the transaxle and prevents the drive wheels from rotating.

Shifting into P (Park) while the vehicle is in motion will cause the drive wheels to lock which will cause you to lose control of the vehicle.

R (Reverse)

Use this position to drive the vehicle backward.

⚠ CAUTION - Shifting

Always come to a complete stop before shifting into or out of R (Reverse); you may damage the transaxle if you shift into R (Reverse) while the vehicle is in motion, except when “Rocking the vehicle” explained in this section.

N (Neutral)

The wheels and transaxle are not engaged. The vehicle will roll freely even on the slightest incline unless the parking brake or service brakes are applied.

- Parking in N (Neutral) gear

Follow below steps when parking and you want the vehicle to move when pushed.

1. After parking your vehicle, step on the brake pedal and move the shift lever to P with the ignition button in ON or while the engine is running.
2. If the parking brake is applied unlock the parking brake.
3. While pressing the brake pedal, turn the ignition button OFF.
 - For smart key equipped vehicles, the ignition switch can be moved to OFF only when the shift lever is in P.
4. Change the gear shift lever to N (Neutral) while pressing the brake pedal and pushing [SHIFT LOCK RELEASE] button or inserting, pressing down a tool (e.g. flathead screw-driver) into the [SHIFT LOCK RELEASE] access hole at the same time. Then, the vehicle will move when external force is applied.

⚠ CAUTION

- ***With the exception of parking in neutral gear, always park the vehicle in P (Park) for safety and engage the parking brake.***
- ***Before parking in N (Neutral) gear, first make sure the parking ground is level and flat. Do not park in N gear on any slopes or gradients.***
If parked and left in N, the vehicle may move and cause serious damage and injury.

D (Drive)

This is the normal forward driving position. The transaxle will automatically shift through a 6-gear sequence, providing the best fuel economy and power.

For extra power when passing another vehicle or climbing grades, depress the accelerator fully, at which time the transaxle will automatically downshift to the next lower gear.

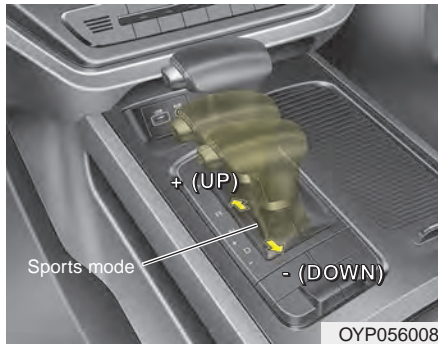

Sports mode

Whether the vehicle is stationary or in motion, sports mode is selected by pushing the shift lever from the D (Drive) position into the manual gate. To return to D (Drive) range operation, push the shift lever back into the main gate.

In sports mode, moving the shift lever backwards and forwards will allow you to make gearshifts rapidly. In contrast to a manual transaxle, the sports mode allows gearshifts with the accelerator pedal depressed.

Up (+) : Push the lever forward once to shift up one gear.

Down (-) : Pull the lever backwards once to shift down one gear.

- In sports mode, the driver must execute upshifts in accordance with road conditions, taking care to keep the engine speed below the red zone.
- In sports mode, only the 6 forward gears can be selected. To reverse or park the vehicle, move the shift lever to the R (Reverse) or P (Park) position as required.
- In sports mode, downshifts are made automatically when the vehicle slows down. When the vehicle stops, 1st gear is automatically selected.
- In sports mode, when the engine rpm approaches the red zone shift points are varied to upshift automatically.

- To maintain the required levels of vehicle performance and safety, the system may not execute certain gearshifts when the shift lever is operated.
- When driving on a slippery road, push the shift lever forward into the +(up) position. This causes the transaxle to shift into the 2nd gear which is better for smooth driving on a slippery road. Push the shift lever to the -(down) side to shift back to the 1st gear.

Shift lock system

For your safety, the automatic transaxle has a shift lock system which prevents shifting the transaxle from P (Park) into R (Reverse) unless the brake pedal is depressed.

To shift the transaxle from P (Park) into R (Reverse):

1. Depress and hold the brake pedal.
2. Start the engine or turn the ignition switch to the ON position.
3. Move the shift lever.

If the brake pedal is repeatedly depressed and released with the shift lever in the P (Park) position, a chattering noise near the shift lever may be heard. It is a normal condition.

⚠ WARNING - Shifting from park

Always fully depress the brake pedal before and while shifting out of the P (Park) position into another position to avoid inadvertent motion of the vehicle which could injure persons in or around the vehicle.

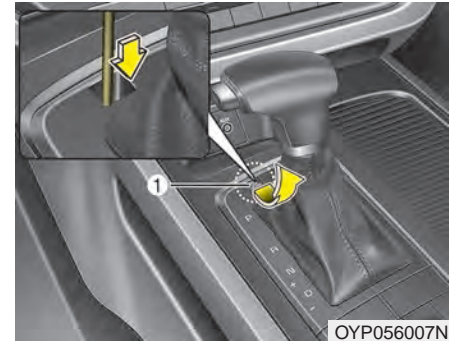

Shift-lock override

If the shift lever cannot be moved from the P (Park) position into R (Reverse) position with the brake pedal depressed, continue depressing the brake, then do the following:

1. Carefully remove the cap covering the shift-lock access hole (1).
2. Insert a screwdriver into the access hole and press down on the screwdriver.
3. Move the shift lever.
4. Have your vehicle inspected by an authorized Kia dealer immediately.

Ignition key interlock system

The ignition key cannot be removed unless the shift lever is in the P (Park) position. Even if the ignition switch is in the LOCK position, the key also cannot be removed.

If your vehicle is equipped with ENGINE START/STOP button, the button will not change to the OFF position unless the shift lever is in the P (Park) position.

Good driving practices

- Never move the gear shift lever from P (Park) to any other position with the accelerator pedal depressed.
- Never move the gear shift lever into P (Park) when the vehicle is in motion.
- Slow down before shifting to a lower gear. Otherwise, the lower gear may not be engaged.
- Always use the parking brake. Do not depend on placing the transaxle in P (Park) to keep the vehicle from moving.
- Optimum vehicle performance and economy is obtained by smoothly depressing and releasing the accelerator pedal.

Moving up a steep grade from a standing start

To move up a steep grade from a standing start, depress the brake pedal, shift the shift lever to D (Drive). Select the appropriate gear depending on load weight and steepness of the grade, and release the parking brake. Depress the accelerator gradually while releasing the service brakes.

When accelerating from a stop on a steep hill, the vehicle may have a tendency to roll backwards. Shifting the shift lever into 2 (Second Gear) will help prevent the vehicle from rolling backwards.

BRAKE SYSTEM

Power brakes

Your vehicle has power-assisted brakes that adjust automatically through normal usage.

In the event that the power-assisted brakes lose power because of a stalled engine or some other reason, you can still stop your vehicle by applying greater force to the brake pedal than you normally would. The stopping distance, however, will be longer.

When the engine is not running, the reserve brake power is partially depleted each time the brake pedal is applied. Do not pump the brake pedal when the power assist has been interrupted.

Pump the brake pedal only when necessary to maintain steering control on slippery surfaces.



CAUTION - Brake Pedal

Do not drive with your foot resting on the brake pedal. This will create abnormally high brake temperatures which can cause excessive brake lining and pad wear.



WARNING - Steep hill braking

Avoid continuous application of the brakes when descending a long or steep hill by shifting to a lower gear. Continuous brake application will cause the brakes to overheat and could result in a temporary loss of braking performance.

Wet brakes may impair the vehicle's ability to safely slow down; the vehicle may also pull to one side when the brakes are applied. Applying the brakes lightly will indicate whether they have been affected in this way. Always test your brakes in this fashion after driving through deep water. To dry the brakes, apply them lightly while maintaining a safe forward speed until brake performance returns to normal.

In the event of brake failure

If service brakes fail to operate while the vehicle is in motion, you can make an emergency stop with the parking brake. The stopping distance, however, will be much greater than normal.

WARNING - Parking brake

Applying the parking brake while the vehicle is moving at normal speeds can cause a sudden loss of control of the vehicle. If you must use the parking brake to stop the vehicle, use great caution in applying the brake.

Disc brakes wear indicator

When your brake pads are worn and new pads are required, you will hear a high-pitched warning sound from your front brakes or rear brakes. You may hear this sound come and go or it may occur whenever you depress the brake pedal.

Please remember that some driving conditions or climates may cause a brake squeal when you first apply (or lightly apply) the brakes. This is normal and does not indicate a problem with your brakes.

Always replace the front or rear brake pads as pairs.

CAUTION - Replace brake pads

Do not continue to drive with worn brake pads. Continuing to drive with worn brake pads can damage the braking system and result in costly brake repairs.

 **WARNING - Brake wear**
Avoid applying the parking brake to stop the vehicle while it is moving except in an emergency situation. If you ignore this audible warning, you will eventually lose braking performance, which could lead to a serious accident.

Parking brake – Foot type

Applying the parking brake

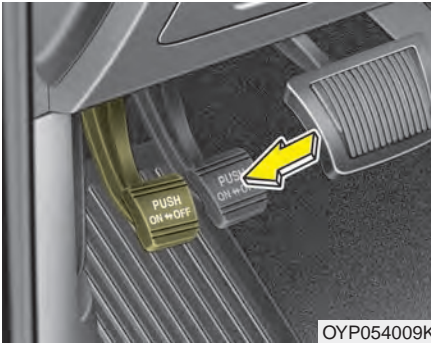

To engage the parking brake, first apply the foot brake and then depress the parking brake pedal down as far as possible.

⚠ CAUTION - Parking brake
Driving with the parking brake applied will cause excessive brake pad (or lining) and brake rotor wear.

Releasing the parking brake

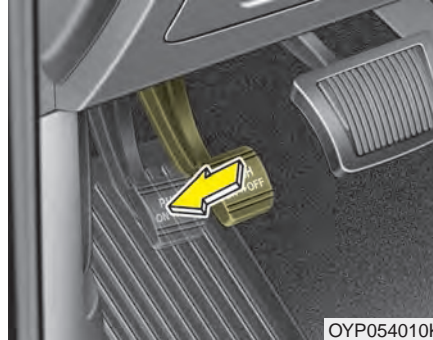

To release the parking brake, depress the parking brake pedal a second time while applying the foot brake. The pedal will automatically extend to the fully released position.

⚠ WARNING - Brake wear
 Do not ignore high pitched wear sounds from your brakes. If you ignore this audible warning, you will eventually lose braking performance, which could lead to a serious accident.

⚠ WARNING - Parking brake use

All vehicles should always have the parking brake fully engaged when parking to avoid inadvertent movement of the vehicle which can injure occupants or pedestrians.



Check the brake warning light by turning the ignition switch ON (do not start the engine). This light will be illuminated when the parking brake is applied with the ignition switch in the START or ON position.

Before driving, be sure the parking brake is fully released and the brake warning light is off.

If the brake warning light remains on after the parking brake is released while the engine is running, there may be a malfunction in the brake system. Immediate attention is necessary.

If at all possible, cease driving the vehicle immediately. If that is not possible, use extreme caution while operating the vehicle and only continue to drive the vehicle until you can reach a safe location or repair shop.

Anti-lock brake system (ABS)

ABS (or ESC) will not prevent accidents due to improper or dangerous driving maneuvers. Even though vehicle control is improved during emergency braking, always maintain a safe distance between you and objects ahead. Vehicle speeds should always be reduced during extreme road conditions. The vehicle should be driven at reduced speeds in the following circumstances:

- When driving on rough, gravel or snow-covered roads
- When driving with tire chains installed
- When driving on roads where the road surface is pitted or has different surface heights.

Driving in these conditions increase the stopping distance for your vehicle.

The ABS continuously senses the speed of the wheels. If the wheels are going to lock, the ABS system repeatedly modulates the hydraulic brake pressure to the wheels.

When you apply your brakes under conditions which may lock the wheels, you may hear a “tik-tik” sound from the brakes, or feel a corresponding sensation in the brake pedal. This is normal and it means your ABS is active.

In order to obtain the maximum benefit from your ABS in an emergency situation, do not attempt to modulate your brake pressure and do not try to pump your brakes. Press your brake pedal as hard as possible or as hard as the situation allows the ABS to control the force being delivered to the brakes.

* NOTICE

A click sound may be heard in the engine compartment when the vehicle begins to move after the engine is started. These conditions are normal and indicate that the anti-lock brake system is functioning properly.

- Even with the anti-lock brake system, your vehicle still requires sufficient stopping distance. Always maintain a safe distance from the vehicle in front of you.
- Always slow down when cornering. The anti-lock brake system cannot prevent accidents resulting from excessive speeds.
- On loose or uneven road surfaces, operation of the anti-lock brake system may result in a longer stopping distance than for vehicles equipped with a conventional brake system.



W-78

The ABS warning light will stay on for approximately 3 seconds after the ignition switch is ON. During that time, the ABS will go through self-diagnosis and the light will go off if everything is normal. If the light stays on, you may have a problem with your ABS. Contact an authorized Kia dealer as soon as possible.

- When you drive on a road having poor traction, such as an icy road, and have operated your brakes continuously, the ABS will be active continuously and the ABS warning light may illuminate. Pull your vehicle over to a safe place and stop the engine.
- Restart the engine. If the ABS warning light goes off, then your ABS system is normal. Otherwise, you may have a problem with the ABS. Contact an authorized Kia dealer as soon as possible.

*** NOTICE**

When you jump start your vehicle because of a drained battery, the engine may not run as smoothly and the ABS warning light may turn on at the same time. This happens because of low battery voltage. It does not mean your ABS has malfunctioned.

- **Do not pump your brakes!**
- **Have the battery recharged before driving the vehicle.**

Electronic stability control (ESC)

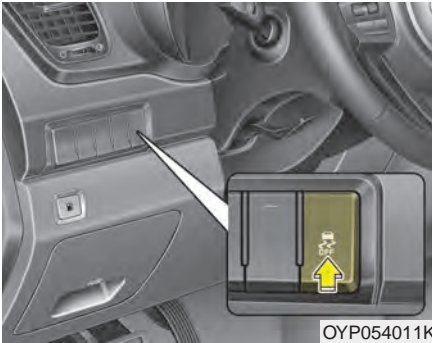

The Electronic Stability control (ESC) system is designed to stabilize the vehicle during cornering maneuvers. ESC checks where you are steering and where the vehicle is actually going. ESC applies the brakes on individual wheels and intervenes with the engine management system to stabilize the vehicle.

Electronic stability control (ESC) will not prevent accidents. Excessive speed in turns, abrupt maneuvers and hydroplaning on wet surfaces can still result in serious accidents. Only a safe and attentive driver can prevent accidents by avoiding maneuvers that cause the vehicle to lose traction. Even with ESC installed, always follow all the normal precautions for driving - including driving at safe speeds for the conditions.

The Electronic Stability Control (ESC) system is an electronic system designed to help the driver maintain vehicle control under adverse conditions. It is not a substitute for safe driving practices. Factors including speed, road conditions and driver steering input can all affect whether ESC will be effective in preventing a loss of control. It is still your responsibility to drive and corner at reasonable speeds and to leave a sufficient margin of safety.

When you apply your brakes under conditions which may lock the wheels, you may hear a “tik-tik” sound from the brakes, or feel a corresponding sensation in the brake pedal. This is normal and it means your ESC is active.

* NOTICE

A click sound may be heard in the engine compartment when the vehicle begins to move after the engine is started. These conditions are normal and indicate that the Electronic Stability Control System is functioning properly.

ESC operation

ESC ON condition

- - When the ignition is turned ON, ESC and ESC OFF indicator lights illuminate for approximately 3 seconds, then ESC is turned on.
 - Press the ESC OFF button for at least half a second after turning the ignition ON to turn ESC off. (ESC OFF indicator will illuminate). To turn the ESC on, press the ESC OFF button (ESC OFF indicator light will go off).
 - When starting the engine, you may hear a slight ticking sound. This is the ESC performing an automatic system self-check and does not indicate a problem.

When operating



When the ESC is in operation, the ESC indicator light blinks.

- When the Electronic Stability Control is operating properly, you can feel a slight pulsation in the vehicle. This is only the effect of brake control and indicates nothing unusual.
- When moving out of the mud or driving on a slippery road, pressing the accelerator pedal may not cause the engine rpm (revolutions per minute) to increase.

ESC operation off

ESC OFF state





This car has 2 kinds of ESC off states.

If the engine stops when ESC is off, ESC remains off. Upon restarting the engine, the ESC will automatically turn on again.





• ESC off state 1

To cancel ESC operation, press the ESC OFF button (ESC OFF ) shortly (ESC OFF indicator light (ESC OFF ) illuminates). At this state, the engine control function does not operate. It means the traction control function does not operate. Brake control function only operates.

If your vehicle is equipped with cluster type B, C, a message also will appear on the LCD display.



• ESC off state 2

To cancel ESC operation, press the ESC OFF button (ESC OFF ) for more than 3 seconds. ESC OFF indicator light (ESC OFF ) illuminates and ESC OFF warning chime will sound. At this state, the engine control function and brake control function do not operate. It means the car stability control function does not operate any more.

If your vehicle is equipped with cluster type B, C, a message also will appear on the LCD display.

Indicator light

■ ESC indicator light



■ ESC OFF indicator light



When ignition switch is turned to ON, the indicator light illuminates, then goes off if the ESC system is operating normally.

The ESC indicator light blinks whenever ESC is operating or illuminates when ESC fails to operate.

The ESC OFF indicator light comes on when the ESC is turned off with the button.

⚠ WARNING - Electronic stability control

Drive carefully even though your vehicle has Electronic Stability Control. It can only assist you in maintaining control under certain circumstances.

ESC OFF usage

When driving

- ESC should be turned on for daily driving whenever possible.
- To turn ESC off while driving, press the ESC OFF button while driving on a flat road surface.

⚠ WARNING - Operating ESC

Never press the ESC OFF button while ESC is operating (ESC indicator light blinks).

If ESC is turned off while ESC is operating, the vehicle may slip out of control.

*** NOTICE**

- When operating the vehicle on a dynamometer, ensure that the ESC is turned off (ESC OFF light illuminated). If the ESC is left on, it may prevent the vehicle speed from increasing, and result in false diagnosis.
- Turning the ESC off does not affect ABS or brake system operation.

Vehicle stability management (VSM) (if equipped)

This system provides further enhancements to vehicle stability and steering responses when a vehicle is driving on a slippery road or a vehicle detects changes in coefficient of friction between right wheels and left wheels when braking.

WARNING - Tire/ Wheel size

When replacing tires and wheels, make sure they are the same size as the original tires and wheels installed. Driving with varying tire or wheel sizes may diminish any supplemental safety benefits of the VSM system.

VSM operation

When the VSM is in operation, ESC indicator light () blinks.

When the vehicle stability management is operating properly, you can feel a slight pulsation in the vehicle and/or abnormal steering responses (EPS). This is only the effect of brake and EPS control and indicates nothing unusual.

The VSM does not operate when:

- Driving on bank road such as gradient or incline
- Driving in reverse
- ESC OFF indicator light () remains on the instrument cluster
- EPS indicator light remains on the instrument cluster

VSM operation off

If you press the ESC OFF button to turn off the ESC, the VSM will also cancel and the ESC OFF indicator light () illuminates.

To turn on the VSM, press the button again. The ESC OFF indicator light goes out.

Malfunction indicator

The VSM can be deactivated even if you don't cancel the VSM operation by pressing the ESC OFF button. It indicates that a malfunction has been detected somewhere in the Electric Power Steering system or VSM system. If the ESC indicator light () or EPS warning light remains on, take your vehicle to an authorized Kia dealer and have the system checked.

*** NOTICE**

- The VSM is designed to function above approximately 13 mph (22 km/h) on curves.
- The VSM is designed to function above approximately 6 mph (10 km/h) when a vehicle is braking on a split-mu road. The split-mu road is made of surfaces which have different friction forces.

- The Vehicle Stability Management system is not a substitute for safe driving practices but a supplementary function only. It is the responsibility of the driver to always check the speed and the distance to the vehicle ahead. Always hold the steering wheel firmly while driving.
- Your vehicle is designed to activate according to the driver's intention, even with installed VSM. Always follow all the normal precautions for driving at safe speeds for the conditions – including driving in clement weather and on a slippery road.

Hill-start assist control (HAC)

A vehicle has the tendency to roll back on a steep hill when it starts to go after stopping. The Hill-start Assist Control (HAC) prevents the vehicle from rolling back by applying the brakes automatically for about 2 seconds. The brakes are released when the accelerator pedal is depressed or after about 2 seconds.

The HAC is activated only for about 2 seconds, so when the vehicle is starting off always depress the accelerator pedal.

⚠ WARNING - Maintaining Brake Pressure on Incline

HAC does not replace the need to apply brakes while stopped on an incline. While stopped, make sure you maintain brake pressure sufficient to prevent your vehicle from rolling backward and causing an accident. Don't release the brake pedal until you are ready to accelerate forward.

Good braking practices

- Check to be sure the parking brake is not engaged and the parking brake indicator light is out before driving away.
- Driving through water may get the brakes wet. They can also get wet when the vehicle is washed. Wet brakes can be dangerous! Your vehicle will not stop as quickly if the brakes are wet. Wet brakes may cause the vehicle to pull to one side.

To dry the brakes, apply the brakes lightly until the braking action returns to normal, taking care to keep the vehicle under control at all times. If the braking action does not return to normal, stop as soon as it is safe to do so and call an authorized Kia dealer for assistance.

- Don't coast down hills with the vehicle out of gear. This is extremely hazardous. Keep the vehicle in gear at all times, use the brakes to slow down, then shift to a lower gear so that engine braking will help you maintain a safe speed.
- Don't "ride" the brake pedal. Resting your foot on the brake pedal while driving can be dangerous because the brakes might overheat and lose their effectiveness. It also increases the wear of the brake components.
- If a tire goes flat while you are driving, apply the brakes gently and keep the vehicle pointed straight ahead while you slow down. When you are moving slowly enough for it to be safe to do so, pull off the road and stop in a safe place.

- If your vehicle is equipped with an automatic transaxle, don't let your vehicle creep forward. To avoid creeping forward, keep your foot firmly on the brake pedal when the vehicle is stopped.
- Be cautious when parking on a hill. Firmly engage the parking brake and place the shift lever in P (automatic transaxle). If your vehicle is facing downhill, turn the front wheels into the curb to help keep the vehicle from rolling. If your vehicle is facing uphill, turn the front wheels away from the curb to help keep the vehicle from rolling. If there is no curb or if it is required by other conditions to keep the vehicle from rolling, block the wheels.
- Under some conditions your parking brake can freeze in the engaged position. This is most likely to happen when there is an accumulation of snow or ice around or near the rear brakes or if the brakes are wet. If there is a risk that the parking brake may freeze, apply it only temporarily while you put the shift lever in P (automatic transaxle) and block the rear wheels so the vehicle cannot roll. Then release the parking brake.
- Do not hold the vehicle on the upgrade with the accelerator pedal. This can cause the transaxle to overheat. Always use the brake pedal or parking brake.

AUTONOMOUS EMERGENCY BRAKING (AEB) (IF EQUIPPED)

The Autonomous Emergency Braking (AEB) system is designed to detect and monitor the vehicle ahead or detect a pedestrian in the roadway through radar signals and camera recognition to warn the driver that a collision is imminent, and if necessary, apply emergency braking.

⚠ WARNING - Autonomous Emergency Braking (AEB) Limitations

The AEB system is a supplemental system and is not a substitute for safe driving practices. It is the responsibility of the driver to always check the speed and distance to the vehicle ahead to ensure it is safety to use the AEB system.

* NOTICE

Take the following precautions when using the Autonomous Emergency Braking (AEB):

- This system is only a supplemental system and it is not intended to, nor does it replace the need for extreme care and attention of the driver. The sensing range and objects detectable by the sensors are limited. Pay attention to the road conditions at all times.
- NEVER drive too fast in accordance with the road conditions or while cornering.
- Always drive cautiously to prevent unexpected and sudden situations from occurring. AEB does not stop the vehicle completely and is not a collision avoidance system.

System Setting and Activation

System setting



The driver can activate the AEB by placing the ignition switch to the ON position and by selecting 'User Settings', 'Driving Assist', and 'AEB (Autonomous Emergency Braking System)'. The AEB deactivates, when the driver deselects the system setting.



The warning light illuminates on the LCD display, when you cancel the AEB system. The driver can monitor the AEB ON/OFF status on the LCD display. If the warning light remains ON when the AEB is activated, have the system checked by an authorized Kia dealer.

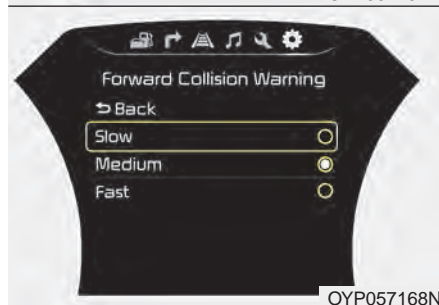

The driver can select the initial warning activation time in the User Settings in the Driver LCD display. The options for the initial Forward Collision Warning include the following:

- **SLOW** - When this condition is selected, the initial Forward Collision Warning is activated slower than normal. This setting reduces the amount of distance between the vehicle ahead before the initial warning occurs.
- **MEDIUM** - When this condition is selected, the initial Forward Collision Warning is activated normally. This setting allows for a nominal amount of distance between the vehicle ahead before the initial warning occurs.
- **FAST** - When this condition is selected, the initial Forward Collision Warning is faster than normal. This setting maximizes the amount of distance between the vehicle ahead before the initial warning occurs.

Prerequisite for activation

The AEB system is on and ready when AEB is selected on the LCD display and when the following prerequisites are satisfied:

- The ESC (Electronic Stability Control) or TCS (Traction Control System) is activated.
- Driving speed exceeds approximately 6 mph (10 km/h). (The AEB is only activated within a certain speed range.)
- The system detects a pedestrian or a vehicle in front, which may collide with your vehicle. (The AEB may not be activated or may sound a warning alarm in accordance with the driving situation or vehicle condition.)

⚠ WARNING

Do not attempt to set or cancel the AEB while your vehicle is moving. Set or cancel the AEB with controlling switches on steering wheel after stopping the vehicle in a safe place for your safety.

- The AEB automatically activates upon placing the ignition switch to the ON position. The driver can deactivate the AEB by canceling the system setting on the LCD display.
- The AEB automatically deactivates when canceling the ESC (Electronic Stability Control). When the ESC is canceled, the AEB cannot be activated on the LCD display.

AEB Warning Message and System Control

The AEB produces warning messages and warning alarms in accordance with the collision risk levels, such as abrupt stopping of the vehicle in front, insufficient braking distance, or pedestrian detection. Also, it controls the brakes in accordance with the collision risk levels.

Forward Warning (1st warning)



This initial warning message appears on the LCD display with a warning chime.

The driver can select the initial warning activation time in the User Settings in the Driver LCD display. The options for the initial Forward Collision Warning include SLOW, MEDIUM, or FAST initial warning time.

Collision Warning (2nd warning)



- This warning message appears on the LCD display with a warning chime.
- The AEB system limitedly controls the brakes to preemptively mitigate impact in a collision.

Emergency Braking (3rd warning)

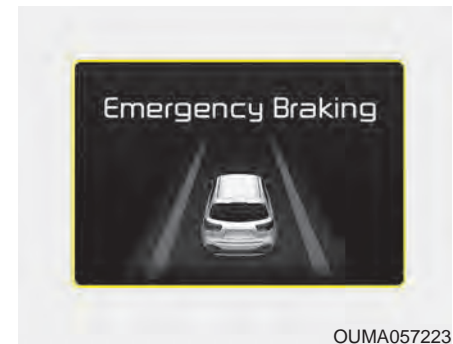

- This warning message appears on the LCD display with a warning alarm.
- The AEB system limitedly controls the brakes to preemptively mitigate impact in a collision.
 - The brake control is maximized just before a collision.

Brake operation

- In an urgent situation, the braking system enters into the ready status for prompt reaction against the driver's depressing the brake pedal.
- The AEB provides additional braking power for optimum braking performance, when the driver depresses the brake pedal.
- The braking control is automatically deactivated, when the driver sharply depresses the brake pedal, or when the driver abruptly operates the steering wheel.
- The AEB braking control is automatically canceled, when risk factors disappear.

The driver should always use extreme caution while operating the vehicle, whether or not there is a warning message or alarm from the AEB system.

⚠ WARNING

The AEB cannot avoid all collisions. The AEB might not completely stop the vehicle before collision, due to ambient weather and road conditions. The driver has the responsibility to drive safely and control the vehicle.

*** NOTICE**

The AEB operates in accordance with the risk levels, such as the distance from the vehicle/passers-by in front, the speed of the vehicle/passers-by in front, and the driver's vehicle operation.

AEB Front Radar Sensor



In order for the AEB system to operate properly, always make sure the radar sensor lens cover is clean and free of dirt, snow, and debris. Dirt, snow, or foreign substances on the lens may adversely affect the sensing performance of the radar.

Warning message and warning light



When the sensor lens cover is blocked with dirt, snow, or debris, the AEB system operation may stop temporarily. If this occurs, a warning message will appear on the LCD display. Remove any dirt, snow, or debris and clean the radar sensor lens cover before operating the AEB system.

The AEB may not properly operate in an area (e.g. open terrain), where any substances are not detected after turning ON the engine.

* NOTICE

- Do not apply foreign objects such as a bumper sticker or a bumper guard near the radar sensor. Doing so may adversely affect the sensing performance of the radar.
- Always keep the radar sensor and lens cover clean and free of dirt and debris.
- Use only a soft cloth to wash the vehicle. Do not spray pressurized water directly on the sensor or sensor cover.
- Be careful not to apply unnecessary force on the radar sensor or sensor cover. If the sensor is forcibly moved out of proper alignment, the AEB system may not operate correctly. In this case, a warning message may not be displayed. Have the vehicle inspected by an authorized Kia dealer.

(Continued)

(Continued)

- If the front bumper becomes damaged in the area around the radar sensor, the AEB system may not operate properly. Have the vehicle inspected by an authorized Kia dealer.
- Use only genuine Kia parts to repair or replace a damaged sensor or sensor cover. Do not apply paint to the sensor cover.

System Malfunction

- Warning light

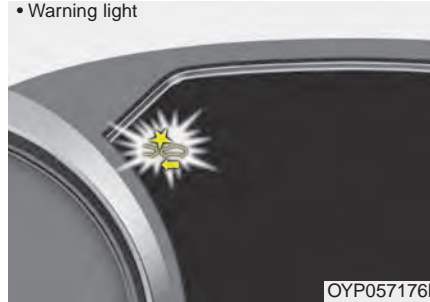

- Warning message

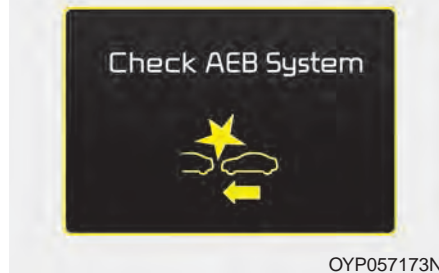

- When the AEB is not working properly, the AEB warning light (🚗) will illuminate and the warning message will appear for a few seconds. After the message disappears, the master warning light (⚠️) will illuminate. In this case, have the vehicle inspected by an authorized Kia dealer.
- The AEB warning message may appear along with the illumination of the ESC warning light.

⚠ WARNING

- The AEB is only a supplemental system for the driver's convenience. The driver still maintains responsibility to control the vehicle. Do not solely depend on the AEB system. Rather, maintain a safe braking distance, and, if necessary, depress the brake pedal to lower the driving speed.
- The AEB cannot recognize cross-traffic or parked vehicles presenting a side-profile. You must maintain a safe braking distance, and if necessary, depress the brake pedal to reduce the driving speed in order to maintain a safe distance.

(Continued)

(Continued)

- The brake control may be insufficient, possibly causing a collision, if a vehicle in front abruptly stops. Always pay extreme caution.
 - Occupants may get injured, if the vehicle abruptly stops by the activated AEB system. Pay extreme caution.
-
- The AEB may unnecessarily produce warning messages and warning alarms. Due to the sensing limitation, the AEB may not produce warning messages or warning alarm at all.
 - When there is a malfunction with the AEB, the braking control does not operate upon detecting a collision risk even with other braking systems normally operating.
 - The AEB operates only for the vehicle / pedestrian in front, while driving forward. It does not operate for any animals or vehicles in the opposite direction.

Limitations of the System

The Autonomous Emergency Braking (AEB) system is designed to monitor the vehicle ahead or a pedestrian in the roadway through radar signals and camera recognition to warn the driver that a collision is imminent, and if necessary, apply emergency braking.

In certain situations, the radar sensor or the camera may not be able to detect the vehicle or pedestrian ahead. In these cases, the AEB system may not operate normally. The driver must pay careful attention in the following situations where the AEB operation may be limited.

Detecting vehicles

The sensor may be limited when:

- The radar sensor or camera is blocked with a foreign object or debris.
 - Inclement weather such as heavy rain or snow obscures the field of view of the radar sensor or camera.
 - There is interference by electromagnetic waves.
 - There is severe irregular reflection from the radar sensor.
 - The vehicle in front is too small to be detected by the camera recognition system (for example a motorcycle or a bicycle, etc.).
 - The vehicle in front is an oversize vehicle or trailer that is too big to be detected by the camera recognition system (for example a tractor trailer, etc.).
 - The driver's field of view is not well illuminated (either too dark or too much reflection or too much back-light that obscures the field of view).
- The vehicle in front does not have their rear lights properly turned ON.
 - The outside brightness changes suddenly, for example when entering or exiting a tunnel.
 - The vehicle in front is driving erratically.
 - The vehicle drives through a construction area, on an unpaved road, or above metal materials, such as a railway.
 - The vehicle drives inside a building, such as a basement parking lot.



- Driving on a curve

The performance of the AEB system may be limited when driving on a curved road.

In certain instances on a curved road, the AEB system may activate prematurely.

Also, in certain instances the front radar sensor or camera recognition system may not detect the vehicle traveling on a curved road.

In these cases, the driver must maintain a safe braking distance, and if necessary, depress the brake pedal to reduce your driving speed in order to maintain a safe distance.

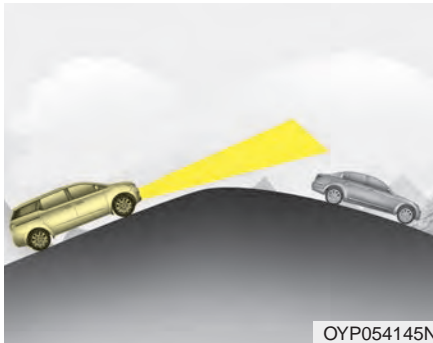

- Driving on a slope

The performance of the AEB decreases while driving upward or downward on a slope, not recognizing the vehicle in front in the same lane. It may unnecessarily produce the warning message and the warning alarm, or it may not produce the warning message and the warning alarm at all.

When the AEB suddenly recognizes the vehicle in front while passing over a slope, you may experience sharp deceleration.

Always keep your eyes forward while driving upward or downward on a slope, and, if necessary, depress the brake pedal to reduce your driving speed in order to maintain distance.

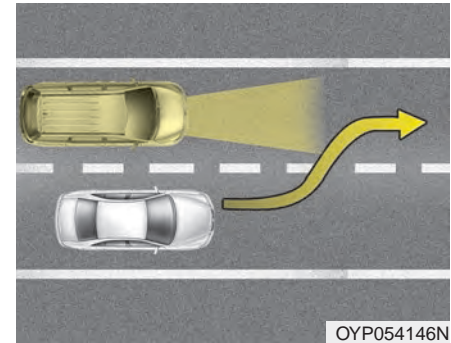

- Changing lanes

When a vehicle changes lanes in front of you, the AEB system may not immediately detect the vehicle, especially if the vehicle changes lanes abruptly. In this case, you must maintain a safe braking distance, and if necessary, depress the brake pedal to reduce your driving speed in order to maintain a safe distance.

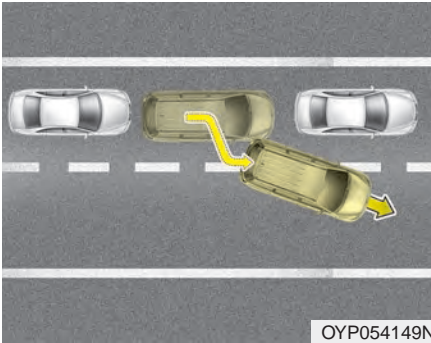

When driving in stop-and-go traffic, and a stopped vehicle in front of you merges out of the lane, the AEB system may not immediately detect the new vehicle that is now in front of you. In this case, you must maintain a safe braking distance, and if necessary, depress the brake pedal to reduce your driving speed in order to maintain a safe distance.

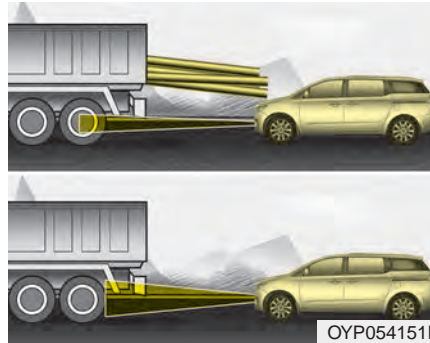

- Detecting the vehicle in front of you
If the vehicle in front of you has cargo that extends rearward from the cab, or when the vehicle in front of you has higher ground clearance, additional special attention is required. The AEB system may not be able to detect the cargo extending from the vehicle. In these instances, you must maintain a safe braking distance from the rearmost object, and if necessary, depress the brake pedal to reduce your driving speed in order to maintain distance.

Detecting pedestrians

The sensor may be limited when:

- The pedestrian is not fully detected by the camera recognition system, for example, if the pedestrian is leaning over or is not fully walking upright.
- The pedestrian is moving very quickly or appears abruptly in the camera detection area.

The pedestrian is wearing clothing that easily blends into the background, making it difficult to be detected by the camera recognition system.

- The outside lighting is too bright (e.g. when driving in bright sunlight or in sun glare) or too dark (e.g. when driving on a dark rural road at night).
- It is difficult to detect and distinguish the pedestrian from other objects in the surroundings, for example, when there is a group of pedestrians or a large crowd.

⚠ WARNING - AEB and Towing

Cancel the AEB in the User Settings on the LCD display, before towing another vehicle. While towing, the brake application may adversely affect your vehicle safety.

⚠ WARNING - Testing the AEB

The AEB does not operate in certain situations. Never test-operate the AEB against a person or an object as such action may cause a severe injury or even death.

*** NOTICE**

In some instances, the AEB system may be cancelled when subjected to electromagnetic interference.

This device complies with Part 15 of the FCC rules.

Operation is subject to the following two conditions:

1. This device may not cause harmful interference, and
2. This device must accept any interference received, including interference that may cause undesired operation.

CRUISE CONTROL SYSTEM (IF EQUIPPED)

The cruise control system allows you to program the vehicle to maintain a constant speed without depressing the accelerator pedal.

This system is designed to function above approximately 20 mph (30 km/h).

If the cruise control is left on, (CRUISE indicator light in the instrument cluster illuminated) the cruise control can be switched on accidentally. Keep the cruise control system off (CRUISE indicator light OFF) when the cruise control is not in use, to avoid inadvertently setting a speed.

Use the cruise control system only when traveling on open highways in good weather.

Do not use the cruise control when driving in heavy or varying traffic, or on slippery (rainy, icy or snow-covered) or winding roads or over 6% up-hill or down-hill roads.

* NOTICE

- During normal cruise control operation, when the SET switch is activated or reactivated after applying the brakes, the cruise control will energize after approximately 3 seconds. This delay is normal.
- To activate cruise control, depress the brake pedal at least once after turning the ignition switch to the ON position or starting the engine. This is to check if the brake switch which is important part to cancel cruise control is in normal condition.

⚠ WARNING - Misuse of Cruise Control

Do not use cruise control if the traffic situation does not allow you to drive safely at a constant speed and with sufficient distance to the vehicle in front.

To set cruise control speed:

■ Type A



■ Type B



1. Press the CRUISE button on the steering wheel to turn the system on. The CRUISE indicator light in the instrument cluster will illuminate.
2. Accelerate to the desired speed, which must be more than 20 mph (30 km/h).



OYP057014

3. Move the lever down (to SET-), and release it at the desired speed. The SET indicator light in the instrument cluster will illuminate. Release the accelerator at the same time. The desired speed will automatically be maintained.

On a steep grade, the vehicle may slow down or speed up slightly while going downhill.

To increase cruise control set speed:



OYP057015

Follow either of these procedures:

- Move the lever up (to RES+) and hold it. Your vehicle will accelerate. Release the lever at the speed you want.
- Move the lever up (to RES+) and release it immediately. The cruising speed will increase by 1.0 mph (2 km/h) each time the lever is operated in this manner.

To decrease the cruising speed:



OYP057014

Follow either of these procedures:

- Move the lever down (to SET-) and hold it. Your vehicle will gradually slow down. Release the lever at the speed you want to maintain.
- Move the lever down (to SET-) and release it immediately. The cruising speed will decrease by 1.0 mph (2 km/h) each time the lever is operated in this manner.

To temporarily accelerate with the cruise control on:

If you want to speed up temporarily when the cruise control is on, depress the accelerator pedal. Increased speed will not interfere with the cruise control operation or change the set speed.

To return to the set speed, take your foot off the accelerator.

To cancel cruise control, do one of the following:

- Depress the brake pedal.
- Shift into N (Neutral) with an automatic transaxle.
- Press the CANCEL switch.
- Decrease the vehicle speed lower than the memory speed by 13 mph (20 km/h).
- Decrease the vehicle speed to less than approximately 20 mph (30 km/h).

Each of these actions will cancel cruise control operation (the SET indicator light in the instrument cluster will go off), but it will not turn the system off. If you wish to resume cruise control operation, move the lever up (to RES+). You will return to your previously preset speed.

*** NOTICE**

Always check the road conditions when you move the lever up (to RES+) to resume the speed.

To resume cruising speed at more than approximately 20 mph (30 km/h):



If any method other than the CRUISE ON-OFF switch was used to cancel cruising speed and the system is still activated, the most recent set speed will automatically resume when you move the lever up.

It will not resume, however, if the vehicle speed has dropped below approximately 20 mph (30 km/h).

To turn cruise control off, do one of the following:



- Press the CRUISE button (the CRUISE indicator light in the instrument cluster will go off).
- Turn the ignition off.

Both of these actions will cancel the cruise control operation. If you want to resume the cruise control operation, repeat the steps provided in “To set cruise control speed” on the previous page.

SMART CRUISE CONTROL SYSTEM (SCC) (IF EQUIPPED)



- ① Cruise indicator
- ② Set speed
- ③ Vehicle-to-vehicle distance

The SCC allows you to program the vehicle to maintain a set speed so long as it is not limited by traffic. When traffic is encountered the vehicle will slow down to maintain a set distance behind traffic without depressing the accelerator or brake pedal.

⚠ WARNING - Smart Cruise Control Inadvertent Activation

If the smart cruise control is left on (CRUISE indicator light in the instrument cluster illuminated), it can be activated inadvertently. Keep the smart cruise control system off (CRUISE indicator light OFF) when the smart cruise control is not in use to avoid setting a speed which the driver is not aware of.

⚠ WARNING - Smart Cruise Control Limitations

- The smart cruise control is a supplemental system and is not a substitute for safe driving practices. It is the responsibility of the driver to always check the speed and distance to the vehicle ahead.
- Do not use the smart cruise control when it may not be safe to keep the car at a constant speed, for instance, driving in heavy or varying traffic, or on slippery (rainy, icy or snow-covered) or winding roads or over 6% up-hill or down-hill roads.

(Continued)

(Continued)

- The smart cruise control system cannot recognize a stopped vehicle, pedestrians or an oncoming vehicle. Always look ahead cautiously to prevent unexpected and sudden situations from occurring.
- Use the smart cruise control system only when traveling on open highways in good weather conditions.

Speed setting (SCC)

To set cruise control speed:



1. Press the CRUISE button, to turn the system on. The CRUISE indicator light in the instrument cluster will illuminate.
2. Accelerate to the desired speed.
 - 20 mph (30 km/h) ~ 110 mph (180 km/h) : when there is no vehicle in front
 - 5 mph (10 km/h) ~ 110 mph (180 km/h) : when there is a vehicle in front



OYP057131N

3. Lever must be moved down (to SET-) prior to setting any desired speed. The SET indicator light, set speed and vehicle to vehicle distance on the LCD screen will illuminate.
4. Release the accelerator pedal. The desired speed will automatically be maintained.

If there is a vehicle in front of you, the speed may decrease to maintain the distance to the vehicle ahead.

On a steep grade, the vehicle may slow down or speed up slightly while going uphill or downhill.

To increase cruise control set speed:



OYP057132N

Follow either of these procedures:

- Move the lever up (to RES+), and hold it. Your vehicle set speed will increase by 5 mph (10 km/h). Release the lever at the speed you want.
- Move the lever up (to RES+), and release it immediately. The cruising speed will increase by 1 mph (1.0 km/h) each time you move the lever up (to RES+) in this manner.

- SCC will operate to a maximum setting of 110 mph (180 km/h). However all local speed limit laws must be followed.

To decrease the cruise control set speed:



Follow either of these procedures:

- Move the lever down (to SET-), and hold it. Your vehicle set speed will decrease by 5 mph (10 km/h). Release the lever at the speed you want.
- Move the lever down (to SET-), and release it immediately. The cruising speed will decrease by 1 mph (1.0 km/h) each time you move the lever down (to SET-) in this manner.
- You can set the cruise control to any speed above 20 mph (30 km/h).

To temporarily accelerate with the cruise control on:

If you want to speed up temporarily when the cruise control is on, depress the accelerator pedal. Increased speed will not interfere with cruise control operation or change the set speed.

To return to the set speed, take your foot off the accelerator.

If you move the lever down (to SET-) at increased speed, the cruising speed will be set again.

* NOTICE

Be careful when accelerating temporarily, because the speed is not regulated automatically at this time even if there is a vehicle in front of you.

SCC will be temporarily canceled when:

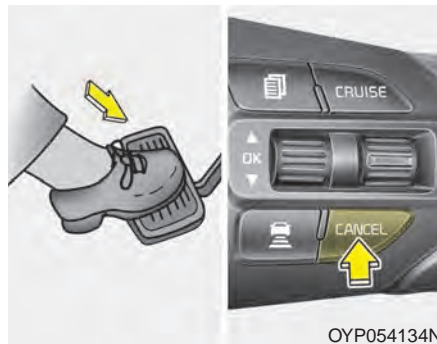

Cancelled manually

- The brake pedal is depressed.
- Press the CANCEL button.

The SCC turns off temporarily when the indicator on the LCD display turns off.

The CRUISE indicator is illuminated continuously.

Cancelled automatically

- The driver's door is opened.
- The shift lever is shifted to N (Neutral), R (Reverse) or P (Parking).
- The vehicle speed is over 120 mph (190 km/h)
- The ESC, ABS or TCS is operating.
- The ESC is turned off.
- The sensor or the cover is dirty or blocked with foreign matter.
- The engine speed is over 7000 RPM.
- The SCC system has malfunctioned.
- Decreasing the vehicle speed to less than approximately 5 mph (10 km/h).

- The accelerator pedal is continuously depressed for more than 5 minute.
- The AEB is activated.

Each of these actions will cancel the SCC operation. (the SET indicator, set speed and vehicle to vehicle distance on the LCD display will go off.)

In a condition the SCC is cancelled automatically, the SCC will not resume even though the RES+ or SET- lever is moved.

If the SCC is cancelled by other than the reasons mentioned, have the system checked by an authorized Kia dealer.

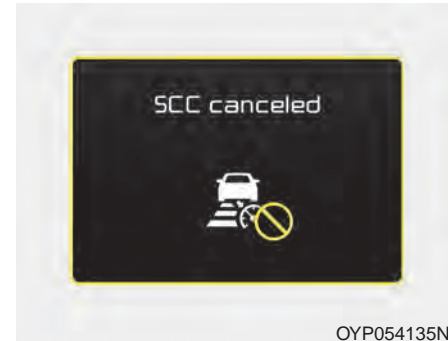

If the system is automatically cancelled, the warning chime will sound and a message will appear for a few seconds.

You must adjust the vehicle speed by depressing the accelerator or brake pedal according to the road condition ahead and driving condition.

Always check the road conditions. Do not rely on the warning chime.

To resume cruise control set speed:



If any method other than the CRUISE button was used to cancel cruising speed and the system is still activated, the cruising speed will automatically resume when you move the lever up/down (to RES+ or SET-).

If you move the lever up (to RES+), the speed will resume to the recently set speed.

It will not resume, however, if the vehicle speed has dropped below approximately 5 mph (10 km/h) when the sensor detects the vehicle ahead or if the vehicle speed has dropped below approximately 20mph (30 km/h) when there is no vehicle in front of your vehicle.

⚠ WARNING - Cruise control reactivation

To reduce the risk of an accident, always check the road conditions when reactivating the smart cruise control using the RES+ lever to ensure the road conditions permit safe use of the cruise control.

To turn cruise control off:



Press the CRUISE button. (the CRUISE indicator light in the instrument cluster will go off).

Vehicle to vehicle distance setting (SCC)

To set vehicle to vehicle distance:



This function allows you to program the vehicle to maintain relative distance to the vehicle ahead without depressing the accelerator pedal or brake pedal.

The vehicle to vehicle distance will automatically activate when the SCC is on.

Select the appropriate distance according to road conditions and vehicle speed.

Each time the button is pressed, the vehicle to vehicle distance changes as follows:

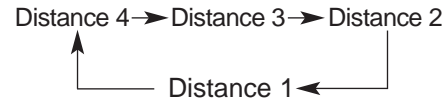

For example, if you drive at 56 mph (90 km/h), the distance is maintained as follows;

Distance 4 - approximately 172 feet (52.5 m)

Distance 3 - approximately 130 feet (40 m)

Distance 2 - approximately 106 feet (32.5 m)

Distance 1 - approximately 82 feet (25 m)

* NOTICE

The 'Distance 4' is always set when the system is used for the first time after starting the engine.

⚠ WARNING - Following distance

- **To avoid collisions, always be aware of the selected speed and vehicle to vehicle distance settings when activating your smart cruise control system.**
- **Always maintain sufficient braking distance and decelerate your vehicle by applying the brakes if necessary.**



- The vehicle will maintain the set speed, when the lane ahead is clear.
- The vehicle will slow down or speed up within selected speed to maintain the selected distance, when there is a vehicle ahead of you in the lane. (A vehicle will appear in front of your vehicle in the LCD display only when there is an actual vehicle in front of you)
- If the vehicle ahead speeds up, your vehicle will travel at a steady cruising speed after accelerating to the selected speed.

- The warning chime sounds and LCD display blinks if it is hard to maintain the selected distance to the vehicle ahead.
- If the warning chime sounds, actively adjust the vehicle speed by depressing the brake pedal according to the road condition ahead and driving condition.
- Even if the warning chime is not activated, always pay attention to the driving conditions to prevent dangerous situations from occurring.



If the vehicle ahead (vehicle speed: less than 20 mph (30 km/h)) moves to the next lane, the warning chime will sound and a message will appear.

If a vehicle enters into your lane moving less than the designated speed, you can adjust your vehicle speed by depressing the brake pedal.

Sensor to detect distance to the vehicle ahead



The sensor detects distance to the vehicle ahead.

If the sensor is covered with dirt or other foreign matter, the vehicle to vehicle distance control may not operate correctly.

Always keep the sensor clean.

Sensor malfunction indicator



If the sensor or cover is dirty or obscured with foreign matter such as snow, the indicator will illuminate. Clean the sensor by using a soft cloth.

SCC malfunction indicator



The warning light illuminates when the vehicle to vehicle distance control system is not functioning normally.

Take your vehicle to an authorized Kia dealer and have the system checked.

- Always keep the sensor and bumper clean.
- Use only a genuine Kia sensor cover for your vehicle.
- Do not install accessories around the sensor and do not replace the bumper by yourself. It may interfere with the sensor performance.
- Do not damage the sensor or sensor area by a strong impact. If the sensor moves slightly off position, the SCC will not operate correctly. If this occurs, have your vehicle checked by an authorized Kia dealer as soon as possible.

 **CAUTION - Sensor Damage**

To prevent sensor cover damage from occurring, wash the car with a soft cloth.

To adjust the sensitivity of Smart Cruise Control

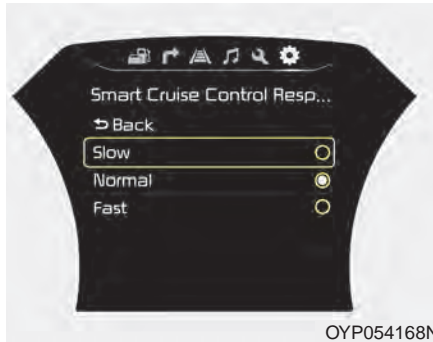

The sensitivity of vehicle speed when following the front vehicle to maintain the set distance can be adjusted. Go to the User Settings Mode (Driving Assist) and select SCC (Smart Cruise Control). You may select one of the three stages you prefer.

- **Slow:**

Vehicle speed following the front vehicle to maintain the set distance is slower than normal speed.

- **Normal:**

Vehicle speed following the front vehicle to maintain the set distance is normal

- **Fast:**

Vehicle speed following the front vehicle to maintain the set distance is faster than normal speed.

* NOTICE

The last selected mode is remained in the system

To convert to cruise control mode:



The driver may choose to only use the cruise control mode (speed control function) by doing as follows:

1. Turn the SCC on (the cruise indicator light will be on but the system will not be activated).
2. Push the distance to distance switch for more than 2 seconds.
3. Choose between "Smart cruise control(SCC) mode" and "Cruise control(CC) mode".

When using the cruise control mode, you must manually assess the distance to other vehicles as the system will not automatically brake to slow down for other vehicles.

Limitations of the system

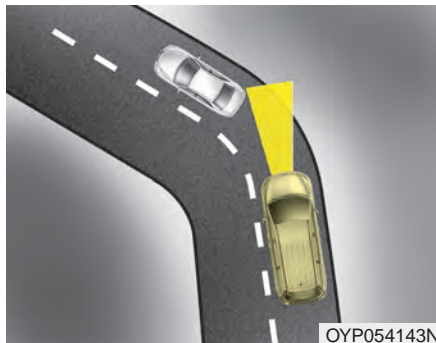

The SCC may have limits to its ability to detect distance to the vehicle ahead due to road and traffic conditions.

On curves

- On curves, the SCC may not detect a moving vehicle in your lane, and then your vehicle could accelerate to the set speed. Also, the vehicle speed will rapidly slow down when the vehicle ahead is recognized suddenly.
- Select the appropriate set speed on curves and adjust your vehicle speed by depressing the accelerator or brake pedal according to the road condition ahead and driving condition.



OYP054144N

- Your vehicle speed can be reduced due to a vehicle in the adjacent lane. Adjust your vehicle speed by depressing the brake pedal according to the road condition ahead and driving condition. Apply the accelerator pedal and select the appropriate set speed. Check to be sure that the road conditions permit safe operation of the SCC.

On inclines

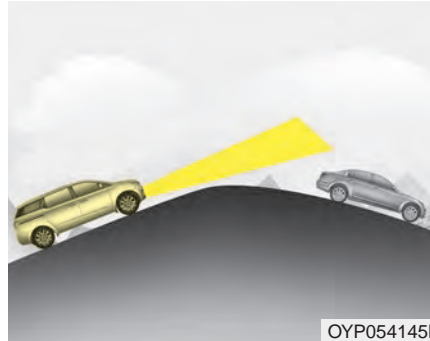

OYP054145N

- During uphill or downhill driving, the SCC may not detect a moving vehicle in your lane, and cause your vehicle to accelerate to the set speed. Also, the vehicle speed will rapidly slow down when the vehicle ahead is recognized suddenly.
- Select the appropriate set speed on inclines and adjust your vehicle speed by depressing the accelerator or brake pedal according to the road condition ahead and driving condition.

Lane changing

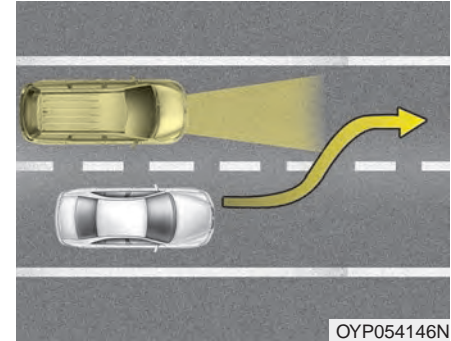

OYP054146N

- A vehicle which moves into your lane from an adjacent lane cannot be recognized by the sensor until it is in the sensor's detection range.
- The sensor may not detect immediately when a vehicle cuts in suddenly. Always pay attention to the traffic, road and driving conditions.
- If a vehicle which moves into your lane is slower than your vehicle, your speed may decrease to maintain the distance to the vehicle ahead.

- If a vehicle which moves into your lane is faster than your vehicle, your vehicle will accelerate to the selected speed.

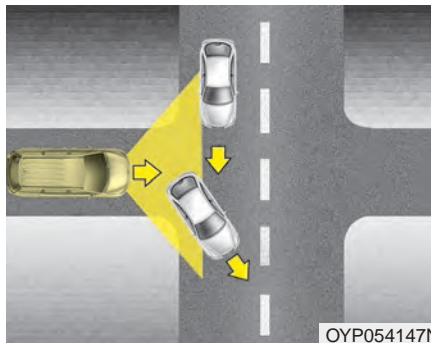

- Your vehicle may accelerate when a vehicle ahead of you disappears.
- When you are warned that the vehicle ahead of you is not detected, drive with caution.

Vehicle recognition

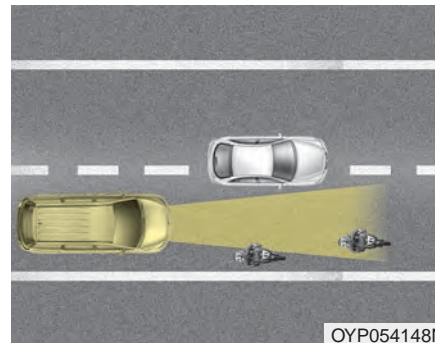

Some vehicles ahead in your lane cannot be recognized by the sensor as follows:

- Narrow vehicles such as motorcycles or bicycles
- Vehicles offset to one side
- Slow-moving vehicles or sudden-decelerating vehicles
- Stopped vehicles
- Vehicles with small rear profile such as trailers with no loads

A vehicle ahead cannot be recognized correctly by the sensor if any of the following occurs:

- When the vehicle is pointing upwards due to overloading in the trunk
- While making turns by steering
- When driving to one side of the lane
- When driving on narrow lanes or on curves

Adjust your vehicle speed by depressing the brake pedal according to the road condition ahead and driving condition.

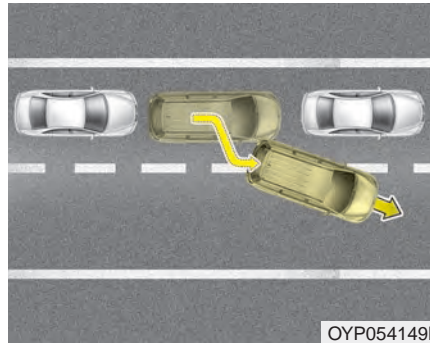

- When vehicles are at a standstill and the vehicle in front of you changes to the next lane, be careful when your vehicle starts to move because it may not recognize the stopped vehicle in front of you.

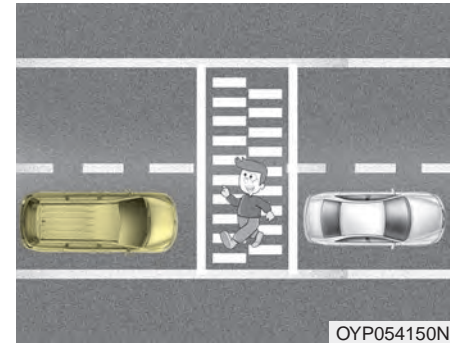

- Always look out for pedestrians when your vehicle is maintaining a distance with the vehicle ahead.

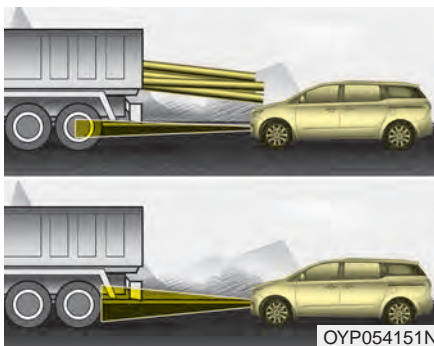

- Always be cautious for vehicles with higher height or vehicles carrying loads that sticks out to the back of the vehicle.

⚠ WARNING - Safe Use of SCC

The SCC can provide you with an additional level of safety and fatigue reduction. However you must maintain careful observation of the roadway in front of and around you and maintain control of your vehicle and spacing around other vehicles as you normally would. For example, this will require you to apply the brakes as needed when coming upon a slower moving vehicle, or when a vehicle from another lane drives quickly in front of you.

- After an engine start, please stop for several seconds. If system initialization is not completed, the SCC does not normally operate.
- After an engine start, if any objects are not detected or the sensor cover is obscured with foreign substances, there is a possibility that the SCC system may not work.
- Below conditions are not allowed: over baggage loading in a trunk, suspension remodeling, tire replacement with unauthorized tires or tires with different worn-out and pressure levels.

⚠ WARNING - Inclines & Towing

Do not use SCC on steep inclines or when towing another vehicle or trailer since such extreme loading can interfere with your vehicle's ability to maintain the selected speed.

This device complies with Part 15 of the FCC rules.

Operation is subject to the following three conditions:

1. This device may not cause harmful interference, and
2. This device must accept any interference received, including interference that may cause undesired operation.
3. Changes or modifications not expressly approved by the party responsible for compliance could void the user's authority to operate the device.

Radio frequency radiation exposure information:

This equipment complies with FCC radiation exposure limits set forth for an uncontrolled environment.

This equipment should be installed and operated with minimum distance of 20 cm between the radiator (antenna) and your body.

This transmitter must not be co-located or operating in conjunction with any other antenna or transmitter.

ACTIVE ECO SYSTEM

Active ECO operation

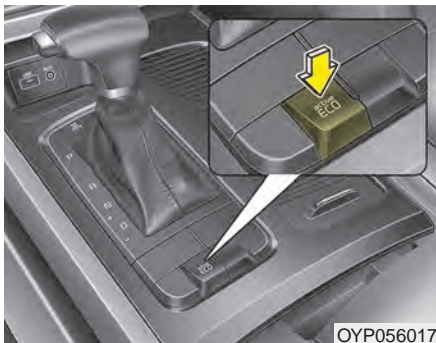

Active ECO helps improve fuel efficiency by controlling the engine and transaxle. But fuel-efficiency can be affected by the driver's driving habits and road conditions.

- When the Active ECO button is pressed the ECO indicator (green) will illuminate to show that the Active ECO is operating.
- When the Active ECO is activated, it does not turn off even though the engine is restarted again. To turn off the system, press the active ECO button again.
- If Active ECO is turned off, it will return to the normal mode.

When Active ECO is activated:

- The engine noise may get louder.
- The vehicle speed may slightly be reduced.
- The air conditioner performance may be affected.

Limitation of Active ECO operation:

If the following conditions occur while Active ECO is operating, the system operation is limited even though there is no change in the ECO indicator.

- When the coolant temperature is low:
The system will be limited until engine performance becomes normal.
- When driving up a hill:
The system will be limited to gain power when driving uphill because the engine torque is restricted.
- When using sports mode:
The system will be limited according to the shift location.
- When the accelerator pedal is deeply pressed for a few seconds:
The system will be limited, as it has determined that the driver has accelerated judging that the driver wants to speed up.

DRIVE MODE INTEGRATED CONTROL SYSTEM (IF EQUIPPED)

DRIVE mode

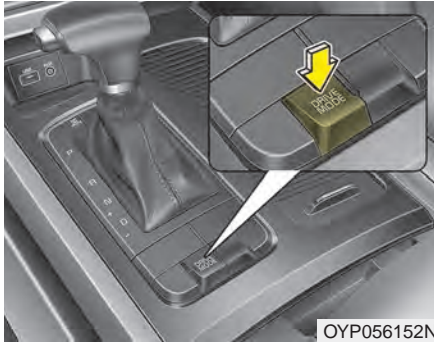

The drive mode may be selected according to the driver's preference or road condition.

The mode changes whenever the DRIVE MODE button is pressed.

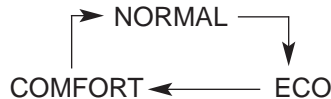

* When normal mode is selected, it is not displayed on the cluster.

ECO mode (Active ECO)

ECO

Active ECO helps improve fuel efficiency by controlling certain engine and transaxle system operating parameters. Fuel efficiency depends on the driver's driving habit and road condition.

- When the DRIVE MODE button is pressed and the ECO mode is selected, the ECO indicator (green) will illuminate to show that the Active ECO is operating.
- When the Active ECO is activated, it does not turn off even though the engine is restarted again. To turn off the system, press the DRIVE MODE button again.

When Active ECO is activated:

- The acceleration may slightly be reduced even though you depress the accelerator fully.
- The air conditioner performance may be limited
- The shift pattern of the automatic transaxle may change.
- The engine noise may get louder.

The above situations are normal conditions when the active eco system is activated to improve fuel efficiency.

Limitation of Active ECO operation:

If the following conditions occur while Active ECO is operating, the system operation is limited even though there is no change in the ECO indicator.

- When the coolant temperature is low:
The system will be limited until engine performance becomes normal.
- When driving up a hill:
The system will be limited to gain power when driving uphill because the engine torque is restricted.
- When using manual mode:
The system will be limited according to the shift location.
- When the accelerator pedal is deeply depressed for a few seconds:
The system will be limited, judging that the driver wants to speed up.

Comfort mode

COMFORT

The steering wheel becomes lighter. The comfort mode is usually used when driving in the city or when parking the vehicle.

- For your safety, if you press the steering mode button while operating the steering wheel, but the steering effort will not change immediately. After operating the steering wheel, the steering effort will change automatically to the selected mode.
- Use caution when changing the steering mode while driving.
- When the electronic power steering is not operating properly, the flex steering wheel will not work.

BLIND SPOT DETECTION SYSTEM (BSD) (IF EQUIPPED)

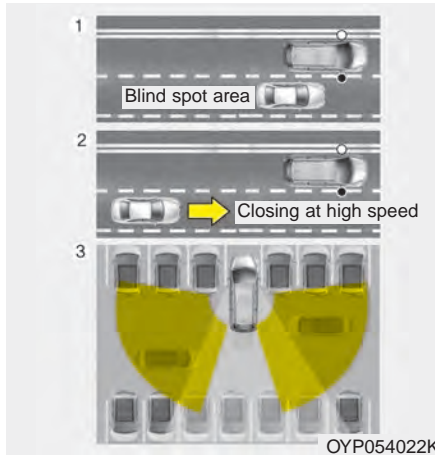

The Blind Spot Detection System (BSD) uses a radar sensor to alert the driver.

It senses the rear side territory of the vehicle and provides an indication to the driver.

(1) BSD (Blind Spot Detection)

The warning range depends on your vehicle speed. However, if your vehicle is about 6 mph (10 km/h) faster than the other vehicle, the system will not warn you.

(2) LCA (Lane Change Assist)

When a vehicle approaches you at high speed, the system will warn you.

(3) RCTA (Rear Cross Traffic Alert)

When your vehicle moves rearward, the sensor detects the approaching vehicle in the left and right side, the system will warn you.

⚠️ WARNING - BSD Limitations

- **The Blind Spot Detection System (BSD) is a supplemental system. Do not solely rely on the system but always pay attention to drive safely.**
- **The Blind Spot Detection System may not detect every object alongside the vehicle and is not a substitute for proper and safe lane changing procedures. Always drive safely and use caution when changing lanes.**

BSD (Blind Spot Detection) / LCA (Lane Change Assist)

Operating conditions

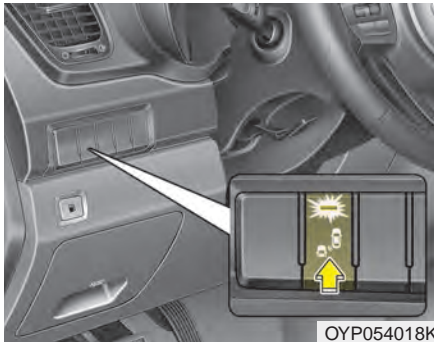

The indicator on the switch will illuminate when the Blind Spot Detection System (BSD) switch is pressed with the Engine Start/Stop Button ON.

If vehicle speed exceeds 18.6 mph (30 km/h), the system will activate.

If you press the switch again, the switch indicator and system will be turned off.

If the ignition switch is turned OFF and ON the system returns to the previous state.

When the system is not used turn the system off by turning off the switch.

When the system is turned on the warning light will illuminate for 3 seconds on the outside rearview mirror.

Warning type

The system will activate when:

- 1.The system is on.
- 2.Vehicle speed is above 18.6 mph (30 km/h).
- 3.Other vehicles are detected in the rear side.

⚠ WARNING

The Blind Spot Detection System with Lane Change Assist and Rear Cross Traffic Alert is not a substitute for proper and safe lane changing procedures. Always drive safely and use caution when changing lanes. The Blind Spot Detection System may not detect every object alongside the vehicle.

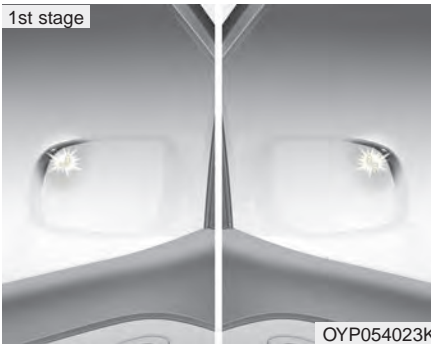

If a vehicle is detected within the boundary of the system, a warning light will illuminate on the outside rearview mirror.

If the detected vehicle is not in detecting range, the warning will turn off according to driving conditions.



The second stage alarm will activate when:

1. The first stage alert is on
2. The turn signal is on to change a lane

When the second stage alert is activated, a warning light will blink on the outside rearview mirror and a alarm will sound.

If you move the turn signal switch to the original position, the second stage alert will be deactivated.

Detecting sensor



The sensors are located inside of the rear bumper.

Always keep the rear bumper clean for the system to work properly.

Warning message

■ Type A



OYP054104N

■ Type B



OYP054105N

The message will appear to notify the driver there are foreign substances on the rear bumper or it is hot near the rear bumper. The light on the switch and the system will turn off automatically.

Remove the foreign substance on the rear bumper.

After the foreign substance is removed, if you drive for approximately 10 minutes, the system will work normally.

This warning message may lit up in rural areas with little traffic or open terrains such as wide expanse of desert. Additionally, heavy snow or rain may trigger the warning message.

If the system does not work normally even though the foreign substance is removed, take your vehicle to an authorized Kia dealer and have the system checked.

■ Type A



OYP054106N

■ Type B

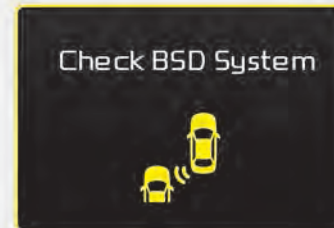

OYP054107N

If the system does not work properly, a warning message will appear and the light on the switch will turn off. The system will turn off automatically.

Have your vehicle inspected by an authorized Kia dealer.

RCTA (Rear Cross Traffic Alert)

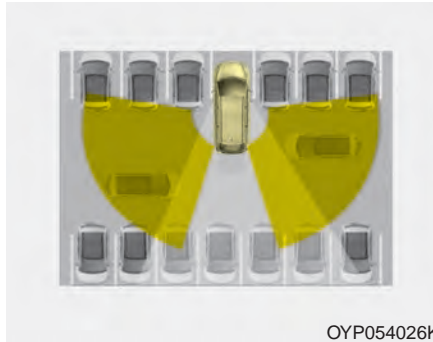

When your vehicle moves backwards from a parking position, the sensor detects approaching vehicles to the left or right side direction and gives information to the driver.

Operating conditions

■ Type A



■ Type B



- Select RCTA (Rear Cross Traffic Alert) in "User Settings" under "Driving Assist" on the instrument cluster. The system will turn on and standby to activate.

- Select RCTA again, to turn the system off.
- If the vehicle is turned off and on again, the RCTA system will return to the state right before the vehicle was turned off. Always turn the RCTA system off when not in use.
- The system operates when the vehicle speed is below 6.2 mph (10 km/h) with the shift lever in R (Reverse).
- The RCTA (Rear Cross Traffic Alert) detecting range is 0.5m ~ 20m based on the side direction. If the approaching vehicle speed is 2.5 mph (4 km/h) ~ 22 mph (36 km/h) within sensing range, it is detected. However, the system sensing range is different base on conditions. Always pay attention to the surrounding.

Warning type

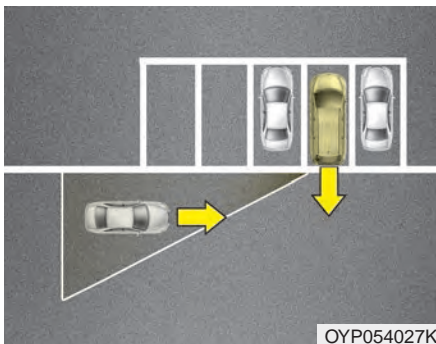

- If the vehicle detected by sensors approaches your vehicle, the warning chime will sound and the warning light will blink on the outside rearview mirror.
- If the detected vehicle is out of the sensing range of your vehicle, move the vehicle away from the detected object slowly; the warning will be cancelled.
- The system may not operate properly due to other factors or circumstances. Always pay attention to your surrounding.

* If your vehicle's left or right side bumper is blinded by barrier or vehicles, the system sensing ability may be deteriorated.

⚠ WARNING

The Blind Spot Detection System with Lane Change Assist and Rear Cross Traffic Alert is not a substitute for proper and safe lane changing procedures. Always drive safely and use caution when changing lanes. The Blind Spot Detection System may not detect every object alongside the vehicle.

* NOTICE

- The system may not work properly if the bumper has been replaced or if a repair work has been done near the sensor.
- The detection area differs according to the roads width. If the road is narrow the system may detect other vehicles in the next lane.
- On the contrary, if the road is very wide the system may not detect other vehicles.
- The system may turn off due to strong electromagnetic waves.

Non-operating condition

Driver's Attention

The driver must be cautious in the below situations for the system may not assist the driver and may not work properly.

- Curved roads, tollgates, etc.
- The surrounding of the sensor is polluted with rain, snow, mud, etc
- The rear bumper near the sensor is covered or hidden with a foreign matter such as a sticker, bumper guard, bicycle stand etc.
- The rear bumper is damaged or the sensor is out of place.
- The height of the vehicle shows much change such as when the trunk is loaded with heavy objects, abnormal tire pressure etc.
- Due to bad weather such as heavy rain or snow.
- A fixed object is near such as a guardrail, etc.
- A lot of amount of metal substances are near the vehicles such as a construction area.
- A big vehicle is near such as a bus or truck.
- A motorcycle or bicycle is near.
- A flat trailer like vehicle is near.
- If the vehicle has started at the same time as the vehicle next to it and has accelerated.
- When the other vehicle passes by very fast.
- When changing lanes.
- When going down or up a steep, uneven road.
- When the other vehicle drives at the rear very nearby or drives very close.
- When a trailer or carrier is installed.
- When the temperature of the rear bumper is very high or low.
- When the sensors are covered by the vehicle, wall and pillar of parking lot.
- When your vehicle moves back, if the detected vehicle also moves back.
- If there is small things like shopping cart and baby carriage.
- If there is a vehicle with decreased ride height (lowered).
- When the vehicle is close to another vehicle.
- When driving through a narrow road with many plants.
- When driving on wet surface.

Outside rearview mirror may not alert the driver when:

- The outside rearview mirror housing is severely polluted
- The window is severely polluted
- The windows are severely tinted.

This device complies with Part 15 of the FCC rules.

Operation is subject to the following two conditions:

1. This device may not cause harmful interference, and
2. This device must accept any interference received, including interference that may cause undesired operation.

LANE DEPARTURE WARNING SYSTEM (LDWS) (IF EQUIPPED)

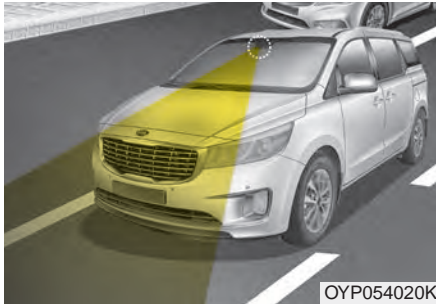

OYP054020K

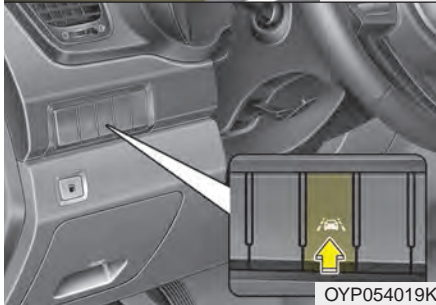

OYP054019K

This system detects the lane with a sensor at the front windshield and notifies you if it detects that your vehicle leaves the lane.

⚠ WARNING - LDWS Alert

The LDWS is only intended to provide you with information regarding your vehicle's position on the roadway. Upon receiving an LDWS alert, you must take the necessary steps to maintain control of your vehicle. The LDWS does not provide any steering inputs into the vehicle for you. It can be dangerous to make a large sudden steering input in response to an alert, since that could result in loss of control.

- The LDWS does not make the vehicle change lanes. It is the driver's responsibility to always check the road conditions.
- If the sensor cannot detect the lane or if the vehicle speed does not exceed 44 mph (70 km/h), the LDWS will not be able to notify you if the vehicle leaves the lane.
- If your vehicle has window tint or other types of coating on the front windshield, the LDWS may not work properly.
- Prevent damage to the LDWS sensor from water or any liquid.
- Do not remove the LDWS parts and do not damage the sensor by a strong impact.
- Do not put objects that reflect light on the dash board.
- The operation of the LDWS can be affected by several factors (including environmental conditions). It is the responsibility of the driver to pay attention to the roadway and to maintain the vehicle in it's lane at all times.



OYP054127N

To operate the LDWS, press the button with the engine start/stop button in the ON position. The indicator (green) illuminates on the cluster. To cancel the LDWS, press the button again.

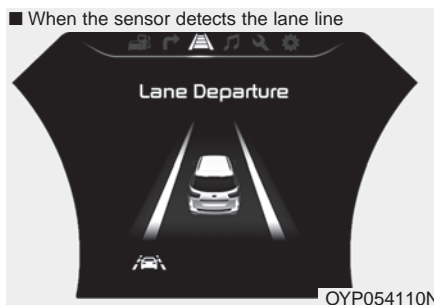

OYP054110N

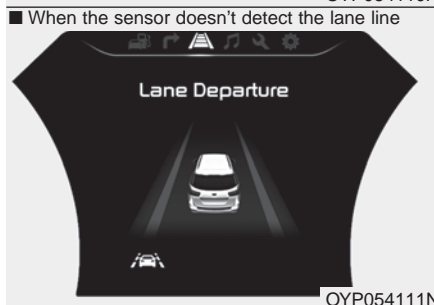

OYP054111N

If the system detects that your vehicle is leaving the lane when the LDWS is operating and vehicle speed exceeds 44 mph (70 km/h), the warning operates as follows:



OYP054112N



OYP054113N

1. Visual warning

If you leave the lane, the lane you leave on the LCD display blinks yellow.

2. Auditory warning

If you leave the lane, the warning sound operates.

Warning indicator

■ Warning message



OYP054114N

■ Master warning light



OYP054119K

When the LDWS is not working properly, the warning light will illuminate and the warning message will come on for a few second. After the message disappears, the master warning light will illuminate.

Take your vehicle to an authorized Kia dealer and have the system checked.

The LDWS does not operate when:

- The driver turns on the turn signal or the hazard warning flasher to change lane.
- Driving on the lane line.

* NOTICE

To change lanes, operate the turn signal switch then change the lane.

▲ WARNING - LDWS Limitations

The Lane Departure Warning System is a supplemental system. Do not solely rely on the system but always pay attention and drive safely.

The LDWS may not warn you even if the vehicle leaves the lane, or may warn you even if the vehicle does not leave the lane when;

- The lane can't be visible due to snow, rain, stain, a puddle or other environmental conditions.
- The brightness of the outside changes suddenly such as tunnel enter/exit.
- The headlights are off at night or in a tunnel.
- The color of the lane marking from the road is difficult to distinguish.
- Driving on a steep grade or a curve.
- Light such as street light, sunlight or oncoming vehicle light reflects from water on the road.
- The lens or windshield is stained with foreign matter.
- The sensor cannot detect the lane because of fog, heavy rain or heavy snow.

- The surrounding of the inside rear view mirror temperature is high due to a direct ray of light.
- The lane is very wide or narrow.
- The lane line is damaged or indistinct.
- The windshield is fogged by humid air in the vehicle.
- The shadow is on the lane line by a median strip.
- The sensor cannot distinguish the lane from the road due to the dust.
- There is a mark similar to a lane line.
- There is a boundary structure.
- The distance from vehicle ahead is very short or the vehicle ahead drives hiding the lane line.
- The vehicle vibrates heavily due to road conditions.
- The lane number increases or decreases or the lane lines are crossing.
- Putting something on the dashboard.
- Driving with the sun in front of you.
- Driving in areas under construction.
- The lane line is more than two in either side (Left/Right)

This device complies with Part 15 of the FCC rules.

Operation is subject to the following two conditions:

1. This device may not cause harmful interference, and
2. This device must accept any interference received, including interference that may cause undesired operation.

ECONOMICAL OPERATION

Your vehicle's fuel economy depends mainly on your style of driving, where you drive and when you drive.

Each of these factors affects how many miles (kilometers) you can get from a gallon (liter) of fuel. To operate your vehicle as economically as possible, use the following driving suggestions to help save money in both fuel and repairs:

- Drive smoothly. Accelerate at a moderate rate. Don't make "jack-rabbit" starts or full-throttle shifts and maintain a steady cruising speed. Don't race between stoplights. Try to adjust your speed to the traffic so you don't have to change speeds unnecessarily. Avoid heavy traffic whenever possible. Always maintain a safe distance from other vehicles so you can avoid unnecessary braking. This also reduces brake wear.
- Drive at a moderate speed. The faster you drive, the more fuel your vehicle uses. Driving at a moderate speed, especially on the highway, is one of the most effective ways to reduce fuel consumption.
- Don't "ride" the brake pedal. This can increase fuel consumption and also increase wear on these components. In addition, driving with your foot resting on the brake pedal may cause the brakes to overheat, which reduces their effectiveness and may lead to more serious consequences.
- Take care of your tires. Keep them inflated to the recommended pressure. Incorrect inflation, either too much or too little, results in unnecessary tire wear. Check the tire pressures at least once a month.
- Be sure that the wheels are aligned correctly. Improper alignment can result from hitting curbs or driving too fast over irregular surfaces. Poor alignment causes faster tire wear and may also result in other problems as well as greater fuel consumption.
- Keep your vehicle in good condition. For better fuel economy and reduced maintenance costs, maintain your vehicle in accordance with the maintenance schedule in section 7. If you drive your vehicle in severe conditions, more frequent maintenance is required (see section 7 for details).
- Keep your vehicle clean. For maximum service, your vehicle should be kept clean and free of corrosive materials. It is especially important that mud, dirt, ice, etc. not be allowed to accumulate on the underside of the vehicle. This extra weight can result in increased fuel consumption and also contribute to corrosion.
- Travel lightly. Don't carry unnecessary weight in your vehicle. Weight reduces fuel economy.
- Don't let the engine idle longer than necessary. If you are waiting (and not in traffic), turn off your engine and restart only when you're ready to go.

- Remember, your vehicle does not require extended warm-up. After the engine has started, allow the engine to run for 10 to 20 seconds prior to placing the vehicle in gear. In very cold weather, however, give your engine a slightly longer warm-up period.
 - Don't "lug" or "over-rev" the engine. Lugging is driving too slowly in a very high gear resulting in engine bucking. If this happens, shift to a lower gear. Over-revving is racing the engine beyond its safe limit. This can be avoided by shifting at the recommended speed.
 - Use your air conditioning sparingly. The air conditioning system is operated by engine power so your fuel economy is reduced when you use it.
 - Open windows at high speeds can reduce fuel economy.
 - Fuel economy is less in crosswinds and headwinds. To help offset some of this loss, slow down when driving in these conditions.
- Keeping a vehicle in good operating condition is important both for economy and safety. Therefore, have an authorized Kia dealer perform scheduled inspections and maintenance.

⚠ WARNING - Engine off during motion

Never turn the engine off to coast down hills or anytime the vehicle is in motion. The power steering and power brakes will not function properly without the engine running. In addition, turning off the ignition while driving could engage the steering wheel lock resulting in loss of vehicle steering. Keep the engine on and downshift to an appropriate gear for engine braking effect.

SPECIAL DRIVING CONDITIONS

Hazardous driving conditions

When hazardous driving conditions are encountered such as water, snow, ice, mud, sand, or similar hazards, follow these suggestions:

- Drive cautiously and allow extra distance for braking.
- Avoid sudden braking or steering.
- When braking with non-ABS brakes pump the brake pedal with a light up-and-down motion until the vehicle is stopped.

Do not pump the brake pedal on a vehicle equipped with ABS.

- If stalled in snow, mud, or sand, use second gear. Accelerate slowly to avoid spinning the drive wheels.
- Use sand, rock salt, or other non-slip material under the drive wheels to provide traction when stalled in ice, snow, or mud.

⚠ WARNING - Downshifting
Do not downshift with an automatic transaxle while driving on slippery surfaces. The sudden change in tire speed could cause the tires to skid and result in an accident.

Reducing the risk of a rollover

This multi-purpose passenger vehicle is defined as a Crossover Utility Vehicle (CUV). CUV's have higher ground clearance and a narrower track to make them capable of performing in a wide variety of off-road applications. Specific design characteristics give them a higher center of gravity than ordinary vehicles. An advantage of the higher ground clearance is a better view of the road, which allows you to anticipate problems. They are not designed for cornering at the same speeds as conventional passenger vehicles, any more than low-slung sports vehicles are designed to perform satisfactorily in off-road conditions. Due to this risk, driver and passengers are strongly recommended to buckle their seat belts. In a rollover crash, an unbelted person is more likely to die than a person wearing a seat belt. There are steps that a driver can make to reduce the risk of a rollover.

If at all possible, avoid sharp turns or abrupt maneuvers, do not load your roof rack with heavy cargo, and never modify your vehicle in any way.

Rocking the vehicle

If it is necessary to rock the vehicle to free it from snow, sand, or mud, first turn the steering wheel right and left to clear the area around your front wheels. Then, shift back and forth between R (Reverse) and any forward gear in vehicles equipped with an automatic transaxle. Do not race the engine, and spin the wheels as little as possible. If you are still stuck after a few tries, have the vehicle pulled out by a tow vehicle to avoid engine overheating and possible damage to the transaxle.



CAUTION - Vehicle rocking
Prolonged rocking may cause engine overheating, transaxle damage or failure, and tire damage.



CAUTION - Spinning tires
Do not spin the wheels, especially at speeds more than 35 mph (56 km/h). Spinning the wheels at high speeds when the vehicle is stationary could cause a tire to overheat which could result in tire damage that may injure bystanders.

The ESC system should be turned OFF prior to rocking the vehicle.

⚠ WARNING - Sudden vehicle movement

Do not attempt to rock the vehicle if people or objects are nearby. The vehicle may suddenly move forward or backwards as it becomes unstuck.

Smooth cornering

Avoid braking or gear changing in corners, especially when roads are wet. Ideally, corners should always be taken under gentle acceleration. If you follow these suggestions, tire wear will be held to a minimum.

Driving at night

Because night driving presents more hazards than driving in the daylight, here are some important tips to remember:

- Slow down and keep more distance between you and other vehicles, as it may be more difficult to see at night, especially in areas where there may not be any street lights.

- Adjust your mirrors to reduce the glare from other driver's headlights.
- Keep your headlights clean and properly aimed. (On vehicles not equipped with the automatic headlight aiming feature.) Dirty or improperly aimed headlights will make it much more difficult to see at night.
- Avoid staring directly at the headlights of oncoming vehicles. You could be temporarily blinded, and it will take several seconds for your eyes to readjust to the darkness.

Driving in the rain



Rain and wet roads can make driving dangerous, especially if you're not prepared for the slick pavement. Here are a few things to consider when driving in the rain:

- A heavy rainfall will make it harder to see and will increase the distance needed to stop your vehicle, so slow down.
- Keep your windshield wiping equipment in good shape. Replace your windshield wiper blades when they show signs of streaking or missing areas on the windshield.
- If your tires are not in good condition, making a quick stop on wet pavement can cause a skid and possibly lead to an accident. Be sure your tires are in good shape.
- Turn on your headlights to make it easier for others to see you.
- Driving too fast through large puddles can affect your brakes. If you must go through puddles, try to drive through them slowly.
- If you believe you may have gotten your brakes wet, apply them lightly while driving until normal braking operation returns.

Driving in flooded areas

Avoid driving through flooded areas unless you are sure the water is no higher than the bottom of the wheel hub. Drive through any water slowly. Allow adequate stopping distance because brake performance may be affected.

After driving through water, dry the brakes by gently applying them several times while the vehicle is moving slowly.

Driving off-road

Drive carefully off-road because your vehicle may be damaged by rocks or roots of trees. Become familiar with the off-road conditions where you are going to drive before you begin driving.

Highway driving

Tires

Adjust the tire inflation pressures to specification. Low tire inflation pressures will result in overheating and possible failure of the tires.

Avoid using worn or damaged tires which may result in reduced traction or tire failure.

Never exceed the maximum tire inflation pressure shown on the tires.

WARNING - Under/over inflated tires

Always check the tires for proper inflation before driving. Underinflated or overinflated tires can cause poor handling, loss of vehicle control, and sudden tire failure leading to accidents, injuries, and even death. For proper tire pressures, refer to "Tires and wheels" in section 8.

⚠ WARNING - Tire tread

Always check the tire tread before driving your vehicle. Worn-out tires can result in loss of vehicle control. Worn-out tires should be replaced as soon as possible. For further information and tread limits, refer to "Tires and wheels" in section 7.

Fuel, engine coolant and engine oil

High speed travel consumes more fuel than urban motoring. Do not forget to check both the engine coolant and engine oil.

Drive belt

A loose or damaged drive belt may result in overheating of the engine.

WINTER DRIVING

Severe weather conditions in the winter result in greater wear and other problems. To minimize the problems of winter driving, you should follow these suggestions:

Snowy or icy conditions

To drive your vehicle in deep snow, it may be necessary to use snow tires or to install tire chains on your tires. If snow tires are needed, it is necessary to select tires equivalent in size and type of the original equipment tires. Failure to do so may adversely affect the safety and handling of your vehicle. Furthermore, speeding, rapid acceleration, sudden brake applications, and sharp turns are potentially very hazardous practices.

During deceleration, use engine braking to the fullest extent. Sudden brake applications on snowy or icy roads may cause skids to occur. You need to keep sufficient distance between the vehicle in operation in front of your vehicle. Also, apply the brake gently. It should be noted that installing tire chains on the tire will provide a greater driving force, but will not prevent side skids.

Tire chains are not legal in all states. Check state laws before fitting tire chains.

Snow tires

If you mount snow tires on your vehicle, make sure they are radial tires of the same size and load range as the original tires. Mount snow tires on all four wheels to balance your vehicle's handling in all weather conditions. Keep in mind that the traction provided by snow tires on dry roads may not be as high as your vehicle's original equipment tires. You should drive cautiously even when the roads are clear. Check with the tire dealer for maximum speed recommendations.

Do not install studded tires without first checking local, state and municipal regulations for possible restrictions against their use.

Tire chains



Since the sidewalls of radial tires are thinner, they can be damaged by mounting some types of snow chains on them. Therefore, the use of snow tires is recommended instead of snow chains. Do not mount tire chains on vehicles equipped with aluminum wheels; snow chains may cause damage to the wheels. If snow chains must be used, use wire-type chains with a thickness of less than 0.59 in (15 mm). Damage to your vehicle caused by improper snow chain use is not covered by your vehicle manufacturer's warranty.

When using tire chains, install them on the front tires only.



CAUTION - Snow chains

Make sure the snow chains are the correct size and type for your tires. Incorrect snow chains can cause damage to the vehicle body and suspension and may not be covered by your vehicle manufacturer warranty.

Chain installation

When installing chains, follow the manufacturer's instructions and mount them as tightly as you can. Drive slowly with chains installed. If you hear the chains contacting the body or chassis, stop and tighten them. If they still make contact, slow down until it stops. Remove the chains as soon as you begin driving on cleared roads.

When mounting snow chains, park the vehicle on level ground away from traffic. Turn on the vehicle Hazard Warning flashers and place a triangular emergency warning device behind the vehicle if available. Always place the vehicle in P (Park), apply the parking brake and turn off the engine before installing snow chains.

- The use of chains may adversely affect vehicle handling.
- Do not exceed 20 mph (30 km/h) or the chain manufacturer's recommended speed limit, whichever is lower.
- Drive carefully and avoid bumps, holes, sharp turns, and other road hazards, which may cause the vehicle to bounce.
- Avoid sharp turns or locked-wheel braking.



CAUTION - Snow chains

- ***Chains that are the wrong size or improperly installed can damage your vehicle's brake lines, suspension, body and wheels.***
- ***Stop driving and retighten the chains any time you hear them hitting the vehicle.***

Use high quality ethylene glycol coolant

Your vehicle is delivered with high quality ethylene glycol coolant in the cooling system. It is the only type of coolant that should be used because it helps prevent corrosion in the cooling system, lubricates the water pump and prevents freezing. Be sure to replace or replenish your coolant in accordance with the maintenance schedule in section 7. Before winter, have your coolant tested to assure that its freezing point is sufficient for the temperatures anticipated during the winter.

Check battery and cables

Winter puts additional burdens on the battery system. Visually inspect the battery and cables as described in section 7. The level of charge in your battery can be checked by an authorized Kia dealer or a service station.

Change to "winter weight" oil if necessary

In some climates it is recommended that a lower viscosity "winter weight" oil be used during cold weather. See section 8 for recommendations. If you aren't sure what weight oil you should use, consult an authorized Kia dealer.

Check spark plugs and ignition system

Inspect your spark plugs as described in section 7 and replace them if necessary. Also check all ignition wiring and components to be sure they are not cracked, worn or damaged in any way.

To keep locks from freezing

To keep the locks from freezing, squirt an approved de-icer fluid or glycerine into the key opening. If a lock is covered with ice, squirt it with an approved de-icing fluid to remove the ice. If the lock is frozen internally, you may be able to thaw it out by using a heated key. Handle the heated key with care to avoid injury.

Use approved window washer anti-freeze in system

To keep the water in the window washer system from freezing, add an approved window washer anti-freeze solution in accordance with instructions on the container. Window washer anti-freeze is available from an authorized Kia dealer and most auto parts outlets. Do not use engine coolant or other types of anti-freeze as these may damage the paint finish.

Don't let your parking brake freeze

Under some conditions your parking brake can freeze in the engaged position. This is most likely to happen when there is an accumulation of snow or ice around or near the rear brakes or if the brakes are wet. If there is a risk the parking brake may freeze, apply it only temporarily while you put the gear shift lever in P (Park, automatic transaxle) and block the rear wheels so the vehicle cannot roll. Then release the parking brake.

Don't let ice and snow accumulate underneath

Under some conditions, snow and ice can build up under the fenders and interfere with the steering. When driving in severe winter conditions where this may happen, you should periodically check underneath the vehicle to be sure the movement of the front wheels and the steering components are not obstructed.

Carry emergency equipment

Depending on the severity of the weather, you should carry appropriate emergency equipment. Some of the items you may want to carry include tow straps or chains, flashlight, emergency flares, sand, shovel, jumper cables, window scraper, gloves, ground cloth, coveralls, blanket, etc.

TRAILER TOWING

If you are considering towing with your vehicle, you should first check with your country's Department of Motor Vehicles to determine their legal requirements.

Since laws vary the requirements for towing trailers, cars, or other types of vehicles or apparatus may differ. Ask an authorized Kia dealer for further details before towing.

WARNING - Towing a trailer

Always check your towing equipment to confirm correct equipment size and installation before use. Using incompatible or incorrectly installed trailer equipment can effect the vehicle operation and endanger you and your passengers.

You may require an additional wiring harness connector to install a trailer hitch. Please contact an authorized Kia dealer for more details.

WARNING - Weight limits

Before towing, make sure the total trailer weight, GCW (gross combination weight), GVW (gross vehicle weight), GAW (gross axle weight) and trailer tongue load are all within the limits.

CAUTION - Trailer installation

Follow instructions in this section when pulling a trailer. Pulling a trailer improperly can damage your vehicle and result in costly repairs not covered by your warranty.

Your vehicle can tow a trailer.* To identify what the vehicle trailering capacity is for your vehicle, you should read the information in "Weight of the trailer" that appears later in this section.

Remember that trailering is different than just driving your vehicle by itself. Trailering means changes in handling, durability, and fuel economy. Successful, safe trailering requires correct equipment, and it has to be used properly.

This section contains many time-tested, important trailering tips and safety rules. Many of these are important for your safety and that of your passengers. Please read this section carefully before you pull a trailer.

Load-pulling components such as the engine, transaxle, wheel assemblies, and tires are forced to work harder against the load of the added weight. The engine is required to operate at relatively higher speeds and under greater loads. This additional burden generates extra heat. The trailer also adds considerably to wind resistance, increasing the pulling requirements.

Hitches

It's important to have the correct hitch equipment. Crosswinds, large trucks going by, and rough roads are a few reasons why you'll need the right hitch. Here are some rules to follow:

- Will you have to make any holes in the body of your vehicle when you install a trailer hitch? If you do, then be sure to seal the holes later when you remove the hitch.
If you don't seal them, deadly carbon monoxide (CO) from your exhaust can get into your vehicle, as well as dirt and water.
- The bumpers on your vehicle are not intended for hitches. Do not attach rental hitches or other bumper-type hitches to them. Use only a frame-mounted hitch that does not attach to the bumper.
- Kia trailer hitch accessory is available at an authorized Kia dealer.

Safety chains

You should always attach chains between your vehicle and your trailer. Cross the safety chains under the tongue of the trailer so that the tongue will not drop to the road if it becomes separated from the hitch.

Instructions about safety chains may be provided by the hitch manufacturer or by the trailer manufacturer. Follow the manufacturer's recommendation for attaching safety chains. Always leave just enough slack so you can turn with your trailer. And, never allow safety chains to drag on the ground.

Trailer brakes

If your trailer is equipped with a braking system, make sure it conforms to your state's regulations and that it is properly installed and operating correctly.

If your trailer weight exceeds the maximum allowed weight without trailer brakes, then the trailer will also require its own brakes as well. Be sure to read and follow the instructions for the trailer brakes so you'll be able to install, adjust and maintain them properly.

- Don't tap into or modify your vehicle's brake system.



WARNING - Trailer brakes

Do not use a trailer with its own brakes unless you are absolutely certain that you have properly set up the brake system. This is not a task for amateurs. Use an experienced, competent trailer shop for this work.

Driving with a trailer

Towing a trailer requires a certain amount of experience. Before setting out for the open road, you must get to know your trailer. Acquaint yourself with the feel of handling and braking with the added weight of the trailer. And always keep in mind that the vehicle you are driving is now a good deal longer and not nearly so responsive as your vehicle is by itself.

Before you start, check the trailer hitch and platform, safety chains, electrical connector(s), lights, tires and mirror adjustment. If the trailer has electric brakes, start your vehicle and trailer moving and then apply the trailer brake controller by hand to be sure the brakes are working. This lets you check your electrical connection at the same time.

During your trip, check occasionally to be sure that the load is secure, and that the lights and any trailer brakes are still working.

Following distance

Stay at least twice as far behind the vehicle ahead as you would when driving your vehicle without a trailer. This can help you avoid situations that require heavy braking and sudden turns.

Passing

You'll need more passing distance up ahead when you're towing a trailer. And, because of the increased vehicle length, you'll need to go much farther beyond the passed vehicle before you can return to your lane. Due to the added load to the engine when going uphill the vehicle may also take longer to pass than it would on flat ground.

Backing up

Hold the bottom of the steering wheel with one hand. Then, to move the trailer to the left, just move your hand to the left. To move the trailer to the right, move your hand to the right. Always back up slowly and, if possible, have someone guide you.

Making turns

When you're turning with a trailer, make wider turns than normal. Do this so your trailer won't strike soft shoulders, curbs, road signs, trees, or other objects near the edge of the road. Avoid jerky or sudden maneuvers. Signal well in advance before turning or lane changes.

Turn signals when towing a trailer

When you tow a trailer, your vehicle has to have a different turn signal flasher and extra wiring. The green arrows on your instrument panel will flash whenever you signal a turn or lane change. Properly connected, the trailer lights will also flash to alert other drivers you're about to turn, change lanes, or stop.

When towing a trailer, the green arrows on your instrument panel will flash for turns even if the bulbs on the trailer are burned out. Thus, you may think drivers behind you are seeing your signals when, in fact, they are not. It's important to check occasionally to be sure the trailer bulbs are still working. You must also check the lights every time you disconnect and then reconnect the wires.

Do not connect a trailer lighting system directly to your vehicle's lighting system. Use only an approved trailer wiring harness.

An authorized Kia dealer can assist you in installing the wiring harness.

 **CAUTION**

Always use an approved trailer wiring harness. Failure to use an approved trailer wiring harness could result in damage to the vehicle electrical system.

Driving on grades

Reduce speed and shift to a lower gear before you start down a long or steep downgrade. If you don't shift down, you might have to use your brakes so much that they would get hot and no longer operate efficiently.

On a long uphill grade, shift down and reduce your speed to around 45 mph (70 km/h) to reduce the possibility of engine and transaxle overheating.

If your trailer weighs more than the maximum trailer weight without trailer brakes and you have an automatic transaxle, you should drive in D (Drive) when towing a trailer.

Operating your vehicle in D (Drive) when towing a trailer will minimize heat build up and extend the life of your transaxle.

Towing up hill

- When towing a trailer on steep grades (in excess of 6%) pay close attention to the engine coolant temperature gauge to ensure the engine does not overheat.

If the needle of the coolant temperature gauge moves across the dial towards "H" (HOT), pull over and stop as soon as it is safe to do so, and allow the engine to idle until it cools down. You may proceed once the engine has cooled sufficiently.

- You must decide driving speed depending on trailer weight and uphill grade to reduce the possibility of engine and transaxle overheating.

Parking on hills

Generally, if you have a trailer attached to your vehicle, you should not park your vehicle on a hill. People can be seriously or fatally injured, and both your vehicle and the trailer can be damaged if they unexpectedly roll downhill.

However, if you ever have to park your trailer on a hill, here's how to do it:

1. Pull the vehicle into the parking space. Turn the steering wheel in the direction of the curb (right if headed downhill, left if headed up hill).
2. If the vehicle has an automatic transaxle, place the vehicle in P (Park).
3. Set the parking brake and shut off the engine.
4. Place chocks under the trailer wheels on the down hill side of the wheels.

5. Start the vehicle, hold the brakes, shift to neutral, release the parking brake and slowly release the brakes until the trailer chocks absorb the load.
6. Reapply the brakes, reapply the parking brake and shift the vehicle to P (Park) for automatic transaxle.
7. Shut off the vehicle and release the vehicle brakes but leave the parking brake set.

When you are ready to leave after parking on a hill

1. With the automatic transaxle in P (Park), apply your brakes and hold the brake pedal down while you:
 - Start your engine;
 - Shift into gear; and
 - Release the parking brake.
2. Slowly remove your foot from the brake pedal.
3. Drive slowly until the trailer is clear of the chocks.
4. Stop and have someone pick up and store the chocks.

Maintenance when trailer towing

Your vehicle will need service more often when you regularly pull a trailer. Important items to pay particular attention to include engine oil, automatic transaxle fluid, axle lubricant and cooling system fluid. Brake condition is another important item to frequently check. Each item is covered in this manual, and the Index will help you find them quickly. If you're trailering, it's a good idea to review these sections before you start your trip.

Don't forget to also maintain your trailer and hitch. Follow the maintenance schedule that accompanied your trailer and check it periodically. Preferably, conduct the check at the start of each day's driving. Most importantly, all hitch nuts and bolts should be tight.



CAUTION - Air condition

Do not use the A/C while using your vehicle to tow uphill. Due to higher load during trailer usage, overheating might occur on hot days or during uphill driving.

- When towing check transaxle fluid more frequently.

If you do decide to pull a trailer

Here are some important points if you decide to pull a trailer:

- Consider using a sway control. You can ask a hitch dealer about sway control.
- Do not do any towing with your vehicle during its first 1,200 miles (2,000 km) in order to allow the engine to properly break in. Failure to heed this caution may result in serious engine or transaxle damage.
- When towing a trailer, be sure to consult an authorized Kia dealer for further information on additional requirements such as a towing kit, etc.

- Always drive your vehicle at a moderate speed (less than 60 mph (100 km/h)).
- On a long uphill grade, do not exceed 45 mph (70 km/h) or the posted towing speed limit, whichever is lower.
- The chart contains important considerations that have to do with weight:

		Engine
		Gasoline Engine
Item		Lambda 3.3 GDI
Maximum trailer weight (lbs. (kg))	Without brake system	1,000 (453)
	With brake system	3,500 (1587)
Maximum tongue weight (lbs. (kg))		350 (158)

To identify what the vehicle trailering capacity is for your vehicle, you should read the information in “Weight of the Trailer” that appears later in this section.

Weight of the trailer

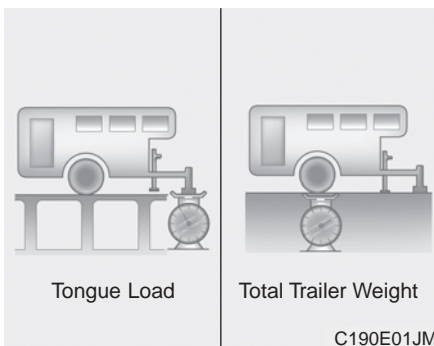

What is the maximum safe weight of a trailer? It should never weigh more than the maximum trailer weight with trailer brakes. But even that can be too heavy.

It depends on how you plan to use your trailer. For example, speed, altitude, road grades, outside temperature and how often your vehicle is used to pull a trailer are all important. The ideal trailer weight can also depend on any special equipment that you have on your vehicle.

Weight of the trailer tongue

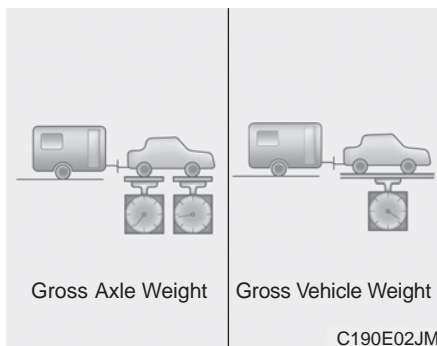

The tongue load of any trailer is an important weight to measure because it affects the total gross vehicle weight (GVW) of your vehicle. This weight includes the curb weight of the vehicle, any cargo you may carry in it, and the people who will be riding in the vehicle. And if you will tow a trailer, you must add the tongue load to the GVW because your vehicle will also be carrying that weight.

The trailer tongue should weigh a maximum of 10% of the total loaded trailer weight, within the limits of the maximum permissible trailer tongue load. After you've loaded your trailer, weigh the trailer and then the tongue, separately, to see if the weights are proper. If they aren't, you may be able to correct them simply by moving some items around in the trailer.

⚠ WARNING - Trailer
Always follow the loading instructions provided with your trailer. Improper loading can effect vehicle operation and result in an accident.

VEHICLE LOAD LIMIT

Tire and loading information label

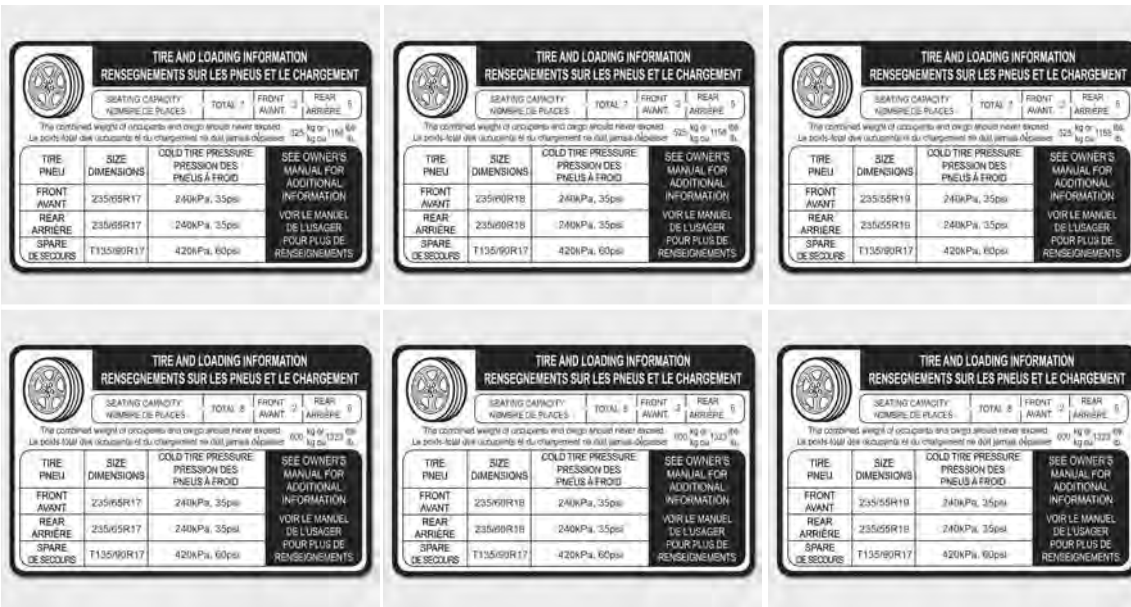

OYP054156N/OYP054157N/OYP054158N/OYP054159N/OYP054160N/OYP054161N

The label located on the driver's door sill gives the original tire size, cold tire pressures recommended for your vehicle, the number of people that can be in your vehicle and vehicle capacity weight.

Vehicle capacity weight:

7 persons : 1,158 lbs. (525 kg)

8 persons : 1,323 lbs. (600 kg)

Vehicle capacity weight is the maximum combined weight of occupants and cargo. If your vehicle is equipped with a trailer, the combined weight includes the tongue load.

Seating capacity:

Total - 7 persons

(Front seat : 2 persons,

Rear seat : 5 persons)

- 8 persons

(Front seat : 2 persons,

Rear seat : 6 persons)

Seating capacity is the maximum number of occupants including a driver, your vehicle may carry.

However, the seating capacity may be reduced based upon the weight of all of the occupants, and the weight of the cargo being carried or towed.

Do not overload the vehicle as there is a limit to the total weight, or load limit including occupants and cargo, the vehicle can carry.

Towing capacity:

3.3L Engine

Without trailer brakes

: 1,000 lbs (453 kg)

With trailer brakes

: 3,500 lbs (1,587 kg)

Towing capacity is the maximum trailer weight including its cargo weight, your vehicle can tow

Cargo capacity:

The cargo capacity of your vehicle will increase or decrease depending on the weight and the number of occupants and the tongue load, if your vehicle is equipped with a trailer.

Steps for determining correct load limit

1. Locate the statement "The combined weight of occupants and cargo should never exceed XXX kg or XXX lbs." on your vehicle's placard.
2. Determine the combined weight of the driver and passengers that will be riding in your vehicle.
3. Subtract the combined weight of the driver and passengers from XXX kg or XXX lbs.
4. The resulting figure equals the available amount of cargo and luggage load capacity. For example, if the "XXX" amount equals 1,400 lbs. and there will be five 150 lbs. passengers in your vehicle, the amount of available cargo and luggage load capacity is 650 lbs.
(1,400-750 (5 x 150) = 650 lbs.)

5. Determine the combined weight of luggage and cargo being loaded on the vehicle. That weight may not safely exceed the available cargo and luggage load capacity calculated in Step 4.
6. If your vehicle will be towing a trailer, load from your trailer will be transferred to your vehicle. Consult this manual to determine how this reduces the available cargo and luggage load capacity of your vehicle.

Example 1



C190F01JM

Item	Description	Total
A	Vehicle Capacity Weight	1,400 lbs (635 kg)
B	Subtract Occupant Weight 150 lbs (68 kg) × 2	300 lbs (136 kg)
C	Available Cargo and Luggage weight	1,100 lbs (499 kg)

Example 2



C190F02JM

Item	Description	Total
A	Vehicle Capacity Weight	1,400 lbs (635 kg)
B	Subtract Occupant Weight 150 lbs (68 kg) × 5	750 lbs (340 kg)
C	Available Cargo and Luggage weight	650 lbs (295 kg)

Example 3

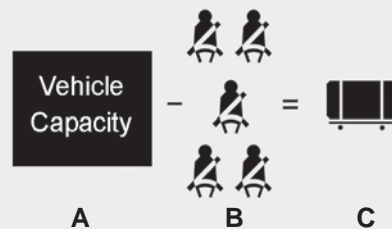

C190F03JM

Item	Description	Total
A	Vehicle Capacity Weight	1,400 lbs (635 kg)
B	Subtract Occupant Weight 172 lbs (78 kg) × 5	860 lbs (390 kg)
C	Available Cargo and Luggage weight	540 lbs (245 kg)

Refer to your vehicle's tire and loading information label for specific information about your vehicle's capacity weight and seating positions. The combined weight of the driver, passengers and cargo should never exceed your vehicle's capacity weight.

Certification label



OEN056020

The certification label is located on the driver's door sill at the center pillar.

This label shows the maximum allowable weight of the fully loaded vehicle. This is called the GVWR (Gross Vehicle Weight Rating). The GVWR includes the weight of the vehicle, all occupants, fuel and cargo.

This label also tells you the maximum weight that can be supported by the front and rear axles, called Gross Axle Weight Rating (GAWR).

To find out the actual loads on your front and rear axles, you need to go to a weigh station and weigh your vehicle. Your dealer can help you with this. Be sure to spread out your load equally on both sides of the centerline.

⚠ WARNING - Over loading
Never exceed the GVWR for your vehicle, the GAWR for either the front or rear axle and vehicle capacity weight. Exceeding these ratings can affect your vehicle's handling and braking ability.

The label will help you decide how much cargo and installed equipment your vehicle can carry.

If you carry items inside your vehicle - like suitcases, tools, packages, or anything else - they are moving as fast as the vehicle. If you have to stop or turn quickly, or if there is a crash, the items will keep going and can cause an injury if they strike the driver or a passenger.

⚠ WARNING - Over loading

Do not overload your vehicle. Overloading your vehicle can cause heat buildup in your vehicle's tires and possible tire failure, increased stopping distances and poor vehicle handling all of which may result in a crash.

⚠ WARNING - Loose cargo

Do not travel with unsecured blunt objects in the passenger compartment of your vehicle (e.g. suit cases or unsecured child seats). These items may strike occupant during a sudden stop or crash.

*** NOTICE**

Overloading your vehicle may cause damage. Repairs would not be covered by your warranty. Do not overload your vehicle.

VEHICLE WEIGHT GLOSSARY

This section will guide you in the proper loading of your vehicle and/or trailer, to keep your loaded vehicle weight within its design rating capability, with or without a trailer. Properly loading your vehicle will provide maximum return of the vehicle design performance. Before loading your vehicle, familiarize yourself with the following terms for determining your vehicle's weight ratings, with or without a trailer, from the vehicle's specifications and the certification label:

Base curb weight

This is the weight of the vehicle including a full tank of fuel and all standard equipment. It does not include passengers, cargo, or optional equipment.

Vehicle curb weight

This is the weight of your new vehicle when you picked it up from your dealer plus any aftermarket equipment.

Cargo weight

This figure includes all weight added to the Base Curb Weight, including cargo and optional equipment.

GAW (Gross axle weight)

This is the total weight placed on each axle (front and rear) - including vehicle curb weight and all payload.

GAWR (Gross axle weight rating)

This is the maximum allowable weight that can be carried by a single axle (front or rear). These numbers are shown on the certification label. The total load on each axle must never exceed its GAWR.

GVW (Gross vehicle weight)

This is the Base Curb Weight plus actual Cargo Weight plus passengers.

GVWR (Gross vehicle weight rating)

This is the maximum allowable weight of the fully loaded vehicle (including all options, equipment, passengers and cargo). The GVWR is shown on the certification label located on the driver's door sill.

What to do in an emergency

Road warning	6-2
• Hazard warning flasher	6-2
In case of an emergency while driving	6-3
• If the engine stalls at a crossroad or crossing.	6-3
• If you have a flat tire while driving	6-3
• If the engine stalls while driving	6-3
If the engine does not start	6-4
• If engine doesn't turn over or turns over slowly	6-4
• If engine turns over normally but does not start	6-4
Emergency starting	6-5
• Jump starting.	6-5
• Push-starting	6-7
If the engine overheats	6-8
Tire Pressure Monitoring System (TPMS)	6-9
• Changing a tire with TPMS	6-12
If you have a flat tire	6-15
• Jack and tools	6-15
• Removing the spare tire	6-16
• Storing the spare tire.	6-17
• Changing tires	6-18

Towing	6-25
• Towing service	6-25
• Removable towing hook (front)	6-26
• Emergency towing.	6-27

ROAD WARNING

Hazard warning flasher

■ Type A



■ Type B



The hazard warning flasher serves as a warning to other drivers to exercise extreme caution when approaching, overtaking, or passing your vehicle.

It should be used whenever emergency repairs are being made or when the vehicle is stopped near the edge of a roadway.

Depress the flasher switch with the ignition switch in any position. The flasher switch is located in the center fascia panel. All turn signal lights will flash simultaneously.

- The hazard warning flasher operates whether your vehicle is running or not.
- The turn signals do not work when the hazard flasher is on.
- Care must be taken when using the hazard warning flasher while the vehicle is being towed.

IN CASE OF AN EMERGENCY WHILE DRIVING

If the engine stalls at a cross-road or crossing

If the engine stalls at a crossroad or crossing, set the shift lever in the N (Neutral) position and then push the vehicle to a safe place.

If you have a flat tire while driving

If a tire goes flat while you are driving:

1. Take your foot off the accelerator pedal and let the vehicle slow down while driving straight ahead. Do not apply the brakes immediately or attempt to pull off the road as this may cause a loss of control. When the vehicle has slowed to such a speed that it is safe to do so, brake carefully and pull off the road. Drive off the road as far as possible and park on a firm level ground. If you are on a divided highway, do not park in the median area between the two traffic lanes.

2. When the vehicle is stopped, turn on your emergency hazard flashers, set the parking brake and put the transaxle in P (Park, automatic transaxle).
3. Have all passengers get out of the vehicle. Be sure they all get out on the side of the vehicle that is away from traffic.
4. When changing a flat tire, follow the instruction provided later in this section.

If the engine stalls while driving

1. Reduce your speed gradually, keeping a straight line. Move cautiously off the road to a safe place.
2. Turn on your emergency flashers.
3. Try to start the engine again. If your vehicle will not start, contact an authorized Kia dealer or seek other qualified assistance.

* NOTICE

If there was a check engine light and loss of power or stall and if safe to do so wait at least 10 seconds to restart the vehicle after it stalls. This may reset the car so it will no longer run at low power (limp home) condition.

IF THE ENGINE WILL NOT START

If engine doesn't turn over or turns over slowly

- 1.If your vehicle has an automatic transaxle, be sure the shift lever is in N (Neutral) or P (Park) and the emergency brake is set.
- 2.Check the battery connections to be sure they are clean and tight.
- 3.Turn on the interior light. If the light dims or goes out when you operate the starter, the battery is discharged.
- 4.Check the starter connections to be sure they are securely tightened.
- 5.Do not push or pull the vehicle to start it. See instructions for "Jump starting".

 **WARNING - Push / Pull start**

Do not push or pull the vehicle to start it. Push or pull starting may cause the catalytic converter to overload and create a fire hazard.

If engine turns over normally but does not start

- 1.Check the fuel level.
- 2.With the ignition switch in the LOCK position, check all connectors at the ignition coils and spark plugs. Reconnect any that may be disconnected or loose.
- 3.Check the fuel line in the engine compartment.
- 4.If the engine still does not start, call an authorized Kia dealer or seek other qualified assistance.

EMERGENCY STARTING

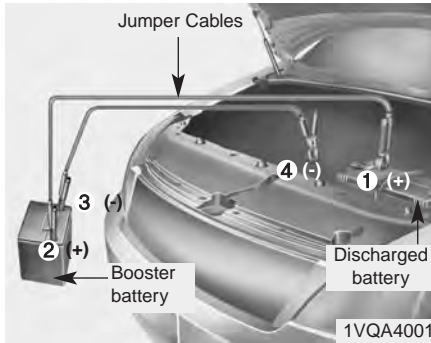

Connect cables in numerical order and disconnect in reverse order.

Jump starting

Jump starting can be dangerous if done incorrectly. Therefore, to avoid harm to yourself or damage to your vehicle or battery, follow these jump starting procedures. If in doubt, we strongly recommend that you have a competent technician or towing service jump start your vehicle.

⚠ CAUTION - 12 volt battery
Use only a 12-volt jumper system. You can damage a 12-volt starting motor, ignition system, and other electrical parts beyond repair by use of a 24-volt power supply (either two 12-volt batteries in series or a 24-volt motor generator set).

⚠ WARNING - Battery
Never attempt to check the electrolyte level of the battery as this may cause the battery to rupture or explode.

⚠ WARNING - Frozen batteries
Do not attempt to jump start the vehicle if the discharged battery is frozen or if the electrolyte level is low as the battery may rupture or explode.

⚠ WARNING - Battery

Keep all flames or sparks away from the battery. The battery produces hydrogen gas which will explode if exposed to flame or sparks.

⚠ WARNING - Sulfuric acid risk

When jump starting your vehicle be careful not to get acid on yourself, your clothing or on the vehicle. Automobile batteries contain sulfuric acid. This is poisonous and highly corrosive.

Jump starting procedure

1. Make sure the booster battery is 12-volt and that its negative terminal is grounded.
2. If the booster battery is in another vehicle, do not allow the vehicles to come in contact.
3. Turn off all unnecessary electrical loads.
4. Connect the jumper cables in the exact sequence shown in the illustration. First connect one end of a jumper cable to the positive terminal of the discharged battery (1), then connect the other end to the positive terminal of the booster battery (2).

Proceed to connect one end of the other jumper cable to the negative terminal of the booster battery (3), then the other end to a solid, stationary, metallic point (for example, the engine lifting bracket) away from the battery (4). Do not connect it to or near any part that moves when the engine is cranked.

Do not allow the jumper cables to contact anything except the correct battery terminals or the correct ground. Do not lean over the battery when making connections.

⚠ WARNING - Battery cables

Do not connect the jumper cable from the negative terminal of the booster battery to the negative terminal of the discharged battery. This can cause the discharged battery to overheat and crack, releasing battery acid.

Make sure to connect one end of the jumper cable to the negative terminal of the booster battery, and the other end to a metallic point, far away from the battery.

5. Start the engine of the vehicle with the booster battery and let it run at 2,000 rpm, then start the engine of the vehicle with the discharged battery.

If the cause of your battery discharging is not apparent, you should have your vehicle checked by an authorized Kia dealer.

Push-starting

Vehicles equipped with automatic transaxle lock system cannot be push-started.

Follow the directions in this section for jump-starting.



WARNING - Tow starting vehicle

Never tow a vehicle to start it because the sudden surge forward when the engine starts could cause a collision with the tow vehicle.

IF THE ENGINE OVERHEATS

If your temperature gauge indicates overheating, you experience a loss of power, or hear loud pinging or knocking, the engine will probably be too hot. If this happens, you should:

1. Pull off the road and stop as soon as it is safe to do so.
2. Place the shift lever in P (Park, automatic transaxle) and set the parking brake. If the air conditioning is on, turn it off.
3. If engine coolant is running out under the vehicle or steam is coming out from underneath the hood, stop the engine. Do not open the hood until the coolant has stopped running or the steaming has stopped. If there is no visible loss of engine coolant and no steam, leave the engine running and check to be sure the engine cooling fan is operating. If the fan is not running, turn the engine off.

4. Check to see if the water pump drive belt is missing. If it is not missing, check to see that it is tight. If the drive belt seems to be satisfactory, check for coolant leaking from the radiator, hoses or under the vehicle. (If the air conditioning had been in use, it is normal for cold water to be draining from it when you stop).

⚠ WARNING - Under the hood

While the engine is running, keep hair, hands and clothing away from moving parts such as the fan and drive belts to prevent injury.

5. If the water pump drive belt is broken or engine coolant is leaking out, stop the engine immediately and call the nearest authorized Kia dealer for assistance.

⚠ WARNING - Radiator cap
Do not remove the radiator cap when the engine is hot. This may result in coolant being blown out of the opening and cause serious burns.

6. If you cannot find the cause of the overheating, wait until the engine temperature has returned to normal. Then, if coolant has been lost, carefully add coolant to the reservoir to bring the fluid level in the reservoir up to the halfway mark.
7. Proceed with caution, keeping alert for further signs of overheating. If overheating happens again, call an authorized Kia dealer for assistance.

Serious loss of coolant indicates there is a leak in the cooling system and this should be checked as soon as possible by an authorized Kia dealer.

TIRE PRESSURE MONITORING SYSTEM (TPMS)



(1) Low tire pressure telltale /
TPMS malfunction indicator

Each tire, including the spare (if provided), should be checked monthly when cold and inflated to the inflation pressure recommended by the vehicle manufacturer on the vehicle placard or tire inflation pressure label. (If your vehicle has tires of a different size than the size indicated on the vehicle placard or tire inflation pressure label, you should determine the proper tire inflation pressure for those tires.)

As an added safety feature, your vehicle has been equipped with a tire pressure monitoring system (TPMS) that illuminates a low tire pressure telltale when one or more of your tires is significantly under-inflated. Accordingly, when the low tire pressure telltale illuminates, you should stop and check your tires as soon as possible, and inflate them to the proper pressure. Driving on a significantly under-inflated tire causes the tire to overheat and can lead to tire failure. Under-inflation also reduces fuel efficiency and tire tread life, and may affect the vehicle's handling and stopping ability.

Please note that the TPMS is not a substitute for proper tire maintenance, and it is the driver's responsibility to maintain correct tire pressure, even if under-inflation has not reached the level to trigger illumination of the TPMS low tire pressure telltale.

Your vehicle has also been equipped with a TPMS malfunction indicator to indicate when the system is not operating properly. The TPMS malfunction indicator is combined with the low tire pressure telltale. When the system detects a malfunction, the telltale will flash for approximately one minute and then remain continuously illuminated. This sequence will continue upon subsequent vehicle start-ups as long as the malfunction exists. When the malfunction indicator is illuminated, the system may not be able to detect or signal low tire pressure as intended. TPMS malfunctions may occur for a variety of reasons, including the installation of replacement or alternate tires or wheels on the vehicle that prevent the TPMS from functioning properly. Always check the TPMS malfunction telltale after replacing one or more tires or wheels on your vehicle to ensure that the replacement or alternate tires and wheels allow the TPMS to continue to function properly.

* NOTICE

If the TPMS, Low Tire Pressure indicator do not illuminate for 3 seconds when the ignition switch is turned to the ON position or engine is running, or if they remain illuminated after coming on for approximately 3 seconds, take your vehicle to your nearest authorized Kia dealer and have the system checked.

CAUTION

- *The tire pressure may change due to factors such as parking condition, driving style, and altitude above sea level.*
- *Low tire pressure warning may sound when a tire's pressure unit is equal or higher than nearby tires. This is a normal occurrence, which is due to the change in tire pressure along with tire temperature.*
- *The tire pressure shown on the dashboard may differ from the tire pressure measured by tire pressure gauge.*



Low tire pressure telltale

When the tire pressure monitoring system warning indicators are illuminated, one or more of your tires is significantly under-inflated.

If the telltale illuminates, immediately reduce your speed, avoid hard cornering and anticipate increased stopping distances. You should stop and check your tires as soon as possible. Inflate the tires to the proper pressure as indicated on the vehicle's placard or tire inflation pressure label located on the driver's side center pillar outer panel. If you cannot reach a service station or if the tire cannot hold the newly added air, replace the low pressure tire with the spare tire.

Then the TPMS malfunction indicator and the Low Tire Pressure telltale may turn on and illuminate after restarting and about 20 minutes of continuous driving before you have the low pressure tire repaired and replaced on the vehicle.

In winter or cold weather, the low tire pressure telltale may be illuminated if the tire pressure was adjusted to the recommended tire inflation pressure in warm weather. It does not mean your TPMS is malfunctioning because the decreased temperature leads to a proportional lowering of tire pressure.

When you drive your vehicle from a warm area to a cold area or from a cold area to a warm area, or the outside temperature is greatly higher or lower, you should check the tire inflation pressure and adjust the tires to the recommended tire inflation pressure.

⚠ WARNING - Low pressure damage

Do not drive on low pressure tires. Significantly low tire pressure can cause the tires to overheat and fail making the vehicle unstable resulting in increased braking distances and a loss of vehicle control.



TPMS (Tire Pressure Monitoring System) malfunction indicator

The low tire pressure telltale will illuminate after it blinks for approximately one minute when there is a problem with the Tire Pressure Monitoring System. If the system is able to correctly detect an underinflation warning at the same time as system failure then it will illuminate both the TPMS malfunction and low tire pressure position telltales e.g. if Front Left sensor fails, the TPMS malfunction indicator illuminates, but if the Front Right, Rear Left, or Rear Right tire is under-inflated, the low tire pressure position telltales may illuminate together with the TPMS malfunction indicator.

Have the system checked by an authorized Kia dealer as soon as possible to determine the cause of the problem.

- The TPMS malfunction indicator may be illuminated if the vehicle is moving around electric power supply cables or radios transmitters such as at police stations, government and public offices, broadcasting stations, military installations, airports, or transmitting towers, etc. This can interfere with normal operation of the Tire Pressure Monitoring System (TPMS).
- The TPMS malfunction indicator may be illuminated if snow chains are used or some separate electronic devices such as notebook computer, mobile charger, remote starter or navigation etc., are used in the vehicle. This can interfere with normal operation of the Tire Pressure Monitoring System (TPMS).

Changing a tire with TPMS

If you have a flat tire, the Low Tire Pressure telltale will come on. Have the flat tire repaired by an authorized Kia dealer as soon as possible or replace the flat tire with the spare tire.

 **CAUTION - Repair Agents**

Never use a puncture-repairing agent not approved by Kia to repair and/or inflate a low pressure tire. The tire sealant not approved by Kia may damage the tire pressure sensor.

Each wheel is equipped with a tire pressure sensor mounted inside the tire behind the valve stem. You must use TPMS specific wheels. It is recommended that you always have your tires serviced by an authorized Kia dealer.

Even if you replace the low pressure tire with the spare tire, the Low Tire Pressure telltale will remain on until the low pressure tire is repaired and placed on the vehicle.

After you replace the low pressure tire with the spare tire, the TPMS malfunction indicator may illuminate after a few minutes because the TPMS sensor mounted on the spare wheel is not initiated.

Once the low pressure tire is reinflated to the recommended pressure and installed on the vehicle or the TPMS sensor mounted on the replaced spare wheel is initiated by an authorized Kia dealer, the TPMS malfunction indicator and the low tire pressure telltale will extinguish within a few minutes of driving.

If the indicator is not extinguished after a few minutes of driving, please visit an authorized Kia dealer.

If an original mounted tire is replaced with the spare tire, the TPMS sensor on the replaced spare wheel should be initiated and the TPMS sensor on the original mounted wheel should be deactivated. If the TPMS sensor on the original mounted wheel located in the spare tire carrier still activates, the tire pressure monitoring system may not operate properly. Have the tire with TPMS serviced or replaced by an authorized Kia dealer.

You may not be able to identify a low tire by simply looking at it. Always use a good quality tire pressure gauge to measure the tire's inflation pressure. Please note that a tire that is hot (from being driven) will have a higher pressure measurement than a tire that is cold (from sitting stationary for at least 3 hours and driven less than 1 mile (1.6 km) during that 3 hour period).

Allow the tire to cool before measuring the inflation pressure. Always be sure the tire is cold before inflating to the recommended pressure.

A cold tire means the vehicle has been sitting for 3 hours and driven for less than 1 mile (1.6 km) in that 3 hour period.

Do not use any tire sealant if your vehicle is equipped with a Tire Pressure Monitoring System. The liquid sealant can damage the tire pressure sensors.

- The TPMS cannot alert you to severe and sudden tire damage caused by external factors such as nails or road debris.
- If you feel any vehicle instability, immediately take your foot off the accelerator, apply the brakes gradually and with light force, and slowly move to a safe position off the road.

*** NOTICE - Protecting TPMS**

Tampering with, modifying, or disabling the Tire Pressure Monitoring System (TPMS) components may interfere with the system's ability to warn the driver of low tire pressure conditions and/or TPMS malfunctions. Tampering with, modifying, or disabling the Tire Pressure Monitoring System (TPMS) components may void the warranty for that portion of the vehicle.

This device complies with Part 15 of the FCC rules.

Operation is subject to the following two conditions:

1. This device may not cause harmful interference, and
2. This device must accept any interference received, including interference that may cause undesired operation.

IF YOU HAVE A FLAT TIRE

Jack and tools

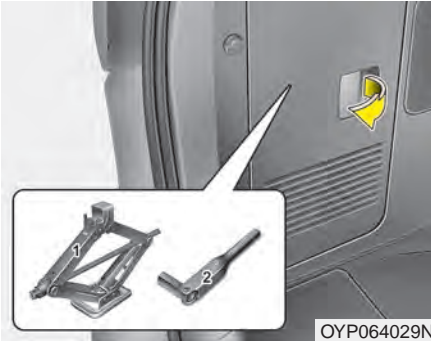

The jack and wheel lug nut wrench are stored in the luggage compartment.

Remove the panel indicated in the illustration.

- (1) Jack
- (2) Wheel lug nut wrench
(Jack handle)

Jacking instructions

The jack is provided for emergency tire changing only.

To prevent the jack from “rattling” while the vehicle is in motion, store it properly.

Follow jacking instructions to reduce the possibility of personal injury.

⚠ WARNING - Tire Jack

Do not place any portion of your body under a vehicle that is only supported by a jack since the vehicle can easily roll off the jack. Use vehicle support stands.

⚠ WARNING - Changing tires

Never attempt vehicle repairs in the traffic lanes of a public road or highway.

- Always move the vehicle completely off the road and onto the shoulder before trying to change a tire. The jack should be used on a firm level ground. If you cannot find a firm, level place off the road, call a towing service company for assistance.
- Be sure to use the correct front and rear jacking positions on the vehicle; never use the bumpers or any other part of the vehicle for jack support.
- Do not allow anyone to remain in the vehicle while it is on the jack.
- Make sure any children present are in a secure place away from the road and from the vehicle to be raised with the jack.

⚠ WARNING

- Running vehicle on jack

Do not start or run the engine of the vehicle while the vehicle is on the jack as this may cause the vehicle to fall off the jack.

Removing the spare tire

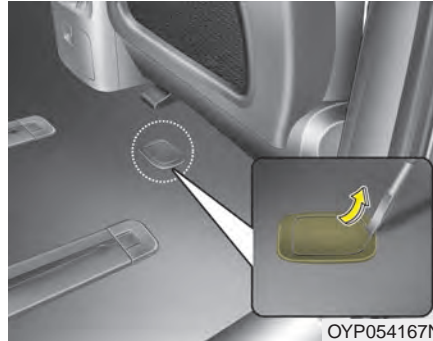

Your spare tire is stored underneath your vehicle, directly below the right sliding door.

1. Open the right sliding door and find the plastic hex bolt cover on the floor.
2. Remove the cover.

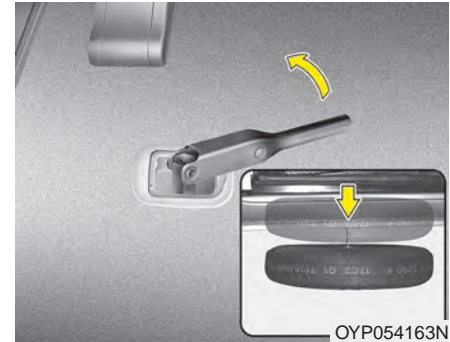

3. Use the wheel lug nut wrench to loosen the bolt enough to lower the spare tire.
Turn the wrench counterclockwise until the spare tire reaches the ground.

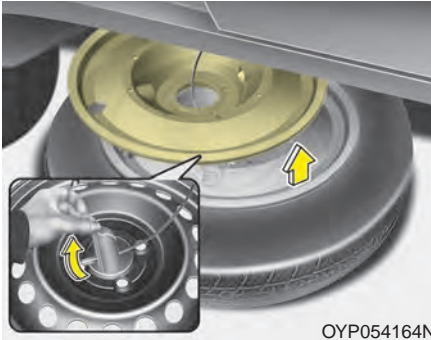

OYP054164N

4. After the spare tire reaches the ground, continue to turn the wrench counterclockwise, and draw the spare tire outside. Never rotate the wrench excessively, otherwise the spare tire carrier may be damaged.
5. Remove the retainer from the center of the spare tire.
6. Remove the cover from the spare tire.

Storing the spare tire

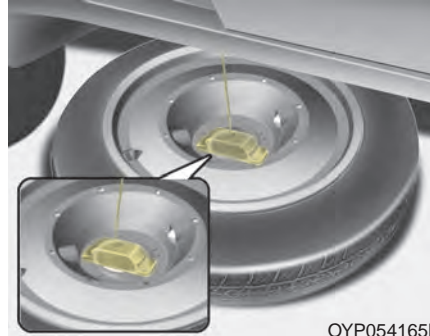

OYP054165N

1. Assemble the cover and spare tire with valve center aligning together.
2. Lay the tire on the ground with the valve stem facing down.

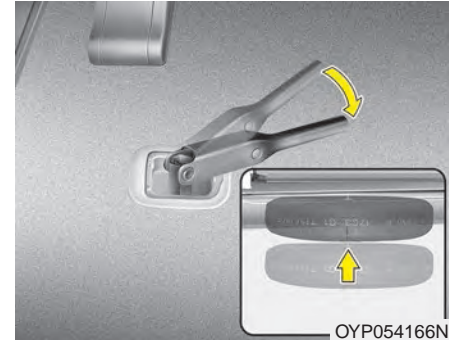

OYP054166N

2. Place the wheel under the vehicle and install the retainer through the wheel center.
3. Turn the wrench clockwise until it clicks.

Ensure the spare tire retainer is properly aligned with the center of the spare tire to prevent the spare tire from "rattling".

Otherwise, it may cause the spare tire to fall off the carrier and lead to an accident.

Changing tires

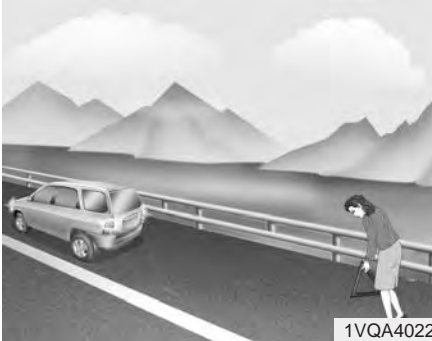

1. Park on a level surface and apply the parking brake firmly.
2. Place the transaxle shift lever in P (Park) with automatic transaxle.
3. Activate the hazard warning flashers.



4. Remove the wheel lug nut wrench, jack and spare tire from the vehicle.
5. Block both the front and rear of the wheel that is diagonally opposite from the jack position.

- To prevent vehicle movement while changing a tire, always set the parking brake fully, and always block the wheel diagonally opposite the wheel being changed.
- We recommend that the wheels of the vehicle be blocked, and that no person remain in a vehicle that is being jacked.



OYP064028N

6. Loosen the wheel lug nuts counter-clockwise one turn each, but do not remove any nut until the tire has been raised off the ground.

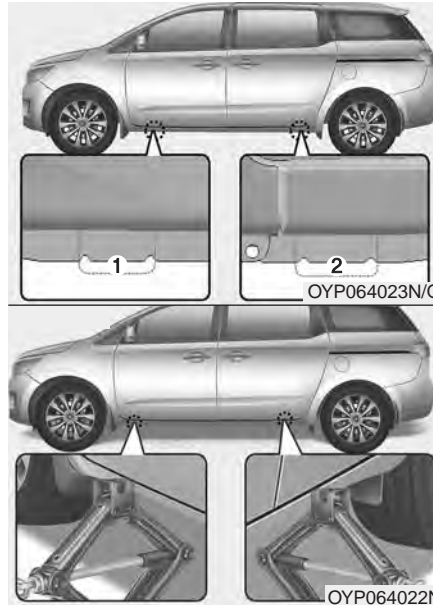

OYP064022N

7. Place the jack at the front (1) or rear (2) jacking position closest to the tire you are changing. Place the jack at the designated locations under the frame. The jacking positions are plates welded to the frame with two tabs and a raised dot to index with the jack.



OYP064021N

8. Insert the wheel lug nut wrench into the jack and turn it clockwise, raising the vehicle until the tire just clears the ground. This measurement is approximately 1 in. (30 mm).

Before removing the wheel lug nuts, make sure the vehicle is stable and that there is no chance for movement or slippage.

9. Loosen the wheel nuts and remove them with your fingers. Slide the wheel off the studs and lay it flat so it cannot roll away. To put the wheel on the hub, pick up the spare tire, line up the holes with the studs and slide the wheel onto them. If this is difficult, tip the wheel slightly and get the top hole in the wheel lined up with the top stud. Then jiggle the wheel back and forth until the wheel can slide over the other studs.

Wheels may have sharp edges. Handle them carefully to avoid possible severe injury. Before putting the wheel into place, be sure that there is nothing on the hub or wheel (such as mud, tar, gravel, etc.) that prevents the wheel from fitting solidly against the hub.

 **WARNING - Installing a wheel**

Make sure the wheel makes good contact with the hub when installed. If the contact of the mounting surface between the wheel and hub is not good, the wheel nuts could come loose and cause the loss of a wheel. Loss of a wheel may result in loss of control of the vehicle.

10. To install the wheel, hold it on the studs, put the wheel nuts on the studs and tighten them finger tight. Jiggle the tire to be sure it is completely seated, then tighten the nuts as much as possible with your fingers again.
11. Insert the wrench into the jack and lower the vehicle to the ground by turning the wheel nut wrench counterclockwise.

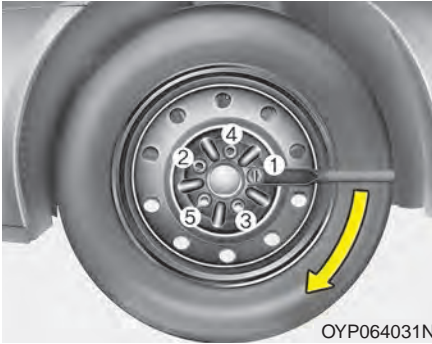

Then position the wrench as shown in the drawing and tighten the wheel nuts. Be sure the socket is seated completely over the nut. Do not stand on the wrench handle or use an extension pipe over the wrench handle. Go around the wheel tightening every nut following the numerical sequence shown in the image until they are all tight. Then double-check each nut for tightness. After changing wheels, have an authorized Kia dealer tighten the wheel nuts to their proper torque as soon as possible.

Wheel nut tightening torque:

65~79 lb-ft (9~11 kg·m)

If you have a tire gauge, remove the valve cap and check the air pressure. If the pressure is lower than recommended, drive slowly to the nearest service station and inflate to the correct pressure. If it is too high, adjust it until it is correct. Always reinstall the valve cap after checking or adjusting the tire pressure. If the cap is not replaced, dust and dirt may get into the tire valve and air may leak from the tire. If you lose a valve cap, buy another and install it as soon as possible.

After you have changed the wheels, always secure the flat tire in its place and return the jack and tools to their proper storage locations.

⚠ CAUTION - Reusing lug nuts

Make certain during wheel removal that the same nuts that were removed are reinstalled - or, if replaced, that nuts with metric threads and the same chamfer configuration are used. Your vehicle has metric threads on the wheel studs and nuts. Installation of a non-metric thread nut on a metric stud will not secure the wheel to the hub properly and will damage the stud so that it must be replaced.

Note that most lug nuts do not have metric threads. Be sure to use extreme care in checking for thread style before installing aftermarket lug nuts or wheels. If in doubt, consult an authorized Kia dealer.

⚠ WARNING - Wheel studs
If the studs are damaged, they may lose their ability to retain the wheel. This could lead to the loss of the wheel and a collision resulting in serious injuries.

To prevent the jack, wheel lug nut wrench and spare tire from rattling while the vehicle is in motion, store them properly.

Check the inflation pressures as soon as possible after installing the spare tire. Adjust it to the specified pressure, if necessary. Refer to “Tires and wheels” in section 8.

Important - use of compact spare tire (if equipped)

Your vehicle is equipped with a compact spare tire. This compact spare tire takes up less space than a regular-size tire. This tire is smaller than a conventional tire and is designed for temporary use only.

- You should drive carefully when the compact spare is in use. The compact spare should be replaced by the proper conventional tire and rim at the first opportunity.
- The operation of this vehicle is not recommended with more than one compact spare tire in use at the same time.

⚠ WARNING
The compact spare tire is for emergency use only. Do not operate your vehicle on this compact spare at speeds over 50 mph (80 km/h). The original tire should be repaired or replaced as soon as possible to avoid failure of the spare possibly leading to personal injury or death.

The compact spare should be inflated to 60 psi (420 kPa).

*** NOTICE**

Check the inflation pressure after installing the spare tire. Adjust it to the specified pressure, as necessary.

When using a compact spare tire, observe the following precautions:

- Under no circumstances should you exceed 50 mph (80 km/h); a higher speed could damage the tire.
- Ensure that you drive slowly enough for the road conditions to avoid all hazards. Any road hazard, such as a pothole or debris, could seriously damage the compact spare.
- Any continuous road use of this tire could result in tire failure, loss of vehicle control, and possible personal injury.
- Do not exceed the vehicle's maximum load rating or the load-carrying capacity shown on the sidewall of the compact spare tire.
- Avoid driving over obstacles. The compact spare tire diameter is smaller than the diameter of a conventional tire and reduces the ground clearance approximately 1 inch (25 mm), which could result in damage to the vehicle.
- Do not take this vehicle through an automatic vehicle wash while the compact spare tire is installed.
- Do not use tire chains on the compact spare tire. Because of the smaller size, a tire chain will not fit properly. This could damage the vehicle and result in loss of the chain.
- Do not use the compact spare tire on any other vehicle because this tire has been designed especially for your vehicle.
- The compact spare tire's tread life is shorter than a regular tire. Inspect your compact spare tire regularly and replace worn compact spare tires with the same size and design, mounted on the same wheel.
- The compact spare tire should not be used on any other wheels, nor should standard tires, snow tires, wheel covers or trim rings be used with the compact spare wheel. If such use is attempted, damage to these items or other vehicle components may occur.
- Do not use more than one compact spare tire at a time.
- Do not tow a trailer while the compact spare tire is installed.

Jack label

- Example
- Type A

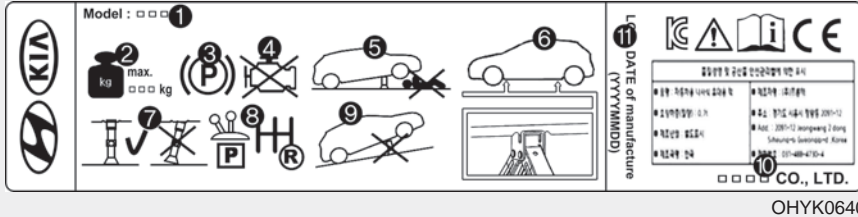

- Type B

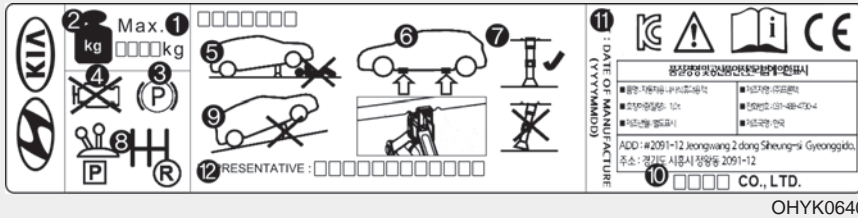

- Type C



1. Model Name
2. Maximum allowable load
3. When using the jack, set your parking brake.
4. When using the jack, stop the engine.
5. Do not get under a vehicle that is supported by a jack.
6. The designated locations under the frame
7. When supporting the vehicle, the base plate of jack must be vertical under the lifting point.
8. Move the shift lever to the P position on vehicles with automatic transmission.
9. The jack should be used on firm level ground.
10. Jack manufacturer
11. Production date
12. Representative company and address

※ The actual Jack label in the vehicle may differ from the illustration. For more detailed specifications, refer to the label attached to the jack.

TOWING

Towing service

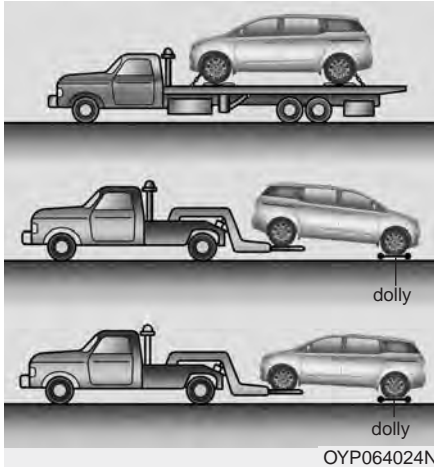

If emergency towing is necessary, we recommend having it done by an authorized Kia dealer or a commercial tow-truck service. Proper lifting and towing procedures are necessary to prevent damage to the vehicle. The use of wheel dollies or flatbed is recommended.

For trailer towing guidelines information, refer to “Trailer towing” in section 5.

It is acceptable to tow the vehicle with the rear wheels on the ground (without dollies) and the front wheels off the ground.

If any of the loaded wheels or suspension components are damaged or the vehicle is being towed with the front wheels on the ground, use a towing dolly under the front wheels.

When being towed by a commercial tow truck and wheel dollies are not used, the front of the vehicle should always be lifted, not the rear.

⚠️ WARNING - Side and curtain Air bag

If your vehicle is equipped with side and curtain air bag, set the ignition switch to **LOCK** or **ACC** position when the vehicle is being towed.

The side and curtain air bag may deploy when the ignitions is **ON**, and the rollover sensor detects the situation as a rollover.



OYP064026N



OYP044260N

CAUTION - Towing

- **Do not tow the vehicle backwards with the front wheels on the ground as this may cause damage to the vehicle.**
- **Do not tow with sling-type equipment. Use wheel lift or flatbed equipment.**

When towing your vehicle in an emergency without wheel dollies :

1. Set the ignition switch in the ACC position.
2. Place the transaxle shift lever in N (Neutral).
3. Release the parking brake.

CAUTION - Towing gear position

Failure to place the transaxle shift lever in N (Neutral) may cause internal damage to the transaxle.

Removable towing hook (front) (if equipped)

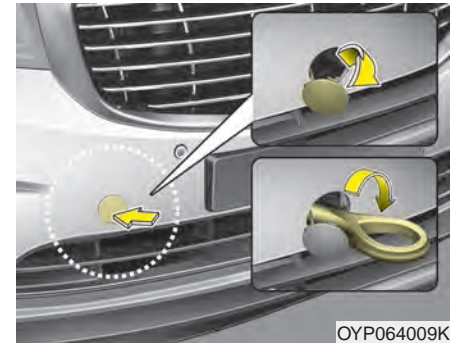

OYP064009K

1. Remove the towing hook from the tool case.
2. Remove the hole cover pressing the lower part of the cover on the front bumper.
3. Install the towing hook by turning it clockwise into the hole until it is fully secured.
4. Remove the towing hook and install the cover after use.

Emergency towing

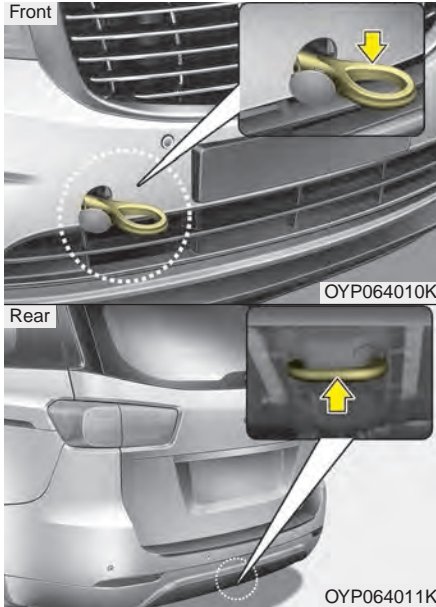

If towing is necessary, we recommend you to have it done by an authorized Kia dealer or a commercial tow truck service.

If towing service is not available in an emergency, your vehicle may be temporarily towed using a cable or chain secured to the emergency towing hook under the front (or rear) of the vehicle. Use extreme caution when towing the vehicle. A driver must be in the vehicle to steer it and operate the brakes.

Towing in this manner may be done only on hard-surfaced roads for a short distance and at low speeds. Also, the wheels, axles, power train, steering and brakes must all be in good condition.

- Do not use the tow hooks to pull a vehicle out of mud, sand or other conditions from which the vehicle cannot be driven out under its own power.
- Avoid towing a vehicle heavier than the vehicle doing the towing.
- The drivers of both vehicles should communicate with each other frequently.

- Attach a towing strap to the tow hook.
- Using a portion of the vehicle other than the tow hooks for towing may damage the body of your vehicle.
- Only use a cable or chain specifically intended for use in towing vehicles. Securely fasten the cable or chain to the towing hook provided.
- Before emergency towing, check that the hook is not broken or damaged.
- Fasten the towing cable or chain securely to the hook.
- Do not jerk the hook. Apply it steadily and with even force.
- To avoid damaging the hook, do not pull from the side or at a vertical angle. Always pull straight ahead.

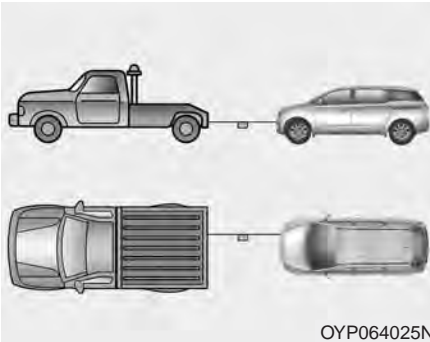

OYP064025N

- Use a towing strap less than 16 feet (5 m) long. Attach a white or red cloth (about 12 inches (30 cm) wide) in the middle of the strap for easy visibility.
- Drive carefully so that the towing strap is not loose during towing.

Emergency towing precautions

- Turn the ignition switch to ACC so the steering wheel isn't locked.
- Place the transaxle shift lever in N (Neutral).
- Release the parking brake.
- Press the brake pedal with more force than usual since you will have reduced brake performance.
- More steering effort will be required because the power steering system will be disabled.
- If you are driving down a long hill, the brakes may overheat and brake performance will be reduced. Stop often and let the brakes cool off.
- If the car is being towed with all four wheels on the ground, it can be towed only from the front. Be sure that the transaxle is in neutral. Be sure the steering is unlocked by placing the ignition switch in the ACC position. A driver must be in the towed vehicle to operate the steering and brakes.

⚠ CAUTION

- **To avoid serious damage to the automatic transaxle, limit the vehicle speed to 10 mph (15 km/h) and drive less than 1 mile (1.5 km) when towing.**
- **Before towing, check the automatic transaxle for fluid leaks under your vehicle. If the automatic transaxle fluid is leaking, a flatbed equipment or towing dolly must be used.**

Maintenance

Engine compartment	7-3	Parking brake	7-39
Maintenance services	7-4	• Checking the parking brake	7-39
• Owner's responsibility	7-4	Air cleaner	7-40
• Owner maintenance precautions	7-5	• Filter replacement	7-40
• NHTSA Safety Corrosion Alert	7-5	Climate control air filter	7-42
Owner maintenance	7-7	• Filter inspection	7-42
• Owner maintenance schedule	7-7	Wiper blades	7-44
Scheduled maintenance service	7-9	• Blade inspection	7-44
Explanation of scheduled maintenance items	7-27	• Blade replacement	7-44
Engine oil	7-32	Battery	7-48
• Checking the engine oil level	7-32	• For best battery service	7-48
• Changing the engine oil and filter	7-33	• Battery recharging	7-49
Engine coolant	7-34	• Recharging Battery	7-50
• Checking the coolant level	7-34	• Reset items	7-50
• Changing the coolant	7-36	Tires and wheels	7-51
Brake fluid	7-37	• Tire care	7-51
• Checking the brake fluid level	7-37	• Recommended cold tire inflation pressures	7-51
Power steering fluid	7-38	• Tire pressure	7-52
• Checking the power steering fluid level	7-38	• Checking tire inflation pressure	7-52
• Checking the power steering hose	7-38	• Tire rotation	7-53
Washer fluid	7-39	• Wheel alignment and tire balance	7-54
• Checking the washer fluid level	7-39	• Tire replacement	7-55
		• Wheel replacement	7-56

- Tire traction 7-56
- Tire maintenance 7-56
- Tire sidewall labeling 7-56
- All season tires 7-63
- Summer tires 7-63
- Snow tires 7-63
- Tire chains 7-63
- Radial-ply tires 7-64
- Low aspect ratio tire 7-65
- Fuses 7-66**
 - Inner panel fuse replacement 7-67
 - Engine compartment fuse replacement 7-68
 - Fuse/relay panel description 7-70
- Light bulbs 7-76**
 - Front light bulb replacement 7-77
 - Side repeater lamp replacement 7-82
 - Rear combination lamp bulb replacement 7-82
 - High mounted stop lamp replacement 7-85
 - License plate light bulb replacement 7-86
 - Interior light bulb replacement 7-87
- Appearance care 7-88**
 - Exterior care 7-88
 - Interior care 7-94
- Emission control system 7-97**
 - Crankcase emission control system 7-97
 - Evaporative emission control (including ORVR:
 - Onboard Refueling Vapor Recovery) system 7-98
 - Exhaust emission control system 7-98
- California perchlorate notice 7-101**

ENGINE COMPARTMENT

■ 3.3L GDI

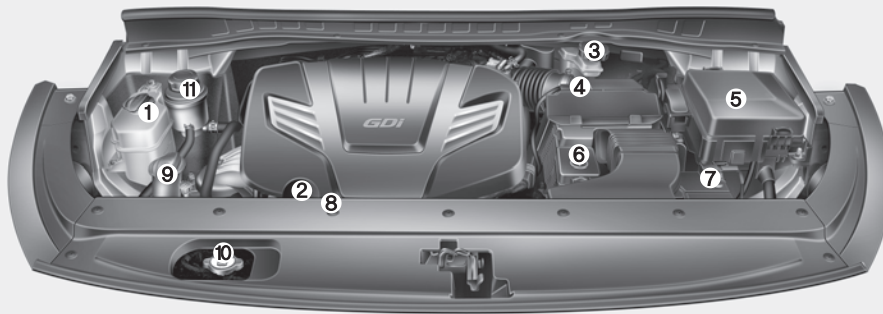

1. Engine coolant reservoir
 2. Engine oil filler cap
 3. Brake fluid reservoir
 4. Air cleaner
 5. Fuse box
 6. Positive battery terminal
 7. Negative battery terminal
 8. Engine oil dipstick
 9. Windshield washer fluid reservoir
 10. Radiator cap
 11. Power steering reservoir*
- * if equipped

* The actual engine compartment in the vehicle may differ from the illustration.

OYP074061N

MAINTENANCE SERVICES

You should exercise the utmost care to prevent damage to your vehicle and injury to yourself whenever performing any maintenance or inspection procedures.

Should you have any doubts concerning the inspection or servicing of your vehicle, we strongly recommend that you have an authorized Kia dealer perform this work.

An authorized Kia dealer has factory trained technicians and genuine Kia parts to service your vehicle properly. For expert advice and quality service, see an authorized Kia dealer.

Inadequate, incomplete or insufficient servicing may result in operational problems with your vehicle that could lead to vehicle damage, an accident, or personal injury.

Owner's responsibility

* NOTICE

Maintenance Service and Record Retention are the owner's responsibility.

You should retain documents that show proper maintenance has been performed on your vehicle in accordance with the scheduled maintenance service charts shown on the following pages. You need this information to establish your compliance with the servicing and maintenance requirements of your vehicle warranties.

Detailed warranty information is provided in your Warranty & Consumer Information manual.

Repairs and adjustments required as a result of improper maintenance or a lack of required maintenance are not covered.

We recommend you have your vehicle maintained and repaired by an authorized Kia dealer. An authorized Kia dealer meets Kia's high service quality standards and receives technical support from Kia in order to provide you with a high level of service satisfaction.

Owner maintenance precautions

Improper or incomplete service may result in problems. This chapter gives instructions only for the maintenance items that are easy to perform.

As explained earlier in this chapter, several procedures can be done only by an authorized Kia dealer with special tools.

* NOTICE

Improper owner maintenance during the warranty period may affect warranty coverage. For details, read the separate **Warranty & Consumer Information** manual provided with the vehicle. If you're unsure about any servicing or maintenance procedure, have it done by an authorized Kia dealer.

WARNING - Maintenance work

Do not wear jewelry or loose clothing while working under the hood of your vehicle with the engine running. These can become entangled in moving parts, if you must run the engine while working under the hood, make certain that you remove all jewelry (especially rings, bracelets, watches, and necklaces) and all neckties, scarves, and similar loose clothing before getting near the engine or cooling fans.

NHTSA Safety Corrosion Alert

The National Highway Traffic Safety Administration (NHTSA) has issued a general warning to all vehicle owners of all brands regarding the risks associated with vehicle underbody corrosion. From your initial purchase, take the following steps to prevent unsafe corrosion damage to your vehicle:

- Wash the undercarriage of your vehicle regularly during the winter and whenever your vehicle has been exposed to such salts or chemicals.
- Do a thorough washing of the undercarriage at the end of the winter.

- Use professional service technicians or governmental inspection stations to annually inspect for corrosion.
- Immediately seek an inspection of your vehicle if you become visually aware of corrosion flaking or scaling or if you become aware of a change in vehicle performance, such as soft or spongy brakes, fluids leaking, impairment of directional control, suspension noises or rattling metal straps.

NHTSA further advises that after a vehicle is 7 years old, it is essential that you take these indicated maintenance steps to ensure that you protect yourself from unsafe corrosion conditions.

OWNER MAINTENANCE

The following lists are vehicle checks and inspections that should be performed by the owner or an authorized Kia dealer at the frequencies indicated to help ensure safe, dependable operation of your vehicle.

Any adverse conditions should be brought to the attention of your dealer as soon as possible.

These Owner Maintenance Checks are generally not covered by warranties and you may be charged for labor, parts and lubricants used.

Owner maintenance schedule

When you stop for fuel:

- Check the engine oil level.
- Check the coolant level in the coolant reservoir.
- Check the windshield washer fluid level.
- Look for low or under-inflated tires.

⚠ WARNING - Hot coolant
Be careful when checking your engine coolant level when the engine is hot. Scalding hot coolant and steam may blow out under pressure.

While operating your vehicle:

- Note any changes in the sound of the exhaust or any smell of exhaust fumes in the vehicle.
- Check for vibrations in the steering wheel. Notice any increased steering effort or looseness in the steering wheel, or change in its straight-ahead position.
- Notice if your vehicle constantly turns slightly or “pulls” to one side when traveling on smooth, level road.
- When stopping, listen and check for unusual sounds, pulling to one side, increased brake pedal travel or “hard-to-push” brake pedal.
- If any slipping or changes in the operation of your transaxle occurs, check the transaxle fluid level.
- Check the automatic transaxle P (Park) function.
- Check the parking brake.
- Check for fluid leaks under your vehicle (water dripping from the air conditioning system during or after use is normal).

At least monthly:

- Check the coolant level in the engine coolant reservoir.
- Check the operation of all exterior lights, including the stoplights, turn signals and hazard warning flashers.
- Check the inflation pressures of all tires including the spare.

At least twice a year (i.e., every Spring and Fall):

- Check the radiator, heater and air conditioning hoses for leaks or damage.
- Check the windshield washer spray and wiper operation. Clean the wiper blades with clean cloth dampened with washer fluid.
- Check the headlight alignment.
- Check the muffler, exhaust pipes, shields and clamps.
- Check the lap/shoulder belts for wear and function.
- Check for worn tires and loose wheel lug nuts.

At least once a year:

- Clean the body and door drain holes.
- Lubricate the door hinges and checks, and hood hinges.
- Lubricate the door and hood locks and latches.
- Lubricate the door rubber weatherstrips.
- Check the air conditioning system.
- Inspect and lubricate the automatic transaxle linkage and controls.
- Clean the battery and terminals.
- Check the brake fluid level.

SCHEDULED MAINTENANCE SERVICE

Follow the Normal Maintenance Schedule if the vehicle is usually operated where none of the following conditions apply. If any of the following conditions apply, follow the Maintenance Under Severe Usage Conditions.

- Repeated driving short distance of less than 5 miles (8 km) in normal temperature or less than 10 miles (16 km) in freezing temperature
- Extensive engine idling or low speed driving for long distances
- Driving on rough, dusty, muddy, unpaved, graveled or salt-spread roads
- Driving in areas using salt or other corrosive materials or in very cold weather
- Driving in heavy dust condition
- Driving in heavy traffic area
- Driving on uphill, downhill, or mountain road repeatedly
- Towing a trailer or using a camper, or roof rack
- Driving as a patrol car, taxi, other commercial use of vehicle towing
- Driving over 106 mph (170 km/h)
- Frequently driving in stop-and-go condition

If your vehicle is operated under the above conditions, you should inspect, replace or refill more frequently than the following Normal Maintenance Schedule. After 120 months or 150,000 miles continue to follow the prescribed maintenance intervals.

NORMAL MAINTENANCE SCHEDULE

The following maintenance services must be performed to ensure good emission control and performance. Keep receipts for all vehicle emission services to protect your warranty. Where both mileage and time are shown, the frequency of service is determined by whichever occurs first.

- *1 : If TOP TIER Detergent Gasoline is not available, one bottle of additive is recommended. Additives are available from your authorized Kia dealer along with information on how to use them. Do not mix other additives.
- *2 : Fuel tank air filter is considered to be maintenance free but periodic inspection is recommended for this maintenance schedule depends on fuel quality.
- *3 : The drive belt should be replaced when cracks occur or tension is reduced excessively.
- *4 : Inspect for excessive tappet noise and/or engine vibration and adjust if necessary.

NORMAL MAINTENANCE SCHEDULE

7,500 miles (12,000 km) or 6 months

- Rotate tire
- Inspect battery condition
- Inspect air cleaner filter
- Inspect vacuum hose
- Inspect power steering fluid (if equipped)
- Inspect power steering pump, belt and hoses (if equipped)
- Replace engine oil and filter
(Every 7,500 miles (12,000 km) or 12 months)
- Add fuel additive *¹
(Every 7,500 miles (12,000 km) or 12 months)

* Inspect : Inspect and if necessary, adjust, correct, clean or replace.

15,000 miles (24,000 km) or 12 months

- Rotate tire
- Inspect battery condition
- Inspect air cleaner filter
- Inspect vacuum hose
- Inspect air conditioning refrigerant
- Inspect brake hoses and lines
- Inspect drive shafts and boots
- Inspect exhaust pipe and muffler
- Inspect front brake disc/pads, calipers
- Inspect rear brake disc/pads
- Inspect steering gear box, linkage & boots/lower arm ball joint, upper arm ball joint
- Inspect suspension mounting bolts
- Inspect power steering fluid (if equipped)
- Inspect power steering pump, belt and hoses (if equipped)
- Replace climate control air filter
(for evaporator and blower unit)
- Replace engine oil and filter
(Every 7,500 miles (12,000 km) or 12 months)
- Add fuel additive *¹
(Every 7,500 miles (12,000 km) or 12 months)

* Inspect : Inspect and if necessary, adjust, correct, clean or replace.

NORMAL MAINTENANCE SCHEDULE

22,500 miles (36,000 km) or 18 months

- Rotate tire
- Inspect battery condition
- Inspect air cleaner filter
- Inspect vacuum hose
- Inspect power steering fluid (if equipped)
- Inspect power steering pump, belt and hoses (if equipped)
- Replace engine oil and filter
(Every 7,500 miles (12,000 km) or 12 months)
- Add fuel additive *¹
(Every 7,500 miles (12,000 km) or 12 months)

* Inspect : Inspect and if necessary, adjust, correct, clean or replace.

30,000 miles (48,000 km) or 24 months

- Rotate tire
- Inspect battery condition
- Inspect vacuum hose
- Inspect air conditioning refrigerant
- Inspect brake hoses and lines
- Inspect drive shafts and boots
- Inspect exhaust system
- Inspect front brake disc/pads, calipers
- Inspect rear brake disc/pads
- Inspect steering gear box, linkage & boots/lower arm ball joint, upper arm ball joint
- Inspect suspension mounting bolts
- Inspect brake fluid
- Inspect fuel lines, fuel hoses and connections
- Inspect fuel tank air filter *²
- Inspect parking brake
- Inspect vapor hose and fuel filler cap
- Inspect power steering fluid (if equipped)
- Inspect power steering pump, belt and hoses (if equipped)
- Replace climate control air filter
(for evaporator and blower unit)

(Continued)

NORMAL MAINTENANCE SCHEDULE

(Continued)

- Replace air cleaner filter
- Replace engine oil and filter
(Every 7,500 miles (12,000 km) or 12 months)
- Add fuel additive *¹
(Every 7,500 miles (12,000 km) or 12 months)

* Inspect : Inspect and if necessary, adjust, correct, clean or replace.

37,500 miles (60,000 km) or 30 months

- Rotate tire
- Inspect battery condition
- Inspect air cleaner filter
- Inspect vacuum hose
- Inspect power steering fluid (if equipped)
- Inspect power steering pump, belt and hoses(if equipped)
- Replace engine oil and filter
(Every 7,500 miles (12,000 km) or 12 months)
- Add fuel additive *¹
(Every 7,500 miles (12,000 km) or 12 months)

* Inspect : Inspect and if necessary, adjust, correct, clean or replace.

NORMAL MAINTENANCE SCHEDULE

45,000 miles (72,000 km) or 36 months

- Rotate tire
- Inspect battery condition
- Inspect air cleaner filter
- Inspect vacuum hose
- Inspect air conditioning refrigerant
- Inspect brake hoses and lines
- Inspect drive shafts and boots
- Inspect exhaust system
- Inspect front brake disc/pads, calipers
- Inspect rear brake disc/pads
- Inspect steering gear box, linkage & boots/lower arm ball joint, upper arm ball joint
- Inspect suspension mounting bolts
- Inspect power steering fluid (if equipped)
- Inspect power steering pump, belt and hoses (if equipped)
- Replace climate control air filter (for evaporator and blower unit)
- Replace engine oil and filter (Every 7,500 miles (12,000 km) or 12 months)
- Add fuel additive *¹ (Every 7,500 miles (12,000 km) or 12 months)

* Inspect : Inspect and if necessary, adjust, correct, clean or replace.

52,500 miles (84,000 km) or 42 months

- Rotate tire
- Inspect battery condition
- Inspect air cleaner filter
- Inspect vacuum hose
- Inspect power steering fluid (if equipped)
- Inspect power steering pump, belt and hoses (if equipped)
- Replace engine oil and filter (Every 7,500 miles (12,000 km) or 12 months)
- Add fuel additive *¹ (Every 7,500 miles (12,000 km) or 12 months)

* Inspect : Inspect and if necessary, adjust, correct, clean or replace.

NORMAL MAINTENANCE SCHEDULE

60,000 miles (96,000 km) or 48 months

- Rotate tire
- Inspect battery condition
- Inspect vacuum hose
- Inspect air conditioning refrigerant
- Inspect brake hoses and lines
- Inspect drive shafts and boots
- Inspect exhaust system
- Inspect front brake disc/pads, calipers
 - Inspect rear brake disc/pads
- Inspect steering gear box, linkage & boots/lower arm ball joint, upper arm ball joint
- Inspect suspension mounting bolts
- Inspect brake fluid
- Inspect fuel lines, fuel hoses and connections
- Inspect fuel tank air filter *2
- Inspect parking brake
- Inspect valve clearance *3
- Inspect vapor hose and fuel filler cap
- Inspect drive belts *3

(First, 60,000 miles (96,000 km) or 72 months after that, every 15,000 miles (24,000 km) or 24 months)
- Inspect power steering fluid (if equipped)

(Continued)

(Continued)

- Inspect power steering pump, belt and hoses (if equipped)
- Replace climate control air filter
(for evaporator and blower unit)
- Replace air cleaner filter
- Replace engine oil and filter
(Every 7,500 miles (12,000 km) or 12 months)
- Add fuel additive *1
(Every 7,500 miles (12,000 km) or 12 months)

* Inspect : Inspect and if necessary, adjust, correct, clean or replace.

NORMAL MAINTENANCE SCHEDULE

67,500 miles (108,000 km) or 54 months

- Rotate tire
- Inspect battery condition
- Inspect air cleaner filter
- Inspect vacuum hose
- Inspect power steering fluid (if equipped)
- Inspect power steering pump, belt and hoses (if equipped)
- Replace engine oil and filter
(Every 7,500 miles (12,000 km) or 12 months)
- Add fuel additive *1
(Every 7,500 miles (12,000 km) or 12 months)

* Inspect : Inspect and if necessary, adjust, correct, clean or replace.

75,000 miles (120,000 km) or 60 months

- Rotate tire
- Inspect battery condition
- Inspect air cleaner filter
- Inspect vacuum hose
- Inspect air conditioning refrigerant
- Inspect brake hoses and lines
- Inspect drive shafts and boots
- Inspect exhaust system
- Inspect front brake disc/pads, calipers
 - Inspect rear brake disc/pads
- Inspect steering gear box, linkage & boots/lower arm ball joint, upper arm ball joint
- Inspect suspension mounting bolts
- Inspect drive belts *3
(First, 60,000 miles (96,000 km) or 72 months after that, every 15,000 miles (24,000 km) or 24 months)
- Inspect power steering fluid (if equipped)
- Inspect power steering pump, belt and hoses (if equipped)
- Replace climate control air filter
(for evaporator and blower unit)
- Replace engine oil and filter
(Every 7,500 miles (12,000 km) or 12 months)

(Continued)

NORMAL MAINTENANCE SCHEDULE

(Continued)

- Add fuel additive *¹

(Every 7,500 miles (12,000 km) or 12 months)

※ Inspect : Inspect and if necessary, adjust, correct, clean or replace.

82,500 miles (132,000 km) or 66 months

- Rotate tire
- Inspect battery condition
- Inspect air cleaner filter
- Inspect vacuum hose
- Inspect power steering fluid (if equipped)
- Inspect power steering pump, belt and hoses (if equipped)
- Replace engine oil and filter
(Every 7,500 miles (12,000 km) or 12 months)
- Add fuel additive *¹
(Every 7,500 miles (12,000 km) or 12 months)

※ Inspect : Inspect and if necessary, adjust, correct, clean or replace.

NORMAL MAINTENANCE SCHEDULE

90,000 miles (144,000 km) or 72 months

- Rotate tire
- Inspect battery condition
- Inspect vacuum hose
- Inspect air conditioning refrigerant
- Inspect brake hoses and lines
- Inspect drive shafts and boots
- Inspect exhaust system
- Inspect front brake disc/pads, calipers
- Inspect rear brake disc/pads
- Inspect steering gear box, linkage & boots/lower arm ball joint, upper arm ball joint
- Inspect suspension mounting bolts
- Inspect brake fluid
- Inspect fuel lines, fuel hoses and connections
- Inspect fuel tank air filter *²
- Inspect parking brake
- Inspect vapor hose and fuel filler cap
- Inspect drive belts *³
(First, 60,000 miles (96,000 km) or 72 months after that,
every 15,000 miles (24,000 km) or 24 months)
- Inspect power steering fluid (if equipped)

(Continued)

(Continued)

- Inspect power steering pump, belt and hoses (if equipped)
- Replace climate control air filter
(for evaporator and blower unit)
- Replace air cleaner filter
- Replace engine oil and filter
(Every 7,500 miles (12,000 km) or 12 months)
- Add fuel additive *¹
(Every 7,500 miles (12,000 km) or 12 months)

* Inspect : Inspect and if necessary, adjust, correct, clean or replace.

NORMAL MAINTENANCE SCHEDULE

97,500 miles (156,000 km) or 78 months

- Rotate tire
- Inspect battery condition
- Inspect air cleaner filter
- Inspect vacuum hose
- Inspect power steering fluid (if equipped)
- Inspect power steering pump, belt and hoses (if equipped)
- Replace spark plugs (iridium coated)
- Replace engine oil and filter
(Every 7,500 miles (12,000 km) or 12 months)
- Add fuel additive *¹
(Every 7,500 miles (12,000 km) or 12 months)

* Inspect : Inspect and if necessary, adjust, correct, clean or replace.

105,000 miles (168,000 km) or 84 months

- Rotate tire
- Inspect battery condition
- Inspect air cleaner filter
- Inspect vacuum hose
- Inspect air conditioning refrigerant
- Inspect brake hoses and lines
- Inspect drive shafts and boots
- Inspect exhaust system
- Inspect front brake disc/pads, calipers
- Inspect rear brake disc/pads
- Inspect steering gear box, linkage & boots/lower arm ball joint, upper arm ball joint
- Inspect suspension mounting bolts
- Inspect drive belts *³
(First, 60,000 miles (96,000 km) or 72 months after that, every 15,000 miles (24,000 km) or 24 months)
- Inspect power steering fluid (if equipped)
- Inspect power steering pump, belt and hoses (if equipped)
- Replace climate control air filter
(for evaporator and blower unit)

(Continued)

NORMAL MAINTENANCE SCHEDULE

(Continued)

- Replace engine oil and filter
(Every 7,500 miles (12,000 km) or 12 months)
- Add fuel additive *¹
(Every 7,500 miles (12,000 km) or 12 months)

* Inspect : Inspect and if necessary, adjust, correct, clean or replace.

112,500 miles (180,000 km) or 90 months

- Rotate tire
- Inspect battery condition
- Inspect air cleaner filter
- Inspect vacuum hose
- Inspect power steering fluid (if equipped)
- Inspect power steering pump, belt and hoses (if equipped)
- Replace engine oil and filter
(Every 7,500 miles (12,000 km) or 12 months)
- Add fuel additive *¹
(Every 7,500 miles (12,000 km) or 12 months)

* Inspect : Inspect and if necessary, adjust, correct, clean or replace.

NORMAL MAINTENANCE SCHEDULE

120,000 miles (192,000 km) or 96 months

- Rotate tire
- Inspect battery condition
- Inspect vacuum hose
- Inspect air conditioning refrigerant
- Inspect brake hoses and lines
- Inspect drive shafts and boots
- Inspect exhaust system
- Inspect front brake disc/pads, calipers
 - Inspect rear brake disc/pads
- Inspect steering gear box, linkage & boots/lower arm ball joint, upper arm ball joint
- Inspect suspension mounting bolts
- Inspect brake fluid
- Inspect fuel lines, fuel hoses and connections
- Inspect fuel tank air filter *2
- Inspect parking brake
- Inspect valve clearance *3
- Inspect vapor hose and fuel filler cap
- Inspect drive belts *3
 - (First, 60,000 miles (96,000 km) or 72 months after that, every 15,000 miles (24,000 km) or 24 months)
- Inspect power steering fluid (if equipped)

(Continued)

(Continued)

- Inspect power steering pump, belt and hoses (if equipped)
- Replace climate control air filter
 - (for evaporator and blower unit)
- Replace air cleaner filter
- Replace engine oil and filter
 - (Every 7,500 miles (12,000 km) or 12 months)
- Replace coolant
 - (First, 120,000 miles (192,000 km) or 120 months after that, every 30,000 miles (48,000 km) or 24 months)
- Add fuel additive *1
 - (Every 7,500 miles (12,000 km) or 12 months)

* Inspect : Inspect and if necessary, adjust, correct, clean or replace.

NORMAL MAINTENANCE SCHEDULE

127,500 miles (204,000 km) or 102 months

- Rotate tire
- Inspect battery condition
- Inspect air cleaner filter
- Inspect vacuum hose
- Inspect power steering fluid (if equipped)
- Inspect power steering pump, belt and hoses (if equipped)
- Replace engine oil and filter
(Every 7,500 miles (12,000 km) or 12 months)
- Add fuel additive *¹
(Every 7,500 miles (12,000 km) or 12 months)

* Inspect : Inspect and if necessary, adjust, correct, clean or replace.

135,000 miles (216,000 km) or 108 months

- Rotate tire
- Inspect battery condition
- Inspect air cleaner filter
- Inspect vacuum hose
- Inspect air conditioning refrigerant
- Inspect brake hoses and lines
- Inspect drive shafts and boots
- Inspect exhaust system
- Inspect front brake disc/pads, calipers
 - Inspect rear brake disc/pads
- Inspect steering gear box, linkage & boots/lower arm ball joint, upper arm ball joint
- Inspect suspension mounting bolts
- Inspect drive belts *³
(First, 60,000 miles (96,000 km) or 72 months after that, every 15,000 miles (24,000 km) or 24 months)
- Inspect power steering fluid (if equipped)
- Inspect power steering pump, belt and hoses (if equipped)
- Replace climate control air filter
(for evaporator and blower unit)
- Replace engine oil and filter
(Every 7,500 miles (12,000 km) or 12 months)

(Continued)

NORMAL MAINTENANCE SCHEDULE

(Continued)

- Add fuel additive *1

(Every 7,500 miles (12,000 km) or 12 months)

* Inspect : Inspect and if necessary, adjust, correct, clean or replace.

142,500 miles (228,000 km) or 114 months

- Rotate tire
- Inspect battery condition
- Inspect air cleaner filter
- Inspect vacuum hose
- Inspect power steering fluid (if equipped)
- Inspect power steering pump, belt and hoses (if equipped)
- Replace engine oil and filter
(Every 7,500 miles (12,000 km) or 12 months)
- Add fuel additive *1
(Every 7,500 miles (12,000 km) or 12 months)

* Inspect : Inspect and if necessary, adjust, correct, clean or replace.

NORMAL MAINTENANCE SCHEDULE

150,000 miles (240,000 km) or 120 months

- Rotate tire
- Inspect battery condition
- Inspect vacuum hose
- Inspect air conditioning refrigerant
- Inspect brake hoses and lines
- Inspect drive shafts and boots
- Inspect exhaust system
- Inspect front brake disc/pads, calipers
 - Inspect rear brake disc/pads
- Inspect steering gear box, linkage & boots/lower arm ball joint, upper arm ball joint
- Inspect suspension mounting bolts
- Inspect brake fluid
- Inspect fuel lines, fuel hoses and connections
- Inspect fuel tank air filter *²
- Inspect parking brake
- Inspect vapor hose and fuel filler cap
- Inspect drive belts *³
(First, 60,000 miles (96,000 km) or 72 months after that, every 15,000 miles (24,000 km) or 24 months)

(Continued)

(Continued)

- Inspect power steering fluid (if equipped)
- Inspect power steering pump, belt and hoses (if equipped)
- Replace climate control air filter
(for evaporator and blower unit)
- Replace air cleaner filter
- Replace engine oil and filter
(Every 7,500 miles (12,000 km) or 12 months)
- Replace coolant
(First, 120,000 miles (192,000 km) or 120 months after that, every 30,000 miles (48,000 km) or 24 months)
- Add fuel additive *¹
(Every 7,500 miles (12,000 km) or 12 months)

※ Inspect : Inspect and if necessary, adjust, correct, clean or replace.

No check, No service required

- Automatic transaxle fluid

MAINTENANCE UNDER SEVERE USAGE CONDITIONS

The following items must be serviced more frequently on cars normally used under severe driving conditions. Refer to the chart below for the appropriate maintenance intervals.

R : Replace I : Inspect and, after inspection, clean, adjust, repair or replace if necessary

MAINTENANCE ITEM	MAINTENANCE OPERATION	MAINTENANCE INTERVALS	DRIVING CONDITION
ENGINE OIL AND FILTER	R	EVERY 3,750 MILES (6,000 KM) OR 6 MONTHS	A, B, C, D, E, F, G, H, I, J, K
AIR CLEANER FILTER	R	MORE FREQUENTLY	C, E
SPARK PLUGS	R	MORE FREQUENTLY	A, B, H, I, K
AUTOMATIC TRANSAXLE FLUID	R	EVERY 60,000 MILES (96,000 KM)	A, C, E, F, G, I
FRONT BRAKE DISC/PADS AND CALIPERS	I	MORE FREQUENTLY	C, D, G, H

MAINTENANCE ITEM	MAINTENANCE OPERATION	MAINTENANCE INTERVALS	DRIVING CONDITION
REAR BRAKE DISC/PADS	I	MORE FREQUENTLY	C, D, G, F
PARKING BRAKE	I	MORE FREQUENTLY	C, D, G, H
STEERING GEAR BOX, LINKAGE & BOOTS/LOWER ARM BALL JOINT AND UPPER ARM BALL JOINT	I	MORE FREQUENTLY	C, D, E, F, G, H, I
DRIVE SHAFTS AND BOOTS	I	EVERY 7,500 MILES (12,000 KM) OR 6 MONTHS	C, D, E, F, G, H, I
CLIMATE CONTROL AIR FILTER (FOR EVAPORATOR AND BLOWER UNIT)	R	MORE FREQUENTLY	C, E

SEVERE DRIVING CONDITIONS

- A - Repeatedly driving short distance of less than 5 miles (8 km) in normal temperature or less than 10 miles (16 km) in freezing temperature
- B - Extensive engine idling or low speed driving for long distances
- C - Driving on rough, dusty, muddy, unpaved, graveled or salt- spread roads
- D - Driving in areas using salt or other corrosive materials or in very cold weather

- E - Driving in heavy dust condition
- F - Driving in heavy traffic area
- G - Driving on uphill, downhill, or mountain road
- H - Towing a Trailer, or using a camper, or roof rack
- I - Driving as a patrol car, taxi, other commercial use or vehicle towing
- J - Driving over 106 mph (170 km/h)
- K - Frequently driving in stop-and-go conditions

EXPLANATION OF SCHEDULED MAINTENANCE ITEMS

Engine oil and filter

The engine oil and filter should be changed at the intervals specified in the maintenance schedule. If the car is being driven in severe conditions, more frequent oil and filter changes are required.

Drive belts

Inspect all drive belts for evidence of cuts, cracks, excessive wear or oil saturation and replace if necessary.

Fuel filter (cartridge)

A clogged filter can limit the speed at which the vehicle may be driven, damage the emission system and cause multiple issues such as hard starting. If an excessive amount of foreign matter accumulates in the fuel tank, the filter may require replacement more frequently.

After installing a new filter, run the engine for several minutes, and check for leaks at the connections. Fuel filters should be installed by an authorized Kia dealer.

Fuel filter (for gasoline)

Kia gasoline vehicle is equipped a lifetime fuel filter that integrated with the fuel tank. Regular maintenance or replacement is not needed but depends on fuel quality. If there are some important safety matters like fuel flow restriction, surging, loss of power, hard starting problem etc, fuel filter inspection or replace is needed.

The fuel filter be Inspected or replaced by an authorized Kia dealer.

Fuel lines, fuel hoses and connections

Check the fuel lines, fuel hoses and connections for leakage and damage. Have an authorized Kia dealer replace any damaged or leaking parts immediately.

Vapor hose and fuel filler cap

The vapor hose and fuel filler cap should be inspected at those intervals specified in the maintenance schedule. Make sure that a new vapor hose or fuel filler cap is correctly replaced.

Vacuum crankcase ventilation hoses

Inspect the surface of hoses for evidence of heat and/or mechanical damage. Hard and brittle rubber, cracking, tears, cuts, abrasions, and excessive swelling indicate deterioration. Particular attention should be paid to examine those hose surfaces nearest to high heat sources, such as the exhaust manifold.

Inspect the hose routing to assure that the hoses do not come in contact with any heat source, sharp edges or moving component which might cause heat damage or mechanical wear. Inspect all hose connections, such as clamps and couplings, to make sure they are secure, and that no leaks are present. Hoses should be replaced immediately if there is any evidence of deterioration or damage.

Air cleaner filter

A Genuine Kia air cleaner filter is recommended when the filter is replaced.

Spark plugs

Make sure to install new spark plugs of the correct heat range.

Valve clearance

Inspect excessive valve noise and/or engine vibration and adjust if necessary. An authorized Kia dealer should perform the operation.

Cooling system

Check cooling system components, such as radiator, coolant reservoir, hoses and connections for leakage and damage. Replace any damaged parts.

Coolant

The coolant should be changed at the intervals specified in the maintenance schedule.

Automatic transaxle fluid

Automatic transaxle fluid does not need to be checked under normal usage conditions.

But in severe conditions, the fluid should be changed at an authorized Kia dealer in accordance to the scheduled maintenance at the beginning of this chapter.

* NOTICE

Automatic transaxle fluid color is basically red.

As the vehicle is driven, the automatic transaxle fluid will begin to look darker.

This a normal condition and you should not judge the need to replace the fluid based upon the changed color.

The use of a non-specified fluid could result in transaxle malfunction and failure.

Use only specified automatic transaxle fluid. (Refer to "Recommended lubricants and capacities" in chapter 8.)



CAUTION

Use only specified automatic transaxle fluid. The use of a non-specified fluid could result in a transaxle malfunction and failure. (Refer to "Recommended lubricants and capacities" in section 8.)

Brake hoses and lines

Visually check for proper installation, chafing, cracks, deterioration and any leakage. Replace any deteriorated or damaged parts immediately.

* NOTICE - NHTSA Safety Corrosion Alert

NHTSA has warned all vehicle owners of all brands that they must maintain their vehicles in a manner which will prevent brake hose and brake line failures due to corrosion when such vehicles are exposed to winter road salt and related chemicals. While serious corrosion conditions typically only manifest themselves as safety issues after 7 years of vehicle use, the corrosion process starts immediately and thus underbody cleaning maintenance must commence from your vehicle's first exposure to road salts and chemicals. NHTSA urges vehicle owners to take the following steps to prevent corrosion:

(Continued)

(Continued)

1. Wash the undercarriage of your vehicle regularly throughout the winter and do a thorough washing in the spring to remove road salt and other de-icing chemicals.
2. Monitor the brake system for signs of corrosion by having regular professional inspections and watching for signs of problems, including loss of brake fluid, unusual leaks and soft or spongy feel in the brake pedal.
3. Replace the entire brake pipe assembly if you find severe corrosion that causes scaling or flaking of brake components.

Brake fluid

Check brake fluid level in the brake fluid reservoir. The level should be between “MIN” and “MAX” marks on the side of the reservoir. Use only hydraulic brake fluid conforming to DOT 3 or DOT 4 specification.

Parking brake

Inspect the parking brake system including the parking brake pedal or lever and cables.

Brake discs, pads, calipers and rotors

Check the pads for excessive wear, discs for run out and wear, and calipers for fluid leakage.

Suspension mounting bolts

Check the suspension connections for looseness or damage. Retighten to the specified torque.

Steering gear box, linkage & boots/lower arm ball joint

With the vehicle stopped and engine off, check for excessive free-play in the steering wheel.

Check the linkage for bends or damage. Check the dust boots and ball joints for deterioration, cracks, or damage. Replace any damaged parts.

Exhaust system

Visually inspect the exhaust pipes, muffler and hangers for cracks, deterioration, or damage. Start the engine and listen carefully for any exhaust gas leakage. Tighten connections or replace parts as necessary.

Drive shafts and boots

Check the drive shafts, boots and clamps for cracks, deterioration, or damage. Replace any damaged parts and, if necessary, repack the grease.

Air conditioning refrigerant

Check the air conditioning lines and connections for leakage and damage.

Power steering pump, belt and hoses (if equipped)

Check the power steering pump and hoses for leakage and damage. Replace any damaged or leaking parts immediately. Inspect the power steering belt (or drive belt) for evidence of cuts, cracks, excessive wear, oiliness and proper tension. Replace or adjust it if necessary.

ENGINE OIL

Checking the engine oil level

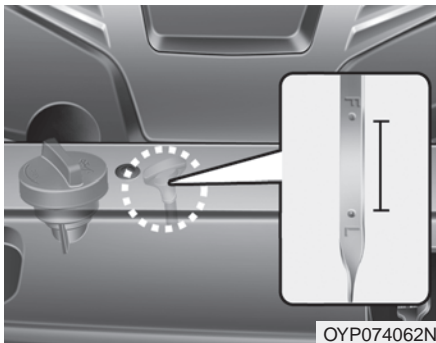

1. Be sure the vehicle is on level ground.
2. Start the engine and allow it to reach normal operating temperature.
3. Turn the engine off and wait for a few minutes (about 5 minutes) for the oil to return to the oil pan.
4. Pull the dipstick out, wipe it clean, and re-insert it fully.

⚠ WARNING - Radiator hose

Be very careful not to touch the radiator hose when checking or adding the engine oil as it may be hot enough to burn you.

5. Pull the dipstick out again and check the level. The level should be between F and L.

⚠ CAUTION - Replacing engine oil

Do not overfill the engine oil. It may damage the engine.



If it is near or at L, add enough oil to bring the level to F. **Do not overfill.**

Use a funnel to help prevent oil from being spilled on engine components.

Use only the specified engine oil. (Refer to "Recommended lubricants and capacities" in chapter 8.)

Changing the engine oil and filter

Have engine oil and filter changed by an authorized Kia dealer according to the Maintenance Schedule at the beginning of this chapter.

⚠ WARNING - California proposition 65

Engine oil contains chemicals known to the State of California to cause cancer, birth defects and reproductive harm. Used engine oil may cause irritation or cancer of the skin if left in contact with the skin for prolonged periods of time. Always protect your skin by washing your hands thoroughly with soap and warm water as soon as possible after handling used oil.

ENGINE COOLANT

The high-pressure cooling system has a reservoir filled with year round antifreeze coolant. The reservoir is filled at the factory.

Check the antifreeze protection and coolant level at least once a year, at the beginning of the winter season, and before traveling to a colder climate.

CAUTION - Radiator cap

Never attempt to remove the radiator cap while the engine is operating or hot. Doing so might lead to cooling system and engine damage.

Checking the coolant level

WARNING



Removing radiator cap

Never attempt to remove the radiator cap while the engine is operating or hot. Doing so could result in serious personal injury from escaping hot coolant or steam.

- Turn the engine off and wait until it cools down. Use extreme care when removing the radiator cap. Wrap a thick towel around it, and turn it counterclockwise slowly to the first stop. Step back while the pressure is released from the cooling system.

When you are sure all the pressure has been released, press down on the cap, using a thick towel, and continue turning counterclockwise to remove it.

- Even if the engine is not operating, do not remove the radiator cap or the drain plug while the engine and radiator are hot. Hot coolant and steam may still blow out under pressure, causing serious injury.

⚠ WARNING - Cooling fan

Use caution when working near the blade of the cooling fan. The electric motor (cooling fan) is controlled by engine coolant temperature, refrigerant pressure and vehicle speed. It may sometimes operate even when the engine is not running.

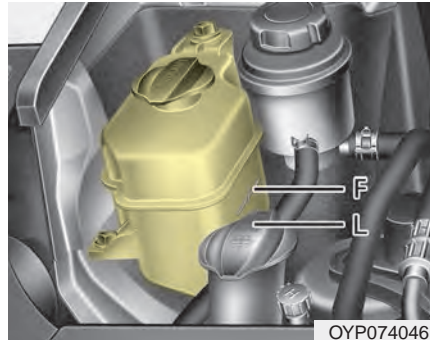

OYP074046K

Check the condition and connections of all cooling system hoses and heater hoses. Replace any swollen or deteriorated hoses.

The coolant level should be filled between F and L marks on the side of the coolant reservoir when the engine is cool.

If the coolant level is low, add enough specified coolant to provide protection against freezing and corrosion. Bring the level to F, but do not overfill. If frequent additions are required, see an authorized Kia dealer for a cooling system inspection.

Recommended engine coolant

- When adding coolant, use only deionized water or soft water for your vehicle and never mix hard water in the coolant filled at the factory. An improper coolant mixture can result in serious malfunction or engine damage.
- The engine in your vehicle has aluminum engine parts and must be protected by an ethylene-glycol-based coolant to prevent corrosion and freezing.
- **DO NOT USE** alcohol or methanol coolant or mix them with the specified coolant.
- Do not use a solution that contains more than 60% antifreeze or less than 35% antifreeze, which would reduce the effectiveness of the solution.

For mixture percentage, refer to the following table.

Ambient Temperature	Mixture Percentage (volume)	
	Antifreeze	Water
5°F (-15°C)	35	65
-13°F (-25°C)	40	60
-31°F (-35°C)	50	50
-49°F (-45°C)	60	40



Changing the coolant

Have the coolant changed by an authorized Kia dealer according to the Maintenance Schedule at the beginning of this chapter.

Put a thick cloth around the radiator cap before refilling the coolant in order to prevent the coolant from overflowing into engine parts such as the alternator.

WARNING Radiator cap



Do not remove the radiator cap when the engine and radiator are hot. Scalding hot coolant and steam may blow out under pressure which may result in serious injury.

BRAKE FLUID

Checking the brake fluid level

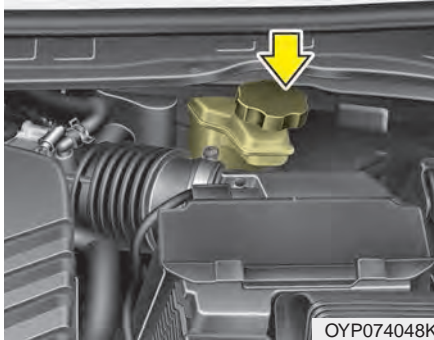

Check the fluid level in the reservoir periodically. The fluid level should be between MAX (Maximum) and MIN (Minimum) marks on the side of the reservoir.

Before removing the reservoir cap and adding brake fluid, clean the area around the reservoir cap thoroughly to prevent brake fluid contamination.



CAUTION - Proper fluid

Only use brake fluid in brake system. Small amounts of improper fluids (such as engine oil) can cause damage to the brake system.

If the level is low, add fluid to the MAX (Maximum) level. The level will fall with accumulated mileage. This is a normal condition associated with the wear of brake linings. If the fluid level is excessively low, have the brake system checked by an authorized Kia dealer.

Use only the specified brake fluid. (Refer to "Recommended lubricants or capacities" in chapter 8.)

Never mix different types of fluid.

In the event the brake system requires frequent additions of fluid, the vehicle should be inspected by an authorized Kia dealer.

When changing and adding brake fluid, handle it carefully. Do not let it come in contact with your eyes. If brake fluid should come in contact with your eyes, immediately flush them with a large quantity of fresh tap water. Have your eyes examined by a doctor as soon as possible.



CAUTION - Brake fluid

Do not allow brake fluid to contact the vehicle's body paint, as paint damage will result.

Brake fluid, which has been exposed to open air for an extended time should never be used as its quality cannot be guaranteed. It should be disposed of properly.

POWER STEERING FLUID (IF EQUIPPED)

Checking the power steering fluid level

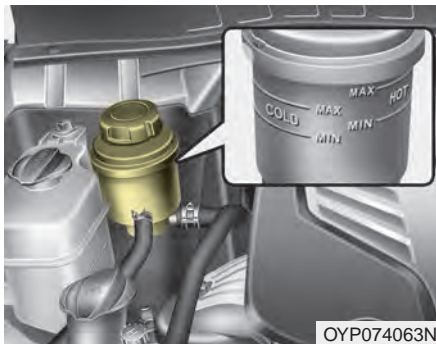

With the vehicle on level ground, check the fluid level in the power steering reservoir periodically. The fluid should be between MAX and MIN marks on the side of the reservoir at the normal temperature.

Before adding power steering fluid, thoroughly clean the area around the reservoir cap to prevent power steering fluid contamination.

If the level is low, add fluid to the MAX level.

In the event the power steering system requires frequent addition of fluid, the vehicle should be inspected by an authorized Kia dealer.

- To avoid damage to the power steering pump, do not operate the vehicle for prolonged periods with a low power steering fluid level.
- Never start the engine when the reservoir tank is empty.
- When adding fluid, be careful that dirt does not get into the tank.
- Too little fluid can result in increased steering effort and/or noise from the power steering system.
- The use of the non-specified fluid could reduce the effectiveness of the power steering system and cause damage to it.

Use only the specified power steering fluid. (Refer to "Recommended lubricants or capacities" in chapter 8.)

Checking the power steering hose

Check the connections for oil leaks, damage and twists in the power steering hose before driving.

WASHER FLUID

Checking the washer fluid level

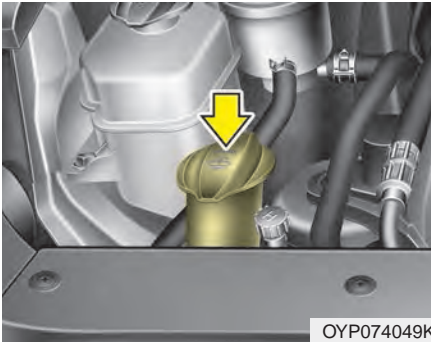

OYP074049K

The reservoir is translucent so that you can check the level with a quick visual inspection.

Check the fluid level in the washer fluid reservoir and add fluid if necessary. Plain water may be used if washer fluid is not available. However, use washer solvent with antifreeze characteristics in cold climates to prevent freezing.

⚠ WARNING - Flammable Fluid

Do not allow the washer fluid to come in contact with open flames or sparks. The windshield washer fluid reservoir is flammable under certain circumstances. This can result in a fire.

⚠ WARNING - Windshield fluid

Do not drink the windshield washer fluid. The windshield washer fluid is poisonous to humans and animals.

PARKING BRAKE

Checking the parking brake

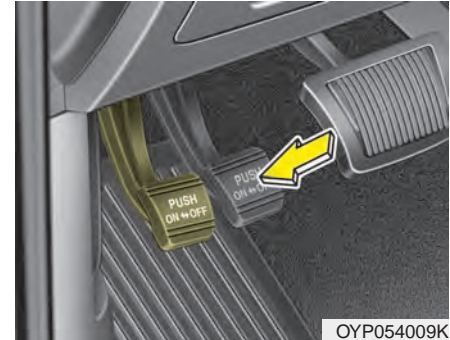

OYP054009K

Check whether the stroke is within specification when the parking brake pedal is depressed with 66 lb, 294 N (30 kg) of force. Also, the parking brake alone should securely hold the vehicle on a fairly steep grade. If the stroke is more or less than specified, have the parking brake adjusted by an authorized Kia dealer.

Stroke : 8~9 notch

AIR CLEANER

Filter replacement

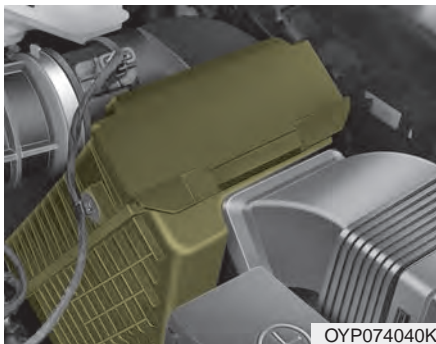

It must be replaced when necessary, and should not be washed.

You can clean the filter when inspecting the air cleaner element.

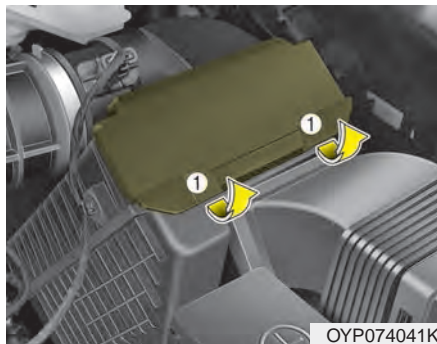

1. Lift up and open the air cleaner cover(1).
2. Rotate the locking lever(2) downward.

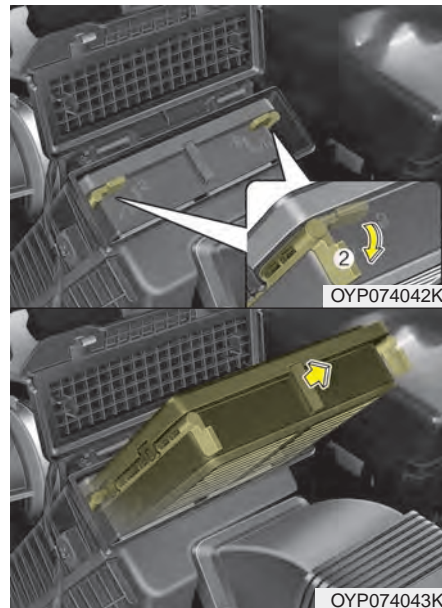

3. Wipe the inside of the air cleaner box. Be careful dust or dirt does not enter the air intake, or damage may result.
4. Replace the air cleaner filter.
5. Lock the cover with the cover attaching clips.

Replace the filter according to the Maintenance Schedule.

If the vehicle is operated in extremely dusty or sandy areas, replace the element more often than the usual recommended intervals. (Refer to "Maintenance under severe usage conditions" in this chapter.)



CAUTION - Air filter maintenance

- ***Do not drive with the air cleaner removed; this will result in excessive engine wear.***
- ***When removing the air cleaner filter, be careful that dust or dirt does not enter the air intake, or damage may result.***
- ***Use a Kia genuine part. Use of non-genuine parts could damage the air flow sensor.***

CLIMATE CONTROL AIR FILTER (IF EQUIPPED)

Filter inspection

The climate control air filter should be replaced according to the maintenance schedule. If the vehicle is operated in severely air-polluted cities or on dusty rough roads for a long period, it should be inspected more frequently and replaced earlier. When you replace the climate control air filter, replace it performing the following procedure, and be careful to avoid damaging other components.



1. Open the glove box and remove the support strap (1).

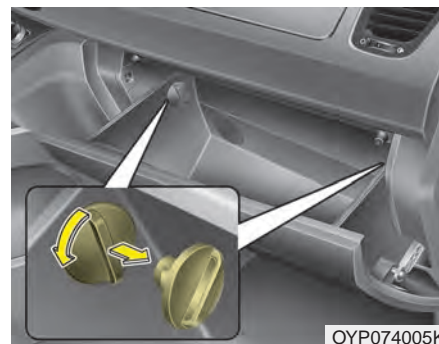

2. With the glove box open, remove the stoppers on both sides.

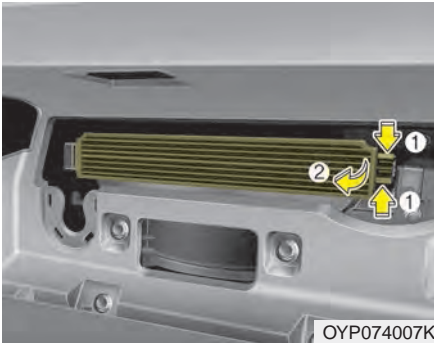

3. Remove the climate control air filter case by pulling out right side of the cover.

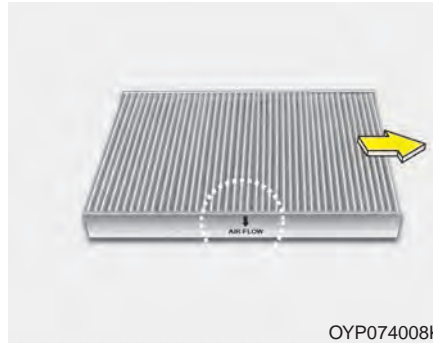

4. Replace the climate control air filter.
5. Reassemble in the reverse order of disassembly.

When replacing the climate control air filter install it properly. Otherwise, the system may produce noise and the effectiveness of the filter may be reduced.

WIPER BLADES

Blade inspection

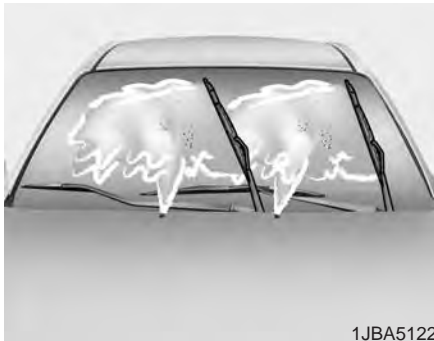

Commercial hot waxes applied by automatic vehicle washes have been known to make the windshield difficult to clean.

Contamination of either the windshield or the wiper blades with foreign matter can reduce the effectiveness of the windshield wipers. Common sources of contamination are insects, tree sap, and hot wax treatments used by some commercial vehicle washes. If the blades are not wiping properly, clean both the window and the blades with a good cleaner or mild detergent, and rinse thoroughly with clean water.



CAUTION - Wiper blades

To prevent damage to the wiper blades, do not use gasoline, kerosene, paint thinner, or other solvents on or near them.

Blade replacement

When the wipers no longer clean adequately, the blades may be worn or cracked, and require replacement.

To prevent damage to the wiper arms or other components, do not attempt to move the wipers manually.

The use of a non-specified wiper blade could result in wiper malfunction and failure.

Front windshield wiper blade

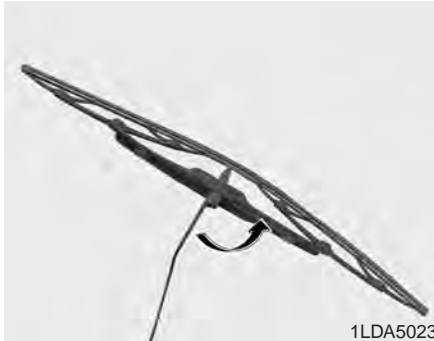

Type A

1. Raise the wiper arm and turn the wiper blade assembly to expose the plastic locking clip.



CAUTION - Wiper arms
Do not allow the wiper arm to fall against the windshield, since it may chip or crack the windshield.

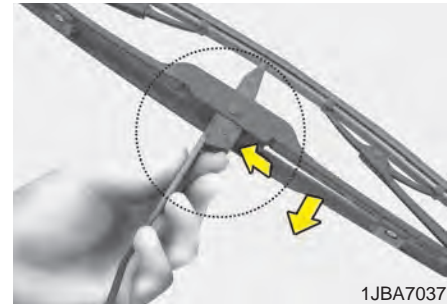

2. Compress the clip and slide the blade assembly downward.
3. Lift it off the arm.
4. Install the blade assembly in the reverse order of removal.



Type B

1. Raise the wiper arm.

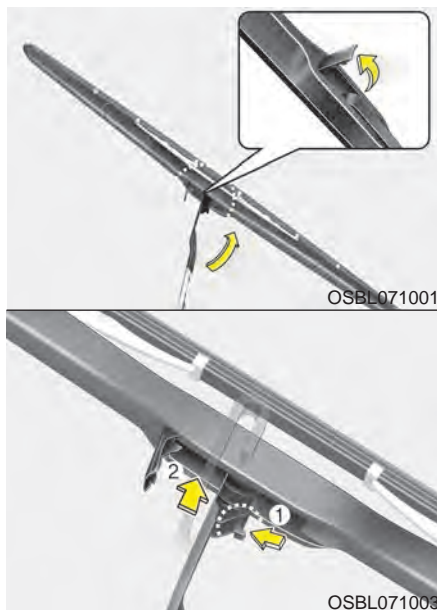

2. Turn the wiper blade clip. Then lift up the blade clip.

3. Push the clip (1) and push up the wiper arm (2).



4. Push down the wiper arm (3) and install the new blade assembly in the reverse order of removal.

5. Return the wiper arm on the windshield.

Rear window wiper blade

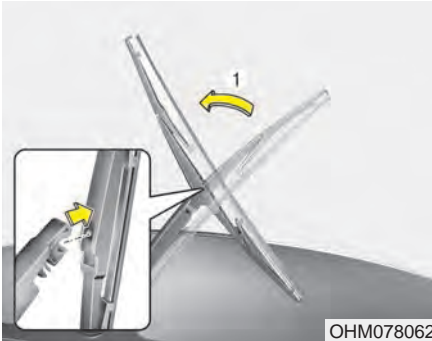

1. Raise the wiper arm and pull out the wiper blade assembly.

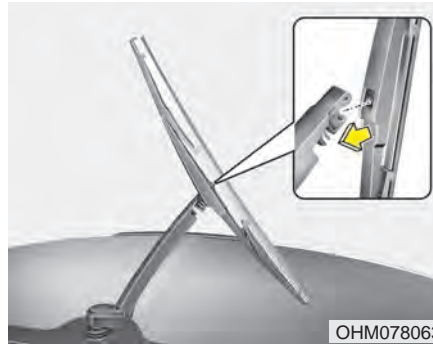

2. Install the new blade assembly by inserting the center part into the slot in the wiper arm until it clicks into place.
3. Make sure the blade assembly is installed firmly by trying to pull it slightly.

To prevent damage to the wiper arms or other components, have an authorized Kia dealer replace the wiper blade.

BATTERY

For best battery service

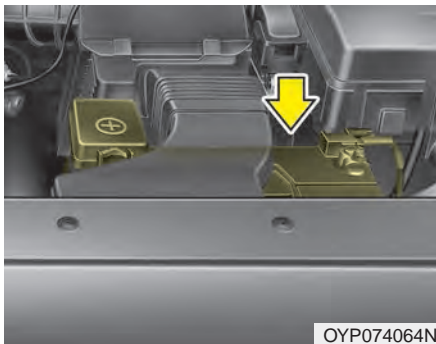

- Keep the battery securely mounted.
- Keep the battery top clean and dry.
- Keep the terminals and connections clean, tight, and coated with petroleum jelly or terminal grease.
- Rinse any spilled electrolyte from the battery immediately with a solution of water and baking soda.
- If the vehicle is not going to be used for an extended time, disconnect the battery cables.

WARNING - Risk of explosion



Keep lit cigarettes and all other flames or sparks away from the battery.



The battery contains hydrogen -- a highly combustible gas which will explode if it comes in contact with a flame or spark.



Keep batteries out of the reach of children because batteries contain highly corrosive SULFURIC ACID and electrolytes. Do not allow battery acid to contact your skin, eyes, clothing or paint finish.



Wear eye protection when charging or working near a battery. Always provide ventilation when working in an enclosed space.



Always read the following instructions carefully when handling a battery.



If any electrolyte gets into your eyes, flush your eyes with clean water for at least 15 minutes and get immediate medical attention.

If electrolyte gets on your skin, thoroughly wash the contacted area. If you feel pain or burning sensation, get medical attention immediately.



An inappropriately disposed battery can be harmful to the environment and human health. Dispose the battery according to your local law(s) or regulation.

Never attempt to recharge the battery when the battery cables are connected.

⚠ WARNING - Risk of electrocution

Never touch the electrical ignition system while the vehicle is running. This system works with high voltage which can "zap" you.

⚠ WARNING - California proposition 65

Battery posts, terminals, and related accessories contain lead and lead compounds, chemicals known to the State of California to cause cancer, birth defects and reproductive harm. Batteries also contain other chemicals known to the State of California to cause cancer. Wash hands after handling.

*** NOTICE**

If you connect unauthorized electronic devices to the battery, the battery may be discharged. Never use unauthorized devices.

Battery recharging

Your vehicle has a maintenance-free, calcium-based battery.

- If the battery becomes discharged in a short time (because, for example, the headlights or interior lights were left on while the vehicle was not in use), recharge it by slow charging (trickle) for 10 hours.
- If the battery gradually discharges because of high electric load while the vehicle is being used, recharge it at 20-30A for two hours.

Recharging Battery

When recharging the battery, observe the following precautions:

- The battery must be removed from the vehicle and placed in an area with good ventilation.
- Do not allow cigarettes, sparks, or flame near the battery.
- Watch the battery during charging, and stop or reduce the charging rate if the battery cells begin gassing (boiling) violently or if the temperature of the electrolyte of any cell exceeds 120°F (49°C).
- Wear eye protection when checking the battery during charging.
- Disconnect the battery charger in the following order.
 1. Turn off the battery charger main switch.
 2. Unhook the negative clamp from the negative battery terminal.
 3. Unhook the positive clamp from the positive battery terminal.

- Before performing maintenance or recharging the battery, turn off all accessories and stop the engine.
- The negative battery cable must be removed first and installed last when the battery is disconnected.

Reset items

Items should be reset after the battery has been discharged or the battery has been disconnected.

- Auto up/down window (See chapter 4)
- Sunroof (See chapter 4)
- Trip computer (See chapter 4)
- Climate control system (See chapter 4)
- Clock (See chapter 4)
- Audio (See chapter 4)

TIRES AND WHEELS

Tire care

For proper maintenance, safety, and maximum fuel economy, you must always maintain recommended tire inflation pressures and stay within the load limits and weight distribution recommended for your vehicle.

Recommended cold tire inflation pressures

All tire pressures (including the spare) should be checked when the tires are cold. "Cold Tires" means the vehicle has not been driven for at least three hours or driven less than one mile (1.6 km).

Recommended pressures must be maintained for the best ride, vehicle handling, and minimum tire wear.

For recommended inflation pressure, refer to "Tire and wheels" in chapter 8.

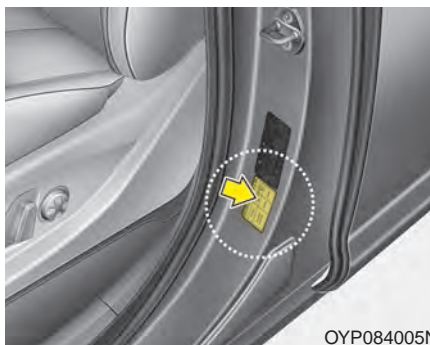

All specifications (sizes and pressures) can be found on a label attached to the driver's side center pillar.

⚠ WARNING - Tire under inflation

Inflate your tire consistent with the instructions provided in this manual. Severe under inflation can lead to severe heat build-up, causing blowouts, tread separation and other tire failures that can result in the loss of vehicle control. This risk is much higher on hot days and when driving for long periods at high speeds.

- Underinflation also results in excessive wear, poor handling and reduced fuel economy. Wheel deformation also is possible. Keep your tire pressures at the proper levels. If a tire frequently needs refilling, have it checked by an authorized Kia dealer.
- Overinflation produces a harsh ride, excessive wear at the center of the tire tread, and a greater possibility of damage from road hazards.
- Warm tires normally exceed recommended cold tire pressures by 4 to 6 psi (28 to 41 kPa). Do not release air from warm tires to adjust the pressure or the tires will be underinflated.
- Be sure to reinstall the tire inflation valve caps. Without the valve cap, dirt or moisture could get into the valve core and cause air leakage. If a valve cap is missing, install a new one as soon as possible.

Tire pressure

Always observe the following:

- Check tire pressure when the tires are cold. (After vehicle has been parked for at least three hours or hasn't been driven more than one mile (1.6 km) since startup.)
- Check the pressure of your spare tire each time you check the pressure of other tires.
- Never overload your vehicle. Be careful not to overload a vehicle luggage rack if your vehicle is equipped with one.

Checking tire inflation pressure

Check your tires once a month or more.

Also, check the tire pressure of the spare tire.

How to check

Use a good quality gauge to check tire pressure. You cannot tell if your tires are properly inflated simply by looking at them. Radial tires may look properly inflated even when they're underinflated.

Check the tire's inflation pressure when the tires are cold. - "Cold" means your vehicle has been sitting for at least three hours or driven no more than 1 mile (1.6 km).

Remove the valve cap from the tire valve stem. Press the tire gauge firmly onto the valve to get a pressure measurement. If the cold tire inflation pressure matches the recommended pressure on the tire and loading information label, no further adjustment is necessary. If the pressure is low, add air until you reach the recommended amount.

If you overfill the tire, release air by pushing on the metal stem in the center of the tire valve. Recheck the tire pressure with the tire gauge. Be sure to put the valve caps back on the valve stems. They help prevent leaks by keeping out dirt and moisture.

- Inspect your tires frequently for proper inflation as well as wear and damage. Always use a tire pressure gauge.
- Tires with too much or too little pressure wear unevenly causing poor handling, loss of vehicle control, and sudden tire failure leading to accidents, injuries, and even death. The recommended cold tire pressure for your vehicle can be found in this manual and on the tire label located on the driver's side center pillar.
- Remember to check the pressure of your spare tire. Kia recommends that you check the spare every time you check the pressure of the other tires on your vehicle.

Tire rotation

To equalize tread wear, it is recommended that the tires be rotated every 7,500 miles (12,000 km) or sooner if irregular wear develops.

During rotation, check the tires for correct balance.

When rotating tires, check for uneven wear and damage. Abnormal wear is usually caused by incorrect tire pressure, improper wheel alignment, out-of-balance wheels, severe braking or severe cornering. Look for bumps or bulges in the tread or side of tire. Replace the tire if you find either of these conditions. Replace the tire if fabric or cord is visible. After rotation, be sure to bring the front and rear tire pressures to specification and check lug nut tightness.

Refer to “Tire and wheels” in chapter 8.

Without a spare tire

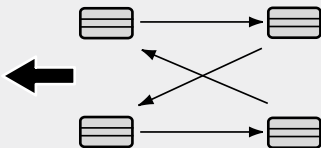

S2BLA790A

Directional tires (if equipped)

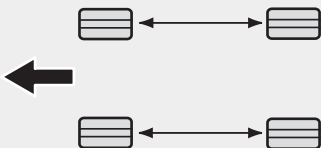

CBGQ0707A

Disc brake pads should be inspected for wear whenever tires are rotated.

Rotate radial tires that have an asymmetric tread pattern only from front to rear and not from right to left.

⚠ WARNING - Mixing tires

- **Do not use the compact spare tire (if equipped) for tire rotation.**
- **Do not mix bias ply and radial ply tires under any circumstances. This may cause unusual handling characteristics.**

Wheel alignment and tire balance

The wheels on your vehicle were aligned and balanced carefully at the factory to give you the longest tire life and best overall performance.

In most cases, you will not need to have your wheels aligned again. However, if you notice unusual tire wear or your vehicle pulling one way or the other, the alignment may need to be reset.

If you notice your vehicle vibrating when driving on a smooth road, your wheels may need to be rebalanced.

⚠ CAUTION - Wheel weight
Improper wheel weights can damage your vehicle's aluminum wheels. Use only approved wheel weights.

Tire replacement



If the tire is worn evenly, a tread wear indicator will appear as a solid band across the tread. This shows there is less than 1/16 inch (1.6 mm) of tread left on the tire. Replace the tire when this happens.

Do not wait for the band to appear across the entire tread before replacing the tire.

The ABS works by comparing the speed of the wheels. The tire size affects wheel speed. When replacing tires, all 4 tires must use the same size originally supplied with the vehicle. Using tires of a different size can cause the ABS (Anti-lock Brake System) and ESC (Electronic Stability Control) to work irregularly.

* NOTICE

We recommend that when replacing tires, use the same originally supplied with the vehicles. If not, that affects driving performance.

Compact spare tire replacement

A compact spare tire has a shorter tread life than a regular size tire. Replace it when you can see the tread wear indicator bars on the tire. The replacement compact spare tire should be the same size and design tire as the one provided with your new vehicle and should be mounted on the same compact spare tire wheel. The compact spare tire is not designed to be mounted on a regular size wheel, and the compact spare tire wheel is not designed for mounting a regular size tire.

⚠ CAUTION - Wheels

Wheels that do not meet Kia specifications may fit poorly and result in damage to the vehicle or unusual handling and poor vehicle control.

Wheel replacement

When replacing the metal wheels for any reason, make sure the new wheels are equivalent to the original factory units in diameter, rim width and offset.

A wheel that is not the correct size may adversely affect wheel and bearing life, braking and stopping abilities, handling characteristics, ground clearance, body-to-tire clearance, snow chain clearance, speedometer and odometer calibration, headlight aim and bumper height.

Tire traction

Tire traction can be reduced if you drive on worn tires, tires that are improperly inflated or on slippery road surfaces. Tires should be replaced when tread wear indicators appear. Slow down whenever there is rain, snow or ice on the road to reduce the possibility of losing control of the vehicle.

Tire maintenance

In addition to proper inflation, correct wheel alignment helps to decrease tire wear. If you find a tire is worn unevenly, have your dealer check the wheel alignment.

When you have new tires installed, make sure they are balanced. This will increase vehicle ride comfort and tire life. Additionally, a tire should always be rebalanced if it is removed from the wheel.

Tire sidewall labeling

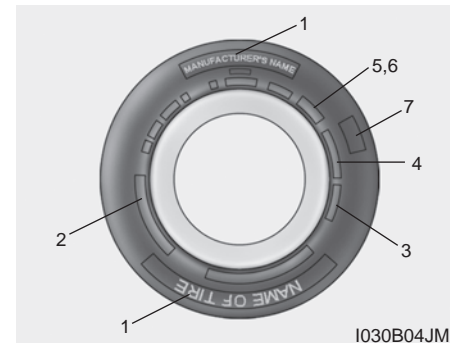

This information identifies and describes the fundamental characteristics of the tire and also provides the tire identification number (TIN) for safety standard certification. The TIN can be used to identify the tire in case of a recall.

1. Manufacturer or brand name
Manufacturer or Brand name is shown.

2. Tire size designation

A tire's sidewall is marked with a tire size designation. You will need this information when selecting replacement tires for your vehicle. The following explains what the letters and numbers in the tire size designation mean.

Example tire size designation:

(These numbers are provided as an example only; your tire size designator could vary depending on your vehicle.)

P235/65R17 108T

P - Applicable vehicle type (tires marked with the prefix "P" are intended for use on passenger vehicles or light trucks; however, not all tires have this marking).

235 - Tire width in millimeters.

65 - Aspect ratio. The tire's chapter height as a percentage of its width.

R - Tire construction code (Radial).

17 - Rim diameter in inches.

108 - Load Index, a numerical code associated with the maximum load the tire can carry.

T - Speed Rating Symbol. See the speed rating chart in this chapter for additional information.

Wheel size designation

Wheels are also marked with important information that you need if you ever have to replace one. The following explains what the letters and numbers in the wheel size designation mean.

Example wheel size designation:

7.0JX17

7.0 - Rim width in inches.

J - Rim contour designation.

17 - Rim diameter in inches.

Tire speed ratings

The chart below lists many of the different speed ratings currently being used for passenger vehicle tires. The speed rating is part of the tire size designation on the sidewall of the tire. This symbol corresponds to that tire's designed maximum safe operating speed.

Speed Rating Symbol	Maximum Speed
S	112 mph (180 km/h)
T	118 mph (190 km/h)
H	130 mph (210 km/h)
V	149 mph (240 km/h)
Z	Above 149 mph (240 km/h)

3. Checking tire life (TIN : Tire Identification Number)

Any tires that are over 6 years old, based on the manufacturing date, (including the spare tire) should be replaced by new ones. You can find the manufacturing date on the tire sidewall (possibly on the inside of the wheel), displaying the DOT Code. The DOT Code is a series of numbers on a tire consisting of numbers and English letters. The manufacturing date is designated by the last four digits (characters) of the DOT code.

DOT : XXXX XXXX OOOO

The front part of the DOT means a plant code number, tire size and tread pattern and the last four numbers indicate week and year manufactured.

For example:

DOT XXXX XXXX 1617 represents that the tire was produced in the 16th week of 2017.

⚠ WARNING - Tire age
Replace tires within the recommended time frame. Failure to replace tires as recommended can result in sudden tire failure, which could lead to a loss of control and an accident.

4. Tire ply composition and material

The number of layers or plies of rubber-coated fabric in the tire. Tire manufacturers also must indicate the materials in the tire, which include steel, nylon, polyester, and others. The letter "R" means radial ply construction; the letter "D" means diagonal or bias ply construction; and the letter "B" means belted-bias ply construction.

5. Maximum permissible inflation pressure

This number is the greatest amount of air pressure that should be put in the tire. Do not exceed the maximum permissible inflation pressure. Refer to the Tire and Loading Information label for recommended inflation pressure.

6. Maximum load rating

This number indicates the maximum load in kilograms and pounds that can be carried by the tire. When replacing the tires on the vehicle, always use a tire that has the same load rating as the factory installed tire.

7. Uniform tire quality grading

Quality grades can be found where applicable on the tire sidewall between tread shoulder and maximum chapter width.

For example:

TREADWEAR 200

TRACTION AA

TEMPERATURE A

Tires degrade over time, even when they are not being used. Regardless of the remaining tread, we recommend that tires be replaced after approximately six (6) years of normal service. Heat caused by hot climates or frequent high loading conditions can accelerate the aging process.

Tread wear

The tread wear grade is a comparative rating based on the wear rate of the tire when tested under controlled conditions on a specified government test course. For example, a tire graded 150 would wear one-and-a-half times ($1\frac{1}{2}$) as well on the government course as a tire graded 100.

The relative performance of tires depends upon the actual conditions of their use, however, and may depart significantly from the norm due to variations in driving habits, service practices and differences in road characteristics and climate.

These grades are molded on the side-walls of passenger vehicle tires. The tires available as standard or optional equipment on your vehicle may vary with respect to grade.

Traction - AA, A, B & C

The traction grades, from highest to lowest, are AA, A, B and C. Those grades represent the tire's ability to stop on wet pavement as measured under controlled conditions on specified government test surfaces of asphalt and concrete. A tire marked C may have poor traction performance.

The traction grade assigned to this tire is based on straight-ahead braking traction tests, and does not include acceleration, cornering, hydroplaning, or peak traction characteristics.

Temperature -A, B & C

The temperature grades are A (the highest), B and C representing the tire's resistance to the generation of heat and its ability to dissipate heat when tested under controlled conditions on a specified indoor laboratory test wheel.

Sustained high temperature can cause the material of the tire to degenerate and reduce tire life, and excessive temperature can lead to sudden tire failure. The grade C corresponds to a level of performance which all passenger vehicle tires must meet under the Federal Motor Vehicle Safety Standard No. 109. Grades B and A represent higher levels of performance on the laboratory test wheel than the minimum required by law.

Tire terminology and definitions

Air Pressure: The amount of air inside the tire pressing outward on the tire. Air pressure is expressed in pounds per square inch (psi) or kilopascal (kPa).

Accessory Weight: This means the combined weight of optional accessories. Some examples of optional accessories are, automatic transaxle, power seats, and air conditioning.

Aspect Ratio: The relationship of a tire's height to its width.

Belt: A rubber coated layer of cords that is located between the plies and the tread. Cords may be made from steel or other reinforcing materials.

Bead: The tire bead contains steel wires wrapped by steel cords that hold the tire onto the rim.

Bias Ply Tire: A pneumatic tire in which the plies are laid at alternate angles less than 90 degrees to the centerline of the tread.

Cold Tire Pressure: The amount of air pressure in a tire, measured in pounds per square inch (psi) or kilopascals (kPa) before a tire has built up heat from driving.

Curb Weight: This means the weight of a motor vehicle with standard and optional equipment including the maximum capacity of fuel, oil and coolant, but without passengers and cargo.

DOT Markings: A code molded into the sidewall of a tire signifying that the tire is in compliance with the U.S. Department of Transportation motor vehicle safety standards. The DOT code includes the Tire Identification Number (TIN), an alphanumeric designator which can also identify the tire manufacturer, production plant, brand and date of production.

GVWR: Gross Vehicle Weight Rating

GAWR FRT: Gross Axle Weight Rating for the Front Axle.

GAWR RR: Gross Axle Weight Rating for the Rear axle.

Intended Outboard Sidewall: The side of an asymmetrical tire, that must always face outward when mounted on a vehicle.

Kilopascal (kPa): The metric unit for air pressure.

Light truck (LT) tire: A tire designated by its manufacturer as primarily intended for use on lightweight trucks or multipurpose passenger vehicles.

Load Index: An assigned number ranging from 1 to 279 that corresponds to the load carrying capacity of a tire.

Load ratings: The maximum load that a tire is rated to carry for a given inflation pressure.

Maximum Inflation Pressure: The maximum air pressure to which a cold tire may be inflated. The maximum air pressure is molded onto the sidewall.

Maximum Load Rating: The load rating for a tire at the maximum permissible inflation pressure for that tire.

Maximum Loaded Vehicle Weight: The sum of curb weight; accessory weight; vehicle capacity weight; and production options weight.

Normal Occupant Weight: The number of occupants a vehicle is designed to seat multiplied by 150 pounds (68 kg).

Occupant Distribution: Designated seating positions.

Outward Facing Sidewall: The side of a asymmetrical tire that has a particular side that faces outward when mounted on a vehicle. The outward facing sidewall bears white lettering or bears manufacturer, brand, and/or model name molding that is higher or deeper than the same moldings on the inner facing sidewall.

Passenger (P-Metric) Tire: A tire used on passenger cars and some light duty trucks and multipurpose vehicles.

Ply: A layer of rubber-coated parallel cords.

Pneumatic tire: A mechanical device made of rubber, chemicals, fabric and steel or other materials, that, when mounted on an automotive wheel, provides the traction and contains the gas or fluid that sustains the load.

Production options weight: The combined weight of installed regular production options weighing over 5 lb.(2.3 kg) in excess of the standard items which they replace, not previously considered in curb weight or accessory weight, including heavy duty brakes, ride levelers, roof rack, heavy duty battery, and special trim.

Recommended Inflation Pressure: Vehicle manufacturer's recommended tire inflation pressure and shown on the tire placard.

Radial Ply Tire: A pneumatic tire in which the ply cords that extend to the beads are laid at 90 degrees to the centerline of the tread.

Rim: A metal support for a tire and upon which the tire beads are seated.

Sidewall: The portion of a tire between the tread and the bead.

Speed Rating: An alphanumeric code assigned to a tire indicating the maximum speed at which a tire can operate.

Traction: The friction between the tire and the road surface. The amount of grip provided.

Tread: The portion of a tire that comes into contact with the road.

Treadwear Indicators: Narrow bands, sometimes called "wear bars," that show across the tread of a tire when only 2/32 inch of tread remains.

UTQGS: Uniform Tire Quality Grading Standards, a tire information system that provides consumers with ratings for a tire's traction, temperature and treadwear. Ratings are determined by tire manufacturers using government testing procedures. The ratings are molded into the sidewall of the tire.

Vehicle Capacity Weight: The number of designated seating positions multiplied by 150 lbs. (68 kg) plus the rated cargo and luggage load.

Vehicle Maximum Load on the Tire: Load on an individual tire due to curb and accessory weight plus maximum occupant and cargo weight.

Vehicle Normal Load on the Tire: Load on an individual tire that is determined by distributing to each axle its share of the curb weight, accessory weight, and normal occupant weight and driving by 2.

Vehicle Placard: A label permanently attached to a vehicle showing the original equipment tire size and recommended inflation pressure.

All season tires

Kia specifies all season tires on some models to provide good performance for use all year round, including snowy and icy road conditions. All season tires are identified by ALL SEASON and/or M+S (Mud and Snow) on the tire sidewall. Snow tires have better snow traction than all season tires and may be more appropriate in some areas.

Summer tires

Kia specifies summer tires on some models to provide superior performance on dry roads. Summer tire performance is substantially reduced in snow and ice. Summer tires do not have the tire traction rating M+S (Mud and Snow) on the tire side wall. if you plan to operate your vehicle in snowy or icy conditions, Kia recommends the use of snow tires or all season tires on all four wheels.

Snow tires

If you equip your vehicle with snow tires, they should be the same size and have the same load capacity as the original tires. Snow tires should be installed on all four wheels; otherwise, poor handling may result.

Snow tires should carry 4 psi (28 kPa) more air pressure than the pressure recommended for the standard tires on the tire label on the driver's side of the center pillar, or up to the maximum pressure shown on the tire sidewall, whichever is less.

Do not drive faster than 75 mph (120 km/h) when your vehicle is equipped with snow tires.

Tire chains

Tire chains, if necessary, should be installed on the front wheels.

Be sure that the chains are installed in accordance with the manufacturer's instructions.

To minimize tire and chain wear, do not continue to use tire chains when they are no longer needed.

- When driving on roads covered with snow or ice, drive at less than 20 mph (30 km/h).
- Use the SAE “S” class or wire chains.
- If you hear noise caused by chains contacting the body, retighten the chain to avoid contact with the vehicle body.
- To prevent body damage, retighten the chains after driving 0.3~0.6 miles (0.5~1.0 km).
- Do not use tire chains on vehicles equipped with aluminum wheels. In unavoidable circumstance, use a wire type chain.
- Use wire chains less than 0.59 inches (15 mm) to prevent damage to the chain’s connection.

Radial-ply tires

Radial-ply tires provide improved tread life, road hazard resistance and smoother high speed ride. The radial-ply tires used on this vehicle are of belted construction, and are selected to complement the ride and handling characteristics of your vehicle. Radial-ply tires have the same load carrying capacity, as bias-ply or bias belted tires of the same size, and use the same recommended inflation pressure. Mixing of radial-ply tires with bias-ply or bias belted tires is not recommended. Any combinations of radial-ply and bias-ply or bias belted tires when used on the same vehicle will seriously deteriorate vehicle handling. The best rule to follow is: Identical radial-ply tires should always be used as a set of four.

Longer wearing tires can be more susceptible to irregular tread wear. It is very important to follow the tire rotation interval shown in this chapter to achieve the tread life potential of these tires. Cuts and punctures in radial-ply tires are repairable only in the tread area, because of sidewall flexing. Consult your tire dealer for radial-ply tire repairs.

Low aspect ratio tire (if equipped)

Low aspect ratio tires, whose aspect ratio is lower than 50, are provided for sporty looks.

Because the low aspect ratio tires are optimized for handling and braking, it may be more uncomfortable to ride in and there is more noise compare with normal tires.

CAUTION

Because the sidewall of the low aspect ratio tire is shorter than the normal, the wheel and tire of the low aspect ratio tire is easier to be damaged. So, follow the instructions below.

- ***When driving on a rough road or off road, drive cautiously because tires and wheels may be damaged. And after driving, inspect tires and wheels.***
- ***When passing over a pothole, speed bump, manhole, or curb stone, drive slowly so that the tires and wheels are not damaged.***
- ***If the tire is impacted, we recommend that you inspect the tire condition or contact an authorized Kia dealer.***
- ***To prevent damage to the tire, inspect the tire condition and pressure every 3,000km.***

CAUTION

- ***It is not easy to recognize the tire damage with your own eyes. But if there is the slightest hint of tire damage, even though you cannot see the tire damage with your own eyes, have the tire checked or replaced because the tire damage may cause air leakage from the tire.***
- ***If the tire is damaged by driving on a rough road, off road, pothole, manhole, or curb stone, it will not be covered by the warranty.***
- ***You can find out the tire information on the tire sidewall.***

FUSES

■ Blade type



Normal



Blown

■ Cartridge type



Normal



Blown

■ Multi fuse



Normal



Blown

OYP074073N

A vehicle's electrical system is protected from electrical overload damage by fuses.

This vehicle has 2 (or 3) fuse panels, one located in the driver's side panel bolster, the other in the engine compartment near the battery.

If any of your vehicle's lights, accessories, or controls do not work, check the appropriate circuit fuse. If a fuse has blown, the element inside the fuse will melt.

If the electrical system does not work, first check the driver's side fuse panel.

Always replace a blown fuse with one of the same rating.

If the replacement fuse blows, this indicates an electrical problem. Avoid using the system involved and immediately consult an authorized Kia dealer.

Three kinds of fuses are used: blade type for lower amperage rating, cartridge type, and multi fuse for higher amperage ratings.

⚠ WARNING - Fuse replacement

- **Never replace a fuse with anything but another fuse of the same rating.**
- **A higher capacity fuse could cause damage and possibly a fire.**
- **Never install a wire or aluminum foil instead of the proper fuse - even as a temporary repair. It may cause extensive wiring damage and a possible fire.**
- **Do not arbitrarily modify or add-on electric wiring of the vehicle.**

⚠ CAUTION

Do not use a screwdriver or any other metal object to remove fuses because it may cause a short circuit and damage the system.

*** NOTICE**

- The actual fuse/relay panel label may differ depending on equipment/options.
- When replacing fuse, turn the ignition “OFF” and turn off switches of all electrical devices then remove battery (-) terminal.
- The actual fuse/relay panel label may differ from equipped items.

Inner panel fuse replacement

1. Turn the ignition switch and all other switches off.
2. Open the fuse panel cover.

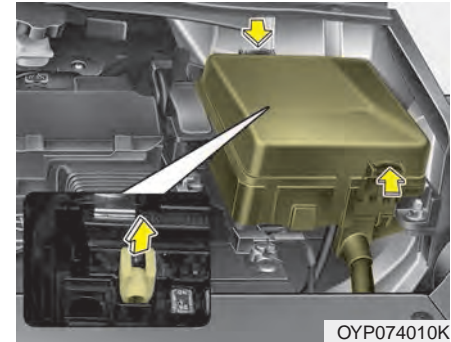

3. Pull the suspected fuse straight out. Use the removal tool provided on the engine compartment fuse panel cover.
4. Check the removed fuse; replace it if it is blown.

Spare fuses are provided in the engine compartment fuse panel.

5. Push in a new fuse of the same rating, and make sure it fits tightly in the clips.

If it fits loosely, consult an authorized Kia dealer.

If you do not have a spare, use a fuse of the same rating from a circuit you may not need for operating the vehicle, such as the power outlet fuse.

If the headlights or other electrical components do not work and the fuses are OK, check the fuse panel in the engine compartment. If a fuse is blown, it must be replaced.

Fuse switch

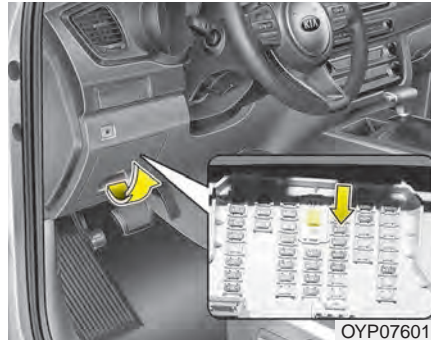

Always, put the fuse switch at the ON position.

If you move the switch to the OFF position, some items such as audio and digital clock must be reset and transmitter (or smart key) may not work properly. When the switch is Off, the caution will be displayed on the instrument cluster.

Always place the fuse switch in the ON position while driving the vehicle.

Engine compartment fuse replacement

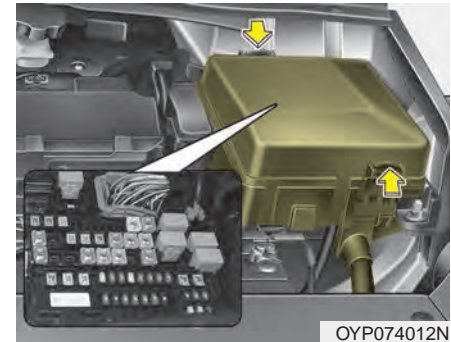

1. Turn the ignition switch and all other switches off.
2. Remove the fuse panel cover by pressing the tab and pulling the cover up.

When the blade type fuse is disconnected, remove it by using the clip designed for changing fuses located in the engine room fuse box. Upon removal, securely insert reserve fuse of equal quantity.

3. Check the removed fuse; replace it if it is blown. To remove or insert the fuse, use the fuse puller in the engine compartment fuse panel.
4. Push in a new fuse of the same rating, and make sure it fits tightly in the clips. If it fits loosely, consult an authorized Kia dealer.

**CAUTION - Fuse panel covers**

After checking the fuse panel in the engine compartment, securely install the fuse panel cover. If not, electrical failures may occur from water contact.

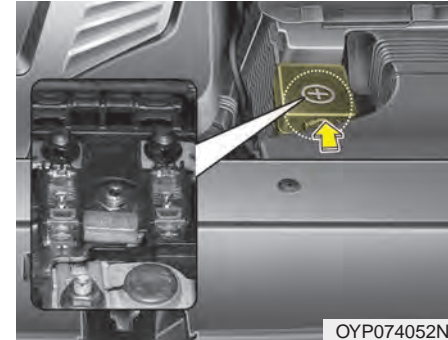
Main fuse

If the main fuse is blown, it must be removed as follows:

1. Turn off the engine.
2. Disconnect the negative battery cable.
3. Remove the nuts shown in the picture above.
4. Replace the fuse with a new one of the same rating.
5. Reinstall in the reverse order of removal.

Fuse/relay panel description



OYP076014

Inside the fuse/relay panel covers, you can find the fuse/relay label describing fuse/relay name and capacity.

* NOTICE

Not all fuse panel descriptions in this manual may be applicable to your vehicle. It is accurate at the time of printing. When you inspect the fuse panel in your vehicle, refer to the fuse panel label.

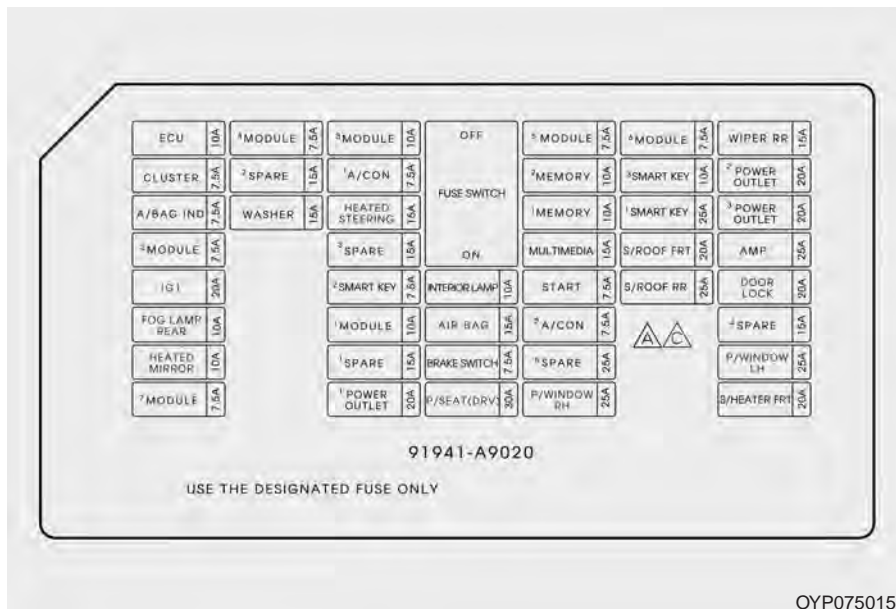

OYP075015N

Inner fuse panel

Fuse Name	Fuse rating	Circuit Protected
ECU	10A	PCM, Injector Drive Box, Smart Key Control Module/Immobilizer Module
MODULE4	7.5A	Head Lamp Leveling Device Actuator LH/RH, Multipurpose Check Connector, Bezel Switch, MTS Module, Electro Chromic, A/V & Navigation Head Unit, A/C Control Module, Heater Control Module, Passenger Ventilation Seat Control Module, Driver IMS Control Module, Rear Seat Heater Control Module, Auto Head Leveling Device Module, ATM Shift Lever ILL.
MODULE3	10A	LDWS Module, Stop Lamp, Front Parking Assist Sensor LH/RH, Front Parking Assist Sensor LH/RH (CENTER), Rear Parking Assist Buzzer, Rear Parking Assist Sensor LH/RH, Rear Parking Assist Sensor LH/RH (CENTER), Blind Spot Detection Radar LH/RH
MODULE5	7.5A	Rear Seat Heater Control Module, AC Inverter Unit, Heater Control Module, Passenger Ventilation Seat Control Module, Portable Lamp, Around View Unit
MODULE6	7.5A	BCM, Smart Key Control Module
WIPER RR	15A	Rear Wiper Motor, Wiper RR Relay
CLUSTER	7.5A	Instrument Cluster
A/CON1	7.5A	A/C Control Module, Ionizer, Rear A/C Control Switch, PCB Block (Blower Relay, Blower RR Relay)
MEMORY2	10A	Data Link Connector, Instrument Cluster, Digital Clock, A/C Control Module, BCM, Power Sliding Door Module, Driver Door Module, Passenger Safety Power Window Switch, Driver IMS Control Module
SMART KEY3	10A	Start/Stop Button Switch, Immobilizer Module
POWER OUTLET2	20A	Console Power Outlet
A/BAG IND	7.5A	Instrument Cluster, Digital Clock, A/C Control Module(Auto)
WASHER	15A	Multifunction Switch, BCM
HEATED STEERING	15A	Clock Spring (Steering Wheel Switch)
MEMORY1	10A	Clock Spring (Steering Wheel Switch)
SMART KEY1	25A	Smart Key Control Module
POWER OUTLET3	20A	Rear Power Outlet
MODULE2	7.5A	BCM, Driver Door Module, Passenger Door Module

Maintenance

Fuse Name	Fuse rating	Circuit Protected
MULTIMEDIA	15A	USB Charger #1/#2, MTS Module, Audio, A/V & Navigation Head Unit
S/ROOF FRT	20A	Front Sunroof Motor
AMP	25A	AMP
IG1	20A	PCB BLOCK (Fuse - ABS3, TCU, MDPS, CRUISE)
SMART KEY2	7.5A	Smart Key Control Module
INTERIOR LAMP	10A	Portable Lamp, Overhead Console Lamp, Cargo Lamp, Front Vinity Lamp Switch LH/RH, Glove Box Lamp, Key Warning Switch
START	7.5A	With IMMO./Smart Key : Transmission Range Switch, W/O IMMO. : PCB Block (B/Alarm Relay)
S/ROOF RR	25A	Rear Sunroof Motor
DOOR LOCK	20A	Tail Gate Relay, Door Lock/Unlock Relay, Sliding Door Lock/Unlock Relay
FOG LAMP REAR	10A	-
MODULE1	10A	Audio, A/V & Navigation Head Unit, Around View Unit, BCM, Overhead Console Lamp, MTS Module, Digital Clock, USB Charger #1/#2
AIR BAG	15A	SRS Control Module, Passenger Occupant Detection Sensor
A/CON2	7.5A	A/C Control Module, Blower Resistor (Manual)
HEATED MIRROR	10A	Passenger Power Outside Mirror, A/C Control Module
BRAKE SWITCH	7.5A	Smart Key Control Module, Stop Lamp Switch
P/WINDOW LH	25A	Driver Safety Window Module, Driver Door Module, Rear Power Window Switch LH, Rear Safety Power Window Switch LH, Rear Safety Power Window Module LH
MODULE7	7.5A	Key Inter Lock Solenoid, Fuel Lid Switch, ATM Lever Switch, Rear A/C Control Switch, Electro Chromic Mirror
POWER OUTLET1	20A	Front Power Outlet
P/SEAT (DRV)	30A	Driver Manual Switch, Driver Lumbar Support Switch, Driver IMS Control Module
P/WINDOW RH	25A	Passenger Safety Window Module, Passenger Power Window Motor, Passenger Door Module, Rear Power Window Switch RH, Rear Safety Power Window Switch RH, Rear Safety Power Window Module RH
S/HEATER FRT	20A	Heater Control Module, Passenger Ventilation Seat Control Module

Engine compartment fuse panel

Fuse Name	Fuse rating	Circuit Protected]
ABS1	40A	ESC Module, Multipurpose Check Connector
ABS2	40A	ESC Module
INVERTER	30A	AC Inverter Unit
IDB	15A	Injector Drive Box
S/HEATER RR	25A	Rear Seat Heater Control Module
FOG LAMP FRONT	15A	Fog Lamp Front Relay
P/SEAT (PASS)	30A	Passenger Manual Switch
COOLING FAN1	60A	Cooling Fna1 Relay
COOLING FAN2	50A	Cooling Fna2 Relay
B+4	50A	Smart Junction Block (IPS Control Module, IPS3, IPS4, IPS5, IPS6, Fuse - MODULE7)
POWER TAIL GATE	40A	Power Tail Gate Module
B+2	50A	Smart Junction Block (Leak Current Autocut Device, Fuse - P/SEAT DRV, P/WDW RH)
IG1	40A	With Smart Key : PDM1/2 Relay, W/O Smart Key : Ignition Switch
IG2	40A	Start Relay, With Smart Key : PDM3 Relay, W/O Smart Key : Ignition Switch,
B+1	50A	Smart Junction Block (IPS Control Module, Fuse - P/WDW LH, S/HEATER FRT, DR LOCK)
TRAILER	30A	Trailer Power Outlet
B+5	50A	Smart Junction Block (Motor Driver, Power Outlet Relay, Fuse - S/ROOF FRT, S/ROOF RR, BRAKE SWITCH, SMART KEY1, SMART KEY3, AMP)
PSD1	40A	Power Sliding Door Module
PSD2	40A	Power Sliding Door Module
B+3	50A	Smart Junction Block (IPS Control Module, IPS1, IPS2)
MDPS	125A	MDPS Unit (Rack)

Fuse Name	Fuse rating	Circuit Protected
BLOWER RR	40A	Blower RR Relay
BLOWER	40A	Blower Relay
SENSOR (B+)	10A	Battery Sensor
B/ALARM HORN	10A	B/Alarm Horn Relay
FUEL LID	10A	Fuel Lid Relay
DEICER	15A	Deicer Relay
FUEL PUMP	15A	Fuel Pump Relay
HORN	15A	Horn Relay
WIPER	25A	Front Wiper (Low) Relay
ECU3	30A	Engine Control Relay, Fuse - ECU1
REAR HEATED	40A	Rear Heated Relay
TCU	15A	Transmission Range Switch
MDPS	10A	MDPS Unit (Rack)
CRUISE	10A	Smart Cruise Control Radar
B/UP LAMP	10A	Audio, A/V & Navigation Head Unit, Rear Combination Lamp (IN) LH/RH, Electro Chromic Mirror
A/CON	7.5A	Rear A/C Control Switch, A/C Control Module
ECU1	15A	PCM
ABS3	7.5A	ESC Module, Steering Angle Sensor
ECU2	10A	Injector Drive Box
SENSOR1	15A	Oxygen Sensor #1/#2/#3/#4, PCM, E/R Junction Box (Cooling Fan1 Relay)
SENSOR2	10A	PCM, Canister Close Valve, Variable Intake Solenoid Valve #1/#2, Purge Control Solenoid Valve, Oil Control Valve #1/#2 (Intake), Oil Control Valve #1/#2 (Exhaust)
SENSOR3	10A	PCM, Fuel Pump Relay
IGN COIL	20A	Ignition Coil #1-#6, Condensor #1/#2

LIGHT BULBS

WARNING - Working on the lights

Prior to working on the light, firmly apply the parking brake, ensure that the ignition switch is turned to the LOCK position and turn off the lights to avoid sudden movement of the vehicle and burning your fingers or receiving an electric shock.

Use only the bulbs of the specified wattage.

CAUTION - Light replacement

Be sure to replace the burned-out bulb with one of the same wattage rating. Otherwise, it may cause damage to the fuse or electric wiring system.

CAUTION - Headlamp Lens

To prevent damage, do not clean headlamp lens with chemical solvents or strong detergents.

* NOTICE

- If the light bulb or lamp connector is removed from an operating lamp activated by electricity, the fuse box's electronic device may scan it as a malfunction. Therefore, a lamp malfunction history may be recorded in Diagnostic Trouble Code (DTC) in the fuse box.
- It is normal for an operating lamp may blink temporarily. Since this occurrence is due stabilization function of the vehicle's electronic control device, if the lamp lights up normally after temporary blinking, there is no problem in the vehicle.
However, if the lamp continues to blink several times or turn off completely, there may be an error in the vehicle's electronic control device. So please have the vehicle checked by an authorized Kia dealer immediately.

If you don't have necessary tools, the correct bulbs and the expertise, consult an authorized Kia dealer. In many cases, it is difficult to replace vehicle light bulbs because other parts of the vehicle must be removed before you can get to the bulb. This is especially true if you have to remove the headlight assembly to get to the bulb(s).

Removing/installing the headlight assembly can result in damage to the vehicle.

Front light bulb replacement

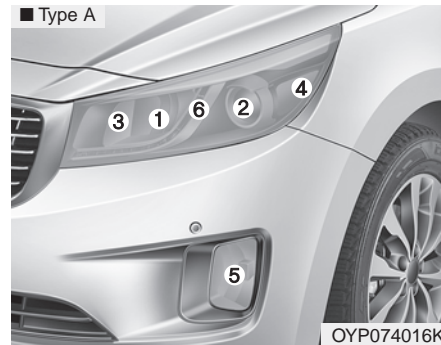

- (1) Headlight (High)
- (2) Headlight (Low)
- (3) Turn signal light / Position light (if equipped)
- (4) Side marker light
- (5) Front fog light (if equipped)
- (6) Position light (if equipped)



- (1) Headlight (High)
- (2) Headlight (Low)
- (3) Turn signal light
- (4) Side marker light
- (5) Front fog light (if equipped)
- (6) Position light

Headlight bulb



⚠ WARNING - Halogen bulbs

Handle halogen bulbs with care. Halogen bulbs contain pressurized gas that will produce flying pieces of glass if broken.

- Always handle them carefully, and avoid scratches and abrasions. If the bulbs are lit, avoid contact with liquids. Never touch the glass with bare hands. Residual oil may cause the bulb to overheat and burst when lit. A bulb should be operated only when installed in a headlight.
- If a bulb becomes damaged or cracked, replace it immediately and carefully dispose of it.
- Wear eye protection when changing a bulb. Allow the bulb to cool down before handling it.

⚠ WARNING - HID Headlamp low beam (if equipped)

Do not attempt to replace or inspect the low beam (XENON bulb) due to electric shock danger.

If the light bulb does not operate, have your vehicle checked by an authorized Kia dealer.

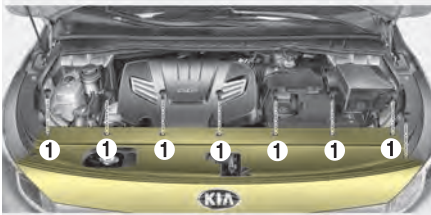
Headlamp (bulb type) -high/low

OYP074068N

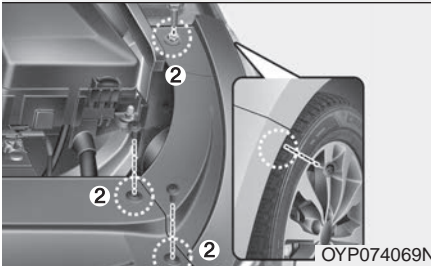

OYP074069N

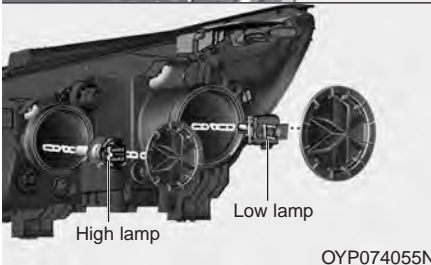

OYP074055N

1. Open the hood.
2. Remove the front cover(1) and headlamp assembly nuts(2).
3. Remove the headlamp assembly from the body of the vehicle
4. Remove the headlamp bulb cover by turning it counterclockwise.
5. Remove the socket from the assembly by turning the socket counterclockwise until the tabs on the socket align with the slots on the assembly.
6. Remove the bulb by pulling it out.
7. Inset a new bulb by inserting it into the socket.
8. Install the socket in the assembly by aligning the tabs on the socket with the slots in the assembly. Push the socket into the assembly and turn the socket clockwise.
9. Install the headlamp bulb cover by turning it clockwise.

Turn signal lamp/Position lamp

OYP074056N

Follow the steps 1 to 3 from the previous page.

4. Remove the socket from the assembly by turning the socket counterclockwise until the tabs on the socket align with the slots on the assembly.
5. Remove the bulb from the socket by pressing it in and rotating it counterclockwise until the tabs on the bulb align with the slots in the socket. Pull the bulb out of the socket

6. Insert a new bulb by inserting it into the socket and rotating it until it locks into place.
7. Install the socket in the assembly by aligning the tabs on the socket with the slots in the assembly. Push the socket into the assembly and turn the socket clockwise.

* NOTICE

If bulb will not rotate inside socket, remove bulb, rotate 180°, and try again.

Front side marker

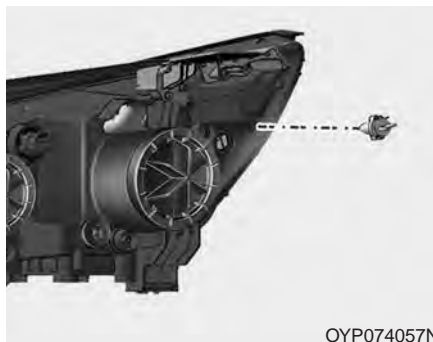

Follow the steps 1 to 3 from the previous page.

4. Remove the socket from the assembly by turning the socket counterclockwise until the tabs on the socket align with the slots on the assembly.
5. Pull the bulb out of the socket.
6. Insert a new bulb into the socket.
7. Install the socket into the assembly by aligning the tabs on the socket with the slots on the assembly and turning the socket clockwise.

Front fog lamp bulbs (if equipped)

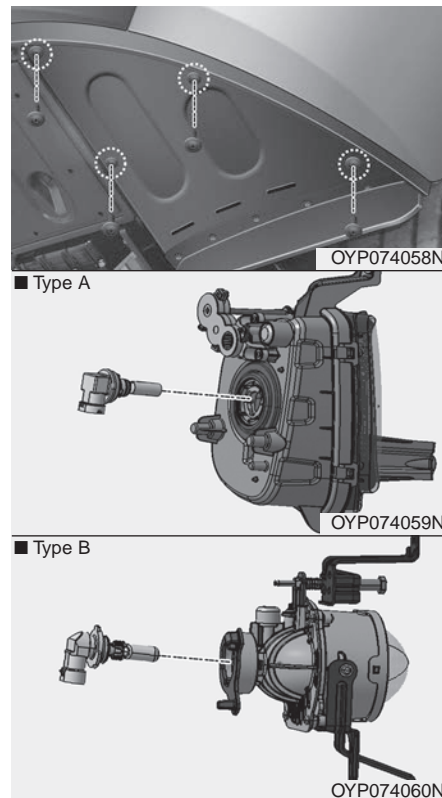

1. Remove the front bumper under cover.
2. Reach your hand into the back of the front bumper.
3. Disconnect the power connector from the socket.
4. Remove the bulb-socket from the housing by turning the socket counter clockwise until the tabs on the socket align with the slots on the housing.
5. Install the new bulb-socket into the housing by aligning the tabs on the socket with the slots in the housing. Push the socket into the housing and turn the socket clockwise.
6. Connect the power connector to the socket.
7. Reinstall the front bumper under cover.

* NOTICE

Always have the headlight aiming Adjusted after an accident or the Headlight assembly is reinstalled at a Authorized Kia dealer.

Headlamp (HID type), Front position (LED), bulb replacement

If the light bulb does not operate, have the vehicle checked by an authorized Kia dealer.

* NOTICE

HID lamps have superior performance vs. halogen bulbs. HID lamps are estimated by the manufacturer to last twice as long or longer than halogen bulbs depending on their frequency of use. They will probably require replacement at some point in the life of the vehicle. Cycling the headlamps on and off more than typical use will shorten HID lamps life. HID lamps do not fail in the same manner as halogen incandescent lamps. If a headlamp goes out after a period of operation but will immediately relamp when the headlamp switch is cycled it is likely the HID lamp needs to be replaced. HID lamping components are more complex than conventional halogen bulbs thus have higher replacement cost.

Side repeater lamp replacement



If the light bulb does not operate, have the vehicle checked by an authorized Kia dealer. A skilled technician should check or repair the side repeater lamp, for it may damage related out side mirror parts of the vehicle.

Rear combination lamp bulb replacement

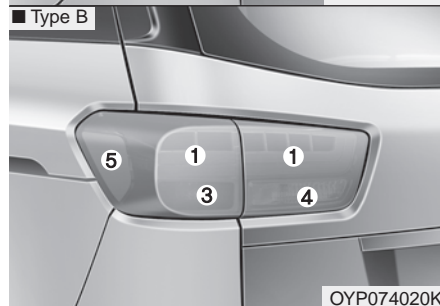
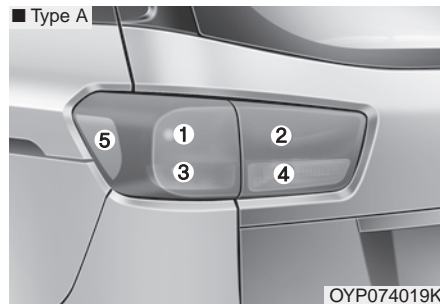

- (4) Back-up light
- (5) Rear side marker light

- (1) Stop and tail light
- (2) Tail light
- (3) Rear turn signal light

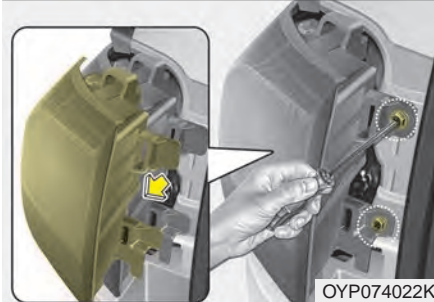
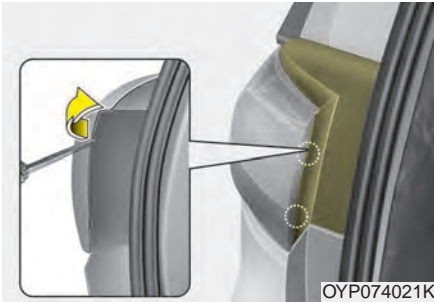
Outside lamp

1. Open the liftgate (tailgate).
2. Loosen the lamp assembly retaining screws with a philips head screwdriver.

3. Remove the rear combination lamp assembly from the body of the vehicle.

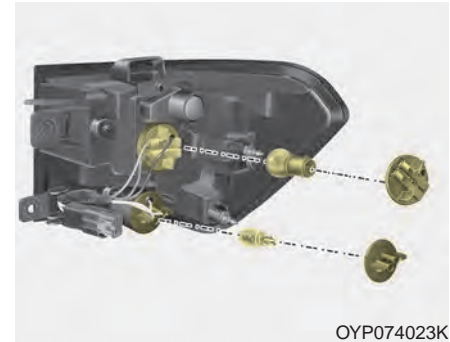

4. Remove the socket from the assembly by turning the socket counterclockwise until the tabs on the socket align with the slots on the assembly.
5. Remove the bulb from the socket by pressing it in and rotating it counterclockwise until the tabs on the bulb align with the slots in the socket. Pull the bulb out of the socket.
6. Insert a new bulb by inserting it into the socket and rotating it until it locks into place.

7. Install the socket in the assembly by aligning the tabs on the socket with the slots in the assembly. Push the socket into the assembly and turn the socket clockwise.
8. Reinstall the light assembly to the body of the vehicle.

* If your vehicle is equipped with LED type stop and tail lights replace with LED assembled units. Please contact an authorized Kia dealer.

Type B (Stop and tail lamp)

If the lamp bulb does not operate, have the vehicle checked by an authorized Kia dealer.

Inside lamp

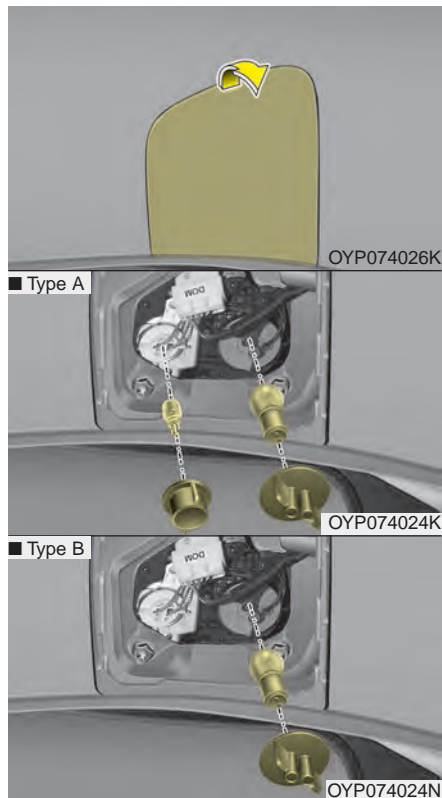

1. Open the liftgate (tailgate).
2. Remove the service cover.
3. Remove the socket from the assembly by turning the socket counterclockwise until the tabs on the socket align with the slots on the assembly.
4. Remove the bulb from the socket by pressing it in and rotating it counterclockwise until the tabs on the bulb align with the slots in the socket. Pull the bulb out of the socket.
5. Insert a new bulb by inserting it into the socket and rotating it until it locks into place.
6. Install the socket in the assembly by aligning the tabs on the socket with the slots in the assembly. Push the socket into the assembly and turn the socket clockwise.

7. Install the service cover by putting it into the service hole.

* If your vehicle is equipped with LED type stop and tail lights replace with LED assembled units. Please contact an authorized Kia dealer.

High mounted stop lamp replacement

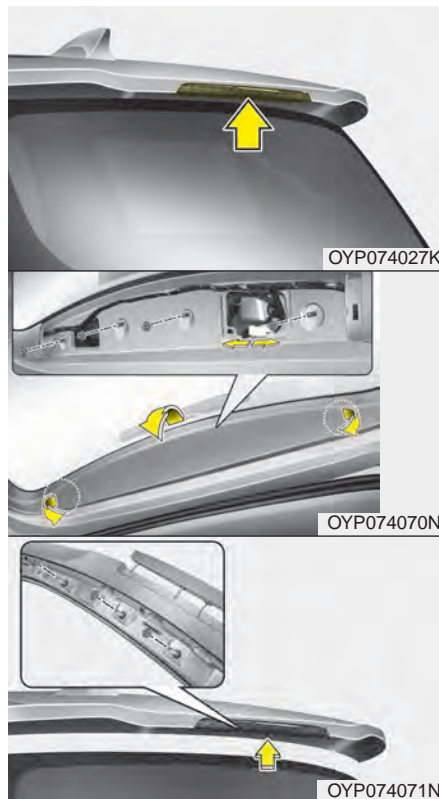

1. Open the liftgate (tailgate).
2. Gently remove the center cover of the rear liftgate (tailgate) trim.
3. Disconnect the electrical connector.
4. Loosen the retaining nuts and remove the spoiler.
5. Remove the high mounted stop light assembly after loosening the screws.
6. Reinstall a new light assembly in the reverse order of removal.

License plate light bulb replacement

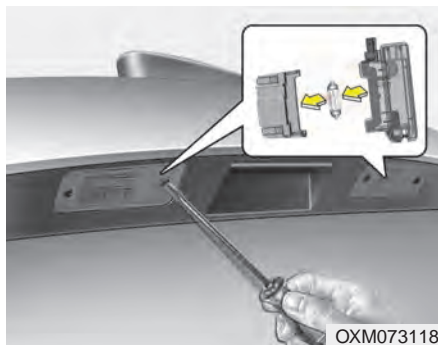

1. Loosen the lens retaining screws with a phillips head screwdriver.
2. Remove the lens.
3. Remove the bulb by pulling it straight out.
4. Install a new bulb.
5. Reinstall the lens securely with the lens retaining screws.

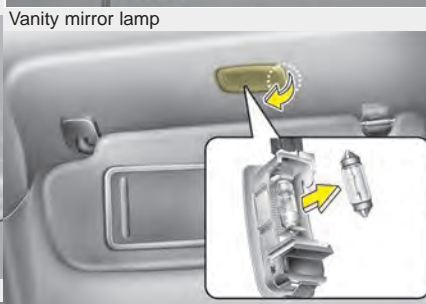
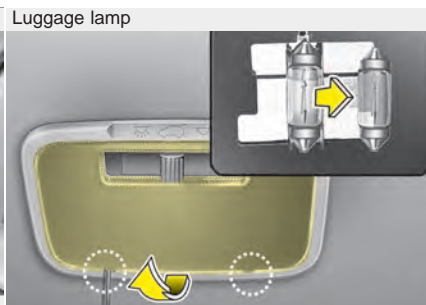
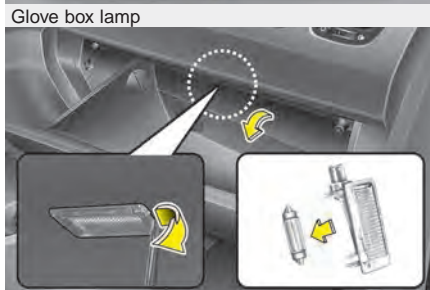
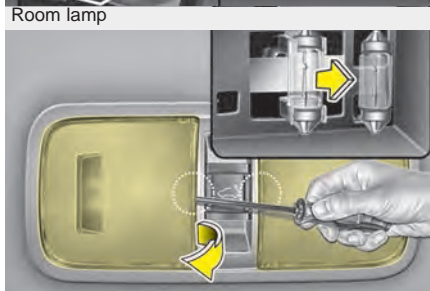

OYP074029K/OYP074031K/OYP074054N/
OYP074032K/OYP074030K

Interior light bulb replacement

1. Using a flat-blade screwdriver, gently pry the lens from the interior light housing.
2. Remove the bulb by pulling it straight out.

⚠ WARNING - Interior lights
Prior to working on the Interior Lights, ensure that the “OFF” button is depressed to avoid burning your fingers or receiving an electric shock.

3. Install a new bulb in the socket.
4. Align the lens tabs with the interior light housing notches and snap the lens into place.

APPEARANCE CARE

Exterior care

Exterior general caution

It is very important to follow the label directions when using any chemical cleaner or polish. Read all warning and caution statements that appear on the label.

Finish maintenance

Washing

To help protect your vehicle's finish from rust and deterioration, wash it thoroughly and frequently at least once a month with lukewarm or cold water.

If you use your vehicle for off-road driving, you should wash it after each off-road trip. Pay special attention to the removal of any accumulation of salt, dirt, mud, and other foreign materials. Make sure the drain holes in the lower edges of the doors and rocker panels are kept clear and clean.

Insects, tar, tree sap, bird droppings, industrial pollution and similar deposits can damage your vehicle's finish if not removed immediately.

Even prompt washing with plain water may not completely remove all these deposits. A mild soap, safe for use on painted surfaces, may be used.

After washing, rinse the vehicle thoroughly with lukewarm or cold water. Do not allow soap to dry on the finish.

After washing the vehicle, test the brakes while driving slowly to see if they have been affected by water. If braking performance is impaired, dry the brakes by applying them lightly while maintaining a slow forward speed.

High-pressure washing

- When using high-pressure washers, make sure to maintain sufficient distance from the vehicle.

Insufficient clearance or excessive pressure can lead to component damage or water penetration.

- Do not spray the camera, sensors or its surrounding area directly with a high pressure washer. Shock applied from high pressure water may cause the device to not operate normally.
- Do not bring the nozzle tip close to boots (rubber or plastic covers) or connectors as they may be damaged if they come into contact with high pressure water.

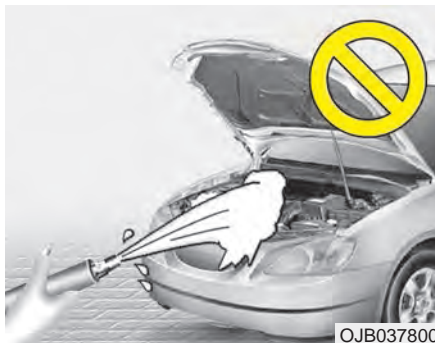

CAUTION - Wet engine

- ***Water washing in the engine compartment including high pressure water washing may cause the failure of electrical circuits located in the engine compartment.***
- ***Never allow water or other liquids to come in contact with electrical/electronic components inside the vehicle as this may damage them.***

Waxing

Wax the vehicle when water will no longer bead on the paint.

Always wash and dry the vehicle before waxing. Use a good quality liquid or paste wax, and follow the manufacturer's instructions. Wax all metal trim to protect it and to maintain its luster.

Removing oil, tar, and similar materials with a spot remover will usually strip the wax from the finish. Be sure to re-wax these areas even if the rest of the vehicle does not yet need waxing.

-  **CAUTION - Drying vehicle**
- ***Wiping dust or dirt off the body with a dry cloth will scratch the finish.***
 - ***Do not use steel wool, abrasive cleaners, acid detergents or strong detergents containing high alkaline or caustic agents on chrome-plated or anodized aluminum parts. This may result in damage to the protective coating and cause discoloration or paint deterioration.***

Finish damage repair

Deep scratches or stone chips in the painted surface must be repaired promptly. Exposed metal will quickly rust and may develop into a major repair expense.

If your vehicle is damaged and requires any metal repair or replacement, be sure the body shop applies anti-corrosion materials to the parts repaired or replaced.

Bright-metal maintenance

- To remove road tar and insects, use a tar remover, not a scraper or other sharp object.
- To protect the surfaces of bright-metal parts from corrosion, apply a coating of wax or chrome preservative and rub to a high luster.
- During winter weather or in coastal areas, cover the bright metal parts with a heavier coating of wax or preservative. If necessary, coat the parts with non-corrosive petroleum jelly or other protective compound.

Underbody maintenance

Road salt and other corrosive chemicals are used in cold weather states to melt snow and prevent ice accumulation. If these chemicals are not regularly removed, they will corrode the vehicle underbody and over time damage fuel lines, the fuel tank retention system, the vehicle suspension, the exhaust system, and even the body frame. The National Highway Traffic Safety Administration has warned all vehicle owners of all brands of the need to take the following steps:

- Wash the undercarriage of your vehicle regularly during the winter and whenever your vehicle has been exposed to such salts or chemicals.
- Do a thorough washing of the undercarriage at the end of the winter.
- Use professional service technicians or governmental inspection stations to annually inspect for corrosion.
- Immediately seek an inspection of your vehicle if you become visually aware of corrosion flaking or scaling or if you become aware of a change in vehicle performance, such as soft or spongy brakes, fluids leaking, impairment of directional control, suspension noises or rattling metal straps.

Aluminum wheel maintenance

The aluminum wheels are coated with a clear protective finish.

- Do not use any abrasive cleaner, polishing compound, solvent, or wire brushes on aluminum wheels. They may scratch the finish.
- Clean the wheel when it has cooled.
- Use only a mild soap or neutral detergent, and rinse thoroughly with water. Also, be sure to clean the wheels after driving on salted roads. This helps prevent corrosion.
- Avoid washing the wheels with highspeed vehicle wash brushes.
- Do not use any alkaline or acid detergents. It may damage and corrode the aluminum wheels coated with a clear protective finish.

Corrosion protection

Protecting your vehicle from corrosion

By using the most advanced design and construction practices to combat corrosion, we produce vehicles of the highest quality. However, this is only part of the job. To achieve the long-term corrosion resistance your vehicle can deliver, the owner's cooperation and assistance is also required.

Common causes of corrosion

The most common causes of corrosion on your vehicle are:

- Road salt, dirt and moisture that is allowed to accumulate underneath the vehicle.
- Removal of paint or protective coatings by stones, gravel, abrasion or minor scrapes and dents which leave unprotected metal exposed to corrosion.

High-corrosion areas

If you live in an area where your vehicle is regularly exposed to corrosive materials, corrosion protection is particularly important. Some of the common causes of accelerated corrosion are road salts, dust control chemicals, ocean air and industrial pollution.

Moisture breeds corrosion

Moisture creates the conditions in which corrosion is most likely to occur. For example, corrosion is accelerated by high humidity, particularly when temperatures are just above freezing. In such conditions, the corrosive material is kept in contact with the vehicle's surface by moisture that evaporates slowly.

Mud is particularly corrosive because it dries slowly and holds moisture in contact with the vehicle. Although the mud appears to be dry, it can still retain the moisture and promote corrosion.

High temperatures can also accelerate corrosion of parts that are not properly ventilated so the moisture can be dispersed. For all these reasons, it is particularly important to keep your vehicle clean and free of mud or accumulations of other materials. This applies not only to the visible surfaces but particularly to the underside of the vehicle.

To help prevent corrosion

You can help prevent corrosion from beginning by observing the following:

Keep your vehicle clean

The best way to prevent corrosion is to keep your vehicle clean and free of corrosive materials. Attention to the underside of the vehicle is particularly important.

- If you live in a high-corrosion area — where road salts are used, near the ocean, areas with industrial pollution, acid rain, etc.—, you should take extra care to prevent corrosion. In winter, hose off the underside of your vehicle at least once a month and be sure to clean the underside thoroughly when winter is over.
- When cleaning underneath the vehicle, give particular attention to the components under the fenders and other areas that are hidden from view. Do a thorough job; just dampening the accumulated mud rather than washing it away will accelerate corrosion rather than prevent it. Water under high pressure and steam are particularly effective in removing accumulated mud and corrosive materials.
- When cleaning lower door panels, rocker panels and frame members, be sure that drain holes are kept open so that moisture can escape and not be trapped inside to accelerate corrosion.

Keep your garage dry

Don't park your vehicle in a damp, poorly ventilated garage. This creates a favorable environment for corrosion. This is particularly true if you wash your vehicle in the garage or drive it into the garage when it is still wet or covered with snow, ice or mud. Even a heated garage can contribute to corrosion unless it is well ventilated so moisture is dispersed.

Keep paint and trim in good condition

Scratches or chips in the finish should be covered with "touch-up" paint as soon as possible to reduce the possibility of corrosion. If bare metal is showing through, the attention of a qualified body and paint shop is recommended.

Bird droppings : Bird droppings are highly corrosive and may damage painted surfaces in just a few hours. Always remove bird droppings as soon as possible.

Don't neglect the interior

Moisture can collect under the floor mats and carpeting and cause corrosion. Check under the mats periodically to be sure the carpeting is dry. Use particular care if you carry fertilizers, cleaning materials or chemicals in the vehicle.

These should be carried only in proper containers and any spills or leaks should be cleaned up, flushed with clean water and thoroughly dried.

Interior care

Interior general precautions

Prevent chemicals such as perfume, cosmetic oil, sun cream, hand cleaner, and air freshener from contacting the interior parts because they may cause damage or discoloration. If they do contact the interior parts, wipe them off immediately. If necessary, use a vinyl cleaner, see product instructions for correct usage.

 **CAUTION - Electrical components**

Never allow water or other liquids to come in contact with electrical/electronic components inside the vehicle as this may damage them.

 **CAUTION - Leather**

When cleaning leather products (steering wheel, seats etc.), use neutral detergents or low alcohol content solutions. If you use high alcohol content solutions or acid/alkaline detergents, the color of the leather may fade or the surface may get stripped off.

Taking care of leather seats

- Vacuum the seat periodically to remove dust and sand on the seat. It will prevent abrasion or damage of the leather and maintain its quality.
- Wipe the natural leather seat cover often with dry or soft cloth.
- Sufficient use of a leather protective may prevent abrasion of the cover and helps maintain the color. Be sure to read the instructions and consult a specialist when using leather coating or protective agents.
- Leather with bright colors (beige, cream beige) is easily contaminated and clear in appearance. Clean the seats frequently.
- Avoid wiping with wet cloth. It may cause the surface to crack.

Cleaning the leather seats

- Remove all contaminations instantly. Refer to instructions below for removal of each contaminant.
- Cosmetic products (sunscreen, foundation, etc.)
 - Apply cleansing cream on a cloth and wipe the contaminated point. Wipe off the cream with a wet cloth and remove water with a dry cloth.
- Beverages (coffee, soft drink, etc.)
 - Apply a small amount of neutral detergent and wipe until contaminations do not smear.
- Oil
 - Remove oil instantly with absorbable cloth and wipe with stain remover for natural leather only.
- Chewing gum
 - Harden the gum with ice and remove gradually.

Fabric seat cover using precautions (If equipped)

Please clean the fabric seats regularly with a vacuum cleaner in consideration of fabric material characteristics. If they are heavily soiled with beverage stains, etc., use a suitable interior cleaner. To prevent damage to seat covers, wipe off the seat covers down to the seams with a large wiping motion and moderate pressure using a soft sponge or microfiber cloth.

Velcro closures on clothing or sharp objects may cause snagging or scratches on the surface of the seats.

Make sure not to rub such objects against the surface.

Cleaning the upholstery and interior trim

Vinyl

Remove dust and loose dirt from vinyl with a whisk broom or vacuum cleaner. Clean vinyl surfaces with a vinyl cleaner.

Fabric

Remove dust and loose dirt from fabric with a whisk broom or vacuum cleaner. Clean with a mild soap solution recommended for upholstery or carpets. Remove fresh spots immediately with a fabric spot cleaner. If fresh spots do not receive immediate attention, the fabric can be stained and its color can be affected. Also, its fire-resistant properties can be reduced if the material is not properly maintained.

Using anything but recommended cleaners and procedures may affect the fabric's appearance and fire-resistant properties.

Cleaning the lap/shoulder belt webbing

Clean the belt webbing with any mild soap solution recommended for cleaning upholstery or carpet. Follow the instructions provided with the soap. Do not bleach or re-dye the webbing because this may weaken it.

Cleaning the interior window glass

If the interior glass surfaces of the vehicle become fogged (that is, covered with an oily, greasy or waxy film), they should be cleaned with a glass cleaner. Follow the directions on the glass cleaner container.

 **CAUTION - Rear window**
Do not scrape or scratch the inside of the rear window. This may result in damage of the rear window defroster grid.

EMISSION CONTROL SYSTEM

The emission control system of your vehicle is covered by a written limited warranty. Please see the warranty information contained in the Warranty & Consumer Information manual in your vehicle.

Your vehicle is equipped with an emission control system to meet all applicable emission regulations.

There are three emission control systems, as follows.

- (1) Crankcase emission control system
- (2) Evaporative emission control system
- (3) Exhaust emission control system

In order to assure the proper function of the emission control systems, it is recommended that you have your vehicle inspected and maintained by an authorized Kia dealer in accordance with the maintenance schedule in this manual.

Caution for the Inspection and Maintenance Test (With Electronic Stability Control (ESC) system)

- **To prevent the vehicle from misfiring during dynamometer testing, turn the Electronic Stability Control (ESC) system off by pressing the ESC switch.**
- **After dynamometer testing is completed, turn the ESC system back on by pressing the ESC switch again.**

1. Crankcase emission control system

The positive crankcase ventilation system is employed to prevent air pollution caused by blow-by gases being emitted from the crankcase. This system supplies fresh filtered air to the crankcase through the air intake hose. Inside the crankcase, the fresh air mixes with blow-by gases, which then pass through the PCV valve into the induction system.

2. Evaporative emission control (including ORVR: Onboard Refueling Vapor Recovery) system

The Evaporative Emission Control System is designed to prevent fuel vapors from escaping into the atmosphere.

(The ORVR system is designed to allow the vapors from the fuel tank to be loaded into a canister while refueling at the gas station, preventing the escape of fuel vapors into the atmosphere.)

Canister

Fuel vapors generated inside the fuel tank are absorbed and stored in the onboard canister. When the engine is running, the fuel vapors absorbed in the canister are drawn into the surge tank through the purge control solenoid valve.

Purge Control Solenoid Valve (PCSV)

The purge control solenoid valve is controlled by the Engine Control Module (ECM); when the engine coolant temperature is low during idling, the PCSV closes so that evaporated fuel is not taken into the engine. After the engine warms up during ordinary driving, the PCSV opens to introduce evaporated fuel to the engine.

3. Exhaust emission control system

The Exhaust Emission Control System is a highly effective system which controls exhaust emissions while maintaining good vehicle performance.

Vehicle modifications

This vehicle should not be modified. Modification of your vehicle could affect its performance, safety or durability and may even violate governmental safety and emissions regulations.

In addition, damage or performance problems resulting from any modification may not be covered under warranty.

- If you use unauthorized electronic devices, it may cause the vehicle to operate abnormally, wire damage, battery discharge and fire. For your safety, do not use unauthorized electronic devices.

Engine exhaust gas precautions (carbon monoxide)

- Carbon monoxide can be present with other exhaust fumes. Therefore, if you smell exhaust fumes of any kind inside your vehicle, have it inspected and repaired immediately. If you ever suspect exhaust fumes are coming into your vehicle, drive it only with all the windows fully open. Have your vehicle checked and repaired immediately.

⚠ WARNING - Exhaust

Engine exhaust gases contain carbon monoxide (CO). Though colorless and odorless, it is dangerous and could be lethal if inhaled. Follow the instructions on this page to avoid CO poisoning.

- Do not operate the engine in confined or closed areas (such as garages) any more than what is necessary to move the vehicle in or out of the area.
- When the vehicle is stopped in an open area for more than a short time with the engine running, adjust the ventilation system (as needed) to draw outside air into the vehicle.
- Never sit in a parked or stopped vehicle for any extended time with the engine running.
- When the engine stalls or fails to start, excessive attempts to restart the engine may cause damage to the emission control system.

Operating precautions for catalytic converters (if equipped)

⚠ WARNING - Catalytic converter

Keep away from the catalytic converter and exhaust system while the vehicle is running or immediately thereafter. The exhaust and catalytic systems are very hot and may burn you.

⚠ WARNING - Fire

- **Do not park, idle or drive the vehicle over or near flammable objects, such as grass, vegetation, paper, leaves, etc. A hot exhaust system can ignite flammable items under your vehicle.**
- **Also, do not remove the heat sink around the exhaust system, do not seal the bottom of the vehicle or do not coat the vehicle for corrosion control. It may present a fire risk under certain conditions.**

Your vehicle is equipped with a catalytic converter emission control device.

Therefore, the following precautions must be observed:

- Use only UNLEADED FUEL for gasoline engines.
- Do not operate the vehicle when there are signs of engine malfunction, such as misfire or a noticeable loss of performance.
- Do not misuse or abuse the engine. Examples of misuse are coasting with the ignition off and descending steep grades in gear with the ignition off.
- Do not operate the engine at high idle speed for extended periods (5 minutes or more).

- Do not modify or tamper with any part of the engine or emission control system. All inspections and adjustments must be made by an authorized Kia dealer.

- Avoid driving with an extremely low fuel level. Running out of fuel could cause the engine to misfire, damaging the catalytic converter.

Failure to observe these precautions could result in damage to the catalytic converter and to your vehicle. Additionally, such actions could void your warranties.

CALIFORNIA PERCHLORATE NOTICE

Perchlorate Material-special handling may apply, See www.dtsc.ca.gov/hazardouswaste/perchlorate.

Notice to California Vehicle Dismantlers:
Perchlorate containing materials, such as air bag inflators, seatbelt pretensioners and keyless remote entry batteries, must be disposed of according to Title 22 California Code of Regulations Chapter 67384.10 (a).

Specifications, Consumer information and Reporting safety defects

Dimensions	8-2
Engine	8-2
Bulb wattage	8-3
Tires and wheels	8-4
Gross vehicle weight	8-5
Luggage volume	8-5
Air conditioning system	8-5
Recommended lubricants and capacities	8-6
• Recommended SAE viscosity number	8-7
Vehicle identification number (VIN)	8-8
Vehicle certification label	8-8
Tire specification and pressure label	8-9
Engine number	8-9
Refrigerant label	8-9
Consumer assistance (U.S. only)	8-10
Electrical Equipment (U.S. only)	8-13
Reporting Safety Defects (U.S. only)	8-14
Online factory authorized manuals (U.S. Only) ..	8-14

DIMENSIONS

Item		in (mm)	
Overall length		201.4 (5,115)	
Overall width		78.1 (1,985)	
Overall height	Without Roof rack		68.5 (1,740)
	With Roof rack		69.1 (1,755)
Tread	Front	235/65 R17	68.7 (1,745)
		235/60 R18	68.5 (1,740)
		235/55 R19	68.3 (1,735)
	Rear	235/65 R17	68.9 (1,752)
		235/60 R18	68.8 (1,747)
		235/55 R19	68.6 (1,742)
Wheelbase		120.5 (3,060)	

ENGINE

Item	LAMBDA 3.3 GDI
Displacement cu. in (cc)	203.94 (3,342)
Bore x Stroke in. (mm)	3.62 X 3.29 (92 X 83.8)
Firing order	1-2-3-4-5-6
No. of cylinders	6, V - type

BULB WATTAGE

Light Bulb		Wattage(W)	Bulb type	
Front	Headlamps (Low)	55	H7 S LL	
	Headlamps (Low) - HID type*	35	D3S	
	Headlamps (High)	55	H7 LL	
	Front turn signal lamps	28	PY28/8W	
	Front position lamps	Bulb type	8	PY28/8W
		LED type	LED	LED
	Daytime running light	24	H7 LL	
	Front fog lamps	MFR	35	H8
		PROJ	55	HB4
	Side Repeater lamps	LED type	LED	LED
	Side Marker lamps	Bulb type	5	W5W
LED type		LED	LED	
Rear	Rear Stop/Tail lamps (outside)	Bulb type	28	P28/8W
	Rear tail lamps (Inside)		8	P28/8W
	Rear Stop/Tail lamps (outside)	LED type	LED	LED
	Rear tail lamps (Inside)		LED	LED
	Rear turn signal lamps	28	P28/8W	
	Back-up lamps	16	W16W	
	Side Marker lamps	Bulb type	5	W5W
		LED type	LED	LED
	High mounted stop lamp*	LED type	LED	LED
License plate lamps	5	W5W		
Interior	Map lamps	10	WEDGE	
	Room lamps	10	FESTOON	
	Vanity mirror lamps	5	FESTOON	
	Glove box lamp	5	WEDGE	
	Luggage lamp	10	FESTOON	

* If equipped

TIRES AND WHEELS

Item	Tire size	Wheel sizee	Inflation pressure [psi (kPa)]				Wheel lug nut torque lbf•ft (kgf•m, N•m)
			Normal load *1		Maximum load		
			Front	Rear	Front	Rear	
Full size tire	235/65 R17	6.5J X 17	35 (240)	35 (240)	35 (240)	35 (240)	65 ~ 79 (9 ~ 11, 88 ~ 107)
	235/60 R18	7.0J X 18	35 (240)	35 (240)	35 (240)	35 (240)	
	235/55 R19	7.5J X 19	35 (240)	35 (240)	35 (240)	35 (240)	
Compact spare tire	T135/90 R17	4.0T X 17	60 (420)	60 (420)	60 (420)	60 (420)	

*1: Normal load : Up to 3 persons

CAUTION

***When replacing tires, use the same size originally supplied with the vehicle.
Using tires of a different size can damage the related parts or make it work irregularly.***

* NOTICE

- It is permissible to add 3 psi (21 kPa) to the standard tire pressure specification if colder temperatures are expected soon.
Tires typically loose 1 psi (7 kPa) for every 12°F (-11°C) temperature drop. If extreme temperature variations are expected, re-check your tire pressure as necessary to keep them properly inflated.
- We recommend that when replacing tires, use the same originally supplied with the vehicles. If not, that affects driving performance.
- When driving in high altitude grades, it is natural for the atmospheric pressure to decrease. Therefore, please check the tire pressure and add more air when necessary.
Additionally required tire air pressure per km above sea level: 1.5 psi (10.5 kPa)

GROSS VEHICLE WEIGHT

Item	LAMBDA 3.3 GDI
Gross vehicle weight lbs. (kg)	6,085 (2,760)

LUGGAGE VOLUME

Item	LAMBDA 3.3 GDI
Luggage volume (SAE) cu ft (l)	33.9 (960) * BEHIND 3RD ROW

AIR CONDITIONING SYSTEM

Item	Weight of volume	Classification
Refrigerant	1,100±25g	R-134a
Compressor lubricant	210±10g	PAG (FD46XG)

We recommend that you contact an authorized Kia dealer for more details.

RECOMMENDED LUBRICANTS AND CAPACITIES

To help achieve proper engine and powertrain performance and durability, use only lubricants of the proper quality. The correct lubricants also help promote engine efficiency that results in improved fuel economy.

These lubricants and fluids are recommended for use in your vehicle.

Lubricant		Volume	Classification
Engine oil *1 *2 (drain and refill) Recommends (or equivalent) 	Lambda 3.3 GDI Engine	6.02 US qt. (5.7L)	ACEA A5*3 or above
Automatic transaxle fluid	Lambda 3.3 GDI Engine	8.24 US qt. (7.8L)	ATF SP-IV or equivalent
Coolant	Lambda 3.3 GDI Engine	12.15 US qt. (11.5L)	Mixture of antifreeze and water (Ethylene glycol base coolant for aluminum radiator)
Power steering fluid (if equipped)		1.06~1.59 US qt. (1.0~1.5L)	PSF-4
Brake fluid		0.61~0.66 US qt. (0.58~0.62L)	SAE J1703, FMVSS 116 DOT-3 or DOT-4
Fuel		84.54 US qt. (80L)	Unleaded gasoline

*1 Refer to the recommended SAE viscosity numbers on the next page.

*2 Engine oils labeled Energy Conserving Oil are now available. Along with other additional benefits, they contribute to fuel economy by reducing the amount of fuel necessary to overcome engine friction. Often, these improvements are difficult to measure in everyday driving, but in a year's time, they can offer significant cost and energy savings.

*3 If the ACEA A5 engine oil is not available in your country, you are able to use API service SL, IL SAC GF-3, ACEA A3.

Recommended SAE viscosity number

Always be sure to clean the area around any filler plug, drain plug, or dipstick before checking or draining any lubricant. This is especially important in dusty or sandy areas and when the vehicle is used on unpaved roads. Cleaning the plug and dipstick areas will prevent dirt and grit from entering the engine and other mechanisms that could be damaged.

Engine oil viscosity (thickness) has an effect on fuel economy and cold weather operating (engine start and engine oil flowability). Lower viscosity engine oils can provide better fuel economy and cold weather performance, however, higher viscosity engine oils are required for satisfactory lubrication in hot weather.

Using oils of any viscosity other than those recommended could result in engine damage.

When choosing an oil, consider the range of temperature your vehicle will be operated in before the next oil change.

Proceed to select the recommended oil viscosity from the chart.

Temperature Range for SAE Viscosity Numbers										
Temperature	°C	-30	-20	-10	0	10	20	30	40	50
	(°F)	-10	0	20	40	60	80	100	120	
Engine Oil *1	10W-30									
	5W-30									

- For better fuel economy, it is recommended to use the engine oil of a viscosity grade SAE 5W-30 (ACEA A5). However, if the engine oil is not available in your country, select the proper engine oil using the engine oil viscosity chart.



VEHICLE IDENTIFICATION NUMBER (VIN)

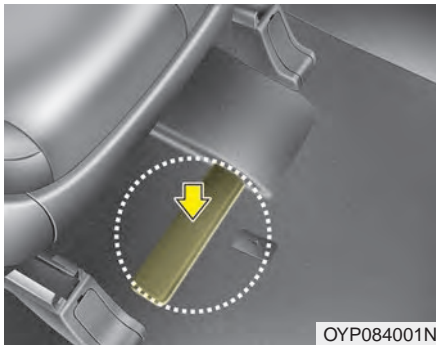

The vehicle identification number (VIN) is the number used in registering your vehicle and in all legal matters pertaining to its ownership, etc.

The number is punched on the floor under the front passenger seat. To check the number, remove the cover.



The VIN is also on a plate attached to the top of the dashboard. The number on the plate can easily be seen through the windshield from outside.

VEHICLE CERTIFICATION LABEL

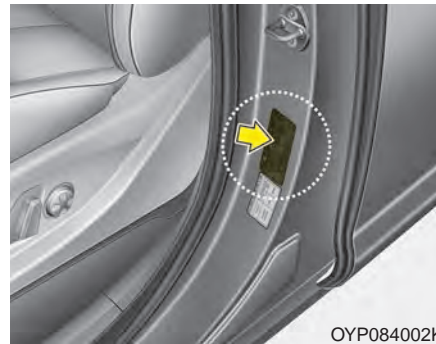

The vehicle certification label attached on the driver's side center pillar gives the vehicle identification number (VIN).

TIRE SPECIFICATION AND PRESSURE LABEL

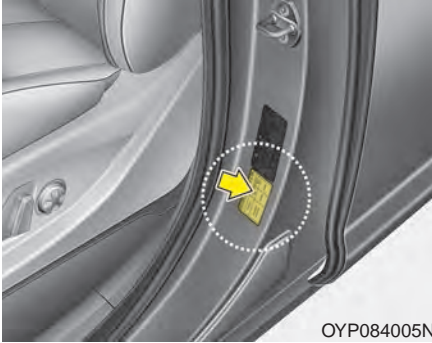

The tires supplied on your new vehicle are chosen to provide the best performance for normal driving.

The tire label located on the driver's side center pillar gives the tire pressures recommended for your vehicle.

ENGINE NUMBER

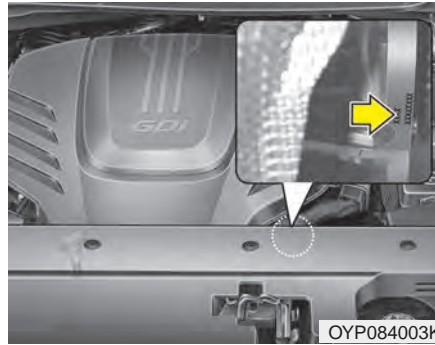

The engine number is stamped on the engine block as shown in the drawing.

REFRIGERANT LABEL (IF EQUIPPED)



The refrigerant label is located on the underside of the hood.

CONSUMER ASSISTANCE (U.S. ONLY)

Roadside Assistance is provided on all new current model year Kia Vehicles from the date the vehicle is delivered to the first retail buyer or otherwise put into use (in-service date), whichever is earlier, for a period of 60 months or 60,000 miles, whichever is earlier, subject to the terms, conditions and exclusions set forth in the Kia Warranty and Consumer Information Manual applicable to your model year vehicle.

KMA reserves the right to limit or deny services or other benefits to any owner or driver when, in KMA's judgment, the claims and/or service requests are excessive in frequency or type of occurrence.

Toll free consumer assistance

Kia's toll-free Consumer Assistance hot line is staffed from 5:00 AM to 6:00 PM PST, Monday through Friday and is accessible by dialing 1-800-333-4Kia (4542).

For more information regarding assistance available, please refer to your Kia Warranty & Consumer Information Manual.

Emergency roadside assistance

Kia's toll free Roadside Assistance hot line is staffed 24 hours a day, 365 days a year and is accessible by dialing 1-800-333-4Kia (4542).

Please note that you must provide your Vehicle Identification Number (VIN) to verify coverage at the time of your call. The VIN can be found on the dash of your vehicle on the driver's side, on the door jamb of the driver's door, your vehicle's registration or proof of insurance card.

Kia utilizes a network of over 30,000 roadside assistance providers. Should you accidentally run out of fuel, require a battery jump, or need help changing a tire, a Kia Roadside Assistance Representative will dispatch someone to deliver a small quantity of gas, change a flat tire with your inflated spare, or arrange a battery jump to allow you to proceed to your destination. We have access to a network of over 10,000 locksmiths to help you should you become locked out of your Kia.

In the event that mechanical difficulty renders your vehicle undriveable due to a warranty-related concern, Kia's Roadside Assistance Representative will arrange to transport your vehicle to the nearest Kia dealer or to an authorized Kia alternative service location.

Your vehicle must be accessible to our dispatch transport vehicle, as determined by our driver, to receive this service.

*** NOTICE**

Roadside Assistance benefits are not available for any Kia vehicle that has ever been or should be issued a “salvage” title or similar “branded” title under any state’s law or has been declared a “total loss” or equivalent by a financial institution or insurance company.

Trip interruption

Trip interruption expense benefits are provided in the event that a warranty-related disablement occurs more than 150 miles from your home, and the repairs require more than 24 hours to complete. Reasonable reimbursement is included for meals, lodging, or rental vehicle expenses. Trip interruption coverage is limited to \$100 per day subject to a three day maximum limit per incident. You must contact the Kia Roadside Assistance Center to obtain pre-authorization of expenses. Once the Kia Roadside Assistance Center gives authorization for trip interruption benefits, they will assist you in making the necessary arrangements. Insurance deductibles, expenses, and claims paid by your insurance company or other providers are not eligible for reimbursement.

Fleet vehicles are excluded from reimbursement under Kia’s Trip Interruption Policy.

Registering your vehicle in a foreign country

If you plan to register your vehicle in a foreign country, you should confirm that it conforms to the regulations in that country. Even if you successfully register the vehicle in a foreign country, you may experience the following problems and should therefore consider the possibility of having to deal with them:

1. The fuel specified for your vehicle may be unavailable. If other than the specified fuel is used, it could cause damage to the engine, the fuel injection system, and other fuel-related parts which may not be covered under your New Vehicle Emissions Limited Warranty.
2. We must, therefore, clearly state that when you leave the country in which you purchased your Kia new and register it in another country, problems arising from the use of fuel other than the specified fuel are not subject to manufacturer's warranty. Because vehicles like yours may not be marketed in the new country of registration, parts, servicing techniques and tools necessary to maintain and repair your vehicle may be unavailable.

Even if vehicles like yours are sold there, mechanical specifications required by the government may vary enough from the country of purchase to cause additional problems.

3. There may not be an Authorized Kia Dealer in the area in which you plan to register your vehicle. You may additionally experience difficulty in obtaining services in a foreign country for any number of reasons.

Further, we cannot assume any responsibility for problems that result from unsatisfactory service or lack of service outside of the United States.

ELECTRICAL EQUIPMENT (U.S. ONLY)

The electrical system of your vehicle is designed to perform under all reasonably expected operating conditions. However, before any additional electrical equipment is installed in your vehicle, consult an Authorized Kia Dealer, in order to ensure that you do not void your warranty.

Certain electrical equipment, or the way in which it is installed, may adversely affect the operation of your vehicle, including such systems as the engine control system, the audio system and the electrical charging system and thus potentially void all or part of your warranty.

We assume no responsibility for any expense you may incur or for any malfunction of your vehicle or any of its components or systems that may result from the installation of additional electrical equipment that is not supplied, or recommended for installation by, Kia.

Installation of a mobile two-way radio system

If a mobile two-way radio system is installed improperly, or if an excessively powerful type of system is used, other electronic systems may be adversely affected. To avoid damage to your vehicle, consult an Authorized Kia Dealer concerning the proper equipment and installation.

Kia motor vehicles are designed and manufactured to meet or exceed all applicable safety standards.

For your safety, however, we strongly urge you to read and follow all directions in this Owner's Manual, particularly the information under the headings "NOTICE", "CAUTION" and "WARNING".

If, after reading this manual, you have any questions regarding the operation of your vehicle, safety issues and defects please contact your Kia's toll-free Consumer Assistance hot line as below:

National Consumer Affairs Manager
Kia Motors America, Inc.
P.O. Box 52410
Irvine, CA 92619-2410
1-800-333-4Kia (4542)

REPORTING SAFETY DEFECTS (U.S. ONLY)

If you believe that your vehicle has a defect which could cause a crash or could cause injury or death, you should immediately inform the National Highway Traffic Safety Administration (NHTSA) in addition to notifying Kia Motors America, Inc.

If NHTSA receives similar complaints, it may open an investigation, and if it finds that a safety defect exists in a group of vehicles, it may order a recall and remedy campaign. However, NHTSA cannot become involved in individual problems between you, your dealer, or Kia Motors America, Inc.

To contact NHTSA, you may call the Vehicle Safety Hotline toll-free at 1-888-327-4236 (TTY: 1-800-424-9153); go to <http://www.safercar.gov>; or write to: Administrator, NHTSA, 1200 New Jersey Ave., SE., West Building, Washington, DC 20590. You can also obtain other information about motor vehicle safety from <http://www.safercar.gov>.

ONLINE FACTORY AUTHORIZED MANUALS (U.S. ONLY)

The following publications are available on www.KiaTechinfo.com.

Service manual:

This manual covers maintenance and recommended procedures for repair to engine and chassis components. It is written for the Journeyman mechanic, but is simple enough for most mechanically inclined owners to understand.

Electrical troubleshooting manual:

This manual complements the Service Manual by providing indepth troubleshooting information for each electrical circuit in your vehicle.

Owner's manual:

This manual describes the overall features and operating procedures for the vehicle.

Index

A	
Active ECO system	5-66
Active ECO operation	5-66
Limitation of Active ECO operation	5-66
When Active ECO is activated	5-66
Air bag - advanced supplemental restraint system	3-60
Air bag warning label	3-87
Air bag warning light	3-63
Curtain air bag	3-79
Driver's and passenger's front air bag	3-74
How does the air bag system operate	3-61
Occupant Detection System(ODS)	3-67
Side air bag	3-77
SRS Care	3-86
SRS components and functions	3-64
Air cleaner	7-40
Filter replacement	7-40
Air conditioning system	8-5
Appearance care	7-88
Exterior care	7-88
Interior care	7-94
Audio	4-208
Declaration of Conformity	4-246
Feature of Your Audio	4-209
Media	4-218
Phone	4-234
Radio	4-215
Setup	4-244
Siri	4-243
SiriusXM	4-216
Audio system	4-203
Antenna	4-203
AUX, USB port	4-203
How vehicle audio works	4-204
Automatic climate control system	4-163
Air Conditioning refrigerant label	4-181
Automatic heating and air conditioning	4-164
Checking the amount of air conditioner refrigerant and compressor lubricant	4-180
Climate control air filter	4-179
From the front seat	4-174
From the rear seat	4-174
Manual heating and air conditioning	4-165
Outside thermometer	4-169
Rear climate control	4-174
System operation	4-177
Automatic transaxle	5-13
Automatic transaxle operation	5-13
Good driving practices	5-18
Autonomous emergency braking (AEB)	5-33
AEB Front Radar Sensor	5-38
AEB Warning Message and System Control	5-35
Limitations of the System	5-40
System Malfunction	5-39
System Setting and Activation	5-33

B

Battery	7-48
Battery recharging	7-49
For best battery service	7-48
Recharging Battery	7-50
Reset items	7-50
Before driving	5-4
Before entering vehicle	5-4
Before starting	5-4
Necessary inspections	5-4
Blind spot detection system (BSD)	5-69
BSD (Blind Spot Detection) /	
LCA (Lane Change Assist)	5-70
Non-operating condition	5-75
RCTA (Rear Cross Traffic Alert)	5-73
Brake fluid	7-37
Checking the brake fluid level	7-37
Brake system	5-19
Anti-lock brake system (ABS)	5-22
Electronic stability control (ESC)	5-25
Good braking practices	5-31
Hill-start assist control (HAC)	5-30
Parking brake – Foot type	5-21
Power brakes	5-19
Vehicle stability management (VSM)	5-29
Bulb wattage	8-3

C

California perchlorate notice	7-101
Child restraint system	3-52
Lower anchor system	3-58
Tether anchor system	3-57
Using a child restraint system	3-53
Clean air	4-187
Climate control air filter	7-42
Filter inspection	7-42
Consumer assistance (U.S. only)	8-10
Cruise Control system	5-45
To cancel cruise control	5-47
To decrease the cruising speed	5-46
To increase cruise control set speed	5-46
To resume cruising speed at more than	
approximately 20 mph (30 km/h)	5-48
To set cruise control speed	5-45
To temporarily accelerate with the cruise	
control on	5-47
To turn cruise control off	5-48

D

Defroster	4-145
Rear window defroster	4-145
Dimensions	8-2
Door locks	4-24

Automatic door lock system	4-29
Child-protector rear door lock	4-29
Impact sensing door unlock system	4-29
Operating door locks from inside the vehicle	4-26
Operating door locks from outside the vehicle	4-24
Drive mode integrated control system	5-67
DRIVE mode	5-67

E

Economical operation	5-81
Electrical Equipment (U.S. only)	8-13
Emergency starting	6-5
Jump starting	6-5
Push-starting	6-7
Emission control system	7-97
Crankcase emission control system	7-97
Evaporative emission control (including ORVR):	
Onboard Refueling Vapor Recovery) system	7-98
Exhaust emission control system	7-98
Engine	8-2
Engine compartment	2-6, 7-3
Engine coolant	7-34
Changing the coolant	7-36
Checking the coolant level	7-34
Engine number	8-9
Engine oil	7-32
Changing the engine oil and filter	7-33

Checking the engine oil level	7-32
Engine start/stop button	5-9
Engine START/STOP button position	5-9
Illuminated Engine START/STOP button	5-9
Starting the engine with a smart key	5-11
Explanation of scheduled maintenance items	7-27
Exterior features	4-201
Roof rack	4-201
Exterior overview	2-2

F

Folding key	4-5
Battery replacement	4-10
Immobilizer system	4-11
Key operations	4-5
Record your key number	4-5
Transmitter precautions	4-9
Fuel filler lid	4-57
Closing the fuel filler lid	4-57
Emergency fuel filler lid release	4-60
Opening the fuel filler lid	4-57
Fuel requirements	1-2
Do not use methanol	1-4
Fuel Additives	1-5
Gasoline containing alcohol and methanol	1-3
Operation in foreign countries	1-5

Fuses	7-66
Engine compartment fuse replacement	7-68
Fuse/relay panel description.	7-70
Inner panel fuse replacement	7-67

G

Gross vehicle weight.	8-5
-------------------------------	-----

H

Hood	4-55
Closing the hood	4-56
Hood open warning	4-56
Opening the hood	4-55
How to use this manual	1-2

I

If the engine does not start	6-4
If engine doesn't turn over or turns over slowly	6-4
If engine turns over normally but does not start	6-4
If the engine overheats	6-8
If you have a flat tire	6-15
Changing tires	6-18
Jack and tools.	6-15
Removing the spare tire	6-16
Storing the spare tire	6-17

In case of an emergency while driving.	6-3
If the engine stalls at a crossroad or crossing	6-3
If the engine stalls while driving	6-3
If you have a flat tire while driving	6-3
Instrument cluster	4-81
Gauges	4-83
Instrument Cluster Control.	4-82
LCD Display Control.	4-82
Transaxle Shift Indicator	4-87
Instrument panel overview	2-5
Interior features.	4-191
AC inverter	4-195
Air ventilation seat.	4-193
Bottle holder.	4-192
Clock	4-198
Coat hook	4-198
Cup holder	4-191
Floor mat anchor (s).	4-199
Power outlet	4-194
Seat warmer	4-192
Side curtain.	4-199
Sunvisor	4-194
USB charger.	4-197
Interior lights	4-141
Automatic turn off function	4-141
Battery replacement	4-144
Luggage lamp.	4-143
Map lamp	4-142

Portable lamp usage	4-143
Room lamp	4-141
Vanity mirror lamp	4-143
Interior overview	2-4

K

Key positions	5-6
Ignition switch position	5-6
Illuminated ignition switch	5-6
Starting the engine	5-7

L

Lane departure warning system (LDWS)	5-77
The LDWS does not operate when:	5-79
Warning indicator	5-79
LCD Display	4-88
A/V Mode	4-95
LCD Modes	4-88
SCC/LDWS Mode	4-95
Service Mode	4-89
Turn By Turn Mode	4-95
User Settings Mode	4-91
Warning Messages	4-96
Liftgate (tailgate) (for manual liftgate (tailgate))	4-30
Closing the liftgate (tailgate)	4-31
Emergency liftgate (tailgate) safety release	4-32

Opening the liftgate (tailgate)	4-30
Light bulbs	7-76
Front light bulb replacement	7-77
High mounted stop lamp replacement	7-85
Interior light bulb replacement	7-87
License plate light bulb replacement	7-86
Rear combination lamp bulb replacement	7-82
Side repeater lamp replacement	7-82
Lighting	4-131
Battery saver function	4-131
Front fog light	4-137
Headlight escort function	4-131
High beam operation	4-133
Lighting control	4-131
Turn signals and lane change signals	4-136
Luggage volume	8-5

M

Maintenance services	7-4
NHTSA Safety Corrosion Alert	7-5
Owner maintenance precautions	7-5
Owner's responsibility	7-4
Manual climate control system	4-146
Air Conditioning refrigerant label	4-161
Checking the amount of air conditioner refrigerant and compressor lubricant	4-161
Climate control air filter	4-160

Heating and air conditioning	4-147
Rear climate control	4-154
System operation	4-157
Mirrors	4-70
Inside rearview mirror	4-70
Outside rearview mirror	4-76

O

Online factory authorized manuals (U.S. Only)	8-14
Owner maintenance	7-7
Owner maintenance schedule	7-7

P

Parking assist system	4-125
Non-operational conditions of parking assist system	4-127
Operation of the parking assist system	4-125
Self-diagnosis	4-128
Parking brake	7-39
Checking the parking brake	7-39
Power sliding door and power liftgate (tailgate)	4-33
Automatic stop and reversal	4-35
Emergency liftgate (tailgate) safety release	4-45
How to reset the power sliding door and power liftgate (tailgate)	4-36
Power door ON/OFF button	4-37

Power liftgate (tailgate) non-opening conditions	4-43
Power liftgate (tailgate) opening height user setting	4-44
Power liftgate (tailgate) operation	4-41
Power sliding door operation	4-38
Smart Liftgate (Tailgate)	4-45
Power steering fluid	7-38
Checking the power steering fluid level	7-38
Checking the power steering hose	7-38

R

Rear parking assist system	4-121
Non-operational conditions of rear parking assist system	4-122
Operation of the rear parking assist system	4-121
Rear parking assist system precautions	4-123
Self-diagnosis	4-124
Rearview camera	4-129
Recommended lubricants and capacities	8-6
Recommended SAE viscosity number	8-7
Refrigerant label	8-9
Reporting Safety Defects (U.S. only)	8-14
Road warning	6-2
Hazard warning flasher	6-2

- S**
- Scheduled maintenance service 7-9
- Seat belts 3-35
- Care of seat belts 3-51
 - Pre-tensioner seat belt 3-46
 - Seat belt precautions 3-48
 - Seat belt restraint system 3-35
- Seats 3-2
- Driver position memory system (for power seat) . . 3-10
 - Front seat adjustment - manual 3-6
 - Front seat adjustment - power 3-8
 - Headrest (for front seat) 3-12
 - Headrest (for rear seat) 3-31
 - Rear seat adjustment 3-16
 - Seatback pocket 3-15
- Smart cruise control system (SCC) 5-49
- Limitations of the system 5-60
 - Speed setting (SCC) 5-50
 - To adjust the sensitivity of Smart Cruise Control . . 5-59
 - To convert to cruise control mode 5-59
 - Vehicle to vehicle distance setting (SCC) 5-55
- Smart key 4-13
- Battery replacement 4-19
 - Loss of the smart key 4-17
 - Record your key number 4-13
 - Smart key function 4-13
 - Smart key immobilizer system 4-20
 - Smart key precautions 4-18
- Special driving conditions 5-83
- Driving at night 5-85
 - Driving in flooded areas 5-87
 - Driving in the rain 5-86
 - Driving off-road 5-87
 - Hazardous driving conditions 5-83
 - Highway driving 5-87
 - Reducing the risk of a rollover 5-83
 - Rocking the vehicle 5-84
 - Smooth cornering 5-85
- Steering wheel 4-66
- Electric power steering 4-66
 - Heated steering wheel 4-68
 - Horn 4-69
 - Power steering 4-66
 - Tilt and telescopic steering 4-67
- Storage compartments 4-188
- Center console storage 4-189
 - Glove box 4-190
 - Sunglass holder 4-190
- Sunroof 4-61
- Rear sunroof lock 4-65
 - Resetting the sunroof 4-64
 - Sliding the sunroof 4-62
 - Sunroof open warning 4-65
 - Sunshade 4-64
 - Tilting the sunroof (for front sunroof) 4-63
- Surround view monitoring system (SVM) 4-130

T

Theft-alarm system	4-21
Armed stage	4-21
Disarmed stage	4-22
Theft-alarm stage	4-22
Tire Pressure Monitoring System (TPMS)	6-9
Changing a tire with TPMS	6-12
Tire specification and pressure label	8-9
Tires and wheels	8-4
Tires and wheels	7-51
All season tires	7-63
Checking tire inflation pressure	7-52
Low aspect ratio tire	7-65
Radial-ply tires	7-64
Recommended cold tire inflation pressures	7-51
Snow tires	7-63
Summer tires	7-63
Tire care	7-51
Tire chains	7-63
Tire maintenance	7-56
Tire pressure	7-52
Tire replacement	7-55
Tire rotation	7-53
Tire sidewall labeling	7-56
Tire traction	7-56
Wheel alignment and tire balance	7-54
Wheel replacement	7-56

Towing	6-25
Emergency towing	6-27
Removable towing hook (front)	6-26
Towing service	6-25
Trailer Towing	5-94
Driving with a trailer	5-96
Hitches	5-95
If you do decide to pull a trailer	5-100
Maintenance when trailer towing	5-100
Safety chains	5-95
Trailer brakes	5-96
Trip computer	4-102
Digital speedometer	4-106
Fuel Economy	4-104
One time driving information mode	4-106
Overview	4-102
Trip A/B	4-103

V

Vehicle break-in process	1-6
Vehicle certification label	8-8
Vehicle data collection and event data recorders	1-7
Vehicle handling instructions	1-6
Vehicle identification number (VIN)	8-8
Vehicle load limit	5-103
Certification label	5-107
Tire and loading information label	5-103

Vehicle weight glossary	5-109
Base curb weight	5-109
Cargo weight	5-109
GAW (Gross axle weight)	5-109
GAWR (Gross axle weight rating)	5-109
GVW (Gross vehicle weight)	5-109
GVWR (Gross vehicle weight rating)	5-109
Vehicle curb weight	5-109

W

Warning and indicator lights	4-107
Indicator Lights	4-115
Warning lights	4-107
Washer fluid	7-39
Checking the washer fluid level	7-39
Windows	4-50
Power windows	4-51
Windshield defrosting and defogging	4-182
Automatic climate control system	4-183
Defogging logic	4-184
Manual climate control system	4-182
Winter driving	5-89
Carry emergency equipment	5-93
Change to "winter weight" oil if necessary	5-92
Check battery and cables	5-92
Check spark plugs and ignition system	5-92
Don't let your parking brake freeze	5-93

Don't let ice and snow accumulate underneath	5-93
Snowy or icy conditions	5-89
To keep locks from freezing	5-92
Use approved window washer anti-freeze in system	5-92
Use high quality ethylene glycol coolant	5-91
Wiper blades	7-44
Blade inspection	7-44
Blade replacement	7-44
Wipers and washers	4-138
Front windshield washers	4-139
Rear window wiper and washer switch	4-140
Windshield wipers	4-138

