

SEDONA

Features & Functions Guide



Delivery First
The priority that delivers more

GETTING TO KNOW YOUR **SEDONA**

Congratulations on Your New Kia Purchase!

Your new Kia vehicle has been designed, engineered and manufactured to provide you with years of comfortable and dependable driving. Kia is committed to quality, innovation, safety and — above all — your satisfaction.

Using This Guide

The information contained in this guide is a brief overview that will help you become familiar with the operation and features of your new Kia vehicle. The flipbook format facilitates information access, while the detailed illustrations help to ensure the instructions are easy to follow.

This **Features & Functions Guide**, and the specific operational and safety information it provides, is not a substitute for your Owner's Manual. In the interest of your safety and that of your family, and to help you avoid risks that may result in death or serious injury, Kia reminds you to carefully read your Owner's Manual in order to fully familiarize yourself with the important information it contains.

While the information contained in this guide is accurate at the time of printing, Kia may change vehicle specifications without notice in advance or after the fact, and assumes no liability in connection with such changes.

www.kia.com

Consumer - Roadside Assistance
1-800-333-4KIA (4542)

See Back Pages for Vehicle Maintenance Schedule

Always check the Owner's Manual for complete operating information and safety warnings.

ESSENTIAL FEATURES

Air Conditioning / Automatic Climate Control*	24
Audio System – Standard Audio System*	19
Audio System – UVO eServices Setup*	20
Audio System – UVO eServices System*	21
Audio System – UVO eServices / Premium Navigation*	22
Aux/USB/iPod® Port, AC Inverter* and Power Outlets	27
Bluetooth® Wireless Technology	16
Cruise Control	15
Digital Clock*	27
Passenger Airbag Off Indicator	44
Service Mode	06
Smart Key*	37
Tire Pressure Monitoring System (TPMS)	04
Trip Modes / Trip Computer	05
User Settings	06
Windshield/Rear Wipers & Washers*	14

Driving while distracted can result in a loss of vehicle control that may lead to an accident, severe personal injury and death. The driver's primary responsibility is in the safe and legal operation of a vehicle, and use of any handheld devices, other equipment or vehicle systems which take the driver's eyes, attention and focus away from the safe operation of a vehicle or that are not permissible by law should never be used during operation of the vehicle.



VIDEOS & QR CODES	02
INSTRUMENT CLUSTER	
Instrument Cluster Overview / Indicators & Warning Lights	03
Tire Pressure Monitoring System (TPMS)	04
Fuel Economy	04
LCD Instrument Cluster Modes	05
Trip Modes / Trip Computer	05
User Settings	06
Service Mode	06
Drive Mode Integrated Control System*	07
ECO Mode (Active ECO)*	07
DRIVER'S PANEL	
Electronic Stability Control (ESC)	08
Hill-Start Assist Control (HAC)	08
Instrument Panel Dimmer	08
AC Inverter*	08
Blind Spot Detection (BSD) System*	09
Lane Departure Warning System (LDWS)*	10
Autonomous Emergency Braking (AEB) / Forward Collision Warning System (FCWS)*	10
Power Windows, Window Lock & Central Door Lock	11
Power Folding Outside Mirrors*	11
Power/Heated Outside Mirrors*	11
Automatic Door Lock/Unlock	11
Fuel Door Release Button	11
Reverse Parking Aid Function*	12
Engine Start/Stop Button*	12
STEERING WHEEL CONTROLS	
Tilt/Telescoping Steering Wheel	13
Headlights & High Beams	13
Turn Signals & Fog Lights*	14
Windshield/Rear Wipers & Washers*	14
Audio Controls	15
Standard Cruise Control	15
Bluetooth® Wireless Technology	16
Smart Cruise Control System (SCC)*	18
AUDIO SYSTEMS	
Standard Audio System*	19
UVO eServices / Android Auto™ / Apple CarPlay® Setup	20
UVO eServices System*	21
UVO eServices with Premium Navigation*	22

CENTER PANEL	
Surround View Monitor (SVM)*	23
Automatic Climate Control*	24
Manual Climate Control*	26
Digital Clock*	27
Aux/USB/iPod® Port, AC Inverter* and Power Outlets	27
Heated Steering Wheel*	28
Seat Warmers / Ventilated Seats*	28
Automatic Gear Shift with Sportmatic® Shifting	29
SEATING	
Front Seat Headrest Adjustment	30
Driver Position Memory System*	30
Power Adjustable Driver's Seat*	31
Manual Adjustable Driver's Seat*	31
2nd-Row Seat	32
2nd-Row Walk-In Seat*	32
2nd-Row First-Class Lounge Seating*	33
2nd-Row Tumble (Center) Seat*	34
Unfastening Center Seat Belt	34
3rd-Row Seat - Folding and Stowing	35
OTHER KEY FEATURES	
Remote Keyless Entry (Folding Key)*	36
Double-Turn Lock/Unlock All	36
Power Sliding Doors	36
Smart Key*	37
Map/Room Lamps	38
Sunvisor	38
Sunroof Operation*	39
Parking Assist System*	39
Rear-Camera Display*	40
Power Liftgate / Smart Liftgate*	40
Hood Release Lever and Latch	42
Fuel Cap / Malfunction Indicator (Check Engine Light)	42
Child-Protector Rear Door Lock	42
HomeLink® with Auto-Dimming Rearview Mirror*	43
SAFETY FEATURES	
Occupant Detection System (ODS) / Passenger Airbag Off Indicator	44
Seat Belts	44
Seat Belt Retractor Locks	44
NORMAL MAINTENANCE SCHEDULE	45
LEGAL DISCLAIMERS	See Back Inside Cover Page

Kia provides a number of video resources at your disposal to assist you with becoming familiar with the features and functions found in your Kia vehicle. You can access these resources by snapping the QR Codes with your smartphone/tablet (mobile devices) or by visiting the following website: www.youtube.com/KiaFeatureVideos. Continue reading for a more in-depth look at QR Codes and for instructions on how to use them.

What are QR Codes?

A QR Code is a square, 2-dimensional barcode that can be read by mobile devices loaded with an appropriate barcode or QR Code Reader App. The app reads the barcode image and then launches/uploads the specific information the code contains, such as URLs, text, photos, videos and so much more.

How to Use QR Codes

If you have a mobile device with a QR Code Reader App, you can snap the code with your phone and you'll be provided a video with additional information pertaining to the topic. For example, in the Fuel Cap section, if you would like additional information, just snap the code with your mobile device to view the selected Kia Features & Functions Video.

How to snap a QR Code

1. With your mobile device, download a QR Code Reader App. With many devices, you can do this through an app store or marketplace
2. Open the QR Code Reader App on your mobile device
3. The app will utilize your device's camera. Center the code in the camera viewing area:
 - With some apps, as soon as the app recognizes the code, it will launch the corresponding video
 - With other apps, you will have to snap or take a picture of the code. The app will then launch the corresponding video
 - For operation specifics, refer to the instructions that come with the QR Code Reader App

QR CODE

One-Click Fuel Cap Video

To view a video on your mobile device, snap this QR Code or visit the listed website.



www.youtube.com/KiaFeatureVideos

REMINDER: When accessing videos on your mobile device, standard cellular data rates may apply.

QUICK TIPS

1. If you're having trouble scanning codes, check the following:
 - The code should be centered and focused in your mobile device's camera screen
 - Consider moving your device closer to or farther away from the code
 - The code should be well lit, without significant shadow
 - Avoid scanning from a significant angle
 - Confirm that the device's app supports 2D QR Code scanning.
 - Try another QR Code Reader App; not all apps are created equal
2. After scanning, if a "connecting" message appears and then nothing happens or there's a "connection error" message, this typically indicates that your device is having trouble connecting to the Internet
3. When accessing videos on your mobile device, standard cellular data rates will apply

Instrument Cluster Overview / Indicators & Warning Lights

- A** Tachometer
- B** Turn Signal Indicators
- C** Speedometer
- D** Engine Temperature Gauge
- E** Indicators & Warning Lights
- F** Gear Shift Position Indicator
- G** Odometer/Trip Computer/Tripmeter
- H** Fuel Gauge

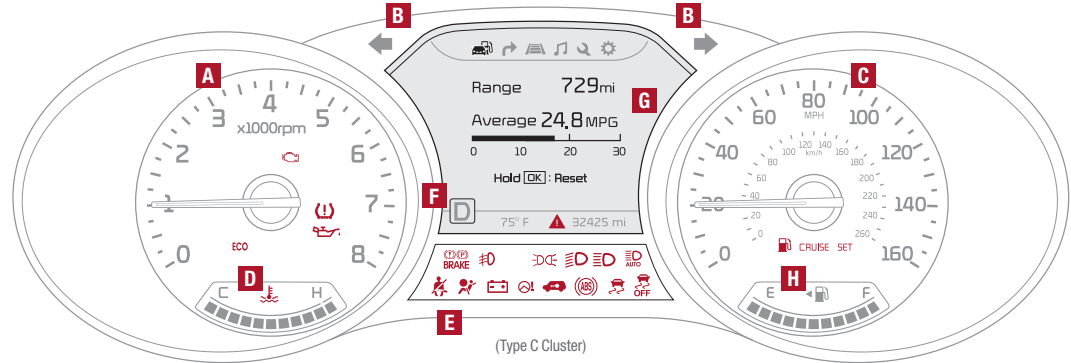



- ECO** ECOMINDER® Indicator
- Malfunction Indicator Lamp (MIL)
- Low Tire Pressure Light / Tire Pressure Monitoring System (TPMS) Malfunction Indicator
- Engine Oil Pressure Warning Light
- Master Warning Light
- Parking Brake & Brake Fluid Warning Light
- Front Fog Light Indicator*
- Light ON Indicator Light
- Washer Fluid Warning Light*
- High Beam Indicator
- High Beam Assist Indicator*
- Seat Belt Warning Light

- Airbag Warning Light
- Charging System Warning Light
- Electronic Power Steering (EPS) Warning Light*
- Immobilizer Indicator Light*
- Anti-Lock Braking System (ABS) Warning Light
- Electronic Brake Force Distribution (EBD) System Warning Light (Two separate indicators on Instrument Cluster lit at same time)
- KEY OUT Indicator*
- Autonomous Emergency Braking (AEB) Warning Light*
- Electronic Stability Control (ESC) Indicator Light
- Electronic Stability Control (ESC) OFF Indicator Light
- Low Fuel Level Warning Light

Your vehicle's instrument cluster & indicator light locations may differ from those in the illustrations. For more information on the instrument cluster, the LCD Warning Messages and the function of all indicator and warning lights, please refer to the Owner's Manual.

- CRUISE** Cruise Indicator Light*
- SET** Cruise SET Indicator
- Door Ajar Warning Light*
- Liftgate (Tailgate) Open Warning Light*
- Sunroof Open Warning Light*
- COMFORT** COMFORT Mode Indicator Light*
- Icy Road Warning Indicator Light
- AFLS** Adaptive Front Lighting System (AFLS) Warning Light*

Tire Pressure Monitoring System (TPMS)

 The TPMS indicator  functions as both Low Tire Pressure Light and TPMS Malfunction Indicator.

The indicator  will illuminate if one or more tires is significantly underinflated, the vehicle has a spare tire installed without TPMS or the outside temperature becomes significantly lower.

Inflate tire(s) to specifications using an accurate digital tire pressure gauge to turn off Low Tire Pressure Light . See front driver's door jamb for PSI specification.

When there is a problem with the TPMS, the TPMS Malfunction Indicator  will blink for approximately one minute and then illuminate. See dealer for service.

Fuel Economy

There are several factors that contribute to your vehicle's fuel economy, including maintenance of your vehicle, driving style, environmental conditions, vehicle weight and vehicle aerodynamics. Below are tips on how to help improve fuel economy:

- Keep your vehicle in good condition with regular maintenance
- Don't let the engine idle longer than necessary
- Drive at a moderate speed, accelerating smoothly and at a moderate rate
- Keep tires inflated to the recommended pressure
- Travel lightly, without carrying unnecessary weight in your vehicles
- Avoid placing large or heavy items on roof racks
- Avoid hilly, winding or poorly maintained roads

REMINDER: Driving range varies depending on a vehicle's fuel tank size, (e.g., 12-gal. vs. 24-gal). Even though the two vehicles MPG may be the same.

For more information on Fuel Economy, you can snap the QR Code above to view a video or refer to the Owner's Manual..

QUICK TIPS

- Even with TPMS, tire pressure should be checked manually at least once a month. Only adjust tire pressure on "cold tires"
- For proper maintenance and optimal fuel economy, maintain recommended tire inflation pressures and stay within the load limits and weight distribution recommended for your vehicle
- In winter or cold weather, the TPMS light may illuminate if the tire pressure was adjusted to the recommended tire inflation pressure during warm weather

REMINDERS:

- Check the recommended tire pressure label located on the left side of driver's door jamb, visible when the door is opened.
- Consult your dealer for service if Low Tire Pressure Light remains illuminated after inflating your tire(s).

QR CODES

To view these videos on your mobile device, snap these QR Codes or visit the listed website.

Refer to page 2 for more information.

Tire Pressure Monitoring System



www.youtube.com/KiaFeatureVideos

Fuel Economy Video



www.youtube.com/KiaFeatureVideos

LCD Instrument Cluster Modes

Press Mode button **A** to cycle through different LCD Instrument Cluster Modes:

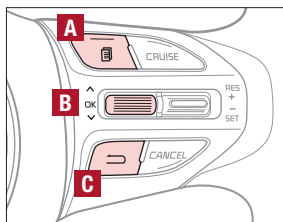

(Type B; Buttons located on Steering Wheel)



Trip Computer Mode: Displays driving information for tripmeter, fuel economy, etc.



Turn-by-Turn Mode*: Displays the state of the navigation system



Smart Cruise Control (SCC) / Lane Departure Warning System (LDWS)*: Displays the state of the SCC and LDWS



A/V Mode*: Displays the state of the A/V System



Information Modes: Informs on service intervals / Informs of warning messages related to washer fluid, Blind Spot Detection (BSD) system malfunction and other systems / Informs when any door is not securely closed



User Settings Mode: Change settings of the Driving Assist, Door/Liftgate, Lights and other features

Your vehicle's steering wheel buttons may differ from those in the illustrations.

Trip Computer / Tripmeter

The Trip Computer is a driver information system that displays information related to driving on the display when the Engine Start/Stop button is in the ON position.

To cycle through the LCD Instrument Cluster modes, press the Mode button **A**.

Trip Computer:

- To select and enter Trip Computer mode , press the Select/Reset button **B** up/down and then press again to enter
- To cycle through and select the different screens (Fuel Economy, Trip A, Trip B, Digital Speed), press the Select/Reset button **B** up/down and then press again to enter
- When displaying TRIP A or TRIP B screens, press and hold the Select/Reset button **B** to reset the Tripmeter to zero.
- Press the Return button* **C** to go back to the previous mode/item. (Button only available with Type B cluster).

REMINDERS:

- Appearance of Tripmeter display may differ as equipped
- All stored driving information (except Odometer and Range) is reset if the battery is disconnected

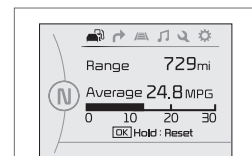

FUEL ECONOMY

- RANGE
- Average MPG
- Instant MPG

TRIP A

- Tripmeter A
- Average MPH
- Elapsed Time (E/T)

TRIP B

- Tripmeter B
- Average MPH
- Elapsed Time (E/T)

DIGITAL SPEEDOMETER

(Type B and C cluster)

User Settings

To enter the User Settings mode in the LCD Instrument Cluster Modes, press the Mode button **A** when the vehicle is at a standstill and with the Engine Start/Stop button* in the ON position and select User Settings  by pressing the OK button **B**.

You can navigate the selections on the display by pressing the OK button **B** up/down, and then selecting the item by pressing the OK button **B** again.

User Settings modes (Type B/C cluster):

Driving Assist

- Smart Cruise Control Response*
- Autonomous Emergency Braking (AEB)*
- Rear Cross Traffic Alert*

Door/Liftgate (Tailgate)

- Automatic Unlock
- Two Press Unlock
- Horn Feedback
- Smart Liftgate (Tailgate)*

Lights

- One-Touch Turn Signal
- Head Lamp Delay*
- Welcome Light*

Sound

- Park Assist System Volume*
- Blind Spot Detection Sound*
- Welcome Sound*

Seat/Steering

- Easy Seat Access*
- Steering Position

Service Interval

- Turn OFF
- Set Mileage/Months

Other Features

- Fuel Economy Auto Reset ON/OFF
- Fuel Economy Unit
- Temperature Unit
- Auto Rear Wiper (Reverse)
- Language

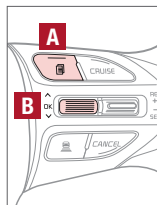

(Buttons located on right side of steering wheel)

Service Mode

To enter Service Mode, press the Mode button **A**, scroll to Service Mode  by pressing the OK button **B** up/down. Then press the OK button **B** again to enter. System will display number of miles remaining until next service is due, as well as the type of service due.

When service is required, the following will be displayed: **Service Required**.

To reset the Service Mode system, press and hold the Select/Reset button **B** for more than 1 second.

Press the Mode button **A** to go back to the previous mode/item

To turn **Service In OFF**, go to User Settings.

Service Interval Setting

To set the service interval in User Settings mode:

- Press the Mode button **A** to cycle to User Settings and press the Select/Reset button **B** to enter
- If Service Interval is OFF, press the Select/Reset button **B** to turn ON
- Press the Select/Reset button **B** up/down to select/change the interval setting
- Press the Select/Reset button **B** again to select the interval

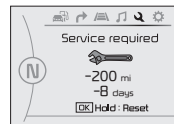

(Type B cluster)

QR CODES

To view these videos on your mobile device, snap these QR Codes or visit the listed website.

Refer to page 2 for more information.

LCD Display Video



www.youtube.com/KiaFeatureVideos

LCD Display: Maintenance Video



www.youtube.com/KiaFeatureVideos

Drive Mode Integrated Control System*

The Drive Mode may be selected depending on driver's preferences and road conditions.

To cycle through the different Drive Modes **A**, press the DRIVE MODE button **B**. The Instrument Cluster will display COMFORT or ECO when selected. When in Normal mode, it will not display in the Instrument Cluster.

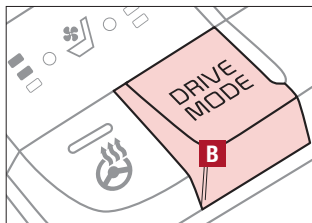

(Located on Center Panel below Gear Shift)*

REMEMINDERS:

- The system is turned ON and in Normal mode when ignition is in the ON position
- When ECO mode is selected, the indicator will display and system remains on, even when ignition is cycled
- Steering effort may be slightly increased in Sport mode

Your vehicle's buttons may differ from those in the illustrations. See your Owner's Manual for more details.

ECO mode (Active ECO)*

The Active ECO system helps improve fuel economy by controlling several vehicle components. When activated, it optimizes drivetrain operations such as engine power and transmission to help improve fuel economy.

To turn ON, press the DRIVE MODE button **B** and scroll through options until in the ECO mode. The green ECO indicator light **C** in the instrument cluster will illuminate, indicating that Active ECO is operating.

The Active ECO system will remain on even when the ignition is cycled.

To turn Active ECO OFF, press the DRIVE MODE button **B** again and change to another mode.

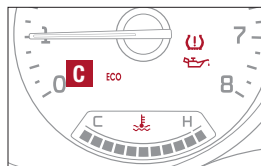

(Located in Instrument Cluster. Type C Cluster shown)

QUICK TIPS

To help improve your fuel economy:

- Drive at a moderate speed, accelerating smoothly and at a moderate rate
- Keep tires inflated to the recommended pressure
- Be sure the wheels are properly aligned

REMINDER: When DRIVE MODE button is ON, and ignition is cycled, the system defaults in the ON position

For more information on Active ECO, refer to your Owner's Manual or contact your local dealership.

QR CODE

Drive Mode Integrated Control System Video

To view a video on your mobile device, snap this QR Code or visit the listed website.

Refer to page 2 for more information.



www.youtube.com/KiaFeatureVideos

Electronic Stability Control (ESC)

The ESC system is designed to help stabilize the vehicle during cornering maneuvers. It is a good idea to keep the ESC turned on for daily driving whenever possible.

Press ESC OFF button **A** to turn Traction Control OFF/ON.

To turn OFF both the Traction Control and Stability Control, press and hold for more than 3 seconds. Press again to turn ON.

REMINDERS:

- ESC is turned ON by default at vehicle start-up. If vehicle power is cycled, ESC will turn ON again
- The ESC Indicator Light  in the instrument cluster will illuminate whenever the ESC is in operation

For more information on Electronic Stability Control (ESC) and its specific features and operations, please refer to your Owner's Manual.

Hill-Start Assist Control (HAC)

HAC helps prevent the vehicle from rolling backwards when accelerating from a stop while on a steep incline. The HAC automatically activates whether the ESC is OFF or ON but does NOT activate when the ESC has malfunctioned.

REMINDER: The HAC does not operate when the gear shift is in the P (Park) or the N (Neutral) position.

QUICK TIPS

- HAC provides a 2-second delay before the vehicle may start rolling backwards
- When HAC is active (e.g., during initial acceleration from a stop on an incline), you may notice that the brakes will momentarily remain engaged after you depress the accelerator – this is normal HAC operation.

Instrument Panel Dimmer

With parking lights/headlights ON, press button **B** (+) or (-) to adjust the brightness of the instrument panel illumination.

REMINDER: The Instrument Panel Dimmer does not adjust brightness on the Standard Audio System/UV0 eServices System/UV0 eServices with Premium Navigation System* screens. Use the system setup menu to adjust brightness on the screen.

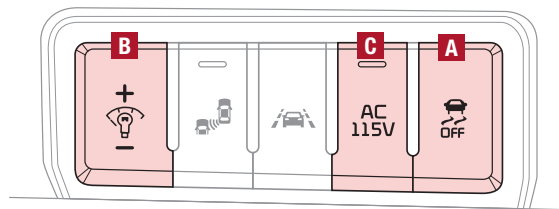

(Button panel located left of Steering Wheel)

AC Inverter*

The AC Inverter supplies 115V/100W electrical power to operate accessories or equipment. Press AC Inverter button **C** to activate.

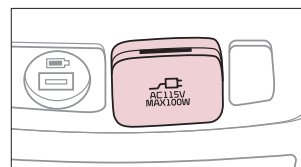

(Outlet located on back of Center Console and the Luggage Zone*)

Blind Spot Detection (BSD) System*

The BSD system uses radar sensors to help alert the driver before changing lanes. The light on the BSD button **A** will illuminate when turned ON. The outside rearview mirror warning lights will also illuminate for 3 seconds.

The system will become active when the vehicle is traveling more than 18 mph and will alert the driver if another vehicle is detected by the radar sensor.

Blind Spot Detection / Lane Change Assist

1st-stage alert: When another vehicle is detected within the BSD System boundary **B**, or vehicle in the LCA boundary **B** approaches at a high speed, a yellow indicator will illuminate on the outside rearview mirrors.

2nd-stage alert: When 1st-stage alert is on and the driver activates a turn signal, a flashing yellow indicator will illuminate on the outside rearview mirrors and the system will sound an alert.

RCTA (Rear Cross Traffic Alert)

If the RCTA system sensors detect approaching vehicles from the left or right side **C**, the system will sound an audible alert, the yellow-flashing indicators on the outside rearview mirror will illuminate and a message will appear on the LCD screen, when these conditions are met:

- The gear shift is in Reverse
- The vehicle is moving less than 6 mph
- The RCTA can be set to on/off in User Settings from the LCD Instrument Cluster modes.

REMINDERS:

- When the BSD is ON and the vehicle power is cycled to OFF then ON again, the BSD system returns to ON
- The RCTA feature can be turned OFF/ON in User Settings. When vehicle power is cycled, the RCTA will remain in the previous state

For more information on the above systems, please refer to the Owner's Manual.

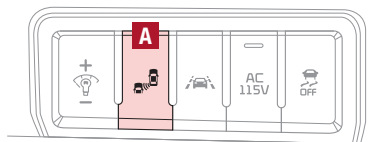

(Button panel located left of Steering Wheel)

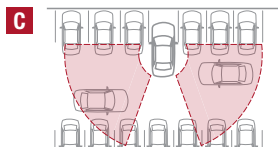
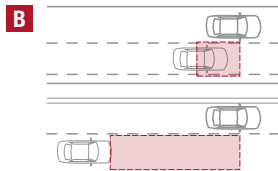

QR CODE

Blind Spot Detection System w/ RCTA Video

To view a video on your mobile device, snap this QR Code or visit the listed website.

Refer to page 2 for more information.



www.youtube.com/KiaFeatureVideos

Lane Departure Warning System (LDWS)*

With the Engine Start/Stop button in the ON position, press the LDWS button **A** to turn system ON. The instrument cluster indicator  will illuminate white.

If the LDWS detects that you are veering outside of your lane, the system may issue a warning on the LCD screen and an alert may sound, under these conditions:

- The vehicle exceeds approximately 40 mph
- The LDWS system recognizes the lane the vehicle is traveling in

If the LDWS button is ON or OFF and ignition is cycled, the system remains in the previous state.

REMINDER: LDWS will not issue a warning if the turn signal or hazard light is activated.

The Lane Departure Warning System (LDWS) is not a substitute for safe and proper driving. Always drive safely and use caution. LDWS may not always alert the driver if the vehicle is driven outside of its lane.

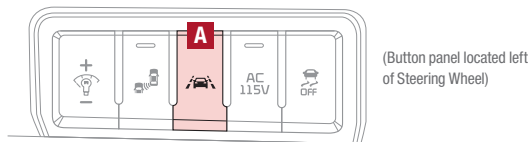

When the LDWS sensor detects the lane traveling in, the lane is illuminated



When the LDWS sensor does not detect the lane traveling in the lane is not illuminated



When the LDWS sensor detects the vehicle veering outside of the lane traveling in, a yellow indicator will illuminate the left or right lane that the vehicle's crossing (shown in both images above)



QR CODE

Lane Departure Warning System Video

To view a video on your mobile device, snap this QR Code or visit the listed website.

Refer to page 2 for more information.



www.youtube.com/KiaFeatureVideos

Autonomous Emergency Braking (AEB) / Forward Collision Warning System (FCWS)*

The AEB and FCWS help to alert the driver when rapidly approaching a vehicle that is slowing down, braking or stopped. A warning message will appear on the LCD screen and a chime will sound. The FCWS will become active when the vehicle is traveling more than 25 mph. The AEB will become active when the vehicle is traveling more than 6 mph.

To turn the AEB/FCWS off, go to User Settings in the LCD Instrument Cluster modes.

REMINDER: The AEB/FCWS will be activated by default when vehicle power is cycled on, even when previous setting to off

The Autonomous (Assist) Emergency Braking (AEB) / Forward Collision Warning System (FCWS) are not substitutes for safe and proper driving. Always drive safely and use caution. FCWS may not always alert the driver when the vehicle is approaching another vehicle.



Power Windows, Window Lock & Central Door Lock

A Pull/Press to operate Front Windows Auto Up/Down*

QUICK TIP

Press button again to stop Auto Up/Down function.

B Press to Unlock/Lock All Doors

C Press to disable Rear Passenger Windows and Rear Sunroof passenger controls

REMINDER: When pressed **C**, window controls for the Rear Passenger Windows are disabled.

Button configuration may vary depending on vehicle model.

Power Folding Outside Mirrors*

Press the L or R buttons **D** to select the mirror to adjust.

Press button arrows **E** left/right or up/down to adjust mirror position.

Toggle button **F** left/right to unfold/fold the outside rearview mirrors.

Toggle button **F** to center to automatically fold/unfold mirrors when:

- The Smart Key* Lock/Unlock buttons are pressed
- The door outside handle button is pressed

QUICK TIP

The mirrors will automatically unfold when the Smart Key* is within close proximity to the vehicle.

REMINDEERS:

- When mirror button **F** is in the center, press the Lock button on the Smart Key to automatically fold the mirrors
- To lock position of mirrors, toggle switch to the neutral (center) position

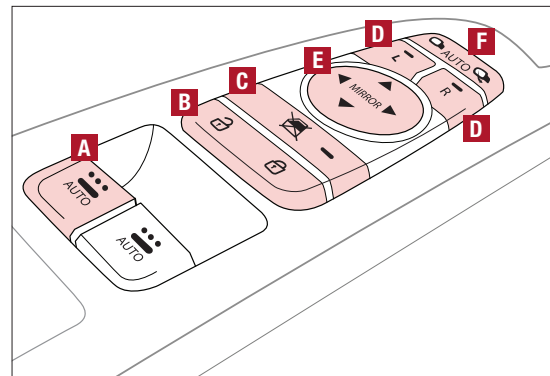

(Button/switch panel located on Driver's Door)

Power/Heated Outside Mirrors*

Mirror heaters automatically turn ON/OFF at the same time the Rear Window Defroster is turned ON/OFF. Rear Window Defroster button* is located on climate control system panel.

Automatic Door Lock/Unlock

When the gear shift is moved into or out of P (PARK), all doors will Lock/Unlock. Refer to the User Settings on how to turn Auto Door Lock/Unlock ON/OFF.

Fuel Door Release Button

Press the Fuel Door Release button to release the fuel door.

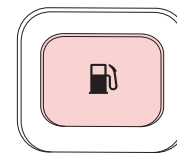

(Button located left of Steering Wheel)

Reverse Parking Aid Function*

The left or right mirror buttons **A** need to be depressed for the Reverse Parking Aid Function to operate.

When the gear shift lever is moved into R (Reverse) and while the vehicle is moving backwards, the outside rearview mirrors **B** will rotate downward to aid in reverse parking.

To turn OFF the function, press the L or R buttons again.

The outside rearview mirrors will automatically return to their original positions when:

- The Engine Start/Stop Button is in the OFF position
- The gear shift lever is moved to any position except R (Reverse)
- Outside rearview mirror switches are not depressed

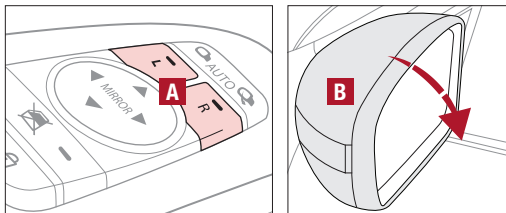

(Button/switch panel located on Driver's Door)

REMINDER: When the outside rearview mirror buttons (L or R) **A** are not depressed, the Reverse Parking Aid Function will not operate and the outside rearview mirrors will not rotate downward.

Engine Start/Stop Button*

To start the engine:

1. Depress the brake pedal
2. Press the ENGINE START/STOP button while gear shift is in P (Park)



To turn the engine OFF: Press the ENGINE START/STOP button.

To use the ENGINE START/STOP button, you must have the Smart Key fob on your person or inside the vehicle.

REMINDERS:

- In an emergency situation while the vehicle is in motion, you are able to turn the engine off and to the ACC position by pressing the ENGINE START/STOP button for more than 2 seconds or 3 times successively within 3 seconds
- If Smart Key fob battery is dead, with the lock button facing the ENGINE START/STOP button, hold the fob up against the ENGINE START/STOP button and press

QUICK TIPS

To use electrical accessories:

ACC position

- When in the OFF position and without depressing the brake pedal, press the ENGINE START/STOP button once (amber light)

ON position

- When already in the ACC position (orange light) and without depressing the brake pedal, press the ENGINE START/STOP button again (reddish orange light)
- When in the OFF position and without depressing the brake pedal, press the ENGINE START/STOP button twice (reddish orange light)

Keeping the vehicle in ACC or the ON position for extended periods of time without turning engine on may discharge the vehicle's battery.

QR CODE

Engine Start/Stop Button & Smart Key Video

To view a video on your mobile device, snap this QR Code or visit the listed website.

Refer to page 2 for more information.



www.youtube.com/KiaFeatureVideos

Tilt/Telescoping Steering Wheel

To adjust the Steering Wheel, press the Lock-Release Lever **A** down and adjust **B** the desired angle and **C** distance.

When finished, pull the Lock-Release Lever **A** up to lock Steering Wheel in place.

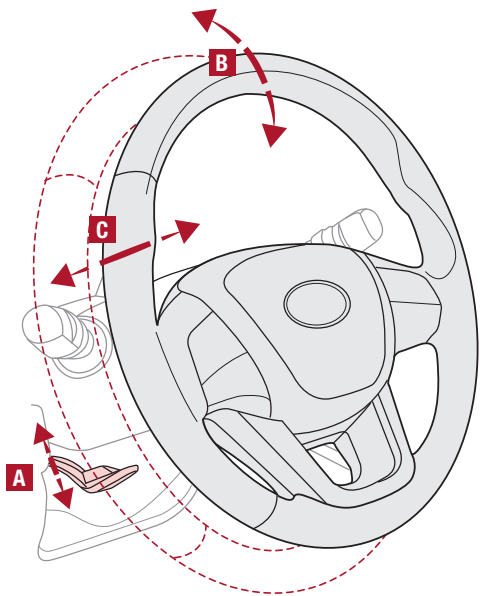

QUICK TIP

It may be helpful to pull/push bottom of Steering Wheel towards/away from you to adjust desired distance prior to adjusting the angle.

Headlights & High Beams

To operate:

- Rotate lever to change the Headlight function
- Push lever to turn High Beams ON
- Pull lever to flash Headlights / High Beams

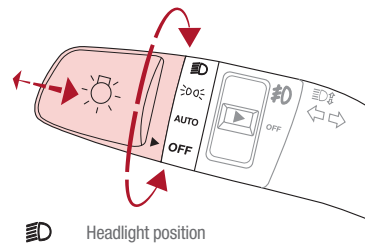

	Headlight position
	Parking light position
AUTO	Auto Light Position* / AFLS (Adaptive Front Lighting System)* / High Beam Assist*
OFF	OFF position

AUTO Light position — When the light switch is in the AUTO Light position, the tail lights and headlights will turn ON/OFF automatically depending on the amount of light outside the vehicle.

Adaptive Front Lighting System (AFLS)* — The Adaptive Front Lighting System helps improve visibility during nighttime driving by aiming the low beam headlights in the direction the vehicle is moving. AFLS controls the aiming direction based on steering angle and speed.

When the headlight switch is in the AUTO Light position, the AFLS will activate.

REMEMBER: When the AFLS indicator illuminates on the instrument cluster, the AFLS is not working properly. See authorized Kia dealer for service.

High Beam Assist (HBA)* — High Beam Assist automatically adjusts the headlight range by switching between high and low beams based on light from other vehicles and road conditions.

To enable HBA, toggle the light switch to the AUTO Light position and turn on the high beams by pushing the lever away from you. The High Beam Assist indicator will illuminate.

REMEMINDERS:

- HBA will operate when vehicle speed exceeds 25 mph
- If the lever is pushed away from you while HBA is operational,
- HBA will turn off and the high beams will be on continuously. If the lever is pulled toward you while HBA is operational, HBA will turn off
- If the light switch is switched to the headlight position, HBA will turn off low beams will be on continuously

Turn Signals & Fog Lights*

To operate:

- Turn Signals - Move lever Up/Down for Right/Left Turn Signal
- Fog Lights - Press switch **A** up/down to turn Fog Lights ON/OFF

REMINDER: Headlights must be ON for Fog Light operation.

One-Touch Lane Change Signal is activated by moving the Turn Signal Lever slightly for less than 1 second and then releasing. The lane change signal will blink 3 times.

To change how many times (3/5/7) the Lane Change Signal blinks, go to User Settings Mode in the LCD Instrument Cluster modes.

For more information on the User Settings Mode, please refer to your Owner's Manual.

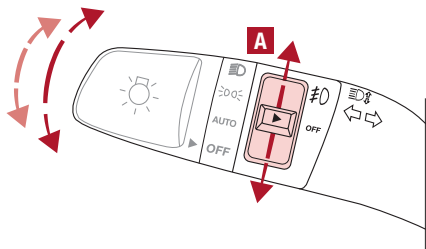

Windshield Wipers & Washers

To operate:

- Move lever Up/Down to change Wiper modes
- Press button **B** to adjust Intermittent Wipe
- Pull lever to spray and wipe

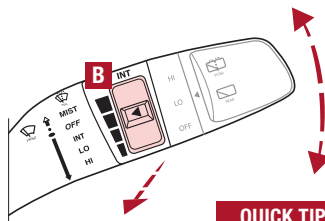

MIST: Single wipe

OFF: Wiper off

INT: Intermittent Wipe

LO: Slow wipe

HI: Fast wipe

QUICK TIPS

- Pressing button up increases Intermittent wipe frequency and wipe speed. Pressing button down decreases frequency of wipes.
- Set the wiper to OFF position when the wiper is not in use

Rear Wiper & Washer*

To operate:

- Rotate Rear Wiper switch to change Wiper modes
- Push to spray and wipe

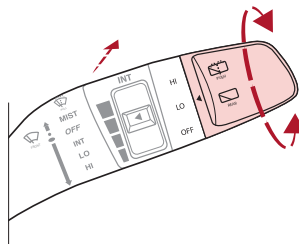

HI: Fast wipe

LO: Slow wipe

OFF: Wiper off

QUICK TIP

LO and HI sets wiper speed. No intermittent wipe function on Rear Wipers.

Audio Controls

Standard Cruise Control

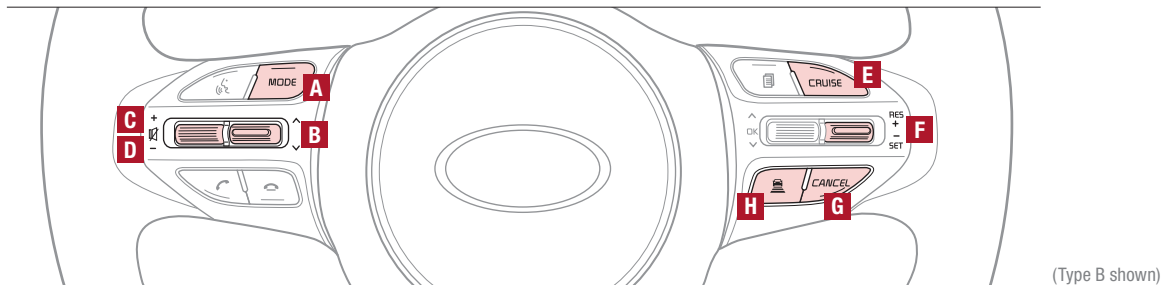

(Type B shown)

A Audio MODE button: Press to cycle through FM/AM/SiriusXM®/Media Modes

B Seek/Presets button:

FM/AM/SiriusXM®: Press up/down to advance through Preset Stations. Press and hold to auto seek

Media Modes: Press up/down to move track up/down. Press and hold to fast forward/rewind

C Volume buttons: Press up/down to raise/lower volume

D Mute button: Press to mute all audio

QUICK TIP

Pressing the Audio MODE button for more than 1 second will turn Audio Mode ON/OFF.

Driving while distracted is dangerous and should be avoided. Drivers should remain attentive to driving and always exercise caution when using the steering-wheel-mounted controls while driving. For further audio system operations, refer to pages 19-22.

E CRUISE Control ON/OFF button: Press to turn the Cruise Control ON/OFF

F Resume Cruising Speed button: Press up to resume or increase cruising speed

F Set Cruising Speed button: Press down to set or decrease cruising speed

G Cruise Control CANCEL button: To cancel Cruise Control setting, do one of the following:

- Press the brake pedal
- Press the CANCEL button

QUICK TIPS

- Cruise Control is designed to function above 25 mph
- The Cruise Control system will not activate until the brake pedal has been depressed at least once after ignition ON or engine start

REMINDER: To switch from Smart Cruise Control System (SCC) to Standard Cruise Control, press and hold the button **H** (the SCC system must not be activated to change modes). Repeat to switch back to SCC mode.

Your vehicle's steering wheel buttons may differ from those in the illustrations. See your Owner's Manual for more details

Bluetooth® Wireless Technology

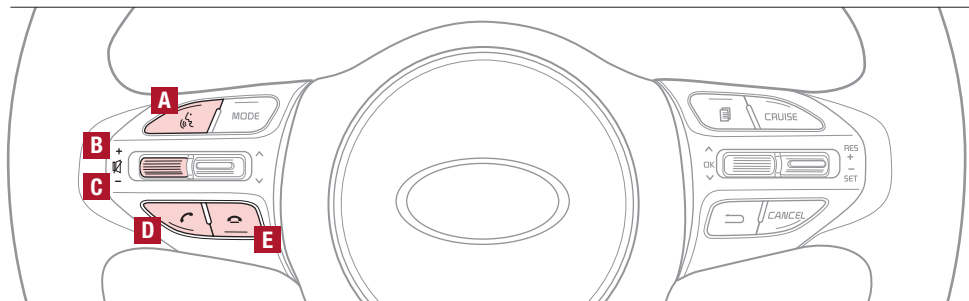

(Type B shown)

A Voice button (Standard Audio System, with iPhone only): Press to activate Siri. Press and hold to cancel Siri.

Talk button (UVO eServices Systems): Press to activate voice recognition/bring up menus/place calls with minimal voice command prompts from the system.

B Volume button: Press up/down to raise/lower speaker volume

C Mute button: Press to mute the microphone during a call

D Call button (Standard Audio System): Press the button to display the Dial Number screen. Press again to display the most recently made call number. Press a third time to initiate making the call to the number displayed

Receive/Place Call button (UVO eServices Systems): Press to receive/place/transfer calls. Press to place a call using voice command prompts from the system, or to answer an incoming call

E End Call button (Standard Audio System): Press to end a call or reject an incoming call

End Call button (UVO eServices Systems): Press to end a call or cancel a function

QUICK TIPS

- When using the voice command feature, wait for the system BEEP before speaking the command.
- Phonebook transfer upload time varies by phone model and with number of phonebook entries
- Because of differences in phone quality, service providers and **Bluetooth®** Wireless Technology chip programming, functionality may differ from one phone to another
- Changing language setting may delete paired phones

Your vehicle's steering wheel buttons may differ from those in the illustrations. See your Owner's Manual for more details.

Driving while distracted is dangerous and should be avoided. Drivers should remain attentive to driving and always exercise caution when using the steering-wheel-mounted controls while driving.

For more information, if equipped, refer to the Car Multimedia System User's Manual. For Bluetooth® Wireless Technology FAQs, go to www.kia.com, Owners section, or call Consumer Information for Bluetooth® Technology at (800) 333-4KIA. Refer to your Owner's Manual for more specific Bluetooth® Wireless Technology phone pairing and operation instructions.

Bluetooth® Wireless Technology (Continued)

Pairing a Phone

For instructions on how to pair a phone, refer to the audio system's user's guide or your vehicle's Quick Start Guide.

QUICK TIP

During the pairing process, be sure to accept the connection requests on the phone for phonebook download and to allow acceptance of all future **Bluetooth®** connection requests.

How to Place a Call

Below are methods for placing a call using the Steering Wheel controls:

Standard Audio System*

- Option 1: Press the Talk button **A** to activate Siri* (iPhone only)
- Option 2: Press the Call button **D** to display the dial number screen. Press again to display the most recently made call number. Press a third time to initiate making the call to the number displayed

UVO eServices System / UVO eServices with Premium Navigation*

When using the voice command feature, waiting for the system BEEP before speaking the command.

- Option 1: Press the Receive/Place Call button **D** (displays the phone screen with number keypad)
- Option 2: Press the Talk button **A**. Then say the command "Call {name}" or Dial {number}

Voice Recognition and Phone Contact Tips

To help optimize the **Bluetooth®** Wireless Technology Voice Recognition system, below are some tips and reminders. Improve the performance by making a few simple changes to your phone contacts:

- Use full names (first and last names) vs. short or single-syllable names ("John Smith" vs. "Dad," "Smith Residence" vs. "Home")
- Avoid using special characters and hyphenated names (@, &, #, /, -, *, +, etc.)
- Avoid using acronyms ("In Case of Emergency" vs. "ICE") or words with all capital letters
- Spell words completely, no abbreviations ("Doctor Smith" vs. "Dr. Smith")
- The system may have difficulty understanding some accents or uncommon names. Below are other tips to optimize using the voice recognition.

QUICK TIPS

- When placing a call, speak in a natural, moderate tone, with clear pronunciation. The system may have trouble recognizing commands if you speak too soft or too loud
- Always wait for the beep before speaking any commands
- Close windows and sunroof and turn off A/C - Open windows, sunroof, weather (wind/rain), or an A/C fan operating at higher speeds can interfere with Voice Recognition
- Press the talk button and say "Help" to get a list of available commands

QR CODE

Voice Recognition* Tips Video

To view a video on your mobile device, snap this QR Code or visit the listed website.

Refer to page 2 for more information.



www.youtube.com/KiaFeatureVideos

Smart Cruise Control System (SCC)*

The Smart Cruise Control System (SCC)* allows you to set the vehicle to maintain a speed so long as it is not limited by traffic. When traffic is encountered, the vehicle will be slowed to maintain a set distance behind traffic without depressing the accelerator or brake pedal.

To set/adjust the SCC speed:

- Press the CRUISE button **A** to turn system ON. The CRUISE indicator will illuminate on the instrument cluster
- Accelerate/decelerate to the desired speed
- Press (SET-) button **B** down to set speed. The SET indicator light will illuminate. The set speed and vehicle-to-vehicle distance will illuminate on the LCD screen.
- Press button **B** up or down to adjust the set speed.

To set the vehicle-to-vehicle distance **C:** Press the SCC button **D** on the steering wheel. The image on the LCD screen **E** will change when scrolling through the settings.

To cancel SCC operation: Press the CANCEL button **F**. The LCD screen will display a message that the SCC operation is cancelled **G**.

To turn SCC system OFF: Press the CRUISE button **A**. The CRUISE indicator on the instrument cluster will turn OFF.

QUICK TIPS

To change the Cruise Control mode from SCC to standard Cruise Control, press and hold button **D**. Repeat to switch modes again (The SCC system must not be activated to change modes).

For the SCC System to operate:

- When no vehicle is in front, you must be travelling at a minimum speed of 20 mph
- When following a vehicle, you must be traveling at a minimum speed of 6 mph

When following a vehicle, the system will automatically adjust your cruise speed based on the vehicle in front. It will even bring the vehicle to a complete stop if necessary. If the vehicle remains at a standstill for more than 3 seconds, the system will disable.

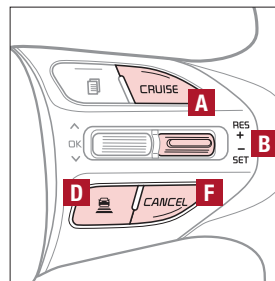

(Buttons located on right side of Steering Wheel)

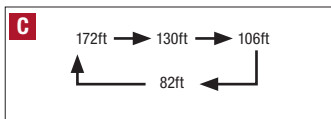

REMINDER: Above are approximate distances based on 56 mph vehicle speed. The SCC vehicle-to-vehicle distance increments are based on vehicle speed.

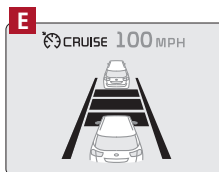

REMINDEES:

- Cruise Control button must be ON in order to turn SCC ON/OFF
- For the SCC System to operate, you must be traveling at a minimum speed of 20 mph, when no vehicle is in front.
- The SCC System is operating when driving above the speed of 6.0 mph

Standard Audio System*

– FM/AM/SiriusXM®/Media (USB, iPod®, Aux, *Bluetooth*® Audio, My Music)*

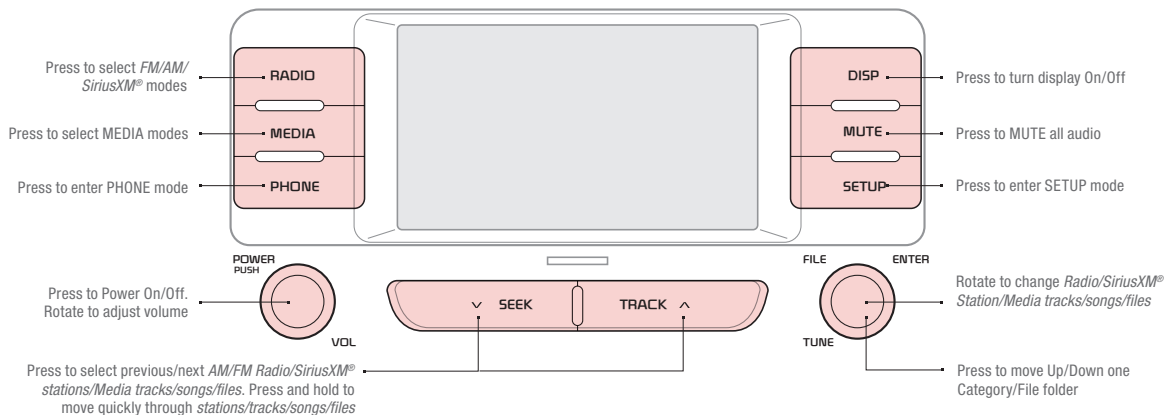

Audio System Setup Options

Press the SETUP key to enter Setup menu. Using the touchscreen press the onscreen buttons, Display/Sound/Phone/System/Display Off, to enter modes. Then follow the onscreen menu items to select and adjust. Audio system setup options may include the following:

- **Display Settings** – Adjusting the Brightness and Brightness Mode
- **Sound Settings** - Sound Settings (Position, Tone, Speed-Dependent Volume, Touch Screen Beep)
- **Bluetooth® Settings** - Connections, Auto Connection Priority, Manual Contacts Download, *Bluetooth*® Voice Prompts
- **System Settings** - Memory Information, Language, Default Reset, System Information
- **Display OFF** - To set the screen off while in operation

Your vehicle's audio system may differ from that in the illustration. See your Owner's Manual for more details on this system. For other audio system operations, refer to pages 20-22.

ALWAYS CHECK THE OWNER'S MANUAL FOR COMPLETE OPERATING INFORMATION AND SAFETY WARNINGS.

QR CODE

Standard Audio System Videos

To view a video on your mobile device, snap this QR Code or visit the listed website.

Refer to page 2 for more information.



www.youtube.com/KiaFeatureVideos

Sound Settings

To adjust the Standard Audio Systems sound settings:

1. Press the SETUP key on the audio control unit or the on-screen MENU button, when in MEDIA mode.
2. Select the on-screen SOUND button
3. Select the menu item (Position, Tone, Speed Dependent Volume, Beep)
4. Using the touchscreen, press arrows to adjust the settings

REMINDER: To minimize driver distraction, some audio system functionalities have been modified while the vehicle is in Drive, Reverse or moved out of Park.

UVO eServices / Android Auto™ / Apple CarPlay® Setup

UVO eServices Registration/Activation – To use UVO eServices:

1. On your Smartphone, go to an app store or marketplace to download the free Kia UVO eServices app.
2. Open the UVO eServices app and create an account by clicking on REGISTER. After entering your information and following the prompts to complete registration, go to your email and click on the confirmation link (You can also register an account by logging into MyUVO.com).
3. In the app, click CONTINUE, accept the terms and click CONTINUE once again.
4. Follow the app's IN-CAR SETUP instructions to connect your smartphone and complete UVO eServices activation.

Android Auto™*

Setting up Android Auto™:

1. From an Android Auto™ compatible device, download the Android Auto™ app from the Google Play™ Store.
2. Open the Android Auto™ app and proceed with the on-screen instructions to complete setup on the mobile device.

How to start Android Auto™:

1. Press the SETUP key on your UVO eServices system's control panel.
2. Press the Phone Projection button  or CONNECTIVITY button, select Android Auto™ then select ENABLE ANDROID AUTO. Accept all terms, conditions and requests on the head unit and phone in order to use Android Auto™
3. Connect the Android™ device with the vehicle's USB port using the manufacturer's cable provided with your phone.
4. From the vehicle's home screen, select the Android Auto™ button, where you'll see all the Android Auto™ supported apps.

Apple CarPlay®*

Setting up and starting Apple CarPlay®:

1. Connect the Apple CarPlay® compatible iPhone with the vehicle's USB port using the manufacture's cable provided with your iPhone.
2. On the UVO eServices System audio control unit, press the SETUP key.
3. Press the Phone Projection button  or CONNECTIVITY button on the screen and select Apple CarPlay®.
4. Select ENABLE APPLE CARPLAY. Accept all terms, conditions and requests on the head unit and phone in order to use Apple CarPlay®
5. From the vehicle's home screen, select the Apple CarPlay® button, where you'll see all the Apple CarPlay® supported apps

REMINDERS:

- Android Auto compatibility requirements: Micro-USB cable that came with your phone, OS Android™ 5.0 or higher, compatible Android smartphone and data and wireless plan for applicable feature(s).
- Apple CarPlay compatibility requirements: Apple Lightning® cable, latest iOS software, iPhone 5 or later and data and wireless plan for applicable feature(s)
- It is recommended to always update your phone to the latest operating system release

For further UVO eServices System operations, refer to the Car Multimedia System User's Manual. For other audio system information, refer to pages 19-22.

UVO eServices System*

– FM/AM/SiriusXM®/Media (USB, iPod®, Aux, *Bluetooth*® Audio, My Music)



Sound Settings

To adjust the UVO eServices System sound settings:

1. Press the SETUP key on the audio control unit or the on-screen MENU button, when in MEDIA mode.
2. Select the on-screen SOUND button, or SOUND SETTINGS
3. Select the menu item (Position, Tone, Advanced, Default)
4. Use the onscreen buttons to adjust settings
5. Press the return button \Rightarrow to save settings

Your vehicle's audio system may differ from that in the illustration. For further UVO eServices System operations, refer to the Car Multimedia System User's Manual. For other audio system information, refer to pages 19-22.

QUICK TIPS

- Navigation may be available when connected to Android Auto™ or Apple CarPlay® supported smartphones.
- When using the voice command feature, wait for the system to BEEP before speaking the command
- At any time, you can interrupt UVO eServices System Command Feedback by pressing the TALK button
- Prolonged use of the UVO eServices system in ACC mode may drain the vehicle's battery
- A warning screen may appear periodically to remind users that the UVO eServices System should be operated when the engine is running to prevent battery discharge

REMINDER: To help minimize driver distraction, some audio system functionalities have been modified while the vehicle is in Drive, Reverse or moved out of Park.

QR CODE

UVO eServices System Videos

To view a video on your mobile device, snap this QR Code or visit the listed website.

Refer to page 2 for more information.



www.youtube.com/KiaFeatureVideos

UVO eServices with Premium Navigation*

– FM/AM/SiriusXM®/Media (CD, USB, iPod®, My Music, Aux, *Bluetooth*® Audio)

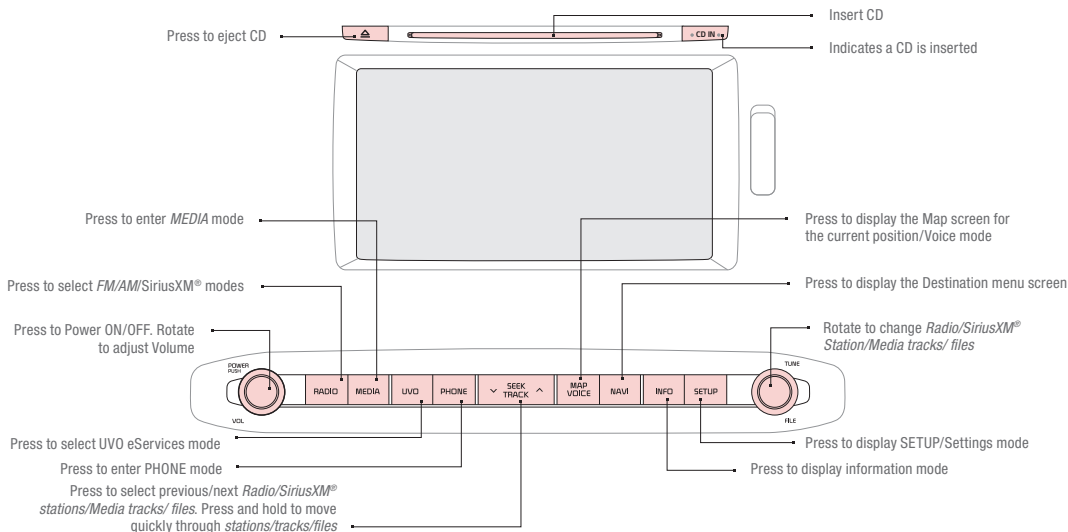

QUICK TIPS

- When using the voice command feature, wait for the system to BEEP before speaking the command
- At any time, you can interrupt UVO eServices System Command Feedback by pressing the TALK button
- Prolonged use of the UVO eServices system in ACC mode may drain the vehicle's battery
- A warning screen may appear periodically to remind users that the navigation system should be operated when the engine is running to prevent battery discharge

REMEMBER: To help minimize driver distraction, some audio system functionalities have been modified while the vehicle is in Drive, Reverse or moved out of Park.

Your vehicle's audio system may differ from that in the illustration. For further UVO eServices System operations, refer to the Car Multimedia System User's Manual. For other audio system information, refer to pages 19-21.

QR CODE

UVO eServices with Premium Navigation Videos

To view a video on your mobile device, snap this QR Code or visit the listed website.

Refer to page 2 for more information.



www.youtube.com/KiaFeatureVideos

Sound Settings

To adjust the sound settings (Position, Tone, Priority, Advanced, Default, Bep) from any audio mode:

1. Press the SETUP key on the audio control unit or the on-screen MENU button, when in MEDIA mode.
2. Select the on-screen SOUND button, or SOUND SETTINGS
3. Select the menu item (Position, Tone, Advanced, Default)
4. Use the onscreen buttons to adjust settings
5. Press the return button  to save settings

Surround View Monitor (SVM)*

The Surround View Monitor (SVM) is a parking support system that shows the areas around the front, rear, left, and right sides of the vehicle via four cameras displayed in the audio system's screen.

Front SVM operation:

- The camera view will display on the audio system's screen in both Drive and Neutral
- In Drive, the camera view will continue to display until the vehicle is above approximately 13 mph
- The camera view will reappear on the audio system's screen whenever the vehicle drops below approximately 13 mph

The Front SVM camera is ON when:

1. The Engine Start/Stop button is On
2. The gear shift is in Drive or Neutral
3. The SVM button **A** is pressed ON (LED illuminated)

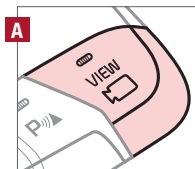

(Located below Gear Shift)

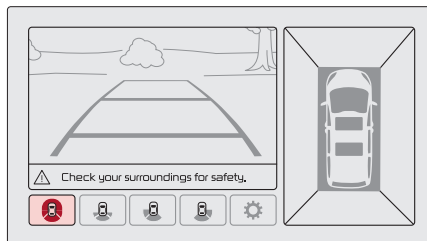

QUICK TIP

The Front SVM camera will turn off when the gear shift is moved into Park or Reverse or the SVM button is pressed.

Rear SVM operation:

- The camera view will automatically display on the audio system's screen when the vehicle is shifted into Reverse
- The camera view will turn off when the vehicle is shifted out of Reverse

Camera View Modes – To change camera view modes, press the icons shown below on the audio system's screen to select the mode.

Front SVM - when in Drive & Neutral:

- Displays the front side and SVM images simultaneously on the screen
- Displays the front side image on the screen
- Displays the front side and left side images simultaneously on the screen
- Displays the front side and right side images simultaneously on the screen

Rear SVM - when in Reverse:

- Displays the rear view and SVM images simultaneously on the screen
- Displays the rear side image on the screen
- Displays the rear and left side images simultaneously on the screen
- Displays the rear and right side images simultaneously on the screen

QR CODE

Surround View Monitor Video

To view a video on your mobile device, snap this QR Code or visit the listed website.

Refer to page 2 for more information.



www.youtube.com/KiaFeatureVideos

REMINDER: The SVM camera is equipped with an optical lens to provide a wider range of vision and may appear different from the actual distance.

The Surround View Monitor system is only a supplemental device. Drivers should not rely solely on the SVM information when parking and backing up. Drivers should always pay attention and directly check the left/right and rear.

Automatic Climate Control*

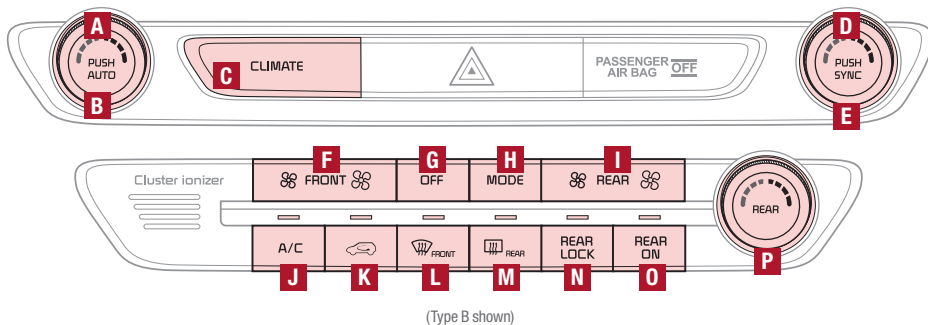

- A** Driver's temperature control knob
- B** AUTO (automatic control) button
- C** Climate information screen selection button
- D** Passenger's temperature control knob
- E** SYNC temperature control selection button
- F** Front fan speed control button
- G** Front Air Conditioning off button
- H** Front Mode Selection button
- I** Rear fan speed control button
- J** A/C on button
- K** Air intake control button
- L** Front windshield defroster button
- M** Rear window defroster button
- N** Rear control lock button
- O** Rear control on button
- P** Rear temperature control knob

Rear Climate Control*

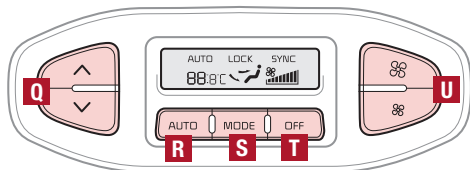

- Q** Rear temperature control buttons
- R** Rear AUTO climate control button
- S** Rear mode selection button
- T** Rear air conditioning OFF button
- U** Rear fan speed control buttons

Your Automatic Climate Control system may differ from those in the illustrations. See your Owner's Manual for more details.

Automatic Climate Control (Continued)

Climate Control Auto Function

1. Press AUTO **B** to select Full Auto Operation - The Auto setting automatically controls the airflow modes, fan speeds, air intake and air conditioning according to the temperature setting selected
2. Set desired **Temperature A**
3. Press SYNC **E** to select Sync Temperature Control Operation which synchronizes the passenger's temperature to the driver's setting

Defrost Outside Windshield:

1. Set Front **Fan Speed F** to the highest position
2. Set **Temperature A** to Hot
3. Press the **Front Defrost** button  **L**

Defog Inside Windshield:

1. Set Front **Fan Speed F** to desired position
2. Set desired **Temperature A**
3. Press the **Front Defrost** button  **L**

QUICK TIPS

- Defrost Mode  activates A/C and opens Fresh Air Vent to help dehumidify the air and improve Defroster performance
- During Auto Operation, the A/C indicator will NOT illuminate. The fan speed, air intake, air flow and air conditioning may automatically be engaged at any time to reach desired temperature and reduce humidity
- Keep inside glass as clean as possible to reduce window fogging

Air Flow Modes

To select Air Flow Modes, press the MODE button **H** to cycle through to desired mode:



REMINDERS:

- Pressing any button during AUTO operation will deactivate the AUTO function and switch to manual mode, except for Temperature Control
- When in AUTO mode, Air Flow Mode and Fan Speed do not display on the Climate Control Display
- Warm air may flow in through vents if Recirculated Air button is not pressed ON (LED lit)

Your Automatic Climate Control system may differ from those in the illustrations. See your Owner's Manual for more details.

Manual Climate Control*

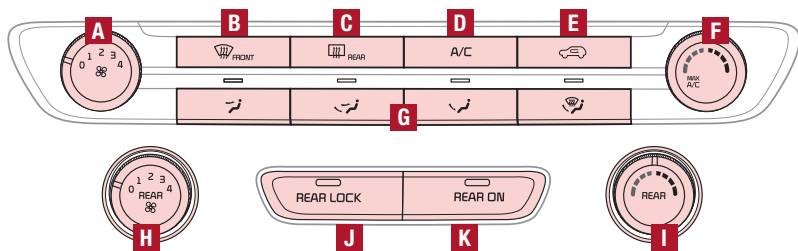

- A** Front fan speed control knob
- B** Front window defroster button
- C** Rear window defroster button
- D** Air conditioning button
- E** Air intake control button
- F** Front temperature control knob

- G** Front mode selection buttons
- H** Rear fan speed control knob
- I** Rear temperature control knob
- J** Rear control lock button
- K** Rear control on button

Defrost Outside Windshield:

1. Set **Fan Speed A** to the highest position
2. Set desired **Temperature F**
3. Press the **Front Defrost** button  **B**

Defog Inside Windshield:

1. Set **Fan Speed A** to desired position
2. Set desired **Temperature F**
3. Press the **Front Defrost** button  **B**

Your Manual Climate Control system may differ from those in the illustrations. See your Owner's Manual for more details.

QUICK TIPS

- Defrost Mode activates A/C and opens Fresh Air Vent
- MAX A/C Mode automatically engages Recirculated Air
- Keep inside glass as clean as possible to reduce window fogging

REMINDER: Warm air may flow in through vents if Recirculated Air button is not pressed ON (LED lit)

Rear Climate Control*

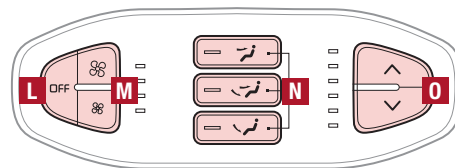

- L** Rear air conditioning OFF button
- M** Rear fan speed control buttons
- N** Rear mode selection buttons
- O** Rear temperature control buttons

Air Flow Modes

To select Air Flow Modes, press the Mode selection buttons **G**:

-  Face-Level
-  Bi-Level
-  Floor-Level
-  Floor/Defrost-Level

Digital Clock*

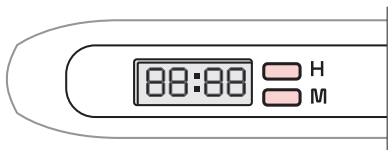

(Clock/buttons located on Center Panel)

Standard Audio System* Clock Setup:

Press the **H** button to advance the time by one hour. Press the **M** button to advance the time by one minute.

QUICK TIP

Press and hold both for more than 3 seconds to switch from 12- to 24-hour formats.

UVO eServices System/ UVO eServices with Premium Navigation System* Clock Setup:

Press the SETUP key, then the CLOCK button to display the Clock and Date setting screen. Then use the on-screen buttons to adjust time and date.

QUICK TIPS

- Press the RETURN button on the navigation screen to ensure changes are saved.
- When needed, Daylight Savings must be enabled in the Clock Settings screen
- To access manual date and time setting, turn GPS time OFF in the Clock Settings (UVO eServices with Premium Navigation System*)

REMINDER: The Center Panel Digital Clock and Navigation System Clock are not synchronized and may differ slightly.

Aux/USB/iPod® Ports, AC Inverter* and Power Outlets

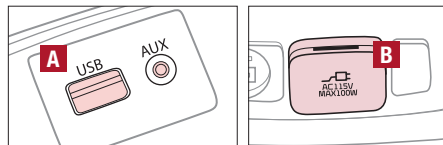

AUX/USB/iPod® ports A - Use the AUX port to connect audio devices and the USB port to connect USB audio devices, smartphones and iPod® devices

AC Inverter* B - 115V/100 watt power inverters are located in the back of the center console and in the luggage zone* (See page 8 for ON/OFF button information)

USB chargers* are located in the center panel and in the back of the center console

Power outlets are located on the center panel, in front of the gear

QUICK TIP

The power outlets are inactive when the Engine Start/Stop* button is OFF.

REMINDEES:

- Using the power outlets (accessory plugs) for prolonged periods of time with the ENGINE START/STOP button in the ACC position (Engine OFF) may cause the battery to discharge
- Use manufacturer cables only that came with your device. Third party cables may cause damage to device

For more information on the Aux/USB/iPod® Port, AC Inverter and Power Outlets, refer to the Owner's Manual.*

Heated Steering Wheel*

Press Heated Steering Wheel button **A** to turn the Steering Wheel Heater on/off, while the ENGINE START/STOP button is in the ON position. Steering Wheel Heater will turn off automatically in 30 minutes, or when button is pressed again to deactivate.

QUICK TIPS

- If ignition is turned OFF, then ON again within 30 minutes of Steering Wheel Heater being turned ON, the system will remain in the ON position
- System does NOT turn off when ignition is cycled. To turn off system, press the Heated Steering Wheel button

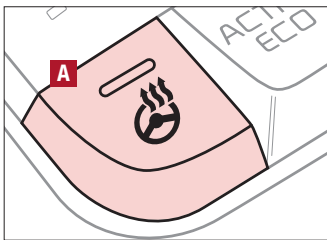

(Buttons located below Gear Shift)

Seat Warmers / Ventilated Seats*

B Seat Warmers

- Press button once for high setting (3 LEDs lit)
- Press button twice for medium setting (2 LEDs lit)
- Press a third time for low setting (1 LED lit) and again to turn OFF

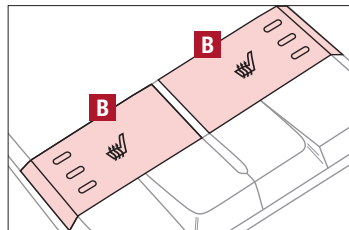

C Seat Warmers / Ventilated Seats

- Press right/left side of button once for high setting (3 LEDs lit)
- Press twice for medium setting (2 LEDs lit)
- Press a third time for low setting (1 LED lit) and again to turn OFF

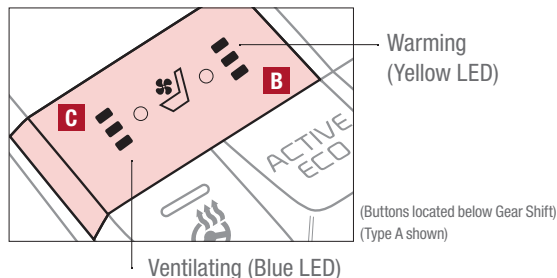

(Buttons located below Gear Shift)
(Type A shown)

QR CODE

Heated and Ventilated Seats Video

To view a video on your mobile device, snap this QR Code or visit the listed website.

Refer to page 2 for more information.



www.youtube.com/KiaFeatureVideos

QUICK TIPS

- With the Seat Warmer switch in the ON position, the heating system in the seat turns OFF or ON automatically depending on the seat temperature.
- When Seat Warmers or Ventilated Seats button is pressed ON and ignition is cycled, the system will turn ON again.

Automatic Gear Shift with Sportmatic® Shifting

P: Park

R: Reverse

N: Neutral

D: Drive

[+]: Sport Mode Upshift

[-]: Sport Mode Downshift

Sport Mode: To enter Sport mode, move shift lever from D to left gate.

To shift while in Sport mode, move shift lever up [+] to upshift or down [-] to downshift.

QUICK TIPS

- Press brake pedal and depress release button to move gearshift from N to P, N to R or from P to any gear
- Sport mode downshifts are made automatically when the vehicle slows down. When the vehicle stops, 1st gear is automatically selected

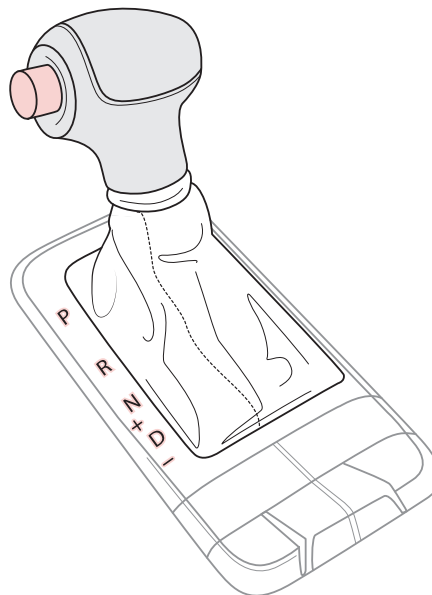

QR CODE

Sportmatic® Shifting Video

To view a video on your mobile device, snap this QR Code or visit the listed website.

Refer to page 2 for more information.



www.youtube.com/KiaFeatureVideos

Front Seat Headrest Adjustment

To raise headrest: Pull headrest up.

To lower headrest: Press lock **A**, then press the headrest down.

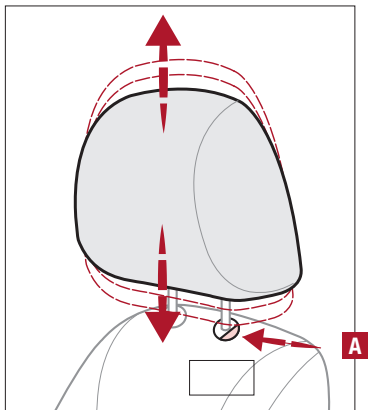

Driver Position Memory System*

The integrated system stores into memory the position of the Driver's Seat and the Outside Rearview Mirrors.

To store positions into memory, first place the Gear Shift into P (Park) while the Engine Start/Stop button* is in the ON position. Then:

1. Adjust the Driver's Seat and the Outside Rearview Mirrors
2. Press the SET button **B** on the control panel. System will beep once
3. Press one of the memory buttons **C** within 5 seconds. The system will beep twice when memory has been stored

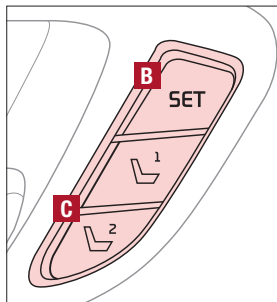

(Buttons located on Driver's Door Panel)

Easy Access Function*

- The system will automatically move the driver's seat forward when the ignition or the Engine Start/Stop button is pressed to ON or the ACC position.
- The system will automatically move the driver's seat rearward when the ignition or the Engine Start/Stop button is pressed to OFF.
- To activate or deactivate the Easy Access Function, go to User Settings in the LCD Instrument Cluster Modes.

Power Adjustable Driver's Seat*

Move/press controls to adjust Seat forward/backward, Seat Cushion tilt up/down, Seatback forward/backward or Lumbar up/down/forward/backward*

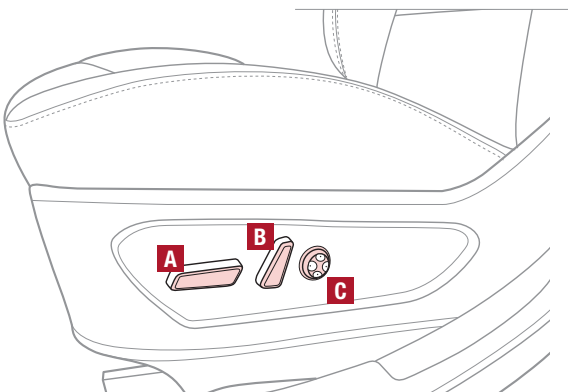
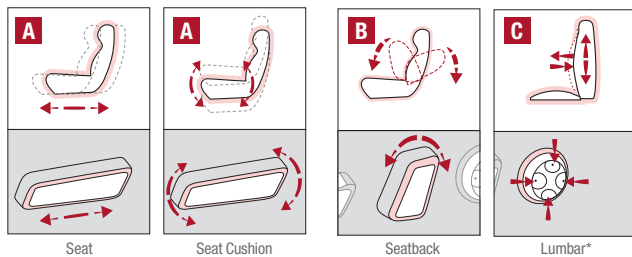

For more information on Power Adjustable Driver's Seat operation, refer to the Owner's Manual.

Manual Adjustable Driver's Seat*

Pull lever **D** to slide Seat forward/backward.

Pull/press lever **E** to adjust Seat height.

Pull lever **F** to adjust Seatback recline.

Press **G** to adjust Lumbar support.

QUICK TIP

When adjusting seat forward or backwards, ensure seat clicks or locks into place before driving the vehicle.

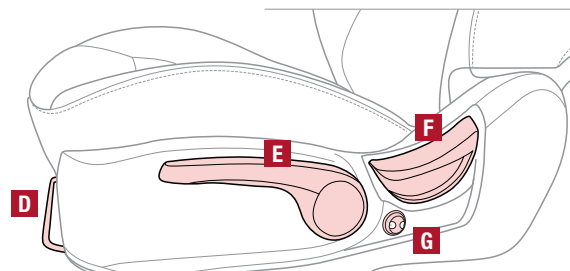

QUICK TIP

When adjusting seat forward or backward, ensure seat clicks or locks into place before driving vehicle.

For more information on Manual Adjustable Driver's Seat operation, refer to the Owner's Manual.

2nd-Row Seat

Folding 2nd-Row Seat

1. Lower the 2nd-Row Seat Headrest to the lowest position
2. Pull up on the Seatback folding lever **A** or strap* and fold the Seatback down

Unfolding 2nd-Row Seat

1. Lift the folding Seatback lever **A** and move the Seatback backward
2. Then lift the lever **A** again or return Seatback to an upright usable position

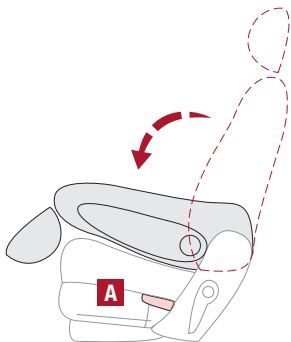

QUICK TIPS

- When you return Seatback to its original position, ensure it locks (clicks) into place
- It may be necessary to slide the front Seat forward and adjust the front Seatbacks to fully lower rear seats
- Lower Rear Headrests to the lowest position

REMINDER: The lever must return to its original position for the Seatback to lock.

QUICK TIP

- For specific information on how to use the 2nd- and 3rd-Row Center Seat Belts, please refer to your Owner's Manual

For more information on 2nd-Row Seat operation, refer to the Owner's Manual.

2nd-Row Walk-In Seat*

To get in and out of the 3rd-Row Seat, adjust the 2nd-Row Walk-In Seat as follows:

1. Lift the 2nd-Row Seat armrest
2. Adjust headrest to the lowest position
3. Accessing from outside of the vehicle: Pull up the Walk-In Lever **A** – the seat will stand up and headrest will fold automatically **C**
4. Accessing from the 3rd-Row seat: Pull the release strap **B** – the seat will stand up and headrest will fold automatically **C**
5. Return the 2nd-Row Seat to its original position and push until it locks (clicks) into place and the headrest unfolds

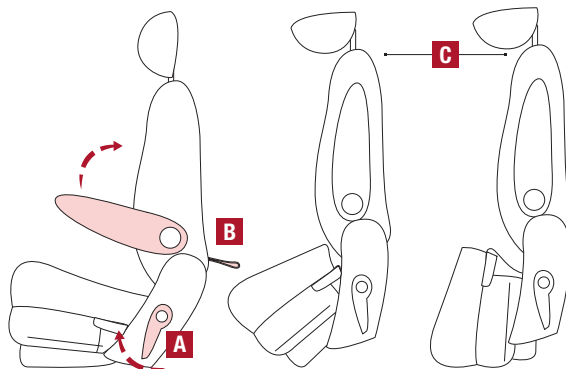

For more information on 2nd-Row Walk-In Seat operation, refer to the Owner's Manual.

2nd-Row First-Class Lounge Seating*

Leg Rest Extension

- Pull control **A** to raise the leg rest extension
- Pull control **A** to lower the leg rest, which partially closes. Then, manually press leg rest extension to fully lock into place

Arm Rest Adjustment

- To raise arm rest – From any position, press the armrest release button **B** (on inside of arm rest) and lift up to desired position
- To lower armrest – Press arm rest down, and it will rest in it's original position.
- To lower armrest further, press the release button (on inside of arm rest) and push the armrest down. Press button again to lift the armrest back up to desired position.

REMINDER: If you lift the armrest to the top without depressing the release button **B**, it will return back to the lowest position previously selected.

Seatback Recline - Pull control **C** to recline Seatback

Seat Forward/Backward - Press control **D** to slide seat forward/ backward

Seat Adjust Inboard/Outboard - Press control **E** to slide seat inward/outward

REMINDER: Always return leg extension to its original position when adjusting seat.

For more information on 2nd-Row First-Class Lounge Seating operation, refer to the Owner's Manual.

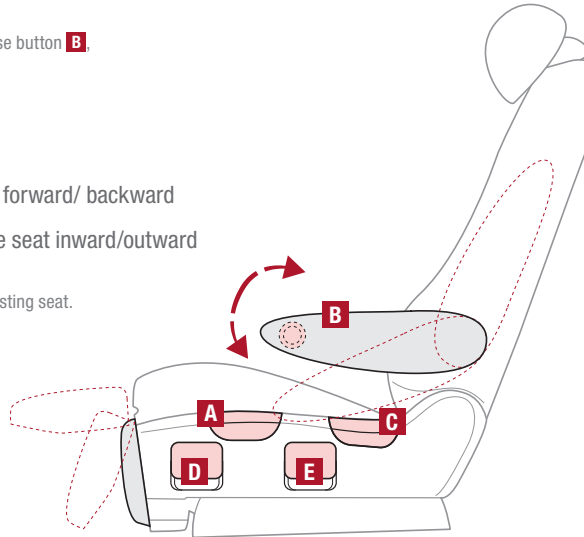

QR CODE

Sedona 2nd and 3rd Row Seats Video

To view a video on your mobile device, snap this QR Code or visit the listed website.

Refer to page 2 for more information.



www.youtube.com/KiaFeatureVideos

2nd-Row Tumble (Center) Seat*

Removing the Tumble Seat

1. Insert the seat belt into the belt assembly cover, and the seat belt buckle into the seat cushion pocket.
2. Lower the headrest **A** to the lowest position
3. Slide the Seat backward to the farthest position
4. Pull up the recline strap **B** and fold the Seatback forward
5. Pull the removal strap **C** and lift the back of the Tumble Seat forward
6. Pull up the catch release lever **D** under the Tumble Seat cushion and lift out of the anchors

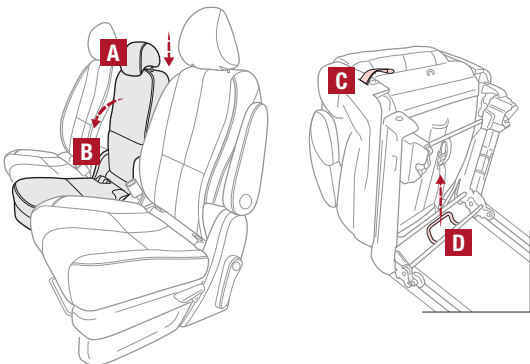

For more information on removing the Tumble Seat, refer to the Owner's Manual.

QUICK TIP

For specific information on how to use the 2nd- and 3rd-Row Center Seat Belts, please refer to your Owner's Manual

Installing Tumble Seat

1. Place and align the Tumble Seat properly **E**
2. Lower Tumble Seat and push down firmly until it clicks into place
3. Ensure the Tumble Seat is latched securely by the green indicator
4. Pull up the Tumble Seatback recline strap **F**, lift Seatback backward until it locks (clicks) into place
5. Return the Seat Belt to its proper position

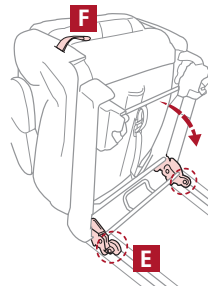

REMINDERS:

- Never install or remove the Tumble Seat while there are occupants in the 3rd-Row Seat
- Ensure to raise up both the left and right side seatbacks before installing tumble seat

Unfastening Center Seat Belt

1. If Seat Belt is buckled, press the release button on the buckle.
2. To retract the center seatbelt webbing **G** in 2nd and/or 3rd rows, use the lap belt tongue plate **H** to push the "release button" in the small slot on the center belt buckle **J**.

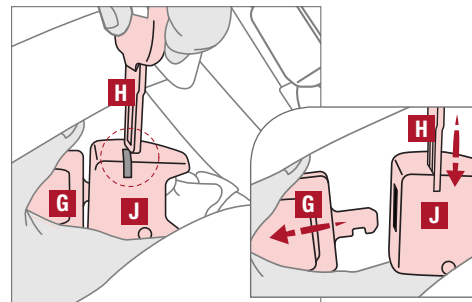

QR CODE

Unfastening Center Seat Belt Video

To view a video on your mobile device, snap this QR Code or visit the listed website.

Refer to page 2 for more information.



www.youtube.com/KiaFeatureVideos

For more information on the Tumble Seat, refer to the Owner's Manual.

3rd-Row Seat – Folding and Stowing

Folding 3rd-Row Seat

1. Fully lower headrest **A**
2. Pull Seat folding strap located in the back of the Seatback **B**
3. Fold Seat down **C**

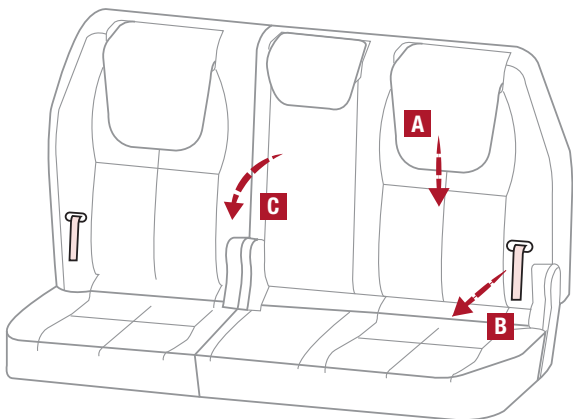

For more information on 3rd-Row Seat operation, refer to the Owner's Manual.

Stowing 3rd-Row Seats*

The rear seats can be folded and stowed in the luggage compartment for additional cargo space.

1. Fully lower headrests **D**
2. Pull release lever **E** and push Seat firmly in place

REMINDER: The seat straps on the front and back of the 3rd-Row Seat are for folding only.

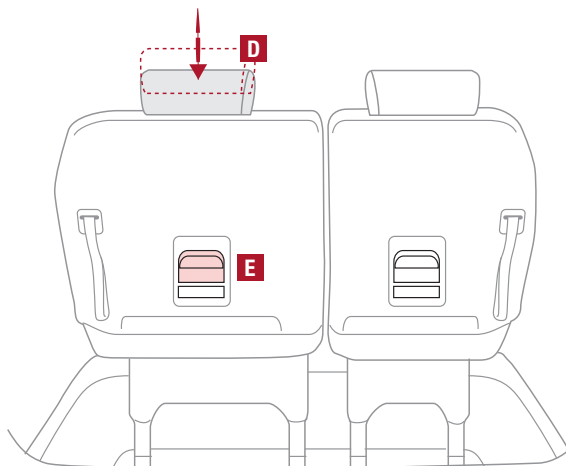

QR CODE

Sedona 2nd and 3rd Row Seat Video

To view a video on your mobile device, snap this QR Code or visit the listed website.

Refer to page 2 for more information.



www.youtube.com/KiaFeatureVideos

QUICK TIP

For specific information on how to use the 2nd- and 3rd-Row Center Seat Belts, please refer to your Owner's Manual

Remote Keyless Entry (Folding Key)*

- A** Press the release button to unfold the key
- B** Press to lock All Doors
- C** Press to unlock Driver's Door: Press twice in 4 seconds to unlock All Doors and Liftgate, and manually open
- D** Press and hold left/right button to automatically open/close the power sliding doors*
- E** Manual Liftgate*: Press and hold for more than 1 second to unlock Liftgate and manually open
Power Liftgate*: Press and hold for more than 1 second for Power Liftgate to automatically open/close
- F** Press and hold more than a half second for Panic Alarm. To turn OFF Alarm, press any button

REMINDERS:

- The Manual Liftgate does not automatically open when the **E** button is pressed.
- The Liftgate unlocks when the Smart Key fob is within close proximity of the rear liftgate

Remote button configuration may vary depending on vehicle options.

Double-Turn Lock/Unlock All

- Turn counterclockwise once to unlock Driver's Door
- Turn counterclockwise again within 4 seconds to unlock All Doors
- Turn clockwise once to lock All Doors

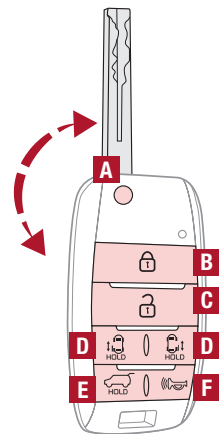
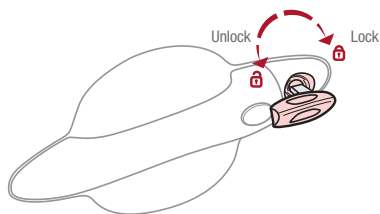

(Type B shown)

Power Sliding Doors*

Press the left/right Power Sliding Door button **G** on the overhead controls, on the Center Pillars **H** or on the key fob **D** to automatically open/close the sliding doors.

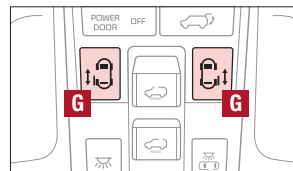

(Buttons located in overhead controls)

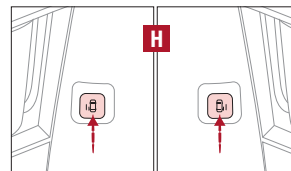

(Buttons located on center pillars)

REMINDER: If the POWER DOOR OFF button is depressed, the Smart Power Liftgate* will not operate.

For more information on the Power Sliding Doors operation, please refer to the Owner's Manual.

Smart Key*

A Press to lock All Doors

B Press to unlock Driver's Door. Press twice within 4 seconds to unlock All Doors.

C Power Sliding Doors:

Option 1 - Press and hold the left/right button to automatically open/close the power sliding doors*

Option 2 - With the Smart Key fob on your person, pull the Power Sliding Door handle once and the door will open/close automatically

D **Manual Liftgate***: Press and hold for more than 1 second to unlock Liftgate. Then lift by the handle to manually open Liftgate.

REMINDERS:

- The Liftgate does not automatically open when the **D** button is pressed.
- The Liftgate unlocks when the Smart Key fob is within close proximity of the vehicle.

Power Liftgate*: Press and hold for Power Liftgate to open automatically. Press again at any time to stop. Press again to automatically close

Smart Power Liftgate*: When enabled, the liftgate will open automatically as you approach the rear of the vehicle with the Smart Key fob with you (For more details, see page 40)

E Press and hold for more than a half second for Panic Alarm. To turn off Alarm, press any button

Driver's Door Lock/Unlock button **G**:

- Press button once to unlock driver's door
- Press again within 4 seconds to unlock all doors
- Press again to lock all doors



Mechanical Key **F**:

- Press button on back of key fob to release Mechanical Key
- Use to unlock driver's door
- Use to enable/disable Child-Protector Rear Door Lock.
- Use to lock glove box

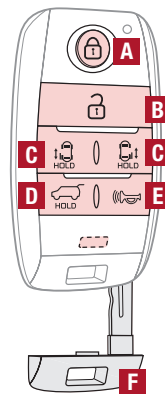

(Type B shown)

QR CODE

Engine Start/Stop Button & Smart Key Video

To view a video on your mobile device, snap this QR Code or visit the listed website.

Refer to page 2 for more information.



www.youtube.com/KiaFeatureVideos

QUICK TIPS

- The Smart Key's signal can be blocked by the normal operation of a cellular phone or smartphone. To help prevent this, store each device separately.
- If the Smart Key battery is weak or not working properly, hold the Smart Key fob up to the Engine Start/Stop button (Lock button side closest) and press to start engine

Remote button configuration may vary depending on vehicle options.

For more information on the Mechanical Key, please refer to your Owner's Manual

Map/Room Lamps

Automatic turn off function*

The interior lights automatically turn off approximately 30 seconds after the Engine Start/Stop button is OFF.

Map/Room Lamp Operation

Press the lens **A** to turn the Map Lamp ON/OFF. This light produces a spot beam for convenient use as a map lamp or as a personal lamp for the driver or the front passenger.

When the  button **B** is pressed the following occurs:

- When any door or the liftgate is opened, the map and room lamps turn ON
- When doors are unlocked from the Smart Key or key removed from ignition, the Map and Room Lamps turn ON for approximately 30 seconds or until a door is opened
- When doors are closed, the lamps will gradually turn OFF after approximately 30 seconds
- When all doors are locked or the ignition is turned ON, the Map Lamp will turn OFF immediately.

When the  button **C** is pressed, the lamps stay ON continuously.

Room Lamp – Press the lens **D** to turn the Room Lamp ON/OFF.

REMANDER: When Room Lamp lens is pressed ON it will remain ON, even when the Map Lamp switch is in the OFF position.

QUICK TIPS

- When doors are unlocked by the Smart Key*, the lamp turns ON for approximately 30 seconds
- If your vehicle is equipped with the theft alarm system, the interior lights automatically turn off approximately 3 seconds after the system is in armed stage
- Using interior lights for an extended period of time may cause battery discharge

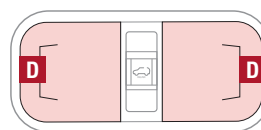
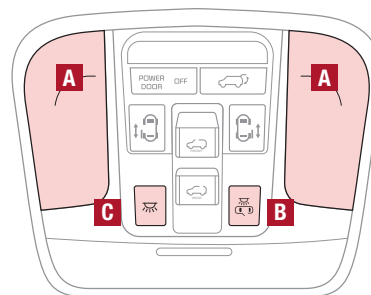

(Lamp controls located in the overhead consoles). Type A shown.

Sunvisor

Use the Sunvisor to shield direct light through the front or side windows. Slide the Sunvisor out and adjust as needed.

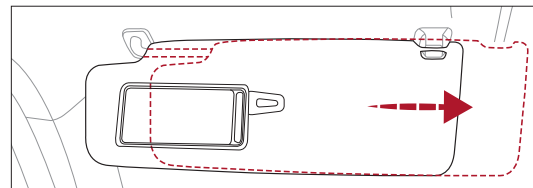

REMANDERS:

- Sunvisor may not shield all direct light
- The Sunvisor may impair visibility if not adjusted properly
- Be aware of seating position when adjusting or swinging Sunvisor around to or from the front or side windows.
- Do not operate the vehicle if the sunvisor is impairing your visibility.

Sunroof Operation*

The Sunroof and Sunshade operation is controlled through multi-directional switches/levers **A**, **B** or **C**. The ignition needs to be ON to operate the sunroof/sunshade.

To slide the Front/Rear Sunshade and Sunroof:

- Auto Open: Slide the levers **A**, **B** or **C** backward to the farthest position and release
- Auto Close (Sunroof only): Slide the levers **A**, **B** or **C** forward to the farthest position and release

REMANDER: The front Sunroof will automatically open all the way. The Rear Sunroof will only partially open. To open all the way, slide the Rear Sunroof lever again.

Tilt the Front Sunroof:

- Raise: Push lever **A** upward
- Lower: Pull lever **A** downward
- Auto Close Sunroof and Sunshade: Slide the Front Sunroof lever **A** forward to the farthest position

REMANDERS:

- When the Power Window Lock is depressed, the Rear Sunroof controls cannot operate the Rear Sunroof
- Sunshade needs to remain OPEN while Sunroof is open and vehicle is moving

QUICK TIP

To stop the Sunroof/Sunshade at any position, push or pull the Sunroof control lever in any direction.

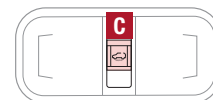
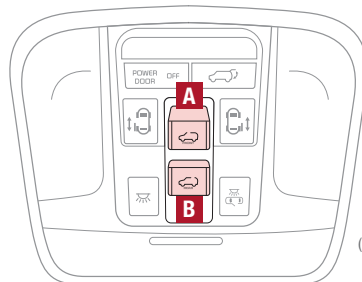

(Rear Sunroof control in the rear overhead console)

(Front overhead console for Front and Rear Sunroof controls)

Parking Assist System*

The Parking Assist System* is not a safety device. The Parking Assist System* is a supplemental system that assists the driver by chiming if any object is detected within the sensing area to the front, rear and side of the vehicle when moving forward or backing up.

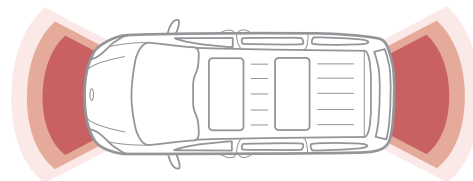

To activate, press button **D** (LED illuminated). The system is also activated when the ignition is ON and the gear shift is moved into R (Reverse). To deactivate the system, press the Parking Assist System* button **D** (LED not illuminated).



(Button located below Gear shift)

REMANDERS:

- If the vehicle is moving at speeds over 3 mph, the system may not activate correctly
- When more than two objects are sensed at the same time, the closest one will be recognized first

The Parking Assist System is not a substitute for proper and safe backing-up procedures. Always drive safely and use caution when backing up. The Parking Assist System* may not detect every object in front of or behind the vehicle.*

Rear-Camera Display*

The Rear-Camera Display system is not a safety device. It is a supplemental system that displays the view behind the vehicle through the Standard Audio System, UVO eServices System and the UVO eServices with Premium Navigation screens while the vehicle is in Reverse.

The Rear-Camera Display* activates when the:

- Ignition or the Engine Start/Stop button* is in the ON position (Green Light)
- Gear Shift Lever is in the R (Reverse) position
- To turn the Rear-Camera Display* OFF, press the camera button **A** (LED not illuminated)

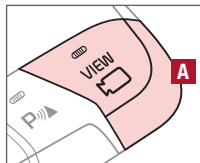

(Button located below Gear shift)

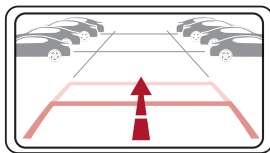
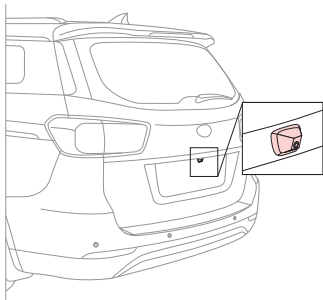

(Navigation screen display shown)

REMINDERS:

- The Rear-Camera Display* is ON by default when ignition is cycled
- While camera is active, only the volume controls on the Audio System can be operated
- The screen image above is for illustration purposes only. The actual image or graphics may differ in your vehicle

The Rear-Camera Display is not a substitute for proper and safe backing-up procedures. The Rear-Camera Display may not display every object behind the vehicle. Always drive safely and use caution when backing up.*

Power Liftgate / Smart Liftgate*

Opening from Inside the Vehicle:

Press the Power Liftgate Open/Close button* **B** to automatically open/close the Liftgate. Depress the POWER DOOR OFF button* **C** to disable.

REMINDER: If POWER DOOR OFF button is pressed, the Power Liftgate button on the Smart Key will be disabled.

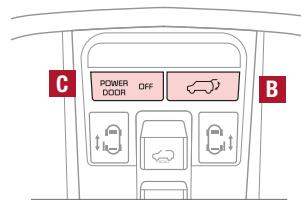

(Buttons located on overhead console)

Opening from Outside the Vehicle:

To open Power Liftgate* automatically, press the Liftgate Release button **D** on exterior of the Liftgate.

Automatically close by pressing Power Liftgate Close button* **E**.

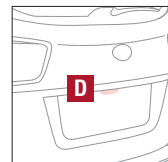

Power Liftgate Height Adjustment:

For your convenience, the liftgate opening height is adjustable. To program the opening height, perform the following:

1. Open liftgate and manually position liftgate to your preferred opening height
2. Depress and hold the close button on the liftgate for 3 seconds or more
3. The system will beep 3 times when the programming is complete

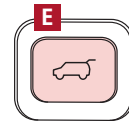

(Button located on inside edge of liftgate)

Power Liftgate / Smart Liftgate* (continued)

Smart Key:

To open the Power Liftgate*, press and hold the Smart key Liftgate button **F** until the Liftgate begins opening. Press again to close.

REMINDER: Pulling the Liftgate upward by the handle or pressing the button a second time will interrupt the automatic opening of the Power Liftgate.

Smart Liftgate*

When the Smart Key fob is on your person and you are near the back of the vehicle, within close proximity, the hazard lights will blink and a chime will sound for about 3 seconds as an alert that the Smart Liftgate* is about to open.

Then the alert system will blink and chime two additional times before opening the Smart Liftgate* **G**.

The Smart Liftgate* feature is OFF by default. To enable the Smart Liftgate*, go to User Settings in the LCD Instrument Cluster modes.

QUICK TIP

- During the Smart Liftgate alert, the Smart Liftgate can be deactivated with the Smart Key by pressing any button on the key fob.
- The open height can be adjusted. For information on how to set open height, see your owner's manual

REMINDEERS:

- All doors are closed and locked after about 15 seconds
- If the POWER DOOR OFF button is depressed, the Smart Liftgate will not operate
- The Smart Liftgate feature will not operate when the doors are recently closed and locked, and the Smart Key is still detected after 15 seconds near the vehicle or within 60 inches of the door handles, a door is not locked or closed or the Smart Key is in the vehicle

For more information on the Smart Power Liftgate operation, please refer to the Owner's Manual.

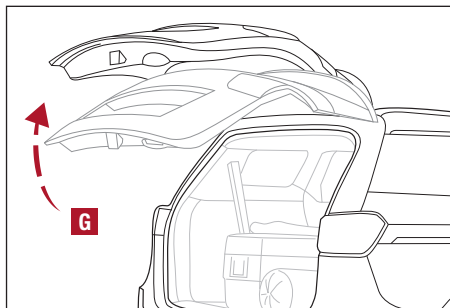
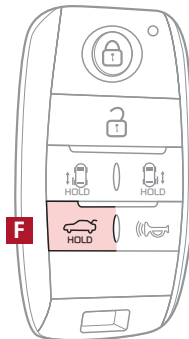

QR CODE

To view a video on your mobile device, snap this QR Code or visit the listed website.

Refer to page 2 for more information.

Smart Power Liftgate Video



Power Liftgate Opening Height Adjustment Video



www.youtube.com/KiaFeatureVideos

Hood Release Lever and Latch

Opening the Hood:

1. Pull the Hood Release Lever **A** to unlatch the Hood
2. In the front of the vehicle, lift the Hood slightly, push the secondary Latch **B** to the left inside of the Hood's center and lift the Hood
3. Pull out the support rod from the Hood and set into place to hold the Hood open

REMINDER: Open the Hood only after turning the engine off, on a flat surface, with the gear shift in P (Park) position and setting the parking brake.

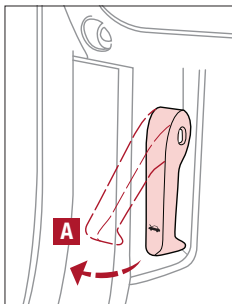

(Lever located near floor below Driver's Panel)

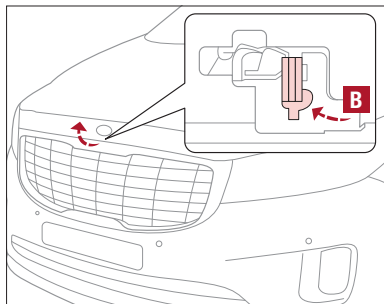

(Secondary latch located inside lip of Hood)

Closing the Hood:

Lower the Hood about halfway and then press down to securely lock in place.

Fuel Cap / Malfunction Indicator (Check Engine Light)

Tighten for ONE CLICK to prevent Malfunction Indicator  from illuminating.

REMINERS:

- The Fuel Filler Door Release button is located on the driver's button panel, left of the Steering Wheel.
- It is normal operation when tightening to hear one click and then when Fuel Cap is released, it clicks back.

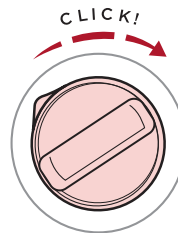

Child-Protector Rear Door Lock

Located on the front edge of the rear passenger doors, move the Child-protector rear door lock to the lock position  to disable the inner door handles from opening the rear passenger doors.

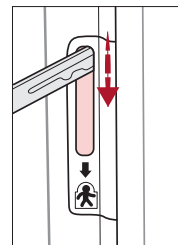

(Located on the front edge of the rear passenger doors)

QR CODE

One-Click Fuel Cap Video

To view a video on your mobile device, snap this QR Code or visit the listed website.

Refer to page 2 for more information.



www.youtube.com/KiaFeatureVideos

HomeLink® with Auto-Dimming Rearview Mirror*

- A** HomeLink® button
- B** HomeLink® button
- C** Indicator light
- D** HomeLink® button
- E** Glare detection sensor
- F** Automatic dimming ON
- G** Automatic dimming OFF

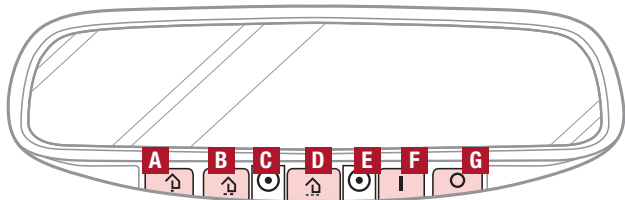

The HomeLink® with Auto-Dimming Rearview Mirror* is designed to reduce glare from a vehicle's headlights located in the rear and also connect up to three electronic transmitters into one location.

- To turn automatic dimming ON, press **↑** button **F**
- To turn automatic dimming OFF, press **⊘** button **G**

REMINDER: Mirror indicator light **C** will illuminate when automatic dimming is ON.

QUICK TIPS

- You can reprogram a single HomeLink® button by repeating Step 2
- Erasing programmed buttons will delete all trained transmitters

How to Sync Transmitter with HomeLink®*

If programming for the first time, begin with Step 1 (repeating this step will delete all information).

To program non-rolling and rolling code garage door openers and other devices:

1. Press and hold the left **A** and center **D** buttons simultaneously until the indicator light **C** begins to flash (to reprogram buttons, skip this step)
2. Press and hold the desired button **A**, **B** or **D** and hold the button on the transmitter while it is approximately 1 to 3 inches away from the mirror. The HomeLink® Indicator light **C** will flash rapidly once the frequency signal has been successfully programmed

To finish programming rolling code garage door openers, complete these steps:

3. Locate the “learn” or “smart” button on the garage door’s motor head unit. Press and release the button and complete Step 4 within 30 seconds
4. Firmly press and release the programmed HomeLink® button up to three times

Operating HomeLink®:

Press one of the programmed HomeLink® buttons.

Erasing programmed buttons:

Press and hold the left **A** and center **D** buttons simultaneously for approximately 20 seconds, and then release both buttons within 30 seconds.

If your garage door opener was manufactured in 2011 or later, and you're unable to program your vehicle's HomeLink® system, you may need to purchase a HomeLink Repeater Kit. For more information, go to www.HomeLink.com or call (800) 355-3515.

Occupant Detection System (ODS) / Passenger Airbag Off Indicator

ODS detects the presence and position of the front passenger and adjusts or turns off airbag deployment accordingly.

Depending on the situation and type of accident, the system may:

- Deploy airbag (Adult)
- Not deploy the airbag (Unoccupied)



(Type A shown)

If the system determines that the airbag should not be deployed, the "PASSENGER AIRBAG OFF" light will illuminate.

Seat Belts

To properly fasten your seat belts:

1. Insert the belt tongue plate **A** into the buckle **B** until it clicks
2. Position the lap portion of the belt across your lap as **LOW ON THE HIPS** as possible **C**. Adjust the belt to a **SNUG FIT** by pulling up on the shoulder portion **D**

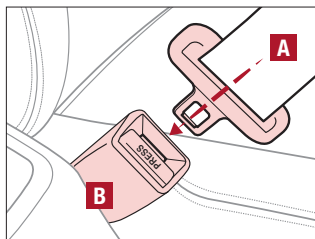

REMINDER: For maximum protection, always wear your seat belt.

Seat Belt Retractor Locks

Retractor locks allow lap/shoulder seat belts to remain unlocked during normal vehicle operation for freedom of movement and increased comfort.

During a **STRONG STOP, SUDDEN TURN OR CERTAIN COLLISIONS**, seat belt retractors will automatically lock the belts to reduce the risk of injury.

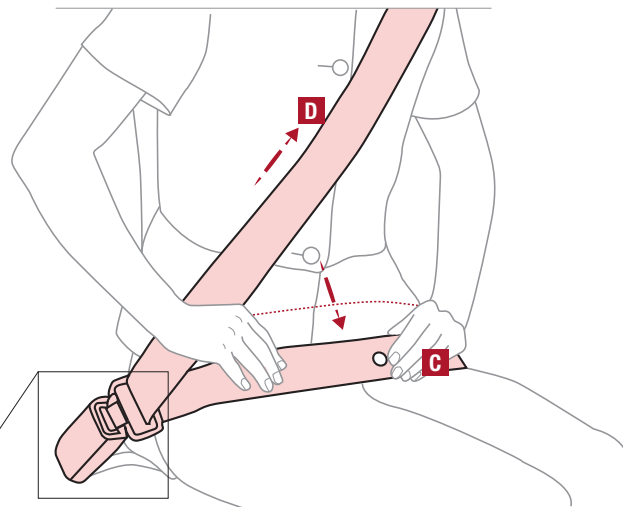

QUICK TIP

The seat belt warning chime operates for driver's seat only.

Normal Maintenance Schedule

When your vehicle requires service, remember that your dealer knows your vehicle best. Your dealer has factory-trained technicians, recommended special tools, genuine Kia replacement parts and is dedicated to your complete satisfaction. For expert advice and quality service, see your authorized Kia dealer.

7,500 miles

PERFORM

- Rotate tire
- Add fuel additive¹ (Every 7,500 miles)

REPLACE

- Engine oil and filter (Every 7,500 miles)

INSPECT*

- Battery condition
- Air cleaner filter
- Vacuum hose
- Power steering fluid**
- Power steering pump, belt and hoses**

*And, if necessary, adjust, correct, clean or replace. **If equipped

1. If TOP TIER detergent gasoline is not available, one bottle of additive is recommended. Additives are available from your authorized Kia dealer along with information on how to use them. Do not mix other additives.

15,000 miles

PERFORM

- Rotate tire
- Add fuel additive¹ (Every 7,500 miles)

REPLACE

- Climate control air filter (For evaporator and blower unit)
- Engine oil and filter (Every 7,500 miles)

INSPECT*

- | | |
|---|--|
| <ul style="list-style-type: none"> • Battery condition • Air cleaner filter • Vacuum hose • Air conditioning refrigerant • Brake hoses and lines • Drive shafts and boots • Exhaust pipe and muffler | <ul style="list-style-type: none"> • Front brake disc/pads, calipers • Rear brake disc/pads • Steering gear box, linkage & boots/lower arm ball joint, upper arm ball joint • Suspension mounting bolts • Power steering fluid** • Power steering pump, belt and hoses** |
|---|--|

*And, if necessary, adjust, correct, clean or replace. **If equipped

1. If TOP TIER detergent gasoline is not available, one bottle of additive is recommended. Additives are available from your authorized Kia dealer along with information on how to use them. Do not mix other additives.

QUICK TIP

Check your Maintenance Schedule or schedule an appointment with a dealer using your UVO eServices account by logging into your UVO App or your account on MyUVO.com (Vehicles equipped with UVO eServices only - See page 20 for setup information)

Normal Maintenance Schedule (Continued)

22,500 miles

PERFORM

- Rotate tire
- Add fuel additive¹ (Every 7,500 miles)

REPLACE

- Engine oil and filter (Every 7,500 miles)

INSPECT*

- Battery condition
- Air cleaner filter
- Vacuum hose
- Power steering fluid**
- Power steering pump, belt and hoses**

*And, if necessary, adjust, correct, clean or replace. **If equipped

1. If TOP TIER Detergent Gasoline is not available, one bottle of additive is recommended. Additives are available from your authorized Kia dealer along with information on how to use them. Do not mix other additives.

30,000 miles

PERFORM

- Rotate tire
- Add fuel additive¹ (Every 7,500 miles)

REPLACE

- Climate control air filter (For evaporator and blower unit)
- Air cleaner filter
- Engine oil and filter (Every 7,500 miles)

INSPECT*

- | | |
|---|--|
| • Battery condition | • Suspension mounting bolts |
| • Vacuum hose | • Brake fluid |
| • Air conditioning refrigerant | • Fuel filter ² |
| • Brake hoses and lines | • Fuel lines, fuel hoses and connections |
| • Drive shafts and boots | • Fuel tank air filter ² |
| • Exhaust system | • Parking brake |
| • Front brake disc/pads, calipers | • Vapor hose and fuel filler cap |
| • Rear brake disc/pads | • Power steering fluid** |
| • Steering gear box, linkage & boots/
lower arm ball joint, upper arm ball joint | • Power steering pump, belt and hoses** |

*And, if necessary, adjust, correct, clean or replace. **If equipped

1. If TOP TIER Detergent Gasoline is not available, one bottle of additive is recommended. Additives are available from your authorized Kia dealer along with information on how to use them. Do not mix other additives. 2. Fuel filter & Fuel tank air filter are considered to be maintenance free but periodic inspection is recommended for this maintenance schedule depends on fuel quality. If there are some important safety matters like fuel flow restriction, surging, loss of power, hard starting problem etc, replace the fuel filter immediately regardless of maintenance schedule and consult an authorized Kia dealer for details.

Normal Maintenance Schedule (Continued)

37,500 miles

PERFORM

- Rotate tire
- Add fuel additive¹ (Every 7,500 miles)

REPLACE

- Engine oil and filter (Every 7,500 miles)

INSPECT*

- Battery condition
- Air cleaner filter
- Vacuum hose
- Power steering fluid**
- Power steering pump, belt and hoses**

*And, if necessary, adjust, correct, clean or replace. **If equipped

1. If TOP TIER Detergent Gasoline is not available, one bottle of additive is recommended. Additives are available from your authorized Kia dealer along with information on how to use them. Do not mix other additives.

45,000 miles

PERFORM

- Rotate tire
- Fuel additive¹ (Every 7,500 miles)

REPLACE

- Climate control air filter (For evaporator and blower unit)
- Engine oil and filter (Every 7,500 miles)

INSPECT*

- Battery condition
- Air cleaner filter
- Vacuum hose
- Air conditioning refrigerant
- Brake hoses and lines
- Drive shafts and boots
- Exhaust system
- Front brake disc/pads, calipers
- Rear brake disc/pads
- Steering gear box, linkage & boots/lower arm ball joint, upper arm ball joint
- Suspension mounting bolts
- Power steering fluid**
- Power steering pump, belt and hoses**

*And, if necessary, adjust, correct, clean or replace. **If equipped

1. If TOP TIER Detergent Gasoline is not available, one bottle of additive is recommended. Additives are available from your authorized Kia dealer along with information on how to use them. Do not mix other additives.

Normal Maintenance Schedule (Continued)

52,500 miles

PERFORM

- Rotate tire
- Add fuel additive¹ (Every 7,500 miles)

REPLACE

- Engine oil and filter (Every 7,500 miles)

INSPECT*

- Battery condition
- Air cleaner filter
- Vacuum hose
- Power steering fluid**
- Power steering pump, belt and hoses**

*And, if necessary, adjust, correct, clean or replace. **If equipped

1. If TOP TIER Detergent Gasoline is not available, one bottle of additive is recommended. Additives are available from your authorized Kia dealer along with information on how to use them. Do not mix other additives.

60,000 miles

PERFORM

- Rotate tire
- Add fuel additive¹ (Every 7,500 miles)

REPLACE

- Climate control air filter (For evaporator and blower unit)
- Air cleaner filter
- Engine oil and filter (Every 7,500 miles)

INSPECT*

- Battery condition
- Vacuum hose
- Air conditioning refrigerant
- Brake hoses and lines
- Drive shafts and boots
- Exhaust system
- Front brake disc/pads, calipers
- Rear brake disc/pads
- Steering gear box, linkage & boots/lower arm ball joint, upper arm ball joint
- Suspension mounting bolts
- Brake fluid
- Fuel filter³
- Fuel lines, fuel hoses and connections
- Fuel tank air filter²
- Parking brake
- Valve clearance³
- Vapor hose and fuel filler cap
- Drive belts⁴ (First, 60,000 miles after that, every 15,000 miles)
- Power steering fluid**
- Power steering pump, belt and hoses**

*And, if necessary, adjust, correct, clean or replace. **If equipped

1. If TOP TIER Detergent Gasoline is not available, one bottle of additive is recommended. Additives are available from your authorized Kia dealer along with information on how to use them. Do not mix other additives. 2. Fuel filter & Fuel tank air filter are considered to be maintenance free but periodic inspection is recommended for this maintenance schedule depends on fuel quality. If there are some important safety matters like fuel flow restriction, surging, loss of power, hard starting problem etc, replace the fuel filter immediately regardless of maintenance schedule and consult an authorized Kia dealer for details. 3. Inspect for excessive tappet noise and/or engine vibration and adjust if necessary. 4. The drive belt should be replaced when cracks occur or tension is reduced excessively.

LEGAL DISCLAIMERS

Driving while distracted is dangerous and should be avoided. Drivers should remain attentive to driving and always exercise caution when using the steering-wheel-mounted controls while driving.

Driving while distracted can result in a loss of vehicle control that may lead to an accident, severe personal injury and death. The driver's primary responsibility is in the safe and legal operation of a vehicle, and use of any handheld devices, other equipment or vehicle systems which take the driver's eyes, attention and focus away from the safe operation of a vehicle or that are not permissible by law should never be used during operation of the vehicle.

Safety Features: No system, no matter how advanced, can compensate for all driver error and/or driving conditions. Always drive responsibly.

Airbags: For maximum protection, always wear your seat belt.

Android Auto™: Android Auto is a trademark of Google, Inc. Android™ is a registered trademark of Google, Inc. Distracted driving can result in a loss of vehicle control. Never use a handheld device or vehicle system that takes your focus away from safe vehicle operation. Navigation is for information purposes only, and Kia does not make any warranties about the accuracy of the information.

Apple CarPlay®: Apple CarPlay® a registered trademark of Apple Inc. Distracted driving can result in a loss of vehicle control. Never use a handheld device or vehicle system that takes your focus away from safe vehicle operation. Navigation is for information purposes only, and Kia does not make any warranties about the accuracy of the information.

Apps: All information contained herein was based upon the latest available information at the time of appstore registration. Descriptions are believed to be correct, and Kia makes every effort to ensure accuracy, however, accuracy cannot be guaranteed. From time to time, Kia may need to update or make changes to the vehicle features and other vehicle information reported in this app. Kia, by the publication and dissemination of this material, does not create any warranties, either express or implied, to any Kia products. Contact your local Kia dealer for the most current information.

Autonomous Emergency Braking System (AEB) / Forward Collision Warning System: These systems are not substitutes for safe driving, and may not detect all objects in front of vehicle. Always drive safely and use caution.

Bluetooth® Wireless Technology: The Bluetooth® word mark and logos are registered trademarks owned by Bluetooth SIG Inc., and any use of such marks by Kia is pursuant to license. A Bluetooth® enabled cell phone is required to use Bluetooth® wireless technology.

Driver Assist Features - Blind Spot Detection (BSD) with Lane Change Assist, Rear Cross Traffic Alert (RCTA), Lane Departure Warning System, Rear-Camera Display: These features are not substitutes for safe driving, and may not detect all objects surrounding vehicle. Always drive safely and use caution.

Electronic Stability Control (ESC) / Traction Control System (TCS)/Hill-start Assist Control (HAC): No system, no matter how advanced, can compensate for all driver error and/or driving conditions. Always drive responsibly.

Engine Start/Stop Button with Smart Key: Always come to a complete stop before turning the engine on or off. However, if you have an emergency while the vehicle is in motion and must turn the engine off, you can turn the engine off to the ACC position by pressing the Start/Stop button for more than 3 seconds or 3 times in succession. If the vehicle is still moving, you can restart the engine by pressing the Start/Stop button with the shift lever in Neutral (N). With the engine off, hydraulic power assist for steering and braking will be disabled and the vehicle will be more difficult to control.

Front Seat Headrest Adjustment: Never attempt to adjust headrests when vehicle is in motion.

Google Play™ Store is a trademark of Google, Inc. © 2012 Google Inc. All rights reserved. Google and the Google Logo are registered trademarks of Google Inc.

HomeLink®: Homelink® is a registered trademark of Gentex Corporation

iPod® is a registered trademark of Apple Inc. iPod® mobile digital device sold separately, and connectivity requires the Kia accessory cable.

Navigation: Distracted driving can result in a loss of vehicle control. When operating a vehicle, never use a vehicle system that takes your focus away from safe vehicle operation. Navigation is for information purposes only, and Kia does not make any warranties about the accuracy of the information.

Occupant Detection System (ODS): Kia vehicles use a number of different ODS types that vary by model.

Roadside Assist: 24-hour Enhanced Roadside Assistance is a service plan provided by Kia Motors America, Inc. Certain limitations apply. Coverage details are available in the Kia Warranty and Consumer Information Manual. For access to Enhanced Roadside Assistance, a connected mobile phone via Bluetooth® within the cellular service coverage area is required.

Seat adjustments: Reclining the passenger seats can reduce the effectiveness of the safety restraint system and may lead to additional injury in an accident.

Seat belts: For maximum protection, always wear your seatbelt.

Seat warmers: Use extreme caution when using the seat warmers to avoid burns. Refer to the Owner's Manual for more information.

SiriusXM®: SiriusXM Satellite Radio, SiriusXM Traffic and SiriusXM Travel Link each require a subscription sold separately, or as a package, by SiriusXM Radio Inc. **If you decide to continue your service at the end of your trial subscription, the plan you choose will automatically renew and bill at then-current rates until you call 1-866-635-2349 to cancel. See SiriusXM Customer Agreement for complete terms at www.siriusxm.com.** Other fees and taxes will apply. All fees and programming are subject to change. Not all vehicles or devices are capable of receiving all services offered by SiriusXM. Data displays and individual product availability vary by vehicle hardware. Current information and features may not be available in all locations, or on all receivers. Weather Forecast, Current Conditions may not be available in all locations. Images above are for representative purposes only and are not real products. For actual features and images of real products, consult the vehicle manufacturer. SiriusXM is not responsible for any errors or inaccuracies in the data services or their use in the vehicle. Travel Link Stocks displays current price and daily delta of around 7,000 actively reported securities traded on the NYSE®, NASDAQ® and AMEX®. The service is delayed approximately 20 minutes. SiriusXM satellite service is available only to those at least 18 years of age in the 48 contiguous USA, DC, and Puerto Rico (with coverage limitations). SiriusXM Internet Radio service is available throughout our satellite service area and in AK and HI. © 2017 SiriusXM Radio Inc. Sirius, XM and all related marks and logos are trademarks of SiriusXM Radio Inc.

Power Liftgate (Tailgate)* / Smart Liftgate®: Driving with the liftgate open may be unlawful and can draw dangerous exhaust fumes into your vehicle; if you choose to do so, keep air vents and all windows open for proper ventilation.

Sportmatic® is a registered trademark of Kia Motors America.

Steering-wheel-mounted controls: Driving while distracted is dangerous and should be avoided. Remain attentive to driving and be cautious when using steering-wheel-mounted controls while driving.

Sunvisors: Sunvisor may not shield all direct light. Do not operate the vehicle if sunvisor is impairing your visibility.

Tilt/Telescoping Steering Wheel: Never attempt to adjust steering wheel position when vehicle is in motion.

Tire Pressure Monitoring System (TPMS): Even with Tire Pressure Monitoring System, check tire pressure on a regular basis.

UVO eServices: Distracted driving can result in a loss of vehicle control. Never use a handheld device or vehicle system that takes your focus away from safe vehicle operation.

UVO eServices app: App uses your smartphone data service. Normal cellular service rates will apply.

UVO eServices with Premium Navigation: Distracted driving can result in a loss of vehicle control. Never use a handheld device or vehicle system that takes your focus away from safe vehicle operation. Navigation is for information purposes only, and Kia does not make any warranties about the accuracy of the information.



SEDONA CUSTOMER DELIVERY CHECKLIST

KEY FEATURE WALKTHROUGH

Demonstrate the following with the customer:

- Standard Audio System – page 19
For further operational information, refer to the Owner's Manual

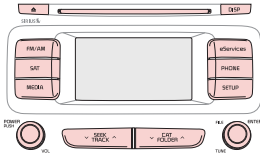

- UVO eServices Setup – page 20
- UVO eServices System* – page 21
For further operational information, refer to the Car Multimedia System User's Manual



- UVO eServices Setup – page 20
- UVO eServices with Premium Navigation System* – page 22
For further operational information, refer to the Car Multimedia System User's Manual

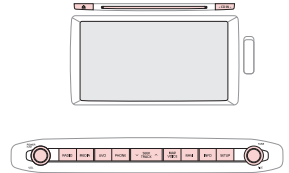

- SCC / Cruise Control – page 18
Demonstrate operation

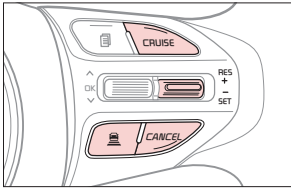

- Bluetooth® Wireless Technology – page 16
Demonstrate operation

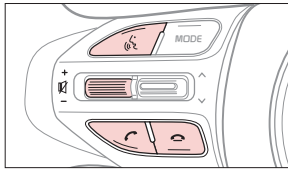

- Power Liftgate / Smart Liftgate* – page 40

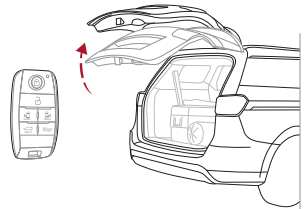

- Tire Pressure Monitoring System (TPMS) – page 4
- Blind Spot Detection (BSD)* – page 9
- Lane Departure Warning System (LDWS)* – page 10
- Engine Start/Stop Button – page 12
- Clock Setup – page 27
- Aux/USB/iPod® Ports, AC Inverter* and Power Outlets – page 27
- Seat Warmers / Ventilated Seats* – page 28
- Smart Key* – page 37

- HomeLink® with Auto-Dimming Rearview Mirror* – page 43
- Sunroof Operation* – page 39
- Parking Assist System* – 39
- Sunvisor – page 39
- Rear-Camera Display* – page 40
- Passenger Airbag Off Indicator – page 44

*if equipped

DURING DELIVERY

- Explain first service process and schedule first service appointment
- Tour Parts & Service departments, introduce staff and explain value of Kia Parts and Service
- Review recommended maintenance schedule and maintenance requirements to validate warranty
- Review business hours and Customer 360° Care
- Review the Kia 10-year/100,000-mile warranty program
- Ensure 100% satisfaction with sales and delivery process and no problems with the vehicle
- Confirm time and best contact number for initial dealer follow-up

Sales Consultant: _____ Date: _____

Sales Manager: _____ Date: _____

Customer: _____ Date: _____



SEDONA CUSTOMER DELIVERY CHECKLIST

Owner's Name: _____ VIN: _____ Mileage: _____

Dealership Name: _____ Sales Consultant: _____ Date: _____

BEFORE DELIVERY

- Test and confirm "Good Battery" using the Kia GR8-1299 battery tester and affix Results Label
- Verify all tire pressures are to spec (see driver's door label) LF _____ LR _____ RF _____ RR _____
- Verify proper operation of Remote Keyless Entry and Smart Key lock/unlock
- Ensure floor mats are snapped into place (if applicable)
- Verify vehicle is clean (interior and exterior), in good condition and free of chips and scratches
- Ensure all key documents are in the vehicle (Owner's Manual, Warranty and Consumer Information booklet, Tire Warranty booklet and Features & Functions Guide and any Audio System User's Manual.)

KEY FEATURE WALKTHROUGH

- Air Conditioning: Automatic/Manual/Rear Climate Control – pages 24-26 – Demonstrate Air Flow Modes, Defog and Defrosting Windshield Fan Speed

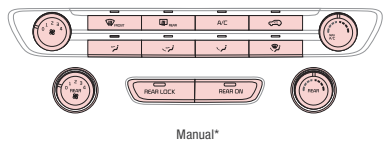
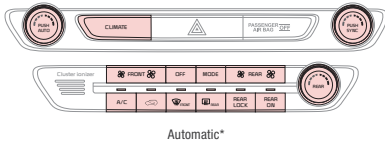

- Front Seat Headrest Adjustment – page 30

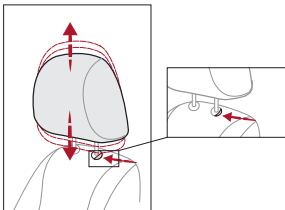

- Windshield/Rear Wipers & Washers – page 14

To operate:

- Move lever Up/Down to change Wiper modes
- Press button to adjust Intermittent Wipe
- Pull lever to spray and wipe

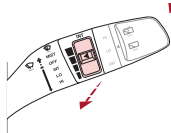

MIST: Single wipe
 OFF: Wiper off
 INT: Intermittent wipe
 LO: Slow wipe
 HI: Fast wipe

To operate:

- Rotate Rear Wiper switch to change Wiper modes
- Push to spray and wipe

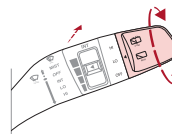

HI: Fast wipe
 LO: Slow wipe
 OFF: Wiper off



© 2017 Kia Motors America, Inc. All rights reserved.

Part Number: UV180-PS-004

Consumer - Roadside Assistance: 1-800-333-4KIA (4542)