

OPTIMA HYBRID/ PLUG-IN HYBRID

Features & Functions Guide



Delivery First
The priority that delivers more

GETTING TO KNOW YOUR **OPTIMA HYBRID** AND **PLUG-IN HYBRID**

Congratulations on Your New Kia Purchase!

Your new Kia vehicle has been designed, engineered and manufactured to provide you with years of comfortable and dependable driving. Kia is committed to quality, innovation, safety and — above all — your satisfaction.

Using This Guide

The information contained in this guide is a brief overview that will help you become familiar with the operation and features of your new Kia vehicle. The flipbook format facilitates information access, while the detailed illustrations help to ensure the instructions are easy to follow.

This **Features & Functions Guide**, and the specific operational and safety information it provides, is not a substitute for your Owner's Manual. In the interest of your safety and that of your family, and to help you avoid risks that may result in death or serious injury, Kia reminds you to carefully read your Owner's Manual in order to fully familiarize yourself with the important information it contains.

While the information contained in this guide is accurate at the time of printing, Kia may change vehicle specifications without notice in advance or after the fact, and assumes no liability in connection with such changes.



Available on the App Store, the Kia AR Owner's Manual App uses AR (Augmented Reality) technology to provide tips and useful information about your vehicle.

To use the Kia AR Owner's Manual App:

- Simply scan the interior or engine (motor) room of your vehicle with your smart phone or tablet, select feature/component and view the video guide.
- If you are unable to scan the vehicle, use the AR Manual (without scan) menu, select feature/component and view the video guide.

www.kia.com

Consumer - Roadside Assistance
1-800-333-4KIA (4542)

See Back Pages for Vehicle
Maintenance Schedule

Always check the Owner's Manual for complete operating information and safety warnings.

ESSENTIAL FEATURES

Air Conditioning / Climate Control	33
Audio System - UVO eServices / Android Auto™ /	
Apple CarPlay® Setup*	29
Audio System – UVO eServices System*	29
Audio System – UVO eServices / Premium Navigation*	30
Aux/USB/iPod® Port & Power Outlets	31
Bluetooth® Wireless Technology	24
Charging the Plug-In Hybrid EV Battery*	14
Cruise Control	25
Digital Clock	31
ECO Mode (Active ECO)	10
Fuel Economy	08
Hybrid/Plug-In Hybrid Displays	11
Instrument Cluster - Hybrid/Plug-In Displays	12
Passenger Airbag Off Indicator	46
Tire Mobility Kit	45
Tire Pressure Monitoring System (TPMS)	05
Windshield Wipers & Washers	22

Driving while distracted can result in a loss of vehicle control that may lead to an accident, severe personal injury and death. The driver's primary responsibility is in the safe and legal operation of a vehicle, and use of any handheld devices, other equipment or vehicle systems which take the driver's eyes, attention and focus away from the safe operation of a vehicle or that are not permissible by law should never be used during operation of the vehicle.



OPTIMA HYBRID / PLUG-IN HYBRID FEATURES & FUNCTIONS GUIDE

VIDEOS & QR CODES	02
INSTRUMENT CLUSTER	
Instrument Cluster Overview	03
Indicators & Warning Lights	04
Tire Pressure Monitoring System (TPMS)	05
Hybrid/Plug-In Indicators at Startup	06
LCD Instrument Cluster Modes	07
Trip Modes / Trip Computer	07
Fuel Economy	08
User Settings	09
Service Mode	09
Drive Mode Integrated Control System*	10
Plug-In Hybrid Modes*	10
HYBRID / PLUG-IN SYSTEM	
UVO eServices with Premium Navigation* Display	11
Instrument Cluster - Energy Flow	12
Charging the Plug-In Hybrid*	14
DRIVER'S PANEL	
Blind Spot Detection System*	16
Lane Departure Warning System (LDWS)*	17
Autonomous Emergency Braking (AEB) /	
Front Collision Warning (FCW)*	17
Electric Parking Brake (EPB)*	18
Auto Hold*	18
Instrument Panel Dimmer	18
Electronic Stability Control (ESC)	18
Hill-Start Assist Control (HAC)	18
Engine Start/Stop Button	19
Power Windows, Window Lock & Central Door Lock	20
Automatic Door Lock/Unlock	20
Power/Heated Outside Mirrors*	20
Power Folding Mirrors*	20
STEERING WHEEL CONTROLS	
Headlights & High Beams	21
High Beam Assist*	21
Turn Signals & Fog Lights	21
Windshield Wipers & Washers	22
Heated Steering Wheel Button*	22
Bluetooth® Wireless Technology	24
Audio Controls	25
Cruise Control	25
Advanced Smart Cruise Control (ASCC)*	26
Tilt/Telescoping Steering Wheel	27

AUDIO SYSTEM	
UVO eServices / Android Auto™ / Apple CarPlay® Setup*	28
UVO eServices System*	29
UVO eServices with Premium Navigation*	30
CENTER PANEL	
Digital Clock	31
Aux/USB/iPod® Port & Power Outlets	31
Surround View Monitoring (SVM) System*	32
Automatic Climate Control (UVO eServices)*	33
Automatic Climate Control	
(UVO eServices with Premium Navigation System)*	34
Automatic Gear Shift with Sportmatic® Shifting	35
Seat Warmers / Ventilated Seats*	35
Electric Parking Brake (EPB)*	36
Auto Hold	36
SEATING	
Driver Position Memory System*	37
Front Seat Headrest Adjustment	37
Power Adjustable Driver's Seat*	38
6-Way Manual Adjustable Driver's Seat*	38
OTHER KEY FEATURES	
Smart Key	39
Double-Turn Lock/Unlock All	39
Smart Trunk*	40
Map/Room Lamps	41
Panoramic Sunroof Operation*	41
Hood Release Lever and Latch	42
Fuel Door and Trunk Release	42
Fuel Cap / Malfunction Indicator	42
Sunvisor	42
Rear Parking Assist System*	43
Rear-Camera Display*	43
Hybrid/Plug-In Battery Vent (Air Intake)	44
Child-Protector Rear Door Lock	45
Tire Mobility Kit	45
SAFETY FEATURES	
Occupant Detection System (ODS) /	
Passenger Airbag Off Indicator	46
Seat Belts	46
Seat Belt Retractor Locks	46
NORMAL MAINTENANCE SCHEDULE	47
LEGAL DISCLAIMERS (See Back Inside Cover Page)	

*IF EQUIPPED

Kia provides a number of video resources at your disposal to assist you with becoming familiar with the features and functions found in your Kia vehicle. You can access these resources by snapping the QR Codes with your smartphone/tablet (mobile devices) or by visiting the following website: www.youtube.com/KiaFeatureVideos . Continue reading for a more in-depth look at QR Codes and for instructions on how to use them.

What are QR Codes?

A QR Code is a square, 2-dimensional barcode that can be read by mobile devices loaded with an appropriate barcode or QR Code Reader App. The app reads the barcode image and then launches/uploads the specific information the code contains, such as URLs, text, photos, videos and so much more.

How to Use QR Codes

If you have a mobile device with a QR Code Reader App, you can snap the code with your phone and you'll be provided a video with additional information pertaining to the topic. For example, in the Fuel Cap section, if you would like additional information, just snap the code with your mobile device to view the selected Kia Features & Functions Video.

How to Snap a QR Code

1. With your mobile device, download a QR Code Reader App. With many devices, you can do this through an app store or marketplace
2. Open the QR Code Reader App on your mobile device
3. The app will utilize your device's camera. Center the code in the camera viewing area:
 - With some apps, as soon as the app recognizes the code, it will launch the corresponding video
 - With other apps, you will have to snap or take a picture of the code. The app will then launch the corresponding video
 - For operation specifics, refer to the instructions that come with the QR Code Reader App

QR CODE

One Click Fuel Cap Video

To view a video on your mobile device, snap this QR Code or visit the listed website.



www.youtube.com/KiaFeatureVideos

REMINDER: When accessing videos on your mobile device, standard cellular data rates may apply.

QUICK TIPS

1. If you're having trouble scanning codes, check the following:
 - The code should be centered and focused in your mobile device's camera screen
 - Consider moving your device closer to or farther away from the code
 - The code should be well lit, without significant shadow
 - Avoid scanning from a significant angle
 - Confirm that the device's app supports 2D QR Code scanning
 - Try another QR Code Reader App; not all apps are created equal
2. After scanning, if a "connecting" message appears and then nothing happens or there's a "connection error" message, this typically indicates that your device is having trouble connecting to the Internet

Instrument Cluster Overview

- A** ECO Guide
- B** State of Charge (SOC) Gauge
- C** Turn Signal Indicators
- D** Gear Shift Position Indicator
- E** Indicator and Warning Lights
- F** Speedometer
- G** Fuel Gauge

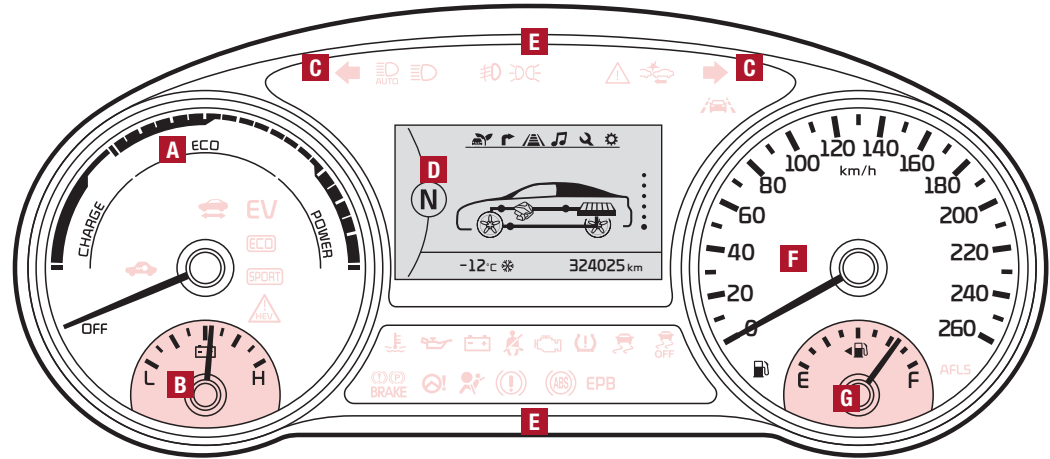

Your vehicle's instrument cluster & indicator light locations may differ from those in the illustrations. For more information on the instrument cluster, the LCD Warning Messages and the function of all indicator and warning lights, please refer to the Owner's Manual.

Indicators & Warning Lights

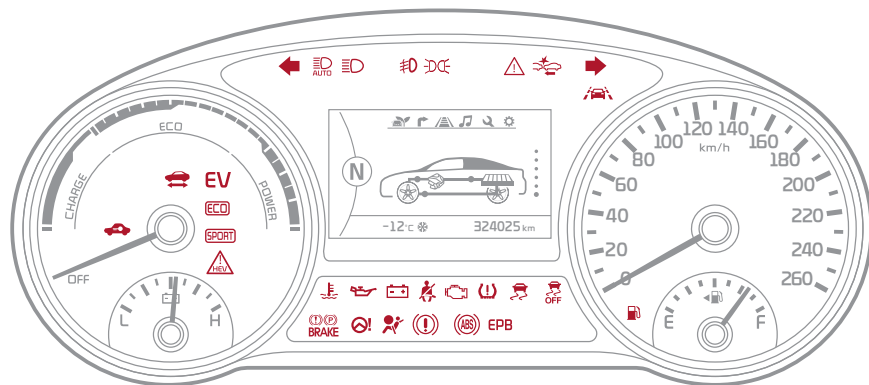

Your vehicle's instrument cluster & indicator light locations may differ from those in the illustrations. For more information on the instrument cluster, the LCD Warning Messages and the function of all indicator and warning lights, please refer to the Owner's Manual.

- | | | | | | |
|--|--|--|--|--|---|
| | High Beam Assist Indicator* | | Active ECO Indicator | | Electronic Power Steering (EPS) System Warning Light* |
| | High Beam Indicator | | SPORT Mode Indicator Light* | | Airbag Warning Light |
| | Tail Light Indicator | | Hybrid System Warning Light* | | Parking Brake Light |
| | Front Fog Light Indicator* | | Engine Coolant Temperature Warning Light* | | Anti-lock Braking System (ABS) Warning Light |
| | Master Warning Light* | | Engine Oil Pressure Warning Light | | EPB Electronic Parking Brake Indicator |
| | Autonomous Emergency Braking (AEB)* | | 12V Charging System Warning Light | | Low Fuel Level Warning Light |
| | Lane Departure Warning System (LDWS) On/Off Indicator Light | | Seat Belt Warning Light | | CRUISE Cruise ON/OFF Indicator* |
| | Electronic Brake Force (EBD) System Warning Light (Two separate indicators on Instrument Cluster lit at same time) | | Malfunction Indicator | | Trunk Open Warning Light |
| | Immobilizer Indicator* | | Low Tire Pressure Light / Tire Pressure Monitoring System (TPMS) Malfunction Indicator | | AUTO HOLD Auto Hold Indicator |
| | READY Indicator | | Electronic Stability Control (ESC) Indicator / ESC Malfunction Indicator | | Door Ajar Warning Light |
| | EV Mode Indicator | | Electronic Stability Control (ESC) OFF Indicator | | Regenerative Brake Warning Light |
| | | | Parking Brake & Brake Fluid Warning Light | | |

Tire Pressure Monitoring System (TPMS)



The TPMS indicator (⚠️) functions as both Low Tire Pressure Light and TPMS Malfunction Indicator. The indicator (⚠️) will illuminate if one or more tires is significantly underinflated, the vehicle has a spare tire installed without TPMS or the outside temperature becomes significantly lower.

The LCD screen in the instrument cluster will display the Low Tire Pressure indicator **A** showing which tire(s) are underinflated. Inflate tire(s) to specifications using an accurate digital tire pressure gauge to turn off Low Tire Pressure Light (⚠️). See front driver's door jamb for PSI specification.

When there is a problem with the TPMS, the TPMS Malfunction Indicator (⚠️) will blink for approximately one minute then illuminate - See dealer for service.

QUICK TIP

- Even with TPMS, tire pressure should be checked manually at least once a month. Only adjust tire pressure on "cold tires"
- For proper maintenance and optimal fuel economy, maintain recommended tire inflation pressures and stay within the load limits and weight distribution recommended for your vehicle
- In winter or cold weather, the TPMS light may illuminate if the tire pressure was adjusted to the recommended tire inflation pressure during warm weather

REMINDER: Consult your dealer for service if Low Tire Pressure Light remains illuminated after inflating your tire(s).

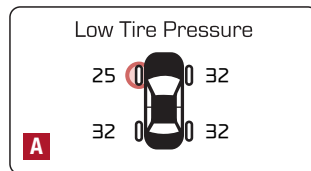

QR CODE

Tire Pressure Monitoring System Video

To view a video on your mobile device, snap this QR Code or visit the listed website.

Refer to page 2 for more information.



www.youtube.com/KiaFeatureVideos

Hybrid / Plug-in Indicators at Startup

A ECO Guide — Indicates how economically the vehicle is being driven.

- **Blue zone:** High-efficiency range
- **Green zone:** Normal-efficiency range
- **White zone:** Low-efficiency range

B EV Mode — Illuminates when the electric motor is powering the vehicle.

C Ready — Illuminates when the Hybrid/Plug-In system is operational. Even if the engine is off, the vehicle can be driven.

D State of Charge (SOC) — Displays the Hybrid/Plug-In battery charge status.

E Active ECO — Automatically activated each time the vehicle is started. Turn system ON/OFF using the ECO button on the center console.

- **Active ECO ON** (Eco indicator illuminated): Adjusts the engine, transaxle and A/C system to conserve fuel
- **Active ECO OFF** (Eco indicator not illuminated): Provides more power when driving up steep roads or carrying heavy loads

F Service Indicator — Illuminates when a malfunction occurs in the vehicle's Hybrid/Plug-In system. Have an authorized Kia dealer address the concern as soon as possible.

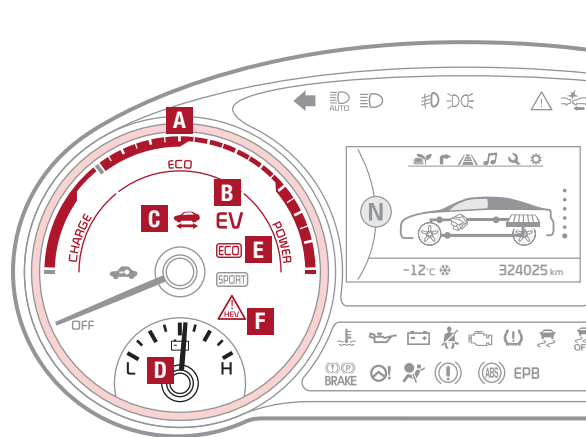

QUICK TIP

If Active ECO is turned off, switch back to Active ECO as soon as possible for maximum fuel efficiency and to restore the ECO ON center display.

REMINDER: Avoid starting or driving the vehicle when the fuel tank is empty. As the engine will be incapable of charging the high-voltage Hybrid/Plug-In battery, the battery will lose its charge and may be damaged.

LCD Instrument Cluster Modes



Press Mode button **A** to scroll through different LCD Instrument Cluster Modes.

 **Trip Computer Mode:** Displays driving information for tripmeter, fuel economy, etc.

 **Turn-by-Turn Mode*:** Displays the state of the navigation

 **ASCC/LDWS* Mode:** Displays the state of the Advanced Smart Cruise Control (ASCC) and the Lane Departure Warning System (LDWS)

 **A/V Mode*:** Displays the state of the A/V System

  **Service Modes:** Informs on upcoming service intervals, tire pressure status, warning messages related to TPMS, BSD malfunction and when any door is not securely closed.

 **User Settings Mode:** Change settings of the doors, lamps and other features

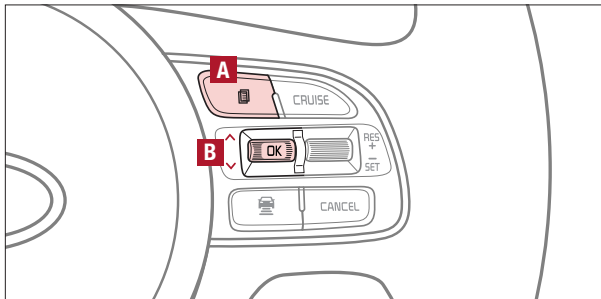

(Buttons located on Steering Wheel – Type A shown)

Your vehicle's steering wheel buttons may differ from those in the illustrations.

Trip Modes / Trip Computer

The Trip Computer is a driver information system that displays information related to driving. It appears on the display when the Engine Start/Stop button is in the ON position.

To cycle through the Trip modes, press the Mode button **A**.

When in the Trip Computer mode , press the Select/Reset button **B** to cycle through the screens. When displaying TRIP A or TRIP B screens, press and hold the Select/Reset button **B** to reset the Tripmeter to zero.

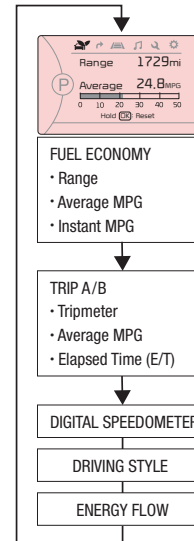

(Hybrid screen shown above)

REMINDERS:

- Appearance of Trip Computer display may differ as equipped
- All stored driving information (except Odometer and Range) is reset if the battery is disconnected

Fuel Economy

There are several factors that contribute to your vehicle's fuel economy, including maintenance of your vehicle, driving style, environmental conditions, vehicle weight and vehicle aerodynamics.

Below are tips on how to help improve fuel economy:

- Keep your vehicle in good condition with regular maintenance
- Don't let the engine idle longer than necessary
- Drive at a moderate speed, accelerating smoothly and at a moderate rate
- Keep tires inflated to the recommended pressure
- Travel lightly, without carrying unnecessary weight in your vehicles
- Avoid placing large or heavy items on roof racks
- Avoid hilly, winding or poorly maintained roads

REMINDER: Driving range can vary depending on your vehicle's fuel tank size, e.g., 12-gal. vs. 24-gal., even though the MPG may be the same

For more information on Fuel Economy, you can snap the QR Code above to view a video or refer to the Owner's Manual.

When the Instrument Cluster LCD screen is in the Trip Computer mode, the screen displays fuel economy information related to the driving range and average fuel economy.

To change modes, go to User Settings in the LCD Instrument Cluster modes.

Range - Estimates how far you can go before refueling is required.

Average Fuel Consumption - Calculates average* fuel consumption from the distance driven and amount of fuel injected into the engine / total fuel used.

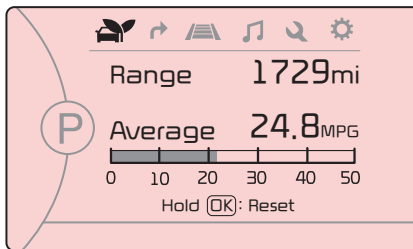

QR CODE

Fuel Economy Video

To view a video on your mobile device, snap this QR Code or visit the listed website.

Refer to page 2 for more information.



www.youtube.com/KiaFeatureVideos

User Settings

To enter the User Settings mode in the LCD Instrument Cluster Modes, press the Mode button **A** when the vehicle is at a standstill and with the ENGINE START/ STOP button* in the ON position and select User Settings .

You can navigate the selections on the display by pressing the Select/Reset button **B** up/down, and then selecting the item by pressing the Select/Reset button **B** again.

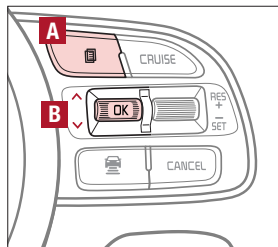

(Buttons located on Steering Wheel – Type A)

Driving Assist:

- Smart Cruise Control Response*
- Rear Cross Traffic Alert*
- AEB (Autonomous Emergency Braking)*
- FCW (Forward Collision Warning)*
- Coasting Guide*

Door/Trunk:

- Auto Door Lock & Unlock*
- Smart Trunk*
- Two Press Unlock*
- Horn Feedback*

Lights:

- One-Touch Turn Signal*
- Headlamp Delay
- Welcome Light*

Sound:

- Park Assist System Volume*
- BSD (Blind Spot Detection) Sound*
- Welcome Sound*
- Cluster Voice Guidance*

Service Interval:

- Set Mileage/Month
- Service Interval ON/OFF

Convenience:

- Easy Seat Access*
- Steering Position
- Wireless Charging System*
- Wiper/Light Display*

Other features:

- Fuel Economy Auto Reset
- Fuel Economy Unit
- Temperature Unit
- Tire Pressure Unit*
- Language*

Service Mode

To enter Service mode, press the Mode button **A**, scroll to Service Mode  and press Select/Reset button **B**. System will display number of miles remaining until next service is due, as well as type of service.

When service is required, the following will be displayed:

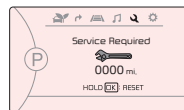

Service Required

To reset the Service mode system, press and hold the Select/Reset button **B** for more than 1 second.

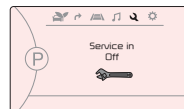

To turn Service In OFF, go to User Settings.



Service Interval Setting

To set the service interval when in User Settings mode:

- Press the Select/Reset button **B** up/down and scroll to Service Interval. Press the Select/Reset button **B** to enter.
- Press the Select/Reset button **B** up/down and toggle to ON, then press the Select/Reset button **B** again. Then press the Select/Reset button **B** to scroll and select the desired miles or months for your next service
- Press the Select/Reset button **B** again to enter

QR CODES

To view a video on your mobile device, snap these QR Codes or visit the listed website.

Refer to page 2 for more information.

LCD Display Video



www.youtube.com/KiaFeatureVideos

LCD Display: Maintenance Video



www.youtube.com/KiaFeatureVideos

Drive Mode Integrated Control System*

The Drive Mode may be selected based on the driver's preferences and road conditions.

To cycle through the different Drive Modes **A**, press the DRIVE MODE button **B**. The instrument cluster will display SPORT* or ECO when selected. When in NORMAL mode, it will not display in the the instrument cluster.

Hybrid*

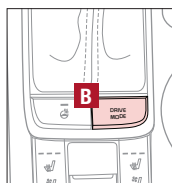
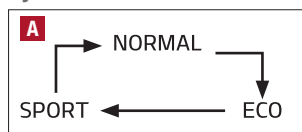

Plug-in Hybrid*

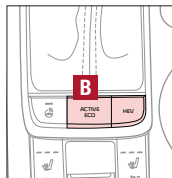
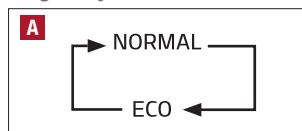

(Buttons located below Gear Shift -Type B shown)

REMINDERS:

- The system is turned ON and in ECO mode when ignition is in the ON position
- When NORMAL mode is selected, the indicator will display and system remains on. When ignition is cycled, the system will default to ECO.

ECO Mode (Active ECO)

Active ECO helps improve fuel economy by controlling several vehicle components. When activated, it optimizes drivetrain operations such as engine power and transmission to help improve fuel economy.

To turn ON, press the DRIVE MODE button **A**. The button light will turn on, and the green ECO indicator light **B** in the instrument cluster will illuminate (indicating that you are getting optimal fuel efficiency). Active ECO system will remain on even when the ignition is cycled.

To turn the Active ECO system OFF, press the DRIVE MODE button **A** again.

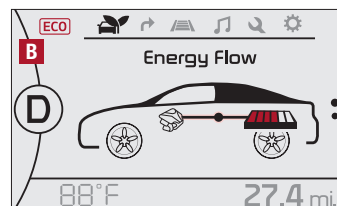

(Located in Instrument Cluster)

QUICK TIPS

To help improve your fuel economy:

- Drive at a moderate speed, accelerating smoothly and at a moderate rate
- Keep tires inflated to the recommended pressure
- Be sure the wheels are properly aligned

For more information on Active ECO, refer to your Owner's Manual or contact your local dealership.

QR CODE

Drive Mode System Video

To view a video on your mobile device, snap this QR Code or visit the listed website.

Refer to page 2 for more information.



www.youtube.com/KiaFeatureVideos

UVO eServices with Premium Navigation Display*

When equipped, Optima Hybrid/Plug-In's UVO eServices with Premium Navigation screen also provides information on economical operation and Hybrid/Plug-In system modes. To enter the Hybrid/Plug-In display mode, press the INFO key on the audio control unit. Press the HYBRID button. Then select one of the three menus **A** - FUEL ECONOMY, ECO DRIVING and ENERGY FLOW.

A Hybrid System Home Screens

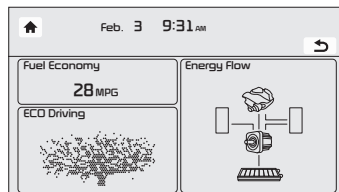

Hybrid Screen

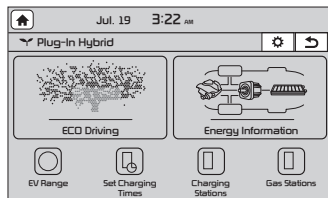

Plug-In Hybrid Screen*

ECO Level - The more economically and environmentally-friendly you drive, the more the ECO Level increases.

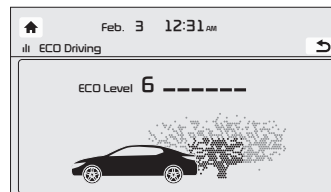

Hybrid Screen

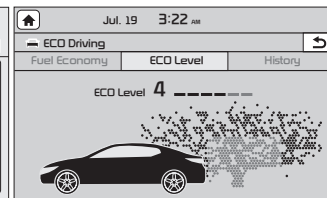

Plug-In Hybrid Screen

Energy Flow - Displays the current flow of power between the Optima Hybrid/Plug-In's main powertrain components.

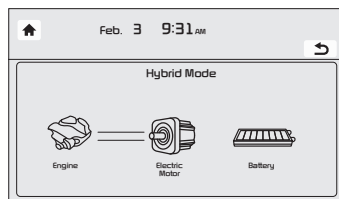

Hybrid Screen

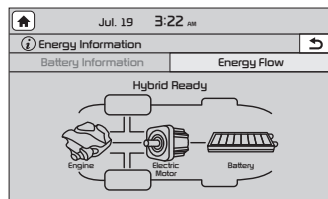

Plug-In Hybrid Screen*

Fuel Economy - Displays the average fuel economy over the duration of a trip.

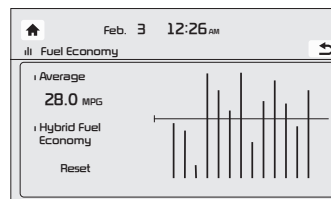

Hybrid Screen

Instrument Cluster – Energy Flow

Optima Hybrid/Plug-In's instrument cluster displays the following Hybrid/Plug-In system modes to inform the driver of its status. To change modes, go to User Settings in the LCD Instrument Cluster modes.

EV Propulsion - The electric motor is moving the vehicle.

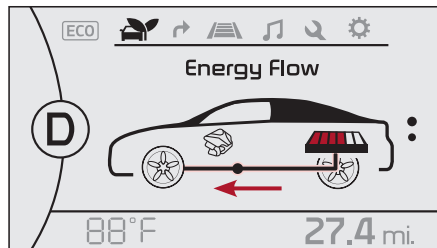

Engine-Only Propulsion - The engine is moving your vehicle.

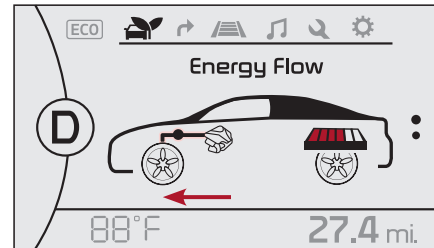

Power Assist - Both the electric motor AND the engine are moving the vehicle.

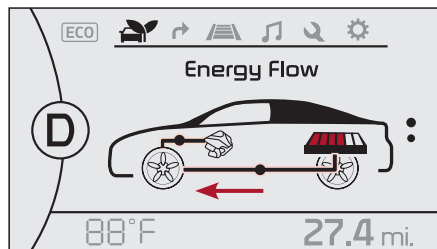

Engine Generation - While the vehicle is stopped, the engine is charging the Hybrid/Plug-In battery.

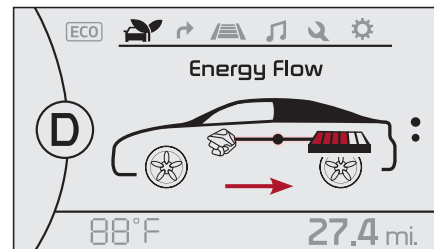

Instrument Cluster - Energy Flow

Optima Hybrid/Plug-In's instrument cluster LCD screen displays the following Hybrid/Plug-In system modes to inform the driver of its status. To change modes, go to User Settings in the LCD Instrument Cluster modes.

Power Reserve - While the engine powers the vehicle, it is also recharging the Hybrid/Plug-In battery.

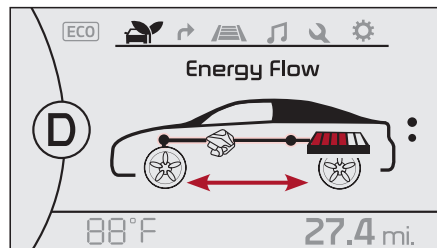

Engine Brake/Regeneration - The regenerative braking system is recharging the Hybrid/Plug-In battery.

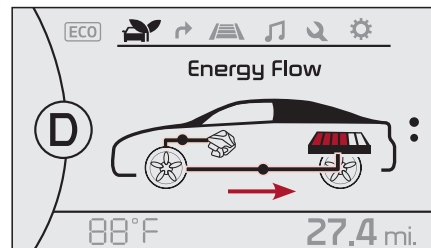

Vehicle Stop - The vehicle's Hybrid/Plug-In system is standing by.

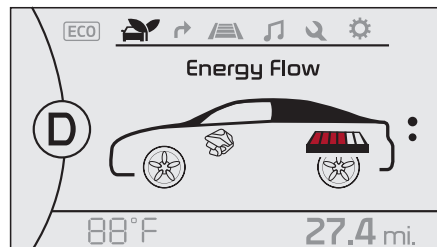

Engine Generation/Regeneration - The engine and the regenerative braking system are both recharging the Hybrid/Plug-In battery.

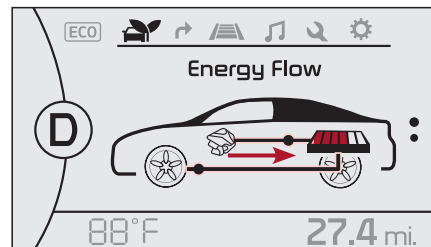

Charging the Plug-In Hybrid Vehicle*

Level 1 Charging – “Trickle” Charge

A Level 1 or “trickle” charger is the most common type of charging system for a Plug-In Hybrid. This type of charger uses 110 volts of household electricity and takes up to 9 hours for a full charge.

Trickle Charger Indicators:

A ICCB – In-Cable Control Box

C Charge – Indicates that the vehicle is charging.

B Power – Indicates that the charger is plugged in and functioning.

D Fault – Indicates charge failure.

REMINDER: Do not use an extension cord. Plug Trickle charger directly into wall socket.

Level 2 Charging – “Normal” Charge

A Level 2 or “normal” 240-volt charger is the recommended charging system for your Optima Plug-In Hybrid. This type of charger uses 240 volts of electricity and takes approximately 2.5-3 hours for a full charge (Based on Kia Motors Corporation testing with SAE J1772 charger performed at 3.3kW). This charger can be installed at your home or found at a public charging station.

REMINDER: Shape of charger and how to use the charger may be different for each manufacturer. Please see Owner’s Manual for more information.

QUICK TIPS

A Level 2 or “normal” 240-volt charger is recommended for regular charging of the vehicle.

REMINDER: For more detail and/or subsequent steps in charging your vehicle, please see the Owner’s Manual.

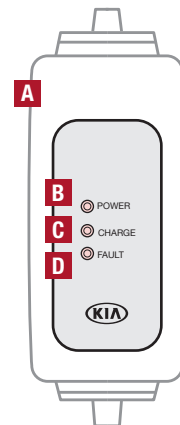

(Control box on charging cable)

Charging the Plug-In Hybrid Vehicle* (Continued)

To charge the Optima Plug-In Hybrid vehicle using a normal/trickle charger:

1. Connect the ICCB **A** plug to an electrical outlet
2. Check if the power light (green) **B** on the ICCB turns on
3. Press the brake pedal and engage the parking brake
4. Turn off all switches, put the shift lever in P (Park), and turn off the vehicle
5. Open the charging door **E** by pressing the charging door (Ensure doors are unlocked).
6. Remove any dust on the charging connector and charging inlet **F**.
7. Hold the charging connector handle **G** and connect it to the vehicle's trickle charging inlet **F** by pushing the connector until you hear a "clicking" sound
8. Charging begins automatically (Ensure the charge indicator light **S** is illuminated on your instrument cluster, indicating the vehicle is charging)

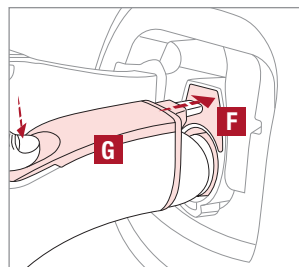
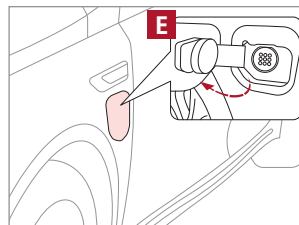

Checking the Charging Status

The charging status can be checked by viewing the charging status indicator on the dash panel. The lights will progressively become lit as the vehicle approaches a full charge.

After charging has started, the estimated charging time is displayed on the Instrument Cluster LCD **I** for about 1 minute. It is also displayed, when the driver's door is opened with charging in progress.

REMINDER: For more detail and/or subsequent steps in charging your vehicle, please see the Owner's Manual.

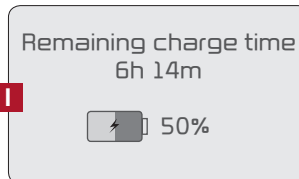

Blind Spot Detection (BSD) System*

The BSD system uses radar sensors to help alert the driver before changing lanes. The light on the BSD button **A** will illuminate when turned ON. The outside rearview mirror warning lights will also illuminate for 3 seconds.

The system will become active when the vehicle is traveling more than 18 mph and will alert the driver if another vehicle is detected by the radar sensor.

Blind Spot Detection / Lane Change Assist

1st-stage alert: When another vehicle is detected within the BSD System boundary **B**, a yellow indicator will illuminate on the outside rearview mirrors.

2nd-stage alert: When 1st-stage alert is on and the driver activates a turn signal, a flashing yellow indicator will illuminate on the outside rearview mirrors and the system will sound an alert.

RCTA (Rear Cross Traffic Alert)

If the RCTA system sensors detect approaching vehicles from the left or right side **C**, the system will sound an audible alert, the warning indicators on the outside rearview mirror will illuminate and a message will appear on the LCD screen, with these conditions:

- When the vehicle is in Reverse
- When the vehicle moves in reverse from a parking position
- When the vehicle is moving less than 6 mph

REMINDERS:

- The BSD system will not show a warning if the vehicle speed is only 6 mph above the surrounding vehicles
- If the BSD is turned ON and the ignition is cycled, the BSD system returns to ON
- The RCTA feature can be turned OFF/ON in User Settings

For more information on the Blind Spot Detection System, please refer to the Owner's Manual.

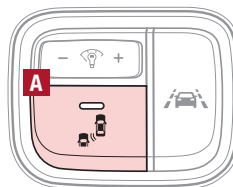

(Buttons are located left of the Steering Wheel)

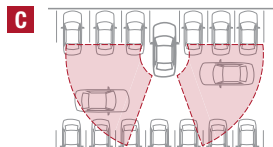
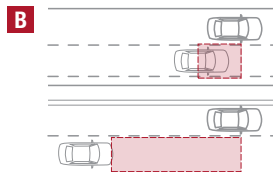

REMINDER: The above images are for illustration purposes only and may not reflect actual operation.

QR CODE

Blind Spot Detection System Video

To view a video on your mobile device, snap this QR Code or visit the listed website.

Refer to page 2 for more information.



www.youtube.com/KiaFeatureVideos

Lane Departure Warning System (LDWS)*

With the ENGINE START/STOP button in the ON position, press the LDWS button **A** to turn system ON. The instrument cluster indicator  will illuminate.

If the LDWS detects that you are veering outside of your lane, the system may issue a warning on the LCD screen and an alert may sound, while applying a slight adjustment to the steering, trying to prevent the vehicle from moving outside its lane.

Standard LDWS is the operating mode by default when the button is depressed to ON. To switch to Active LDWS mode or standard mode, go to User Settings in the Instrument Cluster.

If the LDWS detects that you are veering outside of your lane, the system may issue a warning on the LCD screen and an alert may sound.

All systems will operate under the following conditions:

- The vehicle exceeds approximately 55 mph
- The LDWS system recognizes the lane the vehicle is traveling in
- LDWS will stay on when the ignition is cycled

REMINDER: LDWS will not issue a warning if the turn signal is activated.

Autonomous (Assist) Emergency Braking (AEB) / Forward Collision Warning (FCW)*

The AEB helps to alert the driver when rapidly approaching a vehicle that is slowing down, braking or stopped **B**. A warning message will appear on the LCD screen and a chime will sound. The AEB will become active when the vehicle is traveling more than 6 mph.

To turn the AEB off, go to User Settings in the LCD Instrument Cluster modes.

REMINDER: The AEB will be activated by default when vehicle power is cycled on, even when previously set to off

Autonomous (Assist) Emergency Braking is not a substitute for safe driving, and may not detect all objects in front of vehicle. Always drive safely and use caution.

ALWAYS CHECK THE OWNER'S MANUAL FOR COMPLETE OPERATING INFORMATION AND SAFETY WARNINGS.

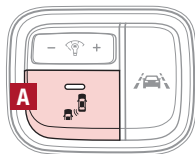

(Buttons are located left of the Steering Wheel)



When the LKAS sensor detects the lane traveling in, both lanes are illuminated



When the LKAS sensor does not detect the lane traveling in the lanes are not illuminated



When the LKAS sensor detects the vehicle veering outside of the lane traveling in, a yellow indicator will illuminate either on the left or right lane (shown in both images above)

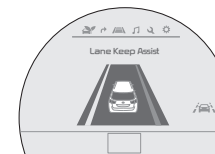

QR CODE

Lane Departure Warning System Video

To view a video on your mobile device, snap this QR Code or visit the listed website.

Refer to page 2 for more information.



www.youtube.com/KiaFeatureVideos



Instrument Panel Dimmer

Toggle switch **A** up or down to adjust display brightness of the instrument panel illumination.

REMINDER: The Instrument Panel Dimmer does not adjust brightness on the UVO eServices System or the UVO eServices with Premium Navigation System screens; use the system's setup menu to adjust brightness on the screens.

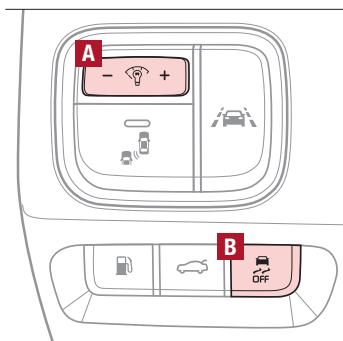

(Located left of Steering Wheel)

Electronic Stability Control (ESC)

The ESC system is designed to help stabilize the vehicle during cornering maneuvers. It is a good idea to keep the ESC turned ON for daily driving whenever possible.

Press ESC OFF button **B** to disable Traction Control in ESC (ESC OFF indicator will illuminate).

To turn both Traction Control and Stability Control off, press and hold ESC OFF button **B** (ESC OFF indicator will illuminate, and an alert sounds).

REMINDEERS:

- ESC is active by default at vehicle start-up
- The ESC Indicator Light  in the instrument cluster will illuminate whenever the ESC is in operation

For more information on Electronic Stability Control (ESC) and its specific features and operations, please refer to your Owner's Manual.

Hill-Start Assist Control (HAC)

HAC helps prevent the vehicle from rolling backward when accelerating from a stop while on a steep incline.

The HAC automatically activates whether the ESC is OFF or ON but does NOT activate when the ESC has malfunctioned.

REMINDEERS:

- The HAC does not operate when the gear shift is in the P (Park) or the N (Neutral) position.
- In the event of HAC system malfunction, see Authorized Kia Dealer for service.

QUICK TIPS

- When HAC is active (e.g., accelerating from a stop on an incline), you may notice that the brakes will momentarily remain engaged after you depress the accelerator
- HAC provides a 2-second delay before the vehicle may start rolling backward

Engine Start/Stop Button

To start the engine:

1. Depress the brake pedal
2. Press the ENGINE START/STOP button while gear shift is in P (Park)

To turn the vehicle OFF, press the ENGINE START/STOP button.

To use the ENGINE START/STOP button, you must have the Smart Key fob on your person.

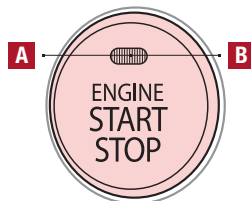

QUICK TIPS

To use electrical accessories:

ACC position

- When in the OFF position and without depressing the brake pedal, press the ENGINE START/STOP button once (amber light **A**)

ON position

- When already in the ACC position (amber light **A**) and without depressing the brake pedal, press the ENGINE START/STOP button again (red light **B**)
- When in the OFF position and without depressing the brake pedal, press the ENGINE START/STOP button twice (red light **B**)

Keeping the vehicle in ACC or ON position without turning engine on may discharge the vehicle's battery.

REMINDERS:

- In an emergency situation while the vehicle is in motion, you are able to turn the engine off and to the ACC position by pressing the ENGINE START/STOP button for more than 2 seconds or 3 times successively within 3 seconds
- If the Smart Key battery is weak or not working properly, hold the Smart Key fob up to the ENGINE START/STOP button (Lock button side closest) and press to start engine

QR CODE

Engine Start/Stop Button & Smart Key Video

To view a video on your mobile device, snap this QR Code or visit the listed website.

Refer to page 2 for more information.



www.youtube.com/KiaFeatureVideos

Power Windows, Window Lock & Central Door Lock

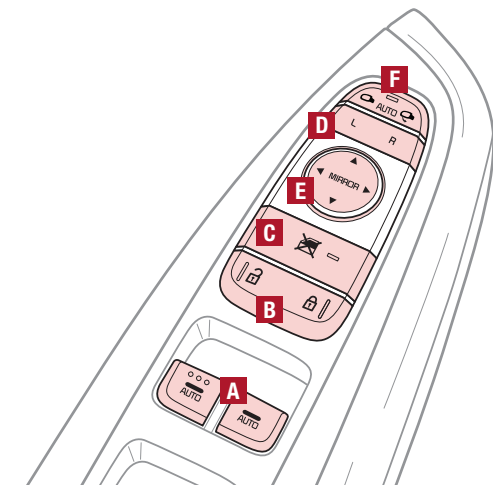

A Pull/Press to operate Driver's and Front Passenger's Windows Auto-Up/Down*

QUICK TIP

Press button again to stop Auto Up/Down function.

B Press to Unlock/Lock All Doors

C Press to disable Rear Passenger Windows

REMINDER: When pressed **C**, window controls for the Rear Passenger Windows are disabled.

Automatic Door Lock/Unlock

Auto Door Lock/Unlock will engage when the gear shift is moved in to or out of the P (Park) position. Refer to the User Settings in the LCD Instrument Cluster modes on how to turn Auto Door Lock/Unlock ON/OFF.

Power/Heated Outside Mirrors*

Mirror heaters controlled with Rear Defroster.

Power Folding Outside Mirrors*

Press L or R buttons **D** (left or right) to select mirrors. Then press arrows **E** to adjust mirror position.

To both fold and unfold the outside rearview mirrors, press the folding mirror button **F** as pictured:

- Left – The mirrors will unfold.
- Right – The mirrors will fold.
- Center – The mirrors will fold/unfold automatically when doors are locked/unlocked with the Smart Key or a door handle button is pressed. Also, the mirrors will unfold when approaching the vehicle with the Smart Key fob in proximity.

QUICK TIP

To automatically fold mirrors when exiting vehicle, press the LOCK button once on the Smart Key*.

REMINDER: To lock position of mirrors, toggle switch to the neutral (center) position.

Headlights & High Beams

To operate:

- Rotate lever to change the Headlight function
- Push lever to turn High Beams ON
- Pull lever to flash Headlights/High Beams

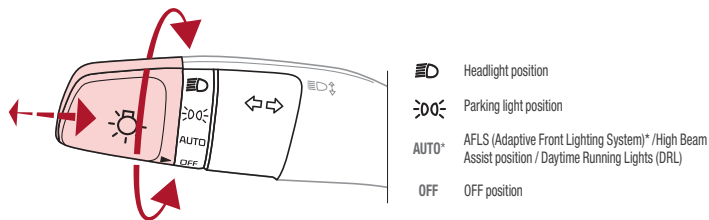

AFLS (Adaptive Front Lighting System)* — When switch is in the AUTO position and the vehicle's ignition or the Engine Start/Stop button* is on, the AFLS system will operate. To turn the system off, change the switch setting. After turning the system off, headlamp swiveling no longer occurs, but leveling operates continuously.

High Beam Assist* — The High Beam Assist will automatically adjust the brightness depending on brightness of oncoming vehicles and road conditions.

When switch is in the AUTO position and the vehicle's ignition or the Engine Start/Stop button* is on, the High Beam Assist will operate. To turn the system off, change the switch setting.

Daytime Running Lights (DRL)* — DRL may help others to see the front of your vehicle during the day. The lights will be on automatically when the ignition or ENGINE START/STOP button* is ON and the headlight switch is in the AUTO position, unless one of the following occurs:

- Headlights are on
- Fog lights are on
- Parking brake is applied
- Engine is turned off

Turn Signals & Fog Lights

To operate:

- Turn Signals - Move lever Up/Down for Right/Left Turn Signal
- Fog Lights - Rotate lever ring to turn Fog Lights ON/OFF

REMINDER: Headlights must be ON for Fog Light operation.

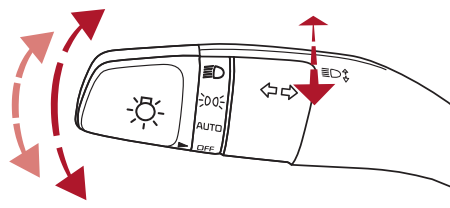

One-Touch Lane Change Signal is activated by moving the Turn Signal Lever slightly for less than 1 second and then releasing. The lane change signal will blink 3 times.

To change how many times (3/5/7) the Lane Change Signal blinks, go to User Settings Mode in the LCD Instrument Cluster modes.

REMINDEERS:

- DRL only operates during the daytime
- The DRL system turns off when the headlights are ON, parking brake is applied or the front fog lights are tuned on

Windshield Wipers & Washers

To operate:

- Move lever Up/Down to change Wiper modes
- Press switch **A** Up/Down to adjust Intermittent Wipe Speed
- Pull lever to spray and wipe

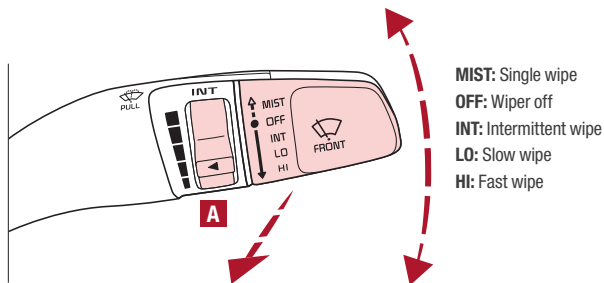

QUICK TIPS

- Pressing lever up increases Intermittent wipe frequency and wipe speed. Pressing lever down decreases frequency of wipes
- Set the wiper to OFF position when the wiper is not in use

Heated Steering Wheel Button*

Press button **B** to turn ON/OFF steering wheel heater, while the ignition or ENGINE START/STOP button is in the ON position.

Steering wheel heater will turn off automatically in 30 minutes, or when button is pressed again to deactivate.

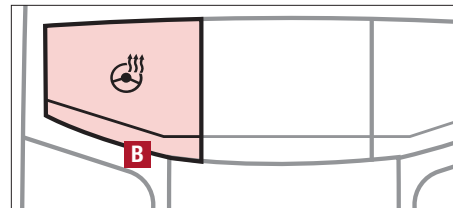

(Located below gear shift. Hybrid button configuration shown)

QUICK TIP

If ignition is turned OFF, then ON again, within 30 minutes of steering wheel heater being turned on, system will automatically be set ON again.

Bluetooth® Wireless Technology

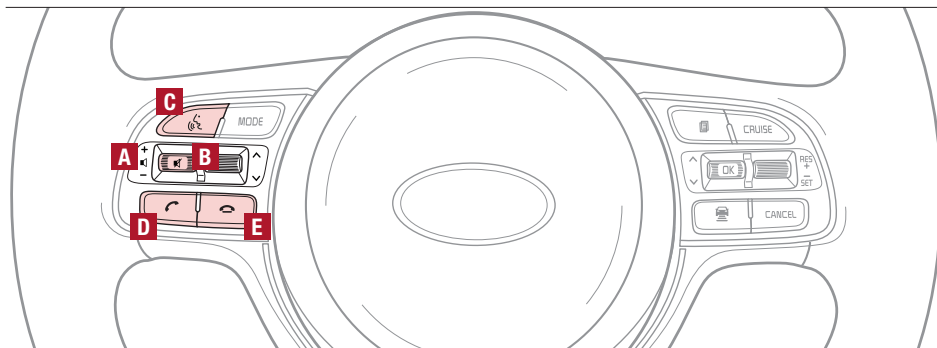

(Type A shown)

- A Volume button:** Press up/down to raise/lower speaker volume
- B Mute button:** Press to mute the microphone during a call
- C Talk button:** Press to activate voice recognition/bring up menus/place calls with minimal voice command prompts from the system

QUICK TIP

When using the voice command feature, wait for the system BEEP before speaking the command.

- D Receive/Place Call button:** Press to receive/place/transfer calls. Press to place a call using voice command prompts from the system, or to answer an incoming call
- E End Call button:** Press to end a call or cancel a function

QUICK TIPS

- Phonebook transfer upload time varies by phone model and with number of phonebook entries
- Because of differences in phone quality, service providers and Bluetooth® Wireless Technology chip programming, functionality may differ from one phone to another
- Changing language setting may delete paired phones

Your vehicle's steering wheel buttons may differ from those in the illustrations. See your Owner's Manual for more details

Driving while distracted is dangerous and should be avoided. Drivers should remain attentive to driving and always exercise caution when using the steering-wheel-mounted controls while driving

For more information, if equipped, refer to the Car Multimedia System User's Manual or the UVO System User's Manual. For Bluetooth® Wireless Technology FAQs, go to www.kia.com, Owners section, or call Consumer Information for Bluetooth® Technology at (800) 333-4KIA. Refer to your Owner's Manual for more specific Bluetooth® Wireless Technology phone pairing and operation instructions.

Bluetooth® Wireless Technology

Pairing a Phone

For instructions on how to pair a phone, refer to the Car Multimedia System User's Manual or your vehicle's Quick Start Guide.

QUICK TIP

During the pairing process, be sure to accept the connection requests on the phone for contacts download and to allow acceptance of all future *Bluetooth*® connection requests.

How to Place a Call

For the UVO eServices System and the UVO eServices System with Premium Navigation, there are two options for placing a call:

- Option 1: Press the Receive/Place Call button **D** (displays the phone screen with number keypad)
- Option 2: Press the Talk button **C**. Then say the command "Call {name}" or "Dial {number}"

QUICK TIP

When using the voice command feature, wait for the system BEEP before speaking the command.

Voice Recognition and Phone Contact Tips

The Kia Voice Recognition System may have difficulty understanding some accents or uncommon names. When using Voice Recognition to place a call, speak in a moderate tone, with clear pronunciation.

Help your *Bluetooth*® Wireless Technology Voice Recognition performance by making a few simple changes to your phone contacts:

- Use full names vs. short or single-syllable names ("John Smith" vs. "Dad"; "Smith Residence" vs. "Home")
- Avoid using special characters, emoji's or hyphens (@, &, #, /, -, *, +, etc.)
- Avoid using acronyms ("In Case Emergency" vs. "ICE")
- Spell words completely, no abbreviations ("Doctor Goodman" vs. "Dr. Goodman")

QR CODE

Voice Recognition Tips Video

To view a video on your mobile device, snap this QR Code or visit the listed website.

Refer to page 2 for more information.



www.youtube.com/KiaFeatureVideos

Audio Controls

Cruise Control

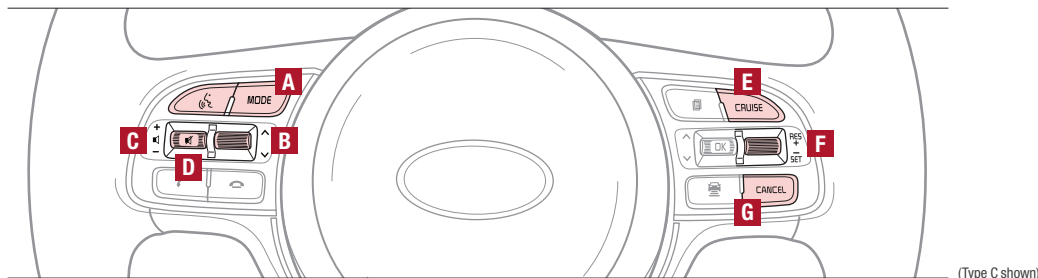

- A Audio MODE button:** Press to cycle through FM 1-2/AM/SAT 1-3/CD/USB/Aux/iPod®
- Audio System ON/OFF:** Press and hold to turn power on; Press to turn power off

- B Seek/Preset button:**
- Radio Mode:* Press to advance through Preset Stations. Press and hold to auto seek
- CD/USB/iPod® Mode:* Press to move Track Up/Down. Press & hold to FF/REW

- C Volume button:** Press up/down to raise/lower volume

- D Mute button:** Press to mute all audio

QUICK TIP

Pressing the Audio Mode button for more than 1 second will turn Audio Mode ON/OFF.

Driving while distracted is dangerous and should be avoided. Drivers should remain attentive to driving and always exercise caution when using the steering-wheel-mounted controls while driving.

For further audio system operations, refer to pages 28-30.

ALWAYS CHECK THE OWNER'S MANUAL FOR COMPLETE OPERATING INFORMATION AND SAFETY WARNINGS.

- E CRUISE Control ON/OFF button:** Press to turn the Cruise Control ON/OFF

- F Resume Cruising Speed button:** Press up to resume or increase Cruising Speed

- F Set Cruising Speed button:** Press down to set or decrease Cruising Speed

- G Cruise Control CANCEL button:** To cancel Cruise Control setting, do one of the following:

- Press the brake pedal
- Press the CANCEL button

QUICK TIPS

- Cruise Control is designed to function above 25 mph
- The Cruise Control system will not activate until the brake pedal has been depressed at least once after ignition ON or engine start

Your vehicle's steering wheel buttons may differ from those in the illustrations. See your Owner's Manual for more details

Advanced Smart Cruise Control (ASCC)*

The Advanced Smart Cruise Control (ASCC)* system allows you to set the vehicle to maintain a speed so long as it is not limited by traffic. When traffic is encountered, the vehicle will be slowed to maintain a set distance behind traffic without depressing the accelerator or brake pedal.

To set/adjust the ASCC speed:

- Push the CRUISE button **A** to turn system ON. The CRUISE indicator will illuminate on the instrument cluster
- Accelerate/decelerate to the desired speed
- Move the ASCC lever **B** to set or adjust speed

To adjust the vehicle-to-vehicle distance setting **C**, press the ASCC button **D** on the steering wheel. The images on the LCD screen **E** and the Instrument Cluster **F** will change when scrolling through the settings. Each time the button is pressed, the vehicle-to-vehicle distance changes.

To turn system OFF, press the CRUISE button **A**. The CRUISE indicator on the instrument cluster will turn OFF and the LCD screen ASCC image will show canceled **G**.

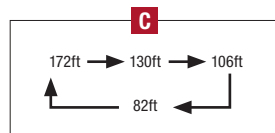
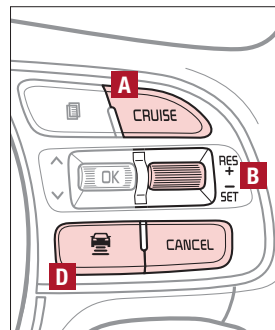

(Distances are approximate and vary depending on vehicle speed)

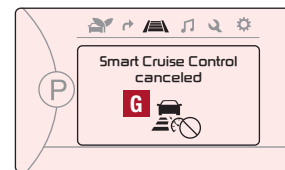
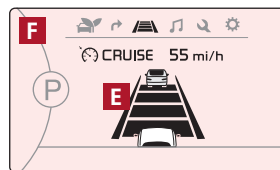

REMINDERS:

- Cruise Control button must be ON in order to turn ASCC ON/OFF
- ASCC system is activated when ignition is turned on. Speed will need to be reset when ignition is cycled on
- The distance settings are approximations and may vary depending on factory settings at the time. See owner's manual for more information

QR CODE

Advanced Smart Cruise Control Video

To view a video on your mobile device, snap this QR Code or visit the listed website.

Refer to page 2 for more information.



www.youtube.com/KiaFeatureVideos

QUICK TIPS

To change the Cruise Control mode from ASCC to standard Cruise Control, press and hold button **A**. Repeat to switch modes again (The ASCC system must not be activated to change modes).

For the ASCC System to operate:

- When no vehicle is in front, you must be travelling at a minimum speed of 20 mph
- When following a vehicle, there is no minimum speed requirement

When following a vehicle, the system will automatically adjust your cruise speed based on the vehicle in front. It will even bring the vehicle to a complete stop if necessary.

Tilt/Telescoping Steering Wheel

To adjust the Steering Wheel, push the lock-release lever **A** down and adjust the desired angle **B** and distance **C**.

When finished, pull the lock-release lever **A** up to lock Steering Wheel in place.

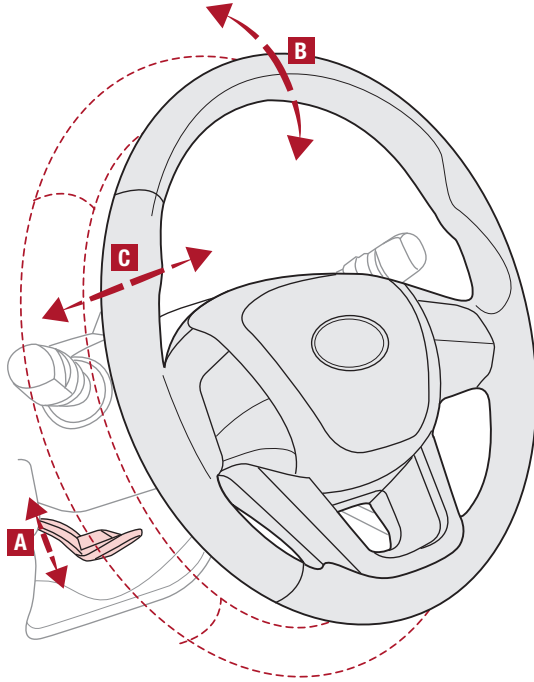

UVO eServices / Android Auto™ / Apple CarPlay® Setup*

UVO eServices Registration/Activation – To use UVO eServices:

1. On your Smartphone, go to an app store or marketplace to download the free Kia UVO eServices app.
2. Open the UVO eServices app and create an account by clicking on REGISTER. After entering your information, accept the terms and conditions to complete registration (you can also register for an account on MyUVO.com).
3. Follow the app's IN-CAR SETUP instructions to connect your smartphone and complete UVO eServices activation.

Android Auto™*

Setting up Android Auto™:

1. From an Android Auto™ compatible device, download the Android Auto™ app from the Google Play™ Store.
2. Open the Android Auto™ app and proceed with the on-screen instructions to complete setup on the mobile device.

How to start Android Auto™:

1. Press the SETUP key on your audio control unit's control panel.
2. Press the PHONE PROJECTION button  or CONNECTIVITY button, select Android Auto™ then select ENABLE ANDROID AUTO. Accept all terms, conditions and requests on the head unit and phone in order to use Android Auto™.
3. Connect the Android™ device with the vehicle's USB port using the manufacturer's cable provided with your phone.
4. From the vehicle's home screen, select the Android Auto™ button, where you'll see all the Android Auto™ supported apps.

For further UVO eServices System operations, refer to the Car Multimedia System User's Manual. For other audio system information, refer to page 29-30.

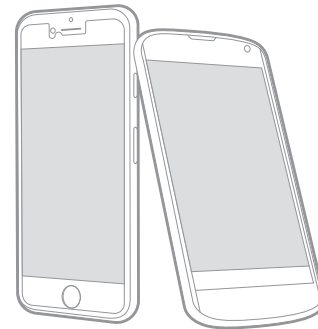

Apple CarPlay®*

Setting up and starting Apple CarPlay®:

1. Connect the Apple CarPlay® compatible iPhone with the vehicle's USB port using the manufacture's cable provided with your iPhone.
 2. On the audio control unit's control panel, press the SETUP key.
 3. Press the PHONE PROJECTION button  or CONNECTIVITY button on the screen and select Apple CarPlay®.
 4. Select ENABLE APPLE CARPLAY. Accept all terms, conditions and requests on the head unit and phone in order to use Apple CarPlay®
1. From the vehicle's home screen, select the Apple CarPlay® button, where you'll see all the Apple CarPlay® supported apps

REMINDERS:

- Android Auto compatibility requirements: Micro-USB cable that came with your phone, OS Android™ 5.0 or higher, compatible Android smartphone and data and wireless plan for applicable feature(s).
- Apple CarPlay compatibility requirements: Apple Lightning® cable, latest iOS software, iPhone 5 or later and data and wireless plan for applicable feature(s)
- It is recommended to always update your phone to the latest operating system release

UVO eServices System (Available on Hybrid)*

FM/AM/SiriusXM®/Media (USB, iPod®, Aux, Bluetooth® Audio, My Music)

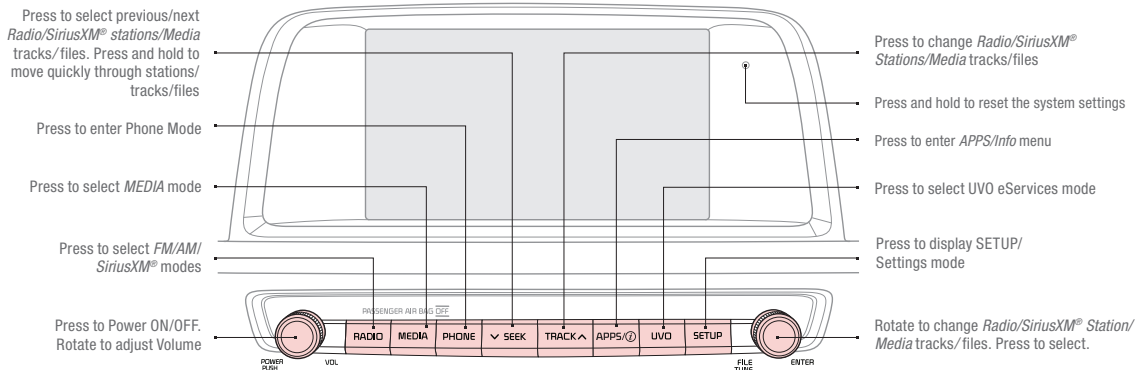

QUICK TIPS

- Navigation may be available when connected to Android Auto or Apple CarPlay supported smartphones
- When using the voice command feature, wait for the system BEEP before speaking the command
- At any time, you can interrupt UVO eServices System Command Feedback by pressing the TALK button
- Prolonged use of the UVO eServices system in ACC mode may drain the vehicle's battery
- A warning screen may appear periodically to remind users that the UVO eServices System should be operated when the engine is running to prevent battery discharge

REMINDER:

To help minimize driver distraction, some audio system functionalities have been modified while the vehicle is in Drive, Reverse or moved out of Park.

ALWAYS CHECK THE OWNER'S MANUAL FOR COMPLETE OPERATING INFORMATION AND SAFETY WARNINGS.

QR CODE

UVO eServices System Videos

To view a video on your mobile device, snap this QR Code or visit the listed website.

Refer to page 2 for more information.



www.youtube.com/KiaFeatureVideos

Sound Settings

To adjust the UVO eServices System sound settings:

1. Press the SETUP key on the audio control unit
2. Select the on-screen SOUND button
3. Select the menu item (Position, Tone, Advanced, Default)
4. Use the onscreen buttons to adjust settings
5. Press the return button \Rightarrow to save settings

UVO eServices with Premium Navigation*

FM/AM/SiriusXM®/Media (USB, iPod®, Aux, Bluetooth® Audio, My Music)

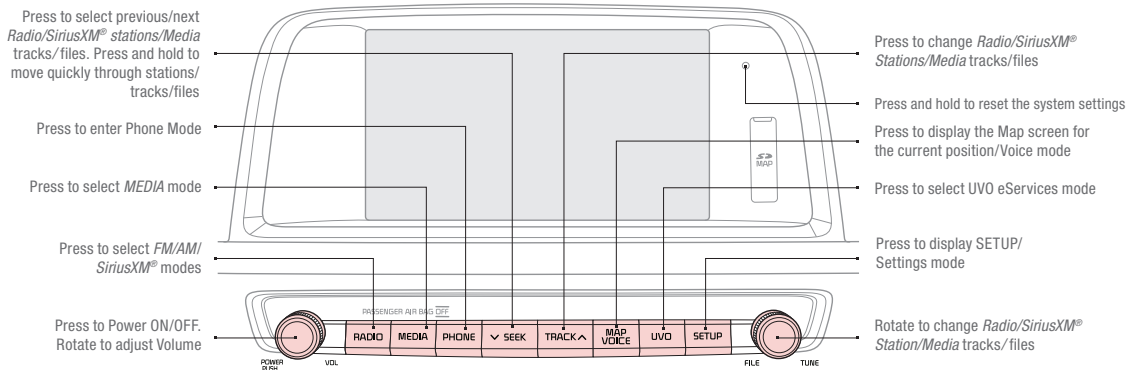

QR CODE

UVO eServices with Premium Navigation Videos

To view a video on your mobile device, snap this QR Code or visit the listed website.

Refer to page 2 for more information.



www.youtube.com/KiaFeatureVideos

QUICK TIPS

- Navigation may be available when connected to Android Auto or Apple CarPlay supported smartphones
- Prolonged use of the UVO eServices with Navigation system in ACC mode may drain the vehicle's battery.
- A warning screen may appear periodically to remind users that the UVO eServices with Premium Navigation System should be operated when the engine is running to prevent battery discharge
- At any time, you can interrupt UVO eServices System Command Feedback by pressing the TALK button
- When using the voice command feature, wait for the system BEEP before speaking the command

Your audio system may differ from those in the illustrations. For further UVO eServices with Premium Navigation* operations, refer to the Car Multimedia System User's Manual. For further audio system operations, refer to pages 28-29.

REMINDER: To help minimize driver distraction, some audio system functionalities have been modified while the vehicle is in Drive, Reverse or moved out of Park.

Sound Settings

To adjust the UVO eServices System with Navigation sound settings:

1. Press the SETUP key on the audio control unit
2. Select the on-screen SOUND button
3. Select the menu item (Position, Tone, Advanced, Default)
4. Use the onscreen buttons to adjust settings
5. Press the return button  to save settings

Digital Clock

UVO eServices System* / UVO eServices with Premium Navigation System* Clock Setup:

Press the SETUP key on the head unit. Then press the on-screen Clock icon to enter clock settings. Follow the onscreen options to adjust the clock settings.

QUICK TIP

Press the on-screen return icon to save changes.

REMINDERS:

- Daylight Savings must be enabled or disabled in the Clock Settings screen.
- To access manual date and time setting, turn GPS time OFF in the Clock Settings (UVO eServices with Navigation System*).

Aux/USB/iPod® Port & Power Outlets

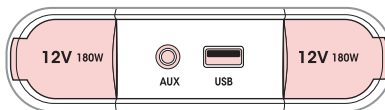

Use the Aux port to connect audio devices and the USB port to connect USB audio devices, smartphones and iPod® devices.

QUICK TIP

The power outlets are inactive when ignition is in the OFF position.

REMANDER: Using the power outlet (accessory plug) for prolonged periods of time with the engine off could cause the battery to discharge.

For more information on the Aux/USB/iPod® Port & Power Outlets, refer to the Owner's Manual.

USB Charger*

The USB charger is located inside the Center Console and on rear of the Center Console.

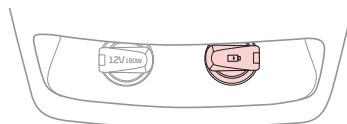

(Rear of Center Console shown)

Surround View Monitoring (SVM) System*

The Surround View Monitor (SVM) system is a parking support system that shows the areas around the front, rear, left, and right sides of the vehicle via four cameras displayed onto the navigation screen. The SVM system will turn on when the SVM button **A** is pressed and the LED is illuminated.

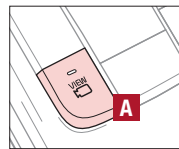





(Located below gear shift)

- The Front SVM camera is ON when the ENGINE START/STOP button is On, the gear shift is in Drive or Neutral and the SVM button is pressed ON
- **Rear SVM:** The camera view will automatically display on the navigation screen when the vehicle is shifted into Reverse. The camera view will turn off when the vehicle is shifted out of Reverse
- **Front SVM:** The camera view will display on the navigation screen in both Drive and Neutral. In Drive, the camera view will continue to display until the vehicle is above approximately 12 mph. The camera view will reappear on the navigation screen whenever the vehicle drops below approximately 12 mph







Camera View Modes – To change camera view modes, press the icons shown below on the navigation screen to select the mode.

Front SVM - when in Drive & Neutral:

-  Displays the front side and SVM images simultaneously on the screen
-  Displays the front side image on the screen
-  Displays the front side and left side images simultaneously on the screen
-  Displays the front side and right side images simultaneously on the screen

Rear SVM - when in Reverse:

-  Displays the rear view and SVM images simultaneously on the screen
-  Displays the rear side image on the screen
-  Displays the rear and left side images simultaneously on the screen
-  Displays the rear and right side images simultaneously on the screen

QR CODE

Surround View Monitor Video

To view a video on your mobile device, snap this QR Code or visit the listed website.

Refer to page 2 for more information.



www.youtube.com/KiaFeatureVideos

REMINDER: The SVM camera is equipped with an optical lens to provide a wider range of vision and may appear different from the actual distance.

The Surround View Monitor system is only a supplemental device. Drivers should not rely solely on the SVM information when parking and backing up. Drivers should always pay attention and directly check the left/right and rear.

Automatic Climate Control*

(Type A – Vehicles equipped with UVO eServices)

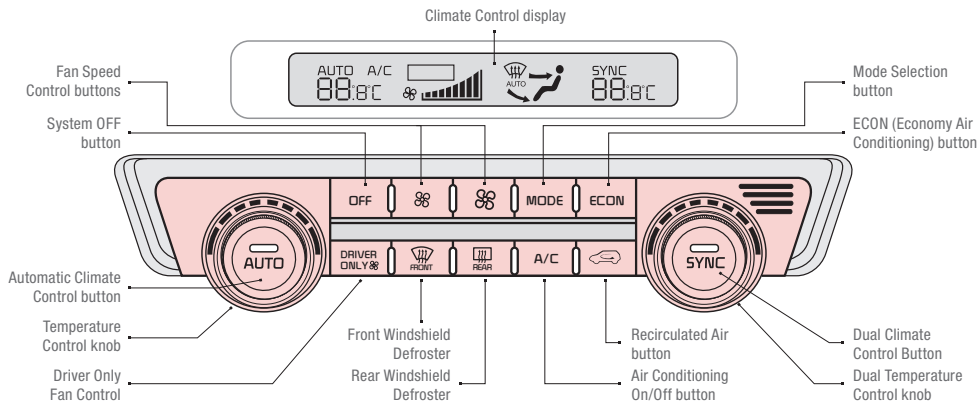

Climate Control Auto Function

1. Press AUTO to select Full Auto Operation. The Auto setting automatically controls the airflow modes, fan speeds, air intake and air conditioning according to the temperature setting selected.
2. Set desired Temperature
3. Press SYNC to synchronize driver and passenger temperature

QUICK TIPS

- Defrost mode activates A/C and opens Fresh Air Vent to help dehumidify the air and improve defroster performance
- During Auto Operation, the A/C indicator will NOT illuminate. The fan speed, air intake, air flow and air conditioning may automatically be engaged at any time to reach desired temperature and reduce humidity
- Keep inside glass as clean as possible to reduce window fogging

Your Automatic Climate Control system may differ from those in the illustrations. See your Owner's Manual for more details.

ALWAYS CHECK THE OWNER'S MANUAL FOR COMPLETE OPERATING INFORMATION AND SAFETY WARNINGS.

Air Flow Modes:

To select Air Flow Modes, press the Mode selection buttons:

- Face-Level
- Bi-Level
- Floor-Level
- Floor/Defrost-Level

Defrost Outside Windshield:

1. Set Fan Speed to the highest position
2. Set Temperature to Hot
3. Press the Front Defrost button

Defog Inside Windshield:

1. Set Fan Speed to desired position
2. Set desired Temperature
3. Press the Front Defrost button

REMINDERS:

- MAX A/C Mode automatically engages Recirculated Air
- Pressing any button during AUTO operation will deactivate the AUTO function and switch to manual mode, except for Temperature Control
- When in AUTO mode, Air Flow mode and Fan Speed do not display on the Climate Control Display
- Warm air may flow in through vents if Recirculated Air button is not pressed ON (LED lit)

Automatic Climate Control*

(Type B – Vehicles equipped with UVO eServices with Premium Navigation)

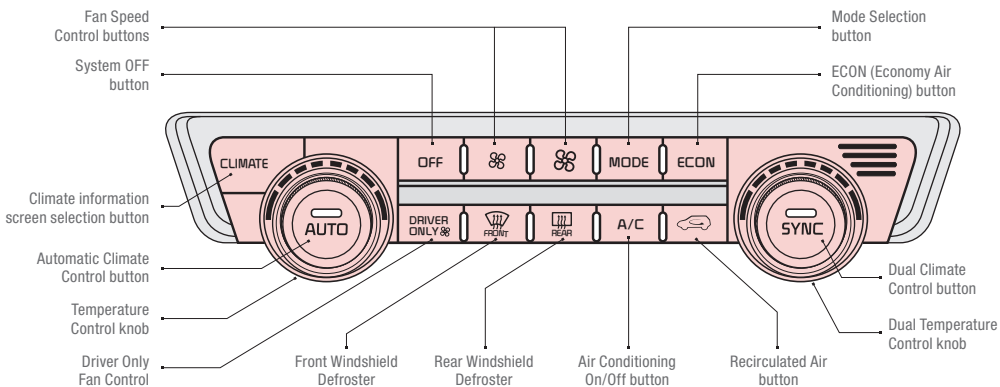

Climate Control Auto Function

1. Press AUTO to select Full Auto Operation. The Auto setting automatically controls the airflow modes, fan speeds, air intake and air conditioning according to the temperature setting selected
2. Set desired Temperature
3. Press SYNC to synchronize driver and passenger temperature

QUICK TIPS

- Defrost mode activates A/C and opens Fresh Air Vent to help dehumidify the air and improve Defroster performance
- During Auto Operation, the A/C indicator will NOT illuminate. The fan speed, air intake, air flow and air conditioning may automatically be engaged at any time to reach desired temperature and reduce humidity
- Keep inside glass as clean as possible to reduce window fogging

Your Automatic Climate Control system may differ from those in the illustrations. See your Owner's Manual for more details.

Air Flow Modes:

To select Air Flow Modes, press the Mode selection buttons:



Defrost Outside Windshield:

1. Set Fan Speed to the highest position
2. Set Temperature to Hot
3. Press the Front Defrost button

Defog Inside Windshield:

1. Set Fan Speed to desired position
2. Set desired Temperature
3. Press the Front Defrost button

REMINDERS:

- MAX A/C Mode automatically engages Recirculated Air
- Pressing any button during AUTO operation will deactivate the AUTO function and switch to manual mode, except for Temperature Control
- When in AUTO mode, Air Flow mode and Fan Speed do not display on the Climate Control Display
- Warm air may flow in through vents if Recirculated Air button is not pressed ON (LED lit)

Automatic Gear Shift with Sportmatic® Shifting

P: Park

R: Reverse

N: Neutral

D: Drive

[+]: Sport Mode Upshift

[-]: Sport Mode Downshift

Sport Mode: To enter Sport mode, move shift lever from D to left gate. To shift while in Sport mode, move shift lever up [+] to upshift or down [-] to downshift.

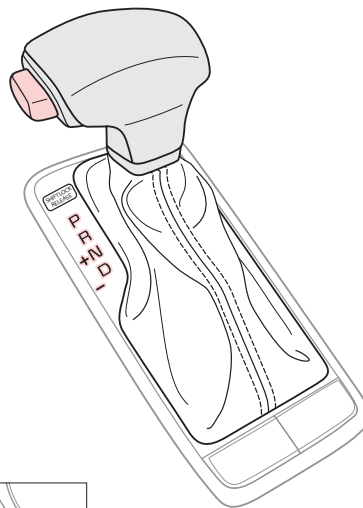

Seat Warmers*

Press button once for high setting (2 LEDs lit), again for low setting (1 LED lit) and again to turn OFF.

Seat Warmers / Ventilated Seats* **A**

Seat Warmers:

- Press top of button for high setting (3 LEDs lit)
- Press button twice for medium setting (2 LEDs lit)
- Press a third time for low setting (1 LED lit) and again to turn OFF

Ventilated Seats:

- Press bottom of button once for high setting (3 LEDs lit)
- Press twice for medium setting (2 LEDs lit)
- Press a third time for low setting (1 LED lit) and again to turn OFF

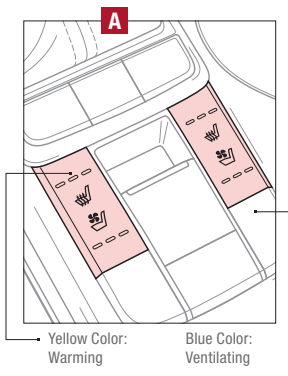

QUICK TIPS

- With the seat warmer switch in the ON position, the heating system in the seat turns OFF or ON automatically depending on the seat temperature
- System is OFF by default

QR CODES

To view these videos on your mobile device, snap these QR codes.

Refer to page 2 for more information.

Sportmatic® Shifting Video



www.youtube.com/KiaFeatureVideos

Heated and Ventilated Seats Video



www.youtube.com/KiaFeatureVideos

Electric Parking Brake (EPB)*

The Electric Parking Brake (EPB) system utilizes an electric motor to engage the parking brake.

Applying the Parking Brake

Depress the brake pedal and pull up the EPB switch **A**. Ensure that the indicator light  is illuminated on the instrument cluster.

Releasing the Parking Brake

The EPB will automatically release when the shifter is placed in Reverse or Drive.

To release EPB manually, depress the brake pedal, then press the EPB switch **A**, with the ignition switch in the ON position. Ensure that the indicator light  is OFF.

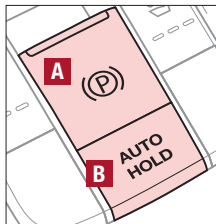

(Located on Center Panel)

QUICK TIPS

- When leaving your keys with parking lot attendants or valet, make sure to inform them how to operate the EPB
- If parked on a steep incline, pull up the EPB switch for more than 3 seconds for a firmer EPB application
- Pull up and hold EPB switch a second time to increase brake pressure if parked on a decline or incline

REMINDERS:

- As a bulb check, the EPB malfunction indicator will illuminate for approximately 3 seconds when the ignition switch is turned ON
- If the warning light does not illuminate temporarily, or continues to remain lit, take your vehicle to an authorized Kia dealer and have the system checked
- The EPB should not be operated while the vehicle is moving
- A click or electric brake motor sound may be heard while operating or releasing the EPB, but these conditions are normal and indicate that the EPB is functioning properly

Auto Hold*

Auto Hold temporarily maintains the vehicle at a standstill even if the brake pedal is released. Auto Hold can be turned ON/OFF using the AUTO HOLD switch **B** on the driver's panel. Before Auto Hold will operate, the driver's door, engine hood and trunk must be closed, and the driver's seat belt must be fastened.

The Auto Hold indicator has four states:

White: Standby - With vehicle at a standstill, and AUTO HOLD switch **B** turned ON, the indicator will illuminate white. While driving the vehicle (vehicle is not at a standstill), the Auto Hold indicator will remain white.

Green: Engaged - When coming to a complete stop by depressing the brake pedal, the Auto Hold indicator changes from white to green.

OFF (not illuminated) - The indicator will turn OFF when the AUTO HOLD switch **B** is turned OFF or when the EPB is manually turned ON.

Yellow: Malfunction - When the indicator is illuminated yellow, there may be a system malfunction. Take your vehicle to a local Kia dealer.

Refer to page 4 for location of Instrument Cluster indicators.

QR CODE

Electric Parking Brake Video

To view a video on your mobile device, snap this QR Code or visit the listed website.

Refer to page 2 for more information.



www.youtube.com/KiaFeatureVideos

Driver Position Memory System*

To store a seating position into memory, first place the shifter into P (Park) while the ignition switch is ON. Then:

1. Adjust the driver's seat
2. Press the SET button **A** on the control panel. System will beep once
3. Press one of the memory buttons **B** within 5 seconds. The system will beep twice when memory has been stored
4. "Driver (1 or 2) set is memorized" will appear on the instrument cluster LCD screen

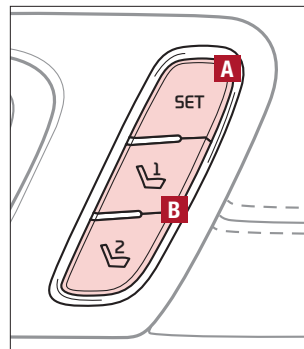

Front Seat Headrest Adjustment

To raise headrest: Pull headrest up.

To lower headrest: Press lock **C**, then press the headrest down.

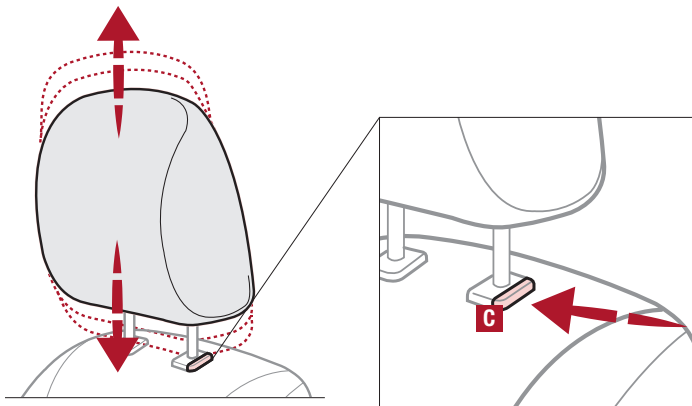

QR CODE

Driver Position Memory System Video

To view a video on your mobile device, snap this QR Code or visit the listed website.

Refer to page 2 for more information.



www.youtube.com/KiaFeatureVideos

Power Adjustable Driver's Seat*

Move/Press controls to adjust Seat forward/backward, Seat Cushion tilt up/down, Seatback forward/backward or Lumbar up/down/forward/backward

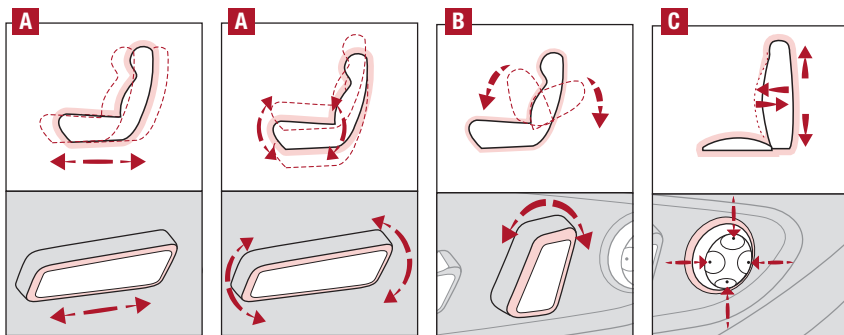
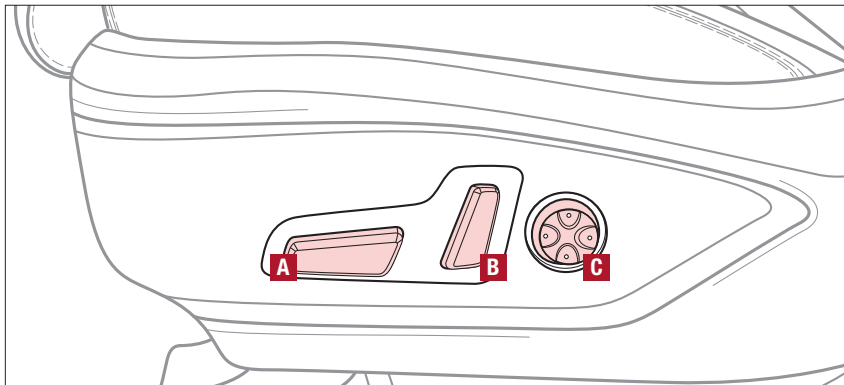

Seat

Seat Cushion

Seatback

Lumbar

6-Way Manual Adjustable Driver's Seat*

Pull lever **D** to slide Seat forward/backward.

Pull/press lever **E** up/down one or more times to adjust Seat height.

Pull lever **F** to adjust Seatback recline.

Press **G** to adjust Lumbar support

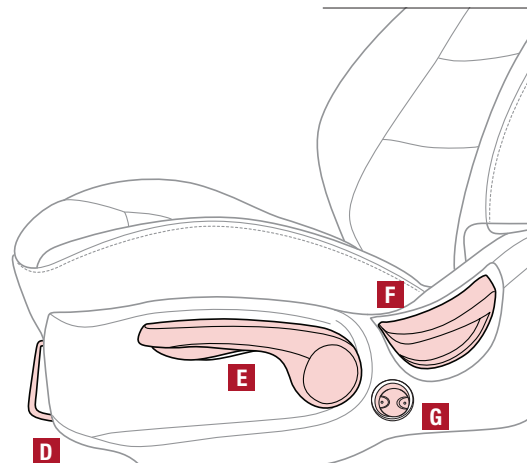

QUICK TIP

When adjusting seat forward or backwards, ensure seat clicks or locks into place before driving vehicle.

Smart Key

Smart Key Fob:

- A** Press to lock All Doors
- B** Press to unlock Driver's Door. Press twice in 4 seconds to unlock All Doors
- C** Press and hold for more than 1 second to unlock Trunk. Then lift the lid to manually open Trunk.

REMINDER:

The Trunk unlocks when the Smart Key fob is within close proximity of the vehicle.

- D** Press and hold more than 1 second for Panic Alarm.
To turn off Alarm, press any button
- E** Press to release Mechanical Key (on reverse side of fob)

Driver's Door Lock/Unlock button **G**:

- Press button once to unlock Driver's Door
- Press again within 4 seconds to unlock All Doors
- Press again to lock All Doors

Mechanical Key **F**:

- Use to unlock/lock Driver's Door:
 1. Remove door handle keyhole cover with Mechanical Key by pressing up into slot as shown
 2. Insert Mechanical Key and turn right to Unlock Driver's Door.
Turn twice within 4 seconds to Unlock all doors
 3. Insert Mechanical Key and turn left to Lock Driver's Door
 4. Return keyhole cover to its original position
- Use to enable/disable Child Safety Locks

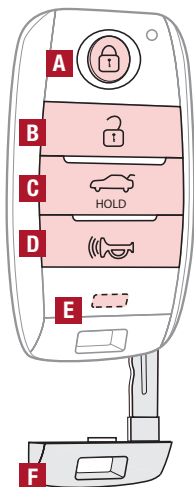

REMINDER: Remote button configuration may vary depending on vehicle options.

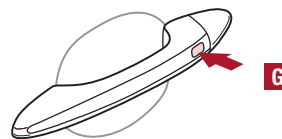

Mechanical Key

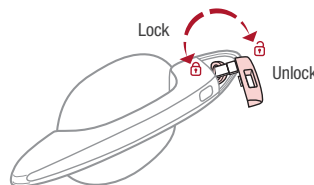
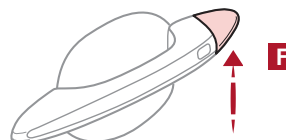

QR CODE

Engine Start/Stop Button & Smart Key Video

To view a video on your mobile device, snap this QR Code or visit the listed website.

Refer to page 2 for more information.



www.youtube.com/KiaFeatureVideos

QUICK TIPS

- If the Smart Key battery is weak or not working properly, hold the Smart Key fob up to the ENGINE START/STOP button (Lock button side closest) and press to start engine
- The Smart Key's signal can be blocked by the normal operation of a cell phone or smartphone. To help prevent this, store each device separately

Power Trunk / Smart Trunk*

Smart Key:

To open the Power Trunk, press and hold the Trunk button **A** until the Trunk begins opening. Press again to cancel.

REMINDER: Pulling the Trunk upward by the handle or pressing the button a second time will interrupt the automatic opening of the Power Trunk.



Outside the Vehicle:

To open Power Trunk automatically, press the Trunk Release button **B** located underneath the Trunk lid.

Mechanical Key can also be used to open trunk **C**.

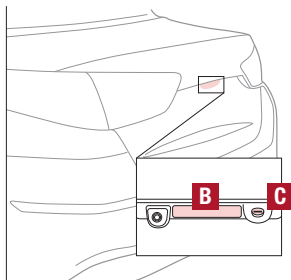

Inside the Vehicle:

Press and hold the Power Trunk Open button **D** to open the Trunk.

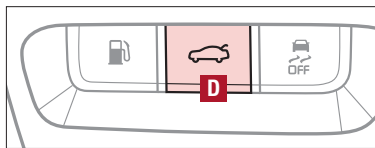

(Button located on Driver's Panel left of Steering Wheel)

Smart Trunk*

When the Smart Key fob is on your person and you are near the back of the vehicle, within close proximity, the hazard lights will blink and a chime will sound for about 3 seconds as an alert that the Power Trunk is about to open. Then the alert system will blink and chime two additional times before opening the Power Trunk.

The Smart Trunk feature is off by default. To enable the Smart Trunk, go to User Settings in the LCD Instrument Cluster modes.

QUICK TIP

During the Smart Trunk alert, the Smart Trunk can be deactivated with the Smart Key by pressing any button on the key fob.

REMINDEERS:

- All doors are closed and locked after about 15 seconds
- The Smart Trunk feature will not operate when:
 - The doors are recently closed and locked, and the Smart Key is still detected after 15 seconds near the vehicle or within 60 inches of the door handles
 - A door is not locked or closed
 - The Smart Key is in the vehicle

For more information on the Smart Trunk operation, please refer to the Owner's Manual.

Map/Room Lamps

Automatic turn off function*

The interior lights automatically turn off approximately 30 seconds after the ENGINE START/STOP button is OFF.

Map/Personal Lamp

Push the lens **A** to turn the Map Lamp ON/OFF. This light produces a spot beam for convenient use as a Map Lamp or Personal Lamp for the driver or front passenger.

Room Lamp

 : When pressed **B**, the lamp turns ON when any door is opened.

 : When pressed **C**, the lamp stays on continuously.

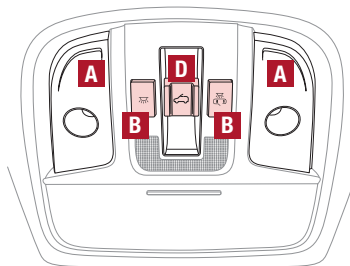

(Type B)

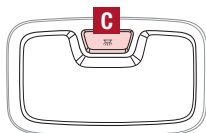

(Type A)

QUICK TIPS

- When doors are unlocked by the Smart Key*, the lamp turns ON for approximately 30 seconds
- If your vehicle is equipped with the theft alarm system, the interior lights automatically turn off approximately 3 seconds after the system is in armed stage
- Using interior lights for an extended period of time may cause battery discharge

Panoramic Sunroof Operation*

The Sunroof and Sunshade operation is controlled through a multi-directional switch/lever, and the ignition needs to be in the ON position to operate the Sunroof/Sunshade.

Slide the Sunshade and Sunroof:

- Auto Open: Slide lever backward to the farthest position and release
- Auto Close (Sunroof only): Slide the lever **D** forward to the farthest position and release

Slide the Sunshade:

- Open: Slide the lever **D** partially backward to the first detent position
- Auto Close: Slide the lever **D** forward to the farthest position

Slide the Sunroof (with Sunshade open):

- Open: Slide the lever **D** backward and release
- Close: Slide the lever **D** partially forward to the first detent position or pull the lever downward

Tilt the Sunroof:

- Raise: Push lever **D** upward
- Lower: Pull lever **D** upward
- Auto Close: Slide the lever **D** forward to the farthest position

REMINDER: Sunshade needs to remain OPEN while Sunroof is open and vehicle is moving.

QUICK TIP

To stop the Sunroof/Sunshade at any position, push or pull the Sunroof control lever in any direction.

Hood Release Lever and Latch

Opening the Hood:

1. Pull the Hood Release Lever **A** to unlatch the Hood
2. In the front of the vehicle, lift the Hood slightly, pull the secondary Latch **B** inside of the Hood's center and lift the Hood

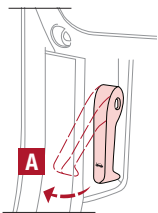

(Located on Driver side kick panel)

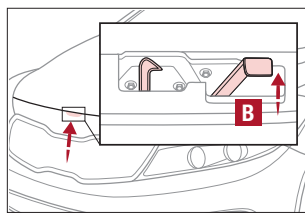

(Latch located inside hood)

Closing the Hood: Lower the Hood about halfway and then press down to securely lock in place.

Fuel Door and Trunk Release

Press the button **C** to release the fuel door.

Pull the button **D** to open the trunk.

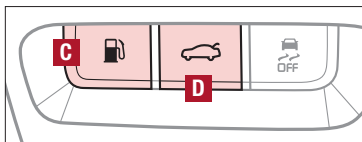

(Buttons located on Driver's Door)

Fuel Cap / Malfunction Indicator (Check Engine Light)

Tighten for **ONE CLICK** to prevent Malfunction Indicator  from illuminating.

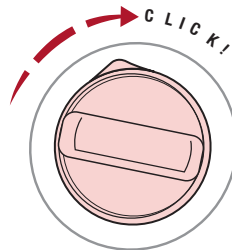

REMINDER: The Fuel Filler Door Release button is located on the lower part of the driver's door panel.

QR CODE

One-Click Fuel Cap Video

To view a video on your mobile device, snap this QR Code or visit the listed website.

Refer to page 2 for more information.



www.youtube.com/KiaFeatureVideos

Sunvisor

Use the Sunvisor to shield direct light through the front or side windows. Slide the Sunvisor out and adjust as needed.

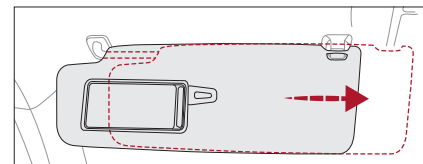

REMINDEERS:

- Sunvisor may not shield all direct light
- Do not operate the vehicle if Sunvisor is impairing your visibility
- Be aware of your seating position when adjusting or swinging Sunvisor around from the front or side windows

Rear Parking Assist System*

The Rear Parking Assist System* is not a safety device. The Rear Parking Assist System* is a supplemental system that assists the driver by chiming if any object is detected within the sensing area to the rear and side of the vehicle when backing up. When the ignition is ON, the system is activated.

REMINDERS:

- If the vehicle is moving at speeds over 3 mph, the system may not activate correctly
- When more than two objects are sensed at the same time, the closest one will be recognized first

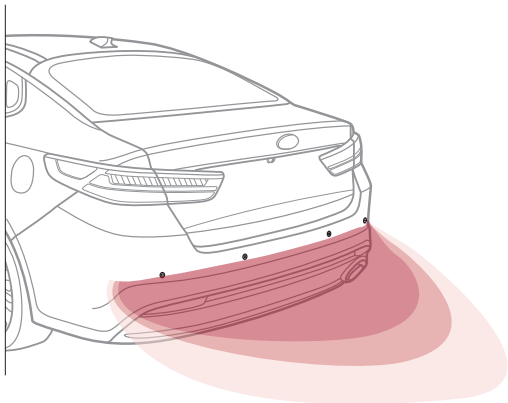

REMINER: The above images are for illustration purposes only and may not reflect actual operation

The Rear Parking Assist System is not a substitute for proper and safe backing-up procedures. Always drive safely and use caution when backing up. The Back-Up Warning System may not detect every object behind the vehicle*

Rear-Camera Display*

The Rear-Camera Display system is not a safety device. It is a supplemental system that displays the view behind the vehicle through the rearview display mirror or the UVO eServices System/UVO eServices with Premium Navigation System* screens while the vehicle is in Reverse.

The Rear-Camera Display activates when the:

- ENGINE START/STOP button is in the ON position (green light)
- Gear Shift Lever is in the R (Reverse) position

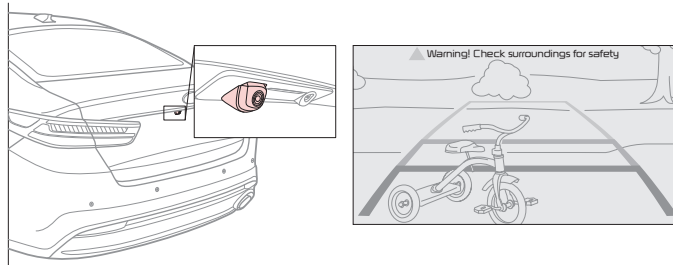

REMINDERS:

- The above images are for illustration purposes only and may not reflect actual operation
- UVO eServices System* — While camera is active, only the volume controls on the Audio System can be operated.
- UVO eServices with Premium Navigation System* — While camera is active, only the Audio System can be operated on the Steering Wheel and Audio Control Unit. Navigation features are disabled.

The Rear-Camera Display is not a substitute for proper and safe backing-up procedures. The Rear-Camera Display may not display every object behind the vehicle. Always drive safely and use caution when backing up

Hybrid/Plug-In Air Intake

The Hybrid/Plug-In Battery Air Intake, located underneath the rear seats, is used to cool down the Hybrid/Plug-In battery. For safety reasons, this vent should never be blocked. Doing so may cause the battery to overheat.

Hybrid*

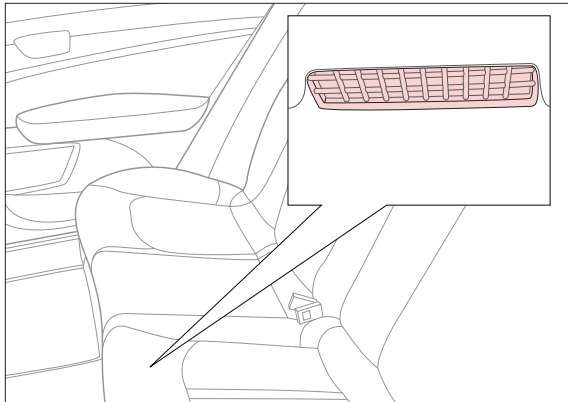

(Vent located underneath rear seats)

QUICK TIP

Clean the air intake for the Hybrid/Plug-In battery regularly with a dry cloth

PRECAUTION: Never clean the battery vent with a WET cloth or spill liquid over the air intake. This could cause an electric shock, which could cause serious damage, injury or death.

Plug-In Hybrid*

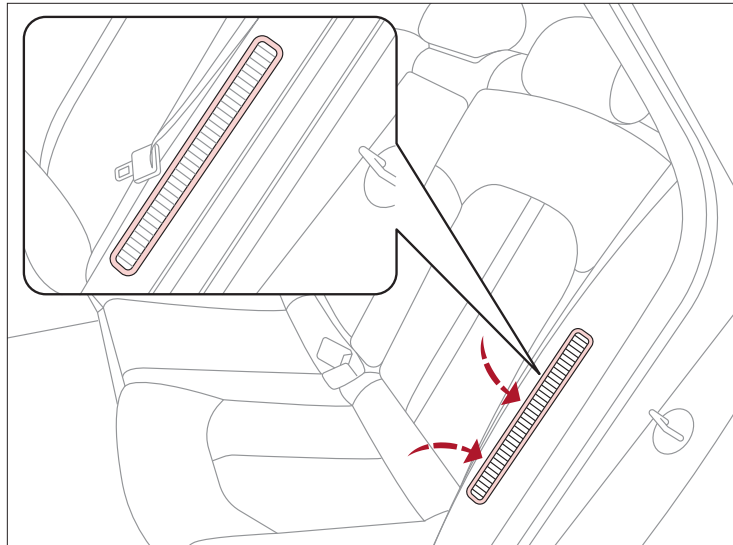

(Vent located on left side of rear seats)

Child-Protector Rear Door Lock

Locate these locks on the rear edge of the rear passenger doors. Turn the safety lock to the LOCK position to disable the inner door handles from opening the rear doors.

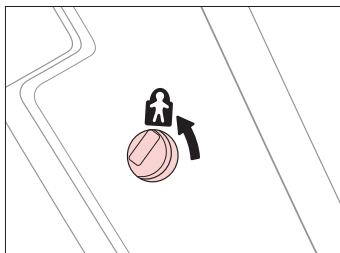

REMINDER: Child-Protector Rear Door Lock is located on rear passenger's door jamb.

Tire Mobility Kit

The Tire Mobility Kit may temporarily seal certain types of tire damage.

For operational information, please refer to the Owner's Manual.

A Sealant Bottle

B Compressor

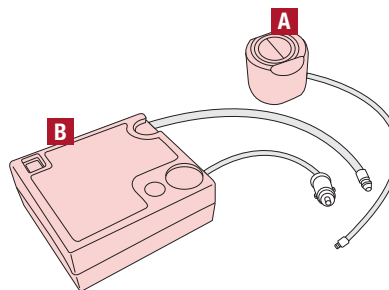

QR CODE

Tire Mobility Kit Video

To view a video on your mobile device, snap this QR Code or visit the listed website.

Refer to page 2 for more information.



www.youtube.com/KiaFeatureVideos

QUICK TIPS

- The Tire Mobility Kit is a temporary fix and is to be used for one tire only; the tire should be inspected as soon as possible
- The kit should only be used for sealing/inflating passenger car tires; do not use for inflating any other type of tires
- Some damaged tires cannot be sealed completely; do not use the kit if it appears a tire is damaged beyond repair

REMINDEES:

- The above images are for illustration purposes only and may not reflect actual operation
- After tire is properly sealed, drive cautiously at a maximum speed of 50 mph for a maximum distance of up to 120 miles.

Occupant Detection System (ODS) / Passenger Airbag Off Indicator

ODS detects the presence and position of the front passenger and adjusts or turns off airbag deployment accordingly.

Depending on the situation and type of accident, the system may:

- Deploy airbag (Adult)
- Not deploy the airbag (Unoccupied)

If the system determines that the airbag should not be deployed, the “PASSENGER AIR BAG OFF” light will illuminate.



Seat Belts

To properly fasten your safety belts:

1. Insert the belt tongue plate **A** into the buckle **B** until it clicks
2. Position the lap portion of the belt across your lap as **LOW ON THE HIPS** as possible **C**. Adjust the belt to a **SNUG FIT** by pulling up on the shoulder portion **D**.

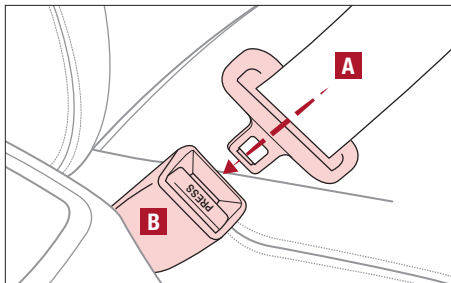

QUICK TIP

The Seat Belt warning chime operates for driver's seat only.

REMINDER: For maximum protection, always wear your Seat Belt.

Seat Belt Retractor Locks

Retractor locks allow lap/shoulder seat belts to remain unlocked during normal vehicle operation for freedom of movement and increased comfort.

During a **STRONG STOP, SUDDEN TURN OR CERTAIN COLLISIONS**, seat belt retractors will automatically lock the belts to reduce the risk of injury.

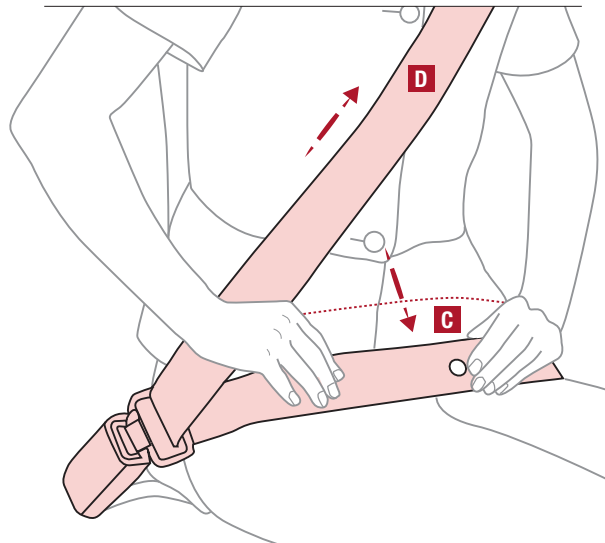

Normal Maintenance Schedule

When your vehicle requires service, remember that your dealer knows your vehicle best. Your dealer has factory-trained technicians, recommended special tools, genuine Kia replacement parts and is dedicated to your complete satisfaction. For expert advice and quality service, see your authorized Kia dealer.

7,500 miles

PERFORM:

- Add fuel additive¹
- Rotate tire position

REPLACE:

- Engine oil and filter

INSPECT*:

- Air cleaner filter
- HSG belt²
- Vacuum hose

* And, if necessary, adjust, correct, clean, or replace.

¹ If TOP TIER detergent gasoline is not available, one bottle of additive is recommended. Additives are available from your authorized Kia dealer along with information on how to use them. Do not mix other additives.

² Inspect HSG belt for evidence of cuts, cracks, excessive wear or oil saturation and replace if necessary. If HSG belt noise occurred, readjust HSG belt tension before replacing.

15,000 miles

PERFORM:

- Add fuel additive¹
- Rotate tire position

REPLACE:

- Climate control air filter (for evaporator and blower unit)
- Engine oil and filter

INSPECT*:

- Air cleaner filter
- HSG belt²
- Vacuum hose
- Air conditioning refrigerant
- Brake hoses and lines
- Drive shafts and boots
- Exhaust pipe and muffler
- Front brake disc/pads, calipers and rotors
- Rear brake disc/pads
- Steering gear box, linkage & boots/lower arm ball joint, upper arm ball joint
- Suspension mounting bolts

* And, if necessary, adjust, correct, clean, or replace.

¹ If TOP TIER detergent gasoline is not available, one bottle of additive is recommended. Additives are available from your authorized Kia dealer along with information on how to use them. Do not mix other additives.

² Inspect HSG belt for evidence of cuts, cracks, excessive wear or oil saturation and replace if necessary. If HSG belt noise occurred, readjust HSG belt tension before replacing.

QUICK TIP

Check your Maintenance Schedule or schedule an appointment with a dealer using your UVO eServices account by logging into your UVO App or your account on MyUVO.com (Vehicles equipped with UVO eServices only; see page 28 for setup information)

Normal Maintenance Schedule (Continued)

22,500 miles

PERFORM:

- Add fuel additive¹
- Rotate tire position

REPLACE:

- Engine oil and filter

INSPECT*:

- Air cleaner filter
- HSG belt²
- Vacuum hose

* And, if necessary, adjust, correct, clean, or replace.

¹ If TOP TIER detergent gasoline is not available, one bottle of additive is recommended. Additives are available from your authorized Kia dealer along with information on how to use them. Do not mix other additives.

² Inspect HSG belt for evidence of cuts, cracks, excessive wear or oil saturation and replace if necessary. If HSG belt noise occurred, readjust HSG belt tension before replacing.

30,000 miles

PERFORM:

- Add fuel additive¹
- Rotate tire position

REPLACE:

- Air cleaner filter
- Climate control air filter (for evaporator and blower unit)
- Engine oil and filter

INSPECT*:

- Air conditioning refrigerant
- Brake fluid
- Brake hoses and lines
- Drive shafts and boots
- Exhaust pipe and muffler
- Front brake disc/pads, calipers and rotors
- Fuel filter²
- Fuel cap, fuel lines, fuel hoses and connections
- Fuel tank air filter^{**2}
- HSG belt (30,000 miles)
- Rear brake disc/pads
- Parking brake
- Steering gear box, linkage & boots/lower arm ball joint, upper arm ball joint
- Suspension mounting bolts
- Vacuum hose
- Vapor hose and fuel filler cap

* And, if necessary, adjust, correct, clean, or replace.

** If equipped

¹ If TOP TIER detergent gasoline is not available, one bottle of additive is recommended. Additives are available from your authorized Kia dealer along with information on how to use them. Do not mix other additives.

² Fuel filter & fuel tank air filter are considered to be maintenance free but periodic inspection is recommended for this maintenance schedule depends on fuel quality. If there are some important safety matters like fuel flow restriction, surging, loss of power, hard starting problem etc., replace the fuel filter immediately regardless of maintenance schedule and consult an authorized Kia dealer for details.

Normal Maintenance Schedule (Continued)

37,500 miles

PERFORM:

- Add fuel additive¹
- Rotate tire position

REPLACE:

- Engine oil and filter

INSPECT*:

- Air cleaner filter
- HSG belt²
- Vacuum hose

* And, if necessary, adjust, correct, clean, or replace.

¹ If TOP TIER detergent gasoline is not available, one bottle of additive is recommended. Additives are available from your authorized Kia dealer along with information on how to use them. Do not mix other additives.

² Inspect HSG belt for evidence of cuts, cracks, excessive wear or oil saturation and replace if necessary. If HSG belt noise occurred, readjust HSG belt tension before replacing.

45,000 miles

PERFORM:

- Fuel additive¹
- Rotate tire position

REPLACE:

- Climate control air filter (for evaporator and blower unit)
- Engine oil and filter

INSPECT*:

- Air cleaner filter
- Air conditioning refrigerant
- Brake hoses and lines
- Drive shafts and boots
- Exhaust pipe and muffler
- Front brake disc/pads and calipers
- HSG belt²
- Rear brake disc/pads
- Steering gear box, linkage & boots/lower arm ball joint, upper arm ball joint
- Suspension mounting bolts
- Vacuum hose

* And, if necessary, adjust, correct, clean, or replace.

¹ If TOP TIER detergent gasoline is not available, one bottle of additive is recommended. Additives are available from your authorized Kia dealer along with information on how to use them. Do not mix other additives.

² Inspect HSG belt for evidence of cuts, cracks, excessive wear or oil saturation and replace if necessary. If HSG belt noise occurred, readjust HSG belt tension before replacing.

Normal Maintenance Schedule (Continued)

52,500 miles

PERFORM:

- Add fuel additive¹
- Rotate tire position

REPLACE:

- Engine oil and filter

INSPECT*:

- Air cleaner filter
- HSG belt²
- Vacuum hose

* And, if necessary, adjust, correct, clean, or replace.

¹ If TOP TIER detergent gasoline is not available, one bottle of additive is recommended. Additives are available from your authorized Kia dealer along with information on how to use them. Do not mix other additives.

² Inspect HSG belt for evidence of cuts, cracks, excessive wear or oil saturation and replace if necessary. If HSG belt noise occurred, readjust HSG belt tension before replacing.

60,000 miles

PERFORM:

- Add fuel additive¹
- Rotate tire position

REPLACE:

- Air cleaner filter
- Climate control air filter (for evaporator and blower unit)
- Engine oil and filter
- HSG belt²

INSPECT*:

- Air conditioning refrigerant
- Brake hoses and lines
- Drive shafts and boots
- Exhaust pipe and muffler
- Front brake disc/pads and calipers
- Rear brake disc/pads
- Steering gear box, linkage & boots/lower arm ball joint, upper arm ball joint
- Suspension mounting bolts
- Brake fluid
- Fuel cap, fuel lines, fuel hoses and connections
- Fuel tank air filter^{**3}
- Parking brake
- Vacuum hose
- Vapor hose and fuel filler cap

* And, if necessary, adjust, correct, clean, or replace.

** If equipped

¹ If TOP TIER detergent gasoline is not available, one bottle of additive is recommended. Additives are available from your authorized Kia dealer along with information on how to use them. Do not mix other additives.

² Inspect HSG belt for evidence of cuts, cracks, excessive wear or oil saturation and replace if necessary. If HSG belt noise occurred, readjust HSG belt tension before replacing.

³ Fuel filter & fuel tank air filter are considered to be maintenance free but periodic inspection is recommended for this maintenance schedule depends on fuel quality. If there are some important safety matters like fuel flow restriction, surging, loss of power, hard starting problem etc., replace the fuel filter immediately regardless of maintenance schedule and consult an authorized Kia dealer for details.

Inspect for excessive tappet noise and/or engine vibration and adjust if necessary.

Driving while distracted is dangerous and should be avoided. Drivers should remain attentive to driving and always exercise caution when using the steering-wheel-mounted controls while driving.

Driving while distracted can result in a loss of vehicle control that may lead to an accident, severe personal injury and death. The driver's primary responsibility is in the safe and legal operation of a vehicle, and use of any handheld devices, other equipment or vehicle systems which take the driver's eyes, attention and focus away from the safe operation of a vehicle or that are not permissible by law should never be used during operation of the vehicle.

Safety Features: No system, no matter how advanced, can compensate for all driver error and/or driving conditions. Always drive responsibly.

Airbags: For maximum protection, always wear your seat belt.

Android Auto: Android Auto is a trademark of Google, Inc. Android™ is a registered trademark of Google, Inc. Distracted driving can result in a loss of vehicle control. Never use a handheld device or vehicle system that takes your focus away from safe vehicle operation. Navigation is for information purposes only, and Kia does not make any warranties about the accuracy of the information.

Apple CarPlay®: Apple CarPlay® a registered trademark of Apple Inc. Distracted driving can result in a loss of vehicle control. Never use a handheld device or vehicle system that takes your focus away from safe vehicle operation. Navigation is for information purposes only, and Kia does not make any warranties about the accuracy of the information.

Apps: All information contained herein was based upon the latest available information at the time of appstore registration. Descriptions are believed to be correct, and Kia Motors Corporation (KMC) makes every effort to ensure accuracy, however, accuracy cannot be guaranteed. From time to time, KMC may need to update or make changes to the vehicle features and other vehicle information reported in this app. KMC, by the publication and dissemination of this material, does not create any warranties, either express or implied, to any Kia products. Contact your local Kia dealer for the most current information.

Autonomous Emergency Braking System (AEB) / Forward Collision Warning System: These systems are not substitutes for safe driving, and may not detect all objects in front of vehicle. Always drive safely and use caution.

Bluetooth® Wireless Technology: A compatible Bluetooth® wireless technology-enabled cell phone is required to use Bluetooth® wireless technology. The Bluetooth® word mark and logos are registered trademarks owned by Bluetooth SIG, Inc. and any use of such marks by Kia is under license. Other trademarks and trade names are those of their respective owners. A Bluetooth® enabled cell phone is required to use Bluetooth® wireless technology.

Driver Assist Features - Advanced Smart Cruise Control (ASCC), Back-Up Warning System (Rear Parking Assist System), Blind Spot Detection (BSD) with Lane Change Assist, Rear Cross Traffic Alert (RCTA), Lane Departure Warning System, Rear-Camera Display: These features are not substitutes for safe driving, and may not detect all objects surrounding vehicle. Always drive safely and use caution.

Electronic Stability Control, Hill-start Assist Control (HAC): No system, no matter how advanced, can compensate for all driver error and/or driving conditions. Always drive responsibly.

Engine Start/Stop Button with Smart Key: Always come to a complete stop before turning the engine on or off. However, if you have an emergency while the vehicle is in motion and must turn the engine off, you can turn the engine off to the ACC position by pressing the Start/Stop button for more than 3 seconds or 3 times in succession. If the vehicle is still moving, you can restart the engine by pressing the Start/Stop button with the shift lever in Neutral (N). With the engine off, power assist for steering and braking will be disabled, and the vehicle will be more difficult to control.

Front Seat Headrest Adjustment: Never attempt to adjust headrests when vehicle is in motion.

Google Play™ Store is a trademark of Google, Inc. © 2016 Google Inc. All rights reserved. Google and the Google Logo are registered trademarks of Google Inc.

HomeLink® is a registered trademark of Genex Corporation.

iPod®/iPhone® are registered trademarks of Apple Inc. iPod® mobile digital device sold separately, and connectivity requires the Kia accessory cable.

Navigation: Distracted driving can result in a loss of vehicle control. When operating a vehicle, never use a handheld device or vehicle system that takes your focus away from safe vehicle operation. Navigation is for information purposes only, and Kia does not make any warranties about the accuracy of the information.

Occupant Detection System (ODS): Kia vehicles use a number of different ODS types that vary by model.

Power Trunk / Smart Trunk: Driving with the trunk open may be unlawful and can draw dangerous exhaust fumes into your vehicle; if you choose to do so, keep air vents and all windows open for proper ventilation.

Seat adjustments: Reclining the passenger seats can reduce the effectiveness of the safety restraint system and may lead to additional injury in an accident.

Seat Belts / Airbags: For maximum protection, always wear your seatbelt.

Seat warmers: Use extreme caution when using the seat warmers to avoid burns. Refer to the Owner's Manual for more information.

SiriusXM®: SiriusXM Satellite Radio, SiriusXM Traffic and SiriusXM Travel Link each require a subscription sold separately, or as a package, by SiriusXM Radio Inc. **If you decide to continue your service at the end of your trial subscription, the plan you choose will automatically renew and bill at then-current rates until you call 1-866-635-2349 to cancel. See SiriusXM Customer Agreement for complete terms at www.siriusxm.com.** Other fees and taxes will apply. All fees and programming are subject to change. Not all vehicles or devices are capable of receiving all services offered by SiriusXM. Data displays and individual product availability vary by vehicle hardware. Current information and features may not be available in all locations, or on all receivers. Weather Forecast, Current Conditions may not be available in all locations. Images above are for representative purposes only and are not real products. For actual features and images of real products, consult the vehicle manufacturer. SiriusXM is not responsible for any errors or inaccuracies in the data services or their use in the vehicle. Travel Link Stocks displays current price and daily delta of around 7,000 actively reported securities traded on the NYSE®, NASDAQ® and AMEX®. The service is delayed approximately 20 minutes. SiriusXM satellite service is available only to those at least 18 years of age in the 48 contiguous USA, DC, and Puerto Rico (with coverage limitations). SiriusXM Internet Radio service is available throughout our satellite service area and in AK and HI. © 2017 SiriusXM Radio Inc. Sirius, XM and all related marks and logos are trademarks of SiriusXM Radio Inc.

Sportmatic® is a registered trademark of Kia Motors America.

Steering Wheel Controls: Driving while distracted is dangerous and should be avoided. Remain attentive to driving and be cautious when using steering-wheel-mounted controls while driving.

Sunvisor: Sunvisor may not shield all direct light. Do not operate the vehicle if Sunvisor is impairing your visibility.

Tilt/Telescoping Steering Wheel: Never attempt to adjust steering wheel position when vehicle is in motion.

TPMS: Even with the Tire-Pressure Monitoring System (TPMS), always check your tire pressure on a regular basis.

UVO eServices: Distracted driving can result in a loss of vehicle control. Never use a handheld device or vehicle system that takes your focus away from safe vehicle operation.

UVO eServices app: App uses your smartphone data service. Normal cellular service rates will apply.

UVO eServices with Premium Navigation: Distracted driving can result in a loss of vehicle control. Never use a handheld device or vehicle system that takes your focus away from safe vehicle operation. Navigation is for information purposes only, and Kia does not make any warranties about the accuracy of the information.



OPTIMA HYBRID PLUG-IN HYBRID CUSTOMER DELIVERY CHECKLIST

KEY FEATURE WALKTHROUGH

- UVO eServices / Android Auto™ / Apple CarPlay® Setup* – page 26

Walk customer through the registration/activation process for UVO eServices.

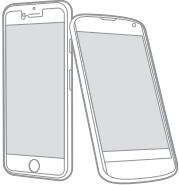

- UVO eServices System* – page 27

For further operational information, refer to the Car Multimedia System User's Manual.

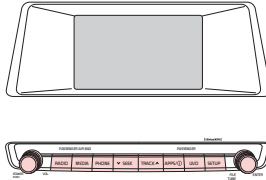

- UVO eServices with Premium-Navigation* – page 28

For further operational information, refer to the Car Multimedia System User's Manual.

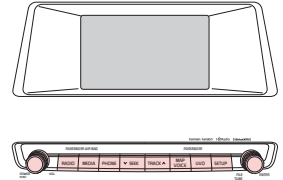

- Aux/USB/iPod® Port – page 29

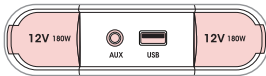

- Cruise Control – page 24

Demonstrate operation

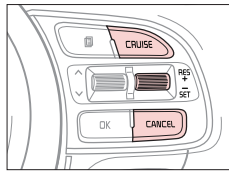

- Bluetooth® Wireless Technology – page 22

Demonstrate operation, and pair customer's phone.

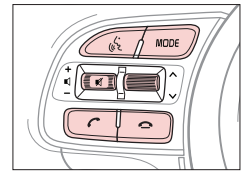

- Tire Pressure Monitoring System (TPMS) – page 5
- Trip Modes / Trip Computer – page 7
- Fuel Economy – page 8
- ECO Mode (Active ECO) – page 10
- Engine Start/Stop Button – page 19
- Audio Controls – page 25
- Digital Clock – page 31
- Seat Warmers/Ventilated Seats* – page 35

- Smart Key – page 39
- Panoramic Sunroof Operation* – page 41
- Sunvisor – page 42
- Back-up Warning System* – page 43
- Rear Parking Assist System* – page 43
- Tire Mobility Kit – page 45
- Passenger Airbag Off Indicator – page 46

*IF EQUIPPED

DURING DELIVERY

- Explain first service process and schedule first service appointment
- Tour Parts & Service departments, introduce staff & explain value of Kia Parts and Service
- Review recommended maintenance schedule and maintenance requirements to validate warranty
- Review business hours & Customer 360° Care
- Review the Kia 10-year/100,000-mile warranty program
- Ensure 100% satisfaction with sales and delivery process and no problems with the vehicle
- Confirm time and best contact number for initial dealer follow-up

Sales Consultant: _____ Date: _____

Sales Manager: _____ Date: _____

Customer: _____ Date: _____



OPTIMA HYBRID / PLUG-IN HYBRID CUSTOMER DELIVERY CHECKLIST

Owner's Name: _____ VIN: _____ Mileage: _____

Dealership Name: _____ Sales Consultant: _____ Date: _____

BEFORE DELIVERY

- Confirm "Good Battery" with Kia battery tester
- Verify all tire pressures are to spec (see driver's door label) LF _____ LR _____ RF _____ RR _____
- Verify proper operation of Remote Keyless Entry and Smart Key lock/unlock
- Ensure floor mats are snapped into place (if applicable)
- Verify vehicle is clean (interior and exterior), in good condition and free of chips and scratches
- Ensure all key documents are in the vehicle (Owner's Manual, Warranty and Consumer Information booklet, Tire Warranty booklet and Features & Functions Guide and any supplemental audio user's guides)

KEY FEATURE WALKTHROUGH

- Instrument Cluster / Hybrid/Plug-In Displays – page 3

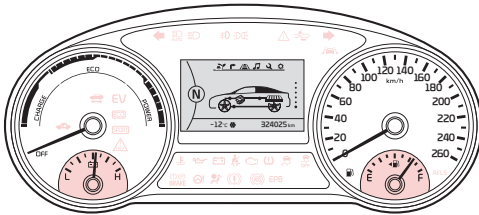

- Hybrid/Plug-In Displays - UVO eServices with Premium Navigation System* – page 11

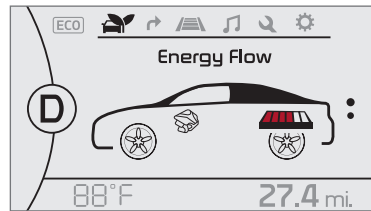

- Climate Control System* – page 33
Demo Defrost and Defog Windshield

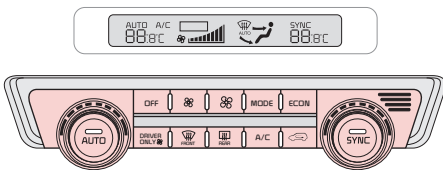

Type A shown

Automatic Climate Control with Standard Audio and UVO eServices shown

- Windshield Wipers & Washers – page 22
Move lever Up/Down to change Wiper modes. Rotate level to adjust Intermittent Wipe Speed.

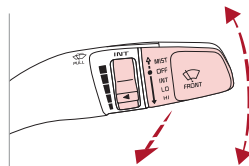

MIST: Single wipe
 OFF: Wipe off
 INT: Intermittent wipe
 LO: Slow wipe
 HI: Fast wipe

Pull to spray and wipe.



© 2017 Kia Motors America, Inc. All rights reserved.

Part Number: UH180-PS-004

Consumer - Roadside Assistance: 1-800-333-4KIA (4542)