

RAM CHASSIS CAB

3500/4500/5500

2017 USER GUIDE



RAM
COMMERCIAL

RAM CHASSIS CAB

3500/4500/5500

2017 USER GUIDE

If you are the first registered retail owner of your vehicle, you may obtain a complimentary printed copy of the Owner's Manual, Navigation/Uconnect Manuals or Warranty Booklets by calling **1 866 726-4636** (U.S.) or **1 800 387-1143** (Canada) or by contacting your dealer.

IMPORTANT

This User Guide is intended to familiarize you with the important features of your vehicle. Your Owner's Manual, Navigation/Uconnect Manuals, Warranty Booklets and Tire Warranty can be found on your DVD (if applicable) or by visiting the website on the back cover of your User Guide. We hope you find it useful. U.S. residents can purchase replacement kits by visiting www.techauthority.com and Canadian residents can purchase replacement kits by calling **1 800 387-1143**.

The driver's primary responsibility is the safe operation of the vehicle. Driving while distracted can result in loss of vehicle control, resulting in a collision and personal injury. FCA US LLC strongly recommends that the driver use extreme caution when using any device or feature that may take their attention off the road. Use of any electrical devices, such as cellular telephones, computers, portable radios, vehicle navigation or other devices, by the driver while the vehicle is moving is dangerous and could lead to a serious collision. Texting while driving is also dangerous and should never be done while the vehicle is moving. If you find yourself unable to devote your full attention to vehicle operation, pull off the road to a safe location and stop your vehicle. Some states or provinces prohibit the use of cellular telephones or texting while driving. It is always the driver's responsibility to comply with all local laws.

TABLE OF CONTENTS

INTRODUCTION/WELCOME

WELCOME FROM FCA US LLC	3
-------------------------	---

CONTROLS AT A GLANCE

DRIVER COCKPIT	6
INSTRUMENT CLUSTER	8

GETTING STARTED

KEY FOB	10
KEYLESS ENTER-N-GO — PASSIVE ENTRY	12
REMOTE START	14
VEHICLE SECURITY ALARM	14
OCCUPANT RESTRAINT SYSTEMS	15
HEAD RESTRAINTS	59
FRONT SEATS	62
HEATED/VENTILATED SEATS	68
HEATED STEERING WHEEL	70
TILT STEERING COLUMN	71

OPERATING YOUR VEHICLE

ENGINE BREAK-IN RECOMMENDATIONS	73
TURN SIGNALS/WIPER/WASHER/HIGH BEAMS LEVER	74
HEADLIGHT SWITCH	75
SPEED CONTROL	77
ELECTRONIC RANGE SELECT (ERS) OPERATION	80
MANUAL CLIMATE CONTROLS WITHOUT TOUCHSCREEN	81
MANUAL CLIMATE CONTROLS WITH TOUCHSCREEN	82
AUTOMATIC CLIMATE CONTROLS WITH TOUCHSCREEN	84
POWER SLIDING REAR WINDOW	87
WIND BUFFETING	87

ELECTRONICS

YOUR VEHICLE'S SOUND SYSTEM	88
CYBERSECURITY	90
IDENTIFYING YOUR RADIO	91
UCONNECT ACCESS	93
RADIO 3.0	107
UCONNECT 3.0	109
UCONNECT 5.0	112
UCONNECT 8.4/8.4 NAV	116
UCONNECT 8.4/8.4 NAV VOICE RECOGNITION QUICK TIPS	130
UCONNECT PHONE	147
STEERING WHEEL AUDIO CONTROLS	157
INSTRUMENT CLUSTER DISPLAY	158
PROGRAMMABLE FEATURES	159
UNIVERSAL GARAGE DOOR OPENER (HomeLink)	162
POWER INVERTER	165
POWER OUTLETS	166

AUXILIARY SWITCHES — IF EQUIPPED	168
----------------------------------	-----

OFF-ROAD CAPABILITIES

FOUR-WHEEL DRIVE OPERATION — IF EQUIPPED	169
--	-----

UTILITY

TOWING & PAYLOAD	171
TOW/HAUL MODE	171
INTEGRATED TRAILER BRAKE MODULE	172
RECREATIONAL TOWING (BEHIND MOTORHOME, ETC.)	174

6.7L CUMMINS DIESEL

DIESEL ENGINE BREAK-IN RECOMMENDATIONS	178
DIESEL ENGINE STARTING PROCEDURES	178
DIESEL EXHAUST BRAKE (ENGINE BRAKING)	181
IDLE-UP FEATURE (AUTOMATIC TRANSMISSION ONLY)	182
ENGINE MOUNTED FUEL FILTER/WATER SEPARATOR	183
UNDERBODY MOUNTED FUEL FILTER/WATER SEPARATOR	184
EXHAUST REGENERATION	185
COOL-DOWN IDLE CHART	187
DIESEL EXHAUST FLUID	188

WHAT TO DO IN EMERGENCIES

ROADSIDE ASSISTANCE	193
WARNING AND INDICATOR LIGHTS	193
IF YOUR ENGINE OVERHEATS	200
JACKING AND TIRE CHANGING	201
HOISTING	208
JUMP-STARTING PROCEDURES	208
EMERGENCY TOW HOOKS	211
GEAR SELECTOR OVERRIDE	212
TOWING A DISABLED VEHICLE	212
FREEDOM A STUCK VEHICLE	213
ENHANCED ACCIDENT RESPONSE SYSTEM (EARS)	214
EVENT DATA RECORDER (EDR)	214

MAINTAINING YOUR VEHICLE

TO OPEN AND CLOSE THE HOOD	215
ENGINE COMPARTMENT — 6.4L	216
ENGINE COMPARTMENT — 6.7L	218
FLUID CAPACITIES — GAS ENGINE	220
FLUIDS, LUBRICANTS, AND GENUINE PARTS — GAS ENGINE	220
FLUID CAPACITIES — 6.7L CUMMINS DIESEL ENGINE	222
FLUIDS, LUBRICANTS, AND GENUINE PARTS — 6.7L CUMMINS DIESEL ENGINE	222

TABLE OF CONTENTS

ADDING FUEL	224
MAINTENANCE PROCEDURES	225
MAINTENANCE SCHEDULE — GASOLINE ENGINE	226
MAINTENANCE SCHEDULE — 6.7L CUMMINS DIESEL ENGINE	231
FUSES	238
TIRE SAFETY INFORMATION	242
TIRES — GENERAL INFORMATION	248
DEPARTMENT OF TRANSPORTATION UNIFORM TIRE QUALITY GRADES	258
REPLACEMENT BULBS	260
CONSUMER ASSISTANCE	
FCA US LLC CUSTOMER CENTER	261

FCA CANADA INC. CUSTOMER CENTER	261
ASSISTANCE FOR THE HEARING IMPAIRED	261
PUBLICATIONS ORDERING	261
REPORTING SAFETY DEFECTS IN THE UNITED STATES	262

MOPAR® ACCESSORIES

AUTHENTIC ACCESSORIES BY MOPAR	263
---	-----

FAQ's

FREQUENTLY ASKED QUESTIONS	264
--------------------------------------	-----

INDEX	266
------------------------	-----

INTRODUCTION/WELCOME

WELCOME FROM FCA US LLC

Congratulations on selecting your new FCA US LLC ("FCA US") vehicle. Be assured that it represents precision workmanship, distinctive styling, and high quality.

Your new FCA US vehicle has characteristics to enhance the driver's control under some driving conditions. These are to assist the driver and are never a substitute for attentive driving. They can never take the driver's place. Always drive carefully.

Your new vehicle has many features for the comfort and convenience of you and your passengers. Some of these should not be used when driving because they take your eyes from the road or your attention from driving. Never text while driving or take your eyes, more than momentarily, off the road.

This guide illustrates and describes the operation of features and equipment that are either standard or optional on this vehicle. This guide may also include a description of features and equipment that are no longer available or were not ordered on this vehicle. Please disregard any features and equipment described in this guide that are not available on this vehicle. FCA US reserves the right to make changes in design and specifications and/or make additions to or improvements to its products without imposing any obligation upon itself to install them on products previously manufactured.

This User Guide has been prepared to help you quickly become acquainted with the important features of your vehicle. It contains most things you will need to operate and maintain the vehicle, including emergency information.

The DVD includes a computer application containing detailed Owner's information which can be viewed on a personal computer or MAC computer. The multimedia DVD also includes videos which can be played on any standard DVD player (including the Uconnect Touchscreen Radios if equipped with DVD player capabilities). Additional DVD operational information is located on the back of the DVD sleeve.

For complete owner information, refer to your Owner's Manual on www.ramtrucks.com/en/owners/manuals.

FCA US is committed to protecting our environment and natural resources. By converting from paper to electronic delivery for the majority of the user information for your vehicle, together we greatly reduce the demand for tree-based products and lessen the stress on our environment.

INTRODUCTION/WELCOME

VEHICLES SOLD IN CANADA

With respect to any vehicles sold in Canada, the name FCA US LLC shall be deemed to be deleted and the name FCA Canada Inc. used in substitution (excluding legal lines).

WARNING!

- Pedals that cannot move freely can cause loss of vehicle control and increase the risk of serious personal injury.
- Always make sure that objects cannot fall into the driver foot well while the vehicle is moving. Objects can become trapped under the brake pedal and accelerator pedal causing a loss of vehicle control.
- Failure to properly follow floor mat installation or mounting can cause interference with the brake pedal and accelerator pedal operation causing loss of control of the vehicle.
- Never leave children alone in a vehicle, or with access to an unlocked vehicle. Allowing children to be in a vehicle unattended is dangerous for a number of reasons. A child or others could be seriously or fatally injured. Children should be warned not to touch the parking brake, brake pedal or the transmission gear selector.
- Do not leave the key fob in or near the vehicle, or in a location accessible to children. A child could operate power windows, other controls, or move the vehicle.
- Never use the 'PARK' position as a substitute for the parking brake. Always apply the parking brake fully when parked to guard against vehicle movement and possible injury or damage.
- Refer to your Owner's Manual for further details.

USE OF AFTERMARKET PRODUCTS (ELECTRONICS)

The use of aftermarket devices including cell phones, MP3 players, GPS systems, or chargers may affect the performance of on-board wireless features including Keyless Enter-N-Go and Remote Start range. If you are experiencing difficulties with any of your wireless features, try disconnecting your aftermarket devices to see if the situation improves. If your symptoms persist, please see an authorized dealer.

When it comes to service, remember that your authorized dealer knows your vehicle best, has factory-trained technicians and genuine MOPAR® parts, and cares about your satisfaction.



CONTROLS AT A GLANCE



DRIVER COCKPIT

1. Headlight Switch pg. 75
2. Turn Signal/Wiper/Washer/High Beams Lever pg. 74
3. Instrument Cluster Display Controls pg. 158
4. Instrument Cluster pg. 8
5. Instrument Cluster Display pg. 8
6. Electronic Speed Control pg. 77
7. Gear Selector
8. Identify Your Audio System pg. 88
9. Upper Storage Compartment

CONTROLS AT A GLANCE

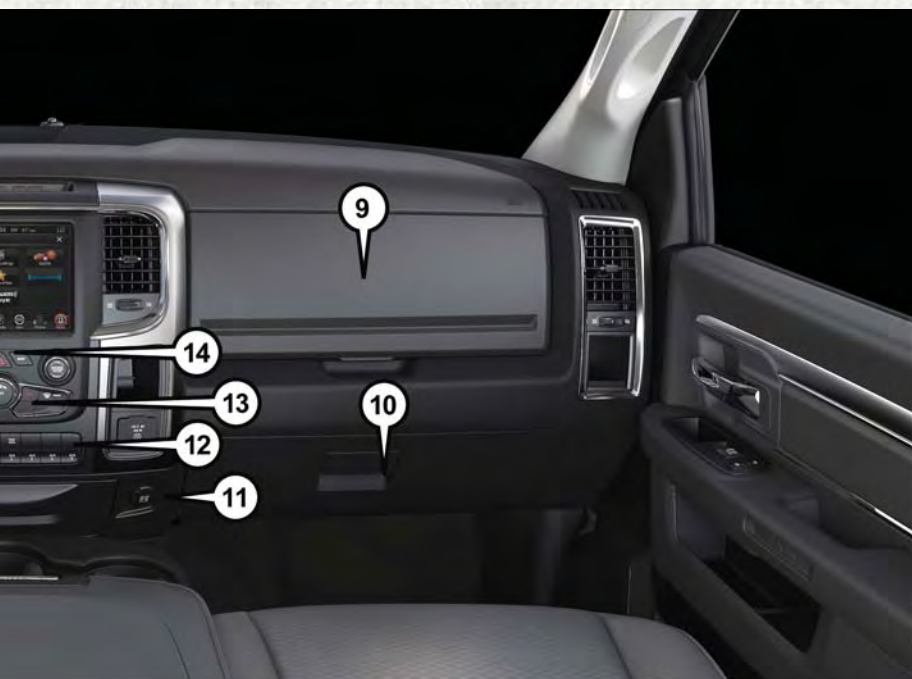

- 10. Lower Storage Compartment
- 11. Power Outlet pg. 166
- 12. Electronic Stability Control OFF pg. 199
- 13. Manual Climate Controls pg. 81
- 14. Hazard Warning Light
- 15. Ignition
- 16. Power Mirrors
- 17. Power Windows
- 18. Power Door Locks

CONTROLS AT A GLANCE



INSTRUMENT CLUSTER

1. Temperature Gauge
2. Tachometer
3. Voltmeter

(See page 193 for Instrument Cluster Warning Lights.)

CONTROLS AT A GLANCE



4. Instrument Cluster Display

5. Oil Pressure Gauge

6. Speedometer

7. Fuel Gauge

(See page 199 for Instrument Cluster Indicator Lights.)

GETTING STARTED

KEY FOB

This feature allows the driver to operate the ignition switch with the push of a button, as long as the Remote Keyless Entry (RKE) key fob is in the passenger compartment.

The Keyless Push Button Ignition has four operating positions, three of which are labeled and will illuminate when in position. The three positions are OFF, ACC, and ON/RUN. The fourth position is START, during start RUN will illuminate.

NOTE:

In case the ignition switch does not change with the push of a button, the key fob may have a low or dead battery. In this situation a back up method can be used to operate the ignition switch. Put the nose side (side opposite of the emergency key) of the key fob against the ENGINE START/STOP button and push to operate the ignition switch.

The Wireless Ignition Node (WIN) operates similar to an ignition switch. It has four operating positions, three with detents and one that is spring-loaded. The detent positions are OFF, ACC, and ON/RUN. The START position is a spring-loaded momentary contact position. When released from the START position, the switch automatically returns to the ON/RUN position.



Key Fob

- 1 — Air Suspension
- 2 — Unlock
- 3 — Lock
- 4 — Remote Start
- 5 — Panic



Key Fob

- 1 — Lock
- 2 — Unlock
- 3 — Remote Start
- 4 — Emergency Key Release
- 5 — Emergency Key

Locking And Unlocking The Doors

Push and release the unlock button on the key fob once to unlock the driver's door. Push and release the unlock button twice within five seconds to unlock all doors, the tailgate, and the RamBox (if equipped). The turn signal lights will flash to acknowledge the unlock signal. The illuminated entry system will also turn on.

All doors can be programmed to unlock on the first push of the unlock button. Refer to "Uconnect Customer Programmable Features" in "Electronics" for further information.

Panic Alarm

1. Push the PANIC button once to turn the Panic Alarm on.
2. Wait approximately three seconds and push the button a second time to turn the Panic Alarm off.

WARNING!

- When leaving the vehicle, always make sure the keyless ignition node is in "OFF" mode, remove the key fob from the vehicle and lock the vehicle.
- Never leave children alone in a vehicle, or with access to an unlocked vehicle. Leaving children in a vehicle unattended is dangerous for a number of reasons. A child or others could be seriously or fatally injured. Children should be warned not to touch the parking brake, brake pedal or the transmission gear selector.
- Do not leave the key fob in or near the vehicle (or in a location accessible to children), and do not leave the ignition (of a vehicle equipped with Keyless Enter-N-Go) in the ACC or ON/RUN mode. A child could operate power windows, other controls, or move the vehicle.
- Do not leave children or animals inside parked vehicles in hot weather. Interior heat build-up may cause serious injury or death.

GETTING STARTED

Emergency Key

Should the battery in the vehicle or the key fob go dead, there is an emergency key located in the key fob that can be used for locking and unlocking the doors.

- To remove the emergency key, slide the button on the key fob with your thumb. Then, pull the key out with your other hand.

WARNING!

- Never leave children alone in a vehicle, or with access to an unlocked vehicle. Allowing children to be in a vehicle unattended is dangerous for a number of reasons. A child or others could be severely injured or killed. Children should be warned not to touch the parking brake, brake pedal, or the transmission gear selector. Do not leave the key fob in or near the vehicle, or in a location accessible to children, and do not leave the ignition of a vehicle equipped with Keyless Enter-N-Go in the ACC or ON/RUN mode. A child could start the vehicle, operate power windows, other controls, or move the vehicle.
- Do not leave children or animals inside parked vehicles in hot weather. Interior heat build-up may cause them to be severely injured or killed.

KEYLESS ENTER-N-GO — PASSIVE ENTRY

Introduction To Keyless Enter-N-Go

The Keyless Enter-N-Go — Passive Entry system is an enhancement to the vehicles key fob. This feature allows you to lock and unlock the vehicle's door(s) without having to push the key fob lock or unlock buttons as well as starting and stopping the vehicle with the push of a button.

NOTE:

The key fob may not be found if it is located next to a mobile phone, lap top or other electronic device; these devices may block the key fob's wireless signal.

To Lock The Vehicle's Doors:

With a valid Keyless Enter-N-Go key fob within 5 ft (1.5 m) of the driver or passenger front door handles, push door handle lock button to lock all doors.

Do NOT grab the door handle, when pushing the door handle lock button. This could unlock the door(s).



Push The Button To Lock



Do NOT Grab The Handle When Locking

NOTE:

- After pushing the door handle lock button, you must wait two seconds before you can lock or unlock the doors, using either Passive Entry door handle. This is done to allow you to check if the vehicle is locked by pulling the door handle without the vehicle reacting and unlocking.
- The Passive Entry system will not operate if the key fob battery is dead.

The vehicle doors can also be locked by using the key fob lock button or the lock button located on the vehicles interior door panel.

To Unlock From The Driver Or Passenger Side:

With a valid Keyless Enter-N-Go key fob located outside the vehicle and within 5 ft (1.5 m) of the driver or passenger side door handle, grab either front door handle to unlock the door automatically.

For further information and applicable warnings and cautions, please refer to your Owner's Manual at www.ramtrucks.com/en/owners/manuals.



Grab The Door Handle To Unlock

GETTING STARTED

REMOTE START

- Push remote start button on the key fob twice within five seconds. Pushing the remote start button a third time shuts the engine off.
- To drive the vehicle, push and release the unlock button on the key fob to unlock the doors and disarm the vehicle security alarm system (if equipped). Then cycle the ignition to the ON/RUN position.

With Remote Start, the engine will only run for 15 minutes (timeout) unless the ignition is cycled to the ON/RUN position.

The vehicle must be started with the key fob after two consecutive timeouts.

WARNING!

- Do not start or run an engine in a closed garage or confined area. Exhaust gas contains Carbon Monoxide (CO) which is odorless and colorless. Carbon Monoxide is poisonous and can cause you or others to be severely injured or killed when inhaled.
- Keep key fobs away from children. Operation of the Remote Start System, windows, door locks or other controls could cause you and others to be severely injured or killed.

VEHICLE SECURITY ALARM

The vehicle security alarm monitors the vehicle doors for unauthorized entry and the ignition for unauthorized operation. While the vehicle security alarm is armed, interior switches for door locks and tailgate are disabled. If something triggers the alarm, the vehicle security alarm will provide the following audible and visible signals: the horn will pulse, the park lamps and/or turn signals will flash, and the vehicle security light in the instrument cluster will flash.

To Arm The System

Lock the door using either the power door lock switch (one door must be open) or the lock button on the key fob (doors can be open or closed), and close all doors.

The vehicle security light in the instrument cluster will flash for 16 seconds. This shows that the vehicle security alarm is arming. During this period, if a door is opened, the ignition is cycled to ON/RUN, or the power door locks are unlocked in any manner, the vehicle security alarm will automatically disarm.

NOTE:

- The vehicle security alarm will not arm if you lock the doors with the manual door lock plungers.
- Once armed, the vehicle security alarm disables the unlock switch on the driver door trim panel and passenger door trim panel.

To Disarm The System

Push the key fob unlock button or cycle the ignition to the ON/RUN position.

The vehicle security alarm is designed to protect your vehicle. However, you can create conditions where the vehicle security alarm will give you a false alarm. If one of the previously described arming sequences has occurred, the vehicle security alarm will arm regardless of whether you are in the vehicle or not. If you remain in the vehicle and open a door, the alarm will sound. If this occurs, disarm the vehicle security alarm.

If the vehicle security alarm is armed and the battery becomes disconnected, the vehicle security alarm will remain armed when the battery is reconnected. The exterior lights will flash, and the horn will sound. If this occurs, disarm the vehicle security alarm.

OCCUPANT RESTRAINT SYSTEMS

Some of the most important safety features in your vehicle are the restraint systems:

Occupant Restraint Systems Features

- Seat Belt Systems
- Supplemental Restraint Systems (SRS) Air Bags
- Child Restraints

Some of the safety features described in this section may be standard equipment on some models, or may be optional equipment on others. If you are not sure, ask your authorized dealer.

Important Safety Precautions

Please pay close attention to the information in this section. It tells you how to use your restraint system properly, to keep you and your passengers as safe as possible.

Here are some simple steps you can take to minimize the risk of harm from a deploying air bag:

1. Children 12 years old and under should always ride buckled up in a vehicle with a rear seat.
2. If a child from 2 to 12 years old (not in a rear-facing child restraint) must ride in the front passenger seat, move the seat as far back as possible and use the proper child restraint (refer to “Child Restraints” in this section for further information).
3. Children that are not big enough to wear the vehicle seat belt properly (refer to “Child Restraints” in this section for further information) should be secured in a vehicle with a rear seat in child restraints or belt-positioning booster seats. Older children who do not use child restraints or belt-positioning booster seats should ride properly buckled up in a vehicle with a rear seat.
4. Never allow children to slide the shoulder belt behind them or under their arm.

GETTING STARTED

5. You should read the instructions provided with your child restraint to make sure that you are using it properly.
6. All occupants should always wear their lap and shoulder belts properly.
7. The driver and front passenger seats should be moved back as far as practical to allow the front air bags room to inflate.
8. Do not lean against the door or window. If your vehicle has side air bags, and deployment occurs, the side air bags will inflate forcefully into the space between occupants and the door and occupants could be injured.
9. If the air bag system in this vehicle needs to be modified to accommodate a disabled person, refer to the “Consumer Assistance” section for customer service contact information.

WARNING!

- Never place a rear-facing child restraint in front of an air bag. A deploying passenger front air bag can cause death or serious injury to a child 12 years or younger, including a child in a rear-facing child restraint.
- Only use a rear-facing child restraint in a vehicle with a rear seat.

Seat Belt Systems

Buckle up even though you are an excellent driver, even on short trips. Someone on the road may be a poor driver and could cause a collision that includes you. This can happen far away from home or on your own street.

Research has shown that seat belts save lives, and they can reduce the seriousness of injuries in a collision. Some of the worst injuries happen when people are thrown from the vehicle. Seat belts reduce the possibility of ejection and the risk of injury caused by striking the inside of the vehicle. Everyone in a motor vehicle should be belted at all times.

Enhanced Seat Belt Use Reminder System (BeltAlert)

Driver And Passenger BeltAlert — If Equipped

 BeltAlert is a feature intended to remind the driver and outboard front seat passenger (if equipped with outboard front passenger seat BeltAlert) to buckle their seat belts. The Belt Alert feature is active whenever the ignition switch is in the START or ON/RUN position.

Initial Indication

If the driver is unbuckled when the ignition switch is first in the START or ON/RUN position, a chime will signal for a few seconds. If the driver or outboard front seat passenger (if equipped with outboard front passenger seat BeltAlert) is unbuckled

when the ignition switch is first in the START or ON/RUN position the Seat Belt Reminder Light will turn on and remain on until both outboard front seat belts are buckled. The outboard front passenger seat BeltAlert is not active when an outboard front passenger seat is unoccupied.

BeltAlert Warning Sequence

The BeltAlert warning sequence is activated when the vehicle is moving above a specified vehicle speed range and the driver or outboard front seat passenger is unbuckled (if equipped with outboard front passenger seat BeltAlert) (the outboard front passenger seat BeltAlert is not active when the outboard front passenger seat is unoccupied). The BeltAlert warning sequence starts by blinking the Seat Belt Reminder Light and sounding an intermittent chime. Once the BeltAlert warning sequence has completed, the Seat Belt Reminder Light will remain on until the seat belts are buckled. The BeltAlert warning sequence may repeat based on vehicle speed until the driver and occupied outboard front seat passenger seat belts are buckled. The driver should instruct all occupants to buckle their seat belts.

Change Of Status

If the driver or outboard front seat passenger (if equipped with outboard front passenger seat BeltAlert) unbuckles their seat belt while the vehicle is traveling, the BeltAlert warning sequence will begin until the seat belts are buckled again.

The outboard front passenger seat BeltAlert is not active when the outboard front passenger seat is unoccupied. BeltAlert may be triggered when an animal or other items are placed on the outboard front passenger seat or when the seat is folded flat (if equipped). It is recommended that pets be restrained in the rear seat (if equipped) in pet harnesses or pet carriers that are secured by seat belts, and cargo is properly stowed.

BeltAlert can be activated or deactivated by your authorized dealer. FCA US LLC does not recommend deactivating BeltAlert.

NOTE:

If BeltAlert has been deactivated and the driver or outboard front seat passenger (if equipped with outboard front passenger seat BeltAlert) is unbuckled the Seat Belt Reminder Light will turn on and remain on until the driver and outboard front seat passenger seat belts are buckled.

GETTING STARTED

Lap/Shoulder Belts

All seating positions except the Crew Cab front center seating position have combination lap/shoulder belts.

The seat belt webbing retractor will lock only during very sudden stops or collisions. This feature allows the shoulder part of the seat belt to move freely with you under normal conditions. However, in a collision the seat belt will lock and reduce your risk of striking the inside of the vehicle or being thrown out of the vehicle.

WARNING!

- Relying on the air bags alone could lead to more severe injuries in a collision. The air bags work with your seat belt to restrain you properly. In some collisions, the air bags won't deploy at all. Always wear your seat belt even though you have air bags.
- In a collision, you and your passengers can suffer much greater injuries if you are not properly buckled up. You can strike the interior of your vehicle or other passengers, or you can be thrown out of the vehicle. Always be sure you and others in your vehicle are buckled up properly.
- It is dangerous to ride in a cargo area, inside or outside of a vehicle. In a collision, people riding in these areas are more likely to be seriously injured or killed.
- Do not allow people to ride in any area of your vehicle that is not equipped with seats and seat belts.
- Be sure everyone in your vehicle is in a seat and using a seat belt properly. Occupants, including the driver, should always wear their seat belts whether or not an air bag is also provided at their seating position to minimize the risk of severe injury or death in the event of a crash.
- Wearing your seat belt incorrectly could make your injuries in a collision much worse. You might suffer internal injuries, or you could even slide out of the seat belt. Follow these instructions to wear your seat belt safely and to keep your passengers safe, too.
- Two people should never be belted into a single seat belt. People belted together can crash into one another in a collision, hurting one another badly. Never use a lap/shoulder belt or a lap belt for more than one person, no matter what their size.

WARNING!

- A lap belt worn too high can increase the risk of injury in a collision. The seat belt forces won't be at the strong hip and pelvic bones, but across your abdomen. Always wear the lap part of your seat belt as low as possible and keep it snug.
- A twisted seat belt may not protect you properly. In a collision, it could even cut into you. Be sure the seat belt is flat against your body, without twists. If you can't straighten a seat belt in your vehicle, take it to your authorized dealer immediately and have it fixed.
- A seat belt that is buckled into the wrong buckle will not protect you properly. The lap portion could ride too high on your body, possibly causing internal injuries. Always buckle your seat belt into the buckle nearest you.
- A seat belt that is too loose will not protect you properly. In a sudden stop, you could move too far forward, increasing the possibility of injury. Wear your seat belt snugly.
- A seat belt that is worn under your arm is dangerous. Your body could strike the inside surfaces of the vehicle in a collision, increasing head and neck injury. A seat belt worn under the arm can cause internal injuries. Ribs aren't as strong as shoulder bones. Wear the seat belt over your shoulder so that your strongest bones will take the force in a collision.
- A shoulder belt placed behind you will not protect you from injury during a collision. You are more likely to hit your head in a collision if you do not wear your shoulder belt. The lap and shoulder belt are meant to be used together.
- A frayed or torn seat belt could rip apart in a collision and leave you with no protection. Inspect the seat belt system periodically, checking for cuts, frays, or loose parts. Damaged parts must be replaced immediately. Do not disassemble or modify the seat belt system. Seat belt assemblies must be replaced after a collision.

GETTING STARTED

Lap/Shoulder Belt Operating Instructions

1. Enter the vehicle and close the door. Sit back and adjust the seat.
2. The seat belt latch plate is above the back of the front seat, and next to your arm in the rear seat (for vehicles equipped with a rear seat). Grasp the latch plate and pull out the seat belt. Slide the latch plate up the webbing as far as necessary to allow the seat belt to go around your lap.



Pulling Out The Latch Plate

3. When the seat belt is long enough to fit, insert the latch plate into the buckle until you hear a “click.”



Inserting Latch Plate Into Buckle

GETTING STARTED

4. Position the lap belt so that it is snug and lies low across your hips, below your abdomen. To remove slack in the lap belt portion, pull up on the shoulder belt. To loosen the lap belt if it is too tight, tilt the latch plate and pull on the lap belt. A snug seat belt reduces the risk of sliding under the seat belt in a collision.
5. Position the shoulder belt across the shoulder and chest with minimal, if any slack so that it is comfortable and not resting on your neck. The retractor will withdraw any slack in the shoulder belt.
6. To release the seat belt, push the red button on the buckle. The seat belt will automatically retract to its stowed position. If necessary, slide the latch plate down the webbing to allow the seat belt to retract fully.



Positioning The Lap Belt

Lap/Shoulder Belt Untwisting Procedure

Use the following procedure to untwist a twisted lap/shoulder belt.

1. Position the latch plate as close as possible to the anchor point.
2. At about 6 to 12 inches (15 to 30 cm) above the latch plate, grasp and twist the seat belt webbing 180 degrees to create a fold that begins immediately above the latch plate.
3. Slide the latch plate upward over the folded webbing. The folded webbing must enter the slot at the top of the latch plate.
4. Continue to slide the latch plate up until it clears the folded webbing and the seat belt is no longer twisted.

GETTING STARTED

Adjustable Upper Shoulder Belt Anchorage

In the driver and front passenger seats, the top of the shoulder belt can be adjusted upward or downward to position the seat belt away from your neck. Push or squeeze the anchorage button to release the anchorage, and move it up or down to the position that serves you best.

As a guide, if you are shorter than average, you will prefer the shoulder belt anchorage in a lower position, and if you are taller than average, you will prefer the shoulder belt anchorage in a higher position. After you release the anchorage button, try to move it up or down to make sure that it is locked in position.

NOTE:

The adjustable upper shoulder belt anchorage is equipped with an Easy Up feature. This feature allows the shoulder belt anchorage to be adjusted in the upward position without pushing or squeezing the release button. To verify the shoulder belt anchorage is latched, pull downward on the shoulder belt anchorage until it is locked into position.



Adjustable Anchorage

WARNING!

- Wearing your seat belt incorrectly could make your injuries in a collision much worse. You might suffer internal injuries, or you could even slide out of the seat belt. Follow these instructions to wear your seat belt safely and to keep your passengers safe, too.
- Position the shoulder belt across the shoulder and chest with minimal, if any slack so that it is comfortable and not resting on your neck. The retractor will withdraw any slack in the shoulder belt.
- Misadjustment of the seat belt could reduce the effectiveness of the safety belt in a crash.

First Row Center Seat Belt Operating Instructions (Regular Cab Only)

The first row center seat belt (Regular Cab only) features a seat belt with a mini-latch plate and buckle, which allows the seat belt to detach from the lower anchor when the seat is folded. The latch plate and regular latch plate can then be stored out of the way in the seat for added convenience to open up utilization of the storage areas behind the front seats when the seat is not occupied.

1. Remove the mini-latch plate and regular latch plate from its stowed position on the seat.
2. Grasp the mini-latch plate and pull the seat belt over the seat.
3. Route the shoulder belt to the inside of the right head restraint.
4. When the seat belt is long enough to fit, insert the mini-latch plate into the mini-buckle until you hear a “click.”
5. Sit back in seat. Slide the regular latch plate up the webbing as far as necessary to allow the seat belt to go around your lap.
6. When the seat belt is long enough to fit, insert the latch plate into the buckle until you hear a “click.”
7. Position the lap belt so that it is snug and lies low across your hips, below your abdomen. To remove slack in the lap belt portion, pull up on the shoulder belt. To loosen the lap belt if it is too tight, pull on the lap belt. A snug seat belt reduces the risk of sliding under the seat belt in a collision.
8. Position the shoulder belt on your chest so that it is comfortable and not resting on your neck. The retractor will withdraw any slack in the seat belt.
9. To release the seat belt, push the red button on the buckle.



Inserting Latch Plate



In Use Position

GETTING STARTED

10. To disengage the mini-latch plate from the mini-buckle for storage, insert the regular latch plate into the center red slot on the mini-buckle. The seat belt will automatically retract to its stowed position. If necessary, slide the latch plate down the webbing to allow the seat belt to retract fully. Insert the mini-latch plate and regular latch plate into its stowed position.



Detaching Buckle With Seat Belt Tongue

WARNING!

- If the mini-latch plate and mini-buckle are not properly connected when the seat belt is used by an occupant, the seat belt will not be able to provide proper restraint and will increase the risk of injury in a collision.
- When reattaching the mini-latch plate and mini-buckle, ensure the seat belt webbing is not twisted. If the webbing is twisted, follow the preceding procedure to detach the mini-latch plate and mini-buckle, untwist the webbing, and reattach the mini-latch plate and mini-buckle.

First Row Center Lap Belt Operating Instructions — If Equipped

The center seating position for the Crew Cab front seat has a lap belt only. To buckle the lap belt, slide the latch plate into the buckle until you hear a "click." To lengthen the lap belt, tilt the latch plate and pull.

To remove slack, pull the loose end of the webbing. Wear the lap belt snug against the hips. Sit back and upright in the seat, then adjust the seat belt as tightly as is comfortable.

Seat Belt Extender

If a seat belt is not long enough to fit properly, even when the webbing is fully extended and the adjustable upper shoulder belt anchorage (if equipped) is in its lowest position, your authorized dealer can provide you with a Seat Belt Extender. The Seat Belt Extender should be used only if the existing seat belt is not long enough. When the Seat Belt Extender is not required for a different occupant, it must be removed.

WARNING!

- **ONLY** use a Seat Belt Extender if it is physically required in order to properly fit the original seat belt system. **DO NOT USE** the Seat Belt Extender if, when worn, the distance between the front edge of the Seat Belt Extender buckle and the center of the occupant's body is **LESS** than 6 inches.
- Using a Seat Belt Extender when not needed can increase the risk of serious injury or death in a collision. Only use the Seat Belt Extender when the lap belt is not long enough and only use in the recommended seating positions. Remove and store the Seat Belt Extender when not needed.

GETTING STARTED

Seat Belts And Pregnant Women

Seat belts must be worn by all occupants including pregnant women: the risk of injury in the event of an accident is reduced for the mother and the unborn child if they are wearing a seat belt.

Position the lap belt snug and low below the abdomen and across the strong bones of the hips. Place the shoulder belt across the chest and away from the neck. Never place the shoulder belt behind the back or under the arm.



Pregnant Women And Seat Belts

Seat Belt Pretensioner — If Equipped

The front seat belt system may be equipped with pretensioning devices that are designed to remove slack from the seat belt in the event of a collision. These devices may improve the performance of the seat belt by removing slack from the seat belt early in a collision. Pretensioners work for all size occupants, including those in child restraints.

NOTE:

These devices are not a substitute for proper seat belt placement by the occupant. The seat belt still must be worn snugly and positioned properly.

The pretensioners are triggered by the Occupant Restraint Controller (ORC). Like the air bags, the pretensioners are single use items. A deployed pretensioner or a deployed air bag must be replaced immediately.

Energy Management Feature — If Equipped

The front seat belt system may be equipped with an Energy Management feature that may help further reduce the risk of injury in the event of a collision. The seat belt system has a retractor assembly that is designed to release webbing in a controlled manner.

Switchable Automatic Locking Retractors (ALR)

The seat belts in the passenger seating positions are equipped with a Switchable Automatic Locking Retractor (ALR) which is used to secure a child restraint system. For additional information, refer to "Installing Child Restraints Using The Vehicle Seat Belt" under the "Child Restraints" section of this manual. The figure below illustrates the locking feature for each seating position.

If the passenger seating position is equipped with an ALR and is being used for normal usage, only pull the seat belt webbing out far enough to comfortably wrap around the occupant's mid-section so as to not activate the ALR. If the ALR is activated, you will hear a clicking sound as the seat belt retracts. Allow the webbing to retract completely in this case and then carefully pull out only the amount of webbing necessary to comfortably wrap around the occupant's mid-section. Slide the latch plate into the buckle until you hear a "click."

In Automatic Locking Mode, the shoulder belt is automatically pre-locked. The seat belt will still retract to remove any slack in the shoulder belt. Use the Automatic Locking Mode anytime a child restraint is installed in a seating position that has a seat belt with this feature. Children 12 years old and under should always be properly restrained in a vehicle with a rear seat.



Regular Cab Automatic Locking Retractor (ALR) Locations

ALR = Switchable Automatic Locking Retractor

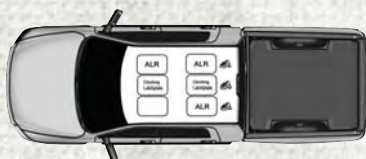

Crew Cab Automatic Locking Retractor (ALR) Locations

ALR = Switchable Automatic Locking Retractor

GETTING STARTED

WARNING!

- Never place a rear-facing child restraint in front of an air bag. A deploying passenger front air bag can cause death or serious injury to a child 12 years or younger, including a child in a rear-facing child restraint.
- Only use a rear-facing child restraint in a vehicle with a rear seat.

How To Engage The Automatic Locking Mode

1. Buckle the combination lap and shoulder belt.
2. Grasp the shoulder portion and pull downward until the entire seat belt is extracted.
3. Allow the seat belt to retract. As the seat belt retracts, you will hear a clicking sound. This indicates the seat belt is now in the Automatic Locking Mode.

How To Disengage The Automatic Locking Mode

Unbuckle the combination lap/shoulder belt and allow it to retract completely to disengage the Automatic Locking Mode and activate the vehicle sensitive (emergency) locking mode.

WARNING!

- The seat belt assembly must be replaced if the switchable Automatic Locking Retractor (ALR) feature or any other seat belt function is not working properly when checked according to the procedures in the Service Manual.
- Failure to replace the seat belt assembly could increase the risk of injury in collisions.
- Do not use the Automatic Locking Mode to restrain occupants who are wearing the seat belt or children who are using booster seats. The locked mode is only used to install rear-facing or forward-facing child restraints that have a harness for restraining the child.

Supplemental Restraint Systems (SRS)

Some of the safety features described in this section may be standard equipment on some models, or may be optional equipment on others. If you are not sure, ask your authorized dealer.

The air bag system must be ready to protect you in a collision. The Occupant Restraint Controller (ORC) monitors the internal circuits and interconnecting wiring associated with the electrical Air Bag System Components. Your vehicle may be equipped with the following Air Bag System Components:

Air Bag System Components

- Occupant Restraint Controller (ORC)
- Air Bag Warning Light 
- Steering Wheel and Column
- Instrument Panel
- Knee Impact Bolsters
- Driver and Front Passenger Air Bags
- Supplemental Side Air Bags — If Equipped
- Front and Side Impact Sensors — If Equipped
- Seat Belt Pretensioners — If Equipped
- Seat Belt Buckle Switch

Air Bag Warning Light

 The ORC monitors the readiness of the electronic parts of the air bag system whenever the ignition switch is in the START or ON/RUN position. If the ignition switch is in the OFF position or in the ACC position, the air bag system is not on and the air bags will not inflate.

The ORC contains a backup power supply system that may deploy the air bag system even if the battery loses power or it becomes disconnected prior to deployment.

The ORC turns on the Air Bag Warning Light in the instrument panel for approximately four to eight seconds for a self-check when the ignition switch is first in the ON/RUN position. After the self-check, the Air Bag Warning Light will turn off. If the ORC detects a malfunction in any part of the system, it turns on the Air Bag Warning Light, either momentarily or continuously. A single chime will sound to alert you if the light comes on again after initial startup.

The ORC also includes diagnostics that will illuminate the instrument panel Air Bag Warning Light if a malfunction is detected that could affect the air bag system. The diagnostics also record the nature of the malfunction. While the air bag system is designed to be maintenance free, if any of the following occurs, have an authorized dealer service the air bag system immediately.

GETTING STARTED

- The Air Bag Warning Light does not come on during the four to eight seconds when the ignition switch is first in the ON/RUN position.
- The Air Bag Warning Light remains on after the four to eight-second interval.
- The Air Bag Warning Light comes on intermittently or remains on while driving.

NOTE:

If the speedometer, tachometer, or any engine related gauges are not working, the Occupant Restraint Controller (ORC) may also be disabled. In this condition the air bags may not be ready to inflate for your protection. Have an authorized dealer service the air bag system immediately.

WARNING!

Ignoring the Air Bag Warning Light in your instrument panel could mean you won't have the air bag system to protect you in a collision. If the light does not come on as a bulb check when the ignition is first turned on, stays on after you start the vehicle, or if it comes on as you drive, have an authorized dealer service the air bag system immediately.

Front Air Bags

This vehicle has front air bags and lap/shoulder belts for both the driver and front passenger. The front air bags are a supplement to the seat belt restraint systems. The driver front air bag is mounted in the center of the steering wheel. The passenger front air bag is mounted in the instrument panel, above the glove compartment. The words "SRS AIRBAG" or "AIRBAG" are embossed on the air bag covers.

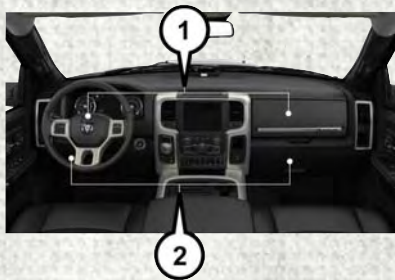

Front Air Bag/Knee Bolster Locations

- 1 — Driver And Passenger Front Air Bags
- 2 — Driver And Passenger Knee Impact Bolsters

WARNING!

- Being too close to the steering wheel or instrument panel during front air bag deployment could cause serious injury, including death. Air bags need room to inflate. Sit back, comfortably extending your arms to reach the steering wheel or instrument panel.
- Never place a rear-facing child restraint in front of an air bag. A deploying passenger front air bag can cause death or serious injury to a child 12 years or younger, including a child in a rear-facing child restraint.
- Only use a rear-facing child restraint in a vehicle with a rear seat.

Driver And Passenger Front Air Bag Features

The Advanced Front Air Bag system has multistage driver and front passenger air bags. This system provides output appropriate to the severity and type of collision as determined by the Occupant Restraint Controller (ORC), which may receive information from the front impact sensors (if equipped) or other system components.

The first stage inflator is triggered immediately during an impact that requires air bag deployment. A low energy output is used in less severe collisions. A higher energy output is used for more severe collisions.

This vehicle may be equipped with a driver and/or front passenger seat belt buckle switch that detects whether the driver or front passenger seat belt is buckled. The seat belt buckle switch may adjust the inflation rate of the Advanced Front Air Bags.

WARNING!

- No objects should be placed over or near the air bag on the instrument panel or steering wheel because any such objects could cause harm if the vehicle is in a collision severe enough to cause the air bag to inflate.
- Do not put anything on or around the air bag covers or attempt to open them manually. You may damage the air bags and you could be injured because the air bags may no longer be functional. The protective covers for the air bag cushions are designed to open only when the air bags are inflating.
- Relying on the air bags alone could lead to more severe injuries in a collision. The air bags work with your seat belt to restrain you properly. In some collisions, air bags won't deploy at all. Always wear your seat belts even though you have air bags.

GETTING STARTED

Front Air Bag Operation

Front Air Bags are designed to provide additional protection by supplementing the seat belts. Front air bags are not expected to reduce the risk of injury in rear, side, or rollover collisions. The front air bags will not deploy in all frontal collisions, including some that may produce substantial vehicle damage — for example, some pole collisions, truck underrides, and angle offset collisions.

On the other hand, depending on the type and location of impact, front air bags may deploy in crashes with little vehicle front-end damage but that produce a severe initial deceleration.

Because air bag sensors measure vehicle deceleration over time, vehicle speed and damage by themselves are not good indicators of whether or not an air bag should have deployed.

Seat belts are necessary for your protection in all collisions, and also are needed to help keep you in position, away from an inflating air bag.

When the ORC detects a collision requiring the front air bags, it signals the inflator units. A large quantity of non-toxic gas is generated to inflate the front air bags.

The steering wheel hub trim cover and the upper right side of the instrument panel separate and fold out of the way as the air bags inflate to their full size. The front air bags fully inflate in less time than it takes to blink your eyes. The front air bags then quickly deflate while helping to restrain the driver and front passenger.

Knee Impact Bolsters

The Knee Impact Bolsters help protect the knees of the driver and front passenger, and position the front occupants for improved interaction with the front air bags.

WARNING!

- Do not drill, cut, or tamper with the knee impact bolsters in any way.
- Do not mount any accessories to the knee impact bolsters such as alarm lights, stereos, citizen band radios, etc.

Supplemental Side Air Bags — If Equipped

Your vehicle is equipped with two types of side air bags:

1. **Supplemental Seat-Mounted Side Air Bags (SABs) (If Equipped):** Located in the outboard side of the front seats. The SABs are marked with a “SRS AIRBAG” or “AIRBAG” label sewn into the outboard side of the seats.

The SABs may help reduce the risk of head or other injuries to front and rear seat outboard occupants in certain side impacts and/or vehicle rollover events, in addition to the injury reduction potential provided by the seat belts and body structure.

When the SAB deploys, it opens the seam on the outboard side of the seatback's trim cover. The inflating SAB deploys through the seat seam into the space between the occupant and the door. The SAB moves at a very high speed and with such a high force that it could injure occupants if they are not seated properly, or if items are positioned in the area where the SAB inflates. Children are at an even greater risk of injury from a deploying air bag.



Supplemental Seat-Mounted Side Air Bag Label

WARNING!

Do not use accessory seat covers or place objects between you and the Side Air Bags; the performance could be adversely affected and/or objects could be pushed into you, causing serious injury.

GETTING STARTED

2. Supplemental Side Air Bag Inflatable Curtains (SABICs) (If Equipped): Located above the side windows. The trim covering the SABICs is labeled “SRS AIRBAG” or “AIRBAG.”

SABICs may help reduce the risk of head or other injuries to front and rear seat outboard occupants in certain side impacts and/or vehicle rollover events, in addition to the injury reduction potential provided by the seat belts and body structure.

The SABICs deploy downward, covering the side windows. An inflating SABIC pushes the outside edge of the trim out of the way and covers the window. The SABICs inflate with enough force to injure occupants if they are not belted and seated properly, or if items are positioned in the area where the SABICs inflate. Children are at an even greater risk of injury from a deploying air bag.



Supplemental Side Air Bag Inflatable Curtain (SABIC) Label Location

WARNING!

- Do not stack luggage or other cargo up high enough to block the deployment of the SABICs. The trim covering above the side windows where the SABIC and its deployment path are located should remain free from any obstructions.
- In order for the SABICs to work as intended, do not install any accessory items in your vehicle which could alter the roof. Do not add an aftermarket sunroof to your vehicle. Do not add roof racks that require permanent attachments (bolts or screws) for installation on the vehicle roof. Do not drill into the roof of the vehicle for any reason.

The SABICs and SABs (Side Air Bags) (if equipped with Side Air Bags) are designed to activate in certain side impacts and certain rollover events. The Occupant Restraint Controller (ORC) determines whether the deployment of the Side Air Bags in a particular side impact or rollover event (if equipped with rollover sensing) is appropriate, based on the severity and type of collision. Vehicle damage by itself is not a good indicator of whether or not Side Air Bags should have deployed.

Side Air Bags are a supplement to the seat belt restraint system. Side Air Bags deploy in less time than it takes to blink your eyes.

WARNING!

- Occupants, including children, who are up against or very close to Side Air Bags can be seriously injured or killed. Occupants, including children, should never lean on or sleep against the door, side windows, or area where the side air bags inflate, even if they are in an infant or child restraint.
- Seat belts (and child restraints where appropriate) are necessary for your protection in all collisions. They also help keep you in position, away from an inflating Side Air Bag. To get the best protection from the Side Air Bags, occupants must wear their seat belts properly and sit upright with their backs against the seats. Children must be properly restrained in a child restraint or booster seat that is appropriate for the size of the child.

WARNING!

- Side Air Bags need room to inflate. Do not lean against the door or window. Sit upright in the center of the seat.
- Being too close to the Side Air Bags during deployment could cause you to be severely injured or killed.
- Relying on the Side Air Bags alone could lead to more severe injuries in a collision. The Side Air Bags work with your seat belt to restrain you properly. In some collisions, Side Air Bags won't deploy at all. Always wear your seat belt even though you have Side Air Bags.

NOTE:

Air bag covers may not be obvious in the interior trim, but they will open during air bag deployment.

Side Impacts — If Equipped With Side Air Bags

In side impacts, the side impact sensors aid the ORC in determining the appropriate response to impact events. The system is calibrated to deploy the Side Air Bags on the impact side of the vehicle during impacts that require Side Air Bag occupant protection. In side impacts, the Side Air Bags deploy independently; a left side impact deploys the left Side Air Bags only and a right side impact deploys the right Side Air Bags only.

The Side Air Bags will not deploy in all side collisions, including some collisions at certain angles, or some side collisions that do not impact the area of the passenger compartment. The Side Air Bags may deploy during angled or offset frontal collisions where the front air bags deploy.

GETTING STARTED

Rollover Events — If Equipped Side Air Bags

Side Air Bags are designed to activate in certain rollover events. The ORC determines whether the deployment of the Side Air Bags in a particular rollover event is appropriate, based on the severity and type of collision. Vehicle damage by itself is not a good indicator of whether or not Side Air Bags should have deployed.

The Side Air Bags will not deploy in all rollover events. The rollover sensing-system determines if a rollover event may be in progress and whether deployment is appropriate. A slower-developing event may deploy the seat belt pretensioners on both sides of the vehicle. A faster-developing event may deploy the seat belt pretensioners as well as the Side Air Bags on both sides of the vehicle. The rollover sensing-system may also deploy the seat belt pretensioners, with or without the Side Air Bags, on both sides of the vehicle if the vehicle experiences a near rollover event.

The SABICs may help reduce the risk of partial or complete ejection of vehicle occupants through side windows in certain rollover (if equipped with rollover sensing) or side impact events.

The Occupant Restraint Controller (ORC) monitors the internal circuits and interconnecting wiring associated with electrical Air Bag System Components listed below:

Air Bag System Components

- Occupant Restraint Controller (ORC)
- Air Bag Warning Light 
- Steering Wheel and Column
- Instrument Panel
- Knee Impact Bolsters
- Driver and Front Passenger Air Bags
- Supplemental Side Air Bags — If Equipped
- Front and Side Impact Sensors — If Equipped
- Seat Belt Pretensioners — If Equipped
- Seat Belt Buckle Switch

If A Deployment Occurs

The front air bags are designed to deflate immediately after deployment.

NOTE:

Front and/or side air bags will not deploy in all collisions. This does not mean something is wrong with the air bag system.

GETTING STARTED

If you do have a collision which deploys the air bags, any or all of the following may occur:

- The air bag material may sometimes cause abrasions and/or skin reddening to the occupants as the air bags deploy and unfold. The abrasions are similar to friction rope burns or those you might get sliding along a carpet or gymnasium floor. They are not caused by contact with chemicals. They are not permanent and normally heal quickly. However, if you haven't healed significantly within a few days, or if you have any blistering, see your doctor immediately.
- As the air bags deflate, you may see some smoke-like particles. The particles are a normal by-product of the process that generates the non-toxic gas used for air bag inflation. These airborne particles may irritate the skin, eyes, nose, or throat. If you have skin or eye irritation, rinse the area with cool water. For nose or throat irritation, move to fresh air. If the irritation continues, see your doctor. If these particles settle on your clothing, follow the garment manufacturer's instructions for cleaning.

Do not drive your vehicle after the air bags have deployed. If you are involved in another collision, the air bags will not be in place to protect you.

WARNING!

Deployed air bags and seat belt pretensioners cannot protect you in another collision. Have the air bags, seat belt pretensioners, and the seat belt retractor assemblies replaced by an authorized dealer immediately. Also, have the Occupant Restraint Controller System serviced as well.

NOTE:

- Air bag covers may not be obvious in the interior trim, but they will open during air bag deployment.
- After any collision, the vehicle should be taken to an authorized dealer immediately.

Enhanced Accident Response System

In the event of an impact, if the communication network remains intact, and the power remains intact, depending on the nature of the event, the ORC will determine whether to have the Enhanced Accident Response System perform the following functions:

- Cut off fuel to the engine.
- Flash hazard lights as long as the battery has power or until the hazard light button is pressed. The hazard lights can be deactivated by pressing the hazard light button.
- Turn on the interior lights, which remain on as long as the battery has power.
- Unlock the power door locks.

GETTING STARTED

Enhanced Accident Response System Reset Procedure

In order to reset the Enhanced Accident Response System functions after an event, the ignition switch must be changed from ignition START or ON/RUN to ignition OFF. Carefully check the vehicle for fuel leaks in the engine compartment and on the ground near the engine compartment and fuel tank before resetting the system and starting the engine.

Maintaining Your Air Bag System

WARNING!

- Modifications to any part of the air bag system could cause it to fail when you need it. You could be injured if the air bag system is not there to protect you. Do not modify the components or wiring, including adding any kind of badges or stickers to the steering wheel hub trim cover or the upper right side of the instrument panel. Do not modify the front bumper, vehicle body structure, or add aftermarket side steps or running boards.
- It is dangerous to try to repair any part of the air bag system yourself. Be sure to tell anyone who works on your vehicle that it has an air bag system.
- Do not attempt to modify any part of your air bag system. The air bag may inflate accidentally or may not function properly if modifications are made. Take your vehicle to an authorized dealer for any air bag system service. If your seat, including your trim cover and cushion, needs to be serviced in any way (including removal or loosening/tightening of seat attachment bolts), take the vehicle to your authorized dealer. Only manufacturer approved seat accessories may be used. If it is necessary to modify the air bag system for persons with disabilities, contact your authorized dealer.

Event Data Recorder (EDR)

This vehicle is equipped with an event data recorder (EDR). The main purpose of an EDR is to record, in certain crash or near crash-like situations, such as an air bag deployment or hitting a road obstacle, data that will assist in understanding how a vehicle's systems performed. The EDR is designed to record data related to vehicle dynamics and safety systems for a short period of time, typically 30 seconds or less. The EDR in this vehicle is designed to record such data as:

- How various systems in your vehicle were operating;
- Whether or not the driver and passenger safety belts were buckled/fastened;
- How far (if at all) the driver was depressing the accelerator and/or brake pedal; and,
- How fast the vehicle was traveling.

These data can help provide a better understanding of the circumstances in which crashes and injuries occur.

NOTE:

EDR data are recorded by your vehicle only if a non-trivial crash situation occurs; no data are recorded by the EDR under normal driving conditions and no personal data (e.g., name, gender, age, and crash location) are recorded. However, other parties, such as law enforcement, could combine the EDR data with the type of personally identifying data routinely acquired during a crash investigation.

To read data recorded by an EDR, special equipment is required, and access to the vehicle or the EDR is needed. In addition to the vehicle manufacturer, other parties, such as law enforcement, that have the special equipment, can read the information if they have access to the vehicle or the EDR.

Child Restraints

Everyone in your vehicle needs to be buckled up at all times, including babies and children. Every state in the United States, and every Canadian province, requires that small children ride in proper restraint systems. This is the law, and you can be prosecuted for ignoring it.

Children 12 years or younger should ride properly buckled up in a rear seat, if available. According to crash statistics, children are safer when properly restrained in the rear seats rather than in the front.

WARNING!

In a collision, an unrestrained child can become a projectile inside the vehicle. The force required to hold even an infant on your lap could become so great that you could not hold the child, no matter how strong you are. The child and others could be badly injured. Any child riding in your vehicle should be in a proper restraint for the child's size.

There are different sizes and types of restraints for children from newborn size to the child almost large enough for an adult safety belt. Always check the child seat Owner's Manual to make sure you have the correct seat for your child. Carefully read and follow all the instructions and warnings in the child restraint Owner's Manual and on all the labels attached to the child restraint.

Before buying any restraint system, make sure that it has a label certifying that it meets all applicable Safety Standards. You should also make sure that you can install it in the vehicle where you will use it.

NOTE:

- For additional information, refer to www.safercar.gov/parents/index.htm or call: 1-888-327-4236
- Canadian residents should refer to Transport Canada's website for additional information: <http://www.tc.gc.ca/eng/motorvehiclesafety/safedrivers-childsafety-index-53.htm>

GETTING STARTED

Summary Of Recommendations For Restraining Children In Vehicles

	Child Size, Height, Weight or Age	Recommended Type of Child Restraint
Infants and Toddlers	Children who are two years old or younger and who have not reached the height or weight limits of their child restraint	Either an Infant Carrier or a Convertible Child Restraint, facing rearward in the rear seat of the vehicle
Small Children	Children who are at least two years old or who have out-grown the height or weight limit of their rear-facing child restraint	Forward-Facing Child Restraint with a five-point Harness, facing forward in the rear seat of the vehicle
Larger Children	Children who have out-grown their forward-facing child restraint, but are too small to properly fit the vehicle's seat belt	Belt Positioning Booster Seat and the vehicle seat belt, seated in the rear seat of the vehicle
Children Too Large for Child Restraints	Children 12 years old or younger, who have out-grown the height or weight limit of their booster seat	Vehicle Seat Belt, seated in the rear seat of the vehicle

Infant And Child Restraints

Safety experts recommend that children ride rear-facing in the vehicle until they are two years old or until they reach either the height or weight limit of their rear-facing child restraint. Two types of child restraints can be used rear-facing: infant carriers and convertible child seats.

The infant carrier is only used rear-facing in the vehicle. It is recommended for children from birth until they reach the weight or height limit of the infant carrier. Convertible child seats can be used either rear-facing or forward-facing in the vehicle. Convertible child seats often have a higher weight limit in the rear-facing direction than infant carriers do, so they can be used rear-facing by children who have outgrown their infant carrier but are still less than at least two years old. Children should remain rear-facing until they reach the highest weight or height allowed by their convertible child seat.

WARNING!

- Never place a rear-facing child restraint in front of an air bag. A deploying passenger front air bag can cause death or serious injury to a child 12 years or younger, including a child in a rear-facing child restraint.
- Only use a rear-facing child restraint in a vehicle with a rear seat.

WARNING!

Do not install a rear-facing car seat using a rear support leg in this vehicle. The floor of this vehicle is not designed to manage the crash forces of this type of car seat. In a crash, the support leg may not function as it was designed by the car seat manufacturer, and your child may be more severely injured as a result.



Older Children And Child Restraints

Children who are two years old or who have outgrown their rear-facing convertible child seat can ride forward-facing in the vehicle. Forward-facing child seats and convertible child seats used in the forward-facing direction are for children who are over two years old or who have outgrown the rear-facing weight or height limit of their rear-facing convertible child seat. Children should remain in a forward-facing child seat with a harness for as long as possible, up to the highest weight or height allowed by the child seat.

All children whose weight or height is above the forward-facing limit for the child seat should use a belt-positioning booster seat until the vehicle's seat belts fit properly. If the child cannot sit with knees bent over the vehicle's seat cushion while the child's back is against the seatback, they should use a belt-positioning booster seat. The child and belt-positioning booster seat are held in the vehicle by the seat belt.

GETTING STARTED

WARNING!

- Improper installation can lead to failure of an infant or child restraint. It could come loose in a collision. The child could be badly injured or killed. Follow the child restraint manufacturer's directions exactly when installing an infant or child restraint.
- After a child restraint is installed in the vehicle, do not move the vehicle seat forward or rearward because it can loosen the child restraint attachments. Remove the child restraint before adjusting the vehicle seat position. When the vehicle seat has been adjusted, reinstall the child restraint.
- When your child restraint is not in use, secure it in the vehicle with the seat belt or LATCH anchorages, or remove it from the vehicle. Do not leave it loose in the vehicle. In a sudden stop or accident, it could strike the occupants or seatbacks and cause serious personal injury.

Children Too Large For Booster Seats

Children who are large enough to wear the shoulder belt comfortably, and whose legs are long enough to bend over the front of the seat when their back is against the seatback, should use the seat belt in a rear seat. Use this simple 5-step test to decide whether the child can use the vehicle's seat belt alone:

1. Can the child sit all the way back against the back of the vehicle seat?
2. Do the child's knees bend comfortably over the front of the vehicle seat – while they are still sitting all the way back?
3. Does the shoulder belt cross the child's shoulder between their neck and arm?
4. Is the lap part of the belt as low as possible, touching the child's thighs and not their stomach?
5. Can the child stay seated like this for the whole trip?

If the answer to any of these questions was "no," then the child still needs to use a booster seat in this vehicle. If the child is using the lap/shoulder belt, check seat belt fit periodically and make sure the seat belt buckle is latched. A child's squirming or slouching can move the belt out of position. If the shoulder belt contacts the face or neck, move the child closer to the center of the vehicle, or use a booster seat to position the seat belt on the child correctly.

WARNING!

Never allow a child to put the shoulder belt under an arm or behind their back. In a crash, the shoulder belt will not protect a child properly, which may result in serious injury or death. A child must always wear both the lap and shoulder portions of the seat belt correctly.

Recommendations For Attaching Child Restraints

Restraint Type	Combined Weight of the Child + Child Restraint	Use Any Attachment Method Shown With An "X" Below			
		LATCH – Lower Anchors Only	Seat Belt Only	LATCH – Lower Anchors + Top Tether Anchor	Seat Belt + Top Tether Anchor
Rear-Facing Child Restraint	Up to 65 lbs (29.5 kg)	X	X		
Rear-Facing Child Restraint	More than 65 lbs (29.5 kg)		X		
Forward-Facing Child Restraint	Up to 65 lbs (29.5 kg)			X	X
Forward-Facing Child Restraint	More than 65 lbs (29.5 kg)				X

Lower Anchors And Tethers For Children (LATCH) Restraint System

Your vehicle is equipped with the child restraint anchorage system called LATCH, which stands for Lower Anchors and Tethers for CHildren. The LATCH system has three vehicle anchor points for installing LATCH-equipped child seats. There are two lower anchorages located at the back of the seat cushion where it meets the seatback and one top tether anchorage located behind the seating position. These anchorages are used to install LATCH-equipped child seats without using the vehicle's seat belts. Some seating positions may have a top tether anchorage but no lower anchorages. In these seating positions, the seat belt must be used with the top tether anchorage to install the child restraint. Please see the following table for more information.



LATCH Label

These anchorages are used to install LATCH-equipped child seats without using the vehicle's seat belts. Some seating positions may have a top tether anchorage but no lower anchorages. In these seating positions, the seat belt must be used with the top tether anchorage to install the child restraint. Please see the following table for more information.

GETTING STARTED

LATCH Positions For Installing Child Restraints In This Vehicle

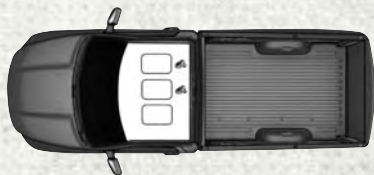

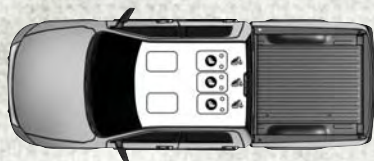

Regular Cab LATCH Positions

 Top Tether Anchorage Symbol



Crew Cab 60/40 Split Bench LATCH Positions

 Lower Anchorage Symbol (2 Anchorages Per Seating Position)

 Top Tether Anchorage Symbol

GETTING STARTED

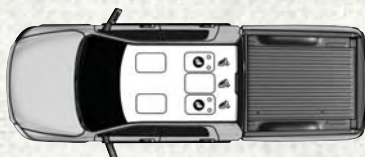

Crew Cab Full Bench LATCH Positions

 Lower Anchorage Symbol (2 Anchorage Per Seating Position)

 Top Tether Anchorage Symbol

Frequently Asked Questions About Installing Child Restraints With LATCH

What is the weight limit (child's weight + weight of the child restraint) for using the LATCH anchorage system to attach the child restraint?	65 lbs (29.5 kg)	Use the LATCH anchorage system until the combined weight of the child and the child restraint is 65 lbs (29.5 kg). Use the seat belt and tether anchor instead of the LATCH system once the combined weight is more than 65 lbs (29.5 kg).
Can the LATCH anchorages and the seat belt be used together to attach a rear-facing or forward-facing child restraint?	No	Do not use the seat belt when you use the LATCH anchorage system to attach a rear-facing or forward-facing child restraint. Booster seats may be attached to the LATCH anchorages if allowed by the booster seat manufacturer. See your booster seat owner's manual for more information.
Can a child seat be installed in the center position using the inner LATCH lower anchorages?	No	Full bench rear seat only: Use the seat belt and tether anchor to install a child seat in the center seating position.

GETTING STARTED

Frequently Asked Questions About Installing Child Restraints With LATCH

Can two child restraints be attached using a common lower LATCH anchorage?	No	Never “share” a LATCH anchorage with two or more child restraints. If the center position does not have dedicated LATCH lower anchorages, use the seat belt to install a child seat in the center position next to a child seat using the LATCH anchorages in an outboard position.
Can the rear-facing child restraint touch the back of the front passenger seat?	Yes	The child seat may touch the back of the front passenger seat if the child restraint manufacturer also allows contact. See your child restraint owner’s manual for more information.
Can the head restraints be removed?	Yes	The head restraints can be removed in each seating position.

Locating The LATCH Anchorages

 The lower anchorages are round bars that are found at the rear of the seat cushion where it meets the seatback. They are just visible when you lean into the rear seat to install the child restraint. You will easily feel them if you run your finger along the gap between the seatback and seat cushion.



Lower Anchors

Locating The Upper Tether Anchorages

 Regular Cab models have tether strap anchorages behind the front center and right seats. Crew Cab models have tether strap anchorages located behind each of the rear seats.

LATCH-compatible child restraint systems will be equipped with a rigid bar or a flexible strap on each side. Each will have a hook or connector to attach to the lower anchorage and a way to tighten the connection to the anchorage. Forward-facing child restraints and some rear-facing child restraints will also be equipped with a tether strap. The tether strap will have a hook at the end to attach to the top tether anchorage and a way to tighten the strap after it is attached to the anchorage.

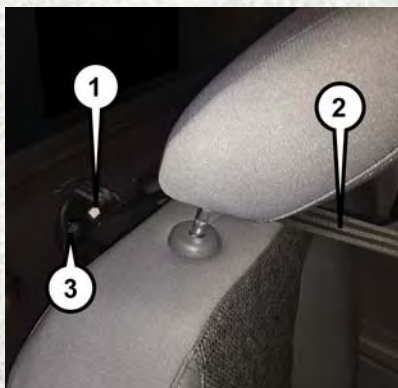

Regular Cab Tether Anchorages

- 1 — Tether Strap Hook
- 2 — Tether Strap To Child Restraint
- 3 — Tether Anchor

Center Seat LATCH

Quad Cab Or Crew Cab Full Bench Rear Seat: No Lower Center LATCH Anchorages Available

WARNING!

- Do not install a child restraint in the center position using the LATCH system. This position is not approved for installing child seats using the LATCH attachments. You must use the seat belt and tether anchor to install a child seat in the center seating position.
- Never use the same lower anchorage to attach more than one child restraint. Please refer to “To Install A LATCH-Compatible Child Restraint” for typical installation instructions.

Mega Cab Or Crew Cab Split Bench Rear Seat: Center LATCH Anchorages Available

If a child restraint installed in the center position blocks the seat belt webbing or buckle for the outboard position, do not use that outboard position. If a child seat in the center position blocks the outboard LATCH anchors or seat belt, do not install a child seat in that outboard position.

GETTING STARTED

WARNING!

Never use the same lower anchorage to attach more than one child restraint. Please refer to “To Install A LATCH-Compatible Child Restraint” for typical installation instructions.

Always follow the directions of the child restraint manufacturer when installing your child restraint. Not all child restraint systems will be installed as described here.

To Install A LATCH-Compatible Child Restraint

If the selected seating position has a Switchable Automatic Locking Retractor (ALR) seat belt, stow the seat belt, following the instructions below. See the section “Installing Child Restraints Using The Vehicle Seat Belt” to check what type of seat belt each seating position has.

1. Loosen the adjusters on the lower straps and on the tether strap of the child seat so that you can more easily attach the hooks or connectors to the vehicle anchorages.
2. Place the child seat between the lower anchorages for that seating position. For some second row seats, you may need to recline the seat and/or raise the head restraint to get a better fit. If the rear seat can be moved forward and rearward in the vehicle, you may wish to move it to its rear-most position to make room for the child seat. You may also move the front seat forward to allow more room for the child seat.
3. Attach the lower hooks or connectors of the child restraint to the lower anchorages in the selected seating position.
4. If the child restraint has a tether strap, connect it to the top tether anchorage. See the section “Installing Child Restraints Using The Top Tether Anchorage” for directions to attach a tether anchor.
5. Tighten all of the straps as you push the child restraint rearward and downward into the seat. Remove slack in the straps according to the child restraint manufacturer's instructions.
6. Test that the child restraint is installed tightly by pulling back and forth on the child seat at the belt path. It should not move more than 1 inch (25.4 mm) in any direction.

How To Stow An Unused Switchable-ALR (ALR) Seat Belt:

When using the LATCH attaching system to install a child restraint, stow all ALR seat belts that are not being used by other occupants or being used to secure child restraints. An unused belt could injure a child if they play with it and accidentally lock the seat belt retractor. Before installing a child restraint using the LATCH system, buckle the seat belt behind the child restraint and out of the child's reach. If the buckled seat belt interferes with the child restraint installation, instead of

buckling it behind the child restraint, route the seat belt through the child restraint belt path and then buckle it. Do not lock the seat belt. Remind all children in the vehicle that the seat belts are not toys and that they should not play with them.

WARNING!

- Improper installation of a child restraint to the LATCH anchorages can lead to failure of the restraint. The child could be badly injured or killed. Follow the child restraint manufacturer's directions exactly when installing an infant or child restraint.
- Child restraint anchorages are designed to withstand only those loads imposed by correctly-fitted child restraints. Under no circumstances are they to be used for adult seat belts, harnesses, or for attaching other items or equipment to the vehicle.

Installing Child Restraints Using The Vehicle Seat Belt

Child restraint systems are designed to be secured in vehicle seats by lap belts or the lap belt portion of a lap/shoulder belt.

WARNING!

- Improper installation or failure to properly secure a child restraint can lead to failure of the restraint. The child could be badly injured or killed.
- Follow the child restraint manufacturer's directions exactly when installing an infant or child restraint.

The seat belts in the passenger seating positions are equipped with either a Switchable Automatic Locking Retractor (ALR) or a cinching latch plate or both. Both types of seat belts are designed to keep the lap portion of the seat belt tight around the child restraint so that it is not necessary to use a locking clip. The ALR retractor can be "switched" into a locked mode by pulling all of the webbing out of the retractor and then letting the webbing retract back into the retractor. If it is locked, the ALR will make a clicking noise while the webbing is pulled back into the retractor. Refer to the "Automatic Locking Mode" description in "Switchable Automatic Locking Retractors (ALR)" under "Occupant Restraint Systems" for additional information on ALR. The cinching latch plate is designed to hold the lap portion of the seat belt tight when webbing is pulled tight and straight through a child restraint's belt path.

Please see the table below and the following sections for more information.

GETTING STARTED

Lap/Shoulder Belt Systems For Installing Child Restraints In This Vehicle



Regular Cab Automatic Locking Retractor (ALR) Locations

ALR = Switchable Automatic Locking Retractor

 Top Tether Anchorage Symbol



Crew Cab Automatic Locking Retractor (ALR) Locations

Cinch = Cinching Latch Plate

ALR = Switchable Automatic Locking Retractor

 Top Tether Anchorage Symbol

Frequently Asked Questions About Installing Child Restraints With Seat Belts

What is the weight limit (child's weight + weight of the child restraint) for using the Tether Anchor with the seat belt to attach a forward facing child restraint?	Weight limit of the Child Restraint	Always use the tether anchor when using the seat belt to install a forward facing child restraint, up to the recommended weight limit of the child restraint.
--	-------------------------------------	---

Frequently Asked Questions About Installing Child Restraints With Seat Belts		
Can the rear-facing child restraint touch the back of the front passenger seat?	Yes	Contact between the front passenger seat and the child restraint is allowed, if the child restraint manufacturer also allows contact.
Can the head restraints be removed?	Yes	The head restraints can be removed in each seating position.
Can the buckle stalk be twisted to tighten the seat belt against the belt path of the child restraint?	Yes	In positions with cinching latch plates (CINCH), the buckle stalk may be twisted up to 3 full turns. Do not twist the buckle stalk in a seating position with an ALR retractor.

Installing A Child Restraint With A Switchable Automatic Locking Retractor (ALR):

Child restraint systems are designed to be secured in vehicle seats by lap belts or the lap belt portion of a lap/shoulder belt.

WARNING!

- Improper installation or failure to properly secure a child restraint can lead to failure of the restraint. The child could be badly injured or killed.
- Follow the child restraint manufacturer's directions exactly when installing an infant or child restraint.

1. Place the child seat in the center of the seating position. For some second row seats, you may need to recline the seat and/or raise the head restraint to get a better fit. If the rear seat can be moved forward and rearward in the vehicle, you may wish to move it to its rear-most position to make room for the child seat. You may also move the front seat forward to allow more room for the child seat.
2. Pull enough of the seat belt webbing from the retractor to pass it through the belt path of the child restraint. Do not twist the belt webbing in the belt path.
3. Slide the latch plate into the buckle until you hear a "click."
4. Pull on the webbing to make the lap portion tight against the child seat.
5. To lock the seat belt, pull down on the shoulder part of the belt until you have pulled all the seat belt webbing out of the retractor. Then, allow the webbing to retract back into the retractor. As the webbing retracts, you will hear a clicking sound. This means the seat belt is now in the Automatic Locking mode.
6. Try to pull the webbing out of the retractor. If it is locked, you should not be able to pull out any webbing. If the retractor is not locked, repeat step 5.

GETTING STARTED

7. Finally, pull up on any excess webbing to tighten the lap portion around the child restraint while you push the child restraint rearward and downward into the vehicle seat.
8. If the child restraint has a top tether strap and the seating position has a top tether anchorage, connect the tether strap to the anchorage and tighten the tether strap. See the section “Installing Child Restraints Using the Top Tether Anchorage” for directions to attach a tether anchor.
9. Test that the child restraint is installed tightly by pulling back and forth on the child seat at the belt path. It should not move more than 1 inch (25.4 mm) in any direction.

Any seat belt system will loosen with time, so check the belt occasionally, and pull it tight if necessary.

Installing A Child Restraint With A Cinching Latch Plate (CINCH) — If Equipped:

Child restraint systems are designed to be secured in vehicle seats by lap belts or the lap belt portion of a lap/shoulder belt.

WARNING!

- Improper installation or failure to properly secure a child restraint can lead to failure of the restraint. The child could be badly injured or killed.
- Follow the child restraint manufacturer’s directions exactly when installing an infant or child restraint.

1. Place the child seat in the center of the seating position. For some second row seats, you may need to recline the seat and / or raise the head restraint to get a better fit. If the rear seat can be moved forward and rearward in the vehicle, you may wish to move it to its rear-most position to make room for the child seat. You may also move the front seat forward to allow more room for the child seat.
2. Next, pull enough of the seat belt webbing from the retractor to pass it through the belt path of the child restraint. Do not twist the belt webbing in the belt path.
3. Slide the latch plate into the buckle until you hear a “click.”
4. Finally, pull up on any excess webbing to tighten the lap portion around the child restraint while you push the child restraint rearward and downward into the vehicle seat.
5. If the child restraint has a top tether strap and the seating position has a top tether anchorage, connect the tether strap to the anchorage and tighten the tether strap. See the section “Installing Child Restraints Using the Top Tether Anchorage” for directions to attach a tether anchor.
6. Test that the child restraint is installed tightly by pulling back and forth on the child seat at the belt path. It should not move more than 1 inch (25.4 mm) in any direction.

Any seat belt system will loosen with time, so check the belt occasionally, and pull it tight if necessary.

If the buckle or the cinching latch plate is too close to the belt path opening of the child restraint, you may have trouble tightening the seat belt. If this happens, disconnect the latch plate from the buckle and twist the short buckle-end belt up to three full turns to shorten it. Insert the latch plate into the buckle with the release button facing out, away from the child restraint. Repeat steps 4 to 6, above, to complete the installation of the child restraint.

If the belt still cannot be tightened after you shorten the buckle, disconnect the latch plate from the buckle, turn the buckle around one half turn, and insert the latch plate into the buckle again. If you still cannot make the child restraint installation tight, try a different seating position.

Installing Child Restraints Using The Top Tether Anchorage

WARNING!

Do not attach a tether strap for a rear-facing car seat to any location in front of the car seat, including the seat frame or a tether anchorage. Only attach the tether strap of a rear-facing car seat to the tether anchorage that is approved for that seating position, located behind the top of the vehicle seat. See the section "Lower Anchors and Tethers for CHildren (LATCH) Restraint System" for the location of approved tether anchorages in your vehicle.

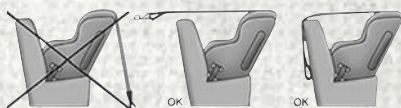

GETTING STARTED

Regular Cab Trucks:

In the regular cab truck, the top tether anchorages are located behind the center and right passenger seats. There is a plastic cover over each anchorage. To attach the tether strap of the child restraint:

1. Place the child restraint on the seat and adjust the tether strap so that it will reach over the seat back, under the head restraint and to the tether anchor directly behind the seat.
2. Route the tether strap to provide the most direct path between the anchorage and the child seat. The tether strap should go between the head restraint posts underneath the head restraint. You may need to adjust the head restraint to the upward position to pass the tether strap underneath the head restraint and between its posts.
3. Lift the cover (if so equipped), and attach the hook to the square opening in the sheet metal. Tighten the tether strap according to the child seat manufacturer's instructions.



Regular Cab Tether Anchorages

- 1 — Tether Strap Hook
- 2 — Tether Strap to Child Restraint
- 3 — Tether Anchor

WARNING!

Never place a rear-facing child restraint in front of an air bag. A deploying Passenger Advanced Front Air Bag can cause death or serious injury to a child 12 years or younger, including a child in a rear-facing child restraint.

Crew Cab Trucks:

The top tether anchorages in this vehicle are tether strap loops located between the rear glass and the back of the rear seat. There is a tether strap loop located behind each seating position. Follow the steps below to attach the tether strap of the child restraint.

GETTING STARTED

Right Or Left Outboard Seats:

1. Raise the head restraint and reach between the rear seat and rear glass to access the tether strap loop.



Head Restraint In Raised Position



Tether Strap Loop With Center Head Restraint In Raised Position

2. Place a child restraint on the seat and adjust the tether strap so that it will reach over the seat back, under the head restraint, through the tether strap loop behind the seat and over to the tether strap loop behind the center seat.

GETTING STARTED

3. Pass the tether strap hook under the head restraint behind the child seat, though the tether strap loop behind the seat and over to the center tether strap loop.

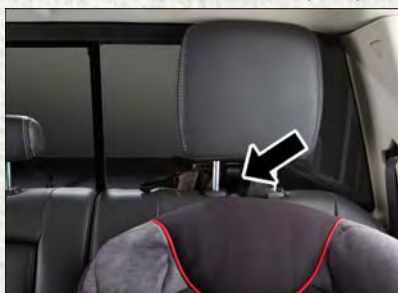

Tether Strap Through Outboard Tether Strap Loop

4. Attach the hook to the center tether strap loop (see diagram). Tighten the tether strap according to the child seat manufacturer's instructions.

NOTE:

If there are child seats in both of the outboard (left and right) seating positions, the tether strap hooks of both child seats should be connected to the center tether strap loop. This is the correct way to tether two outboard child seats.



Tether Strap Through Outboard Tether Strap Loop And Attached To Center Tether Strap Loop

GETTING STARTED

Center Seat:

1. Raise the head restraint and reach between the rear seat and rear glass to access the tether strap loop.
2. Place a child restraint on the seat and adjust the tether strap so that it will reach over the seat back, under the head restraint, through the tether strap loop behind the seat and over to the tether strap loop behind either the right or left outboard seat.



Tether Strap Loop With Head Restraint In Raised Position

3. Pass the tether strap hook under the head restraint behind the child seat, through the tether strap loop behind the seat and over to the right or left outboard tether strap loop.



Tether Strap Through Center Tether Strap Loop

GETTING STARTED

4. Attach the hook to the outboard tether strap loop (see diagram). Tighten the tether strap according to the child seat manufacturer's instructions.



Tether Strap Through Center Tether Strap Loop And Attached To Outboard Tether Strap Loop

Installing Three Child Restraints:

1. Place a child restraint on each outboard rear seat. Route the tether straps following the directions for right and left seating positions, above.
2. Attach both hooks to the center tether strap loop, but do not tighten the straps yet.
3. Place a child restraint on the center rear seat. Route the tether strap following the directions for the center seating position, above.
4. Attach the hook to the outboard tether strap loop.
5. Tighten the tether straps according to the child seat manufacturer's instructions, tightening the right and left tether straps before the center tether strap.



Left Outboard And Center Seating Position Shown

WARNING!

- An incorrectly anchored tether strap could lead to increased head motion and possible injury to the child. Use only the anchorage position directly behind the child seat to secure a child restraint top tether strap.
- If your vehicle is equipped with a split rear seat, make sure the tether strap does not slip into the opening between the seatbacks as you remove slack in the strap.

Transporting Pets

Air Bags deploying in the front seat could harm your pet. An unrestrained pet will be thrown about and possibly injured, or injure a passenger during panic braking or in a collision.

Pets should be restrained in the rear seat in pet harnesses or pet carriers that are secured by seat belts.

HEAD RESTRAINTS

Head restraints are designed to reduce the risk of injury by restricting head movement in the event of a rear impact. Head restraints should be adjusted so that the top of the head restraint is located above the top of your ear.

WARNING!

- All occupants, including the driver, should not operate a vehicle or sit in a vehicle's seat until the head restraints are placed in their proper positions in order to minimize the risk of neck injury in the event of a crash.
- Head restraints should never be adjusted while the vehicle is in motion. Driving a vehicle with the head restraints improperly adjusted or removed could cause serious injury or death in the event of a collision.

GETTING STARTED

Front Head Restraints

To raise the head restraint, pull upward on the head restraint. To lower the head restraint, push the adjustment button located on the base of the head restraint and push downward on the head restraint.

To remove the head restraint, raise it up as far as it can go. Then, push the adjustment button and the release button at the base of each post while pulling the head restraint up. To reinstall the head restraint, put the head restraint posts into the holes. Then, adjust it to the appropriate height.



Head Restraint

- 1 — Release Button
- 2 — Adjustment Button

WARNING!

- A loose head restraint thrown forward in a collision or hard stop could cause serious injury or death to occupants of the vehicle. Always securely stow removed head restraints in a location outside the occupant compartment.
- ALL the head restraints **MUST** be reinstalled in the vehicle to properly protect the occupants. Follow the re-installation instructions above prior to operating the vehicle or occupying a seat.

NOTE:

Do not reposition the head restraint 180 degrees to the incorrect position in an attempt to gain additional clearance to the back of the head.

Rear Head Restraints

The rear seats are equipped with adjustable and removable head restraints. To raise the head restraint, pull upward on the head restraint. To lower the head restraint, push the adjustment button located on the base of the head restraint and push downward on the head restraint.

To remove the head restraint, push the adjustment button and the release button while pulling upward on the whole assembly. To reinstall the head restraint, put the head restraint posts into the holes and adjust it to the appropriate height.

NOTE:

To remove outboard restraints, the rear seat bottom must be folded up.

WARNING!

A loose head restraint thrown forward in a collision or hard stop could cause serious injury or death to occupants of the vehicle. Always securely stow removed head restraints in a location outside the occupant compartment.

NOTE:

- The rear center head restraint (Crew Cab and Quad Cab) has only one adjustment position that is used to aid in the routing of a tether. Refer to “Occupant Restraints” in “Things To Know Before Starting Your Vehicle” in the Owner’s Manual on www.ramtrucks.com/en/owners/manuals for further information.
- Do not reposition the head restraint 180 degrees to the incorrect position in an attempt to gain additional clearance to the back of the head.

WARNING!

ALL the head restraints MUST be reinstalled in the vehicle to properly protect the occupants. Follow the re-installation instructions above prior to operating the vehicle or occupying a seat.

GETTING STARTED

FRONT SEATS

Driver's Power Seat — If Equipped

Some models may be equipped with an eight-way power driver's seat. The power seat switches are located on the outboard side of the driver's seat cushion. There are two power seat switches that are used to control the movement of the seat cushion and the seatback.

Adjusting The Seat Forward Or Rearward

The seat can be adjusted both forward and rearward. Push the seat switch forward or rearward. The seat will move in the direction of the switch. Release the switch when the desired position has been reached.

Adjusting The Seat Up Or Down

The height of the seats can be adjusted up or down. Pull upward or push downward on the seat switch. The seat will move in the direction of the switch. Release the switch when the desired position is reached.

Tilting The Seat Up Or Down

The angle of the seat cushion can be adjusted in four directions. Pull upward or push downward on the front or rear of the seat switch, the front or rear of the seat cushion will move in the direction of the switch. Release the switch when the desired position is reached.

Reclining The Seatback

The angle of the seatback can be adjusted forward or rearward. Push the seatback switch forward or rearward, the seat will move in the direction of the switch. Release the switch when the desired position is reached.



Power Seat Switches

- 1 — Power Seat Switch
 - 2 — Recline Switch
 - 3 — Power Lumbar Switch
-

WARNING!

- Adjusting a seat while driving may be dangerous. Moving a seat while driving could result in loss of control which could cause a collision and serious injury or death.
- Seats should be adjusted before fastening the seat belts and while the vehicle is parked. Serious injury or death could result from a poorly adjusted seat belt.
- Do not ride with the seatback reclined so that the shoulder belt is no longer resting against your chest. In a collision, you could slide under the seat belt, which could result in serious injury or death.

CAUTION!

Do not place any article under a power seat or impede its ability to move as it may cause damage to the seat controls. Seat travel may become limited if movement is stopped by an obstruction in the seat's path.

Passenger's Power Seat — If Equipped

Some models are equipped with a six-way power passenger seat. The power seat switch is located on the outboard side of the seat. The switch is used to control the movement of the seat and seat cushion.

Power Lumbar — If Equipped

Vehicles equipped with power driver or passenger seats may also be equipped with power lumbar. The power lumbar switch is located on the outboard side of the power seat. Push the switch forward to increase the lumbar support. Push the switch rearward to decrease the lumbar support.

GETTING STARTED

Driver Memory Seat — If Equipped

This feature allows the driver to store up to two different memory profiles for easy recall through a memory switch. Each memory profile contains desired position settings for the driver's seat, side mirrors, adjustable pedals (if equipped) and a set of desired radio station presets. Your remote keyless entry key fob can also be programmed to recall the same positions when the unlock button is pushed.

NOTE:

Your vehicle is equipped with two key fobs, one key fob can be linked to memory position 1 and the other key fob can be linked to memory position 2.

The memory seat buttons are located on the outboard side of the driver's seat cushion.

Programming The Memory Feature

To create a new memory profile, perform the following:

1. Cycle the vehicle's ignition to the ON/RUN position (do not start the engine).
2. Adjust all memory profile settings to desired preferences (seat, side mirrors, adjustable pedals and radio station presets).
3. Push and release the S (set) button on the memory switch.
4. Within five seconds, push and release either of the memory buttons (1) or (2). The instrument cluster display will show which memory position has been set.



Memory Seat Button Location

NOTE:

- Memory profiles can be set without the vehicle in PARK, but the vehicle must be in PARK to recall a memory profile.
- To set a memory profile to your key fob, refer to “Linking And Unlinking The Remote Keyless Entry Key Fob To Memory” in this section.

Linking And Unlinking The Remote Keyless Entry Key Fob To Memory

Your key fobs can be programmed to recall one of two pre-programmed memory profiles by pushing the unlock button on the key fob.

NOTE:

Before programming your key fobs to memory the feature has to be selected.

- If your vehicle is equipped with a touchscreen, you must select the “Memory To Fob” feature through the Uconnect system. Refer to “Uconnect Settings” in “Understanding Your Instrument Panel” in the Owner’s Manual on www.ramtrucks.com/en/owners/manuals for further information.
- If your vehicle is not equipped with a touchscreen, you must select the “Key Fob Linked To Memory” feature through the instrument cluster display. Refer to “Instrument Cluster Display” in “Understanding Your Instrument Panel” in the Owner’s Manual on www.ramtrucks.com/en/owners/manuals for further information.

To program your key fobs, perform the following:

1. Cycle the vehicle’s ignition to the OFF position.
2. Select desired memory profile (1) or (2).

NOTE:

If a memory profile has not already been set, refer to "Programming The Memory Feature" for instructions on how to set a memory profile.

3. Once the profile has been recalled, push and release the S (set) button on the memory switch, then push and release button (1) or (2) accordingly. “Memory Profile Set” (1 or 2) will display in the instrument cluster display.
4. Push and release the lock button on the key fob within 10 seconds.

NOTE:

Your key fobs can be unlinked to your memory settings by pushing the S (set) button, and within 10 seconds, followed by pushing the unlock button on the key fob.

GETTING STARTED

Memory Position Recall

NOTE:

- For vehicles equipped with an automatic transmission, the vehicle must be in PARK to recall memory positions. If a recall is attempted when the vehicle is not in PARK, a message will appear in the instrument cluster display.
- For vehicles equipped with a manual transmission, the vehicle speed must be at 0 mph (0 km/h) to recall memory positions. If a recall is attempted with the vehicle speed above 0 mph (0 km/h), a message will appear in the instrument cluster display.

Driver One Memory Position Recall

- To recall the memory settings for driver one using the memory switch, push memory button (1) on the memory switch.
- To recall the memory settings for driver one using the key fob, push the unlock button on the key fob linked to memory position 1.

Driver Two Memory Position Recall

- To recall the memory setting for driver two using the memory switch, push memory button (2) on the memory switch.
- To recall the memory settings for driver two using the key fob, push the unlock button on the key fob linked to memory position 2.

A recall can be cancelled by pushing any of the memory buttons during a recall (S, 1, or 2). When a recall is cancelled, the driver's seat and the power pedals (if equipped) stop moving. A delay of one second will occur before another recall can be selected.

Easy Entry/Exit Seat

This feature provides automatic driver's seat positioning to enhance driver mobility when entering and exiting the vehicle.

The distance the driver's seat moves depends on where you have the driver's seat positioned when you remove the key fob from the ignition (or change the ignition to OFF, for vehicles equipped with Keyless Enter-N-Go).

- When you remove the key fob from the ignition (or change the ignition to OFF, for vehicles equipped with Keyless Enter-N-Go), the driver's seat will move about 2.4 inches (60 mm) rearward if the driver's seat position is greater than or equal to 2.7 inches (67.7 mm) forward of the rear stop. The seat will return to its previously set position when you place the ignition into the ACC or RUN position.
- When you remove the key fob from the ignition (or change the ignition to OFF, for vehicles equipped with Keyless Enter-N-Go), the driver's seat will move to a position 0.3 inches (7.7 mm) forward of the rear stop if the driver's seat position is between 0.9 inches and 2.7 inches (22.7 mm and 67.7 mm) forward of the rear stop. The seat will return to its previously set position when you place the ignition to the ACC or RUN position.

- The Easy Entry/Easy Exit feature is disabled when the driver's seat position is less than 0.9 inches (22.7 mm) forward of the rear stop. At this position, there is no benefit to the driver by moving the seat for Easy Exit or Easy Entry.

Each stored memory setting will have an associated Easy Entry and Easy Exit position.

NOTE:

The Easy Entry/Exit feature is not enabled when the vehicle is delivered from the factory. The Easy Entry/Exit feature is enabled (or later disabled) through the programmable features in the Uconnect system. Refer to "Uconnect Settings/Customer Programmable Features" in "Understanding Your Instrument Panel" in the Owner's Manual on <http://www.ramtrucks.com/en/owners/manuals> for further information.

Manual Seat Adjuster — If Equipped

Both front seats are adjustable forward or rearward. The manual seat adjustment handle is located under the seat cushion at the front edge of each seat.

While sitting in the seat, pull up on the handle and slide the seat forward or rearward. Release the bar once you have reached the desired position. Then, using body pressure, move forward and rearward on the seat to be sure that the seat adjusters have latched.



Manual Seat Adjusting Bar/Recline Lever

- 1 — Recline Lever
2 — Adjusting Bar

WARNING!

- Adjusting a seat while driving may be dangerous. Moving a seat while driving could result in loss of control which could cause a collision and serious injury or death.
- Seats should be adjusted before fastening the seat belts and while the vehicle is parked. Serious injury or death could result from a poorly adjusted seat belt.

GETTING STARTED

Dump Feature (Manual Recline Seat Only) — Standard Cab

Actuating the recliner handle will allow the seatback to swing (dump) forward on manual recliner seats. This “dump” feature allows access to the storage bin behind the seat.

WARNING!



- Do not stand or lean in front of the seat while actuating the handle. The seatback may swing forward and hit you causing injury.
- To avoid injury, place your hand on the seatback and actuate the handle, then position the seatback in the desired position.

HEATED/VENTILATED SEATS

Front Heated Seats

The front heated seats control buttons are located on the center instrument panel below the climate controls.

If your vehicle is equipped with a touchscreen, the front heated seats control buttons are also located within the climate or controls screen of the touchscreen.

- Press the heated seat button  once to turn the HI setting on.
- Press the heated seat button  a second time to turn the LO setting on.
- Press the heated seat button  a third time to turn the heating elements off.

When the HI-level setting is selected, the heater will provide a boosted heat level during the first four minutes of operation. Then, the heat output will drop to the normal HI-level. If the HI-level setting is selected, the system will automatically switch to LO-level after approximately 60 minutes of continuous operation. At that time, the display will change from HI to LO, indicating the change. The LO-level setting will turn off automatically after approximately 45 minutes.

NOTE:

The engine must be running for the heated seats to operate.

Vehicles Equipped With Remote Start



On models that are equipped with remote start, the driver's seat can be programmed to come on during a remote start.

If your vehicle is equipped with a touchscreen, this feature can be programmed through the Uconnect system. Refer to “Uconnect Settings” in “Understanding Your Instrument Panel” in the Owner's Manual on www.ramtrucks.com/en/owners/manuals for further information.

If your vehicle is not equipped with a touchscreen, this feature can be programmed through the instrument cluster display. Refer to “Instrument Cluster Display” in “Understanding Your Instrument Panel” in the Owner's Manual on www.ramtrucks.com/en/owners/manuals for further information.

Rear Heated Seats

The rear heated seat switches are located on the rear of the center console.

- Push the heated seat button  once to turn the HI setting on.
- Push the heated seat button  a second time to turn the LO setting on.
- Push the heated seat button  a third time to turn the heating elements off.

When the HI-level setting is selected, the heater will provide a boosted heat level during the first four minutes of operation. Then, the heat output will drop to the normal HI-level. If the HI-level setting is selected, the system will automatically switch to LO-level after a maximum of 60 minutes of continuous operation. At that time, the number of illuminated LEDs changes from two to one, indicating the change. The LO-level setting will turn off automatically after a maximum of 45 minutes.

WARNING!



- Persons who are unable to feel pain to the skin because of advanced age, chronic illness, diabetes, spinal cord injury, medication, alcohol use, exhaustion or other physical conditions must exercise care when using the seat heater. It may cause burns even at low temperatures, especially if used for long periods of time.
- Do not place anything on the seat that insulates against heat, such as a blanket or cushion. This may cause the seat heater to overheat. Sitting in a seat that has been overheated could cause serious burns due to the increased surface temperature of the seat.

Ventilated Seats — If Equipped

Located in the seat cushion are small fans that draw the air from the passenger compartment and move air through fine perforations in the seat cover to help keep the driver and front passenger cooler in higher ambient temperatures. The fans operate at two speeds, HI and LO.

The front ventilated seats control buttons are located on the center instrument panel below the climate controls.

If your vehicle is equipped with a touchscreen, the front ventilated seats control buttons are also located within the climate or controls screen of the touchscreen.

- Press the ventilated seat button  once to choose HI.
- Press the ventilated seat button  a second time to choose LO.
- Press the ventilated seat button  a third time to turn the ventilated seat off.

NOTE:

The engine must be running for the ventilated seats to operate.

GETTING STARTED

Vehicles Equipped With Remote Start

On models that are equipped with remote start, the ventilated seats can be programmed to come on during a remote start.

If your vehicle is equipped with a touchscreen, this feature can be programmed through the Uconnect system. Refer to “Uconnect Settings” in “Understanding Your Instrument Panel” in the Owner’s Manual on www.ramtrucks.com/en/owners/manuals for further information.



If your vehicle is not equipped with a touchscreen, this feature can be programmed through the instrument cluster display. Refer to “Instrument Cluster Display” in “Understanding Your Instrument Panel” in the Owner’s Manual on www.ramtrucks.com/en/owners/manuals for further information.

HEATED STEERING WHEEL

The steering wheel contains a heating element that helps warm your hands in cold weather. The heated steering wheel has only one temperature setting. Once the heated steering wheel has been turned on, it will operate for an average of 80 minutes before automatically shutting off. This time may vary based on the temperature of the surrounding environment or the heated steering wheel may not turn on when it is already warm.

The heated steering wheel control button is located on the center of the instrument panel below the climate controls.

If your vehicle is equipped with a touchscreen, the heated steering wheel control button is located within the climate or controls screen of the touchscreen.

- Press the heated steering wheel button  once to turn the heating element on.
- Press the heated steering wheel button  a second time to turn the heating element off.

NOTE:

The engine must be running for the heated steering wheel to operate.

Vehicles Equipped With Remote Start

On models that are equipped with remote start, the heated steering wheel can be programmed to come on during a remote start.

If your vehicle is equipped with a touchscreen, this feature can be programmed through the Uconnect system. Refer to “Uconnect Settings” in “Understanding Your Instrument Panel” in the Owner’s Manual on www.ramtrucks.com/en/owners/manuals for further information.

If your vehicle is not equipped with a touchscreen, this feature can be programmed through the instrument cluster display. Refer to “Instrument Cluster Display” in “Understanding Your Instrument Panel” in the Owner’s Manual on www.ramtrucks.com/en/owners/manuals for further information.

WARNING!

- Persons who are unable to feel pain to the skin because of advanced age, chronic illness, diabetes, spinal cord injury, medication, alcohol use, exhaustion, or other physical conditions must exercise care when using the steering wheel heater. It may cause burns even at low temperatures, especially if used for long periods.
- Do not place anything on the steering wheel that insulates against heat, such as a blanket or steering wheel covers of any type and material. This may cause the steering wheel heater to overheat.

TILT STEERING COLUMN

This feature allows you to tilt the steering column upward or downward. The tilt lever is located on the steering column, below the multifunction lever.

Pull the lever toward the steering wheel to unlock the steering column. With one hand firmly on the steering wheel, move the steering column up or down, as desired. Release the lever to lock the steering column firmly in place.



Tilt Lever Location

- 1 — Adjustable Pedal Switch
- 2 — Tilt Lever

WARNING!

Do not adjust the steering column while driving. Adjusting the steering column while driving or driving with the steering column unlocked, could cause the driver to lose control of the vehicle. Failure to follow this warning may result in serious injury or death.

GETTING STARTED

DRIVER ADJUSTABLE PEDALS — IF EQUIPPED

The adjustable pedals system is designed to allow a greater range of driver comfort for steering wheel tilt and seat position. This feature allows the brake, accelerator, and clutch pedals (if equipped) to move toward or away from the driver to provide improved position with the steering wheel.

The adjustable pedal switch is located to the left side of the steering column.

- The pedals can be adjusted with the ignition OFF.
- The pedals **cannot** be adjusted when the vehicle is in REVERSE or when the Speed Control System is on. The following messages will appear on vehicles equipped with an instrument cluster display if the pedals are attempted to be adjusted when the system is locked out: “Adjustable Pedal Disabled — Cruise Control Engaged” or “Adjustable Pedal Disabled — Vehicle In Reverse”.

NOTE:

- Always adjust the pedals to a position that allows full pedal travel.
- Further small adjustments may be necessary to find the best possible seat/pedal position.
- For vehicles equipped with Driver Memory Seat, you can use your remote keyless entry key fob or the memory switch on the driver’s door trim panel to return the adjustable pedals to pre-programmed positions. Refer to “Front Seats” in “Getting Started” for further information.

WARNING!

Do not adjust the pedals while the vehicle is moving. You could lose control and have an accident. Always adjust the pedals while the vehicle is parked.

CAUTION!

Do not place any article under the adjustable pedals or impede its ability to move as it may cause damage to the pedal controls. Pedal travel may become limited if movement is stopped by an obstruction in the adjustable pedal's path.

OPERATING YOUR VEHICLE

ENGINE BREAK-IN RECOMMENDATIONS

A long break-in period is not required for the engine and drivetrain (transmission and axle) in your vehicle.

Drive moderately during the first 300 miles (500 km). After the initial 60 miles (100 km), speeds up to 50 or 55 mph (80 or 90 km/h) are desirable.

While cruising, brief full-throttle acceleration within the limits of local traffic laws contributes to a good break-in. Wide-open throttle acceleration in low gear can be detrimental and should be avoided.

The engine oil installed in the engine at the factory is a high-quality energy conserving type lubricant. Oil changes should be consistent with anticipated climate conditions under which vehicle operations will occur. Refer to “Maintenance Procedures” in “Maintaining Your Vehicle” in your Owner’s Manual on www.ramtrucks.com/en/owners/manuals for further details.

NOTE:

A new engine may consume some oil during its first few thousand miles (kilometers) of operation. This should be considered a normal part of the break-in and not interpreted as an indication of an engine problem or malfunction.

CAUTION!

Never use Non-Detergent Oil or Straight Mineral Oil in the engine or damage may result.

DIESEL ENGINE BREAK-IN RECOMMENDATIONS

For diesel engine break-in recommendations, refer to Diesel Engine Break-In Recommendations on pg. 178

OPERATING YOUR VEHICLE

TURN SIGNALS/WIPER/WASHER/HIGH BEAMS LEVER



Turn Signal/Wiper/Washer/High Beam Lever

Turn Signals/Lane Change Assist

Tap the lever up or down once and the turn signal (right or left) will flash three times and automatically turn off.

Wipers

Intermittent, Low And High Operation

Rotate the end of the lever to the first detent position for one of five intermittent settings, the second detent for low wiper operation and the third detent for high wiper operation.

Washer Operation

Push the end of the lever inward to the second detent and hold for as long as spray is desired.

Mist Feature

When a single wipe to clear off road mist or spray from a passing vehicle is needed, push the washer knob, located on the end of the multifunction lever, inward to the first detent and release. The wipers will cycle one time and automatically shut off.

OPERATING YOUR VEHICLE

High Beams

Push the lever away from you to activate the high beams. A high beam symbol will illuminate in the cluster to indicate the high beams are on.

NOTE:

For safe driving, turn off the high beams when oncoming traffic is present to prevent headlight glare and as a courtesy to other motorists.

HEADLIGHT SWITCH

NOTE:



If your vehicle is equipped with illuminated approach lights under the outside mirrors, they can be turned off through the instrument cluster or the Uconnect radio. For further information, refer to the Owner's Manual on www.ramtrucks.com/en/owners/manuals for further information.



Headlight Switch

- 1 — Auto
- 2 — Rotate Headlight Switch
- 3 — Push Cargo Light
- 4 — Rotate Dimmer
- 5 — Push Fog Light

Automatic Headlights/Parking Lights/Headlights

Rotate the headlight switch, located on the instrument panel to the left of the steering wheel, to the first detent  for parking lights and to the second detent for headlights .

With the parking lights or low beam headlights on, push the headlight switch once for fog lights.

Rotate the headlight switch to AUTO for Automatic headlights.

When set to AUTO, the system automatically turns the headlights on or off based on ambient light levels.

OPERATING YOUR VEHICLE

Automatic High Beams

The Automatic High Beams system provides increased forward lighting at night by automating high beam control through the use of a digital camera mounted above the inside rearview mirror. This camera detects vehicle specific light and automatically switches from high beams to low beams until the approaching vehicle is out of view. This feature is programmable through the Uconnect system. Refer to “Uconnect Settings” in “Understanding Your Instrument Panel” in your Owner’s Manual on www.ramtrucks.com/en/owners/manuals for further information.

Instrument Panel Dimmer

- Rotate the dimmer control to the extreme left position to fully dim the instrument panel lights and prevent the interior lights from illuminating when a door is opened.
- Rotate the dimmer control right to increase the brightness of the instrument panel when the parking lights or headlights are on.
- Rotate the dimmer control right to the next detent position to fully brighten the odometer and radio when the parking lights or headlights are on.
- Rotate the dimmer control right to the last detent position to turn on the interior lighting.

NOTE:

If your vehicle is equipped with a touchscreen, the dimming is programmable through the Uconnect system. Refer to “Uconnect Settings” in “Understanding Your Instrument Panel” in the Owner’s Manual on www.ramtrucks.com/en/owners/manuals for further information.

Cargo Light

The cargo light is turned on by pushing on the cargo light button.

The cargo light will also turn on for approximately 30 seconds when a key fob unlock button is pushed, as part of the Illuminated Entry feature.

OPERATING YOUR VEHICLE

SPEED CONTROL

When engaged, the Speed Control takes over accelerator operations at speeds greater than 25 mph (40 km/h).

The Speed Control buttons are located on the right side of the steering wheel.

NOTE:

In order to ensure proper operation, the Speed Control System has been designed to shut down if multiple speed control functions are operated at the same time. If this occurs, the Speed Control System can be reactivated by pushing the Speed Control ON/OFF button and resetting the desired vehicle set speed.

To Activate

Push the ON/OFF button. The cruise control indicator light in the instrument cluster display will illuminate. To turn the system off, push the ON/OFF button a second time. The cruise control indicator light will turn off. The system should be turned off when not in use.



Speed Control Buttons

- 1 — Push Cancel
- 2 — Push On/Off
- 3 — Push Resume/Accel
- 4 — Push Set/Decel

WARNING!

Leaving the Speed Control system on when not in use is dangerous. You could accidentally set the system or cause it to go faster than you want. You could lose control and have an accident. Always leave the system off when you are not using it.

To Set A Desired Speed

Turn the Speed Control on. When the vehicle has reached the desired speed, push the SET (-) button and release. Release the accelerator and the vehicle will operate at the selected speed.

NOTE:

The vehicle should be traveling at a steady speed and on level ground before pushing the SET (-) button.

OPERATING YOUR VEHICLE

To Deactivate

A soft tap on the brake pedal, pushing the CANCEL button, or normal brake pressure while slowing the vehicle will deactivate Speed Control without erasing the set speed memory. Pushing the ON/OFF button or turning the ignition switch OFF erases the set speed memory.

To Resume Speed

To resume a previously set speed, push the RES (+) button and release. Resume can be used at any speed above 25 mph (40 km/h).

To Vary The Speed Setting

To Increase Speed

When the Speed Control is set, you can increase speed by pushing the RES (+) button.

The driver's preferred units can be selected through the instrument panel settings if equipped. Refer to "Understanding Your Instrument Panel" in the Owner's Manual on www.ramtrucks.com/en/owners/manuals for more information. The speed decrement shown is dependant on the chosen speed unit of U.S. (mph) or Metric (km/h):

U.S. Speed (mph)

- Pushing the RES (+) button once will result in a 1 mph increase in set speed. Each subsequent tap of the button results in an increase of 1 mph.
- If the button is continually pushed, the set speed will continue to increase until the button is released, then the new set speed will be established.

Metric Speed (km/h)

- Pushing the RES (+) button once will result in a 1 km/h increase in set speed. Each subsequent tap of the button results in an increase of 1 km/h.
- If the button is continually pushed, the set speed will continue to increase until the button is released, then the new set speed will be established.

To Decrease Speed

When the Speed Control is set, you can decrease speed by pushing the SET (-) button.

The driver's preferred units can be selected through the instrument panel settings if equipped. Refer to "Understanding Your Instrument Panel" in the Owner's Manual on www.ramtrucks.com/en/owners/manuals for more information. The speed decrement shown is dependant on the chosen speed unit of U.S. (mph) or Metric (km/h):

U.S. Speed (mph)

- Pushing the SET (-) button once will result in a 1 mph decrease in set speed. Each subsequent tap of the button results in a decrease of 1 mph.

OPERATING YOUR VEHICLE

- If the button is continually pushed, the set speed will continue to decrease until the button is released, then the new set speed will be established.

Metric Speed (km/h)

- Pushing the SET (-) button once will result in a 1 km/h decrease in set speed. Each subsequent tap of the button results in a decrease of 1 km/h.
- If the button is continually pushed, the set speed will continue to decrease until the button is released, then the new set speed will be established.

To Accelerate For Passing

Press the accelerator as you would normally. When the pedal is released, the vehicle will return to the set speed.

Using Speed Control On Hills

The transmission may downshift on hills to maintain the vehicle set speed.

NOTE:

The Speed Control system maintains speed up and down hills. A slight speed change on moderate hills is normal.

On steep hills, a greater speed loss or gain may occur, it may be preferable to drive without Speed Control.

WARNING!

Speed Control can be dangerous where the system cannot maintain a constant speed. Your vehicle could go too fast for the conditions, and you could lose control and have an accident. Do not use Speed Control in heavy traffic or on roads that are winding, icy, snow-covered or slippery.

OPERATING YOUR VEHICLE

ELECTRONIC RANGE SELECT (ERS) OPERATION



Electronic Range Select (ERS) allows you to limit the highest available transmission gear, and can be activated during any driving condition. When towing a trailer or operating the vehicle in off-road conditions, using ERS shift control will help you maximize both performance and engine braking.

- Toggle the switch on the column gear selector down (-) or up (+) to select the desired top gear.
- For maximum deceleration (engine braking), push and hold the (-) switch on the gear selector. Your vehicle will automatically select the lowest safe gear for optimal engine braking.
- To disable ERS, push and hold the (+) switch until “D” is displayed in the odometer.

Switching between ERS and DRIVE mode can be done at any vehicle speed.

Refer to your Owner's Manual at www.ramtrucks.com/en/owners/manuals for further details.

OPERATING YOUR VEHICLE

MANUAL CLIMATE CONTROLS WITHOUT TOUCHSCREEN



Manual Climate Controls

- | | |
|-----------------------------------|--------------------------------|
| 1 — Rotate Blower Control | 4 — Push A/C Button |
| 2 — Push Air Recirculation Button | 5 — Rotate Mode Control |
| 3 — Rotate Temperature Control | 6 — Push Rear Defroster Button |

Air Recirculation /Max A/C

- Use Recirculation for maximum A/C operation.
- For window defogging, turn the Recirculation button off.
- Recirculation is not allowed in defrost.
- Recirculation is allowed in floor mode and defrost/floor (mix modes) for approximately five minutes.

Heated Mirrors

The mirrors are heated to melt frost or ice. This feature is activated whenever you turn on the defroster.

OPERATING YOUR VEHICLE

MANUAL CLIMATE CONTROLS WITH TOUCHSCREEN



Uconnect 8.4 Manual Climate Controls

- | | |
|------------------------------|----------------------------------|
| 1 — Max A/C Button | 6 — Blower Speed Up Button |
| 2 — A/C Button | 7 — Mode Control Buttons |
| 3 — Air Recirculation Button | 8 — Blower Speed Down Button |
| 4 — Front Defroster Button | 9 — OFF Button |
| 5 — Rear Defroster Button | 10 — Temperature Control Buttons |

OPERATING YOUR VEHICLE

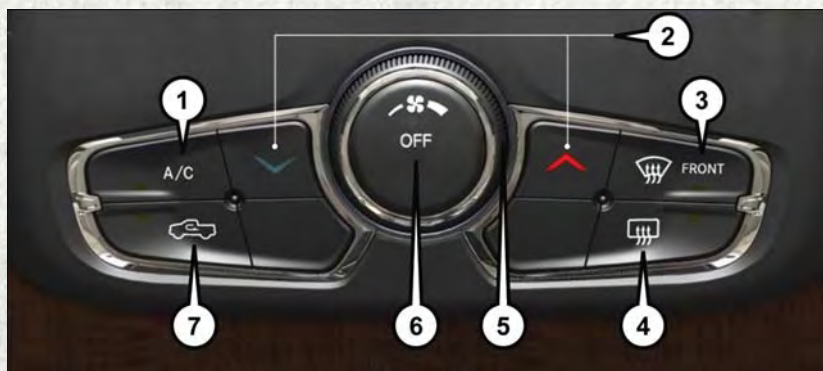

Climate Control Knobs

- | | |
|---------------------------------|------------------------------|
| 1 — A/C Button | 5 — Rotate Blower Control |
| 2 — Temperature Control Buttons | 6 — OFF Button |
| 3 — Front Defroster Button | 7 — Air Recirculation Button |
| 4 — Rear Defroster Button | |

Air Recirculation

- Use Recirculation for maximum A/C operation.
- For window defogging, turn the Recirculation button off.

Heated Mirrors

The mirrors are heated to melt frost or ice. This feature is activated whenever you turn on the defroster.

OPERATING YOUR VEHICLE

AUTOMATIC CLIMATE CONTROLS WITH TOUCHSCREEN



Uconnect 8.4 Automatic Climate Controls

- | | |
|------------------------------|--------------------------------|
| 1 — MAX A/C Button | 8 — Passenger Temperature Down |
| 2 — A/C Button | 9 — SYNC Button |
| 3 — Air Recirculation Button | 10 — Blower Control Buttons |
| 4 — AUTO Button | 11 — Mode Control Buttons |
| 5 — Front Defroster Button | 12 — OFF Button |
| 6 — Rear Defroster Button | 13 — Driver Temperature Down |
| 7 — Passenger Temperature Up | 14 — Driver Temperature Up |

OPERATING YOUR VEHICLE



Climate Control Knobs

- | | |
|------------------------------|--------------------------------|
| 1 — A/C Button | 7 — Rear Defroster Button |
| 2 — Driver Temperature Up | 8 — Passenger Temperature Down |
| 3 — OFF Button | 9 — AUTO Button |
| 4 — Blower Control Knob | 10 — Driver Temperature Down |
| 5 — Passenger Temperature Up | 11 — Recirculation Button |
| 6 — Front Defroster Button | |

OPERATING YOUR VEHICLE

Air Conditioning (A/C)

- If the air conditioning button is pressed while in AUTO mode, the system will exit AUTO mode and stay in A/C. The mode and blower will be set at the closest mode and blower position that the system was operating in AUTO.

SYNC Temperature Button

- Press the “SYNC” button on the touchscreen to control the driver and passenger temperatures simultaneously. Press the “SYNC” button on the touchscreen a second time to control the temperatures individually.

Air Recirculation

- Use Air Recirculation for maximum A/C operation.
- For window defogging, turn the Recirculation button off.
- If the Air Recirculation button is pushed while in the AUTO mode, the indicator light may flash three times to indicate the cabin air is being controlled automatically.

Heated Mirrors

The mirrors are heated to melt frost or ice. This feature is activated whenever you turn on the defroster.

OPERATING YOUR VEHICLE

POWER SLIDING REAR WINDOW

The switch for the power sliding rear window is located on the overhead console.

Push the switch right to open the glass and pull the switch left to close the glass.



Power Sliding Rear Window Switch

WIND BUFFETING

Wind buffeting can be described as a helicopter-type percussion sound. If buffeting occurs with the rear windows open, adjust the front and rear windows together.

If buffeting occurs with the sunroof open, adjust the sunroof opening, or adjust any window. This will minimize buffeting.



YOUR VEHICLE'S SOUND SYSTEM

1. Uconnect Voice Command Button pg. 130
2. Uconnect Phone Button pg. 130
3. Steering Wheel Audio Controls (Left — Behind Steering Wheel) pg. 157
4. Steering Wheel Audio Controls (Right — Behind Steering Wheel) pg. 157
5. Volume Knob — Audio Mute Button
6. Screen Off Button

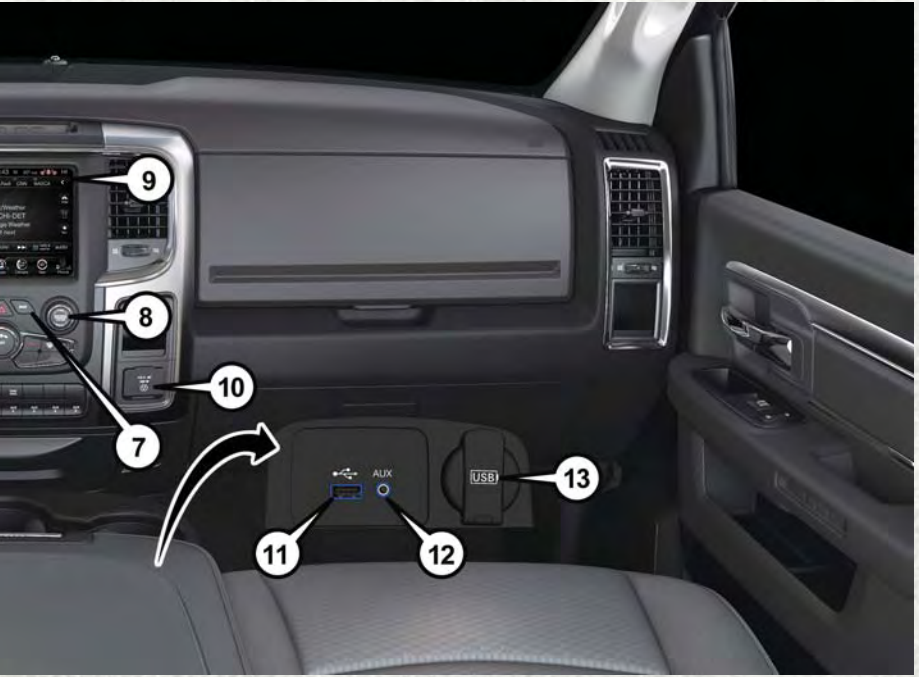

- 7. Back Button
- 8. Tune/Scroll Knob — Browse/Enter Button
- 9. Uconnect 8.4 Radio pg. 119
- 10. Power Inverter (If Equipped) pg. 165
- 11. USB Port pg. 115
- 12. Aux Jack pg. 115
- 13. USB Charge Only Port pg. 166

CYBERSECURITY

Your vehicle may be a connected vehicle and may be equipped with both wired and wireless networks. These networks allow your vehicle to send and receive information. This information allows systems and features in your vehicle to function properly.

Your vehicle may be equipped with certain security features to reduce the risk of unauthorized and unlawful access to vehicle systems and wireless communications. Vehicle software technology continues to evolve over time and FCA US LLC, working with its suppliers, evaluates and takes appropriate steps as needed. Similar to a computer or other devices, your vehicle may require software updates to improve the usability and performance of your systems or to reduce the potential risk of unauthorized and unlawful access to your vehicle systems.

The risk of unauthorized and unlawful access to your vehicle systems may still exist, even if the most recent version of vehicle software (such as Uconnect software) is installed.

WARNING!

- It is not possible to know or to predict all of the possible outcomes if your vehicle's systems are breached. It may be possible that vehicle systems, including safety related systems, could be impaired or a loss of vehicle control could occur that may result in an accident involving serious injury or death.
- ONLY insert media (e.g., USB, SD card, or CD) into your vehicle if it came from a trusted source. Media of unknown origin could possibly contain malicious software, and if installed in your vehicle, it may increase the possibility for vehicle systems to be breached.
- As always, if you experience unusual vehicle behavior, take your vehicle to your nearest authorized dealer immediately.

NOTE:

- FCA or your dealer may contact you directly regarding software updates.
- To help further improve vehicle security and minimize the potential risk of a security breach, vehicle owners should:
 - Routinely check www.driveuconnect.com/software-update to learn about available Uconnect software updates.
 - Only connect and use trusted media devices (e.g. personal mobile phones, USBs, CDs).

Privacy of any wireless and wired communications cannot be assured. Third parties may unlawfully intercept information and private communications without your consent. For further information, refer to "Privacy Practices - If Equipped with Uconnect 8.4 Radio" in your Uconnect Owner's Manual Supplement and "Onboard Diagnostic System (OBD II) Cybersecurity" in "Maintaining Your Vehicle" in your Owner's Manual on www.ramtrucks.com/en/owners/manuals.

IDENTIFYING YOUR RADIO

Radio 3.0

- Two buttons on the faceplate on either side of the display



Radio 3.0

Uconnect 3.0

- Two buttons on the faceplate on either side of the display
- Phone pick up button on the faceplate



Uconnect 3.0

Uconnect 5.0

- 5" Touchscreen
- Three buttons on the faceplate on either side of the display



Uconnect 5.0

ELECTRONICS

Uconnect 8.4

- 8.4" Touchscreen
- HD Button will NOT be visible on right side of screen when viewing AM or FM
- SiriusXM Travel Link feature NOT listed within Apps



Uconnect 8.4

Uconnect 8.4 NAV

- 8.4" Touchscreen
- HD Button will be visible on right side of screen when viewing AM or FM
- SiriusXM Travel Link feature listed within Apps



Uconnect 8.4 NAV

UCONNECT ACCESS**Uconnect Access — If Equipped (Available On Uconnect 8.4/8.4 NAV — U.S. Residents Only)****WARNING!**

ALWAYS drive safely with your hands on the wheel. You have full responsibility and assume all risks related to the use of the Uconnect features and applications in this vehicle. Only use Uconnect when it is safe to do so. Failure to do so may result in an accident involving serious injury or death.

WARNING!

ALWAYS obey traffic laws and pay attention to the road. Some Uconnect Access services, including 9-1-1 and Assist, will NOT work without an operable 1X (voice/data) or 3G (data) network connection.

NOTE:

Your vehicle may be transmitting data as authorized by the subscriber.

Uconnect Access enhances your ownership and driving experience by connecting your vehicle to an operable 1X(voice/data) or 3G(data) network. When connected to an operable 1X (voice/data) or 3G (data) network, you can:

- Place a call to a local 9-1-1 Operator for emergency assistance.
- Remotely lock/unlock your doors and start your vehicle from virtually anywhere, using the Uconnect Access App from your device. You can also do so by logging into your owner site, or by calling Uconnect Access Care when your vehicle has an operable 1X (voice/data) or 3G (data) network connection. Services can only be used where coverage is available; see coverage map for details.
- Turn your vehicle into a 3G Wi-Fi Hotspot and connect your devices to the internet.
- Receive text or email notifications if your vehicle's security alarm goes off.
- Receive stolen vehicle assistance, using GPS technology to help authorities locate your vehicle if it is stolen.
- Listen to your text messages or send free-form text messages with your voice while keeping your hands on the wheel, using the Voice Texting feature requires a device that supports Bluetooth Message Access Profile (MAP).
- Search for places to eat, shop, relax and play with Yelp, using your voice or on-screen menu. Then navigate to them (navigation standard on Uconnect 8.4 NAV, optional on Uconnect 8.4).
- Get operator assistance using the ASSIST button on your interior rearview mirror.

Before you drive, familiarize yourself with the easy-to-use Uconnect Access services.

1. The ASSIST and 9-1-1 buttons are located on your rearview mirror. The ASSIST button is used for contacting Roadside Assistance, Vehicle Care and Uconnect Access Care. The 9-1-1 button connects you to emergency services.

NOTE:

Vehicles sold in Canada and Mexico DO NOT have 9-1-1 call system capabilities. 9-1-1 or other emergency line operators in Canada and Mexico may not answer or respond to 9-1-1 system calls.

2. The Uconnect “Apps  ” button is located in the center of the menu bar of the radio touchscreen. This is where you can manage your Apps and purchase 3G Wi-Fi on demand.
3. The Uconnect Voice Command and Uconnect Phone buttons are located on the left side of your steering wheel. These buttons let you use your voice to give commands, make phone calls, send and receive text messages hands-free, enter navigation destinations, and control your radio and media devices.

Included Trial Period For New Vehicles

Your new vehicle may come with an included trial period for use of the Uconnect Access Services starting at the date of vehicle purchase (date based on vehicle sales notification from your dealer). **To activate the trial, you must first register with Uconnect Access.** After the trial period, if you wish to continue your Uconnect Access Services you can choose to purchase a subscription.

Uconnect Access Subscription

- After the trial period, you can subscribe by pushing the ASSIST button on the rear-view mirror and speaking with a Uconnect Access Care agent or by visiting the owner site Mopar.com. If you need assistance, U.S. residents can call Uconnect Access Care at 1-855-792-4241 .
- For the latest information on packages and pricing information: U.S. residents visit DriveUconnect.com.

Uconnect Access Registration (Uconnect 8.4/8.4 NAV, U.S. 48 Contiguous States, Alaska And Hawaii)

To unlock the full potential of Uconnect Access in your vehicle, you first need to register with Uconnect Access.

1. Push the ASSIST button on your rearview mirror.
2. Press the “Uconnect Care” button on the touchscreen.
3. A helpful Uconnect Care Agent will register your vehicle and handle all of the details.

Signing up is easy! Simply follow the steps above. Or, press the “Apps  ” button on the touchscreen, then select the Uconnect registration app to “Register By Web” and complete the process using your device or computer.

Why sign up for Uconnect Access? Here are just a few examples of things you'll be able to do:

- Know that help, if you need it, is only a button press away.
- Lock and unlock your vehicle doors from hundreds of miles away.
- Discover great, new places around you using Yelp.
- Dictate and send text messages by speaking out loud (all while keeping both hands on the wheel!)

For further information please visit DriveUconnect.com.



ASSIST Button

Download The Uconnect Access App

You're only a few steps away from using remote commands and sending a destination from your phone to your vehicle.

To use the Uconnect Access Mobile App:

- Once you have registered your Uconnect Access services, download the Uconnect Access app to your mobile device. Use your Owner Account login and password to open the app.
- Once on the "Remote" screen, you can begin using Remote Door Lock/Unlock, Remote Vehicle Start, and activate your horn and lights remotely, if equipped.
- Press the "Location" button on the bottom menu bar of the app to bring up a map to locate your vehicle or send a location to your Uconnect Navigation using Vehicle Finder and Send 'n Go, if equipped.
- Press the "Settings" side menu in the upper left corner of the app to bring up app settings.



Mobile App

Vehicle Finder

The Vehicle Finder feature of the Uconnect Access Mobile App allows you to find the location of your vehicle when you have lost it. You can also sound the alarm and flash the lights to make finding your vehicle even easier.

To find your vehicle:

1. Press the “Location” tab on the Uconnect Access Mobile App bottom bar.
2. Select the “Vehicle” icon to determine the location of your vehicle.



Vehicle Icon

3. Select the “Find Route” button that appears, once your vehicle is located.
4. Select your preferred Navigation App to route a path to your vehicle.



Find Route Button

Send 'N Go

The Send 'n Go feature of the Uconnect Access Mobile App allows you to search for a destination on your mobile device and then send the route to your vehicle's native navigation system.

To send a navigation route to your vehicle:

1. Press the "Location" tab on the Uconnect Access Mobile App bottom bar.
2. Either type in the destination you would like to navigate to, or search through one of the categories provided.
3. Select the destination you want to route to from the list that appears.

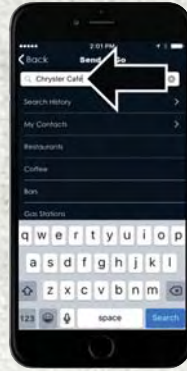

Destination Search Bar

4. Press the "Send To Vehicle" button, and then confirm the destination by pressing "Yes," to send the navigation route to the Uconnect Navigation in your vehicle.
5. Finally, confirm the route inside your vehicle by pressing the "Go Now" option on the pop-up that appears on the touchscreen, when the vehicle is started.



Send To Vehicle Button

Renewing Subscriptions And Purchasing 3G Wi-Fi Hotspot (Uconnect 8.4/8.4 NAV, U.S. 48 Contiguous States, Alaska And Hawaii)

Subscriptions, and 3G Wi-Fi Hotspot, can be purchased from the Uconnect Store within your vehicle, and online at your Owner Site. If you need help push the ASSIST button on the rearview mirror, then select Uconnect Care (or dial 1-855-792-4241).

NOTE:

You must set up a Uconnect Access Payment Account online (login to mopar.com, go to Edit Profile, then Uconnect Payment Account, to set up and manage your Payment Account).

Getting Started With Apps

Applications (Apps for short) in your Uconnect Access system are designed to deliver the features and services that you want. The types of apps you can use with Uconnect Access are:

- **Built-In Features** — use the 1X (voice/data) or 3G (data) network on your Uconnect 8.4 or 8.4 NAV radio.

ELECTRONICS

Apps Main Menu

Press the “Apps  ” button on the touchscreen to open the Apps main menu, in this screen you will be able to access all of your available Apps. To access an App directly, press the corresponding button on the touchscreen and you will be directed to that App. To view the rest of your Apps, press the page forward or page back button.

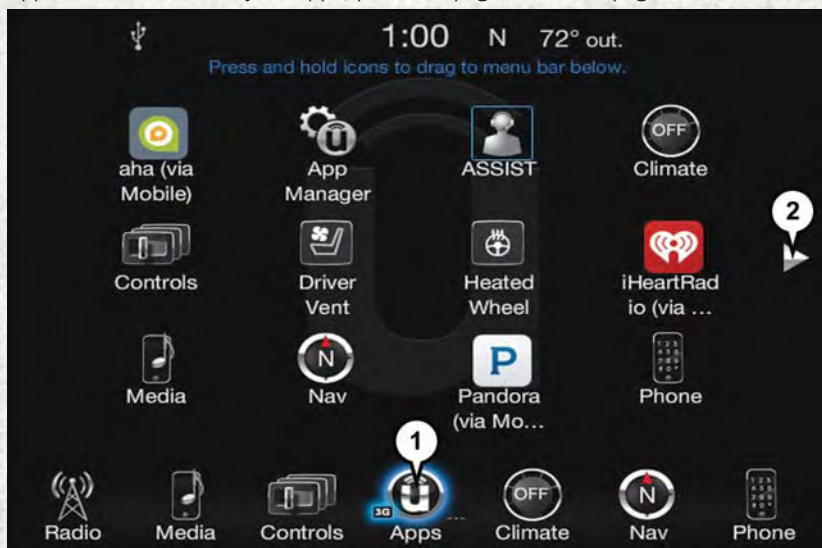

Uconnect Apps

1 — Apps Button

2 — Page Forward Button

App Manager

Press the “App Manager” button to access the following categories:

Favorite Apps — This is the default screen when you first press the “App Manager” button on the touchscreen, and is a good place to put the apps you use most frequently. To make an App a “favorite”, press the “star” button on the touchscreen on the right side of the App.

All Apps — All of your available Apps will reside in the “All Apps” folder.

Running Apps — Press this tab to see which apps are currently running.

Maintaining Your Uconnect Access Account

Selling Your Vehicle

When you sell your vehicle, we recommend that you remove your Uconnect Access Account information from the vehicle. You can do this on your Owner's site website at mopar.com. Removing your account information cancels your subscription and makes your vehicle factory-ready for a new owner/subscriber.

For additional information on Uconnect, visit DriveUconnect.com or call 1-877-855-8400

Built-In Features

WARNING!

ALWAYS drive safely with your hands on the wheel. You have full responsibility and assume all risks related to the use of the Uconnect features and applications in this vehicle. Only use Uconnect when it is safe to do so. Failure to do so may result in an accident involving serious injury or death.

WARNING!

- ALWAYS obey traffic laws and pay attention to the road. Some Uconnect Access services, including 9-1-1 and Assist, will NOT work without an operable 1X (voice/data) or 3G (data) network connection.
- Ignoring the rearview mirror light could mean you may not have 9-1-1 Call service if needed. If the rearview mirror light is illuminated, have an authorized dealer service the 9-1-1 Call system immediately.
- The Occupant Restraint Controller (ORC) turns on the Air Bag Warning Light on the instrument panel if a malfunction is detected in any part of the airbag system. If the Air Bag Warning Light is illuminated, the air bag system may not be working properly and the 9-1-1 system may not send a signal to a 9-1-1 operator if an air bag is deployed. If the Air Bag Warning Light is illuminated, have an authorized dealer service your vehicle immediately.
- If anyone in the vehicle could be in danger (e.g., fire or smoke is visible, dangerous road conditions or location), do not wait for voice contact from a 9-1-1 operator. All occupants should exit the vehicle immediately and move to a safe location.
- The 9-1-1 Call system is embedded into the vehicle's electrical system. Do not add aftermarket electrical equipment to the vehicle's electrical system. This may prevent your vehicle from sending a signal to initiate an emergency call. To avoid interference that can cause the 9-1-1 Call system to fail, never add aftermarket equipment (e.g., two-way mobile radio, CB radio, data recorder, etc.) to your vehicle's electrical system or modify the antennas on your vehicle.
- IF YOUR VEHICLE LOSES BATTERY POWER FOR ANY REASON (INCLUDING DURING OR AFTER AN ACCIDENT), the Uconnect features, apps and services, among others, will not operate.

NOTE:

Your vehicle may be transmitting data as authorized by the subscriber.

ELECTRONICS

1. **Assist Call (8.4/8.4 NAV)** — The rearview mirror contains an ASSIST push button, and the touchscreen contains a Uconnect Access App, which will automatically connect the vehicle occupants to one of these predefined destinations for immediate support:

- **Roadside Assistance Call** — If you get a flat tire, or need a tow, you'll be connected to someone who can help anytime. Additional fees may apply. Additional information in this section.
- **Uconnect Access Care** — In vehicle support for Uconnect Access System, Apps and Features.
- **Vehicle Care** — Total support for your FCA US LLC vehicle.



9-1-1 Button And ASSIST

- 1 — 9-1-1 Button
2 — ASSIST Button

2. **Emergency 9-1-1 Call (If Equipped)** — The rearview mirror contains a 9-1-1 button that, when pushed, may place a call from your vehicle to a local 9-1-1 operator to request help from local police, fire or ambulance personnel. If this button is accidentally pressed, you will have ten seconds to stop the call. To cancel, push the 9-1-1 Call button again or press the "Cancel" button shown on the touchscreen. After ten seconds has passed, the 9-1-1 call will be placed and only the 9-1-1 operator can cancel it. The LED light on the rearview mirror will turn green once a connection to a 9-1-1 operator has been made. The green LED light will turn off once the 9-1-1 call is terminated. Have an authorized dealer service the vehicle if the rearview mirror light is continuously red. On equipped vehicles, this feature requires a functioning electrical system and an operable 1X (voice/data) or 3G (data) network connection to function properly. **If a connection is made between a 9-1-1 operator and your vehicle, you understand and agree that 9-1-1 operators may, like any other 9-1-1 call, record conversations and sounds in and near your vehicle upon connection.**
3. **Roadside Assistance (If Equipped)** — If your vehicle is equipped with this feature and has an operable 1X (voice/data) or 3G (data) network connection, you may be able to connect with Roadside Assistance by pushing the "ASSIST" button on the rearview mirror. You will be presented with Assist Care options. Make a selection by pressing the prompts displayed on the radio. If Roadside Assistance is provided to your vehicle, you agree to be responsible for any additional roadside assistance service costs that you may incur. In order to provide Uconnect Services to you, we may record and monitor your conversations with Roadside Assistance, Uconnect Care or Vehicle Care, whether such conversations are initiated through

the Uconnect Services in your vehicle, your device or via a landline device, and may share information obtained through such recording and monitoring in accordance with regulatory requirements. You acknowledge, agree and consent to any recording, monitoring or sharing of information obtained through any such call recordings.

4. **Yelp** — Customers have the ability to search for nearby destinations or a Point Of Interest (POI) either by category or custom search by using keywords (for example, “Italian restaurant”). Searching can be done by either voice or by using the touchscreen keypad. Using the touchscreen, launch Yelp by selecting the “Apps ” icon, then press “Yelp.” To use voice recognition, push the VR button on the steering wheel and say “launch Yelp,” then follow the instructions on the Teleprompter.
5. **Theft Alarm Notification** — The Theft Alarm Notification feature notifies you via email or text (SMS) message when the vehicle’s factory-installed security alarm system has been set-off. There are a number of reasons why your alarm may have been triggered, one of which could be that your vehicle was stolen. If so, please see the details of the Stolen Vehicle Assistance service below. When you register, Theft Alarm Notification is automatically set to send you an email at the email address you provide should the alarm go off. You may also opt to have a text message sent to your device.
6. **Stolen Vehicle Assistance** — If your vehicle is stolen, contact local law enforcement immediately to file a stolen vehicle report. Once this report has been filed, Uconnect care can help locate your vehicle. The Uconnect Care agent will ask for the stolen vehicle report number issued by local law enforcement. As long as your vehicle has an operable 1X (voice/data) or 3G (data) network connection, the Uconnect Care Agent may be able to locate the stolen vehicle and work with law enforcement to help recover it. Your vehicle must have an operable 1X (voice/data) or 3G (data) network connection and must be registered with Uconnect Access with an active subscription that includes the applicable feature.
7. **3G Wi-Fi Hotspot** — The 3G Wi-Fi Hotspot is an in-vehicle feature that connects your device to an operable 1X (voice/data) or 3G (data) network using Uconnect Access and is ready to go where ever you are. Once your vehicle is registered for Uconnect Access, you can purchase a 3G Wi-Fi Hotspot subscription at the Uconnect Store. After you've made your purchase, turn on your signal and connect your passengers devices. It's never been easier to bring your home or office with you.

WARNING!

NEVER use the 3G Wi-Fi Hotspot when you are driving the vehicle. As the driver, you should only use the 3G Wi-Fi Hotspot when the vehicle is parked in a safe location. Failure to do so may result in an accident involving serious injury or death.

NOTE:

Your vehicle must have a working electrical system for any of the in vehicle Uconnect features to operate.

Uconnect Access Remote Features

If you own a compatible iPhone or Android powered device, the Uconnect Access App allows you to remotely lock or unlock your doors, start your engine or activate your horn and lights from virtually anywhere. Your vehicle must be equipped with remote start and your vehicle must have an operable 1X (voice/data) or 3G (data) network connection. Services can only be used where coverage is available; see coverage map for details. You can download the App from your Owner's site or from the App Store (iPhone) or Google Play Store (Android). Visit UconnectPhone.com to determine if your device is compatible.

U.S. residents - visit UconnectPhone.com or call 1-877-855-8400.

Remote Start (If Equipped) — This feature provides the ability to start the engine on your vehicle, without the keys and from virtually any distance. You can send a request to your vehicle in one of two ways:

1. Using the Uconnect Access App from a compatible device.
2. From your Owner's site website.
 - After 15 minutes, if you have not entered your vehicle with the key, the engine will shut off automatically.
 - You can also send a command to turn-off an engine that has been remote started.
 - This remote function requires your vehicle to be equipped with a factory-installed Remote Start system. To utilize this feature after the Uconnect Access App is downloaded, login with your user name and password.

To use this feature after the Uconnect Access App is downloaded, login using your user name and password. You will need your four digit Uconnect Security PIN to confirm the request. Press the "remote start" icon on your Uconnect Access App to remotely start the vehicle.

You can set-up notifications for your account to receive an email or text (SMS) message every time a command is sent. Login to Mopar Owner Connect at mopar.com, and click on Edit Profile to manage Uconnect Notifications.

Remote Door Lock/Unlock — This feature provides the ability to lock or unlock the door on your vehicle, without the keys and from virtually any distance. You can send a request to your vehicle in one of three ways:

1. Using the Uconnect Access App from a compatible device.
2. From the your Owner's site website.
3. By contacting the Uconnect Care on the phone.

To use this feature after the Uconnect Access App is downloaded, login using your user name and password. You will need your four digit Uconnect Security PIN to confirm the request. Press the "closed lock" icon on your Uconnect Access App to lock the doors, and press the "open lock" icon to unlock the driver's door.

You can set-up notifications for your account to receive an email or text (SMS) message every time a command is sent. Login to Mopar Owner Connect at mopar.com and click on Edit Profile to manage Uconnect Notifications.

Remote Horn And Lights — It's easy to locate a vehicle in a dark, crowded, or noisy parking area by activating the horn and lights. It may also help if you need to draw attention to your vehicle for any reason. You can send a request to your vehicle in one of three ways:

1. Using the Uconnect Access App from a compatible device.
2. From the your Owner's site website.
3. By contacting the Uconnect Care on the phone.

To use this feature after the Uconnect Access App is downloaded, login using your user name and password. You will need your four digit Uconnect Security PIN to confirm the request. You can set-up notifications for your account to receive an email or text (SMS) message every time a command is sent. Login to Mopar Owner Connect at mopar.com and click on Edit Profile to manage Uconnect Notifications.

Voice Texting — Want to dictate a personal message? Register with Uconnect Access to take advantage of a new, cloudbased Voice Texting service: an enhancement to Voice Text Reply.

Voice Texting allows you to compose a new text or reply to an incoming text message. Before you attempt to use the Voice Texting feature, check to ensure you have the following:

1. A paired Bluetooth enabled device with the Message Access Profile (MAP). Not all Bluetooth enabled devices support MAP, including all iPhones (Apple iOS). Visit UconnectPhone.com for system and device compatibility information.
2. An active Uconnect Access trial or paid subscription.
3. Accept the "Allow MAP" profile request on your device. (Please refer to device manufacturer instructions for details).

To Send A Text Message:

1. Push the Uconnect Phone Button  on the steering wheel.
2. Wait for the beep.
3. Say "Text."
4. Uconnect will prompt you "Say the phone number, or full name and phone type of the contact you want to send a message to."
5. Wait for the beep and say a contact that is in your phonebook, or a mobile phone number that you would like to send the message to.
6. Uconnect will prompt you "Please say the message that you would like to send." (If you do not hear this prompt, you may not have an active subscription with Uconnect Access).

7. Wait for the beep, and then dictate any message up to 140 characters. If you exceed 140 characters, you will hear the following prompt: "Message was too long; your message will be truncated."
8. Uconnect will then repeat the message back to you.
9. Uconnect will prompt you: "To add to your message, say "Continue"; To delete the current message and start over, say "Start Over"; to send the current message, say "Send"; to hear the message again, say "Repeat."
10. If you are happy with your message and would like to send it, wait for the beep and say "Send."
11. Uconnect will then say "Sending your message."

Sample Commands For Voice Text Reply And Voice Texting

Example Command	Action
"Text John Smith"	Send a message to specific contact in address book
"Text 123 456 7890"	Send 123 456 7890 a message from your phonebook
"Show messages"	See recent text messages listed by number on Uconnect screen
"Listen to/view (message number four, for example)"	Hear messages or read it on Uconnect screen
"Reply"	Send a voice text reply to a current message
"Forward text/message to "John Smith"	Forward current text to specific contact in address book
"Forward text/message to "123 456 7890"	Forward current text to specific phone number

RADIO 3.0

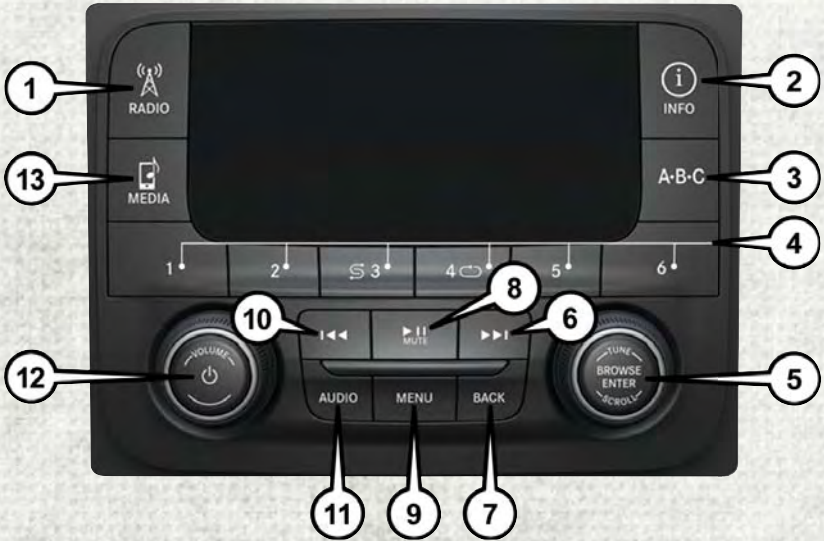

Radio 3.0

- | | |
|---|-------------------------------------|
| 1 — RADIO Button | 8 — Play/Pause — MUTE Button |
| 2 — INFO Button | 9 — MENU Button |
| 3 — A-B-C Button | 10 — SEEK Down Button |
| 4 — Preset Buttons | 11 — AUDIO Button |
| 5 — BROWSE/ENTER Button —
TUNE/SCROLL Knob | 12 — ON/OFF Button — VOLUME
Knob |
| 6 — SEEK Up Button | 13 — MEDIA Button |
| 7 — BACK Button | |

Clock Setting

1. Push the Menu button at the bottom of the radio, and push the Enter/Browse button for System Settings. Next, select the Time and Format setting and then select Set Time by pushing the Enter/Browse button.
2. Adjust the hours or minutes by turning the Tune/Scroll knob, then pushing the Enter/Browse button to move to the next entry. You can also select 12hr or 24hr format by turning the Tune/Scroll knob, then pushing the Enter/Browse button on the desired selection.
3. Once the time is set, press the "Ok" button to exit the time screen.

Audio Setting

- Push the AUDIO button on the radio faceplate.
- The Audio Menu shows the following options for you to customize your audio settings.

Treble, Mid, Bass, Fade, Balance, Speed Adjusted Volume, Loudness and AUX Offset

- Select the desired setting to adjust, then push the ENTER/BROWSE button. Turn the TUNE/SCROLL knob to adjust the setting + or - . Push the “Back” button when done.

Radio Operation

Seek Up/Down Buttons

- Push the up or down button to seek through radio stations in AM, FM or SXM bands.
- Hold either button to bypass stations without stopping.

Store Radio Presets Manually

The presets are available for all Radio Modes, and are activated by pushing any of the six preset buttons. The Radio stores up to 18 presets in each of the Radio modes. Push the A-B-C button on the faceplate to select the A, B, or C preset list.

To store a radio preset manually, follow the steps below:

1. Tune to the desired station.
2. Push and hold the desired numbered button for more than two seconds, or until you hear a confirmation beep.

Disc Operation (If Equipped)

Your vehicle may have a remote CD player located in the lower center console storage bin, or in the lower center bench seat bin.

- CD/Disc Mode is entered by either inserting a CD/Disc or by pushing the MEDIA button located on the side of the display. Once in Media Mode, select “Disc.”

Gently insert one CD into the CD player with the CD label facing as indicated on the illustration located on the Disc player.

Seek Up/Down Buttons

- Push to seek through CD tracks.
- Hold either button to bypass tracks without stopping.

USB/Audio Jack (AUX) Manual Operation

To select a specific audio source, push the MEDIA button on the faceplate and select from the following modes:

USB/iPod

- USB/iPod Mode is entered by either inserting a USB Jump Drive or iPod cable into the USB port or by pushing the MEDIA button located left of the display.

Audio Jack (AUX)

- The AUX allows a device such as an MP3 player or an iPod to be plugged into the radio and utilize the vehicle's audio system, using a 3.5 mm audio cable, to amplify the source and play through the vehicle's speakers.
- The functions of the device are controlled using the device buttons, not the buttons on the radio. The volume may be controlled using the radio or the device.

Uconnect 3.0

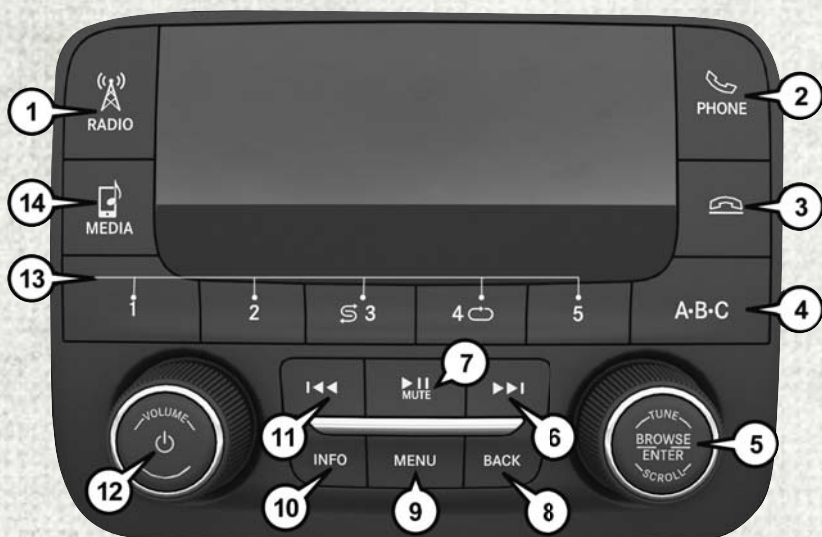

Uconnect 3.0 Radio

- | | |
|---|-------------------------------------|
| 1 — RADIO Button | 8 — BACK Button |
| 2 — PHONE Pick-Up Button | 9 — MENU Button |
| 3 — Phone Hang-Up Button | 10 — INFO Button |
| 4 — A-B-C Button | 11 — SEEK Down Button |
| 5 — BROWSE/ENTER Button —
TUNE/SCROLL Knob | 12 — ON/OFF Button — VOLUME
Knob |
| 6 — SEEK Up Button | 13 — Preset Buttons |
| 7 — Play/Pause — MUTE Button | 14 — MEDIA Button |

Clock Setting

1. Push the Menu button at the bottom of the radio, and push the Enter/Browse button for System Settings. Next, select the Time and Format setting and then select Set Time by pushing the Enter/Browse button.
2. Adjust the hours or minutes by turning the Tune/Scroll knob, then pushing the Enter/Browse button to move to the next entry. You can also select 12hr or 24hr format by turning the Tune/Scroll knob, then pushing the Enter/Browse button on the desired selection.
3. Once the time is set, press the “Ok” button to exit the time screen.

Audio Setting

- Push the AUDIO button on the radio faceplate.
- The Audio Menu shows the following options for you to customize your audio settings.

Treble, Mid, Bass, Fade, Balance, Speed Adjusted Volume, Loudness and AUX Offset

- Select the desired setting to adjust, then push the ENTER/BROWSE button. Turn the TUNE/SCROLL knob to adjust the setting + or - . Push the “Back” button when done.

Radio Operation

Seek Up/Down Buttons

- Push the up or down button to seek through radio stations in AM, FM or SXM bands.
- Hold either button to bypass stations without stopping.

Store Radio Presets Manually

The presets are available for all Radio Modes, and are activated by pushing any of the six preset buttons. The Radio stores up to 18 presets in each of the Radio modes. Push the A-B-C button on the faceplate to select the A, B, or C preset list.

To store a radio preset manually, follow the steps below:

1. Tune to the desired station.
2. Push and hold the desired numbered button for more than two seconds, or until you hear a confirmation beep.

Disc Operation (If Equipped)

Your vehicle may have a remote CD player located in the lower center console storage bin, or in the lower center bench seat bin.

- CD/Disc Mode is entered by either inserting a CD/Disc or by pushing the MEDIA button located on the side of the display. Once in Media Mode, select “Disc.”

Gently insert one CD into the CD player with the CD label facing as indicated on the illustration located on the Disc player.

Seek Up/Down Buttons

- Push to seek through CD tracks.
- Hold either button to bypass tracks without stopping.

USB/Audio Jack (AUX) Manual Operation

To select a specific audio source, push the MEDIA button on the faceplate and select from the following modes:

USB/iPod

- USB/iPod Mode is entered by either inserting a USB Jump Drive or iPod cable into the USB port or by pushing the MEDIA button located left of the display.

Audio Jack (AUX)

- The AUX allows a device such as an MP3 player or an iPod to be plugged into the radio and utilize the vehicle's audio system, using a 3.5 mm audio cable, to amplify the source and play through the vehicle's speakers.
- The functions of the device are controlled using the device buttons, not the buttons on the radio. The volume may be controlled using the radio or the device.

UCONNECT 5.0



Uconnect 5.0 Radio

- | | |
|-------------------------------------|----------------------------------|
| 1 — RADIO Button | 6 — BACK Button |
| 2 — COMPASS Button | 7 — SCREEN OFF Button |
| 3 — SETTINGS Button | 8 — Mute Button — VOLUME Control |
| 4 — MORE Button | 9 — Uconnect PHONE Button |
| 5 — BROWSE/ENTER — Tune/Scroll Knob | 10 — MEDIA Button |

WARNING!

ALWAYS drive safely with your hands on the wheel. You have full responsibility and assume all risks related to the use of the Uconnect features and applications in this vehicle. Only use Uconnect when it is safe to do so. Failure to do so may result in an accident involving serious injury or death.

CAUTION!

Do NOT attach any object to the touchscreen, doing so can result in damage to the screen.

Clock Setting

To start the clock setting procedure, perform the following:

1. Push the SETTINGS button on the faceplate on the right side of the display, then press the “Clock & Date” button on the touchscreen.
2. Press the “Set Time & Format” button on the touchscreen.
3. Press the “Up” or “Down” arrows to adjust the hours or minutes, next select the “AM” or “PM” button on the touchscreen. You can also select 12hr or 24hr format by pressing the desired button on the touchscreen.
4. Once the time is set, press the “Done” button on the touchscreen to exit the time screen.

NOTE:

In the Clock Setting Menu, you can also select “Display Clock”, which turns the clock display in the status bar on or off.

Equalizer, Balance And Fade

1. Push the SETTINGS button on the faceplate on the right side of the unit.
2. Scroll down and press the “Audio” button on the touchscreen to get to the Audio menu.
3. The Audio Menu shows the following options for you to customize your audio settings.

Equalizer

- Press the “Equalizer” button on the touchscreen to adjust the Bass, Mid and Treble. Use the “+” or “-” button on the touchscreen to adjust the equalizer to your desired settings. Press the “Done” button on the touchscreen when finished.

Balance/Fade

- Press the “Balance/Fade” button on the touchscreen to adjust the sound from the speakers. Use the “arrow” button on the touchscreen to adjust the sound level from the front and rear or right and left side speakers. Press the Center “C” button on the touchscreen to reset the balance and fade to the factory setting. Press the “Done” button on the touchscreen when finished.

Speed Adjustable

- Press the “Speed Adjusted Volume” button on the touchscreen to select between OFF, 1, 2 or 3. This will decrease the radio volume relative to a decrease in vehicle speed. Press the “Done” button on the touchscreen when finished.

Loudness

- Press the “Loudness” button on the touchscreen to select the Loudness feature. When this feature is activated it improves sound quality at lower volumes.

Radio Operation



Uconnect 5.0 Radio Screen

- 1 — Radio Station Presets
- 2 — Show All Presets
- 3 — Seek Up
- 4 — Audio Settings

- 5 — Station Info
- 6 — Direct Tune
- 7 — Radio Band
- 8 — Seek Down

Seek Up/Down Buttons

- Press the up or down button to seek through radio stations in AM, FM or SXM bands.
- Hold either button to bypass stations without stopping.

Store Radio Presets Manually

The radio stores up to 12 presets in each of the radio modes. There are four visible presets at the top of the radio screen. Pressing the “All” button on the touchscreen on the radio home screen will display all of the preset stations for that mode.

To store a radio preset manually, follow the steps below:

1. Tune to the desired station.
2. Press and hold the desired preset button on the touchscreen for more than two seconds or until you hear a confirmation beep.

SiriusXM Premier Over 160 Channels

Get every channel available on your satellite radio, and enjoy all you want, all in one place. Hear commercial-free music plus sports, news, talk and entertainment. Get all the premium programming, including Howard Stern, every NFL game, Oprah Radio, every MLB and NHL game, every NASCAR race, Martha Stewart and more. And get 20+ extra channels, including SiriusXM Latino, offering 20 channels of commercial free music, news, talk, comedy, sports and more dedicated to Spanish language programming.

To access SiriusXM Satellite Radio, push the RADIO button on the faceplate and then the SXM button on the touchscreen.

SiriusXM services require subscriptions, sold separately after the 12-month trial included with the new vehicle purchase. **If you decide to continue your service at the end of your trial subscription, the plan you choose will automatically renew and bill at then-current rates until you call SiriusXM at 1-866-635-2349 for U.S. residents and 1-888-539-7474 for Canadian residents to cancel. See SiriusXM Customer Agreement for complete terms at www.siriusxm.com for U.S. residents and www.siriusxm.ca for Canadian residents.** All fees and programming subject to change. Our satellite service is available only to those at least 18 and older in the 48 contiguous USA and D.C. Our Sirius satellite service is also available in PR (with coverage limitations). Our Internet radio service is available throughout our satellite service area and in AK and HI. © 2016 Sirius XM Radio Inc. Sirius, XM and all related marks and logos are trademarks of Sirius XM Radio Inc.

USB/Audio Jack (AUX) — If Equipped

To select a specific audio source, push the MEDIA button on the faceplate. To allow music to play from your device through the vehicle's speakers, press the "Source" button then select one of the following modes:

USB/iPod

- USB/iPod Mode is entered by either inserting a USB Jump Drive or iPod cable into the USB port or by pushing the MEDIA button on the faceplate located left of the display.



Uconnect Media Hub

- 1 — USB Port
2 — Audio/AUX Jack

ELECTRONICS

Audio Jack (AUX)

- The AUX allows a device, such as an MP3 player or an iPod, to be plugged into the radio and utilize the vehicle's audio system, using a 3.5 mm audio cable, to amplify the source and play through the vehicle speakers.
- The functions of the device are controlled using the device buttons, not the buttons on the radio. The volume may be controlled using the radio or device.

Bluetooth

- If using a Bluetooth-equipped device, you may also be able to stream music to your vehicle's sound system.

UCONNECT 8.4/8.4 NAV

Uconnect 8.4/8.4 NAV At A Glance



Uconnect 8.4 NAV Radio Screen

WARNING!

ALWAYS drive safely with your hands on the wheel. You have full responsibility and assume all risks related to the use of the Uconnect features and applications in this vehicle. Only use Uconnect when it is safe to do so. Failure to do so may result in an accident involving serious injury or death.

CAUTION!

Do NOT attach any object to the touchscreen, doing so can result in damage to the screen.

Setting The Time

- Model 8.4 NAV synchronizes time automatically via GPS, so it should not require any time adjustment. If you do need to set the time manually, follow the instructions below for Model 8.4 NAV.
- For Model 8.4, turn the unit on, then press the time display at the top of the screen. Press “Yes.”
- If the time is not displayed at the top of the screen, press the “Settings” button on the touchscreen. In the Settings screen, press the “Clock” button on the touchscreen, then check or uncheck this option.
- Press “+” or “-” next to Set Time Hours and Set Time Minutes to adjust the time.
- If these features are not available, uncheck the Sync Time box.
- Press “X” to save your settings and exit out of the Clock Setting screen.

Background Themes

- Screen background themes are selectable from a pre-loaded list of themes. If you'd like to set a theme, follow the instructions below.
- Press the “Settings” button on the touchscreen.
- Press the “Display” button on the touchscreen.
- Then press “Set Theme” button on the touchscreen and select a theme.

Audio Settings

- Press of the “Audio” button on the touchscreen to activate the Audio settings screen to adjust Balance\Fade, Equalizer, and Speed Adjusted Volume.
- You can return to the Radio screen by pressing the “X” located at the top right.

Balance/Fade

- Press the “Balance/Fade” button on the touchscreen to Balance audio between the front speakers or fade the audio between the rear and front speakers.
- Pressing the “Front,” “Rear,” “Left,” or “Right” buttons on the touchscreen or press and drag the Speaker Icon to adjust the Balance/Fade.

Equalizer

- Press the “Equalizer” button on the touchscreen to activate the Equalizer screen.
- Press the “+” or “-” buttons on the touchscreen, or press and drag over the level bar for each of the equalizer bands. The level value, which spans between plus or minus nine, is displayed at the bottom of each of the Bands.

ELECTRONICS

Speed Adjusted Volume

- Press the “Speed Adjusted Volume” button on the touchscreen to activate the Speed Adjusted Volume screen. The Speed Adjusted Volume is adjusted by pressing the volume level indicator. This alters the automatic adjustment of the audio volume with variation to vehicle speed.

Personalized Menu Bar

The Uconnect features and services in the main menu bar are easily changed for your convenience. Simply follow these steps:

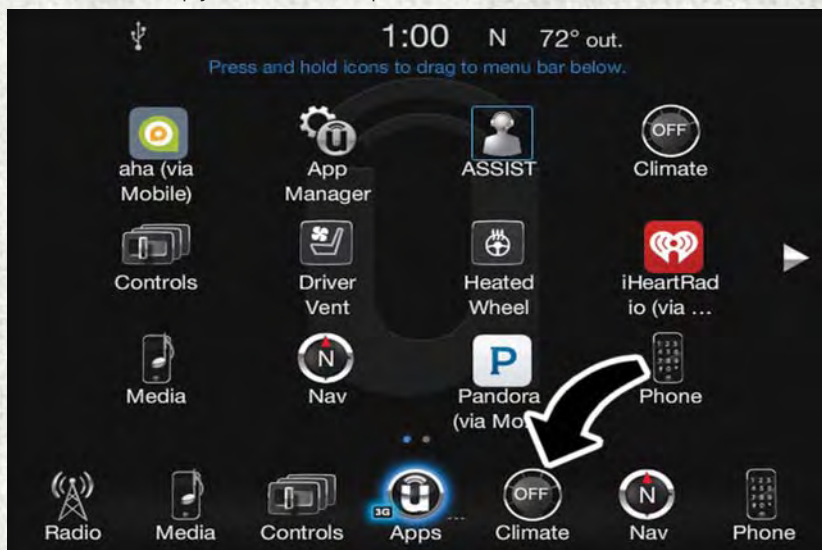

Uconnect 8.4/8.4 NAV Main Menu

1. Press the “Apps (U)” button to open the App screen.
2. Press and hold, then drag the selected App to replace an existing shortcut in the main menu bar.

The new app shortcut, that was dragged down onto the main menu bar, will now be an active App/shortcut.

NOTE:

This feature is only available if the vehicle is in PARK.

Radio



Uconnect 8.4 NAV Radio

- | | |
|-------------------------------|------------------------------------|
| 1 — Radio Station Presets | 7 — Audio Settings |
| 2 — Toggle Between Presets | 8 — Seek Up |
| 3 — Status Bar | 9 — Direct Tune To A Radio Station |
| 4 — View Small Navigation Map | 10 — Seek Down |
| 5 — HD Radio | 11 — Browse And Manage Presets |
| 6 — Main Category Bar | 12 — Radio Bands |

WARNING!

ALWAYS drive safely with your hands on the wheel. You have full responsibility and assume all risks related to the use of the Uconnect features and applications in this vehicle. Only use Uconnect when it is safe to do so. Failure to do so may result in an accident involving serious injury or death.

- To access the Radio mode, press the “Radio” button on the touchscreen.

Selecting Radio Stations

- Press the desired radio band (AM, FM or SXM) button on the touchscreen.

Seek Up/Seek Down

- Press the Seek up or down arrow buttons on the touchscreen for less than two seconds to seek through radio stations.

- Press and hold either arrow button on the touchscreen for more than two seconds to bypass stations without stopping. The radio will stop at the next listenable station once the arrow button on the touchscreen is released.

Direct Tune

- Tune directly to a radio station by pressing the “Tune” button on the screen, and entering the desired station number.

Store Radio Presets Manually

Your radio can store 36 total preset stations, 12 presets per band (AM, FM and SXM). They are shown at the top of your radio screen. To see the 12 preset stations per band, press the arrow button on the touchscreen at the top right of the screen to toggle between the two sets of six presets.

To store a radio preset manually, follow the steps below:

1. Tune to the desired station.
2. Press and hold the desired numbered button on the touchscreen for more than two seconds or until you hear a confirmation beep.

HD Radio — If Equipped

- HD Radio (available on Uconnect 8.4 NAV) operates similar to conventional radio except it allows broadcasters to transmit a high-quality digital signal.
- With an HD radio receiver, the listener is provided with a clear sound that enhances the listening experience. HD radio can also transmit data such as song title or artist.

SiriusXM Premier Over 160 Channels

Get every channel available on your satellite radio, and enjoy all you want, all in one place. Hear commercial-free music plus sports, news, talk and entertainment. Get all the premium programming, including Howard Stern, every NFL game, Oprah Radio, every MLB and NHL game, every NASCAR race, Martha Stewart and more. And get 20+ extra channels, including SiriusXM Latino, offering 20 channels of commercial free music, news, talk, comedy, sports and more dedicated to Spanish language programming.

- To access SiriusXM Satellite Radio, press the “SXM” button on the touchscreen on the main Radio screen.

The following describes features that are available when in SiriusXM Satellite Radio mode:

Seek Up/Seek Down

- Press the Seek arrow buttons on the touchscreen for less than two seconds to seek through channels in SXM mode.
- Press and hold either arrow button on the touchscreen for more than two seconds to bypass channels without stopping. The radio will stop at the next listenable channel once the arrow button on the touchscreen is released.

Direct Tune

- Tune directly to a SXM channel by pressing the “Tune” button on the touchscreen on the screen, and entering the desired station number.

Tune Start

- The Tune Start feature begins playing a song from the beginning when you tune to your favorite preset SXM channel. Tune Start can be enabled or disabled through the SiriusXM setup page.

Jump

- Automatically tells you when Traffic & Weather for a favorite city is available, and gives you the option to switch to that channel. Press “Jump” to activate the feature. After listening to Traffic and Weather, press “Jump” again to return to the previous channel.

Fav

- Activates the favorites menu. You can add up to 50 favorite artists or songs. Just press “Add Fav Artist” or “Add Fav Song” while the song is playing. You will then be alerted any time one of these songs, or works by these artists, is playing on other SiriusXM channels.

Album Art

- When arriving at a station, the Channel Art will be displayed to the left of the station information. After five seconds the Channel Art will be replaced with the Album Art (if available).

SiriusXM Parental Controls

- You can skip or hide certain channels from view if you do not want access to them. Press the “Apps” button on the touchscreen, then the “Settings” button on the touchscreen, next press the “Sirius Setup” button on the touchscreen, then select Channel Skip. Press the box check-mark next to the channel you want skipped. They will not show up in normal usage.
- SiriusXM also offers the option to permanently block selected channels. Call (1-888-601-6297 for U.S. customers, 1-877-438-9677 for Canadian customers) and request the Family-Friendly Package.

ELECTRONICS

Browse

Lets you browse the SiriusXM channel listing or Genre listing. Favorites, Game Zone, Weather and Jump settings also provide a way to browse the SiriusXM channel list.

Browse Sub-Menu	Sub-Menu Description
All	Shows the channel listing.
Genre	Provides a list of all genres, and lets you jump to a channel within the selected genre.
Presets	Lets you scroll the list of Preset satellite channels. Press the channel, or press Enter on the Tune knob, to go to that channel. Press the trash can icon to delete a preset. Your presets are also shown at the top of the main Satellite Radio screen.
Favorites	Lets you manage artists and songs in the Favorites list and configure Alert Settings to let you know when favorite songs or artists are playing on other channels. Also, view a list of channels airing any of your Favorites.
Game Zone	Provides alerts when your favorite sports teams are starting a game which is being aired on other SiriusXM channels, or when their game score is announced. You can select and manage your Teams list here, and configure alerts.
Jump	Lets you select your favorite cities for Traffic & Weather information, which is used by the Jump feature on the main satellite radio screen.

Replay

Lets you replay up to 44 minutes of the content of the current SiriusXM channel.

Replay Option	Option Description
Play/Pause	Press to Pause content playback. Press Pause/Play again to resume playback.
Rewind/RW	Rewinds the channel content in steps of five seconds. Press and hold to rewind continuously, then release to begin playing content at that point.
Fast Forward/FW	Forwards the content, and works similarly to Rewind/RW. However, Fast Forward/FW can only be used when content has been previously rewound.
Replay Time	Displays the amount of time in the upper center of the screen by which your content lags the Live channel.
Live	Resumes playback of Live content at any time while replaying rewind content.

- SiriusXM services require subscriptions, sold separately after the 12-month trial included with the new vehicle purchase. **If you decide to continue your service at the end of your trial subscription, the plan you choose will automatically renew and bill at then-current rates until you call SiriusXM at 1-866-635-2349 for U.S. residents and 1-888-539-7474 for Canadian residents to cancel. See SiriusXM Customer Agreement for complete terms at www.siriusxm.com (U.S. residents) or siriusxm.ca (Canadian residents).** All fees and programming subject to change. Our satellite service is available only to those at least 18 and older in the 48 contiguous USA and D.C.

Our Sirius satellite service is also available in PR (with coverage limitations). Our Internet radio service is available throughout our satellite service area and in AK and HI. ©2016 Sirius XM Radio Inc. Sirius, XM and all related marks and logos are trademarks of Sirius XM Radio Inc.

Disc Operation — If Equipped

- Your vehicle may have a remote CD player located in the lower center console storage bin, or in the lower center bench seat bin.
- CD/Disc Mode is entered by either inserting a CD/Disc or by pressing the MEDIA button. Once in Media Mode, select “Disc.”
- Gently insert one CD into the CD player with the CD label facing as indicated on the illustration located on the Disc player.

Seek Up/Down Buttons

- Press to seek through Disc tracks.
- Hold either button to bypass tracks without stopping.

Browse

- Press the “Browse” button on the touchscreen to scroll through and select a desired track on the Disc. Press the “Exit” button on the touchscreen if you wish to cancel the browse function.

Media Hub — USB/Audio Jack (AUX) — If Equipped

There are many ways to play music from MP3 players or USB devices through your vehicle's sound system. Press your Media button on the touchscreen to begin.

Audio Jack (AUX)

- The AUX allows a device to be plugged into the radio and utilize the vehicle's sound system, using a 3.5 mm audio cable, to amplify the source and play through the vehicle speakers.
- Pressing the “AUX” button on the touchscreen will change the mode to auxiliary device if the audio jack is connected, allowing the music from your device to be heard through the vehicle's speakers. To activate the AUX, plug in the audio jack.

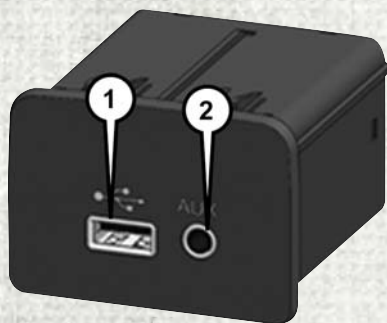

Uconnect Media Hub

- 1 — USB Port
- 2 — Audio/AUX Jack

- The functions of the device are controlled using the device buttons. The volume may be controlled using the radio or device.
- To route the audio cable out of the center console, use the access cut out in the front of the console.

USB Port

- Connect your compatible device using a USB cable into the USB Port. USB Memory sticks with audio files can also be used. Audio from the device can be played on the vehicles sound system while providing metadata (artist, track title, album, etc.) information on the radio display.
- When connected, the compatible USB device can be controlled using the radio or Steering Wheel Audio Controls to play, skip to the next or previous track, browse, and list the contents.
- The battery charges when plugged into the USB port (if supported by the specific device).
- To route the USB cable out of the center console, use the access cut out.

NOTE:

When connecting your device for the first time, the system may take several minutes to read your music, depending on the number of files. For example, the system will take approximately five minutes for every 1,000 songs loaded on the device. Also during the reading process, the Shuffle and Browse functions will be disabled. This process is needed to ensure the full use of your features and only happens the first time it is connected. After the first time, the reading process of your device will take considerably less time unless changes are made or new songs are added to the playlist.

Bluetooth Streaming Audio

- If equipped with Uconnect Voice Command, your Bluetooth-equipped device may also be able to stream music to your vehicle's sound system. Your connected device must be Bluetooth-compatible and paired with your system (see Uconnect Phone for pairing instructions). You can access the music from your connected Bluetooth device by pressing the Bluetooth  button on the touchscreen while in Media mode.

Media Controls



Media Controls

- | | |
|-----------------------------|--|
| 1 — Repeat Music Track | 5 — Show Songs Currently In Queue To Be Played |
| 2 — Music Track And Time | 6 — Browse Music By |
| 3 — Shuffle Music Tracks | 7 — Music Source |
| 4 — Music Track Information | |

The controls are accessed by pressing the desired button on the touchscreen and choosing between AUX, USB or Bluetooth.

NOTE:

Uconnect will automatically switch to the appropriate mode when something is first connected or inserted into the system.

Navigation

- The information in the section below is only applicable if you have the 8.4 NAV system or the Navigation has been activated on your 8.4 system.
- If you have a Uconnect 8.4 system your radio is “Navigation-Ready,” and can be equipped with Navigation at an extra cost. Please see your dealer for details.

Press the “Nav” button on the touchscreen in the menu bar to access the Navigation system.

Changing The Navigation Voice Prompt Volume

1. Press the “View Map” button on the touchscreen from the Nav Main Menu.
2. With the map displayed, press the “Settings” button on the touchscreen in the lower right area of the screen.
3. In the Settings menu, press the “Guidance” button on the touchscreen.
4. In the Guidance menu, adjust the Nav Volume by pressing the “+” or “-” buttons on the touchscreen.



Uconnect 8.4 NAV Navigation

- | | |
|------------------------|----------------------------------|
| 1 — Find A Destination | 5 — Navigation Settings |
| 2 — View Map | 6 — Stop A Route |
| 3 — Information | 7 — Detour A Route |
| 4 — Emergency | 8 — Repeat Route Guidance Prompt |

Finding Points Of Interest

- From the main Navigation menu, press the “Where To?” button on the touchscreen, then press the “Points of Interest” button on the touchscreen.
- Select a category and then a subcategory, if necessary.
- Select your destination and press the “Yes” button on the touchscreen.

Finding A Place By Spelling The Name

- From the Main Navigation Menu press the “Where to?” button on the touchscreen, press the “Points of Interest” button on the touchscreen, then press the “Spell Name” button on the touchscreen.
- Enter the name of your destination.
- Press the “List” button on the touchscreen.
- Select your destination and press the “Yes” button on the touchscreen.

One-Step Voice Destination Entry

- Enter a navigation destination without taking your hands off the wheel.
- Just push the Uconnect Voice Command  button on the steering wheel, wait for the beep and say something like, “**Find Address** 800 Chrysler Drive Auburn Hills MI.”

NOTE:

Destination entry is not available while your vehicle is in motion. However, you can also use Voice Commands to enter an address while moving. Refer to Common Navigation Voice Commands in the Uconnect Voice Command section.

Setting Your Home Location

- Press the “Nav” button on the touchscreen in the menu bar to access the Navigation system and the Main Navigation menu.
- Press the “Where To?” button on the touchscreen, then press the “Go Home” button on the touchscreen.
- You may enter your address directly, use your current location as your home address, or choose from recently found locations.
- To delete your Home location (or other saved locations) so you can save a new Home location, press the “Where To?” button on the touchscreen from the Main Navigation menu, then press the “Go Home” button on the touchscreen, and in the Yes screen press the “Options” button on the touchscreen. In the Options menu press the “Clear Home” button on the touchscreen. Set a new Home location by following the previous instructions.

ELECTRONICS

Go Home

- A Home location must be saved in the system. From the Main Navigation menu, press the “Where To?” button on the touchscreen, then press the “Go Home” button on the touchscreen.



Uconnect 8.4 NAV Map

- | | |
|-------------------------------|--------------------------------|
| 1 — Distance To Next Turn | 5 — Your Location On The Map |
| 2 — Next Turn Street | 6 — Navigation Main Menu |
| 3 — Estimated Time Of Arrival | 7 — Current Street Location |
| 4 — Zoom In And Out | 8 — Navigation Routing Options |

Your route is marked with a blue line on the map. If you depart from the original route, your route is recalculated. A speed limit icon could appear as you travel on major roadways.

Adding A Stop

- To add a stop you must be navigating a route.
- Press the “Menu” button on the touchscreen to return to the Main Navigation menu.
- Press the “Where To?” button on the touchscreen, then search for the extra stop. When another location has been selected, you can choose to cancel your previous route, add as the first destination or add as the last destination.
- Press the desired selection and press the “Yes” button on the touchscreen.

Taking A Detour

- To take a detour you must be navigating a route.
- Press the “Detour” button on the touchscreen.

NOTE:

If the route you are currently taking is the only reasonable option, the device may not calculate a detour. For more information, see your Uconnect Owner's Manual Supplement.

SiriusXM Traffic (8.4 NAV & US Market Only)

Don't Drive Through Traffic. Drive Around It.

Avoid congestion before you reach it. By enhancing your vehicle's navigation system with the ability to see detailed traffic information, you can pinpoint traffic incidents, determine average traffic speed and estimate travel time along your route. Since the service is integrated with a vehicle's navigation system, SiriusXM Traffic can help drivers pick the fastest route based on traffic conditions.

- Detailed information on traffic speed, accidents, construction, and road closings.
- Traffic information from multiple sources, including police and emergency services, cameras and road sensors.
- Coast-to-coast delivery of traffic information.
- View conditions for points along your route and beyond. Available in over 130 markets.

SiriusXM Travel Link (8.4 NAV & US Market Only)

In addition to delivering over 130 channels of the best sports, entertainment, talk, and commercial-free music, SiriusXM offers premium data services that work in conjunction with compatible navigation systems. SiriusXM Travel Link brings a wealth of useful information into your vehicle and right to your fingertips.

- **Fuel Prices** — Check local gas and diesel prices in your area and route to the station of your choice.
- **Movie Listings** — Check local movie theatres and listings in your area and route to the theater of your choice.
- **Sports Scores** — In-game and final scores as well as weekly schedules.
- **Weather** — Check a variety of local and national weather information from radar maps to current and 5-day forecast.

SiriusXM Travel Link feature is completely integrated into your vehicle. A few minutes after you start your vehicle, Travel Link information arrives and updates in the background. You can access the information whenever you like, with no waiting.

ELECTRONICS

To access SiriusXM Travel Link, press “Apps” button on the touchscreen, then press the “SiriusXM Travel Link” button on the touchscreen.

NOTE:

SiriusXM Travel Link requires a subscription, sold separately after the five (5) year trial subscription included with your vehicle purchase.

SiriusXM Travel Link is only available in the United States.

UCONNECT 8.4/8.4 NAV VOICE RECOGNITION QUICK TIPS

Introducing Uconnect

Start using Uconnect Voice Recognition with these helpful quick tips. It provides the key Voice Commands and tips you need to know to control your Uconnect 8.4 NAV system.

If you see the  icon on your touchscreen, you have the Uconnect 8.4 NAV system. If not, you have a Uconnect 8.4 system.

WARNING!

ALWAYS drive safely with your hands on the wheel. You have full responsibility and assume all risks related to the use of the Uconnect features and applications in this vehicle. Only use Uconnect when it is safe to do so. Failure to do so may result in an accident involving serious injury or death.



Get Started

1. Visit **UconnectPhone.com** to check device and feature compatibility and to find device pairing instructions.
2. Reduce background noise. Wind and passenger conversations are examples of noise that may impact recognition.
3. Speak clearly at a normal pace and volume while facing straight ahead. The microphone is positioned on the headliner and aimed at the driver.
4. Each time you give a Voice Command, you must first push either the VR or Phone button, wait until **after** the beep, then say your Voice Command.
5. You can interrupt the help message or system prompts by pushing the VR or Phone button and saying a Voice Command from current category.

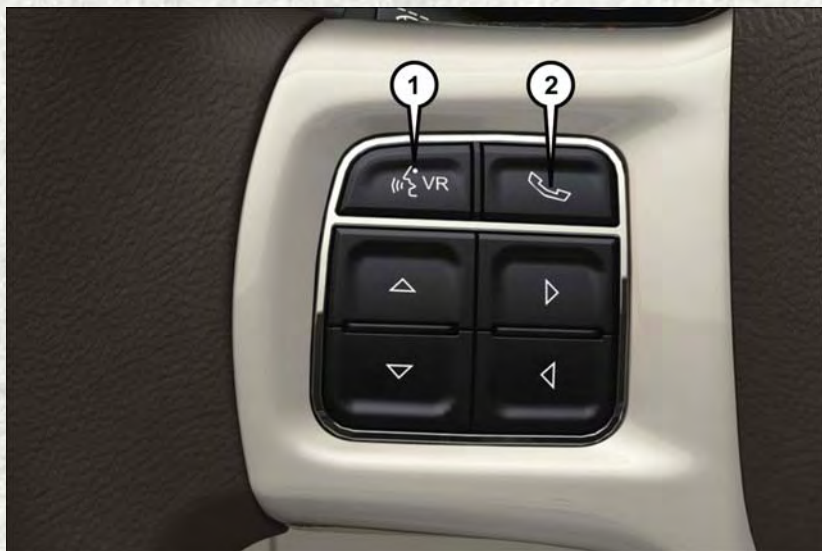
All you need to control your Uconnect system with your voice are the buttons on your steering wheel.



Uconnect VR And Phone Buttons

1. Uconnect Voice Recognition Button  VR.
 - a. Short Press: **Push and release** the VR button to begin Radio, Climate, Navigation, and other embedded functions. After you hear the single beep, say a command.
 - b. Long Press: **Push and hold continuously for a few milliseconds, then release** the VR button for Siri functions. After you hear the familiar Siri "double beep," say a command.
2. Uconnect Phone Button  , Push to initiate, answer, or end a phone call, send or receive a text.

Basic Voice Commands

The basic Voice Commands below can be given at any point while using your Uconnect system.

Push the VR button . After the beep, say:

- **Cancel** to stop a current voice session
- **Help** to hear a list of suggested Voice Commands
- **Repeat** to listen to the system prompts again

Notice the visual cues that inform you of your voice recognition system's status. Cues appear on the touchscreen.



Uconnect 8.4/8.4 NAV

Radio

Use your voice to quickly get to the AM, FM or SiriusXM Satellite Radio stations you would like to hear. (Subscription or included SiriusXM Satellite Radio trial required.)

Push the VR button . After the beep, say:

- **Tune to** ninety-five-point-five FM
- **Tune to** Satellite Channel Hits 1

TIP: At any time, if you are not sure of what to say or want to learn a Voice Command, push the VR button  and say **"Help."** The system will provide you with a list of commands.



Uconnect 8.4/8.4 NAV Radio

Siri Eyes Free — If Equipped

Siri lets you use your voice to send text messages, select media, place phone calls and much more. Siri uses your natural language to understand what you mean and will respond back to confirm your requests. The system is designed to keep your eyes on the road and your hands on the wheel by letting Siri help you perform useful tasks.

To enable Siri push and hold, then release the Uconnect Voice Recognition (VR) button on the steering wheel. After you hear a double beep, you can ask Siri to play podcasts and music, get directions, read text messages, and many other useful requests.



Siri Eyes Free Available

Getting Started

Ensure Siri is enabled on your iPhone.

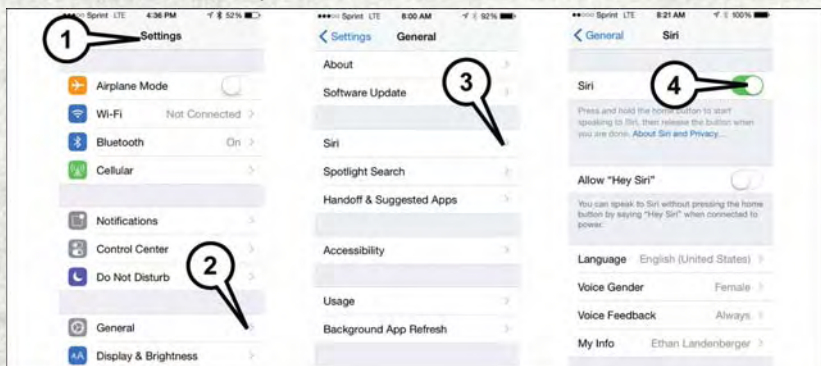

Enable Siri

1 — Select Settings On Your iPhone

2 — Select General

3 — Select Siri

4 — Enable Siri

1. Pair your Siri enabled device to the vehicles sound system. Refer to “Uconnect Phone” in “Electronics” for a detailed pairing procedure.



Pair Your iPhone

ELECTRONICS

2. Push and Hold, then release the Uconnect Voice Recognition (VR) button (Ⓜ️ VR on the steering wheel. After you hear the familiar Siri "double beep," say a command.

NOTE:

A **push and release** of the Ⓜ️ VR button will start normal embedded VR functions. The **push and hold, then release** of the Ⓜ️ VR button will start Siri functions.

3. After the double beep, begin speaking to Siri.

Examples of Siri commands and questions:

- "Play Rolling Stones"
- "Send text message to John"
- "Read text message from Sarah"
- "Take me to the nearest coffee shop"

NOTE:

- Speak clearly at a normal pace and volume while facing straight ahead to ensure your command is understood.
- Siri is available on iPhone 4S and later.



Siri Eyes Free

Media

Uconnect offers connections via USB, Bluetooth, and auxiliary ports (If Equipped). Voice operation is only available for connected USB and iPod devices.

Push the VR button . After the beep, say one of the following commands and follow the prompts to switch your media source or choose an artist.

- **Change source to** Bluetooth
- **Change source to** iPod
- **Change source to** USB
- **Play artist** Beethoven; **Play album** Greatest Hits; **Play song** Moonlight Sonata; **Play genre** Classical

TIP: Press the Browse button on the touchscreen to see all of the music on your iPod or USB device. Your Voice Command must match **exactly** how the artist, album, song and genre information is displayed.

Phone

Making and answering hands-free phone calls is easy with Uconnect. When the Phonebook button is illuminated on your touchscreen, your system is ready.

U.S. residents can visit:

- UconnectPhone.com for device compatibility and pairing instructions.

Canadian residents can visit:

- UconnectPhone.com for device compatibility and pairing instructions.

ELECTRONICS

Push the Phone button . After the beep, say one of the following commands...

- **Call** John Smith
- **Dial** 123-456-7890 and follow the system prompts
- **Redial** (call previous outgoing phone number)
- **Call back** (call previous incoming phone number)

TIP: When providing a Voice Command, push the Phone button  and say “**Call,**” then pronounce the name **exactly** as it appears in your phone book. When a contact has multiple phone numbers, you can say “**Call John Smith work.**”



Uconnect 8.4/8.4 NAV Phone

Voice Text Reply

Uconnect will announce **incoming** text messages. Push the Phone button  and say **Listen**. (Must have compatible device paired to Uconnect system.)

1. Once an incoming text message is read to you, push the Phone button . After the beep, say: **Reply**.
2. Listen to the Uconnect prompts. After the beep, repeat one of the pre-defined messages and follow the system prompts.

PRE-DEFINED VOICE TEXT REPLY RESPONSES		
Yes.	Stuck in traffic.	See you later.
No.	Start without me.	I'll be late.
Okay.	Where are you?	I will be <number> minutes late.
Call me.	Are you there yet?	
I'll call you later.	I need directions.	See you in <number> minutes.
I'm on my way.	Can't talk right now.	Thanks.
I'm lost.		

TIP: Your device must have the full implementation of the **Message Access Profile (MAP)** to take advantage of this feature. For details about MAP, visit UconnectPhone.com for U.S. residents. Apple iPhone iOS6 or later supports reading **incoming** text messages only. To enable this feature on your Apple iPhone, follow these four simple steps:

1. Select "Settings."
2. Select "Bluetooth."
3. Select The (i) For The Paired Vehicle.
4. Turn On "Show Notifications."

TIP: Voice Text Reply is not compatible with iPhone, but if your vehicle is equipped with Siri Eyes Free, you can use your voice to send a text message.



iPhone Notification Setting

ELECTRONICS

Climate (8.4/8.4 NAV)

Too hot? Too cold? Adjust vehicle temperatures hands-free and keep everyone comfortable while you keep moving ahead. (If vehicle is equipped with climate control.)

Push the VR button . After the beep, say one of the following commands:

- **Set driver temperature to 70 degrees**
- **Set passenger temperature to 70 degrees**

TIP: Voice Command for Climate may only be used to adjust the interior temperature of your vehicle. Voice Command will not work to adjust the heated seats or steering wheel (if equipped).



Uconnect 8.4/8.4 NAV Climate

Navigation (8.4/8.4 NAV)

The Uconnect navigation feature helps you save time and become more productive when you know exactly how to get to where you want to go. (Navigation is optional on the Uconnect 8.4 system. See your dealer to activate navigation at any time.)

1. To enter a destination, push the VR button . After the beep, say:

- For the 8.4 Uconnect System, say: **Enter state**.
- For the 8.4 NAV Uconnect System, say: **Find Address** 800 Chrysler Drive Auburn Hills, Michigan.

2. Then follow the system prompts.

TIP: To start a Point Of Interest (POI) search, push the VR button . After the beep, say “**Find nearest** coffee shop.”



Uconnect 8.4/8.4 NAV Navigation

Uconnect Access — If Equipped (8.4/8.4 NAV)

WARNING!

ALWAYS obey traffic laws and pay attention to the road. Some Uconnect Access services, including 9-1-1 and Assist, will NOT work without an operable 1X(voice/data) or 3G(data) network connection.

NOTE:

Your vehicle may be transmitting data as authorized by the subscriber.

An included trial and/or subscription is required to take advantage of the Uconnect Access services in the next section of this guide. To register with Uconnect Access, press the “Apps” button on the 8.4-inch touchscreen to get started. Detailed registration instructions can be found on the next page.

NOTE:



- If your vehicle is not connected to an operable 1X (voice/data) or 3G (data) network, the signal strength bars on the “Apps” button on the touchscreen will show a single bar and a prohibition symbol to indicate your vehicle is not connected to an operable 1X (voice/data) or 3G (data) network.
- Uconnect Access is available only on properly equipped vehicles purchased within the continental United States, Alaska and Hawaii when connected to an operable 1X (voice/data) or 3G (data) network. Services can only be used where coverage is available; see coverage map for details.

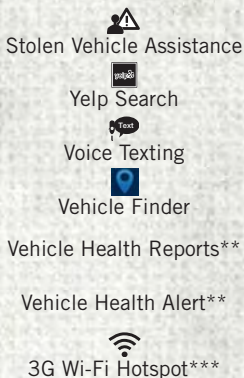
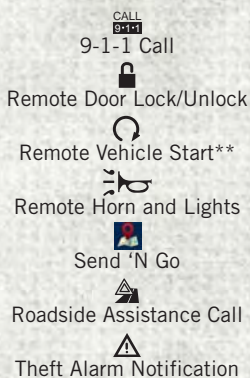

**If vehicle is properly equipped.

***Extra charges apply.

Register (8.4/8.4 NAV)

To unlock the full potential of Uconnect Access in your vehicle, you first need to register with Uconnect Access.

1. Push the ASSIST button on your rearview mirror.
2. Press the “Uconnect Care” button on the touchscreen.
3. A helpful Uconnect Care Agent will register your vehicle and handle all of the details.

Signing up is easy! Simply follow the steps above. Or, press the “Apps  ” button on the touchscreen, then select the Uconnect registration app to “Register By Web” to complete the process using your device or computer.

For further information please visit www.driveuconnect.com



Uconnect 8.4 Registration

Mobile App (8.4/8.4 NAV)

You're only a few steps away from using remote commands and sending a destination from your phone to your vehicle.

To use the Uconnect Access Mobile App:

- Once you have registered your Uconnect Access services, download the Uconnect Access app to your mobile device. Use your Owner Account login and password to open the app.
- Once on the “Remote” screen, you can begin using Remote Door Lock/Unlock, Remote Vehicle Start, and activate your horn and lights remotely, if equipped.
- Press the “Location” button on the bottom menu bar of the app to bring up a map to locate your vehicle or send a location to your Uconnect Navigation using Vehicle Finder and Send 'n Go , if equipped.
- Press the “Settings” side menu in the upper left corner of the app to bring up app settings



Mobile App

Voice Texting (8.4/8.4 NAV)

You must be registered with Uconnect Access and have a compatible MAP – enabled device to use your voice to send a personalized text message. (Not compatible with iPhone.)

1. To send a message, push the Phone button . After the beep, say: “**Send message** to John Smith.”
2. Listen to the prompt. After the beep, dictate the message you would like to send. Wait for Uconnect to process your message.
3. The Uconnect system will repeat your message and provide a variety of options to add to, delete, send or hear the message again. After the beep, tell Uconnect what you’d like to do. For instance, if you’re happy with your message, after the beep, say “**Send.**”

You must be registered with Uconnect Access and have a compatible MAP – enabled device to use your voice to send a personalized text message. For details about MAP, visit UconnectPhone.com. Apple iPhone iOS6 or later supports reading incoming text messages only. To enable this feature on your Apple iPhone, follow these four simple steps:

1. Select “Settings.”
2. Select “Bluetooth.”
3. Select the (i) for the paired vehicle.
4. Turn on “Show Notifications.”

TIP:



- Voice Texting is not compatible with iPhone, but if your vehicle is equipped with Siri Eyes Free, you can use your voice to send a text message.
- Messages are limited to 140 characters.
- The Messaging button on the touchscreen must be illuminated to use the feature.



iPhone Notification Setting

Yelp (8.4/8.4 NAV)

Once registered with Uconnect Access, you can use your voice to search for the most popular places or things around you.

1. Push the VR button . After the beep, say: **Launch YELP.**
2. Once the YELP home screen appears on the touchscreen, push the VR button , then say: **YELP search.**
3. Listen to the system prompts and after the beep, tell Uconnect the place or business that you'd like Uconnect to find.

TIP: Once you perform a search, you can reorganize the results by selecting either the Best Match, Rating or Distance tab on the top of the touchscreen display.



Yelp

SiriusXM Travel Link (8.4/8.4 NAV — US Market Only)

Need to find a gas station, view local movie listings, check a sports score or the five - day weather forecast? SiriusXM Travel Link is a suite of services that brings a wealth of information right to your Uconnect 8.4 NAV system. (Not available for 8.4 system.)

Push the VR button . After the beep, say one of the following commands:

- Show fuel prices
- Show five - day weather forecast
- Show extended weather

TIP: Traffic alerts are not accessible with Voice Command.



SiriusXM Travel Link

Additional Information

© 2017 FCA US LLC. All rights reserved. Mopar, Mopar Owner Connect and Uconnect are registered trademarks of FCA US LLC. Android is a trademark of Google Inc. Yelp, Yelp logo, Yelp burst and related marks are registered trademarks of Yelp. SiriusXM and all related marks and logos are trademarks of SiriusXM Radio Inc.

For Uconnect system support, visit DriveUconnect.com or call: 1-877-855-8400 (24 hours a day 7 days a week)

Uconnect Access Services Support: 1-855-792-4241. Please have your Uconnect Security PIN ready when you call.

UCONNECT PHONE

Uconnect Phone (Bluetooth Hands Free Calling)



Uconnect 5.0 Phone Menu

- | | |
|--------------------------------------|---|
| 1 — Call/Redial/Hold | 7 — Uconnect Phone Settings Menu |
| 2 — Mobile Phone Signal Strength | 8 — Text Messaging |
| 3 — Currently Paired Mobile Phone | 9 — Direct Dial Pad |
| 4 — Mobile Phone Battery Life | 10 — Recent Call Log |
| 5 — Mute Microphone | 11 — Browse Phone Book (Contains 9-1-1) |
| 6 — Transfer To/From Uconnect System | 12 — End Call |



Uconnect 8.4/8.4 NAV Phone Menu

- | | |
|--------------------------------------|---|
| 1 — Favorite Contacts | 12 — Browse Phone Book Entries (Contains 9-1-1) |
| 2 — Mobile Phone Battery Life | 13 — End Call |
| 3 — Currently Paired Mobile Phone | 14 — Call/Redial/Hold |
| 4 — Mobile Phone Signal Strength | 15 — Do Not Disturb |
| 5 — Mute Microphone | 16 — Reply with Text Message |
| 6 — Transfer To/From Uconnect System | * — Conference call feature only available on GSM mobile devices |
| 7 — Conference Call* | ** — Text messaging feature not available on all mobile phones (requires Bluetooth MAP profile) |
| 8 — Manage Paired Mobile Phones | |
| 9 — Text Messaging** | |
| 10 — Direct Dial Pad | |
| 11 — Recent Call Log | |

The Uconnect Phone feature enables you to place and receive hands-free mobile phone calls. Drivers can also place mobile phone calls using their voice or by using the buttons on the touchscreen (see Voice Command section).

The hands-free calling feature is made possible through Bluetooth technology — the global standard that enables different electronic devices to connect to each other wirelessly.

If the Uconnect Phone Button  exists on your steering wheel, you then have the Uconnect Phone features.

NOTE:

- The Uconnect Phone requires a mobile phone equipped with the Bluetooth Hands-Free Profile, Version 1.0 or higher.

- Most mobile phones/devices are compatible with the Uconnect system, however some mobile phones/devices may not be equipped with all of the required features to utilize all of the Uconnect system features.
- For Uconnect Customer Care:
 - U.S. residents visit UconnectPhone.com or call 1-877-855-8400.

Pairing (Wirelessly Connecting) Your Mobile Phone To The Uconnect System

Mobile phone pairing is the process of establishing a wireless connection between a cellular phone and the Uconnect system.

NOTE:

- To use the Uconnect Phone feature, you first must determine if your mobile phone and software are compatible with the Uconnect system. Please visit UconnectPhone.com for complete mobile phone compatibility information.
- Mobile phone pairing is not available while the vehicle is in motion.
- A maximum of ten mobile phones can be paired to the Uconnect system.

Start Pairing Procedure On The Radio

Uconnect 5.0:

1. Place the ignition in the ACC or ON position.
2. Press the "Phone" button.
3. Select "Settings."
4. Select "Paired Phones."
5. Select "Add device."
 - Uconnect Phone will display an "In progress" screen while the system is connecting.



Uconnect 5.0

Uconnect 8.4, 8.4 NAV:

1. Place the ignition in the ACC or ON position.
2. Press the "Phone" button in the Menu Bar on the touchscreen.
3. Select "Settings."
4. Select "Paired Phones."
5. Select "Add device."
 - Uconnect Phone will display an "In progress" screen while the system is connecting.



Uconnect 8.4 & 8.4 NAV

Pair Your iPhone:

To search for available devices on your Bluetooth enabled iPhone:

1. Press the Settings button.
2. Select Bluetooth.
 - Ensure the Bluetooth feature is enabled. Once enabled, the mobile phone will begin to search for Bluetooth connections.
3. When your mobile phone finds the Uconnect system, select "Uconnect".



Bluetooth On/Uconnect Device

Complete The iPhone Pairing Procedure:

1. When prompted on the mobile phone, accept the connection request from Uconnect Phone.

NOTE:

Some mobile phones will require you to enter the PIN number.



Pairing Request

Select The iPhone's Priority Level

When the pairing process has successfully completed, the system will prompt you to choose whether or not this is your favorite mobile phone. Selecting “Yes” will make this mobile phone the highest priority. This mobile phone will take precedence over other paired mobile phones within range and will connect to the Uconnect system automatically when entering the vehicle. Only one mobile phone and/or one Bluetooth audio device can be connected to the Uconnect system at a time. If “No” is selected, simply select “Uconnect” from the mobile phone/audio device Bluetooth screen, and the Uconnect system will reconnect to the Bluetooth device.

Pair Your Android Device:

To search for available devices on your Bluetooth enabled Android Device:

1. Push the Menu button.
2. Select Settings.
3. Select Connections.
4. Turn Bluetooth setting to “On.”
 - Ensure the Bluetooth feature is enabled. Once enabled, the mobile phone will begin to search for Bluetooth connections.
5. Once your mobile phone finds the Uconnect system, select “Uconnect”.
 - You may be prompted by your mobile phone to download the phonebook, check “Do Not Ask Again” to automatically download the phonebook. This is so you can make calls by saying the name of your contact.



Uconnect Device

Complete The Android Pairing Procedure:

1. Confirm the passkey shown on the mobile phone matches the passkey shown on the Uconnect system then accept the Bluetooth pairing request.

NOTE:

Some mobile phones require the PIN to be entered manually, enter the PIN number shown on the Uconnect screen.

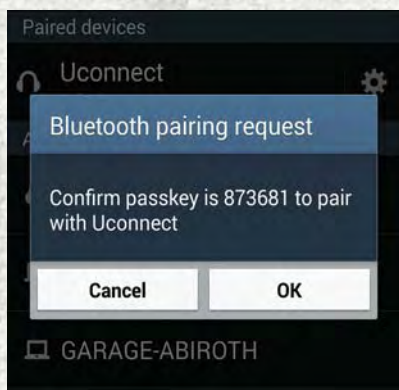

Pairing Request

Select The Android Mobile Phone's Priority Level

When the pairing process has successfully completed, the system will prompt you to choose whether or not this is your favorite mobile phone. Selecting “Yes” will make this mobile phone the highest priority. This mobile phone will take precedence over other paired mobile phones within range and will connect to the Uconnect system automatically when entering the vehicle. Only one mobile phone and/or one Bluetooth audio device can be connected to the Uconnect system at a time. If “No” is selected, simply select “Uconnect” from the mobile phone/audio device Bluetooth screen, and the Uconnect system will reconnect to the Bluetooth device.

You are now ready to make hands-free calls. Press the Uconnect “Phone” button  on your steering wheel to begin.

NOTE:

Refer to UconnectPhone.com website for additional information on mobile phone pairing and for a list of compatible phones.

Common Phone Commands (Examples)

- “Call John Smith”
- “Call John Smith mobile”
- “Dial 1 248 555 1212”
- “Redial”

Mute (Or Unmute) Microphone During Call

- During a call, press the “Mute” button on the Phone main screen to mute and unmute the call.

Transfer Ongoing Call Between Handset And Vehicle

- During an on-going call, press the “Transfer” button on the Phone main screen to transfer an on-going call between handset and vehicle.

Phonebook

The Uconnect system will automatically sync your phonebook from your paired phone, if this feature is supported by your phone. Phonebook contacts are updated each time that the phone is connected. If your phone book entries do not appear, check the settings on your phone. Some phones require you to enable this feature manually.

- Your phonebook can be browsed on the Uconnect system touchscreen, but editing can only be done on your phone. To browse, press the “Phone” button on the touchscreen, then the “Phonebook” button on the touchscreen.

Favorite phonebook entries can be saved as Favorites for quicker access. Favorites are shown at the top of the main phone screen.

Voice Command Tips

- Speaking complete names (i.e; Call John Doe vs. Call John) will result in greater system accuracy.
- You can “link” commands together for faster results. Say “Call John Doe, mobile,” for example.
- If you are listening to available voice command options, you do not have to listen to the entire list. When you hear the command that you need, push the  VR button on the steering wheel, wait for the beep and say your command.



Changing The Volume

- Start a dialogue by pushing the Phone button , then say a command. For example, "Help".
- Use the radio VOLUME/MUTE rotary knob to adjust the volume to a comfortable level while the Uconnect system is speaking.

NOTE:

The volume setting for Uconnect is different than the audio system.

NOTE:

To access help, push the Uconnect Phone button  on the steering wheel and say "help." Push the Uconnect Phone Pickup button  or the VR button  and say "cancel" to cancel the help session.

Using Do Not Disturb

With Do Not Disturb, you can disable notifications from incoming calls and texts, allowing you to keep your eyes on the road and hands on the wheel. For your convenience, there is a counter display to keep track of your missed calls and text messages while you were using Do Not Disturb.

Do Not Disturb can automatically reply with a text message, a call or both, when declining an incoming call and send it to voicemail.

Automatic reply messages can be:

- “I am driving right now, I will get back to you shortly.”
- Create a custom auto reply message up to 160 characters.

While in Do Not Disturb, Conference Call can be selected so you can still place a second call without being interrupted by incoming calls.

NOTE:

- Only the beginning of your custom message will be seen on the touchscreen.
- Reply with text message is not compatible with iPhones.
- Auto reply with text message is only available on phones that supporting Bluetooth MAP.

Incoming Text Messages

After pairing your Uconnect system with a Bluetooth enabled mobile device with the Message Access Profile (MAP), the Uconnect system can announce a new incoming text message and read it to you over the vehicle's audio system.

NOTE:

Only incoming text messages received during the current ignition cycle can be viewed/read.

To enable incoming text messaging:

iPhone

1. Press the settings button on the mobile phone.
2. Select Bluetooth.
 - Ensure Bluetooth is enabled, and the mobile phone is paired to the Uconnect system.
3. Select ⓘ located under DEVICES next to Uconnect.
4. Turn "Show Notifications" to on.



Enable iPhone Incoming Text Messages

Android Devices

1. Push the Menu button on the mobile phone.
2. Select Settings.
3. Select Connections.
4. Turn “Show Notifications” to on.

- A pop up will appear asking you to accept a request for permission to connect to your messages. Select “Don’t ask again” and press OK.

NOTE:

All incoming text messages received during the current ignition cycle will be deleted from the Uconnect system when the ignition is turned to the OFF position.

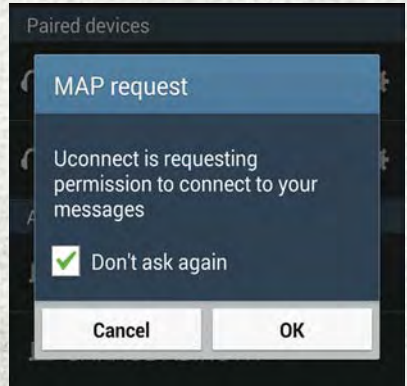

Enable Android Device Incoming Text Messages

Voice Text Reply (Not Compatible With iPhone)

NOTE:

Voice texting reply and voice texting features require a compatible mobile device enabled with Bluetooth Message Access Profile (MAP). iPhone, and some other smartphones, may not entirely support Bluetooth MAP. Visit UconnectPhone.com for the latest system and device compatibility.

- Due to the extremely large number of mobile phone manufacturers, your mobile device may not be listed. For further assistance, contact Uconnect Customer Care at 1-877-855-8400 for U.S. residents or, 1-800-465-2001 (English) / 1-800-387-9983 (French) for Canadian residents.

Once your Uconnect system is paired with a compatible mobile device, the system can announce a new incoming text message, and read it to you over the vehicle audio system. You can reply to the message using Voice Recognition by selecting, or saying, one of the 18 pre-defined messages.

Here's How:

1. Push the Uconnect Phone button  and wait for the beep, then say "reply." Uconnect will give the following prompt: "Please say the message you would like to send."
2. Wait for the beep and say one of the pre-defined messages. (If you are not sure, you can say "help"). Uconnect will then read the pre-defined messages allowed.
3. As soon as you hear the message you would like to send, you can interrupt the list of prompts by pushing the Uconnect phone button and saying the phrase. Uconnect will confirm the message by reading it back to you.
4. Push the Phone button and say "send."

PRE-DEFINED VOICE TEXT REPLY RESPONSES		
Yes.	Stuck in traffic.	See you later.
No.	Start without me.	I'll be late.
Okay.	Where are you?	I will be <5, 10, 15,...etc.> minutes late.
Call me.	Are you there yet?	
I'll call you later.	I need directions.	See you in <5, 10, 15,...etc.> of minutes.
I'm on my way.	Can't talk right now.	
I'm lost.		Thanks.

NOTE:

To make the SMS voice reading function available, the SMS notification option on your phone must be enabled; this option is usually available on the phone, in the Bluetooth connections menu for a device registered as Uconnect. After enabling this function on the mobile phone, it must be disconnected and reconnected with the Uconnect system in order to make it effective.

Helpful Tips And Common Questions To Improve Bluetooth Performance With Your Uconnect System

Mobile Phone won't reconnect to system after pairing:

- Set mobile phone to auto-connect or trusted device in mobile phone Bluetooth settings (Blackberry devices).
- Perform a factory reset on your mobile phone. Refer to your mobile phone manufacturer or cellular provider for instructions.
- Many mobile phones do not automatically reconnect after being restarted (hard reboot). Your mobile phone can still be connected manually. Close all applications that may be operating (refer to mobile phone manufacturer's instructions), and follow "Pairing (Wirelessly Connecting) Your Mobile Phone To The Uconnect System".

Mobile Phone won't pair to system:

- Perform a hard reset in the mobile phone by removing the battery (if removable — see your mobile phone's owner manual).

- Delete pairing history in mobile phone and Uconnect system, usually found in phone's Bluetooth connection settings.
- Verify you are selecting "Uconnect" in the discovered Bluetooth devices on your mobile phone.
- If your vehicle system does not generate a pin code, the default is 0000.

Mobile Phonebook didn't download:

- Check "Do not ask again," then accept the "phonebook download" request on your mobile phone.
- Up to 5,000 contact names with four numbers per contact will transfer to the Uconnect 8.4/8.4 NAV system phonebook.
- Up to 2,000 contact names with six numbers per contact will transfer to the Uconnect 5.0 system phonebook.

Text messaging won't work:

- Check "Do not ask again," then accept the "connect to your messages" request on your mobile phone.
- Verify that your mobile phone has the Bluetooth feature (Message Access Profile).

Can't make a conference call:

- CDMA (Code-Division Multiple Access) carriers do not support conference calling. Refer to your mobile phone user's manual for further information.

Making calls while connected to AUX:

- Plugging in your mobile phone to AUX while connected to Bluetooth will disable Hands-Free Calling. Do not make calls while your mobile phone is plugged into the AUX jack.

STEERING WHEEL AUDIO CONTROLS

The steering wheel audio controls are located on the rear surface of the steering wheel.

Right Switch

- Push the switch up or down to increase or decrease the volume.
- Push the button in the center to change modes AM/FM/CD/SXM.

Left Switch

- Push the switch up or down to search for the next listenable station.
- Push the button in the center to select the next preset station.



Steering Wheel Audio Controls

INSTRUMENT CLUSTER DISPLAY

The instrument cluster display features an interactive display that is located in the instrument cluster. Pushing the controls on the left side of the steering wheel allows the driver to select vehicle information and Personal Settings. Refer to “Programmable Features” in this section for further information.

- Push and release the **up** arrow button to scroll upward through the main menus and submenus (Digital Speedometer, Vehicle Info, Fuel Economy Info, Trip A, Trip B, Stop/Start, Trailer Tow, Audio, Stored Messages, Screen Setup, Vehicle Settings).
- Push and release the **down** arrow button to scroll downward through the main menus and submenus.
- Push and release the **right** arrow button for access to main menus, submenus or to select a personal setting in the setup menu. Push and hold the **right** arrow button for two seconds to reset features.
- Push and release the **left** arrow button to scroll back to a previous menu or submenu.



Instrument Cluster Display Controls

Compass Calibration

This compass is self-calibrating, which eliminates the need to set the compass manually. When the vehicle is new, the compass may appear erratic, and the instrument cluster display will display “CAL” until the compass is calibrated.

You may also calibrate the compass by completing one or more 360 degree turns (in an area free from large metal or metallic objects) until the “CAL” message displayed in the instrument cluster display turns off. The compass will now function normally.

PROGRAMMABLE FEATURES

Instrument Cluster Display Programmable Features

The instrument cluster display can be used to view or change the following settings. Push the **up** or **down** arrow button until System Setup displays, then push the **right** arrow button. Scroll through the settings using the **up** or **down** arrow button. Push the **right** arrow button to change the setting. Push the **left** arrow button to scroll back to a previous menu or sub menu.

- Language Select
- Units
- ParkSense
- Tilt Mirror In Reverse
- Rain Sensing Wipers
- Hill Start Assist
- Headlights Off Delay
- Illuminated Approach
- Headlights On With Wipers
- Automatic Highbeams
- Flash Lights With Lock
- Auto Lock Doors
- Auto Unlock Doors
- Sound Horn With Remote Start
- Sound Horn With Remote Lock
- Remote Unlock Sequence
- Key Fob Linked To Memory
- Passive Entry
- Remote Start Comfort System
- Easy Exit Seat
- Key Off Power Delay
- Commercial Settings
- Air Suspension Display Alerts
- Aero Ride Height Mode
- Tire/Jack Mode
- Transport Mode
- Wheel Alignment Mode
- Horn With Remote Lower
- Lights With Remote Lower
- Trailer Select
- Brake Type
- Trailer Name
- Compass Variance
- Calibrate Compass
- Fuel Saver Display
- Park Assist Front Chime Volume
- Park Assist Rear Chime Volume

Uconnect Customer Programmable Features

The Uconnect system allows you to access Customer Programmable feature settings such as Display, Voice, Clock, Safety & Driving Assistance, Lights, Doors & Locks, Auto-On Comfort, Engine Off Options, Compass Settings (Uconnect 5.0,) Trailer Brake, Suspension, Audio, Phone/Bluetooth, SiriusXM Setup, Restore Settings, Clear Personal Data, and System Information through buttons on the touchscreen.

- Push the SETTINGS button (Uconnect 5.0), or press the “Apps” button (Uconnect 8.4) located near the bottom of the touchscreen, then press the “Settings” button on the touchscreen to access the Settings screen. When making a selection, scroll up or down until the preferred setting is highlighted, then press the preferred setting until a check-mark appears next to the setting, showing that setting has been selected. The following feature settings are available:
 - Display
 - Voice
 - Clock
 - Safety & Driving Assistance
 - Lights
 - Doors & Locks
 - Auto-On Comfort
 - Engine Off Options
 - Trailer Brake
 - Suspension
 - Audio
 - Phone/Bluetooth
 - SiriusXM Setup
 - Restore Settings
 - Clear Personal Data
 - System Information
 - Compass Settings (Uconnect 5.0)

NOTE:

Depending on the vehicles options, feature settings may vary.

Refer to “Uconnect Settings/Customer Programmable Features” found within “Understanding Your Instrument Panel” located in your Owner’s Manual on www.ramtrucks.com/en/owners/manuals for further information.

Instrument Cluster Reconfigurable Screen Setup

The following settings allow you to change what information is displayed in the instrument cluster as well as the location that information is displayed.

Digital Speedometer

- Push the **up** or **down** arrow button until the Digital display icon is highlighted in the instrument cluster display. Push the **right** arrow button to change the display between km/h and mph.

Vehicle Info (Customer Information Features)

- Push the **up** or **down** arrow button until the Vehicle Info icon is highlighted in the instrument cluster display. Push the **right** or **left** arrow button to scroll through the following Vehicle Info submenus:
 - Tire Pressure Monitor System
 - Air Suspension — If Equipped
 - Coolant Temperature (Diesel Only)
 - Transmission Temperature (Automatic Transmission Only)
 - Oil Temperature
 - Oil Pressure
 - Oil Life
 - Fuel Filter Life (Diesel Only)
 - Battery Voltage
 - Exhaust Brake (Diesel Only)
 - Turbo Boost (Diesel Only)
 - Gauge Summary
 - Engine Hours

Trip A

- Push the **up** or **down** arrow button until the Trip A icon is highlighted in the instrument cluster display. Push and hold the **right** arrow button to reset the Trip A information.

Trip B

- Push the **up** or **down** arrow button until the Trip B icon is highlighted in the instrument cluster display. Push and hold the **right** arrow button to reset the Trip B information.

Fuel Economy

- Push the **up** or **down** arrow button until the Fuel Economy icon is highlighted in the instrument cluster display. The screen will display the following:
 - Average Fuel Economy/Miles Per Gallon
 - Range To Empty (RTE)
 - Current Miles Per Gallon (MPG)
 - Dual Tanks — If Equipped (Heavy Duty Only)

Trailer Tow

- Push the **up** or **down** arrow button until the Trailer Tow icon is highlighted in the instrument cluster display. The screen will display the following information:
 - Trailer Trip Distance

Audio

- Push the **up** or **down** arrow button until the Audio display icon is highlighted in the instrument cluster display. This screen will display the current media source.

Screen Setup

- Push the **up** or **down** arrow button until the Screen Setup display icon is highlighted in the instrument cluster display. Push the **right** arrow button to enter the Screen Setup submenu. The Screen Setup feature allows you to change what information is displayed in the instrument cluster as well as the location that information is displayed.

UNIVERSAL GARAGE DOOR OPENER (HOMELINK)

HomeLink replaces up to three hand-held transmitters that operate devices such as garage door openers, motorized gates, lighting or home security systems. The HomeLink unit is powered by your vehicle's 12 Volt battery.

The HomeLink buttons that are located in the overhead console or sunvisor designate the three different HomeLink channels.

The HomeLink indicator is located above the center button.

Before You Begin Programming HomeLink

Ensure that your vehicle is parked outside of the garage before you begin programming.

For efficient programming and accurate transmission of the radio-frequency signal, it is recommended that a new battery be placed in the hand-held transmitter of the device that is being programmed to the HomeLink system.



Universal Garage Door Opener (HomeLink) Buttons

To erase the channels, place the ignition switch into the ON/RUN position, then push and hold the two outside HomeLink buttons (I and III) for up to 20 seconds or until the red indicator flashes.

NOTE:

Erasing all channels should only be performed when programming HomeLink for the first time. Do not erase channels when programming additional buttons.

If you have any problems, or require assistance, please call toll-free 1-800-355-3515 or, on the Internet at HomeLink.com for information or assistance.

Programming A Rolling Code

NOTE:

For programming Garage Door Openers that were manufactured after 1995. These Garage Door Openers can be identified by the "LEARN" or "TRAIN" button located where the hanging antenna is attached to the Garage Door Opener. It is NOT the button that is normally used to open and close the door. The name and color of the button may vary by manufacturer.

1. Place the ignition switch into the ON/RUN position.

For vehicle's equipped with Keyless Enter-N-Go, place the ignition in the RUN position with the Engine ON.

2. Place the hand-held transmitter 1 to 3 inches (3 to 8 cm) away from the HomeLink button you wish to program while keeping the HomeLink indicator light in view.
3. Simultaneously push and hold both the HomeLink button you want to program and the hand-held transmitter button.
4. Continue to hold the buttons until the Instrument Cluster Display changes from "CHANNEL # TRAINING" to "CHANNEL # TRAINED", then release both buttons.

NOTE:

- It may take up to 30 seconds or longer in some cases for the channel to train.
 - If "DID NOT TRAIN" appears in the instrument cluster display repeat from Step 2.
5. At the garage door opener motor (in the garage), locate the "LEARN" or "TRAINING" button. This can usually be found where the hanging antenna wire is attached to the garage door opener motor. Firmly push and release the "LEARN" or "TRAINING" button. On some garage door openers/devices there may be a light that blinks when the garage door opener/device is in the LEARN/TRAIN mode.

NOTE:

You have 30 seconds in which to initiate the next step after the LEARN button has been pushed.

6. Return to the vehicle and push the programmed HomeLink button twice (holding the button for two seconds each time). The instrument cluster display will show "CHANNEL # TRANSMIT". If the garage door opener/device activates, programming is complete.

NOTE:

If the device does not activate, push the button a third time (for two seconds) to complete the training.

7. To program the remaining two HomeLink buttons, repeat each step for each remaining button. DO NOT erase the channels.

Programming A Non-Rolling Code

NOTE:

For programming Garage Door Openers manufactured before 1995:

1. Turn the ignition switch to the ON/RUN position.
For vehicle's equipped with Keyless Enter-N-Go, place the ignition in the RUN position with the Engine ON.
2. Place the hand-held transmitter 1 to 3 inches (3 to 8 cm) away from the HomeLink button you wish to program while keeping the HomeLink indicator light in view.
3. Simultaneously push and hold both the HomeLink button you want to program and the hand-held transmitter button.
4. Continue to hold both buttons until the instrument cluster display changes from "CHANNEL # TRAINING" to "CHANNEL # TRAINED", then release both buttons.
5. Push and hold the programmed HomeLink button and observe the indicator light.

NOTE:

If the instrument cluster display displays "DID NOT TRAIN" repeat from Step 2.

- To program the two remaining HomeLink buttons, repeat each step for each remaining button. DO NOT erase the channels.

Using HomeLink

To operate, push and release the programmed HomeLink button. Activation will now occur for the programmed device (i.e., garage door opener, gate operator, security system, entry door lock, home/office lighting, etc.,). The hand-held transmitter of the device may also be used at any time.

WARNING!

- Your motorized door or gate will open and close while you are programming the universal transceiver. Do not program the transceiver if people or pets are in the path of the door or gate.
- Do not run your vehicle in a closed garage or confined area while programming the transceiver. Exhaust gas from your vehicle contains Carbon Monoxide (CO) which is odorless and colorless. Carbon Monoxide is poisonous when inhaled and can cause you and others to be severely injured or killed.

POWER INVERTER

A 115 Volt, 150 Watt power inverter outlet is located on the lower instrument panel next to the climate control knob. This outlet can power cellular phones, electronics and other low power devices requiring power up to 150 Watts.

To turn on the power outlet, simply plug in the device. The outlet automatically turns off when the device is unplugged.

NOTE:

The power inverter is designed with built-in overload protection. If the power rating of 150 Watts is exceeded, the power inverter will automatically shut down. Once the electrical device has been removed from the outlet, the inverter should automatically reset.



Power Inverter

WARNING!

To Avoid Serious Injury or Death DO NOT:

- insert any objects into the receptacles
- touch with wet hands

Close the lid when not in use. If this outlet is mishandled, it may cause an electric shock and failure.

ELECTRONICS

POWER OUTLETS

The auxiliary 12 Volt (13 Amp) power outlets can provide power for in-cab accessories designed for use with the standard “cigar lighter” plug. The 12 Volt power outlets have a cap attached to the outlet indicating “12V DC”, together with either a key symbol or a battery symbol.

The auxiliary power outlets can be found in the following locations:

- Lower left and lower right in the center of the instrument panel – if equipped with a column or a eight-speed electronic gear selector.
- Inside the top storage tray.



Power Outlet — Center Console

- Rear of the center console storage compartment.



Power Outlet — Rear Console

- Inside the upper lid of the center storage compartment.

NOTE:

- Do not exceed the maximum power of 160 Watts (13 Amps) at 12 Volts. If the 160 Watt (13 Amp) power rating is exceeded, the fuse protecting the system will need to be replaced.
- Power outlets are designed for accessory plugs only. Do not insert any other object in the power outlet as this will damage the outlet and blow the fuse. Improper use of the power outlet can cause damage not covered by your new vehicle warranty.
- The rear center console power outlet can be switched to “ignition” powered all the time by switching the power outlet rear center console fuse in the fuse panel.



Power Outlet (USB Charge Only Port) — Storage Compartment

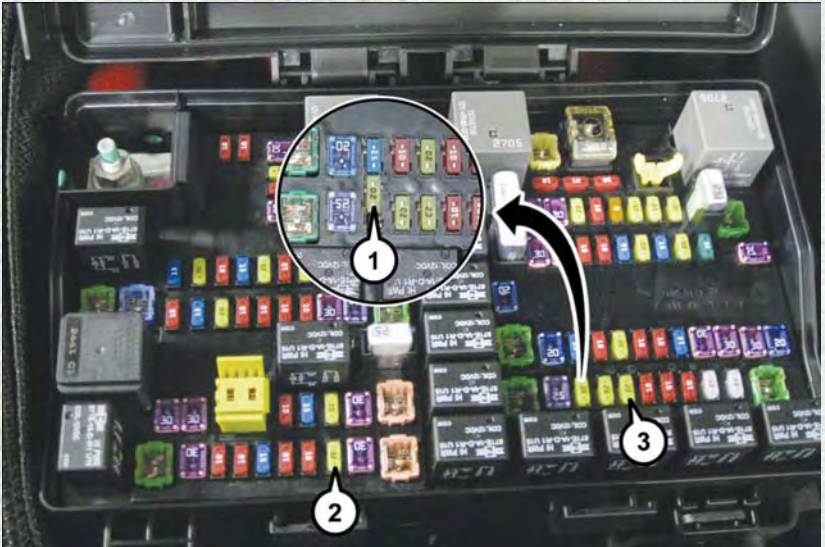

Power Outlet Fuse Locations

- 1 — F90 – F91 Fuse 20A Yellow Power Outlet Rear Center Console
- 2 — F104 Fuse 20A Yellow Power Outlet Center Console
- 3 — F93 Fuse 20A Yellow Cigar Lighter Instrument Panel

AUXILIARY SWITCHES — IF EQUIPPED

There can be up to five auxiliary switches located in the lower switch bank of the instrument panel which can be used to power various electronic devices and PTO (Power Take Off) – If Equipped. If Power Take Off is equipped, it will take the place of the fifth Auxiliary switch. Connections to the switches are found under the hood in the connectors attached to the auxiliary Power Distribution Center.

You have the ability to configure the functionality of the auxiliary switches via the instrument cluster display. All switches can now be configured for setting the switch type operation to latching or momentary, power source of either battery or ignition, and ability to hold last state across key cycles.

NOTE:

Holding last state conditions are met when switch type is set to latching and power source is set to ignition.

For further information on using the auxiliary switches, please refer to the Ram Body Builders Guide by accessing www.rambodybuilder.com and choosing the appropriate links.

OFF-ROAD CAPABILITIES

FOUR-WHEEL DRIVE OPERATION — IF EQUIPPED

- Four-wheel drive trucks are equipped with either a manually shifted transfer case or an electronically shifted transfer case. Refer to the operating instructions for electronic transfer case, located in this section for further information.
- For further information on the manually shifted transfer case, refer to “Four Wheel Drive Operation” in “Starting And Operating” in your Owner’s Manual located on www.ramtrucks.com/en/owners/manuals.

Electronically Shifted Transfer Case (Four-Position Switch) — If Equipped

The electronic shift transfer case is operated by the 4WD Control Switch (Transfer Case Switch), which is located on the instrument panel.

This electronically shifted transfer case provides four mode positions:

- Two-Wheel Drive High Range (2WD)
- Four-Wheel Drive Lock High Range (4WD LOCK)
- Four-Wheel Drive Low Range (4WD LOW)
- Neutral (NEUTRAL)

For additional information on the appropriate use of each transfer case mode position, see the information below:

2WD

Rear Wheel Drive High Range — This range is for normal street and highway driving on dry, hard surfaced roads.

4WD LOCK

Four-Wheel Drive Lock High Range — This range maximizes torque to the front driveshaft, forcing the front and rear wheels to rotate at the same speed. This range provides additional traction for loose, slippery road surfaces only.

4WD LOW

Four-Wheel Drive Low Range — This range provides low speed four-wheel drive. It maximizes torque to the front driveshaft, forcing the front and rear wheels to rotate at the same speed. This range provides additional traction and maximum pulling power for loose, slippery road surfaces only. Do not exceed 25 mph (40 km/h).



Four-Position/Part Time Transfer Case

OFF-ROAD CAPABILITIES

NEUTRAL (N)

Neutral — This range disengages both the front and rear driveshafts from the powertrain. To be used for flat towing behind another vehicle. Refer to “Recreational Towing” in “Starting And Operating” in your Owner’s Manual located on www.ramtrucks.com/en/owners/manuals for further information.

This electronically shifted transfer case is designed to be driven in the two-wheel drive position (2WD) for normal street and highway conditions on dry, hard surfaced roads.

When additional traction is required, the transfer case 4WD LOCK and 4WD LOW positions can be used to maximize torque to the front driveshaft, forcing the front and rear wheels to rotate at the same speed. This is accomplished by rotating the 4WD Control Switch to the desired position.

Refer to “Shifting Procedure” in the “Starting And Operating” section of your Owner’s Manual located on www.ramtrucks.com/en/owners/manuals for specific shifting instructions.

WARNING!

You or others could be injured or killed if you leave the vehicle unattended with the transfer case in the NEUTRAL position without first fully engaging the parking brake. The transfer case NEUTRAL position disengages both the front and rear drive shafts from the powertrain and will allow the vehicle to roll, even if the transmission is in PARK. The parking brake should always be applied when the driver is not in the vehicle.

TOWING & PAYLOAD

NOTE:

For additional trailer towing information (maximum trailer weight ratings), refer to the following website addresses:

- ramtrucks.com/en/towing_guide/
- ramtruck.ca (Canada)
- rambodybuilder.com

TOW/HAUL MODE

When driving in hilly areas, towing a trailer, carrying a heavy load, etc., and frequent transmission shifting occurs, push the TOW/HAUL switch to select TOW/HAUL mode. This will improve performance and reduce the potential for transmission overheating or failure due to excessive shifting. When operating in TOW/HAUL mode, transmission upshifts are delayed, and the transmission will automatically downshift (for engine braking) during steady braking maneuvers.

The “TOW/HAUL Indicator Light” will illuminate in the instrument cluster to indicate that TOW/HAUL mode has been activated. Pushing the switch a second time restores normal operation. If the TOW/HAUL mode is desired, the switch must be pushed each time the engine is started.



TOW/HAUL Switch

INTEGRATED TRAILER BRAKE MODULE

The Integrated Trailer Brake Controller allows you to automatically or manually activate the Electric Trailer Brakes and Electric Over Hydraulic Trailer Brakes for a better braking performance when towing a trailer.

NOTE:

The Integrated Trailer Brake Controller is located in the center stack below the climate controls.

This module will have four different options depending on the type of trailer you want to tow and can be selected through the 3.5" instrument cluster display or touchscreen radio.

- Light Electric
- Heavy Electric
- Light EOH (Electric Over Hydraulic)
- Heavy EOH (Electric Over Hydraulic)

Setting With The Uconnect Touchscreen Radio

To make the proper selection in the Uconnect touchscreen radio, push the More button on the faceplate (Uconnect 5.0) or press the "Apps" button on the touchscreen (Uconnect 8.4), then press the "Settings" button on the touchscreen to display the menu setting screen and press "Trailer Brake". For additional information, refer to your Owner's Manual on www.ramtrucks.com/en/owners/manuals.

Setting With 3.5" Instrument Cluster Display

1. Push the RIGHT arrow on the steering wheel to enter "VEHICLE SETTINGS".
2. Push the UP or DOWN buttons until Trailer Brake Type appears on the screen.
3. Push the RIGHT arrow and then push the UP or DOWN buttons until the proper Trailer Brake Type appears on the screen. For additional information, refer to your Owner's Manual on www.ramtrucks.com/en/owners/manuals.

GAIN Adjustment Buttons (+/-)

Pushing the +/- buttons, located on the left side of the module, will increase/decrease the brake control power output to the trailer brakes in 0.5 increments. The GAIN setting can be increased to a maximum of 10 or decreased to a minimum of 0 (no trailer braking).

Refer to your Owner's Manual on www.ramtrucks.com/en/owners/manuals for further details.



Adjustment Buttons

- 1 — Decrease (-)
- 2 — Increase (+)

WARNING!

Connecting a trailer that is not compatible with the ITBM system may result in reduced or complete loss of trailer braking. There may be an increase in stopping distance or trailer instability which could result in personal injury.

RECREATIONAL TOWING (BEHIND MOTORHOME, ETC.)

Towing This Vehicle Behind Another Vehicle

Towing Condition	Wheels OFF The Ground	Two-Wheel Drive Models	Four-Wheel Drive Models
Flat Tow	NONE	NOT ALLOWED	See Instructions: <ul style="list-style-type: none"> • Automatic transmission in PARK • Manual transmission in gear (NOT in NEUTRAL) • Transfer case in NEUTRAL (N) • Tow in forward direction
Dolly Tow	Front	NOT ALLOWED	NOT ALLOWED
	Rear	OK	NOT ALLOWED
On Trailer	ALL	OK	OK

Recreational Towing — Two-Wheel Drive Models

DO NOT flat tow this vehicle. Damage to the drivetrain will result.

Recreational towing (for two-wheel drive models) is allowed ONLY if the rear wheels are OFF the ground. This may be accomplished using a tow dolly or vehicle trailer. If using a tow dolly, follow this procedure:

1. Properly secure the dolly to the tow vehicle, following the dolly manufacturer's instructions.
2. Drive the rear wheels onto the tow dolly.
3. Firmly apply the parking brake. Place automatic transmission in PARK, manual transmission in gear (not in NEUTRAL).
4. Properly secure the rear wheels to the dolly, following the dolly manufacturer's instructions.
5. Turn the ignition switch to the OFF position and remove the key fob.
6. Install a suitable clamping device, designed for towing, to secure the front wheels in the straight position.

Recreational Towing — Four-Wheel Drive Models

NOTE:

Both the manual shift and electronic shift transfer cases must be shifted into NEUTRAL (N) for recreational towing. Automatic transmissions must be shifted into PARK for recreational towing. Manual transmissions must be placed in gear (NOT in NEUTRAL) for recreational towing. Refer to the Owner's Manual at www.ramtrucks.com/en/owners/manuals for further information.

CAUTION!

- DO NOT dolly tow any 4WD vehicle. Towing with only one set of wheels on the ground (front or rear) will cause severe transmission and/or transfer case damage. Tow with all four wheels either ON the ground, or OFF the ground (using a vehicle trailer).
- Tow only in the forward direction. Towing this vehicle backwards can cause severe damage to the transfer case.
- Before recreational towing, the transfer case must be in NEUTRAL. To be certain the transfer case is fully in NEUTRAL, perform the procedure outlined under "Shifting Into NEUTRAL". Internal transmission damage will result, if the transfer case is not in NEUTRAL during towing.
- Automatic transmissions must be placed in PARK, and manual transmissions must be placed in gear (not in Neutral) for recreational towing.
- Towing this vehicle in violation of the above requirements can cause severe transmission and/or transfer case damage. Damage from improper towing is not covered under the New Vehicle Limited Warranty.
- Do not disconnect the rear driveshaft because fluid will leak from the transfer case, causing damage to internal parts.
- Do not use a bumper-mounted clamp-on tow bar on your vehicle. The bumper face bar will be damaged.

Shifting Into NEUTRAL (N)

Use the following procedure to prepare your vehicle for recreational towing.

WARNING!

You or others could be injured or killed if you leave the vehicle unattended with the transfer case in the NEUTRAL (N) position without first fully engaging the parking brake. The transfer case NEUTRAL (N) position disengages both the front and rear driveshafts from the powertrain, and will allow the vehicle to roll, even if the automatic transmission is in PARK (or manual transmission is in gear). The parking brake should always be applied when the driver is not in the vehicle.

CAUTION!

It is necessary to follow these steps to be certain that the transfer case is fully in NEUTRAL (N) before recreational towing to prevent damage to internal parts.

1. Bring the vehicle to a complete stop, with the engine running. Firmly apply the parking brake.
2. Shift the transmission to NEUTRAL.
3. Press and hold the brake pedal.
4. Depress the clutch pedal on a manual transmission.

5. Shift the transfer case into NEUTRAL:
 - With manual shift transfer case, shift the transfer case lever into NEUTRAL (N).
 - With electronic shift transfer case, push and hold the transfer case NEUTRAL (N) button. Some models have a small, recessed "N" button (at the center of the transfer case switches) that must be pressed using a ballpoint pen or similar object. Other models have a rectangular NEUTRAL switch, below the rotary transfer case control knob. The NEUTRAL (N) indicator light will blink while the shift is in progress. The light will stop blinking (stay on solid) when the shift to NEUTRAL (N) is complete. After the shift is completed and the NEUTRAL (N) light stays on, release the NEUTRAL (N) button.
6. Release the parking brake.
7. Shift the transmission into REVERSE.
8. Release the brake pedal (and clutch pedal on manual transmissions) for five seconds and ensure that there is no vehicle movement.
9. Repeat steps seven and eight with automatic transmission in DRIVE or manual transmission in first gear.
10. Shift the transmission to NEUTRAL. Firmly apply the parking brake. Turn OFF the engine. For vehicles with Keyless Enter-N-Go, push and hold the ENGINE START/STOP button until the engine shuts off.
11. Shift the transmission into PARK or place manual transmission in gear (NOT in NEUTRAL).
12. Place the ignition in the OFF mode, and remove the key fob.
13. Attach the vehicle to the tow vehicle using a suitable tow bar.
14. Release the parking brake.

NOTE:

With electronic shift transfer case:

- Steps 2 through 4 are requirements that must be met before pushing the NEUTRAL (N) button, and must continue to be met until the shift has been completed. If any of these requirements are not met before pushing the NEUTRAL (N) button or are no longer met during the shift, the NEUTRAL (N) indicator light will flash continuously until all requirements are met or until the NEUTRAL (N) button is released.
- The ignition must be in the ON/RUN mode for a shift to take place and for the position indicator lights to be operable. If the ignition is not in the ON/RUN mode, the shift will not take place and no position indicator lights will be on or flashing.
- A flashing NEUTRAL (N) position indicator light indicates that shift requirements have not been met.

Shifting Out Of NEUTRAL (N)

Use the following procedure to prepare your vehicle for normal usage.

1. Bring the vehicle to a complete stop, leaving it connected to the tow vehicle.
2. Firmly apply the parking brake.
3. Turn the ignition to the ON/RUN mode, but do not start the engine.
4. Press and hold the brake pedal.
5. Shift the transmission into NEUTRAL.
 - With manual shift transfer case, shift the transfer case lever to the desired position.
 - With electronic shift transfer case, push and hold the transfer case NEUTRAL (N) button until the NEUTRAL (N) indicator light turns off. After the NEUTRAL (N) indicator light turns off, release the NEUTRAL (N) button. After the NEUTRAL (N) button has been released, the transfer case will shift to the position indicated by the selector switch.

NOTE:

When shifting the transfer case out of NEUTRAL (N), the engine should remain OFF to avoid gear clash.

6. Shift automatic transmission into PARK.
7. Release the brake pedal (and clutch pedal on a manual transmission).
8. Disconnect vehicle from the tow vehicle.
9. Start the engine.
10. Press and hold the brake pedal.
11. Release the parking brake.
12. Shift the transmission into gear, release the brake pedal (and clutch pedal on manual transmissions), and check that the vehicle operates normally.

NOTE:

With electronic shift transfer case:

- Steps three through five are requirements that must be met before pushing the NEUTRAL (N) button, and must continue to be met until the shift has been completed. If any of these requirements are not met before pushing the NEUTRAL (N) button or are no longer met during the shift, the NEUTRAL (N) indicator light will flash continuously until all requirements are met or until the NEUTRAL (N) button is released.
- The ignition must be in the ON/RUN mode for a shift to take place and for the position indicator lights to be operable. If the ignition is not in the ON/RUN mode, the shift will not take place and no position indicator lights will be on or flashing.
- A flashing NEUTRAL (N) position indicator light indicates that shift requirements have not been met.

6.7L CUMMINS DIESEL

DIESEL ENGINE BREAK-IN RECOMMENDATIONS

The Cummins turbocharged diesel engine does not require a break-in period due to its construction. Normal operation is allowed, providing the following recommendations are followed:

- Warm up the engine before placing it under load.
- Do not operate the engine at idle for prolonged periods.
- Use the appropriate transmission gear to prevent engine lugging.
- Observe vehicle oil pressure and temperature indicators.
- Check the coolant and oil levels frequently.
- Vary throttle position at highway speeds when carrying or towing significant weight.

NOTE:

Light duty operation such as light trailer towing or no load operation will extend the time before the engine is at full efficiency. Reduced fuel economy and power may be seen at this time.

Because of the construction of the Cummins turbocharged diesel engine, engine run-in is enhanced by loaded operating conditions which allow the engine parts to achieve final finish and fit during the first 6,000 miles (10 000 km).

DIESEL ENGINE STARTING PROCEDURES

Keyless Enter-N-Go — If Equipped

This feature allows the driver to operate the ignition switch with the push of a button, as long as the Remote Start/Keyless Enter-N-Go key fob is in the passenger compartment.

Normal Starting

Using The ENGINE START/STOP Button

1. The transmission must be in PARK or NEUTRAL.
2. Press and hold the brake pedal while pushing the ENGINE START/STOP button once.
3. The system takes over and attempts to start the vehicle. If the vehicle fails to start, the starter will disengage automatically after 25 seconds.
4. If you wish to stop the cranking of the engine prior to the engine starting, remove your foot from the brake pedal and push the button again.

NOTE:

- Normal starting of either a cold or a warm engine is obtained without pumping or pressing the accelerator pedal.

6.7L CUMMINS DIESEL

- Under cold weather conditions, the engine may not immediately crank if the "Wait To Start" telltale is illuminated. This is normal operation. For vehicles equipped with Keyless Enter-N-Go, the vehicle will automatically crank when the "Wait To Start" time has elapsed. See the section "Starting Procedure Engine Manifold Air Temperature 0°F to 66°F (18° C to 19°C)" in the Diesel Supplement for more information.

To Turn Off The Engine Using ENGINE START/STOP Button

1. Place the gear selector in PARK, then push and release the ENGINE START/STOP button.
2. The ignition will return to the OFF position.
3. If the gear selector is not in PARK, the ENGINE START/STOP button must be held for two seconds or three short pushes in a row with the vehicle speed above 5 mph (8 km/h) before the engine will shut off. The ignition switch position will remain in the ACC position until the gear selector is in PARK and the button is pushed twice to the OFF position. If the gear selector is not in PARK and the ENGINE START/STOP button is pushed once, the instrument cluster display will display a "Vehicle Not In Park" message and the engine will remain running. Never leave a vehicle out of the PARK position, or it could roll.
4. If the gear selector is in NEUTRAL, push and release the ENGINE START/STOP button with the vehicle speed below 5 mph (8 km/h) before the engine will shut off. The ignition will remain in the ACC position.

NOTE:

If the ignition is left in the ACC or ON/RUN (engine not running) position and the transmission is in PARK, the system will automatically time out after 30 minutes of inactivity and the ignition will switch to the OFF position.

ENGINE START/STOP Button Functions — With Driver's Foot OFF The Brake Pedal (In PARK Or NEUTRAL Position)

The ENGINE START/STOP button operates similar to an ignition switch. It has three positions, OFF, ACC, RUN. To change the ignition switch positions without starting the vehicle and use the accessories follow these steps:

1. Starting with the ignition in the OFF position:
2. Push the ENGINE START/STOP button once to change the ignition to the ACC position.
3. Push the ENGINE START/STOP button a second time to change the ignition to the RUN position.
4. Push the ENGINE START/STOP button a third time to return the ignition to the OFF position.

6.7L CUMMINS DIESEL

Engine Block Heater

For ambient temperatures below 0°F (-18°C), engine block heater usage is recommended.

For ambient temperatures below -20°F (-29°C), engine block heater usage is required.

The engine block heater cord is routed under the hood to the right side and can be located just behind the grille near the headlamp.

Connect the heater cord to a ground-fault interrupter protected 110–115 volt AC electrical outlet with a grounded, three-wire extension cord.

NOTE:

The block heater will require 110 volts AC and 6.5 amps to activate the heater element.

The block heater must be plugged in at least one hour to have an adequate warming effect on the coolant.

Water In Fuel Message

If a Water In Fuel message or  indicator appears in the cluster and a chime sounds five times, the fuel/water separator will need to be drained immediately to prevent engine damage.

Refer to “Draining Fuel Water Separator” in this guide for draining instructions or see your dealer.

Cold Start Procedure

Turn the ignition switch to the ON position. If the Wait To Start  light appears in the cluster, wait for the light to turn off before starting.

In extremely cold weather below 0°F (-18°C) it may be beneficial to cycle the manifold heaters twice before attempting to start the engine. This can be accomplished by turning the ignition OFF for at least five seconds and then back ON after the “Wait To Start Light” has turned off, but before the engine is started. However, excessive cycling of the manifold heaters will result in damage to the heater elements or reduced battery voltage.

Refer to the Diesel Supplement at www.ramtrucks.com/en/owners/manuals for further details.

Winter Front Cover Usage

A winter front or cold weather cover is to be used in ambient temperatures below 32°F (0°C), especially during extended idle conditions. This cover is equipped with four flaps for managing total grille opening in varying ambient temperatures. If a winter front or cold weather cover is to be used the flaps should be left in the full open position to allow air flow to the charge air cooler and automatic transmission oil cooler. When ambient temperatures drop below 0°F (-17°C) the four flaps need to be closed. A suitable cold weather cover is available from your Mopar dealer.

Engine Idling

Avoid prolonged engine idling. Long periods of idling may be harmful to your engine because combustion chamber temperatures can drop so low that the fuel may not burn completely.

Incomplete combustion allows carbon and varnish to form on piston rings, engine valves, and injector nozzles. Also, the unburned fuel can enter the crankcase, diluting the oil and causing rapid wear to the engine.

If the engine is allowed to idle, under some conditions the idle speed may increase to 900 RPM then return to normal idle speed. This is normal operation.

WARNING!

Remember to disconnect the cord before driving. Damage to the 110–115 volt electrical cord could cause electrocution.

DIESEL EXHAUST BRAKE (ENGINE BRAKING)

The Exhaust Brake switch is located on the switch bank below the HVAC controls located in the center stack. This switch is used to enable exhaust brake modes.

Pushing the exhaust brake switch once will enable full strength exhaust brake mode, indicated by a yellow icon in the instrument cluster. This mode applies full exhaust braking when the accelerator pedal is released. This is most useful for slowing the vehicle.

Pushing the exhaust brake switch again will enable the Smart Brake (Auto) feature, indicated by a green icon in the instrument cluster. This feature is intended to maintain the vehicle speed present when the accelerator pedal is released. However, when the brakes are applied, full exhaust braking is still enabled to slow the vehicle.

A third push of the brake switch will turn the exhaust brake off, and will extinguish the exhaust brake icon in the instrument cluster.

NOTE:

In general, higher engine speeds result in higher exhaust braking force. For optimum braking power, it is recommended to use the exhaust brake while in TOW/HUAL mode.

CAUTION!

Use of aftermarket exhaust brakes is not recommended and could lead to engine damage.

6.7L CUMMINS DIESEL

WARNING!

Do not use the exhaust brake feature when driving in icy or slippery conditions as the increased engine braking can cause the rear wheels to slide and the vehicle to swing around with the possible loss of vehicle control, which may cause a collision possibly resulting in personal injury or death.

IDLE-UP FEATURE (AUTOMATIC TRANSMISSION ONLY)



Speed Control Switches

- 1 — Push CANCEL
- 2 — Push ON/OFF
- 3 — Push Resume/Accel
- 4 — Push Set/Decel

The Idle-Up Feature uses the speed control switches to increase engine idle speed and quickly warm the vehicle's interior. This feature must be enabled by your dealer. See your local dealer.

With the transmission in PARK, the parking brake applied, and the engine running, push the speed control ON/OFF switch on, then push the SET switch.

The engine RPM will go up to 1100 RPM. To increase the RPM, push and hold the RESUME/ACCEL switch and the idle speed will increase to approximately 1500 RPM. To decrease the RPM, push and hold the SET/DECCEL switch and the idle speed will decrease to approximately 1100 RPM.

To cancel the Idle Up Feature, either push the CANCEL switch, push the ON/OFF switch or push the brake pedal.

ENGINE MOUNTED FUEL FILTER/WATER SEPARATOR

Draining Fuel/Water Separator

If the “Water in Fuel” indicator light  is illuminated and an audible chime is heard five times, you should stop the engine and drain the water from the separator.

The drain is located on the bottom of the Fuel Filter and Water Separator assembly which is located on the driver's side of the engine.

Turn the drain valve (located on the side of the filter) counterclockwise 1/4 turn, then turn the ignition switch to the ON/RUN position to allow any accumulated water to drain.

When clean fuel is visible, close the drain and switch the ignition to OFF.

Refer to the Diesel Supplement at www.ramtrucks.com/en/owners/manuals for further details.

Fuel Filter Replacement

1. With the engine off and a drain pan under the fuel filter drain hose, open the water drain valve 1/4 turn counterclockwise and completely drain fuel and water into the approved container.
2. Close the water drain valve and remove the lid using a socket or strap wrench; rotate counterclockwise for removal. Remove the used o-ring and discard it.
3. Remove the used filter cartridge from the housing and dispose of according to your local regulations.
4. Wipe clean the sealing surfaces of the lid and housing and install the new o-ring into ring groove on the filter housing and lubricate with clean engine oil.
5. Install a new filter in the housing. Push down on the cartridge to ensure it is properly seated. **Do not pre-fill the filter housing with fuel.**
6. Install the lid onto the housing and tighten to 22.5 ft lbs (30.5 N-m). Do not overtighten the lid.
7. Start the engine and confirm no leaks are present.

The engine mounted filter housing is equipped with a No-Filter-No-Run (NFNR) feature. Engine will not run if:

- No filter is installed.
- Inferior/Non-approved filter is used. Use of OEM filter is required to ensure vehicle will run.

6.7L CUMMINS DIESEL

CAUTION!

- Diesel fuel will damage blacktop paving surfaces. Drain the filter into an appropriate container.
- Do not prefill the fuel filter when installing a new fuel filter. There is a possibility debris could be introduced into the fuel filter during this action. It is best to install the filter dry and allow the in-tank lift pump to prime the fuel system.
- If the “Water In Fuel Indicator Light” remains on, DO NOT START the engine before you drain water from the fuel filter to avoid engine damage.

UNDERBODY MOUNTED FUEL FILTER/WATER SEPARATOR

Draining Fuel/Water Separator

If the “Water in Fuel” indicator light  is illuminated and an audible chime is heard five times, you should stop the engine and drain the water from the separator.

The drain is located on the bottom of the Fuel Filter and Water Separator assembly which is located in front of the rear axle above the drive shaft on pick up models. The Chassis Cab models second filter location is on the frame behind the front axle. The best access to this water drain valve is from under the vehicle.

- Turn the drain valve (located on the side of the filter) counterclockwise 1 full turn, then turn the ignition switch to the ON/RUN position to allow any accumulated water to drain.
- When clean fuel is visible, close the drain and switch the ignition to OFF.
- Refer to the Diesel Supplement at www.ramtrucks.com/en/owners/manuals for further details.

Underbody Fuel Filter Replacement

1. With the engine off and a drain pan under the fuel filter drain hose, open the water drain valve 1 full turn counterclockwise and completely drain fuel and water into the approved container.
2. Close the water drain valve and remove the lid using a socket or strap wrench; rotate counterclockwise for removal. Remove the used o-ring and discard it.
3. Remove the used filter cartridge from the housing and dispose of according to your local regulations.
4. Wipe clean the sealing surfaces of the lid and housing and install the new o-ring into ring groove on the filter housing and lubricate with clean engine oil.
5. Install a new filter in the housing. Push down on the cartridge to ensure it is properly seated. **Do not pre-fill the filter housing with fuel.**
6. Start the engine and confirm no leaks are present.

6.7L CUMMINS DIESEL

The underbody mounted filter housing will cause the engine not to run if:

- No filter is installed.

NOTE:

- Using a fuel filter that does not meet the manufacturer's filtration and water separating requirements can severely impact fuel system life and reliability.
- The WIF sensor is re-usable. Service kit comes with new o-ring for filter canister and WIF sensor.

CAUTION!

- Diesel fuel will damage blacktop paving surfaces. Drain the filter into an appropriate container.
- Do not prefill the fuel filter when installing a new fuel filter. There is a possibility debris could be introduced into the fuel filter during this action. It is best to install the filter dry and allow the in-tank lift pump to prime the fuel system.
- If the "Water In Fuel Indicator Light" remains on, DO NOT START the engine before you drain water from the fuel filter to avoid engine damage.

EXHAUST REGENERATION

Under certain conditions, your Cummins diesel engine and exhaust after-treatment system may never reach the conditions required to remove the trapped particulate matter. If this occurs, the "Exhaust System — Regeneration Required Now" message will be displayed on the screen in your instrument cluster and you will hear one chime to alert you of this condition. Driving your vehicle at highway speeds for as little as 45 minutes can remedy the condition and allow the engine and exhaust after-treatment system to remove the trapped particulate matter.

NOTE:

Under typical operating conditions, NO indications of regeneration state will be displayed. If you do reach 80% of filter capacity, the following messages will assist you in inducing and understanding the regeneration process.

Diesel Particulate Filter (DPF) Messages

The Cummins diesel engine meets all diesel emissions standards, resulting in one of the lowest emitting diesel engines ever produced. To achieve these emissions standards, your vehicle is equipped with a state-of-the-art engine and exhaust system. These systems are seamlessly integrated into your vehicle and managed by the Powertrain Control Module (PCM). The PCM manages engine combustion to allow the exhaust system's catalyst to trap and burn Particulate Matter (PM) pollutants, with no input or interaction on your part.

6.7L CUMMINS DIESEL

WARNING!

A hot exhaust system can start a fire if you park over materials that can burn. Such materials might be grass or leaves coming into contact with your exhaust system. Do not park or operate your vehicle in areas where your exhaust system can contact anything that can burn.

Your vehicle has the ability to alert you to additional maintenance required on your vehicle or engine. The following messages may display in your instrument cluster display:

- **Perform Service** — Your vehicle will require emissions maintenance at a set interval. To help remind you when this maintenance is due, the instrument cluster display will display "Perform Service". When the "Perform Service" message is displayed in the instrument cluster display it is necessary to have the emissions maintenance performed. Emissions maintenance may include replacing the Closed Crankcase Ventilation (CCV) filter element. The procedure for clearing and resetting the "Perform Service" indicator message is located in the appropriate Service Information.
- **Exhaust System — Regeneration Required Now** — "Exhaust Filter XX% Full Safely Drive at Highway Speeds to Remedy" will be displayed in the instrument cluster display if the exhaust particulate filter reaches 80% of its maximum storage capacity. Under conditions of exclusive short duration and low speed driving cycles, your Cummins diesel engine and exhaust after-treatment system may never reach the conditions required to remove the trapped PM. If this occurs, the "Exhaust Filter XX% Full Safely Drive at Highway Speeds to Remedy" message will be displayed in the instrument cluster display. If this message is displayed, you will hear one chime to assist in alerting you of this condition

By simply driving your vehicle at highway speeds for as little as 45 minutes, you can remedy the condition in the particulate filter system and allow your Cummins diesel engine and exhaust after-treatment system to remove the trapped PM and restore the system to normal operating condition.

- **Exhaust System — Regeneration In Process Exhaust Filter XX% Full** — Indicates that the Diesel Particulate Filter (DPF) is self-cleaning. Maintain your current driving condition until regeneration is completed.
- **Exhaust System — Regeneration Completed** — This message indicates that the Diesel Particulate Filter (DPF) self-cleaning is completed. If this message is displayed, you will hear one chime to assist in alerting you of this condition.
- **Exhaust Service Required — See Dealer Now** — This message indicates regeneration has been disabled due to a system malfunction. At this point the engine Powertrain Control Module (PCM) will register a fault code, the instrument panel will display a MIL light.

6.7L CUMMINS DIESEL

CAUTION!

See your authorized dealer, as damage to the exhaust system could occur soon with continued operation.

- **Exhaust Filter Full — Power Reduced See Dealer** — This message indicates the PCM has derated the engine to limit the likelihood of permanent damage to the after-treatment system. If this condition is not corrected and a dealer service is not performed, extensive exhaust after-treatment damage can occur. To correct this condition it will be necessary to have your vehicle serviced by your local authorized dealer.

NOTE:

Failing to follow the oil change indicator, changing your oil and resetting the oil change indicator by 0 miles remaining will prevent the diesel exhaust filter from performing its cleaning routine. This will shortly result in a Malfunction Indicator Light (MIL) and reduced engine power. Only an authorized dealer will be able to correct this condition.

CAUTION!

See your authorized dealer, as damage to the exhaust system could occur soon with continued operation.

COOL-DOWN IDLE CHART

TURBO "COOL DOWN" CHART			
Driving Conditions	Load	Turbo Temp	Idle Time (in minutes) Before Shut Down
Stop and Go	Empty	Cool	Less than 1
Stop and Go	Medium	Warm	1
Highway Speeds	Medium	Warm	2
City Traffic	Max. GCWR	Warm	3
Highway Speeds	Max. GCWR	Warm	4
Uphill Grade	Max. GCWR	Hot	5

6.7L CUMMINS DIESEL

DIESEL EXHAUST FLUID

Diesel Exhaust Fluid (DEF) sometimes known simply by the name of its active component, UREA – is a key component of selective catalytic reduction (SCR) systems, which help diesel vehicles meet stringent emission regulations. DEF is a liquid reducing agent that reacts with engine exhaust in the presence of a catalyst to convert smog-forming nitrogen oxides (NOx) into harmless nitrogen and water vapor.

Your vehicle is equipped with a Selective Catalytic Reduction system in order to meet the very stringent diesel emissions standards required by the Environmental Protection Agency. Selective Catalytic Reduction (SCR) is the first and only technology in decades to be as good for the environment as it is good for business and vehicle performance.

The purpose of the SCR system is to reduce levels of NOx (oxides of nitrogen emitted from engines) that are harmful to our health and the environment to an almost near-zero level. Small quantities of Diesel Exhaust Fluid (DEF) are injected into the exhaust upstream of a catalyst where, when vaporized, convert smog-forming nitrogen oxides (NOx) into harmless nitrogen (N₂) and water vapor (H₂O), two natural components of the air we breathe. You can operate with the comfort that your vehicle is contributing to a cleaner, healthier world environment for this and generations to come.

System Overview

This vehicle is equipped with a Diesel Exhaust Fluid (DEF) injection system and a Selective Catalytic Reduction (SCR) catalyst to meet the emission requirements.

The DEF injection system consists of the following components:

- DEF tank
- DEF pump
- DEF injector
- Electronically-heated DEF lines
- DEF control module
- NOx sensors
- NH₃ sensor
- Temperature sensors
- SCR catalyst

The DEF injection system and SCR catalyst enable the achievement of diesel emissions requirements; while maintaining outstanding fuel economy, drivability, torque and power ratings.

NOTE:

- Your vehicle is equipped with a DEF injection system. You may occasionally hear an audible clicking noise. This is normal operation.

- The DEF pump will run for a period of time after engine shutdown to purge the DEF system. This is normal operation.

Diesel Exhaust Fluid Storage

Diesel Exhaust Fluid (DEF) is considered a very stable product with a long shelf life. If DEF is kept in temperatures between 10° to 90°F (-12° to 32°C), it will last a minimum of one year.

DEF is subject to freezing at the lowest temperatures. For example, DEF may freeze at temperatures at or below 12°F (-11°C). The system has been designed to operate in this environment.

NOTE:

When working with DEF, it is important to know that:

- Any containers or parts that come into contact with DEF must be DEF compatible (plastic or stainless steel). Copper, brass, aluminum, iron or non-stainless steel should be avoided as they are subject to corrosion by DEF.
- If DEF is spilled, it should be wiped up completely.

Adding Diesel Exhaust Fluid (DEF)

The DEF gauge (located in the instrument cluster) will display the level of DEF remaining in the tank.

Completely fill the DEF tank through the diesel exhaust fluid fill location at every maintenance interval, or before if prompted by the instrument cluster display.

The DEF tank on these vehicles is designed with a large amount of full reserve. So, the level sensor will indicate a full reading even before the tank is completely full. To put it another way, there's additional storage capacity in the tank above the Full mark that's not represented in the gauge. You may not see any movement in the reading – even after driving up to 2,000 miles in some cases.

NOTE:

- Driving conditions (altitude, vehicle speed, load, etc.) will effect the amount of DEF that is used in your vehicle.
- Another factor is that outside temperature can affect DEF consumption. In cold conditions, 12° F (-11° C) and below, the DEF gauge needle can stay on a fixed position and may not move for extended periods of time. This is a normal function of the system.
- Since DEF will begin to freeze at 12°F (-11°C), your vehicle is equipped with an automatic DEF heating system. This allows the DEF injection system to operate properly at temperatures below 12°F (-11°C). If your vehicle is not in operation for an extended period of time with temperatures below 12°F (-11°C), the DEF in the tank may freeze. If the tank is overfilled and freezes, it could be damaged. Therefore, do not overfill the DEF tank. Extra care should be taken when filling with portable containers to avoid overfilling. Note the level of the DEF gauge in

6.7L CUMMINS DIESEL

your instrument cluster. On pickup applications, you may safely add a maximum of 2 gallons (7.5 liters) of DEF from portable containers when your DEF gauge is reading $\frac{1}{2}$ full. On Chassis Cab applications, a maximum of 2 gallons (7.5 liters) may be added when the DEF gauge is reading $\frac{3}{4}$ full.

- There is an electric heater inside the DEF tank that automatically works when necessary. And if the DEF supply does freeze, the truck will operate normally until it thaws.
- Ensure the DEF cap is reinstalled prior to filling vehicle with diesel fuel to avoid spilling diesel fuel into the DEF Filler.

DEF Fill Procedure

- Remove cap from DEF tank (located on drivers side of the vehicle).
- Insert DEF container into DEF tank.
- Reinstall cap onto DEF tank.
- Refer to your Owner's Manual at www.ramtrucks.com/en/owners/manuals for further details.



Diesel Exhaust Fluid (DEF) Filler Location

CAUTION!

- To avoid DEF spillage and overfilling, do not “top off” the DEF tank after filling.
- When DEF is spilled, clean the area immediately with water or a mild solvent.
- DO NOT OVERFILL. DEF will freeze below 12 degrees F (-11 degrees C). The DEF system is designed to work in temperatures below the DEF freezing point, however, if the tank is overfilled and freezes, the system could be damaged.

Diesel Exhaust Fluid (DEF) Warning Messages

There are four different messages which are displayed if the vehicle detects that the DEF system has been filled with a fluid other than DEF, has experienced component failures, or when tampering has been detected. The vehicle may be limited to a maximum speed of 5 MPH (8 km/H) if the DEF system is not serviced within less than 200 miles (322 km) of the fault being detected.

6.7L CUMMINS DIESEL

When the DEF system needs to be serviced the following warnings will display:

- **DEF Low Refill Soon** — This message will display when the low level is reached, during vehicle start up, and with increased frequency during vehicle operation. It will be accompanied by a single chime. Approximately 5 gallons (19 Liters) of DEF is required to refill the tank when this message is initially displayed. on pickup applications, and approximately 7 gallons (28 Liters) are required on chassis-cab applications.
- **Speed Limited to 5 MPH in XXX mi Refill DEF** — This message will continuously display if the “DEF Low Refill Soon” message is ignored, and the frequency of occurrence of the chime will increase unless up to 2 gallons (7.5 Liters) of DEF is added to the tank.
- **5 MPH Max Speed on Restart, Long Idle or Refuel Refill DEF** — This message will continuously display when the counter reaches zero, and will be accompanied by a periodic chime.

The vehicle will only be capable of a maximum speed of 5 MPH upon the first of the following conditions to occur:

- If the vehicle is shutoff and restarted.
- If the vehicle is idled for an extended period of time, approximately one hour or greater.
- If the system detects that the level of fuel in the tank has increased.

Add a minimum of 2 gallons (9.5 Liters) of DEF to the tank in order to avoid vehicle operation at a maximum speed of 5 MPH (8 km/H).

- **In-corrected DEF Detected** — contact your authorized dealer as soon as possible.
- **NOX Emissions too high check DEF** — contact your authorized dealer as soon as possible.
- **DEF Dosing malfunctioning** — contact your authorized dealer as soon as possible.

NOTE:

A minimum of 2 gallons (9.5 Liters) may be required to restore normal vehicle operation. Although the vehicle will start normally and can be placed in gear after this message has been initially displayed, extreme caution should be utilized since the vehicle will only be capable of maneuvering at a maximum speed of 5 MPH (8 km/H).

Diesel Exhaust Fluid (DEF) Fault Warning Messages

There are five different messages which are displayed if the vehicle detects that the DEF system has been filled with a fluid other than DEF, has experienced component failures, or when tampering has been detected. The vehicle may be limited to a maximum speed of 5 MPH (8 km/H) if the DEF system is not serviced within less than 200 miles (322 km) of the fault being detected.

6.7L CUMMINS DIESEL

When the DEF system needs to be serviced the following warnings will display:

- **Service DEF System See Dealer** — This message will display when the fault is initially detected, each time the vehicle is started, and periodically during driving. The message will be accompanied by a single chime. We recommend you drive to your nearest authorized dealer and have your vehicle serviced as soon as possible.
- **5 MPH Max Speed in 150 mi Service DEF System See Dealer** — This message will display if the DEF system has not been serviced after the “Service DEF System – See Dealer” message is displayed. This message will continuously display until the mileage counter reaches zero, and will be accompanied by a periodic chime. The message will continue to countdown until it reaches zero unless the vehicle is serviced. We recommend you drive to your nearest authorized dealer and have your vehicle serviced immediately.

NOTE:

Under some circumstances this mileage counter may start with a value of less than 150 miles (241 km). For example, if recurring faults are detected in a time interval of less than 40 hours, the counter may restart at the value where it stopped when a previous fault was temporarily remedied, or at a minimum of 50 miles (80 km).

- **5 MPH Max Speed on Restart, Long Idle or Refuel Service DEF See Dealer** — This message will continuously display when the mileage counter reaches zero, and will be accompanied by a periodic chime.

The vehicle will only be capable of a maximum speed of 5 MPH upon the first of the following conditions to occur:

- If the vehicle is shutoff and restarted.
- If the vehicle is idled for an extended period of time, approximately one hour or greater.
- If the system detects that the level of fuel in the tank has increased.
- **5 MPH Max Speed Service DEF System See Dealer** — This message will continuously display, and will be accompanied by a periodic chime. Although the vehicle can be started and placed in gear, the vehicle will only operate at a maximum speed of 5 MPH. Your vehicle will require towing, see your authorized dealer for service.

NOTE:

When this message is displayed, the engine can still be started. However, the vehicle will only operate at a maximum speed of 5 MPH.

- **Incorrect DEF Detected See Dealer** — This message will display when the fault is initially detected, each time the vehicle is started, and periodically during driving. The message will be accompanied by a single chime. We recommend you drive to your nearest authorized dealer and have your vehicle serviced as soon as possible.

WHAT TO DO IN EMERGENCIES

ROADSIDE ASSISTANCE

Dial toll-free

1-800-521-2779

for U.S. Residents or

1-800-363-4869

for Canadian Residents.

- Provide your name, vehicle identification number, license plate number, and your location, including the telephone number from which you are calling.
- Briefly describe the nature of the problem and answer a few simple questions.
- You will be given the name of the service provider and an estimated time of arrival. If you feel you are in an “unsafe situation”, please let us know. With your consent, we will contact local police or safety authorities.

WARNING AND INDICATOR LIGHTS

The warning/indicator lights switch on in the instrument panel together with a dedicated message and/or acoustic signal when applicable. These indications are indicative and precautionary and as such must not be considered as exhaustive and/or alternative to the information contained in the Owner's Manual, which you are advised to read carefully in all cases. Always refer to the information in this chapter in the event of a failure indication.

All active telltales will display first if applicable. The system check menu may appear different based upon equipment options and current vehicle status. Some telltales are optional and may not appear.

Instrument Cluster Warning Lights



— Electronic Stability Control (ESC) Activation/Malfunction Indicator Light

If this indicator light flashes during acceleration, apply as little throttle as possible. While driving, ease up on the accelerator. Adapt your speed and driving to the prevailing road conditions. To improve the vehicle's traction when starting off in deep snow, sand or gravel, it may be desirable to switch the ESC system off.



— Engine Temperature Warning Light

This light warns of an overheated engine condition.

If the light turns on and a warning chime sounds while driving, safely pull over and stop the vehicle. If the A/C system is on, turn it off. Also, shift the transmission into NEUTRAL and idle the vehicle. If the temperature reading does not return to normal, turn the engine off immediately.

We recommend that you do not operate the vehicle or engine damage will occur. Have the vehicle serviced immediately.

WHAT TO DO IN EMERGENCIES

WARNING!

A hot engine cooling system is dangerous. You or others could be badly burned by steam or boiling coolant.

BRAKE – Brake Warning Light

This light monitors various brake functions, including brake fluid level and parking brake application. If the brake light turns on, it may indicate that the parking brake is applied, that the brake fluid level is low, or that there is a problem with the brake system master cylinder reservoir.

If the light remains on when the parking brake has been disengaged, and the fluid level is at the full mark on the master cylinder reservoir, it indicates a possible brake hydraulic system malfunction or that a problem with the Brake Booster has been detected by the Anti-Lock Brake System (ABS)/Electronic Stability Control (ESC) system. In this case, the light will remain on until the condition has been corrected. If the problem is related to the brake booster, the ABS pump will run when applying the brake, and a brake pedal pulsation may be felt during each stop.

The dual brake system provides a reserve braking capacity in the event of a failure to a portion of the hydraulic system. A leak in either half of the dual brake system is indicated by the Brake Warning Light, which will turn on when the brake fluid level in the master cylinder has dropped below a specified level. The light will remain on until the cause is corrected.

Vehicles equipped with the Anti-Lock Brake System (ABS) are also equipped with Electronic Brake Force Distribution (EBD). In the event of an EBD failure, the Brake Warning Light will turn on along with the ABS Light. Immediate repair to the ABS system is required.

Operation of the Brake Warning Light can be checked by turning the ignition switch from the OFF position to the ON/RUN position. The light should illuminate for approximately two seconds. The light should then turn off unless the parking brake is applied or a brake fault is detected. If the light does not illuminate, have the light inspected by an authorized dealer.

The light also will turn on when the parking brake is applied with the ignition switch in the ON/RUN position.

NOTE:

This light shows only that the parking brake is applied. It does not show the degree of brake application.

WARNING!

Driving a vehicle with the red brake light on is dangerous. Part of the brake system may have failed. It will take longer to stop the vehicle. You could have a collision. Have the vehicle checked immediately.

WHAT TO DO IN EMERGENCIES

— Malfunction Indicator Light (MIL)

The Malfunction Indicator Light (MIL) is part of an onboard diagnostic system called OBD II that monitors engine and automatic transmission control systems. The light will illuminate when the key is in the ON/RUN position before engine start. If the bulb does not come on when turning the key from OFF to ON/RUN, have the condition checked promptly.

Certain conditions, poor fuel quality, etc., may illuminate the light after engine start. The vehicle should be serviced if the light stays on through several of your typical driving cycles. In most situations, the vehicle will drive normally and will not require towing.

WARNING!

A malfunctioning catalytic converter, as referenced above, can reach higher temperatures than in normal operating conditions. This can cause a fire if you drive slowly or park over flammable substances such as dry plants, wood, cardboard, etc. This could result in death or serious injury to the driver, occupants or others.

CAUTION!

Prolonged driving with the Malfunction Indicator Light (MIL) on could cause damage to the vehicle control system. It also could affect fuel economy and driveability. If the MIL is flashing, severe catalytic converter damage and power loss will soon occur. Immediate service is required.

— Battery Charge Warning Light

This light illuminates when the battery is not charging properly. If the battery charge warning light remains on, it means that the vehicle is experiencing a problem with the charging system.

We recommend you do not continue driving if it is on. Have the vehicle serviced immediately.

— Oil Pressure Warning Light

This light indicates low engine oil pressure. If the light turns on while driving, stop the vehicle and shut off the engine as soon as possible. A chime will sound for four minutes when this light turns on.

We recommend you do not operate the vehicle or engine damage will occur. Have the vehicle serviced immediately.

WHAT TO DO IN EMERGENCIES

— Anti-Lock Brake (ABS) Light

This light monitors the Anti-Lock Brake System (ABS). The light will turn on when the ignition switch is turned to the ON/RUN position and may stay on for as long as four seconds.

If the ABS light remains on or turns on while driving, it indicates that the Anti-Lock portion of the brake system is not functioning and that service is required. However, the conventional brake system will continue to operate normally if the BRAKE warning light is not on.

If the ABS light is on, the brake system should be serviced as soon as possible to restore the benefits of Anti-Lock brakes. If the ABS light does not turn on when the ignition switch is turned to the ON/RUN position, have the light inspected by an authorized dealer.

— Electronic Throttle Control (ETC) Light

This light informs you of a problem with the Electronic Throttle Control (ETC) system.

If a problem is detected, the light will come on while the engine is running. Cycle the ignition when the vehicle has completely stopped and the gear selector is placed in the PARK position; the light should turn off.

If the light remains lit with the engine running, your vehicle will usually be drivable; however, see an authorized service center immediately. If the light is flashing when the engine is running, immediate service is required and you may experience reduced performance, an elevated/rough idle or engine stall and your vehicle may require towing.

— Air Bag Warning Light

This light will turn on for four to eight seconds as a bulb check when the ignition switch is first turned to the ON/RUN position. If the light is either not on during starting, stays on, or turns on while driving, have the system inspected at an authorized dealer as soon as possible. Refer to “Occupant Restraints” in “Getting Started” for further information.

NOTE:

The Air Bag System is designed to be maintenance free.

— SERV (Service) 4WD Indicator Light

The SERV 4WD light monitors the electric shift four-wheel drive system. If the SERV 4WD light stays on or comes on during driving, it means that the four-wheel drive system is not functioning properly and that service is required.

For vehicles equipped with a premium cluster, this indicator will display in the instrument cluster display.

WHAT TO DO IN EMERGENCIES

— Transmission Temperature Warning Light

This light indicates that there is excessive transmission fluid temperature that might occur with severe usage such as trailer towing. If this light turns on, stop the vehicle and run the engine at idle, with the transmission in NEUTRAL, until the light turns off. Once the light turns off, you may continue to drive normally.

WARNING!

If you continue operating the vehicle when the Transmission Temperature Warning Light is illuminated you could cause the fluid to boil over, come in contact with hot engine or exhaust components and cause a fire.

CAUTION!

Continuous driving with the Transmission Temperature Warning Light illuminated will eventually cause severe transmission damage or transmission failure.

Oil Change Indicator

Message

If an “oil change” message (shown as “Change Oil Soon” and “Oil Change Needed”) appears and a single chime sounds, it is time for your next required oil change.

Resetting The Light After Servicing

1. Turn the ignition switch to the ON/RUN position (do not start engine).
2. Fully depress the accelerator pedal three times within 10 seconds.
3. Turn the ignition switch to the OFF/LOCK position.

— Low Coolant Level Indicator Light

This light indicates low coolant level. If the light turns on while driving, stop the vehicle and shut off the engine as soon as possible.

We recommend you do not operate the vehicle or engine damage will occur. Have the vehicle serviced immediately.

— Tire Pressure Monitoring System (TPMS) Light

Each tire, including the spare (if provided), should be checked monthly when cold and inflated to the inflation pressure recommended by the vehicle manufacturer on the vehicle placard or tire inflation pressure label. (If your vehicle has tires of a different size than the size indicated on the vehicle placard or tire inflation pressure label, you should determine the proper tire inflation pressure for those tires).

As an added safety feature, your vehicle has been equipped with a tire pressure monitoring system (TPMS) that illuminates a low tire pressure telltale when one or more of your tires is significantly under-inflated. Accordingly, when the low tire pressure telltale illuminates, you should stop and check your tires as soon as possible

WHAT TO DO IN EMERGENCIES

and inflate them to the proper pressure. Driving on a significantly under-inflated tire causes the tire to overheat and can lead to tire failure. Under-inflation also reduces fuel efficiency and tire tread life and may affect the vehicle's handling and stopping ability.

IF THE LIGHT STARTS FLASHING INDICATING A LOW TIRE PRESSURE, ADJUST THE AIR PRESSURE IN THE LOW TIRE TO THE AIR PRESSURE SHOWN ON THE VEHICLE PLACARD OR TIRE INFLATION PRESSURE LABEL LOCATED ON THE DRIVER'S DOOR.

NOTE:

AFTER INFLATION, THE VEHICLE MAY NEED TO BE DRIVEN FOR 20 MINUTES BEFORE THE FLASHING LIGHT WILL TURN OFF.

Please note that the TPMS is not a substitute for proper tire maintenance, and it is the driver's responsibility to maintain correct tire pressure, even if under-inflation has not reached the level to trigger illumination of the TPMS low tire pressure telltale.

Your vehicle has also been equipped with a TPMS malfunction indicator to indicate when the system is not operating properly. The TPMS malfunction indicator is combined with the low tire pressure telltale.

When the system detects a malfunction, the telltale will flash for approximately one minute and then remain continuously illuminated. This sequence will continue upon subsequent vehicle start-ups as long as the malfunction exists. When the malfunction indicator is illuminated, the system may not be able to detect or signal low tire pressure as intended. TPMS malfunctions may occur for a variety of reasons, including the installation of replacement or alternate tires or wheels on the vehicle that prevent the TPMS from functioning properly. Always check the TPMS malfunction telltale after replacing one or more tires or wheels on your vehicle to ensure that the replacement or alternate tires and wheels allow the TPMS to continue to function properly.

NOTE:

Tire pressures change by approximately 1 psi (7 kPa) per 12° F (7° C) of air temperature change. Keep this in mind when checking tire pressure inside a garage, especially in the Winter. Example: If garage temperature is 68°F (20°C), and the outside temperature is 32°F (0°C), then the cold tire inflation pressure should be increased by 3 psi (21 kPa), which equals 1 psi (7 kPa) for every 12°F (7°C) for this outside temperature condition.

WHAT TO DO IN EMERGENCIES

CAUTION!

The TPMS has been optimized for the original equipment tires and wheels. TPMS pressures and warning have been established for the tire size equipped on your vehicle. Undesirable system operation or sensor damage may result when using replacement equipment that is not of the same size, type, and/or style. Aftermarket wheels can cause sensor damage. Do not use tire sealant from a can, or balance beads if your vehicle is equipped with a TPMS, as damage to the sensors may result.

Instrument Cluster Indicator Lights

— Turn Signal Indicator

The arrows will flash with the exterior turn signals when the turn signal lever is operated. A tone will chime, and an instrument cluster display message will appear if either turn signal is left on for more than 1 mile (1.6 km).

NOTE:

If either indicator flashes at a rapid rate, check for a defective outside light bulb.

— High Beam Indicator

Indicates that headlights are on high beam.

— Park/Headlight ON Indicator

This indicator will illuminate when the park lights or headlights are turned on.

— Front Fog Light Indicator

This indicator will illuminate when the front fog lights are on.

— Vehicle Security Light

This light will flash rapidly for approximately 15 seconds when the vehicle security alarm is arming. The light will flash at a slower speed continuously after the alarm is set. The security light will also come on for about three seconds when the ignition is first turned on.

— Tow/Haul Mode

Indicates that the Tow/Haul Mode is active.

— Four Wheel Drive Auto

Indicates that the Four Wheel Drive has engaged automatically.

— Electronic Stability Control OFF

This light indicates the ESC system has been turned off by the driver.

— Cargo Light

Indicates that the rear cargo light is on.

WHAT TO DO IN EMERGENCIES

— Door Ajar

Indicates that one of the vehicle's doors is open.

— Speed Control Set

Indicates that the Speed Control has been set.

— Fuel Cap/Loose Gas Cap Message

If a “gas cap” message appears, tighten the gas cap until a “clicking” sound is heard.

Push the odometer reset button to turn the message off.

If the message continues to appear for more than three days after tightening the gas cap, see your authorized service center.

IF YOUR ENGINE OVERHEATS

In any of the following situations, you can reduce the potential for overheating by taking the appropriate action.

- On the highways — slow down.
- In city traffic — while stopped, place the transmission in NEUTRAL, but do not increase the engine idle speed while preventing vehicle motion with the brakes.

NOTE:

There are steps that you can take to slow down an impending overheat condition:

- If your air conditioner (A/C) is on, turn it off. The A/C system adds heat to the engine cooling system and turning the A/C off can help remove this heat.
- You can also turn the temperature control to maximum heat, the mode control to floor and the blower control to high. This allows the heater core to act as a supplement to the radiator and aids in removing heat from the engine cooling system.

WARNING!

You or others can be badly burned by hot engine coolant (antifreeze) or steam from your radiator. If you see or hear steam coming from under the hood, do not open the hood until the radiator has had time to cool. Never try to open a cooling system pressure cap when the radiator or coolant bottle is hot.

CAUTION!

Driving with a hot cooling system could damage your vehicle. If the temperature gauge reads HOT (H), pull over and stop the vehicle. Idle the vehicle with the air conditioner turned off until the pointer drops back into the normal range. If the pointer remains on HOT (H), and you hear continuous chimes, turn the engine off immediately and call for service.

WHAT TO DO IN EMERGENCIES

JACKING AND TIRE CHANGING

WARNING!

- Do not attempt to change a tire on the side of the vehicle close to moving traffic, pull far enough off the road to avoid the danger of being hit when operating the jack or changing the wheel.
- Being under a jacked-up vehicle is dangerous. The vehicle could slip off the jack and fall on you. You could be crushed. Never put any part of your body under a vehicle that is on a jack.
- Never start or run the engine while the vehicle is on a jack. If you need to get under a raised vehicle, take it to a service center where it can be raised on a lift.
- The jack is designed to use as a tool for changing tires only. The jack should not be used to lift the vehicle for service purposes. The vehicle should be jacked on a firm level surface only. Avoid ice or slippery areas.

4500/5500 Models

These vehicles do not come equipped with a jack.

NOTE:

Jacking and tire changing on 4500/5500 models should be performed by an authorized dealer, or knowledgeable service personnel with the appropriate heavy duty equipment, like a tire service company.

Preparations For Jacking

1. Park the vehicle on a firm, level surface. Avoid ice or slippery areas.

WARNING!

Do not attempt to change a tire on the side of the vehicle close to moving traffic, pull far enough off the road to avoid the danger of being hit when operating the jack or changing the wheel.

2. Turn on the Hazard Warning flasher.
3. Apply the parking brake.
4. Place the gear selector into PARK (automatic transmission) or REVERSE (manual transmission). On 4-Wheel drive vehicles, shift the transfer case to the "4L" position.
5. Turn OFF the ignition.

WHAT TO DO IN EMERGENCIES

6. Block both the front and rear of the wheel diagonally opposite of the jacking position. For example, if changing the right front tire, block the left rear wheel.

NOTE:

Passengers should not remain in the vehicle when the vehicle is being jacked.

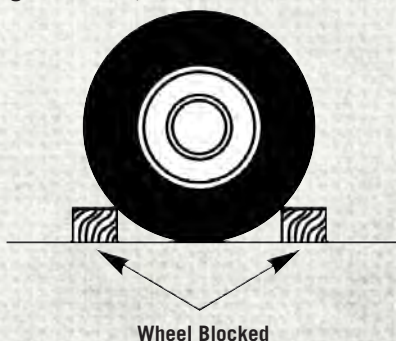

Jacking Instructions

Instructions

WARNING!

Carefully follow these tire changing warnings to help prevent personal injury or damage to your vehicle:

- Always park on a firm, level surface as far from the edge of the roadway as possible before raising the vehicle.
- Turn on the Hazard Warning flasher.
- Block the wheel diagonally opposite the wheel to be raised.
- Apply the parking brake firmly and set an automatic transmission in PARK; a manual transmission in REVERSE.
- Never start or run the engine with the vehicle on a jack.
- Do not let anyone sit in the vehicle when it is on a jack.
- Do not get under the vehicle when it is on a jack. If you need to get under a raised vehicle, take it to a service center where it can be raised on a lift.
- Only use the jack in the positions indicated and for lifting this vehicle during a tire change.
- If working on or near a roadway, be extremely careful of motor traffic.
- To assure that spare tires, flat or inflated, are securely stowed, spares must be stowed with the valve stem facing the ground.



Warning Label

WHAT TO DO IN EMERGENCIES

CAUTION!

Do not attempt to raise the vehicle by jacking on locations other than those indicated in the Jacking Instructions for this vehicle.

1. If equipped, remove the spare wheel, jack, and tools from storage.
2. Using the wheel wrench, loosen, but do not remove, the wheel nuts by turning them counterclockwise one turn while the wheel is still on the ground.
3. When changing the front wheel, assemble the jack drive tube to the jack and connect the drive tube to the extension tube. Place the jack under the axle as close to the tire as possible with the drive tubes extending to the front. Connect the jack tube extension and wheel wrench.



Front Jacking Locations

When changing a rear wheel, assemble the jack drive tube to the jack and connect the drive tube to the extension tube. Securely place the jack under the sway bar bracket (unless both tires are flat on one side, then place jack under shock bracket) facing forward in vehicle. Connect the jack tube extension and lug wrench.

Before raising the wheel off the ground, make sure that the jack will not damage surrounding truck parts and adjust the jack position as required.

NOTE:

If the jack will not lower by turning the dial (thumbwheel) by hand, it may be necessary to use the jack drive tube in order to lower the jack.

4. By rotating the wheel wrench clockwise, raise the vehicle until the wheel just clears the surface.

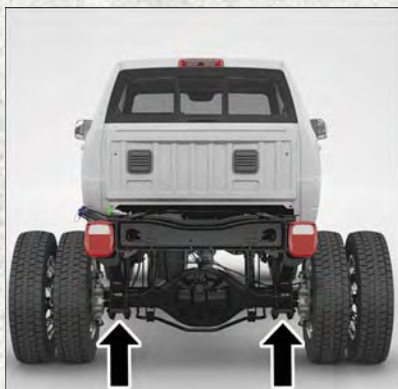

Rear Jacking Locations

WHAT TO DO IN EMERGENCIES

WARNING!

Raising the vehicle higher than necessary can make the vehicle unstable. It could slip off the jack and hurt someone near it. Raise the vehicle only enough to remove the tire.

- Remove the wheel nuts and pull the wheel off. Install the spare wheel and wheel nuts with the cone shaped end of the nuts toward the wheel on single rear wheel (SRW) models. On dual rear wheel models (DRW) the lug nuts are a two-piece assembly with a flat face. Lightly tighten the nuts. To avoid risk of forcing the vehicle off the jack, do not fully tighten the nuts until the vehicle has been lowered.
- Using the wheel wrench, finish tightening the nuts using a crisscross pattern. Use the following chart for the correct tightness of the lug nuts:

Lug Nut/Bolt Torque	Lug Nut/Bolt Type	**Lug Nut/Bolt Size	Lug Nut/Bolt Socket Size
130 Ft-Lbs (176 N·m)	Cone	M14 x 1.50	22 mm
129 Ft-Lbs (175 N·m)	Flanged		

If in doubt about the correct tightness, have them checked with a torque wrench by your authorized dealer or at a service station.

WARNING!

A loose tire or jack thrown forward in a collision or hard stop could injure someone in the vehicle. Always stow the jack parts and the extra tire and wheel in the places provided.

- Install wheel center cap (if equipped) and remove wheel blocks. Do not install chrome or aluminum wheel center caps on the spare wheel. This may result in cap damage.
- Lower the jack to its fully closed position. If the jack will not lower by turning the dial (thumbwheel) by hand, it may be necessary to use the jack drive tube in order to lower the jack. Stow the replaced tire, jack, and tools as previously described.
- Adjust the tire pressure when possible.

WHAT TO DO IN EMERGENCIES

Hub Caps/Wheel Covers — If Equipped

The hub caps must be removed before raising the vehicle off the ground.

CAUTION!

Use extreme caution when removing the front and rear center caps. Damage can occur to the center cap and/or the wheel if screwdriver type tools are used. A pulling motion, not a pry off motion, is recommended to remove the caps.

For single rear wheel (SRW) models, use the flat blade on the end of the lug wrench to pull the hub cap off. Insert the blade end into the pull off notch and carefully pull the hub cap off with a back and forth motion.

On 3500 models with dual rear wheels (DRW), you must first remove the hub caps. The jack handle driver has a hook at one end that will fit in the pull off notch of the rear hub caps. Position the hook and pull straight out on the ratchet firmly. The hub cap should pop off. The wheel skins can now be removed. For the front hub cap, use the flat blade on the end of the lug wrench to pull the caps off. The wheel skin can now be removed.

CAUTION!

- Use a pulling motion to remove the hub cap. Do not use a twisting motion when removing the hub cap, damage to the hub cap; finish may occur.
- The rear hub caps on the dual rear wheel has two pull off notches. Make sure that the hook of the jack handle driver is located squarely in the cap notch before attempting to pull off.

You must use the flat end of the lug wrench to pull off the wheel skins. Locate the hub cap pull notches (2 notches on each cap). Insert the flat tip completely and using a back and forth motion, loosen the wheel skin. Repeat this procedure around the tire until the skin pops off.

Replace the wheel skins first using a rubber mallet. When replacing the hub caps, tilt the cap retainer over the lug nut bolt circle and strike the high side down with a rubber mallet. Be sure that the hub caps and wheel skins are firmly seated around the wheel.

WHAT TO DO IN EMERGENCIES

Dual Rear Wheels

Slots in the wheels will assist in properly orienting the inner and outer wheels. Align these slots when assembling the wheels for best access to the tire valve on the inner wheel. The tires of both dual wheels must be completely off the ground when tightening to insure wheel centering and maximum wheel clamping.

Dual wheel models require a special heavy-duty lug nut tightening adapter (included with the vehicle) to correctly tighten the lug nuts. Also, when it is necessary to remove and install dual rear wheels, use a proper vehicle lifting device.

NOTE:

When installing a spare tire (if equipped) as part of a dual rear wheel end combination, the tire diameter of the two individual tires must be compared. If there is a significant difference, the larger tire should be installed in a front location. The correct direction of rotation for dual tire installations must also be observed.

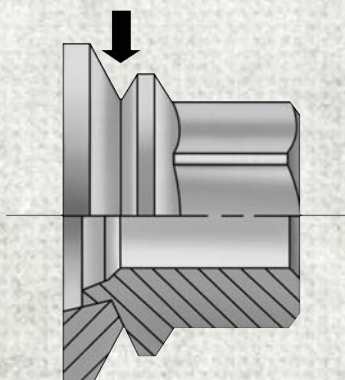

Two-Piece Lug Nut

WHAT TO DO IN EMERGENCIES

These dual rear wheels should be tightened as follows:

It is recommended that wheel stud nuts be kept torqued to specifications at all times. Torque wheel stud nuts to specifications at each lubrication interval.

Wheel Nuts

All wheel nuts should be tightened occasionally to eliminate the possibility of wheel studs being sheared or the bolt holes in the wheels becoming elongated. This is especially important during the first few hundred miles/kilometers of operation to allow the wheel nuts to become properly set. All wheel nuts should first be firmly seated against the wheel. The wheel nuts should then be tightened to recommended torque. Tighten the wheel nuts to final torque in increments. Progress around the bolt circle, tightening the wheel nut opposite to the wheel nut just previously tightened until final torque is achieved.

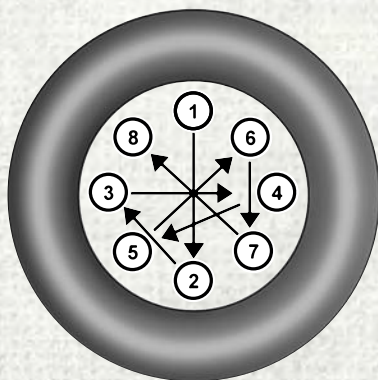

Wheel Nuts Numbered Sequence (8)

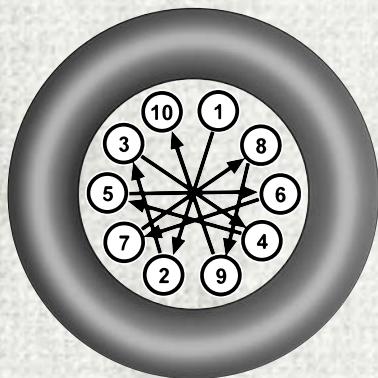

Wheel Nuts Numbered Sequence (10)

Recommended torques are shown in the following chart:

Disc Wheels

Nut Type	Stud Size	Hex Size	Torque Ft Lbs	Torque Newton Meters
Cone	M14 x 1.5	22 mm	130	176
Flanged	M14 x 1.5	22 mm	129	175

To Stow The Flat Or Spare — If Equipped

Refer to Upfitters Body Builders Guide for information on stowing your spare tire (if equipped).

WHAT TO DO IN EMERGENCIES

HOISTING

A conventional floor jack may be used at the jacking locations. Refer to the graphics that show jacking locations. However, a floor jack or frame hoist must never be used on any other parts of the underbody.

CAUTION!

Never use a floor jack directly under the differential housing of a loaded truck or damage to your vehicle may result.

JUMP-STARTING PROCEDURES

If your vehicle has a discharged battery, it can be jump-started using a set of jumper cables and a battery in another vehicle or by using a portable battery booster pack. Jump-starting can be dangerous if done improperly, so please follow the procedures in this section carefully.

NOTE:

When using a portable battery booster pack, follow the manufacturer's operating instructions and precautions.

WARNING!

Do not attempt jump-starting if the battery is frozen. It could rupture or explode and cause personal injury.

CAUTION!

Do not use a portable battery booster pack or any other booster source with a system voltage greater than 12 Volts or damage to the battery, starter motor, alternator or electrical system may occur.

WHAT TO DO IN EMERGENCIES

Preparations For Jump-Start

The battery in your vehicle is located in the front of the engine compartment, behind the left headlight assembly.

NOTE:

The positive battery post may be covered with a protective cap if equipped. Lift up on the cap to gain access to the positive battery post. Do not jump off fuses. Only jump directly off positive post which has a positive (+) symbol on or around the post.



Positive Jumping Location

WARNING!

- Take care to avoid the radiator cooling fan whenever the hood is raised. It can start anytime the ignition switch is ON. You can be injured by moving fan blades.
- Remove any metal jewelry such as rings, watch bands and bracelets that could make an inadvertent electrical contact. You could be seriously injured.
- Batteries contain sulfuric acid that can burn your skin or eyes and generate hydrogen gas which is flammable and explosive. Keep open flames or sparks away from the battery.

1. Apply the parking brake, shift the automatic transmission into PARK and turn the ignition to LOCK.
2. Turn off the heater, radio, and all unnecessary electrical accessories.
3. If using another vehicle to jump-start the battery, park the vehicle within the jumper cables reach, apply the parking brake and make sure the ignition is OFF.

WARNING!

Do not allow vehicles to touch each other as this could establish a ground connection and personal injury could result.

WHAT TO DO IN EMERGENCIES

Jump-Starting Procedure

WARNING!

Failure to follow this jump-starting procedure could result in personal injury or property damage due to battery explosion.

CAUTION!

Failure to follow these procedures could result in damage to the charging system of the booster vehicle or the discharged vehicle.

Connecting The Jumper Cables

1. Connect the positive (+) end of the jumper cable to the positive (+) post of the discharged vehicle.

NOTE:

Do not jump off fuses. Only jump directly off positive post.

2. Connect the opposite end of the positive (+) jumper cable to the positive (+) post of the booster battery.
3. Connect the negative (-) end of the jumper cable to the negative (-) post of the booster battery.
4. Connect the opposite end of the negative (-) jumper cable to a good engine ground (exposed metal part of the discharged vehicle's engine) away from the battery and the fuel injection system.

WARNING!

Do not connect the jumper cable to the negative (-) post of the discharged battery. The resulting electrical spark could cause the battery to explode and could result in personal injury. Only use the specific ground point, do not use any other exposed metal parts.

5. Start the engine in the vehicle that has the booster battery, let the engine idle a few minutes, and then start the engine in the vehicle with the discharged battery.

CAUTION!

Do not connect jumper cable to any of the fuses on the positive battery terminal. The resulting electrical current will blow the fuse.

6. Once the engine is started, remove the jumper cables in the reverse sequence:

WHAT TO DO IN EMERGENCIES

Disconnecting The Jumper Cables

1. Disconnect the negative (-) end of the jumper cable from the engine ground of the vehicle with the discharged battery.
2. Disconnect the opposite end of the negative (-) jumper cable from the negative (-) post of the booster battery.
3. Disconnect the positive (+) end of the jumper cable from the positive (+) post of the booster battery.
4. Disconnect the opposite end of the positive (+) jumper cable from the positive (+) post of the vehicle with the discharged battery.

If frequent jump-starting is required to start your vehicle you should have the battery and charging system inspected at your authorized dealer.

CAUTION!

Accessories plugged into the vehicle power outlets draw power from the vehicle's battery, even when not in use (i.e., cellular devices, etc.). Eventually, if plugged in long enough without engine operation, the vehicle's battery will discharge sufficiently to degrade battery life and/or prevent the engine from starting.

EMERGENCY TOW HOOKS

Your vehicle may be equipped with emergency tow hooks.

NOTE:

For off-road recovery, it is recommended to use both of the front tow hooks to minimize the risk of damage to the vehicle.

WARNING!

- Do not use a chain for freeing a stuck vehicle. Chains may break, causing serious injury or death.
- Stand clear of vehicles when pulling with tow hooks. Tow straps may become disengaged, causing serious injury.

CAUTION!

Tow hooks are for emergency use only to rescue a vehicle stranded off-road. Do not use tow hooks for tow truck hookup or highway towing. You could damage your vehicle.

WHAT TO DO IN EMERGENCIES

GEAR SELECTOR OVERRIDE

If a malfunction occurs and the gear selector cannot be moved out of the PARK position, you can use the following procedure to temporarily move the gear selector:

1. Turn the engine OFF.
2. Firmly apply the parking brake.
3. Tilt the steering wheel to the full up position.
4. Press and maintain firm pressure on the brake pedal.
5. Insert a screwdriver or similar tool into the access port (ringed circle) on the bottom of the steering column, and push and hold the override release lever up.
6. Move the gear selector to the NEUTRAL position.
7. The vehicle may then be started in NEUTRAL.



Gear Selector Override Access Port

TOWING A DISABLED VEHICLE

Towing Condition	Wheels OFF The Ground	2WD Models	4WD Models
Flat Tow	NONE	If transmission is operable: <ul style="list-style-type: none">• Transmission in NEUTRAL• 30 mph (48 km/h) max• 15 miles (24 km) max distance	<ul style="list-style-type: none">• Auto Transmission in PARK• Manual Transmission in gear (NOT NEUTRAL)• Transfer Case in NEUTRAL• Tow in FORWARD direction
			Wheel Lift Or Dolly Tow
	Rear	OK	NOT ALLOWED
Flatbed	ALL	BEST METHOD	BEST METHOD

WHAT TO DO IN EMERGENCIES

FREING A STUCK VEHICLE

If your vehicle becomes stuck in mud, sand, or snow, it can often be moved using a rocking motion. Turn the steering wheel right and left to clear the area around the front wheels. Next, shift back and forth between DRIVE and REVERSE (with automatic transmission) or SECOND GEAR and REVERSE (with manual transmission) while gently pressing the accelerator. Use the least amount of accelerator pedal pressure that will maintain the rocking motion, without spinning the wheels or racing the engine.

CAUTION!

Racing the engine or spinning the wheels may lead to transmission overheating and failure. Allow the engine to idle with the transmission in NEUTRAL for at least one minute after every five rocking-motion cycles. This will minimize overheating and reduce the risk of clutch or transmission failure during prolonged efforts to free a stuck vehicle.

NOTE:

Push the "ESC Off" switch, to place the Electronic Stability Control (ESC) system in "Partial Off" mode, before rocking the vehicle. Refer to "Electronic Brake Control System" in "Starting And Operating" in the Owner's Manual on www.ramtrucks.com/en/owners/manuals for further information. Once the vehicle has been freed, push the "ESC Off" switch again to restore "ESC On" mode.

WARNING!

Fast spinning tires can be dangerous. Forces generated by excessive wheel speeds may cause damage, or even failure, of the axle and tires. A tire could explode and injure someone. Do not spin your vehicle's wheels faster than 30 mph (48 km/h) or for longer than 30 seconds continuously without stopping when you are stuck and do not let anyone near a spinning wheel, no matter what the speed.

CAUTION!

- When "rocking" a stuck vehicle by shifting between DRIVE/SECOND GEAR and REVERSE, do not spin the wheels faster than 15 mph (24 km/h), or drivetrain damage may result.
- Revving the engine or spinning the wheels too fast may lead to transmission overheating and failure. It can also damage the tires. Do not spin the wheels above 30 mph (48 km/h) while in gear (no transmission shifting occurring).

WHAT TO DO IN EMERGENCIES

ENHANCED ACCIDENT RESPONSE SYSTEM (EARS)

This vehicle is equipped with an Enhanced Accident Response System.

Please refer to “Occupant Restraint Systems” in “Getting Started” for further information on the Enhanced Accident Response System (EARS) function.

EVENT DATA RECORDER (EDR)

This vehicle is equipped with an Event Data Recorder (EDR). The main purpose of an EDR is to record, in certain crash or near crash-like situations, such as an air bag deployment or hitting a road obstacle, data that will assist in understanding how a vehicle’s systems performed.

Please refer to “Occupant Restraint Systems” in “Getting Started” for further information on the Event Data Recorder (EDR).

MAINTAINING YOUR VEHICLE

TO OPEN AND CLOSE THE HOOD

To open the hood, two latches must be released.

1. Pull the hood release lever located below the steering wheel at the base of the instrument panel.
2. Reach into the opening beneath the center of the hood and push the safety latch lever to the left to release it, before raising the hood.



Hood Release Lever Location

WARNING!

Be sure the hood is fully latched before driving your vehicle. If the hood is not fully latched, it could open when the vehicle is in motion and block your vision. Failure to follow this warning could result in serious injury or death.

CAUTION!

To prevent possible damage, do not slam the hood to close it. Use a firm downward push at the front center of the hood to ensure that both latches engage.

MAINTAINING YOUR VEHICLE



ENGINE COMPARTMENT — 6.4L

1. Engine Coolant Reservoir
2. Transmission Fluid Dipstick
3. Engine Oil Fill
4. Brake Fluid Reservoir
5. Aux Power Distribution Center (Fuses)
6. Battery

MAINTAINING YOUR VEHICLE

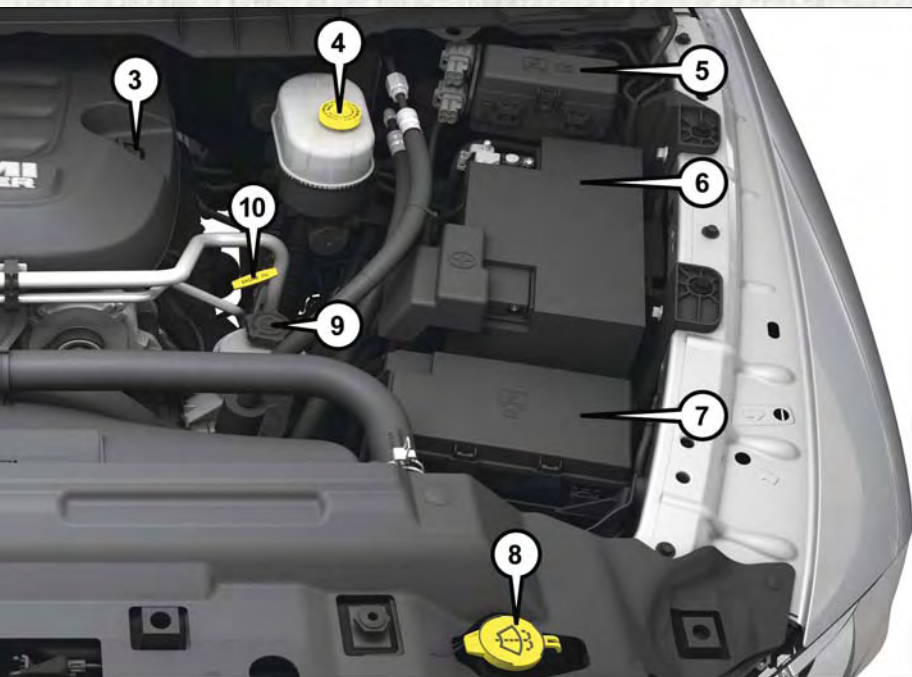

- 7. Power Distribution Center (Fuses)
- 8. Washer Fluid Reservoir
- 9. Power Steering Reservoir
- 10. Engine Oil Dipstick
- 11. Air Cleaner Filter

MAINTAINING YOUR VEHICLE



ENGINE COMPARTMENT — 6.7L

1. Batteries
2. Engine Coolant Reservoir
3. Transmission Fluid Dipstick
4. Brake Fluid Reservoir
5. Aux Power Distribution Center (Fuses)

MAINTAINING YOUR VEHICLE

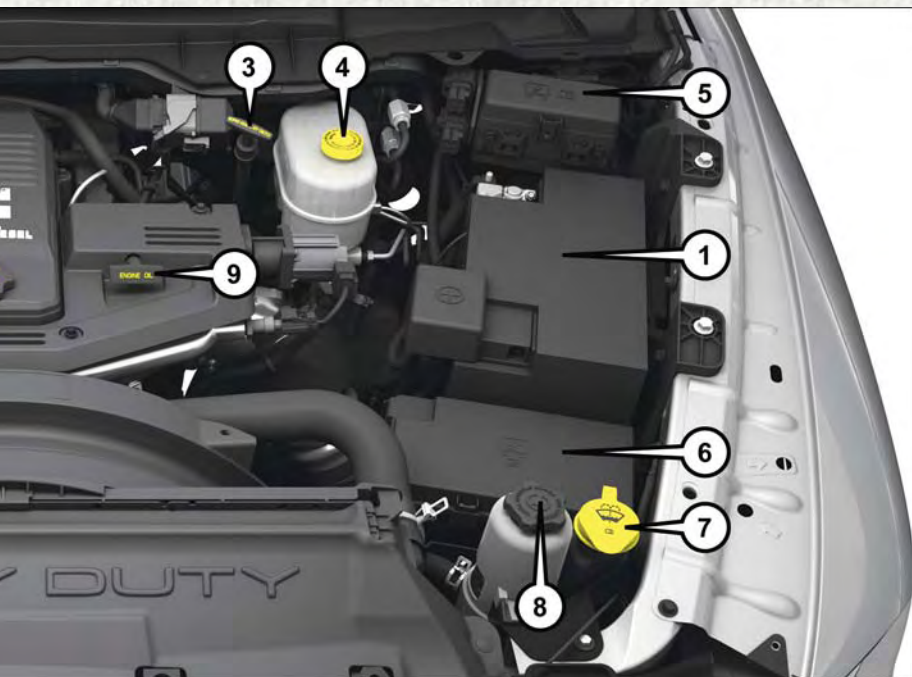

6. Power Distribution Center (Fuses)
7. Washer Fluid Reservoir
8. Power Steering Fluid Reservoir
9. Engine Oil Dipstick
10. Engine Oil Fill
11. Air Cleaner Filter

MAINTAINING YOUR VEHICLE

FLUID CAPACITIES — GAS ENGINE

	U.S.	Metric
Fuel (Approximate)		
Standard Rear Tank	52 Gallons	197 Liters
Optional Midship Tank	22 Gallons	83 Liters
Engine Oil With Filter		
6.4L Engine (We recommend you use SAE 0W-40, Synthetic API Certified)	7 Quarts	6.6 Liters
Cooling System		
6.4L Engine (We recommend you use Mopar Antifreeze/Coolant 10 Year/150,000 Mile Formula).	16.6 Quarts	15.7 Liters

FLUIDS, LUBRICANTS, AND GENUINE PARTS — GAS ENGINE

Engine

Component	Fluid, Lubricant, or Genuine Part
Engine Coolant	We recommend you use Mopar Antifreeze/Coolant 10-Year/150,000 Mile Formula OAT (Organic Additive Technology).
Engine Oil – 6.4L Engine	For best performance and maximum protection under all types of operating conditions, the manufacturer only recommends full synthetic engine oils that meet the American Petroleum Institute (API) categories of SN. The manufacturer recommends the use of Pennzoil Ultra 0W-40 or equivalent Mopar engine oil meeting the requirements of FCA Material Standard MS-12633 for use in all operating temperatures.
Engine Oil Filter – 6.4L Engine	We recommend you use Mopar Engine Oil Filters.
Spark Plugs – 6.4L Engine	We recommend you use Mopar Spark Plugs.
Fuel Selection – 6.4L Engine	89 Octane Recommended - 87 Octane Acceptable, 0-15% Ethanol.

MAINTAINING YOUR VEHICLE

CAUTION!

- Mixing of engine coolant (antifreeze) other than specified Organic Additive Technology (OAT) engine coolant (antifreeze), may result in engine damage and may decrease corrosion protection. Organic Additive Technology (OAT) engine coolant is different and should not be mixed with Hybrid Organic Additive Technology (HOAT) engine coolant (antifreeze) or any “globally compatible” coolant (antifreeze). If a non-OAT engine coolant (antifreeze) is introduced into the cooling system in an emergency, the cooling system will need to be drained, flushed, and refilled with fresh OAT coolant (conforming to MS.90032), by an authorized dealer as soon as possible.
- Do not use water alone or alcohol-based engine coolant (antifreeze) products. Do not use additional rust inhibitors or antirust products, as they may not be compatible with the radiator engine coolant and may plug the radiator.
- This vehicle has not been designed for use with propylene glycol-based engine coolant (antifreeze). Use of propylene glycol-based engine coolant (antifreeze) is not recommended.

Chassis

Component	Fluid, Lubricant, or Genuine Part
Automatic Transmission (6.4L Engine with 66RFE Transmission) (For Diesel Engine See Diesel Section Below)	Use only ATF+4 Automatic Transmission Fluid. Failure to use ATF+4 fluid may affect the function or performance of your transmission. We recommend Mopar ATF+4 fluid.
Automatic Transmission (6.4L Engine with AS66RC Transmission)	Use only Mopar ASRC Automatic Transmission Fluid or equivalent. Failure to use the proper fluid may affect the function or performance of your transmission.
Transfer Case	We recommend you use Mopar BW44-44 Transfer Case Fluid.
Front and Rear Axle Fluid (4500/5500)	We recommend you use GL-5 SAE 75W-90 Synthetic (MS-9763). Limited slip additive is not required for Limited-Slip Rear Axles.
Brake Master Cylinder	We recommend you use Mopar DOT 3 and SAE J1703. If DOT 3 brake fluid is not available, then DOT 4 is acceptable.
Power Steering Reservoir	We recommend you use Mopar Power Steering Fluid +4, Mopar ATF+4 Automatic Transmission Fluid.

MAINTAINING YOUR VEHICLE

FLUID CAPACITIES — 6.7L CUMMINS DIESEL ENGINE

	U.S.	Metric
Fuel (Approximate)		
2500/3500 Standard Cab Longbed Models	28 Gallons	106 Liters
2500/3500 Crew/Mega Cab Shortbed Models	31 Gallons	129 Liters
2500/3500 Crew Cab Longbed Models	32 Gallons	132 Liters
Standard Rear Tank – Chassis Cab Only	52 Gallons	197 Liters
Optional Midship Tank – Chassis Cab Only	22 Gallons	83 Liters
Diesel Exhaust Fluid Tank (Approximate) – 2500/3500 Models	5.5 Gallons	21 Liters
Diesel Exhaust Fluid Tank (Approximate) – Chassis Cab	9 Gallons	34 Liters
Engine Oil With Filter		
6.7L Turbo Diesel Engine	12 Quarts	11.4 Liters
Cooling System		
6.7L Turbo Diesel Engine (Mopar Engine Coolant/Antifreeze 10 Year/150,000 Mile Formula)	5.7 Gallons	21.4 Liters

FLUIDS, LUBRICANTS, AND GENUINE PARTS — 6.7L CUMMINS DIESEL ENGINE

Engine

Component	Fluid, Lubricant, or Genuine Part
Engine Coolant	We recommend you use Mopar Antifreeze/Coolant 10 Year/150,000 Mile Formula OAT (Organic Additive Technology).
Engine Oil	In ambient temperatures above 0°F (-18°C), we recommend you use 15W-40 engine oil such as Mopar, Shell Rotella and Shell Rimula that meets FCA Materials Standard MS-10902 and the API CJ-4 engine oil category is required. Products meeting Cummins CES 20081 may also be used. The identification of these engine oils is typically located on the back of the oil container. In ambient temperatures below 0°F (-18°C), we recommend you use 5W-40 synthetic engine oil such as Mopar, Shell Rotella and Shell Rimula that meets FCA Materials Standard MS-10902 and the API CJ-4 engine oil category is required.
Engine Oil Filter	We recommend you use Mopar Engine Oil Filters.
Fuel Filters	We recommend you use Mopar Fuel Filter. Must meet 3 micron rating. Using a fuel filter that does not meet the manufacturers filtration and water separating requirements can severely impact fuel system life and reliability.
Crankcase Ventilation Filter	We recommend you use Mopar CCV Filter.

MAINTAINING YOUR VEHICLE

Component	Fluid, Lubricant, or Genuine Part
Fuel Selection	<p>Use good quality diesel fuel from a reputable supplier in your vehicle. Federal law requires that you must fuel this vehicle with Ultra Low Sulfur Highway Diesel fuel (15 ppm Sulfur maximum) and prohibits the use of Low Sulfur Highway Diesel fuel (500 ppm Sulfur maximum) to avoid damage to the emissions control system.</p> <p>For most year-round service, No. 2 diesel fuel meeting ASTM specification D-975 Grade S15 will provide good performance.</p> <p>If the vehicle is exposed to extreme cold (below 20°F or -7°C), or is required to operate at colder-than-normal conditions for prolonged periods, use climatized No. 2 diesel fuel or dilute the No. 2 diesel fuel with 50% No. 1 diesel fuel. This will provide better protection from fuel gelling or wax-plugging of the fuel filters.</p> <p>This vehicle is fully compatible with biodiesel blends up to 5% biodiesel meeting ASTM specification D-975. Chassis Cab models and Pickup models configured with optional B20 capability, are additionally compatible with 20% biodiesel meeting ASTM specification D-7467 provided the shortened maintenance intervals are followed as directed.</p>
Diesel Exhaust Fluid	<p>Mopar Diesel Exhaust Fluid (API Certified) (DEF) or equivalent that has been API Certified to the ISO 22241 standard. Use of fluids not API Certified to ISO 22241 may result in system damage. You can receive assistance in locating DEF in the United States by calling 866-RAM-INFO (866-726-4636). In Canada call 1-800-465-2001 (English) or 1-800-387-9983 (French).</p>

CAUTION!

- Mixing of engine coolant (antifreeze) other than specified Organic Additive Technology (OAT) engine coolant (antifreeze), may result in engine damage and may decrease corrosion protection. Organic Additive Technology (OAT) engine coolant is different and should not be mixed with Hybrid Organic Additive Technology (HOAT) engine coolant (antifreeze) or any “globally compatible” coolant (antifreeze). If a non-OAT engine coolant (antifreeze) is introduced into the cooling system in an emergency, the cooling system will need to be drained, flushed, and refilled with fresh OAT coolant (conforming to MS.90032), by an authorized dealer as soon as possible.
- Do not use water alone or alcohol-based engine coolant (antifreeze) products. Do not use additional rust inhibitors or antirust products, as they may not be compatible with the radiator engine coolant and may plug the radiator.
- This vehicle has not been designed for use with propylene glycol-based engine coolant (antifreeze). Use of propylene glycol-based engine coolant (antifreeze) is not recommended.

MAINTAINING YOUR VEHICLE

Chassis

Component	Fluid, Lubricant, or Genuine Part
Automatic Transmission – If Equipped 6.7L Diesel with (Six-Speed 68RFE) – 2500/3500 Pickup models without PTO	Only use ATF+4 Automatic Transmission Fluid. Failure to use ATF+4 fluid may affect the function or performance of your transmission. We recommend Mopar ATF+4 fluid.
Automatic Transmission – If Equipped 6.7L Diesel with (Six-Speed AS69RC) – Pickup models with PTO and All Chassis Cab models	Only use Mopar ASRC Automatic Transmission Fluid or equivalent. Failure to use the proper fluid may affect the function or performance of your transmission.
Transfer Case	We recommend you use Mopar BW44–44 Transfer Case Fluid.
Front and Rear Axle Fluid (2500/3500)	We recommend you use SAE 75W-85 HD Ram GL-5 Synthetic Axle Lubricant. Limited slip additive is not required for Limited-Slip Rear Axles.
Front and Rear Axle Fluid (4500/5500)	We recommend you use GL-5 SAE 75W-90 Synthetic (MS-9763). Limited slip additive is not required for Limited-Slip Rear Axles.
Clutch Linkage	We recommend you use Mopar Multi-Purpose Grease, NLGI Grade 2 E.P. or equivalent.
Manual Transmission (G-56) – If Equipped	We recommend you use Mopar ATF+4 Automatic Transmission Fluid or equivalent licensed ATF+4 product.

ADDING FUEL

CAUTION!

- Damage to the fuel system or emissions control system could result from using an improper fuel tank filler tube cap (fuel filler cap). A poorly fitting cap could let impurities into the fuel system. Also, a poorly-fitted aftermarket cap can cause the MIL (Malfunction Indicator Light) to illuminate due to fuel vapors escaping from the system.
- A poorly fitting fuel filler cap may cause the MIL to turn on.
- To avoid fuel spillage and overfilling, do not “top off” the fuel tank after filling.

NOTE:

When the fuel nozzle “clicks” or shuts off the fuel tank is full.

MAINTAINING YOUR VEHICLE

WARNING!

- Never have any smoking materials lit in or near the vehicle when the gas cap is removed or the tank is being filled.
- Never add fuel to the vehicle when the engine is running. This is in violation of most state and federal fire regulations and may cause the MIL to turn on.

NOTE:

Tighten the gas cap $\frac{1}{4}$ turn until you hear one click. This is an indication that the cap is properly tightened.

If the gas cap is not tightened properly, the Malfunction Indicator Light will come on. Be sure the gas cap is tightened every time the vehicle is refueled.

WARNING!

A fire may result if gasoline is pumped into a portable container that is inside of a vehicle. You could be burned. Always place gas containers on the ground while filling.

Materials Added To Fuel



Designated TOP TIER Detergent Gasoline contains a higher level of detergents to further aid in minimizing engine and fuel system deposits. When available, the usage of Top Tier Detergent gasoline is recommended. Visit www.toptiergas.com for a list of TOP TIER Detergent Gasoline Retailers.

Indiscriminate use of fuel system cleaning agents should be avoided. Many of these materials intended for gum and varnish removal may contain active solvents or similar ingredients. These can harm fuel system gasket and diaphragm materials.

MAINTENANCE PROCEDURES

For information on the maintenance procedures for your vehicle, please refer to "Maintenance Procedures" in "Maintaining Your Vehicle" in your Owner's Manual or an applicable supplement at www.ramtrucks.com/en/owners/manuals for further information.

MAINTAINING YOUR VEHICLE

MAINTENANCE SCHEDULE — GASOLINE ENGINE

Your vehicle is equipped with an automatic oil change indicator system. The oil change indicator system will remind you that it is time to take your vehicle in for scheduled maintenance.

Based on engine operation conditions, the oil change indicator message will illuminate. This means that service is required for your vehicle. Operating conditions such as frequent short-trips, trailer tow, extremely hot or cold ambient temperatures, and E85 fuel usage will influence when the “Oil Change Required” message is displayed. Severe Operating Conditions can cause the change oil message to illuminate as early as 3,500 miles (5,600 km) since last reset. Have your vehicle serviced as soon as possible, within the next 500 miles (805 km).

Your authorized dealer will reset the oil change indicator message after completing the scheduled oil change. If a scheduled oil change is performed by someone other than your authorized dealer, the message can be reset by referring to the steps described under “Instrument Cluster Warning Lights” in “What To Do In Emergencies” in this guide or “Instrument Cluster Display” in “Understanding Your Instrument Panel” in your Owner’s Manual at www.ramtrucks.com/en/owners/manuals for further information.

Gasoline Engines:

Under no circumstances should oil change intervals exceed 8,000 miles (13,000 km), twelve months or 350 hours of engine run time, whichever comes first. The 350 hours of engine run or idle time is generally only a concern for fleet customers.

Severe Duty:

Change Engine Oil at 4,000 miles (6,500 km) if the vehicle is operated in a dusty and off road environment or is operated predominately at idle or very low engine RPM’s. This type of vehicle use is considered Severe Duty.

Once A Month Or Before A Long Trip:

- Check engine oil level
- Check windshield washer fluid level
- Check the tire inflation pressures and look for unusual wear or damage
- Check the fluid levels of the coolant reservoir, brake master cylinder, power steering and automatic transmission, and fill as needed
- Check function of all interior and exterior lights

MAINTAINING YOUR VEHICLE

Maintenance Chart – Gasoline Engine

Required Maintenance

Refer to the Maintenance Schedules on the following pages for required maintenance.

At Every Oil Change Interval As Indicated By Oil Change Indicator System:
• Change oil and filter.
• Rotate the tires. Rotate at the first sign of irregular wear, even if it occurs before the oil indicator system turns on.
• Inspect engine cooling system protection and hoses.
• Inspect exhaust system.
• Inspect engine air cleaner if using in dusty or off-road conditions.
• Inspect battery and clean and tighten terminals as required.
• Inspect automatic transmission fluid if equipped with dipstick.
• Inspect brake pads, shoes, rotors, drums, hoses and park brake.
• Inspect front end, and lubricate — If equipped with serviceable fittings.
• Lube the front drive shaft fitting (4X4 models only).

MAINTAINING YOUR VEHICLE

Mileage or time passed (whichever comes first)	20,000	30,000	40,000	50,000	60,000	70,000	80,000	90,000	100,000	110,000	120,000	130,000	140,000	150,000
	2	3	4	5	6	7	8	9	10	11	12	13	14	15
Or Years:														
Or Kilometers:														
Additional Inspections														
Inspect the CV/Universal joints,		X			X			X			X			X
Inspect front suspension, tie rod ends, and replace if necessary.	X		X		X		X		X		X		X	
Inspect the front and rear axle surfaces. If gear oil leakage is suspected, check the fluid level. If using your vehicle for police, taxi, fleet, off-road or frequent trailer towing, change axle fluid.	X		X		X		X		X		X		X	
Inspect the brake linings, parking brake function.	X		X		X		X		X		X		X	
Additional Maintenance														
Replace engine air filter.		X			X			X			X			X
Replace spark plugs. **									X					
Flush and replace the engine coolant at 10 years or 150,000 miles (240,000 km) whichever comes first.									X					X
Change the automatic transmission fluid (AS66RC Transmission Only).		X						X						X
Change the automatic transmission fluid and sump filter (AS66RC Transmission Only).					X						X			

MAINTAINING YOUR VEHICLE

Mileage or time passed (whichever comes first)	2	3	4	5	6	7	8	9	10	11	12	13	14	15
0r Years:	32,000	48,000	64,000	80,000	96,000	112,000	128,000	144,000	160,000	176,000	192,000	208,000	224,000	240,000
Or Kilometers:														
Change the automatic transmission fluid and filter(s) (66RFE Transmission Only), if using your vehicle for police, taxi, fleet, or frequent trailer towing.			X								X			
Change the automatic transmission fluid and filter(s) (66RFE transmission).											X			
Inspect the transfer case fluid, change for any of the following: police, taxi, fleet, or frequent trailer towing.		X			X						X			X
Change the transfer case fluid.											X			
Inspect and replace PCV valve if necessary.									X					

** The spark plug change interval is mileage based only, yearly intervals do not apply.

WARNING!

- You can be badly injured working on or around a motor vehicle. Do only service work for which you have the knowledge and the right equipment. If you have any doubt about your ability to perform a service job, take your vehicle to a competent mechanic.
- Failure to properly inspect and maintain your vehicle could result in a component malfunction and effect vehicle handling and performance. This could cause an accident.

MAINTAINING YOUR VEHICLE

MAINTENANCE RECORD

	Odometer	Date	Signature, Authorized Service Center
20,000 Miles (32,000 km) or 2 Years			
30,000 Miles (48,000 km) or 3 Years			
40,000 Miles (64,000 km) or 4 Years			
50,000 Miles (80,000 km) or 5 Years			
60,000 Miles (96,000 km) or 6 Years			
70,000 Miles (112,000 km) or 7 Years			
80,000 Miles (128,000 km) or 8 Years			

	Odometer	Date	Signature, Authorized Service Center
90,000 Miles (144,000 km) or 9 Years			
100,000 Miles (160,000 km) or 10 Years			
110,000 Miles (176,000 km) or 11 Years			
120,000 Miles (192,000 km) or 12 Years			
130,000 Miles (208,000 km) or 13 Years			
140,000 Miles (224,000 km) or 14 Years			
150,000 Miles (240,000 km) or 15 Years			

MAINTAINING YOUR VEHICLE

MAINTENANCE SCHEDULE — 6.7L CUMMINS DIESEL ENGINE

CAUTION!

Failure to perform the required maintenance items may result in damage to the vehicle.

At Each Stop For Fuel

Check the engine oil level at least 30 minutes after a fully warmed engine is shut off. Checking the oil level while the vehicle is on level ground will improve the accuracy of the oil level reading. Add oil only when the level is at or below the ADD or MIN mark.

Once A Month

- Inspect the batteries, and clean and tighten the terminals as required.
- Check the fluid levels of the coolant reservoir, brake master cylinder, and automatic transmission (if equipped), and add as needed.

At Each Oil Change

- Change the engine oil filter.
- Inspect the exhaust system.
- Inspect engine air filter.
- Check the coolant level, hoses, and clamps.
- Inspect front end, and lubricate — If equipped with serviceable fittings.
- Lube the front drive shaft fitting (4X4 models only).

Inspection and service should also be performed anytime a malfunction is observed or suspected. Retain all receipts.

Oil Change Indicator System — Cummins Diesel

Your vehicle is equipped with an engine oil change indicator system. This system will alert you when it is time to change your engine oil by displaying the words “Oil Change Due” in your instrument cluster display. The oil change reminder will remind the owner to change the engine oil every 15,000 miles or 500 hours, whichever comes first, except for the Chassis Cab models and Pickup models configured with optional B20 capability that are using B20 biodiesel, which are 12,500 miles or 400 hours, whichever comes first. Failure to change the engine oil per the maintenance schedule can result in internal engine damage.

Your authorized dealer will reset the oil change indicator message after completing the scheduled oil change. If a scheduled oil change is performed by someone other than your authorized dealer, the message can be reset by referring to the steps

MAINTAINING YOUR VEHICLE

described under “Instrument Cluster Warning Lights” in “What To Do In Emergencies” in this guide or “Instrument Cluster Display” in “Understanding Your Instrument Panel” in your Owner’s Manual on www.ramtrucks.com/en/owners/manuals for further information.

Replace the engine oil and oil filter every 15,000 miles (24,000 km) or six months, or sooner if prompted by the oil change indicator system. Under no circumstances should oil change intervals exceed 15,000 miles (24,000 km) or six months, whichever comes first.

NOTE:

- Under no circumstances should oil change intervals exceed 15,000 miles (24,000 km) or six months or 500 Hours, whichever comes first.
- Replace the engine oil and oil filter every 12,500 miles (20 000 km) when running B20 fuel (Chassis Cab Only).

If Chassis Cab models and Pickup models configured with optional B20 capability are operated with greater than 5% levels of biodiesel, the oil change interval must not exceed 12,500 miles (20 000 km) under any circumstances. See the Fuel Requirements section for more information regarding operation of Chassis Cab models and Pickup models configured for use with biodiesel blend (B6-B20) fuel meeting ASTM specification D-7467.

Perform Service Indicator — Cummins Diesel

Your vehicle will require emissions maintenance at a set interval. To help remind you when this maintenance is due, the instrument cluster will display “Perform Service”. When the “Perform Service” message is displayed on the instrument cluster it is necessary to have the emissions maintenance performed. Emissions maintenance may include replacing the Closed Crankcase Ventilation (CCV) filter element. The procedure for clearing and resetting the “Perform Service” indicator message is located in the appropriate Service Information.

Maintenance Chart — Cummins Diesel Engine

Mileage or time passed (whichever comes first):	7,500	15,000	22,500	30,000	37,500	45,000	52,500	60,000	67,500	75,000	82,500	90,000	97,500	105,000	112,500	120,000	127,500	135,000	142,500	150,000	
	9	12	18	24	30	36	42	48	54	60	66	72	78	84	90	96	102	108	114	120	
Or Months:	X	X	X	X	X	X	X	X	X	X	X	X	X	X	X	X	X	X	X	X	X
Or Kilometers:	X	X	X	X	X	X	X	X	X	X	X	X	X	X	X	X	X	X	X	X	X
Change engine oil every 15,000 miles (24 000 km) or six months or 500 Hours or sooner if prompted by the oil change indicator system, whichever comes first. **	X	X	X	X	X	X	X	X	X	X	X	X	X	X	X	X	X	X	X	X	X
Additional Inspections																					
Check the Diesel Exhaust Fluid (DEF) tank, refill if necessary.	X	X	X	X	X	X	X	X	X	X	X	X	X	X	X	X	X	X	X	X	X
Rotate the tires.	X	X	X	X	X	X	X	X	X	X	X	X	X	X	X	X	X	X	X	X	X
Lubricate front drive shaft fitting (4x4).	X	X	X	X	X	X	X	X	X	X	X	X	X	X	X	X	X	X	X	X	X
Inspect front end, and lubricate — if equipped with serviceable fittings.	X	X	X	X	X	X	X	X	X	X	X	X	X	X	X	X	X	X	X	X	X
Inspect engine air filter, replace if necessary. ****		X	X	X	X	X	X	X	X	X	X	X	X	X	X	X	X	X	X	X	X
Inspect the front suspension, tie rod ends and boot seals for cracks or leaks and all parts for damage, wear, improper looseness or end play; replace if necessary.		X	X	X	X	X	X	X	X	X	X	X	X	X	X	X	X	X	X	X	X
Inspect the brake linings.			X	X	X	X	X	X	X	X	X	X	X	X	X	X	X	X	X	X	X
Inspect and adjust parking brake.			X	X	X	X	X	X	X	X	X	X	X	X	X	X	X	X	X	X	X
Inspect drive belt; replace as necessary.		X	X	X	X	X	X	X	X	X	X	X	X	X	X	X	X	X	X	X	X
Inspect wheel bearings.			X	X	X	X	X	X	X	X	X	X	X	X	X	X	X	X	X	X	X
Additional Maintenance																					
Replace cabin air filter.		X	X	X	X	X	X	X	X	X	X	X	X	X	X	X	X	X	X	X	X
Replace engine fuel filter element.		X	X	X	X	X	X	X	X	X	X	X	X	X	X	X	X	X	X	X	X

MAINTAINING YOUR VEHICLE

Mileage or time passed (whichever comes first):	6	12	18	24	30	36	42	48	54	60	66	72	78	84	90	96	102	108	114	120	
	7,500	15,000	22,500	30,000	37,500	45,000	52,500	60,000	67,500	75,000	82,500	90,000	97,500	105,000	112,500	120,000	127,500	135,000	142,500	150,000	
Or Months:	X	X	X	X	X	X	X	X	X	X	X	X	X	X	X	X	X	X	X	X	X
Or Kilometers:	X	X	X	X	X	X	X	X	X	X	X	X	X	X	X	X	X	X	X	X	X
Replace chassis mounted fuel filter element.																					
Inspect the front and rear axle surfaces. If gear oil leakage is suspected, check the fluid level. If using your vehicle for police, taxi, fleet, off-road or frequent trailer towing change the axle fluid. *																					
Inspect the transfer case fluid (4x4), change for any of the following: police, taxi, fleet, or frequent trailer towing.			X					X				X				X					X
Change the transfer case fluid (4x4).								X								X					
Change automatic transmission fluid (AS69RC transmission only).			X					X				X				X					X
Change the automatic transmission fluid and sump filter (AS69RC transmission only).								X								X					
Change automatic transmission fluid and filter(s) if using your vehicle for any of the following: police, fleet, or frequent trailer towing (68RFE transmission only).								X								X					
Change automatic transmission fluid and filter(s).																X					
Change the manual transmission fluid if using your vehicle for any of the following: police, fleet, or frequent trailer towing.								X								X					
Replace Crankcase Ventilation Filter (CCV).									X										X		
Flush and replace power steering fluid.													X								
Flush and replace engine coolant. ***																					X
Adjust valve lash clearance.																					X

Inspection and service should also be performed anytime a malfunction is observed or suspected. Retain all receipts.

* Inspect the front and rear axle surfaces every 20,000 miles (32,000 km). If gear oil leakage is suspected, check the fluid level. If using your vehicle for police, taxi, fleet, off-road or frequent trailer towing change the axle fluid every 20,000 miles (32,000 km).

** Under no circumstances should oil change intervals exceed 15,000 miles (24 000 km) or six months or 500 Hours, whichever comes first.

*** The manufacturer highly recommends that all cooling system service, maintenance, and repairs be performed by your local authorized dealer.

**** Under no circumstances should the air cleaner filter element exceed 30,000 miles (48,000 km) or 24 months, whichever comes first.

WARNING!

- You can be badly injured working on or around a motor vehicle. Do only service work for which you have the knowledge and the right equipment. If you have any doubt about your ability to perform a service job, take your vehicle to a competent mechanic.
- Failure to properly inspect and maintain your vehicle could result in a component malfunction and effect vehicle handling and performance. This could cause an accident.

CAUTION!

***The manufacturer highly recommends that all cooling system service, maintenance, and repairs be performed by your local authorized dealer.

MAINTAINING YOUR VEHICLE

Maintenance Record — Cummins Diesel Engine

	Odometer	Date	Signature, Authorized Service Center
7,500 Miles (12,000 km) or 6 Months			
15,000 Miles (24,000 km) or 12 Months			
22,500 Miles (36,000 km) or 18 Months			
30,000 Miles (48,000 km) or 24 Months			
37,500 Miles (60,000 km) or 30 Months			
45,000 Miles (72,000 km) or 36 Months			
52,500 Miles (84,000 km) or 42 Months			
60,000 Miles (96,000 km) or 48 Months			

	Odometer	Date	Signature, Authorized Service Center
67,500 Miles (108,000 km) or 54 Months			
75,000 Miles (120,000 km) or 60 Months			
82,500 Miles (132,000 km) or 66 Months			
90,000 Miles (144,000 km) or 72 Months			
97,500 Miles (156,000 km) or 78 Months			
105,000 Miles (168,000 km) or 84 Months			
112,500 Miles (180,000 km) or 90 Months			
120,000 Miles (192,000 km) or 96 Months			

MAINTAINING YOUR VEHICLE

	Odometer	Date	Signature, Authorized Service Center
	127,500 Miles (204,000 km) or 102 Months		
	135,000 Miles (216,000 km) or 108 Months		

	Odometer	Date	Signature, Authorized Service Center
	142,500 Miles (228,000 km) or 114 Months		
	150,000 Miles (240,000 km) or 120 Months		

MAINTAINING YOUR VEHICLE

FUSES

WARNING!

- When replacing a blown fuse, always use an appropriate replacement fuse with the same amp rating as the original fuse. Never replace a fuse with another fuse of higher amp rating. Never replace a blown fuse with metal wires or any other material. Failure to use proper fuses may result in serious personal injury, fire and/or property damage.
- Before replacing a fuse, make sure that the ignition is off and that all the other services are switched off and/or disengaged.
- If the replaced fuse blows again, contact an authorized dealer.
- If a general protection fuse for safety systems (air bag system, braking system), power unit systems (engine system, gearbox system) or steering system blows, contact an authorized dealer.

Power Distribution Center

The Power Distribution Center is located in the engine compartment near the battery. This center contains cartridge fuses, micro fuses, relays, and circuit breakers. A description of each fuse and component may be stamped on the inside cover, otherwise the cavity number of each fuse is stamped on the inside cover that corresponds to the following chart.

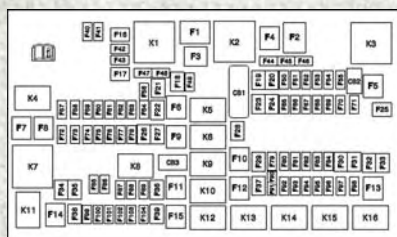

Cavity	Cartridge Fuse	Micro Fuse	Description
F01	80 Amp Black	–	Rad Fan Control Module – If Equipped
F03	60 Amp Yellow	–	Rad Fan – If Equipped
F05	40 Amp Green	–	Compressor for Air Suspension – If Equipped
F06	40 Amp Green	–	Antilock Brakes/Electronic Stability Control Pump
F07	40 Amp Green	–	Starter Solenoid
F08	20 Amp Blue (1500 LD/Cummins Diesel)	–	Emissions Diesel – If Equipped

MAINTAINING YOUR VEHICLE

Cavity	Cartridge Fuse	Micro Fuse	Description
F09	40 Amp Green (Special Services Vehicle & Cummins Diesel)	-	Diesel Fuel Heater – If Equipped
F10	40 Amp Green	-	Body Controller / Exterior Lighting #2
F10	50 Amp Red	-	Body Controller / Exterior Lighting #2 – If Equipped with Stop/Start
F11	30 Amp Pink	-	Integrated Trailer Brake Module – If Equipped
F12	40 Amp Green	-	Body Controller #3 / Power Locks
F13	40 Amp Green	-	Blower Motor
F14	40 Amp Green	-	Body Controller #4 / Interior Lighting
F16	30 Amp Pink	-	Smart Bar – If Equipped
F19	20 Amp Blue (1500 LD Diesel) 30 Amp Pink (Cummins Diesel)	-	SCR – If Equipped
F20	30 Amp Pink	-	Passenger Door Module
F21	30 Amp Pink	-	Drive Train Control Module
F22	20 Amp Blue 30 Amp Pink (Cummins Diesel)	-	Engine Control Module
F23	30 Amp Pink	-	Body Controller #1 / Interior Lighting
F24	30 Amp Pink	-	Driver Door Module
F25	30 Amp Pink	-	Front Wiper
F26	30 Amp Pink	-	Antilock Brakes / Stability Control Module / Valves
F28	20 Amp Blue	-	Trailer Tow Backup Lights – If Equipped
F29	20 Amp Blue	-	Trailer Tow Parking Lights – If Equipped
F30	30 Amp Pink	-	Trailer Tow Receptacle
F31	30 Amp Pink (1500 LD Diesel)	-	Urea Heater Control – If Equipped
F32	-	-	Spare Fuse
F33	20 Amp Blue	-	Special Services Vehicle Only
F34	30 Amp Pink	-	Vehicle System Interface Module #2 – If Equipped
F35	30 Amp Pink	-	Sunroof – If Equipped
F36	30 Amp Pink	-	Rear Defroster – If Equipped
F37	30 Amp Pink	-	Cummins Diesel Fuel Heater #2 – If Equipped
F38	30 Amp Pink	-	Power Inverter 115V AC – If Equipped

MAINTAINING YOUR VEHICLE

Cavity	Cartridge Fuse	Micro Fuse	Description
F39	20 Amp Blue	–	Power Outlet – Special Services Only
F41	–	10 Amp Red	Active Grill Shutter – If Equipped
F42	–	20 Amp Yellow	Horn
F44	–	10 Amp Red	Diagnostic Port
F46	–	10 Amp Red	Upfitter – If Equipped
F49	–	10 Amp Red	Instrument Panel Cluster (Except Fleet Vehicles)
F50	–	20 Amp Yellow	Air Suspension Control Module – If Equipped
F51	–	10 Amp Red	Ignition Node Module / Keyless Ignition (Instrument Panel Cluster – Fleet Vehicles Only)
F52	–	5 Amp Tan	Battery Sensor
F53	–	20 Amp Yellow	Trailer Tow – Left Turn/Stop Lights
F54	–	20 Amp Yellow	Adjustable Pedals
F56	–	15 Amp Blue	Additional Diesel Content – If Equipped
F57	–	20 Amp Yellow	Transmission
F58	–	20 Amp Yellow	Spare Fuse
F59	–	10 Amp Red	SCR Relay – If Equipped
F60	–	15 Amp Blue	Underhood Lamp
F61	–	10 Amp Red (1500 LD Diesel & Cummins Diesel)	PM Sensor – If Equipped
F62	–	10 Amp Red	Air Conditioning Clutch
F63	–	20 Amp Yellow	Ignition Coils (Gas), Urea Heater (Cummins Diesel)
F64	–	25 Amp Clear	Fuel Injectors / Powertrain
F65	–	–	Spare Fuse
F66	–	10 Amp Red	Sunroof / Passenger Window Switches / Rain Sensor
F67	–	10 Amp Red	CD / DVD / Bluetooth Hands-free Module – If Equipped
F69	–	15 Amp Blue	Mod SCR 12V (Cummins Diesel) – If Equipped
F70	–	30 Amp Green	Fuel Pump Motor
F71	–	25 Amp Clear	Amplifier
F72	–	10 Amp Red	PCM – If Equipped
F73	–	20 Amp Yellow	Fuel Transfer Pump (HD Only) – If Equipped

MAINTAINING YOUR VEHICLE

Cavity	Cartridge Fuse	Micro Fuse	Description
F74	–	20 Amp Yellow (Gas Engine & 1500 LD Diesel)	Brake Vacuum Pump Gas/Diesel – If Equipped
F75	–	10 Amp Red	Coolant Temperature Valve Actuator
F76	–	10 Amp Red	Antilock Brakes / Electronic Stability Control
F77	–	10 Amp Red	Drivetrain Control Module/Front Axle Disconnect Module
F78	–	10 Amp Red	Engine Control Module / Electric Power Steering
F79	–	15 Amp Blue	Clearance Lights
F80	–	10 Amp Red	Universal Garage Door Opener / Com- pass
F81	–	20 Amp Yellow	Trailer Tow Right Turn / Stop Lights
F82	–	10 Amp Red	Steering Column Control Module / Cruise Control
F84	–	15 Amp Blue	Switch Bank / Instrument Cluster
F85	–	10 Amp Red	Airbag Module
F86	–	10 Amp Red	Airbag Module
F87	–	10 Amp Red	Air Suspension – If Equipped / Trailer Tow / Steering Column Control Module
F88	–	15 Amp Blue	Instrument Panel Cluster
F90/ F91	–	20 Amp Yellow	Power Outlet (Rear Seats) Customer Selectable
F93	–	20 Amp Yellow	Cigar Lighter
F94	–	10 Amp Red	Shifter / Transfer Case Module
F95	–	10 Amp Red	Rear Camera / Park Assist
F96	–	10 Amp Red	Rear Seat Heater Switch
F97	–	25 Amp Clear	Rear Heated Seats & Heated Steering Wheel – If Equipped
F98	–	25 Amp Clear	Front Heated Seats – If Equipped
F99	–	10 Amp Red	Climate Control
F100	–	10 Amp Red	Upfitters – If Equipped
F101	–	15 Amp Blue	Electrochromatic Mirror / Smart High Beams – If Equipped
F104	–	20 Amp Yellow	Power Outlets (Instrument Panel / Cen- ter Console)

MAINTAINING YOUR VEHICLE

CAUTION!

- When installing the power distribution center cover, it is important to ensure the cover is properly positioned and fully latched. Failure to do so may allow water to get into the power distribution center and possibly result in an electrical system failure.
- When replacing a blown fuse, it is important to use only a fuse having the correct amperage rating. The use of a fuse with a rating other than indicated may result in a dangerous electrical system overload. If a properly rated fuse continues to blow, it indicates a problem in the circuit that must be corrected.

TIRE SAFETY INFORMATION

Tire Markings

NOTE:

- P (Passenger) — Metric tire sizing is based on U.S. design standards. P-Metric tires have the letter “P” molded into the sidewall preceding the size designation. Example: P215/65R15 95H.
- European — Metric tire sizing is based on European design standards. Tires designed to this standard have the tire size molded into the sidewall beginning with the section width. The letter “P” is absent from this tire size designation. Example: 215/65R15 96H.
- LT (Light Truck) — Metric tire sizing is based on U.S. design standards. The size designation for LT-Metric tires is the same as for P-Metric tires except for the letters “LT” that are molded into the sidewall preceding the size designation. Example: LT235/85R16.
- Temporary spare tires are designed for temporary emergency use only. Temporary high pressure compact spare tires have the letter “T” or “S” molded into the sidewall preceding the size designation. Example: T145/80D18 103M.
- High flotation tire sizing is based on U.S. design standards and it begins with the tire diameter molded into the sidewall. Example: 31x10.5 R15 LT.

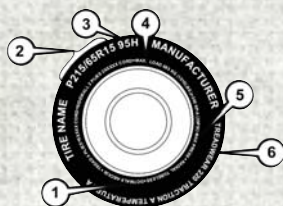

1 — U.S. DOT Safety Standards Code (TIN)	4 — Maximum Load
2 — Size Designation	5 — Maximum Pressure
3 — Service Description	6 — Treadwear, Traction and Temperature Grades

MAINTAINING YOUR VEHICLE

Tire Sizing Chart

EXAMPLE:

Example Size Designation: P215/65R15XL 95H, 215/65R15 96H, LT235/85R16C, T145/80D18 103M, 31x10.5 R15 LT

P = Passenger car tire size based on U.S. design standards, or

"...blank..." = Passenger car tire based on European design standards, or

LT = Light truck tire based on U.S. design standards, or

T or S = Temporary spare tire or

31 = Overall diameter in inches (in)

215, 235, 145 = Section width in millimeters (mm)

65, 85, 80 = Aspect ratio in percent (%)

– Ratio of section height to section width of tire, or

10.5 = Section width in inches (in)

R = Construction code

– "R" means radial construction, or

– "D" means diagonal or bias construction

15, 16, 18 = Rim diameter in inches (in)

Service Description:

95 = Load Index

– A numerical code associated with the maximum load a tire can carry

H = Speed Symbol

– A symbol indicating the range of speeds at which a tire can carry a load corresponding to its load index under certain operating conditions

– The maximum speed corresponding to the speed symbol should only be achieved under specified operating conditions (i.e., tire pressure, vehicle loading, road conditions, and posted speed limits)

Load Identification:

Absence of the following load identification symbols on the sidewall of the tire indicates a Standard Load (SL) tire:

- **XL** = Extra load (or reinforced) tire, or

- **LL** = Light load tire or

- **C, D, E, F, G** = Load range associated with the maximum load a tire can carry at a specified pressure

Maximum Load – Maximum load indicates the maximum load this tire is designed to carry

Maximum Pressure – Maximum pressure indicates the maximum permissible cold tire inflation pressure for this tire

MAINTAINING YOUR VEHICLE

Tire Identification Number (TIN)

The TIN may be found on one or both sides of the tire; however, the date code may only be on one side. Tires with white sidewalls will have the full TIN, including the date code, located on the white sidewall side of the tire. Look for the TIN on the outboard side of black sidewall tires as mounted on the vehicle. If the TIN is not found on the outboard side, then you will find it on the inboard side of the tire.

EXAMPLE:	
DOT MA L9 ABCD 0301	
DOT = Department of Transportation	
<ul style="list-style-type: none">This symbol certifies that the tire is in compliance with the U.S. Department of Transportation tire safety standards and is approved for highway use	
MA = Code representing the tire manufacturing location (two digits)	
L9 = Code representing the tire size (two digits)	
ABCD = Code used by the tire manufacturer (one to four digits)	
03 = Number representing the week in which the tire was manufactured (two digits)	
<ul style="list-style-type: none">03 means the 3rd week	
01 = Number representing the year in which the tire was manufactured (two digits)	
<ul style="list-style-type: none">01 means the year 2001Prior to July 2000, tire manufacturers were only required to have one number to represent the year in which the tire was manufactured. Example: 031 could represent the 3rd week of 1981 or 1991	

Tire Terminology And Definitions

Term	Definition
B-Pillar	The vehicle B-Pillar is the structural member of the body located behind the front door.
Cold Tire Inflation Pressure	Cold tire inflation pressure is defined as the tire pressure after the vehicle has not been driven for at least three hours, or driven less than 1 mile (1.6 km) after sitting for a minimum of three hours. Inflation pressure is measured in units of PSI (pounds per square inch) or kPa (kilopascals).
Maximum Inflation Pressure	The maximum inflation pressure is the maximum permissible cold tire inflation pressure for this tire. The maximum inflation pressure is molded into the sidewall.
Recommended Cold Tire Inflation Pressure	Vehicle manufacturer's recommended cold tire inflation pressure as shown on the tire placard.
Tire Placard	A label permanently attached to the vehicle describing the vehicle's loading capacity, the original equipment tire sizes and the recommended cold tire inflation pressures.

MAINTAINING YOUR VEHICLE

Tire Loading And Tire Pressure

Tire And Loading Information Placard Location

NOTE:

The proper cold tire inflation pressure is listed on the driver's side B-Pillar or the rear edge of the driver's side door.

Check the inflation pressure of each tire, including the spare tire (if equipped), at least monthly and inflate to the recommended pressure for your vehicle.

NOTE:

Refer to the Owner's Manual, or the Tire Information Supplement, located in your Owner's Information kit for more information regarding tire warnings and instructions.



Example Tire Placard Location (Door)

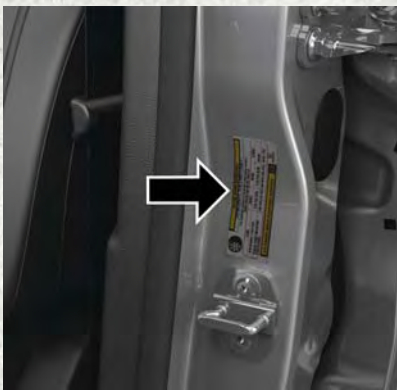

Example Tire Placard Location (B-Pillar)

MAINTAINING YOUR VEHICLE

WARNING!

- Overloading of your tires is dangerous. Overloading can cause tire failure, affect vehicle handling, and increase your stopping distance. Use tires of the recommended load capacity for your vehicle. Never overload them.
- Improperly inflated tires are dangerous and can cause collisions.
- Under-inflation increases tire flexing and can result in over-heating and tire failure.
- Over-inflation reduces a tire's ability to cushion shock. Objects on the road and chuck holes can cause damage that results in tire failure.
- Unequal tire pressures can cause steering problems. You could lose control of your vehicle.
- Unequal tire pressures from one side of the vehicle to the other can cause the vehicle to drift to the right or left.
- Over-inflated or under-inflated tires can affect vehicle handling and can fail suddenly, resulting in loss of vehicle control.
- Always drive with each tire inflated to the recommended cold tire inflation pressure.

Tire And Loading Information Placard

This placard tells you important information about the:

1. Number of people that can be carried in the vehicle.
2. Total weight your vehicle can carry.
3. Tire size designed for your vehicle.
4. Cold tire inflation pressures for the front, rear, and spare tires.

TIRE AND LOADING INFORMATION			
SEATING CAPACITY - TOTAL 5 FRONT 2 REAR 3			
THE COMBINED WEIGHT OF OCCUPANTS AND CARGO SHOULD NEVER EXCEED XXX KG OR XXX LBS.			
TIRE	FRONT	REAR	SPARE
ORIGINAL TIRE SIZE	P195/70R14	P195/70R14	T125/70D15
COLD TIRE INFLATION PRESSURE	200kPa, 29PSI	200kPa, 29PSI	420kPa, 60PSI
SEE OWNER'S MANUAL FOR ADDITIONAL INFORMATION			4N109265

Tire And Loading Information Placard

Loading

The vehicle maximum load on the tire must not exceed the load carrying capacity of the tire on your vehicle. You will not exceed the tire's load carrying capacity if you adhere to the loading conditions, tire size, and cold tire inflation pressures specified on the Tire and Loading Information placard in "Vehicle Loading" in the "Starting And Operating" section of the Owner's Manual, or the Tire Information Supplement, located in your Owner's Information kit.

NOTE:

Under a maximum loaded vehicle condition, gross axle weight ratings (GAWRs) for the front and rear axles must not be exceeded. Refer to "Vehicle Loading" in "Starting And Operating" in the Owner's Manual, or the Tire Information Supplement, located in your Owner's Information kit for further information on GAWRs, vehicle loading, and trailer towing.

MAINTAINING YOUR VEHICLE

To determine the maximum loading conditions of your vehicle, locate the statement “The combined weight of occupants and cargo should never exceed XXX kg or XXX lbs” on the Tire and Loading Information placard. The combined weight of occupants, cargo/luggage and trailer tongue weight (if applicable) should never exceed the weight referenced here.

Steps For Determining Correct Load Limit—

- (1) Locate the statement “The combined weight of occupants and cargo should never exceed XXX kg or XXX lbs.” on your vehicle's placard.
- (2) Determine the combined weight of the driver and passengers that will be riding in your vehicle.
- (3) Subtract the combined weight of the driver and passengers from XXX kg or XXX lbs.
- (4) The resulting figure equals the available amount of cargo and luggage load capacity. For example, if “XXX” amount equals 1400 lbs. and there will be five 150 lb passengers in your vehicle, the amount of available cargo and luggage load capacity is 650 lbs. $(1400 - 750 (5 \times 150) = 650 \text{ lbs.})$
- (5) Determine the combined weight of luggage and cargo being loaded on the vehicle. That weight may not safely exceed the available cargo and luggage load capacity calculated in Step 4.
- (6) If your vehicle will be towing a trailer, load from your trailer will be transferred to your vehicle. Consult this manual to determine how this reduces the available cargo and luggage load capacity of your vehicle.

Metric Example For Load Limit

For example, if “XXX” amount equals 635 kg, and there will be five 68 kg passengers in your vehicle, the amount of available cargo and luggage load capacity is 295 kg $(635 - 340 (5 \times 68) = 295 \text{ kg})$ as shown in step 4.

NOTE:

- If your vehicle will be towing a trailer, load from your trailer will be transferred to your vehicle. The following table shows examples on how to calculate total load, cargo/luggage, and towing capacities of your vehicle with varying seating configurations and number and size of occupants. This table is for illustration purposes only and may not be accurate for the seating and load carry capacity of your vehicle.
- For the following example, the combined weight of occupants and cargo should never exceed 865 lbs (392 kg).

MAINTAINING YOUR VEHICLE

Occupants			Combined weight of occupants and cargo from Tire Placard	MINUS	Combined Occupant's weight	=	AVAILABLE Cargo/Luggage and Trailer Tongue Weight
TOTAL	FRONT	REAR					
EXAMPLE 1							
5	2	3	865 lbs	MINUS	670 lbs	=	195 lbs
EXAMPLE 2							
3	2	1	865 lbs	minus	540 lbs	=	325 lbs
EXAMPLE 3							
2	2	0	865 lbs	minus	400 lbs	=	465 lbs

811a4d11

WARNING!

Overloading of your tires is dangerous. Overloading can cause tire failure, affect vehicle handling, and increase your stopping distance. Use tires of the recommended load capacity for your vehicle. Never overload them.

TIRES — GENERAL INFORMATION

Tire Pressure

Proper tire inflation pressure is essential to the safe and satisfactory operation of your vehicle. Four primary areas are affected by improper tire pressure:

- Safety and Vehicle Stability
- Economy
- Tread Wear
- Ride Comfort

Safety

WARNING!

- Improperly inflated tires are dangerous and can cause collisions.
- Underinflation increases tire flexing and can result in overheating and tire failure.
- Overinflation reduces a tire's ability to cushion shock. Objects on the road and chuckholes can cause damage that result in tire failure.
- Overinflated or underinflated tires can affect vehicle handling and can fail suddenly, resulting in loss of vehicle control.
- Unequal tire pressures can cause steering problems. You could lose control of your vehicle.
- Unequal tire pressures from one side of the vehicle to the other can cause the vehicle to drift to the right or left.
- Always drive with each tire inflated to the recommended cold tire inflation pressure.

Both under-inflation and over-inflation affect the stability of the vehicle and can produce a feeling of sluggish response or over responsiveness in the steering.

NOTE:

- Unequal tire pressures from side to side may cause erratic and unpredictable steering response.
- Unequal tire pressure from side to side may cause the vehicle to drift left or right.

Fuel Economy

Underinflated tires will increase tire rolling resistance resulting in higher fuel consumption.

Ride Comfort And Vehicle Stability

Proper tire inflation contributes to a comfortable ride. Over-inflation produces a jarring and uncomfortable ride.

Tire Inflation Pressures

The proper cold tire inflation pressure is listed on the driver's side B-Pillar or rear edge of the driver's side door.

At least once a month:

- Check and adjust tire pressure with a good quality pocket-type pressure gauge. Do not make a visual judgement when determining proper inflation. Tires may look properly inflated even when they are under-inflated.
- Inspect tires for signs of tire wear or visible damage.

MAINTAINING YOUR VEHICLE

CAUTION!

After inspecting or adjusting the tire pressure, always reinstall the valve stem cap. This will prevent moisture and dirt from entering the valve stem, which could damage the valve stem.

Inflation pressures specified on the placard are always “cold tire inflation pressure”. Cold tire inflation pressure is defined as the tire pressure after the vehicle has not been driven for at least three hours, or driven less than 1 mile (1.6 km) after sitting for a minimum of three hours. The cold tire inflation pressure must not exceed the maximum inflation pressure molded into the tire sidewall.

Check tire pressures more often if subject to a wide range of outdoor temperatures, as tire pressures vary with temperature changes.

Tire pressures change by approximately 1 psi (7 kPa) per 12°F (7°C) of air temperature change. Keep this in mind when checking tire pressure inside a garage, especially in the Winter.

Example: If garage temperature = 68°F (20°C) and the outside temperature = 32°F (0°C) then the cold tire inflation pressure should be increased by 3 psi (21 kPa), which equals 1 psi (7 kPa) for every 12°F (7°C) for this outside temperature condition.

Tire pressure may increase from 2 to 6 psi (13 to 40 kPa) during operation. DO NOT reduce this normal pressure build up or your tire pressure will be too low.

Tire Pressures For High Speed Operation

The manufacturer advocates driving at safe speeds and within posted speed limits. Where speed limits or conditions are such that the vehicle can be driven at high speeds, maintaining correct tire inflation pressure is very important. Increased tire pressure and reduced vehicle loading may be required for high-speed vehicle operation. Refer to your authorized tire dealer or original equipment vehicle dealer for recommended safe operating speeds, loading and cold tire inflation pressures.

WARNING!

High speed driving with your vehicle under maximum load is dangerous. The added strain on your tires could cause them to fail. You could have a serious collision. Do not drive a vehicle loaded to the maximum capacity at continuous speeds above 75 mph (120 km/h).

MAINTAINING YOUR VEHICLE

Tire Maintenance And Replacement

You should follow all maintenance procedures specified by the manufacturer of this vehicle's tires. The tires originally installed on this vehicle were designed to conform to EPA greenhouse gas standards and NHTSA fuel economy standards.

If you need to replace your tires, you should do so with tires that meet those standards. Check with your authorized dealer or with the tire manufacturer for appropriate replacement tires.

Radial Ply Tires

WARNING!

Combining radial ply tires with other types of tires on your vehicle will cause your vehicle to handle poorly. The instability could cause a collision. Always use radial ply tires in sets of four. Never combine them with other types of tires.

Tire Repair

If your tire becomes damaged, it may be repaired if it meets the following criteria:

- The tire has not been driven on when flat.
- The damage is only on the tread section of your tire (sidewall damage is not repairable).
- The puncture is no greater than a $\frac{1}{4}$ of an inch (6 mm).

Consult an authorized tire dealer for tire repairs and additional information.

Damaged Run Flat tires, or Run Flat tires that have experienced a loss of pressure should be replaced immediately with another Run Flat tire of identical size and service description (Load Index and Speed Symbol).

Tire Types

All Season Tires — If Equipped

All season tires provide traction for all seasons (Spring, Summer, Fall and Winter). Traction levels may vary between different all season tires. All season tires can be identified by the M+S, M&S, M/S or MS designation on the tire sidewall. Use all season tires only in sets of four; failure to do so may adversely affect the safety and handling of your vehicle.

Summer Or Three Season Tires — If Equipped

Summer tires provide traction in both wet and dry conditions, and are not intended to be driven in snow or on ice. If your vehicle is equipped with Summer tires, be aware these tires are not designed for Winter or cold driving conditions. Install Winter tires on your vehicle when ambient temperatures are less than 40°F (5°C) or if roads are covered with ice or snow. For more information, contact an authorized dealer.

MAINTAINING YOUR VEHICLE

Summer tires do not contain the all season designation or mountain/snowflake symbol on the tire sidewall. Use Summer tires only in sets of four; failure to do so may adversely affect the safety and handling of your vehicle.

WARNING!

Do not use Summer tires in snow/ice conditions. You could lose vehicle control, resulting in severe injury or death. Driving too fast for conditions also creates the possibility of loss of vehicle control.

Snow Tires

Some areas of the country require the use of snow tires during the Winter. Snow tires can be identified by a “mountain/snowflake” symbol on the tire sidewall.



If you need snow tires, select tires equivalent in size and type to the original equipment tires. Use snow tires only in sets of four; failure to do so may adversely affect the safety and handling of your vehicle.

Snow tires generally have lower speed ratings than what was originally equipped with your vehicle and should not be operated at sustained speeds over 75 mph (120 km/h). For speeds above 75 mph (120 km/h), refer to original equipment or an authorized tire dealer for recommended safe operating speeds, loading and cold tire inflation pressures.

While studded tires improve performance on ice, skid and traction capability on wet or dry surfaces may be poorer than that of non-studded tires. Some states prohibit studded tires; therefore, local laws should be checked before using these tire types.

Run Flat Tires — If Equipped

Run Flat tires allow you the capability to drive 50 miles (80 km) at 50 mph (80 km/h) after a rapid loss of inflation pressure. This rapid loss of inflation is referred to as the Run Flat mode. A Run Flat mode occurs when the tire inflation pressure is of/or below 14 psi (96 kPa). Once a Run Flat tire reaches the Run Flat mode, it has limited driving capabilities and needs to be replaced immediately. A Run Flat tire is not repairable.

It is not recommended to drive a vehicle loaded at full capacity, or to tow a trailer while a tire is in the Run Flat mode.

See the tire pressure monitoring section for more information.

MAINTAINING YOUR VEHICLE

Spare Tires — If Equipped

NOTE:

For vehicles equipped with Tire Service Kit instead of a spare tire, please refer to the “Tire Service Kit” section located in your Owner’s Information kit for further information.

CAUTION!

Because of the reduced ground clearance, do not take your vehicle through an automatic car wash with a compact or limited use temporary spare installed. Damage to the vehicle may result.

Spare Tire Matching Original Equipped Tire And Wheel — If Equipped

Your vehicle may be equipped with a spare tire and wheel equivalent in look and function to the original equipment tire and wheel found on the front or rear axle of your vehicle. This spare tire may be used in the tire rotation for your vehicle. If your vehicle has this option, refer to an authorized tire dealer for the recommended tire rotation pattern.

Compact Spare Tire — If Equipped

The compact spare is for temporary emergency use only. You can identify if your vehicle is equipped with a compact spare by looking at the spare tire description on the Tire and Loading Information Placard located on the driver’s side door opening or on the sidewall of the tire. Compact spare tire descriptions begin with the letter “T” or “S” preceding the size designation. Example: T145/80D18 103M.

T, S = Temporary Spare Tire

Since this tire has limited tread life, the original equipment tire should be repaired (or replaced) and reinstalled on your vehicle at the first opportunity.

Do not install a wheel cover or attempt to mount a conventional tire on the compact spare wheel, since the wheel is designed specifically for the compact spare tire. Do not install more than one compact spare tire and wheel on the vehicle at any given time.

WARNING!

Compact and Collapsible spares are for temporary emergency use only. With these spares, do not drive more than 50 mph (80 km/h). Temporary use spares have limited tread life. When the tread is worn to the tread wear indicators, the temporary use spare tire needs to be replaced. Be sure to follow the warnings, which apply to your spare. Failure to do so could result in spare tire failure and loss of vehicle control.

MAINTAINING YOUR VEHICLE

Full Size Spare — If Equipped

The full size spare is for temporary emergency use only. This tire may look like the originally equipped tire on the front or rear axle of your vehicle, but it is not. This spare tire may have limited tread life. When the tread is worn to the tread wear indicators, the temporary use full size spare tire needs to be replaced. Since it is not the same as your original equipment tire, replace (or repair) the original equipment tire and reinstall on the vehicle at the first opportunity.

Limited Use Spare — If Equipped

The limited use spare tire is for temporary emergency use only. This tire is identified by a label located on the limited use spare wheel. This label contains the driving limitations for this spare. This tire may look like the original equipped tire on the front or rear axle of your vehicle, but it is not. Installation of this limited use spare tire affects vehicle handling. Since it is not the same as your original equipment tire, replace (or repair) the original equipment tire and reinstall on the vehicle at the first opportunity.

WARNING!

Limited use spares are for emergency use only. Installation of this limited use spare tire affects vehicle handling. With this tire, do not drive more than the speed listed on the limit use spare wheel. Keep inflated to the cold tire inflation pressures listed on your Tire and Loading Information Placard located on the driver's side B-Pillar or the rear edge of the driver's side door. Replace (or repair) the original equipment tire at the first opportunity and reinstall it on your vehicle. Failure to do so could result in loss of vehicle control.

Tire Spinning

When stuck in mud, sand, snow, or ice conditions, do not spin your vehicle's wheels above 30 mph (48 km/h) or for longer than 30 seconds continuously without stopping.

Refer to "Freeing A Stuck Vehicle" in "What To Do In Emergencies" for further information.

WARNING!

Fast spinning tires can be dangerous. Forces generated by excessive wheel speeds may cause tire damage or failure. A tire could explode and injure someone. Do not spin your vehicle's wheels faster than 30 mph (48 km/h) for more than 30 seconds continuously when you are stuck, and do not let anyone near a spinning wheel, no matter what the speed.

Tread Wear Indicators

Tread wear indicators are in the original equipment tires to help you in determining when your tires should be replaced.

These indicators are molded into the bottom of the tread grooves. They will appear as bands when the tread depth becomes a 1/16 of an inch (1.6 mm). When the tread is worn to the tread wear indicators, the tire should be replaced. Refer to “Replacement Tires” in this section for further information.



Tire Tread

- 1 — Worn Tire
- 2 — New Tire

Life Of Tire

The service life of a tire is dependent upon varying factors including, but not limited to:

- Driving style.
- Tire pressure – Improper cold tire inflation pressures can cause uneven wear patterns to develop across the tire tread. These abnormal wear patterns will reduce tread life, resulting in the need for earlier tire replacement.
- Distance driven.
- Performance tires, tires with a speed rating of V or higher, and Summer tires typically have a reduced tread life. Rotation of these tires per the vehicle maintenance schedule is highly recommended.

WARNING!

Tires and the spare tire should be replaced after six years, regardless of the remaining tread. Failure to follow this warning can result in sudden tire failure. You could lose control and have a collision resulting in serious injury or death.

Keep dismantled tires in a cool, dry place with as little exposure to light as possible. Protect tires from contact with oil, grease, and gasoline.

MAINTAINING YOUR VEHICLE

Replacement Tires

The tires on your new vehicle provide a balance of many characteristics. They should be inspected regularly for wear and correct cold tire inflation pressures. The manufacturer strongly recommends that you use tires equivalent to the originals in size, quality and performance when replacement is needed. Refer to the paragraph on “Tread Wear Indicator” in this section. Refer to the Tire and Loading Information placard or the Vehicle Certification Label for the size designation of your tire. The Load Index and Speed Symbol for your tire will be found on the original equipment tire sidewall.

See the Tire Sizing Chart example found in the “Tire Safety Information” section of this manual for more information relating to the Load Index and Speed Symbol of a tire.

It is recommended to replace the two front tires or two rear tires as a pair. Replacing just one tire can seriously affect your vehicle’s handling. If you ever replace a wheel, make sure that the wheel’s specifications match those of the original wheels.

It is recommended you contact your authorized tire dealer or original equipment dealer with any questions you may have on tire specifications or capability. Failure to use equivalent replacement tires may adversely affect the safety, handling, and ride of your vehicle.

WARNING!

- Do not use a tire, wheel size or rating other than that specified for your vehicle. Some combinations of unapproved tires and wheels may change suspension dimensions and performance characteristics, resulting in changes to steering, handling, and braking of your vehicle. This can cause unpredictable handling and stress to steering and suspension components. You could lose control and have a collision resulting in serious injury or death. Use only the tire and wheel sizes with load ratings approved for your vehicle.
- Never use a tire with a smaller load index or capacity, other than what was originally equipped on your vehicle. Using a tire with a smaller load index could result in tire overloading and failure. You could lose control and have a collision.
- Failure to equip your vehicle with tires having adequate speed capability can result in sudden tire failure and loss of vehicle control.

CAUTION!

Replacing original tires with tires of a different size may result in false speedometer and odometer readings.

MAINTAINING YOUR VEHICLE

Wheel And Wheel Trim Care

All wheels and wheel trim, especially aluminum and chrome plated wheels, should be cleaned regularly using mild (neutral Ph) soap and water to maintain their luster and to prevent corrosion. Wash wheels with the same soap solution recommended for the body of the vehicle.

Your wheels are susceptible to deterioration caused by salt, sodium chloride, magnesium chloride, calcium chloride, etc., and other road chemicals used to melt ice or control dust on dirt roads. Use a soft cloth or sponge and mild soap to wipe away promptly. Do not use harsh chemicals or a stiff brush. They can damage the wheel's protective coating that helps keep them from corroding and tarnishing.

NOTE:

Many aftermarket wheel cleaners contain strong acids or strong alkaline additives that can harm the wheel surface.

CAUTION!

Avoid products or automatic car washes that use acidic solutions or strong alkaline additives or harsh brushes. Many aftermarket wheel cleaners and automatic car washes may damage the wheel's protective finish. Such damage is not covered by the New Vehicle Limited Warranty. Only car wash soap, Mopar Wheel Cleaner or equivalent is recommended.

When cleaning extremely dirty wheels including excessive brake dust, care must be taken in the selection of tire and wheel cleaning chemicals and equipment to prevent damage to the wheels. Mopar Wheel Treatment, Mopar Chrome Cleaner, or their equivalent is recommended or select a non-abrasive, non-acidic cleaner for aluminum or chrome wheels. Do not use any products on Dark Vapor or Black Satin Chrome Wheels. They will permanently damage this finish and such damage is not covered by the New Vehicle Limited Warranty.

CAUTION!

Do not use scouring pads, steel wool, a bristle brush, metal polishes or oven cleaner. These products may damage the wheel's protective finish. Such damage is not covered by the New Vehicle Limited Warranty. Only car wash soap, Mopar Wheel Cleaner or equivalent is recommended.

NOTE:

If you intend parking or storing your vehicle for an extended period after cleaning the wheels with wheel cleaner, drive your vehicle for a few minutes before doing so. Driving the vehicle and applying the brakes when stopping will reduce the risk of brake rotor corrosion.

MAINTAINING YOUR VEHICLE

Dark Vapor Or Black Satin Chrome Wheels

CAUTION!

If your vehicle is equipped with these specialty wheels, DO NOT USE wheel cleaners, abrasives, or polishing compounds. They will permanently damage this finish and such damage is not covered by the New Vehicle Limited Warranty. HAND WASH ONLY USING MILD SOAP AND WATER WITH A SOFT CLOTH. Used on a regular basis; this is all that is required to maintain this finish.

DEPARTMENT OF TRANSPORTATION UNIFORM TIRE QUALITY GRADES

The following tire grading categories were established by the National Highway Traffic Safety Administration. The specific grade rating assigned by the tire's manufacturer in each category is shown on the sidewall of the tires on your vehicle.

All passenger vehicle tires must conform to Federal safety requirements in addition to these grades.

Treadwear

The Treadwear grade is a comparative rating, based on the wear rate of the tire when tested under controlled conditions on a specified government test course. For example, a tire graded 150 would wear one and one-half times as well on the government course as a tire graded 100. The relative performance of tires depends upon the actual conditions of their use, however, and may depart significantly from the norm due to variations in driving habits, service practices, and differences in road characteristics and climate.

Traction Grades

The Traction grades, from highest to lowest, are AA, A, B, and C. These grades represent the tire's ability to stop on wet pavement, as measured under controlled conditions on specified government test surfaces of asphalt and concrete. A tire marked C may have poor traction performance.

WARNING!

The traction grade assigned to this tire is based on straight-ahead braking traction tests, and does not include acceleration, cornering, hydroplaning, or peak traction characteristics.

Temperature Grades

The temperature grades are A (the highest), B, and C, representing the tire's resistance to the generation of heat and its ability to dissipate heat, when tested under controlled conditions on a specified indoor laboratory test wheel. Sustained high temperature can cause the material of the tire to degenerate and reduce tire life, and excessive temperature can lead to sudden tire failure. The grade C corresponds to a level of performance, which all passenger vehicle tires must meet under the Federal Motor Vehicle Safety Standard No. 109. Grades B and A represent higher levels of performance on the laboratory test wheel, than the minimum required by law.

WARNING!

The temperature grade for this tire is established for a tire that is properly inflated and not overloaded. Excessive speed, under-inflation, or excessive loading, either separately or in combination, can cause heat buildup and possible tire failure.

MAINTAINING YOUR VEHICLE

REPLACEMENT BULBS

LIGHT BULBS — Interior

	Bulb Number
Overhead Console Lamps	TS 212-2
Dome Lamp	7679
For lighted switches, see your authorized dealer for replacement instructions.	

LIGHT BULBS — Exterior

	Bulb Number
Quad Headlamp – Low Beam	H11
Quad Headlamp – High Beam	9005
Quad Headlamp – Front Turn Signal Lamp	3157NA
Premium Headlamp – Low Beam	HIR2
Premium Headlamp – High Beam	9005
Premium Headlamp – Front Turn Signal Lamp	LED (See authorized dealer for service)
Horizontal Fog Lamp	9145
Vertical Fog Lamp	9006
Cab Roof Marker Lamps	194NA
Center High Mounted Stop Lamp	921
Rear Cargo Lamp	921
Box Off Tail Lamps – Stop/Turn/Tail/License Plate	1157
Box Off Tail Lamps – Back Up	1156

CONSUMER ASSISTANCE

FCA US LLC CUSTOMER CENTER

P.O. Box 21-8004 Auburn Hills, MI 48321-8004 Phone: 1-866-726-4636

FCA CANADA INC. CUSTOMER CENTER

P.O. Box 1621 Windsor, Ontario N9A 4H6 Phone: 1-800-465-2001 (English)
Phone: 1-800-387-9983 (French)

ASSISTANCE FOR THE HEARING IMPAIRED

To assist customers who have hearing difficulties, the manufacturer has installed special TDD (Telecommunication Devices for the Deaf) equipment at its customer center. Any hearing or speech impaired customer, who has access to a TDD or a conventional teletypewriter (TTY) in the United States, can communicate with the manufacturer by dialing 1-800-380-CHRY. Canadian residents with hearing difficulties that require assistance can use the special needs relay service offered by Bell Canada. For TTY teletypewriter users, dial 711 and for Voice callers, dial 1-800-855-0511 to connect with a Bell Relay Service operator.

WARNING!

Engine exhaust, some of its constituents, and certain vehicle components contain, or emit, chemicals known to the State of California to cause cancer and birth defects, or other reproductive harm. In addition, certain fluids contained in vehicles and certain products of component wear contain, or emit, chemicals known to the State of California to cause cancer and birth defects, or other reproductive harm.

PUBLICATIONS ORDERING

- If you are the first registered retail owner of your vehicle, you may obtain a complimentary printed copy of the Owner's Manual, Navigation/Uconnect Manuals or Warranty Booklet. United States customers may visit the Ram Truck Contact Us page at www.ramtrucks.com scroll to the bottom of the page and select the "Contact Us" link, then select the "Owner's Manual and Glove Compartment Material" from the left menu. You may also obtain a complimentary copy by calling 1-866-726-4636 (U.S.) or 1-800-387-1143 (Canada).
- Replacement User Guide kits, DVDs, or, if you prefer, additional printed copies of the Owner's Manual, Warranty Booklet, or Radio Manuals may be purchased by visiting www.techauthority.com or by calling 1-800-890-4038 (U.S.) or 1-800-387-1143 (Canada). Visa, Master Card, American Express and Discover orders are accepted.

NOTE:

- The Owner's Manual and User Guide electronic files are also available on the Chrysler, Jeep®, Ram Truck, Dodge and SRT websites.

CONSUMER ASSISTANCE

- Click on the “Owners” tab, select “Owner And Service Manuals”, then select your desired model year and vehicle from the drop down lists.

REPORTING SAFETY DEFECTS IN THE UNITED STATES

If you believe that your vehicle has a defect that could cause a crash or cause injury or death, you should immediately inform the National Highway Traffic Safety Administration (NHTSA) in addition to notifying FCA US LLC.

If NHTSA receives similar complaints, it may open an investigation, and if it finds that a safety defect exists in a group of vehicles, it may order a recall and remedy campaign. However, NHTSA cannot become involved in individual problems between you, your authorized dealer or FCA US LLC.

To contact NHTSA, you may call the Vehicle Safety Hotline toll free at 1-888-327-4236 (TTY: 1-800-424-9153); or go to <http://www.safercar.gov>; or write to: Administrator, NHTSA, 1200 New Jersey Avenue, SE., West Building, Washington, D.C. 20590. You can also obtain other information about motor vehicle safety from <http://www.safercar.gov>.

In Canada

If you believe that your vehicle has a safety defect, you should contact the Customer Service Department immediately. Canadian customers who wish to report a safety defect to the Canadian government should contact Transport Canada, Motor Vehicle Defect Investigations and Recalls at 1-800-333-0510 or go to <http://www.tc.gc.ca/roadsafety/>.

French Canadian customers who wish to report a safety defect to the Canadian government should contact Transport Canada, Motor Vehicle Defect Investigations and Recalls at 1-800-333-0510 or go to <http://www.tc.gc.ca/securiteroutiere/>.

AUTHENTIC ACCESSORIES BY MOPAR

- In choosing Authentic Accessories you gain far more than expressive style, premium protection, or extreme entertainment, you also benefit from enhancing your vehicle with accessories that have been thoroughly tested and factory-approved.
- The following highlights just some of the many Authentic Ram Accessories by Mopar featuring a fit, finish, and functionality specifically for your Ram.
- For the full line of Authentic Ram Accessories by Mopar, visit your local dealership or online at mopar.com for U.S. residents and mopar.ca for Canadian residents.

NOTE:

All parts are subject to availability.

EXTERIOR:

- Tubular Side Steps
- Running Boards
- Stirrup Step
- Bodyside Moldings
- Front Air Deflectors
- Side Window Deflectors

INTERIOR:

- Premium Carpet Mats
- DOT Certified Emergency Kit
- Door Sill Guards
- Bright Pedal Kit
- Slush Mats
- Leather Seats

ELECTRONICS:

- Trailer Brake Module
- Electronic Vehicle Tracking
- Backup Alarm
- Wireless Charging Pad
- Remote Start
- Mopar Connect

FREQUENTLY ASKED QUESTIONS

GETTING STARTED

How do I install my LATCH Equipped Child Seat? pg. 48

How do I program my Front Seat Memory? pg. 64

OPERATING YOUR VEHICLE

How does the Electronic Range Select (ERS) operate? pg. 80

ELECTRONICS

Which radio is in my vehicle?

- Uconnect 3.0 pg. 109
- Uconnect 5.0 pg. 112
- Uconnect 8.4/8.4 NAV pg. 116

How do I activate the Audio Jack?

- Uconnect 3.0 pg. 111
- Uconnect 5.0 pg. 115
- Uconnect 8.4/8.4 NAV pg. 123

How do I set the clock on my radio?

- Uconnect 3.0 pg. 107
- Uconnect 5.0 pg. 113
- Uconnect 8.4/8.4 NAV pg. 116

How do I use the Navigation feature? pg. 125

How do I pair my cell phone via Bluetooth with the Uconnect Phone Hands-Free Voice Activation System? pg. 147

How do I use my USB port to listen to audio through my touchscreen radio? pg. 123

OFF-ROAD CAPABILITIES

How do I shift into different four-wheel drive selections? pg. 169

UTILITY

How do I know how much I can tow with my Ram Truck? pg. 171

How do I adjust the gain on the Integrated Trailer Brake Module? pg. 172

DIESEL

How do I operate my diesel? pg. 178

WHAT TO DO IN EMERGENCIES

How do I change a flat tire? pg. 201

How do I Jump-Start my vehicle? pg. 208

MAINTAINING YOUR VEHICLE

Where is my Fuse Block located? pg. 238

What type of oil do I use for my gasoline engine? pg. 220

What type of oil do I use for my diesel engine? pg. 222

How often should I change my engine's oil?

- Gasoline Engine pg. 226
- Diesel Engine pg. 231

What should my tire pressure be set at? pg. 245

INDEX

- Access
 - Uconnect93, 95, 101
- Adding Engine Coolant (Antifreeze)225
- Adding Fuel224
- Adding Washer Fluid225
- Additives, Fuel225
- Adjust
 - Down62
 - Forward62
 - Rearward62
 - Up62
- Adjustable Pedals72
- Aftermarket5
- Air Bag
 - Air Bag Operation32
 - Air Bag Warning Light . . .29, 196
 - Enhanced Accident Response37, 214
 - Event Data Recorder (EDR) . .214
 - If A Deployment Occurs36
 - Knee Impact Bolsters32
 - Maintaining Your Air Bag System38
 - Side Air Bags33
 - Transporting Pets59
- Air Bag Light29
- Air Bag Maintenance38
- Air Cleaner, Engine (Engine Air Cleaner Filter)225
- Air Conditioner Maintenance . . .225
- Air Conditioning81, 82, 84, 86
- Air Conditioning Refrigerant . . .225
- Air Conditioning System225
- Air Pressure, Tires249
- Alarm
 - Arm The System14
 - Disarm The System15
 - Vehicle Security Alarm14
- Alarm (Security Alarm)14, 199
- Antifreeze (Engine Coolant) . . .225
 - Capacities220, 222
 - Disposal225
- Anti-Lock Brake System (ABS) . .196
- App
 - Uconnect Access96
- Appearance Care225
- Assistance Towing193
- Audio Jack115, 123
- Automatic Headlights75, 200
- Automatic High Beams76
- Automatic Temperature Control (ATC)84
- Automatic Transmission
 - Fluid Type221, 224
- Axle Fluid221, 224
- Battery225
 - Charging System Light195
- Body Mechanism Lubrication . . .225
- B-Pillar Location245
- Brake Fluid221
- Brakes225
- Brake System225
 - Master Cylinder225
 - Warning Light194
- Break-In Recommendations, New Vehicle73
- Bulbs, Light260
- Calibration, Compass158
- Canada4, 262
- Capacities, Antifreeze (Engine Coolant)220, 222
- Capacities, Fluid220, 222
- Caps, Filler
 - Oil (Engine)225
- Cargo Light76
- Car Washes225
- CD (Compact Disc) Player123
- Change Oil Indicator197
- Charging System Light195
- Chart, Tire Sizing243
- Check Engine Light (Malfunction Indicator Light)195
- Child Restraint39
- Child Restraints
 - Booster Seats42
 - Child Restraints39
 - Child Seat Installation . . .50, 51
 - How To Stow An Unused ALR Seat Belt48
 - Infants And Child Restraints . .40
 - Locating The LATCH Anchorages46

- Lower Anchors And Tethers For Children43
- Older Children And Child Restraints41
- Seating Positions43
- Cleaning
 - Wheels225, 257
 - Windshield Wiper Blades . . .225
- Climate Control. . . .81, 82, 84, 140
- Clock.113
- Cluster Warning/Indicator Lights
 - Air Bag Warning Light196
 - Brake Warning Light194
 - Front Fog Light Indicator199
 - Fuel Cap/Loose Gas Cap200
 - High Beam Indicator199
 - Instrument Cluster Warning Lights193
 - Park/Headlight ON Indicator . .199
 - Tire Pressure Monitoring System (TPMS) Light197
 - Turn Signal Indicator199
 - Vehicle Security Light199
- Clutch225
- Clutch Fluid225
- Compact Spare Tire.253
- Compass Calibration158
- Cooling System225
 - Adding Coolant (Antifreeze) . .225
 - Coolant Capacity220, 222
 - Coolant Level225
 - Disposal Of Used Coolant . . .225
 - Drain, Flush, And Refill225
 - Inspection225
 - Points To Remember225
 - Pressure Cap225
 - Selection Of Coolant (Antifreeze)220, 222, 225
- Corrosion Protection225
- Customer Assistance.261, 262
- Customer Programmable
 - Features160
- DEF (Diesel Exhaust Fluid)188
- Defects, Reporting262
- Defroster, Rear Window.81, 82
- Defroster, Windshield81, 82
- Diesel Engine Maintenance183
- Diesel Exhaust Fluid (DEF)188
- Diesel Fuel Water Separator183
- Dimmer Control.76
- Disabled Vehicle Towing193
- Disarming, Security System.15
- Disposal
 - Antifreeze (Engine Coolant) . .225
- Disturb153
- Driver Cockpit6, 7
- Dual Rear Wheels.206
- Electronically Shifted Transfer
 - Case.169
- Electronics5
 - Your Vehicle's Sound System . .88
- Electronic Speed Control (Cruise Control).77
- Electronic Stability Control (ESC). .193
- Electronic Throttle Control Warning Light196
- Emergency, In Case Of
 - Freeing Vehicle When Stuck . .213
 - Jump Starting208
 - Tow Hooks211
 - Towing193, 212
- Engine
 - Air Cleaner225
 - Block Heater180
 - Break-In
 - Recommendations73, 178
 - Checking Oil Level225
 - Coolant (Antifreeze)220, 222
 - Cooling225
 - Jump Starting208
 - Malfunction Indicator (Check Engine)195
 - Oil220, 222, 225
 - Oil Filler Cap225
 - Oil Selection225
 - Overheating200
- Enhanced Accident Response
 - Feature37, 214
- Exhaust Brake181
- Exhaust System.225
- Filters
 - Air Cleaner225
 - Engine Fuel183, 220

INDEX

- Engine Oil220, 222, 225
- Engine Oil Disposal225
- Flashers
 - Turn Signal199
- Flat Tire Stowage207
- Fluid, Brake221
- Fluid Capacities220, 222
- Fluids, Lubricants And Genuine
 - Parts220, 222
- Fog Lights75, 199
- Four Wheel Drive169
- Freeing A Stuck Vehicle213
- Fuel
 - Adding224
 - Additives225
 - Diesel222
 - Filler Cap (Gas Cap)200
 - Filter220
 - Materials Added225
 - Tank Capacity220, 222
- Fuses.238
- Garage Door Opener (HomeLink) . .162
- Gear Select Lever Override.212
- General Maintenance.225
- Glass Cleaning225
- Hands-Free Phone (Uconnect) . . .147
- Headlight75
- Headlights
 - Automatic75
 - Cleaning225
 - Dimmer Switch76
 - High Beam75
 - Switch75
- Head Restraints59
- Heated Seats68
- Heater, Engine Block.180
- High Beam Indicator199
- High Beam/Low Beam Select
 - (Dimmer) Switch75
- Hoisting208
- HomeLink (Garage Door
 - Opener).162
- Hood Release215
- Hub Caps205
- Idle Up Feature182
- Instrument Cluster Display
 - Instrument Cluster Display . . .158
- Instrument Panel Cover225
- Instrument Panel Lens Cleaning . .225
- Integrated Trailer Brake Controls . .172
- Interior Appearance Care.225
- Intermittent Wipers (Delay Wipers) . .74
- Intervention Regeneration
 - Strategy.185
- Introduction3
 - Aftermarket Electronics5
 - Canada4
- In Vehicle Features
 - Uconnect Access101
- Inverter Outlet (115V)165
- Inverter, Power165
- iPod/USB/MP3 Control
 - Bluetooth Streaming Audio . . .147
- Jack Location201
- Jump Starting208
- Key Fob10
 - Arm The Alarm14
 - Disarm The Alarm15
- Keyless Enter-N-Go12, 13, 178
 - Lock/Unlock13
- Lane Change And Turn Signals74
- Lane Change Assist74
- Left Switch
 - Steering Wheel Audio
 - Controls157
- Life Of Tires255
- Lights
 - Air Bag29
 - Bulb Replacement260
 - Cargo76
 - Engine Temperature Warning . .193
 - Fog199
 - High Beam Indicator199
 - Security Alarm199
 - Service260
 - Tire Pressure Monitoring (TPMS)197
 - Turn Signal74
- Loading Vehicle
 - Tires245

- Lubrication, Body225
- Lug Nuts204, 206
- Maintenance Free Battery225
- Maintenance, General225
- Maintenance Procedures225
- Maintenance Record230, 236
- Maintenance
 - Schedule226, 231, 233
- Malfunction Indicator Light
 - (Check Engine)195
- Master Cylinder (Brakes)225
- Media Hub137
- Memory Seat64
- Message Center
 - Water In Fuel180
- Mirrors
 - Memory64
- Mopar Accessories263
- Navigation125, 129, 141
- New Vehicle Break-In Period . .73, 178
- Occupant Restraints15
- Oil Change Indicator197, 231
- Oil Change Indicator, Reset197
- Oil, Engine220, 222, 225
 - Capacity220, 222, 225
 - Change Interval225
 - Checking225
 - Disposal225
 - Filter220, 222, 225
 - Filter Disposal225
 - Materials Added To225
 - Recommendation225
 - Viscosity225
- Oil Filter, Selection225
- Outlet
 - Power166
- Overheating, Engine200
- Paint Care225
- Panic Alarm11
- Pedals, Adjustable72
- Perform Service Indicator, Reset . .232
- Personalized Menu Bar118
- Pets59
- Phone, Hands-Free (Uconnect) . .147
- Phone (Pairing)130, 149
- Phone (Uconnect)137, 147
- Placard, Tire And Loading
 - Information245, 246
- Power
 - Distribution Center (Fuses) . . .238
 - Inverter165
 - Outlet (Auxiliary Electrical
 - Outlet)166
 - Seats62
 - Sliding Rear Window87
- Power Seats
 - Down62
 - Forward62
 - Rearward62
 - Recline62
 - Tilt62
 - Up62
- Power Steering Fluid221
- Pregnant Women And Seat Belts . .26
- Pretensioners
 - Seat Belts26
- Programmable Electronic
 - Features159
- Purchase Apps
 - Uconnect Access99, 143
- Radial Ply Tires251
- Radio112, 133
 - Balance and Fade113
 - Equalizer113
 - Operation114
 - Presets108, 110, 119
 - Setting the Clock113
- Radio 3.0107
- Radio Screens116
- Radio (Sound Systems)112
- Rain Sensitive Wiper System74
- Rear Heated Seats69
- Recreational Towing174
 - Shifting Into Transfer Case
 - Neutral (N)175
 - Shifting Out Of Transfer Case
 - Neutral (N)177
- Refrigerant225
- Reminder, Seat Belt16
- Remote Keyless Entry
 - Arm The Alarm14

INDEX

- Disarm The Alarm15
- Remote Starting System14
- Replacement Tires256
- Reporting Safety Defects.262
- Resetting Perform Service Indicator232
- Restraint, Head59
- Restraints, Child39
- Safety Information, Tire242
- Schedule, Maintenance226
- Seat Belt
 - Adjustable Upper Shoulder Belt Anchorage22
 - Automatic Locking Retractor (ALR)27
 - Lap/Shoulder Belt Operation . .20
 - Lap/Shoulder Belt Untwisting . .21
 - Pregnant Women26
 - Seat Belt Extender25
 - Seat Belt Pretensioner26
 - Seat Belt Reminder16
- Seat Belt Maintenance225
- Seat Belt Reminder16
- Seat Belts16
 - Adjustable Shoulder Belt22
 - Adjustable Upper Shoulder Anchorage22
 - Child Restraint39
 - Extender25
 - Front Seat16, 20
 - Operating Instructions20
 - Pregnant Women26
 - Pretensioners26
 - Untwisting Procedure21
- Seats62
 - Adjustment62
 - Easy Entry66
 - Heated68
 - Memory64
 - Power62
- Security Alarm199
 - Arm The System14
 - Disarm The System15
 - Security Alarm14
- Selection Of Coolant (Antifreeze)220, 222
- Shifting
 - Transfer Case, Shifting Into Transfer Case Neutral (N)175
 - Transfer Case, Shifting Out Of Transfer Case Neutral (N)177
- Shift Lever Override212
- Signals, Turn74, 199
- Siri134, 135
- Sirius Satellite Radio115, 120
 - Traffic & Weather129
- SIRIUS Travel Link129
- Snow Tires252
- Sound Systems
 - (Radio).112, 123, 125
- Spare Tire253, 254
- Spark Plugs220
- Speed Control
 - Accel/Decel79
 - Resume78
- Speed Control (Cruise Control) . . .77
- Starting
 - Cold Weather180
 - Remote14
- Starting Procedures (Diesel Engines)178
- Steering
 - Wheel, Heated70
 - Wheel, Tilt71
- Steering Wheel Mounted Sound System Controls157
- Temperature Control, Automatic (ATC)84
- Text Messaging . .139, 144, 154, 155
- Tilt
 - Down62
 - Up62
- Tilt Steering Column71
- Tire And Loading Information
 - Placard245, 246
- Tire Markings242
- Tires248, 253, 258
 - Aging (Life Of Tires)255
 - Air Pressure245, 248
 - Compact Spare253
 - Dual206
 - General Information248, 253
 - High Speed250

- Inflation Pressures249
- Life Of Tires255
- Load Capacity245, 246
- Quality Grading258
- Radial251
- Replacement256
- Safety242, 248
- Sizes243
- Snow Tires252
- Spare Tire253, 254
- Spinning254
- Tread Wear Indicators255
- Wheel Nut Torque204
- Tire Safety Information242
- Tow/Haul171
- Tow Hooks, Emergency211
- Towing
 - Disabled Vehicle212
 - Guide171
 - Recreational174
 - Weight171
- Towing Vehicle Behind A
 - Motorhome174
- Trailer Towing Guide171
- Trailer Weight171
- Transfer Case
 - Electronically Shifted169
 - Fluid221, 224
- Transmission
 - Fluid221, 224, 225
 - Maintenance225
 - Warning Light197
- Transporting Pets59
- Tread Wear Indicators255
- Turbo Cool Down187
- Turn Signals74, 199
- Uconnect
 - Access93, 95, 101
 - Account95, 101, 104
 - Maintaining Your Account101
 - Registration95, 143
 - Remote Features104
 - Using Access99
- Uconnect 3.0109
- Uconnect 5.0112
- Uconnect 8.4/8.4 NAV116, 142
 - Helpful Tips For Bluetooth156
 - Mute152
 - Phonebook152
 - Transfer Ongoing Call Between
 - Handset And Vehicle152
 - Voice Recognition Tips153
- Uconnect 8.4 NAV Voice
 - Recognition
 - SiriusXM Travel Link146
- Uconnect Access93, 142
 - App96
 - In Vehicle Features101
 - Purchase Apps99, 143
 - Yelp145
- Uconnect (Hands-Free Phone)
 - Making A Phone Call147, 153
 - Receiving A Call147
- Uconnect Phone . .130, 147, 152, 154
- Uconnect Voice Command . .130, 152
- Uniform Tire Quality Grades258
- Untwisting Procedure, Seat Belt . . .21
- USB Port115, 123
- Using Access
 - Uconnect99
- Vehicle Loading246
- Vehicle Security Alarm Disarming . .15
- Voice Command130, 132, 152
- Voice Recognition System
 - (VR)130, 152, 153
- Washer
 - Adding Fluid225
- Washers, Windshield74
- Washing Vehicle225
- Water in Fuel180, 183
- Water Separator, Diesel Fuel183
- Water Separator Draining183
- Wheel And Wheel Trim225, 257
- Wheel And Wheel Trim Care . .225, 257
- Wheel Cover205
- Wheel Nut Torque204, 207
- Wind Buffeting87
- Windshield Washers74
- Windshield Wiper Blades225
- Windshield Wipers74
- Wiper Blade Replacement225

RAM CHASSIS CAB

3500/4500/5500

2017 USER GUIDE

This guide has been prepared to help you get quickly acquainted with your new Ram vehicle and to provide a convenient reference source for common questions. However, it is not a substitute for your Owner's Manual.

For complete operational instructions, maintenance procedures and important safety messages, please consult your Owner's Manual, Navigation/Uconnect Manuals and other Warning Labels in your vehicle.

Not all features shown in this guide may apply to your vehicle. For additional information on accessories to help personalize your vehicle, visit www.mopar.com (U.S.), www.mopar.ca (Canada) or your local Ram dealer.

DRIVING AND ALCOHOL

Drunken driving is one of the most frequent causes of collisions. Your driving ability can be seriously impaired with blood alcohol levels far below the legal minimum. If you are drinking, don't drive. Ride with a designated non-drinking driver, call a cab, a friend, or use public transportation.

WARNING

Driving after drinking can lead to a collision. Your perceptions are less sharp, your reflexes are slower, and your judgment is impaired when you have been drinking. Never drink and then drive.



GUTS · GLORY  **RAM**

DOWNLOAD A FREE ELECTRONIC COPY

OF THE OWNER'S MANUAL AND WARRANTY BOOKLET BY VISITING:

WWW.RAMTRUCKS.COM/EN/OWNERS/MANUALS OR WWW.RAMTRUCKS.COM/EN/WARRANTY (U.S.);
WWW.OWNERS.MOPAR.CA/EN (CANADA).

©2021 FCA US LLC. ALL RIGHTS RESERVED. RAM IS A REGISTERED TRADEMARK OF FCA US LLC.