

F I A T[®] I 2 4 S P I D E R A B A R T H



2 0 1 7 U S E R G U I D E

If you are the first registered retail owner of your vehicle, you may obtain a complimentary printed copy of the Owner's Manual, Navigation/Uconnect Manuals or Warranty Booklets by calling **1 888 242-6342** (U.S.) or **1 800 387-1143** (Canada) or by contacting your dealer.

The driver's primary responsibility is the safe operation of the vehicle. Driving while distracted can result in loss of vehicle control, resulting in an accident and personal injury. FCA US LLC strongly recommends that the driver use extreme caution when using any device or feature that may take their attention off the road. Use of any electrical devices, such as cellular phones, computers, portable radios, vehicle navigation or other devices, by the driver while the vehicle is moving is dangerous and could lead to a serious accident. Texting while driving is also dangerous and should never be done while the vehicle is moving. If you find yourself unable to devote your full attention to vehicle operation, pull off the road to a safe location and stop your vehicle. Some states or provinces prohibit the use of cellular phones or texting while driving. It is always the driver's responsibility to comply with all local laws.

IMPORTANT: This User Guide is intended to familiarize you with the important features of your vehicle. Your Owner's Manual, Navigation/Uconnect Manuals and Warranty Booklets can be found on your DVD (if applicable) or by visiting the website on the back cover of your User Guide. We hope you find it useful. U.S. residents can purchase replacement kits by visiting www.techauthority.com and Canadian residents can purchase replacement kits by calling **1 800 387-1143**.

DEAR CUSTOMER

Dear Customer,

We would like to congratulate and thank you for choosing a Fiat 124 Spider.

We have written this User Guide to help you get to know all the features of your vehicle and use it in the best possible way.

Here you will find information, advice and important warnings regarding use of your vehicle and how to achieve the best performance from the technical features of your vehicle.

You are advised to take the time to read these publications carefully before taking to the road for the first time, to become familiar with the controls and above all with those concerning brakes, steering and transmission; at the same time, you can understand the vehicle behavior on different road surfaces.

This document also provides a description of special features and tips, as well as essential information for the safe driving, care and maintenance of your vehicle over time.

After reading it, you are advised to keep the User Guide inside the vehicle, for an easy reference and for making sure it remains in the vehicle should it be sold.

In the attached Warranty Booklet you will also find a description of the Services that FCA offers to its customers, and the detail of the terms and conditions for maintaining its validity.

We are sure that these will help you to get in touch with and appreciate your new vehicle and the service provided by the people at FCA.

Enjoy reading. Happy motoring!

Note:

This User Guide describes all models of the vehicle; please consider only the information relevant to your vehicle's trim level, engine and model. All data contained in this publication are purely indicative. FCA can modify the vehicle model described in this publication at any time, for technical or commercial purposes. For further information, contact your authorized dealer.

Read This Carefully

REFUELING



Only refuel with unleaded gasoline with a recommended rating of 91 octane. A rating less than 87 octane is not acceptable. Do not use gasoline containing methanol or ethanol E85. Using these mixtures may cause misfiring and handling issues, as well as damage fundamental components of the fuel supply system.

STARTING THE ENGINE



If equipped with a manual transmission: Be sure that the parking brake is engaged; place the gear selector in NEUTRAL, fully depress the clutch pedal without pressing the accelerator, and then push the ignition button. The engine will start as soon as the ignition is pushed.

If equipped with an automatic transmission: Be sure that the parking brake is engaged and that the gear selector is in PARK (P) or NEUTRAL (N), depress the brake pedal, and then push the ignition button. The engine will start as soon as the ignition is pushed.

PARKING ON FLAMMABLE MATERIAL



The catalytic converter develops high temperatures during operation. Do not park the vehicle on grass, dry leaves, pine needles or other flammable material: fire hazard.

RESPECTING THE ENVIRONMENT



The vehicle is equipped with a system that carries out a continuous diagnosis of the emission-related components in order to help protect the environment.

ELECTRICAL ACCESSORIES



Contact your authorized dealer if you decide to add electrical accessories (with the risk of gradually draining the battery) after buying the vehicle. They can calculate the overall electrical requirement and check that the vehicle's electric system can support the required load.

SCHEDULED SERVICING



Correct maintenance of the vehicle is essential for ensuring that it maintains its performance and its safety features, its environmental friendliness and low running costs are unchanged over time.

How To Use This Manual

ESSENTIAL INFORMATION

Each time directions (left/right or forward/backwards) are listed, they are determined by facing forward from the rear of the vehicle or as from the point of view of being seated inside the car. Special cases not complying with this rule will be properly specified in the text.

The figures in the User Guide are provided by way of example only: this might imply that some details of the image do not correspond to the actual arrangement of your vehicle. In addition, the User Guide has been conceived considering vehicles with steering wheel on the left side; it is therefore possible that on vehicles with steering wheel on the right side, the position of some controls or elements is not exactly mirror-like with respect to the figure.

To identify the chapter with the information needed you can consult the index at the end of this User Guide.

Chapters can be rapidly identified by graphic tabs, at the side of each odd page. A key showing the order of the chapter and the corresponding tab symbols appears on another page.

SYMBOLS

While reading this User Guide you will find a series of **WARNINGS** to prevent procedures that could damage your vehicle.

There are also **CAUTIONS** that must be carefully followed to prevent incorrect use of the components of the vehicle, which could cause accidents or injuries.

Therefore, all **WARNINGS** and **CAUTIONS** must always be carefully followed.

WARNINGS and **CAUTIONS** are recalled in the text with the following symbols:



Personal Safety



Vehicle Safety

GETTING TO KNOW YOUR VEHICLE
GETTING TO KNOW YOUR INSTRUMENT
PANEL



SAFETY



STARTING AND OPERATING



IN CASE OF EMERGENCY



SERVICING AND MAINTENANCE



TECHNICAL SPECIFICATIONS



MULTIMEDIA



CUSTOMER ASSISTANCE



INDEX



GETTING TO KNOW YOUR VEHICLE

KEYS	8
IGNITION SWITCH	12
ADVANCED KEYLESS ENTRY SYSTEM — IF EQUIPPED	13
VEHICLE SECURITY ALARM SYSTEM — IF EQUIPPED	14
DOORS	15
SEATS	19
NON-ADJUSTABLE HEAD RESTRAINTS	21
STEERING WHEEL	22
MIRRORS	22
EXTERIOR LIGHTS	25
WINDSHIELD WIPERS / WASHER	27
CLIMATE CONTROL SYSTEM	30
POWER WINDOWS	34
HOMELINK — IF EQUIPPED	36
TRUNK LID	38
TRUNK EMERGENCY RELEASE	40
HOOD	41
CONVERTIBLE TOP (SOFT TOP)	42



KEYS

Key Fob

A code number is stamped on the plate attached to the key set; detach this plate and store it in a safe place (not in the vehicle) for use if you need to make a replacement Emergency Key.

Also, write down the code number and keep it in a separate safe and convenient place, but not in the vehicle. If your key fob is lost, contact an authorized dealer and have your code number ready.

Note:

Your key fob configuration may vary with different feature button icons as well as the total number of feature buttons depending on your vehicle options/features. Key fob example as shown.



04010100-361-002AB

Key Fob

- 1 — Emergency Key
- 2 — Key Fob
- 3 — Key Code Number Plate

To use the Emergency Key, push the mechanical latch on the back side of the key fob and pull the emergency key out that's housed inside the key fob.

Note:

- Always keep a spare key fob in case one is lost. If a key fob is lost, see an authorized dealer as soon as possible.
- The driver must carry the key fob to ensure the Keyless Entry System functions properly.



Warning!

Before exiting a vehicle, always shift the automatic transmission into PARK or the manual transmission into FIRST gear or REVERSE, apply the parking brake, turn the engine OFF, remove the key fob from the vehicle and lock your vehicle.

Never leave children alone in a vehicle, or with access to an unlocked vehicle.

Allowing children to be in a vehicle unattended is dangerous for a number of reasons. A child or others could be seriously or fatally injured. Children should be warned not to touch the parking brake, brake pedal or the gear selector.

Do not leave the key fob in or near the vehicle, or in a location accessible to children. A child could operate power windows, other controls, or move the vehicle.

Do not leave children or animals inside parked vehicles in hot weather. Interior heat build-up may cause serious injury or death.

Key Fob Functions

Lock Button: To lock the doors, the trunk lid and the fuel filler door, push the lock button on the key fob.

An audible beep will be heard and the indicator lights will flash once. Refer to “Personalization Features” located in “Getting To Know Your Instrument Panel” for additional feature programming information.

Note:

The doors, trunk lid, and fuel filler door cannot be locked by pushing the lock button while any other door is open.

Unlock Button: To unlock the doors and the trunk lid, push the button. An audible beep will be heard and the indicator lights will flash twice. Refer to “Personalization Features” located in “Getting To Know Your Instrument Panel” for additional feature programming information.

Trunk Button: To open the trunk lid, push and hold the trunk button until the trunk lid opens.

Panic Button: If you witness from a distance someone attempting to break into or damage your vehicle, push and hold the panic button to activate the vehicles alarm. The panic button will work whether any door or the trunk lid is open or closed.

Key Suspend Function

If a key fob is left in the vehicle, the functions of the key fob left in the vehicle are temporarily suspended to prevent unlawful use of the vehicle.

To restore the functions, push the unlock button on the functions-suspended key fob left in the vehicle.

Key Fob Battery Replacement

If the buttons on the key fob are inoperable and the indicator light does not flash, the battery power level may be low or discharged.

Replace with a new battery (CR2025 type) before the key fob becomes unusable.

The following conditions indicate that the battery power is low:

-  Indicator light (green) flashes in the instrument cluster for about 30 seconds after the engine is placed in the OFF position.
- The system does not operate and the operation indicator light on the key fob does not flash when the buttons are pushed.
- The system's operational range is reduced.

Note:

Replacing the battery at an authorized dealer is recommended to prevent damage to the key fob. If replacing the battery by yourself, follow the instruction below.

Replacing The Key Fob Battery

Proceed as follows:

1. Push the mechanical release button and remove the emergency key.

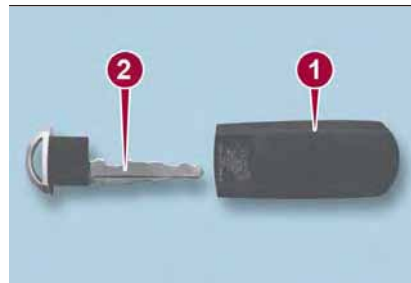

07031301-361-002

Emergency Key Removed

- 1 — Key Fob Case With Mechanical Release Button
- 2 — Emergency Key



2. Insert a coin, a flat blade screw driver, or the tip of your emergency key into the now exposed slot and carefully pry in the direction of the arrows to open the cover (3) slightly.



07031301-362-002

3 – Pry Case Left Side

3. Insert a coin, a flat blade screw driver, or the tip of your emergency key into the side gap and carefully pry in the direction of the arrow to open the cover (4).



07031301-363-002

4 – Pry Case Right Side

4. Separate the key fob case, then remove the battery.

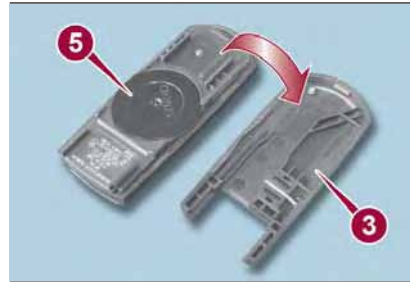

07031301-364-003

Remove Back Cover For Battery Replacement

3 – Key Fob Case
5 – Key Fob Battery

5. Insert a new battery with the positive pole facing up. Then, cover the battery with the battery cap.

6. Close the cover and reinsert the Emergency Key.



07031301-367-001

6 – Install New Battery

Note:

Be careful not to allow the rubber ring shown in call-out (6) to be scratched or damaged. If the rubber ring comes out, reinstall it before inserting a new battery.

Engine Start Function When Key Fob Battery Is Discharged

When starting the engine by holding the Key Fob over the keyless ignition START/STOP button due to a discharged key fob battery or a malfunctioning key fob, be careful not to allow the following, otherwise the signal from the key fob will not be received correctly and the engine may not start: metal parts of other key fobs or metal objects touch the key fob/spare key fobs or key fobs for other vehicles equipped with an immobilizer system touch or come near the key fob/devices for electronic purchases, or security passage touch or come near the key fob. If the engine cannot be started due to a discharged key fob battery, the engine can be started using the following procedure:

1. Continue to depress the brake pedal firmly until the engine has completely started.
2. **Manual Transmission:** continue to depress the clutch pedal firmly until the engine has completely started.
3. Verify that the keyless ignition start indication light (green) flashes.

4. Touch the keyless ignition START/STOP button using the backside of the key fob while the keyless ignition start indicator light (green) flashes.

5. Verify that the keyless ignition start indicator light (green) turns on.

6. Push the keyless ignition START/STOP button to start the engine.



05010201-L12-001AB

Discharged Key Fob Battery Start Procedure

When touching the keyless ignition START/STOP button using the backside of the key fob as shown in the illustration, touch the keyless ignition START/STOP button with the lock switch side of the key fob facing up.

The engine cannot be started unless the clutch pedal is fully depressed

(manual transmission) or the brake pedal is fully depressed (automatic transmission).

If there is a malfunction with the keyless ignition START/STOP button function, the keyless ignition start indicator light (amber) flashes. In this case, the engine may start, however contact an authorized dealer as soon as possible.

If the keyless ignition start indicator light (green) does not illuminate, perform the operation from the beginning again. If it does not illuminate contact an authorized dealer.

To change the ignition position without starting the engine, perform the following operations after the keyless ignition start indicator light (green) turns on:

1. Release the clutch pedal (manual transmission) or brake pedal (automatic transmission).
2. Push the keyless ignition START/STOP button to change the ignition position. The ignition cycles in the order of ACC, ON, and OFF each time the keyless ignition START/STOP button is pushed.

Note:

To change the ignition position again, perform the operation from the beginning.



General Information

The following regulatory statement applies to all Radio Frequency (RF) devices equipped in this vehicle:

This device complies with Part 15 of the FCC Rules and with Industry Canada license-exempt RSS standard(s). Operation is subject to the following two conditions:

1. This device may not cause harmful interference.
2. This device must accept any interference received, including interference that may cause undesired operation.

Note:

Changes or modifications not expressly approved by the party responsible for compliance could void the user's authority to operate the equipment.

IGNITION SWITCH

Push Button Start Positions

The system operates only when the key fob is within operational range.

Each time the keyless ignition START/STOP button is pushed, the ignition cycles in the order of OFF, ACC, and ON. Pushing the START/STOP button again from ON position cycles the ignition to the OFF position.



05010101-L12-001AB

Keyless START/STOP Ignition Button

Note:

□ The engine starts by pushing the keyless ignition START/STOP button while depressing the clutch pedal (manual transmission) or the brake pedal (automatic transmission). To change the ignition position, push the keyless ignition START/STOP button without depressing the clutch or brake pedal.

□ Do not leave the ignition in the ON position while the engine is not running, doing so could result in the battery being discharged. If the ignition is left in ACC position (for automatic transmission, the gear selector is in the P position, and the ignition is in ACC), the ignition cycles to the OFF position automatically after about 25 minutes.

OFF

The power supply to electrical devices turns off and the keyless ignition start indicator light (amber) also turns off. In the OFF position, the steering wheel is locked.

ACC (Accessory)

Some electrical accessories will operate and the indicator light (amber) illuminates. In the ACC position, the steering wheel is unlocked.

The Keyless Entry System does not function while the keyless ignition has been placed in the ACC position, and the doors will not lock/unlock even if they have been locked manually.

ON

This is the normal running position after the engine is started.

Note:

The indicator light (amber) turns off (the indicator light amber illuminates when the ignition has been placed in the ON position and the engine is not running).



Warning!

- ❑ Never use the PARK position as a substitute for the parking brake. Always apply the parking brake fully when exiting the vehicle to guard against vehicle movement and possible injury or damage.
- ❑ When exiting the vehicle, always make sure the ignition is in the OFF mode, remove the key fob from the vehicle, and lock your vehicle.

❑ Never leave children alone in a vehicle, or with access to an unlocked vehicle. Allowing children to be in a vehicle unattended is dangerous for a number of reasons. A child or others could be seriously or fatally injured. Children should be warned not to touch the parking brake, brake pedal or the transmission gear selector.

❑ Do not leave the key fob in or near the vehicle, (or in a location accessible to children), and do not leave the ignition in the ACC or ON/RUN mode. A child could operate power windows, other controls, or move the vehicle.

❑ Be sure the parking brake is fully disengaged before driving; failure to do so can lead to brake failure and a collision.

❑ Always fully apply the parking brake when leaving your vehicle, or it may roll and cause damage or injury. Also be certain to leave the transmission in PARK. Failure to do so may allow the vehicle to roll and cause damage or injury.

❑ Driving the vehicle with the parking brake engaged, or repeated use of the parking brake to slow the vehicle may cause serious damage to the brake system.

ADVANCED KEYLESS ENTRY SYSTEM – IF EQUIPPED

Advanced Keyless Entry System

The Advanced Keyless Entry System is an enhancement that allows you to lock/unlock the doors, trunk lid, fuel door, and opens the trunk lid with the slow and careful push of a button.

The Advanced Keyless Entry System allows the driver to START/STOP the ignition with the push of a button as long as the key fob is in the passenger compartment.

Note:

- ❑ The Advanced Keyless Entry System operational range may vary due to local weather conditions.
- ❑ The Advanced Keyless Entry System is fully operational (door/trunk lid/fuel door lock/unlock) when the ignition is placed in the OFF position. The Keyless Entry System does not operate if the ignition is placed to any position other than the OFF position.



If the key fob does not operate when pushing a button, the operational range becomes too small, or warning light may not illuminate or flash the battery may be weak or discharged. To install a new battery, refer to “Key Fob Battery Replacement.”

Battery life is about one year. Replace the battery with a new one if the  Warning light (green) flashes in the instrument cluster. Replacing the battery about once a year is recommended because the Warning light may not illuminate or flash if the battery is low or discharged.

Additional key fobs may be obtained at an authorized dealer. Up to six key fobs may be used with the Advanced Keyless Entry System per vehicle. Bring all key fobs to an authorized dealer when additional keys are required.

General Information

The following regulatory statement applies to all Radio Frequency (RF) devices equipped in this vehicle:

This device complies with Part 15 of the FCC Rules and with Industry Canada license-exempt RSS standard(s). Operation is subject to the following two conditions:

1. This device may not cause harmful interference.
2. This device must accept any interference received, including interference that may cause undesired operation.

Note:

Changes or modifications not expressly approved by the party responsible for compliance could void the user's authority to operate the equipment.

VEHICLE SECURITY ALARM SYSTEM — IF EQUIPPED

Immobilizer System

The immobilizer system allows the engine to start only with a key fob the system recognizes. If you have a problem with the immobilizer system or the key fob, contact an authorized dealer.

Arming The System: the system is armed when the ignition is cycled from the ON to OFF position. The warning light in the instrument cluster flashes every two seconds until the system is disarmed.

Disarming The System: the system is disarmed when the ignition is placed in the ON position with the correct programmed key fob. The warning light illuminates for about three seconds and then turns off.

If the engine does not start with the correct key fob, and the warning light remains illuminated or flashing, try the following:

- Make sure the key fob is within the operational range for signal transmission.
- Cycle the ignition to the OFF position, and then restart the engine.

If the engine does not start after three or more tries, contact an authorized dealer.

If the warning light flashes continuously while you are driving, do not turn the engine OFF. Contact an authorized dealer and have it checked. If the engine shut's off while the warning light is flashing, you will not be able to restart it.

Vehicle Security Alarm System — If Equipped

How To Arm The System

Proceed as follows:

Close the windows and the convertible top securely, place the ignition in the OFF position and make sure the engine compartment, convertible top, the doors, and the trunk lid are closed.

Push the lock button on the key fob or lock the driver's door from the outside with the emergency key. The hazard warning lights will flash once.

With The Advanced Keyless Function: Push a request switch on the exterior door handles. The warning light in the instrument panel flashes twice per second for 20 seconds. After 20 seconds, the system is fully armed.

DOORS

Lock/Unlock With Emergency Key

Both doors, trunk lid, and fuel door lock automatically when the driver's door is locked using the emergency key.

Lock With Emergency Key — Insert key into driver's door and turn to the left (toward front of car).

Unlock With Emergency Key — Insert key into driver's door and turn to the right (toward back of car).

They both unlock when the driver's door is unlocked using the emergency key.

Turn the emergency key toward the front to lock, toward the back to unlock.



Caution!

An unlocked vehicle is an invitation for thieves. Always remove key fob from the vehicle and lock all doors when leaving the vehicle unattended.

Manual Lock/Unlock Knob

Operation From Inside

To lock any door from the inside, push the door-lock knob. To unlock, pull it outward. This does not operate the other door locks.



04030107-L21-001AB

Inside Door-Lock Knob

- 1 — Door Knob Lock Position (Red Indicator Not Seen When Locked)
- 2 — Door Knob Unlock Position (Red Indicator Seen When Unlocked)

Note:

The red indication can be seen when the door-lock knob is unlocked.



Operation From Outside

To lock the passenger door with the door-lock knob from the outside, push the door-lock knob to the lock position and close the door (holding the door handle in the open position is not required).

Note:

When locking the door this way, be careful not to leave the key fob inside the vehicle. The driver's door lock knob cannot be used while the driver's door is open.



Warning!

- ❑ For personal security and safety in the event of a collision, lock the vehicle doors before you drive as well as when you park and leave the vehicle.
- ❑ When leaving the vehicle, always remove the key fob from the vehicle and lock your vehicle. If equipped with Advanced Keyless Entry, always make sure the keyless ignition is in "OFF" position, remove the key fob from the vehicle and lock the vehicle. Unsupervised use of vehicle equipment may cause severe personal injuries or death.

- ❑ Never leave children alone in a vehicle, or with access to an unlocked vehicle. Allowing children to be in a vehicle unattended is dangerous for a number of reasons. A child or others could be seriously or fatally injured. Children should be warned not to touch the parking brake, brake pedal or the gear selector.
- ❑ Do not leave the key fob in or near the vehicle, or in a location accessible to children, and do not leave the ignition of a vehicle equipped with Advanced Keyless Entry in the ACC or ON/RUN positions. A child could operate power windows, other controls, or move the vehicle.

Central Lock/Unlock

Both doors, trunk lid, and fuel door lock automatically when the lock rocker switch is pushed with both doors closed.

Note:

- ❑ The doors, trunk lid, and the fuel filler door cannot be locked while any other door is open.
- ❑ The key fob may not be able to be detected by the vehicle keyless-go system if it is located next to a mobile phone, laptop or other electronic

device; these devices may block the key fob's wireless signal and prevent the keyless-go system from starting the vehicle.



04030105-12D-002

Central/Power Door Lock Switch

Both unlock when the unlock rocker switch is pushed.

Note:

The doors, trunk lid, and the fuel filler door cannot be locked while any other door is open.

Double Locking System – If Equipped

The double locking system is designed to prevent someone who has broken into your vehicle from opening the door from the inside. If you have any problems with the double locking system, contact an authorized dealer.

System Activation

Proceed as follows:

1. Close both the windows and the convertible top.
2. Place the ignition in the OFF position and take the key fob with you.
3. Close both doors and trunk lid.
4. Insert the emergency key in the driver's door, turn the emergency key to the lock position (counter clockwise/left), and return it to the center position. Then turn it to the lock position (counter clockwise/left) again within three seconds.
5. The  indicator light illuminates for about three seconds to indicate that the system has been activated.



04030102-12A-001

Emergency Key Lock Procedure

The system can be activated by pushing the lock button on the key fob twice within three seconds.

With The Advanced Keyless

Function: the system can be activated by pushing the request switch on the exterior door handle twice within three seconds.

Note:

The system cannot be activated when any door is open.

System Deactivation

Unlock the driver's door or place the ignition in the ON position. If the power supply is interrupted (fuse blows or the battery is disconnected), the system can only be deactivated by unlocking a door with the emergency key.

Lock/Unlock With Advanced Keyless Entry Function — If Equipped

Both doors, trunk lid, and the fuel filler door can be locked/unlocked by pushing the request switch on the exterior door handle while the key fob is being carried.



04000098-121-555

Request Switch On Exterior Door Handle

To Lock

To lock the doors, trunk lid, and the fuel filler door, push the request switch on the exterior door handle and the hazard warning lights will flash once. A beep sound will be heard once.

To Unlock

Driver's door request switch located on the exterior door handle.

To unlock the doors, trunk lid, and the fuel filler door, push the request switch on the exterior door handle and the hazard warning lights will flash twice.

To unlock both doors and the fuel filler door, push the request switch on the exterior door handle again within three seconds and two more beep sounds will be heard.



Front Passenger Door Request**Switch:**

To unlock both doors and the fuel filler door, push the request switch on the exterior door handle. A beep sound will be heard twice and the hazard warning lights will flash twice.

Note:

- Confirm that both doors, and the fuel filler door are securely locked.
- For the trunk lid, move it without pushing the electric trunk lid opener to verify that the trunk lid has not been left open.
- Both doors and the fuel filler door cannot be locked when any door is open.
- It may require a few seconds for the doors to unlock after the request switch on the exterior door handle is pushed.
- The key fob may not be able to be detected by the vehicle keyless-go system if it is located next to a mobile phone, laptop or other electronic device; these devices may block the key fob's wireless signal and prevent the keyless-go system from starting the vehicle.

A beep sound is heard for confirmation when the doors, and fuel filler door are locked/unlocked using the request switch on the exterior door handle. If you prefer, the beep sound can be turned off.

The volume of the beep sound can also be changed. Use the following procedure to change the setting:

1. Place the ignition in the OFF position and close both of the doors and the trunk lid.
2. Open the driver's door.
3. Within 30 seconds of opening the driver's door, push and hold the lock button on the key fob for five seconds or longer. The doors, and fuel filler door will lock, an audible beep will activate at the currently set volume (if the beep sound is currently set to not activate, it will not activate). The setting changes each time the lock button on the key fob is pushed and the beep sound activates at the set volume (if the beep sound has been set to not activate, it will not activate).
4. The setting change is completed by doing any one of the following:
 - Place the ignition in the ACC or ON position.
 - Closing the driver's door.

- Opening the trunk lid.
- Not operating the key fob for ten seconds.
- Pushing any button except the lock button on the key fob.
- Pushing a request switch on the exterior door handle.

With Vehicle Security Alarm System

The hazard warning lights flash when the vehicle security alarm system is armed or disarmed (refer to "Vehicle Security Alarm System" found in "Getting To Know Your Vehicle" for further information).

The setting can be changed so that the doors and the fuel filler door are locked automatically without pushing the request switch on the exterior door handle, (refer to "Personalization Features" section in "Getting To Know Your Instrument Panel" section of your Owner's Manual at www.fiatusa.com/en/owners/manuals for further information).

Auto-Lock Function

A beep sound is heard when both doors are closed while the key is being carried. Both doors, the trunk lid, and fuel door are locked automatically after about three seconds when the Advanced Keyless Entry key fob is out of the operational range.

The hazard warning lights will flash once (even if the driver is in the operational range, both doors, trunk lid, and the fuel filler door are locked automatically after about 30 seconds).

If you are out of the operational range before the doors and the trunk lid are completely closed or another key fob is left in the vehicle, the auto-lock function will not work.

Always make sure that both doors and the trunk lid are closed and locked before leaving the vehicle. The auto-lock function does not close the power windows.

Auto Re-Lock Function

After unlocking with the request switch on the exterior door handle, both doors, and the fuel filler door will automatically lock if any of the following operations are not performed within about 60 seconds.

If your vehicle has a vehicle security alarm system, the hazard warning lights will flash for confirmation.

The time required for the doors to lock automatically can be changed (refer to “Personalization Features” in “Getting To Know Your Instrument Panel” chapter of your Owner’s Manual at www.fiatusa.com/en/owners/manuals for further information).

Opening a door or the trunk lid.

Placing the ignition in any position other than the OFF position.

Locking/Unlocking With A Key Fob

Both doors, trunk lid, and the fuel filler door can be locked/unlocked by operating the keyless entry system key fob: refer to “Keyless Entry System” in “Keys” for further information.

Locking/Unlocking With Door-Lock Switch

Both doors and the fuel filler door lock automatically when the lock side is pushed. They unlock when the unlock side is pushed.

To lock both the doors and the fuel filler door from an open door, push the lock side of the door lock switch and then close the door.

Note:

When locking the doors this way, be careful not to leave the key fob inside the vehicle.

SEATS

Manual Adjustment

Forward / Rearward

To move the seat forward or rearward, pull the adjustment bar. Release the bar once the desired position is reached. Using body pressure, move forward and rearward on the seat to be sure that the seat adjusters have latched.



03010202-12A-003AB

Manual Seat Adjustment

- 1 — Adjustment Bar
- 2 — Height Dial
- 3 — Recline Lever

Height

To adjust the height for front edge of the seat bottom, rotate the dial to the desired position.



Seat Recline

To recline the seatback, lift up the recline lever and lean back until the desired position has been reached, then release the lever. Make sure the lever returns to its original position and the seatback is locked in place by attempting to push it forward and rearward.



Warning!

- Adjusting a seat while driving may be dangerous. Moving a seat while driving could result in loss of control which could cause a collision and serious injury or death.*
- Seats should be adjusted before fastening the seat belts and while the vehicle is parked. Serious injury or death could result from a poorly adjusted seat belt.*
- Do not ride with the seatback reclined so that the shoulder belt is no longer resting against your chest. In a collision you could slide under the seat belt, which could result in serious injury or death.*

Heated Seats

On some models, the front driver and passenger seats may be equipped with heaters in both the seat cushions and seatbacks. The controls for the front heated seats are located on the center instrument panel below the climate controls.

The heated seats have three settings: High, Medium, and Low. Push the switch once to turn the heated seats on High, twice for Medium, and three times for Low. Pushing the switch a fourth time will turn the heated seat off.

Note:

- If the ignition is cycled OFF while the seat warmer is operating (High, Mid or Low), and then cycled ON again, the seat warmer will automatically operate at the temperature set before the ignition was cycled OFF.
- Use the seat warmer when the engine is running. Leaving the seat warmer on for long periods with the engine not running could discharge the battery.

- The temperature of the seat warmer cannot be adjusted beyond High, Mid and Low.
- Once a heat setting is selected, heat will be felt within two to five minutes.



03010203-L12-002

Heated Seat Switches



Warning!

❑ Persons who are unable to feel pain to the skin because of advanced age, chronic illness, diabetes, spinal cord injury, medication, alcohol use, exhaustion or other physical condition must exercise care when using the seat heater. It may cause burns even at low temperatures, especially if used for long periods of time.

❑ Do not place anything on the seat or seatback that insulates against heat, such as a blanket or cushion. This may cause the seat heater to overheat. Sitting in a seat that has been overheated could cause serious burns due to the increased surface temperature of the seat.



Caution!

Do not use organic solvents to clean the seat. It may damage the seat surface and the heater.

NON-ADJUSTABLE HEAD RESTRAINTS

The non-adjustable head restraints are form fitted into the upper structure of the seatback, and are designed to reduce the risk of injury by restricting head movement in the event of a rear impact. The seatback should be properly adjusted to an upright position where the head restraint is positioned as close as possible to the back of the occupant's head.



Warning!

Be certain that the seatback is locked securely into position. Otherwise, the seat will not provide the proper stability for passengers. An improperly latched seatback could cause serious injury.

Driver And Passenger Head Restraints

Your vehicle is equipped with non-adjustable head restraints on the driver's and passenger's seatbacks. The non-adjustable head restraints consist of a trimmed foam covering over the upper structure of the seatbacks and are intended to help protect occupants from neck injury. Adjust the seatbacks to their upright, on-road positions so that the head restraint is positioned as close as possible to the back of the occupant's head.



Warning!

Be certain that the seatback is locked securely into position. Otherwise, the seat will not provide the proper stability for passengers. An improperly latched seatback could cause serious injury.



STEERING WHEEL

Steering Wheel Adjustment

To change the angle of the steering wheel:

1. With the gear selector in the PARK position, pull the lock release lever, located under the steering column, downward.
2. Tilt the steering wheel to the desired position.
3. Push the lock release lever upward to lock the steering column.
4. Attempt to push the steering wheel upward and downward to ensure it is locked before driving.



04050101-12A-001AB

Manual Tilt Adjustment

- 1 — Lock Release Lever



Warning!

Do not adjust the steering column while driving. Adjusting the steering column while driving or driving with the steering column unlocked could cause the driver to lose control of the vehicle. Be sure the steering column is locked before driving your vehicle. Failure to follow this warning may result in serious injury or death.

MIRRORS

Outside Mirrors

Mirror Types:

- Flat Type (Driver Side): flat surface mirror.
- Convex Type (Passenger Side): this mirror has a slight curve.

Note:

The passenger side convex outside mirror will give a much wider view toward the rear of the vehicle, and especially of the adjacent lane.

The outside mirrors may be equipped with a heated mirror system. Refer to “Climate Controls” in “Getting To Know Your Vehicle” in the Owner’s Manual at www.fiatusa.com/en/owners/manuals for more information.



Warning!

Vehicles and other objects seen in the passenger side convex mirror will look smaller and farther away than they really are. Relying too much on your passenger side mirror could cause you to collide with another vehicle or other object. Use your inside mirror when judging the size or distance of a vehicle seen in the passenger side mirror.

Inside Day / Night Mirror

Rear View Mirror Adjustment

Before driving, adjust the rear view mirror to center on the view through the rear window.

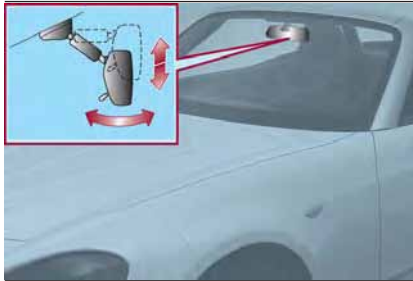

04060102-ADJ-001

Manual Mirror Adjustment

Note:

Before adjusting the manual mirror, place the mirror in the “day driving position” (see below).

Reducing Glare From Headlights

1. Push the lever forward for day driving (A position).
2. Pull the lever rearward to reduce glare of headlights from vehicles at the rear (B position).



04060102-MAN-002AB

Mirror Adjustment Lever

- 1 — Mirror Adjustment Lever
- A — Day Driving Position
- B — Reduced Glare Position

Automatic Dimming Mirror — If Equipped

The automatic dimming mirror automatically reduces glare of headlights from vehicles at the rear when the ignition is cycled ON. Push the off button (**O**) to cancel the automatic dimming function. The indicator light will turn off.



04060102-36E-666

Automatic Dimming Mirror Buttons

- 1 — Off
- 2 — On
- 3 — Light Sensor



Caution!

To avoid damage to the mirror during cleaning, never spray any cleaning solution directly onto the mirror. Apply the solution onto a clean cloth and wipe the mirror clean.

Push the off button (**O**) to cancel the automatic dimming function. The indicator light will turn off.



To reactivate the automatic dimming function, push the on button (I). The indicator light will illuminate.

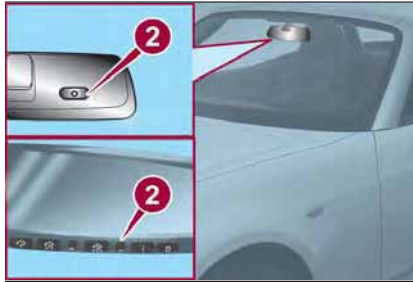

04060102-121-666

Light/Rain Sensor

2 – Light Sensor

Note:

- ❑ Do not use glass cleaner or suspend objects on or around the light sensor. Otherwise, light sensor sensitivity will be affected and may not operate normally.
- ❑ The automatic dimming function is canceled when the ignition is cycled ON and the gear selector is in REVERSE.

Power Mirrors

The ignition must be in the ACC or ON position to adjust the outside power mirrors.

Rotate the mirror switch to the left (L) or right (R) to select which mirror to adjust.

Push the mirror control switch in the direction of the desired position.

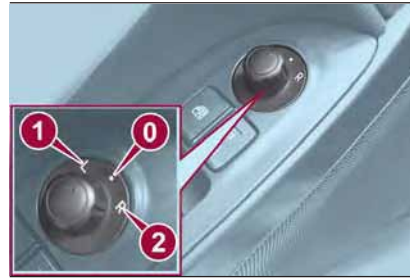

04060101-L12-001

Power Mirror Switch

- 0 – Center Position
- 1 – Left Position
- 2 – Right Position

After adjusting the mirror, lock the control by rotating the switch to the center position to prevent accidental movements.

Folding Mirrors

Manually fold the outside mirror rearward until it is flush with the vehicle.

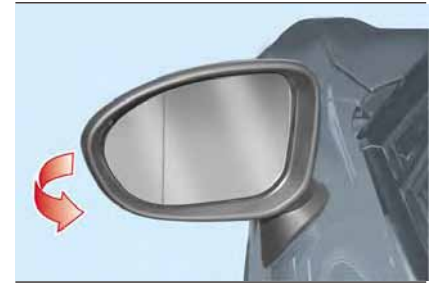

04060101-12R-001AB

Outside Folding Mirror

Your vehicle may be equipped with a driver side automatic-dimming mirror. The automatic-dimming door mirror is linked with the automatic-dimming rearview mirror inside the vehicle to automatically reduce headlight glare from vehicles at the rear. Refer to “Automatic Dimming Mirror” in this section for further information.

Note:

The passenger door mirror does not have the automatic-dimming feature.

EXTERIOR LIGHTS

Headlights

Rotate the headlight switch to activate/deactivate the headlights, other exterior lights and dashboard illumination.

When the lights are turned on, the  indicator in the instrument cluster illuminates.



05030101-132-001AB

Headlight Switch

- 1 — Headlight Switch
- 2 — Fog Light Switch

Note:

To prevent discharge of the battery, do not leave the lights on while the engine is OFF.

Daytime Running Lights (DRL)

The daytime running lights turn on automatically when the vehicle starts moving.

They turn off when the parking brake is engaged or the gear selector is shifted to the PARK position (if equipped with automatic transmission).

Note:

In some markets, the daytime running lights can be deactivated. Refer to “Multimedia” for more information.

High Beams

The headlights can be switched between high and low beams by pushing the headlight switch lever forward for high beams, and pulling the lever rearward to return to low beams.

When the headlight high beams are on, the  high beam indicator is illuminated in the instrument cluster.

Flash To Pass

You can signal another vehicle with your headlights by partially pulling the headlight lever toward the steering wheel. This will cause the high beam headlights to turn on until the lever is released.

The  high beam indicator in the instrument cluster illuminates while the high beams are active.

Automatic Lighting

When the headlight switch is in the AUTO position and the ignition is cycled ON, the light sensor will detect the surrounding light levels and automatically turns the headlights, other exterior lights and dashboard illumination on or off.

The light sensor also works as a rain sensor for the auto-wiper control. Keep hands and scrapers clear of the windshield when the wiper lever is in the AUTO position and the ignition is cycled ON, as fingers could be pinched or the wipers and wiper blades damaged when the wipers activate automatically. If you are going to clean the windshield, be sure the wipers are turned off completely when the engine is running.



Follow Me Home

The Follow Me Home Light System turns on the headlights (low beams) for a period of time after the ignition is cycled OFF.

System Activation

With the ignition cycled to ACC or OFF, pull the headlight control lever rearward and the low beam headlights will turn on.

The headlights turn off after a period of time after all doors are closed.



The time until the headlights turn off after all of the doors are closed can be changed through the Connect system.

The headlights turn off if the lever is pulled again while the headlights are on, or after three minutes of no further action after the first pull of the lever.

Front Fog Lights

The front fog light can be activated when the ignition is in the ON position and the headlights or parking lights are on.

Activation

Turn the headlight switch to the  or  position.

Rotate the fog light switch to the  position.



05030101-132-001AB

Headlight Switch

- 1 — Headlight Switch
- 2 — Fog Light Switch

The  fog light indicator in the instrument cluster illuminates while the front fog lights are on.

Deactivation

Perform one of the following operations to turn off the front fog lights:

- Rotate the fog light switch to the OFF position.
- Turn the headlight switch to the OFF position.
- Cycle the ignition to a position other than ON.

The  fog light indicator in the instrument cluster goes off when the front fog light is turned off.

With Auto-Light Control

When the fog light switch is in the  position and the headlight switch is in AUTO position, the front fog lights will stay on.

Turn Signals

The ignition must be in the ON position to use the turn signals and lane change assist.

Move the signal lever down (for a left turn) or up (for a right turn). The signal will self-cancel after the turn is completed.

If the indicator light continues to flash after a turn, manually return the lever to its original position.

The turn signal indicators (green)  in the instrument cluster flash according to the operation of the turn signal lever to show which signal is active.

Note:

If an indicator light stays on without flashing or if it flashes abnormally, one of the turn signal bulbs may be burned out.

Lane Change Assist

Move the lever halfway toward the direction of the lane change (until the indicator flashes) and hold it there. It will return to the off position when released.

Three-Flash Turn Signal

After releasing the turn signal lever, the turn signal indicator flashes three times.

The operation can be cancelled by moving the lever in the direction opposite to which it was operated.

Adaptive Front Lighting System (AFS) — If Equipped

This system directs the main headlight beams and adapts it to the driving conditions around bends and turns, continuously and automatically.

The system directs the headlight beam to illuminate the road in the best way, taking into account the speed of the vehicle, the bend or corner angle and the speed of steering.

The Adaptive Front Lighting System is automatically activated when the vehicle is started.

Headlamp Leveling System — If Equipped

On some models, the angle of the headlights will be automatically adjusted when turning on the headlights.

WINDSHIELD WIPERS / WASHER

Windshield Wipers And Washer

The windshield wiper/washer lever is located on the right side of the steering wheel. The ignition must be cycled to ON before using these features.

Windshield Wipers

Activate the windshield wipers by pushing the wiper lever up or down.

With Intermittent Wiper

Set the lever to the intermittent position and choose the interval timing by rotating the center switch.

Switch positions:

-  or **MIST**: operation while pushing the lever upward
- OFF**: stop
- or **INT**: intermittent operation
- or **LO**: low speed operation
- =** or **HI**: high speed operation

With Auto-Wiper Control

When the wiper lever is in the AUTO position, the rain sensor will sense the amount of rainfall on the windshield and turns the wipers on or off automatically (off/intermittent/low speed/high speed).

Switch positions:

-  or **MIST**: operation while pulling up lever
- OFF**: stop
- AUTO**: auto control operation
- or **LO**: low speed operation
- =** or **HI**: high speed operation

Adjusting Rain Sensor Sensitivity

The sensitivity of the rain sensor can be adjusted by rotating the switch on the wiper lever.

From the center position (normal), rotate the switch downward for higher sensitivity (+) (faster response) or rotate it upward for less sensitivity (-) (slower response).





05030101-122-001

Windshield Wiper Lever

1 — Rain Sensor Adjustment

When the wiper lever is in the AUTO position and the ignition is cycled ON, the wipers may move automatically in the following cases:

- If the windshield above the rain sensor is touched or wiped with a cloth.
- If the windshield is struck with a hand or other object from either outside or inside the vehicle.



Warning!

Keep hands and scrapers clear of the windshield when the wiper lever is in the AUTO position and the ignition is cycled ON, as fingers could be pinched or the wipers and wiper blades damaged when the wipers activate automatically.

Turning the auto-wiper lever from the OFF to the AUTO position while driving activates the windshield wipers once, after which they operate according to the rainfall amount.

The auto-wiper control may not operate when the rain sensor temperature is about 14 °F (–10 °C) or lower, or about 185 °F (85 °C) or higher.

If the windshield is coated with water repellent, the rain sensor may not be able to sense the amount of rainfall correctly and auto-wiper control may not operate properly.

If dirt or debris (such as ice or debris containing salt water) adheres to the windshield above the rain sensor or if the windshield is iced, it could cause the wipers to move automatically.

However, if the wipers cannot remove this ice, dirt or debris, the auto-wiper control will stop operation. In this case, set the wiper lever to the low speed position or high speed position for manual operation, or remove the ice, dirt or debris by hand to restore the auto-wiper operation.

Because heavy ice and snow can jam the wiper blades, the wiper motor is protected from motor breakdown, overheating and possible fire by a circuit breaker. This mechanism will automatically stop operation of the blades, but only for about five minutes. If this happens, turn off the wiper switch and park off the road and remove the snow and ice. After five minutes, turn on the switch and the blades should operate normally. If they do not resume functioning, contact your authorized dealer as soon as possible. Pull off to the side of the road to a safe location. Wait until the weather clears before trying to drive with the wipers inoperative.

Windshield Washer

Pull the wiper/washer lever rearward and hold it to spray washer fluid onto the windshield.

With the wiper lever in the OFF, intermittent, or AUTO position, the wipers will operate continuously until the lever is released.



Warning!

Sudden loss of visibility through the windshield could lead to a collision. You might not see other vehicles or other obstacles. To avoid sudden icing of the windshield during freezing weather, warm the windshield with defroster before and during windshield washer use.

If the fluid level is normal and the washer does not work, contact your authorized dealer.



04110109-115-001AB

Windshield Washer Nozzles

With Headlight Washers

When the headlights are on, the headlight washers operate automatically once every fifth time the windshield washer operates.



CLIMATE CONTROL SYSTEM

Manual Climate Control System

With MAX A/C function



06010300-122-002

Manual Climate Controls With MAX A/C

- | | |
|------------------------------|--------------------------------|
| 1 — Temperature Control Knob | 4 — Rear Window Defrost Button |
| 2 — Blower Control Knob | 5 — Air Recirculation Button |
| 3 — Mode Selector Knob | 6 — A/C Button |

Controls

1 – Temperature Control Knob: Turn it clockwise for hotter temperatures and counterclockwise for colder temperatures.

2 – Blower Control Knob: The blower has seven speeds. Turn the knob clockwise to increase blower speed or counterclockwise to decrease blower speed.

3 – Mode Selector Knob: Turn the Mode Selector Knob to select the air flow mode. The Mode Selector Knob can be set at the intermediate positions (●) between each mode.

4 – Rear Window Defrost Button: Push the button to turn on the Rear Window Defroster. The Rear Window Defroster operates for about 15 minutes and then turns off automatically.

5 – Recirculation Button: Push the button to select between outside air and recirculated air positions.

6 – A/C Button: Push the A/C button to turn the air conditioner on.



Automatic Climate Control System



06010900-122-999

Automatic Climate Controls — Type A

- | | |
|------------------------------|--------------------------------|
| 1 — Temperature Control Knob | 4 — Rear Window Defrost Button |
| 2 — Blower Control Knob | 5 — Air Recirculation Button |
| 3 — Mode Selector Knob | 6 — A/C Button |



06010900122

Automatic Climate Controls – Type B

- 1 – Temperature Control Knob
- 2 – Blower Control Knob
- 3 – Mode Selector Knob

- 4 – Rear Window Defrost Button
- 5 – Air Recirculation Button
- 6 – A/C Button

Controls

1 – Temperature Control Knob: Turn it clockwise for hotter temperatures and counterclockwise for colder temperatures.

2 – Blower Control Knob: The fan has seven speeds. Turn the knob clockwise to increase blower speed or counterclockwise to decrease blower speed/enter Auto Mode. **AUTO**

position: The blower speed is automatically controlled by the system based upon the set temperature.

0 Position: To turn off the system, set the dial to 0 position.

3 – Mode Selector Knob: Turn the Mode Selector Knob to select air flow mode. **AUTO position:** the air flow automatically adjusts based upon the selected temperature. **Except AUTO position:** the desired air flow position can be selected by turning the knob.

4 – Rear Window Defrost Button: Push the button to turn on the Rear Window Defroster. The Rear Window Defroster operates for about 15 minutes and then turns off automatically.

5 – Recirculation Button: Push the button to select between outside air and recirculated air positions.

6 – A/C Button: The air conditioning (cooling/dehumidifying functions) can be turned on or off by pushing the button while the Blower Control Knob is in a position other than 0.

POWER WINDOWS

Power Window Controls

The ignition must be placed in the ON position for the power windows to operate.

If the power window does not open/close, wait a moment and then operate the switch again.

Passenger Control Switches

The passenger window can also be operated using the master control switches on the driver's door.



04070103-LN2-002

Power Window Switches

- 1 – Driver's Window
- 2 – Passenger's Window

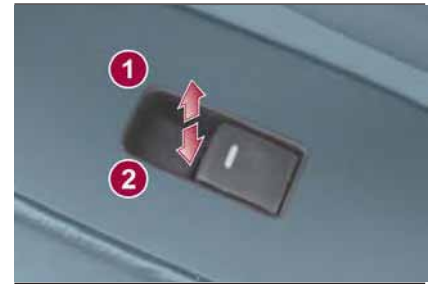

04070103-L12-001

Power Window Switch Function

- 1 – Closing-Lightly Pull The Switch Up
- 2 – Opening-Lightly Hold The Switch Down

Auto-Opening Power Windows

To fully open the window automatically push the switch completely down. To stop the window partway pull or push the switch in the opposite direction and then release it. The power window cannot be fully closed while the door is open.

Power Window System Initialization Procedure

If the battery was disconnected during vehicle maintenance, or for other reasons (such as a switch continues to be operated after the window is open/closed), the window will not fully open automatically.

Resetting of the automatic function can be performed using the master control switches or each passenger door switch.

The power window auto function reset procedure can be done on both door switches. The power window auto function will only resume on the power window that has been reset:

1. Close the doors and the convertible top.
2. Place the ignition in the ON position.
3. Make sure that the power window lock switch located on the driver's door is not depressed.
4. Push the switch and fully open the window.
5. Pull up the switch to fully close the window and continue holding the switch for about two seconds after the window fully closed.
6. Repeat steps four and five for the passenger power window while seated in the passenger seat.
7. Make sure that the power windows operate correctly using the door switches.

After the system has been re-initialized, passenger window can be fully opened automatically using the master control switches. If the automatic power window operation does not operate normally while the doors or convertible top are opened/closed, reset it using the above procedures.



Warning!

Never leave children unattended in a vehicle, and do not let children play with power windows. Do not leave the key fob in or near the vehicle, or in a location accessible to children, and do not leave the ignition of a vehicle equipped with the Keyless Entry System in the ACC or ON/RUN mode. Occupants, particularly unattended children, can become entrapped by the windows while operating the power window switches. Such entrapment may result in serious injury or death.

Power Window Lock Switch

This feature prevents the passengers power window from operating. Keep this switch in the locked position while children are in the vehicle.

1. Locked Position (Button Pushed): only the driver's power window can be operated.

2. Unlocked Position (Button Not Pushed): both power windows on each door can be operated.



04070104-L12-001

Power Window Lockout Switch

- 1 — Locked Position
- 2 — Unlocked Position

Note:

When the power window lock switch is in the locked position, the light on the passenger power window switch turns off. The light may be difficult to see depending on the surrounding brightness.



HOMELINK — IF EQUIPPED

General Information

The HomeLink system replaces up to three hand-held transmitters with a single built-in component in the auto-dimming mirror. Pushing the HomeLink button on the auto-dimming mirror activates garage doors, gates and other devices surrounding your home.

Note:

HomeLink and HomeLink house icon are registered trademarks of Gentex Corporation.



Warning!

- Vehicle exhaust contains carbon monoxide, a dangerous gas. Do not run your vehicle in the garage while programming the transceiver. Exhaust gas can cause serious injury or death.
- Your motorized door or gate will open and close while you are programming the universal transceiver. Do not program the transceiver if people, pets or other objects are in the path of the door or gate. Only use this transceiver with a garage door opener that has a "stop and reverse"

feature as required by Federal safety standards. This includes most garage door opener models manufactured after 1982. Do not use a garage door opener without these safety features. Call toll-free 1-800-355-3515 or, on the Internet at HomeLink.com for safety information or assistance.

Programming The System

Note:

When programming a garage door opener or a gate, disconnect the power to these devices before programming. Continuous operation of the devices could damage the motor.

The HomeLink system provides three buttons which can be individually selected and programmed using the transmitters for current, on-market devices as follows:

1. Disconnect power to the device being programmed.
2. Position the end of your handheld transmitter one to three inches (2.5 - 7.5 cm) away from the HomeLink button you wish to program while keeping the indicator light in view.

3. Simultaneously press and hold both the chosen HomeLink and hand-held transmitter buttons. **Do not release the buttons until step four has been completed.**



04060102-121-999

HomeLink Buttons

- 1 — First HomeLink Button
- 2 — Second HomeLink Button
- 3 — Third HomeLink Button

4. After the HomeLink indicator light changes from a slow to a rapidly blinking light, release both the HomeLink and hand-held transmitter buttons.

Note: If the HomeLink indicator light does not change to a rapidly blinking light, contact HomeLink at www.homelink.com or call **1-800-355-3515** for assistance.

5. Connect power to the device being programmed.

6. Firmly press and hold the programmed HomeLink button for five seconds, and then release it. Perform this operation two times to activate the door or gate. If the door or gate does not activate, press and hold the just-trained HomeLink button and observe the indicator light. If the indicator light stays on constantly, programming is complete and your device should activate when the HomeLink button is pressed and released.

Note:

To program the remaining two HomeLink buttons, begin with step one.

7. If the indicator light blinks **rapidly for two seconds and then turns to a constant light, continue with “Programming” steps (see below)** to complete the programming of a rolling code equipped device (most commonly a garage door opener).

8. At the garage door opener receiver (motor-head unit) in the garage, locate the “learn” or “smart” button. This can usually be found where the hanging antenna wire is attached to the motorhead unit.

9. Press and release the “learn” or “smart” button (the name and color of the button may vary by manufacturer).

Note:

Complete the programming within 30 seconds.

10. Return to the vehicle and firmly **press, hold for two seconds and release** the programmed HomeLink button. Repeat the “**press/hold/release**” sequence a second time, and, depending on the brand of the garage door opener (or other rolling code equipped device), repeat this sequence a third time to complete the programming process. HomeLink should now activate your rolling code equipped device.

Note:

To program the remaining two HomeLink buttons, begin with step one.

Gate Operator/Canadian Programming

Canadian radio-frequency laws require transmitter signals to “time-out” (or quit) after several seconds of transmission - which may not be long enough for HomeLink to pick up the signal during programming.

Similar to this Canadian law, some U.S. gate operators are designed to “time-out” in the same manner.

If you live in Canada or you are having difficulties programming a gate operator by using the “Programming” procedures (regardless of where you live), replace “Programming The System” step three with the following:

Note:

If programming a garage door opener or gate operator, it is advised to unplug the device during the “cycling” process to prevent possible overheating.

1. Continue to press and hold the HomeLink button while you **press and release - every two seconds** (“cycle”) your hand-held transmitter until the frequency signal has successfully been accepted by HomeLink (the indicator light will flash slowly and then rapidly).
2. Proceed with the “Programming” steps to complete.



Operating The System

Push the programmed HomeLink button to operate a programmed device.

The code will continue being transmitted for a maximum of 20 seconds.

Reprogramming The System

To program a device to HomeLink using a HomeLink button previously trained, follow these steps:

1. Push and hold the desired HomeLink button. **DO NOT** release the button;
2. The indicator light will begin to flash after 20 seconds. Without releasing the HomeLink button, proceed with "Programming The System" step one.

Erasing Programmed HomeLink Buttons

To erase the existing programming from all three operating channels, push and hold the two outside buttons 1 and 3 on the auto-dimming mirror until the HomeLink indicator light begins to flash after approximately 10 seconds.

Verify that the programming has been erased when you resell the vehicle.

TRUNK LID

Opening



Warning!

- Before opening the trunk lid, remove any snow and ice accumulation on it. Otherwise, the trunk lid could close under the weight of the snow and ice resulting in injury.
- Be careful when opening/closing the trunk lid during strong winds. If a strong gust blows against the trunk lid, it could close suddenly resulting in injury.
- Fully open the trunk lid and make sure that it stays open. If the trunk lid is only opened partially, it could slam shut by vibration or wind gusts resulting in injury.
- When loading or unloading luggage in the trunk, turn off the engine. Otherwise, you could get burned by the heat of the exhaust gas.

Using The Remote Release Button – If Equipped



04030201-R12-001

Interior Trunk Lid Release Button

The remote release button function can be disabled by locking the doors using the key fob, emergency key, or a request switch on the exterior door handle to prevent an intruder in the vehicle from opening the trunk lid.

To enable the remote release button operation, unlock the doors by using the key fob, emergency key, request switch on the exterior door handle, or place the ignition in the ON position.

Note:

The remote release button cannot be disabled by locking the doors using the door-lock switch/door-lock knob.

Using The Electric Trunk Lid Opener

With the remote release button: a trunk lid can also be opened while the key fob is being carried.

Push the electric trunk lid button and raise the trunk lid when the latch releases.



04030201-12A-001

Electric Trunk Release Button

Without the remote release button: unlock the doors and trunk lid, then push the electric trunk lid opener and raise it when the latch releases.

With The Advanced Keyless Entry Function

A locked trunk lid can also be opened while the key fob is being carried. When opening the trunk lid with the doors locked, it may require a few seconds for the trunk lid latch to release after the electric trunk lid opener is pushed.

The trunk lid can be closed when the doors are locked with the key fob left in the vehicle. However, to prevent locking the key fob in the vehicle, the trunk lid can be opened by pushing the electric trunk lid opener. If the trunk lid cannot be opened despite doing this procedure, push the electric trunk lid opener to fully open the trunk lid after pushing the trunk lid completely closed. If the vehicle battery is discharged or there is a malfunction in the electrical system and the trunk lid cannot be unlocked, the trunk lid can be opened by performing the emergency procedure.

When Trunk Lid Cannot Be Opened

If the battery is discharged, the trunk lid cannot be unlocked and opened. In this case, the trunk can be unlocked by taking care of the discharged battery situation.

If the trunk lid cannot be unlocked even if the discharged battery situation has been resolved, the electrical system may have a malfunction.

Proceed as follows:

1. Close the convertible top and remove the windblocker.



08080100-125-002

Remove Windblocker

2. Remove the fasteners on the right side of the vehicle.

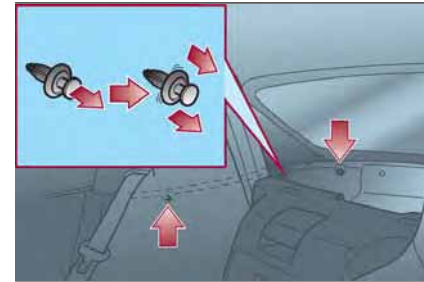

06080100-121-004

Remove Fasteners



- Partially peel back the cover on the right side of the vehicle.



08080100-122-001

Cover Removal

- Turn and loosen the cap screws until the screws start to spin free.

Note:

Do not pull the screw when pulling the cap. Otherwise, the screw may fall off and become lost.

Refer to “Trunk Emergency Release” located in “Getting To Know Your Vehicle” for further information.

Closing

- Use both hands to push the trunk lid down until the lock snaps shut. Do not slam it.
- Pull up on the trunk lid to make sure it is secure.

TRUNK EMERGENCY RELEASE

As a security measure, a trunk internal emergency release lever is built into the rear tail panel. In the event of an adult or child being locked inside the trunk, the trunk can be simply opened by pulling down the lever and open the trunk lid. After performing this emergency measure, contact an authorized dealer as soon as possible.



08080100-123-004

Trunk Emergency Release

Trunk Safety Warning



Warning!

Do not allow children to have access to the trunk, either by climbing into the trunk from outside, or through the inside of the vehicle. Always close the trunk lid when your vehicle is unattended. Once in the trunk, young children may not be able to escape, even if they entered through the rear seat. If trapped in the trunk, children can die from suffocation or heat stroke.

HOOD

Opening The Hood

To open the hood, proceed as follows:

1. With the vehicle in PARK, pull the release handle located to the left of the steering wheel, below the instrument panel.



07030201-L12-001

Releasing The Hood Latch

1 — Hood Release Handle

2. Move to the outside of the vehicle and insert your hand into the hood opening, then slide the latch lever to the right, and lift up the hood.



07030201-122-001AB

Sliding The Latch Lever To The Right

2 — Latch Lever

3. Pull up the support rod from the clip, and insert it into the support rod hole indicated by the arrow to hold the hood open.

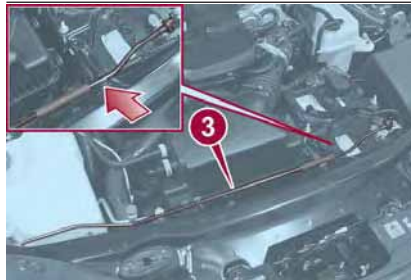

07030201-130-888

Support Rod Location

3 — Support Rod



07030201-123-002

Inserting Support Rod Into Hole

4 — Support Rod Hole

Closing The Hood

To close the hood, proceed as follows:

1. Check under the hood area to make certain all filler caps are in place and all loose items (e.g. tools, oil containers, etc.) have been removed.
2. Lift the hood with one hand, and with the other hand grasp the padded area on the support rod.
3. Secure the support rod into the rod clip.



4. Verify that the support rod is secured in the clip before closing the hood.

5. Lower the hood slowly to a height of about 8 inches (20 cm) above its closed position and then let it drop.



Warning!

Be sure the hood is fully latched before driving your vehicle. If the hood is not fully latched, it could open when the vehicle is in motion and block your vision. Failure to follow this warning could result in serious injury or death.



Caution!

To prevent possible damage, do not slam the hood to close it. Lower hood to approximately 8 inches (20 cm) and drop the hood to close. Make sure hood is fully closed for both latches. Never drive vehicle unless hood is fully closed, with both latches engaged.

CONVERTIBLE TOP (SOFT TOP)

Lowering The Convertible Top



Warning!

Do not sit on the folded convertible top, otherwise the convertible top could be damaged or you may fall off and be injured.

To lower the convertible top, proceed as follows:

1. Make sure the parking brake is applied and the engine is OFF.
2. Make sure there are no objects which have been placed in the area where the convertible top is to be retracted.

3. Push forward on the release latch. There is a red indicator showing that the latch is open.



04110102-L36-006

Lock Release Latch

- 1 — Release Latch Closed
2 — Release Latch Open

4. With the lock release latch pushed forward (red indicator visible), pull the top latch handle rearward to unlock it.



04110102-L21-001

Pulling The Top Latch Handle Rearward

- 3 — Latch Release Handle

5. Remove the striker from the anchor.



04110102-L22-002

Removing Striker From Anchor

- 4 — Striker
5 — Anchor

Note: The power windows will go down automatically when the convertible top is opened. If the power windows do not go down automatically, fully open the windows using the power window switch located on the doors.

6. Standing outside of the vehicle, hold the convertible top along the front edge and pull it toward the rear of the vehicle. To lower the convertible top from inside the vehicle, use the convertible top handles.



04110102-123-002AB

Convertible Top Handles

- 6 — Handles

7. Move the convertible top rearward and while pushing the rear glass lightly with your hand.

8. With the back end of the convertible top pushed down, push the front end until a latching sound is heard. Lightly rock the retracted convertible top to make sure it is securely locked.





04110102-126-001AB

Retracted Convertible Top



Warning!

❑ Always keep your hands and fingers away from the fastening mechanisms when moving the convertible top: it is dangerous to place your hands or fingers near the fastening mechanisms. Your hands or fingers could be caught and injured by the mechanism.

❑ Sit in the seat with the seat belt correctly fastened when the vehicle is moving: standing in the vehicle, or sitting on the convertible top storage area or center console when the vehicle is moving is a dangerous way to ride. During a sudden maneuver or collision you could be seriously injured or even killed.

Raising The Convertible Top

To raise the convertible top, proceed as follows:

1. Make sure the parking brake is applied and the engine is OFF.
2. Pull the unlock lever upward to disengage the lock.

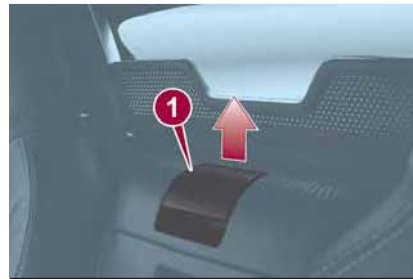

04110103-121-004

Unlock Lever Location

1 — Unlock Lever

3. Standing outside of the vehicle, hold the convertible top along the front edge and pull it towards the vehicle front. To raise the convertible top from inside the vehicle, use the convertible top handles.



04110103-L23-002

Convertible Handle Location

2 — Convertible Top Handles

4. While sitting in a seat, grasp the convertible top handles, and push the convertible top against the windshield. Make sure the striker engages with the anchor, move the top latch slowly, and then push the top latch upward until a latching sound is heard.

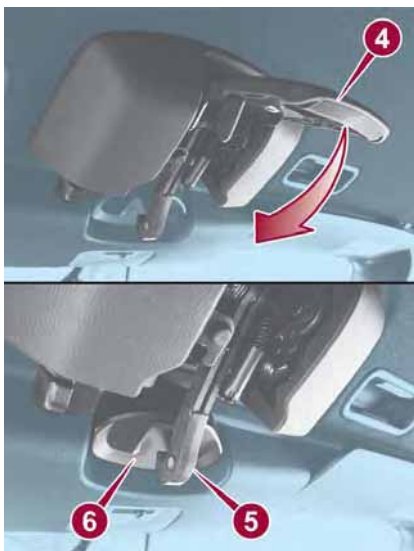

04110103-L24-003

Convertible Top Components

- 4 — Closing Release Latch
- 5 — Striker
- 6 — Anchor

5. If the red indicator is visible on the lock release button, the convertible top is not locked. After locking the convertible top, verify that the red indicator is not visible.

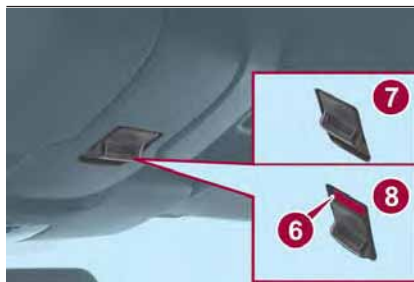

04110103-124-001

Lock Release Button

- 6 — Red Indicator
- 7 — Release Latch Locked
- 8 — Release Latch Unlocked



Caution!

Driving with the convertible top not fully locked could damage the convertible top.

Note: Do not spray water directly near the seam of the window and convertible top when flushing away dirt on the soft top with water. Otherwise, water may enter the vehicle (Refer to “Convertible Top Maintenance” in “Servicing And Maintenance” in the Owner’s Manual at www.fiatusa.com/en/owners/manuals for more information).

Convertible Top Precautions

- Remove leaves or other debris that may accumulate on and around the convertible top. If leaves or other debris block the drain filter, water may enter the vehicle. Clean the drain filter at least once a year.
- Before lowering or raising the convertible top, stop in a safe place off of the road and park on a level surface.
- When lowering the convertible top, make sure objects inside the vehicle are not blown away by the wind.
- Secure all loose objects inside before driving with the convertible top down.
- To help prevent theft or vandalism and to ensure that the passenger compartment stays dry, close the convertible top securely and lock both doors when leaving the vehicle.



- ❑ The soft top is made of high quality material and if it is not maintained correctly, the material could harden, become stained, or have an uneven gloss.
- ❑ Lowering the convertible top while it's wet can also cause water to drip into the cabin.
- ❑ The power windows go down automatically in conjunction with the convertible top opening/closing. However, this is a function for improving the operability, and it does not mean there is a problem. If the vehicle battery is disconnected for vehicle maintenance or other reasons, the power windows will not go down automatically. If the power windows do not go down, the automatic open/close mechanism for the windows must be reset.
- ❑ The windblocker reduces the amount of wind coming into the cabin from behind when driving with the convertible top opened.
- ❑ Before starting the vehicle make sure the convertible top is correctly locked.



Caution!

- ❑ *Before opening the convertible top, make sure the rear window defroster switch is turned off. Otherwise the heat generated from the window defroster could damage the convertible top and the internal material.*
- ❑ *Make sure nothing is on the convertible top or near the back window when raising or lowering the convertible top. Even small objects may interfere and cause damage.*
- ❑ *Do not drive through an automatic car wash; it may damage the convertible top.*
- ❑ *Do not raise or lower the convertible top when the temperature is below 41 °F (5 °C); this will damage the convertible top material.*
- ❑ *Do not lower the convertible top when it's wet. If the convertible top dries while folded, it will deteriorate and mold.*
- ❑ *Do not raise or lower the convertible top in a strong wind as it could damage the convertible top or cause an unexpected accident.*

GETTING TO KNOW YOUR INSTRUMENT PANEL

CONTROL PANEL AND INSTRUMENTS48
MAINTENANCE MONITOR — IF EQUIPPED51
WARNING LIGHTS AND MESSAGES51
ONBOARD DIAGNOSTIC SYSTEM — OBD II68
EMISSIONS INSPECTION AND MAINTENANCE PROGRAMS69



CONTROL PANEL AND INSTRUMENTS

Instrument Cluster



05020103-121-001AB-MPG

Instrument Cluster

- 1 — Odometer/Trip Computer And Trip Computer Button/Dashboard Illumination
- 2 — Tachometer
- 3 — Speedometer
- 4 — Automatic Transmission Info Display
- 5 — Odometer/Trip Computer Info/Engine Coolant Temperature Gauge/Fuel Gauge/Outside Temperature/Cruise Control/Info Switch Display

Odometer/Trip Computer

The display mode can be changed from odometer to "Trip computer A" to "Trip computer B" and then back to odometer by pushing the selector while one of them is displayed.

The selected mode will be displayed.



05020102-121-001AB

Odometer/Trip Reset Button

1 — Odometer/Trip Reset Button

When the ignition is placed in the ACC or OFF position, the odometer or trip cannot be displayed. Pushing the selector can switch the trip or reset it for a ten-minute period in the following cases:

- After the ignition is cycled to OFF from ON.
- After the driver's door is opened.

Trip Computer

The trip computer can record the total distance of two trips. One is recorded in "Trip A", and the other is recorded in "Trip B".

For instance, "Trip A" can record the distance from the point of origin, and "Trip B" can record the distance from where the fuel tank is filled.

Use this meter to measure trip distances and to compute fuel consumption.

If the fuel economy data is reset using the fuel economy monitor or Trip "A" is reset using the trip meter, the fuel economy data and Trip "A" are reset simultaneously when the fuel economy monitor with the trip meter is on.

Note:

Only the trip records tenths of miles (kilometers).

Trip Computer Reset

The trip computer will be erased when the power supply is interrupted (blown fuse or the battery is disconnected) or when the vehicle is driven over 9999.9 miles.

Instrument Panel Illumination

Brightness Adjustment

The brightness of the instrument panel and dashboard illuminations can be adjusted by rotating the knob:

- The brightness decreases by rotating the knob to the left. A beep sound will be heard when the knob has been rotated to the maximum dim position.
- The brightness increases by rotating the knob to the right.



05020102-121-001AB

Dimmer Knob

1 — Instrument Cluster Illumination Dimmer Knob



Cancelling Illumination Dimmer

Rotate the knob to the right until a beep is heard while the instrument cluster is dimmed with the ignition switched ON. If the instrument cluster's visibility is reduced due to glare from surrounding brightness, cancel the illumination dimmer.

When the illumination dimmer is canceled, the instrument cluster cannot be dimmed even if the position lights are turned on. When the illumination dimmer is canceled, the screen in the center display switches to constant display of the daytime screen.

Trip Computer And Info Switch

The following information can be selected by pushing the INFO switch with the ignition in the ON position:

- Distance-to-empty (approximate distance you can travel on the available fuel).
- Average fuel economy.
- Current fuel economy.
- Average vehicle speed.

If you have any problems with your trip computer, contact an authorized dealer.



0620500-122-001

Instrument Cluster Display Controls

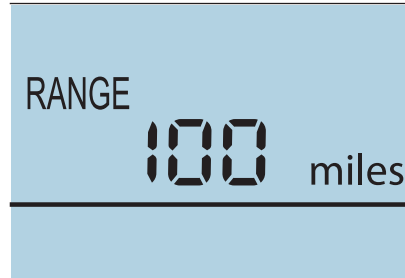

0502011019A019

Distance To Empty Display Screen

When you've slowed to about 3 MPH (5 km/h) , "- - - mpg" ("- - - L/100 km") will be displayed.

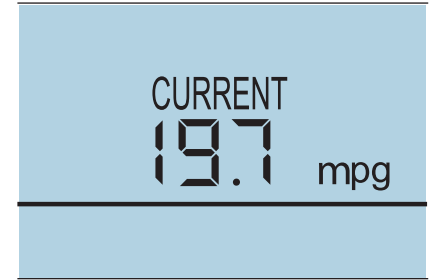

05020110199019

Current Fuel Economy Display Screen

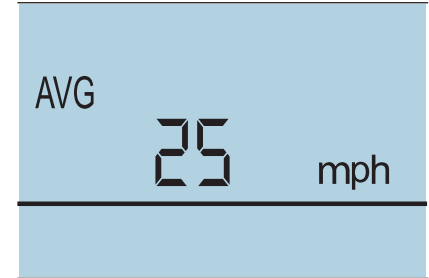

0502011020110C

Average Vehicle Speed Display Screen

MAINTENANCE MONITOR – IF EQUIPPED

Oil Life Reset

Proceed as follows:

1. Select the icon  on the home screen to display the “Applications” screen.
2. Select “Maintenance” to display the maintenance list screen.
3. Switch the tab and select the setting item you want to change: “Scheduled,” “Tire Rotation,” or “Oil Change.”

WARNING LIGHTS AND MESSAGES

Warning Lights And Messages

Note:

- The warning light in the instrument panel appears together with a dedicated message and/or acoustic signal when applicable. These indications are indicative and precautionary and as such must not be considered as exhaustive and/or alternative to the information contained in the User Guide, which you are advised to read carefully in all cases. Always refer to the information in this chapter in the event of a failure indication.
- Failure indications displayed are divided into two categories: serious and less serious failures. Serious failures are indicated by a repeated and prolonged warning "cycle".

Less serious failures are indicated by a warning "cycle" with a shorter duration. The display cycle of both categories can be interrupted. The instrument panel warning light will stay on until the cause of the failure is eliminated.

The warning contents can be verified on the audio system.

Proceed as follows:

1. If the warning light is turned on, select  icon on the home screen to display the application screen.
2. Select “ **Warning Guidance** ” to display the current warnings.
3. Select the applicable warning to view the warning details.



For the following warning/indicator lights:

- Master Warning Light
- Brake System Warning Light
- ABS Warning Light
- Charging System Warning Light
- Engine Oil Warning Light
- Electric Throttle Warning Light
- Cold Start Warning Light
- Check Engine Warning Light
- Coolant Temperature Warning Light
- Automatic Transmission Warning Light
- Power Steering Malfunction Indicator Light
- Air Bag/Seat Belt Pretensioner System Warning Light
- Check Fuel Cap Warning Light

- Low Fuel Warning Light
- Seat Belt Warning Light
- Door Ajar Warning Light
- Low Washer Fluid Level Warning Light
- Tire Pressure Monitoring System Warning Light
- KEY Warning Light
- LED Headlight KEY Warning Light
- BSM (Blind Spot Monitoring) OFF Indicator Light
- TCS/DSC Indicator Light
- DSC OFF Indicator Light
- Security Indicator Light
- Indicator Light
- Passenger Air Bag Deactivation Warning Light

The light turns on when the ignition is switched on for an operation check, and turns off a few seconds later or when the engine is started. If the light does not turn on or remains turned on, have the vehicle inspected at an authorized dealer.

Note:

Only for “Brake System Warning Light:” the light turns on continuously when the parking brake is applied.

Warning Light	What It Means
---------------	---------------

BRAKE



Parking Brake Warning - Warning Light Inspection/Low Brake Fluid Level Warning Parking Brake Warning / Warning Light Inspection

The light illuminates when the parking brake is applied with the ignition switched to START or ON. It turns off when the parking brake is fully released.

Low Brake Fluid Level Warning

If the brake warning light remains illuminated even though the parking brake is released, the brake fluid may be low or there could be a problem with the brake system. Park the vehicle in a safe place immediately and contact an authorized dealer.

Note:

Do not drive with the brake system warning light illuminated. Contact an authorized dealer to have the brakes inspected as soon as possible. Driving with the brake system warning light illuminated is dangerous. It indicates that your brakes may not work at all or that they could completely fail at any time. If this light remains illuminated, after checking that the parking brake is fully released, have the brakes inspected immediately.

The effectiveness of the braking may diminish so you may need to push the brake pedal more strongly than normal to stop the vehicle.

Stop the vehicle in a safe place immediately and contact an authorized dealer.

EBD (Electronic Brake-Force Distribution) System Warning



If the EBD (Electronic Brake-force Distribution) control unit determines that some components are operating incorrectly, the control unit may illuminate the brake system warning light and the ABS warning light simultaneously. The problem is likely to be the electronic brake force distribution system. Stop the vehicle in a safe place immediately and contact an authorized dealer.

Note:

Do not drive with both the ABS warning light and brake warning light illuminated. Contact an authorized dealer to have the brakes inspected as soon as possible. Driving when the brake system warning light and ABS warning light are illuminated simultaneously is dangerous.

When both lights are illuminated, the rear wheels could lock more quickly in an emergency stop than under normal circumstances.



Warning Light	What It Means
	<p>Alternator Failure If the warning light illuminates while driving, it indicates a malfunction of the alternator or of the charging system. Drive to the side of the road and park off the right-of-way. Stop the vehicle in a safe place immediately and contact an authorized dealer.</p> <p>Note: Do not continue driving when the charging system warning light is illuminated because the engine could stop unexpectedly.</p>
	<p>Low Engine Oil Pressure This warning light indicates low engine oil pressure.</p> <p>Note: Do not run the engine if the oil pressure is low. Otherwise, it could result in extensive engine damage. If the light illuminates or the warning indication is displayed while driving:</p> <ol style="list-style-type: none">1. Drive to the side of the road and park off the right-of-way on level ground.2. Turn off the engine and wait five minutes for the oil to drain back into the sump.3. Inspect the engine oil level. If it's low, add the appropriate amount of engine oil while being careful not to overfill.4. Start the engine and check the warning light. <p>Note: Do not run the engine if the oil level is low. Otherwise, it could result in extensive engine damage. If the light remains illuminated even though the oil level is normal or after adding oil, stop the engine immediately and contact an authorized dealer.</p>

Warning Light

What It Means



Door-Open Warning Light

The light turns on if any door is not closed securely.
Close the door securely.





Warning!



Driving a vehicle with the red brake light on is dangerous. Part of the brake system may have failed. It will take longer to stop the vehicle. You could have a collision. Have the vehicle checked immediately.



Red Warning Lights



Warning Light	What It Means
	<p>High Engine Coolant Temperature Warning Light The light flashes when the engine coolant temperature is extremely high, and illuminates when the engine coolant temperature increases further.</p> <p>Handling Procedure</p> <ul style="list-style-type: none"> <input type="checkbox"/> Flashing Light: drive slowly to reduce engine load until you can find a safe place to stop the vehicle and wait for the engine to cool down. <input type="checkbox"/> Illuminated Light: this indicates the possibility of overheating. Park the vehicle in a safe place immediately and stop the engine. Refer to “Overheating” in “In Case Of Emergency” for further information. <p>Note: Do not drive the vehicle with the high engine coolant temperature warning light illuminated. Otherwise, it could result in damage to the engine.</p>
	<p>Air Bag/Seat Belt Pretensioner System Warning A system malfunction is indicated if the warning light constantly flashes, constantly illuminates or does not illuminate at all when the ignition is placed in the ON position. If any of these occur, contact an authorized dealer as soon as possible. The system may not operate in an accident.</p>

Red Warning Lights

Warning Light	What It Means
	<p>Key Warning Light — Illuminated If any malfunction occurs in the keyless entry system, it illuminates continuously.</p> <p>Note: If the key warning indicator light illuminates or the push button start indicator light (amber) flashes, the engine may not start. Contact an authorized dealer as soon as possible.</p> <hr/> <p>Key Warning Light — Flashing Advanced Key Fob Malfunction Take the appropriate action and verify that the warning light turns off.</p> <ul style="list-style-type: none"><input type="checkbox"/> The advanced key fob battery is discharged: replace the key fob battery.<input type="checkbox"/> The advanced key fob is not within the operation range/is placed in areas inside the cabin where it is difficult for the key to be detected: bring the advanced key fob into the operation range.<input type="checkbox"/> A key fob from another manufacturer similar to the advanced key fob is in the operation range: take the key fob from another manufacturer similar to the advanced key out of the operation range.<input type="checkbox"/> Without the ignition switched OFF, the advanced key is taken out of the vehicle, and then all the doors are closed: bring the advanced key fob back into the vehicle.
	<p>Vehicle Security Alarm System The warning light switches on to report a failure of the vehicle security alarm system. Contact an authorized dealer as soon as possible.</p>



Amber Warning Lights

Warning Light	What It Means
	<p>ABS Warning Light If the ABS warning light stays on while you're driving, when the ABS control unit has detected a system malfunction. If this occurs, your brakes will function normally as if the vehicle had no ABS. Should this happen contact an authorized dealer as soon as possible.</p> <p>Note:</p> <ul style="list-style-type: none"> <input type="checkbox"/> When the engine is jump-started to charge the battery, uneven RPM occurs and the ABS warning light may illuminate. If this occurs, it is the result of the weak battery and does not indicate an ABS malfunction. Recharge the battery. <input type="checkbox"/> The brake assist system does not operate while the ABS warning light is illuminated.
	<p>Malfunction Indicator Light If this light illuminates while driving, the vehicle may have a problem. It is important to note the driving conditions when the light illuminated and contact an authorized dealer. The malfunction indicator light may illuminate in the following cases:</p> <ul style="list-style-type: none"> <input type="checkbox"/> The engine's electrical system has a problem. <input type="checkbox"/> The emission control system has a problem. <input type="checkbox"/> The fuel tank level is very low or approaching empty. <input type="checkbox"/> The fuel-filler cap is missing or not tightened securely. <p>If the malfunction indicator light remains on, or it flashes continuously, do not drive at high speeds and contact an authorized dealer as soon as possible.</p>



Warning!

A malfunctioning catalytic converter, as referenced above, can reach higher temperatures than in normal operating conditions. This can cause a fire if you drive slowly or park over flammable substances such as dry plants, wood, cardboard, etc. This could result in death or serious injury to the driver, occupants or others.



Caution!

Prolonged driving with the Malfunction Indicator Light (MIL) on could cause damage to the engine control system. It also could affect fuel economy and driveability. If the MIL is flashing, severe catalytic converter damage and power loss will soon occur. Immediate service is required.



Amber Warning Lights

Warning Light	What It Means
	<p>TPMS (Tire Pressure Monitoring System) Warning Light – If Equipped</p> <p>The warning light switches on and a message is displayed to indicate that the tire pressure is lower than the recommended value and/or that slow pressure loss is occurring. In these cases, optimal tire duration and fuel consumption may not be guaranteed. Should one or more tires be in the condition mentioned above, the display will show the indications corresponding to each tire in sequence.</p> <p>Note:</p> <p>Do not continue driving with one or more flat tires as handling may be compromised. Stop the vehicle, avoiding sharp braking and steering. Repair immediately using the dedicated tire repair kit and contact your authorized dealer as soon as possible.</p> <p>Each tire, including the spare (if provided), should be checked monthly when cold and inflated to the inflation pressure recommended by the vehicle manufacturer on the vehicle placard or tire inflation pressure label. (If your vehicle has tires of a different size than the size indicated on the vehicle placard or tire inflation pressure label, you should determine the proper tire inflation pressure for those tires.)</p> <p>As an added safety feature, your vehicle has been equipped with a tire pressure monitoring system (TPMS) that illuminates a low tire pressure telltale when one or more of your tires is significantly under-inflated. Accordingly, when the low tire pressure telltale illuminates, you should stop and check your tires as soon as possible, and inflate them to the proper pressure. Driving on a significantly under-inflated tire causes the tire to overheat and can lead to tire failure. Under-inflation also reduces fuel efficiency and tire tread life, and may affect the vehicle's handling and stopping ability.</p> <p>Please note that the TPMS is not a substitute for proper tire maintenance, and it is the driver's responsibility to maintain correct tire pressure, even if under-inflation has not reached the level to trigger illumination of the TPMS low tire pressure telltale.</p> <p>The TPMS malfunction indicator is combined with the low tire pressure telltale. When the system detects a malfunction, the telltale will flash for approximately one minute and then remain continuously illuminated. This sequence will continue upon subsequent vehicle start-ups as long as the malfunction exists. When the malfunction indicator is illuminated, the system may not be able to detect or signal low tire pressure as intended. TPMS malfunctions may occur for a variety of reasons, including the installation of replacement or alternate tires or wheels on the vehicle that prevent the TPMS from functioning properly. Always check the TPMS malfunction telltale after replacing one or more tires or wheels on your vehicle to ensure that the replacement or alternate tires and wheels allow the TPMS to continue to function properly.</p>



Caution!





The TPMS has been optimized for the original equipment tires and wheels. TPMS pressures and warning have been established for the tire size equipped on your vehicle. Undesirable system operation or sensor damage may result when using replacement equipment that is not of the same size, type, and/or style. Aftermarket wheels can cause sensor damage. Using aftermarket tire sealants may cause the Tire Pressure Monitoring System (TPMS) sensor to become inoperable. After using an aftermarket tire sealant it is recommended that you take your vehicle to an authorized dealer to have your sensor function checked.

Amber Warning Lights





Warning Light	What It Means
	<p>Power Steering Malfunction Indicator Light</p> <p>The light illuminates if the electric power steering has a malfunction. If the light illuminates, stop the vehicle in a safe place and do not operate the steering wheel. There is no problem if the light turns off after a while. Contact an authorized dealer if the light illuminates continuously.</p> <p>Note:</p> <ul style="list-style-type: none"> <input type="checkbox"/> If the indicator light illuminates, the power steering will not operate normally. If this happens, the steering wheel can still be operated, however, the operation may feel heavy compared to normal, or the steering wheel could vibrate when turning. <input type="checkbox"/> Repeatedly jerking the steering wheel left and right while the vehicle is stopped or moving extremely slowly will cause the power steering system to go into protective mode which will make the steering feel heavy, but this does not indicate a problem. If this occurs, park the vehicle safely and wait several minutes for the system to return to normal.



Amber Warning Lights



Warning Light	What It Means
	<p>Automatic Transmission Warning Light — If Equipped The light illuminates when the transmission has a problem.</p> <p>Note: If the automatic transmission warning light illuminates, the transmission has an electrical problem. Continuing to drive your vehicle in this condition could cause damage to your transmission. Contact an authorized dealer as soon as possible.</p>
	<p>Master Warning Light The warning light turns on when the system has a malfunction. Operate the center display and verify the content.</p>
	<p>Cold Start Disable Indicator Light When the ambient temperature is extremely low, the engine may not crank even when the engine starting procedure is performed. At this time, the Cold Start Disable Indicator light in the instrument cluster flashes. However, this does not indicate a problem.</p> <p>Note: Place your vehicle in a warm garage until the temperature has risen to a sufficient level to enable engine starting.</p>
	<p>Electric Throttle Control Warning Light This light informs you of a problem with the Electronic Throttle Control (ETC) system. If a problem is detected while the engine is running, the light will either stay on or flash depending on the nature of the problem. Cycle the ignition key when the vehicle is safely and completely stopped and the transmission is placed in the PARK position. The light should turn off. If the light remains on with the engine running, your vehicle will usually be drivable; however, see an authorized dealer for service as soon as possible.</p> <p>If the light continues to flash when the engine is running, immediate service is required and you may experience reduced performance, an elevated/rough idle, or engine stall and your vehicle may require towing. The light will come on when the ignition is first turned to ON/RUN and remain on briefly as a bulb check. If the light does not come on during starting, have the system checked by an authorized dealer.</p>

Amber Warning Lights





Warning Lights	What It Means
	<p>Led Headlight Warning Light This light illuminates if there is a malfunction in the LED headlight. Contact an authorized dealer as soon as possible.</p>
	<p>BSM (Blind Spot Monitoring) Off Indicator Light — If Equipped A problem in the system may be indicated under the following conditions:</p> <ul style="list-style-type: none"><input type="checkbox"/> The light does not turn on when the ignition is placed in the ON position.<input type="checkbox"/> The light remains turned on even if the Blind Spot Monitoring (BSM) switch is operated.<input type="checkbox"/> It turns on while driving the vehicle. <p>Contact an authorized dealer as soon as possible. If the vehicle is driven on a road with less traffic and few vehicles that the radar sensors can detect, the system may pause (the warning light illuminates). However, it does not indicate a malfunction.</p>
	<p>Low Fuel Warning Light The light turns on when the remaining fuel is about 2.3 gallons (9.0 liters). The light illumination timing may vary because fuel inside the fuel tank moves around according to the driving conditions and the vehicle posture. Add fuel.</p>
	<p>Low Washer Fluid Level Warning Light — If Equipped This warning light indicates that little washer fluid remains. Add washer fluid.</p>
	<p>Cruise Control Activation — If Equipped The warning light illuminates when the cruise control system is activated.</p>



Amber Warning Lights



Warning Light	What It Means
	<p>TCS / DSC System Indicator Light The warning light turns on when the in case of intervention of TCS/DSC systems. This means that the vehicle is in critical stability and grip conditions.</p>
	<p>DSC Off Indicator Light The warning light turns on when the DSC system is deactivated.</p>
	<p>Loose Fuel Filler Cap Indicator Light If the check fuel filler cap warning light illuminates while driving, the fuel filler cap may not be installed properly. Stop the engine and reinstall the fuel filler cap.</p>

Green Warning Lights

Warning Light	What It Means
	<p>Left Direction Indicator The warning light turns on when the direction indicator control lever is moved downwards or, together with the right direction indicator, when the hazard warning light button is pushed.</p>
	<p>Right Direction Indicator The warning light turns on when the direction indicator control lever is moved upwards or, together with the left direction indicator, when the hazard warning light button is pushed.</p>
	<p>Parking Lights And Normal Beam Headlights The warning light turns on when parking lights or normal beam headlights are turned on.</p>
	<p>Cruise Control — If Equipped The warning light turns on when a cruising speed has been set.</p>
	<p>Key Indicator Light The warning light turns on when the engine is ready to start. Warning Light Flashing When the keyless START/STOP button is pushed from ON to ACC or OFF position, the warning light may flash for approximately 30 seconds indicating that the remaining battery power of the key is low. Replace with a new battery before the key becomes unusable.</p>



Blue Warning Light

Warning Light	What It Means
	<p>High Beam Headlights The warning light switches on when the high beam headlights are turned on.</p>
	<p>Low Engine Coolant Temperature Indicator Light The light illuminates continuously when the engine coolant temperature is low and turns off after the engine is warm. If the low engine coolant temperature indicator light remains illuminated after the engine has been sufficiently warmed up, the temperature sensor could have a malfunction. Contact an authorized dealer.</p>

Warning Light (Red Color) On Dashboard Trim

Warning Light	What It Means
	<p>Seat Belt Warning Light</p> <p>The seat belt warning light turns on if the driver or passengers seat is occupied and the seat belt is not fastened with the ignition placed in the ON position.</p> <p>If the driver or passengers seat belt is unfastened (only when the passenger seat is occupied) and the vehicle is driven at a speed faster than about 12 MPH (20 km/h), the warning light flashes. After a short time, the LED stops flashing, but remains illuminated.</p> <p>If a seat belt remains unfastened, the LED flashes again for a given period of time.</p> <p>If the driver or passengers seat belt is unfastened after the LED turns on, and the vehicle speed exceeds 12 MPH (20 km/h), the LED flashes again.</p> <p>With Passenger Occupant Classification System: to allow the passenger occupant classification sensor to function properly, do not place and sit on an additional seat cushion on the passengers seat. The sensor may not function properly because the additional seat cushion could cause sensor interference.</p> <p>Without Passenger Occupant Classification System: placing heavy items on the passengers seat may cause the passengers seat belt warning function to operate depending on the weight of the item. To allow the passengers seat weight sensor to function properly, do not place and sit on an additional seat cushion on the passengers seat. The sensor may not function properly because the additional seat cushion could cause sensor interference.</p> <p>If a small child is seated on the passengers seat, the warning light may not operate. Fasten the seat belts.</p>

Warning Light (Amber Color) On Instrument Cluster Trim

Warning Light	What It Means
	<p>Passenger Air Bag Deactivation Indicator Light</p> <p>The light turns on when the ignition is switched on for an operation check, and turns off a few seconds later or when the engine is started. If the light does not turn on or remains turned on, contact an authorized dealer.</p>



Message Indicated On Display

If a message is displayed in the center display, take appropriate action (in a calm manner) according to the displayed message.

If the following messages are displayed in the center display, a vehicle system may be malfunctioning:

Engine Coolant Temperature

High: displays if the engine coolant temperature has increased excessively.

Charging System Malfunction:

displays if the charging system has a malfunction.

Temperature Warning: the following message is displayed when the temperature around the center display is high. Lowering the temperature of the inside of the vehicle or the temperature around the center display by avoiding direct sunlight is recommended.

Stop the vehicle in a safe place and contact an authorized dealer.

ONBOARD DIAGNOSTIC SYSTEM – OBD II

Your vehicle is equipped with a sophisticated Onboard Diagnostic system called OBD II. This system monitors the performance of the emissions, engine, and automatic transmission control systems. When these systems are operating properly, your vehicle will provide excellent performance and fuel economy, as well as engine emissions well within current government regulations.

If any of these systems require service, the OBD II system will turn on the Malfunction Indicator Light (MIL). It will also store diagnostic codes and other information to assist your service technician in making repairs. Although your vehicle will usually be drivable and not need towing, see your authorized dealer for service as soon as possible.



Caution!

- Prolonged driving with the MIL on could cause further damage to the emission control system. It could also affect fuel economy and driveability. The vehicle must be serviced before any emissions tests can be performed.*
- If the MIL is flashing while the vehicle is running, severe catalytic converter damage and power loss will soon occur. Immediate service is required.*

Onboard Diagnostic System (OBD II) Cybersecurity

Your vehicle is required to have an Onboard Diagnostic system (OBD II) and a connection port to allow access to information related to the performance of your emissions controls. Authorized service technicians may need to access this information to assist with the diagnosis and service of your vehicle and emissions system.



Warning!

- ❑ ONLY an authorized service technician should connect equipment to the OBD II connection port in order to diagnose or service your vehicle.
- ❑ If unauthorized equipment is connected to the OBD II connection port, such as a driver-behavior tracking device, it may:
 - Be possible that vehicle systems, including safety related systems, could be impaired or a loss of vehicle control could occur that may result in an accident involving serious injury or death.
 - Access, or allow others to access, information stored in your vehicle systems, including personal information.

For further information, refer to “CyberSecurity” in “Tips, Controls, and General Information” in your Owner’s Manual Radio Supplement or “Cybersecurity” in “Multimedia”.

EMISSIONS INSPECTION AND MAINTENANCE PROGRAMS

In some localities, it may be a legal requirement to pass an inspection of your vehicle’s emissions control system. Failure to pass could prevent vehicle registration.



For states that require an Inspection and Maintenance (I/M), this check verifies the “Malfunction Indicator Light (MIL)” is functioning and is not

on when the engine is running, and that the OBD II system is ready for testing. Normally, the OBD II system will be ready. The OBD II system may **not** be ready if your vehicle was recently serviced, recently had a dead battery or a battery replacement. If the OBD II system should be determined not ready for the I/M test, your vehicle may fail the test.

Your vehicle has a simple ignition actuated test, which you can use prior to going to the test station. To check if your vehicle’s OBD II system is ready, you must do the following:

1. Cycle the ignition switch to the ON position, but do not crank or start the engine.

Note:

If you crank or start the engine, you will have to start this test over.

2. As soon as you cycle the ignition switch to the ON position, you will see the “Malfunction Indicator Light (MIL)” symbol come on as part of a normal bulb check.

3. Approximately 15 seconds later, one of two things will happen:

- ❑ The MIL will flash for about 10 seconds and then return to being fully illuminated until you turn OFF the ignition or start the engine. This means that your vehicle’s OBD II system is **not ready** and you should **not** proceed to the I/M station.



□ The MIL will not flash at all and will remain fully illuminated until you place the ignition in the off position or start the engine. This means that your vehicle's OBD II system is **ready** and you can proceed to the I/M station.

If your OBD II system is **not ready**, you should see your authorized dealer or repair facility. If your vehicle was recently serviced or had a battery failure or replacement, you may need to do nothing more than drive your vehicle as you normally would in order for your OBD II system to update. A recheck with the above test routine may then indicate that the system is **now ready**.

Regardless of whether your vehicle's OBD II system is ready or not, if the MIL is illuminated during normal vehicle operation you should have your vehicle serviced before going to the I/M station. The I/M station can fail your vehicle because the MIL is on with the engine running.

SAFETY

SAFETY SYSTEMS	72
AUXILIARY DRIVING SYSTEMS . . .	74
OCCUPANT RESTRAINT SYSTEMS	82
SEAT BELT SYSTEMS	83
CHILD RESTRAINT PRECAUTIONS	89
SUPPLEMENTARY RESTRAINT SYSTEM SRS — AIR BAG	92
EVENT DATA RECORDER (EDR) . .	106
CONSTANT MONITORING	107



SAFETY SYSTEMS

Safety Systems

The vehicle has the following safety systems:

- ❑ Anti-lock Braking System (ABS)
- ❑ Traction Control System (TCS)
- ❑ Dynamic Stability Control (DSC)

For the operation of the systems, see the following pages.

ABS System (Anti-lock Braking System)

The ABS control unit continuously monitors the speed of each wheel. If one wheel is about to lock up, the ABS responds by automatically releasing and reapplying that wheel's brake. The driver will feel a slight vibration in the brake pedal and may hear a chattering noise from the brake system. This is normal ABS system operation. Continue to depress the brake pedal without pumping the brakes. The warning light turns on when the system has a malfunction. Refer to "Warning Lights And Messages" in "Getting To Know Your Instrument Panel" for further information.

Note:

- ❑ Braking distances may be longer on loose surfaces (snow or gravel, for example) which usually have a hard foundation. A vehicle with a normal braking system may require less distance to stop under these conditions because the tires will build up a wedge of surface layer when the wheels skid.
- ❑ The sound of the ABS operating may be heard when starting the engine or immediately after starting the vehicle; however, it does not indicate a malfunction.



Warning!

❑ *The ABS contains sophisticated electronic equipment that may be susceptible to interference caused by improperly installed or high output radio transmitting equipment. This interference can cause possible loss of anti-lock braking capability. Installation of such equipment should be performed by qualified professionals.*

❑ *Pumping of the Anti-Lock Brakes will diminish their effectiveness and may lead to a collision. Pumping makes the stopping distance longer. Just press firmly on your brake pedal when you need to slow down or stop.*

❑ *The ABS cannot prevent the natural laws of physics from acting on the vehicle, nor can it increase braking or steering efficiency beyond that afforded by the condition of the vehicle brakes and tires or the traction afforded.*

❑ *The ABS cannot prevent collisions, including those resulting from excessive speed in turns, following another vehicle too closely, or hydroplaning.*

❑ *The capabilities of an ABS equipped vehicle must never be exploited in a reckless or dangerous manner that could jeopardize the user's safety or the safety of others.*

TCS System (Traction Control System)



Warning!

The capability of the TCS must never be tested irresponsibly and dangerously, in such a way as to compromise personal safety and the safety of others.

The Traction Control System (TCS) enhances traction and safety by controlling engine torque and braking. When the TCS detects driving wheel slippage, it can lower engine torque and operate the brakes to prevent loss of

traction. This means that on a slick surface, the engine adjusts automatically to provide optimum power to the drive wheels, limiting wheel spin and loss of traction.

The indicator light turns on when the system has a malfunction. Refer to “Warning Lights And Messages” in “Getting To Know Your Instrument Panel” for further information.

TCS / DSC Indicator Light

The  indicator light stays on for a few seconds when the ignition is placed in the ON mode.

If the TCS or DSC is operating, the indicator light flashes.

If the  indicator light stays on, the TCS, DSC or the brake assist system may have a malfunction and they may not operate correctly. Contact your authorized dealer.

Note:

- ❑ In addition to the indicator light flashing, a slight sound will come from the engine. This indicates that the TCS/DSC is operating properly.
- ❑ On slippery surfaces, such as fresh snow, it will be impossible to achieve high rpm when the TCS is on.

DSC System (Dynamic Stability Control)

The Dynamic Stability Control (DSC) automatically controls braking and engine torque in conjunction with systems such as ABS and TCS to help control side slip when driving on slippery surfaces, or during sudden or evasive maneuvering, enhancing vehicle safety. Refer to “ABS System (Antilock Brake System)” and “TCS System (Traction Control System)” in this chapter for further information.

DSC operation is possible at speeds greater than 12 mph (20 km/h).

The indicator light turns on when the system has a malfunction. Refer to “Warning Lights And Messages” in “Getting To Know Your Instrument Panel” for further information.

Note:

The DSC may not operate correctly unless the following are observed:

- ❑ Use tires of the correct size specified for your vehicle on all four wheels.

❑ Use tires of the same manufacturer, brand and tread pattern on all four wheels.

❑ Do not mix worn tires.

Note:

The DSC may not operate correctly when tire chains are used.

TCS / DSC Indicator Light

The  indicator light stays on for a few seconds when the ignition is placed in the ON mode. It also illuminates when the DSC OFF switch is pressed and TCS/DSC is switched off.

If the light stays on, the TCS, DSC or the brake assist system may have a malfunction and they may not operate correctly. Take your vehicle to an authorized dealer.

DSC OFF Indicator Light

The  indicator light stays on for a few seconds when the ignition is placed in the ON mode. It also illuminates when the DSC OFF switch is pressed and TCS/DSC is switched off.

If the light remains illuminated and the TCS/DSC is not switched off, contact your authorized dealer. The DSC may have a malfunction.



DSC OFF Switch

Push the switch to turn off the TCS/DSC. The  indicator light in the instrument cluster will illuminate. Push the switch again to turn the TCS/DSC back on. The indicator light will turn off.



05060301-12A-001

DSC OFF Switch**Note:**

- When DSC is on and you attempt to free the vehicle when it is stuck, or drive it out of freshly fallen snow, the TCS (part of the DSC system) will activate. Depressing the accelerator will not increase engine power and freeing the vehicle may be difficult. When this happens, turn off the TCS/DSC.
- If the TCS/DSC is off when the engine is turned off, it automatically activates when the ignition is placed in the ON mode.

**Warning!**

Dynamic Stability Control (DSC) cannot prevent the natural laws of physics from acting on the vehicle, nor can it increase the traction afforded by prevailing road conditions. DSC cannot prevent accidents, including those resulting from excessive speed in turns, driving on very slippery surfaces, or hydroplaning. DSC also cannot prevent accidents resulting from loss of vehicle control due to inappropriate driver input for the conditions. Only a safe, attentive, and skillful driver can prevent accidents. The capabilities of an DSC equipped vehicle must never be exploited in a reckless or dangerous manner which could jeopardize the user's safety or the safety of others.

Vehicle modifications, or failure to properly maintain your vehicle, may change the handling characteristics of your vehicle, and may negatively affect the performance of the DSC system. Changes to the steering system, suspension, braking system, tire type and size or wheel size may adversely affect DSC performance. Improperly inflated and unevenly worn tires may also degrade DSC performance. Any vehicle modification or poor vehicle maintenance that reduces the effectiveness of the DSC system can increase the risk of loss of vehicle control, vehicle rollover, personal injury and death.

AUXILIARY DRIVING SYSTEMS**Blind Spot Monitoring (BSM) System**

The Blind Spot Monitoring (BSM) system is designed to assist the driver during lane changes by alerting the driver to the presence of vehicles approaching from the rear in an adjacent lane.

The system detects vehicles approaching from the rear while traveling in the forward direction at a speed of 19 mph (30 km/h) or faster, and will activate the BSM warning lights equipped within the door mirrors.

If the turn signal lever is operated to signal a lane change in the direction in which the warning light is illuminated, the system warns the driver of a vehicle in the detection area by flashing the warning light and activating an audible alert.

The detection area on this system covers the driving lanes on both sides of the vehicle and from the rear part of the doors to about 164 ft (50 m) behind the vehicle.

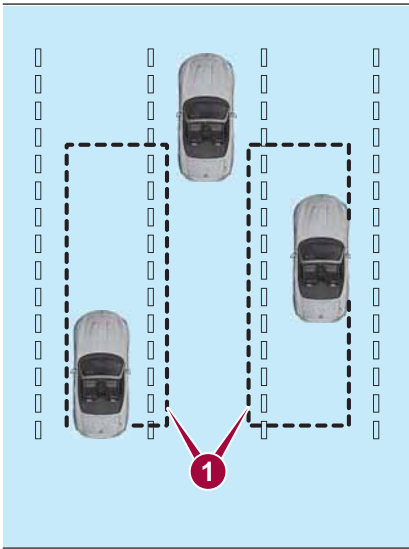

0528070012A002

BSM Detection Areas

1 — Detection Area

Activation / Deactivation

The Blind Spot Monitoring (BSM) system will operate when all of the following conditions are met:

- The ignition is ON.
- The BSM switch is pushed and the warning light in the instrument cluster is turned off.

The vehicle speed is 19 mph (30 km/h) or faster.
The BSM system will not operate under the following conditions:

The vehicle speed falls below about 15 mph (25 km/h) even though the warning light is turned off.

The gear selector is shifted to REVERSE.

In the following cases, the warning light in the instrument cluster illuminates and operation of the BSM system is deactivated.

A problem with the system (including the BSM warning lights) is detected.

A large change in position of a rear radar sensor on the vehicle has occurred.

There is a large accumulation of snow or ice on the rear bumper near a rear radar sensor . Remove any snow, ice or mud on the rear bumper.

Driving on snow covered roads for long periods.

The temperature near the rear radar sensors becomes extremely hot due to driving for long periods on inclines during warm weather.

The battery voltage has decreased.

If the warning light in the instrument cluster remains illuminated, have the vehicle inspected at an authorized dealer as soon as possible.

Note:

Under the following conditions, the rear radar sensors cannot detect objects, or it may be difficult to detect them:

A vehicle is in the detection area at the rear in an adjacent driving lane but it does not approach. The BSM system determines the condition based on radar detection data.

A vehicle is traveling alongside your vehicle at nearly the same speed for an extended period of time.

Vehicles approaching in the opposite direction.

A vehicle in an adjacent driving lane is attempting to pass your vehicle.

A vehicle is in an adjacent lane on a road with extremely wide driving lanes. The detection area of the rear radar sensors is set at the road width of expressways.



In the following cases, the activation of the BSM warning lights and the audible alert may not occur, or they may be delayed:

- ❑ A vehicle makes a lane change from a driving lane two lanes over to an adjacent lane.
- ❑ Driving on steep inclines.
- ❑ Crossing the summit of a hill or mountain pass.
- ❑ The turning radius is small (making a sharp turn or turning at intersections).
- ❑ When there is a difference in the height between your driving lane and the adjacent lane.
- ❑ Immediately after pushing the BSM switch and the system becomes operable.

If the road width is extremely narrow, vehicles two lanes over may be detected. The detection area of the rear radar sensors is set according to the road width of expressways.

The BSM warning lights may turn on in reaction to stationary objects on the road or the roadside such as guardrails, tunnels, sidewalls, and parked vehicles. A BSM warning light may flash or the audible alert may be activated several times when making a turn at a city intersection.

Turn off the BSM system while pulling a trailer or while an accessory such as a bicycle carrier is installed to the rear of the vehicle. Otherwise, the radar's sound system waves will be blocked causing the system to not operate normally.

In the following cases, it may be difficult to view the illumination/flashing of the BSM warning lights equipped on the door mirrors:

- ❑ Snow or ice is adhering to the door mirrors.
- ❑ The door glass is fogged or covered in snow, frost or dirt.

The system switches to the Rear Cross Traffic Alert function when the gear selector is shifted to the REVERSE position.

BSM Warning Lights

The BSM warning lights are equipped on the left and right door mirrors.

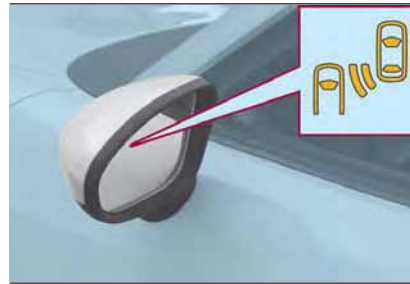

05280701-12A-001

BSM Warning Light

The warning lights turn on when a vehicle approaching from the rear in an adjacent lane is detected.

When the ignition is cycled ON, the malfunction warning light in the instrument cluster illuminates momentarily and then turns off after a few seconds.

Forward Driving (BSM System Operation)



The BSM system detects vehicles approaching from the rear and turns on the warning lights equipped on the door mirrors according to the conditions.

Additionally, while a warning light is illuminated, if the turn signal lever is operated to signal a turn in the direction in which the warning light is illuminated, the warning light flashes.

Reverse Driving (RCTA System Operation)

The Rear Cross Traffic Alert (RCTA) system detects vehicles approaching from the left and right of your vehicle and flashes the BSM warning lights.

Function For Canceling Illumination Dimmer

When the headlight switch is in the  or  position, the brightness of the Blind Spot Monitoring (BSM) warning lights is dimmed. If the Blind Spot Monitoring (BSM) warning lights are difficult to see due to glare from surrounding brightness when traveling on snow-covered roads or under foggy conditions, push the dimmer cancellation button to cancel the dimmer and increase the brightness of Blind Spot Monitoring (BSM) warning lights when they turn on.

Refer to “Instrument Panel Illumination” in “Getting To Know Your Instrument Panel” for further information.

BSM Warning Beep

The BSM audible alert is activated simultaneously with the flashing of a BSM warning light.

BSM Switch

When the BSM switch is pushed, the BSM and RCTA systems are turned off and the BSM off indicator light in the instrument cluster turns on.

If the switch is pushed again, the BSM and RCTA systems become operable and the BSM off indicator light turns off.



05280703-12A-001

BSM Switch Location

Note:

- When the ignition is cycled OFF, the condition before the system was turned off is maintained. For example, if the ignition is cycled OFF while the BSM and RCTA systems are operational, the BSM and RCTA systems remain operational the next time the ignition is cycled ON.
- The BSM and RCTA systems are turned off when the battery is disconnected such as when the battery terminals or fuses have been removed and reinstalled. To turn the BSM and RCTA systems back on, push the BSM switch.

RCTA (Rear Cross Traffic Alert) Function

The RCTA system is designed to assist the driver in checking the area to the rear of the vehicle on both sides while the vehicle is in REVERSE by alerting the driver to the presence of vehicles approaching the rear of the vehicle.

The RCTA system detects vehicles approaching from the left and right sides of the vehicle while the vehicle is reversing out of a parking space, and notifies the driver of possible danger using the BSM warning lights and an audible alert.

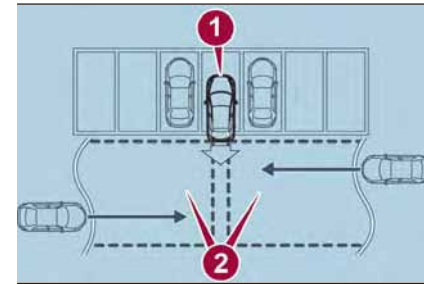

05281200-03A-001

Rear Cross Traffic Alert

- 1 — Your Vehicle
- 2 — Approaching Vehicles Left And Right



RCTA Operation

The RCTA system operates when the gear selector is shifted to the REVERSE position.

If there is the possibility of a collision with an approaching vehicle, the BSM warning light flashes and the audible alert is activated simultaneously.

With Rear View Camera

The Rear Cross Traffic Alert (RCTA) warning indication in the rearview monitor also synchronizes with the Blind Spot Monitoring (BSM) warning indicator light on the door mirrors.

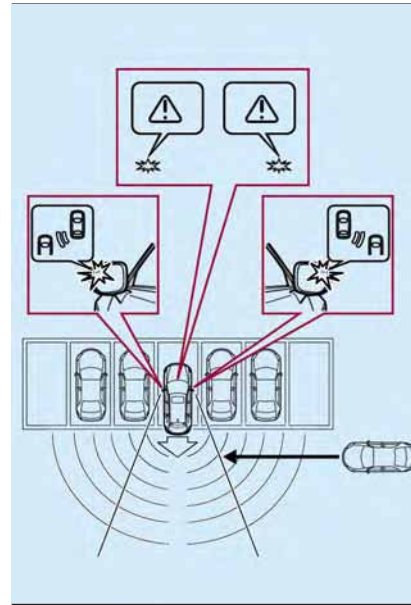

0528140012A002

RCTA Detection

In the following cases, the BSM off indicator light turns on and operation of the system is deactivated. If the BSM off indicator light in the instrument cluster remains illuminated:

- A problem with the system including the BSM warning lights has occurred.
- A large change in the position of a rear radar sensor on the vehicle has occurred.
- There is a large accumulation of snow or ice on the rear bumper near a rear radar sensor.
- Driving on snow-covered roads for long periods.
- The temperature near the radar sensors becomes extremely hot due to driving for long periods on inclines during warm weather.
- The battery voltage has decreased. Have the vehicle inspected at an authorized dealer as soon as possible.

Note:

Under the following conditions, the rear radar sensors cannot detect objects or it may be difficult to detect them:

- The vehicle speed while in REVERSE is about 6 mph (10 km/h) or faster.
- The rear radar sensor detection area is obstructed by a nearby wall or parked vehicle (reverse the vehicle to a position where the radar sensor detection area is no longer obstructed).
- A vehicle is approaching directly to the rear of your vehicle.
- The vehicle is parked on an incline.
- Immediately after pushing the BSM switch and the system becomes operable.

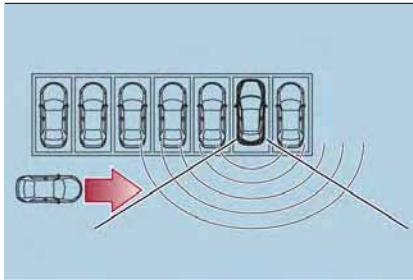

Sensors Obstructed By Nearby Vehicles

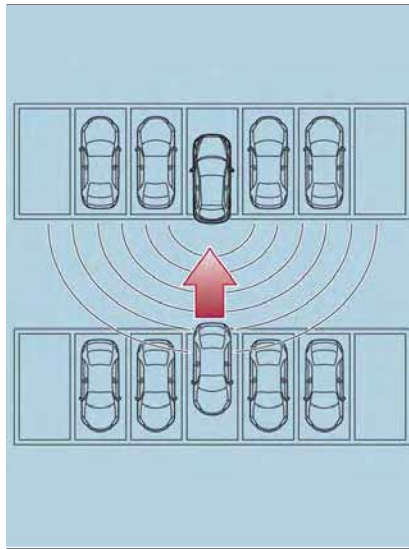

Another Vehicle Approaching Directly To The Rear Of Your Vehicle

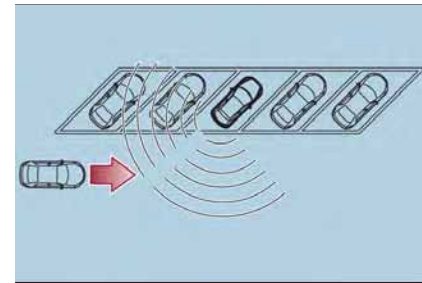

Your Vehicle Parked On An Incline

In the following cases, it may be difficult to view the illumination/flashing of the BSM warning lights equipped on the door mirrors:

- Snow or ice adheres to the door mirrors.
 - The door glass is fogged or covered in snow, frost or dirt.
- Turn off the RCTA system while pulling a trailer or while an accessory such as a bicycle carrier is installed to the rear of the vehicle.
- Otherwise, the sound system waves emitted by the radar will be blocked causing the system to not operate normally.



TPMS (Tire Pressure Monitoring System)

Tire Pressure Monitoring System — Abarth

The TPMS system monitors the pressure for each tire.

If tire pressure is too low in one or more tires, the system will inform the driver via the (!) warning light in the instrument cluster and by the warning beep sound.

The tire pressure sensors installed on each wheel send tire pressure data by radio signal to the receiver unit in the vehicle.

TPMS does not alleviate your need to check the pressure and condition of all four tires regularly.

Each tire, including the spare (if equipped), should be checked monthly when cold and inflated to the inflation pressure recommended by the vehicle manufacturer on the vehicle placard or tire inflation pressure label. (If your vehicle has tires of a different size than the size indicated on the vehicle placard or tire inflation pressure label, you should determine the proper tire inflation pressure for those tires.)

As an added safety feature, your vehicle has been equipped with a tire pressure monitoring system (TPMS) that illuminates a low tire pressure telltale

when one or more of your tires is significantly under-inflated. Accordingly, when the low tire pressure telltale illuminates, you should stop and check your tires as soon as possible, and inflate them to the proper pressure. Driving on a significantly under-inflated tire causes the tire to overheat and can lead to tire failure. Under-inflation also reduces fuel efficiency and tire tread life, and may affect the vehicle's handling and stopping ability. Please note that the TPMS is not a substitute for proper tire maintenance, and it is the driver's responsibility to maintain correct tire pressure, even if under-inflation has not reached the level to trigger illumination of the TPMS low tire pressure telltale. Your vehicle has also been equipped with a TPMS malfunction indicator to indicate when the system is not operating properly. When the system detects a malfunction, the telltale will flash for approximately one minute and then remain continuously illuminated. This sequence will continue upon subsequent vehicle start-ups as long as the malfunction exists. When the malfunction indicator is illuminated, the system may not be able to detect or signal low tire pressure as intended. TPMS malfunctions may occur for a variety of reasons, including the installation of replacement or alternate

tires or wheels on the vehicle that prevent the TPMS from functioning properly. Always check the TPMS malfunction telltale after replacing one or more tires or wheels on your vehicle to ensure that the replacement or alternate tires and wheels allow the TPMS to continue to function properly.

System Error Activation

When the (!) warning light flashes, there may be a system malfunction. Contact your authorized dealer.

A system error activation may occur in the following cases:

- When there is equipment or a device near the vehicle using the same radio frequency as that of the tire pressure sensors.
- When a metallic device such as a non-genuine navigation system is equipped near the center of the dashboard, which may block radio signals from the tire pressure sensor to the receiver unit.
- When using the following devices in the vehicle that may cause radio interference with the receiver unit.
 - A digital device such as a personal computer.
 - A current converter device such as a DC-AC converter.

When excess snow or ice adheres to the vehicle, especially around the wheels.

When the tire pressure sensor batteries are discharged.

When using a wheel with no tire pressure sensor installed.

When using tires with steel wire reinforcement in the side walls.

When using tire chains.

Tires And Wheels

Note:

When inspecting or adjusting the tire air pressures, do not apply excessive force to the stem portion of the wheel unit. The stem portion could be damaged.

Changing Tires And Wheels

The following procedure allows the TPMS to recognize a tire pressure sensor's unique ID signal code whenever tires or wheels are changed, such as changing to and from winter tires.

Note:

Each tire pressure sensor has a unique ID signal code. The signal code must be registered with the TPMS before it can work. The easiest way to do it is to have your authorized dealer change your tire and complete ID signal code registration.

When your authorized dealer changes your vehicle's tires, they will complete the tire pressure sensor ID signal code registration.

If you or someone else changes tires, you or someone else can also undertake the steps for the TPMS to complete the ID signal code registration:

After tires have been changed, place the ignition in the ON mode, then back to ACC or OFF modes.

Wait for about 15 minutes.

After about 15 minutes, drive the vehicle at a speed of at least 16 mph (25 km/h) for 20 minutes and the tire pressure sensor ID signal code will be registered automatically.

Note: If the vehicle is driven within about 15 minutes of changing tires, the  warning light will flash because the sensor ID signal code would not have been registered. If this happens, park the vehicle for about 15 minutes, after which the sensor ID signal code will register upon driving the vehicle for 20 minutes.

Replacing Tires And Wheels

Note:

When replacing/repairing the tires or wheels or both, have the work done by your authorized dealer, or the tire pressure sensors may be damaged.

The wheels equipped on your vehicle are specially designed for installation of the tire pressure sensors. Do not use non-genuine wheels, otherwise it may not be possible to install the tire pressure sensors.

Be sure to have the tire pressure sensors installed whenever tires or wheels are replaced.

When having a tire or wheel or both replaced, the following types of tire pressure sensor installations are possible:

The tire pressure sensor is removed from the old wheel and installed to the new one.

The same tire pressure sensor is used with the same wheel. Only the tire is replaced.

A new tire pressure sensor is installed to a new wheel.



Note:

- ❑ The tire pressure sensor ID signal code must be registered when a new tire pressure sensor is purchased. For purchase of a tire pressure sensor and registration of the tire pressure sensor ID signal code, consult your authorized dealer.
- ❑ When reinstalling a previously removed tire pressure sensor to a wheel, replace the grommet (seal between valve body/sensor and wheel) for the tire pressure sensor.

**Caution!**

❑ *The TPMS has been optimized for the original equipment tires and wheels. TPMS pressures and warning have been established for the tire size equipped on your vehicle. Undesirable system operation or sensor damage may result when using replacement equipment that is not of the same size, type, and/or style. The TPM sensor is not designed for use on aftermarket wheels and may contribute to a poor overall system performance or sensor damage. Customers are encouraged to use OEM wheels to assure proper TPM feature operation.*

❑ *Using aftermarket tire sealants may cause the Tire Pressure Monitoring System (TPMS) sensor to become inoperable.*

After using an aftermarket tire sealant it is recommended that you take your vehicle to your authorized dealer to have your sensor function checked.

❑ *After inspecting or adjusting the tire pressure always reinstall the valve stem cap. This will prevent moisture and dirt from entering the valve stem, which could damage the TPMS sensor.*

The following regulatory statement applies to all radio frequency (RF) devices equipped in this vehicle:

This device complies with Part 15 of the FCC Rules and with Industry Canada license-exempt RSS standard(s). Operation is subject to the following two conditions:

- (1) This device may not cause harmful interference, and
- (2) This device must accept any interference received, including interference that may cause undesired operation.

Note:

Changes or modifications not expressly approved by the party responsible for compliance could void the user's authority to operate the equipment.

OCCUPANT RESTRAINT SYSTEMS

The most important safety equipment of the vehicle comprise the following protection systems:

- ❑ Seat Belts
- ❑ SBA (Seat Belt Alert) System
- ❑ Head Restraints
- ❑ Child Restraint Systems
- ❑ Front Air Bags And Side Air Bags

Read the information given in the following pages with the utmost care.

It is of fundamental importance that the protection systems are used in the correct way to guarantee the maximum possible safety level for the driver and the passengers.

SEAT BELT SYSTEMS

Buckle up even though you are an excellent driver, even on short trips. Someone on the road may be a poor driver and could cause a collision that includes you. This can happen far away from home or on your own street.

Research has shown that seat belts save lives, and they can reduce the seriousness of injuries in a collision. Some of the worst injuries happen when people are thrown from the vehicle. Seat belts reduce the possibility of ejection and the risk of injury caused by striking the inside of the vehicle. Everyone in a motor vehicle should be belted at all times.

Seat Belt Precautions

Seat belts help to decrease the possibility of severe injury during accidents and sudden stops. FCA recommends that the driver and passengers always wear seat belts.

Mexico

All the seats have lap/shoulder belts. These belts have retractors with inertia locks that keep them out of the way when not in use.

The locks allow the belts to remain comfortable on users, but they will lock in position during a collision.

Except Mexico

All of the seat belt retractors are designed to keep the lap/shoulder belts out of the way when not in use.

The driver's seat belt has no provisions for child-restraint systems and has only an emergency locking mode.

The driver may wear it comfortably, and it will lock during a collision.

However, the passenger's seat lap/shoulder belt retractor operates in two modes: emergency locking mode, and for child-restraint systems, automatic locking mode. If you must use the passenger seat for a child, slide the passenger seat as far back as possible and make sure any child restraint system is secured properly. Belt retraction may become difficult if the belts and seat belt guides are soiled, so try to keep them clean. Refer to "Lap/Shoulder Belt" in "Interiors," found in Servicing And Maintenance" for further information.



03020100-12A-001

Seat Belt Routing Guide



Warning!

- Relying on the air bags alone could lead to more severe injuries in a collision. The air bags work with your seat belt to restrain you properly. In some collisions, the air bags won't deploy at all. Always wear your seat belt even though you have air bags.
- In a collision, you and your passengers can suffer much greater injuries if you are not properly buckled up. You can strike the interior of your vehicle or other passengers, or you can be thrown out of the vehicle. Always be sure you and others in your vehicle are buckled up properly.
- It is dangerous to ride in a cargo area, inside or outside of a vehicle. In a collision, people riding in these areas are more likely to be seriously injured or killed.



- ❑ Do not allow people to ride in any area of your vehicle that is not equipped with seats and seat belts.
- ❑ Be sure everyone in your vehicle is in a seat and using a seat belt properly. Occupants, including the driver, should always wear their seat belts whether or not an air bag is also provided at their seating position to minimize the risk of severe injury or death in the event of a crash.
- ❑ Wearing your seat belt incorrectly could make your injuries in a collision much worse. You might suffer internal injuries, or you could even slide out of the seat belt. Follow these instructions to wear your seat belt safely and to keep your passengers safe, too.
- ❑ Two people should never be belted into a single seat belt. People belted together can crash into one another in a collision, hurting one another badly. Never use a lap/shoulder belt or a lap belt for more than one person, no matter what their size.
- ❑ A lap belt worn too high can increase the risk of injury in a collision. The seat belt forces won't be at the strong hip and pelvic bones, but across your abdomen. Always wear the lap part of your seat belt as low as possible and keep it snug.
- ❑ A twisted seat belt may not protect you properly. In a collision, it could even cut into you. Be sure the seat belt is flat against your body, without twists. If you can't straighten a seat belt in your vehicle, take it to your authorized dealer immediately and have it fixed.

- ❑ A seat belt that is buckled into the wrong buckle will not protect you properly. The lap portion could ride too high on your body, possibly causing internal injuries. Always buckle your seat belt into the buckle nearest you.
- ❑ A seat belt that is too loose will not protect you properly. In a sudden stop, you could move too far forward, increasing the possibility of injury. Wear your seat belt snugly.
- ❑ A seat belt that is worn under your arm is dangerous. Your body could strike the inside surfaces of the vehicle in a collision, increasing head and neck injury. A seat belt worn under the arm can cause internal injuries. Ribs aren't as strong as shoulder bones. Wear the seat belt over your shoulder so that your strongest bones will take the force in a collision.
- ❑ A shoulder belt placed behind you will not protect you from injury during a collision. You are more likely to hit your head in a collision if you do not wear your shoulder belt. The lap and shoulder belt are meant to be used together.
- ❑ A frayed or torn seat belt could rip apart in a collision and leave you with no protection. Inspect the seat belt system periodically, checking for cuts, frays, or loose parts. Damaged parts must be replaced immediately. Do not disassemble or modify the seat belt system. Seat belt assemblies must be replaced after a collision.

Seat Belts And Pregnant Women

Pregnant Women And Persons With Serious Medical Conditions

Pregnant women should always wear seat belts. Ask your doctor for specific recommendations.

The lap belt should be worn **SNUGLY AND AS LOW AS POSSIBLE OVER THE HIPS**. The shoulder belt should be worn across your shoulder properly, but never across the stomach area.



06050100-CHD-003

Seat Belts And Pregnant Women

Persons with serious medical conditions also should wear seat belts. Check with your doctor for any special instructions regarding specific medical conditions.

Emergency Locking Mode

When the seat belt is fastened, it will always be in the emergency locking mode.

In the emergency locking mode, the belt remains comfortable on the occupant and the retractor will lock in position during a collision.

If the belt is locked and cannot be pulled out, retract the belt once, and then try pulling it out slowly. If this fails, pull the belt strongly one time and loosen, then pull it out again slowly.

Seat Belt With Automatic Locking Mode

When the seat belt is fastened, it will always be in the emergency locking mode until it is switched to automatic locking mode by pulling it all the way out to its full length.

If the belt feels tight and hinders comfortable movement while the vehicle is stopped or in motion, it may be in the automatic locking mode because the belt has been pulled too far out.

To return the belt to the more comfortable emergency locking mode, wait until the vehicle has stopped in a safe, level area, retract the belt fully to convert it back to emergency locking mode and then extend it around you again.

Automatic Locking Mode

Always use the automatic locking mode to keep the child-restraint system from shifting to an unsafe position in the event of an accident.

To enable seat belt automatic locking mode, pull it all the way out and connect it as instructed on the child restraint system. It will retract down to the child restraint system and stay locked on it.



Warning!

The seat belt assembly must be replaced if the switchable Automatic Locking Retractor (ALR) feature or any other seat belt function is not working properly when checked according to the procedures in the Service Manual.

Failure to replace the seat belt assembly could increase the risk of injury in collisions.

Do not use the Automatic Locking Mode to restrain occupants who are wearing the seat belt or children who are using booster seats. The locked mode is only used to install rear-facing or forward-facing child restraints that have a harness for restraining the child.

Lap/Shoulder Belts

Fastening The Seat Belt

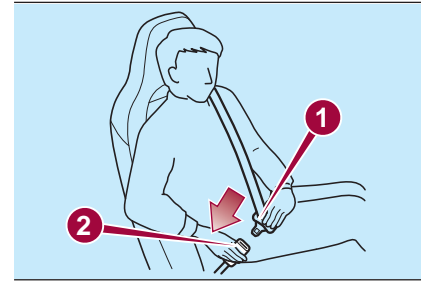

03020201121001

Fastening The Seat Belt

1 — Seat Belt
Tongue

2 — Seat Belt
Buckle



Position the lap belt as low as possible, not on the abdominal area 2, then adjust the shoulder belt 3 so that it fits snugly against your body.

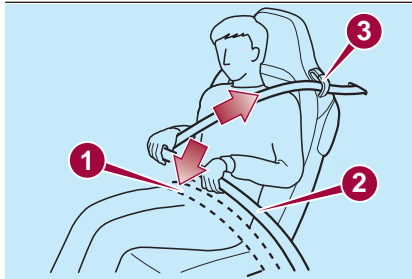

03020201122002

Adjusting The Seat Belt

- 1 — Position Lap Belt Across Lap Area
- 2 — Lap Belt Routing
- 3 — Shoulder Belt Routing

Unfastening The Seat Belt

Depress the button on the seat belt buckle. If the belt does not fully retract, pull it out and check for kinks or twists. Then make sure it remains untwisted as it retracts.

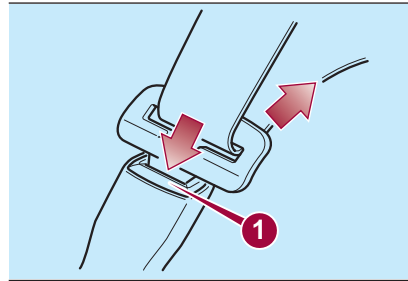

03020202UNF001

Latching/Unlatching The Seat Belt

- 1 — Seat Belt Release Button

Note:

- If a belt does not fully retract, inspect it for kinks and twists. If it is still not retracting properly, have it inspected: contact an authorized dealer.
- Always wear the seat belt with it correctly routed in its guide. Wearing a seat belt without the seat belt routed in its guide is dangerous because the seat belt would not be able to provide adequate protection in an accident, which could result in serious injury.

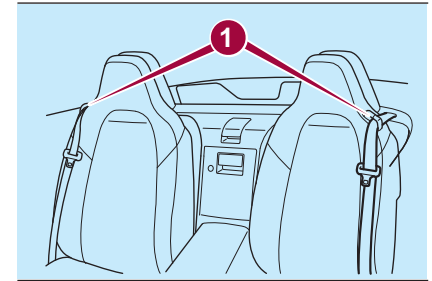

0302020012A001

Seat Belt Routing Guides

- 1 — Shoulder Belt Routing Guides

Seat Belt Warning Systems

If it detects that the occupant seat belt is unfastened, the warning light or beep alerts the occupant.

Refer to “Warning Lights And Messages” in “Getting To Knowing Your Instrument Panel” for further information.

Refer to “Seat Belt Warning Light” in “Getting To Knowing Your Instrument Panel” for further information.

Seat Belt Extender

If your seat belt is not long enough, even when fully extended, a seat belt extender may be available to you at no charge from authorized dealer.

This extender will be only for you and for the particular vehicle and seat. Even if it plugs into other seat belts, it may not hold in the critical moment of a crash.

When ordering an extender, only order one that provides the necessary additional length to fasten the seat belt properly. Please contact authorized dealer for more information.

When not in use, remove the seat belt extender and store it in the vehicle. If the seat belt extender is left connected, the seat belt extender might get damaged as it will not retract with the rest of the seat belt and can easily fall out of the door when not in use and be damaged.

In addition, the seat belt warning light will not illuminate and function properly.



Warning!

Do not use a seat belt extender unless it is necessary. Using a seat belt extender when not necessary is dangerous. The seat belt will be too long and not fit properly. In an accident, the seat belt will not provide adequate protection and you could be seriously injured. Only use the extender when it is required to fasten the seat belt properly.

Do not use an improper extender. Using a seat belt extender that is for another person or a different vehicle or seat is dangerous. The seat belt will not provide adequate protection and the user could be seriously injured in an accident. Only use the extender provided for you and for the particular vehicle and seat.

NEVER use the extender in a different vehicle or seat. If you sell your vehicle, do not leave your seat belt extender in the vehicle. It could be used accidentally by the new owner of the vehicle. After removing the seat belt extender, discard it. Never use the seat belt extender in any other vehicle you may own in the future.

Do not use an extender that is too long. Using an extender that is too long is dangerous. The seat belt will not fit properly. In an accident, the seat belt will not provide adequate protection and you could be seriously injured. Do not use the extender or choose one shorter in length if the distance between the extender's buckle and the center of the user's body is less than 6 inches (15 cm).

Do not leave a seat belt extender connected to the buckle. Leaving a seat belt extender connected to the buckle without using the seat belt is dangerous. When the seat belt extender is connected to the driver's seat belt buckle (or passenger) seat, the SRS driver's (or passenger's) air bag system will determine that the driver (or passenger) is wearing the seat belt even if the driver (or passenger) is not wearing it. This condition could cause the driver's (or passenger's) air bag to not activate correctly and result in death or serious injury in the event of collision. Always wear the seat belt with the seat belt extender.

Do not use the seat belt extender when installing a child restraint system on the passenger seat. Using a seat belt extender to fasten a child restraint system on any seat is dangerous. Always follow the child restraint system manufacturer's installation instructions and never use a seat belt extender.



Driver And Passenger BeltAlert (If Equipped)

Seat Belt Warning Systems

The LED on dashboard trim turns on if the driver or passenger's seat is occupied and the seat belt is not fastened with the ignition switched ON. If the driver or passenger's seat belt is unfastened (only when the passenger seat is occupied) and the vehicle is driven at a speed faster than about 12 MPH (20 km/h), the  LED flashes. After a short time, the LED stops flashing, but remains illuminated.

If a seat belt remains unfastened, the LED flashes again for a given period of time. In this case, fasten the seat belt.

Seat Belt Pretensioner

For optimum protection, the driver and passenger seat belts are equipped with pretensioner and load limiting systems. For both these systems to work properly you must wear the seat belt properly.

The seat belt pretensioners are designed to deploy in moderate or severe frontal, near frontal collisions.

In addition, during a side collision, the pretensioner operates on the side in which the collision occurs. The pretensioners operate differently depending on what types of air bags are equipped. For details on the seat belt pretensioner operation, refer to the "SRS Air Bag Deployment Criteria" paragraph in this chapter.

When a collision is detected, the pretensioners deploy simultaneously with the air bags. For deployment details, refer to the "SRS Air Bag Deployment Criteria" paragraph in this chapter.

The seat belt retractors remove slack quickly as the air bags are expanding. Any time the air bags and seat belt pretensioners have fired they must be replaced.

With Passenger Occupant Classification System

In addition, the pretensioner system for the passenger, like the front and side passenger Air Bag, is designed to only deploy when the passenger occupant classification sensor detects a passenger sitting on the passenger's seat.

Note:

- These devices are not a substitute for proper seat belt placement by the occupant. The seat belt still must be worn snugly and positioned properly.
- The pretensioners are triggered by the Occupant Restraint Controller (ORC). Like the air bags, the pretensioners are single use items. A deployed pretensioner or a deployed air bag must be replaced immediately.

Load Limiter

The load limiting system releases belt webbing in a controlled manner to reduce belt force on the occupant's chest.

While the most severe load on a seat belt occurs in frontal collisions, the load limiter has an automatic mechanical function and can activate in any accident mode with sufficient occupant movement.

Even if the pretensioners have not fired, the load limiting function must be checked by an authorized dealer.

CHILD RESTRAINT PRECAUTIONS

Child Restraints

FCA strongly urges the use of child-restraint systems for children small enough to use them.

Before buying any restraint system, make sure that it has a label certifying that it meets all applicable Safety Standards. You should also make sure that you can install it in the vehicle where you will use it.

Check your local and state or provincial laws for specific requirements regarding the safety of children riding in your vehicle.

Whatever child-restraint system you consider, please pick the appropriate one for the age and size of the child, obey the law and follow the instructions that come with the individual child-restraint system.

A child who has outgrown child-restraint systems should use seat belts, both lap and shoulder. If the shoulder belt crosses the neck or face, move the child closer to the center of the vehicle.

A rear-facing child-restraint system should **NEVER** be used on the passenger seat with the Air Bag system activated. In the event of an impact the Air Bag activation may cause fatal injuries to the transported child.

With Passenger Occupant Classification System

To reduce the chance of injuries caused by deployment of the passenger Air Bag, the passenger occupant classification sensor work as a part of the supplementary restraint system.

This system deactivates the passenger front and side Air Bags and also the passenger seat belt pretensioner system when the  **OFF** passenger Air Bag deactivation indicator light illuminates.

When an infant or small child sits on the passenger seat, the system shuts off the passenger front and side Air Bags and seat belt pretensioner system, so make sure the  **OFF** passenger Air Bag deactivation indicator light illuminates. For more details, refer to "Passenger Occupant Classification Sensor" in "Supplementary Restraint System SRS — Air Bag" for additional information.

Note:

A seat belt or child-restraint system can become very hot in a closed vehicle during warm weather. To avoid burning yourself or a child, check them before you or your child touches them.



Warning!

Improper installation can lead to failure of an infant or child restraint. It could come loose in a collision. The child could be badly injured or killed. Follow the child restraint manufacturer's directions exactly when installing an infant or child restraint.

After a child restraint is installed in the vehicle, do not move the vehicle seat forward or rearward because it can loosen the child restraint attachments. Remove the child restraint before adjusting the vehicle seat position. When the vehicle seat has been adjusted, reinstall the child restraint.

When your child restraint is not in use, secure it in the vehicle with the seat belt or LATCH anchorages, or remove it from the vehicle. Do not leave it loose in the vehicle. In a sudden stop or accident, it could strike the occupants or seatbacks and cause serious personal injury.



Child Restraint System Types

In this User Guide, explanation of child restraint systems secured with seat belts is provided for the following three types of popular child-restraint systems: infant seat, child seat, booster seat.

Note:

- ❑ Installation position is determined by the type of child restraint system. Always read the manufacturer's instructions and this User Guide carefully.
- ❑ Due to variations in the design of child restraint systems, vehicle seats and seat belts, not all child restraint may fit all seating positions.
- ❑ Before purchasing a child-restraint system, it should be tested in the specific vehicle seating position (or positions) where it is intended to be used. If a previously purchased child-restraint system does not fit, you may need to purchase a different one that will.

Infant Seat

An infant seat provides restraint by bracing the infant's head, neck and back against the seating surface.

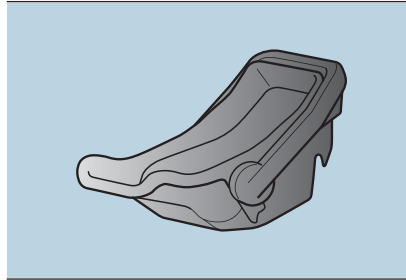

06070809INF001

Infant Seat

Child Seat

A child seat restrains a child's body using the harness.



03030202CHD001

Child Seat

Booster Seat

A booster seat is a child restraint accessory designed to improve the fit of the seat belt system around the child's body.

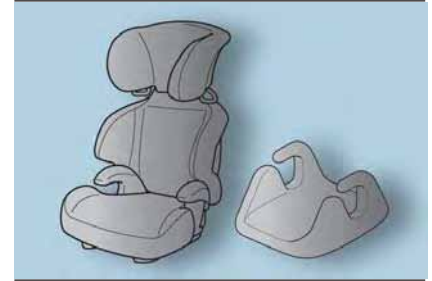

03030202BOO001

Booster Seat



Warning!

Never allow a child to put the shoulder belt under an arm or behind their back. In a crash, the shoulder belt will not protect a child properly, which may result in serious injury or death. A child must always wear both the lap and shoulder portions of the seat belt correctly.

Child Seat Installation Position

The passenger lap/shoulder belt can easily be converted into the automatic locking mode, which must be done to hold the child-restraint system.

Note:

To check if your seats have side air bags: FCA vehicles equipped with side air bag will have an embossed "SRS AIRBAG" marking on the outboard shoulder of the seats.

Follow the child restraint system manufacturer's instructions carefully. Depending on the type of child restraint system, it may not employ seat belts which are in automatic locking mode, however if it uses an upper tether, it may not be mounted properly in this vehicle as there is no safe way to anchor the tether. Confirm whether the child restraint system can be used with seat belts by reading the child restraint system manufacturer's instructions.

Passengers Seat Child Restraint System Installation (With Passenger Occupant Classification System)

Proceed as follows:

- Make sure the ignition is switched off.
- Slide the seat as far back as possible.
- Place the child-restraint system on the seat without putting your weight on the seat and secure the child-restraint system with the lap portion of the lap/shoulder belt. See the manufacturer's instructions on the child-restraint system for belt routing instructions.
- To get the retractor into the automatic locking mode, pull the shoulder belt portion of the seat belt until the entire length of the belt is out of the retractor.
- Push the child-restraint system firmly into the vehicle seat. Be sure the belt retracts as snugly as possible. A clicking noise from the retractor will be heard during retraction if the system is in automatic locking mode. If the belt does not lock the seat down tight, repeat the previous step and also this one.

Seat your child safely in the child-restraint system and secure the child according to the instructions from the child-restraint system manufacturer.

Note: Inspect this function before each use of the child restraint system. You should not be able to pull the shoulder belt out of the retractor while the system is in the automatic locking mode. When you remove the child-restraint system, be sure the belt fully retracts to return the system to emergency locking mode before occupants use the seat belts.

Place the ignition in the ON position and make sure the passenger air bag deactivation indicator light illuminates after installing a child restraint system on the passenger seat. If the passenger air bag deactivation indicator light does not illuminate, remove the child restraint system, place the ignition in the OFF position, and then reinstall the child restraint system.





06070400567567

Passenger Air Bag Deactivation Light



Warning!

- Never place a rear-facing child restraint in front of an air bag. A deploying passenger Advanced Front Air Bag can cause death or serious injury to a child 12 years or younger, including a child in a rear-facing child restraint.
- Only use a rear-facing child restraint in a vehicle with a rear seat.
- An incorrectly anchored tether strap could lead to increased head motion and possibly injury to the child. Use only the anchorage position directly behind the child seat to secure a child restraint top tether strap.

SUPPLEMENTARY RESTRAINT SYSTEM SRS – AIR BAG

Description

The front and side Supplementary Restraint Systems (SRS) include different types of Air Bags.

Note:

Please verify which kinds of Air Bags are equipped on your vehicle by locating the “SRS AIR BAG” location indicators.

These indicators are visible in the area where the Air Bags are installed.

The Air Bags are installed in the following locations:

- The steering wheel hub (Driver Air Bag)
- The passenger dashboard (Passenger Air Bag)
- The outer sides of the seat backs (Side Air Bags)

This vehicle has front air bags and lap/shoulder belts for both the driver and front passenger. The front air bags are a supplement to the seat belt restraint systems.

The Air Bag supplementary restraint systems are designed to provide supplementary protection in certain situations so seat belts are always important in the following ways.

Without seat belt usage, the Air Bags cannot provide adequate protection during an accident. Seat belt usage is necessary to:

- Keep the occupant from being thrown into an inflating Air Bag.
- Reduce the possibility of injuries during an accident that is not designed for Air Bag inflation, such as roll-over or rear impact.
- Reduce the possibility of injuries in frontal, near frontal or side collisions that are not severe enough to activate the Air Bags.
- Reduce the possibility of being thrown from your vehicle.
- Reduce the possibility of injuries to lower body and legs during an accident because the Air Bags provide no protection to these parts of the body.
- Hold the driver in a position which allows better control of the vehicle.



Warning!

In order for the Side Air Bags to work as intended, do not install any accessory items in your vehicle which could alter the roof. Do not add an aftermarket sunroof to your vehicle. Do not add roof racks that

require permanent attachments (bolts or screws) for installation on the vehicle roof. Do not drill into the roof of the vehicle for any reason.

If your vehicle is also equipped with a passenger occupant classification system, refer to the “Passenger Occupant Classification System” paragraph for further information.

If your vehicle is equipped with a passenger occupant classification system, the passenger Air Bag deactivation indicator light illuminates for a specified time after the ignition has been placed in the ON position.



Passenger Air Bag Deactivated Light

Small children must be protected by a child-restraint system as stipulated by law in every state and province.

In certain states and provinces, larger children must use a child-restraint system. Carefully consider which child-restraint system is necessary for your child and follow the installation directions in this User Guide as well as the child-restraint system manufacturer's instructions.

Do not use a child-restraint system which employs an upper tether because there is no appropriate means to anchor the tether.



Warning!

If the Indicator Light remains illuminated for an adult passenger, have an authorized dealer service the air bag system immediately. Failure to do so may cause serious injury or death. If the Indicator Light is illuminated with the words “PASS AIRBAG OFF,” the Passenger Advanced Front Air Bag will not deploy in the event of a collision.

Never place a rear-facing child restraint in front of an air bag. A deploying passenger front air bag can cause death or serious injury to a child 12 years or younger, including a child in a rear-facing child restraint.

- Only use a rear-facing child restraint in a vehicle with a rear seat.
- Children 12 years or younger should always ride buckled up in a vehicle with a rear seat.



Warning!

Unapproved modifications or service procedures to the passenger seat assembly, its related components, seat cover or cushion may inadvertently change the air bag deployment in case of a frontal collision. This could result in death or serious injury to the front passenger if the vehicle is involved in a collision. A modified vehicle may not comply with required Federal Motor Vehicle Safety Standards (FMVSS) and/or Canadian Motor Vehicle Safety Standards (CMVSS).

If it is necessary to modify the air bag system for persons with disabilities, contact your authorized dealer.



Supplementary Restraint System Components

With Passenger Occupant Classification System

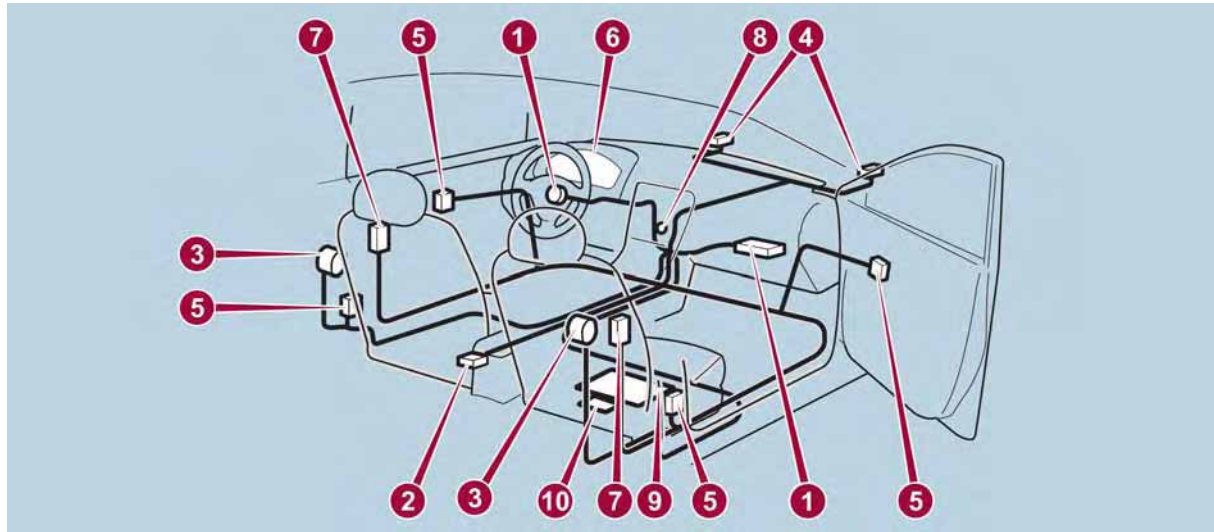

03040300-121-002

With Passenger Occupant Classification System

1 — Driver/Passenger Inflators And Air Bags
 2 — Crash Sensors And Diagnostic Module (Sas Unit)
 3 — Seat Belt Pretensioners
 4 — Front Air Bag Sensors

5 — Side Crash Sensors
 6 — Air Bag/Seat Belt Pretensioner System Warning Light
 7 — Side Inflators And Air Bags
 8 — Passenger Air Bag Deactivation Indicator Light

9 — Passenger Occupant Classification Sensor
 10 — Passenger Occupant Classification Module

Without Passenger Occupant Classification System

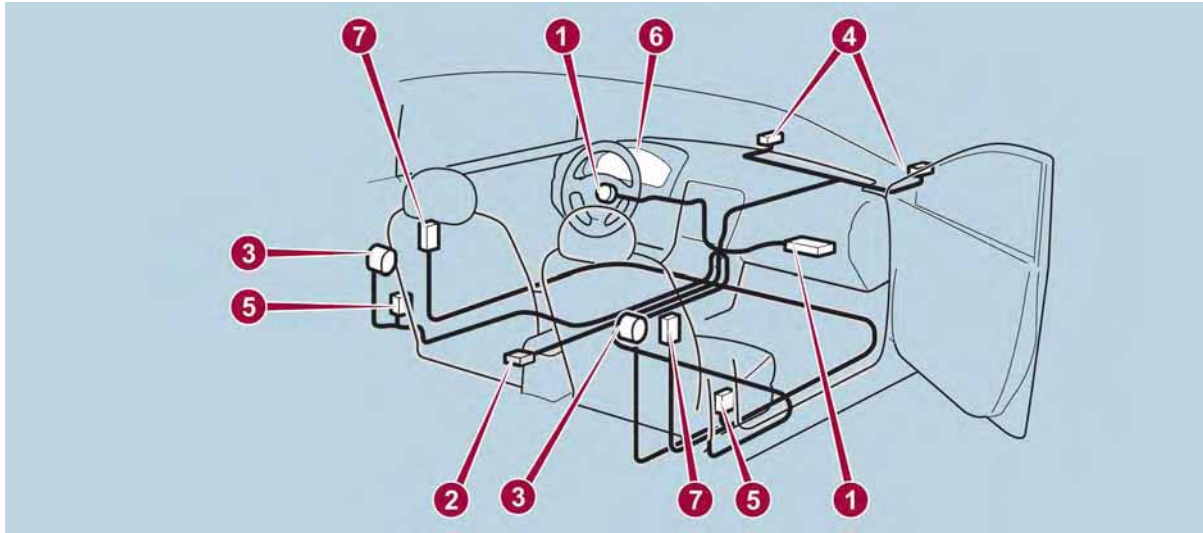

03040300-122-003

Without Passenger Occupant Classification System

- | | | |
|--|---|---------------------------------|
| 1 — Driver/Passenger Inflators And Air Bags | 4 — Front Air Bag Sensors | 7 — Side Inflators And Air Bags |
| 2 — Crash Sensors And Diagnostic Module (Sas Unit) | 5 — Side Crash Sensors | |
| 3 — Seat Belt Pretensioners | 6 — Air Bag/Seat Belt Pretensioner System Warning Light | |



How The SRS Air Bags Work

This vehicle has front air bags and lap/shoulder belts for both the driver and front passenger. The front air bags are a supplement to the seat belt restraint systems. The SRS Air Bags are designed to provide further protection for passengers in addition to the seat belt functions. Be sure to wear seat belts properly.

Seat Belt Pretensioners

The seat belt pretensioners are designed to deploy in moderate or severe frontal, near frontal collisions. In addition, during a side collision, the pretensioner operates on the side in which the collision occurs.

The pretensioners operate differently depending on what types of air bags are equipped. For details on the seat belt pretensioner operation, refer to the "SRS Air Bag Deployment Criteria".

Driver Air Bag

The driver's air bag is mounted in the steering wheel.



06010203-126-123

Driver Side Air Bags

When Air Bag crash sensors detect a frontal impact of greater than moderate force, the driver's Air Bag inflates quickly helping to reduce injury mainly to the driver's head or chest caused by directly hitting the steering wheel. For more details about Air Bag deployment, refer to "SRS Air Bag Deployment Criteria" in this chapter for further information.

(With Passenger Occupant Classification System)

The driver's dual-stage air bag controls air bag inflation in two energy stages. During an impact of moderate severity, the driver's air bag deploys with lesser energy, whereas during more severe impacts, it deploys with more energy.

Passenger Air Bag

(Dual Stage)

The passenger Air Bag is mounted in the passenger dashboard.



06010204-126-123

Passenger Side Air Bag

The inflation mechanism for the passenger Air Bag is the same as the driver's Air Bag, as mentioned above. For more details about Air Bag deployment, refer to "SRS Air Bag Deployment Criteria" in this chapter. For further details about air bag deployment, refer to "SRS Air Bag Deployment Criteria" in this chapter.

Side Air Bags

The side air bags are mounted in the outer sides of the seat backs. When the air bag crash sensors detect a side

impact of greater than moderate force, the system inflates the side air bag only on the side in which the vehicle was hit.



06010205-126-123

Side Air Bags

The side air bag inflates quickly to reduce injury to the driver or passenger's head and chest caused by directly hitting interior parts such as a door or window. For more details about air bag deployment, refer to "SRS Air Bag Deployment Criteria" in this chapter for further information.



Warning!

- ❑ Occupants, including children, who are up against or very close to SABs can be seriously injured or killed. Occupants, including children, should never lean on or sleep against the door, side windows, or area where the side air bags inflate, even if they are in an infant or child restraint.
- ❑ Seat belts (and child restraints where appropriate) are necessary for your protection in all collisions. They also help keep you in position, away from an inflating SAB. To get the best protection from the SABs, occupants must wear their seat belts properly and sit upright with their backs against the seats. Children must be properly restrained in a child restraint or booster seat that is appropriate for the size of the child.

With Passenger Occupant Classification System

In addition, the passenger side bag is designed to only deploy when the passenger occupant classification sensor detects a passenger sitting on the passenger's seat.



Warning!

- ❑ If a child restraint system, child, small teenager or adult in the front passenger seat is seated improperly, the occupant may provide an output signal to the OCS that is different from the occupant's properly seated weight input. This may result in serious injury or death in a collision.
- ❑ Always wear your seat belt and sit properly, with the seatback in an upright position, your back against the seatback, sitting upright, facing forward, in the center of the seat, with your feet comfortably on or near the floor.
- ❑ Do not carry or hold any objects (e.g., backpacks, boxes, etc.) while seated in the front passenger seat. Holding an object may provide an output signal to the OCS that is different than the occupant's properly seated weight input, which may result in serious injury or death in a collision.
- ❑ Placing an object on the floor under the front passenger seat may prevent the OCS from working properly, which may result in serious injury or death in a collision. Do not place any objects on the floor under the front passenger seat.



Warning Light/Bleep

A system malfunction or operation conditions are indicated by a warning. Refer to the beginning paragraph of “Warning Lights And Messages” in “Getting To Know Your Instrument Panel” for further information.



Warning!

Ignoring the Air Bag Warning Light in your instrument panel could mean you won't have the air bags to protect you in a collision. If the light does not come on as a bulb check when the ignition is first turned on, stays on after you start the vehicle, or if it comes on as you drive, have an authorized dealer service the air bag system immediately.

Passenger Side Front Air Bag And Child Restraint Systems

Rearward-facing child restraint systems must **NEVER** be fitted on the front seat with an active passenger side air bag since in the event of an impact the air bag activation may cause fatal injuries to the transported child.

ALWAYS comply with the instructions on the label stuck on the passenger side sun visor : **A** = Mexico market/ **B** = U.S.A. and Canada market.



03030101-121-001

Sun Visor Air Bag Labels



Warning!

Do not use accessory seat covers or place objects between you and the Side Air Bags; the performance could be adversely affected and/or objects could be pushed into you, causing serious injury.





Warning!

- Side Air Bags need room to inflate. Do not lean against the door or window. Sit upright in the center of the seat.
- Being too close to the Side Air Bags during deployment could cause you to be severely injured or killed.
- Relying on the Side Air Bags alone could lead to more severe injuries in a collision. The Side Air Bags work with your seat belt to restrain you properly. In some collisions, Side Air Bags won't deploy at all. Always wear your seat belt even though you have Side Air Bags.

SRS Air Bag Deployment Criteria

This chart indicates the applicable SRS equipment that will deploy depending on the type of collision (the illustrations are the representative cases of collisions).

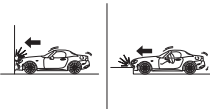
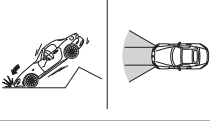
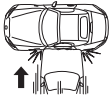
Deployed air bags and seat belt pretensioners cannot protect you in another collision. Have the air bags, seat belt pretensioners, and the seat belt retractor assemblies replaced by an authorized dealer immediately. Also, have the Occupant Restraint Controller System serviced as well.

SRS Equipment	Types Of Collision		
	A Severe Frontal/Near Frontal Collision	A Severe Side Collision (*)	A Rear Collision
			
			
			
Seat Belt Pretensioner	X (**)	X (**)	No air bag and seat belt pretensioner will be activated in a rear collision
Driver Air Bag	X		
Passenger Air Bag	X (**)		
Side Air Bag		X (**)	

X: the SRS air bag equipment is designed to deploy in a collision.

(*) In a side collision, the seat belt pretensioners and the side air bags deploy (only on the side in which the collision occurs).

(**) **Passenger Occupant Classification System:** the passenger front and side air bags and the seat belt pretensioner are designed to deploy when the passenger occupant classification sensor detects a passenger sitting on the passenger's seat.



Note:

In a frontal offset collision, the equipped air bags and pretensioners may all deploy depending on the direction, angle, and rate of impact.

**Warning!**

- Unapproved modifications or service procedures to the passenger seat assembly, its related components, seat cover, or cushion may inadvertently change the air bag deployment in case of a frontal collision. This could result in death or serious injury to the front passenger if the vehicle is involved in a collision. A modified vehicle may not comply with required Federal Motor Vehicle Safety Standards (FMVSS) and/or Canadian Motor Vehicle Safety Standards (CMVSS).*
- If it is necessary to modify the air bag system for persons with disabilities, contact your authorized dealer.*

**Warning!**

Deployed air bags and seat belt pretensioners cannot protect you in another collision. Have the air bags, seat belt pretensioners, and the seat belt retractor assemblies replaced by an authorized dealer immediately. Also, have the Occupant Restraint Controller System serviced as well.

**Warning!**

- Ignoring the Air Bag Warning Light in your instrument panel could mean you won't have the air bags to protect you in a collision. If the light does not come on as a bulb check when the ignition is first turned on, stays on after you start the vehicle, or if it comes on as you drive, have an authorized dealer service the air bag system immediately.*
- Placing an object on the floor under the front passenger seat may prevent the occupant classification sensor from working properly, which may result in serious injury or death in a collision. Do not place any objects on the floor under the front passenger seat.*

- If there is a fault present in the occupant classification sensor, both the Indicator Light and the Air Bag Warning Light will illuminate to show that the Passenger Advanced Front Air Bag is deactivated. Should this occur, the Passenger Advanced Front Air Bag will remain deactivated until the fault is cleared. This indicates that you should take the vehicle to an authorized dealer for service immediately.*

Limitations To SRS Air Bag

In severe collisions such as those described in "SRS Air Bag Deployment Criteria" paragraph, the applicable SRS air bag equipment will deploy. However, in some accidents, the equipment may not deploy depending on the type of collision and its severity.

Limitations To Front / Near Front Collision Detection

Front/near front collisions may not be detected as severe enough to deploy the SRS air bag equipment:

- Impacts involving trees or poles A.
- Frontal offset impact to the vehicle B.
- Rear-ending or running under a truck's tail gate.

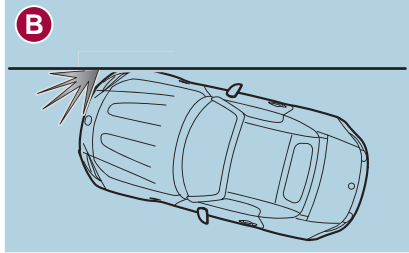
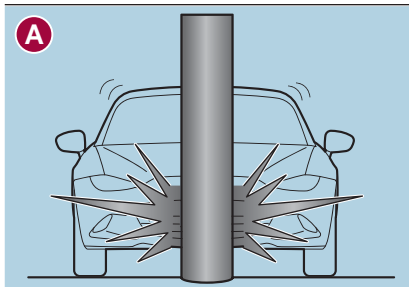

03040600-121-001

Front/Near Front Collision

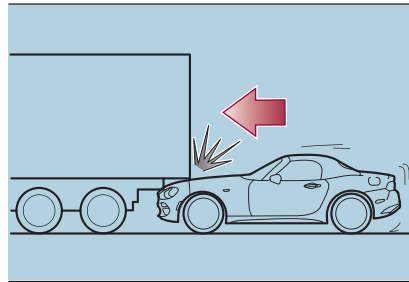

03040600-122-001

Rear End Collision

Limitations To Side Collision Detection

Side collisions may not be detected as severe enough to deploy the SRS air bag equipment:

- Side impacts involving trees or poles A.
- Side impacts with two-wheeled vehicles B.
- Roll-over.

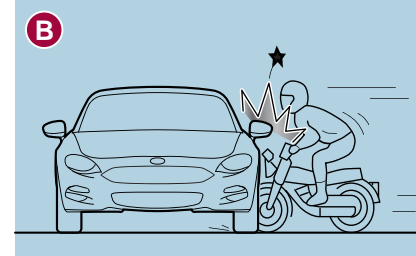
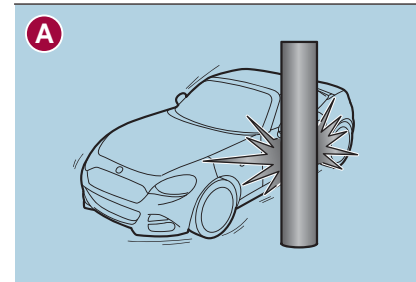

03040600-123-001

Side Collision

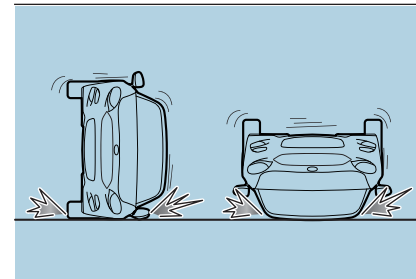

03040600-124-002

Roll-Over Collision



Passenger Occupant Classification Sensor

Your vehicle is equipped with a passenger occupant classification sensor as a part of the supplementary restraint system. This sensor is equipped in the passenger's seat cushion. This sensor measures the electrostatic capacity of the passenger's seat.

The SRS unit is designed to prevent the passenger front and side Air Bags and seat belt pretensioner system from deploying if the passenger Air Bag deactivation indicator light turns on.

To reduce the chance of injuries caused by deployment of the passenger Air Bag, the system deactivates the passenger front and side Air Bags and also the seat belt pretensioner system when the passenger Air Bag deactivation indicator light turns on.

This system shuts off the passenger front and side Air Bags and seat belt pretensioner system, so make sure the passenger Air Bag deactivation indicator light turns on.

The air bag/seat belt pretensioner system warning light flashes and the passenger Air Bag deactivation indicator light illuminates if the sensors have a possible malfunction. If this happens, the passenger front and side Air Bags and seat belt pretensioner system will not deploy.

Note:

If a passenger is seated as shown in the following figure the passenger occupant classification sensor cannot detect a passenger sitting on the passenger's seat correctly and the deployment/non-deployment of the Air Bags cannot be controlled as indicated in the passenger Air Bag deactivation indicator light on/off condition chart.



Warning!

If a child restraint system, child, small teenager or adult in the front passenger seat is seated improperly, the occupant may provide an output signal to the occupant classification sensor that is different from the occupant's properly seated weight input. This may result in serious injury or death in a collision.



Warning!

- Ignoring the Air Bag Warning Light in your instrument panel could mean you won't have the air bags to protect you in a collision. If the light does not come on as a bulb check when the ignition is first turned on, stays on after you start the vehicle, or if it comes on as you drive, have an authorized dealer service the air bag system immediately.
- Placing an object on the floor under the front passenger seat may prevent the occupant classification sensor from working properly, which may result in serious injury or death in a collision. Do not place any objects on the floor under the front passenger seat.
- If there is a fault present in the occupant classification sensor, both the Indicator Light and the Air Bag Warning Light will illuminate to show that the Passenger Advanced Front Air Bag is deactivated. Should this occur, the Passenger Advanced Front Air Bag will remain deactivated until the fault is cleared. This indicates that you should take the vehicle to an authorized dealer for service immediately.



03040702-12A-001

Passenger Not Sitting Correct



Warning!

Do not carry or hold any objects (e.g., backpacks, boxes, etc.) while seated in the front passenger seat. Holding an object may provide an output signal to the occupant classification sensor that is different than the occupant's properly seated weight input, which may result in serious injury or death in a collision.

Passenger Air Bag Deactivation Indicator Lights

These indicator lights turn on to remind you that the passenger front and side Air Bags and seat belt pretensioner will or will not deploy during a collision.



06070400567567

Passenger Air Bag Deactivated



Warning!

If the Indicator Light remains illuminated for an adult passenger, have an authorized dealer service the air bag system immediately. Failure to do so may cause serious injury or death. If the Indicator Light is illuminated with the words "PASS AIRBAG OFF," the Passenger Advanced Front Air Bag will not deploy in the event of a collision.

Never place a rear-facing child restraint in front of an air bag. A deploying passenger front air bag can cause death or serious injury to a child 12 years or younger, including a child in a rear-facing child restraint.

Only use a rear-facing child restraint in a vehicle with a rear seat.

Children 12 years or younger should always ride buckled up in a vehicle with a rear seat.

Note:

The system requires about 10 seconds to alternate between turning the passenger front and side Air Bags and seat belt pretensioner system on or off.

The passenger air bag deactivation indicator light may turn on repeatedly if luggage or other items are put on the passenger seat, or if the temperature of the vehicle's interior changes suddenly.

The passenger air bag deactivation indicator light may turn on for 10 seconds if the electrostatic capacity on the passenger seat changes.

The air bag/seat belt pretensioner system warning light might turn on if the passenger seat receives a severe impact.



❑ If the passenger Air Bag deactivation indicator light does not turn on after installing a child restraint system on the passenger seat, first, reinstall your child restraint system according to the procedure in this User Guide. Then, if the passenger Air Bag deactivation OFF indicator light still does not turn on, contact an authorized dealer as soon as possible.

❑ If the passenger Air Bag deactivation indicator light turns on when an occupant is seated directly in the passenger seat, have the passenger readjust their posture by sitting with their feet on the floor, and then refastening the seat belt. If the passenger Air Bag deactivation indicator light remains turned on, slide the passenger seat as far back as possible. Contact an authorized dealer as soon as possible.

Passenger Air Bag Deactivation Indicator Light On/Off Condition Chart

If the passenger occupant classification sensor is normal, the indicator light turns on when the ignition is switched ON. The light turns off after a few seconds. Then, the indicator light turns on or is off under the following conditions:

Condition Detected By The Passenger Occupant Classification System	Passenger Air Bag Deactivation Indicator Light	Passenger Front And Side Air Bags	Passenger Seat Belt Pretensioner System
Empty (Not occupied)	On	Deactivated	Deactivated
A child is seated in a child restraint system (*)	On	Deactivated	Deactivated
Adult (**)	Off	Ready	Ready

(*) The occupant classification sensor may not detect a child seated on the seat, in a child restraint system, or a junior seat depending on the child's physical size and seated posture.

(**) If a smaller adult sits on the passenger seat, the sensors might detect the person as being a child depending on the person's physique.

If the passenger air bag deactivation indicator light does not turn on when the ignition is switched ON and does not turn on as indicated in the passenger air bag deactivation indicator light on/off condition chart, do not allow an occupant to sit in the passenger seat and contact an authorized dealer as soon as possible. The system may not work properly in an accident.



Warning!

Never place a rear-facing child restraint in front of an air bag. A deploying passenger front air bag can cause death or serious injury to a child 12 years or younger, including a child in a rear-facing child restraint.

Only use a rear-facing child restraint in a vehicle with a rear seat.

Children 12 years or younger should always ride buckled up in a vehicle with a rear seat.



Warning!

No objects should be placed over or near the air bag on the instrument panel or steering wheel because any such objects could cause harm if the vehicle is in a collision severe enough to cause the air bag to inflate.

Do not put anything on or around the air bag covers or attempt to open them manually. You may damage the air bags and you could be injured because the air bags may no longer be functional. The protective covers for the air bag cushions are designed to open only when the air bags are inflating.

Relying on the air bags alone could lead to more severe injuries in a collision. The air bags work with your seat belt to restrain you properly. In some collisions, air bags won't deploy at all. Always wear your seat belts even though you have air bags.

Maintaining Your Air Bag System



Warning!

Modifications to any part of the air bag system could cause it to fail when you need it. You could be injured if the air bag system is not there to protect you. Do not modify the components or wiring, including adding any kind of badges or stickers to the steering wheel hub trim cover or the upper right side of the instrument panel. Do not modify the front bumper, vehicle body structure, or add aftermarket side steps or running boards.

It is dangerous to try to repair any part of the air bag system yourself. Be sure to tell anyone who works on your vehicle that it has an air bag system.

Do not attempt to modify any part of your air bag system. The air bag may inflate accidentally or may not function properly if modifications are made. Take your vehicle to an authorized dealer for any air bag system service. If your seat, including your trim cover and cushion, needs to be serviced in any way (including removal or loosening/tightening of seat attachment bolts), take the vehicle to your authorized dealer. Only manufacturer approved seat accessories may be used. If it is necessary to modify the air bag system for persons with disabilities, contact your authorized dealer.



EVENT DATA RECORDER (EDR)

The main purpose of an EDR is to record, in certain crash or near crash-like situations, such as an air bag deployment or hitting a road obstacle, data that will assist in understanding how a vehicle's systems performed. The EDR is designed to record data related to vehicle dynamics and safety systems for a short period of time, typically 30 seconds or less.

The EDR in this vehicle is designed to record such data as:

- How various systems in your vehicle were operating.
- Whether or not the driver and passenger safety belts were buckled/fastened.
- How far (if at all) the driver was pushing the accelerator and/or brake pedal.
- How fast the vehicle was traveling.

This data can help provide a better understanding of the circumstances in which crashes and injuries occur.

Note:

EDR data are recorded by your vehicle only if a non-trivial crash or near crash-like situation occurs; no data are recorded by the EDR under normal driving conditions and no personal data (e.g., name, gender, age, and crash location) are recorded. However, other parties, such as law enforcement, could combine the EDR data with the type of personally identifying data routinely acquired during a crash investigation.

To read data recorded by an EDR, special equipment is required, and access to the vehicle or the EDR is needed. In addition to the vehicle manufacturer, other parties, such as law enforcement, that have the special equipment, can read the information if they have access to the vehicle or the EDR.

FCA will not disclose any of the data recorded in an EDR to a third party unless:

- A written agreement from the vehicle owner or the lessee is obtained.
- Officially requested by the police or other law enforcement authorities.

Used as a defense for FCA in a law suit, claim, or arbitration.

Ordered by a judge or court.

However, if necessary, FCA will:

Use the data for research on FCA vehicle performance, including safety.

Disclose the data or the summarized data to a third party for research purposes without disclosing vehicle or owner identification information.

Recording Of Vehicle Data

This vehicle is equipped with a computer which records the following main vehicle data related to vehicle controls, operation, and other driving conditions.

Recorded Data

Vehicle conditions such as engine speed and vehicle speed.

Driving operation conditions such as accelerator and brake pedals, and information related to the environmental circumstances while the vehicle is driven.

Malfunction diagnosis information from each on-vehicle computer.

- Information related to controls of other on-vehicle computers.

The recorded data may vary depending on the vehicle grade and optional equipment. Voice and images are not recorded.

Data Handling

FCA and its subcontracting parties may obtain and use the recorded data for vehicle malfunction diagnosis, research and development, and quality improvement.

FCA will not disclose or provide any of the obtained data to a third party unless:

- An agreement from the vehicle owner (agreements from lessor and lessee for leased vehicle) is obtained.
- Officially requested by the police or other law enforcement authorities.
- For statistical processing by a research institution, after processing the data so that identification of the owner or the vehicle is impossible.

CONSTANT MONITORING

The following components of the Air Bag systems are monitored by a diagnostic system:

- Crash Sensors, And Diagnostic Module (Sas Unit)
- Front Air Bag Sensors
- Air Bag Modules
- Side Crash Sensors
- Air Bag/Seat Belt Pretensioner System Warning Light
- Seat Belt Pretensioners
- Related Wiring

With Passenger Occupant Classification System

- Passenger Air Bag Deactivation Indicator Light
- Passenger Occupant Classification Sensor
- Passenger Occupant Classification Module — If Equipped

The diagnostic module continuously monitors the system's readiness. This begins when the ignition is switched ON and continues while the vehicle is being driven.



STARTING AND OPERATING

STARTING THE ENGINE	110
BRAKE SYSTEM	111
MANUAL TRANSMISSION	112
AUTOMATIC TRANSMISSION —	
IF EQUIPPED	113
SPORT MODE	119
SPEED CONTROL	119
REAR PARK ASSIST —	
IF EQUIPPED	122
PARKVIEW REAR BACKUP	
CAMERA — IF EQUIPPED	123
REFUELING THE VEHICLE	126
TOWING TRAILERS	130



STARTING THE ENGINE

Starting The Engine

Before starting the engine, adjust the seat, the interior rear view mirrors, and the door mirrors, and fasten the seat belt correctly.



Warning!

- When leaving the vehicle, always remove the key fob from the vehicle and lock your vehicle.
- Never leave children alone in a vehicle, or with access to an unlocked vehicle.
- Allowing children to be in a vehicle unattended is dangerous for a number of reasons. A child or others could be seriously or fatally injured. Children should be warned not to touch the parking brake, brake pedal or the transmission gear selector.
- Do not leave the key fob in or near the vehicle, or in a location accessible to children, and do not leave the ignition of a vehicle equipped with Advanced Keyless Entry in the ACC or ON/RUN mode. A child could operate power windows, other controls, or move the vehicle.
- Do not leave children or animals inside parked vehicles in hot weather. Interior heat build-up may cause serious injury or death.

Never press the accelerator pedal for starting the engine.

Models Equipped With A Manual Transmission

Proceed as follows:

1. Engage the parking brake and place the gear selector in NEUTRAL.
2. Place the start button in the ACC mode.
3. Fully depress the clutch pedal without touching the accelerator.
4. Place the start button in the ON mode, push and release it as soon as the engine starts. If the engine does not start within 10 seconds, push the start button to OFF mode and wait for 10-15 seconds before repeating the starting procedure.

Models Equipped With An Automatic Transmission

Proceed as follows:

1. Engage the parking brake and place the gear selector to P (PARK) or N (NEUTRAL).
2. Fully depress the brake pedal without touching the accelerator.

3. Place the start button in the ACC mode.

4. Place the start button in the ON mode, push and release it as soon as the engine starts. If the engine does not start within 10 seconds, push the start button to OFF mode and wait for 10-15 seconds before repeating the starting procedure.

Stopping The Engine

Proceed as follows:

1. Park the car in a position that is not dangerous for oncoming traffic, if equipped with manual transmission place gear selector in FIRST (1st) or REVERSE (R) gear, if equipped with automatic transmission place the gear selector to PARK (P).
2. Push and release the ignition button to STOP the engine.

BRAKE SYSTEM

This vehicle has power-assisted brakes that adjust automatically through normal use. Should power-assist fail, you can stop by applying greater force than normal to the brake pedal. But the distance required to stop will be greater than usual.

Note:

Always depress the brake pedal with the right foot. Applying the brakes with the unaccustomed left foot could slow your reaction time to an emergency situation resulting in insufficient braking operation.

Do not drive with your foot held on the clutch pedal or brake pedal, or hold the clutch pedal depressed halfway unnecessarily. Doing so could result in the following:

- ❑ The clutch and brake parts will wear out more quickly.
- ❑ The brakes can overheat and adversely affect brake performance.



Warning!

❑ *Riding the brakes can lead to brake failure and possibly a collision. Driving with your foot resting or riding on the brake pedal can result in abnormally high brake temperatures, excessive lining wear, and possible brake damage. You would not have your full braking capacity in an emergency.*

❑ *Driving a vehicle with the “Brake Warning Light” on is dangerous. A significant decrease in braking performance or vehicle stability during braking may occur. It will take you longer to stop the vehicle or will make your vehicle harder to control. You could have a collision. Have the vehicle checked immediately.*



Caution!

Wear shoes appropriate for driving in order to avoid your shoe contacting the brake pedal when depressing the accelerator pedal.

Parking Brake

Note:

Driving with the parking brake on will cause excessive wear of the brake parts.



Warning!

❑ *Never leave children alone in a vehicle, or with access to an unlocked vehicle.*

❑ *Allowing children to be in a vehicle unattended is dangerous for a number of reasons. A child or others could be seriously or fatally injured. Children should be warned not to touch the park brake, brake pedal or the gear selector.*

❑ *Do not leave the key fob in or near the vehicle or in a location accessible to children. A child could operate power windows, other controls, or move the vehicle.*

❑ *Be sure the park brake is fully disengaged before driving; failure to do so can lead to brake failure and a collision.*

❑ *Always fully apply the park brake when leaving your vehicle, or it may roll and cause damage or injury. Also be certain to leave a manual transmission in REVERSE (R) or FIRST (1st) gear. Failure to do so may allow the vehicle to roll and cause damage or injury.*



Setting the Parking Brake

Depress the brake pedal and then firmly pull the parking brake lever fully upwards with sufficient force to hold the vehicle in a stationary position.

Releasing the Parking Brake

Depress the brake pedal and pull the parking brake lever upwards, then press the release button. While holding the button, lower the parking brake lever all the way down to the released position.



05050102-12A-001AB

Parking Brake

- 1 — Parking Brake Lever
- 2 — Parking Brake Release Button

Warning Light

The warning light turns on when the system has a malfunction. Refer to “Warning Lights And Messages” in “Getting To Know Your Instrument Panel” for further information.

Brake Pad Wear Indicator

When the disc brake pads become worn, the built-in wear indicators contact the rotors. This causes a screeching noise to warn that the pads should be replaced. When you hear this noise contact your authorized dealer as soon as possible.

Brake Assist

During emergency braking situations when it is necessary to depress the brake pedal with greater force, the brake assist system provides braking assistance, thus enhancing braking performance. When the brake pedal is depressed hard or depressed more quickly, the brakes apply more firmly.

Note:

- When the brake pedal is depressed hard or depressed more quickly, the pedal will feel softer but the brakes will apply more firmly. This is a normal effect of the brake assist operation and does not indicate a malfunction.
- When the brake pedal is depressed hard or depressed more quickly, a motor/pump operation noise may be heard. This is a normal effect of the brake assist and does not indicate a malfunction.
- The brake assist equipment does not supersede the functionality of the vehicle's main braking system.

MANUAL TRANSMISSION

Manual Transmission



Warning!

You or others could be injured if you leave the vehicle unattended without having the park brake fully applied. The park brake should always be applied when the driver is not in the vehicle, especially on an incline.



Caution!

Never drive with your foot resting on the clutch pedal, or attempt to hold the vehicle on a hill with the clutch pedal partially engaged, as this will cause abnormal wear on the clutch.

To engage the gears, press the clutch pedal fully and put the gear selector into the required position. The diagram for gear engagement is shown on the knob.



05987654-12A-001AB

Gear Selector

Depress the clutch pedal all the way down while shifting, then release it slowly.

Your vehicle is equipped with a device to prevent shifting to REVERSE (R) by mistake. Push the gear selector downward and shift to REVERSE (R).

A natural driving posture can be achieved by lightly gripping the gear selector from the side without having to rest your elbow on the center console.

If shifting to REVERSE (R) is difficult, shift back into neutral, release the clutch pedal, and try again.

With Parking Sensor System

When the gear selector is shifted to the REVERSE (R) position with the ignition placed in the ON mode, the parking sensor system is activated and an audible sound is heard.



Caution!

- Keep your foot off the clutch pedal except when shifting gears. Also, do not use the clutch to hold the vehicle on an hill or grade. Riding the clutch will cause needless clutch wear and damage.*
- Do not apply any excessive lateral force to the gear selector when changing from fifth to fourth gear. This could lead to the accidental selection of second gear, which could result in damage to the transmission.*
- Make sure the vehicle comes to a complete stop before shifting to REVERSE (R). Shifting to REVERSE (R) while the vehicle is still moving may damage the transmission.*
- Reverse can only be engaged when the vehicle is completely stationary. With the engine running, wait at least two seconds with the clutch pedal fully pressed before engaging reverse to prevent damage to the gears.*

AUTOMATIC TRANSMISSION — IF EQUIPPED

Shift Interlock

This vehicle is equipped with an interlock system that holds the transmission gear selector in PARK (P) unless the brakes are applied. To shift the transmission out of PARK (P), the ignition must be placed in the ON/RUN mode (engine running or not) and the brake pedal must be pressed.



Warning!

- It is dangerous to shift out of PARK or NEUTRAL if the engine speed is higher than idle speed. If your foot is not firmly pressing the brake pedal, the vehicle could accelerate quickly forward or in reverse. You could lose control of the vehicle and hit someone or something. Only shift into gear when the engine is idling normally and your foot is firmly pressing the brake pedal.*



- ❑ Unintended movement of a vehicle could injure those in or near the vehicle. As with all vehicles, you should never exit a vehicle while the engine is running. Before exiting a vehicle, always apply the park brake, shift the transmission into PARK, and turn the ignition OFF. When the ignition is in the OFF mode, the transmission is locked in PARK, securing the vehicle against unwanted movement.
- ❑ When leaving the vehicle, always make sure the ignition is in the OFF mode, remove the key fob from the vehicle, and lock the vehicle.
- ❑ Never leave children alone in a vehicle, or with access to an unlocked vehicle. Allowing children to be in a vehicle unattended is dangerous for a number of reasons. A child or others could be seriously or fatally injured. Children should be warned not to touch the parking brake, brake pedal or the transmission gear selector.
- ❑ Do not leave the key fob in or near the vehicle (or in a location accessible to children), and do not leave the ignition in the ACC or ON/RUN mode. A child could operate power windows, other controls, or move the vehicle.



Caution!

Damage to the transmission may occur if the following precautions are not observed:

- ❑ Shift into or out of PARK or REVERSE only after the vehicle has come to a complete stop.
- ❑ Do not shift between PARK, REVERSE, NEUTRAL, or DRIVE when the engine is above idle speed.
- ❑ Before shifting into any gear, make sure your foot is firmly pressing the brake pedal.

The gear selector must be in PARK (P) or NEUTRAL (N) to operate the starter.

The transmission gear selector has PARK (P), REVERSE (R), NEUTRAL (N), DRIVE (D), and MANUAL (M)(+/-) shift positions.

The transmission may be shifted freely from REVERSE (R), to NEUTRAL (N), to DRIVE (D), to MANUAL (M)(+/-).

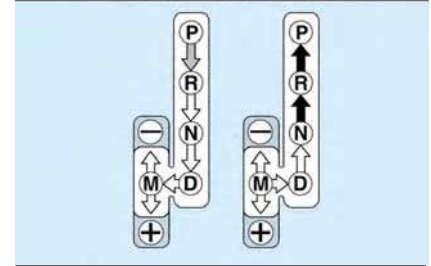

05210200-LHD12AT-001AB

Gear Selector And Pattern

Note:

Even if you intend to use the automatic transmission functions as a traditional automatic, you should also be aware that you can inadvertently shift into manual shift mode and an inappropriate gear may be retained as the vehicle speed increases. If you notice the engine speed going higher or hear the engine racing, confirm you have not

accidentally slipped into manual shift mode (refer to “Manual Shift Mode” paragraph in this section).

Gear Selector Positions

PARK (P)

PARK (P) locks the transmission and prevents the driveshaft from rotating.



Warning!

- ❑ Never use the PARK position as a substitute for the park brake. Always apply the park brake fully when parked to guard against vehicle movement and possible injury or damage.
- ❑ Your vehicle could move and injure you and others if it is not in PARK. Check by trying to move the gear selector out of PARK with the brake pedal released. Make sure the transmission is in PARK before leaving the vehicle.
- ❑ It is dangerous to shift out of PARK or NEUTRAL if the engine speed is higher than idle speed. If your foot is not firmly pressing the brake pedal, the vehicle could accelerate quickly forward or in reverse. You could lose control of the vehicle and hit someone or something. Only shift into gear when the engine is idling normally and your foot is firmly pressing the brake pedal.

❑ Unintended movement of a vehicle could injure those in or near the vehicle. As with all vehicles, you should never exit a vehicle while the engine is running. Before exiting a vehicle, always apply the park brake, shift the transmission into PARK, and turn the ignition OFF. When the ignition is in the OFF mode, the transmission is locked in PARK, securing the vehicle against unwanted movement.

❑ When leaving the vehicle, always make sure the ignition is in the OFF mode, remove the key fob from the vehicle, and lock the vehicle.

❑ Never leave children alone in a vehicle, or with access to an unlocked vehicle. Allowing children to be in a vehicle unattended is dangerous for a number of reasons. A child or others could be seriously or fatally injured. Children should be warned not to touch the park brake, brake pedal or the transmission gear selector.

❑ Do not leave the key fob in or near the vehicle (or in a location accessible to children), and do not leave the ignition in the ACC or ON/RUN mode. A child could operate power windows, other controls, or move the vehicle.



Caution!

❑ Before moving the transmission gear selector out of PARK, you must place the ignition from the LOCK/OFF mode to the ON/RUN mode, and also press the brake pedal. Otherwise, damage to the gear selector could result.

❑ DO NOT race the engine when shifting from PARK or NEUTRAL into another gear range, as this can damage the drivetrain.

Note:

❑ Shifting into PARK (P), NEUTRAL (N) or REVERSE (R) while the vehicle is moving can damage your transmission.

❑ Shifting into DRIVE (D) or REVERSE (R) when the engine is running faster than idle can damage the transmission.

REVERSE (R)

This range is for moving the vehicle backward. Shift into REVERSE only after the vehicle has come to a complete stop.

With Parking Sensor system: when the gear selector is shifted to the REVERSE (R) position with the ignition placed in the ON mode, the parking sensor system is activated and an audible sound is heard.



NEUTRAL (N)

In NEUTRAL (N), the wheels and transmission are not locked. The vehicle will roll freely even on the slightest incline unless the parking brake or brakes are applied.

**Warning!**

Do not coast in NEUTRAL and never turn off the ignition to coast down a hill. These are unsafe practices that limit your response to changing traffic or road conditions. You might lose control of the vehicle and have a collision.

Note:

Do not shift into NEUTRAL (N) when driving the vehicle. Doing so will damage the transmission. Press the parking brake or depress the brake pedal before moving the gear selector from NEUTRAL (N) to prevent the vehicle from moving unexpectedly.

DRIVE (D)

DRIVE (D) is the normal driving position. From a stop, the transmission will automatically shift through all available gears.

MANUAL (M)

MANUAL (M) is the manual shift mode position. Gears can be shifted up or down by operating the gear selector.

(Refer to “Manual Shift Mode” paragraph in this section).

**Warning!**

Do not downshift for additional engine braking on a slippery surface. The drive wheels could lose their grip and the vehicle could skid, causing a collision or personal injury.

Shift-Lock System

The shift-lock system prevents shifting out of PARK (P) unless the brake pedal is depressed.

To shift from PARK (P):

1. Depress and hold the brake pedal.
2. Turn the ignition to the ON/RUN mode.
3. Press and hold the lock-release button on the gear selector.
4. Move the gear selector.

When the ignition is in the ACC or OFF mode, the gear selector cannot be shifted from PARK (P).

The ignition cannot be placed in the OFF mode if the gear selector is not in PARK (P).

Shift Lock Override

If the gear selector will not move from PARK (P) using the proper shift procedure, continue to press the brake pedal and proceed as follows:

1. Remove the shift lock override cover using a cloth wrapped flat head screwdriver.
2. Insert a screwdriver or similar tool into the Override Access Hole, and push the override button down.



05210206-12A-002

Shift Lock Override Access Hole

3. Push and hold the lock release button on the gear selector and move the gear selector.
4. Take the vehicle to your authorized dealer.

For Some Models

Proceed as follows:

1. Push the lock release button on the gear selector while also pushing down on the Shift Lock Override button.
2. Move the gear selector.
3. Take the vehicle to your authorized dealer.



005210206-122-001

Shift Lock Override

Manual Shift Mode

The manual shift mode gives you the feel of driving a manual transmission vehicle by allowing you to operate the gear selector manually.

This allows you to control engine rpm and torque to the drive wheels much like a manual transmission when more control is desired.

To change to MANUAL (M) shift mode, shift the gear selector from DRIVE (D) to MANUAL (M). To return to automatic shift mode, shift the gear selector from MANUAL (M) to DRIVE (D).

You can shift between DRIVE (D) and MANUAL (M) mode at any time, without taking your foot off the accelerator.

Note:

- If you change to manual shift mode when the vehicle is stopped, the gear will shift to M1.
- If you change to manual shift mode while the vehicle is moving it will remain in the current gear until a manual shift request is made.

Indicators

Manual Shift Mode Indication

In manual shift mode, the “M” of the shift position indication in the instrument panel illuminates.

Gear Position Indication

The numeral for the selected gear illuminates.



05210207-12A-002AB

Instrument Panel

- 1 — Manual Shift Mode Indication
- 2 — Gear Position Indication

Manually Shifting Up/Down

To shift up to a higher gear, tap the gear selector rearward once (or tap the [+] shift paddle on the steering wheel, if equipped).

To shift down to a lower gear, tap the gear selector forward once (or tap the [-] shift paddle on the steering wheel, if equipped).

Note:

- If a requested downshift would cause the engine to over-speed, that shift will not occur.
- The system will ignore attempts to upshift at too low of a vehicle speed.



- ❑ Do not drive the vehicle with the tachometer needle in the red zone while in manual shift mode.
- ❑ During deceleration, the transmission may automatically shift down depending on vehicle speed.
- ❑ You can start out, from a stop, in first or second gear. Tapping the gear selector rearward (+) (at a stop) will allow starting in second gear. Starting out in second gear can be helpful in snowy or icy conditions.

Paddle Mode — If Equipped

Tapping one of the steering wheel-mounted shift paddles (+/-), if equipped, while the gear selector is in DRIVE (D), will activate Paddle Mode (a temporary manual mode). The current gear will be displayed in the instrument cluster, with the "M" also illuminated. The transmission will revert back to normal operation (if the gear selector remains in DRIVE) after a period of time, depending on accelerator pedal activity.

Note:

Because Paddle mode is only temporary, use of the MANUAL (M) position is recommended if you need to drive the vehicle in a particular gear for long periods.

Driving Tips

Overtaking

For extra power when passing another vehicle or climbing steep grades, press the accelerator fully. The transmission will shift to a lower gear, depending on vehicle speed.

Note:

- ❑ The accelerator pedal may initially feel heavy as it is being pressed, then feel lighter as it is pressed further. This change in pedal force controls whether or not kickdown should be performed.
- ❑ While the gear selector is in the MANUAL (M) position and the Dynamic Stability Control (DSC) is turned off, manual shift mode does not switch to automatic shift mode even if the accelerator pedal is completely pressed. Tap the gear selector forward or rearward to select the appropriate gear.

Climbing steep grades from a stop

To climb a steep grade from a stopped position:

1. Press the brake pedal.
2. Shift to DRIVE (D) or M1, depending on the load weight and grade steepness.
3. Release the brake pedal while gradually accelerating.

Descending steep grades

When descending a steep grade, shift to lower gears, depending on load weight and grade steepness.

Descend slowly, using the brakes only occasionally to prevent them from overheating.

SPORT MODE

The Sport mode increases steering feedback to the driver with slight increase in effort and changes the transmission shift schedules for more aggressive shifting. This driving mode is useful while driving on twisty roads where more steering precision is desired in spirited cornering.

To activate Sport mode, toggle the Sport Mode button forward and hold for approximately 2 seconds. You will see "Sport" illuminate in the Instrument Panel cluster.



05210101-12A-001AB

SPORT Button

SPEED CONTROL

Speed Control

This is an electronically controlled driving assistance feature that allows the desired vehicle speed to be maintained, without having to press the accelerator pedal.

This feature can be used at a speed above 25 mph (40 km/h) on long stretches of dry, straight roads with few variations (e.g. motorways).

It is therefore not recommended to use this feature on city roads with traffic. Do not use it in town.

Activation / Deactivation

Note:

When the ignition is cycled OFF, the system status before it was turned off is stored. For example, if the ignition is cycled OFF while the Speed Control is operating, the system will be operable when the ignition is cycled ON the next time.

Activating Speed Control

Push the ON button located on the right side of the steering wheel with the other Speed Control buttons. The warning light (amber) in the instrument cluster will illuminate.



05100101-877-877AB

Speed Control Buttons





Warning!

Leaving the Speed Control system on when not in use is dangerous. You could accidentally set the system or cause it to go faster than you want. You could lose control and have an accident. Always leave the system off when you are not using it.



Deactivating Speed Control

Push the OFF/CAN button. The  warning light (amber) in the instrument cluster turns off.

When a speed has been set: the  warning light (green) in the instrument cluster is illuminated, push and hold the OFF/CAN button or push the OFF/CAN button twice to deactivate.

When a speed has not been set: the  warning light (amber) in the instrument cluster is illuminated, push the OFF/CAN button to deactivate.

Setting A Desired Speed

Proceed as follows:

1. Activate the Speed Control device by pushing the ON button. The cruise warning light (amber) illuminates.
2. Accelerate to the desired speed, which must be more than 25 mph (40 km/h).
3. Set the Speed Control by pushing the SET (-) button at the desired speed. The Speed Control is set at the moment the SET (-) button is pushed. Release the accelerator pedal simultaneously. The  warning light (green) illuminates.

Note:

The Speed Control setting cannot be performed under the following conditions:

- Automatic transmission:** the gear selector is in the PARK or NEUTRAL position.
- Manual transmission:** the gear selector is in the NEUTRAL position or when the clutch is disengaged (clutch is depressed).

- The parking brake is applied.

Release the SET (-) button at the desired speed, otherwise the speed will continue decreasing while the SET (-) button is pushed and held (except when the accelerator pedal is depressed).

Note:

- Release the SET (-) button at the desired speed, otherwise the speed will continue decreasing while the SET (-) button is pushed and held (except when the accelerator pedal is depressed).

- On a steep grade, the vehicle may momentarily slow down while ascending, or speed up while descending.

- The Speed Control will cancel if the vehicle speed decreases below 16 mph (25 km/h) when climbing a steep incline.

- The Speed Control may cancel at about 9 mph (15 km/h) below the preset speed such as when climbing a long, steep incline.

The vehicle's set speed is displayed in the instrument cluster.

Increasing / Decreasing Speed**To Increase Speed**

With the Speed Control button: push the RES (+) button and hold it your vehicle will accelerate. Release the button at the desired speed. Push the RES (+) button and release it immediately to adjust the set speed. Multiple operations will increase the set speed according to the number of times it is operated.

Using accelerator pedal: press the accelerator pedal to accelerate to the desired speed. Push the SET (-) button and release it immediately.

Note:

Accelerate the vehicle to speed up temporarily with the accelerator pedal when the Speed Control is on. Increasing the speed will not interfere with, or change the set speed. Take your foot off the accelerator to return to the set speed.

Resume Speed

If any other method besides the OFF/CAN button was used to cancel cruising speed (such as applying the brake pedal or pressing in the clutch pedal) and the system is still activated, the most recent set speed will automatically resume when the RES (+) button is pushed.

If vehicle speed is below 25 mph (40 km/h), increase the vehicle speed up to 16 mph (25 km/h) or more and push RES (+) button.

Temporarily Canceling The System



Warning!

Leaving the Speed Control system on when not in use is dangerous. You could accidentally set the system or cause it to go faster than you want. You could lose control and have an accident. Always leave the system OFF when you are not using it.

To temporarily cancel the system, use one of these methods:

- Slightly press the brake pedal.
- Press the clutch pedal (if equipped with a manual transmission).
- Push OFF/CAN button.

If the RES (+) button is pushed when the vehicle speed is 25 mph (40 km/h) or higher, the system reverts to the previously set speed.

Note:

If any of the following conditions occur, the Speed Control system is temporarily canceled:

- The parking brake is applied.
- Automatic Transmission:** the gear selector is in the PARK or NEUTRAL position.
- Manual Transmission:** the gear selector is in the NEUTRAL position.

Automatic Transmission: the Speed Control cannot be canceled while driving in manual mode (gear selector shifted from D to M position). Therefore, engine braking will not be applied even if the transmission is shifted down to a lower gear. If deceleration is required, lower the set speed or press the brake pedal.

When the Speed Control system is temporarily canceled, the speed cannot be reset.



REAR PARK ASSIST — IF EQUIPPED

Rear Park Assist



Warning!

❑ Do not rely completely on the parking sensor system and be sure to confirm the safety around your vehicle visually when driving. This system can assist the driver in operating the vehicle in the forward and backward directions while parking. The detection ranges of the sensors are limited, therefore, driving the vehicle while relying only on the system may cause an accident. Always confirm the safety around your vehicle visually when driving.

❑ Parking and other potentially dangerous maneuvers are, however, always the driver's responsibility. When performing these operations, always make sure that there are no other people (especially children) or animals on the route you want to drive into. The parking sensors are an aid for the driver, but the driver must never allow their attention to lapse during potentially dangerous maneuvers, even those executed at low speeds.

The Rear Park Assist System uses four ultrasonic sensors (two rear sensors and two rear corner sensors) to detect obstructions around the vehicle while parking the vehicle in a garage or during parallel parking when the gear selector is in REVERSE.



05200100-121-001AB

Parking Sensor Locations



Caution!

❑ Only have repairs on the bumper in the area of the sensors carried out by your authorized dealer. Repairs on the bumper that are not carried out properly may compromise the operation of the parking sensors.

❑ Only have the bumpers repainted or any retouches to the paint work in the area of the sensors carried out by your authorized dealer. Incorrect paint application could affect the operation of the parking sensors.

Sensor Detection Range

The sensors detect obstructions within the following range:

❑ Lateral Detection Range:

19 inches (50 cm)

❑ Rear Detection Range:

59 inches (150 cm)

System Operation

The system is operational when the ignition is cycled ON and the gear selector is shifted to REVERSE. When an audible signal sounds, the system is enabled for use.

PARKVIEW REAR BACKUP CAMERA — IF EQUIPPED

Operation

The camera is located on the trunk lid, above the license plate.



07040110-124-008AB

Rear Camera Location

Switching The Display To Rear View Camera Mode:

Place the gear selector in the REVERSE position, after the ignition is cycled ON, to switch the display to rear-view camera mode.

Note:

- ❑ When parking in REVERSE, take care over obstacles that may be above or under the camera's display range.
- ❑ When the display is cold, the images could be more blurred than usual, making it difficult to check the conditions of the area around the vehicle. Always use extreme caution and verify the real conditions of the area behind the vehicle with you own eyes.
- ❑ If water, snow, or mud is deposited on the camera lens, clean it with a soft cloth. If this does not clean it, use a mild detergent.
- ❑ If the camera is subjected to abrupt temperature changes (from hot to cold or vice versa), the rear-view monitor may not work properly.
- ❑ When replacing tires, contact an authorized dealer. Replacing the tires can cause the guide lines that appear on the display to be misaligned.



Warning!

- ❑ Always use extreme caution and verify the real conditions of the area behind the vehicle. Backing up while looking only at the screen is dangerous and can lead to an accident or collision with an object. The rear-view monitor is simply a system to aid reversing. The view on the display can show a situation that differs from the real one.
- ❑ Do not use the rear-view monitor under the following conditions:
 - Roads covered in ice or snow.
 - When snow chains are mounted or the temporary space saver spare wheel is fitted.
 - The rear trunk is not completely closed.
 - The vehicle is on a sloping road.
- ❑ Using the rear-view monitor under the conditions listed above is dangerous and can cause damage to persons and/or the vehicle.



Caution!

- ❑ Do not apply excessive force to the camera. You could alter the position and angle of the camera. Do not disassemble, modify or remove it as this could compromise the seal.



- ❑ *The camera's cover is made of plastic. Do not apply degreasers, organic solvents, wax or glass polish to the camera's cover. If some substance ends up on the cover, clean it off immediately with a soft cloth.*
- ❑ *Do not rub the cover too much, nor polish it with abrasive compounds or hard brushes. The cover could be damaged and create image problems.*
- ❑ *If the vehicle has been involved in a frontal, lateral or rear collision, the rear parking camera's alignment (location or installation angle) may have been altered. Contact a authorized dealer.*
- ❑ *If the display shows "no video signal", there may be a problem with the camera. Contact your authorized dealer.*

Looking At The Display

The vehicle width guide lines are displayed on the screen as a reference to show the width of the vehicle compared to the width of the parking space to be entered while in REVERSE.

- ❑ **Vehicle Width Guide Lines:** these guide lines serve as a reference showing the width of the vehicle.
- ❑ **Distance Guide Lines:** these lines indicate the approximate distance from the rear of the vehicle (the rear edge of the bumper). The red and yellow lines

indicates the points at about 19 inches (50 cm), for the red line and 39 inches (1 m) for the yellow line, from the rear bumper (central point of each line).



07080913-111-111

Vehicle Width Guide Lines

Warning!

Drivers must be careful when backing up even when using the ParkView Rear Back Up Camera. Always check carefully behind your vehicle, and be sure to check for pedestrians, animals, other vehicles, obstructions, or blind spots before backing up. You are responsible for the safety of your surroundings and must continue to pay attention while backing up. Failure to do so can result in serious injury or death.

Rear View Camera Operation

1. Place the gear selector in the REVERSE position to switch the display to rear view camera mode.
2. Check the surrounding conditions and begin backing up.

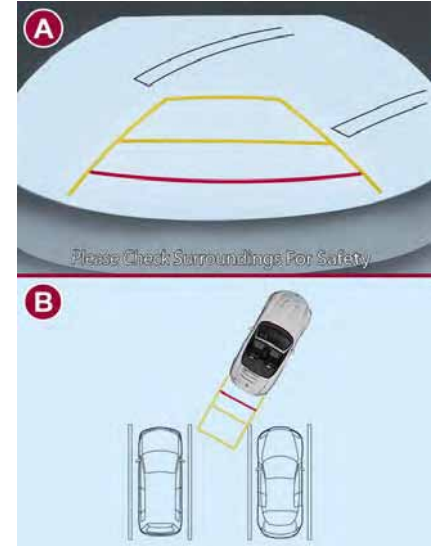

07080913989969

Entering Parking Spot

- A — Rear Camera View
- B — Check Surrounding Area

3. Once the vehicle starts to enter the parking space, proceed slowly in REVERSE while keeping the vehicle width guide lines away from the two sides of the parking space.

4. Continue to adjust the steering wheel until the vehicle width guide lines are parallel with the two sides of the parking space.

5. Once the guide lines are parallel, straighten the steering wheel and reverse slowly into the parking space. Continue to check the vehicle's surroundings and stop in the best position possible (if the parking space has dividing lines, check that the vehicle width guide lines are parallel with them).

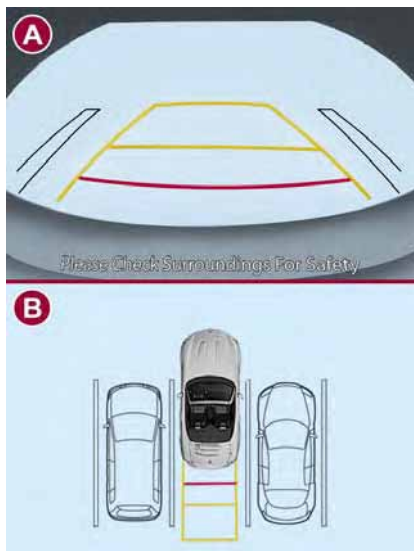

Entering Parking Spot

- A — Rear Camera View
B — Check Surrounding Area

6. When the gear selector is moved from the REVERSE position and put in any other position, the screen returns to the previous display mode.

Note:

- Since there may be some differences between the displayed image and the real conditions, always visually inspect the area behind the vehicle, and the surrounding areas, to make sure they are completely clear.
- In the image of the parking space (or garage) shown above, the rear of the vehicle and the distance guide lines may seem parallel on the monitor, but may not be when the parked vehicle is inspected.
- When you enter a parking space with a dividing line only on one side, the dividing line and the vehicle width guide lines may appear parallel on the monitor, but may not be when the parked vehicle is inspected.

Adjusting The Image Quality

The image quality can be adjusted with the gear selector in the REVERSE position.

Four adjustments can be made: brightness, contrast, tint and color. Give attention to the vehicle's surroundings while making adjustments:

1. Select the icon on the top left of the screen to display the tabs.



2. Select the desired tab.
3. Use the cursor to adjust the brightness, contrast, tint and color. If a reset is needed, press the reset button.
4. Select the icon on the top left of the screen to close the tabs.

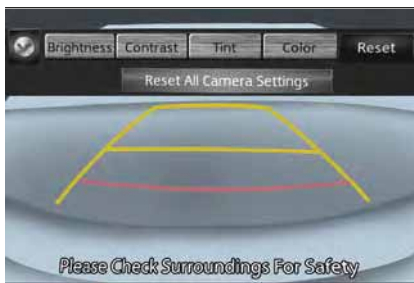

07080914-111-111

Image Quality Adjustments



Warning!

Adjusting the rear-view camera image quality must always be done when the vehicle is stationary. Do not adjust the rear-view camera image quality while vehicle driving. Adjusting the image quality (brightness, contrast, color and tint) of the rear-view camera while driving the vehicle is dangerous since it could distract the driver and cause a serious accident.

REFUELING THE VEHICLE

Refueling The Vehicle

Stop the engine before refueling.

Fuel Requirements

Vehicles with catalytic converters or oxygen sensors must use ONLY UNLEADED FUEL, which will reduce exhaust emissions and keep spark plug fouling to a minimum.



Fuel: Premium unleaded fuel.

Octane Rating (Anti-knock index): 91 (R + M)/2 method or above (96 RON or above) (U.S. federal

law requires that octane ratings be posted on gasoline station pumps). Regular unleaded fuel with an octane rating from 87 to 90 (91 to 95 RON) can be used, but this will reduce performance slightly, such as reduced engine output, and engine knocking.

Fuel with a rating lower than 87 octane (91 RON) will negatively affect the emission control system performance and could also cause engine knocking and serious engine damage.

While operating on gasoline with an octane number of 87, hearing a light knocking sound from the engine is not

a cause for concern. However, if the engine is heard making a heavy knocking sound, see your authorized dealer immediately. Use of gasoline with an octane number lower than 87 can cause engine failure and may void or not be covered by the New Vehicle Limited Warranty. Poor quality gasoline can cause problems such as hard starting, stalling, and hesitations. If you experience these symptoms, try another brand of gasoline before considering service for the vehicle.

Gasoline blended with oxygenates such as alcohol or ether compounds are generally referred to as oxygenated fuels.

The common gasoline blend that can be used with your vehicle is ethanol blended at no more than 15%. Gasoline containing alcohol, such as ethanol or methanol, may be marketed under the name "Gasohol".

Vehicle damage and problems resulting from the use of the following may not be covered by the New Vehicle Limited Warranty:

- Alcohol containing more than 15% ethanol.
- Gasoline or alcohol containing methanol.
- Leaded fuel or leaded alcohol.

Reformulated Gasoline

Many areas of the country require the use of cleaner burning gasoline referred to as “Reformulated Gasoline”. Reformulated gasoline contains oxygenates and are specifically blended to reduce vehicle emissions and improve air quality.

The use of reformulated gasoline is recommended. Properly blended reformulated gasoline will provide improved performance and durability of engine and fuel system components.

Gasoline/Oxygenate Blends

Some fuel suppliers blend unleaded gasoline with oxygenates such as ethanol.



Caution!

DO NOT use gasoline containing methanol or gasoline containing more than 15% ethanol (E-15). Use of these blends may result in starting and drivability problems, damage critical fuel system components, cause emissions to exceed the applicable standard, and/or cause the “Malfunction Indicator Light” to illuminate. Please observe pump labels as they should clearly communicate if a fuel contains greater than 15% ethanol (E-15).

Problems that result from using gasoline containing more than 15% ethanol (E-15) or gasoline containing methanol are not the responsibility of the manufacturer and may void or not be covered under New Vehicle Limited Warranty.

E-85 Usage In Non-Flex Fuel Vehicles

Non-Flex Fuel Vehicles (FFV) are compatible with gasoline containing up to 15% ethanol (E-15). Use of gasoline with higher ethanol content may void the New Vehicle Limited Warranty.

If a Non-FFV vehicle is inadvertently fueled with E-85 fuel, the engine will have some or all of these symptoms:

- Operate in a lean mode.
- OBD II “Malfunction Indicator Light” on.
- Poor engine performance.
- Poor cold start and cold drivability.
- Increased risk for fuel system component corrosion.

MMT In Gasoline

Methylcyclopentadienyl Manganese Tricarbonyl (MMT) is a manganese-containing metallic additive that is blended into some gasoline to increase octane. Gasoline blended with MMT

provides no performance advantage beyond gasoline of the same octane number without MMT. Gasoline blended with MMT reduces spark plug life and reduces emissions system performance in some vehicles. The manufacturer recommends that gasoline without MMT be used in your vehicle. The MMT content of gasoline may not be indicated on the gasoline pump; therefore, you should ask your gasoline retailer whether the gasoline contains MMT. MMT is prohibited in Federal and California reformulated gasoline.

Materials Added To Fuel



Designated TOP TIER Detergent Gasoline contains a higher level of detergents to further aid in minimizing engine and fuel system deposits.

When available, the usage of Top Tier Detergent gasoline is recommended. Visit www.toptiergas.com for a list of TOP TIER Detergent Gasoline Retailers.

Indiscriminate use of fuel system cleaning agents should be avoided. Many of these materials intended for gum and varnish removal may contain active solvents or similar ingredients. These can harm fuel system gasket and diaphragm materials.



Fuel System Cautions



Caution!

Follow these guidelines to maintain your vehicle's performance:

- ❑ The use of leaded gasoline is prohibited by Federal law. Using leaded gasoline can impair engine performance and damage the emissions control system.
- ❑ An out-of-tune engine or certain fuel or ignition malfunctions can cause the catalytic converter to overheat. If you notice a pungent burning odor or some light smoke, your engine may be out of tune or malfunctioning and may require immediate service. Contact your authorized dealer for service assistance.
- ❑ The use of fuel additives, which are now being sold as octane enhancers, is not recommended. Most of these products contain high concentrations of methanol. Fuel system damage or vehicle performance problems resulting from the use of such fuels or additives is not the responsibility of the manufacturer and may void or not be covered under the New Vehicle Limited Warranty.

Note:

Intentional tampering with the emissions control system can result in civil penalties being assessed against you.

Carbon Monoxide Warnings



Warning!

Carbon monoxide (CO) in exhaust gases is deadly. Follow the precautions below to prevent carbon monoxide poisoning:

- ❑ Do not inhale exhaust gases. They contain carbon monoxide, a colorless and odorless gas, which can kill. Never run the engine in a closed area, such as a garage, and never sit in a parked vehicle with the engine running for an extended period. If the vehicle is stopped in an open area with the engine running for more than a short period, adjust the ventilation system to force fresh, outside air into the vehicle.
- ❑ Guard against carbon monoxide with proper maintenance. Have the exhaust system inspected every time the vehicle is raised. Have any abnormal conditions repaired promptly. Until repaired, drive with all side windows fully open.

Refueling Procedure

Fuel Filler Door

Note:

Always use only a designated FCA fuel filler cap or an approved equivalent, available at your authorized dealer. The wrong cap can result in a serious malfunction of the fuel and emission control systems.

When the fuel filler door end is pressed with the doors unlocked, the fuel filler door rises.



04040201-12A-002AB

Fuel Filler Door

The fuel filler door operates in conjunction with the door locking/unlocking mechanism.

To close, press the fuel filler door until a click sound is heard.

Note:

- ❑ Make sure to lock both the doors when leaving the vehicle.
- ❑ Lock the doors after closing the fuel filler door. If the fuel filler door is closed after locking the doors, the fuel filler door cannot be locked.

Fuel Filler Cap

To remove the fuel filler cap, turn it counterclockwise. Attach the removed cap to the inner side of the fuel filler door.

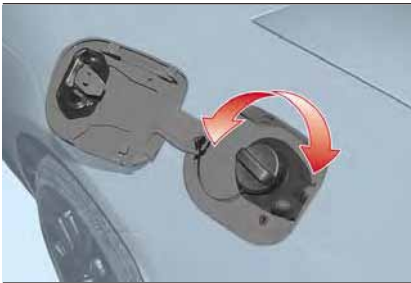

04040202-12A-001AB

Fuel Filler Cap

To close the fuel filler cap, turn it clockwise until a click is heard.



Warning!

- ❑ *Never have any smoking materials lit in or near the vehicle when the gas cap is removed or the tank is being filled.*
- ❑ *Never add fuel when the engine is running. This is in violation of most state and federal fire regulations and may cause the MIL to turn on.*
- ❑ *A fire may result if gasoline is pumped into a portable container that is inside of a vehicle. You could be burned. Always place gas containers on the ground while filling.*
- ❑ *Do not apply any object/plug to the end of the filler which is not provided for the vehicle. The use of non-compliant objects/plugs could cause a pressure increase inside the tank, resulting in dangerous situations.*
- ❑ *Do not use a mobile phone near the refueling pump: risk of fire.*

Emergency Fuel Filler Door Release

If the battery is discharged, the fuel filler door cannot be opened. In this case, the fuel filler door can be opened by taking care of the discharged battery situation.

If the fuel filler door cannot be opened even if the discharged battery situation has been resolved, the electrical system may have a malfunction.

In this case, the fuel filler door can be opened using the following procedure as an emergency measure:

1. Open the trunk and pull the center section of the plastic fastener and remove the fastener.

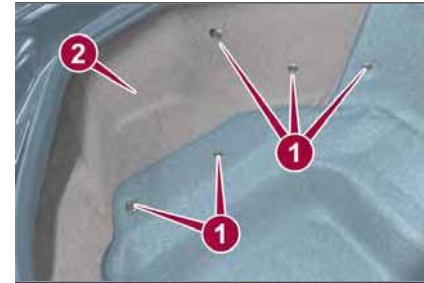

08100100-121-002

Trunk Interior

- 1 — Plastic Fasteners
- 2 — Cover



2. Partially peel back the cover inside the trunk, then pull the emergency release lever.

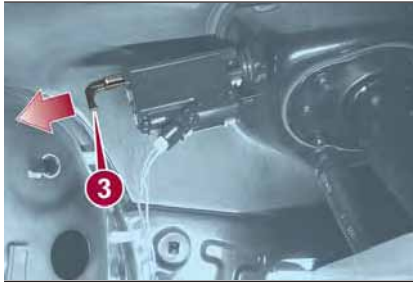

08100100-122-001

Fuel Door Emergency Release

3 — Emergency Release Lever

TOWING TRAILERS

Trailer Towing

Your car is not designed for towing.

Recreational Towing

An example of "recreational towing" is towing your vehicle behind a motorhome.

The transmission is not designed for towing this vehicle on all four wheels.



Caution!

- DO NOT flat tow this vehicle. Damage to the drivetrain will result. If this vehicle requires towing, make sure the drive wheels are OFF the ground.*
- Towing this vehicle in violation of the above requirements can cause severe transmission damage. Damage from improper towing is not covered under the New Vehicle Limited Warranty.*

IN CASE OF EMERGENCY

HAZARD WARNING LIGHTS	132
REPLACING A BULB.	132
REPLACING FUSES	141
JACKING AND TIRE CHANGING . . .	150
TIRE SERVICE KIT	155
JUMP STARTING	164
IF YOUR ENGINE OVERHEATS . . .	165
TOWING THE VEHICLE	166
EVENT DATA RECORDER (EDR) . .	169



HAZARD WARNING LIGHTS

Control

The Hazard Warning Light switch is located on the center instrument panel below the radio. Push the switch to turn the Hazard Warning Lights on or off.



05031100-L12-001AB

Hazard Warning Light Switch

When the switch is pushed, the Hazard Warning Lights are active and all directional turn signals will flash on and off to warn oncoming traffic of an emergency. Push the switch a second time to turn off the Hazard Warning Lights. The hazard warning indicator lights in the instrument cluster will flash simultaneously.

Note:

- ❑ The turn signals do not work while the Hazard Warning Lights are activated.
- ❑ Check local regulations about the use of Hazard Warning Lights while the vehicle is being towed to verify that it is not in violation of the law.
- ❑ If the brake pedal is pressed while driving on slippery roads, the emergency stop signal system could operate causing all of the directional turn signals to flash.
- ❑ While the emergency stop signal system is operating, all of the directional turn signals automatically flash rapidly to caution the driver of a vehicle following behind of a sudden braking situation.

REPLACING A BULB

General Instructions



Warning!

- ❑ Before proceeding with the replacement of the lamp wait for the exhaust pipes are cool: **DANGER OF BURNS!**
- ❑ Modifications or repair of the electrical system performed incorrectly and without taking into account the technical characteristics can cause malfunctions with the risk of fire.
- ❑ Halogen lamps contain gas under pressure, in the event of breakage be careful of the projection of fragments of glass.
- ❑ Halogen lamps must be handled by touching only the metallic part. If the transparent bulb is in contact with the fingers, reduces the intensity of the emitted light and you can also affect the life of the lamp. In case of accidental contact, rub the bulb with a cloth dampened with alcohol and allow to dry.

- ❑ Before replacing a bulb check the contacts for oxidation.
- ❑ Replace blown bulbs with others of the same type and power.
- ❑ After replacing a headlight bulb, always check its alignment.
- ❑ To replace the bulb, contact your authorized dealer.
- ❑ When a light is not working, check that the corresponding fuse is intact before replacing the bulb. For the location of fuses, refer to the section on “Replacing Fuses” in this chapter.



Caution!

Use the protective cover and carton for the replacement bulb to dispose of the old bulb promptly and out of the reach of children.

Note:

- ❑ When removing the lens or light unit using a flathead screwdriver, make sure that the flathead screwdriver does not contact the interior terminal. If the flathead screwdriver contacts the terminal, a short circuit may occur.
- ❑ When the weather is cold or damp or after heavy rain or washing, the surface of headlights or rear lights may steam up and/or form drops of condensation on the inside. This is a natural phenomenon due to the difference in temperature and humidity between the inside and the outside of the glass which does not indicate a fault and does not compromise the normal operation of lighting devices. The mist disappears quickly when the lights are turned on, starting from the center of the diffuser, extending progressively towards the edges.



Replacement Bulbs

Light Bulbs	Type	Power
Front Position	LED	–
Front Side-Maker Lights (If Equipped With Full-LED Headlights)	W5W	5 W
Front Positions/Side-Maker Lights (If Equipped With Halogen Headlights)	WY5W	5 W
High Beam (If Equipped With Full-LED Headlights)	LED	–
High Beam/Daytime Running Lights (DRL) (If Equipped With Halogen Headlights)	HB3	60 W
Daytime Running Lights (DRL) (If Equipped With Full-LED Headlights)	LED	–
Low Beam (If Equipped With Full-LED Headlights)	LED	–
Low Beam (If Equipped With Halogen Headlights)	H11	55 W
Front Direction Indicator Light	WY21W	21 W
Side Direction Indicator Light	WY5W	5 W
Fog Light	H11	55 W
Rear Position Lights	LED	–
Stop Lights	LED	–
Center High Mount Stop Lamp (CHMSL)	LED	–
Rear Direction Indicator Light	WY21W	21 W
Rear Side Marker	W5W	5 W
Reverse Light	W21W	21 W
License Plate Light	W5W	5 W
Overhead Light		10 W
Trunk Lid Light		5 W

Replacing Exterior Lights

Headlights (low beam) (If Equipped with halogen bulb)

Proceed as follows:

1. If you are changing the right bulb, start the engine, turn the steering wheel all the way to the right, and turn off engine. If you are changing the left bulb, turn the steering wheel to the left.
2. Make sure the ignition is placed in the OFF mode, and the headlight switch is off.
3. Remove the fasteners in the seven locations and partially peel back the mud guard.

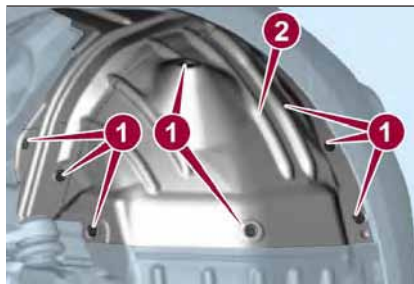

08020499000002

Mud Guard

- 1 — Fasteners
- 2 — Mud Guard

4. Turn the cover counterclockwise and remove it, disconnect the connector from the unit by pressing the tab on the connector with your finger and pulling the connector.
5. Turn the socket and bulb assembly counterclockwise and remove it.
6. Disconnect the bulb from the socket.
7. Install the new bulb in the reverse order of the removal procedure.

Headlights (High Beam) With Daytime Running Lights (If Equipped With LED Lamps)

Proceed as follows:

1. If you are changing the right bulb, start the engine, turn the steering wheel all the way to the right, and turn off engine. If you are changing the left bulb, turn the steering wheel to the left.
2. Make sure the ignition is placed in the OFF mode, and the headlight switch is off.
3. Remove the fasteners in the seven locations and partially peel back the mud guard.
4. Turn the socket and bulb assembly counterclockwise and remove it.
5. Turn the cover counterclockwise and remove it, disconnect the connector from the unit by pressing the tab on the connector with your finger and pulling the connector.



6. Turn the socket and bulb assembly counterclockwise and remove it.
7. Disconnect the bulb from the socket.
8. Install the new bulb in the reverse order of the removal procedure.

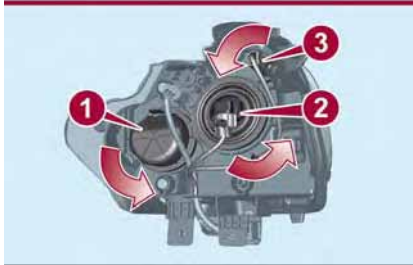
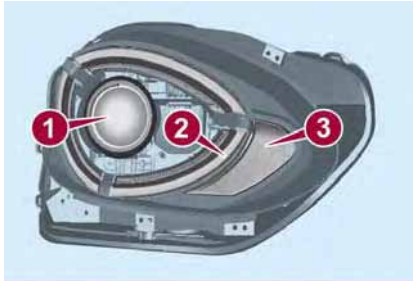

08020499000010

Head Lamp Assembly

- 1 — High Beam Lamp
- 2 — Position Lamp
- 3 — Daytime Running Lamp

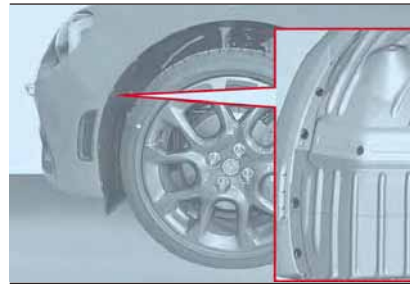

07031501-206-002AB

Mud Guard

Front Direction Indicator Lights

Proceed as follows:

1. If you are changing the right bulb, start the engine, turn the steering wheel all the way to the right, and turn off engine. If you are changing the left bulb, turn the steering wheel to the left.
2. Make sure the ignition is placed in the OFF mode, and the headlight switch is off.
3. Remove the fasteners in the five locations and partially peel back the mud guard.
4. Disconnect the connector from the unit by pressing the tab on the connector with your finger and pulling the connector rearward.

5. Turn the socket and bulb assembly counterclockwise and remove it.



07031501-207-001

Front Direction Indicator Housing

- 1 — Socket Assembly
- 2 — Bulb

6. Disconnect the bulb from the socket.



07031501-208-002AB

Direction Indicator Lamp Connector

7. Install the new bulb in the reverse order of the removal procedure.

Fog Lights

Proceed as follows:

1. If you are changing the right bulb, start the engine, turn the steering wheel all the way to the right, and turn off engine. If you are changing the left bulb, turn the steering wheel to the left.
2. Make sure the ignition is switched off, and the headlight switch is off.
3. Remove the fasteners in the five locations and partially peel back the mud guard.
4. Disconnect the connector from the unit by pressing the tab on the connector with your finger and pulling the connector.
5. Turn the socket and bulb assembly counterclockwise, extract the bulb and remove it.
6. Disconnect the bulb from the socket.
7. Install the new bulb in the reverse order of the removal procedure.

Brake lights / Tail lights

Go to your authorized dealer when the replacement of this lights is necessary.

Side Direction Indicator Lights

Proceed as follows:

1. Make sure the ignition is placed in the OFF mode, and the headlight switch is off.
2. If you are changing the right bulb, start the engine, turn the steering wheel all the way to the right, and turn off engine. If you are changing the left bulb, turn the steering wheel to the left.
3. Remove the fasteners in the five locations and partially peel back the mud guard.
4. Disconnect the electrical connector from the bulb by pressing the tab on the connector with your finger and pulling the connector.
5. Remove the lens assembly by pressing the tab on the unit with your finger and pulling the unit forward to compress in the internal catch, then pull the cluster outwards.
6. Lift up the lens assembly, and then remove the cluster and install the new side direction indicator lens assembly in the reverse order of the removal procedure.



08020499-000-011AB

Side Direction Indicator

1 — Fasteners

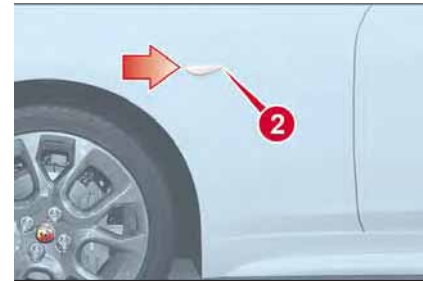

07031501-210-001AB

Side Direction Indicator

2 — Lens Assembly



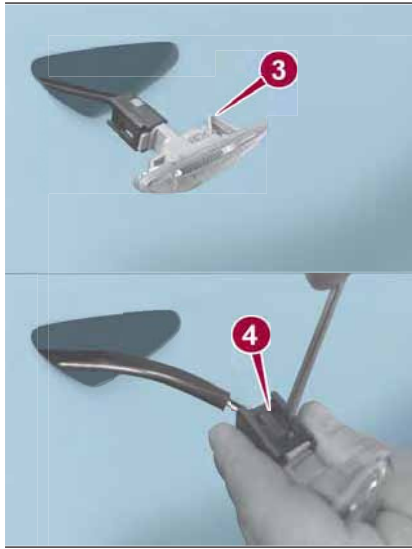

07031501211001

Side Direction Indicator

- 3 — Internal Catch
- 4 — Lens Assembly

Front Side Marker (If Equipped With Halogen Bulb)

Proceed as follows:

1. Remove the fasteners in the seven locations and partially peel back the upper side of the mud guard.

2. Turn the socket counterclockwise, remove socket assembly then remove the bulb.

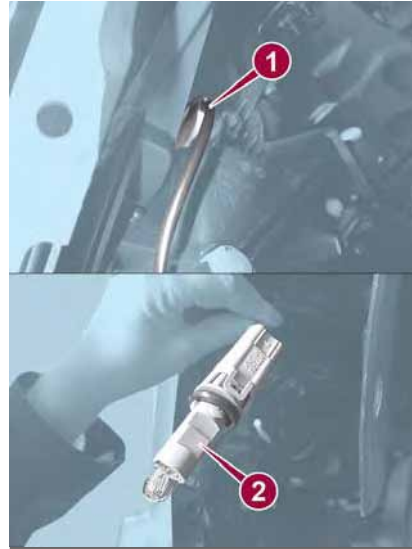

08070604-123-100

Front Side Marker

- 1 — Socket
- 2 — Bulb Assembly

3. Install the new bulb in the reverse order of the removal procedure.

Rear Direction Indicator Lights

Proceed as follows:

1. Remove the retainers and the trunk lid end trim.

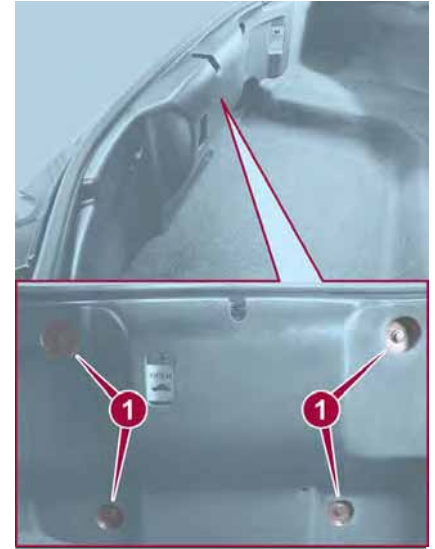

07031501-212-002

Trunk Trim

- 1 — Retainers



07031501214002

Trunk Trim

2 — Connector

2. Disconnect the connector from the unit by pressing the tab on the connector with your finger.



07031501213002

Rear Direction Indicator Socket

3 — Connector

3. Remove the screw and nuts.

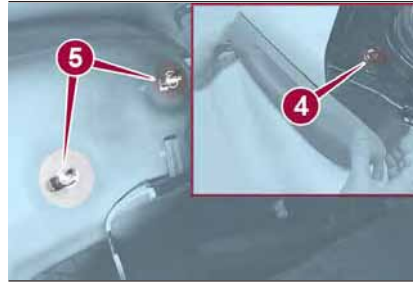

07031501-215-001

Taillight Housing Fasteners

4 — Screw
5 — Nuts

4. Pull the taillight housing rearward to remove it.



07031501-216-001AB

Rear of Vehicle

6 — Taillight Housing

5. Turn the socket and bulb assembly counterclockwise to remove from taillight housing, and remove bulb.



07031501-203-002

Taillight Housing

7 — Socket and Bulb Assembly

6. Install the new bulb in the reverse order of the removal procedure.



Reverse Light

Proceed as follows:

1. Make sure the ignition is placed in the OFF mode, and the headlight switch is off.
2. Turn the socket assembly counterclockwise to remove, and remove bulb.

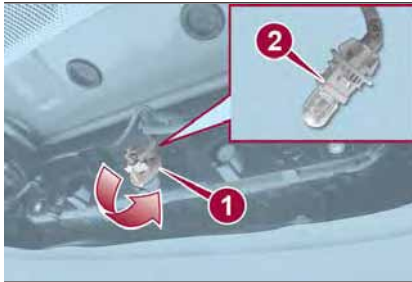

07031501-219-001

Reverse Light

- 1 — Socket Assembly
- 2 — Bulb

3. Install the new bulb in the reverse order of the removal procedure.

Rear Side Marker

Proceed as follows:

1. Push the lens assembly rearward to compress the internal catch, then pull the lens assembly outwards.



08070605AB

Rear Side Marker

- 1 — Rear Side Marker Lens Assembly

2. Turn the socket and bulb assembly counterclockwise to remove, and remove bulb.



08070606-123-100

Side Marker Housing

- 2 — Socket and Bulb Assembly

3. Install the new bulb and then reinstall the socket in the reverse order of the removal procedure.

License Plate Lights

Proceed as follows:

1. Make sure the ignition is placed in the OFF mode, and the headlight switch is off.
2. Slide the unit as shown in the figure to remove it.

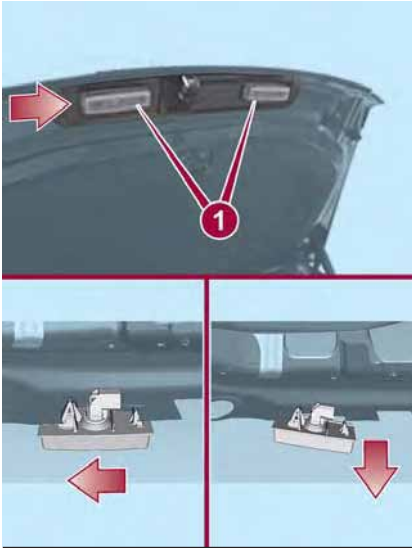

07031501220001

Trunk Lid

- 1 — License Plate Light Assembly

3. Turn the socket and bulb assembly counterclockwise and remove, remove bulb.

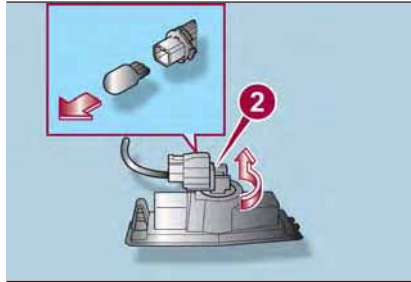

07031501-221-001

License Plate Light Housing

- 2 — Socket and Bulb Assembly

4. Install the new bulb in the reverse order of the removal procedure. Insert catch and push the housing back into place.

REPLACING FUSES

General Information



Warning!

❑ When replacing a blown fuse, always use an appropriate replacement fuse with the same amp rating as the original fuse. Never replace a fuse with another fuse of higher amp rating. Never replace a blown fuse with metal wires or any other material. Failure to use proper fuses may result in serious personal injury, fire and/or property damage.

❑ Before replacing a fuse, make sure that the ignition is off and that all the other services are switched off and/or disengaged.

❑ If the replaced fuse blows again, contact an authorized dealer.

❑ If a general protection fuse for safety systems (air bag system, braking system), power unit systems (engine system, transmission system) or steering system blows, contact an authorized dealer.



Your vehicle's electrical system is protected by fuses.

If any lights, accessories, or controls do not work, inspect the appropriate circuit protector. If a fuse has blown, the inside element will be melted. If the same fuse blows again, go to an authorized dealer as soon as possible.

Fuse location

Fuses are grouped together in two fuse boxes located in the interior on the left side of the vehicle and under the hood.

Interior Fuses

If the electrical system does not work, first inspect the fuses on the vehicle's left side.

Proceed as follows:

1. Make sure the ignition is placed in the OFF mode, and other switches are turned off.
2. Open the fuse panel cover (located near the door).

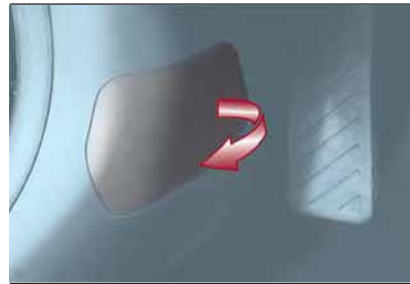

07031601-121-001

Fuse Panel Cover

3. Press retaining clip and remove protection cover.
4. Pull the fuse straight out with the fuse puller provided on the fuse block located in the engine compartment.

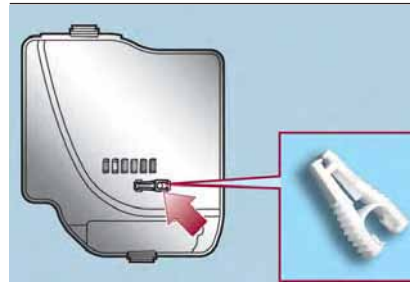

07031601-122-001

Fuse Puller

5. Inspect the fuse and replace it if it is blown.

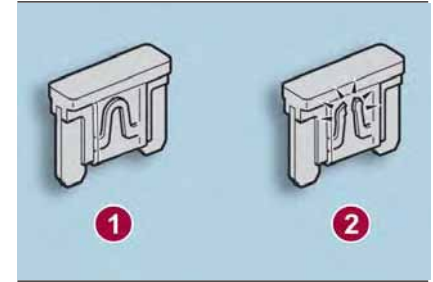

07031601-ALL-001

Fuses

- 1 — Normal Fuse
2 — Blown Fuse

6. Insert a new fuse of the same amperage rating, and make sure it fits tightly. If it does not fit tightly, contact your authorized dealer. If you have no spare fuses, borrow one of the same rating from a circuit not essential to vehicle operation, such as the audio or outlet circuit.

7. Reinstall the cover and make sure that it is securely installed.

Note:

Always replace a fuse with a genuine FCA fuse or equivalent of the same rating. Otherwise you may damage the electric system.

Underhood Fuses

If the headlights or other electrical components do not work and the fuses in the cabin are normal, inspect the fuse block in the engine compartment. If a fuse is blown, it must be replaced.

Make sure the ignition is placed in the OFF mode, and other switches are turned off and remove the fuse block cover. If the lock is forcefully opened, the fuse block cover may come in contact with the frame when it is removed and become scratched.

When removing the cover, remove it slowly according to the following procedure:

1. Disengage the rear lock by pressing down on the front tab with your fingers.

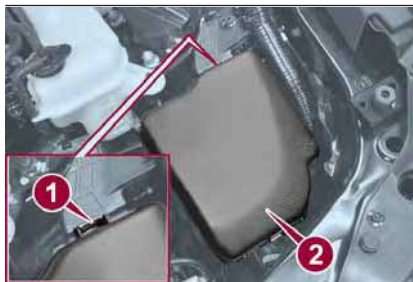

07031601-123-001

Underhood Fuse Block

- 1 — Lock
- 2 — Cover

2. Remove the front tab while slightly lifting the front of the cover.
3. Remove the cover while lifting it and sliding it to the rear.

4. If any fuse but the main fuse is blown, replace it with a new one of the same amperage rating.

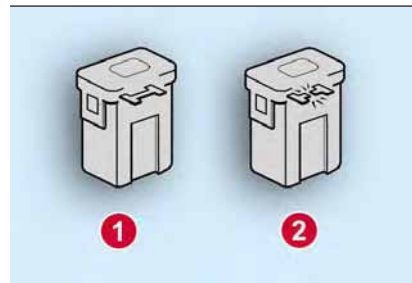

07031601-ALL-002AB

Fuse

- 1 — Normal Fuse
- 2 — Blown Fuse

5. Reinstall the cover and make sure that it is securely installed.



Fuse Block (Engine Compartment)

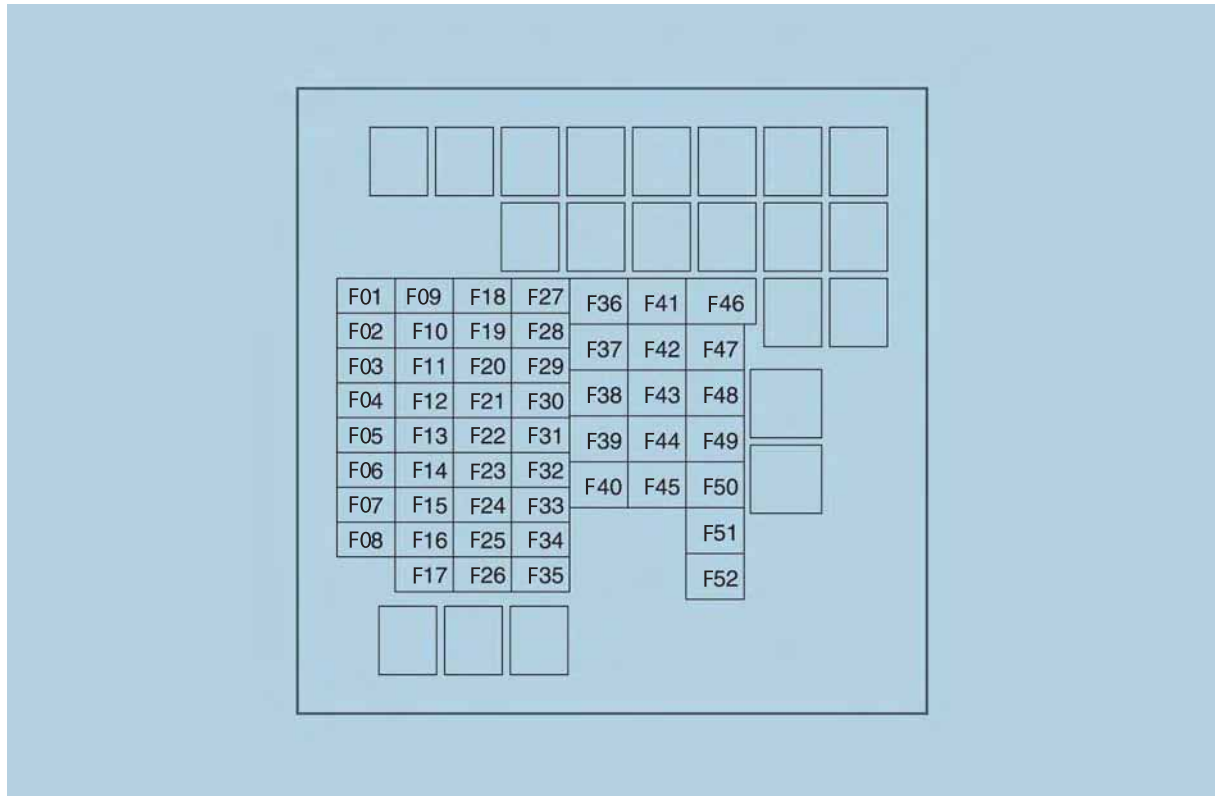

DESCRIPTION		FUSE RATING	PROTECTED COMPONENT
F01	ENG IG3	5 A	Engine Control Systems
F02	ENG IG2	5 A	Engine Control Systems
F03	HORN2	7.5 A	Horn
F04	C/U IG1	15 A	For Protection Of Various Circuits
F05	ENG IG1	7.5 A	Engine Control System
F06	—	—	—
F07	INTERIOR	15 A	Overhead Light
F08	—	—	—
F09	AUDIO2	15 A	Audio System
F10	METER1	10 A	Instrument Cluster
F11	SRS1	7.5 A	Air Bag
F12	—	—	—
F13	RADIO	7.5 A	Audio System
F14	ENGINE3	20 A	Engine Control System
F15	ENGINE1	10 A	Engine Control System
F16	ENGINE2	15 A	Engine Control System
F17	AUDIO1	25 A	Audio System
F18	A/C MAG	7.5 A	Air Conditioner
F19	AT PUMP H/L HI	20 A	Transmission Control System (If Equipped)
F20	AT	15 A	Transmission Control System (If Equipped)
F21	D LOCK	25 A	Power Door Locks



DESCRIPTION		FUSE RATING	PROTECTED COMPONENT
F22	H/L RH	20 A	Headlight (RH)
F23	ENG + B2	7.5 A	Engine Control System
F24	TAIL	20 A	Taillights/Number Plate Lights/Position Lights
F25	—	—	—
F26	ROOM	25 A	Overhead Light
F27	FOG	15 A	Fog Lights
F28	H/CLEAN	20 A	Headlight Washer (If Equipped)
F29	STOP	10 A	Stop Lights/Rear Fog Light (If Equipped)
F30	HORN	15 A	Horn
F31	H/L LH	20 A	Headlight (LH)
F32	ABS/DSC S	30 A	ABS/DSC System
F33	HAZARD	15 A	Hazard Warning Flashers/Direction Indicators Lights
F34	FUEL PUMP	15 A	Fuel System
F35	ENG + B3	5 A	Engine Control System
F36	WIPER	20 A	Windshield Wipers
F37	CABIN + B	50 A	For Protection Of Various Circuits
F38	—	—	—
F39	—	—	—
F40	ABS/DSC M	50 A	ABS/DSC System
F41	EWVT A/R PUMP	20 A	Engine Control System
F42	—	—	—

DESCRIPTION	FUSE RATING	PROTECTED COMPONENT
F43	—	—
F44	FAN2	Cooling Fan
F45	ENG.MAIN	Engine Control System
F46	EPS	Power Steering System
F47	DEFOG	Rear Window Defogger
F48	IG2	For Protection Of Various Circuits
F49	—	—
F50	HEATER	Air Conditioner
F51	—	—
F52	—	—



Fuse Block Interior

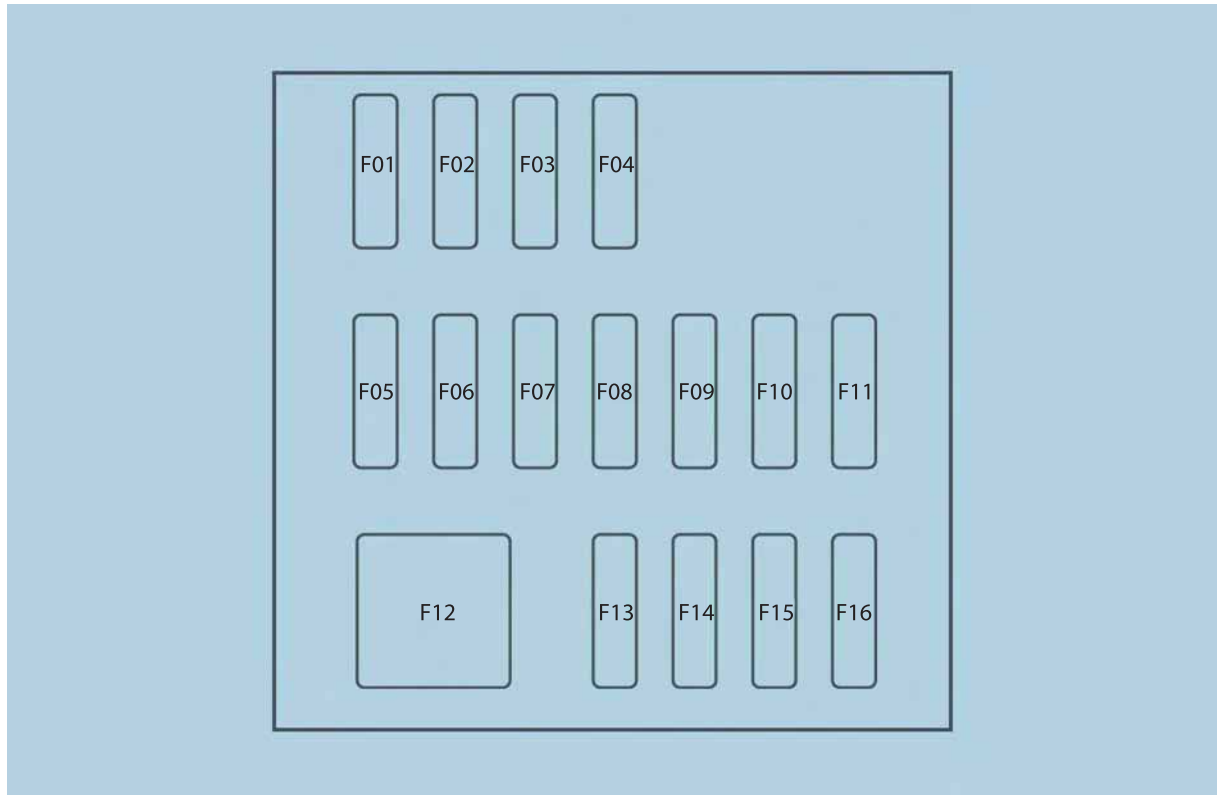

DESCRIPTION		FUSE RATING	PROTECTED COMPONENT
F01	RHT R	30 A	—
F02	RHT L	30 A	—
F03	—	—	—
F04	—	—	—
F05	F.OUTLET	15 A	Accessory Sockets
F06	—	—	—
F07	AT IND	7.5 A	AT Shift Indicator — If Equipped
F08	MIRROR	7.5 A	Power Control Mirror
F09	R_DECK R	30 A	—
F10	R_DECK L	30 A	—
F11	F.WASHER	15 A	Windshield Washer
F12	P.WINDOW	30 A	Power Windows
F13	—	—	—
F14	SRS2/ESCL	15 A	—
F15	—	—	—
F16	—	—	—



JACKING AND TIRE CHANGING



Warning!

- ❑ Do not attempt to change a tire on the side of the vehicle close to moving traffic. Pull far enough off the road to avoid the danger of being hit when operating the jack or changing the wheel.
- ❑ Being under a jacked-up vehicle is dangerous. The vehicle could slip off the jack and fall on you. You could be crushed. Never put any part of your body under a vehicle that is on a jack. If you need to get under a raised vehicle, take it to a service center where it can be raised on a lift.
- ❑ The jack is designed to be used as a tool for changing tires only. The jack should not be used to lift the vehicle for service purposes. The vehicle should be jacked on a firm level surface only. Avoid ice or slippery areas.

Tools Location

Your vehicle may be equipped with a spare tire, jack, lug wrench and tow eyes. For details, contact your authorized dealer.

Tools are stored in the trunk.

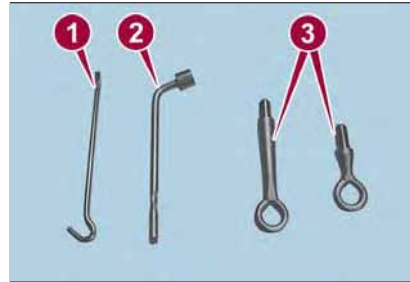

08020100-122-002

Jack Tools

- 1 — Jack Lever
- 2 — Lug Wrench (If Equipped)
- 3 — Tow Eyes (If Equipped)

Preparations For Jacking

To Remove The Jack

Proceed as follows:

1. In the right side of the trunk, pull the cover tab to remove cover.



08020101-124-001

Jack Location

- 1 — Cover Tab
- 2 — Jack And Tools Cover

2. Turn the wing bolt and jack screw counterclockwise.

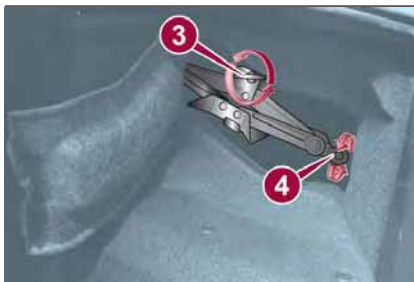

08020101-122-001

Jack Components

- 3 — Wing Bolt
- 4 — Jack Screw

To Secure The Jack

Proceed as follows:

1. Insert the wing bolt into the jack with the jack screw pointing back, and turn the wing bolt clockwise to temporarily tighten it.
2. Turn the jack screw clockwise.
3. Turn the wing bolt completely to secure the jack.
4. Insert the cover tabs and install the cover.



Warning!

A loose tire or jack thrown forward in a collision or hard stop could endanger the occupants of the vehicle. Always stow the jack parts and the spare tire in the places provided. Have the deflated (flat) tire repaired or replaced immediately.

Maintenance

- Always keep the jack clean.
- Make sure the moving parts are kept free from dirt or rust.
- Make sure the screw thread is adequately lubricated.

Conditions Of Non-Use

- Temperatures below -40°F (-40°C)
- On sandy or muddy ground
- On uneven ground
- On steep roads
- In extreme weather conditions
- In direct contact with the engine or for repairs under the vehicle
- On boats

Jacking Instructions

Note:

Make sure the jack is well lubricated before using it.



Warning!

Do not attempt to change a tire on the side of the vehicle close to moving traffic, pull far enough off the road to avoid being hit when operating the jack or changing the wheel.

Proceed as follows:

1. Stop the vehicle in a position that does not cause any danger to traffic and lets you change the tire in safety, as far as possible from the edge of the driving lane. The ground must be flat and sufficiently compact.
2. Turn on the Hazard Warning Lights and engage the parking brake.
3. For vehicles with automatic transmission, place the gear selector in PARK. For vehicles with manual transmission, place gear selector in REVERSE and cycle the engine to OFF.



4. Stop the engine. The motor must be kept off as long as the vehicle is lifted off the ground.
5. Remove the jack and tools.
6. Block both the front and rear of the wheel diagonally opposite of the jacking position. For example, if changing the right front tire, block the left rear wheel.



08020300-121-001

Blocking Right Front Tire And Left Rear Tire

Removing A Tire



Warning!

Carefully follow these tire changing warnings to help prevent personal injury or damage to your vehicle:

- Always park on a firm, level surface as far from the edge of the roadway as possible before raising the vehicle.
- Turn on the Hazard Warning flasher.
- Block the wheel diagonally opposite the wheel to be raised.
- Set the parking brake firmly and set the transmission in PARK.
- Do not let any passenger sit in the vehicle when it is on a jack.
- Do not get under the vehicle when it is on a jack. If you need to get under a raised vehicle, take it to a service center where it can be raised on a lift.
- Only use the jack in the positions indicated and for lifting this vehicle during a tire change.
- If working on or near a roadway, be extremely careful of motor traffic.

Proceed as follows:

1. Loosen the lug nuts by turning them counterclockwise one turn each, but do not remove any lug nuts until the tire has been raised off the ground.



08020301-123-001

Loosen Lug Nuts Counterclockwise

2. Place the jack under the lift point closest to the tire being changed with the jack head squarely under the jacking location.
3. Turn the jack screw in the direction shown and adjust the jack head so that it is close to the jacking location.

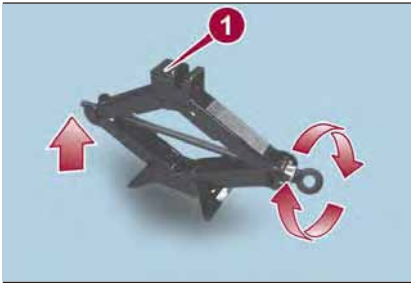

08020301-ALL-003

Raising The Jack

1 — Jack Head

4. Continue raising the jack head gradually by rotating the screw with your hand until the jack head is inserted into the lift point.



Caution!

Do not attempt to raise the vehicle by jacking on locations other than those indicated in the Jacking Instructions for this vehicle.



08020301-121-001

Front Jacking Location

5. Insert the jack lever and attach the lug wrench to tire jack.



08020301-ALL-006

Jack With Lug Wrench Attached



Warning!

Being under a jacked-up vehicle is dangerous. The vehicle could slip off the jack and fall on you. You could be crushed. Never get any part of your body under a vehicle that is on a jack. If you need to get under a raised vehicle, take it to a service center where it can be raised on a lift.

6. Turn the jack handle clockwise and raise the vehicle high enough so that the tire is just raised off the ground and can be removed. Before removing the lug nuts, make sure your vehicle is firmly in position and that it cannot slip or move.



Warning!

Raising the vehicle higher than necessary can make the vehicle less stable. It could slip off the jack and hurt someone near it. Raise the vehicle only enough to remove the tire.

7. Remove the lug nuts by turning them counterclockwise, then remove the wheel.



Mounting The Tire

Proceed as follows:

1. Remove dirt and grime from the mounting surfaces of the wheel and hub, including the hub bolts, with a cloth.

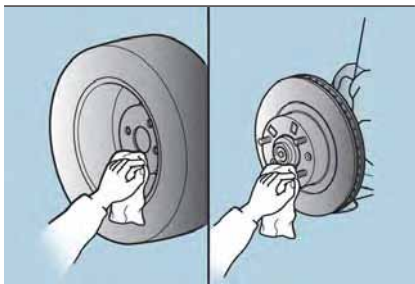

08020303-XX4-001

Clean Mounting Surface

2. Mount the tire and install the lug nuts with the beveled edge inward, then tighten them by hand.



Caution!

Be sure to mount the spare tire with the valve stem facing outward. The vehicle could be damaged if the spare tire is mounted incorrectly.

3. Turn the lug wrench counterclockwise and lower the vehicle. Use the lug wrench to tighten the nuts in the order shown.

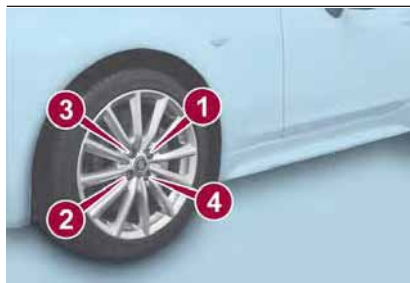

08020303-122-001

Lug Nut Tightening Order



Warning!

To avoid the risk of forcing the vehicle off the jack, do not tighten the wheel nuts fully until the vehicle has been lowered. Failure to follow this warning may result in serious injury.

4. After tightening the lug nuts, have them checked with a torque wrench by your authorized dealer or service station to verify correct tightness.

5. Remove the tire blocks and store the tools and jack.

6. Check the inflation pressure. Refer to “Recommended Tire Inflation Pressure” in “Technical Specifications” for more information.

With TPMS

Do not push the tire pressure monitoring system set switch after installing the spare tire. The switch is only to be pushed after installing the repaired flat tire or installing a replacement tire.

Note:

To prevent the jack and tool from rattling, store them properly.



Warning!

A loose tire or jack thrown forward in a collision or hard stop could endanger the occupants of the vehicle. Always stow the jack parts and the spare tire in the places provided. Have the deflated (flat) tire repaired or replaced immediately.

TIRE SERVICE KIT

Tire Service Storage

The Tire Service Kit is located inside the trunk.

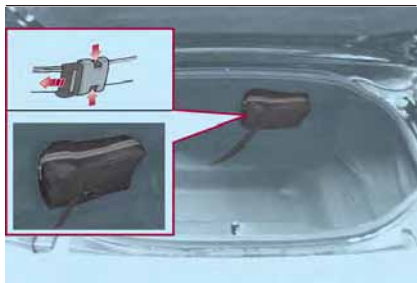

08020202-121-003

Tire Service Kit Location

Note:

Your vehicle is not equipped with a spare tire. In the event of a flat tire, use the Tire Service Kit to repair the tire temporarily. When doing the repair, refer to the instructions included in the Tire Service Kit. If an emergency repair was performed on a flat tire using the Tire Service Kit, contact your authorized dealer to repair or replace the tire as soon as possible.

Tire Service Usage Precautions

The tire sealant cannot be reused. If the sealant has been used, or is expired, purchase new tire sealant at your authorized dealer.

Note:

The Tire Service Kit cannot be used in the following cases. Consult your authorized dealer if any of these conditions exist:

- The period of effective use for the tire sealant has expired (the period of effectiveness is indicated on the bottle label)
- The tear or puncture in the tire exceeds about 0.16 inches (4 mm)
- The damage has occurred to an area of the tire other than the tread
- The vehicle has been driven with nearly no air remaining in the tire
- The tire has come off the wheel rim
- Damage to the wheel rim has occurred
- The tire has two or more punctures

Sealing A Tire With Tire Service Kit



Warning!

- Do not attempt to seal a tire on the side of the vehicle closest to traffic. Pull far enough off the road to avoid the danger of being hit when using the Tire Service Kit.
- Do not use Tire Service Kit or drive the vehicle under the following circumstances:
 - If the puncture in the tire tread is approximately 1/4 inch (6 mm) or larger.
 - If the tire has any sidewall damage.
 - If the tire has any damage from driving with extremely low tire pressure.
 - If the tire has any damage from driving on a flat tire.
 - If the wheel has any damage.
 - If you are unsure of the condition of the tire or the wheel.
- Keep Tire Service Kit away from open flames or heat sources.
- A loose Tire Service Kit thrown forward in a collision or hard stop could endanger the occupants of the vehicle. Always stow the Tire Service Kit in the place provided. Failure to follow these warnings can result in injuries that are serious or fatal to you, your passengers, and others around you.



❑ Take care not to allow the contents of Tire Service Kit to come in contact with hair, eyes, or clothing. Tire Service Kit sealant is harmful if inhaled, swallowed, or absorbed through the skin. It causes skin, eye, and respiratory irritation. Flush immediately with plenty of water if there is any contact with eyes or skin. Change clothing as soon as possible, if there is any contact with clothing.

❑ Tire Service Kit Sealant solution contains latex. In case of an allergic reaction or rash, consult a physician immediately. Keep Tire Service Kit out of reach of children. If swallowed, rinse mouth immediately with plenty of water and drink plenty of water. Do not induce vomiting! Consult a physician immediately.

U.S.A. And CANADA Markets:

Proceed as follows:

1. Pull over to a safe location and turn on the vehicle's Hazard Warning Lights.
2. Verify that the valve stem (on the wheel with the deflated tire) is in a position that is near to the ground. This will allow the Tire Service Kit hoses to reach the valve stem and keep the Tire Service Kit flat on the ground. This will provide the best positioning of the kit when injecting the sealant into the deflated tire and running the air pump.

Move the vehicle as necessary to place the valve stem in this position before proceeding.

3. Place the gear selector in REVERSE for a manual transmission, and PARK for automatic transmission.
4. Apply the parking brake with the brake pedal pressed and cycle the engine OFF.
5. Unload passengers and cargo, then remove the Tire Service Kit.

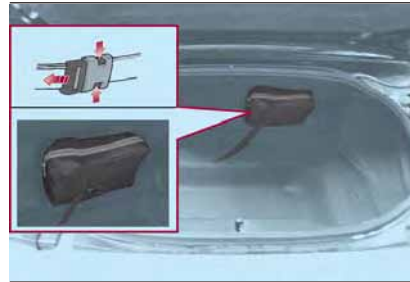

08020202-121-003

Tire Service Kit Location

6. Gently shake the sealant bottle to mix the contents. Then extend the injection hose.



08020202-03A-666

Sealant Bottle With Injection Hose

1 — Injection Hose

Note:

- ❑ Do not shake the bottle excessively. Otherwise, the sealant could spray out of the injection hose. If the sealant contacts clothing or other objects, you may not be able to remove it.
- ❑ The sealant hardens easily, and injecting it will be difficult under cold weather conditions (32 °F (0 °C) or below). Warm the sealant inside the vehicle to facilitate injection.

7. Pull out the air compressor hose and the air compressor plug from the air compressor.

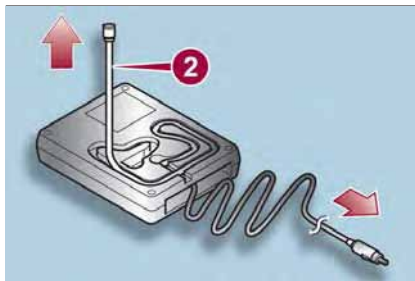

08020202-36A-004

Air Compressor With Hose And Plug

2 — Air Compressor Hose

8. Install the air compressor hose, which was pulled out of the air compressor, into the injection valve of the bottle.

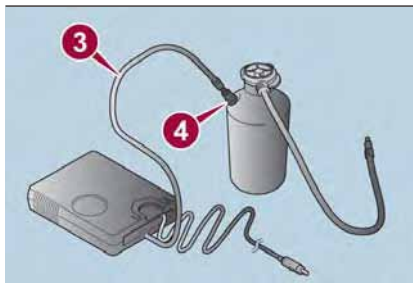

08020202-031-670

Install Air Compressor To Sealant Bottle

3 — Air Compressor Hose
4 — Injection Valve

Note: Make sure that the air compressor switch is off before inserting the air compressor hose into the injection valve of the bottle. If the air compressor hose is not installed to the injection valve of the bottle securely, the sealant may leak.

9. Remove the valve cap from the valve of the flat tire, install the injection hose to the tire valve, and turn the sleeve to the right to tighten.

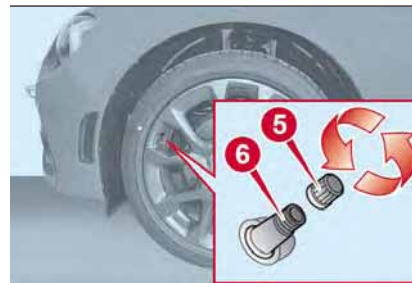

08020202-03A-004AB

Valve And Valve Cover

5 — Valve Cap
6 — Valve

10. Install the bottle to the air compressor and push it in until the left and right tabs are engaged securely.

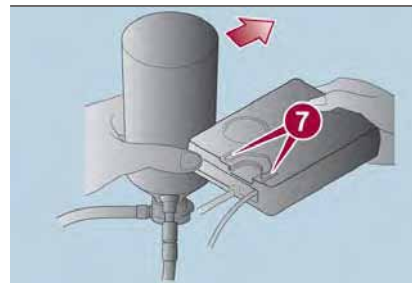

08020202-031-669

Sealant Bottle Into Air Compressor

7 — Air Compressor Tabs



11. Insert the air compressor plug into the accessory socket inside the vehicle and cycle the ignition to ACC.

Note: When inserting the air compressor plug into or removing it from the accessory socket, make sure that the air compressor switch is off. When turning the air compressor on/off, use the air compressor switch. Before checking the tire inflation pressure using the tire pressure gauge, turn the air compressor switch off.

12. The sealant is injected into the tire when the air compressor is switched on. After the sealant is injected completely, wait until the tire inflation pressure increases to the specified tire inflation pressure. For the correct pressure, check the tire inflation pressure label on the driver's door frame.

Note: The inflation pressure may increase to about 43.5 psi (3 Bar) temporarily to inject the sealant through the valve. Normally, the inflation pressure decreases gradually and it reaches the actual inflation pressure after about 30 seconds.



Warning!

Never use the air compressor above 3 Bar (43.5 psi). Using the air compressor at an inflation pressure above 3 Bar (43.5 psi) continuously is dangerous. If the air compressor overheats, hot air will be exhausted and you could get burned.



Caution!

If the tire inflation pressure does not increase, repair of the tire is not possible. If the tire does not reach the specified tire inflation pressure within 10 minutes, it may have received extensive damage. In this case, the repair using the tire service kit was not successful.

Do not operate the air compressor for a continuous 10 minutes or longer because using it for long periods could cause a malfunction.

13. Adhere the speed restriction sticker to an area where it can be viewed easily by the driver.



Warning!

Do not adhere the speed restriction sticker to the padded area on the steering wheel. Adhering the speed restriction sticker to the padded area on the steering wheel is dangerous because the air bag may not operate (deploy) normally resulting in serious injury. In addition, do not adhere the sticker to areas where warning lights or the speedometer cannot be viewed.

14. Adhere the repaired tire sticker to the wheel of the flat tire.

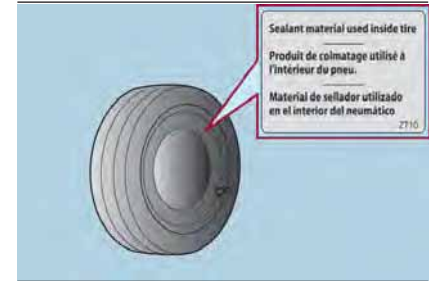

08020202-031-667

Repaired Tire Sticker

15. When the tire inflates to the specified tire inflation pressure, turn the air compressor switch off, turn the sleeve of the injection hose to the left, and pull it out of the tire valve.

16. Remove the air compressor hose from the injection valve of the bottle. Then, install the injection hose to the injection valve of the bottle to prevent leakage of any remaining sealant.

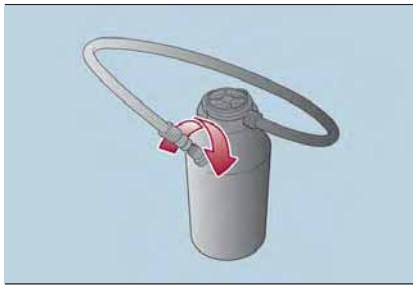

08020202-031-668

Install Injection Hose To Sealant Bottle

Note: The remaining sealant in the hose may spray out when the hose is removed. Remove the hose carefully because you may not be able to remove the sealant contacting clothing or other objects.

17. Install the tire valve cap.

18. Place the Tire Service Kit back into its storage location.

19. Start driving immediately to spread the sealant in the tire.

Note:

Carefully drive the vehicle at a speed of 50 mph (80 km/h) or less. If the vehicle is driven at a speed of 50 mph (80 km/h) or more, the vehicle may vibrate.

Note: With TPMS System: if the tire is not properly inflated, the (!) warning light will illuminate.

☐ After driving the vehicle for about 10 minutes or 3 miles (5 km), connect the air compressor to the tire using Step nine of the procedure, and check the tire inflation pressure using the tire pressure gauge on the air compressor. If the tire inflation pressure is lower than the specified tire inflation pressure, turn the air compressor on and wait until it reaches the specified tire inflation pressure.

☐ The Tire Service Kit is completed successfully if the tire inflation pressure does not decrease. Carefully drive the vehicle to the nearest authorized dealer immediately and have the flat tire replaced. Replacement with a new tire is recommended. If the tire is to be repaired or reused, consult your authorized dealer.

Note:

☐ If an emergency flat tire repair has been performed using the Tire Service Kit, FCA recommends that the tire be replaced with a new one as soon as possible. If the tire is to be repaired or reused, contact your authorized dealer.

☐ The wheel can be reused if the sealant adhering to it is removed. However, replace the valve with a new one.



Sealing A Tire With Tire Service Kit



Warning!

- ❑ Do not attempt to seal a tire on the side of the vehicle closest to traffic. Pull far enough off the road to avoid the danger of being hit when using the Tire Service Kit.
- ❑ Do not use Tire Service Kit or drive the vehicle under the following circumstances:
 - If the puncture in the tire tread is approximately 1/4 inch (6 mm) or larger.
 - If the tire has any sidewall damage.
 - If the tire has any damage from driving with extremely low tire pressure.
 - If the tire has any damage from driving on a flat tire.
 - If the wheel has any damage.
 - If you are unsure of the condition of the tire or the wheel.
- ❑ Keep Tire Service Kit away from open flames or heat sources.
- ❑ A loose Tire Service Kit thrown forward in a collision or hard stop could endanger the occupants of the vehicle. Always stow the Tire Service Kit in the place provided. Failure to follow these warnings can result in injuries that are serious or fatal to you, your passengers, and others around you.

❑ Take care not to allow the contents of Tire Service Kit to come in contact with hair, eyes, or clothing. Tire Service Kit sealant is harmful if inhaled, swallowed, or absorbed through the skin. It causes skin, eye, and respiratory irritation. Flush immediately with plenty of water if there is any contact with eyes or skin. Change clothing as soon as possible, if there is any contact with clothing.

❑ Tire Service Kit Sealant solution contains latex. In case of an allergic reaction or rash, consult a physician immediately. Keep Tire Service Kit out of reach of children. If swallowed, rinse mouth immediately with plenty of water and drink plenty of water. Do not induce vomiting! Consult a physician immediately.

Mexico Market

Proceed as follows:

1. Pull over to a safe location and turn on the vehicle's Hazard Warning Lights.
2. Verify that the valve stem (on the wheel with the deflated tire) is in a position that is near to the ground. This will allow the Tire Service Kit hoses to reach the valve stem and keep the Tire Service Kit flat on the ground. This will provide the best positioning of the kit when injecting the sealant into the deflated tire and running the air pump.

Move the vehicle as necessary to place the valve stem in this position before proceeding.

3. Place the gear selector in REVERSE for a manual transmission, or PARK for automatic transmission.
4. Apply the parking brake with the brake pedal pressed and cycle the engine OFF.
5. Unload passengers and cargo, then remove the Tire Service Kit.
6. Gently shake the tire sealant. If the bottle is shaken after the injection hose is screwed on, tire sealant could spray out from the injection hose. Tire sealant contacting clothing or other objects may be impossible to remove. Shake the bottle before screwing on the injection hose.

Note:

- ❑ Do not shake the bottle excessively. Otherwise, the sealant could spray out of the injection hose, and if the sealant contacts clothing or other objects, you may not be able to remove it.
- ❑ The sealant hardens easily and injecting it will be difficult under cold weather conditions 32 °F (0 °C) or below. Warm the sealant inside the vehicle to facilitate injection.

7. Remove the cap from the bottle and screw on the injection hose with the bottle's inner cap left on to break the inner cap.



0802020203A003

Attaching Injection Hose To Sealant Bottle

8. Remove the valve cap from the flat tire. Push the back of a valve core tool to the core of the tire valve and bleed out all of the remaining air.

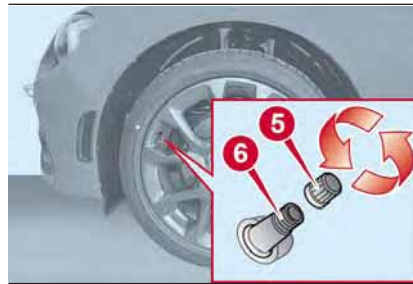

08020202-03A-004AB

Valve And Valve Cover

- 5 — Valve Cap
- 6 — Tire Valve

Note: If there is air remaining in the tire when the valve core is removed, the valve core could fly out. Remove the valve core carefully.

9. Turn the valve core counter clockwise with the valve core tool and remove the valve core.



08020202-03A-005AB

Turn Valve Core Counterclockwise

Note: Store the valve core in a place where it will not get dirty.

10. Insert the injection hose into the valve.

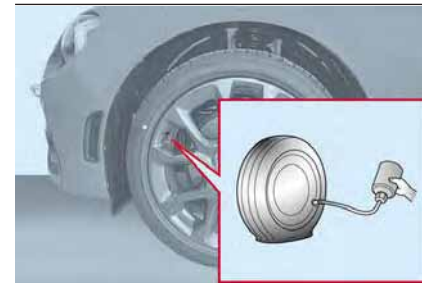

08020202-03A-008AB

Injection Hose Into Valve



11. Hold the bottom of the bottle upright, squeeze the bottle with your hands, and inject the entire amount of tire sealant into the tire.

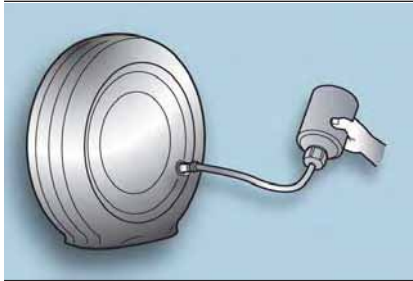

08020202-03A-008

Squeeze Sealant Into Tire

12. Pull out the injection hose from the valve.



08020202-03A-007AB

Turn Valve Core Clockwise To Reinstall

13. Reinsert the valve core into the valve and turn it clockwise to install.

Note:

- ❑ The tire sealant cannot be reused. If the tire sealant kit has been used, or is expired, purchase new one at your authorized dealer.
- ❑ Do not throw away the empty tire sealant bottle after use. Return the empty tire sealant bottle to your authorized dealer when replacing the tire. The empty tire sealant bottle will need to be used to extract and dispose of the used sealant from the tire.

14. Install the injection hose to the tab of the bottle to prevent leakage of any remaining sealant.

15. Adhere the speed restriction sticker to an area where it can be viewed easily by the driver.



Warning!

Do not adhere the speed restriction sticker to the padded area on the steering wheel. Adhering the speed restriction sticker to the padded area on the steering wheel is dangerous because the air bag may not operate (deploy) normally resulting in serious injury. In addition, do not adhere the sticker to areas where warning lights or the speedometer cannot be viewed.

16. Pull out the air compressor hose and the air compressor plug from the air compressor.

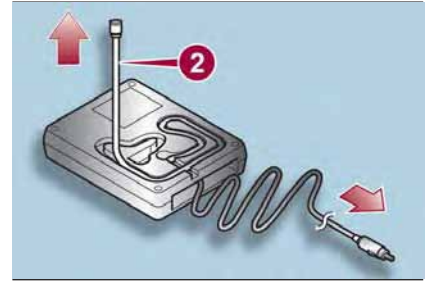

08020202-36A-004

Air Compressor With Hose And Plug

- 2 — Air Compressor Hose

17. Install the air compressor hose to the tire valve.



08020202-03A-008AB

Air Compressor Hose Into Valve

18. Insert the air compressor plug into the accessory socket inside the vehicle and cycle the ignition to ACC.

19. Turn the air compressor switch on and inflate the tire carefully to the correct inflation pressure. For the correct pressure, check the tire inflation pressure label on the driver's door frame.

Note: When inserting the air compressor plug into or removing it from the accessory socket, make sure that the air compressor switch is off. When turning the air compressor on/off, use the air compressor switch. Before checking the tire inflation pressure using the tire pressure gauge, turn the air compressor switch off.



Caution!

If the tire inflation pressure does not increase, repair of the tire is not possible. If the tire does not reach the specified tire inflation pressure within 10 minutes, it may have received extensive damage. In this case, the repair using the tire service kit was not successful.

Do not operate the air compressor for a continuous 10 minutes or longer because using it for long periods could cause a malfunction.

Note: If the tire has been over inflated, loosen the screw cap on the air compressor and bleed some of the air out.

20. When the tire inflates to the specified tire inflation pressure, turn the air compressor switch off, turn the sleeve of the air compressor hose to the left, and pull it out of the tire valve.

21. Install the tire valve cap.

22. Place the Tire Service Kit back into its storage location.

23. Start driving immediately to spread the sealant in the tire.

Note:

Carefully drive the vehicle at a speed of 50 mph (80 km/h) or less. If the vehicle is driven at a speed of 50 mph (80 km/h) or more, the vehicle may vibrate.

With TPMS System: if the tire is not properly inflated, the (!) warning light will illuminate.

After driving the vehicle for about 10 minutes or 3 miles (5 km), connect the air compressor to the tire using step nine of the procedure, and check the tire inflation pressure using the tire pressure gauge on the air compressor.

If the tire inflation pressure is lower than the specified tire inflation pressure, turn the air compressor on and wait until it reaches the specified tire inflation pressure;

The emergency flat tire repair is completed successfully if the tire inflation pressure does not decrease. Carefully drive the vehicle to the nearest authorized dealer and have the flat tire replaced. Replacement with a new tire is recommended. If the tire is to be repaired or reused, contact your authorized dealer.

If an emergency flat tire repair has been performed using the Tire Service Kit, FCA recommends that the tire be replaced with a new one as soon as possible. If the tire is to be repaired or reused, contact your authorized dealer.

The tire can be reused if the sealant adhering to it is removed. However, replace the valve with a new one.



JUMP STARTING

Preparations For Jump Starting

Jump starting is dangerous if done incorrectly, so follow the procedure in this section carefully. If you feel unsure about jump starting, it is strongly recommended that you have a competent service technician do the work.

Note:

When a booster battery is being used, comply with the utilization and precaution instructions specified by the manufacturer.

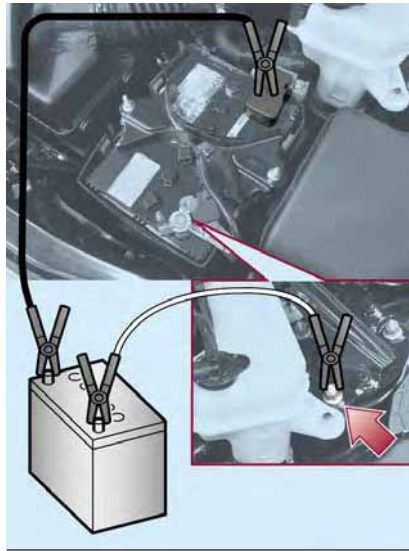

08030100121001

Jump Start Locations



Warning!

Do not attempt jump starting if the battery is frozen. It could rupture or explode and cause personal injury.



Caution!

Do not use a portable battery booster pack or any other booster source with a system voltage greater than 12 Volts or damage to the battery, starter motor, alternator or electrical system may occur.

Jump Starting Procedure



Warning!

Failure to follow this jump starting procedure could result in personal injury or property damage due to battery explosion.



Caution!

Failure to follow these procedures could result in damage to the charging system of the booster vehicle or the discharged vehicle.

To jump start the vehicle, follow this procedure:

1. Remove the positive terminal cover.



08030100-122-001

Positive Terminal Cover

2. Make sure the booster battery is 12 Volts and that the negative terminal is grounded.
3. Make sure the engine of the vehicle with the booster battery is OFF and all unnecessary electrical loads in both vehicles.



Warning!

Do not allow vehicles to touch each other as this could establish a ground connection and personal injury could result.

4. Connect the positive end of the jumper cable to the positive terminal on the discharged battery.

5. Connect the opposite end of the positive jumper cable to the positive terminal on the booster battery.

6. Connect the negative end of the negative jumper cable to the negative terminal of the booster battery.

7. Connect the opposite end of the negative jumper cable to a good engine ground of the vehicle with the discharged battery (exposed metal part of the engine) away from the battery and the fuel injection system.

8. Start the engine of the booster vehicle and run it a few minutes. Then start the engine of the other vehicle.

9. Once the engine is started, remove the jumper cables in the reverse sequence.

10. Replace the positive terminal cover. Make sure cover is secure.

IF YOUR ENGINE OVERHEATS

If Your Engine Overheats

In any of the following situations, you can reduce the potential for overheating by taking the appropriate action.

- On highways — slow down.
- In city traffic — while stopped, place the transmission in NEUTRAL, but do not increase engine idle speed.

Note: There are steps that you can take to slow down an impending overheating condition:

- If your air conditioner (A/C) is on, turn it off. The A/C system adds heat to the engine cooling system and turning the A/C off can help remove this heat.
- You can also turn the temperature control to maximum heat, the mode control to floor and the blower control to high. This allows the heater core to act as a supplement to the radiator and aids in removing heat from the engine cooling system.



**Warning!**

You or others can be badly burned by hot engine coolant (antifreeze) or steam from your radiator. If you see or hear steam coming from under the hood, do not open the hood until the radiator has had time to cool. Never try to open a cooling system pressure cap when the radiator or coolant bottle is hot.

**Caution!**

Driving with a hot cooling system could damage your vehicle. If temperature gauge reads "H", pull over and stop the vehicle. Idle the vehicle with the air conditioner turned off until the pointer drops back into the normal range. If the pointer remains on the "H", turn the engine off immediately, and call for service.

If Steam Is Coming From The Engine Compartment:

Do not go near the front of the vehicle. Stop the engine. Wait until the steam dissipates, then open the hood and start the engine.

If Neither Coolant Nor Steam Is Escaping:

Open the hood and idle the engine until it cools.

Note:

- If the cooling fan does not operate while the engine is running, the engine temperature will increase. Stop the engine and contact your authorized dealer.
- If the engine continues to overheat or frequently overheats, have the cooling system inspected. The engine could be seriously damaged unless repairs are made. Contact your authorized dealer.

TOWING THE VEHICLE**Attaching The Tow Eyes – If Equipped****Warning!**

Stand clear of vehicles when pulling with tow eyes.

- Do not use a chain with a tow eye. Chains may break, causing serious injury or death.
- Do not use a tow strap with a tow eye. Tow straps may break or become disengaged, causing serious injury or death.
- Failure to follow proper tow eye usage may cause components to break resulting in serious injury or death.

**Caution!**

- The tow eye must be used exclusively for roadside assistance operations. Only use the tow eye with an appropriate device in accordance with the highway code (a rigid bar or rope) to flat tow the vehicle for a short distance to the nearest service location.

❑ Tow eyes **MUST NOT** be used to tow vehicles off the road or where there are obstacles.

❑ In compliance with the above conditions, towing with a tow eye must take place with two vehicles (one towing, the other towed) aligned as much as possible along the same center line. Damage to your vehicle may occur if these guidelines are not followed.

❑ When towing, only use a facility that can tow vehicles with low ground clearances as extensive damage can result by using a standard tow truck platform.

Proceed as follows:

1. Remove the towing eyelet and the lug wrench from the luggage compartment.
2. Wrap a flathead screwdriver or similar tool with a soft cloth to prevent damage to a painted bumper, and open the cap located on the front or rear bumper.

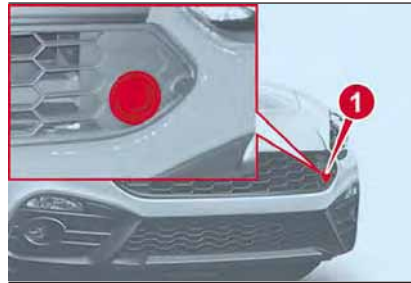

08060203-121-001AB

Front Bumper Cap Location

1 — Front Bumper Cap



08060203-122-001AB

Rear Bumper Cap Location

Note: Do not use excessive force as it may damage the cap or scratch the painted bumper surface. Remove the cap completely and store it so as not to lose it.

3. Securely install the tow eye in front or rear using the lug wrench or equivalent.

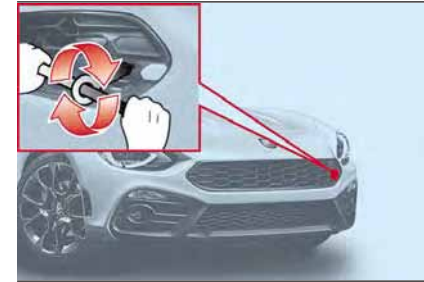

08060201-121-001AB

Installing Front Towing Eye

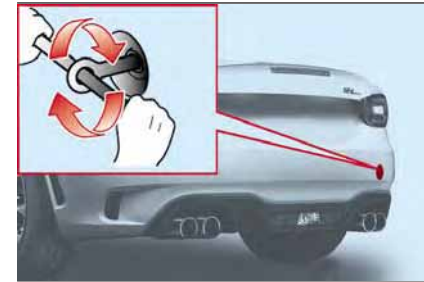

08060201-122-001AB

Installing Rear Tow Eye

4. Hook the towing rope to the tow eye.



**Caution!**

Tow eyes are for emergency use only, to rescue a vehicle stranded off road. Do not use tow eyes for tow truck hookup or highway towing. You could damage your vehicle.

When using the tow eyes, always pull the lead or chain in a straight direction with respect to the eyelet. Never apply a sideways force.

Note: Follow the precautions below to avoid damage to the towing eyelet and towing hook, vehicle body, or transmission system when towing:

- Do not tow a vehicle heavier than yours.
- Do not suddenly accelerate your vehicle as it will apply a severe shock to the tow eye and towing hook or rope.
- Do not attach any rope other than to the tow eye and towing hook.

Emergency Towing**Towing Description**

Proper lifting and towing are necessary to prevent damage to the vehicle. Government and local laws must be followed.

A towed vehicle usually should have its drive wheels (rear wheels) OFF of the ground. If excessive damage or other conditions prevent this, use wheel dollies.

When towing with the rear wheels on the ground, release the parking brake.

**Caution!**

DO NOT use sling-type equipment when towing. When securing the vehicle to a flatbed truck, do not attach to front or rear suspension components. Damage to your vehicle may result from improper towing.

If towing service is not available in an emergency, the vehicle may be towed with all four wheels on the ground using the towing hook at the front of the vehicle. Only tow the vehicle on paved surfaces for short distances at low speeds.

Follow these instructions when towing the vehicle with all wheels on the ground:

1. Shift to NEUTRAL for manual transmission or automatic transmission.
2. Place the ignition in ACC mode.
3. Release the parking brake.

Note:

Remember that power assist for the brakes and steering will not be available when the engine is not running.

EVENT DATA RECORDER (EDR)

This vehicle is equipped with an Event Data Recorder (EDR). The main purpose of an EDR is to record data that will assist in understanding how a vehicle's systems performed under certain crash or near crash-like situations, such as an air bag deployment or hitting a road obstacle.

Please refer to "Occupant Restraint Systems" in "Safety" for further information on the Event Data Recorder (EDR).



SERVICING AND MAINTENANCE

INTRODUCTION	172
ENGINE COMPARTMENT	180
BATTERY RECHARGING	184
RAISING THE VEHICLE	184
WHEELS AND TIRES	185
DEPARTMENT OF TRANSPORTATION UNIFORM TIRE QUALITY GRADES	201
BODYWORK	202
INTERIORS	205



INTRODUCTION

Be extremely careful and prevent injury to yourself and others or damage to your vehicle when using this User Guide for inspection and maintenance.

If you are unsure about any procedure it describes, we strongly urge you to have a reliable and qualified service shop perform the work, preferably at your authorized dealer.

Factory-trained FCA technicians and genuine FCA parts are best for your vehicle. Without this expertise and the parts that have been designed and made especially for your vehicle, inadequate, incomplete, and insufficient servicing may result in problems. This could lead to vehicle damage or an accident and injuries.

For expert advice and quality service, contact your authorized dealer.

Note:

Under no circumstances should oil change intervals exceed 10,000 miles (16,000 kilometers) or 1 year.

To continue New Vehicle Limited Warranty eligibility and to protect your investment, it is your responsibility to properly maintain your vehicle according to factory recommended schedules outlined in this User Guide.

As part of this you must keep your maintenance records, receipts, repair orders and any other documents as evidence this maintenance was performed. You must present these documents, should any New Vehicle Limited Warranty coverage disagreement occur. Failure to do so can result in your New Vehicle Limited Warranty being voided either in whole or in part.

This evidence may consist of the following:

- The FCA Scheduled Maintenance Record, refer to the Warranty Booklet, must be completely filled out showing mileage, repair order number, date for each service, and signed by a qualified automotive service technician who service vehicles.
- Original copies of repair orders or other receipts that include the mileage and date the vehicle was serviced. Each receipt should be signed by a qualified automotive service technician.
- For self maintenance, a statement that you completed the maintenance yourself, displaying mileage and the date the work was performed. Also, receipts for the replacement parts (fluid, filters, etc.) indicating the date and mileage must accompany this statement.

Note:

If you elect to perform maintenance yourself or have your vehicle serviced at a location other than an authorized dealer, FCA requires that all fluids, parts and materials must meet FCA standards for durability and performance as described in this User Guide.

Claims against the warranty resulting from lack of maintenance, as opposed to defective materials or authorized FCA workmanship, will not be honored.

Any auto repair shop using parts equivalent to your vehicle's original equipment may perform maintenance. But we recommend that it always be done by an authorized dealer using genuine FCA parts. Selecting "Maintenance Monitor" enables the system to notify you of your vehicle's approaching inspection/servicing period.

Owner Maintenance Precautions

The owner or a qualified service technician should make these vehicle inspections at the indicated intervals to ensure safe and dependable operation. Bring any problem to the attention of an authorized dealer or qualified service technician as soon as possible.

When refueling perform inspection of:

- Brake and clutch fluid level
- Engine coolant level
- Engine oil level
- Washer fluid level

At least monthly perform inspection of:

Tire inflation pressures

At least twice a year (for example, every spring and fall) perform inspection of:

- Engine coolant
- Engine oil

As explained in the “Introduction” paragraph, several procedures can be done only by a qualified service technician with special tools.

For details, read the separate Warranty Booklet provided with the vehicle. If you are unsure about any servicing or maintenance procedure, have it done by an authorized dealer.

There are strict environmental laws regarding the disposal of waste oil and fluids. Please dispose of your waste properly and with due regard to the environment.

We recommend that you entrust the oil and fluid changes of your vehicle to an authorized dealer.

Periodic Checks

Every **620 miles (1,000 km)** or before long trips check and, if necessary, top off:

- Engine coolant level.
- Brake fluid level.
- Windshield washer fluid level.
- Tire inflation pressure and condition.
- Operation of lighting system (headlights, direction indicators, hazard warning lights, etc.).

Operation of windshield washer/wiper system and positioning/wear of windshield wiper blades.

Every **1860 miles (3,000 km)** check and top off the engine oil level if required.

Heavy-Duty Use Of The Vehicle

If the vehicle is used under one of the following conditions:

- Dusty roads.
- Short, repeated trips less than 4.4 - 5 miles (7 - 8 km) at sub-zero outside temperatures.
- Engine idling for long periods of time or driving long distances at low speeds or long periods of inactivity.

The following checks must be carried out more often than indicated in the Scheduled Servicing Plan:

- Check front disc brake pad condition and wear.
- Check cleanliness of underhood area and all door and trunk locks, cleanliness and lubrication of linkage.

Visually inspect conditions of the: engine, transmission, lines and hoses (exhaust/fuel system/brakes) and rubber elements (hoses/belts/etc.).

Check battery charge and battery fluid level.

Visually inspect conditions of the accessory drive belts.

Check and, if necessary, change engine oil and replace oil filter.

Check and, if necessary, replace cabin air filter.

Check and, if necessary, replace air cleaner.

Severe Duty All Models

Change Engine Oil at 4,000 miles (6,500 km) if the vehicle is operated in a dusty and off road environment or is operated predominately at idle or only very low engine RPM's. This type of vehicle use is considered Severe Duty.



Scheduled Servicing Plan

Mileage or time passed (whichever comes first)	10,000	20,000	30,000	40,000	50,000	60,000	70,000	80,000	90,000	100,000	110,000	120,000	130,000	140,000	150,000
Or Years:	1	2	3	4	5	6	7	8	9	10	11	12	13	14	15
Or Kilometers:	16,000	32,000	48,000	64,000	80,000	96,000	112,000	128,000	144,000	160,000	176,000	192,000	208,000	224,000	240,000
Check tire condition/wear and adjust pressure, if necessary, check TIREKIT expiration date (if provided).	•	•	•	•	•	•	•	•	•	•	•	•	•	•	•
Check operation of lighting system (headlamps, direction indicators, hazard warning lights, luggage compartment, passenger compartment, glove compartment, instrument panel warning lights, etc.).	•	•	•	•	•	•	•	•	•	•	•	•	•	•	•
Check and, if necessary, top up fluid levels (brakes/hydraulic clutch, windshield washer, battery, engine coolant, etc.).	•	•	•	•	•	•	•	•	•	•	•	•	•	•	•

Mileage or time passed (whichever comes first)	10,000	20,000	30,000	40,000	50,000	60,000	70,000	80,000	90,000	100,000	110,000	120,000	130,000	140,000	150,000
Or Years:	1	2	3	4	5	6	7	8	9	10	11	12	13	14	15
Or Kilometers:	16,000	32,000	48,000	64,000	80,000	96,000	112,000	128,000	144,000	160,000	176,000	192,000	208,000	224,000	240,000
Check engine control system operation (via diagnostic tool).	•	•	•	•	•	•	•	•	•	•	•	•	•	•	•
Visually inspect condition of: exterior bodywork, underbody protection, pipes and hoses (exhaust - fuel system - brakes), rubber elements (boots, sleeves, bushings, etc.).		•		•		•		•		•		•		•	
Visually inspect conditions of steering elements and check their operation.		•		•		•		•		•		•		•	
Check the front and rear suspension, tie rods, CV Joints, and replace if necessary.		•		•		•		•		•		•		•	
Check endfloat of wheel bearings.		•		•		•		•		•		•		•	



Mileage or time passed (whichever comes first)	10,000	20,000	30,000	40,000	50,000	60,000	70,000	80,000	90,000	100,000	110,000	120,000	130,000	140,000	150,000
Or Years:	1	2	3	4	5	6	7	8	9	10	11	12	13	14	15
Or Kilometers:	16,000	32,000	48,000	64,000	80,000	96,000	112,000	128,000	144,000	160,000	176,000	192,000	208,000	224,000	240,000
Check windshield/rear window wiper blade position/wear.	•		•		•		•		•		•		•		•
Check operation of windshield washer system and adjust jets if necessary.	•		•		•		•		•		•		•		•
Check cleanliness of hood and trunk locks and cleanliness and lubrication of linkages.	•		•		•		•		•		•		•		•
Check parking brake lever travel and adjust, if necessary.	•	•	•	•	•	•	•	•	•	•	•	•	•	•	•
Visually check the condition and wear of the front and rear brakes.	•	•	•	•	•	•	•	•	•	•	•	•	•	•	•
Visually inspect condition of evaporation control system.			•			•			•			•			•

Mileage or time passed (whichever comes first)	10,000	20,000	30,000	40,000	50,000	60,000	70,000	80,000	90,000	100,000	110,000	120,000	130,000	140,000	150,000
Or Years:	1	2	3	4	5	6	7	8	9	10	11	12	13	14	15
Or Kilometers:	16,000	32,000	48,000	64,000	80,000	96,000	112,000	128,000	144,000	160,000	176,000	192,000	208,000	224,000	240,000
Visual inspect the condition and tensioning of the accessory drive belt.				•				•				•			
Replace the accessory drive belt. ****								•							
Inspect and replace PCV valve if necessary.										•					
Change engine oil and replace oil filter.*	In accordance with Oil Change Indicator System OR Severe Duty Mileage, whichever occurs first.														

****Replace belt every 40,000 miles (60,000 km) for use on dusty roads.

*The oil and oil filter replacement must be carried out when indicated by a warning light or message on the instrument panel, or in any case should not exceed one year.



Mileage or time passed (whichever comes first)	10,000	20,000	30,000	40,000	50,000	60,000	70,000	80,000	90,000	100,000	110,000	120,000	130,000	140,000	150,000
Or Years:	1	2	3	4	5	6	7	8	9	10	11	12	13	14	15
Or Kilometers:	16,000	32,000	48,000	64,000	80,000	96,000	112,000	128,000	144,000	160,000	176,000	192,000	208,000	224,000	240,000
Replace spark plugs (1.4L Turbo engine).**			•			•			•			•			•
Replace engine air filter.#			•			•			•			•			•
Replace Cabin Air Filter – If Equipped. ***		•		•		•		•		•		•		•	
Flush and replace the engine coolant at 10 years or 150,000 miles (240,000 km) whichever comes first.										•					•

**The spark plug change is distance based only, yearly intervals do not apply. The following are essential to ensure correct operation and prevent serious damage to the engine:

- Only use spark plugs of the same make and type which are specially certified for such engines (refer to “Engine” in “Technical Specifications” for further information).
- Strictly comply with the spark plug replacement interval given in the scheduled servicing plan for spark plug replacement.
- Contact your authorized dealer if you have any questions.

#The engine air cleaner should be inspected at every oil change if used in dusty areas.

***Replace every 20,000 miles (32,000 km) or two years. Replacement every 10,000 miles (16,000 km) or one year in dusty conditions or as optional/suggested replacement.

Mileage or time passed (whichever comes first)	10,000	20,000	30,000	40,000	50,000	60,000	70,000	80,000	90,000	100,000	110,000	120,000	130,000	140,000	150,000
Or Years:	1	2	3	4	5	6	7	8	9	10	11	12	13	14	15
Or Kilometers:	16,000	32,000	48,000	64,000	80,000	96,000	112,000	128,000	144,000	160,000	176,000	192,000	208,000	224,000	240,000
Replace the timing belt (1.4L Turbo Engine).															•



Warning!

- You can be badly injured working on or around a motor vehicle. Do only service work for which you have the knowledge and the right equipment. If you have any doubt about your ability to perform a service job, take your vehicle to a competent mechanic.
- Failure to properly inspect and maintain your vehicle could result in a component malfunction and effect vehicle handling and performance. This could cause an accident.



ENGINE COMPARTMENT

Checking Levels



07030300-121-003

- 1 — Window Washer Reservoir
- 2 — Engine Oil Dipstick
- 3 — Engine Oil Cap

- 4 — Engine Coolant Reservoir
- 5 — Brake/Clutch Fluid Reservoir
- 6 — Battery

Engine Oil



Warning!

- Be very careful when working in the engine compartment when the engine is hot: you may get burned.
- Do not get too close to the radiator cooling fan: the electric fan may start; danger of injury.
- Loose clothing might be pulled by moving parts.

Recommended Oil

Refer to “Fluids And Lubricants” in “Technical Specifications” for further information.

Inspecting engine oil level

Proceed as follows:

1. Be sure the vehicle is on a level surface.
2. Warm up the engine to normal operating temperature.
3. Turn it off and wait at least five minutes for the oil to return to the sump.
4. Pull out the dipstick, wipe it clean, and reinsert it fully.

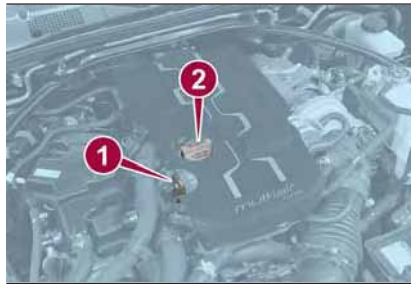

07030403-121-001

Engine Compartment

- 1 — Engine Oil Dipstick
- 2 — Engine Oil Cap

5. Pull the dipstick out again and examine the level. The level is normal if it is between Low and Full. If it is near or below Low, open the engine oil cap/filler 2 and add enough oil to bring the level to Full.

Note: Do not overfill the engine oil. This may cause engine damage.

6. Make sure the O-ring on the dipstick is positioned properly before reinserting the dipstick.

7. Reinsert the dipstick fully.

Engine Oil Consumption

During the initial period of use the engine oil consumption conditions should stabilize after the first 3000 – 3500 miles (5000 – 6000 km).

Engine Coolant



Warning!

- Turn vehicle off and disconnect the fan motor lead before working near the radiator cooling fan.
- You or others can be badly burned by hot engine coolant (antifreeze) or steam from your radiator. If you see or hear steam coming from under the hood, do not open the hood until the radiator has had time to cool. Never open a cooling system pressure cap when the radiator or coolant bottle is hot.
- Keep hands, tools, clothing, and jewelry away from the radiator cooling fan when the hood is raised. The fan starts automatically and may start at any time, whether the engine is running or not.
- When working near the radiator cooling fan, disconnect the fan motor lead or turn the ignition to the OFF mode. The fan is temperature controlled and can start at any time the ignition is in the ON mode.
- You or others can be badly burned by hot engine coolant (antifreeze) or steam from your radiator. If you see or hear steam coming from under the hood, do not open the hood until the radiator has had time to cool. Never try to open a cooling system pressure cap when the radiator is hot.



Inspecting Coolant Level

Note:

Changing the coolant should be done by your authorized dealer.

Inspect the antifreeze protection and coolant level in the coolant reservoir at least once a year, at the beginning of the winter season, and before traveling where temperatures may drop below freezing.

Inspect the condition and connections of all cooling system and heater hoses. Replace any that are worn or deteriorated.



Warning!

- Do not open hot engine cooling system. Never add engine coolant (antifreeze) when the engine is overheated. Do not loosen or remove the cap to cool an overheated engine. Heat causes pressure to build up in the cooling system. To prevent scalding or injury, do not remove the pressure cap while the system is hot or under pressure.
- Do not use a pressure cap other than the one specified for your vehicle. Personal injury or engine damage may result.

The coolant should be at full in the radiator and between the F (Full) and L (Low) marks on the coolant reservoir when the engine is cool.



07030501-121-001

Coolant Reservoir

If it is at or near L (Low), add coolant by mixing a minimum solution of 50% Mopar Long Life Coolant Concentrate for FIAT Spider. Use higher concentrations (not to exceed 70%) if temperatures below -34°F (-37°C) are anticipated. Bring the level to F (Full). Please contact your authorized dealer for assistance.

Securely tighten the coolant reservoir tank cap after adding coolant.

If the coolant reservoir is empty or new coolant is required frequently, contact your authorized dealer.

Brake/Clutch Fluid

Inspecting Brake/Clutch Fluid Level

- The brakes and clutch draw fluid from the same reservoir.
- Inspect the fluid level in the reservoir regularly.
- It should be kept between the MAX and MIN lines.
- The level normally drops with accumulated use, a condition associated with wear of brake and clutch linings. If it is excessively low, have the brake/clutch system inspected. Contact your authorized dealer.



07030601-121-002

Brake Fluid Reservoir



Warning!

- Use only manufacturer's recommended brake fluid. Refer to "Fluids And Lubricants" in "Technical Specifications" for further information. Using the wrong type of brake fluid can severely damage your brake system and/or impair its performance. The proper type of brake fluid for your vehicle is also identified on the original factory installed hydraulic master cylinder reservoir.
- To avoid contamination from foreign matter or moisture, use only new brake fluid or fluid that has been in a tightly closed container. Keep the master cylinder reservoir cap secured at all times. Brake fluid in an open container absorbs moisture from the air resulting in a lower boiling point. This may cause it to boil unexpectedly during hard or prolonged braking, resulting in sudden brake failure. This could result in a collision.
- Overfilling the brake fluid reservoir can result in spilling brake fluid on hot engine parts, causing the brake fluid to catch fire. Brake fluid can also damage painted and vinyl surfaces, care should be taken to avoid its contact with these surfaces.
- Do not allow petroleum based fluid to contaminate the brake fluid. Brake seal components could be damaged, causing partial or complete brake failure. This could result in a collision.

Windshield And Headlight Washer Fluid Inspecting Washer Fluid Level

Inspect fluid level in the washer fluid reservoir, open the cap and add fluid if necessary.



07030901-121-001

Windshield Washer Fluid Reservoir

Use plain water if washer fluid is unavailable. But use only washer fluid in cold weather to prevent it from freezing.

Automatic Transmission Control Unit

The transmission oil level should only be checked at your authorized dealer.

Battery Maintenance

To get the best service from a battery:

- Keep it securely mounted.
- Keep the top clean and dry.
- Keep terminals and connections clean, tight, and coated with petroleum jelly or terminal grease.

- Rinse off spilled electrolyte immediately with a solution of water and baking soda.
- If the vehicle will not be used for an extended time, disconnect the battery leads and charge the battery every six weeks.

Battery Replacement

Contact your authorized dealer to purchase a replacement battery.



Warning!

- Battery fluid is a corrosive acid solution and can burn or even blind you. Do not allow battery fluid to contact your eyes, skin, or clothing. Do not lean over a battery when attaching clamps. If acid splashes in eyes or on skin, flush the area immediately with large amounts of water. Refer to "Jump-Starting Procedure" in "In Case Of Emergency" for further information.
- Battery gas is flammable and explosive. Keep flame or sparks away from the battery. Do not use a booster battery or any other booster source with an output greater than 12 Volts. Do not allow cable clamps to touch each other.
- Battery posts, terminals, and related accessories contain lead and lead compounds. Wash hands after handling.



BATTERY RECHARGING

BATTERY CHARGING PROCEDURE



Warning!

- Battery fluid is a corrosive acid solution and can burn or even blind you. Do not allow battery fluid to contact your eyes, skin, or clothing. Do not lean over a battery when attaching clamps. If acid splashes in eyes or on skin, flush the area immediately with large amounts of water. Refer to “Jump-Starting Procedure” in “In Case Of Emergency” for further information.
- Battery gas is flammable and explosive. Keep flame or sparks away from the battery. Do not use a booster battery or any other booster source with an output greater than 12 Volts. Do not allow cable clamps to touch each other.
- Battery posts, terminals, and related accessories contain lead and lead compounds. Wash hands after handling.



Caution!

- It is essential when replacing the cables on the battery that the positive cable is attached to the positive post and the negative cable is attached to the negative post. Battery posts are marked positive (+) and negative (-) and are identified on the battery case. Cable clamps should be tight on the terminal posts and free of corrosion.
- If a “fast charger” is used while the battery is in the vehicle, disconnect both vehicle battery cables before connecting the charger to the battery. Do not use a “fast charger” to provide starting voltage.

Charge battery as follows:

- Before recharging the battery, turn off all accessories and turn the engine off by placing the ignition in the OFF mode.
- Disconnect the negative battery cable.
- Connect the charger cables to the battery terminals, observing the polarity (+,-).
- Turn on the charger.
- When finished, turn the charger off before disconnecting the battery.
- Reconnect the negative battery terminal.

RAISING THE VEHICLE

If the vehicle needs to be raised, see an authorized dealer which is equipped with arm hoists or workshop lifts.

The vehicle's lifting points are marked on the side skirts with the ▼ symbols.

WHEELS AND TIRES

Tire Safety Information

Tire safety information will cover aspects of the following information: Tire Markings, Tire Identification Numbers, Tire Terminology and Definitions, Tire Pressures, and Tire Loading.

Tire Markings

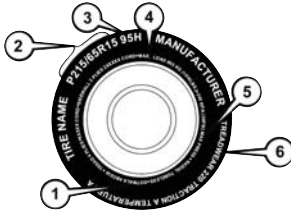

0549116444US

Tire Markings

1 — U.S. DOT Safety Standards Code (TIN)	4 — Maximum Load
2 — Size Designation	5 — Maximum Pressure
3 — Service Description	6 — Treadwear, Traction and Temperature Grades

Note:

❑ P (Passenger) — Metric tire sizing is based on U.S. design standards. P-Metric tires have the letter “P” molded into the sidewall preceding the size designation. Example: P215/65R15 95H.

❑ European — Metric tire sizing is based on European design standards. Tires designed to this standard have the tire size molded into the sidewall beginning with the section width. The letter “P” is absent from this tire size designation. Example: 215/65R15 96H.

❑ LT (Light Truck) — Metric tire sizing is based on U.S. design standards. The size designation for LT-Metric tires is the same as for P-Metric tires except for the letters “LT” that are molded into the sidewall preceding the size designation. Example: LT235/85R16.

❑ Temporary spare tires are designed for temporary emergency use only. Temporary high pressure compact spare tires have the letter “T” or “S” molded into the sidewall preceding the size designation. Example: T145/80D18 103M.

❑ High flotation tire sizing is based on U.S. design standards and it begins with the tire diameter molded into the sidewall. Example: 31x10.5 R15 LT.



Tire Sizing Chart

EXAMPLE:

Example Size Designation: P215/65R15XL 95H, 215/65R15 96H, LT235/85R16C, T145/80D18 103M, 31x10.5 R15 LT

P = Passenger car tire size based on U.S. design standards, or

"...blank..." = Passenger car tire based on European design standards, or

LT = Light truck tire based on U.S. design standards, or

T or S = Temporary spare tire or

31 = Overall diameter in inches (in)

215, 235, 145 = Section width in millimeters (mm)

65, 85, 80 = Aspect ratio in percent (%)

Ratio of section height to section width of tire, or

10.5 = Section width in inches (in)

R = Construction code

"R" means radial construction, or

"D" means diagonal or bias construction

15, 16, 18 = Rim diameter in inches (in)

Service Description:

95 = Load Index

A numerical code associated with the maximum load a tire can carry

H = Speed Symbol

A symbol indicating the range of speeds at which a tire can carry a load corresponding to its load index under certain operating conditions

The maximum speed corresponding to the speed symbol should only be achieved under specified operating conditions (i.e., tire pressure, vehicle loading, road conditions, and posted speed limits)

EXAMPLE:

Load Identification:

Absence of the following load identification symbols on the sidewall of the tire indicates a Standard Load (SL) tire:

- XL** = Extra load (or reinforced) tire, or
- LL** = Light load tire or
- C, D, E, F, G** = Load range associated with the maximum load a tire can carry at a specified pressure

Maximum Load – Maximum load indicates the maximum load this tire is designed to carry

Maximum Pressure – Maximum pressure indicates the maximum permissible cold tire inflation pressure for this tire

Tire Identification Number (TIN)

The TIN may be found on one or both sides of the tire; however, the date code may only be on one side. Tires with white sidewalls will have the full TIN, including the date code, located on the white sidewall side of the tire. Look for the TIN on the outboard side of black sidewall tires as mounted on the vehicle. If the TIN is not found on the outboard side, then you will find it on the inboard side of the tire.

EXAMPLE:

DOT MA L9 ABCD 0301

DOT = Department of Transportation

- This symbol certifies that the tire is in compliance with the U.S. Department of Transportation tire safety standards and is approved for highway use

MA = Code representing the tire manufacturing location (two digits)

L9 = Code representing the tire size (two digits)

ABCD = Code used by the tire manufacturer (one to four digits)



EXAMPLE:

03 = Number representing the week in which the tire was manufactured (two digits)

03 means the 3rd week

01 = Number representing the year in which the tire was manufactured (two digits)

01 means the year 2001

Prior to July 2000, tire manufacturers were only required to have one number to represent the year in which the tire was manufactured. Example: 031 could represent the 3rd week of 1981 or 1991

Tire Terminology And Definitions

Term	Definition
B-Pillar	The vehicle B-Pillar is the structural member of the body located behind the front door.
Cold Tire Inflation Pressure	Cold tire inflation pressure is defined as the tire pressure after the vehicle has not been driven for at least three hours, or driven less than 1 mile (1.6 km) after sitting for a minimum of three hours. Inflation pressure is measured in units of PSI (pounds per square inch) or kPa (kilopascals).
Maximum Inflation Pressure	The maximum inflation pressure is the maximum permissible cold tire inflation pressure for this tire. The maximum inflation pressure is molded into the sidewall.
Recommended Cold Tire Inflation Pressure	Vehicle manufacturer's recommended cold tire inflation pressure as shown on the tire placard.
Tire Placard	A label permanently attached to the vehicle describing the vehicle's loading capacity, the original equipment tire sizes and the recommended cold tire inflation pressures.

Tire Loading And Tire Pressure

Note:

The proper cold tire inflation pressure is listed on the driver's side B-Pillar or the rear edge of the driver's side door.



0906115154US

**Example Tire Placard Location
(Door)**

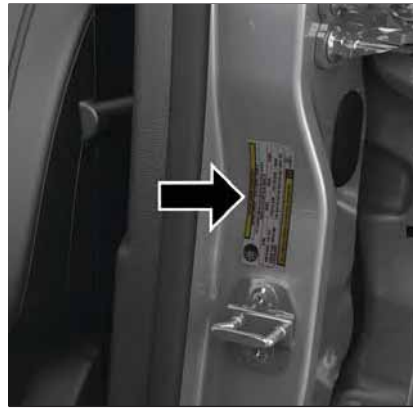

0906115155US

**Example Tire Placard Location
(B-Pillar)**

Tire And Loading Information Placard

TIRE AND LOADING INFORMATION			
SEATING CAPACITY - TOTAL 5 FRONT 2 REAR 3			
THE COMBINED WEIGHT OF OCCUPANTS AND GARGO SHOULD NEVER EXCEED XXX KG OR XXX LBS.			
TIRE	FRONT	REAR	SPARE
ORIGINAL TIRE SIZE	P195/70R14	P195/70R14	T125/70D15
COLD TIRE INFLATION PRESSURE	200kPa, 29PSI	200kPa, 29PSI	420kPa, 60PSI
SEE OWNER'S MANUAL FOR ADDITIONAL INFORMATION			4N102268

811b5a0a

GUID-054900418-high.tif

**Tire And Loading Information
Placard**

This placard tells you important information about the:

1. Number of people that can be carried in the vehicle.
2. Total weight your vehicle can carry.
3. Tire size designed for your vehicle.
4. Cold tire inflation pressures for the front, rear, and spare tires.

Loading

The vehicle maximum load on the tire must not exceed the load carrying capacity of the tire on your vehicle. You will not exceed the tire's load carrying capacity if you adhere to the loading conditions, tire size, and cold tire inflation pressures specified on the Tire and Loading Information placard in "Vehicle Loading" in the "Starting And Operating" section of this manual.

Note:

Under a maximum loaded vehicle condition, gross axle weight ratings (GAWRs) for the front and rear axles must not be exceeded.



To determine the maximum loading conditions of your vehicle, locate the statement “The combined weight of occupants and cargo should never exceed XXX kg or XXX lbs” on the Tire and Loading Information placard. The combined weight of occupants, cargo/luggage and trailer tongue weight (if applicable) should never exceed the weight referenced here.

Steps For Determining Correct Load Limit—

- (1) Locate the statement “The combined weight of occupants and cargo should never exceed XXX kg or XXX lbs.” on your vehicle's placard.
- (2) Determine the combined weight of the driver and passengers that will be riding in your vehicle.
- (3) Subtract the combined weight of the driver and passengers from XXX kg or XXX lbs.

(4) The resulting figure equals the available amount of cargo and luggage load capacity. For example, if “XXX” amount equals 1400 lbs. and there will be five 150 lb passengers in your vehicle, the amount of available cargo and luggage load capacity is 650 lbs. $(1400-750 (5 \times 150) = 650 \text{ lbs.})$

(5) Determine the combined weight of luggage and cargo being loaded on the vehicle. That weight may not safely exceed the available cargo and luggage load capacity calculated in Step 4.

(6) If your vehicle will be towing a trailer, load from your trailer will be transferred to your vehicle. Consult this manual to determine how this reduces the available cargo and luggage load capacity of your vehicle.

Metric Example For Load Limit

For example, if “XXX” amount equals 635 kg and there will be five 68 kg passengers in your vehicle, the amount of available cargo and luggage load capacity is 295 kg $(635-340 (5 \times 68) = 295 \text{ kg})$ as shown in step 4.

Note:

- ❑ If your vehicle will be towing a trailer, load from your trailer will be transferred to your vehicle. The following table shows examples on how to calculate total load, cargo/luggage, and towing capacities of your vehicle with varying seating configurations and number and size of occupants. This table is for illustration purposes only and may not be accurate for the seating and load carry capacity of your vehicle.
- ❑ For the following example, the combined weight of occupants and cargo should never exceed 865 lbs (392 kg).

Occupants			Combined weight of occupants and cargo from Tire Placard	MINUS	Combined Occupant's weight	=	AVAILABLE Cargo/Luggage and Trailer Tongue Weight
TOTAL	FRONT	REAR					
EXAMPLE 1			865 lbs	minus	670 lbs	=	195 lbs
5	2	3					
EXAMPLE 2			865 lbs	minus	540 lbs	=	325 lbs
3	2	1					
EXAMPLE 3			865 lbs	minus	400 lbs	=	465 lbs
2	2	0					

Occupant 1: 200 lbs
 Occupant 2: 130 lbs
 Occupant 3: 160 lbs
 Occupant 4: 100 lbs
 Occupant 5: 80 lbs
 TOTAL WEIGHT: 670 lbs

Occupant 1: 210 lbs
 Occupant 2: 180 lbs
 Occupant 3: 150 lbs
 TOTAL WEIGHT: 540 lbs

Occupant 1: 200 lbs
 Occupant 2: 200 lbs
 TOTAL WEIGHT: 400 lbs

EXAMPLE

811a4d11

GUID-054900419-high.tif



Warning!

Overloading of your tires is dangerous. Overloading can cause tire failure, affect vehicle handling, and increase your stopping distance. Use tires of the recommended load capacity for your vehicle. Never overload them.



Tires — General Information

Tire Pressure

Proper tire inflation pressure is essential to the safe and satisfactory operation of your vehicle. Four primary areas are affected by improper tire pressure:

- Safety and Vehicle Stability
- Economy
- Tread Wear
- Ride Comfort

Safety



Warning!

- Improperly inflated tires are dangerous and can cause collisions.
- Underinflation increases tire flexing and can result in overheating and tire failure.
- Overinflation reduces a tire's ability to cushion shock. Objects on the road and chuckholes can cause damage that result in tire failure.
- Overinflated or underinflated tires can affect vehicle handling and can fail suddenly, resulting in loss of vehicle control.
- Unequal tire pressures can cause steering problems. You could lose control of your vehicle.

Unequal tire pressures from one side of the vehicle to the other can cause the vehicle to drift to the right or left.

Always drive with each tire inflated to the recommended cold tire inflation pressure.

Both under-inflation and over-inflation affect the stability of the vehicle and can produce a feeling of sluggish response or over responsiveness in the steering.

Note:

Unequal tire pressures from side to side may cause erratic and unpredictable steering response.

Unequal tire pressure from side to side may cause the vehicle to drift left or right.

Fuel Economy

Underinflated tires will increase tire rolling resistance resulting in higher fuel consumption.

Tread Wear

Improper cold tire inflation pressures can cause abnormal wear patterns and reduced tread life, resulting in the need for earlier tire replacement.

Ride Comfort And Vehicle Stability

Proper tire inflation contributes to a comfortable ride. Over-inflation produces a jarring and uncomfortable ride.

Tire Inflation Pressures

The proper cold tire inflation pressure is listed on the driver's side B-Pillar or rear edge of the driver's side door.

At least once a month:

Check and adjust tire pressure with a good quality pocket-type pressure gauge. Do not make a visual judgement when determining proper inflation. Tires may look properly inflated even when they are under-inflated.

Inspect tires for signs of tire wear or visible damage.



Caution!

After inspecting or adjusting the tire pressure, always reinstall the valve stem cap. This will prevent moisture and dirt from entering the valve stem, which could damage the valve stem.

Inflation pressures specified on the placard are always "cold tire inflation pressure". Cold tire inflation pressure is defined as the tire pressure after the vehicle has not been driven for at least three hours, or driven less than 1 mile (1.6 km) after sitting for a minimum of three hours. The cold tire inflation

pressure must not exceed the maximum inflation pressure molded into the tire sidewall.

Check tire pressures more often if subject to a wide range of outdoor temperatures, as tire pressures vary with temperature changes.

Tire pressures change by approximately 1 psi (7 kPa) per 12°F (7°C) of air temperature change. Keep this in mind when checking tire pressure inside a garage, especially in the Winter.

Example: If garage temperature = 68°F (20°C) and the outside temperature = 32°F (0°C) then the cold tire inflation pressure should be increased by 3 psi (21 kPa), which equals 1 psi (7 kPa) for every 12°F (7°C) for this outside temperature condition.

Tire pressure may increase from 2 to 6 psi (13 to 40 kPa) during operation. DO NOT reduce this normal pressure build up or your tire pressure will be too low.

Tire Pressures For High Speed Operation

The manufacturer advocates driving at safe speeds and within posted speed limits. Where speed limits or conditions are such that the vehicle can be driven at high speeds, maintaining correct tire inflation pressure is very important.

Increased tire pressure and reduced vehicle loading may be required for high-speed vehicle operation. Refer to your authorized tire dealer or original equipment vehicle dealer for recommended safe operating speeds, loading and cold tire inflation pressures.



Warning!

High speed driving with your vehicle under maximum load is dangerous. The added strain on your tires could cause them to fail. You could have a serious collision. Do not drive a vehicle loaded to the maximum capacity at continuous speeds above 75 mph (120 km/h).

Radial Ply Tires



Warning!

Combining radial ply tires with other types of tires on your vehicle will cause your vehicle to handle poorly. The instability could cause a collision. Always use radial ply tires in sets of four. Never combine them with other types of tires.

Tire Repair

If your tire becomes damaged, it may be repaired if it meets the following criteria:

- The tire has not been driven on when flat.
- The damage is only on the tread section of your tire (sidewall damage is not repairable).
- The puncture is no greater than a ¼ of an inch (6 mm).

Consult an authorized tire dealer for tire repairs and additional information.

Damaged Run Flat tires, or Run Flat tires that have experienced a loss of pressure should be replaced immediately with another Run Flat tire of identical size and service description (Load Index and Speed Symbol).

Run Flat Tires – If Equipped

Run Flat tires allow you the capability to drive 50 miles (80 km) at 50 mph (80 km/h) after a rapid loss of inflation pressure. This rapid loss of inflation is referred to as the Run Flat mode. A Run Flat mode occurs when the tire inflation pressure is of/or below 14 psi (96 kPa). Once a Run Flat tire reaches the run flat mode it has limited driving capabilities and needs to be replaced immediately. A Run Flat tire is not repairable.



It is not recommended driving a vehicle loaded at full capacity or to tow a trailer while a tire is in the run flat mode.

See the tire pressure monitoring section for more information.

Tire Spinning

When stuck in mud, sand, snow, or ice conditions, do not spin your vehicle's wheels above 30 mph (48 km/h) or for longer than 30 seconds continuously without stopping.



Warning!

Fast spinning tires can be dangerous. Forces generated by excessive wheel speeds may cause tire damage or failure. A tire could explode and injure someone. Do not spin your vehicle's wheels faster than 30 mph (48 km/h) for more than 30 seconds continuously when you are stuck, and do not let anyone near a spinning wheel, no matter what the speed.

Tread Wear Indicators

Tread wear indicators are in the original equipment tires to help you in determining when your tires should be replaced.

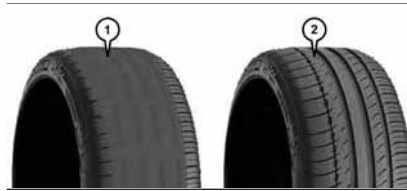

0906115139US

Tire Tread

- 1 — Worn Tire
- 2 — New Tire

These indicators are molded into the bottom of the tread grooves. They will appear as bands when the tread depth becomes a 1/16 of an inch (1.6 mm). When the tread is worn to the tread wear indicators, the tire should be replaced. Refer to "Replacement Tires" in this section for further information.

Life Of Tire

The service life of a tire is dependent upon varying factors including, but not limited to:

- Driving style.
- Tire pressure - Improper cold tire inflation pressures can cause uneven wear patterns to develop across the tire tread. These abnormal wear patterns will reduce tread life, resulting in the need for earlier tire replacement.

- Distance driven.

Performance tires, tires with a speed rating of V or higher, and Summer tires typically have a reduced tread life. Rotation of these tires per the vehicle scheduled maintenance is highly recommended.



Warning!

Tires and the spare tire should be replaced after six years, regardless of the remaining tread. Failure to follow this warning can result in sudden tire failure. You could lose control and have a collision resulting in serious injury or death.

Keep dismantled tires in a cool, dry place with as little exposure to light as possible. Protect tires from contact with oil, grease, and gasoline.

Replacement Tires

The tires on your new vehicle provide a balance of many characteristics. They should be inspected regularly for wear and correct cold tire inflation pressures. The manufacturer strongly recommends that you use tires equivalent to the originals in size, quality and performance when replacement is needed. Refer to the paragraph on "Tread Wear Indicators" in this section.

Refer to the Tire and Loading Information placard or the Vehicle Certification Label for the size designation of your tire. The Load Index and Speed Symbol for your tire will be found on the original equipment tire sidewall.

See the Tire Sizing Chart example found in the “Tire Safety Information” section of this manual for more information relating to the Load Index and Speed Symbol of a tire.

It is recommended to replace the two front tires or two rear tires as a pair. Replacing just one tire can seriously affect your vehicle’s handling. If you ever replace a wheel, make sure that the wheel’s specifications match those of the original wheels.

It is recommended you contact your authorized tire dealer or original equipment dealer with any questions you may have on tire specifications or capability. Failure to use equivalent replacement tires may adversely affect the safety, handling, and ride of your vehicle.

 **Warning!**

- Do not use a tire, wheel size, load rating, or speed rating other than that specified for your vehicle. Some combinations of unapproved tires and wheels may change suspension dimensions and performance characteristics, resulting in changes to steering, handling, and braking of your vehicle. This can cause unpredictable handling and stress to steering and suspension components. You could lose control and have a collision resulting in serious injury or death. Use only the tire and wheel sizes with load ratings approved for your vehicle.*
- Never use a tire with a smaller load index or capacity, other than what was originally equipped on your vehicle. Using a tire with a smaller load index could result in tire overloading and failure. You could lose control and have a collision.*
- Failure to equip your vehicle with tires having adequate speed capability can result in sudden tire failure and loss of vehicle control.*

 **Caution!**

Replacing original tires with tires of a different size may result in false speedometer and odometer readings.

Tire Types

All Season Tires – If Equipped

All Season tires provide traction for all seasons (Spring, Summer, Fall, and Winter). Traction levels may vary between different all season tires. All season tires can be identified by the M+S, M&S, M/S or MS designation on the tire sidewall. Use all season tires only in sets of four; failure to do so may adversely affect the safety and handling of your vehicle.

Summer Or Three Season Tires – If Equipped

Summer tires provide traction in both wet and dry conditions, and are not intended to be driven in snow or on ice. If your vehicle is equipped with Summer tires, be aware these tires are not designed for Winter or cold driving conditions. Install Winter tires on your vehicle when ambient temperatures are less than 40°F (5°C) or if roads are covered with ice or snow. For more information, contact an authorized dealer.

Summer tires do not contain the all season designation or mountain/snowflake symbol on the tire sidewall. Use Summer tires only in sets of four; failure to do so may adversely affect the safety and handling of your vehicle.



**Warning!**

Do not use Summer tires in snow/ice conditions. You could lose vehicle control, resulting in severe injury or death. Driving too fast for conditions also creates the possibility of loss of vehicle control.

Snow Tires

Some areas of the country require the use of snow tires during the Winter. Snow tires can be identified by a “mountain/snowflake” symbol on the tire sidewall.



If you need snow tires, select tires equivalent in size and type to the original equipment tires. Use snow tires only in sets of four; failure to do so may

adversely affect the safety and handling of your vehicle.

Snow tires generally have lower speed ratings than what was originally equipped with your vehicle and should not be operated at sustained speeds over 75 mph (120 km/h). For speeds above 75 mph (120 km/h) refer to

original equipment or an authorized tire dealer for recommended safe operating speeds, loading and cold tire inflation pressures.

While studded tires improve performance on ice, skid and traction capability on wet or dry surfaces may be poorer than that of non-studded tires. Some states prohibit studded tires; therefore, local laws should be checked before using these tire types.

Spare Tires — If Equipped

Note: For vehicles equipped with Tire Service Kit instead of a spare tire, please refer to “Tire Service Kit” in “In Case Of Emergency” in your Owner’s Manual on www.fiatusa.com/en/owners/manuals for further information.

**Caution!**

Because of the reduced ground clearance, do not take your vehicle through an automatic car wash with a compact or limited use temporary spare installed. Damage to the vehicle may result.

Spare Tire Matching Original Equipped Tire And Wheel — If Equipped

Your vehicle may be equipped with a spare tire and wheel equivalent in look and function to the original equipment tire and wheel found on the front or rear axle of your vehicle. This spare tire may be used in the tire rotation for your vehicle. If your vehicle has this option, refer to an authorized tire dealer for the recommended tire rotation pattern.

Compact Spare Tire — If Equipped

The compact spare is for temporary emergency use only. You can identify if your vehicle is equipped with a compact spare by looking at the spare tire description on the Tire and Loading Information Placard located on the driver’s side door opening or on the sidewall of the tire. Compact spare tire descriptions begin with the letter “T” or “S” preceding the size designation. Example: T145/80D18 103M. T, S = Temporary Spare Tire. Since this tire has limited tread life, the original equipment tire should be repaired (or replaced) and reinstalled on your vehicle at the first opportunity.

Do not install a wheel cover or attempt to mount a conventional tire on the compact spare wheel, since the wheel is designed specifically for the compact spare tire. Do not install more than one compact spare tire and wheel on the vehicle at any given time.



Warning!

Compact and collapsible spares are for temporary emergency use only. With these spares, do not drive more than 50 mph (80 km/h). Temporary use spares have limited tread life. When the tread is worn to the tread wear indicators, the temporary use spare tire needs to be replaced. Be sure to follow the warnings, which apply to your spare. Failure to do so could result in spare tire failure and loss of vehicle control.

Collapsible Spare Tire — If Equipped

The collapsible spare is for temporary emergency use only. You can identify if your vehicle is equipped with a collapsible spare by looking at the spare tire description on the Tire and Loading Information Placard located on the driver's side door opening or on the sidewall of the tire.

Collapsible spare tire description example: 165/80-17 101P.

Since this tire has limited tread life, the original equipment tire should be repaired (or replaced) and reinstalled on your vehicle at the first opportunity.

Inflate collapsible tire only after the wheel is properly installed to the vehicle. Inflate the collapsible tire using the electric air pump before lowering the vehicle.

Do not install a wheel cover or attempt to mount a conventional tire on the collapsible spare wheel, since the wheel is designed specifically for the collapsible spare tire.



Warning!

Compact and Collapsible spares are for temporary emergency use only. With these spares, do not drive more than 50 mph (80 km/h). Temporary use spares have limited tread life. When the tread is worn to the tread wear indicators, the temporary use spare tire needs to be replaced. Be sure to follow the warnings, which apply to your spare. Failure to do so could result in spare tire failure and loss of vehicle control.

Full Size Spare — If Equipped

The full size spare is for temporary emergency use only. This tire may look like the originally equipped tire on the front or rear axle of your vehicle, but it is not. This spare tire may have limited tread life. When the tread is worn to the tread wear indicators, the temporary use full size spare tire needs to be replaced. Since it is not the same as your original equipment tire, replace (or repair) the original equipment tire and reinstall on the vehicle at the first opportunity.

Limited Use Spare — If Equipped

The limited use spare tire is for temporary emergency use only. This tire is identified by a label located on the limited use spare wheel. This label contains the driving limitations for this spare. This tire may look like the original equipped tire on the front or rear axle of your vehicle, but it is not. Installation of this limited use spare tire affects vehicle handling. Since it is not the same as your original equipment tire, replace (or repair) the original equipment tire and reinstall on the vehicle at the first opportunity.



**Warning!**

Limited use spares are for emergency use only. Installation of this limited use spare tire affects vehicle handling. With this tire, do not drive more than the speed listed on the limited use spare wheel. Keep inflated to the cold tire inflation pressures listed on your Tire and Loading Information Placard located on the driver's side B-Pillar or the rear edge of the driver's side door. Replace (or repair) the original equipment tire at the first opportunity and reinstall it on your vehicle. Failure to do so could result in loss of vehicle control.

Wheel And Wheel Trim Care

All wheels and wheel trim, especially aluminum and chrome plated wheels, should be cleaned regularly using mild (neutral Ph) soap and water to maintain their luster and to prevent corrosion. Wash wheels with the same soap solution recommended for the body of the vehicle.

Your wheels are susceptible to deterioration caused by salt, sodium chloride, magnesium chloride, calcium chloride, etc., and other road chemicals used to melt ice or control dust on dirt

roads. Use a soft cloth or sponge and mild soap to wipe away promptly. Do not use harsh chemicals or a stiff brush. They can damage the wheel's protective coating that helps keep them from corroding and tarnishing.

**Caution!**

Avoid products or automatic car washes that use acidic solutions or strong alkaline additives or harsh brushes. Many aftermarket wheel cleaners and automatic car washes may damage the wheel's protective finish. Such damage is not covered by the New Vehicle Limited Warranty. Only car wash soap, Mopar Wheel Cleaner or equivalent is recommended.

When cleaning extremely dirty wheels including excessive brake dust, care must be taken in the selection of tire and wheel cleaning chemicals and equipment to prevent damage to the wheels. Mopar Wheel Treatment or Mopar Chrome Cleaner or their equivalent is recommended or select a non-abrasive, non-acidic cleaner for aluminum or chrome wheels.

**Caution!**

Do not use scouring pads, steel wool, a bristle brush, metal polishes or oven cleaner. These products may damage the wheel's protective finish. Such damage is not covered by the New Vehicle Limited Warranty. Only car wash soap, Mopar Wheel Cleaner or equivalent is recommended.

Note:

If you intend parking or storing your vehicle for an extended period after cleaning the wheels with wheel cleaner, drive your vehicle and apply the brakes to remove the water droplets from the brake components. This activity will remove the red rust on the brake rotors and prevent vehicle vibration when braking.

Dark Vapor Chrome, Black Satin Chrome, or Low Gloss Clear Coat Wheels



Caution!

If your vehicle is equipped with these specialty wheels, DO NOT USE wheel cleaners, abrasives, or polishing compounds. They will permanently damage this finish and such damage is not covered by the New Vehicle Limited Warranty. HAND WASH ONLY USING MILD SOAP AND WATER WITH A SOFT CLOTH. Used on a regular basis; this is all that is required to maintain this finish.

Snow Chains

The use of snow chains should be in compliance with local regulations of each country. In certain countries, tires marked with code M+S (Mud and Snow) are considered as winter equipment; therefore their use is equivalent to that of the snow chains.

The snow chains may be applied only to the front wheel tires. Check the tension of the snow chains after the first few feet have been driven.



Warning!

Using tires of different size and type (M+S, Snow) between front and rear axles can cause unpredictable handling. You could lose control and have a collision.



Caution!

To avoid damage to your vehicle or tires, observe the following precautions:

Because of restricted traction device clearance between tires and other suspension components, it is important that only traction devices in good condition are used. Broken devices can cause serious damage. Stop the vehicle immediately if noise occurs that could indicate device breakage. Remove the damaged parts of the device before further use.

Install device as tightly as possible and then retighten after driving about ½ mile (0.8 km).

Do not exceed 30 mph (48 km/h).

Drive cautiously and avoid severe turns and large bumps, especially with a loaded vehicle.

Do not drive for a prolonged period on dry pavement.

Observe the traction device manufacturer's instructions on the method of installation, operating speed, and conditions for use. Always use the suggested operating speed of the device manufacturer's if it is less than 30 mph (48 km/h).

Do not use traction devices on a compact spare tire.



Caution!

Using snow chains with tires with non-original dimensions may damage the vehicle.

Using different size or type (M+S, snow, etc.) tires between front and rear axle may adversely affect vehicle driveability, with the risk of losing control of the vehicle and resulting accidents.



Tire Rotation Recommendations

The front and rear tires are subject to different loads and stress due to steering, maneuver and braking. For this reason they are subject to uneven wear. To resolve this problem, tires should be rotated at the appropriate time.

❑ The following rotation methods must NOT be used with one-way unidirectional tires! This type of tires can only be switched from the front axle to the rear axle and vice versa, keeping them on the same side of the vehicle.

❑ Rotate one-way unidirectional tires and radial tires that have an asymmetrical tread pattern only from front to rear, not from side to side. Tire performance will be reduced if rotated from side to side.

Tire rotation means moving the wheels to a different position, with respect to the vehicle. During rotation, inspect tires for correct balance.

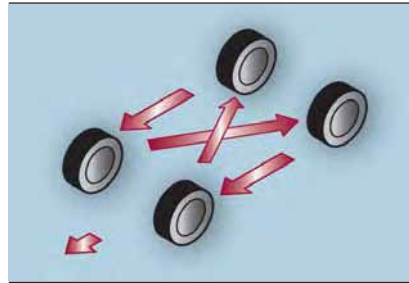

07031402-FRT-001

Rotation Diagram

The single wheel will therefore operate on a different axle and, where possible, on the opposite side of the vehicle.

Note:

❑ Rotate tires periodically. Irregular tire wear is dangerous. To equalize tread wear for maintaining good performance in handling and braking, rotate the tires every 6,200 miles (10,000 km), or sooner if irregular wear develops.

❑ To equalize tread wear, rotate the tires every 7,500 miles (12,000 km) at the latest or sooner if irregular wear develops. FCA recommends to rotate every 5,000 miles (8,000 km) to help increase tire life and distribute wear more evenly.

❑ Because your vehicle is not equipped with a spare tire, you cannot do a tire rotation safely with the jack that may come with your vehicle if so equipped. Contact an authorized dealer for tire rotation.

Also, inspect them for uneven wear and damage. Abnormal wear is usually caused by one or a combination of the following:

- ❑ Incorrect tire pressure
- ❑ Improper wheel alignment
- ❑ Out-of-balance wheel
- ❑ Severe braking

After rotation, inflate all tire pressures to specification and inspect the wheel nuts for tightness.

With Tire Pressure Monitor System (TPMS)

The TPM system must be initialized after adjusting the tire pressure, to make the system operate normally. Refer to "Tire Pressure Monitoring System" in "Safety" for further information.

Rotate unidirectional tires and radial tires that have an asymmetrical tread pattern only from front to rear, not from side to side. Tire performance will be reduced if rotated from side to side.

DEPARTMENT OF TRANSPORTATION UNIFORM TIRE QUALITY GRADES

The following tire grading categories were established by the National Highway Traffic Safety Administration. The specific grade rating assigned by the tire's manufacturer in each category is shown on the sidewall of the tires on your vehicle.

All passenger vehicle tires must conform to Federal safety requirements in addition to these grades.

Treadwear

The Treadwear grade is a comparative rating, based on the wear rate of the tire when tested under controlled conditions on a specified government test course. For example, a tire graded 150 would wear one and one-half times as well on the government course as a tire graded 100. The relative performance of tires depends upon the actual conditions of their use, however,

and may depart significantly from the norm due to variations in driving habits, service practices, and differences in road characteristics and climate.

Traction Grades

The Traction grades, from highest to lowest, are AA, A, B, and C. These grades represent the tire's ability to stop on wet pavement, as measured under controlled conditions on specified government test surfaces of asphalt and concrete. A tire marked C may have poor traction performance.



Warning!

The traction grade assigned to this tire is based on straight-ahead braking traction tests, and does not include acceleration, cornering, hydroplaning, or peak traction characteristics.

Temperature Grades

The Temperature grades are A (the highest), B, and C, representing the tire's resistance to the generation of

heat and its ability to dissipate heat, when tested under controlled conditions on a specified indoor laboratory test wheel.

Sustained high temperature can cause the material of the tire to degenerate and reduce tire life, and excessive temperature can lead to sudden tire failure. The grade C corresponds to a level of performance, which all passenger vehicle tires must meet under the Federal Motor Vehicle Safety Standard No. 109. Grades B and A represent higher levels of performance on the laboratory test wheel, than the minimum required by law.



Warning!

The temperature grade for this tire is established for a tire that is properly inflated and not overloaded. Excessive speed, under-inflation, or excessive loading, either separately or in combination, can cause heat buildup and possible tire failure.



BODYWORK

Preserving The Paintwork

Touch up abrasions and scratches immediately to prevent the formation of rust.

Maintenance of paintwork consists of washing the vehicle: the frequency depends on the conditions and environment in which the vehicle is used.

For example, it is advisable to wash the vehicle more often in areas with high levels of atmospheric pollution or salted roads.

To correctly wash the vehicle, follow these instructions:

- ❑ If high pressure jets or cleaners are used to wash the vehicle, keep a distance of at least 1.3 ft (40 cm) from the bodywork to avoid damage or alteration. Build up of water could cause damage to the vehicle in the long term.
- ❑ Wash the vehicle using a low pressure jet of water if possible.
- ❑ Wipe a sponge with a slightly soapy solution over the bodywork, frequently rinsing the sponge.
- ❑ Rinse well with water and dry with a jet of air or a chamois leather.

Dry the less visible parts (e.g. door frames, hood, headlight frames, etc.) with special care, as water may stagnate more easily in these areas. Do not wash the vehicle after it has been left in the sun or with the hood hot: this may alter the shine of the paintwork.

Exterior plastic parts must be cleaned in the same way as the rest of the vehicle.

Note:

- ❑ Avoid parking under trees; the sap dropped by trees makes the paint work go dull and increases the possibility of corrosion.
- ❑ Bird droppings must be washed off immediately and thoroughly as the acid they contain is particularly aggressive.

Etching caused by acid rain or industrial fallout

Cause:

Industrial pollutants and vehicle emissions drift into the air and mix with rain or dew to form acids. These acids can settle on a vehicle's finish. As the water evaporates, the acid becomes concentrated and can damage the finish.

The longer the acid remains on the surface, the greater the chance is for damage.

Prevention:

It is necessary to wash and wax your vehicle to preserve its finish according to the instructions in this section. These steps should be taken immediately after you suspect that acid rain has settled on your vehicle's finish.

Damage caused by bird dropping/insects/tree sap

Problem:

Bird droppings contain acids. If these are not removed they can eat away the clear and color base coat of the vehicle's paintwork.

When insects stick to the paint surface and decompose, corrosive compounds form. These can erode the clear and color base coat of the vehicle's paintwork if they are not removed.

Tree sap will harden and adhere permanently to the paint finish. If you scratch the sap off while it is hard, some vehicle paint could come off with it.

Prevention:

It is necessary to have your vehicle washed and waxed to preserve its finish according to the instructions in this section. This should be done as soon as possible.

Bird droppings can be removed with a soft sponge and water. If you are travelling and these are not available, a moistened tissue may also take care of the problem. The cleaned area should be waxed according to the instructions in this section. Insects and tree sap are best removed with a soft sponge and water or a commercially available chemical cleaner.

Another method is to cover the affected area with dampened newspaper for one to two hours. After removing the newspaper, rinse off the loosened debris with water.

Water marks

Problem:

Rain, fog, dew, and even tap water can contain harmful minerals such as salt and lime. If moisture containing these minerals settles on the vehicle and evaporates, the minerals will concentrate and harden to form white rings. The rings can damage your vehicle's finish.

Prevention:

It is necessary to wash and wax your vehicle to preserve its finish according to the instructions in this section. These steps should be taken immediately after you find water marks on your vehicle's finish.

Paint chipping

Problem:

Paint chipping occurs when gravel thrown in the air by another vehicle's tires hits your vehicle.

How to avoid paint chipping:

Keeping a safe distance between you and the vehicle ahead reduces the chances of having your paint chipped by flying gravel.

Note:

- The paint chipping zone varies with the speed of the vehicle. For example, when travelling at 55 mph (90 km/h), the paint chipping zone is 164 ft (50 m).
- In low temperatures, a vehicle's finish hardens. This increases the chance of paint chipping.
- Chipped paint can lead to rust forming on your vehicle. Before this happens, repair the damage by using FCA touch-up paint according to the instructions in this section. Failure to repair the affected area could lead to serious rusting and expensive repairs.

Follow all label and container directions when using a chemical cleaner or polish. Read all warnings and cautions.

Maintaining The Finish

Washing

To help protect the finish from rust and deterioration, wash your vehicle thoroughly and frequently, at least once a month, with lukewarm or cold water.

If the vehicle is washed improperly, the paint surface could be scratched. Here are some examples of how scratching could occur:

- The vehicle is washed without first rinsing off dirt and other foreign matter.
- The vehicle is washed with a rough, dry, or dirty cloth.
- The vehicle is washed at a car wash that uses brushes that are dirty or too stiff.
- Cleansers or wax containing abrasives are used.

Note:

FCA is not responsible for scratches caused by automatic car washes or improper washing. Scratches are more noticeable on vehicles with darker paint finishes.



When the wiper lever is in the AUTO position and the ignition is placed in the ON mode, the wipers may move automatically in the following cases:

- ❑ If the windshield above the rain sensor is touched or wiped with a cloth.
- ❑ If the windshield is struck with a hand or other object from either outside or inside the vehicle.

Note:

- ❑ Keep hands and scrapers clear of the windshield when the wiper lever is in the AUTO position and the ignition is placed in the ON mode as fingers could be pinched or the wipers and wiper blades damaged when the wipers activate automatically. If you are going to clean the windshield, be sure the wipers are turned off completely (when it is most likely that the engine is left running) this is particularly important when clearing ice and snow.
- ❑ Do not spray water in the engine compartment. Otherwise, it could result in engine-starting problems or damage to electrical parts.

- ❑ When washing and waxing the vehicle, be careful not to apply excessive force to any single area of the vehicle hood. Otherwise, you could dent the vehicle.

- ❑ Do not use automatic car washing machines and car washing devices using high water pressure.

- ❑ Make sure that the fuel door is closed and lock the doors. Otherwise, the fuel door may be forcefully opened by water pressure causing damage to the vehicle or fuel door.

To minimize scratches on the vehicle's paint finish:

- ❑ Rinse off any dirt or other foreign matter using lukewarm or cold water before washing.
- ❑ Use plenty of lukewarm or cold water and a soft cloth when washing the vehicle. Do not use a nylon cloth.
- ❑ Rub gently when washing or drying the vehicle.
- ❑ Take your vehicle only to a car wash that keeps its brushes well maintained.
- ❑ Do not use abrasive cleansers or wax that contain abrasives.



Caution!

Do not use steel wool, abrasive cleaners, or strong detergents containing highly alkaline or caustic agents on chrome plated or anodized aluminium parts. This may damage the protective coating; also, cleaners and detergents may discolor or deteriorate the paint.

Pay special attention to removing salt, dirt, mud, and other foreign material from the underside of the fenders, and make sure the drain holes in the lower edges of the doors and rocker panels are clean.

Insects, tar, tree sap, bird droppings, industrial fallout, and similar deposits can damage the finish if not removed immediately. When prompt washing with plain water is ineffective, use a mild soap made for use on vehicles.

Thoroughly rinse off all soap with lukewarm or cold water. Do not allow soap to dry on the finish.

After washing the vehicle, dry it with a clean chamois to prevent water spots from forming.

Waxing

Your vehicle needs to be waxed when water no longer beads on the finish.

Always wash and dry the vehicle before waxing it. In addition to the vehicle body, wax the metal trim to maintain its lustre:

- Use wax which contains no abrasives. Waxes containing abrasive will remove paint and could damage bright metal parts.
- Use a good grade of natural wax for metallic, mica, and solid colors.
- When waxing, coat evenly with the sponge supplied or a soft cloth.
- Wipe off the wax with a soft cloth.

Note:

A spot remover to remove oil, tar, and similar materials will usually also take off the wax. Rewax these areas even if the rest of the vehicle does not need it.

INTERIORS

Seats And Fabric Parts



Warning!

Do not use volatile solvents for cleaning purposes. Many are potentially flammable, and if used in closed areas they may cause respiratory harm.

Do not keep aerosol cans in the car: they might explode. Aerosol cans must not be exposed to a temperature exceeding 122°F (50°C). When the vehicle is exposed to sunlight the internal temperature can greatly exceed this value.



Caution!

Direct contact of air fresheners, insect repellents, suntan lotions, or hand sanitizers, to the plastic, painted, or decorated surfaces of the interior may cause permanent damage. Wipe away immediately.

Damage caused by these type of products may not be covered by your New Vehicle Limited Warranty.

Rubbing the interior side of the convertible top vigorously with a stiff brush or cloth may cause damage.

Interior Panels

When the interior panels need to be cleaned, use soft material such as a soft cloth soaked in clean water and wrung out well and lightly wipe off dirt from the surface.

If a panel requires further cleaning, wipe dirt off using a soft cloth soaked in mild detergent (about 5% solution) and wipe off any remaining detergent using a cloth soaked in clean water and wrung out well.



Caution!

Do not wipe leather parts using alcohol, chlorine bleach, or organic solvents such as thinner, benzene, or gasoline. Otherwise, it may cause discoloration or stains.

Note:

- Scratches or nicks on the panels and metallic trim resulting from the use of a hard brush or cloth may not be repairable.
- Be particularly careful when cleaning high gloss panels and metallic trim as they can be easily scratched.



Lap / Shoulder Belt



Warning!

A frayed or torn belt could rip apart in a collision and leave you with no protection. Inspect the belt system periodically, checking for cuts, frays, or loose parts. Damaged parts must be replaced immediately. Do not disassemble or modify the system. Seat belt assemblies must be replaced after a collision if they have been damaged (i.e., bent retractor, torn webbing, etc.).

Clean the webbing with a mild soap solution recommended for upholstery or carpets. Follow instructions. Do not bleach or dye the belts, this may weaken them.

After cleaning the belts, thoroughly dry the belt webbing and make sure there is no remaining moisture before retracting them.

Plastic And Coated Parts

Instrument panel precautions

Prevent caustic solutions such as perfume and cosmetic oils from contacting the instrument panel. They will damage and discolor the instrument panel. If these solutions get on the instrument panel, wipe them off immediately.

Note:

Never use alcohol, gasoline and derivatives to clean the instrument panel lens.



Caution!

Do not use glazing agents. Glazing agents contain ingredients which may cause discoloration, wrinkling, cracks and peeling.

TECHNICAL SPECIFICATIONS

IDENTIFICATION DATA208
ENGINE210
DIMENSIONS211
FLUID CAPACITIES212
FLUIDS AND LUBRICANTS213
PERFORMANCE215



IDENTIFICATION DATA

Identification Numbers

Model Plate

The model plate is located on the left side of door pillar.



10010103121001

Model Plate Location

Chassis Number/Vehicle Identification Number

The Vehicle Identification Number is located below the left side (driver side) of the windshield.



10010104-122-001AB

Vehicle Identification Number

Motor Vehicle Safety Standard Label

(U.S.A. and Canada)

The motor vehicle safety standard label is located on the left side of door pillar.

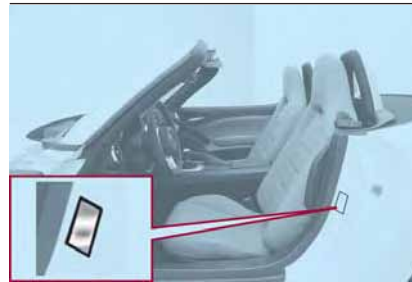

10010109-121-001

Motor Vehicle Safety Standard Label

Vehicle Emission Control Information Label

(U.S.A. and Canada)

The vehicle emission control information label is located under the hood.



10010106-121-001

Vehicle Emission Control Information Label

Tire Pressure Label

The tire pressure label is located on the left side of door pillar.



10010107-121-002

Tire Pressure Label

Engine Number

The engine number label is located on the engine.



ENGINE**Engine**

	1.4 Turbo Multi Air
Cycle	Four
Number and position of cylinders	4 in line
Piston bore and stroke (mm)	72.0 x 80.4
Total displacement (cm ³)	1368
Compression ratio	9.8:1
Maximum power (kW)	122
Maximum power (HP)	164
Corresponding engine speed (rpm)	5500
Maximum torque (Nm)	250
Maximum torque (lb.-ft.)	184
Corresponding engine speed (rpm)	2500
Spark plugs	We recommend you use Mopar Spark Plugs.
Fuel	91 Octane Recommended (87 Octane Acceptable) Maximum 15% Ethanol Content

Note:

When cleaning the iridium plugs, do not use a wire brush. The fine particulate coating on the iridium alloy and platinum tips could be damaged.

**Warning!**

Modifications or repairs to the fuel supply system that are not carried out correctly or do not take the system's technical specifications into account, can cause malfunctions leading to the risk of fire.

DIMENSIONS

Dimensions

Dimensions are expressed in inches and refer to the vehicle equipped with its standard-supplied tires. Height is measured with vehicle unloaded.

Trunk Volume: 4.9 cu. ft. (140 Liters)

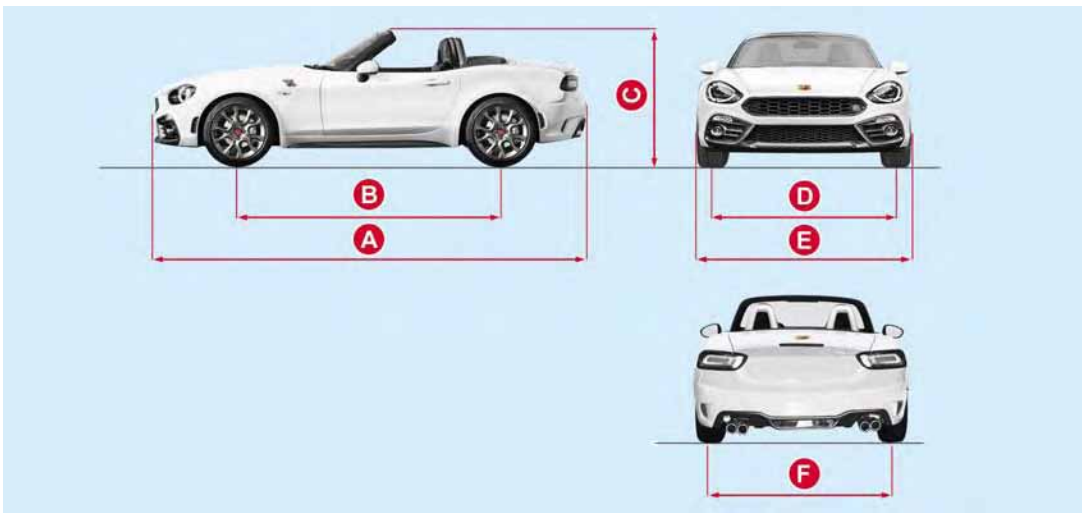

Vehicle Dimension Chart

10000555-122-333AB

A	B	C	D	E	F
159.6 (4054 mm)	90.9 (2309 mm)	48.5 (1232 mm)	58.9 (1496 mm)	68.5 (1740 mm)	59.1 (1503 mm)

Weights

Curb Weight: 2477 lbs (1124 kg) (if equipped with manual transmission) / 2516 lbs (1141 kg) (if equipped with automatic transmission).



FLUID CAPACITIES

Item	Capacities
Fuel tank	11.9 (gallons) / 45 (liters)
Engine oil (without oil filter replacement)	3.3 (quarts) / 3.2 (liters)
Engine oil (with oil filter replacement)	4.0 (quarts) / 3.8 (liters)
Coolant (with manual transmission)	7.6 (quarts) / 7.2 (liters)
Coolant (with automatic transmission)	7.5 (quarts) / 7.1 (liters)
Manual transmission oil	2.2 (quarts) / 2.1 (liters)
Automatic transmission fluid	7.8 (quarts) / 7.5 (liters)
Rear differential oil	0.63 (quarts) / 0.6 (liters)
Limited slip differential oil	0.63 (quarts) / 0.6 (liters)
Brake fluid (& clutch fluid)	0.57 (quarts) / 0.55 (liters)

FLUIDS AND LUBRICANTS

Fluids And Lubricants

Your vehicle is equipped with an engine oil that has been thoroughly developed and tested in order to meet the requirements of the Scheduled Servicing Plan.

Constant use of the prescribed lubricants guarantees the fuel consumption and emission specifications. Lubricant quality is crucial for engine operation and duration.

Lubricant	Specification	Replacement interval
Engine oil	We recommend you use API Certified SAE 5W-40 Full Synthetic Engine Oil, meeting the requirements of FCA Material Standard MS-12991. Refer to your engine oil filler cap for correct SAE grade.	According to Scheduled Servicing Plan
Coolant	Mopar Long Life Coolant Concentrate for FIAT Spider	According to Scheduled Servicing Plan
Manual transmission oil	Mopar Manual Transmission Long Life Gear Oil for FIAT Spider	
Automatic transmission fluid	Mopar Automatic Transmission Long Life Fluid for FIAT Spider	
Rear differential oil	Mopar Long Life Hypoid Gear Oil for FIAT Spider	



Lubricant	Specification	Replacement interval
Limited slip differential oil	Mopar Long Life Limited Slip Additive for FIAT Spider	
Brake/clutch fluid	We recommend you use Mopar DOT 3. If DOT 3 brake fluid is not available, then DOT 4 is acceptable.	

If lubricants compliant with the required specifications are not available, products that comply with the minimum required characteristics can be used for topping up; in this case optimal performance of the engine is not guaranteed.



Caution!

- ❑ *Mixing of engine coolant (antifreeze) other than specified Organic Additive Technology (OAT) engine coolant (antifreeze), may result in engine damage and may decrease corrosion protection. Organic Additive Technology (OAT) engine coolant is different and should not be mixed with Hybrid Organic Additive Technology (HOAT) engine coolant (antifreeze) or any “globally compatible” coolant (antifreeze). If a non-OAT engine coolant (antifreeze) is introduced into the cooling system in an emergency, the cooling system will need to be drained, flushed, and refilled with fresh OAT coolant (conforming to MS.90032), by an authorized dealer as soon as possible.*
- ❑ *Do not use water alone or alcohol-based engine coolant (antifreeze) products. Do not use additional rust inhibitors or antirust products, as they may not be compatible with the radiator engine coolant and may plug the radiator.*
- ❑ *This vehicle has not been designed for use with propylene glycol-based engine coolant (antifreeze). Use of propylene glycol-based engine coolant (antifreeze) is not recommended.*

PERFORMANCE

Performance

Top speed after the initial period of usage of the vehicle.

Version	MPH (km/h)
1.4 Turbo Multi Air 164HP	130 (209.2)



MULTIMEDIA

CYBERSECURITY218
TIPS, CONTROLS AND GENERAL INFORMATION219
FIAT CONNECT 7.0220



CYBERSECURITY

Your vehicle may be a connected vehicle and may be equipped with both wired and wireless networks. These networks allow your vehicle to send and receive information. This information allows systems and features in your vehicle to function properly.

Your vehicle may be equipped with certain security features to reduce the risk of unauthorized and unlawful access to vehicle systems and wireless communications. Vehicle software technology continues to evolve over time, and FCA US LLC, working with its suppliers, evaluates and takes appropriate steps as needed. Similar to a computer or other devices, your vehicle may require software updates to improve the usability and performance of your systems, or to reduce the potential risk of unauthorized and unlawful access to your vehicle systems.

The risk of unauthorized and unlawful access to your vehicle systems may still exist, even if the most recent version of vehicle software (such as Connect software) is installed.



Warning!

It is not possible to know or to predict all of the possible outcomes if your vehicle's systems are breached. It may be possible that vehicle systems, including safety related systems, could be impaired or a loss of vehicle control could occur that may result in an accident involving serious injury or death.

ONLY insert media (e.g., USB or SD card) into your vehicle if it came from a trusted source. Media of unknown origin could possibly contain malicious software, and if installed in your vehicle, it may increase the possibility for vehicle systems to be breached.

As always, if you experience unusual vehicle behavior, take your vehicle to your nearest authorized dealer immediately.

Note:

FCA US LLC or your dealer may contact you directly regarding software updates.

To help further improve vehicle security and minimize the potential risk of a security breach, vehicle owners should:

- Only connect and use trusted media devices (e.g. personal mobile phones or USBs).

Privacy of any wireless and wired communications cannot be assured. Third parties may unlawfully intercept information and private communications without your consent.

TIPS, CONTROLS AND GENERAL INFORMATION

Road Safety

Read the instructions for the various systems carefully before operating your vehicle.



Warning!

❑ Always drive safely with your hands on the steering wheel and obey all applicable laws. You have full responsibility and assume all risks related to the use of the features and applications in this vehicle.

Only use the features and applications in this vehicle when it is safe to do so. Failure to do so may result in an accident involving in serious injury or death.

❑ It can be dangerous, if the volume of the sound system is too loud. If the volume is too loud to hear background noises (e.g. horns, ambulances, police vehicles, etc.) injury may occur.

Reception Conditions

Reception conditions change constantly while driving.

Reception may be interfered with by the presence of mountains, buildings or bridges, especially when you are far away from the broadcaster.

Note:

The volume may be increased when receiving traffic alerts and news.

Care And Maintenance

Observe the following precautions to ensure the system is fully operational:



Caution!

❑ The display lens should not come into contact with pointed or rigid objects, which could damage its surface. Use a soft, dry anti-static cloth to clean.

❑ Prevent any liquid from entering the system. This could damage it beyond repair.

❑ Do not attach any object to the touchscreen. Doing so can result in damage to the touchscreen. Do not press the screen with any hard or sharp objects (pen, USB stick, jewelry, etc.). It could scratch the touchscreen surface!

❑ Do not spray any liquids or chemicals directly on the screen! Use a clean and dry micro fiber lens cleaning cloth in order to clean the touchscreen.

Note:

❑ If necessary, use a lint-free cloth dampened with a cleaning solution, such as isopropyl alcohol, or an isopropyl alcohol and water solution ratio of 50:50.

❑ Be sure to follow the solvent manufacturer's precautions and directions.

Important Information

Look at the screen only when it is necessary and safe. If you need to look at the screen for a long time, pull over to a safe place to prevent a distraction while driving.

Immediately stop using the system in the event of a fault. Otherwise, the system might be damaged.

Contact an authorized dealer as soon as possible to have the system repaired.



FIAT CONNECT 7.0

Steering Wheel Controls

The controls for the main system functions are located on the steering wheel.

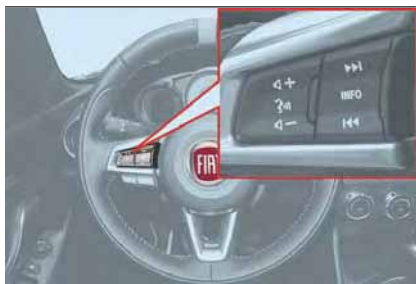

0620500-122-001AB

Steering Wheel Controls

Volume Switches

Push up on the volume switch + to increase the volume. Push down on the volume switch – to decrease the volume.

Seek Switch AM/FM Radio

Push the seek switch |◀◀/▶▶|. The radio switches to the previous/next stored station in the order that it was stored.

Push and hold the seek switch to seek all usable stations at a lower or higher frequency whether programmed or not.

Radio stations which have been previously stored in the favorite radio can be called up by pushing the seek switch while any radio station stored in the radio presets is being received.

Radio stations can be called up in the order they were stored with each push of the switch.

Sirius XM Satellite Radio – If Equipped

Push the Seek switch while listening to Sirius XM Satellite Radio to call up a station previously stored to the favorites list.

Push and hold the seek switch to go to the next station or return to the previous station.

USB Audio Bluetooth/Audio

Push the seek switch to skip forward to the next track.

Push the seek switch within a few seconds after playback begins to return to the previous track. Push the seek switch after a few seconds of playback to start from the beginning of the current track.

Aha/Stitcher Radio – If Equipped

Push the seek switch to skip forward to the beginning of the next track.

Push and hold the seek switch to evaluate the playback of the current song as “Like”. Push and hold the seek switch to evaluate the playback of the current song as “Dislike”.

Mute Switch

Push the mute switch  once to mute audio. Push it again to resume audio output.

If the ignition is placed off with the audio muted, the mute will be canceled. Therefore, when the engine is restarted, the audio is not muted. To mute the audio again, push the mute switch .

Audio Set

Multimedia Control Knob Operation

Note:



For safety reasons, some operations are disabled while the vehicle is being driven.



06020400-122-002

Multimedia Control Knob

The following operations can be done by pushing the switches around the commander knob:

-  Displays the Home screen.
-  Displays the Entertainment screen.
- NAV: Displays the Navigation screen (if equipped). If the SD card for the navigation system is not inserted, the compass, indicating the vehicle's direction, is displayed.

-  Displays the Favorites screen. Long-press to store particular items in "Favorites" (radio, phonebook, and destination of the navigation system can be programmed).

-  Returns to previous screen.

Volume Knob Operation

Push the **VOL** knob to switch MUTE on and off.

Turn the volume knob to adjust the volume. The volume increases by turning the knob clockwise, and decreases by turning it counterclockwise.

Selection Of Icons On Screen

Tilt or turn the Commander knob and move the cursor to the desired icon. Push the Commander knob and select the icon.

Note:

Long-press operation of the Commander knob is also possible for some functions.

Touch Panel Operation

Touch & Tap: Touch or tap on the item indicated on the screen. The operation is launched and the next item is displayed.

Slide: Touch the setting item displaying a slider bar. Touch the slider with your finger and move to the desired level.

Swipe: Touch the screen with your finger and move up or down. Items which were not displayed can be displayed.



Do not press the screen strongly or press it with a sharp-pointed object. Otherwise, the screen could be damaged.

Note:

For safety reasons, touchscreen operation is disabled while the vehicle is moving.





Audio Sound Adjustment

Select the  icon on the home screen to display the Settings screen.

Select **Sound** to select the item you would like to change:



- Bass (Low pitch sound): Increase or decrease the Bass (low pitch sound).
- Treble (Treble sound): Increase or decrease the Treble.





-  Fade (Front/rear volume balance): Adjust the audio volume from either the front or rear speakers.
-  Balance (Left/right volume balance): Adjust the audio volume from either the right or left speakers.
-  ALC (Automatic volume adjustment) (standard audio): Adjust the levels in which the audio volume increase or decreases in relation to vehicle speed.
-  Bose Audio Pilot — If Equipped (Automatic volume adjustment): Turn the Bose Audio Pilot system ON or OFF.
-  Beep (Audio operation sound): Turn the audio system operation “beep” ON or OFF.

Home Screen

Icons visualized on home screen are:



-  Applications: Information such as average fuel economy, maintenance, and warnings can be verified. Depending on the grade and specification, the screen display may differ.
-  Entertainment: Operates the audio systems such as the radio and CDs. The audio source most recently used is displayed. An audio source which cannot be used at that time is skipped, and the previous audio source







is displayed. To change the audio source, select the icon displayed at the bottom of the screen.

-  Communication: Bluetooth related functions are available.
-  Navigation — If Equipped: Navigation screen is displayed. If the SD card for the navigation system is not inserted, the compass indicating the direction in which the vehicle is moving is displayed. The compass may not indicate the correct bearing when the vehicle is stopped or travelling at a slow speed.
-  Settings: Settings for the menu (such as display, sound, Bluetooth and Language). Depending on the grade and specification, the screen display may differ.

Operating The Radio

Select the icon  on the home screen to display the “Entertainment” screen. When selecting the desired radio, the following icons are indicated in the lower part of the display:

-  Displays the “Entertainment” menu. Use to switch to a different audio source;
-  Displays the list of receivable radio stations (FM only);

-  Displays the station list (AM only). Select “**Update Station List**” to display the frequencies of up to ten radio stations on the auto memory preset list. Select the desired frequency.
-  Displays the Favorites list. Push and hold to store radio station currently being aired.
-  You can search for receivable radio stations. Scanning stops at each station for about five seconds. Select again to continue receiving the radio station.
-  You can change the radio frequency manually. Rotate the commander knob, slide the screen, or touch the radio frequency. Push the forward or back buttons to change the radio frequency one step at a time. When the forward or back button is held, the radio frequency changes continually. It stops when you remove your hand from the icon or the commander knob.
-  Switches the TA mode on and off.
-  Automatic radio station selection. When held, the radio frequency changes continually. It stops when you remove your hand from the icon or the commander knob.

 Displays the FM settings screen (FM only). Selectable “On” or “Off” for alternative frequency and Region lock can be set.

 Displays sound settings to adjust audio quality level.

Note:

When the Seek icon is selected while FM mode, each program is selected.

Settings

Note:

Depending on the grade and specification, the screen display may differ.

Select the  icon on the home screen to display the Settings screen. Switch the tab and select the setting item you want to change. For example, you can enable/disable the “Daytime Running Lights” feature through the settings menu by selecting the “Vehicle” option, then selecting the “Lighting” option with in the “Vehicle” menu, and then selecting the preferred option of “On” or “Off” for the “Daytime Running Lights” feature (Daytime Running Lights cannot be turned off in vehicles sold in the Canadian market).

You can customize settings in the setup display as follows:

Display: Refer to the FIAT Connect 7.0 supplement for further information.

Safety: Blind Spot Monitoring Volume or Other

Sound: Refer to the FIAT Connect 7.0 supplement for further information.

Clock: Adjust Time, GPS Sync, Time Format, Time Zone Select, or Daylight Savings Time.

Vehicle: Rain sensing Wiper, Door Lock, or Other.

Devices: Select Bluetooth or Network Management.

System: Tool Tips, Language, Temperature, Distance, Music Database Update, Factory Reset, About (agreements and disclaimers), or About (version information).

AUX/USB/iPod Mode — If Equipped

Audio can be heard from the vehicle's speakers by connecting a portable audio device to the auxiliary jack. An Auxiliary cable is required.

In addition, audio can be played from the vehicle audio system by connecting a USB device or an iPod to the USB port.



06020700-122-001

USB/Auxiliary Jack Location

- 1 — USB Port
- 2 — Auxiliary Jack

How To Connect USB Port/Auxiliary Jack

If there is a cover on the AUX jack or USB port, remove the cover.

Connecting A USB — If Equipped:

Connect the connector on the device to the USB port.

Connecting With An Auxiliary Cable:

Connect the device plug/connector lead to the auxiliary jack.



How To Use AUX Mode

Select the  icon to display “Entertainment” on the home screen. Select “Audio Source” to see a list of sources available. Select **AUX** to switch to the AUX mode.

Playable Data: MP3/WMA/AAC/OGG file.

Note:

- If a device is not connected to the auxiliary jack, the mode will not switch to the AUX mode.
- Adjust the audio volume using the portable audio device, commander switch, or audio control switch. Audio adjustments can also be made using the portable audio device's volume setting.
- If the connection plug is pulled out from the auxiliary jack while in AUX mode, noise may occur.
- This unit does not support a USB 3.0 device. In addition, other devices may not be supported depending on the model or OS version. USB devices formatted to FAT32 are supported (USB devices formatted to other formats such as NTFS are not supported).

Bluetooth Hands Free



Warning!

- Always drive safely with your hands on the steering wheel and obey all applicable laws. You have full responsibility and assume all risks related to the use of the features and applications in this vehicle. Only use the features and applications in this vehicle when it is safe to do so. Failure to do so may result in an accident involving in serious injury or death.*
- It can be dangerous, if the volume of the sound system is too loud. If the volume is too loud to hear background noises (e.g. horns, ambulances, police vehicles, etc.) injury may occur.*

Device Pairing

To use Bluetooth audio and Hands-Free, the device equipped with Bluetooth has to be paired to the unit using the following procedure. A maximum of seven devices including Bluetooth audio devices and hands-free mobile phones can be paired.

Note:

The Bluetooth system may not operate for one or two minutes after the ignition is switched to ACC or ON. However, this does not indicate a problem. If the Bluetooth system does not connect automatically after one or two minutes have elapsed, make sure that the Bluetooth setting on the device is normal and attempt to reconnect the Bluetooth device from the vehicle side.

Pairing Procedure

Proceed as follows:

1. Select the  icon on the home screen to display the “Settings” screen.
2. Select the **Devices** tab.
3. Select Bluetooth and turn the Bluetooth setting on
4. Select Add New Device to display the message and switch to the device operation. Using your device, perform a search for the Bluetooth device (external device).
5. Select “124 Spider” from the device list searched by the device.

6. Device with Bluetooth version 2.0 input the displayed 4-digit pairing code into the device. Device with Bluetooth version 2.1 or higher make sure the displayed 6-digit code on the audio is also displayed on the device, and touch the Yes. Connection permission and phonebook access permission for your mobile device may be required depending on the mobile device. If pairing is successful, the functions of the device connected to Bluetooth are displayed.

7. Devices compatible with SMS function SMS messages is downloaded automatically. A download permission operation for your device may be required depending on the device. After a device is registered, the system automatically identifies the device.

Device Selection

If several devices have been paired, the Bluetooth unit links the device last paired. If you would like to link a different paired device, it is necessary to change the link. The order of device priority after the link has been changed is maintained even when the ignition is switched off.

Connecting Other Devices

Proceed as follows:

1. Select the  icon on the home screen to display the “Settings” screen.
2. Select the Devices tab then select Bluetooth. Turn the Bluetooth setting on and select the name of the device you would like to connect.
3. Phone and Audio selection connects both devices as hands-free and Bluetooth audio. Phone Only selection connects as a hands-free device. Audio Only selection connects as Bluetooth audio.

Making A Call

Telephone calls can be made by saying the contact name in the downloaded phonebook or the name of a person whose phone number has been registered in the Bluetooth hands-free. Push the talk button and wait for the beep sound, say: “Call XXXXX... (Ex. “John”) Mobile” and follow the voice guidance to place the call.

Import Contact (download Phonebook)

Phonebook data from your device (Mobile phone) can be sent and registered to your Bluetooth hands-free phonebook using Bluetooth.

Automatic Downloading: The “Auto Download Contacts” setting must be on. When hands-free is connected to the device, the phonebook is downloaded automatically.

Manually Downloading: If the “Auto Download Contacts” setting is off, download the phonebook using the following procedure:

1. Select the  icon on the home screen to display the “Communication” screen.
2. Select Contacts to display the contact list.
3. Select Edit Contacts.
4. Select Import All Contacts or Import Selected Contact to switch to the device operation. If Import All Contacts is selected, select Download. Download will be started from the mobile phone.

Note:

A maximum of 1000 contacts can be registered to the phonebook.



Receiving An Incoming Call

When an incoming call is received, the incoming call notification screen is displayed. The “Incoming Call Notifications” setting must be on.

To accept the call: Push the steering wheel button on the audio control switch, or select Answer on the screen.
To reject the call: Push the hang-up button on the audio control switch, or select Ignore on the screen.

Navigation — If Equipped SD Card — If Equipped

To use the navigation system, the SD card containing the map information needs to be inserted in the SD card slot. When inserting the SD card, never move the slider on the side of the SD card to the LOCK position. If the slider is set to LOCK, the SD card cannot be read and the navigation system will not operate.

This SD card is valid for use in only one vehicle. Never use it in another vehicle. If the SD card is used first in one vehicle and then in another, the navigation system for either one of the vehicles may become inoperable.



Navigation Menu





Select  and open the navigation menu. You have the following options :



11000001-121-112

Navigation Screen

-  /  Open / Close. Opens and closes the UMP (menu bar). The UMP (menu bar) is displayed on the lower part of the screen.
-  Adds a destination. Select your destination by entering an address, selecting a POI (Point Of Interest), selecting a location on the map, or selecting one of your Favorite destinations. You can also look up your recent destinations from the Smart History by entering the coordinates. If an internet connection is available, Local Search can be of further help to find your destination.

- Displays the screen where traffic information and the GPS reception conditions can be set and verified.
-  Cancels waypoint/route.
-  Finds Places nearby. You can search for Points Of Interest (POI) near the vehicle position.
-  Displays the route parameters and the route in its full length on the map. You can also perform route-related actions such as editing or cancelling your route, picking route alternatives, avoiding parts of the route, simulating navigation or adding the destination to your Favorites.
- 2D / 3D Change View Mode. The map view mode can be changed (2D north up/2D heading up/3D).
-  Switches to the Settings screen where you change navigation settings.

Note:

Some functions are not available depending on some countries and regions.

Navigating On The Map

The data fields are different when you are navigating an active route and when you have no specified destination (the burgundy line is not displayed).



11000001-121-111

Navigating A Route On The Map

Current Speed Limit (represented by the 48 in the red circle): shows the speed limit of the current road if the map contains it.

Distance and Time to Arrival (represented by 2.0 km/8:31): shows the distance you need to travel on the route before reaching your final destination and the estimated arrival time at the final destination of the route.

Note:

Some functions are not available depending on some countries and regions.

Objects On The Map

Streets And Roads: the navigation system shows the roads in different widths and colors so that they can be easily identified. A highway will be thicker and a different color than a small street.

Turn Preview And Next Street: when navigating a route, the top section of the Map screen shows information about the next maneuver, street or town. There is an area at the top left part of screen which indicates the next operation. Displays both the event type (such as turning, detouring, exiting expressways) and the distance from the current position.

Lane Information And Signposts: when navigating on multilane roads, it is important to take the appropriate lane in order to follow the recommended route. If lane information is available in the map data, the navigation system displays the lanes and their directions using small arrows at the bottom of the map. Highlighted arrows represent the lanes and direction you need to take.

Junction View: if you are approaching a highway exit or a complex intersection and the needed information exists, the map is replaced with a 3D view of the junction.

Expressway Exit Services: you may need a petrol station or a restaurant during your journey. This feature displays a new button on the map when you are driving on highways. Select this Open button to open a panel with the details of the next few exits or service stations.

Elements Of The Active Route: the navigation system shows the route in the following way.

Selecting The Destination Of A Route

To enter an address as the destination, do as follows:

1. Select the “Add A Destination” button after selecting the “Open/Close Menu” button on the MAP screen.
2. Select Find Address. By default, the navigation system locates the country and town where you are. If needed, select the Country, enter the first few letters of the country name on the keyboard, and select one country from the list of results.
3. If needed, select a new town. Select Town and start entering the name of the town on the keyboard. Find the town you need: the most likely town name is always shown in the input field.



To accept it, select the checkbox. If the desired name does not show up, the names that match the string appear in a list after entering a couple of characters (to open the list of results before it appears automatically, select the “Receivable Audio Stations” button and select the town from the list).

4. Enter the street name: select <Street Name> and start entering the name of the town on the keyboard. Find the street you need: the most likely street name is always shown in the input field. To accept it, select the checkbox. If the desired name does not show up, the names that match the string appear in a list after entering a couple of characters (to open the list of results before it appears automatically, select the “Receivable Audio Stations” button and select the street from the list).

5. Enter the house number: select House Number then enter the house number on the keyboard (to enter letters, select **QWE**). Select the checkbox to finish entering the address. (If the entered house number cannot be found, the midpoint of the street is selected as the destination.

6. The selected location is shown on the map. Navigation starts if Start is selected, or after 10 seconds of no user

interaction. By touching the location displayed on the screen, you can verify the route. Additionally, the route can be revised by selecting other options.

Selecting The Destination From The POI (Point Of Interest)

If the name for a POI (Point Of Interest) is input, a search candidate list is displayed.

Proceed as follows:

1. Select the “Add A Destination” button after selecting the “Open/Close Menu” button on the MAP screen.
2. Select **Find Places**.
3. Select **Filter by Name**.
4. Using the keyboard, enter the name of the POI (Point Of Interest). After entering a few letters, select to open the list of POI with names containing the entered character sequence.
5. The selected location is shown on the map. The system transitions to the next screen by selecting Navigate To, or it returns to the previous screen by selecting the < button.

Note:

By touching the location displayed on the screen, you can change the destination to anywhere on the map.

Selecting The Destination From Your Favorites

Proceed as follows:

1. Select the “Add A Destination” button after selecting the “Open/Close Menu” button on the MAP screen.
2. In the Navigation menu, select Favorites. When Favorites is selected, the screen transfers to the Favorites screen. Select your registered favorite.
3. The selected location is shown on the map. The system transitions to the next screen by selecting Navigate To, or it returns to the previous screen by selecting the < button. By touching the location displayed on the screen, you can change the destination to anywhere on the map.
4. Navigation starts if Start is selected, or after 10 seconds of no user interaction. By touching the location displayed on the screen, you can verify the route. Additionally, the route can be revised by selecting other options.

Modifying The Route



Proceed as follows:

1. Select “New Route” to plan a new route to the newly selected location. The previous destination and waypoint(s) are deleted.

2. Select “Waypoint” to add the newly selected location as an intermediate destination to your route. The other destinations of the route remain intact. The new waypoint is placed among destinations to keep the route optimal. To decide where a waypoint will appear, use the “Edit Route” feature.

3. Select “Final Destination” to append the newly selected destination at the end of the route. The other destinations of the route remain intact. The previous final destination is now the last waypoint.

Settings Menu

Select the  icon after selecting the  on the MAP screen.

Settings menu options:

Map Settings: Fine-tune the appearance of the Map screen, adjust the map view to your needs, Show or hide 3D buildings, or Manage POI (point of interest) display settings (which POI to show on map).

Guidance Settings: a guidance-related setting is available during route guidance.

Warning Settings: a setting related to warnings.

Route Settings: a setting related to updating the route.

Traffic Settings: a setting for traffic information.

Connected Settings: a setting for online service.

Note:

Some functions are not available depending on some countries and regions.

Map Settings

The map is always shown on the screen. Scroll the screen downward to display the setting behind the lower part of the screen:

View Mode: when this button is selected, the map view mode can be changed. 3D displays things such as actual construction sites three dimensionally on the map. 2D the map is rotated so that the direction of travel is displayed in the upward direction/2D N the map is displayed so that north is up (regardless of the direction of travel).

Viewpoint: adjust the basic zoom and tilt levels to your needs. Three levels are available.

Automatic Zoom: during route guidance in any map view mode, the function for zooming in on approaching intersections automatically turns on/off.

Buildings: show or hide 3D town models, 3D artistic or block representation of all town building data containing actual building sizes and positions on the map.

Highway Overview: when enabled, the map zooms out to show an overview of the surrounding area if the next route event is far away. The system goes back to the normal map view when you approach the next event.

Place Markers: select which Places to show on the map while navigating. Too many Places make the map crowded; it is a good idea to show as few as possible. You have the following possibilities. Select the checkbox to show or hide the Place category, or select the name of the Place category to open the list of its subcategories.



CUSTOMER ASSISTANCE

SUGGESTIONS FOR OBTAINING SERVICE FOR YOUR VEHICLE232
IF YOU NEED ASSISTANCE232
WARRANTY INFORMATION234
REPORTING SAFETY DEFECTS234
PUBLICATION ORDER FORMS235



SUGGESTIONS FOR OBTAINING SERVICE FOR YOUR VEHICLE

Prepare For The Appointment

If you are having warranty work done, be sure to bring the right papers with you, as well as your warranty folder. All work to be performed may not be covered by the warranty. Discuss additional charges with the service manager. Keep a maintenance log of your vehicle's service history, as this can often provide a clue to the current problem.

Prepare A List

Make a written list of your vehicle's problems or the specific work you want done. If you've had an accident or work done that is not on your maintenance log, let the service advisor know.

Be Reasonable With Requests

If you list a number of items and you must have your vehicle by the end of the day, discuss the situation with the service advisor and list the items in order of priority. At many authorized dealers, you may obtain a rental vehicle at a minimal daily charge. If you need a rental, it is advisable to make these arrangements when you call for an appointment.

IF YOU NEED ASSISTANCE

The manufacturer and its authorized dealer are vitally interested in your satisfaction. We want you to be happy with our products and services.

Warranty service must be done by an authorized dealer. We strongly recommend that you take the vehicle to an authorized dealer. They know your vehicle the best, and are most concerned that you get prompt and high quality service. The manufacturer's authorized dealer have the facilities, factory-trained technicians, special tools, and the latest information to ensure the vehicle is fixed correctly and in a timely manner.

This is why you should always talk to an authorized dealer service manager first. Most matters can be resolved with this process.

- If for some reason you are still not satisfied, talk to the general manager or owner of the authorized dealer. They want to know if you need assistance.
- If an authorized dealer is unable to resolve the concern, you may contact the manufacturer's customer center.

Any communication to the manufacturer's customer center should include the following information:

- Owner's name and address
- Owner's telephone number (home and office)
- Authorized dealer name
- Vehicle Identification Number (VIN)
- Vehicle delivery date and mileage

FIAT Customer Center

P.O. Box 21-8004 Auburn Hills, MI 48321-8004

Phone: 1-888-242-6342

FIAT Canada Customer Center

P.O. Box 1621

Windsor, Ontario N9A 4H6

Phone: (800) 465-2001 English / (800) 387-9983 French

In Mexico Contact

Av. Prolongacion Paseo de la Reforma, 1240

Sante Fe C.P. 05109

Mexico, D. F.

In Mexico City: 5081-7568

Outside Mexico City: 1-800-505-1300

Puerto Rico And U.S. Virgin Islands

Customer Service Chrysler International Services LLC

P.O. Box 191857

San Juan 00919-1857

Tel.: (787) 782-5757

Fax: (787) 782-3345

Customer Assistance For The Hearing Or Speech Impaired (TDD/TTY)

To assist customers who have hearing difficulties, the manufacturer has installed special TDD (Telecommunication Devices for the Deaf) equipment at its customer center. Any hearing or speech impaired customer, who has access to a TDD or a conventional teletypewriter (TTY) in the United States, can communicate with the manufacturer by dialing 1-800-380-CHRY.

Canadian residents with hearing difficulties that require assistance can use the special needs relay service offered by Bell Canada. For TTY teletypewriter users, dial 711 and for Voice callers, dial 1-800-855-0511 to connect with a Bell Relay Service operator.

Service Contract

You may have purchased a service contract for a vehicle to help protect you from the high cost of unexpected repairs after the manufacturer's New Vehicle Limited Warranty expires. The manufacturer stands behind only the manufacturer's service contracts. If you purchased a manufacturer's service contract, you will receive Plan Provisions and an Owner Identification Card in the mail within three weeks of the vehicle delivery date. If you have any questions about the service contract, call the manufacturer's Service Contract National Customer Hotline at 1-800-521-9922 (Canadian residents, call (800) 465-2001 English / (800) 387-9983 French).

The manufacturer will not stand behind any service contract that is not the manufacturer's service contract. It is not responsible for any service contract other than the manufacturer's service contract. If you purchased a service contract that is not a manufacturer's service contract, and you require service after the manufacturer's New Vehicle Limited Warranty expires, please refer to the contract documents, and contact the person listed in those documents.

We appreciate that you have made a major investment when you purchased the vehicle. An authorized dealer has also made a major investment in facilities, tools, and training to assure that you are absolutely delighted with the ownership experience. You will be pleased with their sincere efforts to resolve any warranty issues or related concerns.



Warning!

Engine exhaust (internal combustion engines only), some of its constituents, and certain vehicle components contain, or emit, chemicals known to the State of California to cause cancer and birth defects, or other reproductive harm. In addition, certain fluids contained in vehicles and certain products of component wear contain, or emit, chemicals known to the State of California to cause cancer and birth defects, or other reproductive harm.



WARRANTY INFORMATION

See the Warranty Information Booklet, for the terms and provisions of FCA US LLC warranties applicable to this vehicle and market.

REPORTING SAFETY DEFECTS

In The 50 United States And Washington, D.C.

If you believe that your vehicle has a defect that could cause a crash or cause injury or death, you should immediately inform the National Highway Traffic Safety Administration (NHTSA) in addition to notifying FCA US LLC.

If NHTSA receives similar complaints, it may open an investigation, and if it finds that a safety defect exists in a group of vehicles, it may order a recall and remedy campaign. However, NHTSA cannot become involved in individual problems between you, your authorized dealer or FCA US LLC.

To contact NHTSA, you may call the Vehicle Safety Hotline toll free at 1-888-327-4236 (TTY: 1-800-424-9153); or go to <http://www.safercar.gov>; or write to: Administrator, NHTSA, 1200 New Jersey Avenue, SE., West Building, Washington, D.C. 20590. You can also obtain other information about motor vehicle safety from <http://www.safercar.gov>.

In Canada

If you believe that your vehicle has a safety defect, you should contact the Customer Service Department immediately. Canadian customers who wish to report a safety defect to the Canadian government should contact Transport Canada, Motor Vehicle Defect Investigations and Recalls at 1-800-333-0510 or go to <http://www.tc.gc.ca/roadsafety/>.

PUBLICATION ORDER FORMS

To order the following manuals, you may use either the website or the phone numbers listed below. Visa, Mastercard, American Express, and Discover orders are accepted.

Service Manuals

These comprehensive Service Manuals provide the information that students and professional technicians need in diagnosing/troubleshooting, problem solving, maintaining, servicing, and repairing FCA US LLC vehicles.

A complete working knowledge of the vehicle, system, and/or components is written in straightforward language with illustrations, diagrams, and charts.

Diagnostic Procedure Manuals

Diagnostic Procedure Manuals are filled with diagrams, charts and detailed illustrations. These practical manuals make it easy for students and technicians to find and fix problems on computer-controlled vehicle systems and features. They show exactly how to find and correct problems the first time,

using step-by-step troubleshooting and drivability procedures, proven diagnostic tests, and a complete list of all tools and equipment.

User Guide

These User Guides have been prepared with the assistance of service and engineering specialists to acquaint you with specific FCA US LLC vehicles. Included are starting, operating, emergency and maintenance procedures as well as specifications, capabilities and safety tips.

Call toll free at:

1-800-890-4038 (U.S.)

1-800-387-1143 (Canada)

Or

Visit us on the Worldwide Web at:

www.techauthority.com



INDEX

About Your Brakes	111	B-Pillar Location	189	Close The Hood	41
ABS System	72	Battery (Maintenance).	183	Compact Spare Tire.	196
Adaptive Front Lighting System (AFS)	27	Battery Charging Procedure.	184	Contract, Service	233
Additives, Fuel	127	Battery Recharging	184	Convertible Top	42
Advanced Keyless Entry System		Blind Spot Monitoring	74	Customer Assistance	232
Key Left In Trunk	13	Bodywork (care and maintenance)	202	Data Recorder, Event	106
Locking Doors	13	Boot, Convertible Top Lowering	42	Daytime Running Lights	25
Passive Entry	13	Boot, Convertible Top Precautions	45	Diagnostic System, Onboard	68
Request Switch	13	Boot, Convertible Top Raising	44	Dimensions	211
Unlocking Doors	13	Brake System.	111	Disabled Vehicle Towing	166,168
Air Bag.	92,96	Brake/Clutch Fluid (Level Check).	182	Driver's Seat Back Tilt	19
Advance Front Air Bag	92,96	Brakes	111	Electric Remote Mirrors	24
Air Bag Warning Light	107	Camera, Rear.	123	Electronic Brake Control System Traction Control System	72
Event Data Recorder (EDR)	106,169	Carbon Monoxide Warning	128	Electronic Speed Control (Cruise Control)	119
Front Air Bag	107	Changing A Flat Tire.	150,151,184	Emergency Fuel Filler Door Release.	129
Maintaining Your Air Bag System	105	Chart, Tire Sizing.	186	Emergency Key	9
Air Bag Maintenance	105	Check Engine Light (Malfunction Indicator Light)	69	Emergency, In Case Of.	155
Air Pressure, Tires	192	Checking Levels	180	Hazard Warning Flasher	132
Alarm		Child Restraint	89	Jacking	150,151,184
Vehicle Security Alarm	14,15	Child Restraints		Jump Starting	164
Alarm (Security Alarm)	14,15	Child Restraints	89	Overheating	165
Automatic Dimming Mirror.	23	Clean Air Gasoline	127	Towing	166,168
Automatic Headlights.	25	Cleaning			
Automatic Temperature Control (ATC)	32	Wheels	198		
Automatic Transmission	113	Climate Control	30		

Emission Control System Maintenance	69	Fuel Additives127	Hood Release41
Engine210	Clean Air127	How To Use This Manual3
Exhaust Gas Caution128	Ethanol127	Identification Data208
Jump Starting164	Materials Added127	Inside Rearview Mirror23
Overheating165	Methanol127	Instrument Cluster Display Information Display48,49
Starting12	Fuel Filler Cap129	Interiors205
Engine Compartment180	Fuel Filler Door128	Jack Location.150
Engine Coolant (Level Check).181	Fuse Block (Engine Compartment).144	Jack Operation150,151,184
Engine Oil (Level Check)181	Fuse Block (Interior)148	Jump Starting.164
Essential information3	Fuses (Interior)142	Key Fob8
Ethanol127	Fuses (Underhood)143	Emergency Key8
Event Data Recorder106	Gasoline, Clean Air127	Key-In Reminder.12
Exhaust Gas Caution128	Gasoline, Reformulated127	Keyless Entry System.13
Exterior Lights25	Gear Selector Positions115	Lane Change And Turn Signals26
FIAT Connect 7.0220	General Information219	Lane Change Assist.26
Flash-To-Pass25	Hazard Warning Flasher132	Lap/Shoulder Belts83,85
Flashers Hazard Warning132	Head Restraints21	Life Of Tires194
Turn Signal26	Headlight25	Lights Daytime Running25
Fluid And Lubricants213	Headlights High Beam25	Fog26
Fluid Capacities212	Passing25	Hazard Warning Flasher132
Fog Lights.26	Heavy-Duty Use Of The Vehicle (Scheduled Servicing)173	Passing25
Follow Me Home26	HomeLink (Garage Door Opener)36	Turn Signal26
Front Wipers Wiper Operation27				



Loading Vehicle	Parking Brake.111	Replacing A Bulb132
Tires	Passing Light.25	Replacing Exterior Light Bulbs135
Locks	Performance215	Replacing Fuses141
Power Door	Periodic Checks (Scheduled Servicing)173	Reporting Safety Defects234
Maintaining The Finish	Placard, Tire And Loading Information.189	Restraint, Head21
Maintenance Monitor	Power		Restraints, Child89
Malfunction Indicator Light (Check Engine)	Brakes111	Safety Defects, Reporting234
Manual Climate Control System	Door Locks15	Safety Information, Tire.185
Manual Transmission	Mirrors24	Safety Systems72
Manual, Service	Pregnant Women And Seat Belts84	Scheduled servicing.172
Methanol.	Pretensioners		Seat Belt	
Mirrors	Seat Belts88	Energy Management Feature88
Automatic Dimming	Radial Ply Tires193	Lap/Shoulder Belts83,85
Electric Remote	Radio Frequency		Pregnant Women84
Exterior Folding	General Information12,14	Seat Belt Extender87
Outside	Rear Camera123	Seat Belt Pretensioner88
Rearview	Rear Park Assist System.122	Seat Belt Reminder88
Navigation	Rearview Mirrors.23	Seat Belt Reminder88
Occupant Restraints	Recorder, Event Data106	Seat Belts83
Onboard Diagnostic System	Recreational Towing.130	Child Restraint89
Operating Precautions	Reformulated Gasoline127	Extender87
Outside Rearview Mirrors	Refueling Procedure.128	Front Seat83
Overheating, Engine.	Refueling The Vehicle126	Pregnant Women84
Owner's Manual	Reminder, Seat Belt.88	Pretensioners88
(Operator Manual)	Replacement Tires.194	Rear Seat83
			Seats.19,20
			Adjustment19
			Heated20

Seatback Release	19	Tire And Loading Information	To Open Deck Lid38
Tilting	19	Placard	To Open Hood41
Seats And Fabric Parts		Tire Markings	Towing	
(Cleaning).205	Tire Rotation	Disabled Vehicle166,168
Security Alarm		Tire Safety Information	Towing Eyes.166
Security Alarm14,15	Tire Service Kit	Towing Trailers130
Service Assistance232	Tires	TPMS (Tire Pressure Monitoring	
Service Contract233	Aging (Life Of Tires)	System).80
Service Manuals235	Air Pressure	Tread Wear Indicators.194
Shift Lever Override116	Changing	Trunk Lid	
Shoulder Belts83,85	Compact Spare	Closing40
Signals, Turn26	Flat Changing	Opening38
Snow chains199	General Information	Turn Signals.26
Snow Tires196	High Speed		
Spare Tire150,196,197	Inflation Pressures	Uniform Tire Quality Grades201
Sport Mode119	Jacking	Vehicle Loading189
Starting12	Life Of Tires		
Starting And Operating.12	Load Capacity		
Starting Procedures.12	Pressure Monitor System	Warning Flasher, Hazard132
Starting the engine110	(TPMS)	Warranty Information234
Steering		Quality Grading	Washer Operation.27,29
Column Lock22	Radial	Washers, Windshield27
Tilt Column22	Replacement	Wheel And Wheel Trim198
Wheel, Tilt22	Safety	Wheel And Wheel Trim Care.198
Supplemental Restraint System -		Sizes	Wheels And Tires185
Air Bag92,96	Snow Tires	Window And Headlight Washer	
Symbols.3	Spare Tire	Fluid (Level Check)183
		Spinning		
Tilt Steering Column22	Tread Wear Indicators		



Windows

Driver/Passenger Window	
Controls34
Power Windows34
Window Lockout35
Windshield Wipers27
Wrecker Towing166,168

This guide has been prepared to help you get quickly acquainted with your new Abarth and to provide a convenient reference source for common questions. However, it is not a substitute for your Owner's Manual.

For complete operational instructions, maintenance procedures and important safety messages, please consult your Owner's Manual, Navigation/Uconnect Manuals and other Warning Labels in your vehicle.

Not all features shown in this guide may apply to your vehicle.

For additional information on accessories to help personalize your vehicle, visit **mopar.com** (U.S.), **mopar.ca** (Canada) or your local FIAT dealer.

DRIVING AND ALCOHOL: Drunken driving is one of the most frequent causes of collisions. Your driving ability can be seriously impaired with blood alcohol levels far below the legal minimum. If you are drinking, don't drive. Ride with a designated non-drinking driver, call a cab, a friend, or use public transportation.

WARNING

Driving after drinking can lead to a collision. Your perceptions are less sharp, your reflexes are slower, and your judgment is impaired when you have been drinking. Never drink and then drive.

Whether it's providing information about specific product features, taking a tour through your vehicle's heritage, knowing what steps to take following an accident, or scheduling your next appointment, we know you'll find the app an important extension of your vehicle. Simply download the app, select your make and model and enjoy the ride. **To get this app**, go directly to the App Store or Google Play and enter the search keyword "MY FIAT", (U.S. market only).

fiatusa.com/en/owners provides special offers tailored to your needs, customized vehicle galleries, personalized service records and more. To get this information, just create an account and check back often.

Download a FREE electronic copy
of the Owner's Manual or Warranty Booklet by visiting:

mopar.com/fiat,

fiatusa.com/en/owners/manuals or

fiatusa.com/en/warranty (U.S.);

owners.mopar.ca/en (Canada).

©2017 FCA US LLC. All Rights Reserved.
FIAT, ABARTH and the scorpion design are registered trademarks, used under license by FCA US LLC.

17BAFX124-926-AA
FIAT® 124 SPIDER ABARTH
Fourth Edition
User Guide

