

SEDONA

Features & Functions Guide



Delivery First
The priority that delivers more

GETTING TO KNOW YOUR **SEDONA**

Congratulations on Your New Kia Purchase!

Your new Kia vehicle has been designed, engineered and manufactured to provide you with years of comfortable and dependable driving. Kia is committed to quality, innovation, safety and — above all — your satisfaction.

Using This Guide

The information contained in this guide is a brief overview that will help you become familiar with the operation and features of your new Kia vehicle. The flipbook format facilitates information access, while the detailed illustrations help to ensure the instructions are easy to follow.

This **Features & Functions Guide**, and the specific operational and safety information it provides, is not a substitute for your Owner's Manual. In the interest of your safety and that of your family, and to help you avoid risks that may result in death or serious injury, Kia reminds you to carefully read your Owner's Manual in order to fully familiarize yourself with the important information it contains.

While the information contained in this guide is accurate at the time of printing, Kia may change vehicle specifications without notice in advance or after the fact, and assumes no liability in connection with such changes.

www.kia.com

Consumer - Roadside Assistance
1-800-333-4KIA (4542)

See Back Pages for Vehicle Maintenance Schedule

Always check the Owner's Manual for complete operating information and safety warnings.

ESSENTIAL FEATURES

Air Conditioning / Automatic Climate Control*	26
Audio System – Standard Audio System*	20
Audio System – UVO eServices System*	21
Audio System – UVO eServices / Premium Navigation*	22
Aux/USB/iPod® Port, AC Inverter* and Power Outlets	24
<i>Bluetooth</i> ® Wireless Technology	16
Cruise Control	18
Digital Clock	24
Passenger Airbag Off Indicator	44
Service Mode	07
Smart Key*	37
Tire Pressure Monitoring System (TPMS)	05
Trip Computer / Tripmeter	06
User Settings	07
Windshield/Rear Wipers & Washers*	15

Driving while distracted can result in a loss of vehicle control that may lead to an accident, severe personal injury and death. The driver's primary responsibility is in the safe and legal operation of a vehicle, and use of any handheld devices, other equipment or vehicle systems which take the driver's eyes, attention and focus away from the safe operation of a vehicle or that are not permissible by law should never be used during operation of the vehicle.

VIDEOS & QR CODES	02
------------------------------	----

INSTRUMENT CLUSTER

Instrument Cluster Overview	03
Indicators & Warning Lights	04
Tire Pressure Monitoring System (TPMS)	05
Fuel Economy	05
LCD Instrument Cluster Modes	06
Trip Computer / Tripmeter	06
User Settings	07
Service Mode	07
Drive Mode Integrated Control System*	08
Active ECO System*	08

DRIVER'S PANEL

Electronic Stability Control (ESC)	09
Hill-Start Assist Control (HAC)	09
Instrument Panel Dimmer	09
AC Inverter*	09
Blind Spot Detection (BSD) System*	10
Lane Departure Warning System (LDWS)*	11
Forward Collision Warning System (FCWS)*	11
Power Windows, Window Lock & Central Door Lock	12
Power Folding Outside Mirrors*	12
Heated Outside Mirrors*	12
Automatic Door Lock/Unlock	12
Fuel Door Release Button	12
Reverse Parking Aid Function*	13
Engine Start/Stop Button	13

STEERING WHEEL CONTROLS

Tilt/Telescoping Steering Wheel	14
Headlights & High Beams	14
Turn Signals & Fog Lights*	15
Windshield/Rear Wipers & Washers*	15
<i>Bluetooth</i> ® Wireless Technology	16
Audio Controls	18
Standard Cruise Control	18
Smart Cruise Control System (SCC)*	19

AUDIO SYSTEM

Standard Audio System*	20
UVO eServices System*	21
UVO eServices with Premium Navigation*	22

CENTER PANEL

Surround View Monitor (SVM)*	23
Digital Clock	24
Aux/USB/iPod® Port, AC Inverter* and Power Outlets	24
Automatic Gear Shift with Sportmatic® Shifting	25
Automatic Climate Control*	26
Manual Climate Control*	28
Heated Steering Wheel*	29
Seat Warmers / Ventilated Seats*	29

SEATING

Front Seat Headrest Adjustment	30
Driver Position Memory System*	30
Power Adjustable Driver's Seat*	31
Manual Adjustable Driver's Seat*	31
2nd-Row Seat	32
2nd-Row Slide-N-Stow Seat*	32
2nd-Row First-Class Lounge Seating*	33
2nd-Row Tumble (Center) Seat*	34
3rd-Row Seat - Folding and Stowing	35

OTHER KEY FEATURES

Remote Keyless Entry (Folding Key)*	36
Double-Turn Lock/Unlock All	36
Power Sliding Doors	36
Smart Key*	37
HomeLink® with Auto-Dimming Rearview Mirror*	38
Map/Room Lamps	39
Sunvisor	39
Sunroof Operation*	40
Parking Assist System*	40
Back-Up Warning System (Rear Parking Assist System)*	41
Rear-Camera Display*	41
Power Liftgate (Tailgate)*	42
Hood Release Lever and Latch	43
Fuel Cap / Malfunction Indicator (Check Engine Light)	43
Child Safety Locks	43

SAFETY FEATURES

Occupant Detection System (ODS) /	
Passenger Airbag Off Indicator	44
Seat Belts	44
Seat Belt Retractor Locks	44

NORMAL MAINTENANCE SCHEDULE 45

LEGAL DISCLAIMERS (See Back Inside Cover Page)



Kia provides a number of video resources at your disposal to assist you with becoming familiar with the features and functions found in your Kia vehicle. You can access these resources by snapping the QR Codes with your smartphone/tablet (mobile devices) or by visiting the following website: www.KuTechVideos.com/yp13/2016. Continue reading for a more in-depth look at QR Codes and for instructions on how to use them.

What are QR Codes?

A QR Code is a square, 2-dimensional barcode that can be read by mobile devices loaded with an appropriate barcode or QR Code Reader App. The app reads the barcode image and then launches/uploads the specific information the code contains, such as URLs, text, photos, videos and so much more.

How to Use QR Codes

If you have a mobile device with a QR Code Reader App, you can snap the code with your phone and you'll be provided a video with additional information pertaining to the topic. For example, in the Fuel Cap section, if you would like additional information, just snap the code with your mobile device to view the selected Kia Features & Functions Video.

How to snap a QR Code

1. With your mobile device, download a QR Code Reader App. With many devices, you can do this through an app store or marketplace
2. Open the QR Code Reader App on your mobile device
3. The app will utilize your device's camera. Center the code in the camera viewing area:
 - With some apps, as soon as the app recognizes the code, it will launch the corresponding video
 - With other apps, you will have to snap or take a picture of the code. The app will then launch the corresponding video
 - For operation specifics, refer to the instructions that come with the QR Code Reader App

QR CODE

One-Click Fuel Cap Video

To view a video on your mobile device, snap this QR Code or visit the listed website.



www.KuTechVideos.com/yp13/2016

REMINDER: When accessing videos on your mobile device, standard cellular data rates may apply.

QUICK TIPS

1. If you're having trouble scanning codes, check the following:
 - The code should be centered and focused in your mobile device's camera screen
 - Consider moving your device closer to or farther away from the code
 - The code should be well lit, without significant shadow
 - Avoid scanning from a significant angle
 - Confirm that the device's app supports 2D QR Code scanning.
 - Try another QR Code Reader App; not all apps are created equal
2. After scanning, if a "connecting" message appears and then nothing happens or there's a "connection error" message, this typically indicates that your device is having trouble connecting to the Internet
3. When accessing videos on your mobile device, standard cellular data rates will apply

Instrument Cluster Overview

- A** Tachometer
- B** Turn Signal Indicators
- C** Speedometer
- D** Engine Temperature Gauge
- E** Indicators & Warning Lights
- F** Gear Shift Position Indicator
- G** Odometer/Trip Computer/Tripmeter
- H** Fuel Gauge

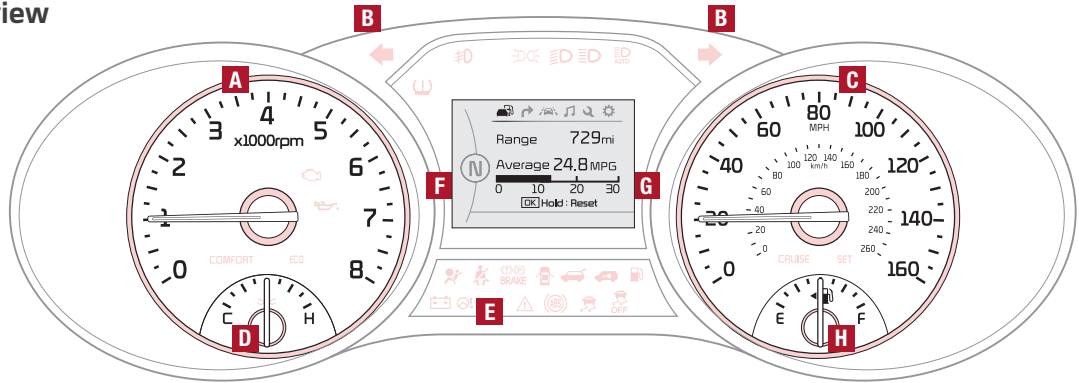

(Type B Cluster)

REMINDERS:

- Your vehicle's instrument cluster & indicator light locations may differ from those in the illustrations
- For more information on the instrument cluster and the function of all indicator and warning lights, please refer to the Owner's Manual

Indicators & Warning Lights

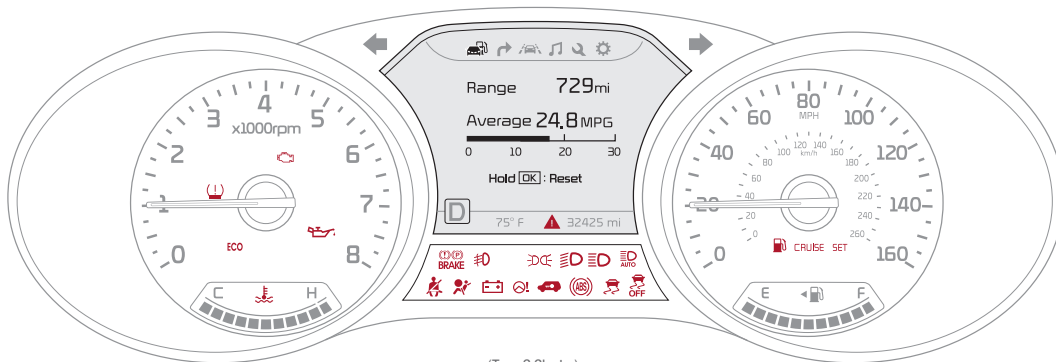

(Type C Cluster)

REMINDERS:

- Your vehicle's instrument cluster & indicator light locations may differ from those in the illustrations
- For more information on the instrument cluster and the function of all indicator and warning lights, please refer to the Owner's Manual

ECO ECOMINDER® Indicator

MIL Malfunction Indicator Lamp (MIL)

TPMS Low Tire Pressure Light / Tire Pressure Monitoring System (TPMS) Malfunction Indicator

Engine Oil Pressure Engine Oil Pressure Warning Light

Master Warning Master Warning Light

Parking Brake & Brake Fluid Parking Brake & Brake Fluid Warning Light

Front Fog Light Front Fog Light Indicator*

Light ON Light ON Indicator Light

Washer Fluid Washer Fluid Warning Light*

High Beam High Beam Indicator

High Beam Assist High Beam Assist Indicator*

Seat Belt Seat Belt Warning Light

Airbag Airbag Warning Light

Charging System Charging System Warning Light

Electronic Power Steering (EPS) Electronic Power Steering (EPS) Warning Light*

Immobilizer Immobilizer Indicator Light*

ABS Anti-Lock Braking System (ABS) Warning Light

EBD Electronic Brake Force Distribution (EBD) System Warning Light

KEY OUT KEY OUT Indicator*

ESC Electronic Stability Control (ESC) Indicator Light

ESC OFF Electronic Stability Control (ESC) OFF Indicator Light

Low Fuel Low Fuel Level Warning Light

CRUISE Cruise Indicator Light*

SET Cruise SET Indicator

Door Ajar Door Ajar Warning Light*

Liftgate (Tailgate) Open Liftgate (Tailgate) Open Warning Light*

Sunroof Open Sunroof Open Warning Light*

COMFORT COMFORT Mode Indicator Light*

Tire Pressure Monitoring System (TPMS)



The TPMS indicator  functions as both Low Tire Pressure Light and TPMS Malfunction Indicator.

The indicator  will illuminate if one or more tires is significantly underinflated, the vehicle has a spare tire installed without TPMS or the outside temperature becomes significantly lower.

Inflate tire(s) to specifications using an accurate digital tire pressure gauge to turn off Low Tire Pressure Light . See front driver's door jamb for PSI specification.

When there is a problem with the TPMS, the TPMS Malfunction Indicator  will blink for approximately one minute and then illuminate. See dealer for service.

Fuel Economy

There are several factors that contribute to your vehicle's fuel economy, including maintenance of your vehicle, driving style, environmental conditions, vehicle weight and vehicle aerodynamics. Below are tips on how to help improve fuel economy:

- Keep your vehicle in good condition with regular maintenance
- Don't let the engine idle longer than necessary
- Drive at a moderate speed, accelerating smoothly and at a moderate rate
- Keep tires inflated to the recommended pressure
- Travel lightly, without carrying unnecessary weight in your vehicles
- Avoid placing large or heavy items on roof racks
- Avoid hilly, winding or poorly maintained roads

REMINDER: Driving range varies depending on a vehicle's fuel tank size, (e.g., 12-gal. vs. 24-gal.). Even though the two vehicles MPG may be the same, the vehicle with the larger tank will have the greater range.

For more information on Fuel Economy, you can snap the QR code above to view a video or refer to the brochure "GETTING MORE OUT OF EVERY GALLON, FUEL-SAVING TIPS TO DRIVE BY" available at your local dealership.

ALWAYS CHECK THE OWNER'S MANUAL FOR COMPLETE OPERATING INFORMATION AND SAFETY WARNINGS.

QUICK TIPS

- Even with TPMS, tire pressure should be checked manually at least once a month. Only adjust tire pressure on "cold tires"
- For proper maintenance and optimal fuel economy, maintain recommended tire inflation pressures and stay within the load limits and weight distribution recommended for your vehicle
- In winter or cold weather, the TPMS light may illuminate if the tire pressure was adjusted to the recommended tire inflation pressure during warm weather

REMINDER: Consult your dealer for service if Low Tire Pressure Light remains illuminated after inflating your tire(s).

QR CODES

To view these videos on your mobile device, snap these QR Codes or visit the listed website.

Refer to page 2 for more information.

Tire Pressure Monitoring System



www.KuTechVideos.com/yp13/2016

Fuel Economy Video



www.KuTechVideos.com/yp13/2016

LCD Instrument Cluster Modes

Press Mode button **A** to cycle through different LCD Instrument Cluster Modes:

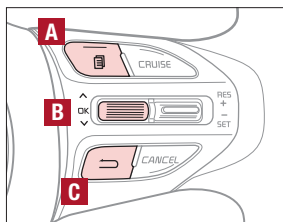

(Type B/C; Buttons located on Steering Wheel)



Trip Computer Mode: Displays driving information for tripmeter, fuel economy, etc.



Turn-by-Turn Mode*: Displays the state of the navigation system



Smart Cruise Control (SCC) / Lane Departure Warning System (LDWS)*: Displays the state of the SCC and LDWS



A/V Mode: Displays the state of the A/V System



Information Modes: Informs on service intervals / Informs of warning messages related to washer fluid, Blind Spot Detection (BSD) system malfunction and other systems / Informs when any door is not securely closed



User Settings Mode: Change settings of the lamps and other features

Your vehicle's steering wheel buttons may differ from those in the illustrations.

Trip Computer / Tripmeter

The Trip Computer is a driver information system that displays information related to driving on the display when the ENGINE START/STOP button is in the ON position.

To cycle through the LCD Instrument Cluster modes, press the Mode button **A**.

Trip Computer:

- To select and enter Trip Computer mode , roll the OK button **B** and then press to enter
- To cycle through and select the different screens (Fuel Economy, Trip A, Trip B), roll the OK button **B** and then press enter
- When displaying TRIP A or TRIP B screens, press and hold the OK button **B** to reset the Tripmeter to zero.
- Press the Return button **C** to go back to the previous mode/item

REMINDERS:

- Appearance of Tripmeter display may differ as equipped
- All stored driving information (except Odometer and Range) is reset if the battery is disconnected

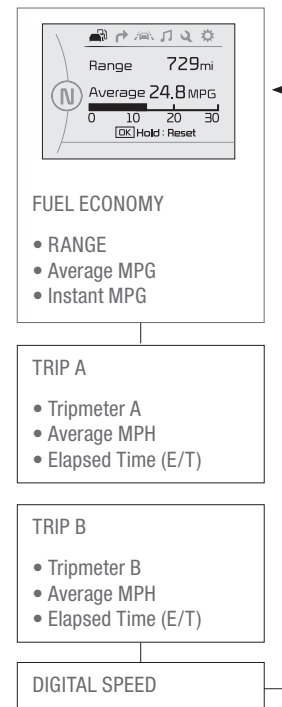

(Type B and C cluster)

User Settings

To enter the User Settings mode in the LCD Instrument Cluster Modes, press the Mode button **A** when the vehicle is at a standstill and with the ENGINE START/ STOP button in the ON position and select User Settings by pressing the OK button **B**.

You can navigate the selections on the display by rolling the OK button **B**, and then selecting the item by pressing the OK button **B**.

Press the Return button **C** to go back to the previous mode/item

User Settings modes

(Type B/C clusters):

Driving Assist

- Smart Cruise Control Response*
- Rear Cross Traffic Alert*
- Forward Collision Warning*

Door/Liftgate (Tailgate)

- Automatic Unlock
- Two Press Unlock
- Horn Feedback
- Smart Liftgate (Tailgate)*

Lights

- One-Touch Turn Signal
- Head Lamp Delay*
- Welcome Light*

Sound

- Park Assist System Volume*
- Blind Spot Detection Sound*
- Welcome Sound*

Seat/Steering

- Easy Seat Access*
- Steering Position

Service Interval

- ON/OFF
- Set mileage/months

Other Features

- Fuel Economy Auto Reset ON/OFF
- Auto Rear Wiper (Reverse)
- Fuel Economy Unit
- Temperature Unit
- Language

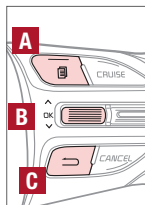

(Buttons located on right side of steering wheel)

Service Mode

To enter Service Mode, press the Mode button **A**, scroll to Service Mode by rolling the OK button **B**. Then press the OK button **B** to enter. System will display number of miles remaining until next service is due, as well as the type of service due.

When service is required, the following will be displayed: **Service Required**.

To reset the Service Mode system, press and hold the OK button **B** for more than 1 second.

Press the Return button **C** to go back to the previous mode/item

To turn **Service In OFF**, go to User Settings.

Service Interval Setting

To set the service interval in User Settings mode:

- Press the Mode button **A** to cycle to User Settings and press the OK button **B** to enter
- If Service Interval is OFF, press the OK button **B** to turn ON
- Roll the OK button **B** to select/change the interval setting
- Press the OK button **B** to select the interval

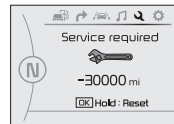

(Type B cluster)

QR CODES

To view these videos on your mobile device, snap these QR Codes or visit the listed website.

Refer to page 2 for more information.

LCD Display Video



www.KuTechVideos.com/yp13/2016

LCD Display: Maintenance Video



www.KuTechVideos.com/yp13/2016

Drive Mode Integrated Control System*

The Drive Mode may be selected depending on driver's preferences and road conditions.

To cycle through the different Drive Modes **A**, press the DRIVE MODE button **B**. The Instrument Cluster will display COMFORT or ECO when selected. When in Normal mode, it will not display in the Instrument Cluster.

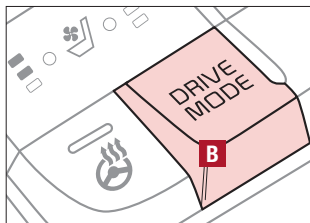

(Located on Center Panel below Gear Shift)*

REMINDERS:

- The system is turned ON and in Normal mode when ignition is in the ON position
- When ECO mode is selected, the indicator will display and system remains on, even when ignition is cycled

Your vehicle's steering wheel buttons may differ from those in the illustrations. See your Owner's Manual for more details.

Active ECO System*

The Active ECO system helps improve fuel economy by controlling several vehicle components. When activated, it optimizes drivetrain operations such as engine power and transmission to help improve fuel economy.

To turn ON, press the ACTIVE ECO button **C**. The button light will turn on, and the green ECO indicator light **D** in the instrument cluster will illuminate, indicating that Active ECO is operating.

The Active ECO system will remain on even when the ignition is cycled.

To turn the Active ECO system OFF, press the ACTIVE ECO button **C** again.



(Located below Gear Shift)

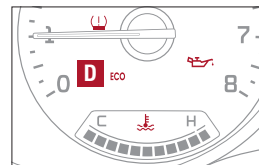

(Located in Instrument Cluster)

QUICK TIPS

To help improve your fuel economy:

- Drive at a moderate speed, accelerating smoothly and at a moderate rate
- Keep tires inflated to the recommended pressure
- Be sure the wheels are properly aligned

REMINDER: When Active ECO button is ON, and ignition is cycled, the system defaults in the ON position

For more information on Active ECO, refer to your Owner's Manual or contact your local dealership.

QR CODE

Active ECO System Video

To view a video on your mobile device, snap this QR Code or visit the listed website.

Refer to page 2 for more information.



www.KuTechVideos.com/yp13/2016

Electronic Stability Control (ESC)

The ESC system is designed to help stabilize the vehicle during cornering maneuvers. It is a good idea to keep the ESC turned on for daily driving whenever possible.

Press ESC OFF button **A** to turn Traction Control OFF/ON.

To turn OFF both the Traction Control and Stability Control, press and hold for more than 3 seconds. Press again to turn ON.

REMINDERS:

- ESC is turned ON by default at vehicle start-up. If vehicle power is cycled, ESC will turn ON again
- The ESC Indicator Light  in the instrument cluster will illuminate whenever the ESC is in operation

For more information on Electronic Stability Control (ESC) and its specific features and operations, please refer to your Owner's Manual.

Hill-Start Assist Control (HAC)

HAC helps prevent the vehicle from rolling backwards when accelerating from a stop while on a steep incline. The HAC automatically activates whether the ESC is OFF or ON but does NOT activate when the ESC has malfunctioned.

REMINDER: The HAC does not operate when the gear shift is in the P (Park) or the N (Neutral) position.

QUICK TIPS

- HAC provides a 2-second delay before the vehicle may start rolling backwards
- When HAC is active (e.g., during initial acceleration from a stop on an incline), you may notice that the brakes will momentarily remain engaged after you depress the accelerator – this is normal HAC operation.

Instrument Panel Dimmer

With parking lights/headlights ON, press button **B** (+) or (-) to adjust the brightness of the instrument panel illumination.

REMINDER: The Instrument Panel Dimmer does not adjust brightness on the Standard Audio System/UVO eServices System/UVO eServices with Premium Navigation System* screens. Use the system setup menu to adjust brightness on the screen.

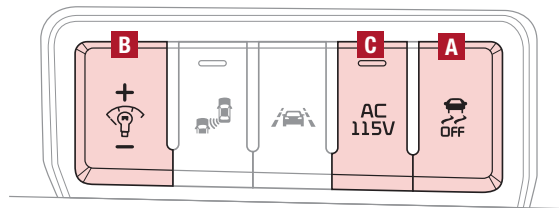

(Button panel located left of Steering Wheel)

AC Inverter*

The AC Inverter supplies 115V/100W electrical power to operate accessories or equipment. Press AC Inverter button **C** to activate.

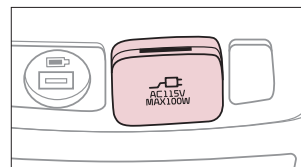

(Outlet located on back of Center Console and the Luggage Zone*)

Blind Spot Detection (BSD) System*

The BSD system uses radar sensors to help alert the driver before changing lanes. The light on the BSD button **A** will illuminate when turned ON. The outside rearview mirror warning lights will also illuminate for 3 seconds.

The system will become active when the vehicle is traveling more than 9 mph and will alert the driver if another vehicle is detected by the radar sensor.

Blind Spot Detection / Lane Change Assist

1st-stage alert: When another vehicle is detected within the BSD System boundary **B**, a yellow indicator will illuminate on the outside rearview mirrors.

2nd-stage alert: When 1st-stage alert is on and the driver activates a turn signal, a flashing yellow indicator will illuminate on the outside rearview mirrors and the system will sound an alert.

RCTA (Rear Cross Traffic Alert)

If the RCTA system sensors detect approaching vehicles from the left or right side **C**, the system will sound an audible alert, the warning indicators on the outside rearview mirror will illuminate and a message will appear on the LCD screen, when these conditions are met:

- The gear shift is in Reverse
- The vehicles moves in reverse
- The vehicle is moving less than 6 mph
- The RCTA can be set to on/off in User Settings from the LCD Instrument Cluster modes.

REMINDERS:

- When the BSD is ON and the vehicle power is cycled to OFF then ON again, the BSD system returns to ON
- The RCTA feature can be turned OFF/ON in User Settings. When vehicle power is cycled, the RCTA will remain in the previous state

For more information on the above systems, please refer to the Owner's Manual.

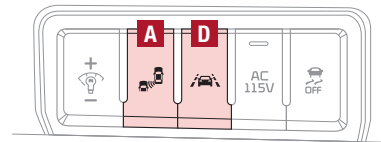

(Button panel located left of Steering Wheel)

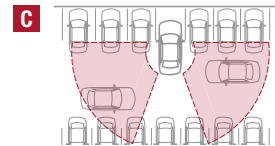
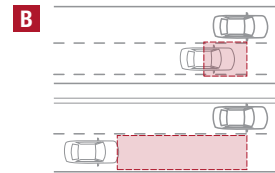

QR CODE

Blind Spot Detection System w/ RCTA Video

To view a video on your mobile device, snap this QR Code or visit the listed website.

Refer to page 2 for more information.



www.KuTechVideos.com/yp13/2016

Lane Departure Warning System (LDWS)*

With the ENGINE START/STOP button in the ON position, press the LDWS button **D** to turn system ON. The instrument cluster indicator  will illuminate green.

If the LDWS detects that you are veering outside of your lane, the system may issue a warning on the LCD screen and an alert may sound, under these conditions:

- The vehicle exceeds approximately 43 mph
- The LDWS system recognizes the lane the vehicle is traveling in

REMINDERS:

- LDWS will not issue a warning if the turn signal is activated
- If the LDWS button is ON and ignition is cycled, the system will turn ON again. If the LDWS button is OFF, the system remains OFF

The Lane Departure Warning System (LDWS) is not a substitute for safe and proper driving. Always drive safely and use caution. LDWS may not always alert the driver if the vehicle is driven outside of its lane.

Forward Collision Warning System (FCWS)*

The FCWS helps to alert the driver when rapidly approaching a vehicle that is slowing down, braking or stopped. A warning message will appear on the LCD screen and a chime will sound. The FCWS will become active when the vehicle is traveling more than 25 mph.

To turn the FCWS off, go to User Settings in the LCD Instrument Cluster modes.

REMINDERS:

- The FCWS will be activated by default when vehicle power is cycled on, even when previous setting to off
- The FCWS will not operate when the vehicle is traveling more than approximately 50 mph

The Forward Collision Warning System (FCWS) is not a substitute for safe and proper driving. Always drive safely and use caution. FCWS may not always alert the driver when the vehicle is approaching another vehicle.

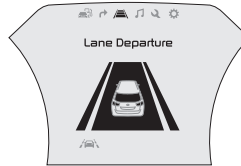

When the LDWS sensor detects the lane traveling in, both lanes are illuminated

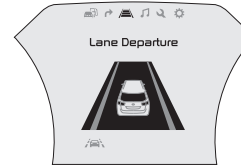

When the LDWS sensor does not detect the lane traveling in the lanes are not illuminated

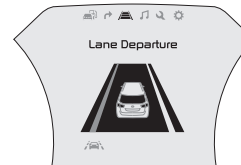

When the LDWS sensor detects the vehicle veering outside of the lane traveling in, a yellow indicator will illuminate either on the left or right lane (shown in both images above)

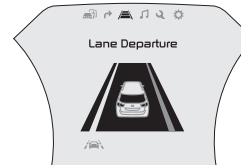

QR CODE

Lane Departure Warning System Video

To view a video on your mobile device, snap this QR Code or visit the listed website.

Refer to page 2 for more information.



www.KuTechVideos.com/yp13/2016



Power Windows, Window Lock & Central Door Lock

A Pull/Press to operate Front Windows Auto Up/Down*

B Press to Unlock/Lock All Doors

C Press to disable Rear Passenger Windows

REMINDER: When pressed **C** window controls for the Rear Passenger Windows are disabled.

Power Folding Outside Mirrors*

Press the L or R buttons **D** to select the mirror to adjust.

Press button arrows **E** left/right or up/down to adjust mirror position.

Toggle button **F** left/right to unfold/fold the outside rearview mirrors.

Toggle button **F** to center to automatically fold/unfold mirrors when:

- The Smart Key Lock/Unlock buttons are pressed
- The door outside handle button is pressed

QUICK TIP

The mirrors will automatically unfold when the Smart Key* is within close proximity to the vehicle.

REMINDERS:

- When mirror button **F** is in the center, press the Lock button on the Smart Key to automatically fold the mirrors
- To lock position of mirrors, toggle switch to the neutral (center) position

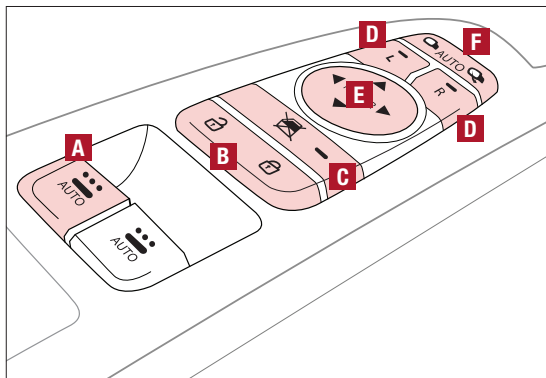

(Button/switch panel located on Driver's Door)

Heated Outside Mirrors*

Mirror heaters are controlled with Rear Defroster.

Automatic Door Lock/Unlock

Auto Door Lock/Unlock will engage when the gear shift is moved in to or out of the P (Park) position.

Fuel Door Release Button

Press the Fuel Door Release button to release the fuel door.

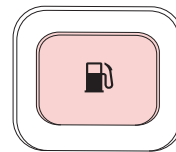

(Button located left of Steering Wheel)

Reverse Parking Aid Function*

When the gear shift lever is moved into R (Reverse) and while the vehicle is moving backwards, the outside rearview mirrors **A** will rotate downward to aid in reverse parking.

When the left or right mirror buttons **B** are depressed, the Reverse Parking Aid Function will operate.

To turn OFF the function, press the switches again.

The outside rearview mirrors will automatically return to their original positions when:

- The ENGINE START/STOP Button is in the OFF position
- The gear shift lever is moved to any position except R (Reverse)
- Outside rearview mirror switches are not depressed

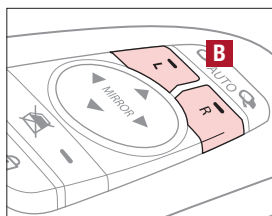
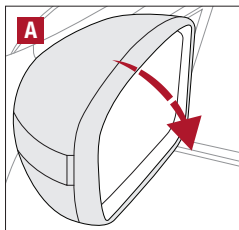

(Button/switch panel located on Driver's Door)

REMINDER: When the outside rearview mirror switches **B** are not depressed, the Reverse Parking Aid Function will not operate and the outside rearview mirrors will not rotate downward.

Engine Start/Stop Button

To start the engine:

1. Depress the brake pedal
2. Press the ENGINE START/STOP button while gear shift is in P (Park)



To turn the engine OFF: Press the ENGINE START/STOP button.

To use the ENGINE START/STOP button, you must have the Smart Key fob on your person or inside the vehicle.

REMINDERS:

- In an emergency situation while the vehicle is in motion, you are able to turn the engine off and to the ACC position by pressing the ENGINE START/STOP button for more than 2 seconds or 3 times successively within 3 seconds
- If Smart Key fob battery is dead, with the lock button facing the ENGINE START/STOP button, hold the fob up against the ENGINE START/STOP button and press

QUICK TIPS

To use electrical accessories:

ACC position

- When in the OFF position and without depressing the brake pedal, press the ENGINE START/STOP button once (orange light)

ON position

- When already in the ACC position (orange light) and without depressing the brake pedal, press the ENGINE START/STOP button again (red light)
- When in the OFF position and without depressing the brake pedal, press the ENGINE START/STOP button twice (red light)

Keeping the vehicle in ACC or the ON position for extended periods of time without turning engine on may discharge the vehicle's battery.

QR CODE

Engine Start/Stop Button & Smart Key Video

To view a video on your mobile device, snap this QR Code or visit the listed website.

Refer to page 2 for more information.



www.KuTechVideos.com/yp13/2016

Tilt/Telescoping Steering Wheel

To adjust the Steering Wheel, press the Lock-Release Lever **A** down and adjust **B** the distance and **C** desired angle.

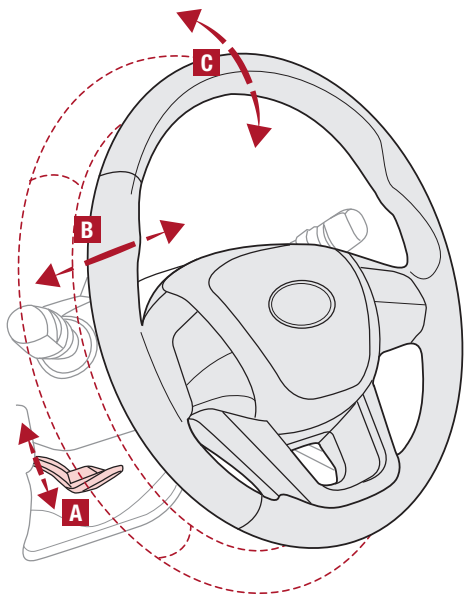

When finished, pull the Lock-Release Lever **A** up to lock Steering Wheel in place.



Headlights & High Beams

To operate:

- Rotate lever to change the Headlight function
- Push lever to turn High Beams ON
- Pull lever to flash Headlights/High Beams

-  Headlight position
-  Parking light position
- AUTO** Automatic Headlights position
- OFF** OFF position

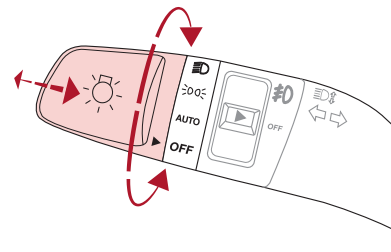

AUTO Light function — When the light switch is in the AUTO Light position, the tail lights and headlights will turn ON/OFF automatically depending on the amount of light outside the vehicle.

Turn Signals & Fog Lights*

To operate:

- Turn Signals - Move lever Up/Down for Right/Left Turn Signal
- Fog Lights - Push toggle switch to turn Fog Lights ON/OFF

REMINDER: Headlights must be ON for Fog Light operation.

One-Touch Lane Change Signal is activated by moving the Turn Signal Lever slightly for less than 1 second and then releasing. The lane change signal will blink 3 times.

To change how many times (3/5/7) the Lane Change Signal blinks, go to User Settings Mode in the LCD Instrument Cluster modes.

For more information on the User Settings Mode, please refer to your Owner's Manual.

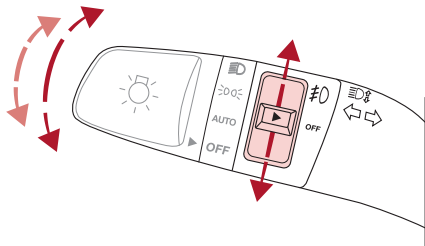

Windshield Wipers & Washers

To operate:

- Move lever Up/Down to change Wiper modes
- Press button **A** to adjust Intermittent Wipe
- Pull lever to spray and wipe

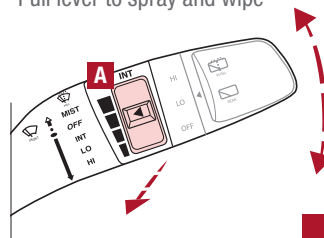

MIST: Single wipe

OFF: Wiper off

INT: Intermittent Wipe

LO: Slow wipe

HI: Fast wipe

QUICK TIP

Pressing button up increases Intermittent wipe frequency and wipe speed. Pressing button down decreases frequency of wipes.

Rear Wiper & Washer*

To operate:

- Rotate Rear Wiper switch to change Wiper modes
- Push to spray and wipe

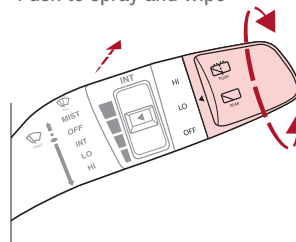

HI: Fast wipe

LO: Slow wipe

OFF: Wiper off

QUICK TIP

LO and HI sets wiper speed. No intermittent wipe function on Rear Wipers.

Bluetooth® Wireless Technology

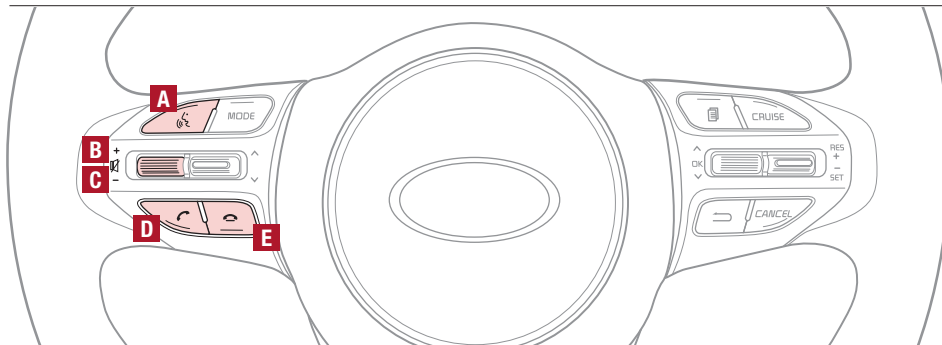

A Talk button: Press to activate voice recognition/bring up menus/place calls with minimal voice command prompts from the system

B Volume button: Roll up/down to raise/lower speaker volume

C Mute button: Press to mute the microphone during a call

QUICK TIP

When using the voice command feature, wait for the system BEEP before speaking the command.

D Receive/Place Call button: Press to receive/place/transfer calls. Press to place a call using voice command prompts from the system, or to answer an incoming call

E End Call button: Press to end a call or cancel a function

QUICK TIPS

- Phonebook transfer upload time varies by phone model and with number of phonebook entries
- Because of differences in phone quality, service providers and **Bluetooth®** Wireless Technology chip programming, functionality may differ from one phone to another
- Changing language setting may delete paired phones

REMINDER: Your vehicle's steering wheel buttons may differ from those in the illustrations. See your Owner's Manual for more details.

Driving while distracted is dangerous and should be avoided. Drivers should remain attentive to driving and always exercise caution when using the steering-wheel-mounted controls while driving.

For more information, if equipped, refer to the Car Multimedia System User's Manual or the UVO System User's Manual. For Bluetooth® Wireless Technology FAQs, go to www.kia.com, Owners section, or call Consumer Information for Bluetooth® Technology at (800) 333-4KIA. Refer to your Owner's Manual for more specific Bluetooth® Wireless Technology phone pairing and operation instructions.

Bluetooth® Wireless Technology (Continued)

Pairing a Phone

For instructions on how to pair a phone, refer to the audio system's user's guide or your vehicle's Quick Start Guide.

QUICK TIP

During the pairing process, be sure to accept the connection requests on the phone for phonebook download and to allow acceptance of all future **Bluetooth®** connection requests.

How to Place a Call

When using the voice command feature, wait for the system BEEP before speaking the command.

There are two options for placing a call using the Steering Wheels controls:

Standard Audio System*

- Option 1: Press the Receive/Place Call button **D** (system will prompt you through call process)
- Option 2: Press the Talk button **A** (system will BEEP to indicate it is ready for call placement). Then say the command "Call {name}" or "Dial {number}"

UVO eServices System / UVO eServices with Premium Navigation*

- Option 1: Press the Receive/Place Call button **D** (displays the phone screen with number keypad)
- Option 2: Press the Talk button **A**. Then say the command "Call {name}" or "Dial {number}"

Voice Recognition and Phone Contact Tips

The Kia Voice Recognition System may have difficulty understanding some accents or uncommon names. When using Voice Recognition to place a call, speak in a moderate tone, with clear pronunciation.

Help your **Bluetooth®** Wireless Technology Voice Recognition performance by making a few simple changes to your phone contacts:

- Use full names vs. short or single-syllable names ("John Smith" vs. "Dad"; "Smith Residence" vs. "Home")
- Avoid using special characters or hyphens (@, &, #, /, -, *, +, etc.)
- Avoid using acronyms ("In Case Emergency" vs. "ICE")
- Spell words completely, no abbreviations ("Doctor Goodman" vs. "Dr. Goodman")

QR CODE

Voice Recognition Tips Video

To view a video on your mobile device, snap this QR Code or visit the listed website.

Refer to page 2 for more information.



www.KuTechVideos.com/yp13/2016

Audio Controls

Standard Cruise Control

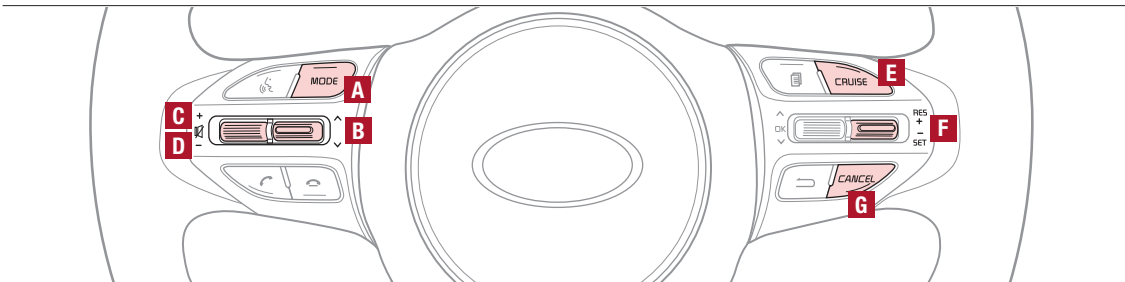

A Audio MODE button: Press to cycle through FM 1-2/AM/SiriusXM® 1-3/USB/iPod®/Aux/Bluetooth® Audio Streaming/My Music modes

B Seek/Preset button: FM/AM/SiriusXM® Modes: Press up/down to advance through Preset Stations. Press and hold to auto seek

Media Modes: Press up/down to move track up/down. Press and hold to fast forward / rewind

C Volume buttons: Roll up/down to raise/lower volume

D Mute button: Press to mute all audio

QUICK TIP

Pressing the Audio MODE button for more than 1 second will turn Audio Mode ON/OFF.

Driving while distracted is dangerous and should be avoided. Drivers should remain attentive to driving and always exercise caution when using the steering-wheel-mounted controls while driving.

E CRUISE Control ON/OFF button: Press to turn the Cruise Control ON/OFF

F Resume Cruising Speed button: Press up to resume or increase cruising speed

F Set Cruising Speed button: Press down to set or decrease cruising speed

G Cruise Control CANCEL button: To cancel Cruise Control setting, do one of the following:

- Press the brake pedal
- Press the CANCEL button

QUICK TIPS

- Cruise Control is designed to function above 25 mph
- The Cruise Control system will not activate until the brake pedal has been depressed at least once after ignition ON or engine start

REMINDER: Standard Cruise Control is a part of the Smart Cruise Control System (SCC) and can be set as the operating mode. To switch from SCC to Standard Cruise Control, press and hold the CRUISE button (the SCC system must not be activated to change modes). Repeat to switch back to SCC mode

Your vehicle's steering wheel buttons may differ from those in the illustrations. See your Owner's Manual for more details

Smart Cruise Control System (SCC)*

The Smart Cruise Control System (SCC)* allows you to set the vehicle to maintain a speed so long as it is not limited by traffic. When traffic is encountered, the vehicle will be slowed to maintain a set distance behind traffic without depressing the accelerator or brake pedal.

To set/adjust the SCC speed:

- Press the CRUISE button **A** to turn system ON. The CRUISE indicator will illuminate on the instrument cluster
- Accelerate/decelerate to the desired speed
- Press the SCC button **B** up or down to adjust or set speed

To set the vehicle-to-vehicle distance: Press the SCC button **C** on the steering wheel. The image on the LCD screen **E** will change when scrolling through the settings.

To turn system OFF: Press the CANCEL button **D**. The CRUISE indicator on the instrument cluster will turn OFF and the LCD screen SCC image will show "SCC canceled" **F**.

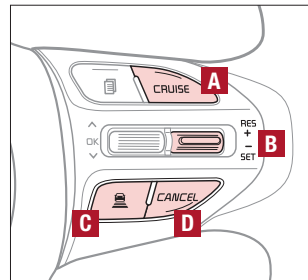

(Buttons located on right side of Steering Wheel)

QR CODE

Smart Cruise Control Video

To view a video on your mobile device, snap this QR Code or visit the listed website.

Refer to page 2 for more information.



www.KuTechVideos.com/yp13/2016

QUICK TIPS

To change the Cruise Control mode from SCC to standard Cruise Control, press and hold button **C**. Repeat to switch modes again (The SCC system must not be activated to change modes).

For the SCC System to operate:

- When no vehicle is in front, you must be travelling at a minimum speed of 19 mph
- When following a vehicle, there is no minimum speed requirement

When following a vehicle, the system will automatically adjust your cruise speed based on the vehicle in front. It will even bring the vehicle to a complete stop if necessary. If the vehicle remains at a standstill for more than 3 seconds, the system will disable.

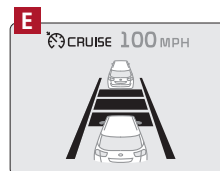

REMINDERS:

- Cruise Control button must be ON in order to turn SCC ON/OFF
- SCC is automatically activated by default when ignition is cycled

Standard Audio System*

– FM/AM/Sirius®/Media (CD, USB, iPod®, Aux, BT Audio, My Music)*

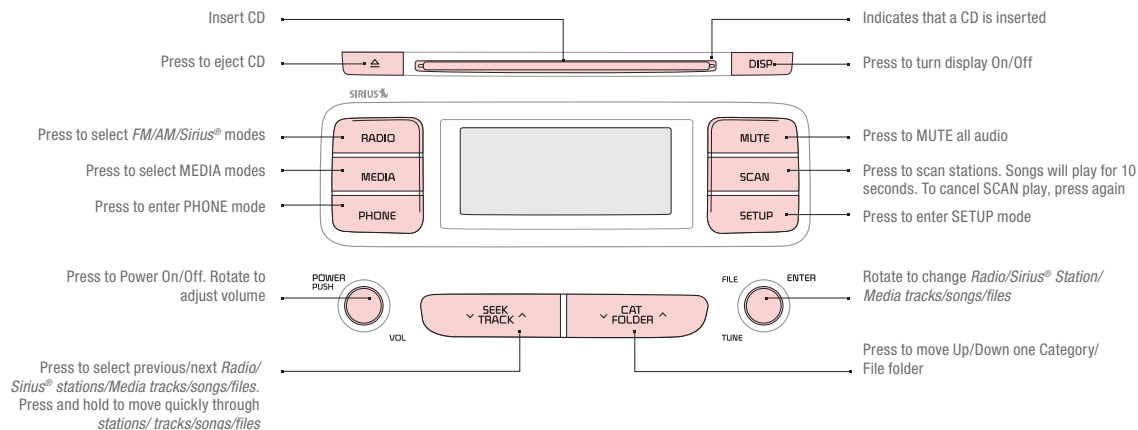

Audio System Setup Options

Press the SETUP key to enter setup menu. Using the touchscreen press the onscreen buttons, Display/Sound/Phone/System, to enter modes. Then follow the onscreen menu items to select and adjust. Audio system setup options may include the following:

- **Display Settings** – Adjusting the Brightness, Mode Popup, MP3 Information Display
- **Sound Settings** – Sound Settings, SDVC (Speed-Dependent Volume Control), Voice Recognition Volume, Touch Screen Beep
- **System Settings** – Memory Information, Prompt Feedback, Language
- **Phone Settings** – Pair Phone, Paired Phone List, Contacts Download, Outgoing Volume, *Bluetooth*® System off

Sound Settings – To adjust the sound settings (Bass, middle, treble, fader, balance), press the SETUP key, select SOUND, then SOUND SETTING. Using the touchscreen, press arrows to adjust the sound settings.

Your vehicle's audio system may differ from that in the illustration. See your Owner's Manual for more details on this system. For other audio system operations, refer to pages 21-22.

UVO eServices System*

– FM/AM/SiriusXM®/Media (CD, USB, iPod®, Jukebox, Aux, BT Audio, Pandora®)

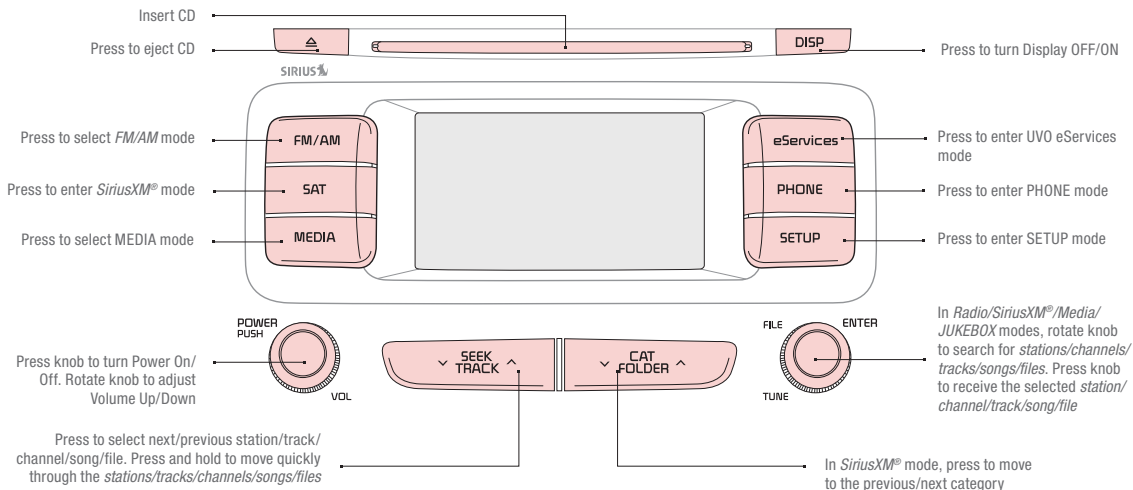

QR CODE

UVO eServices System Videos

To view a video on your mobile device, snap this QR Code or visit the listed website.

Refer to page 2 for more information.



www.KuTechVideos.com/audio/UVO_eServices

UVO eServices Registration/Activation – To use UVO eServices:

1. On your Smartphone, go to an app store or marketplace to download the UVO eServices App and log in to the app using your MyUVO.com account credentials
2. Register through your UVO eServices App or at MyUVO.com
3. Follow the Apps phone pairing and activation steps

Sound Settings – To adjust the sound settings, press the SOUND button on the main screen of an audio mode. Then press the selection (Fader, Balance, Tone), and use the on-screen arrows to adjust setting. When done, press return symbol to save and go back to previous screen.

QUICK TIPS

- When using the voice command feature, wait for the system to BEEP before speaking the command
- Only MP3 or WMA files may be played or copied to Jukebox. Commercial CDs or CDs with a CDDA (compact disc digital audio) format cannot be copied to Jukebox
- At any time, you can interrupt UVO eServices System Command Feedback by pressing the TALK button
- Prolonged use of the UVO eServices system in ACC mode may drain the vehicle's battery

Your vehicle's audio system may differ from that in the illustration. For further UVO eServices System operations, refer to the UVO System User's Manual. For other audio system information, refer to pages 20-22.

UVO eServices with Premium Navigation*

– FM/AM/SiriusXM®/Media (Disc, USB, iPod®, Aux, BT Audio, My Music)

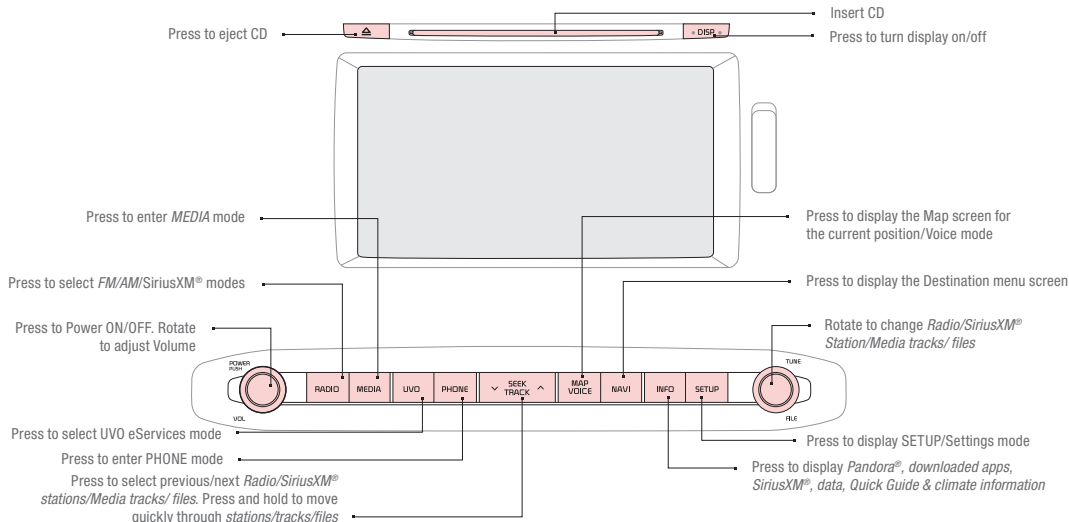

UVO eServices Registration/Activation - To use UVO eServices:

1. On your Smartphone, go to an app store or marketplace to download the UVO eServices App and log in to the app using your MyUVO.com account credentials.
2. Register through your UVO eServices App or at MyUVO.com
3. Follow the Apps phone pairing and activation steps

QUICK TIPS

- Prolonged use of the system in ACC mode may drain the vehicle's battery. A warning screen may appear periodically to remind users that the Navigation System should be operated when the engine is running to prevent battery discharge
- When using the voice command feature, wait for the system BEEP before speaking the command

QR CODE

UVO eServices with Premium Navigation Videos

To view a video on your mobile device, snap this QR Code or visit the listed website.

Refer to page 2 for more information.



www.KuTechVideos.com/audio/avn4

Sound Settings

To adjust the sound settings - Fader/Balance, Tone, Touch-Screen Beep ON/OFF and Speed-Dependent Volume Control ON/OFF - from any audio mode:

1. Press the **SETUP** button on the Audio Control Unit
2. Select the on-screen **SOUND** button
3. Select the menu item to change settings
4. Use the on-screen buttons to adjust setting
5. Press the return button to save settings

Your audio system may differ from those in the illustrations. For further UVO eServices with Premium Navigation operation, refer to the Car Multimedia System User's Manual. For other audio system information, refer to pages 20-21.*

Surround View Monitor (SVM)*

The Surround View Monitor (SVM) is a parking support system that shows the areas around the front, rear, left, and right sides of the vehicle via four cameras displayed in the navigation screen.

Front SVM operation:

- The camera view will display on the navigation screen in both Drive and Neutral
- In Drive, the camera view will continue to display until the vehicle is above approximately 13 mph
- The camera view will reappear on the navigation screen whenever the vehicle drops below approximately 13 mph

The Front SVM camera is ON when:

1. The ENGINE START/STOP button is On
2. The gear shift is in Drive or Neutral
3. The SVM button **A** is pressed ON (LED illuminated)

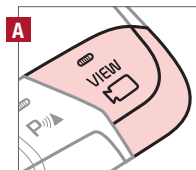

(Located below Gear Shift)

Rear SVM operation:

- The camera view will automatically display on the navigation screen when the vehicle is shifted into Reverse
- The camera view will turn off when the vehicle is shifted out of Reverse

Camera View Modes – To change camera view modes, press the icons shown below on the navigation screen to select the mode.

Front SVM - when in Drive & Neutral:

- Displays the front side and SVM images simultaneously on the screen
- Displays the front side image on the screen
- Displays the front side and left side images simultaneously on the screen
- Displays the front side and right side images simultaneously on the screen

Rear SVM - when in Reverse:

- Displays the rear view and SVM images simultaneously on the screen
- Displays the rear side image on the screen
- Displays the rear and left side images simultaneously on the screen
- Displays the rear and right side images simultaneously on the screen

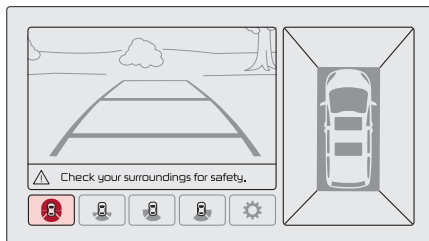

QUICK TIP

The Front SVM camera will turn off when the gear shift is moved into Park or Reverse or the SVM button is pressed.

QR CODE

Surround View Monitor Video

To view a video on your mobile device, snap this QR Code or visit the listed website. Refer to page 2 for more information.



www.KuTechVideos.com/yp13/2016

REMINDER: The SVM camera is equipped with an optical lens to provide a wider range of vision and may appear different from the actual distance.

The Surround View Monitor system is only a supplemental device. Drivers should not rely solely on the SVM information when parking and backing up. Drivers should always pay attention and directly check the left/right and rear.

Clock*

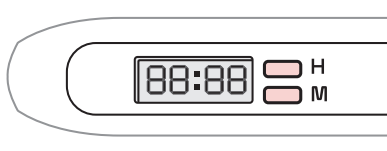

(Clock/buttons located on Center Panel)

Standard Audio System* Clock Setup:

Press the H button to advance the time by one hour. Press the M button to advance the time by one minute.

QUICK TIP

Press and hold both for more than 3 seconds to switch from 12- to 24-hour formats.

UVO eServices System* Clock Setup:

Press the CLOCK button to display the Clock setting screen. Then use the on-screen buttons to navigate through setup.

UVO eServices with Navigation System* Clock Setup:

Press the Setup button. Then press the on-screen Clock icon to enter clock settings.

QUICK TIP

Press the DONE button on the screen to ensure changes are saved.

Aux/USB/iPod® Port, AC Inverter* and Power Outlets

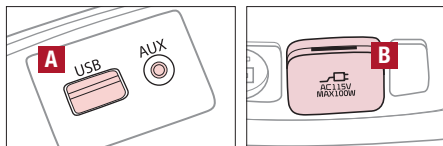

USB, iPod® and AUX ports **A** to connect audio devices and an iPod®

AC Inverter* **B** - 115V/100 watt power inverters are located in the back of the center console and in the luggage zone* (See page 9 for ON/OFF button information)

USB chargers* are located in the center panel and in the back of the center console

Power outlets are located in the center console, passenger console and the luggage zone*

QUICK TIP

The power outlets are inactive when the ENGINE START/STOP button is OFF.

REMINDER: Using the power outlets (accessory plugs) for prolonged periods of time with the ENGINE START/STOP button in the ACC position (Engine OFF) could cause the battery to discharge.

For more information on the Aux/USB/iPod® Port, AC Inverter and Power Outlets, refer to the Owner's Manual.*

QR CODE

USB Port Video

To view a video on your mobile device, snap this QR Code or visit the listed website.

Refer to page 2 for more information.



www.KuTechVideos.com/yp13/2016

Automatic Gear Shift with Sportmatic® Shifting

P: Park

R: Reverse

N: Neutral

D: Drive

[+]: Sport Mode Upshift

[-]: Sport Mode Downshift

Sport Mode: To enter Sport mode, move shift lever from D to left gate.

To shift while in Sport mode, move shift lever up [+] to upshift or down [-] to downshift.

QUICK TIPS

- Press brake pedal and depress release button to move gearshift from N to P, N to R or from P to any gear
- Sport mode downshifts are made automatically when the vehicle slows down. When the vehicle stops, 1st gear is automatically selected

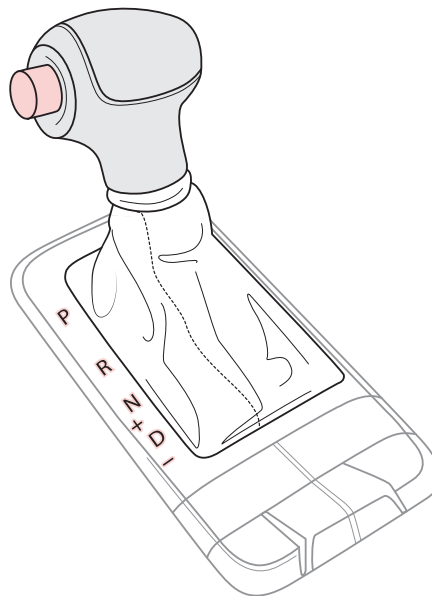

QR CODE

Sportmatic® Shifting Video

To view a video on your mobile device, snap this QR Code or visit the listed website.

Refer to page 2 for more information.



www.KuTechVideos.com/yp13/2016

Automatic Climate Control

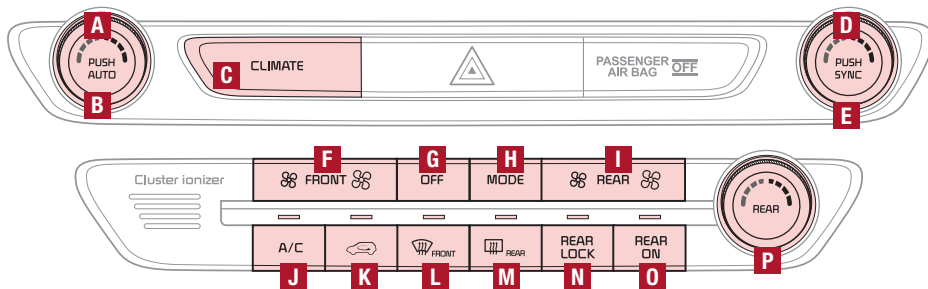

- A** Driver's temperature control knob
- B** AUTO (automatic control) button
- C** Climate information screen selection button
- D** Passenger's temperature control knob
- E** SYNC temperature control selection button
- F** Front fan speed control button
- G** Air Conditioning Off button
- H** Mode Selection button
- I** Rear fan speed control button
- J** A/C on button
- K** Air intake control button
- L** Front windshield defroster button
- M** Rear window defroster button
- N** Rear control lock button
- O** Rear control on button
- P** Rear temperature control knob

Rear Climate Control

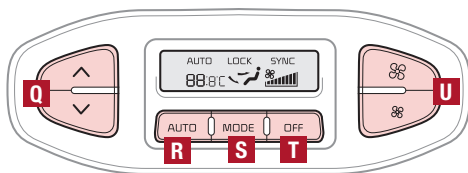

- Q** Rear temperature control buttons
- R** Rear AUTO climate control button
- S** Rear mode selection button
- T** Rear air conditioning OFF button
- U** Rear fan speed control buttons

Automatic Climate Control (Continued)

Climate Control Auto Function

1. Press **AUTO** to select Full Auto Operation - The Auto setting automatically controls the airflow modes, fan speeds, air intake and air conditioning according to the temperature setting selected
2. Set desired **Temperature**
3. Press **SYNC** to select Sync Temperature Control Operation which synchronizes the passenger's temperature to the driver's setting

Defrost Outside Windshield:

1. Set Front **Fan Speed** to the highest position
2. Set **Temperature** to **Hot**
3. Press the **Front Defrost** button 

Defog Inside Windshield:

1. Set Front **Fan Speed** to desired position
2. Set desired **Temperature**
3. Press the **Front Defrost** button 

QUICK TIPS

- Defrost Mode  activates A/C and opens Fresh Air Vent to help dehumidify the air and improve Defroster performance
- During Auto Operation, the A/C indicator will NOT illuminate. The fan speed, air intake, air flow and air conditioning may automatically be engaged at any time to reach desired temperature and reduce humidity
- Keep inside glass as clean as possible to reduce window fogging

Air Flow Modes

To select Air Flow Modes, press the mode buttons to cycle through to desired mode:



Face-Level



Floor-Level



Bi-Level



Floor/Defrost-Level

REMINDERS:

- Pressing any button during AUTO operation will deactivate the AUTO function and switch to manual mode, except for Temperature Control
- When in AUTO mode, Air Flow Mode and Fan Speed do not display on the Climate Control Display
- Warm air may flow in through vents if Recirculated Air button is not pressed ON (LED lit)
- Your Automatic Climate Control system may differ from those in the illustrations. See your Owner's Manual for more details

Manual Climate Control*

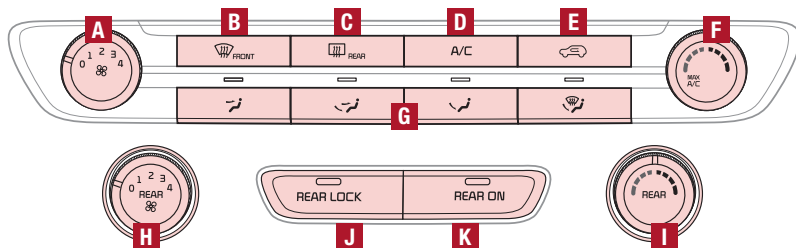

- A** Front fan speed control knob
- B** Front window defroster button
- C** Rear window defroster button
- D** Air conditioning button
- E** Air intake control button
- F** Front temperature control knob

- G** Front mode selection buttons
- H** Rear fan speed control knob
- I** Rear temperature control knob
- J** Rear control lock button
- K** Rear control on button

Defrost Outside Windshield:

1. Set Fan Speed to the highest position
2. Set desired Temperature
3. Press the Defrost button 

Defog Inside Windshield:

1. Set Fan Speed to desired position
2. Set desired Temperature
3. Press the Defrost button 

Your Manual Climate Control system may differ from those in the illustrations. See your Owner's Manual for more details.

Rear Climate Control*

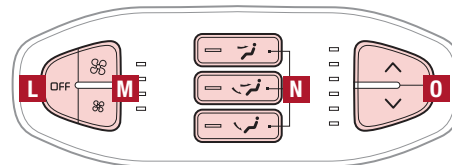

- L** Rear air conditioning OFF button
- M** Rear fan speed control buttons
- N** Rear mode selection buttons
- O** Rear temperature control buttons

Air Flow Modes

To select Air Flow Modes, press the Mode selection buttons:

-  Face-Level
-  Bi-Level
-  Floor-Level
-  Floor/Defrost-Level

Heated Steering Wheel*

Press Heated Steering Wheel button **A** to turn the Steering Wheel Heater on/off, while the ENGINE START/STOP button is in the ON position. Steering Wheel Heater will turn off automatically in 30 minutes, or when button is pressed again to deactivate.

QUICK TIPS

- If ignition is turned OFF, then ON again within 30 minutes of Steering Wheel Heater being turned ON, the system will remain in the ON position
- System does NOT turn off when ignition is cycled. To turn off system, press the Heated Steering Wheel button

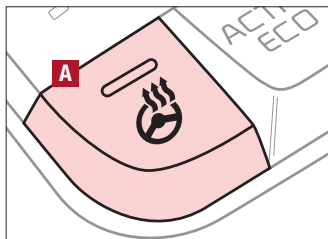

(Buttons located below Gear Shift)

Seat Warmers / Ventilated Seats*

Seat Warmers

- Press right side of button **B** once for high setting (3 LEDs lit)
- Press button twice for medium setting (2 LEDs lit)
- Press a third time for low setting (1 LED lit) and again to turn OFF

Ventilated Seats

- Press left side of button **C** once for high setting (3 LEDs lit)
- Press twice for medium setting (2 LEDs lit)
- Press a third time for low setting (1 LED lit) and again to turn OFF

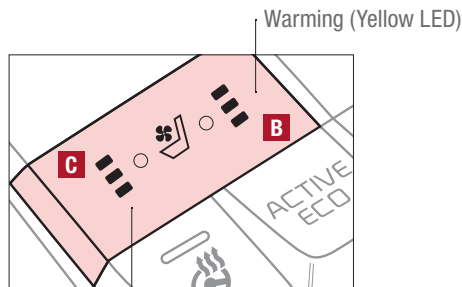

(Buttons located below Gear Shift)

QR CODE

Heated and Ventilated Seats Video

To view a video on your mobile device, snap this QR Code or visit the listed website.

Refer to page 2 for more information.



www.KuTechVideos.com/yp13/2016

QUICK TIPS

- With the Seat Warmer switch in the ON position, the heating system in the seat turns OFF or ON automatically depending on the seat temperature.
- When Seat Warmers or Ventilated Seats button is pressed ON and ignition is cycled, the system will turn ON again.

Front Seat Headrest Adjustment

To raise headrest: Pull headrest up.

To lower headrest: Press lock **A**, then press the headrest down.

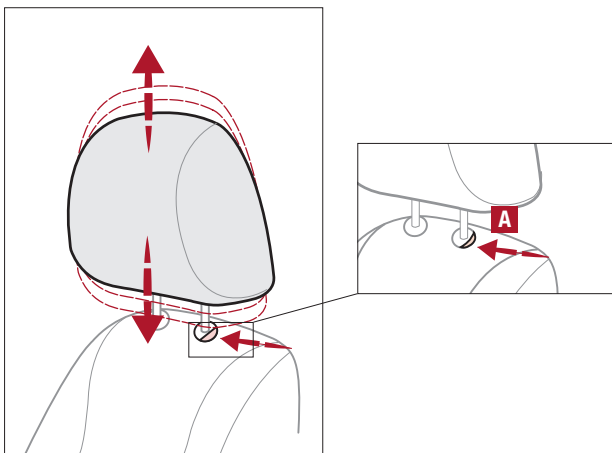

Driver Position Memory System*

The integrated system stores into memory the position of the Driver's Seat and the Outside Rearview Mirrors.

To store positions into memory, first place the Gear Shift into P (Park) while the ENGINE START/STOP button is in the ON position. Then:

1. Adjust the Driver's Seat and the Outside Mirrors
2. Press the SET button **B** on the control panel. System will beep once
3. Press one of the memory buttons **C** within 5 seconds. The system will beep twice when memory has been stored

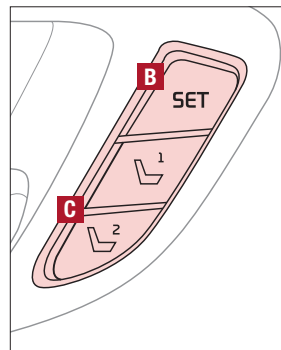

(Buttons located on Driver's Door Panel)

Power Adjustable Driver's Seat*

Move/Press controls to adjust Seat, Seat Cushion, Seatback or Lumbar support

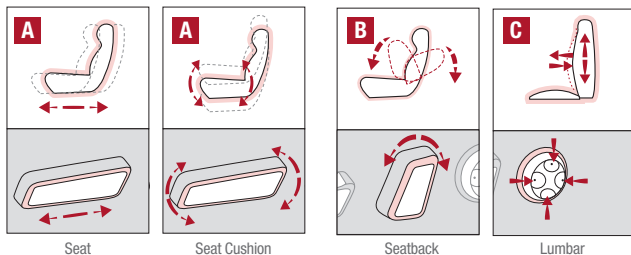

Seat

Seat Cushion

Seatback

Lumbar

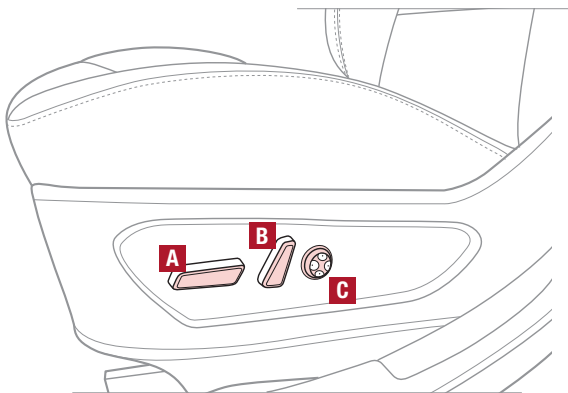

For more information on Power Adjustable Driver's Seat operation, refer to the Owner's Manual.

Manual Adjustable Driver's Seat*

Pull lever **D** to slide Seat forward/backward.

Pull/press lever **E** to adjust Seat height.

Pull lever **F** to adjust Seatback recline.

Press **G** to adjust Lumbar support.

QUICK TIP

When adjusting seat forward or backwards, ensure seat clicks or locks into place before driving the vehicle.

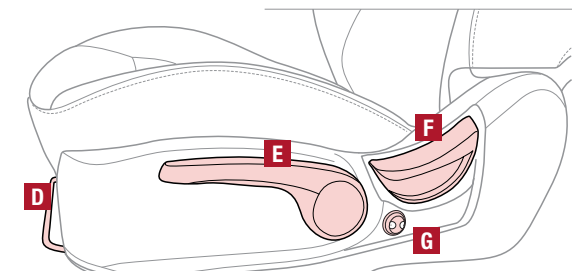

For more information on Manual Adjustable Driver's Seat operation, refer to the Owner's Manual.

2nd-Row Seat

Folding 2nd-Row Seat

1. Lower the 2nd-Row Seat Headrest to the lowest position
2. Pull up on the Seatback folding lever or strap and fold the Seatback down

Unfolding 2nd-Row Seat

1. Lift the folding Seatback lever and move the Seatback backward
2. Then lift the lever again or return it to an upright usable position

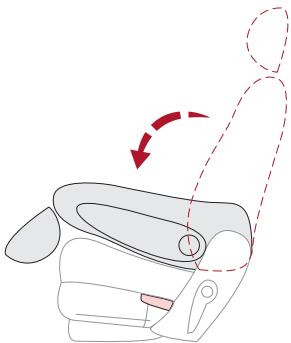

QUICK TIPS

- When you return Seatback to its original position, ensure it locks (clicks) into place
- It may be necessary to slide the front Seat forward and adjust the front Seatbacks to fully lower rear seats
- Lower Rear Headrests to the lowest position

For more information on 2nd-Row Seat operation, refer to the Owner's Manual.

2nd-Row Slide-N-Stow Seat*

To get in and out of the 3rd-Row Seat:

1. Lift the 2nd-Row Seat armrest
2. Adjust headrest to the lowest position
3. Accessing from outside of the vehicle: Pull up the Walk-In Lever **A** - the seat will stand up and headrest will fold automatically **C**
4. Accessing from the 3rd-Row seat: Pull the release strap **B** - the seat will stand up and headrest will fold automatically **C**
5. Return the 2nd-Row Seat to its original position and push until it locks (clicks) into place and the headrest unfolds

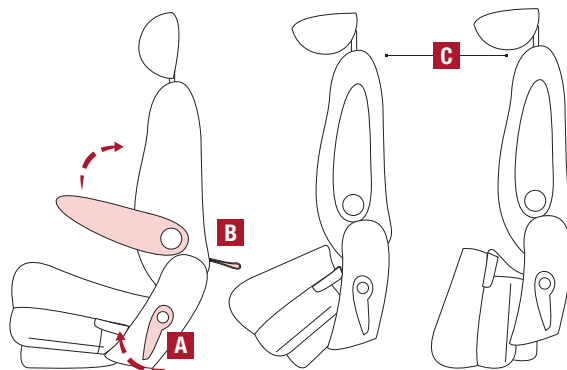

For more information on 2nd-Row Slide-N-Stow Seat operation, refer to the Owner's Manual.

2nd-Row First-Class Lounge Seating*

Leg Rest Extension

- Pull control **A** to raise the leg rest extension
- Press control **A** to lower the leg rest, which partially closes. Then, manually press leg rest extension to fully lock into place

Arm Rest Adjustment

- To raise arm rest – From any position, press the armrest release button **B** (on inside of arm rest) and lift up to desired position
- To lower armrest – Press arm rest down, and it will rest in it's original position.
- To lower armrest further, press the release button (on inside of arm rest) and push the armrest down. Press button again to lift the armrest back up to desired position.

REMINDER: If you lift the armrest to the top without depressing the release button **B**, it will return back to the lowest position previously selected.

Seatback Recline - Pull control **C** to recline Seatback

Seat Forward/Backward - Pull/press control **D** to slide seat forward/ backward

Seat Adjust Inboard/Outboard - Pull/press control **E** to slide seat inward/outward

REMINDER: Always return leg extension to its original position when adjusting seat.

For more information on 2nd-Row First-Class Lounge Seating operation, refer to the Owner's Manual.

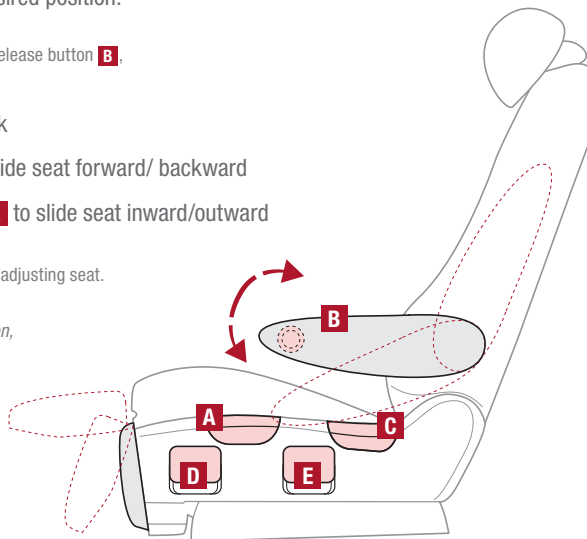

QR CODE

Sedona 2nd and 3rd Row Seats Video

To view a video on your mobile device, snap this QR Code or visit the listed website.

Refer to page 2 for more information.



www.KuTechVideos.com/yp13/2016

2nd-Row Tumble (Center) Seat*

Removing the Tumble Seat

1. Insert the seat belt into the belt assembly cover, and the seat belt buckle into the seat cushion pocket.
2. Lower the headrest **A** to the lowest position
3. Slide the Seat backward to the farthest position
4. Pull up the recline strap **B** and fold the Seatback forward
5. Pull the removal strap **C** and lift the back of the Tumble Seat forward
6. Pull up the catch release lever **D** under the Tumble Seat cushion and lift out of the anchors

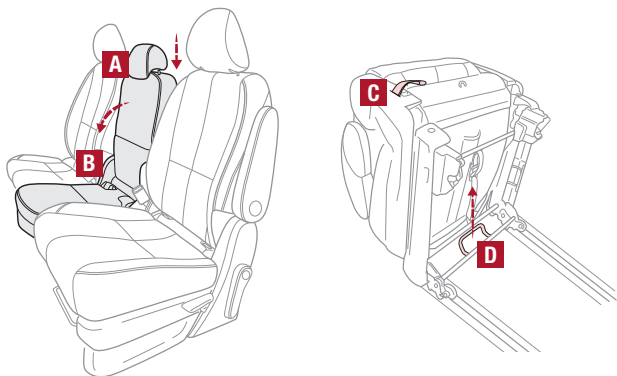

For more information on removing the Tumble Seat, refer to the Owner's Manual.

Installing Tumble Seat

1. Place and align the Tumble Seat properly **E**
2. Lower Tumble Seat and push down firmly until it clicks into place
3. Ensure the Tumble Seat is latched securely by the green indicator
4. Pull up the Tumble Seatback recline strap **F**, lift Seatback backward until it locks (clicks) into place
5. Return the Seat Belt to its proper position

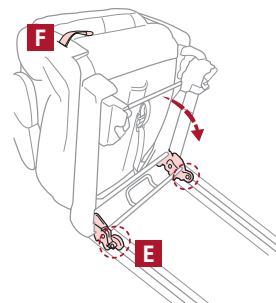

REMINDERS:

- Never install or remove the Tumble Seat while there are occupants in the 3rd-Row Seat
- Ensure to raise up both the left and right side seatbacks before installing tumble seat

For more information on the Tumble Seat, refer to the Owner's Manual.

3rd-Row Seat – Folding and Stowing

Folding 3rd-Row Seat

1. Fully lower headrest **A**
2. Pull Seat folding strap located in the back of the Seatback **B**
3. Fold Seat down **C**

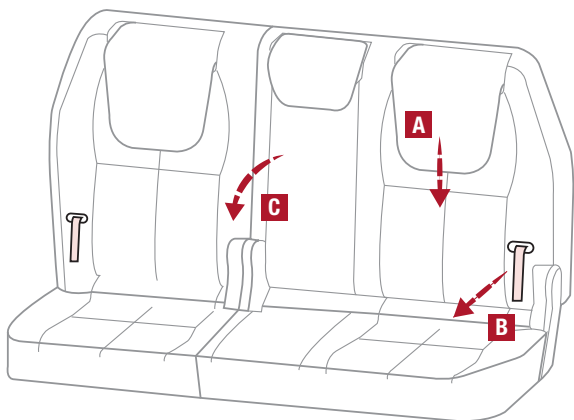

For more information on 3rd-Row Seat operation, refer to the Owner's Manual.

Stowing 3rd-Row Seats*

The rear seats can be folded and stowed in the luggage compartment for additional cargo space.

1. Fully lower headrests **D**
2. Pull release lever **E** and push Seat firmly in place

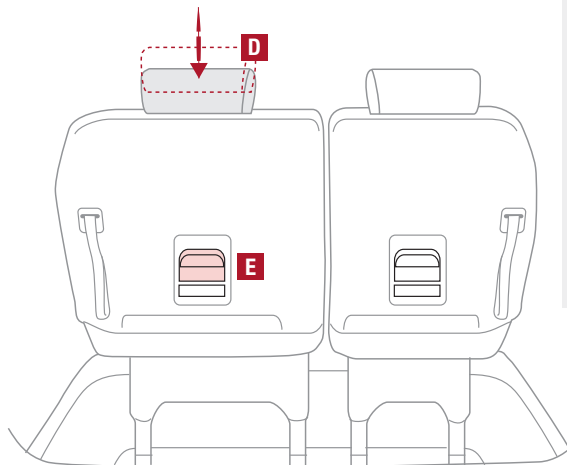

REMINDER: The seat straps on the front and back of the 3rd-Row Seat are for folding only.

QR CODE

Sedona 2nd and 3rd Row Seat Video

To view a video on your mobile device, snap this QR Code or visit the listed website.

Refer to page 2 for more information.



www.KuTechVideos.com/yp13/2016

Remote Keyless Entry (Folding Key)*

- A** Press the release button to unfold the key
- B** Press to lock All Doors
- C** Press to unlock Driver's Door: Press twice in 4 seconds to unlock All Doors and Rear Hatch, and manually open
- D** Press and hold left/right button to automatically open/close the power sliding doors*
- E** Manual Liftgate*: Press and hold for more than 1 second to unlock Rear Hatch and manually open.
- E** Power Liftgate*: Press and hold for more than 1 second for Power Liftgate to automatically open/close
- F** Press and hold more than a half second for Panic Alarm. To turn OFF Alarm, press any button

Remote button configuration may vary depending on vehicle options.

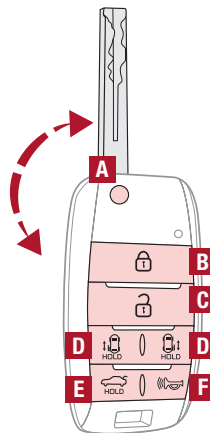

Double-Turn Lock/Unlock All

- Turn clockwise once to unlock Driver's Door
- Turn clockwise again within 4 seconds to unlock All Doors
- Turn counterclockwise once to lock All Doors

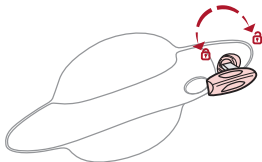

Power Sliding Doors*

Press the left/right Power Sliding Door button **G** on the overhead controls or on the key fob **D** to automatically open/close the sliding doors.

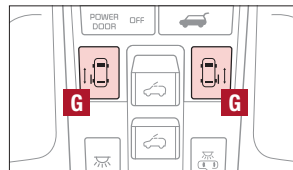

(Buttons located in overhead controls)

REMINDER: If the POWER DOOR OFF button is depressed, the Smart Liftgate will not operate.
For more information on the Power Sliding Doors operation, please refer to the Owner's Manual.

Smart Key*

- A** Press to lock All Doors
- B** Press to unlock Driver's Door. Press twice within 4 seconds to unlock All Doors.
- C** Power Sliding Doors:
 - Option 1 - Press and hold the left/right button to automatically open/close the power sliding doors*
 - Option 2 - With the Smart Key fob on your person, pull the Power Sliding Door handle once and the door will open/close automatically
- D** Manual Liftgate*: Press and hold for more than 1 second to unlock Rear Hatch and manually open.

REMINDERS:

- The Rear Hatch does not automatically open when the **D** button is pressed.
- The Rear Hatch unlocks when the Smart Key fob is within close proximity of the vehicle.
- D** Power Liftgate*: Press and hold for Power Liftgate to open automatically. Press again at any time to stop. Press again to automatically close
- E** Press and hold for more than a half second for Panic Alarm. To turn off Alarm, press any button

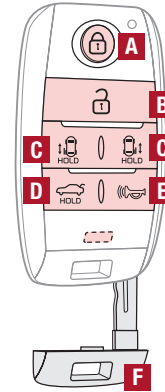

Driver's Door Lock/Unlock button **G**:

- Press button once to unlock driver's door
- Press again within 4 seconds to unlock all doors
- Press again to lock all doors

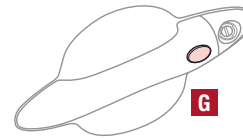

Mechanical Key **F**:

- Press button on back of key fob to release Mechanical Key
- Use to unlock driver's door
- Use to enable/disable Child Safety Locks
- Use to lock glove box

QR CODE

Engine Start/Stop Button & Smart Key Video

To view a video on your mobile device, snap this QR Code or visit the listed website.

Refer to page 2 for more information.



www.KuTechVideos.com/yp13/2016

QUICK TIP

The Smart Key's signal can be blocked by the normal operation of a cellular phone or smartphone. To help prevent this, store each device separately.

Remote button configuration may vary depending on vehicle options.

HomeLink® with Auto-Dimming Rearview Mirror*

- | | |
|---------------------------|---------------------------------|
| A HomeLink® button | E Glare detection sensor |
| B HomeLink® button | F Automatic dimming ON |
| C Indicator light | G Automatic dimming OFF |
| D HomeLink® button | |

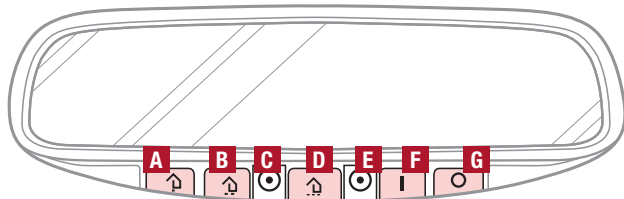

The HomeLink® with Auto-Dimming Rearview Mirror* is designed to reduce glare from a vehicle's headlights located in the rear and also connect up to three electronic transmitters into one location.

- To turn automatic dimming ON, press **I** button **F**
- To turn automatic dimming OFF, press **O** button **G**

REMINDER: Mirror indicator light **C** will illuminate when automatic dimming is ON.

QUICK TIPS

- You can reprogram a single HomeLink® button by repeating Step 2
- Erasing programmed buttons will delete all trained transmitters

How to Sync Transmitter with HomeLink®*

If programming for the first time, begin with Step 1 (repeating this step will delete all information).

To program non-rolling and rolling code garage door openers and other devices:

1. Press and hold the left **A** and center **D** buttons simultaneously until the indicator light **C** begins to flash (to reprogram buttons, skip this step)
2. Press and hold the desired button **A**, **B** or **D** and hold the button on the transmitter while it is approximately 1 to 3 inches away from the mirror. The HomeLink® Indicator light **C** will flash rapidly once the frequency signal has been successfully programmed

To finish programming rolling code garage door openers, complete these steps:

3. Locate the “learn” or “smart” button on the garage door’s motor head unit. Press and release the button and complete Step 4 within 30 seconds
4. Firmly press and release the programmed HomeLink® button up to three times

Operating HomeLink®:

Press one of the programmed HomeLink® buttons.

Erasing programmed buttons:

Press and hold the left **A** and center **D** buttons simultaneously for approximately 20 seconds, and then release both buttons within 30 seconds.

If your garage door opener was manufactured in 2011 or later, and you're unable to program your vehicle's HomeLink® system, you may need to purchase a HomeLink Repeater Kit. For more information, go to www.HomeLink.com or call (800) 355-3515.

Map/Room Lamps

Automatic turn off function*

The interior lights automatically turn off approximately 30 seconds after the ENGINE START/STOP button is OFF.

Map/Room Lamp Operation

Press the lens **A** to turn the Map Lamp ON/OFF. This light produces a spot beam for convenient use as a map lamp or as a personal lamp for the driver or the front passenger.

When the  button **B** is pressed the following occurs:

- When any door or the liftgate is opened, the map and room lamps turn ON
- When doors are unlocked from the Smart Key or key removed from ignition, the Map and Room Lamps turn ON for approximately 30 seconds or until a door is opened
- When doors are closed, the lamps will gradually turn OFF after approximately 30 seconds
- When all doors are locked or the ignition is turned ON, the Map Lamp will turn OFF immediately.

When the  button **C** is pressed, the lamps stay ON continuously.

Room Lamp - Press the lens **D** to turn the Room Lamp ON/OFF.

REMINDER: When Room Lamp lens is pressed ON it will remain ON, even when the Map Lamp switch is in the OFF position.

QUICK TIPS

- When doors are unlocked by the Smart Key*, the lamp turns ON for approximately 30 seconds
- If your vehicle is equipped with the theft alarm system, the interior lights automatically turn off approximately 3 seconds after the system is in armed stage
- Using interior lights for an extended period of time may cause battery discharge

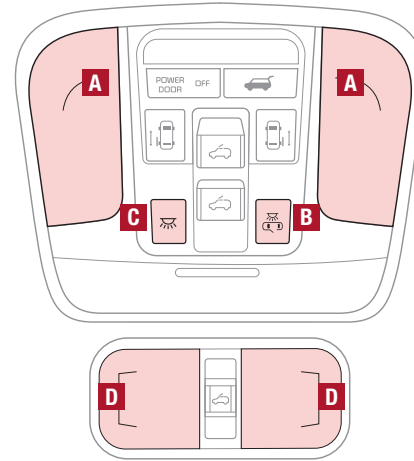

(Lamp controls located in the overhead consoles)

Sunvisor

Use the Sunvisor to shield direct light through the front or side windows. Slide the Sunvisor out and adjust as needed.

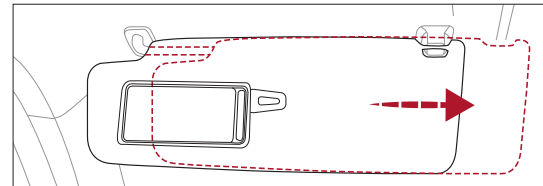

REMINDEES:

- Sunvisor may not shield all direct light
- The Sunvisor may impair visibility if not adjusted properly
- Be aware of seating position when adjusting or swinging Sunvisor around to or from the front or side windows.

Sunroof Operation*

The Sunroof and Sunshade operation is controlled through multi-directional switches/levers **A**, **B** or **C**. The ignition needs to be ON to operate the sunroof/sunshade.

To slide the Front/Rear Sunshade and Sunroof:

- Auto Open: Slide the levers **A**, **B** or **C** backward to the farthest position and release
- Auto Close (Sunroof only): Slide the levers **A**, **B** or **C** forward to the farthest position and release

REMINDER: The front Sunroof will automatically open all the way. The Rear Sunroof will only partially open. To open all the way, slide the Rear Sunroof lever again.

Tilt the Front Sunroof:

- Raise: Push lever **A** upward
- Lower: Pull lever **A** downward
- Auto Close Sunroof and Sunshade: Slide the Front Sunroof lever **A** forward to the farthest position

REMINDEERS:

- When the Power Window Lock is depressed, the Rear Sunroof controls cannot operate the Rear Sunroof
- Sunshade needs to remain OPEN while Sunroof is open and vehicle is moving

QUICK TIP

To stop the Sunroof/Sunshade at any position, push or pull the Sunroof control lever in any direction.

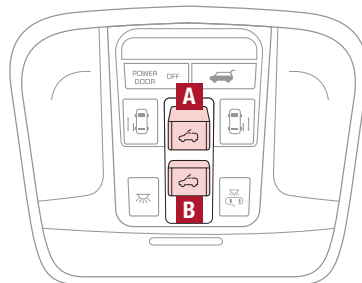

(Front overhead console for Front and Rear Sunroof controls)

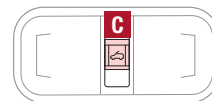

(Rear Sunroof control in the rear overhead console)

Parking Assist System*

The Parking Assist System* is not a safety device. The Parking Assist System* is a supplemental system that assists the driver by chiming if any object is detected within the sensing area to the front, rear and side of the vehicle when moving forward or backing up.

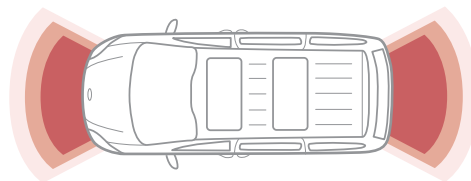

(Button located below Gear shift)

The system is activated when the ignition is ON and the vehicle is in R (Reverse). To deactivate the system, press the Parking Assist System* button **D** (LED illuminated).

REMINDEERS:

- If the vehicle is moving at speeds over 3 mph, the system may not activate correctly
- When more than two objects are sensed at the same time, the closest one will be recognized first

The Parking Assist System is not a substitute for proper and safe backing-up procedures. Always drive safely and use caution when backing up. The Parking Assist System* may not detect every object in front of or behind the vehicle.*

Back-Up Warning System (Rear Parking Assist System)*

The Back-Up Warning System is not a safety device. The Back-Up Warning System is a supplemental system that assists the driver by chiming if any object is detected within the sensing area to the rear and side of the vehicle when backing up.

The system is activated when the ignition is ON and the vehicle is in R (Reverse). To deactivate the system, press the Back-Up Warning System button **A** (LED illuminated).

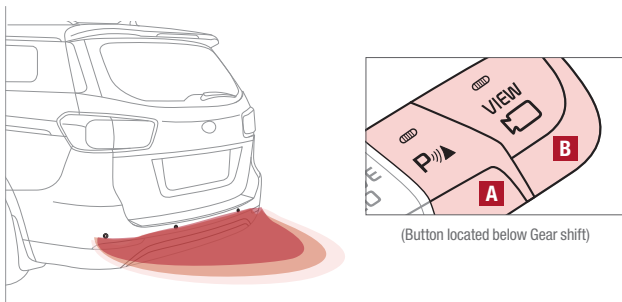

(Button located below Gear shift)

REMINDERS:

- If the vehicle is moving at speeds over 3 mph, the system may not activate correctly
- When more than two objects are sensed at the same time, the closest one will be recognized first

The Back-Up Warning System is not a substitute for proper and safe backing-up procedures. Always drive safely and use caution when backing up. The Back-Up Warning System may not detect every object behind the vehicle.

Rear-Camera Display*

The Rear-Camera Display system is not a safety device. It is a supplemental system that displays the view behind the vehicle through the Standard Audio System, UVO eServices System and the UVO eServices with Premium Navigation screens while the vehicle is in Reverse.

The Rear-Camera Display* activates when the:

- ENGINE START/STOP button is in the ON position (Green Light)
- Gear Shift Lever is in the R (Reverse) position
- To turn the Rear-Camera Display* OFF, press the camera button **B**

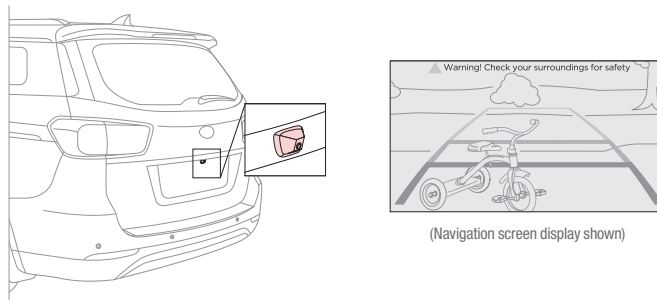

(Navigation screen display shown)

REMINDERS:

- The Rear-Camera Display* is ON by default when ignition is cycled
- While camera is active, only the volume controls on the Audio System can be operated
- The screen image above is for illustration purposes only. The actual image or graphics may differ in your vehicle

The Rear-Camera Display is not a substitute for proper and safe backing-up procedures. The Rear-Camera Display may not display every object behind the vehicle. Always drive safely and use caution when backing up.*

Power Liftgate (Tailgate)*

Inside the Vehicle:

Press the Power Liftgate Open/Close button* **A** to automatically open/close the Liftgate.

Depress the POWER DOOR OFF button* **B** to disable.

REMINDER: If POWER DOOR OFF button is pressed, the Power Liftgate button on the Smart Key will be disabled.

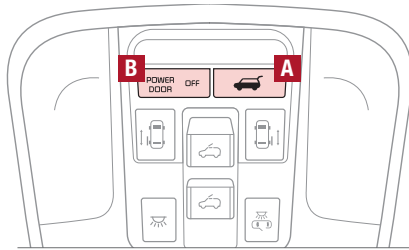

(Buttons located on overhead console)

Outside the Vehicle:

To open Power Liftgate* automatically, press the Rear Hatch Release button **C** on exterior of the Liftgate.

Automatically close by pressing Power Liftgate Close button* **D**.

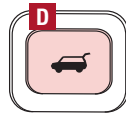
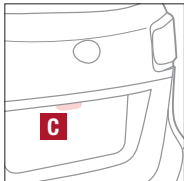

(Button located on inside edge of liftgate)

Smart Key:

To open the Power Liftgate*, press and hold the Smart key Liftgate button **E** until the Liftgate begins opening. Press again to close.

REMINDER: Pulling the Rear Hatch upward by the handle or pressing the button a second time will interrupt the automatic opening of the Power Liftgate.



Smart Power Liftgate*

When the Smart Key fob is on your person and you are near the back of the vehicle, within close proximity, the hazard lights will blink and a chime will sound for about 3 seconds as an alert that the Smart Power Liftgate* is about to open.

Then the alert system will blink and chime two additional times before opening the Smart Power Liftgate*.

The Smart Power Liftgate* feature is OFF by default. To enable the Smart Power Liftgate*, go to User Settings in the LCD Instrument Cluster modes.

QUICK TIPS

During the Smart Power Liftgate alert, the Smart Power Liftgate can be deactivated with the Smart Key by pressing any button on the key fob.

REMINERS:

- All doors are closed and locked after about 15 seconds
- If the POWER DOOR OFF button is depressed, the Smart Liftgate will not operate
- The Smart Power Liftgate feature will not operate when the doors are recently closed and locked, and the Smart Key is still detected after 15 seconds near the vehicle or within 60 inches of the door handles, a door is not locked or closed or the Smart Key is in the vehicle

For more information on the Smart Power Liftgate operation, please refer to the Owner's Manual.

QR CODE

Smart Power Liftgate Video

To view a video on your mobile device, snap this QR Code or visit the listed website. Refer to page 2 for more information.



www.KuTechVideos.com/yp13/2016

Hood Release Lever and Latch

Opening the Hood:

1. Pull the Hood Release Lever **A** to unlatch the Hood
2. In the front of the vehicle, lift the Hood slightly, push the secondary Latch **B** to the left inside of the Hood's center and lift the Hood
3. Pull out the support rod from the Hood and set into place to hold the Hood open

REMINDER: Open the Hood only after turning the engine off, on a flat surface, with the gear shift in P (Park) position and setting the parking brake.

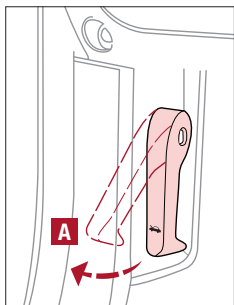

(Lever located near floor below Driver's Panel)

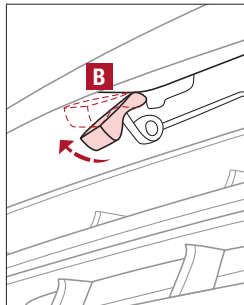

(Secondary latch located inside lip of Hood)

Closing the Hood:

Lower the Hood about halfway and then press down to securely lock in place.

Fuel Cap/Malfunction Indicator (Check Engine Light)

Tighten for ONE CLICK to prevent Malfunction Indicator  from illuminating.

REMINDER: The Fuel Filler Door Release button is located on the driver's button panel, left of the Steering Wheel.

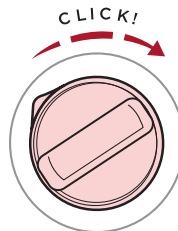

Child Safety Locks

Located on the front edge of the rear passenger doors, press the Child Safety Lock to the lock position  to disable the inner door handles from opening the rear passenger doors.

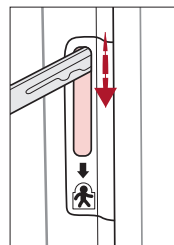

(Located on the front edge of the rear passenger doors)

QR CODE

One-Click Fuel Cap Video

To view a video on your mobile device, snap this QR Code or visit the listed website.

Refer to page 2 for more information.



www.KuTechVideos.com/yp13/2016

Occupant Detection System (ODS) / Passenger Airbag Off Indicator

ODS detects the presence and position of the front passenger and adjusts or turns off airbag deployment accordingly.

Depending on the situation and type of accident, the system may:

- Deploy airbag (Adult)
- Not deploy the airbag (Unoccupied)



If the system determines that the airbag should not be deployed, the “PASSENGER AIRBAG OFF” light will illuminate.

Seat Belts

To properly fasten your seat belts:

1. Insert the belt tongue plate **A** into the buckle **B** until it clicks
2. Position the lap portion of the belt across your lap as **LOW ON THE HIPS** as possible **C**. Adjust the belt to a **SNUG FIT** by pulling up on the shoulder portion **D**

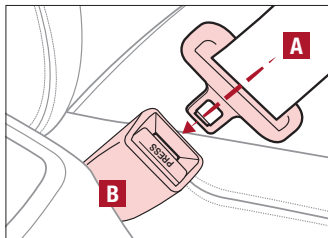

REMINDER: For maximum protection, always wear your seat belt.

Seat Belt Retractor Locks

Retractor locks allow lap/shoulder seat belts to remain unlocked during normal vehicle operation for freedom of movement and increased comfort.

During a **STRONG STOP, SUDDEN TURN OR CERTAIN COLLISIONS**, seat belt retractors will automatically lock the belts to reduce the risk of injury.

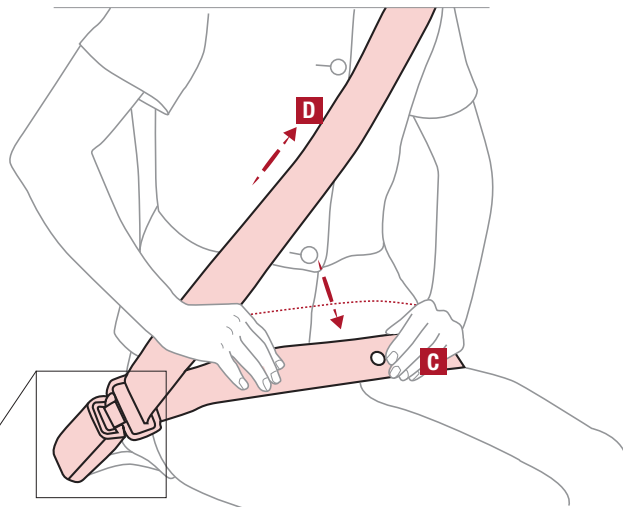

QUICK TIP

The seat belt warning chime operates for driver's seat only.

Normal Maintenance Schedule

When your vehicle requires service, remember that your dealer knows your vehicle best. Your dealer has factory-trained technicians, recommended special tools, genuine Kia replacement parts and is dedicated to your complete satisfaction. For expert advice and quality service, see your authorized Kia dealer.

7,500 miles

PERFORM

- Rotate tire
- Add fuel additive¹ (Every 7,500 miles)

REPLACE

- Engine oil and filter (Every 7,500 miles)

INSPECT*

- Battery condition
- Air cleaner filter
- Vacuum hose
- Power steering fluid**
- Power steering pump, belt and hoses**

*And, if necessary, adjust, correct, clean or replace. **If equipped

1. If TOP TIER detergent gasoline is not available, one bottle of additive is recommended. Additives are available from your authorized Kia dealer along with information on how to use them. Do not mix other additives.

15,000 miles

PERFORM

- Rotate tire
- Add fuel additive¹ (Every 7,500 miles)

REPLACE

- Climate control air filter (For evaporator and blower unit)
- Engine oil and filter (Every 7,500 miles)

INSPECT*

- | | |
|---|--|
| <ul style="list-style-type: none"> • Battery condition • Air cleaner filter • Vacuum hose • Air conditioning refrigerant • Brake hoses and lines • Drive shafts and boots • Exhaust pipe and muffler | <ul style="list-style-type: none"> • Front brake disc/pads, calipers • Rear brake disc/pads • Steering gear box, linkage & boots/lower arm ball joint, upper arm ball joint • Suspension mounting bolts • Power steering fluid** • Power steering pump, belt and hoses** |
|---|--|

*And, if necessary, adjust, correct, clean or replace. **If equipped

1. If TOP TIER detergent gasoline is not available, one bottle of additive is recommended. Additives are available from your authorized Kia dealer along with information on how to use them. Do not mix other additives.

QUICK TIP

Check your Maintenance Schedule or schedule an appointment with a dealer using your UVO eServices account by logging into your UVO App or your account on MyUVO.com (Vehicles equipped with UVO eServices only - See page 21/22 for setup information)

Normal Maintenance Schedule (Continued)

22,500 miles

PERFORM

- Rotate tire
- Add fuel additive¹ (Every 7,500 miles)

REPLACE

- Engine oil and filter (Every 7,500 miles)

INSPECT*

- Battery condition
- Air cleaner filter
- Vacuum hose
- Power steering fluid**
- Power steering pump, belt and hoses**

*And, if necessary, adjust, correct, clean or replace. **If equipped

1. If TOP TIER Detergent Gasoline is not available, one bottle of additive is recommended. Additives are available from your authorized Kia dealer along with information on how to use them. Do not mix other additives.

30,000 miles

PERFORM

- Rotate tire
- Add fuel additive¹ (Every 7,500 miles)

REPLACE

- Climate control air filter (For evaporator and blower unit)
- Air cleaner filter
- Engine oil and filter (Every 7,500 miles)

INSPECT*

- | | |
|---|--|
| • Battery condition | • Suspension mounting bolts |
| • Vacuum hose | • Brake fluid |
| • Air conditioning refrigerant | • Fuel filter ² |
| • Brake hoses and lines | • Fuel lines, fuel hoses and connections |
| • Drive shafts and boots | • Fuel tank air filter ² |
| • Exhaust system | • Parking brake |
| • Front brake disc/pads, calipers | • Vapor hose and fuel filler cap |
| • Rear brake disc/pads | • Power steering fluid** |
| • Steering gear box, linkage & boots/
lower arm ball joint, upper arm ball joint | • Power steering pump, belt and hoses** |

*And, if necessary, adjust, correct, clean or replace. **If equipped

1. If TOP TIER Detergent Gasoline is not available, one bottle of additive is recommended. Additives are available from your authorized Kia dealer along with information on how to use them. Do not mix other additives. 2. Fuel filter & Fuel tank air filter are considered to be maintenance free but periodic inspection is recommended for this maintenance schedule depends on fuel quality. If there are some important safety matters like fuel flow restriction, surging, loss of power, hard starting problem etc, replace the fuel filter immediately regardless of maintenance schedule and consult an authorized Kia dealer for details.

Normal Maintenance Schedule (Continued)

37,500 miles

PERFORM

- Rotate tire
- Add fuel additive¹ (Every 7,500 miles)

REPLACE

- Engine oil and filter (Every 7,500 miles)

INSPECT*

- Battery condition
- Air cleaner filter
- Vacuum hose
- Power steering fluid**
- Power steering pump, belt and hoses**

*And, if necessary, adjust, correct, clean or replace. **If equipped

1. If TOP TIER Detergent Gasoline is not available, one bottle of additive is recommended. Additives are available from your authorized Kia dealer along with information on how to use them. Do not mix other additives.

45,000 miles

PERFORM

- Rotate tire
- Fuel additive¹ (Every 7,500 miles)

REPLACE

- Climate control air filter (For evaporator and blower unit)
- Engine oil and filter (Every 7,500 miles)

INSPECT*

- Battery condition
- Air cleaner filter
- Vacuum hose
- Air conditioning refrigerant
- Brake hoses and lines
- Drive shafts and boots
- Exhaust system
- Front brake disc/pads, calipers
- Rear brake disc/pads
- Steering gear box, linkage & boots/lower arm ball joint, upper arm ball joint
- Suspension mounting bolts
- Power steering fluid**
- Power steering pump, belt and hoses**

*And, if necessary, adjust, correct, clean or replace. **If equipped

1. If TOP TIER Detergent Gasoline is not available, one bottle of additive is recommended. Additives are available from your authorized Kia dealer along with information on how to use them. Do not mix other additives.

Normal Maintenance Schedule (Continued)

52,500 miles

PERFORM

- Rotate tire
- Add fuel additive¹ (Every 7,500 miles)

REPLACE

- Engine oil and filter (Every 7,500 miles)

INSPECT*

- Battery condition
- Air cleaner filter
- Vacuum hose
- Power steering fluid**
- Power steering pump, belt and hoses**

*And, if necessary, adjust, correct, clean or replace. **If equipped

1. If TOP TIER Detergent Gasoline is not available, one bottle of additive is recommended. Additives are available from your authorized Kia dealer along with information on how to use them. Do not mix other additives.

60,000 miles

PERFORM

- Rotate tire
- Add fuel additive¹ (Every 7,500 miles)

REPLACE

- Climate control air filter (For evaporator and blower unit)
- Air cleaner filter
- Engine oil and filter (Every 7,500 miles)

INSPECT*

- Battery condition
- Vacuum hose
- Air conditioning refrigerant
- Brake hoses and lines
- Drive shafts and boots
- Exhaust system
- Front brake disc/pads, calipers
- Rear brake disc/pads
- Steering gear box, linkage & boots/lower arm ball joint, upper arm ball joint
- Suspension mounting bolts
- Brake fluid
- Fuel filter³
- Fuel lines, fuel hoses and connections
- Fuel tank air filter²
- Parking brake
- Valve clearance³
- Vapor hose and fuel filler cap
- Drive belts⁴ (First, 60,000 miles after that, every 15,000 miles)
- Power steering fluid**
- Power steering pump, belt and hoses**

*And, if necessary, adjust, correct, clean or replace. **If equipped

1. If TOP TIER Detergent Gasoline is not available, one bottle of additive is recommended. Additives are available from your authorized Kia dealer along with information on how to use them. Do not mix other additives. 2. Fuel filter & Fuel tank air filter are considered to be maintenance free but periodic inspection is recommended for this maintenance schedule depends on fuel quality. If there are some important safety matters like fuel flow restriction, surging, loss of power, hard starting problem etc, replace the fuel filter immediately regardless of maintenance schedule and consult an authorized Kia dealer for details. 3. Inspect for excessive tappet noise and/or engine vibration and adjust if necessary. 4. The drive belt should be replaced when cracks occur or tension is reduced excessively.

LEGAL DISCLAIMERS

Driving while distracted is dangerous and should be avoided. Drivers should remain attentive to driving and always exercise caution when using the steering-wheel-mounted controls while driving.

Driving while distracted can result in a loss of vehicle control that may lead to an accident, severe personal injury and death. The driver's primary responsibility is in the safe and legal operation of a vehicle, and use of any handheld devices, other equipment or vehicle systems which take the driver's eyes, attention and focus away from the safe operation of a vehicle or that are not permissible by law should never be used during operation of the vehicle.

Safety Features: No system, no matter how advanced, can compensate for all driver error and/or driving conditions. Always drive responsibly.

Airbags: For maximum protection, always wear your seat belt.

Apps: All information contained herein was based upon the latest available information at the time of appstore registration. Descriptions are believed to be correct, and Kia Motors Corporation (KMC) makes every effort to ensure accuracy, however, accuracy cannot be guaranteed. From time to time, KMC may need to update or make changes to the vehicle features and other vehicle information reported in this app. KMC, by the publication and dissemination of this material, does not create any warranties, either express or implied, to any Kia products. Contact your local Kia dealer for the most current information.

Bluetooth® Wireless Technology: A compatible *Bluetooth®* wireless technology-enabled cell phone is required to use *Bluetooth®* wireless technology. The *Bluetooth®* word mark and logos are registered trademarks owned by Bluetooth SIG, Inc. and any use of such marks by Kia is under license. Other trademarks and trade names are those of their respective owners. A *Bluetooth®* enabled cell phone is required to use *Bluetooth®* wireless technology.

Driver Assist Features - Advanced Smart Cruise Control (ASCC), Back-Up Warning System (Rear Parking Assist System), Blind Spot Detection (BSD) with Lane Change Assist, Rear Cross Traffic Alert (RCTA), Forward Collision Warning System, Lane Departure Warning System, Park Assist System, Rear-Camera Display, Surround View Monitor (SVM): These features are not substitutes for safe driving, and may not detect all objects surrounding vehicle. Always drive safely and use caution.

Electronic Stability Control, Hill-start Assist Control (HAC): No system, no matter how advanced, can compensate for all driver error and/or driving conditions. Always drive responsibly.

Engine Start/Stop Button with Smart Key: Always come to a complete stop before turning the engine on or off. However, if you have an emergency while the vehicle is in motion and must turn the engine off, you can turn the engine off to the ACC position by pressing the Start/Stop button for more than 3 seconds or 3 times in succession. If the vehicle is still moving, you can restart the engine by pressing the Start/Stop button with the shift lever in Neutral (N). With the engine off, power assist for steering and braking will be disabled, and the vehicle will be more difficult to control.

Front Seat Headrest Adjustment: Never attempt to adjust headrests when vehicle is in motion.

Seat Belts / Airbags: For maximum protection, always wear your seatbelt.

HomeLink® is a registered trademark of Gentex Corporation.

iPod® is a registered trademark of Apple Inc. iPod® mobile digital device sold separately, and connectivity requires the Kia accessory cable.

Navigation: Distracted driving can result in a loss of vehicle control. When operating a vehicle, never use a handheld device or vehicle system that takes your focus away from safe vehicle operation. Navigation is for information purposes only, and Kia does not make any warranties about the accuracy of the information.

Occupant Detection System (ODS): Kia vehicles use a number of different ODS types that vary by model.

SiriusXM®: SiriusXM Satellite Radio, SiriusXM Traffic and SiriusXM Travel Link each require a subscription sold separately, or as a package, by SiriusXM Radio Inc. If you decide to continue your service at the end of your trial subscription, the plan you choose will automatically renew and bill at then-current rates until you call 1-866-635-2349 to cancel. See SiriusXM Customer Agreement for complete terms at www.siriusxm.com. Other fees and taxes will apply. All fees and programming are subject to change. Not all vehicles or devices are capable of receiving all services offered by SiriusXM. Data displays and individual product availability vary by vehicle hardware. Current information and features may not be available in all locations, or on all receivers. Weather Forecast, Current Conditions may not be available in all locations. Images above are for representative purposes only and are not real products. For actual features and images of real products, consult the vehicle manufacturer. SiriusXM is not responsible for any errors or inaccuracies in the data services or their use in the vehicle. Travel Link Stocks displays current price and daily delta of around 7,000 actively reported securities traded on the NYSE®, NASDAQ® and AMEX®. The service is delayed approximately 20 minutes. SiriusXM satellite service is available only to those at least 18 years of age in the 48 contiguous USA, DC, and Puerto Rico (with coverage limitations). SiriusXM Internet Radio service is available throughout our satellite service area and in AK and HI. © 2015 SiriusXM Radio Inc. Sirius, XM and all related marks and logos are trademarks of SiriusXM Radio Inc.

Sportmatic® is a registered trademark of Kia Motors America.

Steering Wheel Controls: Driving while distracted is dangerous and should be avoided. Remain attentive to driving and be cautious when using steering-wheel-mounted controls while driving.

Sunvisor: Sunvisor may not shield all direct light. Do not operate the vehicle if Sunvisor is impairing your visibility.

Tilt/Telescoping Steering Wheel: Never attempt to adjust steering wheel position when vehicle is in motion.

TPMS: Even with the Tire-Pressure Monitoring System (TPMS), always check your tire pressure on a regular basis.

UVO eServices: Distracted driving can result in a loss of vehicle control. Never use a handheld device or vehicle system that takes your focus away from safe vehicle operation.

UVO eServices app: App uses your smartphone data service. Normal cellular service rates will apply.

UVO eServices with Navigation: Distracted driving can result in a loss of vehicle control. Never use a handheld device or vehicle system that takes your focus away from safe vehicle operation. Navigation is for information purposes only, and Kia does not make any warranties about the accuracy of the information.



SEDONA CUSTOMER DELIVERY CHECKLIST

Owner's Name: _____ VIN: _____ Mileage: _____

Dealership Name: _____ Sales Consultant: _____ Date: _____

BEFORE DELIVERY

- Test and confirm "Good Battery" using the Kia GR8-1299 battery tester and affix Results Label
- Verify all tire pressures are to spec (see driver's door label) LF _____ LR _____ RF _____ RR _____
- Verify proper operation of Remote Keyless Entry and Smart Key lock/unlock
- Ensure floor mats are snapped into place (if applicable)
- Verify vehicle is clean (interior and exterior), in good condition and free of chips and scratches
- Ensure all key documents are in the vehicle (Owner's Manual, Warranty and Consumer Information booklet, Tire Warranty booklet and Features & Functions Guide and any Audio System User's Manual.)

KEY FEATURE WALKTHROUGH

- Air Conditioning: Automatic/Manual/Rear Climate Control - pages 26-28 – Demonstrate Air Flow Modes, Defog and Defrosting Windshield Fan Speed

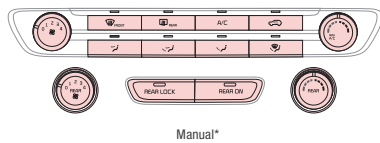
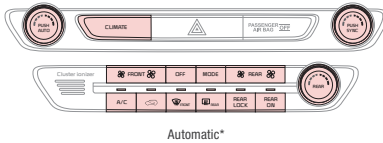

- Front Seat Headrest Adjustment – page 30

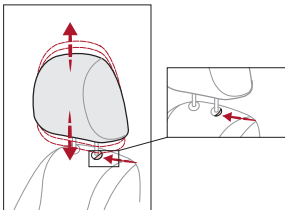

- Windshield/Rear Wipers & Washers – page 15

To operate:

- Move lever Up/Down to change Wiper modes
- Press button to adjust Intermittent Wipe
- Pull lever to spray and wipe

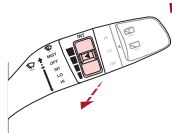

MIST: Single wipe
 OFF: Wiper off
 INT: Intermittent wipe
 LO: Slow wipe
 HI: Fast wipe

To operate:

- Rotate Rear Wiper switch to change Wiper modes
- Push to spray and wipe

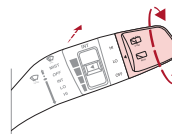

HI: Fast wipe
 LO: Slow wipe
 OFF: Wiper off



SEDONA CUSTOMER DELIVERY CHECKLIST

KEY FEATURE WALKTHROUGH

Demonstrate the following with the customer:

- Standard Audio System – page 20
For further operational information, refer to the Owner's Manual

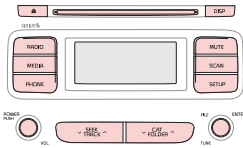

- UVO eServices System* – page 21
For further operational information, refer to the UVO System User's Manual

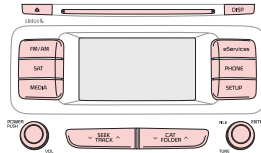

- UVO eServices with Premium Navigation System* – page 22
For further operational information, refer to the Car Multimedia System User's Manual

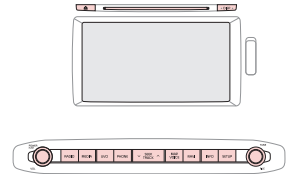

- SCC / Cruise Control – page 18-19
Demonstrate operation

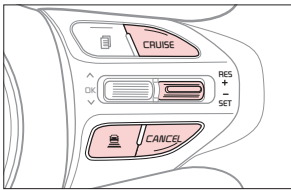

- Bluetooth® Wireless Technology – pages 16-17
Demonstrate operation

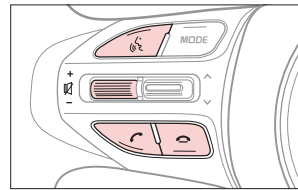

- Tire Pressure Monitoring System (TPMS) – page 5
- Blind Spot Detection (BSD)* – page 10
- Lane Departure Warning System (LDWS)* – page 11
- Engine Start/Stop Button – page 13
- Clock Setup – page 24
- Aux/USB/iPod® Port, AC Inverter* and Power Outlets – page 24
- Seat Warmers / Ventilated Seats* – page 29
- Smart Key* – page 37

- HomeLink® with Auto-Dimming Rearview Mirror* – page 38
- Sunroof Operation* – page 40
- Parking Assist System* – 40
- Backup Warning System* – 41
- Sunvisor – page 39
- Rear-Camera Display* – page 41
- Passenger Airbag Off Indicator – page 44

*if equipped

DURING DELIVERY

- Explain first service process and schedule first service appointment
- Tour Parts & Service departments, introduce staff and explain value of Kia Parts and Service
- Review recommended maintenance schedule and maintenance requirements to validate warranty
- Review business hours and Customer 360° Care
- Review the Kia 10-year/100,000-mile warranty program
- Ensure 100% satisfaction with sales and delivery process and no problems with the vehicle
- Confirm time and best contact number for initial dealer follow-up

Sales Consultant: _____ Date: _____

Sales Manager: _____ Date: _____

Customer: _____ Date: _____



© 2015 Kia Motors America, Inc. All rights reserved.

Part Number: UV160-PS-004

Consumer - Roadside Assistance: 1-800-333-4KIA (4542)