



SOUL EV

FEATURES & FUNCTIONS GUIDE

www.kia.com

Consumer - Roadside Assistance

1-800-333-4KIA (4542)

See Back Cover for Vehicle Maintenance Schedule

Always check the Owner's Manual for complete operating information and safety warnings.

GETTING TO KNOW YOUR **SOUL EV**

Congratulations on Your New Kia Purchase!

Your new Kia vehicle has been designed, engineered and manufactured to provide you with years of comfortable and dependable driving. Kia is committed to quality, innovation, safety and — above all — your satisfaction.

Using This Guide

The information contained in this guide is a brief overview that will help you become familiar with the operation and features of your new Kia vehicle. The flipbook format facilitates information access, while the detailed illustrations help to ensure the instructions are easy to follow.

This Features & Functions Guide and the specific operational and safety information it provides is not a substitute for your Owner's Manual. In the interest of your safety and that of your family, and to help you avoid risks that may result in death or serious injury, Kia reminds you to carefully read your Owner's Manual in order to fully familiarize yourself with the important information it contains.

While the information contained in this guide is accurate at the time of printing, Kia may change vehicle specifications without notice in advance or after the fact, and assumes no liability in connection with such changes.

ESSENTIAL FEATURES

Air Conditioning / Climate Control	26
AVN (Audio/Video/Navigation) System	24
Aux/USB/iPod® Port & Power Outlets	27
<i>Bluetooth</i> ® Wireless Technology	22
Charging your Electric Vehicle.	10
Cruise Control	21
Digital Clock.	27
ECO System	09
Folding Rear Seatback	32
Passenger Airbag Off Indicator	40
Tire Mobility Kit	36
Tire Pressure Monitoring System (TPMS)	06
Windshield/Rear Wipers & Washers.	20

Driving while distracted can result in a loss of vehicle control that may lead to an accident, severe personal injury and death. The driver's primary responsibility is in the safe and legal operation of a vehicle, and use of any handheld devices, other equipment or vehicle systems which take the driver's eyes, attention and focus away from the safe operation of a vehicle or that are not permissible by law should never be used during operation of the vehicle.



VIDEOS & QR CODES	02
--	----

INSTRUMENT CLUSTER

Instrument Cluster Overview	03
Indicators & Warning Lights	04
Electric Vehicle (EV) Indicators	05
Energy Consumption.	06
Tire Pressure Monitoring System (TPMS).	06
LCD Instrument Cluster Modes.	07
Trip Computer / Tripmeter	07
User Settings Mode	08
Service Mode	08

ELECTRIC VEHICLE (EV) FEATURES

ECO System	09
Charging Your Electric Vehicle	10
EV Information Modes - Instrument Cluster	13
EV System Information - AVN Screen	14

DRIVER'S PANEL

Instrument Panel Dimmer	16
Electronic Stability Control (ESC)	16
Heated Steering Wheel Button	16
Hill-Start Assist Control	16
Power Windows, Window Lock & Central Door Lock	17
Automatic Door Lock/Unlock.	17
Heated Outside Mirrors*	17
Power Folding Outside Mirrors*	17

STEERING WHEEL CONTROLS

Tilt/Telescoping Steering Wheel	18
Headlights & High Beams	19
Turn Signals & Fog Lights	19
Windshield Wipers & Washers	20
Rear Wiper & Washer	20
FlexSteer™ Steering Wheel Mode	20
Audio Controls.	21
Cruise Control	21
<i>Bluetooth</i> ® Wireless Technology	22

CENTER PANEL

AVN (Audio/Video/Navigation) System	24
Power Button	25
Automatic Climate Control	26
Driver Only Ventilation	27
Reserved Climate Control	27
Digital Clock.	27
Aux/USB/iPod® Port & Power Outlets	27
Electric Parking Brake (EPB)	28
Automatic Gear Shift with Regenerative Brake Mode	29
Seat Warmers / Ventilated Seats*	30

SEATING

6-Way Adjustable Driver's Seat	31
Front Seat Headrest Adjustment	31
Folding Rear Seatback.	32

OTHER KEY FEATURES

Smart Key	33
Double-Turn Lock/Unlock All.	33
Map/Room Lamps.	34
Pedestrian Warning System	34
Sunvisor.	34
Rear-Camera Display	35
Parking Assist System	35
Hood Release Lever and Latch	36
Tire Mobility Kit	36
High-Voltage Areas	37
Air Inlet	37
Rear Hatch Release Button.	38
Child Safety Locks.	38

SAFETY FEATURES

Seat Belts	39
Seat Belt Retractor Locks	39
Occupant Detection System (ODS) / Passenger Airbag Off Indicator	40

LEGAL DISCLAIMERS (See Back Inside Cover Page)

MAINTENANCE (See Back Cover)

Kia provides a number of video resources at your disposal to assist you with becoming familiar with the features and functions found in your Kia vehicle. You can access these resources by snapping the QR Codes with your smartphone/tablet (mobile devices) or by visiting the following website: www.KuTechVideos.com/ps23/2015. Continue reading for a more in-depth look at QR Codes and for instructions on how to use them.

What are QR Codes?

A QR Code is a square, 2-dimensional barcode that can be read by mobile devices loaded with an appropriate barcode or QR Code Reader App. The app reads the barcode image and then launches/uploads the specific information the code contains, such as URLs, text, photos, videos and so much more.

How to use QR Codes

If you have a mobile device with a QR Code Reader App, you can snap the code with your phone and you'll be provided a video with additional information pertaining to the topic. For example, in the Instrument Cluster Overview section, if you would like additional information, just snap the code with your mobile device to view the selected Kia Features & Functions Video.

How to snap a QR Code

1. With your mobile device, download a QR Code Reader App. With many devices, you can do this through an app store or marketplace
2. Open the QR Code Reader App on your mobile device
3. The app will utilize your device's camera. Center the code in the camera viewing area:
 - With some apps, as soon as the app recognizes the code, it will launch the corresponding video
 - With other apps, you will have to snap or take a picture of the code. The app will then launch the corresponding video
 - For operation specifics, refer to the instructions that come with the QR Code Reader App

QR CODE

EV Overview Video

To view a video on your mobile device, snap this QR Code or visit the listed website.



www.KuTechVideos.com/ps23/2015

REMINDER: When accessing videos on your mobile device, standard cellular data rates may apply.

© QUICK TIPS

1. If you're having trouble scanning codes, check the following:
 - The code should be centered and focused in your mobile device's camera screen
 - Consider moving your device closer to or farther away from the code
 - The code should be well lit, without significant shadow
 - Avoid scanning from a significant angle
 - Confirm that the device's app supports 2D QR Code scanning
 - Try another QR Code Reader App; not all apps are created equal
2. After scanning, if a "connecting" message appears and then nothing happens or there's a "connection error" message, this typically indicates that your device is having trouble connecting to the Internet
3. When accessing videos on your mobile device, standard cellular data rates will apply

Instrument Cluster Overview

A Motor Operation Gauge

B Range Meter

C Turn Signal Indicators

D State-of-Charge Gauge

E Indicators & Warnings Lights

F Gear Shift Position

G Trip Computer / Trip Meter

H Odometer

I Speedometer

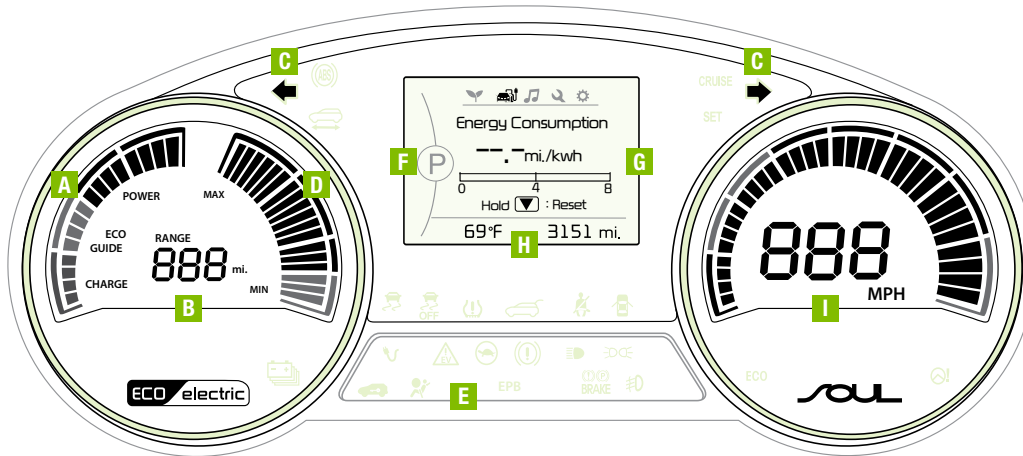

QR CODE

EV Overview Video

To view a video on your mobile device, snap this QR Code or visit the listed website.



www.KuTechVideos.com/ps23/2015





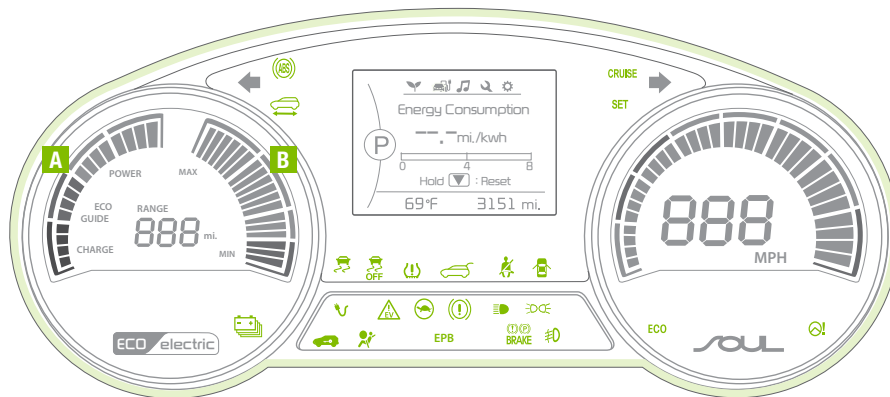

REMINDER: Your vehicle's instrument cluster & indicator light locations may differ from those in the illustrations. See your Owner's Manual for more details.

QUICK TIPS

For more information on the function of all indicator and warning lights, please refer to the Owner's Manual.

Indicators & Warning Lights



-  Ready Indicator Light
-  Service Warning Light
-  Charging Indicator Light
-  Power Down Warning Light
-  High-Voltage Battery Level Warning Light
-  Anti-lock Braking System (ABS) Warning Light
- CRUISE** Cruise ON/OFF Indicator
- SET** Cruise SET Indicator
-  Electronic Stability Control (ESC) Indicator

-  Electronic Stability Control (ESC) OFF Indicator
-  Low Tire Pressure Light / Tire Pressure Monitoring System (TPMS) Malfunction Indicator
-  Tailgate Open Warning Light
-  Seat Belt Warning Light
-  Door Ajar Warning Light
-  Regenerative Brake Warning Light (red/yellow)
-  High Beam Indicator
-  Tail Light Indicator*

-  Immobilizer Indicator Light*
-  Airbag Warning Light
- EPB** Electric Parking Brake (EPB)
-  Parking Brake & Brake Fluid Warning Light
-  Electronic Brake Force Distribution (EBD) System Warning Light
-  Front Fog Light Indicator*
- ECO** ECO System Indicator
-  Electronic Power Steering Warning Light

QR CODE

EV Cluster Overview Video

To view a video on your mobile device, snap this QR Code or visit the listed website.



www.KuTechVideos.com/ps23/2015

REMINDER: Your vehicle's instrument cluster & indicator light locations may differ from those in the illustrations. See your Owner's Manual for more details.

QUICK TIPS

For more information on the function of all indicator and warning lights, please refer to the Owner's Manual.

Electric Vehicle Indicators

A Motor operation gauge

Soul EV's motor operation gauge provides information on the energy consumption rate of the vehicle and the charge status of the regenerative brakes.

- **CHARGE** – Shows the charging status of the battery when it is being charged by the regenerative brakes. The more electric energy charged, the lower the gauge level
- **ECO GUIDE** – Shows the energy consumption rate during normal driving conditions
- **POWER** – Shows the energy consumption rate of the vehicle when driving uphill or accelerating. The more electric energy used, the higher the gauge level

B State of Charge gauge (SOC)

The State of Charge gauge displays the high-voltage battery charge status.

- MIN position on the gauge indicates that the driving battery energy is low
- MAX position on the gauge indicates that the driving battery is fully charged



Ready indicator light – Illuminates when the vehicle is ready to drive. When the ready indicator light is OFF or blinking, a malfunction has occurred. Have an authorized Kia dealer address the concern as soon as possible.



ECO display light – Indicates that the ECO System is operational. This indicator light is always illuminated unless the ECO System is turned OFF.



Service warning light – Illuminates when there is a malfunction related to the electric vehicle control system. Have an authorized Kia dealer address the concern as soon as possible.



Power down warning light – Illuminates when the power is limited for the safety of the electric vehicle.



Charging indicator light – Shows the charging status of the high-voltage battery. When charging, the red indicator turns on. When charging is complete, the green indicator turns on.



High-voltage battery level warning light – Illuminates when the high-voltage battery charge level is insufficient.



Regenerative brake warning lights (when both indicators are lit) – Illuminates when the regenerative brake system is not functioning correctly.

Energy Consumption

There are several factors that contribute to your electric vehicle's energy consumption, including maintenance of your vehicle, driving style, environmental conditions, vehicle weight and vehicle aerodynamics.

Below are tips on how to help reduce energy consumption:

- Keep your vehicle in good condition with regular maintenance
- Don't "ride" the brake pedal
- Drive at a moderate speed, accelerating smoothly and at a moderate rate
- Keep tires inflated to the recommended pressure
- Travel lightly, without carrying unnecessary weight in your vehicles
- Ensure wheels are aligned correctly
- Avoid placing large or heavy items on roof racks
- Avoid hilly, winding or poorly maintained roads

REMINDER: Do not turn the vehicle off by pushing the POWER button while the vehicle is in motion. If the vehicle has been turned off the power brake and power steering system cannot operate.

Tire Pressure Monitoring System (TPMS)



The indicator (🚗) functions as both Low Tire Pressure Light and TPMS Malfunction Indicator.

The TPMS indicator illuminates if one or more tires is significantly underinflated, the vehicle has a spare tire installed without TPMS or the outside temperature becomes significantly lower.

Inflate tire(s) to specifications using an accurate digital tire pressure gauge to turn off Low Tire Pressure Light (🚗). See front driver's door jamb for PSI specification.

When there is a problem with the TPMS, the TPMS Malfunction Indicator (🚗) will blink for approximately one minute and then illuminate - see dealer for service.

REMINDER: Consult your dealer for service if Low Tire Pressure Light remains illuminated after inflating your tire(s).

🕒 QUICK TIPS

- Even with TPMS, tire pressure should be checked manually at least once a month. Only adjust Tire Pressure on "cold tires"
- For proper maintenance and optimal fuel economy, maintain recommended tire inflation pressures and stay within the load limits and weight distribution recommended for your vehicle
- In winter or cold weather, the TPMS light may illuminate if the tire pressure was adjusted to the recommended tire inflation pressure during warm weather

📱 QR CODE

Tire Pressure Monitoring System Video

To view a video on your mobile device, snap this QR Code or visit the listed website.

Refer to page 2 for more information.



www.KuTechVideos.com/ps23/2015

LCD Instrument Cluster Modes

To cycle through the LCD Instrument Cluster modes, press the Mode/Select button **A**

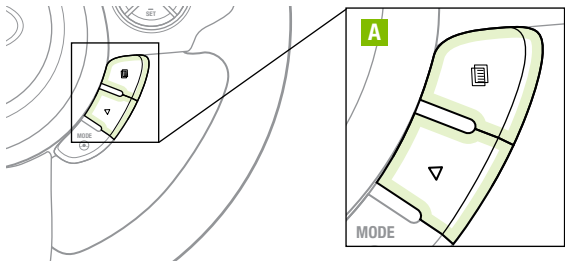

(LCD Instrument Cluster mode buttons located on Steering Wheel)



EV Information: Displays EV System energy flow and ECO level



Trip Computer Mode: Displays driving information for tripmeter, energy consumption, etc.



A/V Mode: Displays the state of the A/V System



Master Warning / Service Modes: Informs on upcoming service intervals, and warning messages related to TPMS and others



User Settings Mode: Change settings of the doors, lamps and other features

Trip Computer / Tripmeter

The Trip Computer is a driver information system that displays information related to driving — such as Average and Instant Energy Consumption, Tripmeter, Average Vehicle Speed and Driving Time — on the display when the ignition switch is in the ON position.

To cycle through the LCD Instrument Cluster modes, press the Mode/Select button **B**.

When in the Trip Computer mode , press the Move/Reset button **C** to cycle through the screens. When displaying Trip A or Trip B screens, press and hold the Move/Reset button **C** to reset the Tripmeter to zero.

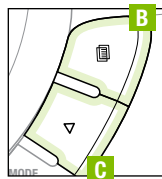

(Buttons located on Steering Wheel)

REMINDERS:

- Appearance of Tripmeter display may differ as equipped
- All stored driving information (except Odometer and Range) is reset if the battery is disconnected

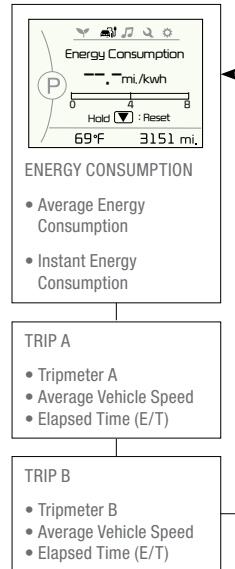

User Settings Mode

To enter the User Settings mode in the LCD Instrument Cluster Modes, press the Mode/Select button **A** when the vehicle is at a standstill and with the POWER button in the ON position and select User Settings .

You can navigate the selections on the display by pressing the Move/Reset button **B**, and then selecting the item by pressing the Mode/Select button **A**.

Door:

- Auto Door Lock & Unlock
- Two Press Unlock
- Horn Feedback

Lights:

- One-Touch Turn Lamp
- Headlamp Delay*

Settings:

- Language
- Temperature Unit
- AVG Fuel Economy Reset
- Welcome Sound

Service:

- ON/OFF
- Set mileage/months

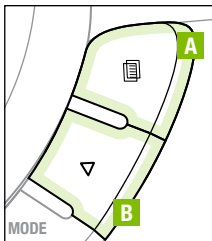

(Buttons located on Steering Wheel)

Service Mode

To enter Service Mode, press the Mode/Select button **A**, scroll to Service Mode  by pressing Move/Reset button **B**. Then press the Mode/Select button **A** to enter. System will display number of miles remaining until next service is due, and type of service.

When service is required, the following will be displayed: **Service Required**.

To reset the Service Mode system, press and hold the Move/Reset button **B** for more than 1 second.

To turn **Service In** mode OFF, go to User Settings in the LCD Instrument Cluster Modes.

Service Interval Setting

To set the service interval when in User Settings mode:

- Press the Move/Reset button **B** and scroll to Service Interval. Press the Mode/Select button **A** to enter
- Press the Move/Reset button **B** and toggle to ON, then press the Mode/Select button **A**. Then press the Move/Reset button **B** to scroll and select the desired miles or months for your next service
- Press the Mode/Select button **A** to enter

(Instrument Cluster LCD Screens)

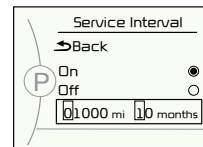
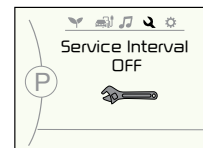
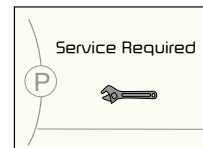

ECO System

Soul EV is equipped with an ECO feature that improves energy efficiency and helps extend battery life. The ECO System helps reduce energy consumption by controlling several vehicle components. When activated, it optimizes drivetrain operations such as engine power and transmission to help improve energy economy.

ECO System ON results in reduced torque, higher energy efficiency, and enhanced regenerative braking.

ECO System OFF results in more torque, lower energy efficiency, and reduced regenerative braking.

The ECO System is enabled by default and can be disabled by pressing the ECO OFF button **A**. The green ECO indicator light **B** in the instrument cluster will illuminate, indicating that ECO is operating.



(Button located below Gear Shift)

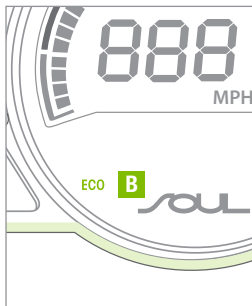

(Instrument Cluster)

Regenerative Brake Mode “B” – Move the gear shift to the “B” position **C** to enter the maximum regenerative braking drive mode. This mode helps to minimize energy loss and increase the distance to empty.

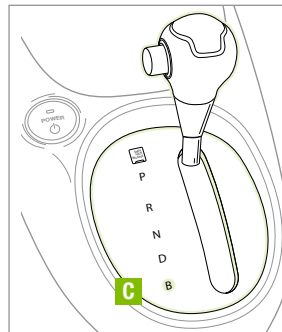

🕒 QUICK TIPS

To help reduce energy consumption:

- Drive at a moderate speed, accelerating smoothly and at a moderate rate
- Keep tires inflated to the recommended pressure and wheels aligned properly

For more information on the ECO System, refer to your Owner’s Manual or contact your local dealership.

📱 QR CODE

EV Active ECO Video

To view a video on your mobile device, snap this QR Code or visit the listed website.

Refer to page 2 for more information.



www.KuTechVideos.com/ps23/2015

Charging Your Electric Vehicle

Level 1 Charging – “Trickle” Charge

A Level 1 or “trickle” charger is the most common type of charging system for an electric vehicle. This type of charger uses 110 volts of household electricity and takes approximately 24 hours for a full charge.

Trickle Charger Indicators:

A ICCB – In-Cable Control Box

C Charge – Indicates that the vehicle is charging.

B Power – Indicates that the charger is plugged in and functioning.

D Fault – Indicates charge failure.

REMINDER: Do not use an extension cord. Plug Trickle charger directly into wall socket.

Level 2 Charging – “Normal” Charge

A Level 2 or “normal” charger is the recommended charging system for your Soul EV. This type of charger uses 240 volts of electricity and takes approximately 4-5 hours for a full charge (Based on Kia Motors Corporation testing with SAE J1772 charger performed at 6.6kW). This charger can be installed at your home or found at a public charging station.

REMINDER: Shape of charger and how to use the charger may be different for each manufacturer. Please see Owner’s Manual for more information.

Level 3 Charging - “Quick” Charge

A Level 3 or “Quick” charger are usually found at public charging stations. This type of charge may charge an electric vehicle in as little as 33 minutes to about an 80% charge.

For more information on Level 3 Charging, refer to the Owner’s Manual

Ⓢ QUICK TIPS

A Level 2 or “normal” 240-volt charger is recommended for regular charging of the vehicle.

REMINDER: For more detail and/or subsequent steps in charging your vehicle, please see the Owner’s Manual.

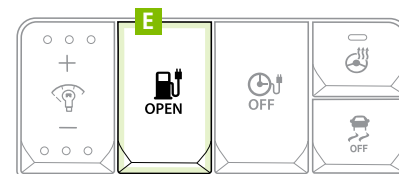
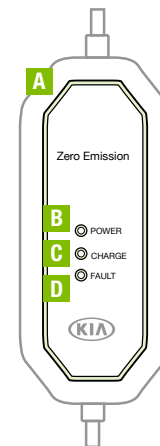

(Buttons located left of steering column)

Charging Your Electric Vehicle

To charge the Soul EV using a normal/trickle charger:

1. Connect the ICCB **A** plug to an electrical outlet
2. Check if the power light (green) **B** on the ICCB turns on
3. Press the brake pedal and engage the parking brake
4. Turn off all switches, put the shift lever in P (Park), and turn off the vehicle
5. Release the charging door by pressing the charging door open button **E** located to the left of the steering column
6. Open the charging door **F** at the front of the vehicle and press the trickle charging inlet release tab to open the inlet cover **G**
7. Open the protective cover **G** of the trickle charger's charging connector
8. Hold the charging connector handle and connect it to the vehicle's trickle charging inlet **H** by pushing the connector until you hear a "clicking" sound
9. Charging begins automatically (Ensure the charge indicator light **I** is illuminated on your instrument cluster, indicating the vehicle is charging)

Checking the Charging Status

The charging status can be checked by viewing the charging status indicator **I** on the dash panel. The lights will progressively become lit as the vehicle approaches a full charge.

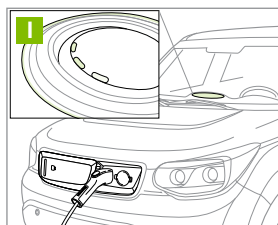
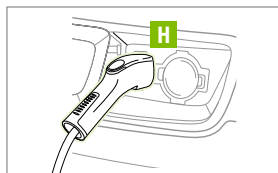
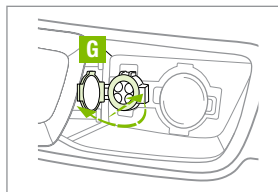
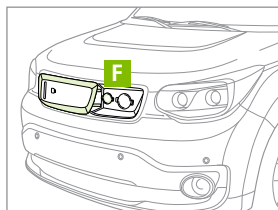

QR CODE

EV Charging, Charging Station Search Video

To view a video on your mobile device, snap this QR Code or visit the listed website.

Refer to page 2 for more information.



www.KuTechVideos.com/ps23/2015

Charging Your Electric Vehicle

Reserved Charging - Charging times can be set using the AVN System settings when in EV Mode. You can also use the Reserved Charging App on your smartphone.

Reserved Charging with the UVO EV Services App:

The UVO EV Services App can help you find the nearest charging station, displays charging-status information and the lists the Reserved Charging schedule. On your Smartphone, go to an app store or marketplace to download the UVO EV Services App.

REMINDER: When Reserved Charging is set and the charger is plugged in, charging of the electric vehicle will not begin until the time and date set

For more information on UVO EV Services and using the app refer to the Car Multimedia System User's Manual.

Deactivate reserved charging - Depress the Deactivate Reserved Charging button **A** to disable the reserved charging feature when immediate charging is required.

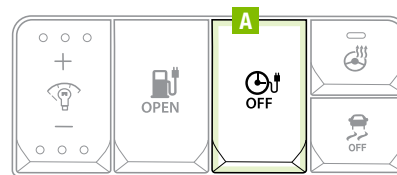

(Buttons located left of steering column)

🕒 QUICK TIPS

When you press the Deactivate Reserved Charge button for immediate charging, the reserved charge setting is not completely deactivated. If you need to completely deactivate the reserved charge setting, use the AVN System to finalize the deactivation.

EV Information Modes – Instrument Cluster

To access the EV Information Mode screen, use the control buttons located on the steering wheel. Press the Mode/Select button **A** to enter.

You can navigate the selections on the screen by pressing the following buttons:

- Use the Mode/Select button **A** for changing modes and setting a selected item
- Use the Move button **B** for changing items

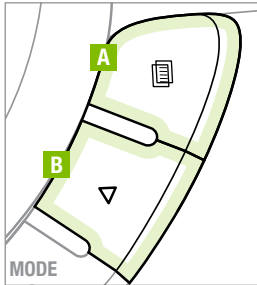

(Buttons located on Steering Wheel)

Soul EV's instrument cluster LCD displays the following EV system screens to inform the driver of the current energy flow and ECO level.

The EV Energy Flow screen notifies the driver of the EV system's energy flow in operating modes.

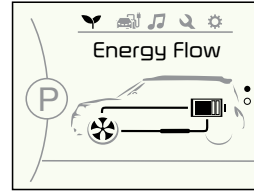

EV Propulsion – Energy flows from high-voltage battery to the wheel when the accelerator pedal is released or the vehicle is driven by motor.

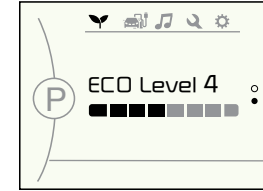

Regenerative Braking – Energy flows from wheel to high-voltage battery when the accelerator pedal is released or the brake pedal is pressed.

The ECO Level screen displays the current ECO driving level. If you drive economically, the ECO level will increase. If you do not drive economically, the ECO level will decrease.

EV System Information - AVN Screen

EV mode on the AVN screen allows you to navigate to a total of six menus that include available driving range, nearby charging stations, energy usage, ECO driving, charging and climate settings, and EV settings.

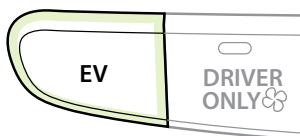

(Button located on Center Panel)

EV button - Press the EV button to access the EV mode screen

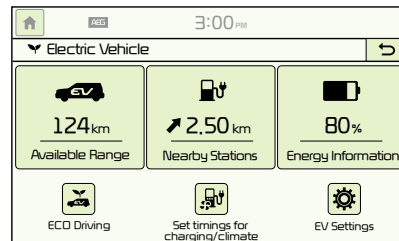

EV mode menu - The EV mode menu allows you to access six EV menus.



Available range - Displays the available driving distance according to the vehicle's current location and charge amount. Reachable areas are displayed within a green circle. Risky areas are displayed within a red circle. Unreachable areas are displayed in a gray shaded area.

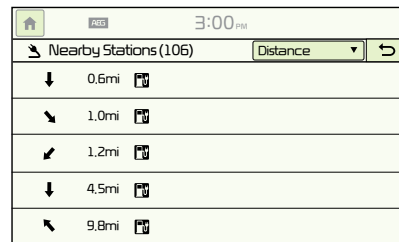

Nearby stations - Displays charging stations near the vehicle's current location. The station locations are categorized as reachable, risky or unreachable areas.

EV System Information - AVN Screen

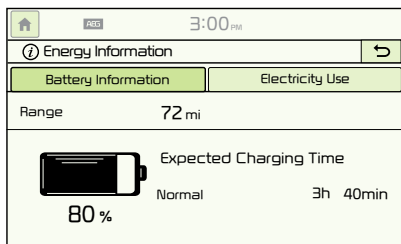

Energy information - Displays battery charge information and electrical power consumption.

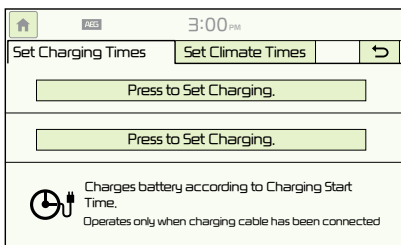

Set timings for charging/climate - Allows you to select the time and date you wish to reserve for automatic charging and automatic climate control.

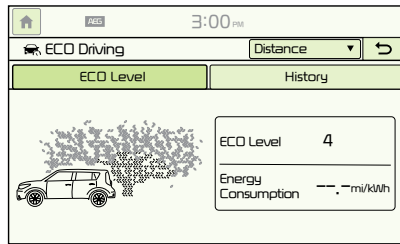

ECO driving - Displays ECO level information and ECO driving history.

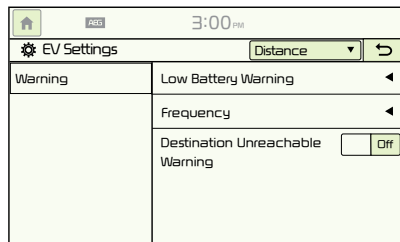

EV Settings - Allows the user to change the EV warning alarm settings.

QR CODE

EV Energy Information AVN Screen Video

To view a video on your mobile device, snap this QR Code or visit the listed website.

Refer to page 2 for more information.



www.KuTechVideos.com/ps23/2015

Instrument Panel Dimmer

With parking lights / headlights ON, press button **A** + or – to adjust display brightness of the instrument panel illumination.

REMINDERS:

- Door Mood Lamp is a fixed brightness and cannot be adjusted (not to be confused with Advanced Mood Lighting Speaker)
- The Instrument Panel Dimmer does not adjust brightness on the AVN System screen; use AVN setup to adjust brightness on the AVN System

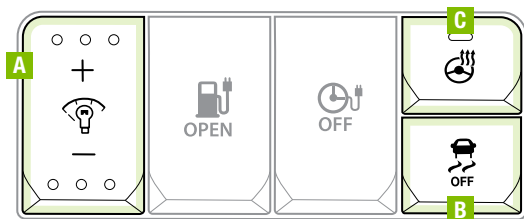

(Buttons located left of steering column)

Electronic Stability Control (ESC)

The ESC system is designed to help stabilize the vehicle during cornering maneuvers. It is a good idea to keep the ESC turned ON for daily driving whenever possible.

Press ESC button **B** to turn ESC OFF/ON.

REMINDERS:

- ESC is turned ON at vehicle start-up
- The ESC Indicator Light in the instrument cluster will be lit momentarily whenever the ESC is active

Heated Steering Wheel Button*

Press button **C** to turn ON/OFF steering wheel heater, while the Engine Start/Stop Button is in the ON position. Steering wheel heater will turn off automatically in 30 minutes, or when button is pressed again to deactivate.

Ⓢ QUICK TIPS

If ignition is turned OFF, then ON again, within 30 minutes of steering wheel heater being turned on, system will automatically be set ON again.

Hill-Start Assist Control (HAC)

HAC helps prevent the vehicle from rolling backward when accelerating from a stop while on a steep incline. The HAC automatically activates whether the ESC is OFF or ON but does NOT activate when the ESC has malfunctioned.

REMEMBER: The HAC does not operate when the gear shift is in the P (Park) or the N (Neutral) position.

Ⓢ QUICK TIPS

- HAC provides a 2-second delay before the vehicle may start rolling backwards
- When HAC is active (e.g., accelerating from a stop on an incline), you may notice that the brakes will momentarily remain engaged after you depress the accelerator

Power Windows, Window Lock & Central Door Lock

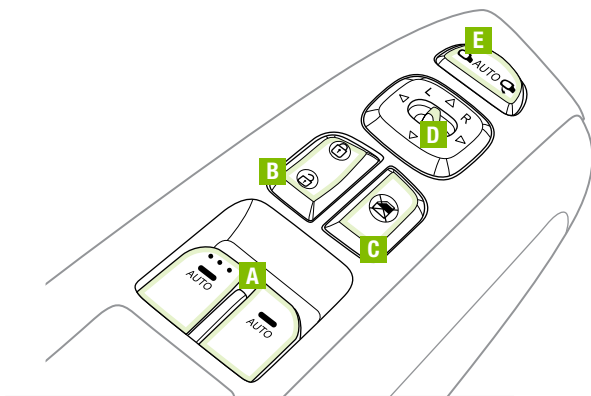

A Pull/Press to operate Driver's and Front Passenger's window Auto Up/Down

B Press to Unlock/Lock All Doors

C Press to disable Rear Passenger Windows

REMINDER: When button **C** is pressed, window controls for the Rear Passenger Windows are disabled.

Automatic Door Lock/Unlock

Auto Door Lock/Unlock will engage when the gear shift is moved in to or out of the P (Park) position. Refer to the User Settings in the LCD Instrument Cluster modes on how to turn Auto Door Lock/Unlock ON/OFF.

Heated Outside Mirrors*

Mirror heaters controlled with Rear Defroster.

Power Folding Outside Mirrors*

Toggle switch **D** left or right to select mirror. Then press arrows to adjust mirror position.

Toggle button **E** left/right to unfold/fold the outside rearview mirrors.

Toggle button **E** to center to automatically fold/unfold mirrors when:

- The Smart Key Lock/Unlock buttons are pressed
- The door outside handle button is pressed

REMINDERS:

- To automatically fold mirrors when exiting vehicle, press the LOCK button on the Smart Key
- To lock position of mirrors, toggle switch to the neutral (center) position

🕒 QUICK TIPS

The mirrors will automatically unfold when the Smart Key* is within close proximity to the vehicle.

Tilt/Telescoping Steering Wheel

To adjust the Steering Wheel, push down the lock-release lever **A** and adjust to desired angle **B** and distance **C**.

When finished, pull up the lock-release lever **A** to lock Steering Wheel in place.

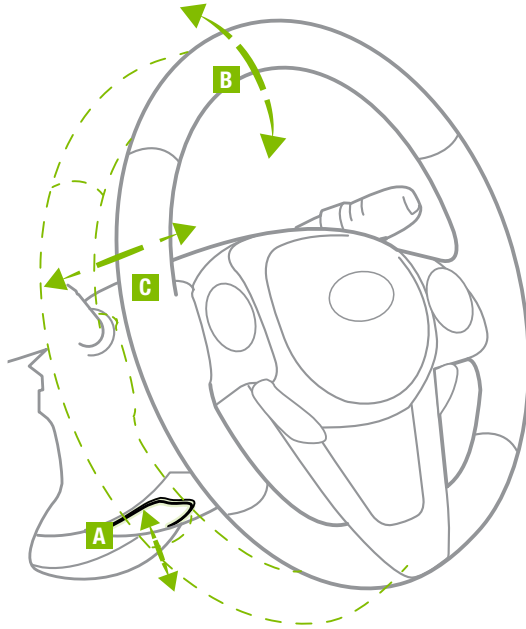

Headlights & High Beams

To operate:

- Rotate lever to change the Headlight function
- Push lever to turn High Beams ON
- Pull lever to flash Headlights / High Beams

AUTO Light* function — When the light switch is in the AUTO Light position, the tail lights and headlights will turn ON/OFF automatically, depending on the amount of light outside the vehicle.

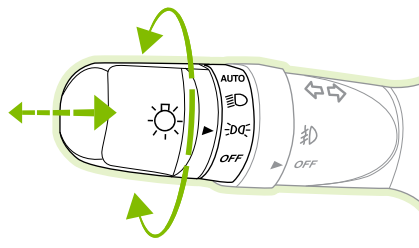

- AUTO* Automatic Headlights position
- ☹️ Headlight position
- ☹️ Parking light position
- OFF OFF position

Turn Signals & Fog Lights*

To operate:

- Turn Signals - Move lever Up/Down for Right/Left Turn Signal
- Rotate lever ring to turn Fog Lights ON/OFF

One-Touch Lane Change Signal is activated by moving the Turn Signal Lever slightly for less than 1 second and then releasing. The lane change signal will blink 3 times.

To change how many times (3/5/7) the Lane Change Signal blinks, go to User Settings Mode* in the LCD Instrument Cluster modes (Type B cluster).

For more information on the User Settings Mode, please refer to your Owner's Manual.

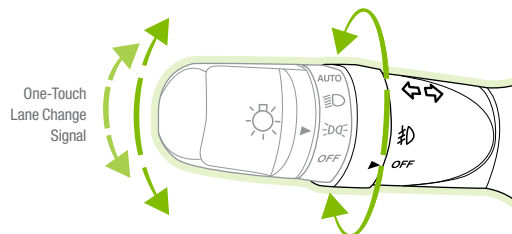

Windshield Wipers & Washers

To operate:

- Move lever Up/Down to change Wiper modes
- Rotate lever to adjust Intermittent Wipe Speed
- Pull to spray and wipe

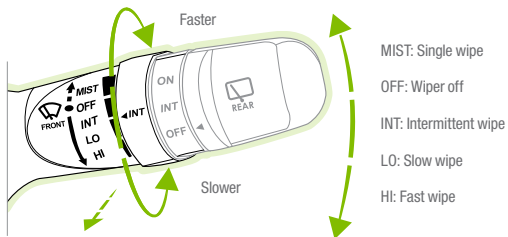

Rear Wiper & Washer

To operate:

- Rotate Rear Wiper switch to change Wiper modes
- Push to spray and wipe

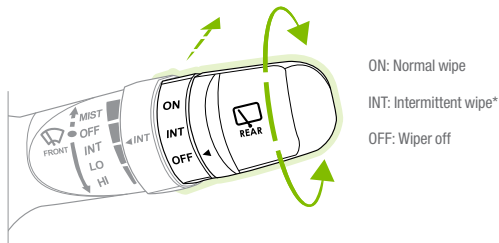

FlexSteer™ Steering Wheel Mode

Select the desired steering mode by toggling through the steering modes.

- Press FlexSteer™ Steering Wheel Mode button **A** to display the steering mode on the LCD screen
- Then press the button **A** again within 4 seconds to switch modes

REMINDER: Your vehicle's steering wheel buttons may differ from those in the illustrations. See your Owner's Manual for more details.

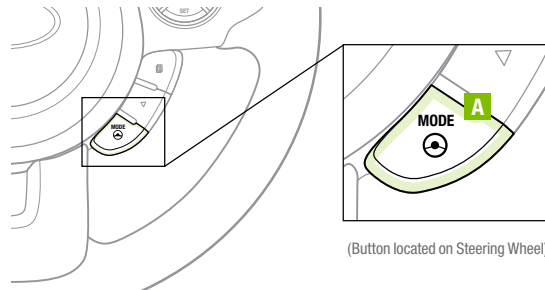
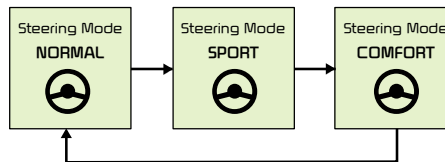

QR CODE

FlexSteer™ Steering Wheel Mode Video

To view a video on your mobile device, snap this QR Code or visit the listed website.

Refer to page 2 for more information.



www.KuTechVideos.com/ps23/2015

Audio Controls

Cruise Control

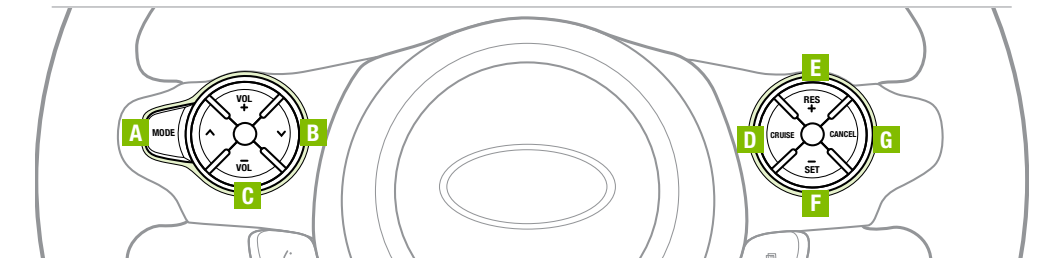

A Audio MODE button: Press to cycle through FM/AM/Sirius®/Media (USB, iPod®, Aux, BT Audio, My Music)

B Seek/Presets button

Radio Mode: Press to advance through Preset Stations. Press and hold to AUTO SEEK

USB/iPod® Mode: Press to move track up/down. Press & hold to FF/REW

C Volume button: Press up/down to raise/lower volume

REMINDERS:

- Your vehicle's steering wheel buttons may differ from those in the illustrations. See your Owner's Manual for more details
- Driving while distracted is dangerous and should be avoided. Drivers should remain attentive to driving and always exercise caution when using the steering-wheel-mounted controls while driving

D CRUISE Control On/Off button: Press to turn the Cruise Control ON/OFF

E Resume Cruising Speed button: Press to resume or increase Cruising Speed

F Set Cruising Speed button: Press to set or decrease Cruising Speed

G Cruise Control Cancel button: To cancel Cruise Control, do one of the following:

- Press the brake pedal
- Press the CANCEL button **G**

ⓘ QUICK TIPS

- Cruise Control is designed to function above 25 mph.
- The Cruise Control system will not activate until the brake pedal has been depressed at least once after ignition ON or engine starting

ⓘ QUICK TIPS

Pressing the Audio Mode button for more than 1 second will turn Audio Mode ON/OFF.

For further audio system operations, refer to page 24.

Bluetooth® Wireless Technology

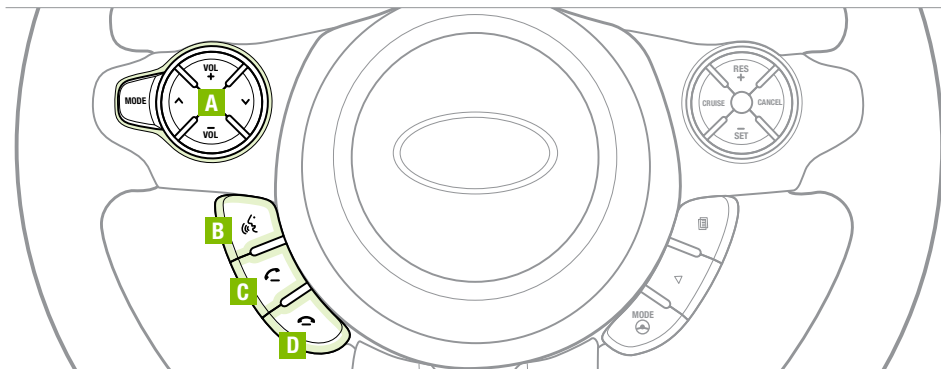

A Volume button: Press up/down to raise/lower speaker volume

B Talk button: Press to activate voice recognition / bring up menus / place calls with minimal voice command prompts from the system

🕒 QUICK TIPS

When using the voice command feature, wait for the system BEEP before speaking the command.

C Receive/Place Call button: Press to receive/place/transfer calls. Press to place a call using vocal command prompts from the system, or to answer an incoming call

D End Call button: Press to end a call or cancel a function

REMINDERS:

- Microphone is located in the overhead console
- Your vehicle's steering wheel buttons may differ from those in the illustrations. See your Owner's Manual for more details

🕒 QUICK TIPS

- Phonebook transfer upload time varies by phone model and with number of phonebook entries
- Because of differences in phone quality, service providers and Bluetooth® Wireless Technology chip programming, functionality may differ from one phone to another

Driving while distracted is dangerous and should be avoided. Drivers should remain attentive to driving and always exercise caution when using the steering-wheel-mounted controls while driving.

For more information, if equipped, refer to the Car Multimedia System User's Manual or the UVO System User's Manual. For Bluetooth® Wireless Technology FAQs, go to www.kia.com, Owners section, or call Consumer Information for Bluetooth® Technology at (800) 333-4KIA. Refer to your Owner's Manual for more specific Bluetooth® Wireless Technology phone pairing and operation instructions.

Bluetooth® Wireless Technology

Pairing a Phone

For instructions on how to pair a phone, refer to the audio system's user's guide or your vehicle's Quick Start Guide.

📌 QUICK TIPS

During the pairing process, be sure to accept the connection requests on the phone for phonebook download and to allow acceptance of all future **Bluetooth®** connection requests.

How to Place a Call

When using the voice command feature, wait for the system BEEP before speaking the command.

There are two options for placing a call:

- Option 1: Press the Receive/Place Call button **C** (displays the phone screen with number keypad)
- Option 2: Press the Talk button **B**. Then say the command "Call {name}" or "Dial {number}"

Voice Recognition and Phone Contact Tips

The Kia Voice Recognition System may have difficulty understanding some accents or uncommon names. When using Voice Recognition to place a call, speak in a moderate tone, with clear pronunciation.

Help your **Bluetooth®** Wireless Technology Voice Recognition performance by making a few simple changes to your phone contacts:

- Use full names vs. short or single syllable names ("John Smith" vs. "Dad"; "Smith Residence" vs. "Home")
- Avoid using special characters or hyphens (@, &, #, /, -, *, +, etc.)
- Avoid using acronyms ("In Case of Emergency" vs. "ICE")
- Spell words completely, no abbreviations ("Doctor Goodman" vs. "Dr. Goodman")

📌 QUICK TIPS

Contacts Sync Tips

- If Contact Sync is set to ON, contacts stored in your phone will download each time your phone is connected. There may be a delay before the system is available to place a call
- If Contact Sync is set to OFF, your phone contacts will download only at the initial pairing. This allows you to make calls without waiting for your phone contact list to download

📌 QR CODE

Voice Recognition Tips Video

To view a video on your mobile device, snap this QR Code or visit the listed website.

Refer to page 2 for more information.



www.KiTechVideos.com/ps23/2015

AVN (Audio/Video/Navigation) System

– FM/AM/Sirius®/Media (Aux/USB/iPod®/BT Audio/My Music)

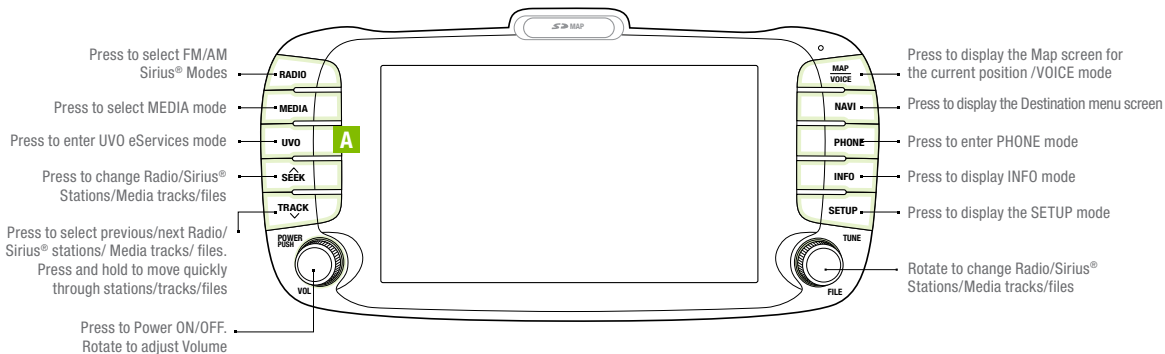

To use UVO EV Services:

1. Register through your AVN System or at MyUVO.com account
2. On the AVN System screen, verify the vehicle by pressing the UVO button **A** and press the on-screen ACTIVATE button
3. Select the EXISTING ACCOUNT TAB and enter your email address and password from your MyUVO.com account
4. Then press the on-screen SUBMIT button to complete verification
5. On your Smartphone, go to an app store or marketplace to download the UVO EV Services App and log in to the app using your MyUVO.com account credentials.

To adjust the Sound settings (bass, middle, treble, fader, balance)

- Select the on-screen SOUND button on the audio mode's main screen. To adjust, press the on-screen arrows.

QUICK TIPS

- When using the voice command feature, wait for the system BEEP before speaking the command
- Prolonged use of the AVN System in ACC mode may drain the vehicle's battery. A warning screen may appear periodically to remind users that the AVN System should be operated with the engine running to prevent battery discharge

REMINDERS:

- Your vehicle's audio system may differ from that in the illustration. See your Owner's Manual for more details.
- The registered MyUVO.com account is activated for five years with no charges. When it expires, go to MyUVO.com and register for the plan of your choice

For further AVN System operation and using the app, refer to the Car Multimedia System User's Manual.

QR CODE

To view these videos on your mobile device, snap these QR Codes or visit the listed website.

Refer to page 2 for more information.

EV AVN System Videos



www.KuTechVideos.com/audio/evavn

EV Services Activation Video



www.KuTechVideos.com/ps23/2015

Power Button

To start the vehicle:

1. Turn off all electrical devices
2. Depress the brake pedal
3. Press the POWER button while gear shift is in P (Park)

When Ready Indicator Light  is ON, the vehicle can be driven.

To turn the power off, press the POWER button again, and ensure the gear shift is in (P) Park.

To use the POWER button, you must have the Smart Key fob on your person or inside the vehicle.

REMINDERS:

- When the Ready Indicator Light is illuminated, the vehicle can be operated
- Do not operate the vehicle if the Ready Indicator Light is not illuminated
- In an emergency situation while the vehicle is in motion, you are able to turn the vehicle off by pressing the Power button for more than 2 seconds or 3 times within 3 seconds
- If Smart Key fob battery is dead, hold the fob up against the POWER button

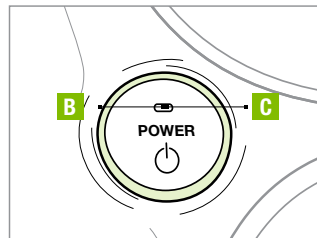

QR CODE

EV Power Button and Smart Key Video

To view a video on your mobile device, snap this QR Code or visit the listed website.

Refer to page 2 for more information.



www.KuTechVideos.com/ps23/2015

🕒 QUICK TIPS

To use electrical accessories:

Accessory position

- When in the OFF position (no light) and without depressing the brake pedal, press the POWER button once (Amber light **B**)

On position

- When already in the ACC position (Amber light **B**) and without depressing the brake pedal, press the POWER button again (Reddish-orange light **C**)
- When in the OFF position (no light) and without depressing the brake pedal, press the POWER button twice (Reddish-orange light **C**)

Keeping the vehicle in ACC or the ON position without driving may discharge the vehicle's battery.

Automatic Climate Control

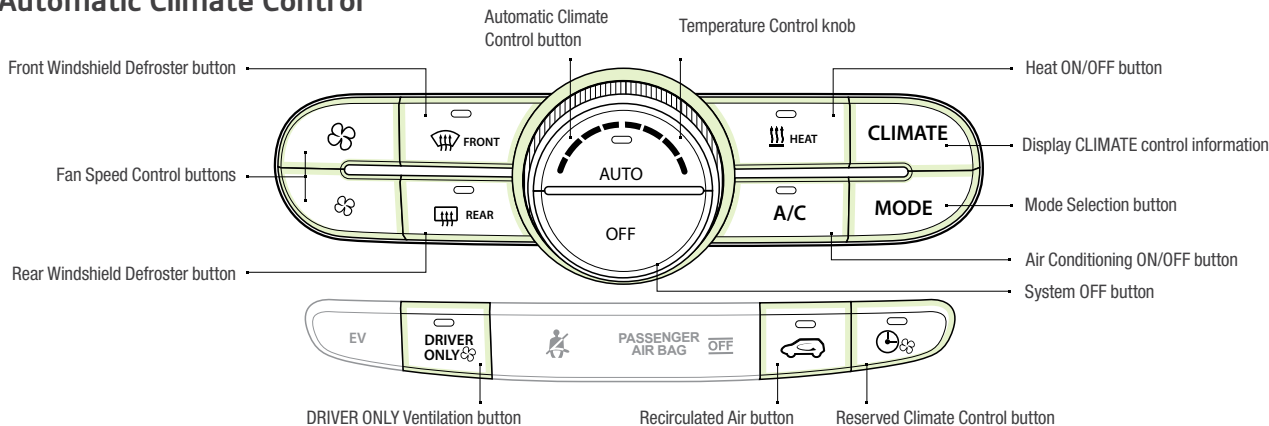

Air Flow Modes

To select Air Flow Modes, press the Mode selection buttons:

-  Face-Level
-  Bi-Level
-  Floor-Level
-  Floor/Defrost-Level

Climate Control Auto Function:

1. Press **AUTO** to select Full Auto Operation
2. Press **MODE** buttons to control which vents air flows through

Defrost Outside Windshield:

1. Set **Fan Speed** to the highest position
2. Set **Temperature** to **Hot**
3. Press the **Defrost button** 

Defog Inside Windshield:

1. Set desired fan **Fan Speed**
2. Set desired **Temperature**
3. Press the **Defrost button** 

QUICK TIPS

- Keep inside glass as clean as possible to reduce window fogging
- Defrost  Mode activates A/C and opens Fresh Air Vent
- During Auto Operation, the A/C indicator will NOT illuminate. The fan speed, air intake, air flow and air conditioning may automatically engage at any time to reach desired temperature and reduce humidity

REMINDERS:

- Warm air may flow in through vents if Recirculated Air button is not pressed ON (LED lit)
- Your Automatic Climate Control system may differ from those in the illustrations. See your Owner's Manual for more details

Driver Only Ventilation

Driver Only Ventilation restricts air flow to the driver's side vents only. This helps to optimize driving range by limiting the power drawn from the battery.

Press DRIVER ONLY button **A** to enable air flow through the driver's side vents only.



(Buttons located on Center Panel)

Reserved Climate Control

Reserved Climate Control is designed to pre-cool or heat the vehicle's interior to the preferred temperature while the vehicle is plugged into a charger.

When Reserved Climate Control is set and the charging cable is connected, climate control begins operating 30 minutes before the set departure time.

Press the Reserved Climate Control button **B** to display the settings for appointed ventilation on the AVN.

The Reserved Climate Control can also be set using the UVO EV Services App.

For more information, refer to the Car Multimedia System User's Manual.

Digital Clock

AVN System Clock Setup*:

Press the SETUP key, then the CLOCK button to display the Clock setting screen. Then use the on-screen buttons to navigate through setup.

Aux/USB/iPod® Port & Power Outlets

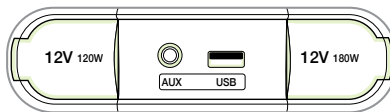

(Located on lower part of Center Panel)

REMINDER: For the Tire Mobility Kit, only use the 12V/15A/180W Power Outlet, located on the right side of the outlet/aux. port area.

QUICK TIPS

The power outlets are inactive when ignition is in the OFF position.

QR CODE

To view these videos on your mobile device, snap these QR Codes or visit the listed website.

Refer to page 2 for more information.

EV A/C and Driver Only Ventilation Video



www.KuTechVideos.com/ps23/2015

USB Port Video



www.KuTechVideos.com/ps23/2015

Electric Parking Brake (EPB)*

The Electric Parking Brake (EPB) system utilizes an electric motor to engage the parking brake.

Applying the Parking Brake

Depress the brake pedal and pull up the EPB switch **A**. Ensure that the indicator light **ⓐ** BRAKE is illuminated on the instrument cluster.

Releasing the Parking Brake

The EPB will automatically release when the shifter is placed in Reverse or Drive.

To release EPB manually, depress the brake pedal, then press the EPB switch **A**, with the ignition switch in the ON position. Ensure that the indicator light **ⓐ** BRAKE is OFF.

REMINDERS:

- As a bulb check, the EPB malfunction indicator will illuminate for approximately 3 seconds when the ignition switch is turned ON
- If the warning light does not illuminate temporarily, or continues to remain lit, take your vehicle to an authorized Kia dealer and have the system checked
- The EPB should not be operated while the vehicle is moving
- A click or electric brake motor sound may be heard while operating or releasing the EPB, but these conditions are normal and indicate that the EPB is functioning properly

ⓐ QUICK TIPS

- When leaving your keys with parking lot attendants or valet, make sure to inform them how to operate the EPB
- If parked on a steep incline/decline, pull up the EPB switch for more than 3 seconds for a firmer EPB application

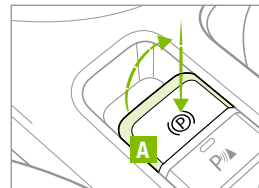

(Located below Gear Shift)

QR CODE

Electric Parking Brake Video

To view a video on your mobile device, snap this QR Code or visit the listed website.

Refer to page 2 for more information.



www.kutechvideos.com/audio/avn4

Automatic Gear Shift with Regenerative Brake Mode

- P:** Park
- R:** Reverse
- N:** Neutral
- D:** Drive
- B:** Regenerative Brake Mode

Regenerative Brake Mode “B” – Move the gear shift to the “B” position **B** to enter the maximum regenerative braking drive mode. This mode helps to minimize energy loss and increase the distance to empty.

For more information on Regenerative Brake Mode, refer to the Owner’s Manual.

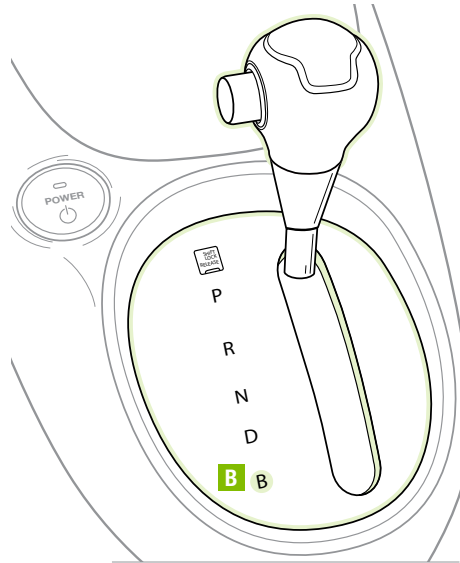

QR CODE

EV Regenerative Braking Video

To view a video on your mobile device, snap this QR Code or visit the listed website.

Refer to page 2 for more information.



www.KuTechVideos.com/ps23/2015

Seat Warmers / Ventilated Seats*

Seat Warmers – Press top of button once for high setting (3 LEDs lit). Press button twice for medium setting (2 LEDs lit). Press a third time for low setting (1 LED lit) and again to turn OFF.

Ventilated Seats – Press bottom of button once for high setting (3 LEDs lit). Press twice for medium setting (2 LEDs lit). Press a third time for low setting (1 LED lit) and again to turn OFF.

Seat Warmers*

Press button once for high setting (2 LEDs lit). Press button twice for low setting (1 LED lit). Press again to turn OFF.

🕒 QUICK TIPS

- System turns OFF when ignition is cycled. To turn system ON, press the seat warmer switch
- With the seat warmer switch in the ON position, the heating system in the seat turns off or on automatically depending on the seat temperature

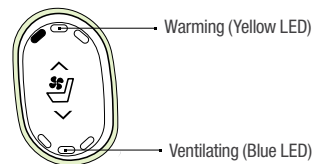

(Buttons located on Center Panel)



(Buttons located on Center Panel)

📱 QR CODE

Heated and Ventilated Seats Video

To view a video on your mobile device, snap this QR Code or visit the listed website.

Refer to page 2 for more information.



www.KuTechVideos.com/ps23/2015

6-Way Adjustable Driver's Seat

Pull lever **A** to slide Seat forward/backward

Pull/press lever **B** to adjust Seat Height

Pull lever **C** to adjust Seatback Recline

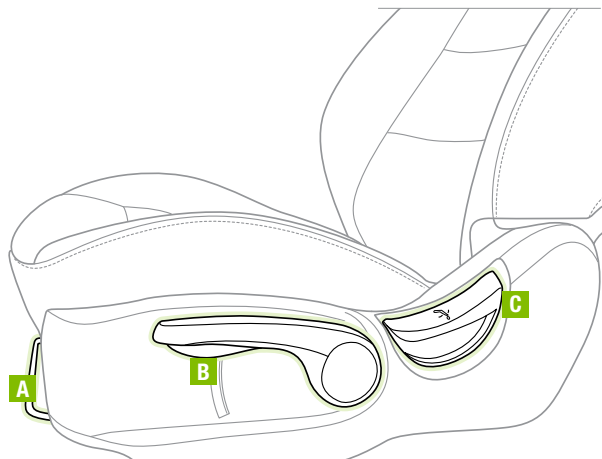

Front Seat Headrest Adjustment

To adjust headrest forward*: Pull headrest forward to one of several positions.

To adjust headrest back*: Pull headrest completely forward, then release.

To raise headrest: Pull headrest up.

To lower headrest: Press lock, then press the headrest down.

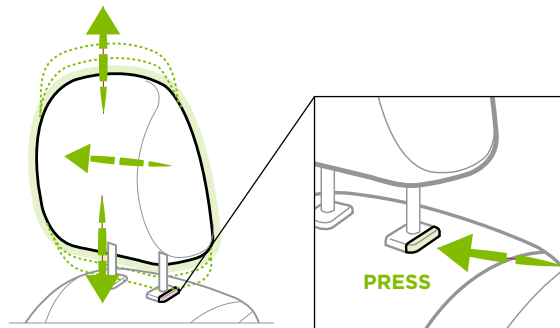

© QUICK TIPS

For easy adjustments, hold a headrest post with one hand while using the other hand to pull the headrest from underneath.

Folding Rear Seatback

To Fold:

1. Adjust the Front Seatback in the upright position and/or slide the Front Seat forward
2. Insert the rear seat belt strap into the clip located on the side panel next to the Seatback
3. Lower the Rear Headrests to the lowest position
4. Pull on the Rear Seatback folding lever **A**, then fold the seat towards the front

REMINDER: Always make sure the seat back is locked in place when unfolded.

To Unfold:

1. Lift and pull the Seatback backward by pulling on the folding lever **A**. Pull the Seatback firmly until it clicks and is locked into place
2. Return the rear seat belt to the proper position

© QUICK TIPS

It may be necessary to adjust the front seatbacks to fully lower rear seats.

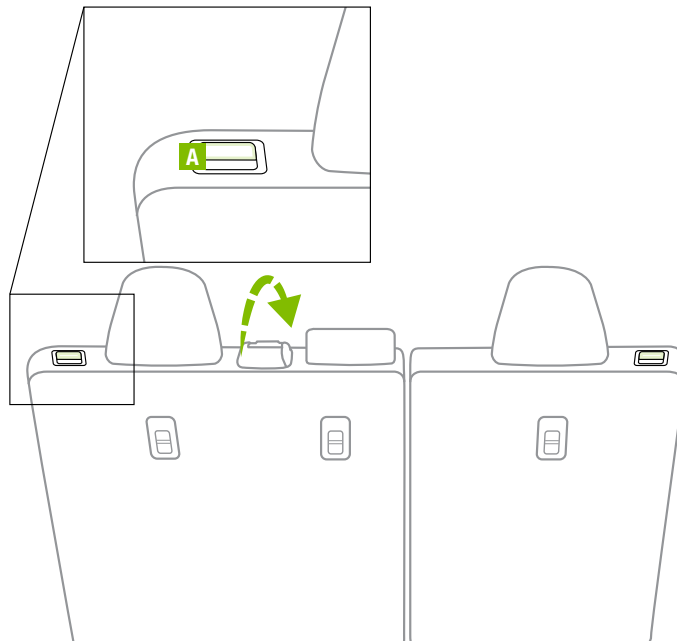

Smart Key

Smart Key Fob:

- A** Press to lock All Doors
 - B** Press to unlock Driver's Door. Press twice in 4 seconds to unlock All Doors
 - C** Press and hold to unlock Rear Hatch and manually open
- REMINDER:** The Rear Hatch unlocks when the Smart Key fob is within close proximity of the vehicle.
- D** Press and hold more than 1 second for Panic Alarm. To turn off Alarm, press any button
 - E** Press to release Mechanical Key (Button located on back of Smart Key)

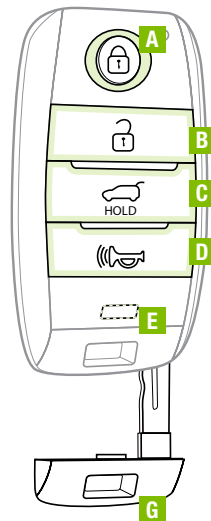

Driver's Door Lock/Unlock button **F**:

- Press button once to unlock driver's door
- Press again within 4 seconds to unlock all doors
- Press again to lock all doors

Mechanical Key **G**:

- Use to unlock driver's door
- Use to turn Child Safety Locks

For more information on the Mechanical Key, please refer to your Owner's Manual.

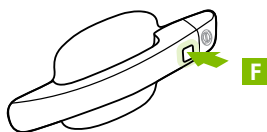

Double-Turn Lock / Unlock All

- Turn counterclockwise once to unlock Driver's Door
- Turn counterclockwise again within 4 seconds to unlock All Doors
- Turn clockwise once to Lock All Doors



QR CODE

EV Power Button and Smart Key Video

To view a video on your mobile device, snap this QR Code or visit the listed website.

Refer to page 2 for more information.



www.KuTechVideos.com/ps23/2015

QUICK TIPS

The Smart Key's signal can be blocked by the normal operation of a cell or smart phone. To help prevent this, store each device separately.

REMINDER: Remote button configuration may vary depending on vehicle options.

Map/Room Lamps

Push the lens **A** to turn the Map Lamp ON/OFF. This light produces a spot beam for convenient use as a map lamp or personal lamp for the driver or front passenger.

When the DOOR button **B** is pressed, the Map Lamp turns ON when any door is opened.

When the ROOM button **C** is pressed, the Map and Room Lamps turn ON.

Room Lamp

When the Room Lamp button **D** is pressed, the lamp turns ON.

Automatic turn off function*

The interior lights automatically turn off approximately 30 seconds after the Engine System Start/Stop button* is OFF.

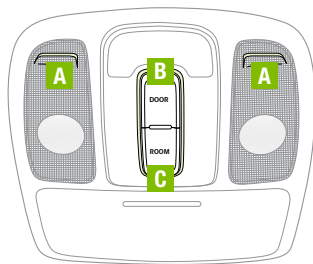

(Type A)

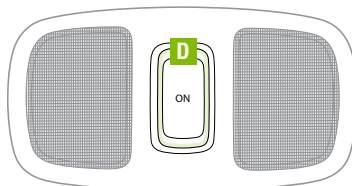

(Type A)

Ⓢ QUICK TIPS

- When doors are unlocked by the Smart Key*, the lamp turns ON for approximately 30 seconds
- If your vehicle is equipped with the theft alarm system, the interior lights automatically turn off approximately 3 seconds after the system is in armed stage
- Using interior lights for an extended period of time may cause battery discharge

Pedestrian Warning System

The Pedestrian Warning System generates engine sound for pedestrians to hear the vehicle since an Electric Vehicle (EV) has no sound when operating.

The Pedestrian Warning System will operate when:

- The EV vehicle is moving at a low speed
- The gear shift is moved to the (R) Reverse position

Sunvisor

Use the Sunvisor to shield direct light through the front or side windows. Slide the Sunvisor out and adjust as needed.

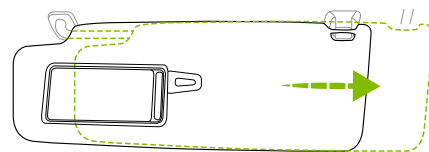

REMINDERS:

- Sunvisor may not shield all direct light
- Do not operate the vehicle if Sunvisor is impairing your visibility
- The Sunvisor may impair visibility if not adjusted properly

Rear-Camera Display*

The Rear-Camera Display system is not a safety device. It is a supplemental system that displays the view behind the vehicle through the AVN System screen while the vehicle is in Reverse.

The Rear-Camera Display activates when the:

- POWER Start/Stop* button is in the ON position (Green Light)
- Gear Shift Lever is in the R (Reverse) position



(Rear-Camera Display)

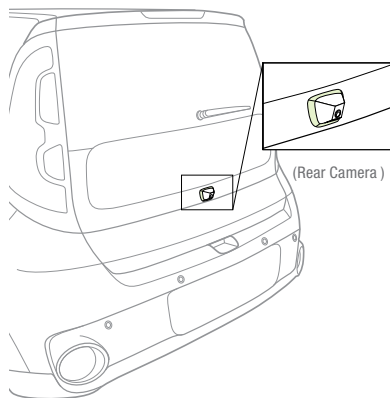

REMINDER: While camera is active, only the volume controls on the Audio System can be operated.

The Rear-Camera Display is not a substitute for proper and safe backing-up procedures. The Rear-Camera Display may not display every object behind the vehicle. Always drive safely and use caution when backing up.

Parking Assist System

The Parking Assist System is not a safety device. The Parking Assist System is a supplemental system that assists the driver by chiming if any object is detected within the sensing areas to the rear and side of the vehicle when backing up. When the POWER Start/Stop button is ON, the system is activated.

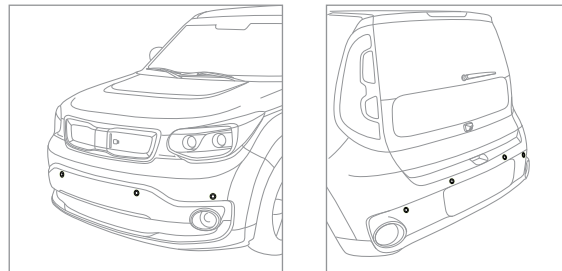

(Front and rear sensor location shown)

REMINDEES:

- If the vehicle is moving at speeds over 3 mph, the system may not activate correctly
- When more than two objects are sensed at the same time, the closest one will be recognized first
- The above images are for illustration purposes only and may not reflect actual operation

The Parking Assist System is not a substitute for proper and safe parking and backing-up procedures. Always drive safely and use caution when parking and backing up. The Parking Assist System may not detect every object around the vehicle

Hood Release Lever and Latch

Opening the Hood:

1. Located on the bottom left of the driver's panel, pull the Hood Release Lever **A** to unlatch the Hood
2. In the front of the vehicle, lift the Hood slightly, push the secondary Latch **B** up inside of the Hood's center and lift the Hood

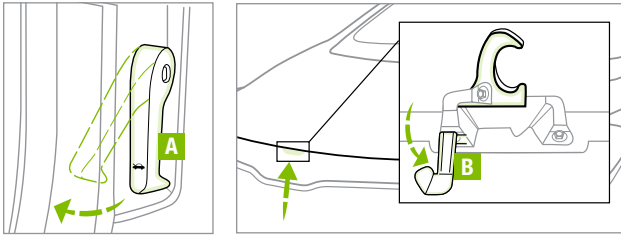

Closing the Hood:

Lower the Hood by pressing the front center of the Hood. Then, press down to securely lock in place.

REMINDER: While lowering and closing, keep hands away from under the Hood.

Tire Mobility Kit

The Tire Mobility Kit may temporarily seal certain types of tire damage.

For operational information, please refer to section 6 of your Owner's Manual.

C Sealant Bottle

D Compressor

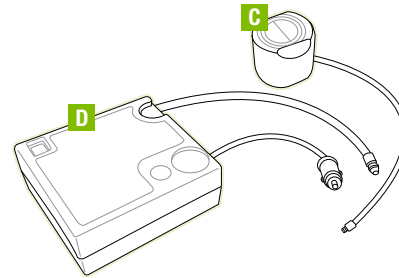

Ⓢ QUICK TIPS

- The Tire Mobility Kit is a temporary fix and is to be used for one tire only; the tire should be inspected as soon as possible
- The kit should only be used for sealing/ inflating passenger car tires; do not use for inflating any other type of tires
- Some damaged tires cannot be sealed completely; do not use the kit if a tire is damaged beyond repair

📱 QR CODE

Tire Mobility Kit Video

To view a video on your mobile device, snap this QR Code or visit the listed website.

Refer to page 2 for more information.



www.KuTechVideos.com/ps23/2015

REMINDEMS:

- The Tire Mobility Kit requires the use of the 12V/15A/180W Power Outlet, which is located on the right side of the outlet/aux port area
- After tire is properly sealed, drive cautiously at no more than a total distance speed of 50 mph for no longer than a maximum distance of up to 120 miles

High-Voltage Areas

High-voltage areas are marked with an orange color with warning labels attached.

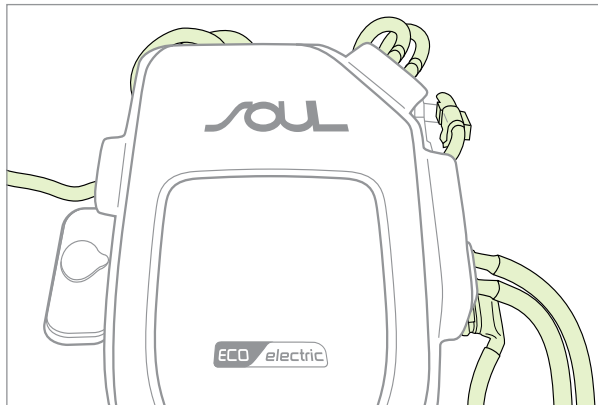

REMINDER: Never touch the high voltage components marked in orange on the vehicle.

Air Inlet

The air inlets **A**, located underneath both front seats, are used to cool the driving battery. For safety reasons, these air inlets should never be blocked. Doing so may cause the battery to overheat.

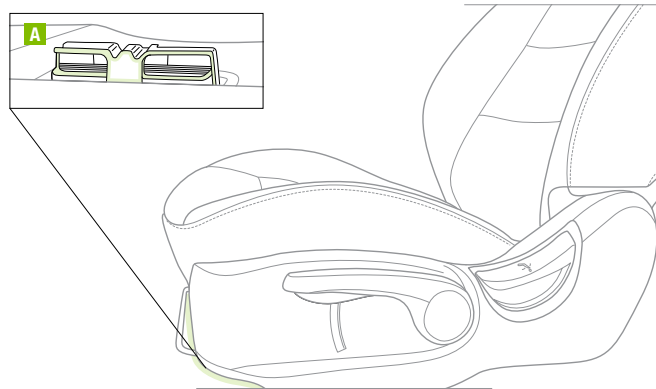

Rear Hatch Release Button

Button is located underneath the Rear Hatch lid. With Rear Hatch unlocked, press the Rear Hatch Release button **A** and pull the Rear Hatch lid up by the handle to open.

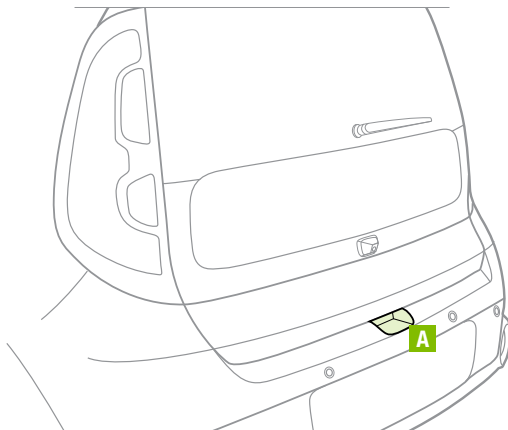

© QUICK TIPS

- The Rear Hatch must be unlocked before it can be opened by the Rear Hatch Release Button
- The Rear Hatch unlocks automatically and then can be opened manually when the Smart Key* is within close proximity to the vehicle

Child Safety Locks

Located on the rear edge of the rear passenger doors, adjust switch **B** to the LOCK position to disable the inner door handles from opening the rear doors.

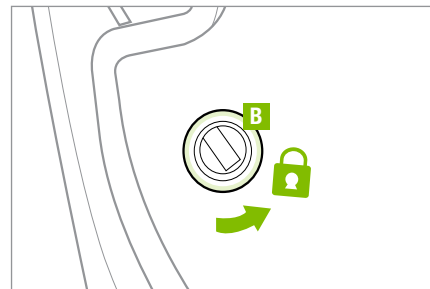

REMINDER: Child Safety Lock is located on rear passenger's door jamb.

Seat Belts

To properly fasten your seat belts:

1. Insert the tongue belt plate **A** into the buckle **B** until it clicks
2. Position the lap portion of the belt across your lap as **LOW ON THE HIPS** as possible **C**. Adjust the belt to a **SNUG FIT** by pulling up on the shoulder portion **D**

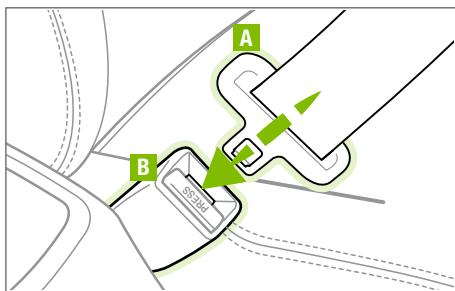

Seat Belt Retractor Locks

- Retractor locks allow lap/shoulder seat belts to remain unlocked during normal vehicle operation for freedom of movement and increased comfort
- During a **STRONG STOP, SUDDEN TURN OR CERTAIN COLLISIONS**, seat belt retractors will automatically lock the belts to reduce the risk of injury

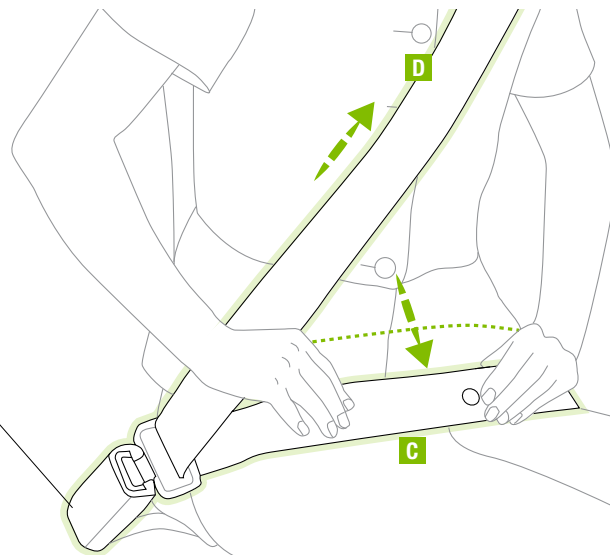

Ⓢ QUICK TIPS

The Seat Belt warning chime operates for driver's seat only.

For more detailed information regarding your vehicle's safety belts, please refer to your Owner's Manual and the separate brochure titled "Understanding Your Safety Belt & Supplemental Restraint System".

Occupant Detection System (ODS) / PASSENGER AIRBAG OFF Indicator

ODS detects the presence and position of the front passenger and adjusts or turns off airbag deployment accordingly.

Depending on the situation and type of accident, the system may:

- Deploy airbag (Adult)
- Not deploy the airbag (Unoccupied)

If the system determines that the airbag should not be deployed, the “PASSENGER AIRBAG OFF” light will illuminate.

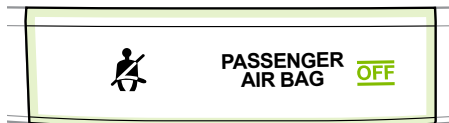

LEGAL DISCLAIMERS

Warning: Driving while distracted can result in a loss of vehicle control that may lead to an accident, severe personal injury and death. The driver's primary responsibility is in the safe and legal operation of a vehicle, and use of any handheld devices, other equipment or vehicle systems which take the driver's eyes, attention and focus away from the safe operation of a vehicle or that are not permissible by law should never be used during operation of the vehicle.

Safety Features: No system, no matter how advanced, can compensate for all driver error and/or driving conditions. Always drive responsibly.

Parking Assist System / Rear-Camera Display: The Parking Assist System and Rear-Camera Display are not substitutes for proper and safe backing-up procedures. The Parking Assist System / Rear-Camera Display may not detect every object alongside or behind the vehicle. Always drive safely and use caution when backing up.

Tilt/Telescoping Steering Wheel: Never attempt to adjust steering wheel position when vehicle is in motion.

Front Seat Headrest Adjustment: Never attempt to adjust headrests when vehicle is in motion.

Seat Belts / Airbags: For maximum protection, always wear your seatbelt.

Navigation: GPS maps and directions are for information purposes only, and Kia does not make any warranties about the accuracy of that information. Kia is not responsible for loss or delay resulting from the use of the navigation system. Caution: Do not enter information into the navigation system while the vehicle is moving. Failure to pay attention to travel conditions and vehicle operation while the vehicle is in motion could result in loss of vehicle control. Operate the system only when it is safe and legal to do so.

TPMS: Even with the Tire-Pressure Monitoring System (TPMS), always check your tire pressure on a regular basis.

Bluetooth® Wireless Technology: A compatible Bluetooth® wireless technology-enabled cell phone is required to use Bluetooth® wireless technology. The Bluetooth® word mark and logos are registered trademarks owned by Bluetooth SIG, Inc. and any use of such marks by Kia is under license. Other trademarks and trade names are those of their respective owners. A Bluetooth® enabled cell phone is required to use Bluetooth® wireless technology.

SiriusXM®: SiriusXM Satellite Radio, SiriusXM Traffic and SiriusXM Travel Link each require a subscription sold separately, or as a package, by SiriusXM Radio Inc. **If you decide to continue your service at the end of your trial subscription, the plan you choose will automatically renew and bill at then-current rates until you call 1-866-635-2349 to cancel. See SiriusXM Customer Agreement for complete terms at www.siriusxm.com.** Other fees and taxes will apply. All fees and programming are subject to change. Not all vehicles or devices are capable of receiving all services offered by SiriusXM. Data displays and individual product availability vary by vehicle hardware. Current information and features may not be available in all locations, or on all receivers. Weather Forecast, Current Conditions may not be available in all locations. Images above are for representative purposes only and are not real products. For actual features and images of real products, consult the vehicle manufacturer. SiriusXM is not responsible for any errors or inaccuracies in the data services or their use in the vehicle. Travel Link Stocks displays current price and daily delta of around 7,000 actively reported securities traded on the NYSE®, NASDAQ® and AMEX®. The service is delayed approximately 20 minutes. SiriusXM satellite service is available only to those at least 18 years of age in the 48 contiguous USA, DC, and Puerto Rico (with coverage limitations). SiriusXM Internet Radio service is available throughout our satellite service area and in AK and HI. © 2014 SiriusXM Radio Inc. Sirius, XM and all related marks and logos are trademarks of SiriusXM Radio Inc.

UVO eServices app: Apple iPhone® and select Android™ devices only are UVO eServices compatible. iPhone® is a registered trademark of Apple Inc. Android™ is a registered trademark of Google Inc. No subscription fee for UVO eServices. No charge for the UVO eServices app. App uses your smartphone cellular data service. Normal data rates will apply.

iPod® is a registered trademark of Apple Inc. iPod® mobile digital device sold separately, and connectivity requires the Kia accessory cable.



NORMAL MAINTENANCE SCHEDULE

When your vehicle requires service, remember that your dealer knows your vehicle best. Your dealer has factory-trained technicians, recommended special tools, genuine Kia replacement parts, and is dedicated to your complete satisfaction. For expert advice and quality service, see your authorized Kia dealer.

INTERVAL MAINTENANCE CHART			
7,500 miles	A		
15,000 miles	A		
22,500 miles			
30,000 miles	A		
37,500 miles		B	
45,000 miles	A		
52,500 miles			
60,000 miles	A		
67,500 miles			
75,000 miles	A		
82,500 miles			
90,000 miles	A		
97,500 miles			
105,000 miles	A		
112,500 miles		B	
120,000 miles	A		C

3,750 miles — At every 3,750 miles or 6 months, rotate tires, check tire pressure and tread wear.

A Inspect* — Brake lines, hoses and connections, disc brakes and pads, brake pedal and operation, brake fluid, steering gear rack, linkage and boots, suspension mounting bolts and ball joints, drive shaft and boots, air conditioning compressor, air conditioning refrigerant/performance, cooling system¹, 12V battery condition

Replace — Climate control air filter

B Inspect* — Reduction gear oil

C Replace — Engine coolant²

* and, if necessary, adjust, clean, replace or correct

** If equipped

*** Check and adjust level and check for leaks. Inspect regularly

Check tire pressure once a month or more.

Transfer case oil and rear differential oil should be changed anytime they have been submerged in water.

¹ When adding coolant, use only deionized water or soft water for your vehicle and never mix hard water in the coolant filled at the factory. An improper coolant mixture can result in serious malfunction or engine damage.

² When replacing coolant, use only a qualified coolant additive for your vehicle and never mix hard water in the coolant filled at the factory. An improper coolant mixture can result in serious malfunction or engine damage.

See your owner's manual for more details and complete maintenance information, including severe maintenance schedule.

Warranty may be voided if maintenance schedule is not followed.

Call 1-800-333-4kia (4542) for roadside assistance.



SOUL EV CUSTOMER DELIVERY CHECKLIST

Owner's Name: _____ VIN: _____ Mileage: _____

Dealership Name: _____ Sales Consultant: _____ Date: _____

BEFORE DELIVERY

- Verify all tire pressures are to spec (see driver's door label) LF _____ LR _____ RF _____ RR _____
- Verify proper operation of Smart Key lock/unlock
- Ensure floor mats are snapped into place (if applicable)
- Verify vehicle is clean (interior and exterior), in good condition and free of chips and scratches
- Ensure all key documents are in the vehicle (Owner's Manual, Warranty and Consumer Information booklet, Tire Warranty booklet and Features & Functions Guide and Car Multimedia System User's Manual.)

KEY FEATURE WALKTHROUGH

- Air Conditioning / Climate Control – page 26
Demonstrate Air Flow Modes, Defog and Defrosting Windshield

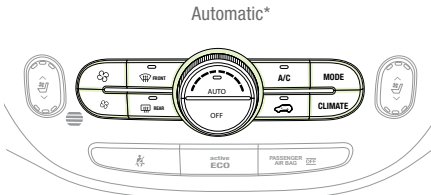

- Driver Only Ventilation/Reserved Climate Control – page 27



- Windshield/Rear Wipers & Washers* – page 20

Rotate level to adjust Intermittent Wipe Speed.

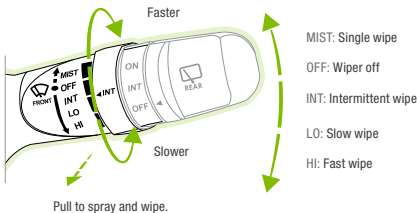

Move lever Up/Down to change Wiper modes.

Push to spray and wipe.

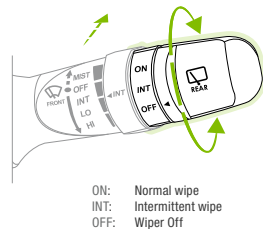



SOUL EV CUSTOMER DELIVERY CHECKLIST

KEY FEATURE WALKTHROUGH

Demonstrate the following with the customer:

- Charging Your Electric Vehicle – page 10

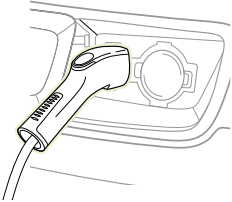

- ECO System – page 9



- AVN System – page 24

For further AVN System operation, refer to the Car Multimedia System User's Manual.

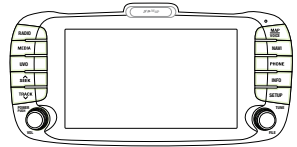

- Aux/USB/iPod® Port – page 27



- Cruise Control – page 21

Demonstrate operation

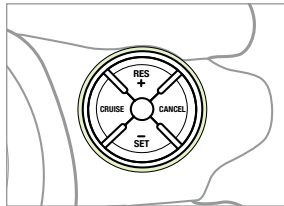

- Bluetooth® Wireless Technology – page 22

Demonstrate operation

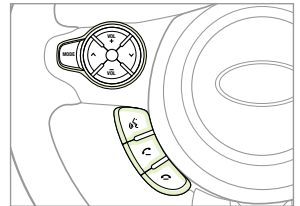

- Digital Clock – page 27
- Power Button – page 25
- Folding Rear Seatback – page 32
- Passenger Airbag Off Indicator – page 40
- Rear-Camera Display* – page 35

*IF EQUIPPED

- Seat Warmers / Ventilated Seats* – page 30
- Smart Key – page 33
- Tire Mobility Kit – page 36
- Tire Pressure Monitoring System (TPMS) – page 6

DURING DELIVERY

- Explain first service process and schedule first service appointment
- Tour Parts & Service departments, introduce staff & explain value of Kia Parts and Service
- Review recommended maintenance schedule and maintenance requirements to validate warranty
- Review business hours & Customer 360° Care
- Review the Kia 10-year/100,000-mile warranty program
- Ensure 100% satisfaction with sales and delivery process and no problems with the vehicle
- Confirm time and best contact number for initial dealer follow-up

Sales Consultant: _____ Date: _____

Sales Manager: _____ Date: _____

Customer: _____ Date: _____