



OPTIMA

FEATURES & FUNCTIONS GUIDE

www.kia.com

Consumer - Roadside Assistance

1-800-333-4KIA (4542)

See Back Cover for Vehicle Maintenance Schedule

Always check the Owner's Manual for complete operating information and safety warnings.

GETTING TO KNOW YOUR **OPTIMA**

Congratulations on Your New Kia Purchase!

Your new Kia vehicle has been designed, engineered and manufactured to provide you with years of comfortable and dependable driving. Kia is committed to quality, innovation, safety and — above all — your satisfaction.

Using This Guide

The information contained in this guide is a brief overview that will help you become familiar with the operation and features of your new Kia vehicle. The flipbook format facilitates information access, while the detailed illustrations ensure the instructions are easy to follow.

This **Features & Functions Guide** and the specific operational and safety information it provides is not a substitute for your Owner's Manual. In the interest of your safety and that of your family, and to help you avoid risks that may result in death or serious injury, Kia reminds you to carefully read your Owner's Manual in order to fully familiarize yourself with the important information it contains.

While the information contained in this guide is accurate at the time of printing, Kia may change vehicle specifications without notice in advance or after the fact, and assumes no liability in connection with such changes.

ESSENTIAL FEATURES

Air Conditioning / Climate Control	25
Active ECO System	09
Audio System – Standard*	21
Audio System – UVO eServices System*	23
Audio System – Navigation System*	22
Aux/USB/iPod®* Port* & Power Outlets	24
Bluetooth® Wireless Technology	18
Cruise Control	20
Digital Clock	24
Passenger Airbag Off Indicator	38
Tire Mobility Kit	37
Tire Pressure Monitoring System (TPMS)	05
Windshield Wipers & Washers	16

Driving while distracted can result in a loss of vehicle control that may lead to an accident, severe personal injury and death. The driver's primary responsibility is in the safe and legal operation of a vehicle, and use of any handheld devices, other equipment or vehicle systems which take the driver's eyes, attention and focus away from the safe operation of a vehicle or that are not permissible by law should never be used during operation of the vehicle.



VIDEOS & QR CODES	02
-----------------------------	----

INSTRUMENT CLUSTER

Instrument Cluster Overview	03
Indicators & Warning Lights	04
Tire Pressure Monitoring System (TPMS)	05
LCD Instrument Cluster Modes	06
Trip Computer / Tripmeter	06
Instant Fuel Consumption Mode*	07
Fuel Economy	07
User Settings	08
Service Mode	08
Drive Mode Integrated Control System*	09
Active ECO System	09

DRIVER'S PANEL

Blind Spot Detection System*	10
Electric Parking Brake (EPB)*	11
AUTO HOLD*	11
Instrument Panel Dimmer*	12
Electronic Stability Control (ESC)	12
Hill-Start Assist Control (HAC)	12
Engine Start/Stop Button*	13
Power Windows, Window Lock & Central Door Lock*	14
Automatic Door Lock/Unlock	14
Power/Heated Outside Mirrors*	14
Power Folding Mirrors*	14

STEERING WHEEL CONTROLS

Headlights & High Beams	15
Turn Signals & Fog Lights	15
Windshield Wipers & Washers	16
Heated Steering Wheel Button*	16
Tilt/Telescoping Steering Wheel*	17
Bluetooth® Wireless Technology	18
Audio Controls*	20
Cruise Control	20

AUDIO SYSTEM

Standard Audio System* Operation/Overview	21
Navigation System*	22
UVO eServices System*	23

CENTER PANEL

Digital Clock	24
Aux/USB/iPod® Port & Power Outlets	24
Automatic Climate Control*	25
Manual Climate Control*	26
Automatic Gear Shift with Sportmatic® Shifting	27
Paddle Shifters*	27

SEATING

Driver Position Memory System*	28
Power Adjustable Driver's Seat*	28
Seat Warmers / Ventilated Seats*	29
6-Way Manual Adjustable Driver's Seat	29
Front Seat Headrest Adjustment	30

OTHER KEY FEATURES

Smart Key*	31
Remote Keyless Entry (Folding Key)*	32
Double-Turn Lock/Unlock All	32
Fuel Cap / Malfunction Indicator (Check Engine Light)	32
HomeLink® with Auto-Dimming Rearview Mirror*	33
Map/Room Lamps	34
Panoramic Sunroof Operation*	34
Hood Release Lever and Latch	35
Fuel Door and Trunk Release	35
Trunk Release Button (Exterior)	35
Sunvisor	35
Back-Up Warning System (Rear Parking Assist System)*	36
Rear-Camera Display*	36
Child Safety Locks	37
Tire Mobility Kit	37

SAFETY FEATURES

Occupant Detection System (ODS) /	
Passenger Airbag Off Indicator	38
Seat Belts	39
Seat Belt Retractor Inertia Locks	39

NOTES

40

LEGAL DISCLAIMERS (See Back Inside Cover Page)

MAINTENANCE (See Back Cover)

Kia provides a number of video resources at your disposal to assist you with becoming familiar with the features and functions found in your Kia vehicle. You can access these resources by snapping the QR Codes with your smartphone/tablet (mobile devices) or by visiting the following website: www.KuTechVideos.com/qf13/2015. Continue reading for a more in-depth look at QR Codes and for instructions on how to use them.

What are QR Codes?

A QR Code is a square, 2-dimensional barcode that can be read by mobile devices loaded with an appropriate barcode or QR Code Reader App. The app reads the barcode image and then launches/uploads the specific information the code contains, such as URLs, text, photos, videos and so much more.

How to Use QR Codes

If you have a mobile device with a QR Code Reader App, you can snap the code with your phone and you'll be provided a video with additional information pertaining to the topic. For example, in the Fuel Cap section, if you would like additional information, just snap the code with your mobile device to view the selected Kia Features & Functions Video.

How to Snap a QR Code

1. With your mobile device, download a QR Code Reader App. With many devices, you can do this through an app store or marketplace
2. Open the QR Code Reader App on your mobile device
3. The app will utilize your device's camera. Center the code in the camera viewing area:
 - With some apps, as soon as the app recognizes the code, it will launch the corresponding video
 - With other apps, you will have to snap or take a picture of the code. The app will then launch the corresponding video
 - For operation specifics, refer to the instructions that come with the QR Code Reader App

QR CODE

One Click Fuel Cap Video

To view a video on your mobile device, snap this QR Code or visit the listed website.



www.KuTechVideos.com/qf13/2015

REMINDER: When accessing videos on your mobile device, standard cellular data rates may apply.

QUICK TIPS

1. If you're having trouble scanning codes, check the following:
 - The code should be centered and focused in your mobile device's camera screen
 - Consider moving your device closer to or farther away from the code
 - The code should be well lit, without significant shadow
2. After scanning, if a "connecting" message appears and then nothing happens or there's a "connection error" message, this typically indicates that your device is having trouble connecting to the Internet
 - Avoid scanning from a significant angle
 - Confirm that the device's app supports 2D QR Code scanning
 - Try another QR Code Reader App; not all apps are created equal

Instrument Cluster Overview

- A** Tachometer
- B** Indicator & Warning Lights
- C** Speedometer
- D** LCD Screen
- E** Turn Signal Indicators
- F** Engine Temperature Gauge*
- G** Fuel Gauge
- H** Gear Shift Position Indicator*

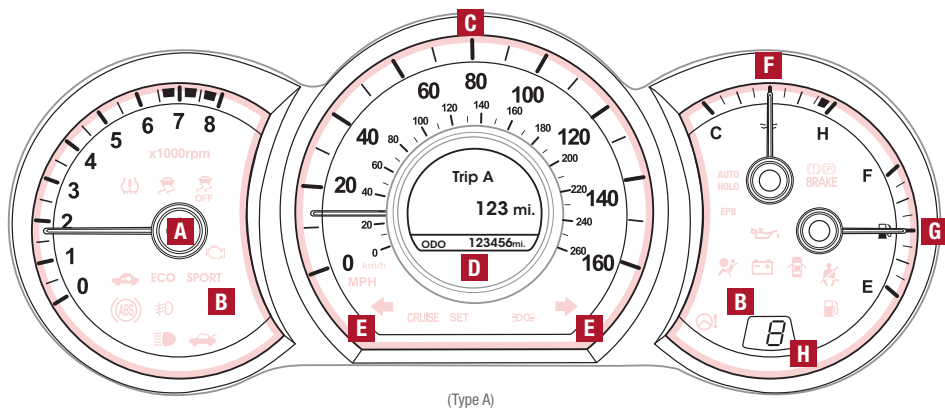

REMINDER: Your vehicle's instrument cluster & indicator light locations may differ from those in the illustrations. See your Owner's Manual for more details.

QR CODE

Optima Analog Cluster Video

To view a video on your mobile device, snap this QR Code or visit the listed website.

Refer to page 2 for more information.



www.KuTechVideos.com/qf13/2015

QUICK TIP

For more information on the function of all indicator and warning lights, please refer to the Owner's Manual.

Indicators & Warning Lights

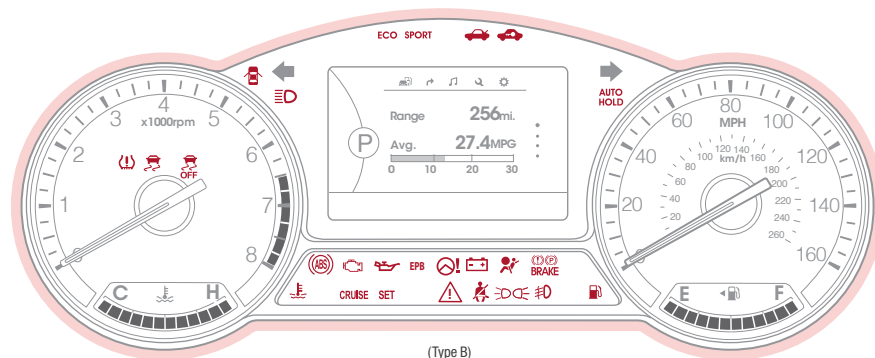

(Type B)

QUICK TIP

For more information on the function of all indicator and warning lights, please refer to the Owner's Manual.

REMINDER: Your vehicle's instrument cluster & indicator light locations may differ from those in the illustrations. See your Owner's Manual for more details.

QR CODE

Optima Supervision Cluster Video

To view a video on your mobile device, snap this QR Code or visit the listed website.



Refer to page 2 for more information.



www.KuTechVideos.com/qf13/2015

- | | | | | | |
|--|--|--|--|--|---|
| | Low Tire Pressure Indicator / TPMS Malfunction Indicator | | ECO Active ECO System Indicator* | | Charging System Warning Indicator |
| | Electronic Stability Control Indicator | | SPORT Sport Mode ON Indicator | | Seat Belt Warning Light |
| | Electronic Stability Control OFF Indicator | | Engine Oil Pressure Warning Light | | Airbag Warning Light |
| | Door Ajar Warning Indicator | | SET Cruise Control Set Indicator* | | Tail Light Indicator |
| | High Beam Indicator | | EPB Electronic Parking Brake | | Parking Brake & Brake Fluid Warning Light |
| | Engine Coolant Temperature Warning Light | | Electric Power Steering (EPS) System Warning Lights* | | Front Fog Light Indicator |
| | Anti-lock Braking System (ABS) Warning Light | | Master Warning Light | | Low Fuel Level Warning Light |
| | Malfunction Indicator* | | Trunk Open Warning Light | | AUTO HOLD AUTO HOLD Indicator* |
| | CRUISE Cruise Control ON Indicator* | | Immobilizer Indicator* | | |

Tire Pressure Monitoring System (TPMS)

The TPMS indicator  functions as both Low Tire Pressure Light and TPMS Malfunction Indicator. The indicator  will illuminate if one or more tires is significantly underinflated, the vehicle has a spare tire installed without TPMS or the outside temperature becomes significantly colder.

The Low Tire Pressure Position Indicator **A** is displayed on the LCD screen in the Instrument Cluster when the tire(s) are underinflated. Inflate tire(s), using an accurate digital tire pressure gauge, to specifications to turn off Low Tire Pressure Position Indicator **A** - See front driver's door jamb for PSI specification.

When there is a problem with the TPMS, the TPMS Malfunction Indicator  will blink for approximately one minute then illuminate - see dealer for service.

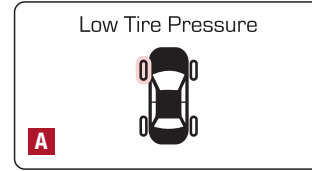

(Type B Cluster)

ⓘ QUICK TIPS

- Even with TPMS, tire pressure should be checked manually at least once a month. Only adjust tire pressure on "cold tires"
- For proper maintenance and optimal fuel economy, maintain recommended tire inflation pressures and stay within the load limits and weight distribution recommended for your vehicle
- In winter or cold weather, the TPMS light may illuminate if the tire pressure was adjusted to the recommended tire inflation pressure during warm weather

REMINDER: Consult your dealer for service if Low Tire Pressure Light remains illuminated after inflating your tire(s).

📱 QR CODE

Tire Pressure Monitoring System Video

To view a video on your mobile device, snap this QR Code or visit the listed website.

Refer to page 2 for more information.



www.KuTechVideos.com/qf13/2015

LCD Instrument Cluster Modes*

Press Mode button **A** to scroll through different LCD Instrument Cluster Modes.

Type B cluster:



Trip Computer Mode: Displays driving information for tripmeter, fuel economy, etc.



Turn-by-Turn Mode*: Displays the state of the navigation



A/V Mode*: Displays the state of the A/V System



Service Modes / Master Warning: Informs on upcoming service intervals, and warning messages related to TPMS and others



User Settings Mode: Change settings of the doors, lamps and other features

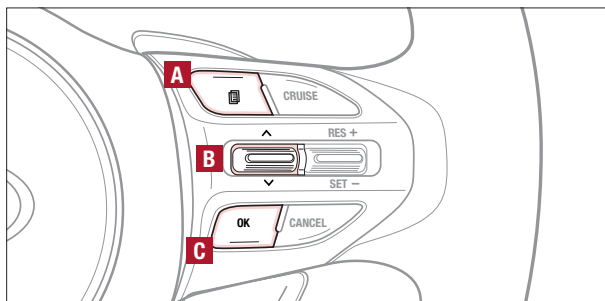

(Buttons located on Steering Wheel)

Your vehicle's steering wheel buttons may differ from those in the illustrations.

Trip Computer / Tripmeter

The Trip Computer is a driver information system that displays information related to driving. It appears on the display when the ignition switch or the ENGINE START/STOP button* is in the ON position.

To cycle through the LCD Instrument Cluster modes, press the Mode button **A**.

When in the Trip Computer mode , press the Move button **B** to cycle through the screens. When displaying TRIP A or TRIP B screens, press and hold the Select/Reset button **C** to reset the Tripmeter to zero.

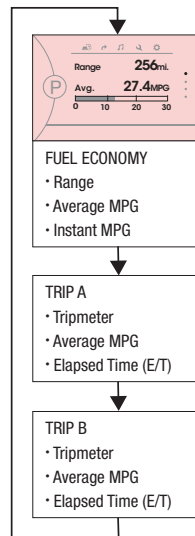

(Type B Cluster)

REMINDERS:

- Appearance of Tripmeter display may differ as equipped
- All stored driving information (except Odometer and Range) is reset if the battery is disconnected

Instant Fuel Consumption Mode*

When in Fuel Economy screen in the Trip Computer, press the Mode button **A** to cycle to the Instant Fuel Consumption Mode and press Select/Reset button **B** to select. This screen displays the calculated fuel consumption during the past few seconds.

1. Keep your vehicle in good condition with regular maintenance
2. Travel lightly, without carrying unnecessary weight in your vehicles
3. Don't let the engine idle longer than necessary

REMINDERS:

- Not to be used in calculating or as a reference for AVERAGE fuel economy
- If the vehicle speed exceeds 1 MPH (1.6 km/h) after being refueled with more than 1.6 gallons (6 liters), the average fuel economy will be cleared to zero (---)

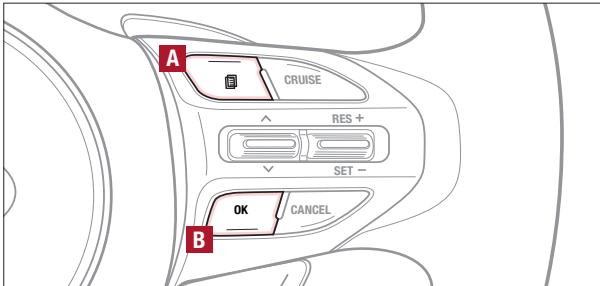

(Buttons located on Steering Wheel)

Your vehicle's steering wheel buttons may differ from those in the illustrations.

Fuel Economy

There are several factors that contribute to your vehicle's fuel economy, including maintenance of your vehicle, driving style, environmental conditions, vehicle weight and vehicle aerodynamics. Below are tips on how to help improve fuel economy:

- Keep your vehicle in good condition with regular maintenance
- Don't let the engine idle longer than necessary
- Drive at a moderate speed, accelerating smoothly and at a moderate rate
- Keep tires inflated to the recommended pressure
- Travel lightly, without carrying unnecessary weight in your vehicles
- Avoid placing large or heavy items on roof racks
- Avoid hilly, winding or poorly maintained roads

REMINDERS: Driving range can vary depending on your vehicle's fuel tank size, e.g., 12-gal. vs. 24-gal., even though the MPG may be the same

For more information on Fuel Economy, you can snap the QR Code above to view a video or refer to the brochure "GETTING MORE OUT OF EVERY GALLON, FUEL-SAVING TIPS TO DRIVE BY" available at your local dealership.

QR CODE

Fuel Economy Video

To view a video on your mobile device, snap this QR Code or visit the listed website.

Refer to page 2 for more information.



www.KuTechVideos.com/qf13/2015

User Settings

To enter the User Settings mode in the LCD Instrument Cluster Modes, press the Mode button **A** when the vehicle is at a standstill and with the ignition switch or the ENGINE START/STOP button in the ON position and select User Settings .

You can navigate the selections on the display by pressing the Move button **B**, and then selecting the item by pressing the Select/Reset button **C**.

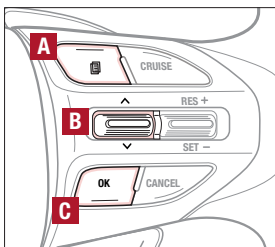

(Located on Steering Wheel)

Door:

- Auto Door Lock & Unlock*
- Two Press Unlock*
- Horn Feedback*

Lamp:

- One-Touch Turn Lamp*
- Headlamp Delay
- Welcome Light*

Convenience:

- Language
- Temperature Unit
- AVG Fuel Economy Reset
- Easy Seat Access*
- Welcome Sound*
- Steering Position*

Service Interval:

- ON/OFF
- Set mileage/months

Driving Assist*: RCTA

Service Mode

To enter Service mode, press the Mode button **A**, scroll to Service Mode , and press Select/Reset button **C**. System will display number of miles remaining until next service is due, as well as type of service.

When service is required, the following will be displayed:
Service Required.

To reset the Service mode system, press and hold the Select/Reset button **C** for more than 1 second.

To turn Service In OFF, go to User Settings.

Service Interval Setting

To set the service interval when in User Settings mode:

- Press the Move button **B** and scroll to Service Interval. Press the Select/Reset button **C** to enter
- Press the Move button **B** and toggle to ON, then press the Select/Reset button **C**. Then press the Move button **B** to scroll and select the desired miles or months for your next service
- Press the Select/Reset button **C** to enter

(Type B cluster)

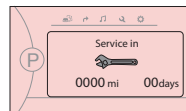
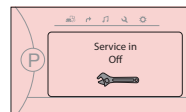

QR CODES

To view a video on your mobile device, snap these QR Codes or visit the listed website.

Refer to page 2 for more information.

LCD Display: Maintenance Video



www.KuTechVideos.com/qf13/2015

LCD Display Video



www.KuTechVideos.com/qf13/2015

Drive Mode Integrated Control System*

The Drive Mode may be selected depending on driver's preferences and road conditions.

To cycle through the different Drive Modes **A**, press the DRIVE MODE button **B**. The Instrument Cluster will display SPORT or ECO when selected. When in Normal mode, it will not display in the Instrument Cluster.

REMINDERS:

- The system is turned ON and in Normal mode when ignition is in the ON position
- When ECO mode is selected, the indicator will display and system remains on, even when ignition is cycled

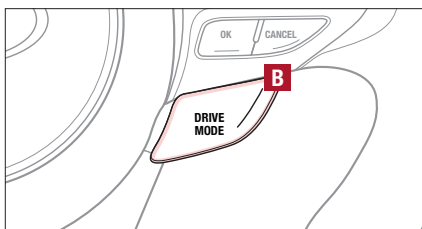

(Located on Steering Wheel)*

Active ECO System*

The Active ECO system helps improve fuel economy by controlling several vehicle components. When activated, it optimizes drivetrain operations such as engine power and transmission to help improve fuel economy.

To turn ON, press the ECO button **C**. The button light will turn on, and the green ECO indicator light **D** in the instrument cluster will illuminate (indicating that you are getting optimal fuel efficiency). The Active ECO system will remain on even when the ignition is cycled.

To turn the Active ECO system OFF, press ECO button **C** again.

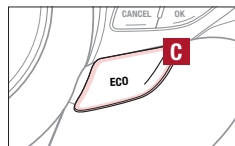

(Located on Steering Wheel)



(Located in Instrument Cluster)

Ⓢ QUICK TIPS

To help improve your fuel economy:

- Drive at a moderate speed, accelerating smoothly and at a moderate rate
- Keep tires inflated to the recommended pressure
- Be sure the wheels are properly aligned

For more information on Active ECO, refer to your Owner's Manual or contact your local dealership.

QR CODE

Optima Active ECO System Video

To view a video on your mobile device, snap this QR Code or visit the listed website.

Refer to page 2 for more information.



www.KuTechVideos.com/qf13/2015

Blind Spot Detection (BSD) System*

The BSD system uses radar sensors to help alert the driver before changing lanes. The light on the BSD button **A** will illuminate when turned ON. The outside rearview mirror warning lights will also illuminate for 3 seconds.

The system will become active when the vehicle is traveling more than 18 mph and will alert the driver if another vehicle is detected by the radar sensor.

Blind Spot Detection / Lane Change Assist

1st-stage alert: When another vehicle is detected within the BSD System boundary **B**, a yellow indicator will illuminate on the outside rearview mirrors.

2nd-stage alert: When 1st-stage alert is on and the driver activates a turn signal, a flashing yellow indicator will illuminate on the outside rearview mirrors and the system will sound an alert.

RCTA (Rear Cross Traffic Alert)

If the RCTA system sensors detect approaching vehicles from the left or right side **C**, the system will sound an audible alert, the warning indicators on the outside rearview mirror will illuminate and a message will appear on the LCD screen, with these conditions:

- When the vehicle is in Reverse
- When the vehicle moves in reverse from a parking position
- When the vehicle is moving less than 6 mph

REMINDERS:

- The BSD system will not show a warning if the vehicle speed is only 6 mph above the surrounding vehicles
- If the BSD is turned ON and the ignition is cycled, the BSD system returns to ON
- The RCTA feature can be turned OFF/ON in User Settings

For more information on the Blind Spot Detection System, please refer to the Owner's Manual.

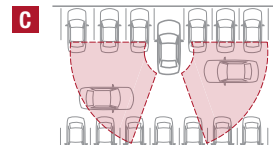
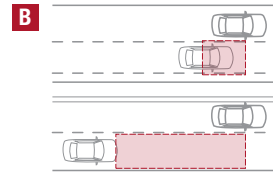
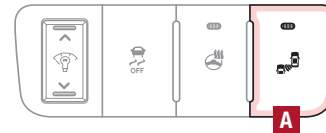

REMINDER: The above images are for illustration purposes only and may not reflect actual operation.

QR CODE

Blind Spot Detection System Video

To view a video on your mobile device, snap this QR Code or visit the listed website.

Refer to page 2 for more information.



www.KuTechVideos.com/qf13/2015

Electric Parking Brake (EPB)*

The Electric Parking Brake (EPB) system utilizes an electric motor to engage the parking brake.

Applying the Parking Brake

Depress the brake pedal and pull up the EPB switch **A**. Ensure that the indicator light  is illuminated on the instrument cluster.

Releasing the Parking Brake

The EPB will automatically release when the shifter is placed in Reverse or Drive.

To release EPB manually, depress the brake pedal, then press the EPB switch **A**, with the ignition switch in the ON position. Ensure that the indicator light  is OFF.

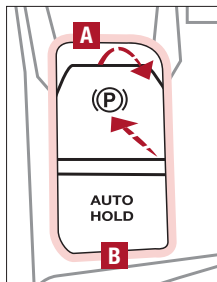

(Located on Center Panel)

REMINDERS:

- As a bulb check, the EPB malfunction indicator will illuminate for approximately 3 seconds when the ignition switch is turned ON
- If the warning light does not illuminate temporarily, or continues to remain lit, take your vehicle to an authorized Kia dealer and have the system checked
- The EPB should not be operated while the vehicle is moving
- A click or electric brake motor sound may be heard while operating or releasing the EPB, but these conditions are normal and indicate that the EPB is functioning properly

🕒 QUICK TIPS

- When leaving your keys with parking lot attendants or valet, make sure to inform them how to operate the EPB
- If parked on a steep incline, pull up the EPB switch for more than 3 seconds for a firmer EPB application
- Pull up and hold EPB switch a second time to increase brake pressure if parked on a decline or incline

AUTO HOLD*

AUTO HOLD temporarily maintains the vehicle at a standstill even if the brake pedal is released. AUTO HOLD can be turned ON/OFF using the AUTO HOLD switch **B** on the driver's panel. Before AUTO HOLD will operate, the driver's door, engine hood and trunk must be closed, and the driver's seat belt must be fastened.

The AUTO HOLD indicator has four states:

White: Standby - With vehicle at a standstill, and AUTO HOLD switch **B** turned ON, the indicator will illuminate white. While driving the vehicle (vehicle is not at a standstill), the AUTO HOLD indicator will remain white.

Yellow: Malfunction - When the indicator is illuminated yellow, there may be a system malfunction. Take your vehicle to a local Kia dealer.

Green: Engaged - When coming to a complete stop by depressing the brake pedal, the AUTO HOLD indicator changes from white to green.

OFF (not illuminated) - The indicator will turn OFF when the AUTO HOLD switch **B** is manually turned OFF or when the EPB is manually turned ON.

📱 QR CODE

Electric Parking Brake (EPB)/AUTO HOLD Video

To view a video on your mobile device, snap this QR Code or visit the listed website.

Refer to page 2 for more information.



www.KuTechVideos.com/qf13/2015

Refer to page 4 for location of Instrument Cluster indicators.

Instrument Panel Dimmer

Toggle switch **A** up or down to adjust display brightness of the instrument panel illumination.

REMINDER: The Instrument Panel Dimmer does not adjust brightness on the Navigation System screen, use Navigation setup to adjust brightness on the Navigation System.

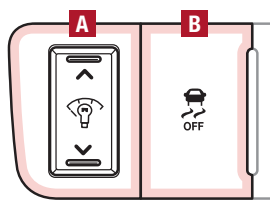

(Located left of Steering Wheel)

Electronic Stability Control (ESC)

The ESC system is designed to help stabilize the vehicle during cornering maneuvers. It is a good idea to keep the ESC turned ON for daily driving whenever possible.

Press ESC OFF button **B** to disable Traction Control in ESC (ESC OFF indicator will illuminate).

To turn both Traction Control and Stability Control off, press and hold ESC OFF button **B** (ESC OFF indicator will illuminate, and an alert sounds).

REMINDEES:

- ESC is active by default at vehicle start-up
- The ESC Indicator Light  in the instrument cluster will illuminate whenever the ESC is in operation

For more information on Electronic Stability Control (ESC) and its specific features and operations, please refer to your Owner's Manual.

Hill-Start Assist Control (HAC)

HAC helps prevent the vehicle from rolling backward when accelerating from a stop while on a steep incline.

The HAC automatically activates whether the ESC is OFF or ON but does NOT activate when the ESC has malfunctioned.

REMINDEES:

- The HAC does not operate when the gear shift is in the P (Park) or the N (Neutral) position.
- In the event of HAC system malfunction, see Authorized Kia Dealer for service.

🔍 QUICK TIPS

- When HAC is active (e.g., accelerating from a stop on an incline), you may notice that the brakes will momentarily remain engaged after you depress the accelerator
- HAC provides a 2-second delay before the vehicle may start rolling backward

Engine Start/Stop Button*

To start the engine:

1. Depress the brake pedal
2. Press the ENGINE START/STOP button while gear shift is in P (Park)

To turn the vehicle OFF, press the ENGINE START/STOP button.

To use the ENGINE START/STOP button, you must have the Smart Key fob on your person.

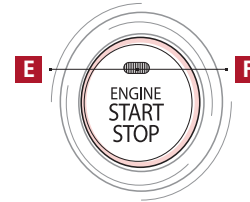

REMINDERS:

- In an emergency situation while the vehicle is in motion, you are able to turn the engine off and to the ACC position by pressing the ENGINE START/STOP button for more than 2 seconds or 3 times successively within 3 seconds
- If Smart Key fob battery is dead, hold the fob up against the ENGINE START/STOP button and press

🕒 QUICK TIPS

To use electrical accessories:

ACC position

- When in the OFF position and without depressing the brake pedal, press the ENGINE START/STOP button once (orange light **E**)

ON position

- When already in the ACC position (orange light **E**) and without depressing the brake pedal, press the ENGINE START/STOP button again (green light **F**)
- When in the OFF position and without depressing the brake pedal, press the ENGINE START/STOP button twice (green light **F**)

Keeping the vehicle in ACC or ON position without turning engine on may discharge the vehicle's battery.

📱 QR CODE

Engine Start/Stop Button & Smart Key Video

To view a video on your mobile device, snap this QR Code or visit the listed website.

Refer to page 2 for more information.



www.KuTechVideos.com/qf13/2015

Power Windows, Window Lock & Central Door Lock*

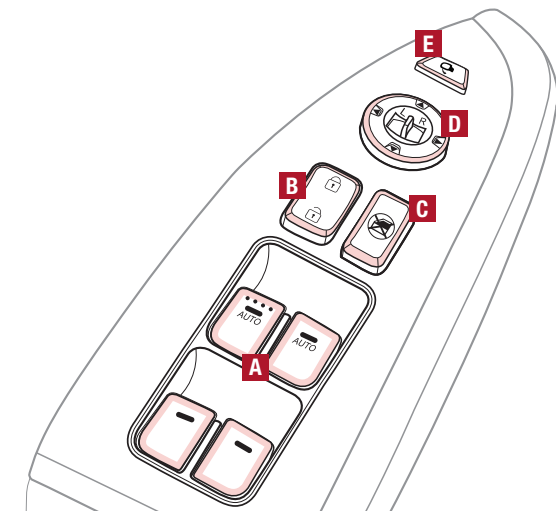

A Pull/Press to operate Driver's and Front Passenger's Windows Auto-Up/Down*

B Press to Unlock/Lock All Doors

C Press to disable Rear Passenger Windows

REMINDER: When pressed **C**, window controls for the Rear Passenger Windows are disabled.

Automatic Door Lock/Unlock*

Auto Door Lock/Unlock will engage when the gear shift is moved in to or out of the P (Park) position. Refer to the User Settings in the LCD Instrument Cluster modes on how to turn Auto Door Lock/Unlock ON/OFF.

Power/Heated Outside Mirrors*

Mirror heaters controlled with Rear Defroster.

Power Folding Outside Mirrors*

Toggle **D** left or right to select mirror. Then press arrows to adjust mirror position.

To both fold and unfold the outside rearview mirror, press the folding mirror button **E** as pictured.

REMINDER: To lock position of mirrors, toggle switch to the neutral (center) position.

🕒 QUICK TIP

To automatically fold mirrors when exiting vehicle, press the LOCK button once on the key fob or Smart Key*.

Headlights & High Beams

To operate:

- Rotate lever to change the Headlight function
- Push lever to turn High Beams ON
- Pull lever to flash Headlights/High Beams

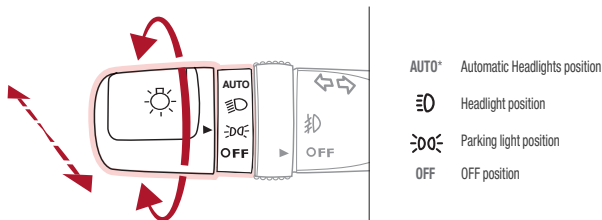

AUTO Light* function — When the light switch is in the AUTO Light position, the tail lights and headlights will turn ON/OFF automatically depending on the amount of light outside the vehicle.

Daytime Running Lights (DRL)*

DRL may help others to see the front of your vehicle during the day. The lights will be on automatically when the ignition or ENGINE START/STOP button* is ON and the headlight switch is in the AUTO position, unless one of the following occurs:

- Headlights are on
- Fog lights are on
- Parking brake is applied
- Engine is turned off

REMINDERS:

- DRL only operates during the daytime
- The DRL system turns off when the headlights are ON, parking brake is applied or the front fog lights are tuned on

Turn Signals & Fog Lights*

To operate:

- Turn Signals - Move lever Up/Down for Right/Left Turn Signal
- Fog Lights - Rotate lever ring to turn Fog Lights ON/OFF

REMINDER: Headlights must be ON for Fog Light operation.

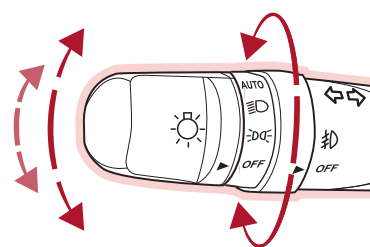

One-Touch Lane Change Signal is activated by moving the Turn Signal Lever slightly for less than 1 second and then releasing. The lane change signal will blink 3 times.

To change how many times the Lane Change Signal blinks (3/5/7), go to User Settings Mode in the LCD Instrument Cluster modes.

For more information on the User Settings Mode, please refer to your Owner's Manual.

Windshield Wipers & Washers

To operate:

- Move lever Up/Down to change Wiper modes
- Rotate lever to adjust Intermittent Wipe Speed
- Pull lever to spray and wipe

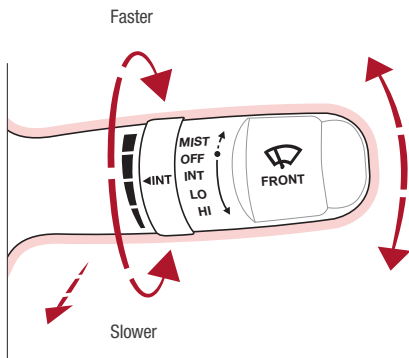

MIST: Single wipe
OFF: Wiper off
INT: Intermittent wipe
LO: Slow wipe
HI: Fast wipe

Ⓢ QUICK TIP

If the wiper switch is in AUTO mode when the ignition is ON, the wiper will operate once to perform a self-check of the system. Set the wiper to OFF position when the wiper is not in use.

Heated Steering Wheel Button*

Press button **A** to turn ON/OFF steering wheel heater, while the ignition or ENGINE START/STOP button is in the ON position.

Steering wheel heater will turn off automatically in 30 minutes, or when button is pressed again to deactivate.

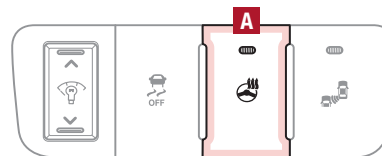

Ⓢ QUICK TIP

If ignition is turned OFF, then ON again, within 30 minutes of steering wheel heater being turned on, system will automatically be set ON again.

Tilt/Telescoping Steering Wheel*

To adjust the Steering Wheel, push the lock-release lever **B** down and adjust to desired angle **C** and distance **D**.

When finished, pull the lock-release lever **B** up to lock Steering Wheel in place.

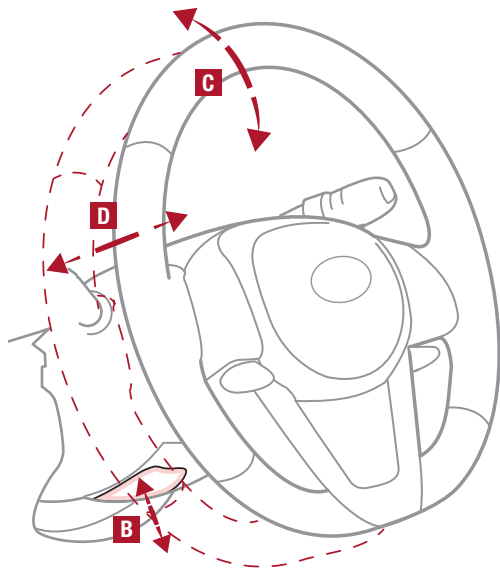

Bluetooth® Wireless Technology

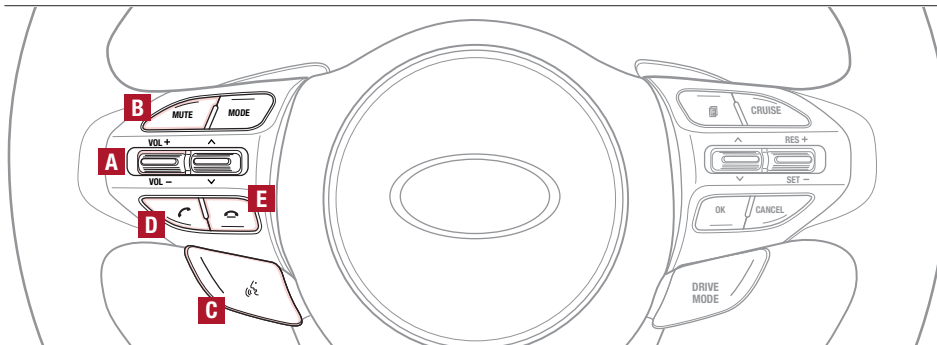

A Volume button: Press up/down to raise/lower speaker volume

B MUTE button: Press to mute the microphone during a call

C Talk button: Press to activate voice recognition/bring up menus/place calls with minimal voice command prompts from the system

Ⓢ QUICK TIP

When using the voice command feature, wait for the system BEEP before speaking the command.

D Receive/Place Call button: Press to receive/place/transfer calls. Press to place a call using voice command prompts from the system, or to answer an incoming call

E End Call button: Press to end a call or cancel a function

Ⓢ QUICK TIPS

- Phonebook transfer upload time varies by phone model and with number of phonebook entries
- Because of differences in phone quality, service providers and **Bluetooth®** Wireless Technology chip programming, functionality may differ from one phone to another
- Changing language setting may delete paired phones

REMINDER: Your vehicle's steering wheel buttons may differ from those in the illustrations. See your Owner's Manual for more details

Driving while distracted is dangerous and should be avoided. Drivers should remain attentive to driving and always exercise caution when using the steering-wheel-mounted controls while driving

For more information, if equipped, refer to the Car Multimedia System User's Manual or the UVO System User's Manual. For Bluetooth® Wireless Technology FAQs, go to www.kia.com, Owners section, or call Consumer Information for Bluetooth® Technology at (800) 333-4KIA. Refer to your Owner's Manual for more specific Bluetooth® Wireless Technology phone pairing and operation instructions.

Bluetooth® Wireless Technology

Pairing a Phone

For instructions on how to pair a phone, refer to the audio system's user's guide or your vehicle's Quick Start Guide.

Ⓢ QUICK TIP

During the pairing process, be sure to accept the connection requests on the phone for phonebook download and to allow acceptance of all future **Bluetooth®** connection requests.

How to Place a Call

When using the voice command feature, wait for the system BEEP before speaking the command.

There are two options for placing a call:

Standard Audio System

- Option 1: Press the Receive/Place Call button **D** (system will prompt you through call process)
- Option 2: Press the Talk button **C** (system will BEEP to indicate it is ready for call placement). Then say the command "Call {name}" or "Dial {number}"

UVO eServices System

- Option 1: Press the Receive/Place Call button **D** (displays the phone screen with number keypad)
- Option 2: Press the Talk button **C**. Then say the command "Call {name}" or "Dial {number}"

Navigation System

- Option 1: Press the Receive/Place Call button **D** (displays the phone screen with number keypad)
- Option 2: Press the Talk button **C**. Then say the command "Call Name" or "Dial Number," followed by phone book name or number

Voice Recognition and Phone Contact Tips

The Kia Voice Recognition System may have difficulty understanding some accents or uncommon names. When using Voice Recognition to place a call, speak in a moderate tone, with clear pronunciation.

Help your **Bluetooth®** Wireless Technology Voice Recognition performance by making a few simple changes to your phone contacts:

- Use full names vs. short or single-syllable names ("John Smith" vs. "Dad"; "Smith Residence" vs. "Home")
- Avoid using special characters or hyphens (@, &, #, /, -, *, +, etc.)
- Avoid using acronyms ("In Case Emergency" vs. "ICE")
- Spell words completely, no abbreviations ("Doctor Goodman" vs. "Dr. Goodman")

Ⓢ QUICK TIPS

Contacts Sync Tips

- If Contact Sync is set to ON, contacts stored in your phone will download each time your phone is connected. There may be a delay before the system is available to place a call
- If Contact Sync is set to OFF, your phone contacts will download only at the initial pairing. This allows you to make calls without waiting for your phone contact list to download

📱 QR CODE

Voice Recognition Tips Video

To view a video on your mobile device, snap this QR Code or visit the listed website.

Refer to page 2 for more information.



www.KuTechVideos.com/qf13/2015

Audio Controls*

Cruise Control*

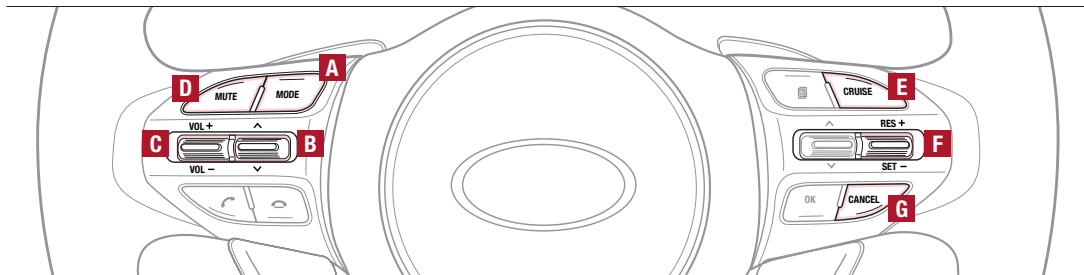

A Audio MODE button: Press to cycle through FM 1-2/AM/SAT 1-3/CD/USB/Aux/iPod®

Audio System ON/OFF: Press and hold to turn power on; Press to turn power off

B Seek/Presets button:

Radio Mode: Press to advance through Preset Stations. Press and hold to auto seek

CD/USB/iPod® Mode: Press to move Track Up/Down. Press & hold to FF/REW

C Volume button: Press up/down to raise/lower volume

D MUTE button: Press to mute all audio

Ⓢ QUICK TIP

Pressing the Audio Mode button for more than 1 second will turn Audio Mode ON/OFF.

Driving while distracted is dangerous and should be avoided. Drivers should remain attentive to driving and always exercise caution when using the steering-wheel-mounted controls while driving.

For further audio system operations, refer to pages 21 - 23.

E CRUISE Control ON/OFF button: Press to turn the Cruise Control ON/OFF

F Resume Cruising Speed button: Press up to resume or increase Cruising Speed

F Set Cruising Speed button: Press down to set or decrease Cruising Speed

G Cruise Control CANCEL button: To cancel Cruise Control setting, do one of the following:

- Press the brake pedal
- Press the CANCEL button **G**

Ⓢ QUICK TIPS

- Cruise Control is designed to function above 25 mph
- The Cruise Control system will not activate until the brake pedal has been depressed at least once after ignition ON or engine start

REMINDER: Your vehicle's steering wheel buttons may differ from those in the illustrations. See your Owner's Manual for more details.

Standard Audio System Overview/Operation

– FM/AM/Sirius®/Media (CD, USB, iPod®, Aux, BT Audio, My Music)*

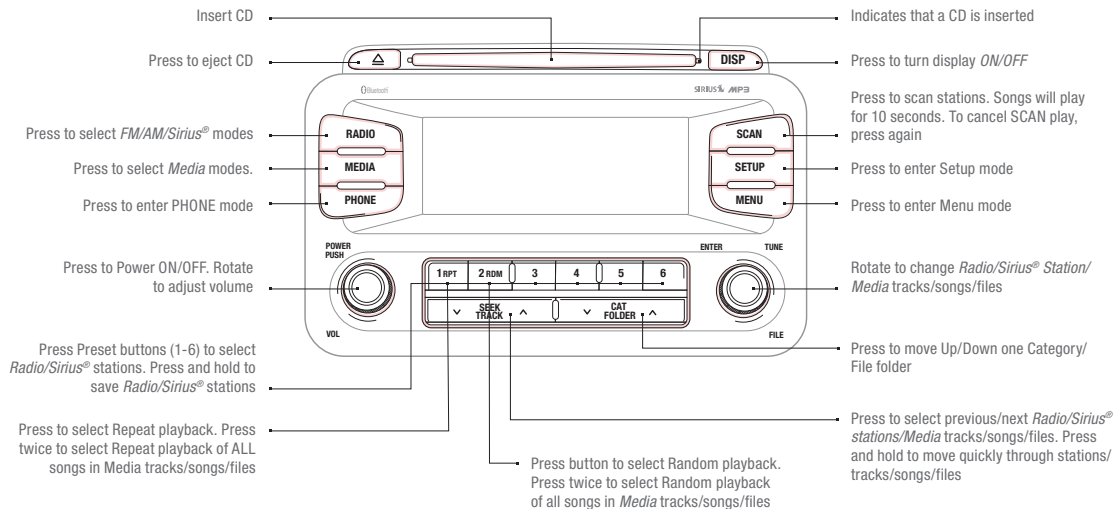

Audio System Setup Options

Press the SETUP button, then use the TUNE knob to cycle through the available settings for each equipped audio option. Press the TUNE knob to adjust the audio option selected. Audio options may include the following:

- **Display Setup** – Mode Popup, Text Scroll, Media Display
- **Sound Setup** – Sound Settings, Speed-Dependent Volume, Voice Recognition Volume
- **Phone Setup** – Pair Phone, Phone List, Contacts Download, Auto Download, Audio Streaming, Outgoing Volume, *Bluetooth*® System off
- **System Setup** – Memory Information, Prompt Feedback, Language

For further audio system operations, refer to pages 20 - 23.

QR CODE

Standard Audio System Videos

To view a video on your mobile device, snap this QR Code or visit the listed website.

Refer to page 2 for more information.



http://kutechvideos.com/audio/base_system

REMINDER: Your vehicle's audio system may differ from that in the illustration. See your Owner's Manual for more details.

To adjust the sound settings (Bass, middle, treble, fader, balance), select Sound settings in the SETUP menu. Then use the TUNE knob to cycle to the selection and press the TUNE knob to select. Turn the TUNE knob left/right to adjust sound setting.

Navigation System*

– FM/AM/Sirius®/Media (Disc,USB, iPod®, Aux, BT Audio, My Music)

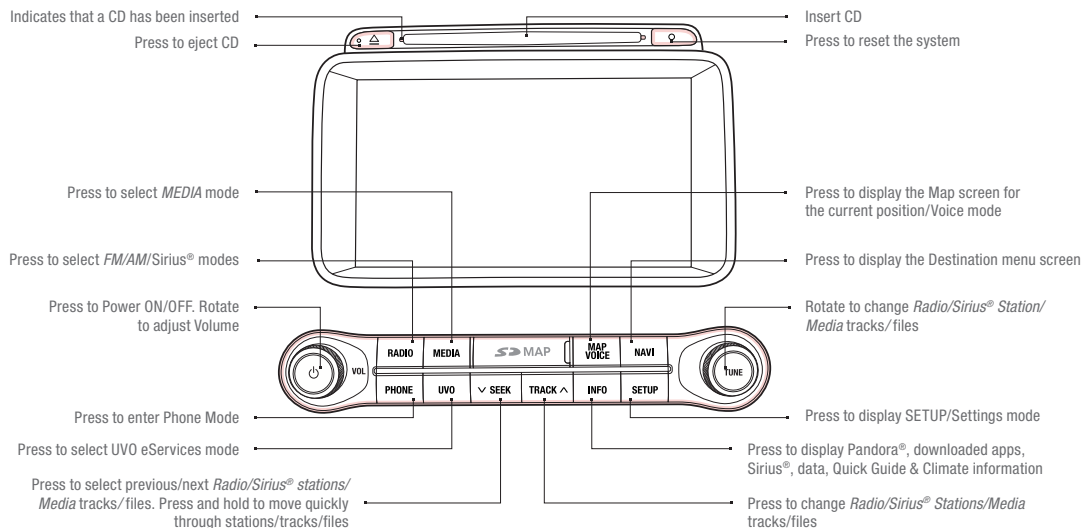

QR CODE

Navigation Audio System Videos

To view a video on your mobile device, snap this QR Code or visit the listed website.
Refer to page 2 for more information.



<http://kutechvideos.com/audio/avn4>

QUICK TIPS

- Prolonged use of the Navigation System in ACC mode may drain the vehicle's battery. A warning screen may appear periodically to remind users that the Navigation System should be operated when the engine is running to prevent battery discharge
- When using the voice command feature, wait for the system BEEP before speaking the command

REMINDER: Your audio system may differ from those in the illustrations.

For further Navigation System operations, refer to the Car Multimedia System User's Manual.
For further audio system operations, refer to pages 20 - 23.

Sound Settings

To adjust the sound settings - Fader/Balance, Tone, Touch-Screen Beep ON/OFF and Speed-Dependent Volume Control ON/OFF - from any audio mode:

1. Press the SETUP button on the Audio Control Unit
2. Select the on-screen SOUND button
3. Select the menu item to change settings
4. Use the on-screen buttons to adjust setting
5. Press the return button to save settings

UVO eServices System*

– FM/AM/Sirius®/Media (CD, USB, iPod®, Jukebox, Aux, BT Audio, Pandora®)

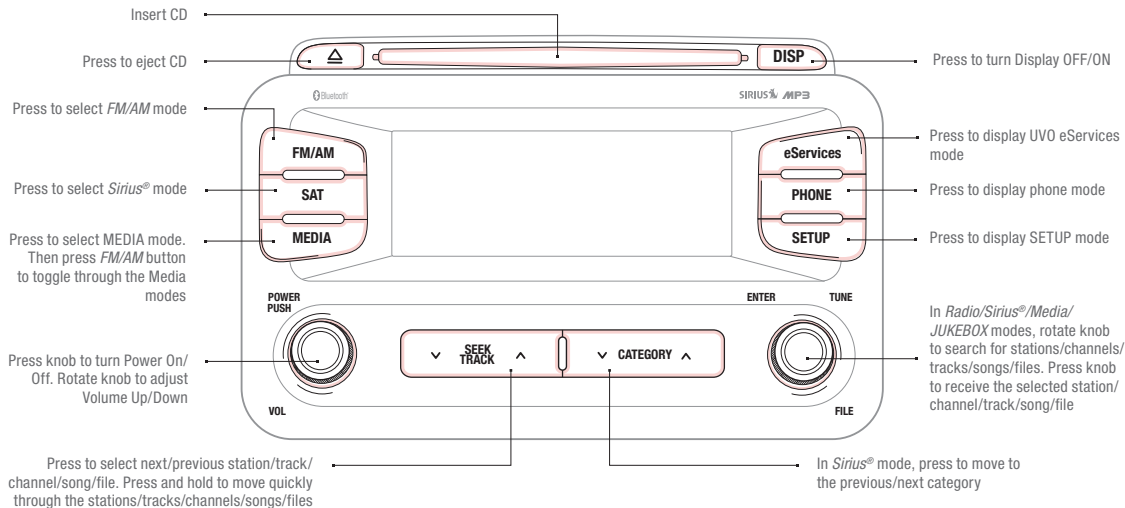

QR CODE

UVO eServices System Videos

To view a video on your mobile device, snap this QR Code or visit the listed website. Refer to page 2 for more information.



http://kutechvideos.com/audio/UVO_eServices

REMINDER: Your vehicle's audio system may differ from that in the illustration. See your Owner's Manual for more details.

QUICK TIPS

- When using the voice command feature, wait for the system BEEP before speaking the command
- Only MP3 or WMA files may be played or copied to Jukebox. Commercial CDs or CDs with a CDDA (compact disc digital audio) format cannot be copied to Jukebox
- At any time, you can interrupt UVO eServices System Command Feedback by pressing the TALK button
- Prolonged use of the UVO eServices system in ACC mode may drain the vehicle's battery

For further UVO eServices System operations, refer to the UVO System User's Manual. For further audio system operations, refer to pages 20-22.

Digital Clock*

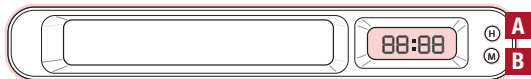

Standard Audio System Clock Setup:

Press the H button **A** to advance the time by one hour. Press the M button **B** to advance the time by one minute.

ⓘ QUICK TIP

Press and hold both for more than 5 seconds to switch from 12- to 24-hour formats.

UVO eServices System Clock Setup:

Press the CLOCK button to display the Clock setting screen. Then use the on-screen buttons to navigate through setup.

Navigation System Clock Setup:

Press the Setup button. Then press the on-screen Clock icon to enter clock settings.

ⓘ QUICK TIP

Press the on-screen return icon to save changes.

Aux/USB/iPod® Port & Power Outlets

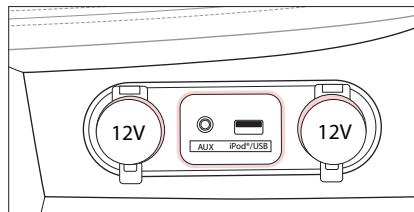

ⓘ QUICK TIP

The power outlets are inactive when ignition is in the OFF position.

REMINDER: Using the power outlet (accessory plug) for prolonged periods of time with the engine off could cause the battery to discharge.

For more information on the Aux/USB/iPod® Port & Power Outlets, refer to the Owner's Manual.

📱 QR CODE

USB Port Video

To view a video on your mobile device, snap this QR Code or visit the listed website.

Refer to page 2 for more information.



www.KuTechVideos.com/qt13/2015

Automatic Climate Control*

(Type B)

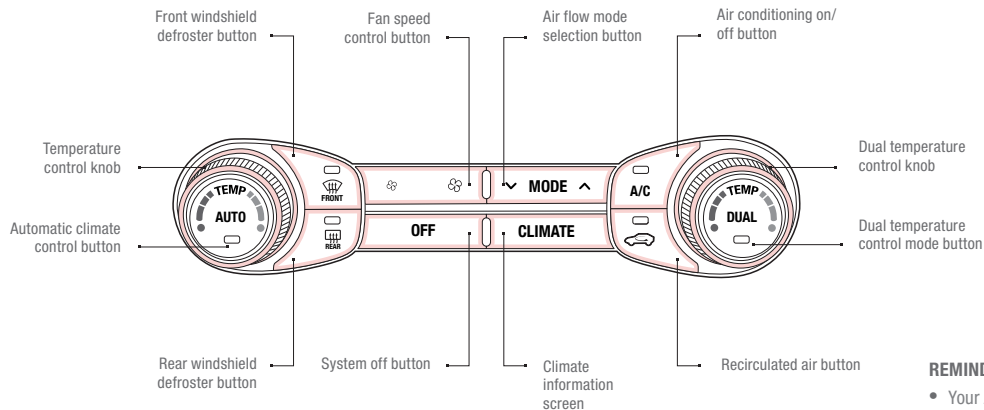

Air Flow Modes

To select Air Flow Modes, press the Mode selection buttons:



Climate Control Auto Function

1. Press AUTO to select Full Auto Operation
2. Press MODE button to control which vents air flows through
3. Press DUAL to select Dual Temperature Control Operation

Defrost Outside Windshield:

1. Set Fan Speed to the highest position
2. Set desired Temperature
3. Press the Defrost button 

Defog Inside Windshield:

1. Set Fan Speed to desired position
2. Set desired Temperature
3. Press the Defrost button 

REMINDERS:

- Your Automatic Climate Control system may differ from those in the illustrations. See your Owner's Manual for more details
- When in AUTO mode, Air Flow mode and Fan Speed do not display on the Climate Control Display
- Warm air may flow in through vents if Recirculated Air button is not pressed ON (LED lit)

QUICK TIPS

- Defrost mode  activates A/C and opens Fresh Air Vent to help dehumidify the air and improve Defroster performance
- During Auto Operation, the A/C indicator will NOT illuminate. The fan speed, air intake, air flow and air conditioning may automatically be engaged at any time to reach desired temperature and reduce humidity
- Keep inside glass as clean as possible to reduce window fogging

Manual Climate Control*

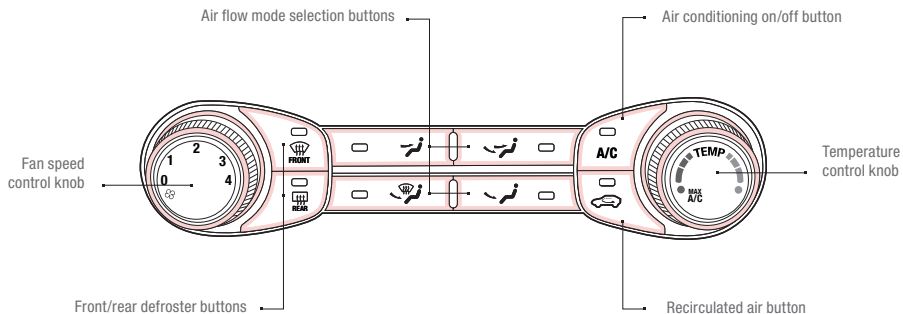

Air Flow Modes

To select Air Flow Modes, press the Mode selection buttons:



Defrost Outside Windshield:

1. Set Fan Speed to the highest position
2. Set desired Temperature
3. Press the Defrost button 

Defog Inside Windshield:

4. Set Fan Speed to desired position
5. Set desired Temperature
6. Press the Defrost button 

REMINDER: Your Manual Climate Control system may differ from those in the illustrations. See your Owner's Manual for more details.

Automatic Gear Shift with Sportmatic® Shifting

P: Park

R: Reverse

N: Neutral

D: Drive

[+]: Sport Mode Upshift

[-]: Sport Mode Downshift

Sport Mode: To enter Sport mode, move shift lever from D to left gate.

To shift while in Sport mode, move shift lever up [+] to upshift or down [-] to downshift.

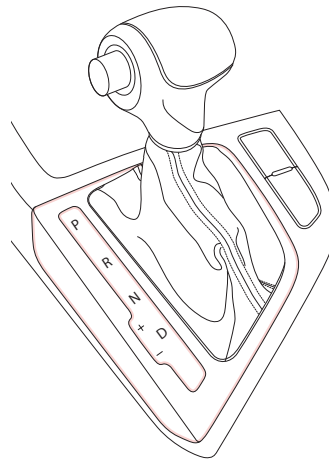

Paddle Shifters*

Paddle Shifters are operable when the shift lever is in the D position or in Sport mode.

Paddle Shifting: Pull the [+] or [-] paddle shifter once to shift up or down one gear.

REMINDERS:

- The Paddle Shifters can be operated when the vehicle speed is more than 6 mph
- When in Sport mode, pulling the left and right paddle shifters at the same time will NOT shift gears

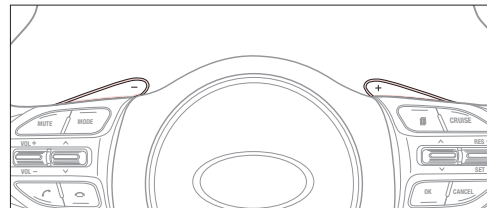

Ⓢ QUICK TIPS

- Press brake pedal and depress release button to move gearshift from N to P, N to R or from P to any gear
- Sport mode downshifts are made automatically when the vehicle slows down. When the vehicle stops, 1st gear is automatically selected

QR CODES

To view a video on your mobile device, snap this QR Code or visit the listed website.

Refer to page 2 for more information.

Sportmatic® Shifting Video



www.KuTechVideos.com/qf13/2015

Paddle Shifters Video



www.KuTechVideos.com/qf13/2015

Driver Position Memory System*

To store a seating position into memory, first place the shifter into P (Park) while the ignition switch is ON. Then:

1. Adjust the driver's seat
2. Press the SET button **A** on the control panel. System will beep once
3. Press one of the memory buttons **B** within 5 seconds. The system will beep twice when memory has been stored
4. "Driver (1 or 2) set is memorized" will appear on the instrument cluster LCD screen

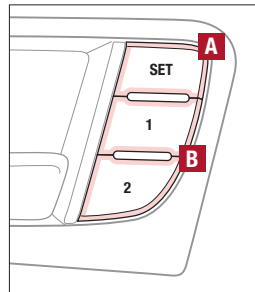

QR CODE

Optima Driver's Seat Memory Video

To view a video on your mobile device, snap this QR Code or visit the listed website.

Refer to page 2 for more information.



www.KuTechVideos.com/qf13/2015

Power Adjustable Driver's Seat*

Move/Press controls to adjust Seat forward/backward, Seat Cushion, Seatback or Lumbar

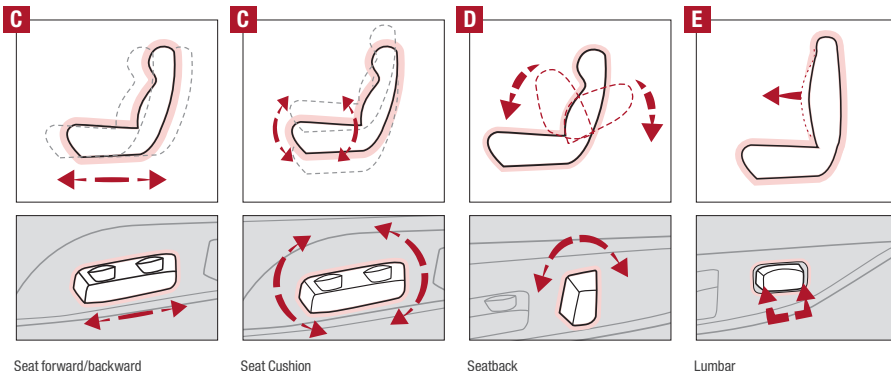

Seat forward/backward

Seat Cushion

Seatback

Lumbar

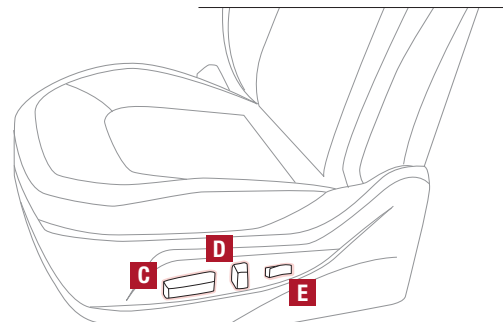

Seat Warmers*

Press button once for high setting (2 LEDs lit), again for low setting (1 LED lit) and again to turn OFF.

Seat Warmers/ Ventilated Seats*

Seat Warmers — Press top of button once for high setting (2 LEDs lit), again for low setting (1 LED lit) and again to turn OFF.

Ventilated Seats — Press bottom of button once for high setting (2 LEDs lit), again for low setting (1 LED lit) and again to turn OFF.

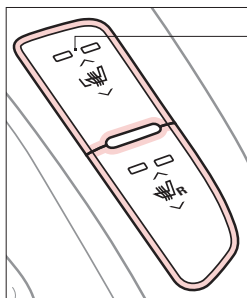

Yellow Color:
Warming

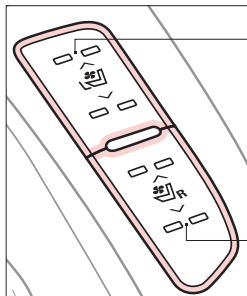

Yellow Color:
Warming

Blue Color:
Ventilating

Ⓢ QUICK TIPS

- With the seat warmer switch in the ON position, the heating system in the seat turns OFF or ON automatically depending on the seat temperature
- System turns OFF when the ignition is cycled

📱 QR CODE

Heated and Ventilated Seats Video

To view a video on your mobile device, snap this QR Code or visit the listed website.

Refer to page 2 for more information.



www.KuTechVideos.com/qf13/2015

6-Way Manual Adjustable Driver's Seat

Pull lever **A** to slide Seat forward/backward.

Pull/press lever **B** to adjust Seat height.

Pull lever **C** to adjust Seatback recline.

Press **D** to adjust Lumbar support

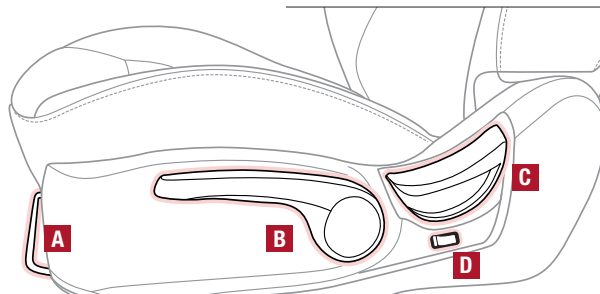

Front Seat Headrest Adjustment

To adjust headrest forward: Pull headrest forward at an upward angle to one of three positions.

To adjust headrest back: Pull headrest completely forward at an upward angle, then release.

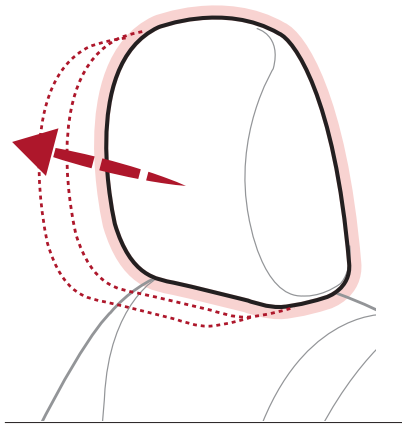

To raise headrest: Pull headrest up.

To lower headrest: Press lock **A**, then press the headrest down.

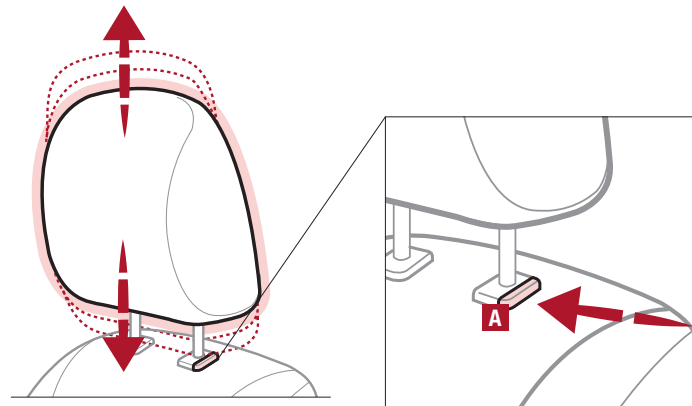

© QUICK TIP

When adjusting the headrest back, you may need to raise headrest to allow space for the headrest to fully adjust backward.

Smart Key*

Smart Key Fob:

- A** Press to lock All Doors
- B** Press to unlock Driver's Door. Press twice in 4 seconds to unlock All Doors
- C** Press and hold to unlock Trunk and manually open

REMINDER: The Trunk unlocks when the Smart Key fob is within close proximity of the vehicle.

- D** Press and hold more than 1 second for Panic Alarm. To turn off Alarm, press any button
- E** Press to release Mechanical Key (on reverse side of fob)

Mechanical Key **F**:

- Use to unlock Driver's Door
- Use to turn Child Safety Locks

Driver's Door Lock/Unlock button **G**:

- Press button once to unlock Driver's Door
- Press again within 4 seconds to unlock All Doors
- Press again to lock All Doors

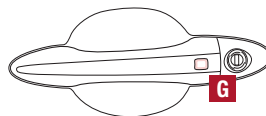
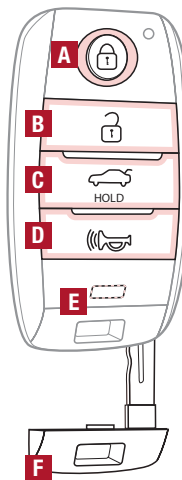

QR CODE

Engine Start/Stop Button & Smart Key Video

To view a video on your mobile device, snap this QR Code or visit the listed website.

Refer to page 2 for more information.



www.KuTechVideos.com/qf13/2015

QUICK TIPS

- If the Smart Key battery is weak or not working properly, hold the Smart Key fob up to the ENGINE START/STOP button (Lock button side closest) and press to start engine
- The Smart Key's signal can be blocked by the normal operation of a cell phone or smartphone. To help prevent this, store each device separately

REMINDER: Remote button configuration may vary depending on vehicle options.

Remote Keyless Entry (Folding Key)*

- A** Press to release Folding Key
- B** Press to lock All Doors
- C** Press to unlock Driver's Door.
Press twice in 4 seconds to unlock All Doors
- D** Press and hold to unlock Trunk and manually open
- E** Press and hold more than 1 second for Panic Alarm. To turn off Alarm, press any button

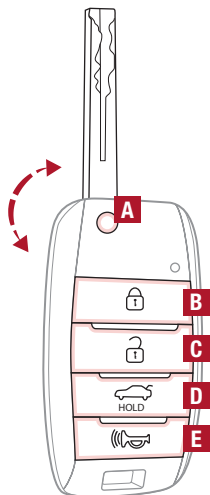

REMINDER: Remote button configuration may vary depending on vehicle options.

Fuel Cap/Malfunction Indicator (Check Engine Light)

Tighten for ONE CLICK to prevent Malfunction Indicator  from illuminating.

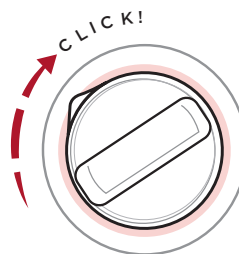

REMINDER: The Fuel Filler Door Release button is located on the lower part of the driver's door panel.

Double-Turn Lock/Unlock All

- Turn clockwise once to unlock Driver's Door
- Turn clockwise again within 4 seconds to unlock All Doors
- Turn counterclockwise once to lock All Doors

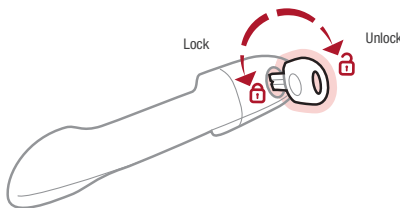

QR CODE

One-Click Fuel Cap Video

To view a video on your mobile device, snap this QR Code or visit the listed website.

Refer to page 2 for more information.



www.KuTechVideos.com/qt13/2015

HomeLink® with Auto-Dimming Rearview Mirror*

- | | |
|---------------------------|-----------------------------------|
| A HomeLink® button | E Glare detection sensor |
| B HomeLink® button | F Automatic dimming ON/OFF |
| C Indicator light | G Compass Control button |
| D HomeLink® button | H Compass display |

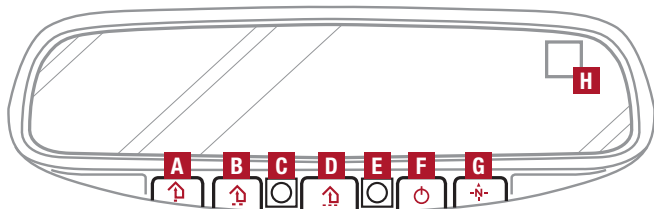

The HomeLink® / Auto-Dimming Rearview Mirror* is designed to reduce glare from a vehicle's headlights located in the rear and also connect up to three electronic transmitters into one location.

REMINDER: Mirror indicator light **C** will illuminate when automatic dimming is ON.

ⓘ QUICK TIPS

- You can reprogram a single HomeLink® button by repeating Step 2
- Erasing programmed buttons will delete all trained transmitters

How to Sync Transmitter with HomeLink®*

If programming for the first time, begin with Step 1 (repeating this step will delete all information).

To program non-rolling and rolling code garage door openers and other devices:

1. Press and hold the left **A** and center **D** buttons simultaneously until the indicator light **C** begins to flash (to reprogram buttons, skip this step)
2. Press and hold the desired button **A B D** and hold the button on the transmitter while it is approximately 1 to 3 inches away from the mirror. The HomeLink® Indicator light **C** will flash rapidly once the frequency signal has been successfully programmed

To finish programming rolling code garage door openers, complete these steps:

3. Locate the “learn” or “smart” button on the garage door’s motor head unit. Press and release the button and complete Step 4 within 30 seconds
4. Firmly press and release the programmed HomeLink® button up to three times

Operating HomeLink®:

Press one of the programmed HomeLink® buttons.

Erasing programmed buttons:

Press and hold the left **A** and center **D** buttons simultaneously for approximately 20 seconds, and then release both buttons within 30 seconds.

If your garage door opener was manufactured in 2011 or later, and you're unable to program your vehicle's HomeLink® system, you may need to purchase a HomeLink® Repeater Kit. For more information, go to www.HomeLink.com or call (800) 355-3515.

Map/Room Lamps

Automatic turn off function*

The interior lights automatically turn off approximately 30 seconds after the ENGINE START/STOP button is OFF.

Map/Personal Lamp

Push the lens **A** to turn the Map Lamp ON/OFF. This light produces a spot beam for convenient use as a Map Lamp or Personal Lamp for the driver or front passenger.

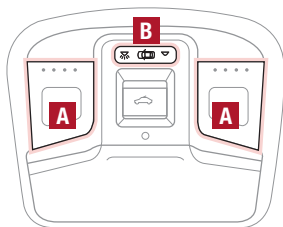

Room Lamp **B**

- ☾ : In the off position, the lamp is OFF even if the door is opened.
- ☾☾ : In the door position, the lamp turns ON when any door is opened.
- ☾☾☾ : In the on position, the lamp stays on continuously.

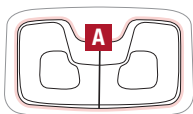

(Type A)

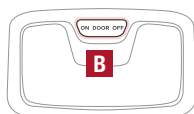

(Type B)

Ⓢ QUICK TIPS

- When doors are unlocked by the Smart Key*, the lamp turns ON for approximately 30 seconds
- If your vehicle is equipped with the theft alarm system, the interior lights automatically turn off approximately 3 seconds after the system is in armed stage
- Using interior lights for an extended period of time may cause battery discharge

Panoramic Sunroof Operation*

The Sunroof and Sunshade operation is controlled through a multidirectional switch/lever, and the ignition needs to be in the ON position to operate the Sunroof/Sunshade.

Slide the Sunshade and Sunroof:

- Auto Open: Slide lever **C** backward to the farthest position and release.
- Auto Close (Sunroof only): Slide the lever **C** forward to the farthest position and release.

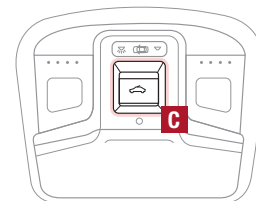

Slide the Sunshade:

- Open: Slide the lever **C** partially backward to the first detent position.
- Auto Close: Slide the lever **C** forward to the farthest position.

Slide the Sunroof (with Sunshade open):

- Open: Slide the lever **C** backward and release.
- Close: Slide the lever **C** partially forward to the first detent position or pull the lever downward.

Tilt the Sunroof:

- Raise: Push lever **C** upward.
- Lower: Pull lever **C** downward.
- Auto Close: Slide the lever **C** forward to the farthest position.

REMINDER: Sunshade needs to remain OPEN while Sunroof is open and vehicle is moving.

Ⓢ QUICK TIP

To stop the Sunroof/Sunshade at any position, push or pull the Sunroof control lever in any direction.

Hood Release Lever and Latch

Opening the Hood:

1. Pull the Hood Release Lever **A** to unlatch the Hood
2. In the front of the vehicle, lift the Hood slightly, pull the secondary Latch **B** inside of the Hood's center and lift the Hood

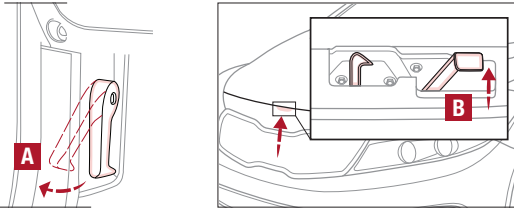

(Located on Driver side kick panel)

Closing the Hood:

Lower the Hood about halfway and then press down to securely lock in place.

Fuel Door and Trunk Release

Press the button **C** to release the fuel door.

Pull the button **D** to open the trunk.

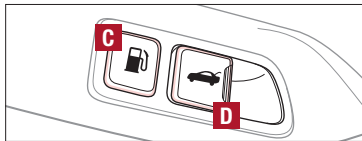

(Buttons located on Driver's Door)

Trunk Release Button (Exterior)

Located underneath the Trunk lid. With Trunk unlocked, press the Trunk Release button **E** and pull the Trunk lid up by the handle to open.

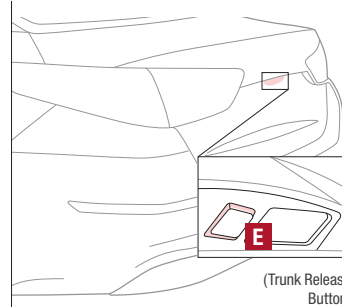

(Trunk Release Button)

Ⓢ QUICK TIPS

- The Trunk must be unlocked before it can be opened by the Trunk Release Button
- Smart Key* - The Trunk unlocks automatically, and can then be opened manually, when the Smart Key fob* is within close proximity to the vehicle

Sunvisor

Use the Sunvisor to shield direct light through the front or side windows. Slide the Sunvisor out and adjust as needed.

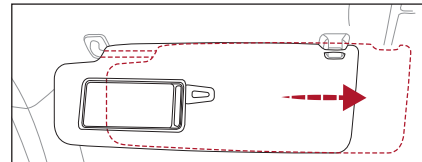

REMINDEES:

- Sunvisor may not shield all direct light
- Do not operate the vehicle if Sunvisor is impairing your visibility

Back-Up Warning System (Rear Parking Assist System)*

The Back-Up Warning System is not a safety device. The Back-Up Warning System is a supplemental system that assists the driver by chiming if any object is detected within the sensing area to the rear and side of the vehicle when backing up. When the ignition is ON, the system is activated.

REMINDERS:

- If the vehicle is moving at speeds over 3 mph, the system may not activate correctly
- When more than two objects are sensed at the same time, the closest one will be recognized first

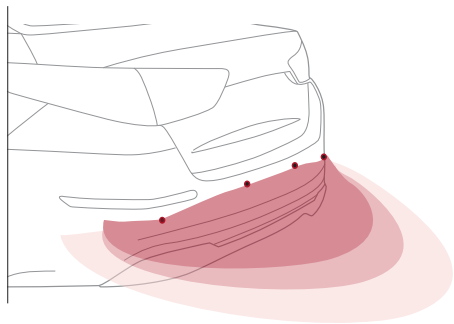

REMINER: The above images are for illustration purposes only and may not reflect actual operation

The Back-Up Warning System is not a substitute for proper and safe backing-up procedures. Always drive safely and use caution when backing up. The Back-Up Warning System may not detect every object behind the vehicle

Rear-Camera Display*

The Rear-Camera Display system is not a safety device. It is a supplemental system that displays the view behind the vehicle through the Navigation System* or UVO eServices System* screen while the vehicle is in Reverse.

The Rear-Camera Display activates when the:

- ENGINE START/STOP button is in the ON position (green light)
- Gear Shift Lever is in the R (Reverse) position

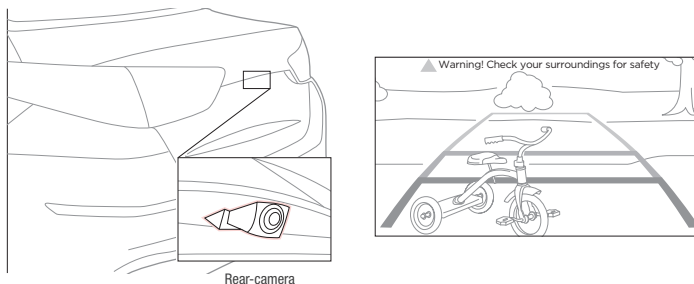

REMINER: The above images are for illustration purposes only and may not reflect actual operation

REMINER: While camera is active, only the volume controls on the Audio System can be operated

The Rear-Camera Display is not a substitute for proper and safe backing-up procedures. The Rear-Camera Display may not display every object behind the vehicle. Always drive safely and use caution when backing up

Child Safety Locks

Locate these locks on the rear edge of the rear passenger doors. Turn the safety lock to the LOCK position to disable the inner door handles from opening the rear doors.

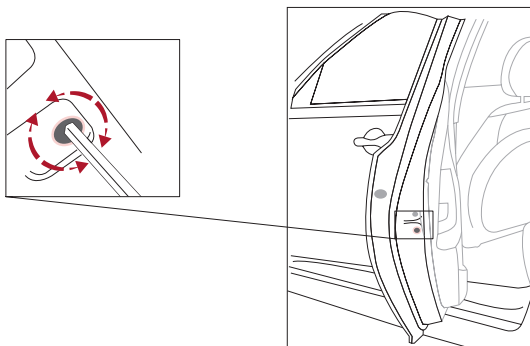

REMINDER: Child Safety Lock is located on rear passenger's door jamb.

Tire Mobility Kit*

The Tire Mobility Kit may temporarily seal certain types of tire damage.

For operational information, please refer to the Owner's Manual.

A Sealant Bottle

B Compressor

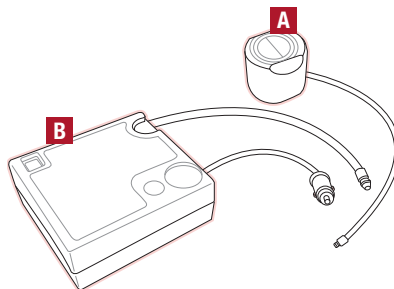

REMINDER: The above images are for illustration purposes only and may not reflect actual operation

REMINDER: After tire is properly sealed, drive cautiously at a maximum speed of 50 mph for a maximum distance of up to 120 miles.

Ⓢ QUICK TIPS

- The Tire Mobility Kit is a temporary fix and is to be used for one tire only; the tire should be inspected as soon as possible
- The kit should only be used for sealing/inflating passenger car tires; do not use for inflating any other type of tires
- Some damaged tires cannot be sealed completely; do not use the kit if it appears a tire is damaged beyond repair

📱 QR CODE

Tire Mobility Kit Video

To view a video on your mobile device, snap this QR Code or visit the listed website.

Refer to page 2 for more information.



www.KuTechVideos.com/qf13/2015

Occupant Detection System (ODS) / Passenger Air Bag Off Indicator

ODS detects the presence and position of the front passenger and adjusts or turns off airbag deployment accordingly.

Depending on the situation and type of accident, the system may:

- Deploy airbag (Adult)
- Not deploy the airbag (Unoccupied)

If the system determines that the airbag should not be deployed, the “PASSENGER AIR BAG OFF” light will illuminate.



Seat Belts

To properly fasten your safety belts:

1. Insert the tongue belt plate **A** into the buckle **B** until it clicks
2. Position the lap portion of the belt across your lap as LOW ON THE HIPS as possible **C**. Adjust the belt to a SNUG FIT by pulling up on the shoulder portion **D**

REMINDER: For maximum protection, always wear your Seat Belt.

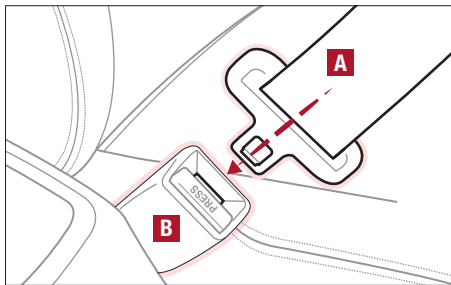

Ⓢ QUICK TIP

The Seat Belt warning chime operates for driver's seat only.

Seat Belt Retractor Inertia Locks

Inertia locks allow lap/shoulder safety belts to remain unlocked during normal vehicle operation for freedom of movement and increased comfort.

During CERTAIN COLLISIONS, STRONG STOPS, OR SUDDEN TURNS, seat belt retractors will automatically lock the belts.

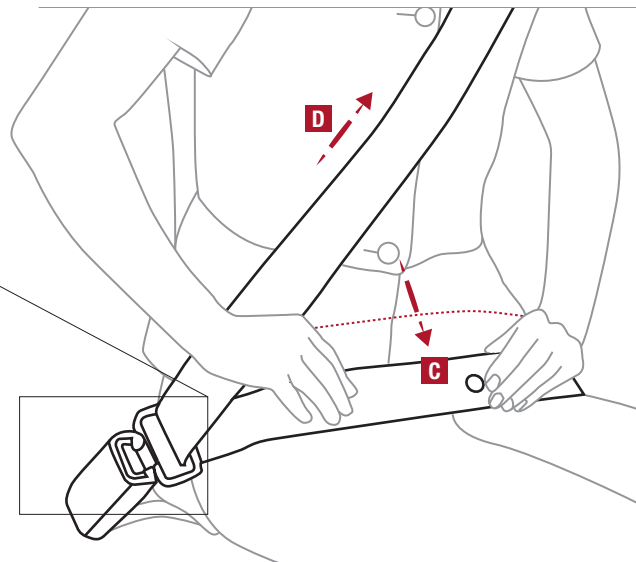

For more detailed information regarding your vehicle's safety belts, please refer to your Owner's Manual and the separate brochure titled "Understanding Your Safety Belt & Supplemental Restraint System."

LEGAL DISCLAIMERS

Driving while distracted is dangerous and should be avoided. Drivers should remain attentive to driving and always exercise caution when using the steering-wheel-mounted controls while driving.

Driving while distracted can result in a loss of vehicle control that may lead to an accident, severe personal injury and death. The driver's primary responsibility is in the safe and legal operation of a vehicle, and use of any handheld devices, other equipment or vehicle systems which take the driver's eyes, attention and focus away from the safe operation of a vehicle or that are not permissible by law should never be used during operation of the vehicle.

Safety Features: No system, no matter how advanced, can compensate for all driver error and/or driving conditions. Always drive responsibly.

Blind Spot Detection: The Blind Spot Detection system is not a substitute for proper and safe lane changing procedures. Always drive safely and use caution when changing lanes. The Blind Spot Detection system may not detect every object alongside the vehicle.

Back-Up Warning System (Rear Parking Assist System) / Rear-Camera Display: The Back-Up Warning System (Rear Parking Assist System) / Rear-Camera Display are not substitutes for proper and safe backing-up procedures. The Back-Up Warning System (Rear Parking Assist System) / Rear-Camera Display may not detect every object alongside or behind the vehicle. Always drive safely and use caution when backing up.

Tilt/Telescoping Steering Wheel: Never attempt to adjust steering wheel position when vehicle is in motion.

Front Seat Headrest Adjustment: Never attempt to adjust headrests when vehicle is in motion.

Seat Belts/Airbags: For maximum protection, always wear your seatbelt.

Navigation: GPS maps and directions are for information purposes only, and Kia does not make any warranties about the accuracy of that information. Kia is not responsible for loss or delay resulting from the use of the navigation system. Caution: Do not enter information into the navigation system while the vehicle is moving. Failure to pay attention to travel conditions and vehicle operation while the vehicle is in motion could result in loss of vehicle control. Operate the system only when it is safe and legal to do so.

TPMS: Even with the Tire-Pressure Monitoring System (TPMS), always check your tire pressure on a regular basis.

Bluetooth® Wireless Technology: A compatible Bluetooth® wireless technology-enabled cell phone is required to use Bluetooth® wireless technology. The Bluetooth® word mark and logos are registered trademarks owned by Bluetooth SIG, Inc. and any use of such marks by Kia is under license. Other trademarks and trade names are those of their respective owners. A Bluetooth® enabled cell phone is required to use Bluetooth® wireless technology.

SiriusXM®: SiriusXM Satellite Radio, SiriusXM Traffic and SiriusXM Travel Link each require a subscription sold separately, or as a package, by SiriusXM Radio Inc. **If you decide to continue your service at the end of your trial subscription, the plan you choose will automatically renew and bill at then-current rates until you call 1-866-635-2349 to cancel. See SiriusXM Customer Agreement for complete terms at www.siriusxm.com.** Other fees and taxes will apply. All fees and programming are subject to change. Not all vehicles or devices are capable of receiving all services offered by SiriusXM. Data displays and individual product availability vary by vehicle hardware. Current information and features may not be available in all locations, or on all receivers. Weather Forecast, Current Conditions may not be available in all locations. Images above are for representative purposes only and are not real products. For actual features and images of real products, consult the vehicle manufacturer. SiriusXM is not responsible for any errors or inaccuracies in the data services or their use in the vehicle. Travel Link Stocks displays current price and daily delta of around 7,000 actively reported securities traded on the NYSE®, NASDAQ® and AMEX®. The service is delayed approximately 20 minutes. SiriusXM satellite service is available only to those at least 18 years of age in the 48 contiguous USA, DC, and Puerto Rico (with coverage limitations). SiriusXM Internet Radio service is available throughout our satellite service area and in AK and HI. © 2014 SiriusXM Radio Inc. Sirius, XM and all related marks and logos are trademarks of SiriusXM Radio Inc.

UVO eServices app: Apple iPhone® and select Android™ devices only are UVO eServices compatible. iPhone® is a registered trademark of Apple Inc. Android™ is a registered trademark of Google Inc. No subscription fee for UVO eServices. No charge for the UVO eServices app. App uses your smartphone cellular data service. Normal data rates will apply.

Sportmatic® is a registered trademark of Kia Motors America.

iPod® is a registered trademark of Apple Inc. iPod® mobile digital device sold separately.

HomeLink® is a registered trademark of Gentex Corporation.

Pandora is a registered trademark of Pandora Media, Inc.



NORMAL MAINTENANCE SCHEDULE

When your vehicle requires service, remember that your dealer knows your vehicle best. Your dealer has factory-trained technicians, recommended special tools, genuine Kia replacement parts, and is dedicated to your complete satisfaction. For expert advice and quality service, see your authorized Kia dealer.

INTERVAL MAINTENANCE CHART							
7,500 miles	A						
15,000 miles	A	B					
22,500 miles	A						
30,000 miles	A	B	C				
37,500 miles	A						
45,000 miles	A	B				F	
52,500 miles	A						
60,000 miles	A	B	C	D	E		
67,500 miles	A						
75,000 miles	A	B		D			
82,500 miles	A						
90,000 miles	A	B	C			F	
97,500 miles	A						
105,000 miles	A	B		D			G
112,500 miles	A						
120,000 miles	A	B	C	D	E		H

A Inspect* — Air cleaner filter* and vacuum hose

Replace — Engine oil and oil filter (2.0 T-GDI - At first, replace at 3,000 miles or 6 months. After that, every 5,000 miles or 6 months)

Perform — Rotate tires; add fuel additive¹

B Inspect* — Brake hoses and lines, drive shafts and boots, exhaust pipe and muffler, front disc brake/pads, calipers and rotors, steering gear box, linkage & boots/lower arm ball joint, upper arm ball joint, suspension mounting bolts, air conditioning refrigerant, rear disc brake/pads, parking brake

Replace — Climate control air filter (for evaporator and blower unit)

C Inspect* — Brake fluid, fuel filter², fuel lines, fuel hoses and connections, fuel tank air filter^{**2}, vapor hose, fuel filler cap, fuel tank

Replace — Air cleaner filter

D Inspect* — Drive belt³ (auto-tensioner, generator, power steering, air conditioning, water pump)

E Inspect* — Valve clearance⁴

F Replace — Spark plugs (iridium coated), 2.0 T-GDI

G Replace — Spark Plugs (iridium coated), 2.4 GDI

H Replace — Engine coolant⁵, inverter coolant

* and, if necessary, adjust, clean, replace or correct

** If equipped

*** Check and adjust level and check for leaks. Inspect regularly

Check tire pressure frequently, at least once per month or more.

Transfer case oil and rear differential oil should be changed anytime they have been submerged in water.

¹ If TOP TIER Detergent Gasoline is not available, one bottle of additive is recommended. Additives are available from your authorized Kia dealer along with information on how to use them. Do not mix other additives.

² Fuel filter & Fuel tank air filter are considered to be maintenance free but periodic inspection is recommended for this maintenance schedule depends on fuel quality. If there are some important safety matters like fuel flow restriction, surging, loss of power, hard starting problem etc., replace the fuel filter immediately regardless of maintenance schedule and consult an authorized Kia dealer for details.

³ The drive belt should be replaced when cracks occur or tension is reduced excessively.

⁴ Inspect for excessive tappet noise and/or engine vibration and adjust if necessary.

⁵ When replacing coolant, use only deionized water or soft water for your vehicle and never mix hard water in the coolant filled at the factory. An improper coolant mixture can result in serious malfunction or engine damage.

See your owner's manual for more details and complete maintenance information, including severe maintenance schedule. Warranty may be voided if maintenance schedule is not followed.

Call 1-800-333-4Kia (4542) for roadside assistance.

© 2014 Kia Motors America, Inc. All rights reserved.

Part Number: UT150-PS-004



OPTIMA CUSTOMER DELIVERY CHECKLIST

Owner's Name: _____ VIN: _____ Mileage: _____

Dealership Name: _____ Sales Consultant: _____ Date: _____

BEFORE DELIVERY

- Confirm "Good Battery" with Kia GR8-1299 battery tester
- Verify all tire pressures are to spec (see driver's door label) LF _____ LR _____ RF _____ RR _____
- Verify proper operation of Remote Keyless Entry and Smart Key lock/unlock
- Ensure floor mats are snapped into place (if applicable)
- Verify vehicle is clean (interior and exterior), in good condition and free of chips and scratches
- Ensure all key documents are in the vehicle (Owner's Manual, Warranty and Consumer Information booklet, Tire Warranty booklet and Features & Functions Guide and any supplemental audio user's guides)

KEY FEATURE WALKTHROUGH

- Air Conditioning / Climate Control – pages 25 - 26
Demonstrate Air Flow modes, Defog and Defrosting Windshield.

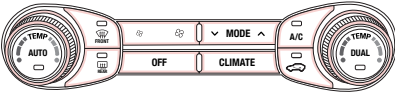

Automatic Climate Control

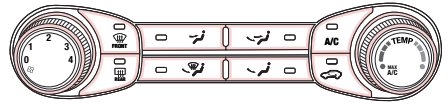

Manual Climate Control

- Electric Parking Brake (EPB)* and AUTO HOLD* – page 11
Demonstrate operation.

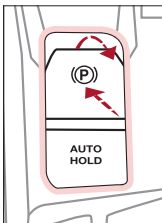

- Windshield Wipers & Washers* – page 16

Move lever Up/Down to change Wiper modes.
Rotate level to adjust Intermittent Wipe Speed.

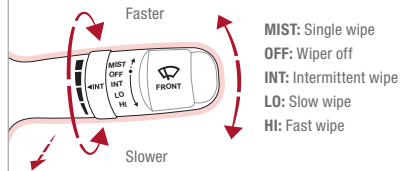

Pull to spray and wipe.



KEY FEATURE WALKTHROUGH

Demonstrate the following with the customer

- Standard Audio System* – page 21
For more information, refer to the Owner's Manual.

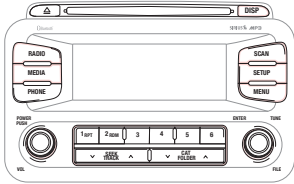

- UVO eServices System* – page 23
For more information, refer to the UVO System User's Manual.

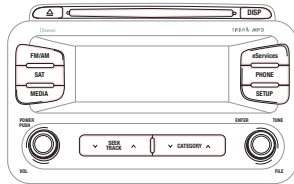

- Navigation System* – page 22
For more information, refer to the Car Multimedia System User's Manual.



- Aux/USB/iPod® Port – page 24

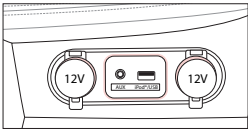

- Cruise Control* – page 20
Demonstrate operation.

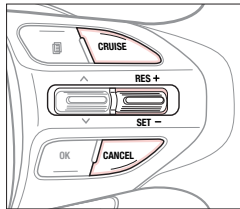

- Bluetooth® Wireless Technology* – page 18
Demonstrate operation.

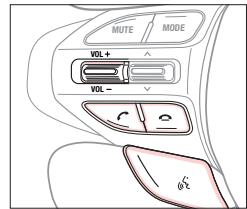

- Active ECO System* – page 9
- Tire Pressure Monitoring System (TPMS) – page 5
- Engine Start/Stop Button* – page 13
- Digital Clock – page 24
- Seat Warmers/Ventilated Seats* – page 29
- Sunvisor – page 35
- Panoramic Sunroof Operation* – page 34

- Rear-Camera Display* – page 36 *IF EQUIPPED
- Smart Key* – page 31
- HomeLink® with Auto-Dimming Rearview Mirror* – page 33
- Back-Up Warning System* – page 36
- Passenger Airbag Off Indicator – page 38
- Tire Mobility Kit* – page 37

DURING DELIVERY

- Explain first service process and schedule first service appointment
- Tour Parts & Service departments, introduce staff & explain value of Kia Parts and Service
- Review recommended maintenance schedule and maintenance requirements to validate warranty
- Review business hours & Customer 360° Care
- Review the Kia 10-year/100,000-mile warranty program
- Ensure 100% satisfaction with sales and delivery process and no problems with the vehicle
- Confirm time and best contact number for initial dealer follow-up

Sales Consultant: _____ Date: _____

Sales Manager: _____ Date: _____

Customer: _____ Date: _____