

2015

OWNER'S MANUAL

Durango

## **VEHICLES SOLD IN CANADA**

With respect to any Vehicles Sold in Canada, the name FCA US LLC shall be deemed to be deleted and the name FCA Canada Inc. used in substitution therefore.

## **DRIVING AND ALCOHOL**

Drunken driving is one of the most frequent causes of accidents.

Your driving ability can be seriously impaired with blood alcohol levels far below the legal minimum. If you are drinking, don't drive. Ride with a designated non-drinking driver, call a cab, a friend, or use public transportation.

### **WARNING!**

**Driving after drinking can lead to an accident. Your perceptions are less sharp, your reflexes are slower, and your judgment is impaired when you have been drinking. Never drink and then drive.**

This manual illustrates and describes the operation of features and equipment that are either standard or optional on this vehicle. This manual may also include a description of features and equipment that are no longer available or were not ordered on this vehicle. Please disregard any features and equipment described in this manual that are not on this vehicle.

FCA US LLC reserves the right to make changes in design and specifications, and/or make additions to or improvements to its products without imposing any obligation upon itself to install them on products previously manufactured.



# TABLE OF CONTENTS

SECTION		PAGE
1	INTRODUCTION .....	3
2	THINGS TO KNOW BEFORE STARTING YOUR VEHICLE .....	11
3	UNDERSTANDING THE FEATURES OF YOUR VEHICLE .....	115
4	UNDERSTANDING YOUR INSTRUMENT PANEL .....	285
5	STARTING AND OPERATING .....	417
6	WHAT TO DO IN EMERGENCIES .....	543
7	MAINTAINING YOUR VEHICLE .....	579
8	MAINTENANCE SCHEDULES .....	643
9	IF YOU NEED CONSUMER ASSISTANCE .....	649
10	INDEX .....	659

1

2

3

4

5

6

7

8

9

10



# INTRODUCTION

## CONTENTS

---

■ INTRODUCTION . . . . .	4	■ WARNINGS AND CAUTIONS . . . . .	8
■ ROLLOVER WARNING . . . . .	5	■ VEHICLE IDENTIFICATION NUMBER . . . . .	8
■ HOW TO USE THIS MANUAL . . . . .	6	■ VEHICLE MODIFICATIONS/ALTERATIONS . . . . .	9

### INTRODUCTION

Congratulations on selecting your new FCA US LLC vehicle. Be assured that it represents precision workmanship, distinctive styling, and high quality - all essentials that are traditional to our vehicles.

This is a specialized utility vehicle. It can go places and perform tasks that conventional passenger cars are not intended. It handles and maneuvers differently from many passenger cars both on-road and off-road, so take time to become familiar with your vehicle.

The two-wheel drive version of this vehicle was designed for on-road use only. It is not intended for off-road driving or use in other severe conditions suited for a four-wheel drive vehicle.

Before you start to drive this vehicle, read the Owner's Manual. Be sure you are familiar with all vehicle controls, particularly those used for braking, steering, transmission, and transfer case shifting. Learn how your vehicle handles on different road surfaces. Your driving skills will improve with experience. When driving off-road or working the vehicle, don't overload the vehicle or expect the vehicle to overcome the natural laws of physics. Always observe federal, state, provincial and local laws wherever you drive.

As with other vehicles of this type, failure to operate this vehicle correctly may result in loss of control or a collision. Refer to "On-Road/Off-Road Driving Tips" in "Starting And Operating" for further information.

This Owner's Manual has been prepared with the assistance of service and engineering specialists to acquaint you with the operation and maintenance of your vehicle. It is supplemented by Warranty Information, and various customer-oriented documents. Please take the time to read these publications carefully. Following the instructions and recommendations in this manual will help assure safe and enjoyable operation of your vehicle.

**NOTE: After reviewing the owner information, it should be stored in the vehicle for convenient referencing and remain with the vehicle when sold.**

When it comes to service, remember that your authorized dealer knows your vehicle best, has factory-trained technicians and genuine MOPAR® parts, and cares about your satisfaction.

## ROLLOVER WARNING

Utility vehicles have a significantly higher rollover rate than other types of vehicles. This vehicle has a higher ground clearance and a higher center of gravity than many passenger vehicles. It is capable of performing better in a wide variety of off-road applications. Driven in an unsafe manner, all vehicles can go out of control. Because of the higher center of gravity, if this vehicle is out of control it may roll over while some other vehicles may not.

Do not attempt sharp turns, abrupt maneuvers, or other unsafe driving actions that can cause loss of vehicle control. Failure to operate this vehicle safely may result in a collision, rollover of the vehicle, and severe or fatal injury. Drive carefully.



80bfe0f0

### Rollover Warning Label

Failure to use the driver and passenger seat belts provided is a major cause of severe or fatal injury. In fact, the U.S. government notes that the universal use of existing seat belts could cut the highway death toll by 10,000 or more each year and could reduce disabling injuries by

two million annually. In a rollover crash, an unbelted person is significantly more likely to die than a person wearing a seat belt. Always buckle up.

### HOW TO USE THIS MANUAL















Consult the Table of Contents to determine which section contains the information you desire.

Since the specification of your vehicle depends on the items of equipment ordered, certain descriptions and illustrations may differ from your vehicle's equipment.

The detailed index at the back of this Owner's Manual contains a complete listing of all subjects.

Consult the following table for a description of the symbols that may be used on your vehicle or throughout this Owner's Manual:



											<b>ESP BAS</b> ELECTRONIC STABILITY PROGRAM / BRAKE ASSIST SYSTEM
											 <b>BRAKE ASSIST SYSTEM</b>
											 <b>FAILURE OF ANTI-LOCK BRAKING SYSTEM</b>
											 <b>BRAKE SYSTEM WARNING PARKING BRAKE</b>
											 <b>TOW / HAUL</b>
											 <b>4 LOW</b>
										 <b>A/C PUSH</b>	 <b>ELECTRONIC STABILITY CONTROL OFF</b>

## WARNINGS AND CAUTIONS

This Owner's Manual contains **WARNINGS** against operating procedures that could result in a collision or bodily injury. It also contains **CAUTIONS** against procedures that could result in damage to your vehicle. If you do not read this entire Owner's Manual, you may miss important information. Observe all Warnings and Cautions.

## VEHICLE IDENTIFICATION NUMBER

The Vehicle Identification Number (VIN) is found on a plate located on the left front corner of the instrument panel pad, visible from outside of the vehicle through the windshield. This number also is stamped into the right front body, behind the right front seat. Move the right front seat forward to allow better viewing of the stamped VIN. This number also appears on the Automobile Information Disclosure Label affixed to a window on your

vehicle. Save this label for a convenient record of your vehicle identification number and optional equipment.

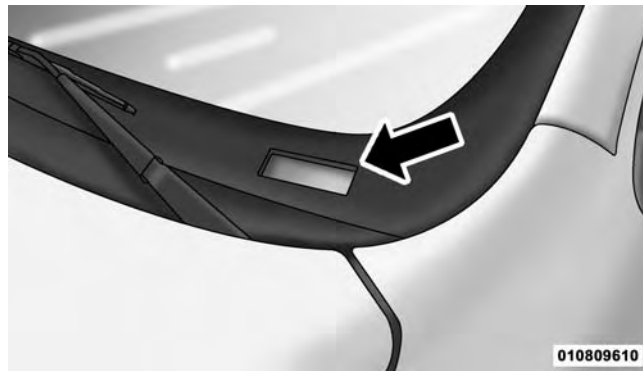

VIN Location

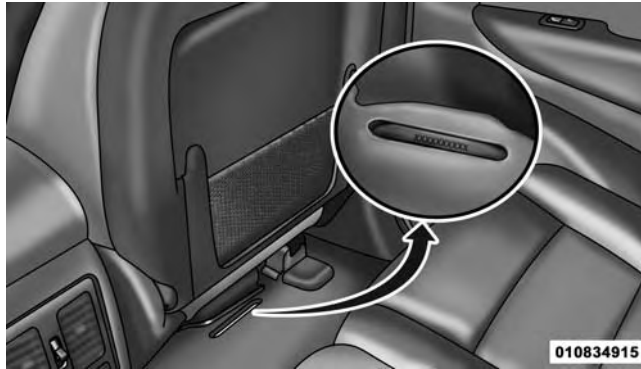

**Right Front Body VIN Location**

**NOTE:** It is illegal to remove or alter the VIN.

## VEHICLE MODIFICATIONS/ALTERATIONS

### WARNING!

Any modifications or alterations to this vehicle could seriously affect its roadworthiness and safety and may lead to a collision resulting in serious injury or death.



# THINGS TO KNOW BEFORE STARTING YOUR VEHICLE

## CONTENTS

---

■ A WORD ABOUT YOUR KEYS . . . . .	.13	□ To Disarm The System . . . . .	.21
□ Keyless Push Button Ignition . . . . .	.13	□ Tamper Alert . . . . .	.22
□ Key Fob . . . . .	.14	■ ILLUMINATED ENTRY . . . . .	.22
□ Ignition Or Accessory On Message . . . . .	.16	■ REMOTE KEYLESS ENTRY (RKE) . . . . .	.23
■ SENTRY KEY® . . . . .	.17	□ To Unlock The Doors And Liftgate . . . . .	.24
□ Replacement Keys . . . . .	.18	□ To Lock The Doors And Liftgate . . . . .	.25
□ Customer Key Programming . . . . .	.19	□ Using The Panic Alarm . . . . .	.25
□ General Information . . . . .	.19	□ Programming Additional Transmitters . . . . .	.26
■ VEHICLE SECURITY ALARM — IF EQUIPPED .19		□ Transmitter Battery Replacement . . . . .	.26
□ To Arm The System . . . . .	.20	□ General Information . . . . .	.27
□ Rearming The System . . . . .	.20		

## 12 THINGS TO KNOW BEFORE STARTING YOUR VEHICLE

- REMOTE STARTING SYSTEM — IF EQUIPPED .28
  - How To Use Remote Start . . . . . .28
- DOOR LOCKS . . . . . .31
  - Manual Door Locks . . . . . .31
  - Power Door Locks . . . . . .33
  - Child-Protection Door Lock System — Rear Doors . . . . . .34
- KEYLESS ENTER-N-GO™ . . . . . .35
- WINDOWS . . . . . .41
  - Power Windows . . . . . .41
  - Wind Buffeting . . . . . .45
- LIFTGATE . . . . . .45
  - Power Liftgate — If Equipped . . . . . .46
- OCCUPANT RESTRAINT SYSTEMS . . . . . .49
  - Important Safety Precautions . . . . . .49
  - Seat Belt Systems . . . . . .51
  - Supplemental Restraint System (SRS) . . . . . .67
  - Child Restraints . . . . . .82
  - Transporting Pets . . . . . .109
- ENGINE BREAK-IN RECOMMENDATIONS . . .109
- SAFETY TIPS . . . . . .110
  - Transporting Passengers . . . . . .110
  - Exhaust Gas . . . . . .111
  - Safety Checks You Should Make Inside The Vehicle . . . . . .112
  - Periodic Safety Checks You Should Make Outside The Vehicle . . . . . .114

## A WORD ABOUT YOUR KEYS

Your vehicle uses a keyless ignition system. This system consists of a Key Fob with Remote Keyless Entry (RKE) transmitter and a Keyless Push Button Ignition.

### Keyless Enter-N-Go™ Feature

This vehicle is equipped with the Keyless Enter-N-Go™ feature (refer to "Keyless Enter-N-Go™" in "Things To Know Before Starting Your Vehicle" for further information).

## Keyless Push Button Ignition

This feature allows the driver to operate the ignition switch with the push of a button, as long as the Remote Keyless Entry (RKE) transmitter is in the passenger compartment.

The Keyless Push Button Ignition has four operating positions; three of which are labeled and will illuminate when in position. The three positions are OFF, ACC, and ON/RUN. The fourth position is START, during start RUN will illuminate.

## 14 THINGS TO KNOW BEFORE STARTING YOUR VEHICLE

**NOTE:** In case the ignition switch does not change with the push of a button, the RKE transmitter (Key Fob) may have a low or dead battery. In this situation, a back up method can be used to operate the ignition switch. Put the nose side (side opposite of the emergency key) of the Key Fob against the ENGINE START/STOP button and push to operate the ignition switch.

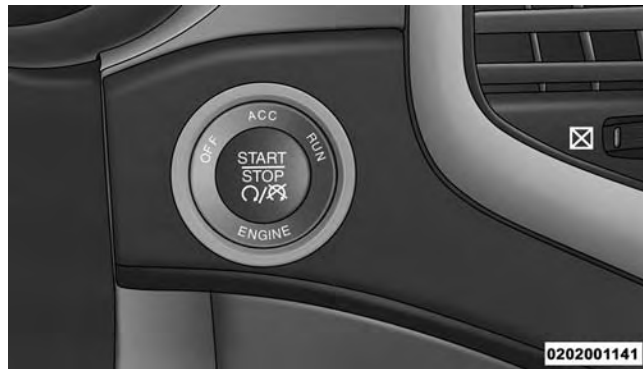

**Keyless Push Button Ignition**

### **Key Fob**

The Key Fob also contains the Remote Keyless Entry (RKE) transmitter and an emergency key, which stores in the rear of the Key Fob.

The emergency key allows for entry into the vehicle should the battery in the vehicle or the Key Fob go dead.



The emergency key is also for locking the glove box. You can keep the emergency key with you when valet parking.

To remove the emergency key, slide the mechanical latch at the top of the Key Fob sideways with your thumb and then pull the key out with your other hand.



0202008731

Keyless Enter-N-Go™ Key Fob



2

0202008739

### Emergency Key Removal

**NOTE:** You can insert the double-sided emergency key into the lock cylinders with either side up.

## Ignition Or Accessory On Message

Upon opening the driver's door when the ignition is in ACC or ON (engine not running), a chime will sound to remind you to cycle the ignition to OFF. In addition to the chime, the ignition or accessory on message will display in the cluster.

**NOTE:** With the Uconnect® system, the power window switches, radio, power sunroof (if equipped), and power outlets will remain active for up to 10 minutes after the ignition is cycled to the OFF position. Opening either front door will cancel this feature. The time for this feature is programmable. Refer to "Uconnect® Settings" in "Understanding Your Instrument Panel" for further information.

### WARNING!

- When leaving the vehicle, always remove the Key Fob from the vehicle and lock your vehicle.
- Never leave children alone in a vehicle, or with access to an unlocked vehicle.
- Allowing children to be in a vehicle unattended is dangerous for a number of reasons. A child or others could be seriously or fatally injured. Children should be warned not to touch the parking brake, brake pedal or the gear selector.
- Do not leave the Key Fob in or near the vehicle, or in a location accessible to children, and do not leave the ignition of a vehicle equipped with Keyless Enter-N-Go™ in the ACC or ON/RUN mode. A child could operate power windows, other controls, or move the vehicle.

*(Continued)*

**WARNING!** *(Continued)*

- **Do not leave children or animals inside parked vehicles in hot weather. Interior heat build-up may cause serious injury or death.**

**CAUTION!**

**An unlocked car is an invitation to thieves. Always remove the Key Fob from vehicle, place the ignition in the OFF position and lock all doors when leaving the vehicle unattended.**

**SENTRY KEY®**

The Sentry Key® Immobilizer system prevents unauthorized vehicle operation by disabling the engine. The system does not need to be armed or activated. Operation is automatic, regardless of whether the vehicle is locked or unlocked.

The system uses a Key Fob with a factory-mated Remote Keyless Entry (RKE) transmitter, a Keyless Push Button Ignition, and a RF receiver to prevent unauthorized vehicle operation. Therefore, only Key Fobs that are programmed to the vehicle can be used to start and operate the vehicle. The system will not allow the engine to crank if an invalid Key Fob is used to start and operate the vehicle. The system will shut the engine off in two seconds if an invalid Key Fob is used to start the engine.

After placing the ignition to the ON/RUN position, the Vehicle Security Light will turn on for three seconds for a bulb check. If the light remains on after the bulb check, it indicates that there is a problem with the electronics. In addition, if the light begins to flash after the bulb check, it indicates that someone used an invalid Key Fob to start the engine. Either of these conditions will result in the engine being shut off after two seconds.

If the Vehicle Security Light turns on during normal vehicle operation (vehicle running for longer than 10 seconds), it indicates that there is a fault in the electronics. Should this occur, have the vehicle serviced as soon as possible by an authorized dealer.

**CAUTION!**

- Do not make modifications or alterations to the immobilizer system. Modifications or alterations to the immobilization system may result in a loss of security protection.
- The Sentry Key® Immobilizer system is not compatible with some aftermarket remote starting systems. Use of these systems may result in vehicle starting problems and loss of security protection.

All of the Key Fobs provided with your new vehicle have been programmed to the vehicle electronics.

**Replacement Keys**

**NOTE:** Only Key Fobs that are programmed to the vehicle electronics can be used to start and operate the vehicle. Once a Key Fob is programmed to a vehicle, it cannot be programmed to any other vehicle.

**CAUTION!**

- Always remove the Key Fobs from the vehicle and lock all doors when leaving the vehicle unattended.
- For vehicles equipped with Keyless Enter-N-Go™, always remember to place the ignition in the OFF position.

Duplication of Key Fobs may be performed at an authorized dealer. This procedure consists of programming a blank Key Fob to the vehicle electronics. A blank Key Fob is one that has never been programmed.

**NOTE:** When having the Sentry Key® Immobilizer System serviced, bring all vehicle keys with you to an authorized dealer.

### **Customer Key Programming**

Programming Key Fobs or RKE transmitters may be performed at an authorized dealer.

### **General Information**

The Sentry Key® system complies with FCC rules part 15 and with RSS-210 of Industry Canada. Operation is subject to the following conditions:

- This device may not cause harmful interference.
- This device must accept any interference that may be received, including interference that may cause undesired operation.

**NOTE:** Changes or modifications not expressly approved by the party responsible for compliance could void the user's authority to operate the equipment.

### **VEHICLE SECURITY ALARM — IF EQUIPPED**

This Vehicle Security Alarm monitors the vehicle doors, liftgate, and ignition for unauthorized operation. When the alarm is activated, the interior switches for door locks and power liftgate are disabled. The Vehicle Security Alarm provides both audio and visual signals, the horn will sound, the headlights will turn on, park lamps, and/or turn signals will flash repeatedly for three minutes. If the disturbance is still present (driver's door, passenger door, other doors, ignition) after three minutes, the headlights, park lamps, and/or turn signals will flash for an additional 15 minutes.

**NOTE:** The Panic and Security alarms are quite different. Please take a moment to activate the Panic and the Security modes to hear the differences in the horn. In case one should go off in the future, you will need to know which mode has been activated in order to deactivate it.

### To Arm The System

Follow these steps to arm the Vehicle Security Alarm:

1. Make sure the vehicles ignition is cycled to the "OFF" position (refer to "Starting Procedures" in "Starting And Operating" for further information).
  - For vehicles equipped with Keyless Enter-N-Go™, make sure the vehicle ignition system is OFF.
  - For vehicles not equipped with Keyless Enter-N-Go™, make sure the vehicle ignition system is OFF, and the key is physically removed from the ignition.
2. Perform one of the following methods to lock the vehicle:

- Push LOCK on the interior power door lock switch with the driver and/or passenger door open.
  - Push the LOCK button on the exterior Passive Entry Door Handle with a valid Key Fob available in the same exterior zone (refer to "Keyless Enter-N-Go™" in "Things To Know Before Starting Your Vehicle" for further information).
  - Push the LOCK button on the Remote Keyless Entry (RKE) transmitter.
3. If any doors are open, close them.

### Rearming The System

If something triggers the alarm, and no action is taken to disarm it, the Vehicle Security Alarm will turn off the horn after three minutes, turn off all of the visual signals after 15 minutes, and then the Vehicle Security Alarm will rearm itself.

## To Disarm The System

The Vehicle Security Alarm can be disarmed using any of the following methods:

- Push the UNLOCK button on the Remote Keyless Entry (RKE) transmitter.
- Grasp the Passive Entry Unlock Door Handle (if equipped, refer to "Keyless Enter-N-Go™" in "Things To Know Before Starting Your Vehicle" for further information).
- Cycle the vehicle ignition system out of the OFF position.
  - For vehicles equipped with Keyless Enter-N-Go™, push the Keyless Enter-N-Go™ START/STOP button (requires at least one valid Key Fob in the vehicle).

- For vehicles not equipped with Keyless Enter-N-Go™, insert a valid key into the ignition switch and turn the key to the ON position.

### NOTE:

- The driver's door key cylinder and the liftgate button on the RKE transmitter cannot arm or disarm the Vehicle Security Alarm.
- The Vehicle Security Alarm remains armed during power liftgate entry. Pushing the liftgate button will not disarm the Vehicle Security Alarm. If someone enters the vehicle through the liftgate and opens any door, the alarm will sound.
- When the Vehicle Security Alarm is armed, the interior power door lock switches will not unlock the doors.

The Vehicle Security Alarm is designed to protect your vehicle. However, you can create conditions where the system will give you a false alarm. If one of the previously described arming sequences has occurred, the Vehicle Security Alarm will arm regardless of whether you are in the vehicle or not. If you remain in the vehicle and open a door, the alarm will sound. If this occurs, disarm the Vehicle Security Alarm.

If the Vehicle Security Alarm is armed and the battery becomes disconnected, the Vehicle Security Alarm will remain armed when the battery is reconnected; the exterior lights will flash, and the horn will sound. If this occurs, disarm the Vehicle Security Alarm.

### **Tamper Alert**

If something has triggered the Vehicle Security Alarm in your absence, the horn will sound three times, and the exterior lights blink three times when you unlock the doors. Check the vehicle for tampering.

### **ILLUMINATED ENTRY**

The courtesy lights will turn on when you use the Remote Keyless Entry (RKE) transmitter to unlock the doors or open any door.

This feature also turns on the approach lighting in the outside mirrors — if equipped. Refer to “Mirrors” in “Understanding The Features Of Your Vehicle” for further information.

The lights will fade to off after approximately 30 seconds, or they will immediately fade to off once the ignition switch is turned to ON/RUN from the OFF position.



**NOTE:**

- The front courtesy overhead console and door courtesy lights do not turn on if the dimmer control is in the “Dome defeat” position (extreme bottom position).
- The Illuminated Entry system will not operate if the dimmer control is in the “Dome defeat” position (extreme bottom position).

**REMOTE KEYLESS ENTRY (RKE)**

The RKE system allows you to lock or unlock the doors, open the power liftgate, or activate the Panic Alarm from distances up to approximately 66 ft (20 m) using a hand-held Key Fob with RKE transmitter. The RKE transmitter does not need to be pointed at the vehicle to activate the system.

**NOTE:** Driving at speeds 5 MPH (8 km/h) and above disables the system from responding to all RKE transmitter buttons for all RKE transmitters.

2



0202008731

**Keyless Enter-N-Go™ Fob**

## To Unlock The Doors And Liftgate

Push and release the UNLOCK button on the RKE transmitter once to unlock the driver's door or twice within five seconds to unlock all doors and liftgate. The turn signal lights will flash to acknowledge the unlock signal. The illuminated entry system will also turn on.

If the vehicle is equipped with Passive Entry, refer to "Keyless Enter-N-Go™" in "Things To Know Before Starting Your Vehicle" for further information.

### 1st Press Of Key Fob Unlocks

This feature lets you program the system to unlock either the driver's door or all doors on the first push of the UNLOCK button on the RKE transmitter. To change the current setting, refer to "Uconnect® Settings" in "Understanding Your Instrument Panel" for further information.

## Flash Lamps With Lock

This feature will cause the turn signal lights to flash when the doors are locked or unlocked with the RKE transmitter. This feature can be turned on or turned off. To change the current setting, refer to "Uconnect® Settings" in "Understanding Your Instrument Panel" for further information.

## Headlight Illumination On Approach

This feature activates the headlights for up to 90 seconds when the doors are unlocked with the RKE transmitter. The time for this feature is programmable on vehicles equipped through Uconnect®. To change the current setting, refer to "Uconnect® Settings" in "Understanding Your Instrument Panel" for further information.

## To Lock The Doors And Liftgate

Push and release the LOCK button on the RKE transmitter to lock all doors and liftgate. The turn signal lights will flash, and the horn will chirp to acknowledge the signal.

If the vehicle is equipped with Passive Entry, refer to “Keyless Enter-N-Go™” in “Things To Know Before Starting Your Vehicle” for further information.

## Sound Horn With Lock

This feature will cause the horn to chirp when the doors are locked with the RKE transmitter. This feature can be turned on or turned off. To change the current setting, refer to “Uconnect® Settings” in “Understanding Your Instrument Panel” for further information.

## Using The Panic Alarm

To turn the Panic Alarm feature on or off, push and hold the PANIC button on the RKE transmitter for at least one

second and release. When the Panic Alarm is activated, the turn signals will flash, the horn will pulse on and off, and the interior lights will turn on.

The Panic Alarm will stay on for three minutes unless you turn it off by either pushing the PANIC button a second time or drive the vehicle at a speed of 15 MPH (24 km/h) or greater.

### NOTE:

- The interior lights will turn off if you place the ignition in the ACC or ON/RUN position while the Panic Alarm is activated. However, the exterior lights and horn will remain on.
- You may need to be less than 35 ft (11 m) from the vehicle when using the RKE transmitter to turn off the Panic Alarm due to the radio frequency noises emitted by the system.

## Programming Additional Transmitters

Programming Key Fobs or RKE transmitters may be performed at an authorized dealer.

## Transmitter Battery Replacement

The recommended replacement battery is one CR2032 battery.

### NOTE:

- Perchlorate Material — special handling may apply. Batteries could contain dangerous materials. Please dispose of them according to respect for environment and local laws.
- Used batteries are harmful to the environment. You can dispose of them either in the correct containers as specified by law or by taking them to a Dealership, which will deal with their disposal.

- Do not touch the battery terminals that are on the back housing or the printed circuit board.
1. Remove the emergency key by sliding the mechanical latch on the back of the RKE transmitter sideways with your thumb and then pull the key out with your other hand.
  2. Insert the tip of the emergency key or a #2 flat blade screwdriver into the slot and gently pry the two halves of the RKE transmitter apart. Make sure not to damage the seal during removal.



0213004940

### Separating RKE Transmitter Case

3. Remove the battery by turning the back cover over (battery facing downward) and tapping it lightly on a solid surface such as a table or similar, then replace the battery. When replacing the battery, match the + sign on the battery to the + sign on the inside of the battery clip, located on the back cover. Avoid touching the

new battery with your fingers. Skin oils may cause battery deterioration. If you touch a battery, clean it with rubbing alcohol.

4. To assemble the RKE transmitter case, snap the two halves together.

### General Information

This device complies with Part 15 of the FCC rules and RSS-210 of Industry Canada. Operation is subject to the following conditions:

- This device may not cause harmful interference.
- This device must accept any interference received, including interference that may cause undesired operation.

**NOTE:** Changes or modifications not expressly approved by the party responsible for compliance could void the user's authority to operate the equipment.

## 28 THINGS TO KNOW BEFORE STARTING YOUR VEHICLE

If your RKE transmitter fails to operate from a normal distance, check for these two conditions:

1. A weak battery in the transmitter. The expected life of the battery is a minimum of three years.
2. Closeness to a radio transmitter such as a radio station tower, airport transmitter, and some mobile or CB radios.

### REMOTE STARTING SYSTEM — IF EQUIPPED

 This system uses the Remote Keyless Entry (RKE) transmitter to start the engine conveniently from outside the vehicle while still maintaining security. The system has a range of approximately 300 ft (91 m).

#### NOTE:

- The vehicle must be equipped with an automatic transmission to be equipped with Remote Start.

- Obstructions between the vehicle and RKE transmitter may reduce this range.

### How To Use Remote Start

All of the following conditions must be met before the engine will remote start:

- Shift Lever in PARK
- Doors closed
- Hood closed
- Liftgate closed
- Hazard switch off
- Brake switch inactive (brake pedal not pushed)
- Battery at an acceptable charge level
- RKE PANIC button not pushed
- System not disabled from previous remote start event

- Vehicle alarm system indicator flashing
- Ignition in OFF position for Keyless Enter-N-Go™ vehicle
- Fuel level meets minimum requirement

**WARNING!**

- **Do not start or run an engine in a closed garage or confined area. Exhaust gas contains Carbon Monoxide (CO) which is odorless and colorless. Carbon Monoxide is poisonous and can cause serious injury or death when inhaled.**
- **Keep Remote Keyless Entry (RKE) transmitters away from children. Operation of the Remote Start System, windows, door locks or other controls could cause serious injury or death.**

**Remote Start Abort Message On Driver Information Display (DID) — If Equipped**

The following messages will display in the DID if the vehicle fails to remote start or exits remote start prematurely:

- Remote Start Aborted — Door Ajar
- Remote Start Aborted — Hood Ajar
- Remote Start Aborted — Liftgate Ajar
- Remote Start Aborted — Fuel Low
- Remote Start Disabled — Start Vehicle To Reset

The DID message stays active until the ignition is turned to the ON/RUN position.

## To Enter Remote Start Mode

 Push and release the REMOTE START button on the RKE transmitter twice within five seconds. The vehicle doors will lock, the parking lights will flash, and the horn will chirp twice (if programmed). Then, the engine will start, and the vehicle will remain in the Remote Start mode for a 15-minute cycle.

### NOTE:

- If an engine fault is present or fuel level is low, the vehicle will start and then shut down in 10 seconds.
- The park lamps will turn on and remain on during Remote Start mode.
- For security, power window and power sunroof operation (if equipped) are disabled when the vehicle is in the Remote Start mode.

- The engine can be started two consecutive times with the RKE transmitter. However, the ignition must be cycled by pushing the START/STOP button twice (or the ignition switch must be cycled to the ON/RUN position) before you can repeat the start sequence for a third cycle.

## To Exit Remote Start Mode Without Driving The Vehicle

Push and release the REMOTE START button one time or allow the engine to run for the entire 15-minute cycle.

**NOTE:** To avoid unintentional shutdowns, the system will disable the one time push of the REMOTE START button for two seconds after receiving a valid Remote Start request.

## To Exit Remote Start Mode And Drive The Vehicle

Before the end of 15 minute cycle, push and release the UNLOCK button on the RKE transmitter to unlock the



doors and disarm the Vehicle Security Alarm (if equipped). Then, prior to the end of the 15 minute cycle, push and release the START/STOP button.

**NOTE:**

- For vehicles equipped with the Keyless Enter-N-Go™ feature, the message “Remote Start Active — Push Start Button” will display in the DID until you push the START button.

### **Remote Start Comfort Systems — If Equipped**

When Remote Start is activated, the heated steering wheel and driver heated seat features will automatically turn on in cold weather. In warm weather, the driver vented seat feature will automatically turn on when the remote start is activated. These features will stay on through the duration of Remote Start or until the ignition switch is cycled to the ON/RUN position.

**NOTE:** The Remote Start Comfort System can be activated and deactivated through the Uconnect® SETTINGS. For more information on Remote Start Comfort System operation, refer to “Uconnect® Settings” in “Multimedia.”

## **DOOR LOCKS**

### **Manual Door Locks**

The power door locks can be manually locked from inside the vehicle by using the door lock knob. To lock each door, push the door lock knob on each door trim panel downward. To unlock the front doors, pull the inside door handle to the first detent. To unlock the rear doors, pull the door lock knob on the door trim panel upward. If the lock knob is down when the door is closed, the door will lock. Therefore, make sure the key is not inside the vehicle before closing the door.

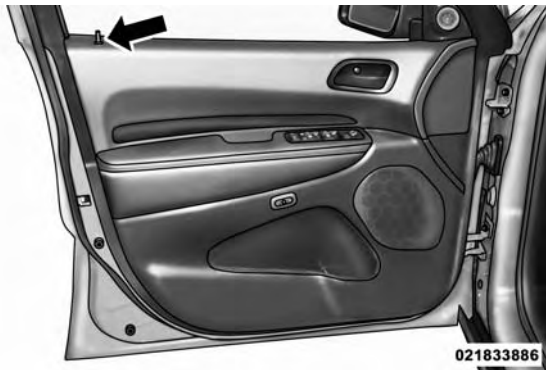

Manual Door Lock Knob

**WARNING!**

- For personal security and safety in the event of an collision, lock the vehicle doors as you drive as well as when you park and leave the vehicle.

*(Continued)***WARNING! (Continued)**

- Never leave children alone in a vehicle, or with access to an unlocked vehicle.
- Allowing children to be in a vehicle unattended is dangerous for a number of reasons. A child or others could be seriously or fatally injured. Children should be warned not to touch the parking brake, brake pedal or the gear selector.
- Do not leave the Key Fob in or near the vehicle, or in a location accessible to children, and do not leave the ignition of a vehicle equipped with Keyless Enter-N-Go™ in the ACC or ON/RUN mode. A child could operate power windows, other controls, or move the vehicle.

## Power Door Locks

The power door lock switch is located on each front door panel. Push the switch to lock or unlock the doors.



**Power Door Lock Switch**

If the lock knob is down when the door is closed, the door will lock. Therefore, make sure the Key Fob is not inside the vehicle before closing the door.

If you push the door lock switch while the ignition position is in ACC or ON/RUN and the driver or front passenger's door is open, the doors will not lock.

If a rear door is locked, it cannot be opened from inside the vehicle without first unlocking the door. The door may be unlocked manually by raising the lock knob.

## Automatic Door Locks — If Equipped

When enabled, the door locks will lock automatically when the vehicle's speed exceeds 15 MPH (24 km/h). Auto door lock feature is enabled/Disabled in the Uconnect Settings sections in the radio. Refer to "Uconnect® Settings" located in "Understanding Your Instrument Panel."

### **Automatic Unlock On Exit Feature — If Equipped**

If Auto Unlock is enabled, this feature will unlock all the doors when any door is opened if the vehicle is stopped and in PARK. Refer to “Uconnect® Settings” in “Understanding Your Instrument Panel” for further information.

### **Child-Protection Door Lock System — Rear Doors**

To provide a safer environment for small children riding in the rear seats, the rear doors are equipped with Child-Protection Door Lock system.

#### **To Engage Or Disengage The Child-Protection Door Lock System**

1. Open the rear door.
2. Insert the tip of the emergency key into the lock and rotate to the LOCK or UNLOCK position.
3. Repeat steps 1 and 2 for the opposite rear door.

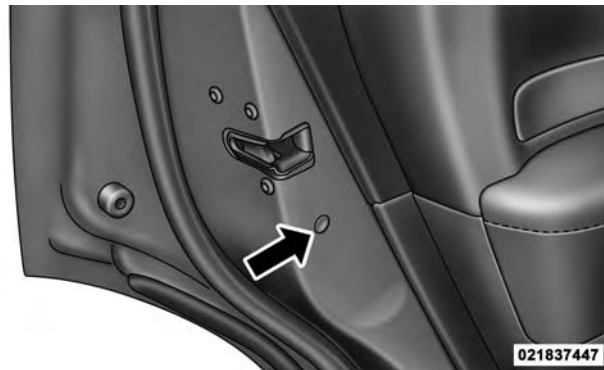

Child-Protection Door Lock Location



Child-Protection Door Lock Function

**WARNING!**

Avoid trapping anyone in a vehicle in a collision. Remember that the rear doors can only be opened from the outside when the Child-Protection locks are engaged (locked).

**NOTE:** For emergency exit with the system engaged, move the lock knob up (unlocked position), roll down the window, and open the door with the outside door handle.

2

**KEYLESS ENTER-N-GO™**

The Passive Entry system is an enhancement to the vehicle's Remote Keyless Entry (RKE) system and a feature of Keyless Enter-N-Go™. This feature allows you to lock and unlock the vehicle's door(s) without having to push the RKE transmitter lock or unlock buttons.

**NOTE:**

- Passive Entry may be programmed ON/OFF. Refer to "Uconnect® Settings" in "Understanding Your Instrument Panel" for further information.

## 36 THINGS TO KNOW BEFORE STARTING YOUR VEHICLE

- If wearing gloves on your hands, or if it has been raining on the Passive Entry door handle, the unlock sensitivity can be affected, resulting in a slower response time.
- If the vehicle is unlocked by Passive Entry and no door goes ajar within 60 seconds, the vehicle will re-lock, and if equipped, will arm the security alarm.

### To Unlock From The Driver's Side:

With a valid Passive Entry RKE transmitter within 5 ft (1.5 m) of the driver's door handle, grab the driver's front door handle to unlock the driver's door automatically. The interior door panel lock knob will raise when the door is unlocked.



### Grab The Door Handle To Unlock

**NOTE:** If “Unlock All Doors 1st Press” is programmed, all doors will unlock when you grab hold of the driver's front door handle. To select between “Unlock Driver Door 1st Press” and “Unlock All Doors 1st Press”, refer to “Uconnect® Settings” in “Understanding Your Instrument Panel” for further information.

**To Unlock From The Passenger Side:**

With a valid Passive Entry RKE transmitter within 5 ft (1.5 m) of the passenger door handle, grab the front passenger door handle to unlock all four doors automatically. The interior door panel lock knob will raise when the door is unlocked.

**NOTE:** All doors will unlock when the front passenger door handle is grabbed regardless of the driver's door unlock preference setting ("Unlock Driver Door 1st Press" or "Unlock All Doors 1st Press").

**Preventing Inadvertent Locking Of Passive Entry RKE Transmitter In Vehicle**

To minimize the possibility of unintentionally locking a Passive Entry RKE transmitter inside your vehicle, the

Passive Entry system is equipped with an automatic door unlock feature, which will function if the ignition is OFF.

If one of the vehicle doors is open, and the door panel switch is used to lock the vehicle, once all open doors have been closed, the vehicle checks the inside and outside of the vehicle for any valid Passive Entry RKE transmitters. If one of the vehicle's Passive Entry RKE transmitters is detected inside the vehicle, and no other valid Passive Entry RKE transmitters are detected outside the vehicle, the Passive Entry System automatically unlocks all vehicle doors and chirps the horn three times (on the third attempt, ALL doors will lock, and the Passive Entry RKE transmitter can be locked in the vehicle).

## To Unlock/Enter The Liftgate

The liftgate passive entry unlock feature is built into the electronic liftgate handle. With a valid Passive Entry RKE transmitter within 3 ft (1.0 m) of the liftgate, push the electronic liftgate handle for a power open on vehicles equipped with Power Liftgate. Push the electronic liftgate handle and lift for Manual Liftgate vehicles.

**NOTE:** If the vehicle is unlocked, the liftgate will open with the handle and no RKE Transmitter is required.

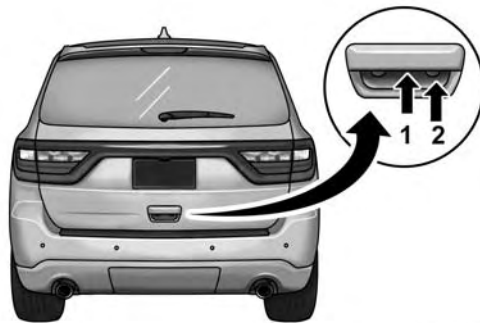

0222008149

Passive Entry/Lock Button Location

- 1 — Electronic Release Switch
  - 2 — Lock Button Location
-



## To Lock The Liftgate

With a valid Passive Entry RKE transmitter within 3 ft (1.0 m) of the liftgate, push the passive entry lock button located to the right of electronic liftgate handle.

**NOTE:** If “Unlock All Doors 1st Press” is programmed in Uconnect® Settings, all doors will unlock when you push the button on the liftgate. If “Unlock Driver Door 1st Press” is programmed in Uconnect® Settings, the liftgate will unlock when you push the button on the liftgate. For further information, refer to “Uconnect® Settings” in “Understanding Your Instrument Panel.”

## To Lock The Vehicle’s Doors

With one of the vehicle’s Passive Entry RKE transmitters within 5 ft (1.5 m) of the driver or passenger front door handle, push the door handle LOCK button to lock all four doors and liftgate.

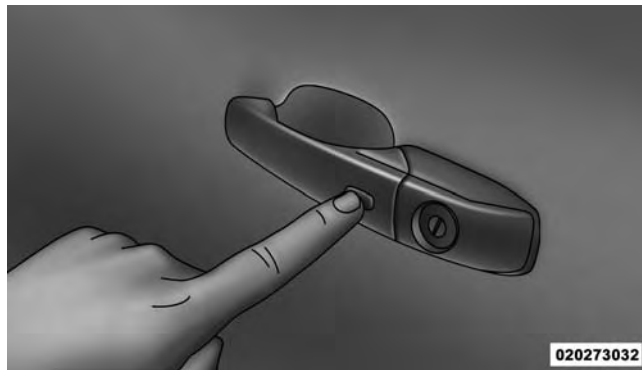

Push The Door Handle Button To Lock

## 40 THINGS TO KNOW BEFORE STARTING YOUR VEHICLE

Do NOT grab the door handle, when pushing the door handle button. This could unlock the door(s).



**Do NOT Grab The Door Handle When Locking**

### NOTE:

- After pushing the door handle button, you must wait two seconds before you can lock or unlock the doors, using either Passive Entry door handle. This is done to allow you to check if the vehicle is locked by pulling the door handle, without the vehicle reacting and unlocking.
- The Passive Entry system will not operate if the RKE transmitter battery is dead.

The vehicle doors can also be locked by using the RKE transmitter lock button or the lock button located on the vehicle's interior door panel.

## WINDOWS

### Power Windows

The power window controls are located on the driver's door trim panel. There is a single switch on the front passenger door/rear doors which operates the front passenger/rear passenger door windows. The window controls will operate only when the ignition switch is in the ON/RUN or ACC position.



2

### Power Window Switches

The power window switches remain active for up to 10 minutes after the ignition switch has been turned OFF. Opening a vehicle front door will cancel this feature.

### Auto-Down

Both the driver and front passenger window switches have an “Auto-Down” feature. Push the window switch past the first detent, release, and the window will go down automatically. To cancel the “Auto-Down” movement, operate the switch in either the up or down direction and release the switch.

To open the window part way, push to the first detent and release it when you want the window to stop.

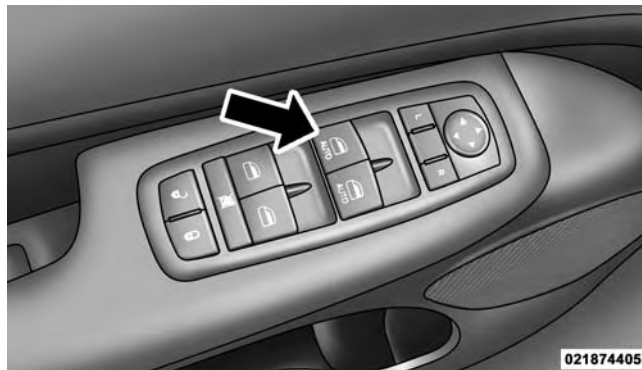

Auto-Down Window Switches

### Auto Up Feature With Anti-Pinch Protection — Driver And Front Passenger Door Only

Lift the window switch fully upward to the second detent, release, and the window will go up automatically.

To stop the window from going all the way up during the “Auto Up” operation, push down on the switch briefly.

To close the window part way, lift the window switch to the first detent and release when you want the window to stop.

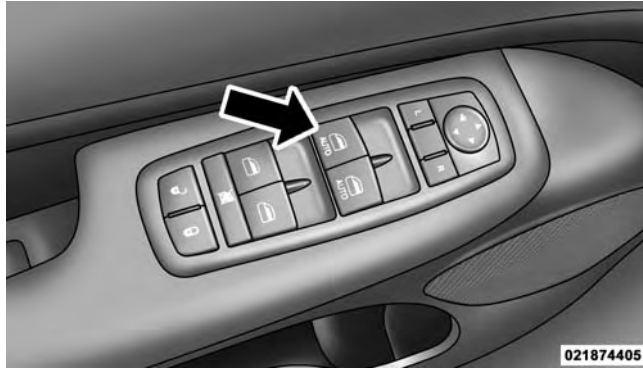

Auto-Up Window Switches

**NOTE:** If the window runs into any obstacle during “Auto Up,” it will reverse direction and then go back down. Remove the obstacle and use the window switch again to close the window. Any impact due to rough road conditions may trigger the auto reverse function unexpectedly during “Auto-Up.” If this happens, pull the switch lightly to the first detent and hold it to close the window manually.

### WARNING!

There is no anti-pinch protection when the window is almost closed. Be sure to clear all objects from the window before closing.

## Resetting The Auto Up Feature

Should the “Auto Up” feature stop working, the window probably needs to be reset. To reset “Auto Up”:

1. Pull the window switch up to close the window completely and continue to hold the switch up for an additional two seconds after the window is closed.
2. Push the window switch down firmly to the second detent to open the window completely and continue to hold the switch down for an additional two seconds after the window is fully open.

## Window Lockout Button

The Window Lockout button on the driver’s door allows you to disable the window controls on the rear doors. To disable the window controls on the rear doors, push the Window Lockout button. To enable the window controls, push the Window Lockout button again.

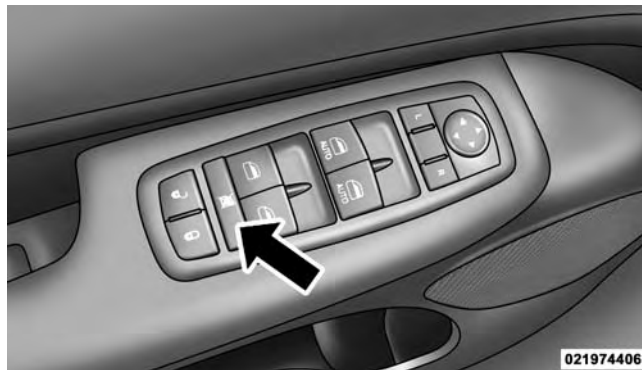

Window Lockout Button

## Wind Buffeting

Wind buffeting can be described as the perception of pressure on the ears or a helicopter-type sound in the ears. Your vehicle may exhibit wind buffeting with the windows down, or the sunroof (if equipped) in certain open or partially open positions. This is a normal occurrence and can be minimized. If the buffeting occurs with the rear windows open, then open the front and rear windows together to minimize the buffeting. If the buffeting occurs with the sunroof open, adjust the sunroof opening to minimize the buffeting.

## LIFTGATE

### To Unlock/Enter The Liftgate

The liftgate passive entry unlock feature is built into the electronic liftgate handle. With a valid Passive Entry RKE transmitter within 3 ft (1.0 m) of the liftgate, push the electronic liftgate handle to open with one fluid motion.

**NOTE:** If “Unlock All Doors 1st Press” is programmed in Uconnect® Settings, all doors will unlock when you push the button on the liftgate. If “Unlock Driver Door 1st Press” is programmed in Uconnect® Settings, the liftgate will unlock when you push the button on the liftgate. For further information, refer to “Uconnect® Settings” in “Understanding Your Instrument Panel.”

### To Lock The Liftgate

With a valid Passive Entry RKE transmitter within 3 ft (1.0 m) of the liftgate, push the passive entry lock button located to the right of electronic liftgate handle.

**NOTE:** The liftgate passive entry lock button will only lock the liftgate; the liftgate unlock feature is built into the electronic liftgate handle.

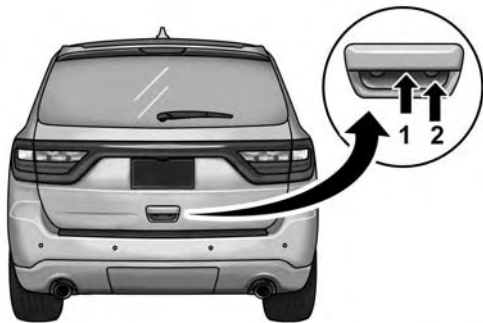

0222008149

### Passive Entry/Lock Button Location

1 — Electronic Release Switch

2 — Lock Button Location

### WARNING!

Driving with the liftgate open can allow poisonous exhaust gases into your vehicle. You and your passengers could be injured by these fumes. Keep the liftgate closed when you are operating the vehicle.

### Power Liftgate — If Equipped



The power liftgate may be opened by pushing the electronic liftgate release located handle (refer to “Keyless Enter-N-Go™” located in “Things To Know Before Starting”) or by pushing the LIFTGATE button on the Remote Keyless Entry (RKE) transmitter. Push the LIFTGATE button on the RKE transmitter twice within five seconds to open the power liftgate. Once the liftgate is open, pushing the button twice within five seconds a second time will close the liftgate.



The power liftgate may also be opened or closed by pushing the LIFTGATE button located on the front overhead console, or closed by pushing the LIFTGATE button located on left rear trim panel, near the liftgate opening. Pushing the LIFTGATE button located on left rear trim panel once will close the liftgate only. This button cannot be used to open the liftgate.

When the LIFTGATE button on the RKE transmitter is pushed two times, the turn signals will flash twice to signal that the liftgate is preparing open or close (if Flash Lamps with Lock is enabled in the Uconnect® Settings) and the liftgate chime (Selectable in Uconnect® Settings) will be audible. For further information, refer to "Uconnect® Settings" in "Understanding Your Instrument Panel."

**NOTE:**

- In the event of a power malfunction to the liftgate, an emergency liftgate latch release can be used to open the liftgate. The emergency liftgate latch release can be accessed through a snap-in cover located on the liftgate trim panel.
- If the liftgate is left open for an extended period of time, the liftgate may need to be closed manually to reset power liftgate functionality.

**WARNING!**

**During power operation, personal injury or cargo damage may occur. Ensure the liftgate travel path is clear. Make sure the liftgate is closed and latched before driving away.**

**NOTE:**

- The power liftgate buttons will not operate if the vehicle is in gear or the vehicle speed is above 0 MPH (0 km/h).
- The power liftgate will not operate in temperatures below  $-22^{\circ}\text{F}$  ( $-30^{\circ}\text{C}$ ) or temperatures above  $150^{\circ}\text{F}$  ( $65^{\circ}\text{C}$ ). Be sure to remove any buildup of snow or ice from the liftgate before pushing any of the power liftgate switches.
- If anything obstructs the power liftgate while it is closing or opening, the liftgate will automatically reverse to the closed or open position, provided it meets sufficient resistance.
- There are also pinch sensors attached to the side of the liftgate. Light pressure anywhere along these strips will cause the liftgate to return to the open position.
- The power liftgate must be in the full open position for rear liftgate close button on the left rear trim, near the liftgate opening, to operate. If the liftgate is not fully open, push the Liftgate button on the Key Fob to fully open the liftgate, and then push it again to close.
- If the liftgate handle switch is pushed while the power liftgate is closing, the liftgate will reverse to the full open position.
- If the liftgate handle switch is pushed while the power liftgate is opening, the liftgate motor will disengage to allow manual operation.
- If the power liftgate encounters multiple obstructions within the same cycle, the system will automatically stop and the liftgate must be opened or closed manually.
- If your liftgate is power closing and you put the vehicle in gear, the liftgate will continue to power

close. However, vehicle movement may result in a detection of an obstruction.

### WARNING!

- Driving with the liftgate open can allow poisonous exhaust gases into your vehicle. You and your passengers could be injured by these fumes. Keep the liftgate closed when you are operating the vehicle.
- If you are required to drive with the liftgate open, make sure that all windows are closed, and the climate control blower switch is set at high speed. Do not use the recirculation mode.

## OCCUPANT RESTRAINT SYSTEMS

Some of the most important safety features in your vehicle are the restraint systems:

- Seat Belt Systems

- Supplemental Restraint Systems (SRS) Air Bags
- Supplemental Active Head Restraints
- Child Restraints

### Important Safety Precautions

Please pay close attention to the information in this section. It tells you how to use your restraint system properly, to keep you and your passengers as safe as possible.

Here are some simple steps you can take to minimize the risk of harm from a deploying air bag:

1. Children 12 years old and under should always ride buckled up in a vehicle with a rear seat.
2. If a child from 2 to 12 years old (not in a rear-facing child restraint) must ride in the front passenger seat, move the seat as far back as possible and use the proper child restraint. (Refer to “Child Restraints”)

## 50 THINGS TO KNOW BEFORE STARTING YOUR VEHICLE

- Children that are not big enough to wear the vehicle seat belt properly (Refer to "Child Restraints") should be secured in a vehicle with a rear seat in child restraints or belt-positioning booster seats. Older children who do not use child restraints or belt-positioning booster seats should ride properly buckled up in a vehicle with a rear seat.
- Never allow children to slide the shoulder belt behind them or under their arm.
- You should read the instructions provided with your child restraint to make sure that you are using it properly.
- All occupants should always wear their lap and shoulder belts properly.
- The driver and front passenger seats should be moved back as far as practical to allow the Advanced Front Air Bags room to inflate.
- Do not lean against the door or window. If your vehicle has side air bags, and deployment occurs, the side air bags will inflate forcefully into the space between occupants and the door and occupants could be injured.
- If the air bag system in this vehicle needs to be modified to accommodate a disabled person, contact the Customer Center. Phone numbers are provided under "If You Need Assistance."

### **WARNING!**

- **Never place a rear-facing child restraint in front of an air bag. A deploying passenger Advanced Front Air Bag can cause death or serious injury to a child 12 years or younger, including a child in a rear-facing child restraint.**
- **Only use a rear-facing child restraint in a vehicle with a rear seat.**

## Seat Belt Systems

Buckle up even though you are an excellent driver, even on short trips. Someone on the road may be a poor driver and could cause a collision that includes you. This can happen far away from home or on your own street.

Research has shown that seat belts save lives, and they can reduce the seriousness of injuries in a collision. Some of the worst injuries happen when people are thrown from the vehicle. Seat belts reduce the possibility of ejection and the risk of injury caused by striking the inside of the vehicle. Everyone in a motor vehicle should be belted at all times.

### Enhanced Seat Belt Use Reminder System (BeltAlert)

 BeltAlert is a feature intended to remind the driver and outboard front passenger (if equipped with outboard front passenger BeltAlert) to buckle their seat belts. The feature is active whenever the ignition

switch is in the START or ON/RUN position. If the driver or outboard front seat passenger is unbelted, the Seat Belt Reminder Light will turn on and remain on until both outboard front seat belts are buckled.

The BeltAlert warning sequence begins after the vehicle speed is over 5 mph (8 km/h) by blinking the Seat Belt Reminder Light and sounding an intermittent chime. Once the sequence starts, it will continue for the entire duration or until the respective seat belts are buckled. After the sequence completes, the Seat Belt Reminder Light remains illuminated until the respective seat belts are buckled. The driver should instruct all other occupants to buckle their seat belts. If an outboard front seat belt is unbuckled while traveling at speeds greater than 5 mph (8 km/h), BeltAlert will provide both audio and visual notification.

The outboard front passenger seat BeltAlert is not active when the outboard front passenger seat is unoccupied.

BeltAlert may be triggered when an animal or heavy object is on the outboard front passenger seat or when the seat is folded flat (if equipped). It is recommended that pets be restrained in the rear seat (if equipped) in pet harnesses or pet carriers that are secured by seat belts, and cargo is properly stowed.

BeltAlert can be activated or deactivated by your authorized dealer. FCA US LLC does not recommend deactivating BeltAlert.

**NOTE:** If BeltAlert has been deactivated, the Seat Belt Reminder Light will continue to illuminate while the driver's or outboard front passenger's (if equipped with BeltAlert) seat belt remains unbuckled.

### **Lap/Shoulder Belts**

All seating positions in your vehicle are equipped with lap/shoulder belts.

The seat belt webbing retractor will lock only during very sudden stops or collisions. This feature allows the shoulder part of the seat belt to move freely with you under normal conditions. However, in a collision the seat belt will lock and reduce your risk of striking the inside of the vehicle or being thrown out of the vehicle.

### **WARNING!**

- **Relying on the air bags alone could lead to more severe injuries in a collision. The air bags work with your seat belt to restrain you properly. In some collisions, the air bags won't deploy at all. Always wear your seat belt even though you have air bags.**
- **In a collision, you and your passengers can suffer much greater injuries if you are not properly buckled up. You can strike the interior of your vehicle or**

*(Continued)*

**WARNING! (Continued)**

other passengers, or you can be thrown out of the vehicle. Always be sure you and others in your vehicle are buckled up properly.

- It is dangerous to ride in a cargo area, inside or outside of a vehicle. In a collision, people riding in these areas are more likely to be seriously injured or killed.
- Do not allow people to ride in any area of your vehicle that is not equipped with seats and seat belts.
- Be sure everyone in your vehicle is in a seat and using a seat belt properly.
- Wearing your seat belt incorrectly could make your injuries in a collision much worse. You might suffer internal injuries, or you could even slide out of the seat belt. Follow these instructions to wear

*(Continued)*

**WARNING! (Continued)**

your seat belt safely and to keep your passengers safe, too.

- Two people should never be belted into a single seat belt. People belted together can crash into one another in a collision, hurting one another badly. Never use a lap/shoulder belt or a lap belt for more than one person, no matter what their size.
- A lap belt worn too high can increase the risk of injury in a collision. The seat belt forces won't be at the strong hip and pelvic bones, but across your abdomen. Always wear the lap part of your seat belt as low as possible and keep it snug.
- A twisted seat belt may not protect you properly. In a collision, it could even cut into you. Be sure the seat belt is flat against your body, without twists. If you can't straighten a seat belt in your vehicle, take

*(Continued)*

**WARNING! (Continued)**

it to your authorized dealer immediately and have it fixed.

- A seat belt that is buckled into the wrong buckle will not protect you properly. The lap portion could ride too high on your body, possibly causing internal injuries. Always buckle your seat belt into the buckle nearest you.
- A seat belt that is too loose will not protect you properly. In a sudden stop, you could move too far forward, increasing the possibility of injury. Wear your seat belt snugly.
- A seat belt that is worn under your arm is dangerous. Your body could strike the inside surfaces of the vehicle in a collision, increasing head and neck injury. A seat belt worn under the arm can cause internal injuries. Ribs aren't as strong as shoulder

**WARNING! (Continued)**

bones. Wear the seat belt over your shoulder so that your strongest bones will take the force in a collision.

- A shoulder belt placed behind you will not protect you from injury during a collision. You are more likely to hit your head in a collision if you do not wear your shoulder belt. The lap and shoulder belt are meant to be used together.
- A frayed or torn seat belt could rip apart in a collision and leave you with no protection. Inspect the seat belt system periodically, checking for cuts, frays, or loose parts. Damaged parts must be replaced immediately. Do not disassemble or modify the seat belt system. Seat belt assemblies must be replaced after a collision.

*(Continued)*



## Lap/Shoulder Belt Operating Instructions

1. Enter the vehicle and close the door. Sit back and adjust the seat.
2. The seat belt latch plate is above the back of the front seat, and next to your arm in the rear seat (for vehicles equipped with a rear seat). Grasp the latch plate and pull out the seat belt. Slide the latch plate up the webbing as far as necessary to allow the seat belt to go around your lap.



Pulling Out The Latch Plate

3. When the seat belt is long enough to fit, insert the latch plate into the buckle until you hear a “click.”



**Inserting Latch Plate Into Buckle**

4. Position the lap belt so that it is snug and lies low across your hips, below your abdomen. To remove slack in the lap belt portion, pull up on the shoulder belt. To loosen the lap belt if it is too tight, tilt the latch

plate and pull on the lap belt. A snug seat belt reduces the risk of sliding under the seat belt in a collision.



**Positioning The Lap Belt**

5. Position the shoulder belt across the shoulder and chest with minimal, if any slack so that it is comfortable and not resting on your neck. The retractor will withdraw any slack in the shoulder belt.

6. To release the belt, push the red button on the buckle. The seat belt will automatically retract to its stowed position. If necessary, slide the latch plate down the webbing to allow the seat belt to retract fully.
3. Slide the latch plate upward over the folded webbing. The folded webbing must enter the slot at the top of the latch plate.
4. Continue to slide the latch plate up until it clears the folded webbing and the seat belt is no longer twisted.

### Lap/Shoulder Belt Untwisting Procedure

Use the following procedure to untwist a twisted lap/shoulder belt.

1. Position the latch plate as close as possible to the anchor point.
2. At about 6 to 12 inches (15 to 30 cm) above the latch plate, grasp and twist the seat belt webbing 180 degrees to create a fold that begins immediately above the latch plate.

### Adjustable Upper Shoulder Belt Anchorage

In the driver and front passenger seats, the top of the shoulder belt can be adjusted upward or downward to position the seat belt away from your neck. Push or squeeze the anchorage button to release the anchorage, and move it up or down to the position that serves you best.



### Adjustable Anchorage

As a guide, if you are shorter than average, you will prefer the shoulder belt anchorage in a lower position, and if you are taller than average, you will prefer the shoulder belt anchorage in a higher position. After you release the anchorage button, try to move it up or down to make sure that it is locked in position.

**NOTE:** The adjustable upper shoulder belt anchorage is equipped with an Easy Up feature. This feature allows the shoulder belt anchorage to be adjusted in the upward position without pushing or squeezing the release button. To verify the shoulder belt anchorage is latched, pull downward on the shoulder belt anchorage until it is locked into position.

### Seat Belt Extender

If a seat belt is not long enough to fit properly, even when the webbing is fully extended and the adjustable upper shoulder belt anchorage (if equipped) is in its lowest position, your authorized dealer can provide you with a Seat Belt Extender. The Seat Belt Extender should be used only if the existing seat belt is not long enough. When the Seat Belt Extender is not required for a different occupant, it must be removed.

**WARNING!**

- **ONLY use a Seat Belt Extender if it is physically required in order to properly fit the original seat belt system. DO NOT USE the Seat Belt Extender if, when worn, the distance between the front edge of the Seat Belt Extender buckle and the center of the occupant's body is LESS than 6 inches.**
- **Using a Seat Belt Extender when not needed can increase the risk of serious injury or death in a collision. Only use the Seat Belt Extender when the lap belt is not long enough and only use in the recommended seating positions. Remove and store the Seat Belt Extender when not needed.**

**Seat Belts And Pregnant Women**

We recommend that pregnant women use the seat belts throughout their pregnancy. Keeping the mother safe is the best way to keep the baby safe.

Pregnant women should wear the lap part of the seat belt across the thighs and as snug across the hips as possible. Keep the seat belt low so that it does not come across the abdomen. That way the strong bones of the hips will take the force if there is a collision.

**Seat Belt Pretensioner**

The front seat belt system is equipped with pretensioning devices that are designed to remove slack from the seat belt in the event of a collision. These devices may improve the performance of the seat belt by removing slack from the seat belt early in a collision. Pretensioners work for all size occupants, including those in child restraints.

**NOTE:** These devices are not a substitute for proper seat belt placement by the occupant. The seat belt still must be worn snugly and positioned properly.

The pretensioners are triggered by the Occupant Restraint Controller (ORC). Like the air bags, the pretensioners are single use items. A deployed pretensioner or a deployed air bag must be replaced immediately.

### Energy Management Feature

This vehicle has a seat belt system with an Energy Management feature in the front seating positions that may help further reduce the risk of injury in the event of a collision. This seat belt system has a retractor assembly that is designed to release webbing in a controlled manner.

### Automatic Locking Retractor (ALR) — If Equipped

The seat belts in the passenger seating positions may be equipped with a Switchable Automatic Locking Retractor (ALR) which is used to secure a child restraint system. For additional information, refer to “Installing Child Restraints Using The Vehicle Seat Belt” under the “Child

Restraints” section of this manual. The table below defines the type of feature for each seating position.

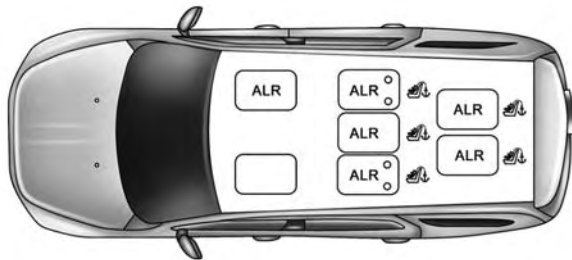

022668724

60/40 Second Row (7 passenger)

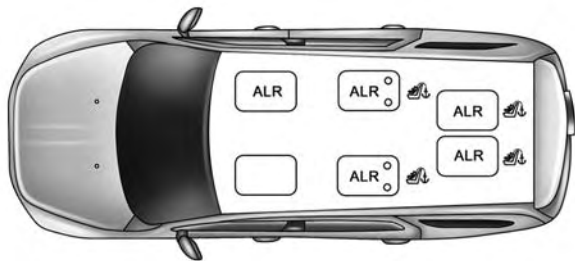

022668726

### Captains Chairs Second Row (6 Passenger)

- ALR = Switchable Automatic Locking Retractor

If the passenger seating position is equipped with an ALR and is being used for normal usage, only pull the seat belt webbing out far enough to comfortably wrap around the occupant's mid-section so as to not activate the ALR. If the ALR is activated, you will hear a clicking

sound as the seat belt retracts. Allow the webbing to retract completely in this case and then carefully pull out only the amount of webbing necessary to comfortably wrap around the occupant's mid-section. Slide the latch plate into the buckle until you hear a "click."

In Automatic Locking Mode, the shoulder belt is automatically pre-locked. The seat belt will still retract to remove any slack in the shoulder belt. Use the Automatic Locking Mode anytime a child restraint is installed in a seating position that has a seat belt with this feature. Children 12 years old and under should always be properly restrained in a vehicle with a rear seat.

### WARNING!

- **Never place a rear-facing child restraint in front of an air bag. A deploying Passenger Advanced Front Air Bag can cause death or serious injury to a child**

*(Continued)*

**WARNING! (Continued)**

12 years or younger, including a child in a rear-facing child restraint.

- Only use a rear-facing child restraint in a vehicle with a rear seat.

**How To Engage The Automatic Locking Mode**

1. Buckle the combination lap and shoulder belt.
2. Grasp the shoulder portion and pull downward until the entire seat belt is extracted.
3. Allow the seat belt to retract. As the seat belt retracts, you will hear a clicking sound. This indicates the seat belt is now in the Automatic Locking Mode.

**How To Disengage The Automatic Locking Mode**

Unbuckle the combination lap/shoulder belt and allow it to retract completely to disengage the Automatic Locking

Mode and activate the vehicle sensitive (emergency) locking mode.

**WARNING!**

- The seat belt assembly must be replaced if the switchable Automatic Locking Retractor (ALR) feature or any other seat belt function is not working properly when checked according to the procedures in the Service Manual.
- Failure to replace the seat belt assembly could increase the risk of injury in collisions.
- Do not use the Automatic Locking Mode to restrain occupants who are wearing the seat belt or children who are using booster seats. The locked mode is only used to install rear-facing or forward-facing child restraints that have a harness for restraining the child.



### Supplemental Active Head Restraints (AHR)

These head restraints are passive, deployable components, and vehicles with this equipment cannot be readily identified by any markings, only through visual inspection of the head restraint. The head restraint will be split in two halves, with the front half being soft foam and trim, the back half being decorative plastic.

#### How The Active Head Restraints (AHR) Work

The Occupant Restraint Controller (ORC) determines whether the severity, or type of rear impact will require the Active Head Restraints (AHR) to deploy. If a rear impact requires deployment, both the driver and front passenger seat AHRs will be deployed.

When AHRs deploy during a rear impact, the front half of the head restraint extends forward to minimize the gap between the back of the occupant's head and the AHR. This system is designed to help prevent or reduce the extent of injuries to the driver and front passenger in certain types of rear impacts.

**NOTE:** The Active Head Restraints (AHR) may or may not deploy in the event of a front or side impact. However, if during a front impact, a secondary rear impact occurs, the AHR may deploy based on the severity and type of the impact.

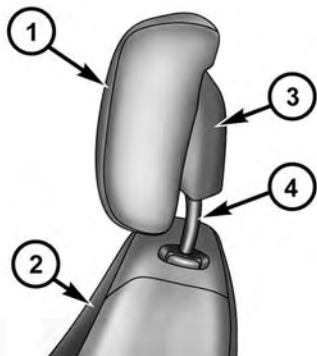

022607508

### Active Head Restraint (AHR) Components

- 1 — Head Restraint Front Half (Soft Foam and Trim)
- 2 — Seatback
- 3 — Head Restraint Back Half (Decorative Plastic Rear Cover)
- 4 — Head Restraint Guide Tubes

### WARNING!

All occupants, including the driver, should not operate a vehicle or sit in a vehicle's seat until the head restraints are placed in their proper positions in order to minimize the risk of neck injury in the event of a collision.

**NOTE:** For more information on properly adjusting and positioning the head restraint, refer to "Adjusting Active Head Restraints" in "Understanding The Features Of Your Vehicle."

### Resetting Active Head Restraints (AHR)

If the Active Head Restraints are triggered in a collision, you must reset the head restraint on the driver's and front passenger's seat before driving. You can recognize when the Active Head Restraint has been triggered by the fact that they have moved forward (as shown in step three of the resetting procedure).

1. Grasp the deployed AHR from the rear seat.

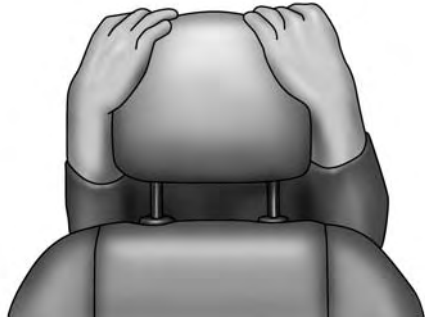

022607492

**Hand Positioning Points On AHR**

2. Position the hands on the top of the deployed AHR at a comfortable position.

3. Pull down then rearward towards the rear of the vehicle then down to engage the locking mechanism.

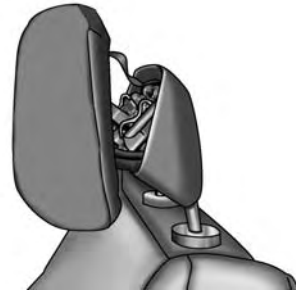

0226048657



0226048658

Review Table Below

- A — Downward Movement  
B — Rearward Movement  
C — Final Downward Movement To Engage Locking Mechanism
- 

4. The AHR front soft foam and trim half should lock into the back decorative plastic half.

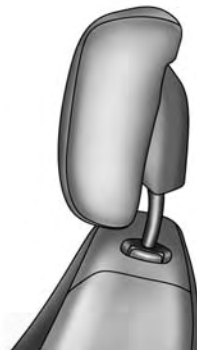

022607494

AHR In Reset Position

**NOTE:**

- If you have difficulties or problems resetting the Active Head Restraints, see an authorized dealer.

- For safety reasons, have the Active Head Restraints checked by a qualified specialist at an authorized dealer.

## Supplemental Restraint System (SRS)

### Air Bag System Components

Your vehicle may be equipped with the following air bag system components:

- Occupant Restraint Controller (ORC)
- Air Bag Warning Light 
- Steering Wheel and Column
- Instrument Panel
- Knee Impact Bolsters
- Advanced Front Air Bags
- Supplemental Side Air Bags

- Supplemental Knee Air Bags
- Front and Side Impact Sensors
- Seat Belt Pretensioners
- Seat Belt Buckle Switch
- Seat Track Position Sensors

### Advanced Front Air Bags

This vehicle has Advanced Front Air Bags for both the driver and front passenger as a supplement to the seat belt restraint systems. The driver's Advanced Front Air Bag is mounted in the center of the steering wheel. The passenger's Advanced Front Air Bag is mounted in the instrument panel, above the glove compartment. The words "SRS AIRBAG" or "AIRBAG" are embossed on the air bag covers.

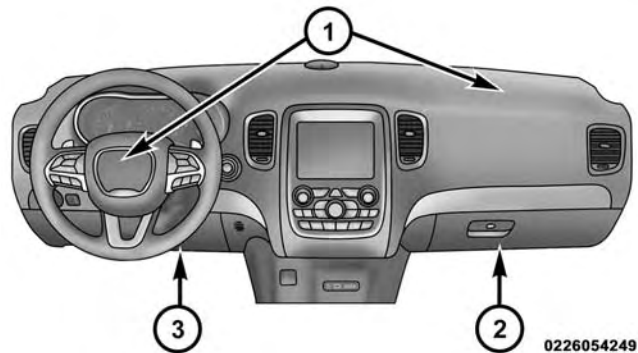

### Advanced Front Air Bag And Knee Bolster Locations

- 1 — Driver And Passenger Advanced Front Air Bags  
2 — Passenger Knee Impact Bolster  
3 — Driver Knee Impact Bolster/Supplemental Driver Knee Air Bag

### WARNING!

- Being too close to the steering wheel or instrument panel during Advanced Front Air Bag deployment could cause serious injury, including death. Air bags need room to inflate. Sit back, comfortably extending your arms to reach the steering wheel or instrument panel.
- Never place a rear-facing child restraint in front of an air bag. A deploying Passenger Advanced Front Air Bag can cause death or serious injury to a child 12 years or younger, including a child in a rear-facing child restraint.
- Only use a rear-facing child restraint in a vehicle with a rear seat.

## Advanced Front Air Bag Features

The Advanced Front Air Bag system has multistage driver and front passenger air bags. This system provides output appropriate to the severity and type of collision as determined by the Occupant Restraint Controller (ORC), which may receive information from the front impact sensors or other system components.

The first stage inflator is triggered immediately during an impact that requires air bag deployment. A low energy output is used in less severe collisions. A higher energy output is used for more severe collisions.

This vehicle may be equipped with driver and/or front passenger seat track position sensors that may adjust the inflation rate of the Advanced Front Air Bags based upon seat position.

This vehicle may be equipped with a driver and/or front passenger seat belt buckle switch that detects whether

the driver or front passenger seat belt is buckled. The seat belt buckle switch may adjust the inflation rate of the Advanced Front Air Bags.

### WARNING!

- No objects should be placed over or near the air bag on the instrument panel or steering wheel, because any such objects could cause harm if the vehicle is in a collision severe enough to cause the air bags to inflate.
- Do not put anything on or around the air bag covers or attempt to open them manually. You may damage the air bags and you could be injured because the air bags may no longer be functional. The protective covers for the air bag cushions are designed to open only when the air bags are inflating.

*(Continued)*

**WARNING! (Continued)**

- **Relying on the air bags alone could lead to more severe injuries in a collision. The air bags work with your seat belt to restrain you properly. In some collisions, air bags won't deploy at all. Always wear your seat belts even though you have air bags.**

**Advanced Front Air Bag Operation**

Advanced Front Air Bags are designed to provide additional protection by supplementing the seat belts. Advanced Front Air Bags are not expected to reduce the risk of injury in rear, side, or rollover collisions. The Advanced Front Air Bags will not deploy in all frontal collisions, including some that may produce substantial vehicle damage — for example, some pole collisions, truck underrides, and angle offset collisions.

On the other hand, depending on the type and location of impact, Advanced Front Air Bags may deploy in crashes with little vehicle front-end damage but that produce a severe initial deceleration.

Because air bag sensors measure vehicle deceleration over time, vehicle speed and damage by themselves are not good indicators of whether or not an air bag should have deployed.

Seat belts are necessary for your protection in all collisions, and also are needed to help keep you in position, away from an inflating air bag.

When the ORC detects a collision requiring the Advanced Front Air Bags, it signals the inflator units. A large quantity of non-toxic gas is generated to inflate the Advanced Front Air Bags.



The steering wheel hub trim cover and the upper right side of the instrument panel separate and fold out of the way as the air bags inflate to their full size. The Advanced Front Air Bags fully inflate in less time than it takes to blink your eyes. The air bags then quickly deflate while helping to restrain the driver and front passenger.

### **Knee Impact Bolsters**

The Knee Impact Bolsters help protect the knees of the driver and front passenger, and position the front occupants for improved interaction with the Advanced Front Air Bags.

#### **WARNING!**

- **Do not drill, cut, or tamper with the knee impact bolsters in any way.**

#### **WARNING! (Continued)**

- **Do not mount any accessories to the knee impact bolsters such as alarm lights, stereos, citizen band radios, etc.**

### **Supplemental Driver Knee Air Bag**

This vehicle is equipped with a Supplemental Driver Knee Air Bag mounted in the instrument panel below the steering column. The Supplemental Driver Knee Air Bag provides enhanced protection during a frontal impact by working together with the seat belts, pretensioners, and Advanced Front Air Bags.

## Supplemental Side Air Bags

Your vehicle is equipped with two types of side air bags:

1. Supplemental Seat-Mounted Side Air Bags (SABs): Located in the outboard side of the front seats. The SABs are marked with a “SRS AIRBAG” or “AIRBAG” label sewn into the outboard side of the seats.

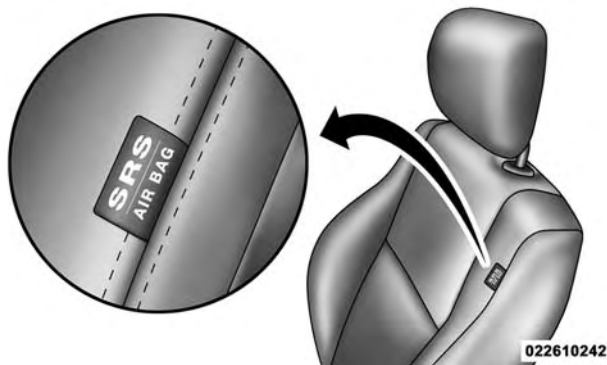

Front Supplemental Seat-Mounted Side Air Bag Label

The SABs may help to reduce the risk of occupant injury during certain side impact and certain rollover events, in addition to the injury reduction potential provided by the seat belts and body structure.

When the SAB deploys, it opens the seam on the outboard side of the seatback's trim cover. The inflating SAB deploys through the seat seam into the space between the occupant and the door. The SAB moves at a very high speed and with such a high force that it could injure you if you are not seated properly, or if items are positioned in the area where the SAB inflates. Children are at an even greater risk of injury from a deploying air bag.

### WARNING!

Do not use accessory seat covers or place objects between you and the Side Air Bags; the performance could be adversely affected and/or objects could be pushed into you, causing serious injury.

2. Supplemental Side Air Bag Inflatable Curtains (SABICs): Located above the side windows. The trim covering the SABICs is labeled “SRS AIRBAG” or “AIRBAG.”

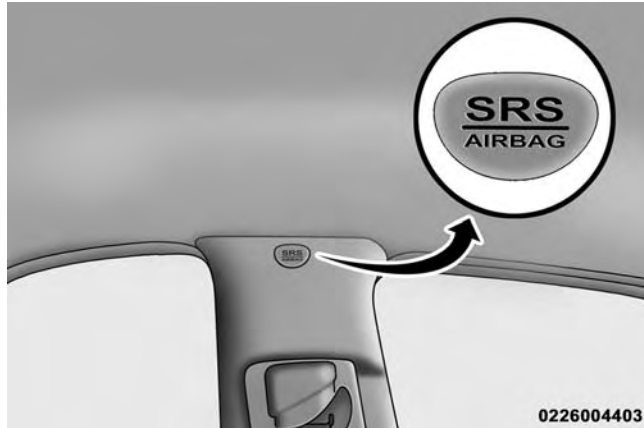

**Supplemental Side Air Bag Inflatable Curtain (SABIC)  
Label Location**

SABICs may help reduce the risk of head injury to front and rear seat outboard occupants. SABICs may reduce the risk of injuries in certain side impact and vehicle rollover events, in addition to the injury reduction potential provided by the seat belts and body structure.

The SABICs deploy downward, covering the side windows. An inflating SABIC pushes the outside edge of the trim out of the way and covers the window. The SABICs inflate with enough force to injure you if you are not belted and seated properly, or if items are positioned in the area where the SABICs inflate. Children are at an even greater risk of injury from a deploying air bag.

The SABICs may help reduce the risk of partial or complete ejection of vehicle occupants through side windows in certain rollover or side impact events.

**WARNING!**

- **Your vehicle is equipped with left and right Supplemental Side Air Bag Inflatable Curtains (SABICs). Do not stack luggage or other cargo up high enough to block the deployment of the SABICs. The trim covering above the side windows where the SABIC and its deployment path are located should remain free from any obstructions.**
- **Your vehicle is equipped with SABICs. In order for the SABICs to work as intended, do not install any accessory items in your vehicle which could alter the roof. Do not add an aftermarket sunroof to your vehicle. Do not add roof racks that require permanent attachments (bolts or screws) for installation on the vehicle roof. Do not drill into the roof of the vehicle for any reason.**

The SABICs and SABs (“Side Air Bags”) are designed to activate in certain side impacts and certain rollover events. The Occupant Restraint Controller (“ORC”) determines whether the deployment of the Side Air Bags in a particular side impact or rollover event is appropriate, based on the severity and type of collision. Vehicle damage by itself is not a good indicator of whether or not Side Air Bags should have deployed.

Side Air Bags are a supplement to the seat belt restraint system. Side Air Bags deploy in less time than it takes to blink your eyes. Occupants, including children, who are up against or very close to Side Air Bags can be seriously injured or killed. Occupants, including children, should never lean on or sleep against the door, side windows, or area where the Side Air Bags inflate, even if they are in an infant or child restraint.

Seat belts (and child restraints where appropriate) are necessary for your protection in all collisions. They also

help keep you in position, away from inflating Side Air Bags. To get the best protection from the Side Air Bags, occupants must wear their seat belts properly and sit upright with their backs against the seats. Children must be properly restrained in a child restraint or booster seat that is appropriate for the size of the child.

### WARNING!

- **Side Air Bags need room to inflate. Do not lean against the door or window. Sit upright in the center of the seat.**
- **Being too close to the Side Air Bags during deployment could cause you to be severely injured or killed.**
- **Relying on the Side Air Bags alone could lead to more severe injuries in a collision. The Side Air Bags work with your seat belt to restrain you**

*(Continued)*

### WARNING! *(Continued)*

**properly. In some collisions, Side Air Bags won't deploy at all. Always wear your seat belt even though you have Side Air Bags.**

**NOTE:** Air bag covers may not be obvious in the interior trim, but they will open during air bag deployment.

### Side Impacts

In side impacts, the side impact sensors aid the ORC in determining the appropriate response to impact events. The system is calibrated to deploy the Side Air Bags on the impact side of the vehicle during impacts that require Side Air Bag occupant protection. In side impacts, the Side Air Bags deploy independently; a left side impact deploys the left Side Air Bags only and a right side impact deploys the right Side Air Bags only.

The Side Air Bags will not deploy in all side collisions, including some collisions at certain angles, or some side collisions that do not impact the area of the passenger compartment. The Side Air Bags may deploy during angled or offset frontal collisions where the Advanced Front Air Bags deploy.

### Rollover Events

Side Air Bags are designed to activate in certain rollover events. The ORC determines whether the deployment of the Side Air Bags in a particular rollover event is appropriate, based on the severity and type of collision. Vehicle damage by itself is not a good indicator of whether or not Side Air Bags should have deployed.

The Side Air Bags will not deploy in all rollover events. The rollover sensing-system determines if a rollover event may be in progress and whether deployment is appropriate. A slower-developing event may deploy the seat belt pretensioners on both sides of the vehicle. A

faster-developing event may deploy the seat belt pretensioners as well as the SABs and SABICs on both sides of the vehicle. The rollover sensing-system may also deploy the seat belt pretensioners, with or without the SABs and SABICs, on both sides of the vehicle if the vehicle experiences a near rollover event.

### If A Deployment Occurs

The Advanced Front Air Bags are designed to deflate immediately after deployment.

**NOTE:** Front and/or side air bags will not deploy in all collisions. This does not mean something is wrong with the air bag system.

If you do have a collision which deploys the air bags, any or all of the following may occur:

- The air bag material may sometimes cause abrasions and/or skin reddening to the occupants as the air bags

deploy and unfold. The abrasions are similar to friction rope burns or those you might get sliding along a carpet or gymnasium floor. They are not caused by contact with chemicals. They are not permanent and normally heal quickly. However, if you haven't healed significantly within a few days, or if you have any blistering, see your doctor immediately.

- As the air bags deflate, you may see some smoke-like particles. The particles are a normal by-product of the process that generates the non-toxic gas used for air bag inflation. These airborne particles may irritate the skin, eyes, nose, or throat. If you have skin or eye irritation, rinse the area with cool water. For nose or throat irritation, move to fresh air. If the irritation continues, see your doctor. If these particles settle on your clothing, follow the garment manufacturer's instructions for cleaning.

Do not drive your vehicle after the air bags have deployed. If you are involved in another collision, the air bags will not be in place to protect you.

### **WARNING!**

**Deployed air bags and seat belt pretensioners cannot protect you in another collision. Have the air bags, seat belt pretensioners, and the seat belt retractor assemblies replaced by an authorized dealer immediately. Also, have the Occupant Restraint Controller System serviced as well.**

### **NOTE:**

- Air bag covers may not be obvious in the interior trim, but they will open during air bag deployment.
- After any collision, the vehicle should be taken to an authorized dealer immediately.

## Enhanced Accident Response System

In the event of an impact, if the communication network remains intact, and the power remains intact, depending on the nature of the event, the ORC will determine whether to have the Enhanced Accident Response System perform the following functions:

- Cut off fuel to the engine.
- Flash hazard lights as long as the battery has power or until the ignition switch is turned to the “OFF” position.
- Turn on the interior lights, which remain on as long as the battery has power or until the ignition switch is turned to the “OFF” position.
- Unlock the doors automatically.

## System Reset Procedure

In order to reset the Enhanced Accident Response System functions after an event, the ignition switch must be changed from ignition START or ON/RUN to ignition OFF.

## Air Bag Warning Light



The air bags must be ready to inflate for your protection in a collision. The Occupant Restraint Controller (ORC) monitors the internal circuits and interconnecting wiring associated with air bag system electrical components.

The ORC monitors the readiness of the electronic parts of the air bag system whenever the ignition switch is in the START or ON/RUN position. If the ignition switch is in the OFF position or in the ACC position, the air bag system is not on and the air bags will not inflate.



The ORC contains a backup power supply system that may deploy the air bags even if the battery loses power or it becomes disconnected prior to deployment.

The ORC turns on the Air Bag Warning Light in the instrument panel for approximately four to eight seconds for a self-check when the ignition switch is first turned to the ON/RUN position. After the self-check, the Air Bag Warning Light will turn off. If the ORC detects a malfunction in any part of the system, it turns on the Air Bag Warning Light, either momentarily or continuously. A single chime will sound to alert you if the light comes on again after initial startup.

The ORC also includes diagnostics that will illuminate the instrument panel Air Bag Warning Light if a malfunction is detected that could affect the air bag system. The diagnostics also record the nature of the malfunction. While the air bag system is designed to be maintenance

free, if any of the following occurs, have an authorized dealer service the air bag system immediately.

- The Air Bag Warning Light does not come on during the four to eight seconds when the ignition switch is first turned to the ON/RUN position.
- The Air Bag Warning Light remains on after the four to eight-second interval.
- The Air Bag Warning Light comes on intermittently or remains on while driving.

**NOTE:** If the speedometer, tachometer, or any engine related gauges are not working, the Occupant Restraint Controller (ORC) may also be disabled. In this condition the air bags may not be ready to inflate for your protection. Have an authorized dealer service the air bag system immediately.

**WARNING!**

Ignoring the Air Bag Warning Light in your instrument panel could mean you won't have the air bags to protect you in a collision. If the light does not come on as a bulb check when the ignition is first placed in the on position, and stays on after you start the vehicle, or if it comes on as you drive, have an authorized dealer service the air bag system immediately.

**Maintaining Your Air Bag System****WARNING!**

- Modifications to any part of the air bag system could cause it to fail when you need it. You could be injured if the air bag system is not there to

*(Continued)*

**WARNING! (Continued)**

protect you. Do not modify the components or wiring, including adding any kind of badges or stickers to the steering wheel hub trim cover or the upper right side of the instrument panel. Do not modify the front bumper, vehicle body structure, or add aftermarket side steps or running boards.

- It is dangerous to try to repair any part of the air bag system yourself. Be sure to tell anyone who works on your vehicle that it has an air bag system.
- Do not attempt to modify any part of your air bag system. The air bag may inflate accidentally or may not function properly if modifications are made. Take your vehicle to an authorized dealer for any air bag system service. If your seat, including your trim cover and cushion, needs to be serviced in any way (including removal or loosening/tightening of

*(Continued)*

**WARNING! (Continued)**

seat attachment bolts), take the vehicle to your authorized dealer. Only manufacturer approved seat accessories may be used. If it is necessary to modify the air bag system for persons with disabilities, contact your authorized dealer.

**Event Data Recorder (EDR)**

This vehicle is equipped with an event data recorder (EDR). The main purpose of an EDR is to record, in certain crash or near crash-like situations, such as an air bag deployment or hitting a road obstacle, data that will assist in understanding how a vehicle's systems performed. The EDR is designed to record data related to vehicle dynamics and safety systems for a short period of time, typically 30 seconds or less. The EDR in this vehicle is designed to record such data as:

- How various systems in your vehicle were operating

- Whether or not the driver and passenger safety belts were buckled/fastened
- How far (if at all) the driver was depressing the accelerator and/or brake pedal
- How fast the vehicle was traveling

These data can help provide a better understanding of the circumstances in which crashes and injuries occur.

**NOTE:** EDR data are recorded by your vehicle only if a non-trivial crash situation occurs; no data are recorded by the EDR under normal driving conditions and no personal data (e.g., name, gender, age, and crash location) are recorded. However, other parties, such as law enforcement, could combine the EDR data with the type of personally identifying data routinely acquired during a crash investigation.

To read data recorded by an EDR, special equipment is required, and access to the vehicle or the EDR is needed. In addition to the vehicle manufacturer, other parties, such as law enforcement, that have the special equipment, can read the information if they have access to the vehicle or the EDR.

### **Child Restraints**

Everyone in your vehicle needs to be buckled up at all times, including babies and children.

Every state in the United States, and every Canadian province, requires that small children ride in proper restraint systems. This is the law, and you can be prosecuted for ignoring it.

Children 12 years or younger should ride properly buckled up in a rear seat, if available. According to crash statistics, children are safer when properly restrained in the rear seats rather than in the front.

### **WARNING!**

**In a collision, an unrestrained child can become a projectile inside the vehicle. The force required to hold even an infant on your lap could become so great that you could not hold the child, no matter how strong you are. The child and others could be badly injured. Any child riding in your vehicle should be in a proper restraint for the child's size.**

There are different sizes and types of restraints for children from newborn size to the child almost large enough for an adult safety belt. Always check the child seat Owner's Manual to make sure you have the correct seat for your child. Carefully read and follow all the instructions and warnings in the child restraint Owner's Manual and on all the labels attached to the child restraint.

Before buying any restraint system, make sure that it has a label certifying that it meets all applicable Safety Standards. You should also make sure that you can install it in the vehicle where you will use it.

**NOTE:**

- For additional information, refer to [www.seatcheck.org](http://www.seatcheck.org) or call 1-866-732-8243.
- Canadian residents should refer to Transport Canada's website for additional information: [www.tc.gc.ca/eng/motorvehiclesafety/safedrivers-childsafety-index-53.htm](http://www.tc.gc.ca/eng/motorvehiclesafety/safedrivers-childsafety-index-53.htm)

## Summary Of Recommendations For Restraining Children In Vehicles

	<b>Child Size, Height, Weight Or Age</b>	<b>Recommended Type Of Child Restraint</b>
Infants and Toddlers	Children who are two years old or younger and who have not reached the height or weight limits of their child restraint	Either an Infant Carrier or a Convertible Child Restraint, facing rearward in the rear seat of the vehicle
Small Children	Children who are at least two years old or who have out-grown the height or weight limit of their rear-facing child restraint	Forward-Facing Child Restraint with a five-point Harness, facing forward in the rear seat of the vehicle
Larger Children	Children who have out-grown their forward-facing child restraint, but are too small to properly fit the vehicle's seat belt	Belt Positioning Booster Seat and the vehicle seat belt, seated in the rear seat of the vehicle
Children Too Large for Child Restraints	Children 12 years old or younger, who have out-grown the height or weight limit of their booster seat	Vehicle Seat Belt, seated in the rear seat of the vehicle

## Infants And Child Restraints

Safety experts recommend that children ride rear-facing in the vehicle until they are two years old or until they reach either the height or weight limit of their rear-facing child restraint. Two types of child restraints can be used rear-facing: infant carriers and convertible child seats.

The infant carrier is only used rear-facing in the vehicle. It is recommended for children from birth until they reach the weight or height limit of the infant carrier. Convertible child seats can be used either rear-facing or forward-facing in the vehicle. Convertible child seats often have a higher weight limit in the rear-facing direction than infant carriers do, so they can be used rear-facing by children who have outgrown their infant

carrier but are still less than at least two years old. Children should remain rear-facing until they reach the highest weight or height allowed by their convertible child seat.

### WARNING!

- **Never place a rear-facing child restraint in front of an air bag. A deploying passenger Advanced Front Air Bag can cause death or serious injury to a child 12 years or younger, including a child in a rear-facing child restraint.**
- **Only use a rear-facing child restraint in a vehicle with a rear seat.**

**WARNING!**

Do not install a rear-facing car seat using a rear support leg in this vehicle. The floor of this vehicle is not designed to manage the crash forces of this type of car seat. In a crash, the support leg may not function as it was designed by the car seat manufacturer, and your child may be more severely injured as a result.



0226047161

**Older Children And Child Restraints**

Children who are two years old or who have outgrown their rear-facing convertible child seat can ride forward-facing in the vehicle. Forward-facing child seats and convertible child seats used in the forward-facing direction are for children who are over two years old or who have outgrown the rear-facing weight or height limit of their rear-facing convertible child seat. Children should remain in a forward-facing child seat with a harness for as long as possible, up to the highest weight or height allowed by the child seat.

All children whose weight or height is above the forward-facing limit for the child seat should use a belt-positioning booster seat until the vehicle's seat belts fit properly. If the child cannot sit with knees bent over the vehicle's seat cushion while the child's back is against the seatback, they should use a belt-positioning booster



seat. The child and belt-positioning booster seat are held in the vehicle by the seat belt.

### **WARNING!**

- **Improper installation can lead to failure of an infant or child restraint. It could come loose in a collision. The child could be badly injured or killed. Follow the child restraint manufacturer's directions exactly when installing an infant or child restraint.**
- **After a child restraint is installed in the vehicle, do not move the vehicle seat forward or rearward because it can loosen the child restraint attachments. Remove the child restraint before adjusting the vehicle seat position. When the vehicle seat has been adjusted, reinstall the child restraint.**

*(Continued)*

### **WARNING! (Continued)**

- **When your child restraint is not in use, secure it in the vehicle with the seat belt or LATCH anchorages, or remove it from the vehicle. Do not leave it loose in the vehicle. In a sudden stop or accident, it could strike the occupants or seatbacks and cause serious personal injury.**

2

### **Children Too Large For Booster Seats**

Children who are large enough to wear the shoulder belt comfortably, and whose legs are long enough to bend over the front of the seat when their back is against the seatback, should use the seat belt in a rear seat. Use this simple 5-step test to decide whether the child can use the vehicle's seat belt alone:

1. Can the child sit all the way back against the back of the vehicle seat?

## 88 THINGS TO KNOW BEFORE STARTING YOUR VEHICLE

2. Do the child's knees bend comfortably over the front of the vehicle seat – while they are still sitting all the way back?
3. Does the shoulder belt cross the child's shoulder between their neck and arm?
4. Is the lap part of the belt as low as possible, touching the child's thighs and not their stomach?
5. Can the child stay seated like this for the whole trip?

If the answer to any of these questions was “no,” then the child still needs to use a booster seat in this vehicle. If the child is using the lap/shoulder belt, check seat belt fit periodically and make sure the seat belt buckle is latched. A child's squirming or slouching can move the belt out of

position. If the shoulder belt contacts the face or neck, move the child closer to the center of the vehicle, or use a booster seat to position the seat belt on the child correctly.

### **WARNING!**

**Never allow a child to put the shoulder belt under an arm or behind their back. In a crash, the shoulder belt will not protect a child properly, which may result in serious injury or death. A child must always wear both the lap and shoulder portions of the seat belt correctly.**

## Recommendations For Attaching Child Restraints

Restraint Type	Combined Weight of the Child + Child Restraint	Use any attachment method shown with an "X" Below			
		LATCH – Lower Anchors Only	Seat Belt Only	LATCH – Lower Anchors + Top Tether Anchor	Seat Belt + Top Tether Anchor
Rear-Facing Child Restraint	Up to 65 lbs (29.5 kg)	X	X		
Rear-Facing Child Restraint	More than 65 lbs (29.5 kg)		X		
Forward-Facing Child Restraint	Up to 65 lbs (29.5 kg)			X	X
Forward-Facing Child Restraint	More than 65 lbs (29.5 kg)				X

## Lower Anchors And Tethers For Children (LATCH) Restraint System



022668173

Your vehicle is equipped with the child restraint anchorage system called LATCH, which stands for Lower

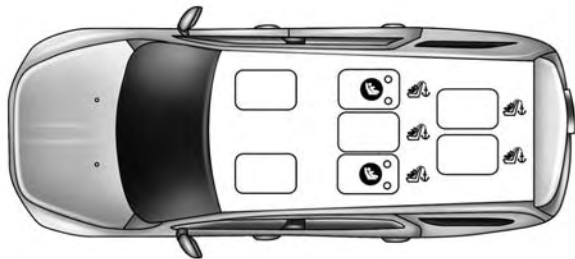

Anchors and Tethers for CHildren. The LATCH system has three vehicle anchor points for installing LATCH-equipped child seats. There are two lower anchorages located at the back of the seat cushion where it meets the seatback and one top tether anchorage located behind the seating position. These anchorages are used to install LATCH-equipped child seats without using the vehicle's seat belts. Some seating positions may have a top tether anchorage but no lower anchorages. In these seating positions, the seat belt must be used with the top tether anchorage to install the child restraint. Please see the following table for more information.

## LATCH Positions For Installing Child Restraints In This Vehicle



022668564

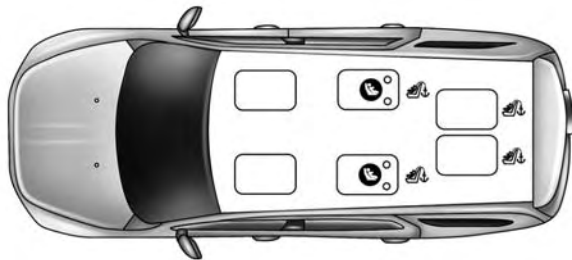

### 60/40 Second Row (7 Passenger)

-  Lower Anchorage Symbol 2 anchorages per seating position
-  Top Tether Anchorage Symbol



022668565

### Captains Chairs Second Row (6 Passenger)

-  Lower Anchorage Symbol 2 anchorages per seating position
-  Top Tether Anchorage Symbol

What is the weight limit (child's weight + weight of the child restraint) for using the LATCH anchorage system to attach the child restraint?	65 lbs (29.5 kg)	Use the LATCH anchorage system until the combined weight of the child and the child restraint is 65 lbs (29.5 kg). Use the seat belt and tether anchor instead of the LATCH system once the combined weight is more than 65 lbs (29.5 kg).
Can the LATCH anchorages and the seat belt be used together to attach a rear-facing or forward-facing child restraint?	No	Do not use the seat belt when you use the LATCH anchorage system to attach a rear-facing or forward-facing child restraint.
Can a child seat be installed in the center position using the inner LATCH lower anchorages?	N/A — 6 Passenger No — 7 Passenger	7 Passenger: Use the seat belt and tether anchor to install a child seat in the center seating position.

<p>Can two child restraints be attached using a common lower LATCH anchorage?</p>	<p>No</p>	<p>Never “share” a LATCH anchorage with two or more child restraints. If the center position does not have dedicated LATCH lower anchorages, use the seat belt to install a child seat in the center position next to a child seat using the LATCH anchorages in an outboard position.</p>
<p>Can the rear-facing child restraint touch the back of the front passenger seat?</p>	<p>Yes</p>	<p>The child seat may touch the back of the front passenger seat if the child restraint manufacturer also allows contact. See your child restraint owner’s manual for more information.</p>
<p>Can the head restraints be removed?</p>	<p>No — 6 Passenger Yes — 7 Passenger</p>	<p>7 Passenger: Only the head restraint in the center position may be removed.</p>

## Locating LATCH Anchorages



The lower anchorages are round bars that are found at the rear of the seat cushion where it meets the seatback. They are just visible when you lean into the rear seat to install the child restraint. You will easily feel them if you run your finger along the gap between the seatback and seat cushion.

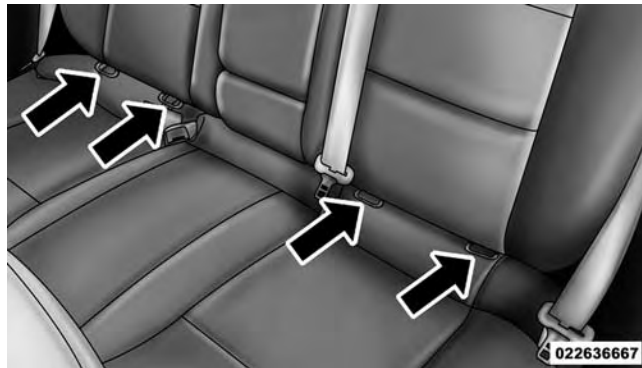

Rear Seat Lower Anchorages



## Locating Tether Anchorages — 2nd Row



There are tether strap anchorages behind each rear seating position located on the back of the seat.



2

Top Tether Strap Mounting (Captain's Chair)

## Locating Tether Anchorages — 3rd Row



There are tether strap anchorages behind each rear seating position located on the back of the seat. To access them, pull the carpeted floor panel away from the seat back, this will expose the top tether strap anchorages.



**Pulling Down The Carpet Floor Panel To Access Top Tether Strap**

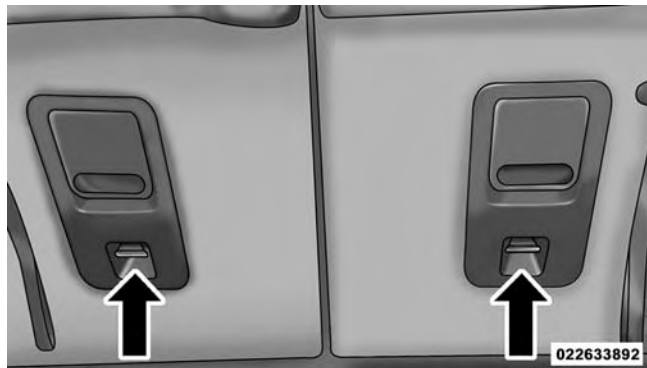

**Pulling Down The Carpet Floor Panel To Access Top Tether Strap**

LATCH-compatible child restraint systems will be equipped with a rigid bar or a flexible strap on each side. Each will have a hook or connector to attach to the lower anchorage and a way to tighten the connection to the anchorage. Forward-facing child restraints and some rear-facing child restraints will also be equipped with a

tether strap. The tether strap will have a hook at the end to attach to the top tether anchorage and a way to tighten the strap after it is attached to the anchorage.

### Center Seat LATCH:

#### **WARNING!**

- Do not install a child restraint in the center position using the LATCH system. This position is not approved for installing child seats using the LATCH attachments. You must use the seat belt and tether anchor to install a child seat in the center seating position.
- Never use the same lower anchorage to attach more than one child restraint. Please refer to "Installing The LATCH-Compatible Child Restraint System" for typical installation instructions.

Always follow the directions of the child restraint manufacturer when installing your child restraint. Not all child restraint systems will be installed as described here.

### Center Arm Rest Tether

For rear-facing child restraints secured in the center seat position with the vehicle seat belts, the rear center seat position has an armrest tether that secures the arm rest in the upward position.

1. To access the center seat arm rest tether, first lower the arm rest. The tether is located behind the armrest and hooked onto the plastic seat backing.



### Center Seat Position Arm Rest Tether

2. Pull down on the tether to unhook it from the plastic seat backing.
3. Raise the armrest and attach the tether hook to the strap located on the front of the arm rest.

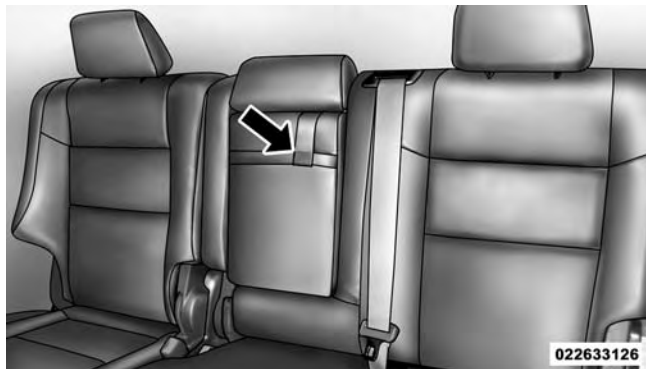

#### Center Seat Position Arm Rest Tether Attached

Always follow the directions of the child restraint manufacturer when installing your child restraint. Not all child restraint systems will be installed as described here.

### To Install A LATCH-Compatible Child Restraint

If the selected seating position has a Switchable Automatic Locking Retractor (ALR) seat belt, stow the seat belt, following the instructions below. See the section “Installing Child Restraints Using the Vehicle Seat Belt” to check what type of seat belt each seating position has.

1. Loosen the adjusters on the lower straps and on the tether strap of the child seat so that you can more easily attach the hooks or connectors to the vehicle anchorages.
2. Place the child seat between the lower anchorages for that seating position. For some second row seats, you may need to recline the seat and / or raise the head restraint to get a better fit. If the rear seat can be moved forward and rearward in the vehicle, you may wish to move it to its rear-most position to make room for the child seat. You may also move the front seat forward to allow more room for the child seat.

3. Attach the lower hooks or connectors of the child restraint to the lower anchorages in the selected seating position.
4. If the child restraint has a tether strap, connect it to the top tether anchorage. See the section “Installing Child Restraints Using the Top Tether Anchorage” for directions to attach a tether anchor.
5. Tighten all of the straps as you push the child restraint rearward and downward into the seat. Remove slack in the straps according to the child restraint manufacturer’s instructions.
6. Test that the child restraint is installed tightly by pulling back and forth on the child seat at the belt path. It should not move more than 1 inch (25.4 mm) in any direction.

### **How To Stow An Unused ALR Seat Belt:**

When using the LATCH attaching system to install a child restraint, stow all ALR seat belts that are not being used by other occupants or being used to secure child restraints. An unused belt could injure a child if they play with it and accidentally lock the seat belt retractor. Before installing a child restraint using the LATCH system, buckle the seat belt behind the child restraint and out of the child’s reach. If the buckled seat belt interferes with the child restraint installation, instead of buckling it behind the child restraint, route the seat belt through the child restraint belt path and then buckle it. Do not lock the seat belt. Remind all children in the vehicle that the seat belts are not toys and that they should not play with them.

**WARNING!**

- **Improper installation of a child restraint to the LATCH anchorages can lead to failure of the restraint. The child could be badly injured or killed. Follow the child restraint manufacturer's directions exactly when installing an infant or child restraint.**
- **Child restraint anchorages are designed to withstand only those loads imposed by correctly-fitted child restraints. Under no circumstances are they to be used for adult seat belts, harnesses, or for attaching other items or equipment to the vehicle.**

### Installing Child Restraints Using the Vehicle Seat Belt

The seat belts in the passenger seating positions are equipped with a Switchable Automatic Locking Retractor

(ALR) that is designed to keep the lap portion of the seat belt tight around the child restraint so that it is not necessary to use a locking clip. The ALR retractor can be “switched” into a locked mode by pulling all of the webbing out of the retractor and then letting the webbing retract back into the retractor. If it is locked, the ALR will make a clicking noise while the webbing is pulled back into the retractor. For additional information on ALR, refer to the “Automatic Locking Mode” description under “Occupant Restraints.”

## Lap/Shoulder Belt Systems For Installing Child Restraints In This Vehicle

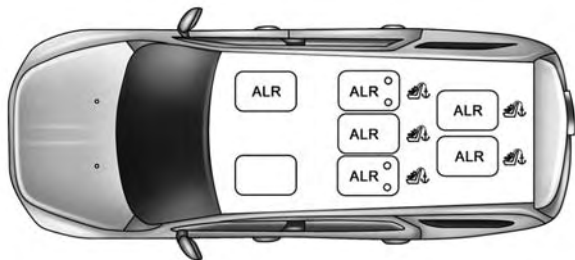

60/40 Second Row (7 passenger)

022668724

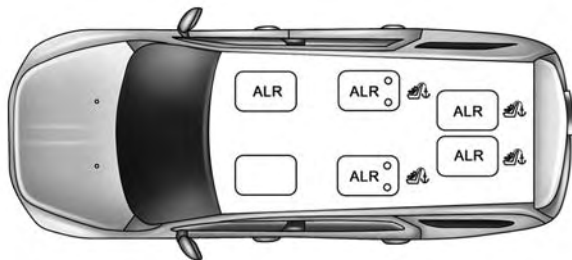

022668726

### Captains Chairs Second Row (6 Passenger)

- ALR = Switchable Automatic Locking Retractor
-  Top Tether Anchorage Symbol



<p>What is the weight limit (child's weight + weight of the child restraint) for using the Tether Anchor with the seat belt to attach a forward facing child restraint?</p>	<p>Weight limit of the Child Restraint</p>	<p>Always use the tether anchor when using the seat belt to install a forward facing child restraint, up to the recommended weight limit of the child restraint.</p>
<p>Can the rear-facing child restraint touch the back of the front passenger seat?</p>	<p>Yes</p>	<p>Contact between the front passenger seat and the child restraint is allowed, if the child restraint manufacturer also allows contact.</p>
<p>Can the head restraints be removed?</p>	<p>No — 6 Passenger Yes — 7 Passenger</p>	<p>7 Passenger: Only the head restraint in the center position may be removed.</p>
<p>Can the buckle stalk be twisted to tighten the seat belt against the belt path of the child restraint?</p>	<p>No</p>	<p>Do not twist the buckle stalk in a seating position with an ALR retractor.</p>

### Installing A Child Restraint With A Switchable Automatic Locking Retractor (ALR)

1. Place the child seat in the center of the seating position. For some second row seats, you may need to recline the seat and/or raise the head restraint to get a better fit. If the rear seat can be moved forward and rearward in the vehicle, you may wish to move it to its rear-most position to make room for the child seat. You may also move the front seat forward to allow more room for the child seat.
2. Pull enough of the seat belt webbing from the retractor to pass it through the belt path of the child restraint. Do not twist the belt webbing in the belt path.
3. Slide the latch plate into the buckle until you hear a "click."
4. Pull on the webbing to make the lap portion tight against the child seat.
5. To lock the seat belt, pull down on the shoulder part of the belt until you have pulled all the seat belt webbing out of the retractor. Then, allow the webbing to retract back into the retractor. As the webbing retracts, you will hear a clicking sound. This means the seat belt is now in the Automatic Locking mode.
6. Try to pull the webbing out of the retractor. If it is locked, you should not be able to pull out any webbing. If the retractor is not locked, repeat step 5.
7. Finally, pull up on any excess webbing to tighten the lap portion around the child restraint while you push the child restraint rearward and downward into the vehicle seat.
8. If the child restraint has a top tether strap and the seating position has a top tether anchorage, connect the tether strap to the anchorage and tighten the tether

strap. See the section “Installing Child Restraints Using the Top Tether Anchorage” for directions to attach a tether anchor.

- Test that the child restraint is installed tightly by pulling back and forth on the child seat at the belt path. It should not move more than 1 inch (25.4 mm) in any direction.

Any seat belt system will loosen with time, so check the belt occasionally, and pull it tight if necessary.

### Installing Child Restraints Using the Top Tether Anchorage

#### **WARNING!**

Do not attach a tether strap for a rear-facing car seat to any location in front of the car seat, including the seat frame or a tether anchorage. Only attach the

*(Continued)*

#### **WARNING! (Continued)**

tether strap of a rear-facing car seat to the tether anchorage that is approved for that seating position, located behind the top of the vehicle seat. See the section “Lower Anchors and Tethers for Children (LATCH) Restraint System” for the location of approved tether anchorages in your vehicle.



## 106 THINGS TO KNOW BEFORE STARTING YOUR VEHICLE

1. Look behind the seating position where you plan to install the child restraint to find the tether anchorage. You may need to move the seat forward to provide better access to the tether anchorage. If there is no top tether anchorage for that seating position, move the child restraint to another position in the vehicle if one is available.



2. To access the top tether strap anchorages behind the rear seat, pull the carpeted floor panel away from the seat back, this will expose the top tether strap anchorages.



**Pulling Down The Carpet Floor Panel To Access Top Tether Strap**

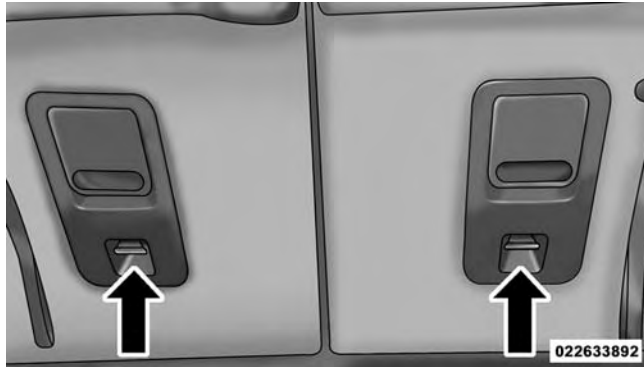

Top Tether Strap Anchorage (Located on Seatback)

3. Route the tether strap to provide the most direct path for the strap between the anchor and the child seat. If your vehicle is equipped with adjustable rear head restraints, raise the head restraint, and where possible, route the tether strap under the head restraint and between the two posts. If not possible, lower the head restraint and pass the tether strap around the outboard side of the head restraint.
4. For the center seating position, route the tether strap over the seatback and headrest then attach the hook to the tether anchor located on the back of the seat.
5. Attach the tether strap hook of the child restraint to the top tether anchorage as shown in the diagram.



**Top Tether Strap Mounting (60/40 Seat)**



**Top Tether Strap Mounting (Captain's Chair)**

6. Remove slack in the tether strap according to the child restraint manufacturer's instructions.

**WARNING!**

- The top tether anchorages are not visible until the gap panel is folded down. Do not use the visible cargo tie down hooks, located on the floor behind the seats, to attach a child restraint tether anchor.
- An incorrectly anchored tether strap could lead to increased head motion and possible injury to the child. Use only the anchorage position directly behind the child seat to secure a child restraint top tether strap.
- If your vehicle is equipped with a split rear seat, make sure the tether strap does not slip into the opening between the seatbacks as you remove slack in the strap.

**Transporting Pets**

Air Bags deploying in the front seat could harm your pet. An unrestrained pet will be thrown about and possibly injured, or injure a passenger during panic braking or in a collision.

Pets should be restrained in the rear seat in pet harnesses or pet carriers that are secured by seat belts.

**ENGINE BREAK-IN RECOMMENDATIONS**

A long break-in period is not required for the engine and drivetrain (transmission and axle) in your vehicle.

Drive moderately during the first 300 miles (500 km). After the initial 60 miles (100 km), speeds up to 50 or 55 mph (80 or 90 km/h) are desirable.

While cruising, brief full-throttle acceleration within the limits of local traffic laws contributes to a good break-in. Wide-open throttle acceleration in low gear can be detrimental and should be avoided.

The engine oil installed in the engine at the factory is a high-quality energy conserving type lubricant. Oil changes should be consistent with anticipated climate conditions under which vehicle operations will occur. For the recommended viscosity and quality grades, refer to "Maintenance Procedures" in "Maintaining Your Vehicle."

**CAUTION!**

Never use Non-Detergent Oil or Straight Mineral Oil in the engine or damage may result.

**NOTE:** A new engine may consume some oil during its first few thousand miles (kilometers) of operation. This should be considered a normal part of the break-in and not interpreted as a problem.

**SAFETY TIPS****Transporting Passengers**

NEVER TRANSPORT PASSENGERS IN THE CARGO AREA.

**WARNING!**

- Do not leave children or animals inside parked vehicles in hot weather. Interior heat build-up may cause serious injury or death.
- It is extremely dangerous to ride in a cargo area, inside or outside of a vehicle. In a collision, people riding in these areas are more likely to be seriously injured or killed.

*(Continued)*



**WARNING! (Continued)**

- Do not allow people to ride in any area of your vehicle that is not equipped with seats and seat belts.
- Be sure everyone in your vehicle is in a seat and using a seat belt properly.

**Exhaust Gas****WARNING!**

Exhaust gases can injure or kill. They contain carbon monoxide (CO), which is colorless and odorless. Breathing it can make you unconscious and can eventually poison you. To avoid breathing (CO), follow these safety tips:

- Do not run the engine in a closed garage or in confined areas any longer than needed to move your vehicle in or out of the area.

*(Continued)***WARNING! (Continued)**

- If you are required to drive with the trunk/liftgate/rear doors open, make sure that all windows are closed and the climate control BLOWER switch is set at high speed. DO NOT use the recirculation mode.
- If it is necessary to sit in a parked vehicle with the engine running, adjust your heating or cooling controls to force outside air into the vehicle. Set the blower at high speed.

The best protection against carbon monoxide entry into the vehicle body is a properly maintained engine exhaust system.

Whenever a change is noticed in the sound of the exhaust system, when exhaust fumes can be detected inside the vehicle, or when the underside or rear of the vehicle is damaged, have a competent mechanic inspect the complete exhaust system and adjacent body areas for broken,

damaged, deteriorated, or mispositioned parts. Open seams or loose connections could permit exhaust fumes to seep into the passenger compartment. In addition, inspect the exhaust system each time the vehicle is raised for lubrication or oil change. Replace as required.

## **Safety Checks You Should Make Inside The Vehicle**

### **Seat Belts**

Inspect the seat belt system periodically, checking for cuts, frays, and loose parts. Damaged parts must be replaced immediately. Do not disassemble or modify the system.

Front seat belt assemblies must be replaced after a collision. Rear seat belt assemblies must be replaced after a collision if they have been damaged (i.e., bent retractor, torn webbing, etc.). If there is any question regarding seat belt or retractor condition, replace the seat belt.

### **Air Bag Warning Light**



The light should come on and remain on for four to eight seconds as a bulb check when the ignition switch is first turned ON. If the light is not lit during starting, see your authorized dealer. If the light stays on, flickers, or comes on while driving, have the system checked by an authorized dealer.

### **Defroster**

Check operation by selecting the defrost mode and place the blower control on high speed. You should be able to feel the air directed against the windshield. See your authorized dealer for service if your defroster is inoperable.

## Floor Mat Safety Information

Always use floor mats designed to fit the footwell of your vehicle. Use only floor mats that leave the pedal area unobstructed and that are firmly secured so that they cannot slip out of position and interfere with the pedals or impair safe operation of your vehicle in other ways.

### WARNING!

Pedals that cannot move freely can cause loss of vehicle control and increase the risk of serious personal injury.

- Always make sure that floor mats are properly attached to the floor mat fasteners.
- Never place or install floor mats or other floor coverings in the vehicle that cannot be properly secured to prevent them from moving and interfering with the pedals or the ability to control the vehicle.

*(Continued)*

### WARNING! *(Continued)*

- Never put floor mats or other floor coverings on top of already installed floor mats. Additional floor mats and other coverings will reduce the size of the pedal area and interfere with the pedals.
- Check mounting of mats on a regular basis. Always properly reinstall and secure floor mats that have been removed for cleaning.
- Always make sure that objects cannot fall into the driver footwell while the vehicle is moving. Objects can become trapped under the brake pedal and accelerator pedal causing a loss of vehicle control.
- If required, mounting posts must be properly installed, if not equipped from the factory.

Failure to properly follow floor mat installation or mounting can cause interference with the brake pedal and accelerator pedal operation causing loss of control of the vehicle.

## **Periodic Safety Checks You Should Make Outside The Vehicle**

### **Tires**

Examine tires for excessive tread wear and uneven wear patterns. Check for stones, nails, glass, or other objects lodged in the tread or sidewall. Inspect the tread for cuts and cracks. Inspect sidewalls for cuts, cracks, and bulges. Check the wheel nuts for tightness. Check the tires (including spare) for proper cold inflation pressure.

### **Lights**

Have someone observe the operation of brake lights and exterior lights while you work the controls. Check turn signal and high beam indicator lights on the instrument panel.

### **Door Latches**

Check for proper closing, latching, and locking.

### **Fluid Leaks**

Check area under vehicle after overnight parking for fuel, engine coolant, oil, or other fluid leaks. Also, if gasoline fumes are detected or if fuel, power steering fluid (if equipped), or brake fluid leaks are suspected. The cause should be located and corrected immediately.

# UNDERSTANDING THE FEATURES OF YOUR VEHICLE

## CONTENTS

---

■ MIRRORS . . . . .	.122	□ Tilt Mirrors In Reverse (Available With Memory Seat Only) — If Equipped . . . . .	.131
□ Inside Day/Night Mirror — If Equipped . . .	.122	□ Illuminated Vanity Mirrors . . . . .	.131
□ Outside Mirrors . . . . .	.122	□ Sun Visor Extension — If Equipped . . . . .	.132
□ Automatic Dimming Mirror — If Equipped . .	.123	■ BLIND SPOT MONITORING (BSM) — IF EQUIPPED . . . . .	.132
□ Outside Mirrors Folding Feature . . . . .	.129	□ Rear Cross Path (RCP) . . . . .	.139
□ Outside Automatic Dimming Mirror — If Equipped . . . . .	.129	□ Modes Of Operation . . . . .	.140
□ Power Mirrors . . . . .	.129	□ General Information. . . . .	.141
□ Heated Mirrors — If Equipped . . . . .	.130	■ SEATS . . . . .	.142

## 116 UNDERSTANDING THE FEATURES OF YOUR VEHICLE

- Power Seats — If Equipped . . . . .142
- Passenger's Power Seat — If Equipped . . . . .144
- Power Lumbar — If Equipped . . . . .145
- Manual Front Passenger Seat Forward/Rearward Adjustment . . . . .146
- Manual Front Passenger Seatback Adjustment — Recline . . . . .147
- Front Passenger Seat Fold-Flat Feature — If Equipped . . . . .148
- Heated Seats — If Equipped. . . . .148
- Front Ventilated Seats — If Equipped . . . . .152
- Head Restraints . . . . .152
- 60/40 Split Rear Seat . . . . .158
- Rear Captain Chairs — If Equipped. . . . .161
- Folding Third Row . . . . .164
- DRIVER MEMORY SEAT — IF EQUIPPED . . . . .165
  - Programming The Memory Feature. . . . .167
  - Linking And Unlinking The Remote Keyless Entry Transmitter To Memory . . . . .168
  - Memory Position Recall . . . . .169
  - Easy Entry/Exit Seat . . . . .170
- TO OPEN AND CLOSE THE HOOD . . . . .171
- LIGHTS . . . . .172
  - Headlight Switch . . . . .172
  - Automatic Headlights — If Equipped . . . . .174
  - Headlights On Automatically With Wipers . . .174
  - Automatic High Beam — If Equipped . . . . .174

□ Daytime Running Lights — If Equipped . . . . .	175	<b>UNDERSTANDING THE FEATURES OF YOUR VEHICLE</b> 117	
□ Headlight Delay . . . . .	176	□ Flash-To-Pass . . . . .	182
□ Parking Lights And Panel Lights. . . . .	176	□ High/Low Beam Switch. . . . .	182
□ Fog Lights — If Equipped . . . . .	176	■ <b>WINDSHIELD WIPERS AND WASHERS</b> . . . . .	183
□ Interior Lights . . . . .	177	□ Windshield Wiper Operation . . . . .	184
□ Lights-On Reminder . . . . .	178	□ Intermittent Wiper System . . . . .	184
□ Battery Saver. . . . .	179	□ Windshield Washer Operation. . . . .	185
□ Front Map/Reading Lights — If Equipped . . .	179	□ Mist . . . . .	186
□ Courtesy Lights. . . . .	180	□ Rain Sensing Wipers — If Equipped . . . . .	187
□ Ambient Light — If Equipped . . . . .	181	■ <b>TILT/TELESCOPING STEERING COLUMN</b> . . .	188
□ Multifunction Lever . . . . .	181	■ <b>POWER TILT/TELESCOPING STEERING</b> <b>COLUMN — IF EQUIPPED</b> . . . . .	189
□ Turn Signals . . . . .	182	■ <b>HEATED STEERING WHEEL — IF EQUIPPED</b> .	191
□ Lane Change Assist . . . . .	182	■ <b>ELECTRONIC SPEED CONTROL — IF</b> <b>EQUIPPED</b> . . . . .	192

## 118 UNDERSTANDING THE FEATURES OF YOUR VEHICLE

- To Activate . . . . .193
- To Set A Desired Speed . . . . .193
- To Deactivate . . . . .194
- To Resume Speed . . . . .194
- To Vary The Speed Setting . . . . .194
- To Accelerate For Passing . . . . .195
- ADAPTIVE CRUISE CONTROL (ACC) — IF EQUIPPED . . . . .196
  - Adaptive Cruise Control (ACC) Operation . . . . .198
  - Activating Adaptive Cruise Control (ACC). . . . .199
  - To Activate/Deactivate. . . . .200
  - To Set A Desired ACC Speed . . . . .201
  - To Cancel . . . . .202
  - To Turn Off . . . . .202
  - To Resume . . . . .203
  - To Vary The Speed Setting . . . . .203
  - Setting The Following Distance In ACC . . . . .206
  - Overtake Aid . . . . .210
  - ACC Operation At Stop . . . . .210
  - Adaptive Cruise Control (ACC) Menu . . . . .211
  - Display Warnings And Maintenance . . . . .212
  - Precautions While Driving With ACC . . . . .215
  - General Information. . . . .219
  - Normal (Fixed Speed) Electronic Speed Control Mode . . . . .219
- FORWARD COLLISION WARNING (FCW) WITH MITIGATION — IF EQUIPPED . . . . .223



□ Forward Collision Warning (FCW) With Mitigation Operation . . . . .	.223
□ Turning FCW ON Or OFF . . . . .	.225
□ Changing FCW And Active Braking Status. . . . .	.226
□ FCW Limited Warning . . . . .	.227
□ Service FCW Warning . . . . .	.227
■ PARKSENSE® REAR PARK ASSIST — IF EQUIPPED . . . . .	.228
□ ParkSense® Sensors . . . . .	.228
□ ParkSense® Warning Display . . . . .	.228
□ ParkSense® Display . . . . .	.229
□ Enabling And Disabling ParkSense® . . . . .	.234
□ Service The ParkSense® Rear Park Assist System . . . . .	.234

<b>UNDERSTANDING THE FEATURES OF YOUR VEHICLE</b> . . . . .	<b>119</b>
□ Cleaning The ParkSense® System . . . . .	.235
□ ParkSense® System Usage Precautions. . . . .	.235
■ PARKVIEW® REAR BACK UP CAMERA — IF EQUIPPED . . . . .	.237
■ OVERHEAD CONSOLE . . . . .	.240
□ Front Map/Reading Lights — If Equipped . . . . .	.240
□ Courtesy Lights . . . . .	.241
□ Sunglasses Bin Door . . . . .	.242
■ GARAGE DOOR OPENER — IF EQUIPPED . . . . .	.242
□ Before You Begin Programming HomeLink® . . . . .	.244
□ Programming A Rolling Code . . . . .	.244
□ Programming A Non-Rolling Code . . . . .	.246
□ Canadian/Gate Operator Programming . . . . .	.248

## 120 UNDERSTANDING THE FEATURES OF YOUR VEHICLE

- Using HomeLink® . . . . . 249
- Security . . . . . 249
- Troubleshooting Tips . . . . . 250
- General Information. . . . . 251
- POWER SUNROOF — IF EQUIPPED . . . . . 252
  - Opening Sunroof — Express . . . . . 253
  - Opening Sunroof — Manual Mode . . . . . 253
  - Closing Sunroof — Express. . . . . 253
  - Closing Sunroof — Manual Mode . . . . . 253
  - Pinch Protect Feature . . . . . 253
  - Venting Sunroof — Express . . . . . 254
  - Sunshade Operation. . . . . 254
  - Wind Buffeting . . . . . 254
  - Sunroof Maintenance . . . . . 254
  - Ignition OFF Operation . . . . . 255
- ELECTRICAL POWER OUTLETS . . . . . 255
- POWER INVERTER — IF EQUIPPED . . . . . 259
- CUPHOLDERS . . . . . 261
  - Front Seat Cupholders . . . . . 261
  - Rear Cupholders . . . . . 261
- STORAGE . . . . . 263
  - Glove Compartment . . . . . 263
  - Door Storage. . . . . 264
  - Front Center Console . . . . . 264
  - Rear Full Center Console — If Equipped . . . . 265
  - Rear Mini Center Console — If Equipped . . . 269

<hr/>		<b>UNDERSTANDING THE FEATURES OF YOUR VEHICLE</b>	<b>121</b>
■ CARGO AREA FEATURES	. . . . .	□ Rear Window Wiper/Washer	. . . . . 274
□ Rechargeable Flashlight	. . . . . 270	□ Rear Window Defroster	. . . . . 276
□ Cargo Storage	. . . . . 271	■ ROOF LUGGAGE RACK — IF EQUIPPED	. . . . . 277
□ Retractable Cargo Area Cover — If Equipped	. 272	□ Deploying the Crossbars.	. . . . . 278
□ Cargo Tie-Down Hooks	. . . . . 273	□ Stowing The Crossbars.	. . . . . 280
■ REAR WINDOW FEATURES	. . . . . 274		

## MIRRORS

### Inside Day/Night Mirror — If Equipped

A single ball joint mirror is provided in the vehicle. It is a twist on mirror that has a fixed position at the windshield. The mirror installs on the windshield button with a counterclockwise rotation and requires no tools for mounting. The mirror head can be adjusted up, down, left, and right for various drivers. The mirror should be adjusted to center on the view through the rear window.

Headlight glare from vehicles behind you can be reduced by moving the small control under the mirror to the night position (toward the rear of the vehicle). The mirror should be adjusted while the small control under the mirror is set in the day position (toward the windshield).

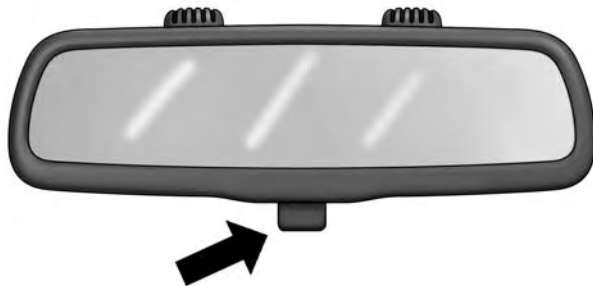

0304049206

Adjusting Rearview Mirror

### Outside Mirrors

To receive maximum benefit, adjust the outside mirrors to center on the adjacent lane of traffic with a slight overlap of the view obtained on the inside mirror.

**WARNING!**

Vehicles and other objects seen in the passenger side convex mirror will look smaller and farther away than they really are. Relying too much on your passenger side convex mirror could cause you to collide with another vehicle or other object. Use your inside mirror when judging the size or distance of a vehicle seen in the passenger side convex mirror. Some vehicles will not have a convex passenger side mirror.

**Automatic Dimming Mirror — If Equipped**

A single ball joint mirror is provided in the vehicle. It is a twist on mirror that has a fixed position at the windshield. The mirror installs on the windshield button with a counterclockwise rotation and requires no tools for mounting. The mirror head can be adjusted up, down,

left, and right for various drivers. The mirror should be adjusted to center on the view through the rear window.

This mirror automatically adjusts for headlight glare from vehicles behind you.

**NOTE:** The Automatic Dimming Mirror feature is disabled when the vehicle is in reverse gear to improve rear view viewing.

The Automatic Dimming Mirror feature can be turned On or Off through the touchscreen.

- Push the Mirror Dimmer button once to turn the feature On.
- Push the Mirror Dimmer button a second time to turn the feature Off.



0304049205

### Automatic Dimming Mirror

If equipped, the rearview mirror contains an ASSIST and a 9-1-1 button.

**NOTE:** The ASSIST and 9-1-1 features operate through the Uconnect® Access service. These buttons will only operate as long as your Uconnect® Access service is active. Refer to your “Uconnect® System supplement manual” for further information.

### ASSIST Call

The ASSIST Button is used to automatically connect you to any one of the following support centers:

- Roadside Assistance – If you get a flat tire, or need a tow, just push the Assist button and you’ll be connected to someone who can help. Roadside Assistance will know what vehicle you’re driving and its location. Additional fees may apply for roadside Assistance.
- Uconnect® Access Customer Care – In-vehicle support for Uconnect® Access and Uconnect® Access Via Mobile features.
- Vehicle Customer Care – Total support for all other vehicle issues.

## 9-1-1 Call

1. Push the 9-1-1 Call button on the Rearview Mirror.

**NOTE:** In case the 9-1-1 Call button is pushed in error, there will be a 10 second delay before the 9-1-1 Call system initiates a call to a 9-1-1 operator. To cancel the 9-1-1 Call connection, push the 9-1-1 Call button on the Rearview Mirror or press the cancellation button on the Phone Screen. Termination of the 9-1-1 Call will turn off the green LED light on the Rearview Mirror.

2. The LED light located between the Assist and 9-1-1 buttons on the Rearview Mirror will turn green once a connection to a 9-1-1 operator has been made.

3. Once a connection between the vehicle and a 9-1-1 operator is made, the 9-1-1 Call system may transmit the following important vehicle information to a 9-1-1 operator:

- Indication that the occupant placed a 9-1-1 Call.

- The vehicle brand.

- The last known GPS coordinates of the vehicle.

4. You should be able to speak with the 9-1-1 operator through the vehicle audio system to determine if additional help is needed.

**NOTE:** Once a connection is made between the vehicle's 9-1-1 Call system and the 9-1-1 operator, the 9-1-1 operator may be able to open a voice connection with the vehicle to determine if additional help is needed. Once the 9-1-1 operator opens a voice connection with the vehicle's 9-1-1 Call system, the operator should be able to speak with you or other vehicle occupants and hear sounds occurring in the vehicle. The vehicle's 9-1-1 Call system will attempt to remain connected with the 9-1-1 operator until the 9-1-1 operator terminates the connection.

5. The 9-1-1 operator may attempt to contact appropriate emergency responders and provide them with important vehicle information and GPS coordinates.

**WARNING!**

- If anyone in the vehicle could be in danger (e.g., fire or smoke is visible, dangerous road conditions or location), do not wait for voice contact from a 9-1-1 operator. All occupants should exit the vehicle immediately and move to a safe location.
- The 9-1-1 Call system is embedded into the vehicle's electrical system. Do not add aftermarket electrical equipment to the vehicle's electrical system. This may prevent your vehicle from sending a signal to initiate an emergency call. To avoid interference that can cause the 9-1-1 Call system to fail, never add aftermarket equipment (e.g., two-way

*(Continued)*

**WARNING! (Continued)**

- mobile radio, CB radio, data recorder, etc.) to your vehicle's electrical system or modify the antennas on your vehicle. **IF YOUR VEHICLE LOSES BATTERY POWER FOR ANY REASON (INCLUDING DURING OR AFTER AN ACCIDENT), THE UCONNECT FEATURES, APPS AND SERVICES, AMONG OTHERS, WILL NOT OPERATE.**
- Modifications to any part of the 9-1-1 Call system could cause the air bag system to fail when you need it. You could be injured if the air bag system is not there to help protect you.

**9-1-1 Call System Limitations**

Vehicles sold in Canada and Mexico **DO NOT** have 9-1-1 Call system capabilities.

9-1-1 or other emergency line operators in Canada and Mexico may not answer or respond to 9-1-1 system calls.



If the 9-1-1 Call system detects a malfunction, any of the following may occur at the time the malfunction is detected, and at the beginning of each ignition cycle:

- The Rearview Mirror light located between the Assist and 9-1-1 buttons will continuously be illuminated red.
- The Phone Screen will display the following message “Vehicle phone requires service. Please contact your dealer.”
- An In-Vehicle Audio message will state “Vehicle phone requires service. Please contact your dealer.”

### **WARNING!**

- **Ignoring the Rearview Mirror light could mean you will not have 9-1-1 Call services. If the Rearview Mirror light is illuminated, have an authorized dealer service the 9-1-1 Call system immediately.**

*(Continued)*

### **WARNING! (Continued)**

- **The Occupant Restraint Control module turns on the Air Bag Warning Light on the instrument panel if a malfunction in any part of the system is detected. If the Air Bag Warning Light is illuminated, the air bag system may not be working properly and the 9-1-1 system may not be able to send a signal to a 9-1-1 operator. If the Air Bag Warning Light is illuminated, have an authorized dealer service the ORC system immediately.**

Even if the 9-1-1 Call system is fully functional, factors beyond FCA US LLC’s control may prevent or stop the 9-1-1 Call system operation. These include, but are not limited to, the following factors:

- Delayed accessories mode is active.
- The ignition is in the OFF position.

- The vehicle's electrical systems are not intact.
- The 9-1-1 Call system software and/or hardware are damaged during a crash.
- The vehicle battery loses power or becomes disconnected during a vehicle crash.
- Wireless and/or Global Positioning Satellite signals are unavailable or obstructed.
- Equipment malfunction at the 9-1-1 operator facility.
- Operator error by the 9-1-1 operator.
- Wireless network congestion.
- Weather.
- Buildings, structures, geographic terrain, or tunnels.

**NOTE:** Never place anything on or near the vehicle's wireless and GPS antennas. You could prevent wireless and GPS signal reception, which can prevent your vehicle from placing an emergency call. Wireless and GPS signal reception is required for the 9-1-1 Call system to function properly.

### **General Information**

This device complies with Part 15 of the FCC Rules. Operation is subject to the following two conditions: (1) This device may not cause harmful interference, and (2) this device must accept any interference received, including interference that may cause undesired operation.

**NOTE:** Changes or modifications not expressly approved by the party responsible for compliance could void the user's authority to operate the equipment.

**CAUTION!**

To avoid damage to the mirror during cleaning, never spray any cleaning solution directly onto the mirror. Apply the solution onto a clean cloth and wipe the mirror clean.

**Outside Mirrors Folding Feature**

All outside mirrors are hinged and may be moved either forward or rearward to resist damage. The hinges have three detent positions:

- Full forward position
- Full rearward position
- Normal position

**Outside Automatic Dimming Mirror — If Equipped**

The Drivers side mirror will automatically adjust for glare from vehicles behind you. This feature is controlled by the inside automatic dimming mirror. The mirrors will automatically adjust for headlight glare when the inside mirror adjusts.

**Power Mirrors**

The power mirror switch is located on the driver's side door trim panel.

The power mirror controls consist of mirror select buttons and a four-way mirror control switch. To adjust a mirror, push the mirror select button for the mirror that you want to adjust. Using the mirror control switch, push on any of the four arrows for the direction that you want the mirror to move.

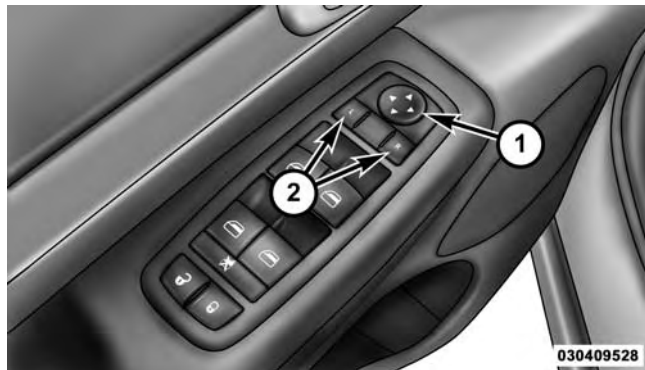

**Power Mirror Switch**

- 1 — Mirror Direction Control
- 2 — Mirror Selection

Power mirror preselected positions can be controlled by the optional Memory Seat Feature. Refer to “Driver Memory Seat” in “Understanding The Features Of Your Vehicle” for further information.

### **Heated Mirrors — If Equipped**



These mirrors are heated to melt frost or ice. This feature can be activated whenever you turn on the rear window defroster (if equipped). Refer to “Rear Window Features” in “Understanding The Features Of Your Vehicle” for further information.

### Tilt Mirrors In Reverse (Available With Memory Seat Only) — If Equipped

Tilt Mirrors in Reverse provides automatic outside mirror positioning which will aid the driver's view of the ground rearward of the front doors. Outside mirrors will move slightly downward from the present position when the vehicle is shifted into REVERSE. Outside mirrors will then return to the original position when the vehicle is shifted out of REVERSE position. Each stored memory setting will have an associated Tilt Mirrors in Reverse position.

**NOTE:** The Tilt Mirrors in Reverse feature is not turned on when delivered from the factory. The Tilt Mirrors in Reverse feature can be turned on and off using the Uconnect System. Refer to "Uconnect Settings/Customer Programmable Features" in "Understanding Your Instrument Panel" for further information.

### Illuminated Vanity Mirrors

To access an illuminated vanity mirror, flip down one of the visors.

Lift the cover to reveal the mirror. The light will turn on automatically.

3

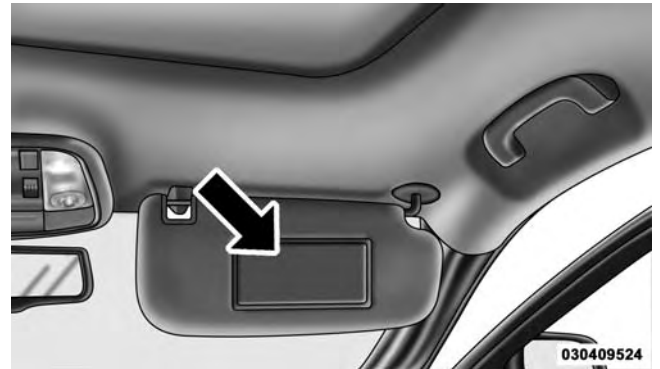

Illuminated Vanity Mirror

### Sun Visor Extension — If Equipped

This feature has a pull out extension on the sun visor for increased coverage.

### BLIND SPOT MONITORING (BSM) — IF EQUIPPED

The Blind Spot Monitoring (BSM) system uses two radar-based sensors, located inside the rear bumper fascia, to detect highway licensable vehicles (automobiles, trucks, motorcycles, etc.) that enter the blind spot zones from the rear/front/side of the vehicle.

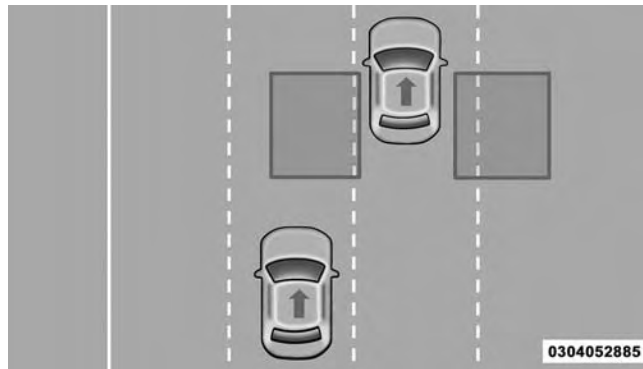

#### Rear Detection Zones

When the vehicle is started, the BSM warning light will be momentarily illuminated in both outside rear view mirrors to let the driver know that the system is operational. The BSM system sensors operate when the vehicle is in any forward gear or REVERSE and enters stand by mode when the vehicle is in PARK.

The BSM detection zone covers approximately one lane on both sides of the vehicle (12 ft or 3.8 m). The zone length starts at the outside rear view mirror and extends approximately 10 ft (3 m) beyond the rear bumper of the vehicle. The BSM system monitors the detection zones on both sides of the vehicle when the vehicle speed has reached approximately 6 mph (10 km/h) or higher and will alert the driver of vehicles in these areas.

**NOTE:**

- The BSM system does NOT alert the driver about rapidly approaching vehicles that are outside the detection zones.

- The BSM system detection zone DOES NOT change if your vehicle is towing a trailer. Therefore, visually verify the adjacent lane is clear for both your vehicle and trailer before making a lane change. If the trailer or other object (i.e., bicycle, sports equipment) extends beyond the side of your vehicle, this may result in the BSM warning light remaining illuminated or the alert chime remaining on the entire time the vehicle is in a forward gear. Refer to “Uconnect® Settings” in “Understanding Your Instrument Panel” for more information.

## 134 UNDERSTANDING THE FEATURES OF YOUR VEHICLE

The area on the rear fascia where the radar sensors are located must remain free of snow, ice, and dirt/road contamination so that the BSM system can function properly. Do not block the area of the rear fascia where the radar sensors are located with foreign objects (bumper stickers, bicycle racks, etc.).



0304007714

Sensor Location (Left Side Shown)

The BSM system notifies the driver of objects in the detection zones by illuminating the BSM warning light located in the outside mirrors in addition to sounding an audible (chime) alert and reducing the radio volume. Refer to “Modes Of Operation” for further information.



030433315

BSM Warning Light



The BSM system monitors the detection zone from three different entry points (Side, Rear, Front) while driving to see if an alert is necessary. The BSM system will issue an alert during these types of zone entries.

### Entering From The Side

Vehicles that move into your adjacent lanes from either side of the vehicle.

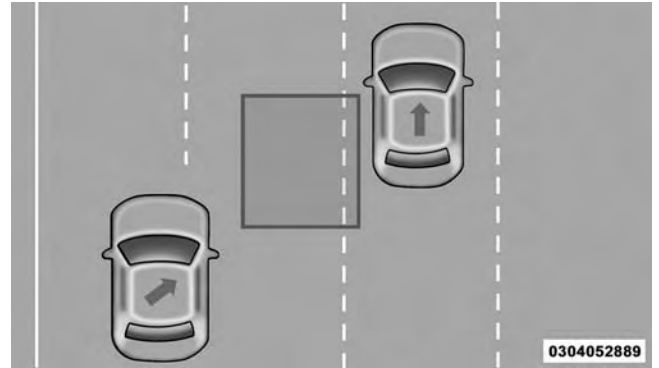

Side Monitoring

### Entering From The Rear

Vehicles that come up from behind your vehicle on either side and enter the rear detection zone with a relative speed of less than 30 mph (48 km/h).

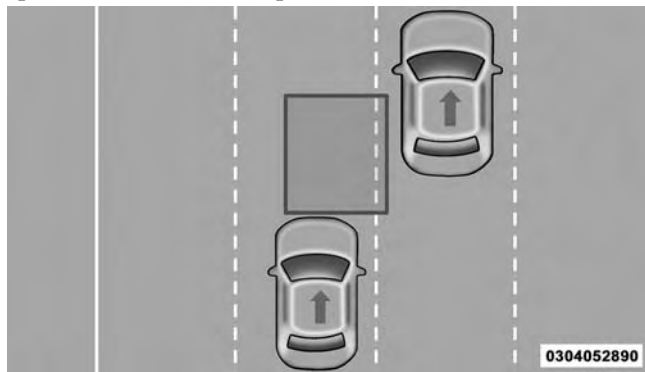

Rear Monitoring

### Overtaking Traffic

If you pass another vehicle slowly (with a relative speed of less than 15 mph (24 km/h) and the vehicle remains in the blind spot for approximately 1.5 seconds, the warning light will be illuminated. If the difference in speed between the two vehicles is greater than 15 mph (24 km/h), the warning light will not illuminate.

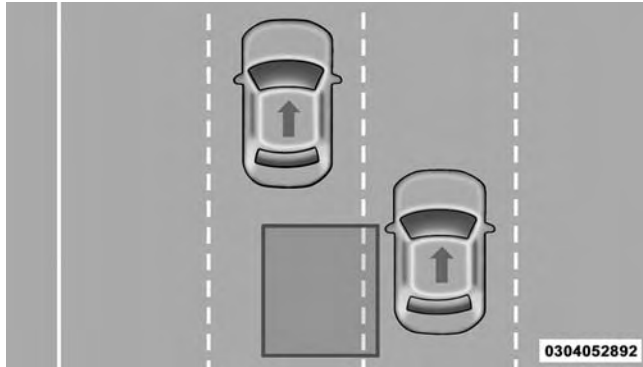

Overtaking/Approaching

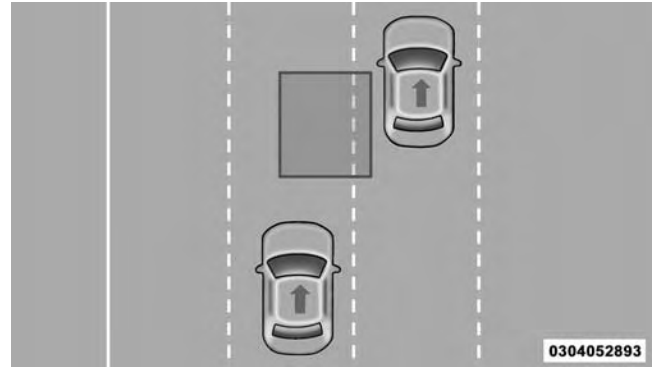

Overtaking/Passing

## 138 UNDERSTANDING THE FEATURES OF YOUR VEHICLE

The BSM system is designed not to issue an alert on stationary objects such as guardrails, posts, walls, foliage, berms, etc. However, occasionally the system may alert on such objects. This is normal operation and your vehicle does not require service.

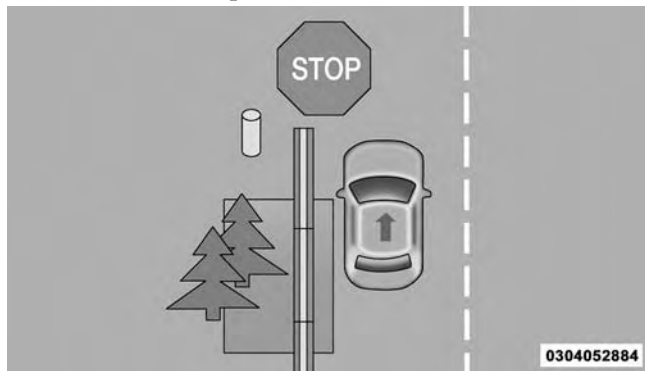

Stationary Objects

The BSM system will not alert you of objects that are traveling in the opposite direction of the vehicle in adjacent lanes.

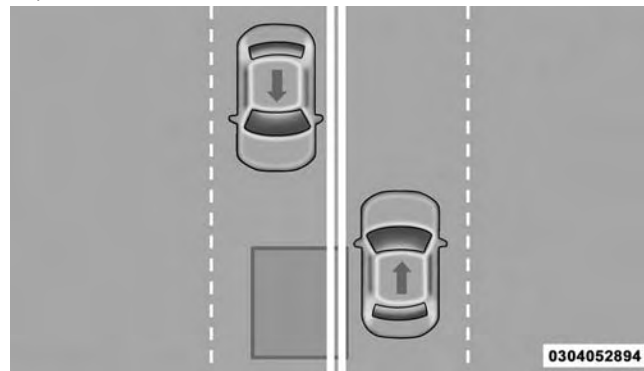

Opposing Traffic

**WARNING!**

The Blind Spot Monitoring system is only an aid to help detect objects in the blind spot zones. The BSM system is not designed to detect pedestrians, bicyclists, or animals. Even if your vehicle is equipped with the BSM system, always check your vehicles mirrors, glance over your shoulder, and use your turn signal before changing lanes. Failure to do so can result in serious injury or death.

**Rear Cross Path (RCP)**

The Rear Cross Path (RCP) feature is intended to aid the driver when backing out of parking spaces where their vision of oncoming vehicles may be blocked. Proceed slowly and cautiously out of the parking space until the rear end of the vehicle is exposed. The RCP system will then have a clear view of the cross traffic and if an oncoming vehicle is detected, alert the driver.

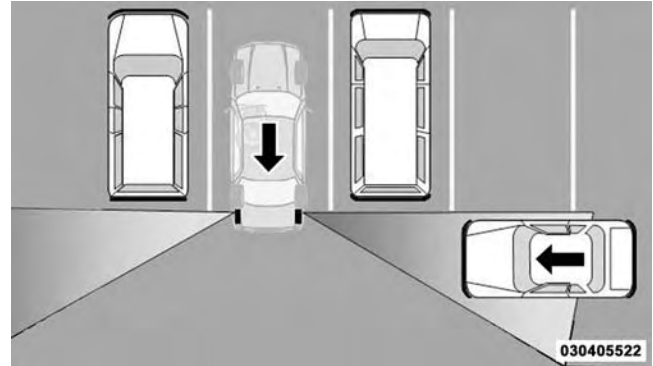
**RCP Detection Zones**

RCP monitors the rear detection zones on both sides of the vehicle, for objects that are moving toward the side of the vehicle with a minimum speed of approximately 3 mph (5 km/h), to objects moving a maximum of approximately 20 mph (32 km/h), such as in parking lot situations.

**NOTE:** In a parking lot situation, oncoming vehicles can be obscured by vehicles parked on either side. If the sensors are blocked by other structures or vehicles, the system will not be able to alert the driver.

When RCP is on and the vehicle is in REVERSE, the driver is alerted using both the visual and audible alarms, including reducing the radio volume.

### **WARNING!**

**RCP is not a Back Up Aid system. It is intended to be used to help a driver detect an oncoming vehicle in a parking lot situation. Drivers must be careful when backing up, even when using RCP. Always check carefully behind your vehicle, look behind you, and be sure to check for pedestrians, animals, other vehicles, obstructions, and blind spots before backing up. Failure to do so can result in serious injury or death.**

### **Modes Of Operation**

Three selectable modes of operation are available in the Uconnect® System. Refer to “Uconnect® Settings/Customer Programmable Features” in “Understanding Your Instrument Panel” for further information.

#### **Blind Spot Alert Lights Only**

When operating in Blind Spot Alert mode, the BSM system will provide a visual alert in the appropriate side view mirror based on a detected object. However, when the system is operating in Rear Cross Path mode, the system will respond with both visual and audible alerts when a detected object is present. Whenever an audible alert is requested, the radio volume is reduced.

#### **Blind Spot Alert Lights/Chime**

When operating in Blind Spot Alert Lights/Chime mode, the BSM system will provide a visual alert in the appropriate side view mirror based on a detected object. If the

turn signal is then activated, and it corresponds to an alert present on that side of the vehicle, an audible chime will also be sounded. Whenever a turn signal and detected object are present on the same side at the same time, both the visual and audio alerts will be issued. In addition to the audible alert the radio (if on) volume will be reduced.

**NOTE:**

- Whenever an audible alert is requested by the BSM system, the radio volume is reduced.
- If the hazard flashers are on, the system will request the appropriate visual alert only.

When the system is in RCP, the system shall respond with both visual and audible alerts when a detected object is present. Whenever an audible alert is requested, the radio volume is reduced. Turn/hazard signal status is ignored; the RCP state always requests the chime.

### **Blind Spot Alert Off**

When the BSM system is turned off there will be no visual or audible alerts from either the BSM or RCP systems.

**NOTE:** The BSM system will store the current operating mode when the vehicle is shut off. Each time the vehicle is started the previously stored mode will be recalled and used.

### **General Information**

This vehicle has systems that operate on radio frequency that comply with Part 15 of the Federal Communications Commission (FCC) rules and with Industry Canada Standards RSS- GEN/210/220/310.

Operation is subject to the following two conditions:

1. The device may not cause harmful interference.

2. The device must accept any interference received, including interference that may cause undesired operation of the device.

Changes or modifications to any of these systems by other than an authorized service facility could void authorization to use this equipment.

## SEATS

Seats are part of the Occupant Restraint System of the vehicle.

### WARNING!

- **It is dangerous to ride in a cargo area, inside or outside of a vehicle. In a collision, people riding in these areas are more likely to be seriously injured or killed.**

*(Continued)*

### WARNING! *(Continued)*

- **Do not allow people to ride in any area of your vehicle that is not equipped with seats and seat belts. In a collision, people riding in these areas are more likely to be seriously injured or killed.**
- **Be sure everyone in your vehicle is in a seat and using a seat belt properly.**

### Power Seats — If Equipped

Some models may be equipped with eight-way power driver and front passenger seats. The power seat switches are located on the outboard side of the seat. There are two switches that control the movement of the seat cushion and the seatback.



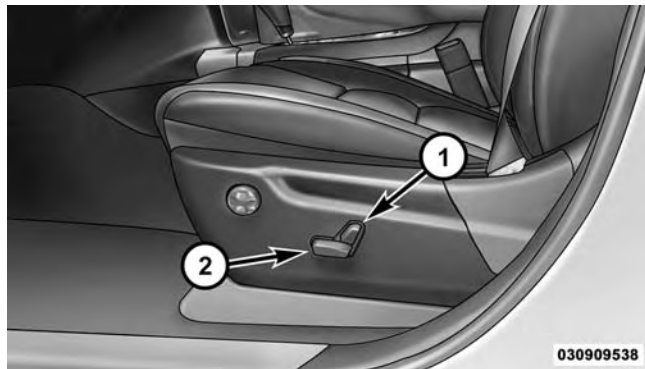

**Power Seat Switches**

- 1 — Seatback Switch
- 2 — Seat Switch

### Adjusting The Seat Forward Or Rearward

The seat can be adjusted both forward and rearward. Push the seat switch forward or rearward. The seat will

move in the direction of the switch. Release the switch when the desired position has been reached.

### Adjusting The Seat Up Or Down

The height of the seats can be adjusted up or down. Pull upward or push downward on the seat switch, the seat will move in the direction of the switch. Release the switch when the desired position has been reached.

### Tilting The Seat Up Or Down

The angle of the seat cushion can be adjusted up or down. Pull upward or push downward on the front of the seat switch. The front of the seat cushion will move in the direction of the switch. Release the switch when the desired position has been reached.

### Reclining The Seatback

The angle of the seatback can be adjusted forward or rearward. Push the seatback switch forward or rearward,

the seat will move in the direction of the switch. Release the switch when the desired position is reached.

### **WARNING!**

- **Adjusting a seat while driving may be dangerous. Moving a seat while driving could result in loss of control which could cause a collision and serious injury or death.**
- **Seats should be adjusted before fastening the seat belts and while the vehicle is parked. Serious injury or death could result from a poorly adjusted seat belt.**
- **Do not ride with the seatback reclined so that the shoulder belt is no longer resting against your chest. In a collision you could slide under the seat belt, which could result in serious injury or death.**

### **CAUTION!**

**Do not place any article under a power seat or impede its ability to move as it may cause damage to the seat controls. Seat travel may become limited if movement is stopped by an obstruction in the seat's path.**

### **Passenger's Power Seat — If Equipped**

Some models are equipped with a six-way power passenger seat. The power seat switch is located on the outboard side of the seat. The switch is used to control the movement of the seat and seat cushion.

### **Adjusting The Seat Forward Or Rearward**

The seat can be adjusted both forward and rearward. Push the seat switch forward or rearward. The seat will move in the direction of the switch. Release the switch when the desired position has been reached.

### Adjusting The Seat Up Or Down

The height of the seats can be adjusted up or down. Pull upward or push downward on the seat switch, the seat will move in the direction of the switch. Release the switch when the desired position has been reached.

### Tilting The Seat Up Or Down

The angle of the seat cushion can be adjusted up or down. Pull upward or push downward on the front of the seat switch. Release the switch when the desired position has been reached.

### Power Lumbar — If Equipped

Vehicles equipped with power driver or passenger seats may also be equipped with power lumbar. The power lumbar switch is located on the outboard side of the power seat. Push the switch forward to increase the lumbar support. Push the switch rearward to decrease

the lumbar support. Pushing upward or downward on the switch will raise and lower the position of the support.

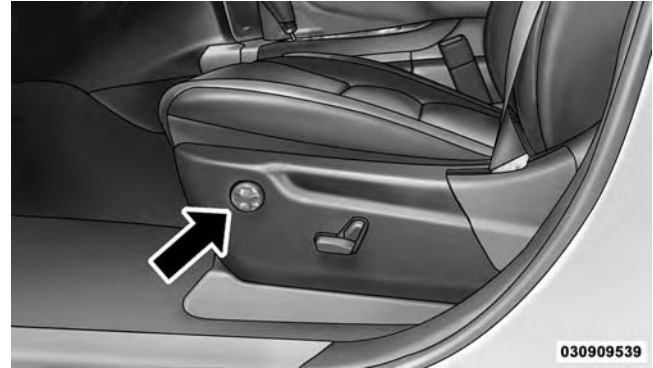

Power Lumbar Switch

## Manual Front Passenger Seat Forward/Rearward Adjustment

Some models may be equipped with a manual front passenger seat. The passenger seat can be adjusted forward or rearward by using a bar located by the front of the seat cushion, near the floor.

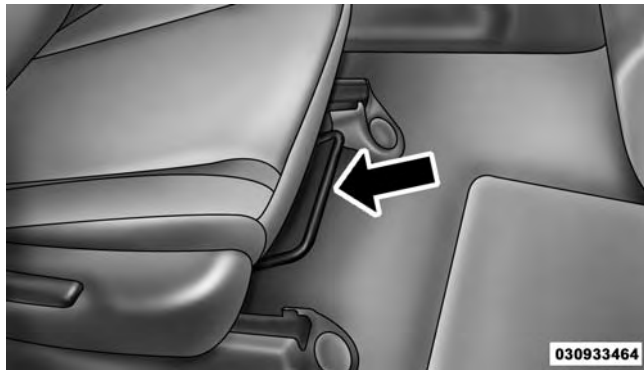

Adjustment Bar

While sitting in the seat, lift up on the bar located under the seat cushion and move the seat forward or rearward. Release the bar once you have reached the desired position. Then, using body pressure, move forward and rearward on the seat to be sure that the seat adjusters have latched.

### WARNING!

- Adjusting a seat while driving may be dangerous. Moving a seat while driving could result in loss of control which could cause a collision and serious injury or death.
- Seats should be adjusted before fastening the seat belts and while the vehicle is parked. Serious injury or death could result from a poorly adjusted seat belt.

### Manual Front Passenger Seatback Adjustment — Recline

To adjust the seatback, lift the lever located on the outboard side of the seat, lean back to the desired position and release the lever. To return the seatback, lift the lever, lean forward and release the lever.

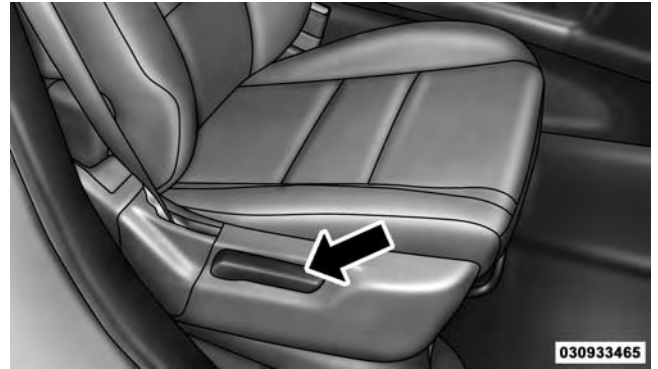

Recline Lever

**WARNING!**

Do not ride with the seatback reclined so that the shoulder belt is no longer resting against your chest. In a collision you could slide under the seat belt, which could result in serious injury or death.

**Front Passenger Seat Fold-Flat Feature — If Equipped**

To fold the seatback to the flat load-floor position, lift the recline lever and push the seatback forward. To return to the seating position, raise the seatback and lock it into place.

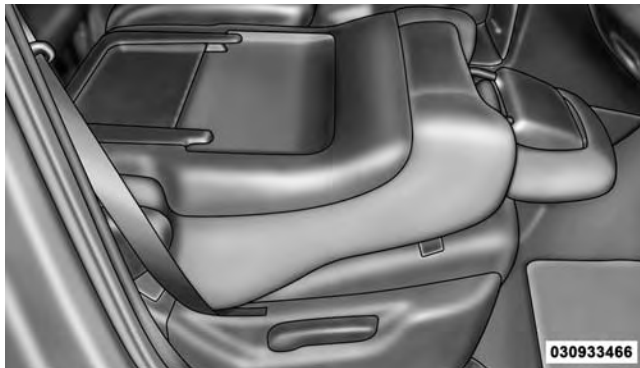
**Fold-Flat Passenger Seat  
Heated Seats — If Equipped**

On some models, the front and rear seats may be equipped with heaters located in the seat cushions and seat backs.



**WARNING!**

- Persons who are unable to feel pain to the skin because of advanced age, chronic illness, diabetes, spinal cord injury, medication, alcohol use, exhaustion or other physical condition must exercise care when using the seat heater. It may cause burns even at low temperatures, especially if used for long periods of time.
- Do not place anything on the seat or seatback that insulates against heat, such as a blanket or cushion. This may cause the seat heater to overheat. Sitting in a seat that has been overheated could cause serious burns due to the increased surface temperature of the seat.

**Front Heated Seats**

The front heated seats control buttons are located within the climate or controls screen of the touchscreen.

You can choose from HI, LO or OFF heat settings. The indicator lights in each switch indicate the level of heat in use. Two indicator lights will illuminate for HI, one for LO and none for OFF.

- Press the heated seat button  once to turn the HI setting ON.
- Press the heated seat button  a second time to turn the LO setting ON.
- Press the heated seat button  a third time to turn the heating elements OFF.

If the HI-level setting is selected, the system will automatically switch to LO-level after approximately 60 minutes of continuous operation. At that time, the display will change from HI to LO, indicating the change. The LO-level setting will turn OFF automatically after approximately 45 minutes.

**NOTE:**

- Once a heat setting is selected, heat will be felt within two to five minutes.
- The engine must be running for the heated seats to operate.

**Vehicles Equipped With Remote Start**

On models that are equipped with remote start, the heated seats can be programmed to come on during a remote start.

This feature can be programmed through the Uconnect® system. Refer to “Uconnect® Settings” in “Understanding Your Instrument Panel” for further information.

**Rear Heated Seats — If Equipped**

On some models, the two rear outboard seats may be equipped with heated seats. There are two heated seat switches that allow the rear passengers to operate the seats independently. The heated seat switches for each heater are located on the rear of the center console.

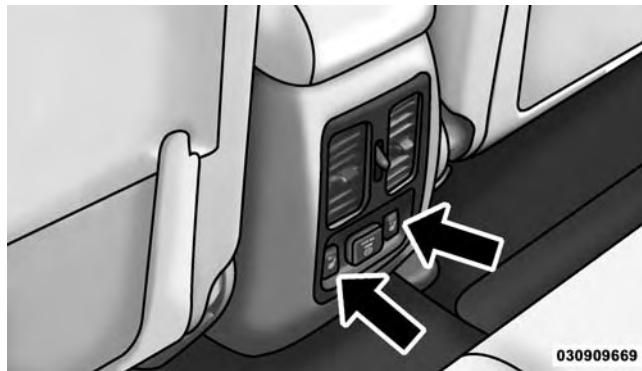

Rear Heated Seat Switches



You can choose from HI, LO or OFF heat settings. Amber indicator lights in each switch indicate the level of heat in use. Two indicator lights will illuminate for HI, one for LO and none for OFF.



Push the switch once to select HI-level heating. Push the switch a second time to select LO-level heating. Push the switch a third time to shut the heating elements OFF.

When the HI-level setting is selected, the heater will provide a boosted heat level during the first four minutes of operation. Then, the heat output will drop to the normal HI-level. If the HI-level setting is selected, the system will automatically switch to LO-level after approximately 60 minutes of continuous operation. At that time, the number of illuminated LEDs changes from two to one, indicating the change. The LO-level setting will turn OFF automatically after approximately 45 minutes.



### WARNING!

- **Persons who are unable to feel pain to the skin because of advanced age, chronic illness, diabetes, spinal cord injury, medication, alcohol use, exhaustion or other physical condition must exercise care when using the seat heater. It may cause burns even at low temperatures, especially if used for long periods of time.**
- **Do not place anything on the seat or seatback that insulates against heat, such as a blanket or cushion. This may cause the seat heater to overheat. Sitting in a seat that has been overheated could cause serious burns due to the increased surface temperature of the seat.**

## Front Ventilated Seats — If Equipped

Located in the seat cushion and seat back are fans that draw the air from the passenger compartment and move air through fine perforations in the seat cover to help keep the driver and front passenger cooler in higher ambient temperatures. The fans operate at two speeds, HI and LO.

The front ventilated seats control buttons are located within the Uconnect® system. You can gain access to the control buttons through the climate screen or the controls screen.

- Press the ventilated seat button  once to choose HI.
- Press the ventilated seat button  a second time to choose LO.
- Press the ventilated seat button  a third time to turn the ventilated seat OFF.

**NOTE:** The engine must be running for the ventilated seats to operate. **Vehicles Equipped With Remote Start**

On models that are equipped with remote start, the ventilated seats can be programmed to come on during a remote start.

This feature can be programmed through the Uconnect® system. Refer to “Uconnect® Settings” in “Understanding Your Instrument Panel” for further information.

## Head Restraints

Head restraints are designed to reduce the risk of injury by restricting head movement in the event of a rear-impact. Head restraints should be adjusted so that the top of the head restraint is located above the top of your ear.

**WARNING!**

**The head restraints for all occupants must be properly adjusted prior to operating the vehicle or occupying a seat. Head restraints should never be adjusted while the vehicle is in motion. Driving a vehicle with the head restraints improperly adjusted or removed could cause serious injury or death in the event of a collision.**

**Active Head Restraints — Front Seats**

Active Head Restraints are passive, deployable components, and vehicles with this equipment cannot be readily

identified by any markings, only through visual inspection of the head restraint. The Active Head Restraints (AHR) will be split in two halves, with the front half being soft foam and trim, the back half being decorative plastic.

When AHRs deploy during a rear impact, the front half of the head restraint extends forward to reduce the gap between the back of the occupant's head and the AHR. This system is design to reduce the risk of injury to the driver or front passenger in certain types of rear impacts. Refer to "Occupant Restraints" in "Things To Know Before Starting Your Vehicle" for further information.

## 154 UNDERSTANDING THE FEATURES OF YOUR VEHICLE

To raise the head restraint, pull upward on the head restraint. To lower the head restraint, push the adjustment button, located at the base of the head restraint, and push downward on the head restraint.

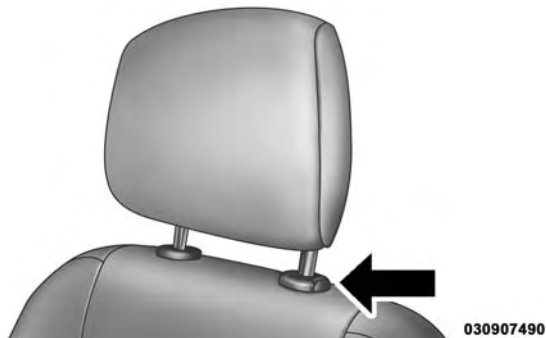

**Adjustment Button**

For comfort the Active Head Restraints can be tilted forward and rearward. To tilt the head restraint closer to

the back of your head, pull forward on the bottom of the head restraint. Push rearward on the bottom of the head restraint to move the head restraint away from your head.

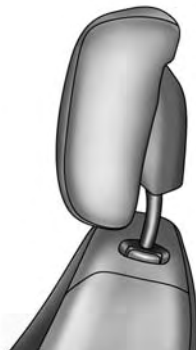

**Active Head Restraint (Normal Position)**

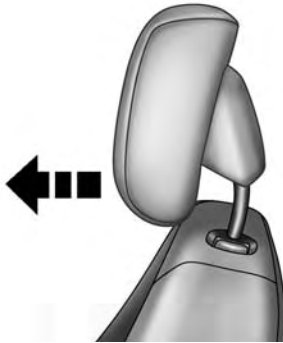

030907533

Active Head Restraint (Tilted)

**NOTE:**

- The head restraints should only be removed by qualified technicians, for service purposes only. If either of the head restraints require removal, see your authorized dealer.

- In the event of deployment of an Active Head Restraint, refer to “Occupant Restraints/Resetting Active Head Restraints (AHR)” in “Things To Know Before Starting Your Vehicle” for further information.

**WARNING!**

- Do not place items over the top of the Active Head Restraint, such as coats, seat covers or portable DVD players. These items may interfere with the operation of the Active Head Restraint in the event of a collision and could result in serious injury or death.
- Active Head Restraints may be deployed if they are struck by an object such as a hand, foot or loose cargo. To avoid accidental deployment of the Active Head Restraint ensure that all cargo is secured,

*(Continued)*

**WARNING! (Continued)**

as loose cargo could contact the Active Head Restraint during sudden stops. Failure to follow this warning could cause personal injury if the Active Head Restraint is deployed.

**Head Restraints — Rear Seats**

The head restraints on the outboard seats are not adjustable. They automatically fold forward when the rear seat is folded to a load floor position but do not return to their normal position when the rear seat is raised. After returning either seat to its upright position, raise the head restraint until it locks in place. The outboard head restraints are not removable.

The center head restraint has limited adjustment. Lift upward on the head restraint to raise it, or push downward on the head restraint to lower it.

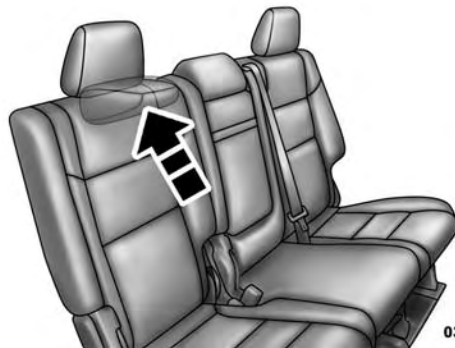

030933142

**Rear Head Restraint**

**WARNING!**

**Sitting in a seat with the head restraint in its lowered position could result in serious injury or death in a collision. Always make sure the outboard head restraints are in their upright positions when the seat is to be occupied.**

**NOTE:** For proper routing of a Child Seat Tether, refer to “Occupant Restraints” in “Things to Know Before Starting Your Vehicle” for further information.

**Power Folding Third Row Head Restraints**

For improved visibility when in reverse, the third row head restraints can be folded using the Uconnect® System.

Press the “Controls” button located on the bottom of the Uconnect® display.

Press the Headrest Fold button  to power fold the third row head restraints.

**NOTE:**

- The head restraints can only be folded downward using the Headrest button. The head restraints must be raised manually when occupying the third row.
- Do not fold if there are passengers seated in the third row seats.

## 60/40 Split Rear Seat

### Fold-Flat

The second row seats can be folded flat to carry cargo.

Pull upward on the release lever located on the outboard side of the seat.



Release Lever

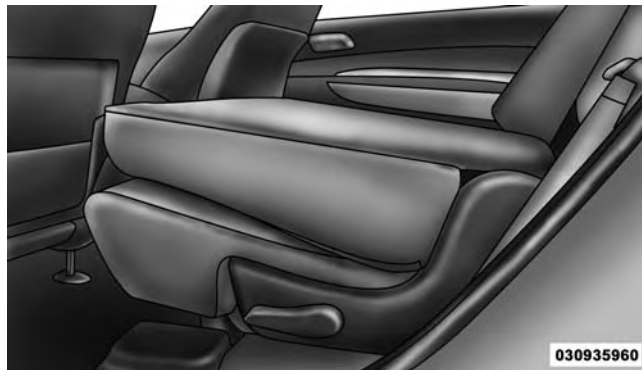

Fold-Flat Second Row Seat

### Easy Access For Third Row

Either side of the rear seat can be tumbled forward to allow passengers to easily access the third row seats.



1. Pull upward on the release lever to release the seat.



Release Lever

2. Tumble the seat forward using the pull strap located behind the seatback.

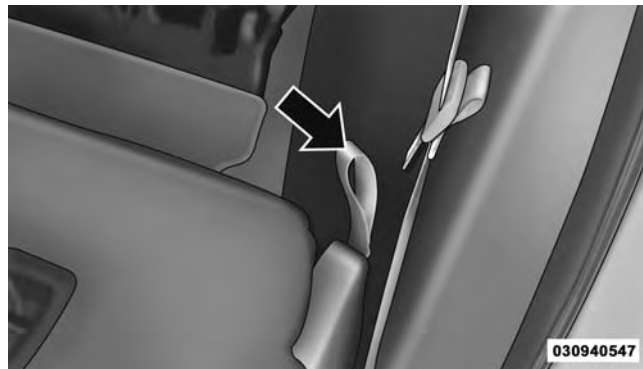

Tumble Strap

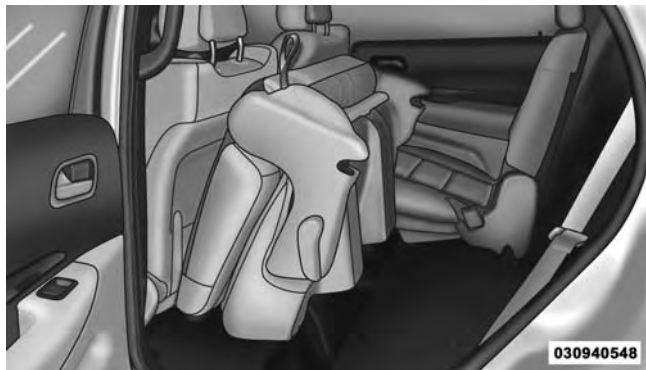

Tumbled Second Row

**WARNING!**

Do not drive the vehicle with the second row seats in the tumbled position. The second row seats are only intended to be tumbled for entry and exit to the third

*(Continued)*

**WARNING! (Continued)**

row seat. Failure to follow these instructions could result in personal injury.

**To Raise Rear Seat**

Tumbled the seat rearward and lock it into place.

**WARNING!**

Be certain that the seatback is securely locked into position. If the seatback is not securely locked into position the seat will not provide the proper stability for child seats and/or passengers. An improperly latched seat could cause serious injury.

## Rear Captain Chairs — If Equipped

### Fold-Flat

The second row seats can be folded flat to carry cargo.

Pull upward on the release lever located on the outboard side of the seat.



Release Lever

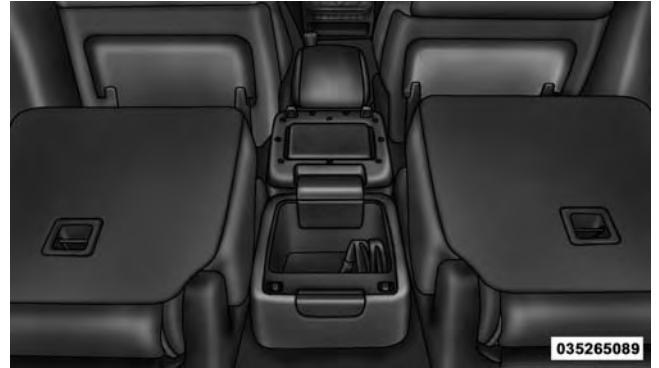

Fold-Flat Second Row Seats

### Easy Access For Third Row

Either side of the rear seat can be tumbled forward to allow passengers to easily access the third row seats.

1. Pull upward on the release lever to release the seat.



Release Lever

2. Tumble the seat forward using the pull strap located behind the seatback.

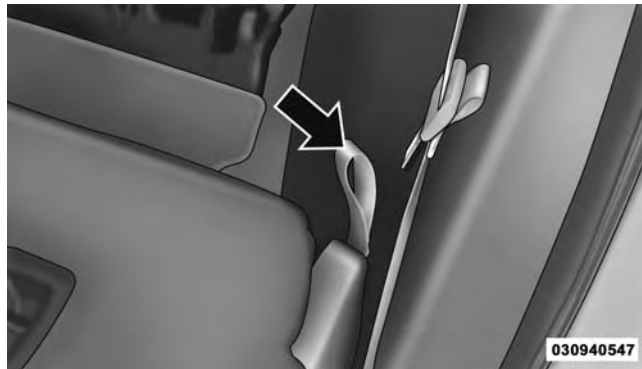

Tumble Strap

**WARNING!**

Do not drive the vehicle with the second row seats in the tumbled position. The second row seats are only intended to be tumbled for entry and exit to the third row seat. Failure to follow these instructions could result in personal injury.

3. If your vehicle is equipped with a mini console there is a stepping pad to allow passengers to easily access the third row seats.

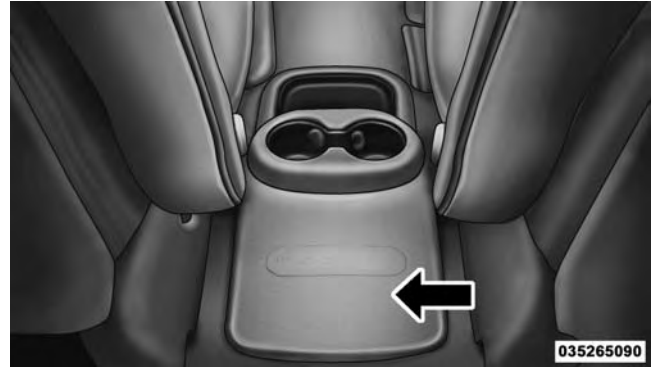

Mini Console Stepping Pad

### To Raise Rear Seat

Tumbled the seat rearward and lock it into place.

#### **WARNING!**

Be certain that the seatback is securely locked into position. If the seatback is not securely locked into position the seat will not provide the proper stability for child seats and/or passengers. An improperly latched seat could cause serious injury.

### Folding Third Row

Both third row seats can be folded forward to increase the cargo area. To lower either seat pull on the release handle located on back of the seat and lower the seat using the pull strap located next to the release handle.

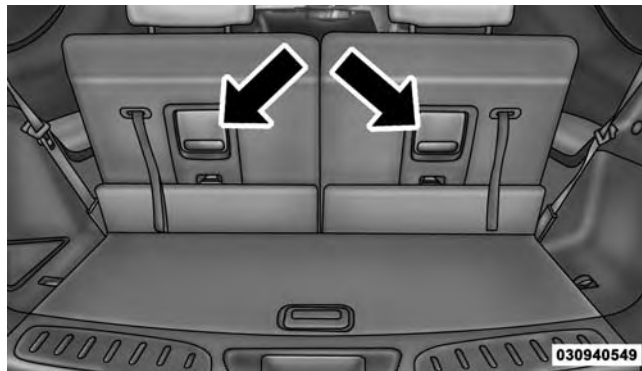

Release Handles



**Third Row Folded**

**NOTE:** The second row seats must be in their full upright position, or tumbled when folding the third row seats.

To raise the seat, pull the seat toward you using the strap located on the back of the seat.

### **WARNING!**

Be certain that the seatback is securely locked into position. If the seatback is not securely locked into position the seat will not provide the proper stability for child seats and/or passengers. An improperly latched seat could cause serious injury.

**3**

### **DRIVER MEMORY SEAT — IF EQUIPPED**

This feature allows the driver to store up to two different memory profiles for easy recall through a memory switch. Each memory profile contains desired position settings for the driver seat, side mirrors, adjustable pedals (if equipped), and power tilt and telescopic steering column (if equipped) and a set of desired radio station presets. Your Remote Keyless Entry (RKE) transmitter can also be programmed to recall the same positions when the UNLOCK button is pushed.

**NOTE:** Your vehicle is equipped with two RKE transmitters, one RKE transmitter can be linked to memory position 1 and the other transmitter can be linked to memory position 2.

The memory seat switch is located on the driver's door trim panel. The switch consists of three buttons:

- The (S) button, which is used to activate the memory save function.
- The (1) and (2) buttons which are used to recall either of two pre-programmed memory profiles.

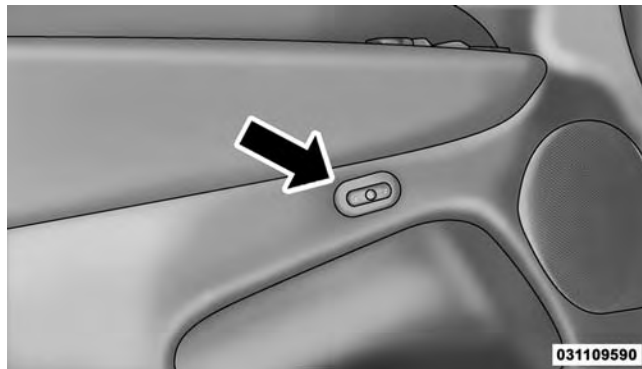

Memory Seat Switch



## Programming The Memory Feature

**NOTE:** To create a new memory profile, perform the following:

### *Vehicles Equipped With Keyless Enter-N-Go™*

1. Without pushing the brake pedal, push the ENGINE START/STOP button and cycle the ignition to the ON/RUN position (Do not start the engine).
2. Adjust all memory profile settings to desired preferences (i.e., seat, side mirror, adjustable pedals [if equipped], power tilt and telescopic steering column [if equipped], and radio station presets).
3. Push and release the S (Set) button on the memory switch.

4. Within five seconds, push and release either of the memory buttons (1) or (2). The Driver Information Display (DID) will display which memory position has been set.

### *Vehicles Not Equipped With Keyless Enter-N-Go™*

1. Insert the ignition key fob, and turn the ignition switch to the ON/RUN position.
2. Adjust all memory profile settings to desired preferences (i.e., seat, side mirror, adjustable pedals [if equipped], power tilt and telescopic steering column [if equipped], and radio station presets).
3. Push and release the S (Set) button on the memory switch.
4. Within five seconds, push and release either of the memory buttons (1) or (2). The Driver Information Display (DID) will display which memory position has been set.

**NOTE:**

- Memory profiles can be set without the vehicle in PARK, but the vehicle must be in PARK to recall a memory profile.
- The Recall Memory with the “Memory To FOB” feature can be enabled through the Uconnect® system screen. Refer to “Customer- Programmable Features — Uconnect® Access 8.4 Settings ” in “Understanding Your Instrument Panel” for further information.

**Linking And Unlinking The Remote Keyless Entry Transmitter To Memory**

Your RKE transmitters can be programmed to recall one of two pre-programmed memory profiles by pushing the UNLOCK button on the RKE transmitter.

**NOTE:** Before programming your RKE transmitters you must select the “Memory To FOB” feature through the Uconnect® system screen. Refer to “Uconnect® Settings ” in “Understanding Your Instrument Panel” for further information.

To program your RKE transmitters, perform the following:

1. Cycle the vehicles ignition to the OFF position.
2. Select a desired memory profile (1) or (2).

**NOTE:** If a memory profile has not already been set, refer to “Programming The Memory Feature” in this section for instructions on how to set a memory profile.

3. Once the profile has been recalled, push and release the SET (S) button on the memory switch.

4. Within five seconds, push and release button (1) or (2) accordingly. "Memory Profile Set" (1 or 2) will display in the instrument cluster.
5. Push and release the LOCK button on the RKE transmitter within 10 seconds.

**NOTE:** Your RKE transmitters can be unlinked to your memory settings by pushing the SET (S) button, and within 10 seconds, followed by pushing the UNLOCK button on the RKE transmitter.

### **Memory Position Recall**

**NOTE:** The vehicle must be in PARK to recall memory positions. If a recall is attempted when the vehicle is not in PARK, a message will be displayed in the Driver Information Display (DID).

#### *Driver One Memory Position Recall*

- To recall the memory settings for driver one using the memory switch, push MEMORY button number 1 on the memory switch.
- To recall the memory settings for driver one using the RKE transmitter, push the UNLOCK button on the RKE transmitter linked to memory position 1.

#### *Driver Two Memory Position Recall*

- To recall the memory setting for driver two using the memory switch, push MEMORY button number 2 on the memory switch.
- To recall the memory settings for driver two using the RKE transmitter, push the UNLOCK button on the RKE transmitter linked to memory position 2.

A recall can be cancelled by pushing any of the MEMORY buttons during a recall (S, 1, or 2). When a recall is cancelled, the driver's seat, and the power pedals (if equipped) stop moving. A delay of one second will occur before another recall can be selected.

### Easy Entry/Exit Seat

This feature provides automatic driver seat positioning to enhance driver mobility when entering and exiting the vehicle.

The distance the driver seat moves depends on where you have the driver seat positioned when you remove the Key Fob from the ignition (or change the ignition to OFF, for vehicles equipped with Keyless Enter-N-Go™).

- When you remove the Key Fob from the ignition (or change the ignition to OFF, for vehicles equipped with Keyless Enter-N-Go™), the driver seat will move about 2.4 in (60 mm) rearward if the driver seat position is greater than or equal to 2.7 in (67.7 mm)

forward of the rear stop. The seat will return to its previously set position when you place the ignition into the ACC or RUN position.

- When you remove the Key Fob from the ignition (or change the ignition to OFF, for vehicles equipped with Keyless Enter-N-Go™), the driver seat will move to a position 0.3 in (7.7 mm) forward of the rear stop if the driver seat position is between 0.9 in and 2.7 in (22.7 mm and 67.7 mm) forward of the rear stop. The seat will return to its previously set position when you place the ignition to the ACC or RUN position.
- The Easy Entry/Easy Exit feature is disabled when the driver seat position is less than 0.9 in (22.7 mm) forward of the rear stop. At this position, there is no benefit to the driver by moving the seat for Easy Exit or Easy Entry.

Each stored memory setting will have an associated Easy Entry and Easy Exit position.

**NOTE:** The Easy Entry/Exit feature is not enabled when the vehicle is delivered from the factory. The Easy Entry/Exit feature is enabled (or later disabled) through the programmable features in the Uconnect® system. Refer to “Uconnect® Settings/Customer Programmable Features” in “Understanding Your Instrument Panel” for further information.

### TO OPEN AND CLOSE THE HOOD

To open the hood, two latches must be released.

1. Pull the release lever located below the instrument panel and in front of the driver's door.

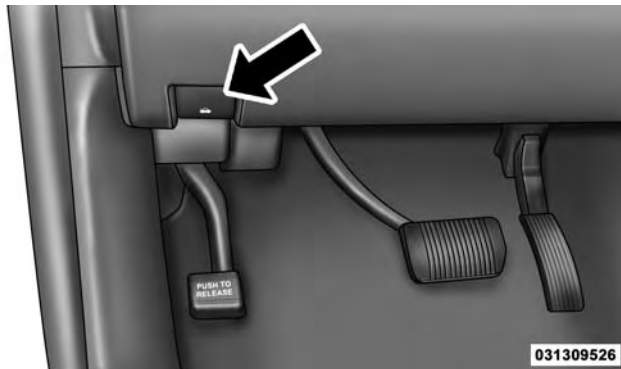

#### Hood Release

2. Reach under the hood from outside the vehicle, move the safety latch to the left and lift the hood.



0313050378

Safety Latch Location

**CAUTION!**

To prevent possible damage, do not slam the hood to close it. Use a firm downward push at the front center of the hood to ensure that both latches engage.

**WARNING!**

Be sure the hood is fully latched before driving your vehicle. If the hood is not fully latched, it could open when the vehicle is in motion and block your vision. Failure to follow this warning could result in serious injury or death.

**LIGHTS****Headlight Switch**

The headlight switch is located on the left side of the instrument panel, next to the steering wheel. The headlight switch controls the operation of the headlights, parking lights, instrument panel lights, cargo lights and fog lights (if equipped).



### Headlight Switch



To turn on the headlights, rotate the headlight switch clockwise. When the headlight switch is on the parking lights, taillights, license plate light and instrument panel lights are also turned on. To turn off the headlights, rotate the headlight switch back to the O (Off) position.

### NOTE:

- Your vehicle is equipped with plastic headlight and fog light (if equipped) lenses that are lighter and less susceptible to stone breakage than glass lights. Plastic is not as scratch resistant as glass and therefore different lens cleaning procedures must be followed.
- To minimize the possibility of scratching the lenses and reducing light output, avoid wiping with a dry cloth. To remove road dirt, wash with a mild soap solution followed by rinsing.

### CAUTION!

**Do not use abrasive cleaning components, solvents, steel wool or other abrasive materials to clean the lenses.**

### **Automatic Headlights — If Equipped**

This system automatically turns the headlights on or off according to ambient light levels. To turn the system on, rotate the headlight switch counterclockwise to the AUTO position. When the system is on, the headlight time delay feature is also on. This means the headlights will stay on for up to 90 seconds after you place the ignition into the OFF position. To turn the automatic system off, move the headlight switch out of the AUTO position.

**NOTE:** The engine must be running before the headlights will come on in the automatic mode.

### **Headlights On Automatically With Wipers**

If your vehicle is equipped with Automatic Headlights, it also has this customer-programmable feature. When your headlights are in the automatic mode and the engine is running, they will automatically turn on when the wiper system is on. This feature is programmable

through the Uconnect® system. Refer to “Uconnect® Settings/Customer Programmable Features” in “Understanding Your Instrument Panel” for further information.

**NOTE:** When your headlights come on during the daytime, the vehicle will monitor outside brightness and decide if the instrument panel needs to be dimmed or not. Refer to “Lights” in this section for further information.

### **Automatic High Beam — If Equipped**

The Automatic High Beam Headlamp Control system provides increased forward lighting at night by automating high beam control through the use of a digital camera mounted on the inside rearview mirror. This camera detects vehicle specific light and automatically switches from high beams to low beams until the approaching vehicle is out of view.



**NOTE:**

- The Automatic High Beam Headlamp Control can be turned on or off using the Uconnect® System. Refer to “Uconnect® Settings” in “Understanding Your Instrument Panel” for further information.
- Broken, muddy, or obstructed headlights and taillights of vehicles in the field of view will cause headlights to remain on longer (closer to the vehicle). Also, dirt, film, and other obstructions on the windshield or camera lens will cause the system to function improperly.
- To opt out of the Advanced Auto High-Beam Sensitivity Control (default) and enter Reduced High-Beam Sensitivity Control (not recommended), toggle high-beam lever 6 full on/off cycles within 10 seconds of ignition ON. System will return to default setting upon ignition off.

If the windshield or Automatic High Beam Headlamp Control mirror is replaced, the mirror must be re-aimed to ensure proper performance. See your local authorized dealer.

**Daytime Running Lights — If Equipped**

The Daytime Running Lights come on whenever the engine is running, and the transmission is not in the PARK position. The lights will remain on until the ignition is switched to the OFF or ACC position or the parking brake is engaged. The headlight switch must be used for normal nighttime driving.

**NOTE:** If allowed by law in the country in which the vehicle was purchased the Daytime Running Lights can be turned on and off using the Uconnect® System, refer to “Uconnect® Settings” in “Understanding Your Instrument Panel” for further information.

## Headlight Delay

To aid in your exit, your vehicle is equipped with a headlight delay that will leave the headlights on for approximately 90 seconds. This delay is initiated when the ignition is turned OFF while the headlight switch is on, and then the headlight switch is cycled off. Headlight delay can be cancelled by either turning the headlight switch on then off, or by turning the ignition ON.

**NOTE:** The headlight delay time is programmable through the Uconnect® System. Refer to “Uconnect® Settings/Customer Programmable Features” in “Understanding Your Instrument Panel” for further information.

## Parking Lights And Panel Lights

 To turn on the parking lights and instrument panel lights, rotate the headlight switch clockwise. To turn off the parking lights, rotate the headlight switch back to the O (Off) position.

## Fog Lights — If Equipped

The fog lights are turned on by rotating the headlight switch to the parking light or headlight position and pushing in the headlight rotary control.

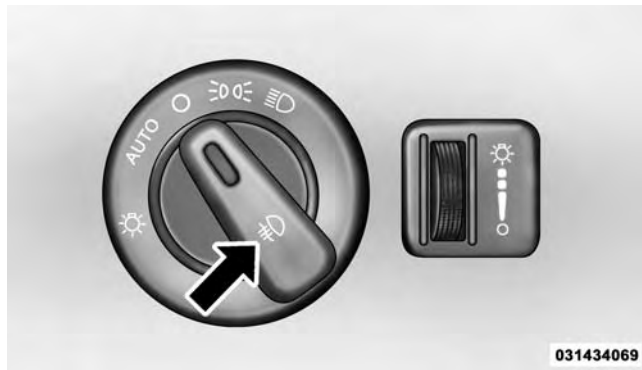

Fog Light Operation

031434069

The fog lights will operate only when the parking lights are on or when the vehicle headlights are on low beam. An indicator light located in the instrument cluster will illuminate when the fog lights are on. The fog lights will turn off when the switch is pushed a second time, when the headlight switch is rotated to the off position, or the high beam is selected.

### **Interior Lights**

Courtesy and dome lights are turned on when the front doors are opened or when the dimmer control (rotating wheel on the right side of the headlight switch) is rotated

to the its farthest upward position. If your vehicle is equipped with Remote Keyless Entry (RKE) and the UNLOCK button is pushed on the RKE transmitter, the courtesy and dome lights will turn on. When a door is open and the interior lights are on, rotating the dimmer control all the way down, to the OFF detent, will cause all the interior lights to go out. This is also known as the “Party” mode because it allows the doors to stay open for extended periods of time without discharging the vehicle’s battery.

The brightness of the instrument panel lighting can be regulated by rotating the dimmer control up (brighter) or down (dimmer). When the headlights are on you can supplement the brightness of the odometer, trip odometer, radio and overhead console by rotating the control to its farthest position up until you hear a click. This feature is termed the “Parade” mode and is useful when headlights are required during the day.

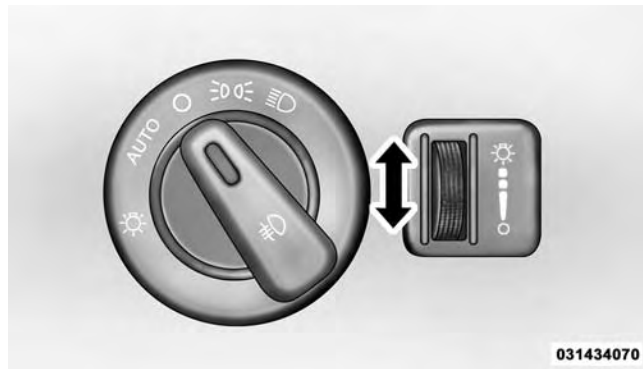

Dimmer Control

### Lights-On Reminder

If the headlights, parking lights, or cargo lights are left on after the ignition is turned OFF, a chime will sound when the driver's door is opened.

## Battery Saver

To protect the life of your vehicle's battery, load shedding is provided for both the interior and exterior lights.

If the ignition is OFF and any door is left ajar for 10 minutes or the dimmer control is rotated all the way up to the dome ON position for 10 minutes, the interior lights will automatically turn off.

**NOTE:** Battery saver mode is cancelled if the ignition is ON.

If the headlights remain on while the ignition is cycled OFF, the exterior lights will automatically turn off after eight minutes. If the headlights are turned on and left on for eight minutes while the ignition is OFF, the exterior lights will automatically turn off.

## Front Map/Reading Lights — If Equipped

The front map/reading lights are mounted in the overhead console.



Front Map/Reading Lights

031433150

Each light can be turned on by pushing a switch on either side of the console. These buttons are backlit for night time visibility. To turn the lights off, push the switch a second time. The lights will also turn on when the UNLOCK button on the Remote Keyless Entry (RKE) is pushed.



031433151

Front Map/Reading Light Switches

## Courtesy Lights

The courtesy lights can be turned on by pushing the top corner of the lens. To turn the lights off, push the lens a second time.



031464435

Courtesy Lights

### Ambient Light — If Equipped

The overhead console is equipped with an ambient light feature. This light casts illumination for improved visibility of the floor and center console area.



Ambient Light

033333449

### Multifunction Lever

The multifunction lever is located on the left side of the steering column.



Multifunction Lever

031563090

## Turn Signals

Move the multifunction lever up or down and the arrows on each side of the instrument cluster flash to show proper operation of the front and rear turn signal lights.

**NOTE:** If either light remains on and does not flash, or there is a very fast flash rate, check for a defective outside light bulb. If an indicator fails to light when the lever is moved, it would suggest that the indicator bulb is defective.

When the Daytime Running Lights are on and a turn signal is activated, the Daytime Running Lamp will turn off on the side of the vehicle in which the turn signal is flashing. The Daytime Running Lamp will turn back on when the turn signal is turned off.

## Lane Change Assist

Tap the lever up or down once, without moving beyond the detent, and the turn signal (right or left) will flash three times then automatically turn off.

## Flash-To-Pass

You can signal another vehicle with your headlights by partially pulling the multifunction lever toward the steering wheel. This will cause the high beam headlights to turn on until the lever is released.

## High/Low Beam Switch

Push the multifunction lever toward the instrument panel to switch the headlights to high beam. Pulling the multifunction back toward the steering wheel will turn the low beams back on, or shut the high beams off.



## WINDSHIELD WIPERS AND WASHERS

The windshield wiper/washer controls are located on the multifunction lever on the left side of the steering column. The front wipers are operated by rotating a switch, located on the end of the lever. For information on the rear wiper/washer, refer to “Rear Window Features” in “Understanding The Features Of Your Vehicle”.



031563090

Multifunction Lever

## Windshield Wiper Operation

Rotate the end of the lever to one of the first four detent positions for intermittent settings, the fifth detent for low wiper operation and the sixth detent for high wiper operation.



031563345

Windshield Wiper Operation

## CAUTION!

Always remove any buildup of snow that prevents the windshield wiper blades from returning to the "park" position. If the windshield wiper switch is turned off, and the blades cannot return to the "park" position, damage to the wiper motor may occur.

## Intermittent Wiper System

Use one of the four intermittent wiper settings when weather conditions make a single wiping cycle, with a variable delay between cycles, desirable. At driving speeds above 10 mph (16 km/h), the delay can be regulated from a maximum of approximately 18 seconds between cycles (first detent), to a cycle every one second (fourth detent).



031563345

**Intermittent Wiper Operation**

**NOTE:** If the vehicle is moving less than 10 mph (16 km/h), delay times will be doubled.

**Windshield Washer Operation**

To use the washer, push on the end of the lever (toward the steering wheel) and hold while spray is desired. If the lever is pushed while in the intermittent setting, the

wipers will turn on and operate for several wipe cycles after the end of the lever is released, and then resume the intermittent interval previously selected.



031563350

**Windshield Washer Operation**

If the end of the lever is pushed while the wipers are in the off position, the wipers will operate for several wipe cycles, then turn off.

### WARNING!

Sudden loss of visibility through the windshield could lead to a collision. You might not see other vehicles or other obstacles. To avoid sudden icing of the windshield during freezing weather, warm the windshield with the defroster before and during windshield washer use.

### Mist

Use the Mist feature when weather conditions make occasional usage of the wipers necessary. Rotate the end of the lever downward to the Mist position and release for a single wiping cycle.

**NOTE:** The mist feature does not activate the washer pump; therefore, no washer fluid will be sprayed on the windshield. The wash function must be used in order to spray the windshield with washer fluid.



031563345

Mist Control

## Rain Sensing Wipers — If Equipped

This feature senses moisture on the windshield and automatically activates the wipers for the driver. The feature is especially useful for road splash or overspray from the windshield washers of the vehicle ahead. Rotate the end of the multifunction lever to one of four settings to activate this feature.

The sensitivity of the system can be adjusted with the multifunction lever. Wiper delay position one is the least sensitive, and wiper delay position four is the most sensitive. Setting three should be used for normal rain conditions. Settings one and two can be used if the driver desires less wiper sensitivity. Setting four can be used if the driver desires more sensitivity. Place the wiper switch in the OFF position when not using the system.

### NOTE:

- The Rain Sensing feature will not operate when the wiper switch is in the low or high-speed position.

- The Rain Sensing feature may not function properly when ice, or dried salt water is present on the windshield.
- Use of Rain-X® or products containing wax or silicone may reduce Rain Sensing performance.
- The Rain Sensing feature can be turned on and off using the Uconnect® System, refer to “Uconnect® Settings” in “Understanding Your Instrument Panel” for further information.

The Rain Sensing system has protection features for the wiper blades and arms, and will not operate under the following conditions:

- **Low Ambient Temperature** — When the ignition is first turned ON, the Rain Sensing system will not operate until the wiper switch is moved, vehicle speed is greater than 0 mph (0 km/h), or the outside temperature is greater than 32°F (0°C).

- **Transmission In NEUTRAL Position** — When the ignition is ON, and the automatic transmission is in the NEUTRAL position, the Rain Sensing system will not operate until the wiper switch is moved, vehicle speed is greater than 5 mph (8 km/h), or the shift lever/gear selector is moved out of the NEUTRAL position.

**Remote Start Mode Inhibit** — On vehicles equipped with Remote Starting system, Rain Sensing wipers are not operational when the vehicle is in the remote start mode. Once the operator is in the vehicle and has placed the ignition switch in the RUN position, rain sensing wiper operation can resume, if it has been selected, and no other inhibit conditions (mentioned previously) exist.

## TILT/TELESCOPING STEERING COLUMN

This feature allows you to tilt the steering column upward or downward. It also allows you to lengthen or shorten the steering column. The tilt/telescoping lever is located below the steering wheel at the end of the steering column.

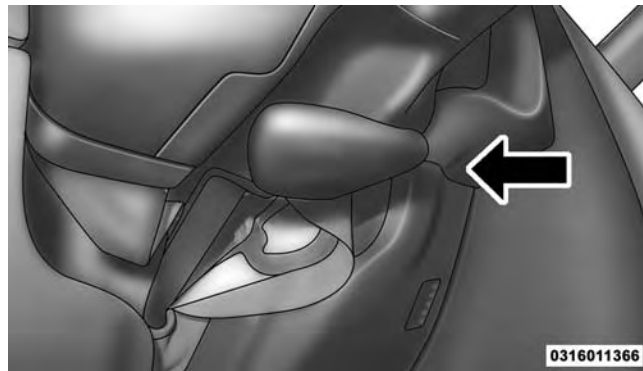

Tilt/Telescoping Lever

To unlock the steering column, push the lever downward (toward the floor). To tilt the steering column, move the steering wheel upward or downward as desired. To lengthen or shorten the steering column, pull the steering wheel outward or push it inward as desired. To lock the steering column in position, push the lever upward until fully engaged.

### **WARNING!**

**Do not adjust the steering column while driving. Adjusting the steering column while driving or driving with the steering column unlocked, could cause the driver to lose control of the vehicle. Failure to follow this warning may result in serious injury or death.**

### **POWER TILT/TELESCOPING STEERING COLUMN — IF EQUIPPED**

This feature allows you to tilt the steering column upward or downward. It also allows you to lengthen or shorten the steering column. The power tilt/telescoping steering column lever is located below the multifunction lever on the steering column.

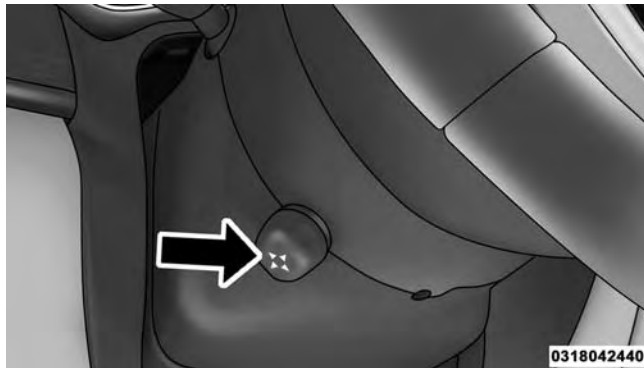

### Power Tilt/Telescoping Steering Column

To tilt the steering column, move the lever up or down as desired. To lengthen or shorten the steering column, pull the lever toward you or push the lever away from you as desired.

**NOTE:** For vehicles equipped with Driver Memory Seat, you can use your Remote Keyless Entry (RKE) transmitter or the memory switch on the driver's door trim panel to return the tilt/telescopic steering column to pre-programmed positions. Refer to "Driver Memory Seat" in this section for further information.

### WARNING!



**Do not adjust the steering column while driving. Adjusting the steering column while driving or driving with the steering column unlocked, could cause the driver to lose control of the vehicle. Failure to follow this warning may result in serious injury or death.**



## HEATED STEERING WHEEL — IF EQUIPPED

The steering wheel contains a heating element that helps warm your hands in cold weather. The heated steering wheel has only one temperature setting. Once the heated steering wheel has been turned on it will operate for up to 80 minutes before automatically shutting off. The heated steering wheel can shut off early or may not turn on when the steering wheel is already warm.

The heated steering wheel control button is located within the Uconnect® system. You can gain access to the control button through the climate screen or the controls screen.

- Press the heated steering wheel button  once to turn the heating element ON.
- Press the heated steering wheel button  a second time to turn the heating element OFF.

**NOTE:** The engine must be running for the heated steering wheel to operate.

### Vehicles Equipped With Remote Start

On models that are equipped with remote start, the heated steering wheel can be programmed to come on during a remote start through the Uconnect® system. Refer to “Uconnect® Settings” in “Understanding Your Instrument Panel” for further information.

#### **WARNING!**

- **Persons who are unable to feel pain to the skin because of advanced age, chronic illness, diabetes, spinal cord injury, medication, alcohol use, exhaustion, or other physical conditions must exercise care when using the steering wheel heater. It may cause burns even at low temperatures, especially if used for long periods.**

*(Continued)*

**WARNING! (Continued)**

- Do not place anything on the steering wheel that insulates against heat, such as a blanket or steering wheel covers of any type and material. This may cause the steering wheel heater to overheat.

**ELECTRONIC SPEED CONTROL — IF EQUIPPED**

When engaged, the Electronic Speed Control takes over accelerator operations at speeds greater than 25 mph (40 km/h).

The Electronic Speed Control buttons are located on the right side of the steering wheel.

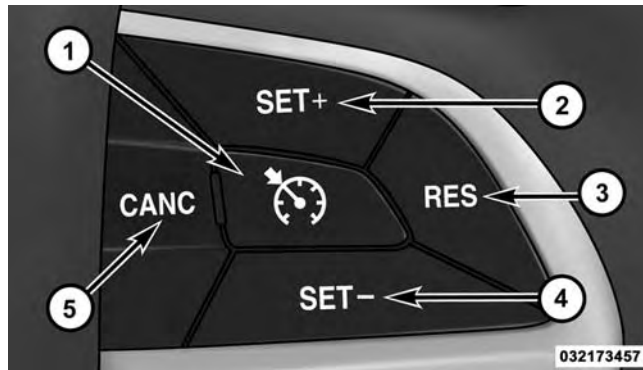

**Electronic Speed Control Buttons**

- |                |                 |
|----------------|-----------------|
| 1 — ON/OFF     | 4 — SET-/DECCEL |
| 2 — SET+/ACCEL | 5 — CANCEL      |
| 3 — RESUME     |                 |

**NOTE:** In order to ensure proper operation, the Electronic Speed Control System has been designed to shut down if multiple Speed Control functions are operated at the same time. If this occurs, the Electronic Speed Control System can be reactivated by pushing the Electronic Speed Control ON/OFF button and resetting the desired vehicle set speed.

### **To Activate**

Push the ON/OFF button to activate the electronic speed control. CRUISE CONTROL READY will appear on the instrument cluster to indicate the electronic speed control is on. To turn the system off, push the ON/OFF button a second time. CRUISE CONTROL OFF will appear on the instrument cluster to indicate the electronic speed control is off. The system should be turned off when not in use.

### **WARNING!**

**Leaving the Electronic Speed Control system on when not in use is dangerous. You could accidentally set the system or cause it to go faster than you want. You could lose control and have an accident. Always leave the system OFF when you are not using it.**

### **To Set A Desired Speed**

Turn the Electronic Speed Control ON. When the vehicle has reached the desired speed, push the SET (+) or SET (-) button and release. Release the accelerator and the vehicle will operate at the selected speed. Once a speed has been set a message CRUISE CONTROL SET TO MPH (km/h) will appear indicating what speed was set. A CRUISE indicator lamp, along with set speed will also appear and stay on in the instrument cluster when the speed is set.

### **To Deactivate**

A soft tap on the brake pedal, pushing the CANCEL button, or normal brake pressure while slowing the vehicle will deactivate the Electronic Speed Control without erasing the set speed from memory.

Pushing the ON/OFF button or turning the ignition switch OFF erases the set speed from memory.

### **To Resume Speed**

To resume a previously set speed, push the RES (+) button and release. Resume can be used at any speed above 20 mph (32 km/h).

### **To Vary The Speed Setting**

#### **To Increase Speed**

When the Electronic Speed Control is set, you can increase speed by pushing the SET + button.

The drivers preferred units can be selected through the instrument panel settings if equipped. Refer to “Understanding Your Instrument Panel” for more information. The speed increment shown is dependant on the chosen speed unit of U.S. (mph) or Metric (km/h):

#### *U.S. Speed (mph)*

- Pushing the SET + button once will result in a 1 mph increase in set speed. Each subsequent tap of the button results in an increase of 1 mph.
- If the button is continually pushed, the set speed will continue to increase until the button is released, then the new set speed will be established.

#### *Metric Speed (km/h)*

- Pushing the SET + button once will result in a 1 km/h increase in set speed. Each subsequent tap of the button results in an increase of 1 km/h.

- If the button is continually pushed, the set speed will continue to increase until the button is released, then the new set speed will be established.

### To Decrease Speed

When the Electronic Speed Control is set, you can decrease speed by pushing the SET - button.

The drivers preferred units can be selected through the instrument panel settings if equipped. Refer to “Understanding Your Instrument Panel” for more information. The speed decrement shown is dependant on the chosen speed unit of U.S. (mph) or Metric (km/h):

#### *U.S. Speed (mph)*

- Pushing the SET - button once will result in a 1 mph decrease in set speed. Each subsequent tap of the button results in a decrease of 1 mph.

- If the button is continually pushed, the set speed will continue to decrease until the button is released, then the new set speed will be established.

#### *Metric Speed (km/h)*

- Pushing the SET - button once will result in a 1 km/h decrease in set speed. Each subsequent tap of the button results in a decrease of 1 km/h.
- If the button is continually pushed, the set speed will continue to decrease until the button is released, then the new set speed will be established.

### To Accelerate For Passing

Press the accelerator as you would normally. When the pedal is released, the vehicle will return to the set speed.

### Using Electronic Speed Control On Hills

The transmission may downshift on hills to maintain the vehicle set speed.

**NOTE:** The Electronic Speed Control system maintains speed up and down hills. A slight speed change on moderate hills is normal.

On steep hills, a greater speed loss or gain may occur so it may be preferable to drive without Electronic Speed Control.

### **WARNING!**

**Electronic Speed Control can be dangerous where the system cannot maintain a constant speed. Your vehicle could go too fast for the conditions, and you could lose control and have an accident. Do not use Electronic Speed Control in heavy traffic or on roads that are winding, icy, snow-covered or slippery.**

### **ADAPTIVE CRUISE CONTROL (ACC) — IF EQUIPPED**

Adaptive Cruise Control (ACC) increases the driving convenience provided by cruise control while traveling on highways and major roadways. However, it is not a safety system and not designed to prevent collisions. **Electronic Speed Control function performs differently. Please refer to the proper section within this chapter.**

ACC will allow you to keep cruise control engaged in light to moderate traffic conditions without the constant need to reset your cruise control. ACC utilizes a radar sensor and a forward facing camera designed to detect a vehicle directly ahead of you.

#### **NOTE:**

- If the sensor does not detect a vehicle ahead of you, ACC will maintain a fixed set speed.

- If the ACC sensor detects a vehicle ahead, ACC will apply limited braking or acceleration (not to exceed the original set speed) automatically to maintain a preset following distance, while matching the speed of the vehicle ahead.

The Cruise Control system has two control modes:

- Adaptive Cruise Control mode for maintaining an appropriate distance between vehicles.
- Normal (fixed speed) electronic speed control mode for cruising at a constant preset speed. For additional information, refer to “Normal (Fixed Speed) Cruise Control Mode” in this section.

**NOTE:** Normal (fixed speed) electronic speed control will not react to preceding vehicles. Always be aware of the mode selected.

You can change the mode by using the Cruise Control buttons. The two control modes function differently. Always confirm which mode is selected.

### WARNING!

- **Adaptive Cruise Control (ACC) is a convenience system. It is not a substitute for active driving involvement. It is always the driver’s responsibility to be attentive of road, traffic, and weather conditions, vehicle speed, distance to the vehicle ahead; and, most importantly, brake operation to ensure safe operation of the vehicle under all road conditions. Your complete attention is always required while driving to maintain safe control of your vehicle. Failure to follow these warnings can result in a collision and death or serious personal injury.**

*(Continued)*

**WARNING! (Continued)**

- The ACC system:
  - Does not react to pedestrians, oncoming vehicles, and stationary objects (e.g., a stopped vehicle in a traffic jam or a disabled vehicle).
  - Cannot take street, traffic, and weather conditions into account, and may be limited upon adverse sight distance conditions.
  - Does not always fully recognize complex driving conditions, which can result in wrong or missing distance warnings.
  - Will bring the vehicle to a complete stop while following a target vehicle and hold the vehicle for 2 seconds in the stop position. If the target vehicle does not start moving within two seconds the ACC system will display a message that the system will release the brakes and that the

*(Continued)*

**WARNING! (Continued)**

brakes must be applied manually. An audible chime will sound when the brakes are released.

You should switch off the ACC system:

- When driving in fog, heavy rain, heavy snow, sleet, heavy traffic, and complex driving situations (i.e., in highway construction zones).
- When entering a turn lane or highway off ramp; when driving on roads that are winding, icy, snow-covered, slippery, or have steep uphill or downhill slopes.
- When towing a trailer up or down steep slopes.
- When circumstances do not allow safe driving at a constant speed.

**Adaptive Cruise Control (ACC) Operation**

The speed control buttons (located on the right side of the steering wheel) operates the ACC system.



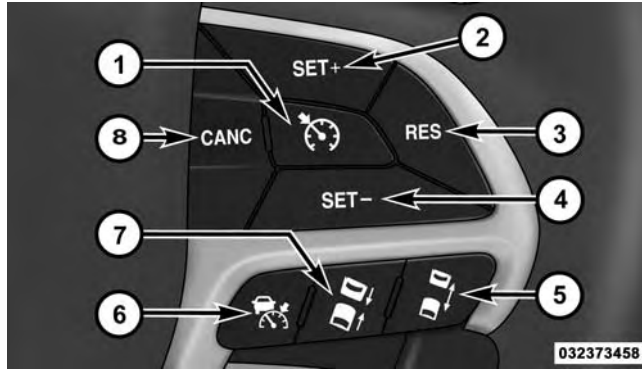

Adaptive Cruise Control Buttons

- 1 — NORMAL (FIXED SPEED) CRUISE CONTROL ON/OFF
- 2 — SET+/ACCEL
- 3 — RESUME
- 4 — SET-/DECEL
- 5 — DISTANCE SETTING — INCREASE
- 6 — ADAPTIVE CRUISE CONTROL (ACC) ON/OFF
- 7 — DISTANCE SETTING — DECREASE
- 8 — CANCEL

**NOTE:** Any chassis/suspension or tire size modifications to the vehicle will effect the performance of the Adaptive Cruise Control and Forward Collision Warning System.

### Activating Adaptive Cruise Control (ACC)

You can only engage ACC if the vehicle speed is above 0 mph (0 km/h).

The minimum Set Speed for the ACC system is 20 mph (32 km/h).

When the system is turned on and in the READY state, the Driver Information Display (DID) displays “ACC Ready.”

When the system is OFF, the DID displays “Adaptive Cruise Control (ACC) Off.”

**NOTE:** You cannot engage ACC under the following conditions:

- When in Four-Wheel Drive Low.

- When you apply the brakes.
- When the parking brake is set.
- When the automatic transmission is in PARK, REVERSE or NEUTRAL.
- When the Vehicle speed is outside of the speed range.
- When the brakes are overheated.
- When the driver door is open.
- When the driver seat belt is unbuckled.

### **To Activate/Deactivate**

Push and release the Adaptive Cruise Control (ACC) ON/OFF button. The ACC menu in the DID displays “ACC Ready.”

# ACC Ready

0323001278

### **Adaptive Cruise Control Ready**

To turn the system OFF, push and release the Adaptive Cruise Control (ACC) ON/OFF button again. At this time, the system will turn off and the DID will display “Adaptive Cruise Control (ACC) Off.”

# Adaptive Cruise Control (ACC) Off

0323001263

Adaptive Cruise Control Off

**WARNING!**

Leaving the Adaptive Cruise Control (ACC) system on when not in use is dangerous. You could accidentally set the system or cause it to go faster than you

*(Continued)***WARNING! (Continued)**

want. You could lose control and have a collision. Always leave the system off when you are not using it.

3

**To Set A Desired ACC Speed**

When the vehicle reaches the speed desired, push the SET + button or the SET - button and release. The DID will display the set speed.

If the system is Set when the vehicle speed is below 20 mph (32 km/h), the Set Speed shall be defaulted to 20 mph (32 km/h). If the system is Set when the vehicle speed is above 20 mph (32 km/h), the Set Speed shall be the current speed of the vehicle.

**NOTE:** ACC cannot be set if there is a stationary vehicle in front of your vehicle in close proximity.

Remove your foot from the accelerator pedal. If you do not, the vehicle may continue to accelerate beyond the set speed. If this occurs:

- The message “DRIVER OVERRIDE” will display in the DID.
- The system will not be controlling the distance between your vehicle and the vehicle ahead. The vehicle speed will only be determined by the position of the accelerator pedal.

### **To Cancel**

The following conditions cancel the system:

- The brake pedal is applied.
- The CANCEL button is pushed.
- An Anti-Lock Brake System (ABS) event occurs.

- The shift lever/gear selector is removed from the Drive position.
- The Electronic Stability Control/Traction Control System (ESC/TCS) activates.
- The vehicle parking brake is applied.
- Driver seatbelt is unbuckled at low speeds.
- Driver door is opened at low speeds.
- A Trailer Sway Control (TSC) event occurs.
- The driver switches ESC to full-off mode.

### **To Turn Off**

The system will turn off and clear the set speed in memory if:

- The Adaptive Cruise Control (ACC) ON/OFF button is pushed.

- The Normal (Fixed Speed) Electronic Speed Control ON/OFF button is pushed.
- The ignition is turned OFF.
- You switch to Four-Wheel Drive Low.

### To Resume

If there is a set speed in memory push the RES (resume) button and then remove your foot from the accelerator pedal. The DID will display the last set speed.

#### NOTE:

- If your vehicle stays at standstill for longer than two seconds, then the system will cancel and the brake force will be ramped-out. The driver will have to apply the brakes to keep the vehicle at a standstill.
- ACC cannot be resumed if there is a stationary vehicle in-front of your vehicle in close proximity.

### WARNING!

The Resume function should only be used if traffic and road conditions permit. Resuming a set speed that is too high or too low for prevailing traffic and road conditions could cause the vehicle to accelerate or decelerate too sharply for safe operation. Failure to follow these warnings can result in a collision and death or serious personal injury.

### To Vary The Speed Setting

#### To Increase Speed

While ACC is set, you can increase the set speed by pushing the SET + button.

The drivers preferred units can be selected through the instrument panel settings if equipped. Refer to “Understanding Your Instrument Panel” for more information.

The speed increment shown is dependant on the chosen speed unit of U.S. (mph) or Metric (km/h):

#### *U.S. Speed (mph)*

- Pushing the SET + button once will result in a 1 mph increase in set speed. Each subsequent tap of the button results in an increase of 1 mph.
- If the button is continually pushed, the set speed will continue to increase in 5 mph increments until the button is released. The increase in set speed is reflected in the DID.

#### *Metric Speed (km/h)*

- Pushing the SET + button once will result in a 1 km/h increase in set speed. Each subsequent tap of the button results in an increase of 1 km/h.

- If the button is continually pushed, the set speed will continue to increase in 10 km/h increments until the button is released. The increase in set speed is reflected in the DID.

#### **To Decrease Speed**

While ACC is set, the set speed can be decreased by pushing the SET - button.

The drivers preferred units can be selected through the instrument panel settings if equipped. Refer to “Understanding Your Instrument Panel” for more information. The speed decrement shown is dependant on the chosen speed unit of U.S. (mph) or Metric (km/h):

#### *U.S. Speed (mph)*

- Pushing the SET - button once will result in a 1 mph decrease in set speed. Each subsequent tap of the button results in a decrease of 1 mph.

- If the button is continually pushed, the set speed will continue to decrease in 5 mph decrements until the button is released. The decrease in set speed is reflected in the DID.

### *Metric Speed (km/h)*

- Pushing the SET - button once will result in a 1 km/h decrease in set speed. Each subsequent tap of the button results in a decrease of 1 km/h.
- If the button is continually pushed, the set speed will continue to decrease in 10 km/h decrements until the button is released. The decrease in set speed is reflected in the DID.

### **NOTE:**

- When you override and push the SET + button or SET - buttons, the new Set Speed will be the current speed of the vehicle.

- When you use the SET - button to decelerate, if the engine's braking power does not slow the vehicle sufficiently to reach the set speed, the brake system will automatically slow the vehicle.
- The ACC system applies the brake down to a full stop when following a target vehicle. If an ACC host vehicle follows a target vehicle to a standstill, the host vehicle will release the vehicle brakes two seconds after coming to a full stop.
- The ACC system maintains set speed when driving up hill and down hill. However, a slight speed change on moderate hills is normal. In addition, downshifting may occur while climbing uphill or descending downhill. This is normal operation and necessary to maintain set speed. When driving up hill and down hill, the ACC system will cancel if the braking temperature exceeds normal range (overheated).

## Setting The Following Distance In ACC

The specified following distance for ACC can be set by varying the distance setting between four bars (longest), three bars (long), two bars (medium) and one bar (short). Using this distance setting and the vehicle speed, ACC calculates and sets the distance to the vehicle ahead. This distance setting displays in the DID.

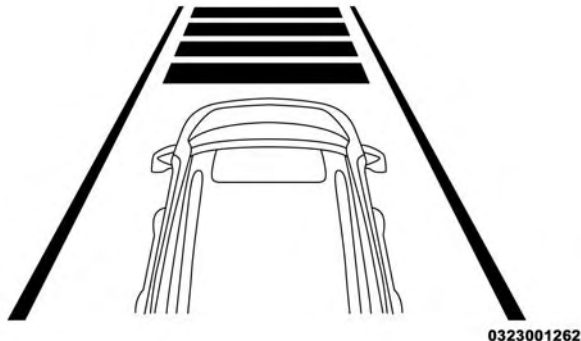

Distance Setting 4 Bars (Longest)



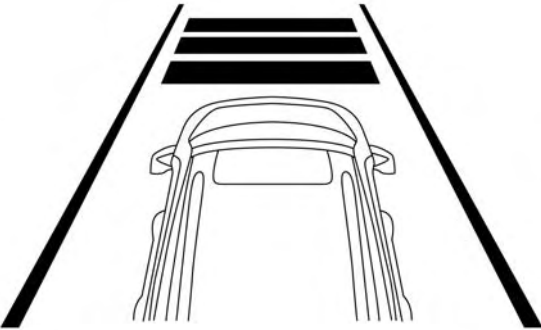

0323001261

Distance Setting 3 Bars (Long)

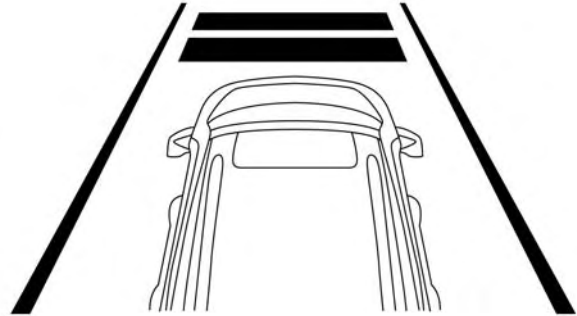

0323001260

Distance Setting 2 Bars (Medium)

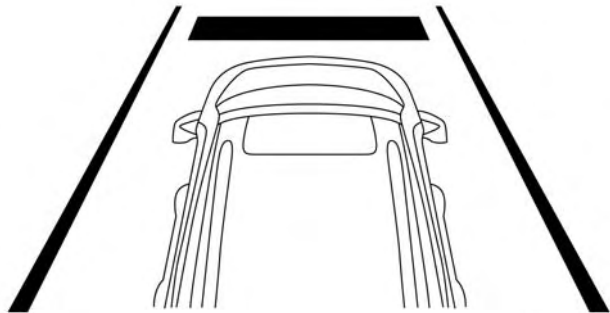

0323001259

### Distance Setting 1 Bar (Short)

To increase the distance setting, push the Distance Setting — Increase button and release. Each time the button is pushed, the distance setting increases by one bar (longer).

To decrease the distance setting, push the Distance Setting — Decrease button and release. Each time the button is pushed, the distance setting decreases by one bar (shorter).

If there is no vehicle ahead, the vehicle will maintain the set speed. If a slower moving vehicle is detected in the same lane, the DID displays the “Sensed Vehicle Indicator” icon, and the system adjusts vehicle speed automatically to maintain the distance setting, regardless of the set speed.

The vehicle will then maintain the set distance until:

- The vehicle ahead accelerates to a speed above the set speed.
- The vehicle ahead moves out of your lane or view of the sensor.
- The distance setting is changed.

- The system disengages. (Refer to the information on ACC Activation).

The maximum braking applied by ACC is limited; however, the driver can always apply the brakes manually, if necessary.

**NOTE:** The brake lights will illuminate whenever the ACC system applies the brakes.

A Proximity Warning will alert the driver if ACC predicts that its maximum braking level is not sufficient to maintain the set distance. If this occurs, a visual alert “BRAKE” will flash in the DID and a chime will sound while ACC continues to apply its maximum braking capacity.

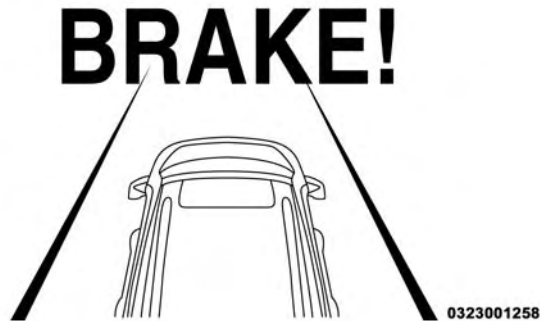

**Brake Alert**

**NOTE:** The “Brake!” Screen in the DID is a warning for the driver to take action and does not necessarily mean that the Forward Collision Warning system is applying the brakes autonomously.

## Overtake Aid

When driving with ACC engaged and following a vehicle, the system will provide an additional acceleration up to the ACC set speed to assist in passing the vehicle. This additional acceleration is triggered when the driver utilizes the left turn signal and will only be active when passing on the left hand side.

## ACC Operation At Stop

If the ACC system brings your vehicle to a standstill while following a target vehicle, if the target vehicle starts moving within two seconds of your vehicle coming to a standstill, your vehicle will resume motion without the need for any driver action.

If the target vehicle does not start moving within two seconds of your vehicle coming to a standstill, the ACC with Stop system will cancel and the brakes will release.

A cancel message will display on the DID and produce a warning chime. Driver intervention will be required at this moment.

While ACC with Stop is holding your vehicle at a standstill, if the driver seatbelt is unbuckled or the driver door is opened, the ACC with Stop system will cancel and the brakes will release. A cancel message will display on the DID and produce a warning chime. Driver intervention will be required at this moment.

### **WARNING!**

**When the ACC system is resumed, the driver must ensure that there are no pedestrians, vehicles or objects in the path of the vehicle. Failure to follow these warnings can result in a collision and death or serious personal injury.**

## Adaptive Cruise Control (ACC) Menu

The DID displays the current ACC system settings. The DID is located in the center of the instrument cluster. The information it displays depends on ACC system status.

Push the ADAPTIVE CRUISE CONTROL (ACC) ON/OFF button (located on the steering wheel) until one of the following displays in the DID:

### *Adaptive Cruise Control Off*

When ACC is deactivated, the display will read “Adaptive Cruise Control Off.”

### *Adaptive Cruise Control Ready*

When ACC is activated but the vehicle speed setting has not been selected, the display will read “Adaptive Cruise Control Ready.”

Push the SET + or the SET- button (located on the steering wheel) and the following will display in the DID:

### *ACC SET*

When ACC is set, the set speed will display in the instrument cluster.

The ACC screen may display once again if any ACC activity occurs, which may include any of the following:

- System Cancel
- Driver Override
- System Off
- ACC Proximity Warning
- ACC Unavailable Warning
- The DID will return to the last display selected after five seconds of no ACC display activity

## Display Warnings And Maintenance

### “Wipe Front Radar Sensor In Front Of Vehicle” Warning

The “ACC/FCW Unavailable Wipe Front Radar Sensor” warning will display and also a chime will indicate when conditions temporarily limit system performance.

This most often occurs at times of poor visibility, such as in snow or heavy rain. The ACC system may also become temporarily blinded due to obstructions, such as mud, dirt or ice. In these cases, the DID will display “ACC/FCW Unavailable Wipe Front Radar Sensor” and the system will deactivate.

The “ACC/FCW Unavailable Wipe Front Radar Sensor” message can sometimes be displayed while driving in highly reflective areas (i.e. tunnels with reflective tiles, or ice and snow). The ACC system will recover after the

vehicle has left these areas. Under rare conditions, when the radar is not tracking any vehicles or objects in its path this warning may temporarily occur.

**NOTE:** If the “ACC/FCW Unavailable Wipe Front Radar Sensor” warning is active Normal (Fixed Speed) Cruise Control is still available. For additional information refer to “Normal (Fixed Speed) Cruise Control Mode” in this section.

If weather conditions are not a factor, the driver should examine the sensor. It may require cleaning or removal of an obstruction. The sensor is located in the center of the vehicle behind the lower grille.

To keep the ACC System operating properly, it is important to note the following maintenance items:

- Always keep the sensor clean. Carefully wipe the sensor lens with a soft cloth. Be cautious not to damage the sensor lens.

- Do not remove any screws from the sensor. Doing so could cause an ACC system malfunction or failure and require a sensor realignment.
- If the sensor or front end of the vehicle is damaged due to a collision, see your authorized dealer for service.
- Do not attach or install any accessories near the sensor, including transparent material or aftermarket grilles. Doing so could cause an ACC system failure or malfunction.

When the condition that deactivated the system is no longer present, the system will return to the “Adaptive Cruise Control Off” state and will resume function by simply reactivating it.

**NOTE:**

- If the “ACC/FCW Unavailable Wipe Front Radar Sensor” message occurs frequently (e.g. more than

- once on every trip) without any snow, rain, mud, or other obstruction, have the radar sensor realigned at your authorized dealer.
- Installing a snow plow, front-end protector, an aftermarket grille or modifying the grille is not recommended. Doing so may block the sensor and inhibit ACC/FCW operation.

**“Clean Front Windshield” Warning**

The “ACC/FCW Limited Functionality Clean Front Windshield” warning will display and also a chime will indicate when conditions temporarily limit system performance. This most often occurs at times of poor visibility, such as in snow or heavy rain and fog. The ACC system may also become temporarily blinded due to obstructions, such as mud, dirt, or ice on windshield and fog on the inside of glass. In these cases, the DID will

display “ACC/FCW Limited Functionality Clean Front Windshield” and the system will have degraded performance.

The “ACC/FCW Limited Functionality Clean Front Windshield” message can sometimes be displayed while driving in adverse weather conditions. The ACC/FCW system will recover after the vehicle has left these areas. Under rare conditions, when the camera is not tracking any vehicles or objects in its path this warning may temporarily occur.

If weather conditions are not a factor, the driver should examine the windshield and the camera located on the back side of the inside rear view mirror. They may require cleaning or removal of an obstruction.

When the condition that created limited functionality is no longer present, the system will return to full functionality.

**NOTE:** If the “ACC/FCW Limited Functionality Clean Front Windshield” message occurs frequently (e.g. more than once on every trip) without any snow, rain, mud, or other obstruction, have the windshield and forward facing camera inspected at your authorized dealer.

### **Service ACC/FCW Warning**

If the system turns off, and the DID displays “ACC/FCW Unavailable Service Required” or “Cruise/FCW Unavailable Service Required”, there may be an internal system fault or a temporary malfunction that limits ACC functionality. Although the vehicle is still drivable under normal conditions, ACC will be temporarily unavailable. If this occurs, try activating ACC again later, following an ignition cycle. If the problem persists, see your authorized dealer.



## Precautions While Driving With ACC

In certain driving situations, ACC may have detection issues. In these cases, ACC may brake late or unexpectedly. The driver needs to stay alert and may need to intervene.

## Towing A Trailer

Towing a trailer is not advised when using ACC.

## Offset Driving

ACC may not detect a vehicle in the same lane that is offset from your direct line of travel, or a vehicle merging in from a side lane. There may not be sufficient distance to the vehicle ahead. The offset vehicle may move in and out of the line of travel, which can cause your vehicle to brake or accelerate unexpectedly.

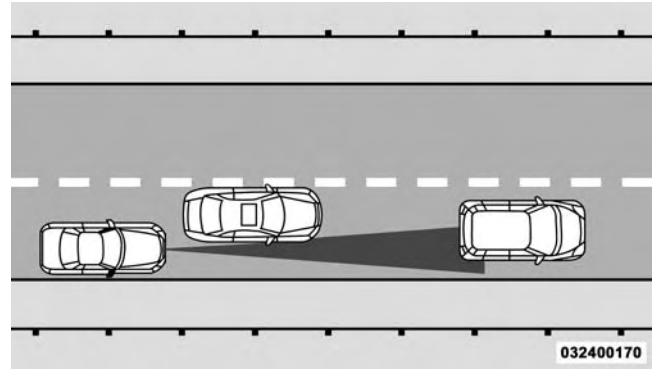

Offset Driving Condition Example

## Turns And Bends

When driving on a curve with ACC engaged, the system may decrease the vehicle speed and acceleration for stability reasons, with no target vehicle detected. Once

the vehicle is out of the curve the system will resume your original Set Speed. This is a part of normal ACC system functionality.

**NOTE:** On tight turns ACC performance may be limited.

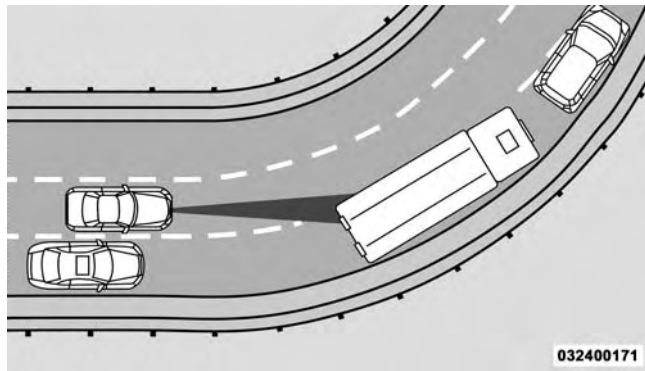

Turn Or Bend Example

### Using ACC On Hills

When driving on hills, ACC may not detect a vehicle in your lane. Depending on the speed, vehicle load, traffic conditions, and the steepness of the hills, ACC performance may be limited.



ACC Hill Example

## Lane Changing

ACC may not detect a vehicle until it is completely in the lane in which you are traveling. In the illustration shown, ACC has not yet detected the vehicle changing lanes and it may not detect the vehicle until it's too late for the ACC system to take action. ACC may not detect a vehicle until it is completely in the lane. There may not be sufficient distance to the lane-changing vehicle. Always be attentive and ready to apply the brakes if necessary.

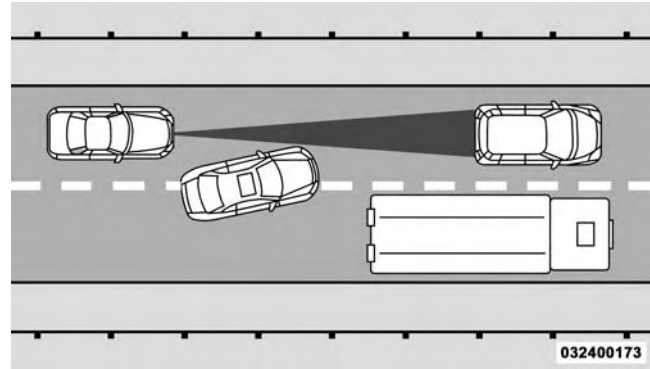

Lane Changing Example

## Narrow Vehicles

Some narrow vehicles traveling near the outer edges of the lane or edging into the lane are not detected until they have moved fully into the lane. There may not be sufficient distance to the vehicle ahead.

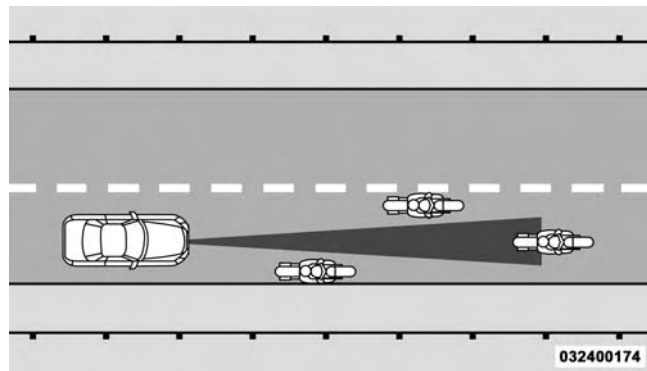

Narrow Vehicle Example

## Stationary Objects And Vehicles

ACC does not react to stationary objects and stationary vehicles. For example, ACC will not react in situations where the vehicle you are following exits your lane and the vehicle ahead is stopped in your lane. Always be attentive and ready to apply the brakes if necessary.

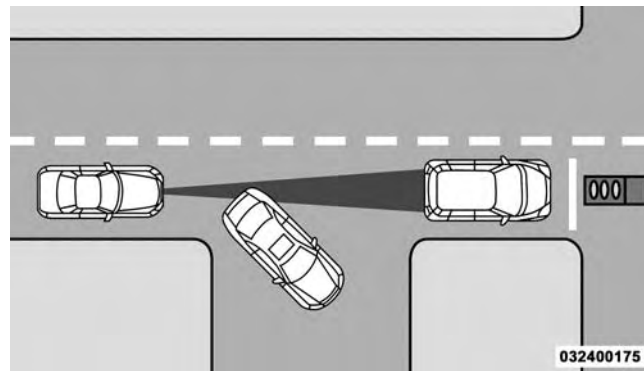

Stationary Object And Stationary Vehicle Example

## General Information

This vehicle has systems that operate on radio frequency that comply with Part 15 of the Federal Communications Commission (FCC) rules and with Industry Canada Standards RSS- GEN/210/220/310.

Operation is subject to the following two conditions:

1. The device may not cause harmful interference.
2. The device must accept any interference received, including interference that may cause undesired operation of the device.

Changes or modifications to any of these systems by other than an authorized service facility could void authorization to use this equipment.

## Normal (Fixed Speed) Electronic Speed Control Mode

In addition to Adaptive Cruise Control mode, a Normal (Fixed Speed) Electronic Speed Control mode is available for cruising at fixed speeds. The Normal (Fixed Speed) Electronic Speed Control mode is designed to maintain a set cruising speed without requiring the driver to operate the accelerator. Electronic Speed Control can only be operated if the vehicle speed is above 20 mph (32 km/h).

To change between the different control modes, push the ADAPTIVE CRUISE CONTROL (ACC) ON/OFF button which turns the ACC and the NORMAL (Fixed Speed) ELECTRONIC SPEED CONTROL OFF. Pushing of the NORMAL (Fixed Speed) ELECTRONIC SPEED CONTROL ON/OFF button will result in turning ON (changing to) the Normal (Fixed Speed) Electronic Speed Control mode.

**WARNING!**

In the normal Cruise Control mode, the system will not react to vehicles ahead. In addition, the proximity warning does not activate and no alarm will sound even if you are too close to the vehicle ahead since neither the presence of the vehicle ahead nor the vehicle-to vehicle distance is detected. Be sure to maintain a safe distance between your vehicle and the vehicle ahead. Always be aware which mode is selected.

**To Set A Desired Speed**

Turn the Normal (Fixed Speed) Electronic Speed Control ON. When the vehicle has reached the desired speed, push the SET (+) or

SET (-) button and release. Release the accelerator and the vehicle will operate at the selected speed. Once a speed has been set a message (CRUISE CONTROL SET TO MPH/KM) will appear indicating what speed was set. This light will turn on when the electronic speed control is SET.

**To Vary The Speed Setting****To Increase Speed**

When the Normal (Fixed Speed) Electronic Speed Control is set, you can increase speed by pushing the SET + button.

The drivers preferred units can be selected through the instrument panel settings if equipped. Refer to “Understanding Your Instrument Panel” for more information. The speed increment shown is dependant on the speed of U.S. (mph) or Metric (km/h) units:

#### *U.S. Speed (mph)*

- Pushing the SET + button once will result in a 1 mph increase in set speed. Each subsequent tap of the button results in an increase of 1 mph.
- If the button is continually pushed, the set speed will continue to increase in 5 mph increments until the button is released. The increase in set speed is reflected in the DID display.

#### *Metric Speed (km/h)*

- Pushing the SET + button once will result in a 1 km/h increase in set speed. Each subsequent tap of the button results in an increase of 1 km/h.

- If the button is continually pushed, the set speed will continue to increase in 10 km/h increments until the button is released. The increase in set speed is reflected in the DID display.

#### **To Decrease Speed**

When the Normal (Fixed Speed) Cruise Control is set, you can decrease speed by pushing the SET - button.

The drivers preferred units can be selected through the instrument panel settings if equipped. Refer to “Understanding Your Instrument Panel” for more information. The speed decrement shown is dependant on the speed of U.S. (mph) or Metric (km/h) units:

#### *U.S. Speed (mph)*

- Pushing the SET - button once will result in a 1 mph decrease in set speed. Each subsequent tap of the button results in a decrease of 1 mph.

- If the button is continually pushed, the set speed will continue to decrease in 5 mph decrements until the button is released. The decrease in set speed is reflected in the DID display.

### *Metric Speed (km/h)*

- Pushing the SET - button once will result in a 1 km/h decrease in set speed. Each subsequent tap of the button results in a decrease of 1 km/h.
- If the button is continually pushed, the set speed will continue to decrease in 10 km/h decrements until the button is released. The decrease in set speed is reflected in the DID display.

### **To Cancel**

The following conditions will cancel the Normal (Fixed Speed) Electronic Speed Control without clearing the memory:

- The brake pedal is applied.
- The CANCEL button is pushed.
- The Electronic Stability Control/Traction Control System (ESC/TCS) activates.
- The vehicle parking brake is applied.
- The braking temperature exceeds normal range (overheated).
- The shift lever/gear selector is removed from the Drive position.



### To Resume Speed

To resume a previously set speed, push the RES button and release. Resume can be used at any speed above 20 mph (32 km/h).

### To Turn Off

The system will turn off and erase the set speed in memory if:

- The Normal (Fixed Speed) Electronic Speed Control ON/OFF button is pushed.
- The ignition is turned off.
- You engage Four-Wheel Drive Low.
- The Adaptive Cruise Control (ACC) On/Off button is pushed.

## FORWARD COLLISION WARNING (FCW) WITH MITIGATION — IF EQUIPPED

### Forward Collision Warning (FCW) With Mitigation Operation

The Forward Collision Warning (FCW) system with mitigation provides the driver with audible warnings, visual warnings (within the DID), and may apply a brake jerk to warn the driver when it detects a potential frontal collision. The warnings and limited braking are intended to provide the driver with enough time to react, avoid or mitigate the potential collision.

**NOTE:** FCW monitors the information from the forward looking sensors as well as the Electronic Brake Controller (EBC), to calculate the probability of a forward collision. When the system determines that a forward collision is probable, the driver will be provided with audible and visual warnings and may provide a brake jerk warning. If the driver does not take action based upon these progressive warnings, then the system will provide a limited level of active braking to help slow the vehicle and mitigate the potential forward collision. If the driver reacts to the warnings by braking and the system determines that the driver intends to avoid the collision by braking but has not applied sufficient brake force, the system will compensate and provide additional brake force as required.



#### FCW Message

When the system determines a collision with the vehicle in front of you is no longer probable, the warning message will be deactivated.

**NOTE:**

- The minimum speed for FCW activation is 5 mph (8 km/h).
- The FCW alerts may be triggered on objects other than vehicles such as guard rails or sign posts based on the course prediction. This is expected and is a part of normal FCW activation and functionality.
- It is unsafe to test the FCW system. To prevent such misuse of the system, after four Active Braking events within an ignition cycle, the Active Braking portion of FCW will be deactivated until the next ignition cycle.
- The FCW system is intended for on-road use only. If the vehicle is taken off-road, the FCW system should be deactivated to prevent unnecessary warnings to the surroundings. If the vehicle enters 4WD Low Range, the FCW system will be automatically deactivated.

**WARNING!**

**Forward Collision Warning (FCW) is not intended to avoid a collision on its own, nor can FCW detect every type of potential collision. The driver has the responsibility to avoid a collision by controlling the vehicle via braking and steering. Failure to follow this warning could lead to serious injury or death.**

**Turning FCW ON Or OFF**

**NOTE:** The default status of FCW is “On”, this allows the system to warn you of a possible collision with the vehicle in front of you.

The forward collision button is located on the switch panel below the Uconnect® display.

To turn the FCW system OFF, push the forward collision button once to turn the system OFF (led turns on).

To turn the FCW system back ON, push the forward collision button again to turn the system ON (led turns off).

Changing the FCW status to “Off” prevents the system from warning you of a possible collision with the vehicle in front of you.

Changing the Active Braking status to “Off” prevents the system from providing limited autonomous braking, or additional brake support if the driver is not braking adequately in the event of a potential frontal collision.

**NOTE:** The FCW system state is kept in memory from one ignition cycle to the next. If the system is turned OFF, it will remain off when the vehicle is restarted.

## Changing FCW And Active Braking Status

The FCW Sensitivity And Active Braking Settings are programmable through the Uconnect® System. Refer to “Uconnect® Settings” in “Understanding Your Instrument Panel” for further information.

The default status of FCW is the “Far” setting and the Active Braking is the “On” setting, this allows the system to warn you of a possible collision with the vehicle in front of you when you are farther away and it applies limited braking. This gives you the most reaction time to avoid a possible collision.

Changing the FCW status to the “Near” setting, allows the system to warn you of a possible collision with the vehicle in front of you when you are much closer. This setting provides less reaction time than the “Far” setting, which allows for a more dynamic driving experience.

**NOTE:**

- The system will retain the last setting selected by the driver after ignition shut down.
- FCW may not react to irrelevant objects such as overhead objects, ground reflections, objects not in the path of the car, stationary objects that are far away, oncoming traffic, or leading vehicles with the same or higher rate of speed.
- FCW will be disabled like ACC, with the unavailable screens.

**FCW Limited Warning**

If the DID displays “ACC/FCW Limited Functionality” or “ACC/FCW Limited Functionality Clean Front Windshield” momentarily, there may be a condition that limits FCW functionality. Although the vehicle is still drivable under normal conditions, the active braking may not be

fully available. Once the condition that limited the system performance is no longer present, the system will return to its full performance state. If the problem persists, see your authorized dealer.

**Service FCW Warning**

If the system turns off, and the DID displays:

- ACC/FCW Unavailable Service Required
- Cruise/FCW Unavailable Service Required

This indicates there is an internal system fault. Although the vehicle is still drivable under normal conditions, have the system checked by an authorized dealer.

## **PARKSENSE® REAR PARK ASSIST — IF EQUIPPED**

The ParkSense® Rear Park Assist system provides visual and audible indications of the distance between the rear fascia and a detected obstacle when backing up, e.g. during a parking maneuver. Refer to ParkSense® System Usage Precautions for limitations of this system and recommendations.

ParkSense® will retain the last system state (enabled or disabled) from the last ignition cycle when the ignition is changed to the ON/RUN position.

ParkSense® can be active only when the shift lever/gear selector is in REVERSE. If ParkSense® is enabled at this shift lever/gear selector position, the system will remain active until the vehicle speed is increased to approximately 7 mph (11 km/h) or above. When in REVERSE and above the system's operating speed, a warning will appear within the Driver Information Display (DID)

indicating the vehicle speed is too fast. The system will become active again if the vehicle speed is decreased to speeds less than approximately 6 mph (9 km/h).

### **ParkSense® Sensors**

The four ParkSense® sensors, located in the rear fascia/bumper, monitor the area behind the vehicle that is within the sensors' field of view. The sensors can detect obstacles from approximately 12 in (30 cm) up to 79 in (200 cm) from the rear fascia/bumper in the horizontal direction, depending on the location, type and orientation of the obstacle.

### **ParkSense® Warning Display**

The ParkSense® Warning screen will only be displayed if Sound and Display is selected from the Customer - Programmable Features section of the Uconnect® System. Refer to "Uconnect® Settings" in "Understanding Your Instrument Panel" for further information.

The ParkSense® Warning screen is located within the DID. It provides visual warnings to indicate the distance between the rear fascia/bumper and the detected obstacle. Refer to “Driver Information Display (DID)” for further information.

### **ParkSense® Display**

When the vehicle is in REVERSE, the DID will display the park assist ready system status.

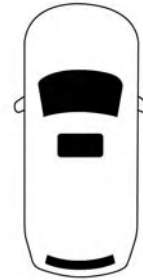

**Park Assist  
Ready**

0328050370

### **Park Assist Ready**

The system will indicate a detected obstacle by showing a single arc in the left and/or right rear regions based on the obstacle's distance and location relative to the vehicle.

## 230 UNDERSTANDING THE FEATURES OF YOUR VEHICLE

If an obstacle is detected in the left and/or right rear region, the display will show a single arc in the left and/or right rear region and the system will produce a tone. As the vehicle moves closer to the obstacle, the display will show the single arc moving closer to the vehicle and the tone will change from a single 1/2 second tone to slow, to fast, to continuous.

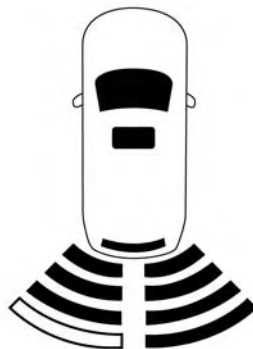

Single 1/2 Second Tone

0328050371



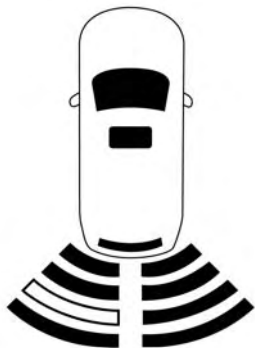

Slow Tone

0328050372

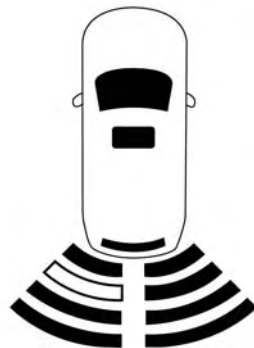

Fast Tone

0328050373

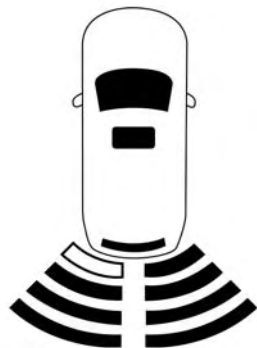

Continuous Tone

The vehicle is close to the obstacle when the warning display shows one flashing arc and sounds a continuous tone. The following chart shows the warning alert operation when the system is detecting an obstacle:

0328050374

WARNING ALERTS					
Rear Distance (in/cm)	Greater than 79 in (200 cm)	79-39 in (200-100 cm)	39-25 in (100-65 cm)	25-12 in (65-30 cm)	Less than 12 in (30 cm)
Audible Alert Chime	None	Single 1/2 Second Tone	Slow	Fast	Continuous
Arc	None	4th Solid	3rd Solid	2nd Flashing	1st Flashing
Radio Volume Reduced	No	Yes	Yes	Yes	Yes

**NOTE:** ParkSense® will reduce the volume of the radio, if on, when the system is sounding an audio tone.

### Adjustable Chime Volume Settings

Rear chime volume settings can be selected from the Customer-Programmable Features section of the Uconnect® System, refer to “Uconnect Settings” in “Understanding Your Instrument Panel” for further information.

The chime volume settings include LOW, MEDIUM, and HIGH. The factory default volume setting is MEDIUM.

ParkSense® will retain its last known configuration state through ignition cycles.

## Enabling And Disabling ParkSense®

ParkSense® can be enabled and disabled with the ParkSense® switch.



When the ParkSense® switch is pushed to disable the system, the instrument cluster will display the “PARKSENSE OFF” message for approximately five seconds. Refer to “Driver Information Display (DID)” in “Understanding Your Instrument Panel” for further information. When the shift lever/gear selector is moved to REVERSE and the system is disabled, the DID will display the “PARKSENSE OFF” message for as long as the vehicle is in REVERSE.

The ParkSense® switch LED will be ON when ParkSense® is disabled or requires service. The ParkSense® switch LED will be OFF when the system is enabled. If the ParkSense® switch is pushed, and the

system requires service, the ParkSense® switch LED will blink momentarily, and then the LED will be ON.

## Service The ParkSense® Rear Park Assist System

During vehicle start up, when the ParkSense® Rear Park Assist System has detected a faulted condition, the instrument cluster will actuate a single chime, once per ignition cycle, and it will display the “PARKSENSE UNAVAILABLE WIPE REAR SENSORS” or the “PARKSENSE UNAVAILABLE SERVICE REQUIRED” message. Refer to “Driver Information Display (DID)” for further information. When the shift lever/gear selector is moved to REVERSE and the system has detected a faulted condition, the DID will display the “PARKSENSE UNAVAILABLE WIPE REAR SENSORS” or “PARKSENSE UNAVAILABLE SERVICE REQUIRED” message for as long as the vehicle is in REVERSE. Under this condition, ParkSense® will not operate.

If “PARKSENSE UNAVAILABLE WIPE REAR SENSORS” appears in the Driver Information Display (DID) make sure the outer surface and the underside of the rear fascia/bumper is clean and clear of snow, ice, mud, dirt or other obstruction and then cycle the ignition. If the message continues to appear, see an authorized dealer.

If “PARKSENSE UNAVAILABLE SERVICE REQUIRED” appears in the DID, see an authorized dealer.

### **Cleaning The ParkSense® System**

Clean the ParkSense® sensors with water, car wash soap and a soft cloth. Do not use rough or hard cloths. Do not scratch or poke the sensors. Otherwise, you could damage the sensors.

### **ParkSense® System Usage Precautions**

#### **NOTE:**

- Ensure that the rear bumper is free of snow, ice, mud, dirt and debris to keep the ParkSense® system operating properly.
- Jackhammers, large trucks, and other vibrations could affect the performance of ParkSense®.
- When you turn ParkSense® OFF, the instrument cluster will display “PARKSENSE OFF” Furthermore, once you turn ParkSense® off, it remains off until you turn it on again, even if you cycle the ignition.
- When you move the shift lever to the REVERSE position and ParkSense® is turned OFF, the DID will display “PARKSENSE OFF” message for as long as the vehicle is in REVERSE.

- ParkSense®, when on, will reduce the volume of the radio when it is sounding a tone.
- Clean the ParkSense® sensors regularly, taking care not to scratch or damage them. The sensors must not be covered with ice, snow, slush, mud, dirt or debris. Failure to do so can result in the system not working properly. The ParkSense® system might not detect an obstacle behind the fascia/bumper, or it could provide a false indication that an obstacle is behind the fascia/bumper.
- Use the ParkSense® switch to turn the ParkSense® system OFF if objects such as bicycle carriers, trailer hitches, etc. are placed within 12 in (30 cm) from the rear fascia/bumper. Failure to do so can result in the system misinterpreting a close object as a sensor problem, causing the “PARKSENSE UNAVAILABLE SERVICE REQUIRED” message to be displayed in the DID.

**CAUTION!**

- **ParkSense® is only a parking aid and it is unable to recognize every obstacle, including small obstacles. Parking curbs might be temporarily detected or not detected at all. Obstacles located above or below the sensors will not be detected when they are in close proximity.**
- **The vehicle must be driven slowly when using ParkSense® in order to be able to stop in time when an obstacle is detected. It is recommended that the driver looks over his/her shoulder when using ParkSense®.**

**WARNING!**

- **Drivers must be careful when backing up even when using ParkSense®. Always check carefully**

*(Continued)*

**WARNING! (Continued)**

behind your vehicle, look behind you, and be sure to check for pedestrians, animals, other vehicles, obstructions, and blind spots before backing up. You are responsible for safety and must continue to pay attention to your surroundings. Failure to do so can result in serious injury or death.

- Before using ParkSense®, it is strongly recommended that the ball mount and hitch ball assembly is disconnected from the vehicle when the vehicle is not used for towing. Failure to do so can result in injury or damage to vehicles or obstacles because the hitch ball will be much closer to the obstacle than the rear fascia when the loudspeaker sounds the continuous tone. Also, the sensors could detect the ball mount and hitch ball assembly, depending on its size and shape, giving a false indication that an obstacle is behind the vehicle.

**PARKVIEW® REAR BACK UP CAMERA — IF EQUIPPED**

Your vehicle may be equipped with the ParkView® Rear Back Up Camera that allows you to see an on-screen image of the rear surroundings of your vehicle whenever the shift lever/gear selector is put into REVERSE. The image will be displayed on the Navigation/Multimedia radio display screen along with a caution note to “check entire surroundings” across the top of the screen. After five seconds this note will disappear. The ParkView® camera is located on the rear of the vehicle above the rear License plate.

When the vehicle is shifted out of REVERSE (with camera delay turned OFF), the rear camera mode is exited and the navigation or audio screen appears again.

When the vehicle is shifted out of REVERSE (with camera delay turned ON), the rear view image with dynamic grid lines will be displayed for up to 10 seconds after

shifting out of "REVERSE" unless the forward vehicle speed exceeds 8 mph (13 km/h), the transmission is shifted into "PARK" or the ignition is switched to the OFF position.

**NOTE:** The ParkView® Rear Back Up Camera has programmable modes of operation that may be selected through the Uconnect® System. Refer to "Uconnect® Settings" in "Understanding Your Instrument Panel" for further information.

When enabled, active guide lines are overlaid on the image to illustrate the width of the vehicle and its projected backup path based on the steering wheel position. A dashed center line overlay indicates the center of the vehicle to assist with parking or aligning to a hitch/receiver. "Different colored zones indicate the distance to the rear of the vehicle." The following table shows the approximate distances for each zone:

Zone	Distance to the rear of the vehicle
Red	0 - 1 ft (0 - 30 cm)
Yellow	1 ft - 6.5 ft (30 cm - 2 m)
Green	6.5 ft or greater (2 m or greater)



**WARNING!**

Drivers must be careful when backing up even when using the ParkView® Rear Back Up Camera. Always check carefully behind your vehicle, and be sure to check for pedestrians, animals, other vehicles, obstructions, or blind spots before backing up. You are responsible for the safety of your surroundings and must continue to pay attention while backing up. Failure to do so can result in serious injury or death.

**CAUTION!**

- To avoid vehicle damage, ParkView® should only be used as a parking aid. The ParkView® camera is unable to view every obstacle or object in your drive path.

*(Continued)*

**CAUTION! (Continued)**

- To avoid vehicle damage, the vehicle must be driven slowly when using ParkView® to be able to stop in time when an obstacle is seen. It is recommended that the driver look frequently over his/her shoulder when using ParkView®.

**NOTE:** If snow, ice, mud, or any foreign substance builds up on the camera lens, clean the lens, rinse with water, and dry with a soft cloth. Do not cover the lens.

## OVERHEAD CONSOLE

The overhead console contains courtesy/reading lights and storage for sunglasses. Universal Garage Door Opener (HomeLink®), power liftgate and power sunroof switches may also be included, if equipped.



033333450

Overhead Console

## Front Map/Reading Lights — If Equipped

Lights are mounted in the overhead console. Each light can be turned on by pushing the switch on either side of the console. These buttons are backlit for night time visibility.



031433150

Front Map/Reading Lights

To turn the lights off, push the switch a second time. The lights also turn on when a door is opened. The lights will also turn on when the UNLOCK button on the RKE is pushed.



031433151

Front Map/Reading Light Switches

### Courtesy Lights

The courtesy lights can be turned on by pushing the top corner of the lens. To turn the lights off, push the lens a second time.



031464435

Courtesy Lights

### Sunglasses Bin Door

At the front of the console a compartment is provided for the storage of a pair of sunglasses. The storage compartment access is a “push/push” design. Push the chrome pad on the door to open. Push the chrome pad on the door to close.



03333448

Sunglasses Bin Door

### GARAGE DOOR OPENER — IF EQUIPPED

HomeLink® replaces up to three remote controls (hand-held transmitters) that operate devices such as garage door openers, motorized gates, lighting or home security systems. The HomeLink® unit operates off your vehicle's battery.

The HomeLink® buttons, located on either the overhead console, or sunvisor, designate the three different HomeLink® channels. The HomeLink® indicator is located above the center button.

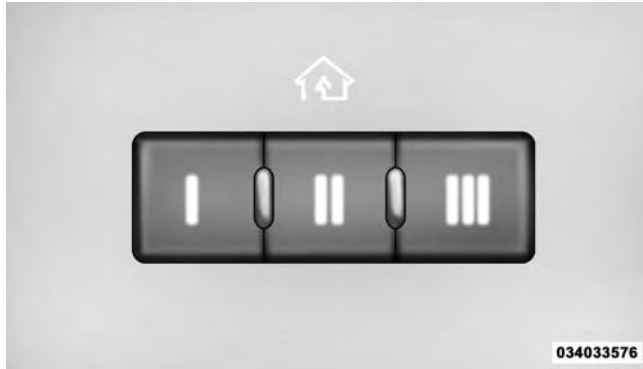

HomeLink® Buttons/Overhead Consoles



HomeLink® Buttons/Sunvisor

**NOTE:** HomeLink® is disabled when the Vehicle Security Alarm is active.

## Before You Begin Programming HomeLink®

Be sure that your vehicle is parked outside of the garage before you begin programming.

For more efficient programming and accurate transmission of the radio-frequency signal it is recommended that a new battery be placed in the hand-held transmitter of the device that is being programmed to the HomeLink® system.

To erase the channels place the ignition in the ON/RUN position and push and hold the two outside HomeLink® buttons (I and III) for up 20 seconds or until the red  indicator flashes.

### NOTE:

- Erasing all channels should only be performed when programming HomeLink® for the first time. Do not erase channels when programming additional buttons.
- If you have any problems, or require assistance, please call toll-free 1-800-355-3515 or, on the Internet at [HomeLink.com](http://HomeLink.com) for information or assistance.

## Programming A Rolling Code

For programming garage door openers that were manufactured after 1995. These garage door openers can be identified by the “LEARN” or “TRAIN” button located where the hanging antenna is attached to the garage door opener. It is NOT the button that is normally used to open and close the door. The name and color of the button may vary by manufacturer.

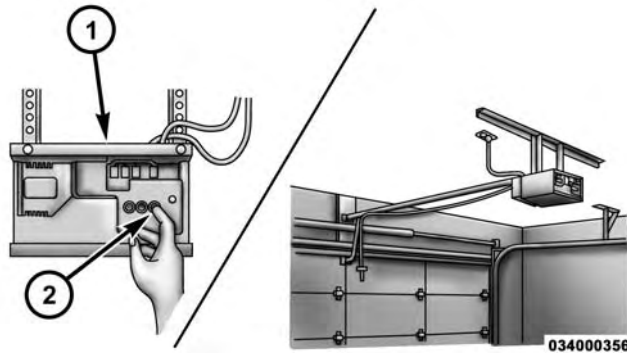

Training The Garage Door Opener

- 1 — Door Opener  
2 — Training Button

1. Place the ignition in the ON/RUN position.

2. Place the hand-held transmitter 1 to 3 inches (3 to 8 cm) away from the HomeLink® button you wish to program while keeping the HomeLink® indicator light in view.
3. Push and hold the HomeLink® button you want to program while you push and hold the hand-held transmitter button.
4. Continue to hold both buttons and observe the indicator light. The HomeLink® indicator  will flash slowly and then rapidly after HomeLink® has received the frequency signal from the hand-held transmitter. Release both buttons after the indicator light changes from slow to rapid.
5. At the garage door opener motor (in the garage), locate the “LEARN” or “TRAINING” button. This can usually be found where the hanging antenna wire is attached to the garage door opener/device motor.

Firmly push and release the “LEARN” or “TRAINING” button. On some garage door openers/devices there may be a light that blinks when the garage door opener/device is in the LEARN/TRAIN mode.

**NOTE:** You have 30 seconds in which to initiate the next step after the LEARN button has been pushed.

6. Return to the vehicle and push the programmed HomeLink® button twice (holding the button for two seconds each time). If the garage door opener/device activates, programming is complete.

**NOTE:** If the garage door opener/device does not activate, push the button a third time (for two seconds) to complete the training.

To program the remaining two HomeLink® buttons, repeat each step for each remaining button. DO NOT erase the channels.

### Reprogramming A Single HomeLink® Button (Rolling Code)

To reprogram a channel that has been previously trained, follow these steps:

1. Cycle the ignition to the ON/RUN position.
2. Push and hold the desired HomeLink® button until the indicator light begins to flash after 20 seconds. **Do not release the button.**
3. **Without releasing the button** proceed with “Programming A Rolling Code” step 2 and follow all remaining steps.

### Programming A Non-Rolling Code

For programming Garage Door Openers manufactured before 1995.

1. Place the ignition in the ON/RUN position.



2. Place the hand-held transmitter 1 to 3 inches (3 to 8 cm) away from the HomeLink® button you wish to program while keeping the HomeLink® indicator light in view.
3. Push and hold the Homelink® button you want to program while you push and hold the hand-held transmitter button.
4. Continue to hold both buttons and observe the indicator light. The Homelink® indicator  will flash slowly and then rapidly after HomeLink® has received the frequency signal from the hand-held transmitter. Release both buttons after the indicator light changes from slow to rapid.
5. Push and hold the programmed HomeLink® button and observe the indicator light.
  - If the indicator light stays on constantly, programming is complete and the garage door/device should activate when the HomeLink® button is pushed.

- To program the two remaining HomeLink® buttons, repeat each step for each remaining button. **DO NOT** erase the channels.

### Reprogramming A Single HomeLink® Button (Non-Rolling Code)

To reprogram a channel that has been previously trained, follow these steps:

1. Cycle the ignition to the ON/RUN position.
2. Push and hold the desired HomeLink® button until the indicator light begins to flash after 20 seconds. **Do not release the button.**
3. **Without releasing the button** proceed with “Programming A Non-Rolling Code” step 2 and follow all remaining steps.

### Canadian/Gate Operator Programming

For programming transmitters in Canada/United States that require the transmitter signals to “time-out” after several seconds of transmission.

Canadian radio frequency laws require transmitter signals to time-out (or quit) after several seconds of transmission – which may not be long enough for HomeLink® to pick up the signal during programming. Similar to this Canadian law, some U.S. gate operators are designed to time-out in the same manner.

It may be helpful to unplug the device during the cycling process to prevent possible overheating of the garage door or gate motor.

1. Cycle the ignition to the ON/RUN position.

2. Place the hand-held transmitter 1 to 3 inches (3 to 8 cm) away from the HomeLink® button you wish to program while keeping the HomeLink® indicator light in view.
3. Continue to push and hold the HomeLink® button, while you push and release (“cycle”) your hand-held transmitter every two seconds until HomeLink® has successfully accepted the frequency signal. The indicator light will flash slowly and then rapidly when fully trained.
4. Watch for the HomeLink® indicator to change flash rates. When it changes, it is programmed. It may take up to 30 seconds or longer in rare cases. The garage door may open and close while you are programming.
5. Push and hold the programmed HomeLink® button and observe the indicator light.

- If the indicator light stays on constantly, programming is complete and the garage door/device should activate when the HomeLink® button is pushed.
- To program the two remaining HomeLink® buttons, repeat each step for each remaining button. **DO NOT** erase the channels.

If you unplugged the garage door opener/device for programming, plug it back in at this time.

### Reprogramming A Single HomeLink® Button (Canadian/Gate Operator)

To reprogram a channel that has been previously trained, follow these steps:

1. Cycle the ignition to the ON/RUN position.
2. Push and hold the desired HomeLink® button until the indicator light begins to flash after 20 seconds. **Do not release the button.**

3. **Without releasing the button** proceed with “Canadian/Gate Operator Programming” step 2 and follow all remaining steps.

### Using HomeLink®

To operate, press and release the programmed HomeLink® button. Activation will now occur for the trained device (i.e., garage door opener, gate operator, security system, entry door lock, home/office lighting, etc.). The handheld transmitter of the device may also be used at any time.

### Security

It is advised to erase all channels before you sell or turn in your vehicle.

To do this, push and hold the two outside buttons for 20 seconds until the red indicator flashes. Note that all channels will be erased. Individual channels cannot be erased.

The HomeLink® Universal Transceiver is disabled when the Vehicle Security Alarm is active.

### Troubleshooting Tips

If you are having trouble programming HomeLink®, here are some of the most common solutions:

- Replace the battery in the original transmitter.
- Press the LEARN button on the Garage Door Opener to complete the training for a Rolling Code.
- Did you unplug the device for training, and remember to plug it back in?

If you have any problems, or require assistance, please call toll-free 1-800-355-3515 or, on the Internet at [www.HomeLink.com](http://www.HomeLink.com) for information or assistance.

### WARNING!

Vehicle exhaust contains carbon monoxide, a dangerous gas. Do not run your vehicle in the garage while programming the transceiver. Exhaust gas can cause serious injury or death.

### WARNING!

- Vehicle exhaust contains carbon monoxide, a dangerous gas. Do not run your vehicle in the garage while programming the transceiver. Exhaust gas can cause serious injury or death.
- Your motorized door or gate will open and close while you are programming the universal transceiver. Do not program the transceiver if people, pets or other objects are in the path of the door or gate. Only use this transceiver with a garage door

*(Continued)*

**WARNING! (Continued)**

opener that has a “stop and reverse” feature as required by Federal safety standards. This includes most garage door opener models manufactured after 1982. Do not use a garage door opener without these safety features. Call toll-free 1-800-355-3515 or, on the Internet at [HomeLink.com](http://HomeLink.com) for safety information or assistance.

**General Information**

This device complies with FCC rules Part 15 and Industry Canada RSS-210. Operation is subject to the following two conditions:

1. This device may not cause harmful interference.

2. This device must accept any interference that may be received including interference that may cause undesired operation.

**NOTE:**

- The transmitter has been tested and it complies with FCC and IC rules. Changes or modifications not expressly approved by the party responsible for compliance could void the user's authority to operate the device.
- The term IC before the certification/registration number only signifies that Industry Canada technical specifications were met.

**POWER SUNROOF — IF EQUIPPED**

The power sunroof switch is located between the sun visors on the overhead console.



Power Sunroof Switch

0333063940

**WARNING!**

- Never leave children unattended in a vehicle, or with access to an unlocked vehicle. Never leave the Key Fob in or near the vehicle, or in a location accessible to children. Do not leave the ignition of a vehicle equipped with Keyless Enter-N-Go™ in the ACC or ON/RUN mode. Occupants, particularly unattended children, can become entrapped by the power sunroof while operating the power sunroof switch. Such entrapment may result in serious injury or death.
- In a collision, there is a greater risk of being thrown from a vehicle with an open sunroof. You could also be seriously injured or killed. Always fasten your seat belt properly and make sure all passengers are also properly secured.
- Do not allow small children to operate the sunroof.

*(Continued)*

**WARNING! (Continued)**

Never allow your fingers, other body parts, or any object, to project through the sunroof opening. Injury may result.

**Opening Sunroof — Express**

Push the switch rearward and release it within one-half second. The sunroof and sunshade will open automatically from any position. The sunroof and sunshade will open fully and stop automatically. This is called “Express Open.” During Express Open operation, any movement of the sunroof switch will stop the sunroof.

**Opening Sunroof — Manual Mode**

To open the sunroof, push and hold the switch rearward to full open. Any release of the switch will stop the movement. The sunroof and sunshade will remain in a partially opened condition until the switch is pushed and held rearward again.

**Closing Sunroof — Express**

Push the switch forward and release it within one-half second and the sunroof will close automatically from any position. The sunroof will close fully and stop automatically. This is called “Express Close.” During Express Close operation, any movement of the switch will stop the sunroof.

**Closing Sunroof — Manual Mode**

To close the sunroof, push and hold the switch in the forward position. Any release of the switch will stop the movement and the sunroof will remain in a partially closed condition until the switch is pushed and held forward again.

**Pinch Protect Feature**

This feature will detect an obstruction in the opening of the sunroof during Express Close operation. If an obstruction in the path of the sunroof is detected, the

sunroof will automatically retract. Remove the obstruction if this occurs. Next, push the switch forward and release to Express Close.

**NOTE:** If three consecutive sunroof close attempts result in Pinch Protect reversals, the fourth close attempt will be a Manual Close movement with Pinch Protect disabled.

### **Venting Sunroof — Express**

Push and release the Vent button within one half second and the sunroof will open to the vent position. This is called “Express Vent”, and it will occur regardless of sunroof position. During Express Vent operation, any movement of the switch will stop the sunroof.

### **Sunshade Operation**

The sunshade can be opened manually. However, the sunshade will open automatically as the sunroof opens.

**NOTE:** The sunshade cannot be closed if the sunroof is open.

### **Wind Buffeting**

Wind buffeting can be described as the perception of pressure on the ears or a helicopter-type sound in the ears. Your vehicle may exhibit wind buffeting with the windows down, or the sunroof (if equipped) in certain open or partially open positions. This is a normal occurrence and can be minimized. If the buffeting occurs with the rear windows open, open the front and rear windows together to minimize the buffeting. If the buffeting occurs with the sunroof open, adjust the sunroof opening to minimize the buffeting or open any window.

### **Sunroof Maintenance**

Use only a non-abrasive cleaner and a soft cloth to clean the glass panel.



## Ignition OFF Operation

The power sunroof switch will remain active for up to approximately ten minutes after the ignition switch is turned to the LOCK position. Opening either front door will cancel this feature.

**NOTE:** Ignition Off time is programmable through the Uconnect® System. Refer to “Uconnect® Settings/ Customer Programmable Features” in “Understanding Your Instrument Panel” for further information.

## ELECTRICAL POWER OUTLETS

Your vehicle is equipped with 12 Volt (13 Amp) power outlets that can be used to power cellular phones, small electronics and other low powered electrical accessories. The power outlets are labeled with either a “key” or a “battery” symbol to indicate how the outlet is powered. Power outlets labeled with a “key” are powered when

the ignition switch is in the ON or ACC position, while the outlets labeled with a “battery” are connected directly to the battery and powered at all times.

### NOTE:

- All accessories connected to the “battery” powered outlets should be removed or turned off when the vehicle is not in use to protect the battery against discharge.
- To ensure proper operation a MOPAR® knob and element must be used.
- Do not exceed the maximum power of 160 Watts (13 Amps) at 12 Volts. If the 160 Watt (13 Amp) power rating is exceeded the fuse protecting the system will need to be replaced.
- Power outlets are designed for accessory plugs only. Do not insert any other object in the power outlets as

this will damage the outlet and blow the fuse. Improper use of the power outlet can cause damage not covered by your New Vehicle Limited Warranty.

The front power outlet is located inside the storage area on the center stack of the instrument panel.



**Front Power Outlet**

In addition to the front power outlet, there is also a power outlet located in the storage area of the center console.



**Front Center Console Outlet**

If your vehicle is equipped with a rear full center console, there is also a power outlet located in the lower storage area of the rear full center console.



### Rear Full Center Console Outlet

The rear cargo power outlet is located in the right rear cargo area.



### Rear Cargo Power Outlet

**NOTE:** The rear cargo power outlet can be changed to “battery” powered all the time by switching the power outlet right rear quarter panel fuse in the fuse panel from fuse location F90 to F91.

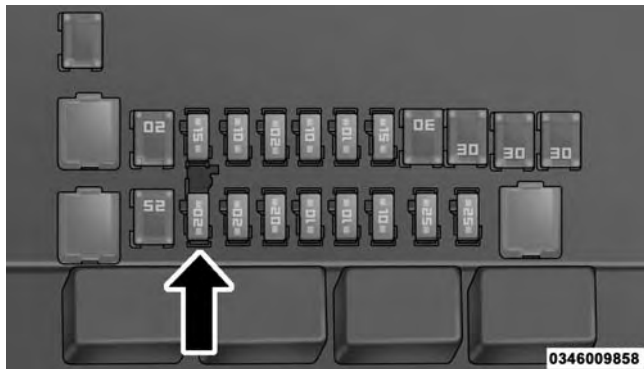

Rear Cargo Power Outlet Fuse

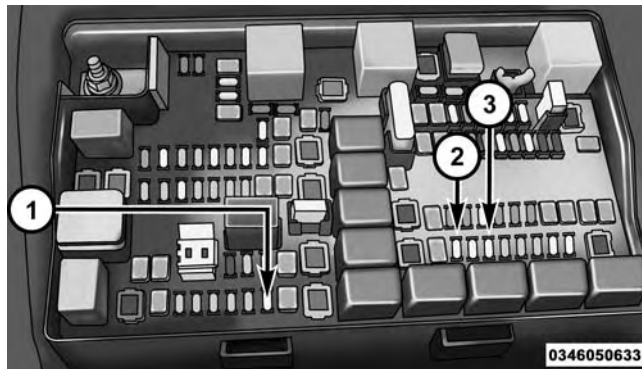

Power Outlet Fuse Locations

- 1 — F104 Fuse 20 A Yellow Power Outlet Console Bin
- 2 — F90–F91 Fuse 20 A Yellow Power Outlet Right Rear Quarter Panel
- 3 — F93 Fuse 20 A Yellow Cigar Lighter Instrument Panel

**WARNING!**

To avoid serious injury or death:

- Only devices designed for use in this type of outlet should be inserted into any 12 Volt outlet.
- Do not touch with wet hands.
- Close the lid when not in use and while driving the vehicle.
- If this outlet is mishandled, it may cause an electric shock and failure.

**CAUTION!**

- Many accessories that can be plugged in draw power from the vehicle's battery, even when not in use (i.e., cellular phones, etc.). Eventually, if plugged in long enough, the vehicle's battery will discharge sufficiently to degrade battery life and/or

*(Continued)*

**CAUTION! (Continued)**

prevent the engine from starting.

- Accessories that draw higher power (i.e., coolers, vacuum cleaners, lights, etc.) will degrade the battery even more quickly. Only use these intermittently and with greater caution.
- After the use of high power draw accessories, or long periods of the vehicle not being started (with accessories still plugged in), the vehicle must be driven a sufficient length of time to allow the generator to recharge the vehicle's battery.

**POWER INVERTER — IF EQUIPPED**

There is a 115 Volt, 150 Watt inverter outlet located on the back of the center console to convert DC current to AC current. This outlet can power cellular phones, electronics and other low power devices requiring power up to

150 Watts. Certain high-end video games, such as PlayStation3 and Xbox360 will exceed this power limit, as will most power tools.

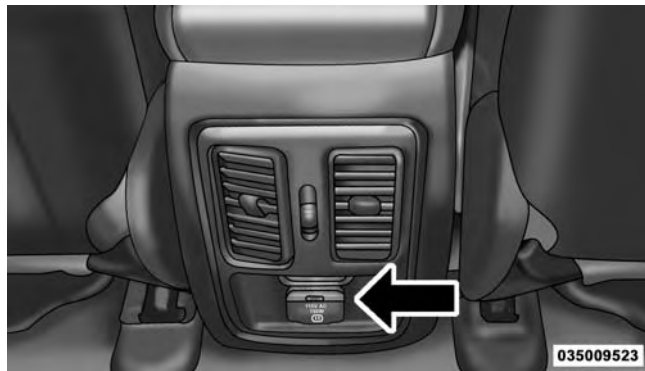

**Power Inverter**

The power inverter is designed with built-in overload protection. If the power rating of 150 Watts is exceeded,

the power inverter will automatically shut down. Once the electrical device has been removed from the outlet the inverter should automatically reset. To avoid overloading the circuit, check the power ratings on electrical devices prior to using the inverter.

**WARNING!**

**To avoid serious injury or death:**

- Do not insert any objects into the receptacles.
- Do not touch with wet hands.
- Close the lid when not in use.
- If this outlet is mishandled, it may cause an electric shock and failure.

## CUPHOLDERS

### Front Seat Cupholders

There are two cupholders for the front seat passengers located in the center console.

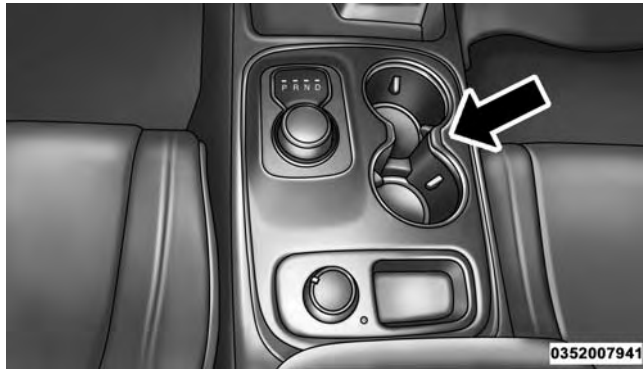

Front Cupholder Location

### Rear Cupholders

#### Rear Center Arm Rest Cupholders — If Equipped

There are two cupholders for the rear seat passengers located in the fold-down center armrest.

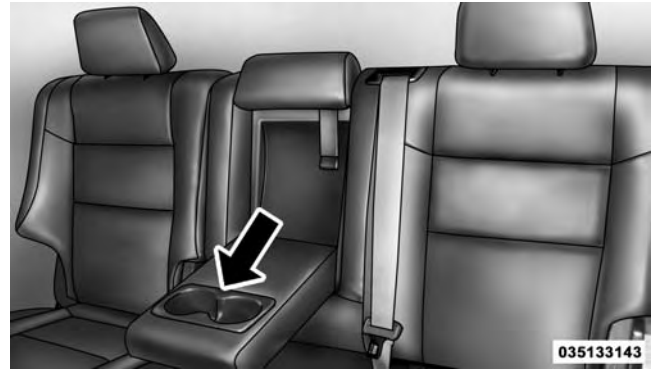

Rear Center Arm Rest Cupholders

### Rear Full Console Cupholders — If Equipped

There are two cupholders for the rear seat passengers located in the front of the rear full console.

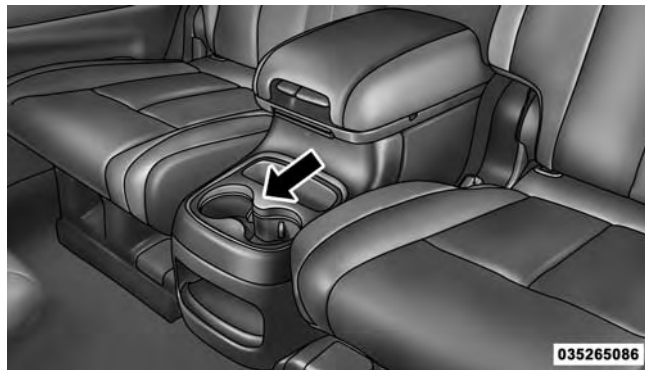

#### Rear Full Console Cupholders

The rear full console cupholders are equipped with a light ring that illuminates the cupholders for the rear passengers. The light ring is controlled by the Dimmer

Control. Refer to “Lights” in “Understanding The Features Of Your Vehicle” for further information.



#### Light Ring In Rear Full Console Cupholders



### Rear Mini Console Cupholders — If Equipped

There are two cupholders for the rear seat passengers located in the front of the rear mini console.

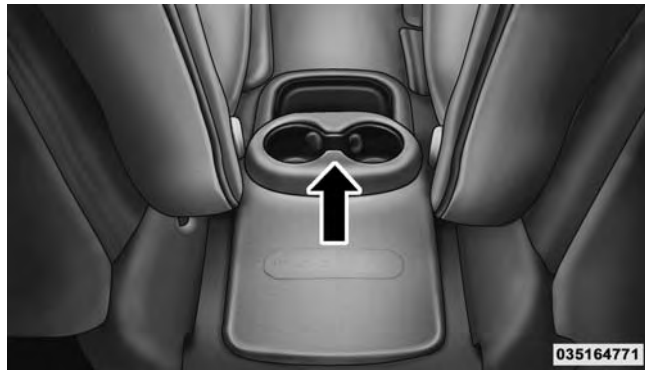

Rear Mini Console Cupholders

## STORAGE

### Glove Compartment

The glove compartment is located on the right side of the instrument panel.



Glove Compartment

To open the glove compartment, pull outward on the latch and lower the glove box door.

### Door Storage

Large storage areas are built into the door panels for easy access.



Door Panel Storage

### Front Center Console

The front center console contains both an upper and a lower storage area.

To open the upper storage compartment, pull upward on the small latch located on the lid.

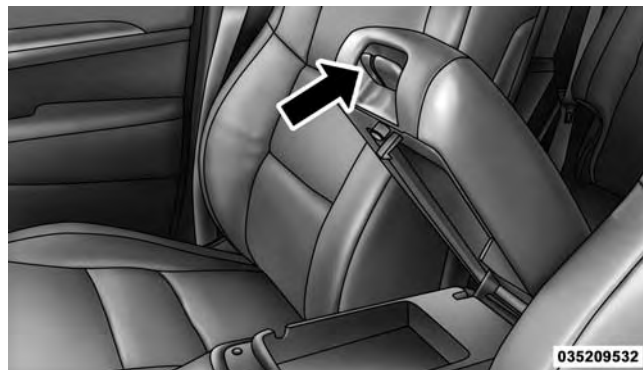

Storage Compartment Latches

Lift upward on the larger of the latches to access the lower storage compartment.

### Rear Full Center Console — If Equipped

The rear full center console contains both an upper and a lower storage area.

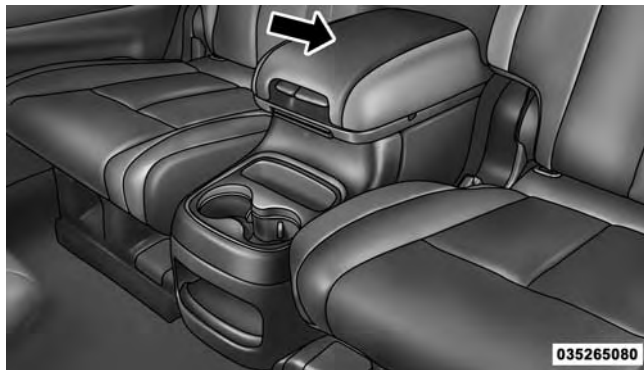

Storage Compartment

To open the upper storage compartment, pull upward on the small latch located on the front of the lid.

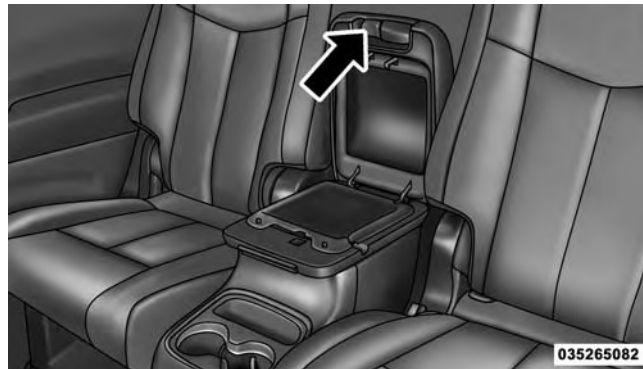

### Upper Storage Compartment

Lift upward on the larger of the latches to access the lower storage compartment.

**NOTE:** Lower storage compartment light is always on with ignition in the ON/RUN position.

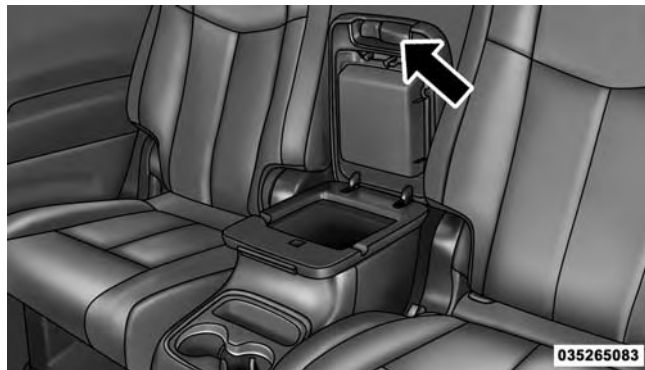

Lower Storage Compartment

The upper storage compartment may also be lifted forward. Push in the release button located on the back of the lid.

**CAUTION!**

Remove any items stored in the console cupholders or devices with cords routing through upper storage area. Damage may occur to upper console lid and device cables when upper storage compartment is lifted forward.



Storage Compartment Rear Push Button

When lifted forward there is access to the lower storage compartment.

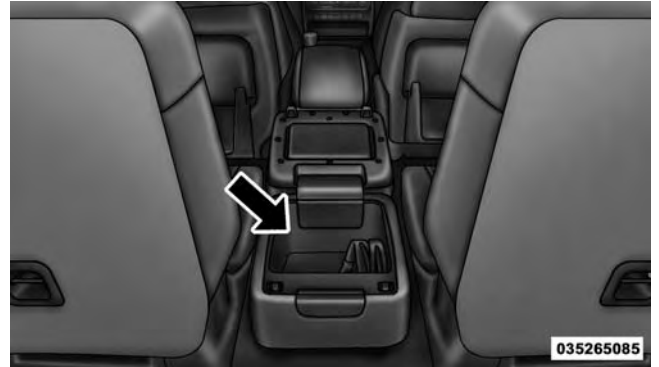

Lower Storage Compartment

**NOTE:** When the lower storage compartment is accessed it allows the armrest to flip forward for “fold flat mode”. Fold flat mode allows the console armrest to be lowered below fold flat seat plane and protect the armrest vinyl from damage when using the vehicle to haul cargo.

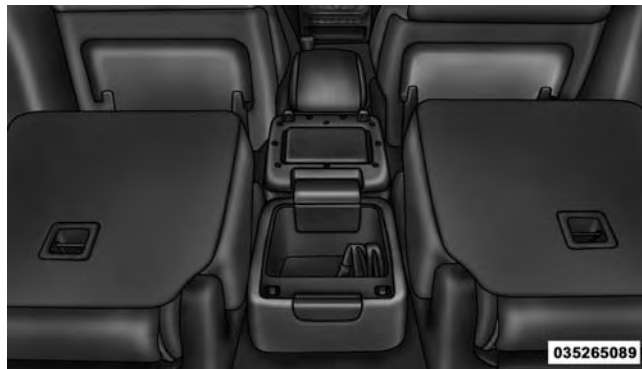

Fold Flat Mode

Open storage areas, or cubby bins with removable liners, are located rearward of the cupholders and in the lower front of the console.

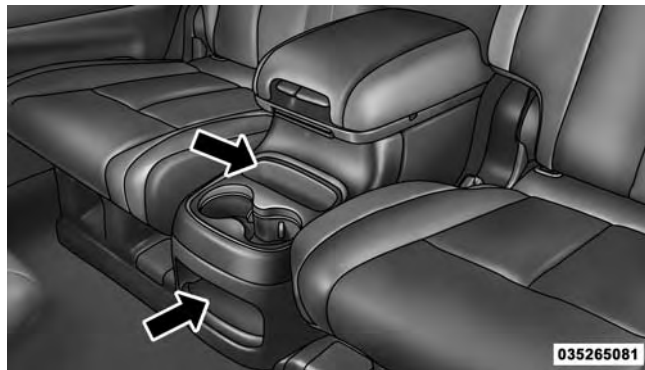

Console Cubby Bins

### Rear Mini Center Console — If Equipped

An open storage area, or cubby bin with removable liner, is located in the front of the console.



Console Cubby Bin

## CARGO AREA FEATURES

### Rechargeable Flashlight

The rechargeable flashlight is mounted on the left side of the cargo area. The flashlight snaps out of the bezel when needed. The flashlight features two bright LED light bulbs and is powered by rechargeable lithium batteries that recharge when snapped back into place.

Push in on the flashlight to release it.



Push And Release



To operate the flashlight, push the switch once for high, twice for low, and a third time to return to off.

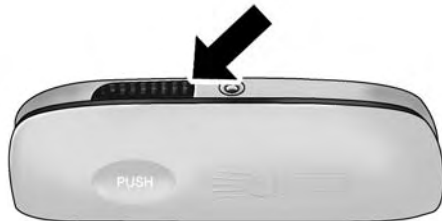

035410217

**Three-Push Switch**

## Cargo Storage

There is a removable storage bin located on the left side of the rear cargo area.

Additional storage can be found in the load floor. To access the lower storage, lift the handle and raise the storage lid.

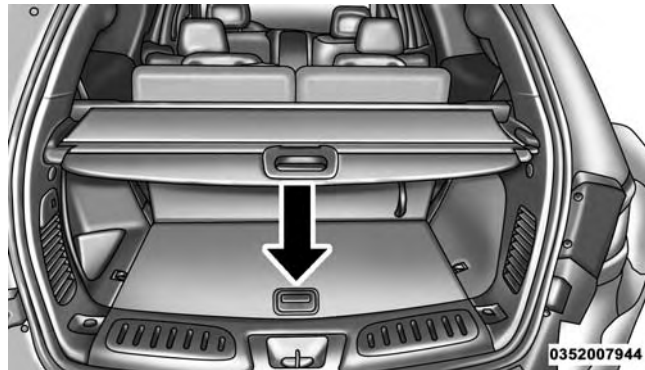

0352007944

**Load Floor Handle**

### Retractable Cargo Area Cover — If Equipped

**NOTE:** The purpose of this cover is for privacy, not to secure loads. It will not prevent cargo from shifting or protect passengers from loose cargo.

To cover the cargo area:

1. Grasp the cover at the center handle. Pull it over the cargo area.
2. Insert the pins on the ends of the cover into the slots in the pillar trim cover.
3. The liftgate may be opened with the cargo cover in place.

#### **WARNING!**

**In a collision, a loose cargo cover in the vehicle could cause injury. It could fly around in a sudden stop and strike someone in the vehicle. Do not store the cargo cover on the cargo floor or in the passenger compartment. Remove the cover from the vehicle when taken from its mounting. Do not store it in the vehicle.**

## Cargo Tie-Down Hooks

The cargo tie-downs, located on the cargo area floor, should be used to safely secure loads when the vehicle is

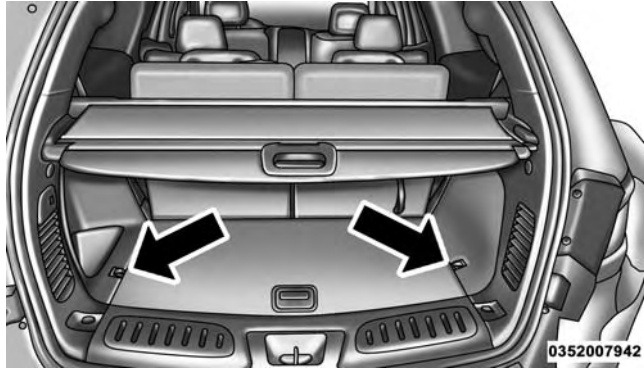

Tie-Down Hooks

### WARNING!

- To help protect against personal injury, passengers should not be seated in the rear cargo area. The rear cargo space is intended for load carrying purposes only, not for passengers, who should sit in seats and use seat belts.
- Cargo tie-down hooks are not safe anchors for a child seat tether strap. In a sudden stop or accident, a hook could pull loose and allow the child seat to come loose. A child could be badly injured. Use only the anchors provided for child seat tethers.

3

*(Continued)*

**WARNING! (Continued)**

The weight and position of cargo and passengers can change the vehicle center of gravity and vehicle handling. To avoid loss of control resulting in personal injury, follow these guidelines for loading your vehicle:

- Do not carry loads which exceed the load limits described on the label attached to the left door or left door center pillar.
- Always place cargo evenly on the cargo floor. Put heavier objects as low and as far forward as possible.
- Place as much cargo as possible in front of the rear axle. Too much weight or improperly placed weight over or behind the rear axle can cause the rear of the vehicle to sway.

*(Continued)*

**WARNING! (Continued)**

- Do not pile luggage or cargo higher than the top of the seatback. This could impair visibility or become a dangerous projectile in a sudden stop or accident.

**REAR WINDOW FEATURES****Rear Window Wiper/Washer**

The rear wiper/washer controls are located on the multifunction lever on the left side of the steering column. The rear wiper/washer is operated by rotating a switch, located at the middle of the lever.



036463509

### Rear Wiper/Washer Control

 Rotate the center portion of the lever upward to the first detent for intermittent operation and to the second detent for continuous rear wiper operation.



Rotating the center portion upward once more will activate the washer pump which will continue to operate as long as the switch is held.

Upon release of the switch, the wipers will resume the continuous rear wiper operation. When this rotary control is in the OFF position, rotating it downward will activate the rear washer pump which will continue to operate as long as the switch is held. Once the switch is released it will return to the OFF position and the wipers will cycle several times before returning to the parked position.

**NOTE:** As a protective measure, the pump will stop if the switch is held for more than 20 seconds. Once the switch is released the pump will resume normal operation.

If the rear wiper is operating when the ignition is turned OFF, the wiper will automatically return to the “park” position.

## Rear Window Defroster



The rear window defroster button is located on the climate control panel. Push this button to turn on the rear window defroster and the heated outside mirrors (if equipped). An indicator in the button will illuminate when the rear window defroster is on. The rear window defroster automatically turns off after approximately 10 minutes. For an additional five minutes of operation, push the button a second time.

**NOTE:** To prevent excessive battery drain, use the rear window defroster only when the engine is operating.

### CAUTION!

Failure to follow these cautions can cause damage to the heating elements:

- Use care when washing the inside of the rear window. Do not use abrasive window cleaners on the interior surface of the window. Use a soft cloth and a mild washing solution, wiping parallel to the heating elements. Labels can be peeled off after soaking with warm water.
- Do not use scrapers, sharp instruments, or abrasive window cleaners on the interior surface of the window.
- Keep all objects a safe distance from the window.

## ROOF LUGGAGE RACK — IF EQUIPPED

The crossbars and side rails are designed to carry weight on vehicles equipped with a luggage rack. **The load must not exceed 150 lbs (68 kg), and should be uniformly distributed over the luggage rack crossbars.**

The crossbars on your vehicle are delivered stowed within the roof rack side rails. Crossbars should always be used whenever cargo is placed on the roof rack. Check the straps frequently to be sure that the load remains securely attached.

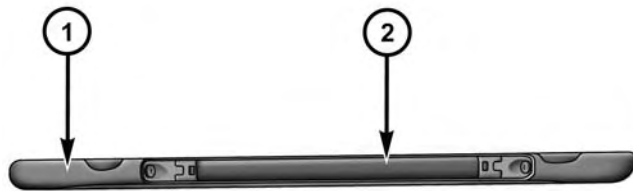

037635136

- 1 — Side Rail
- 2 — Crossbar

The roof rack does not increase the total load carrying capacity of the vehicle. Be sure the total load of cargo inside the vehicle plus that on the external rack does not exceed the maximum vehicle load capacity.

## Deploying the Crossbars

Starting with one crossbar, completely loosen the thumb screws at both ends of the crossbar.



Thumb Screw

**NOTE:** The thumb screws cannot be fully removed.

Remove the crossbar from the stowed position by sliding the crossbar towards the center of the roof. Repeat with crossbar on the opposite side.

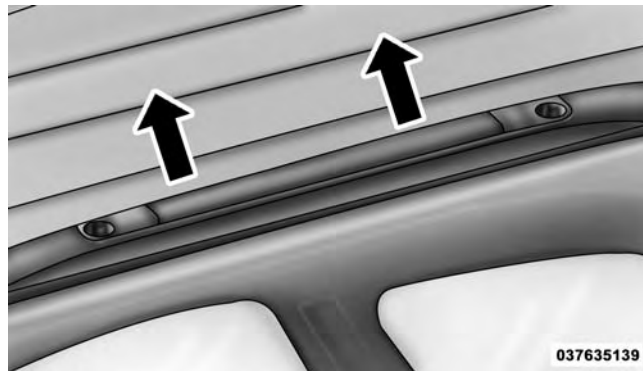

Removing Crossbars



**CAUTION!**

Be careful when handling the crossbars to prevent damage to the vehicle.

Starting with one crossbar, bend down the pivot supports at each end.

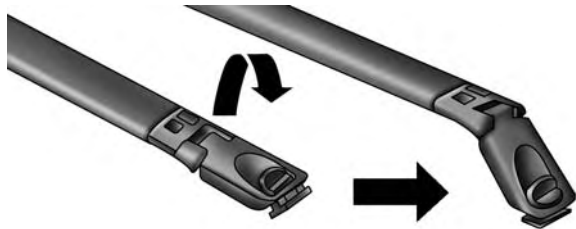

037635140

Bending Pivot

Position the crossbars across the roof making sure the letters on the crossbars align with the matching letters on the side rail.

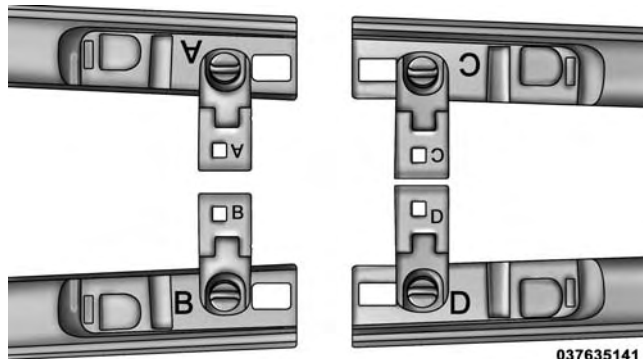

037635141

**Positioning Crossbars**

Slide the cross bar into to the deploy position by moving it towards the matching letter in the side rail. Be sure the

crossbar is fully deployed with the crossbar pushed as far into the slot as possible. Once the crossbar is in place, tighten both thumb screws completely.

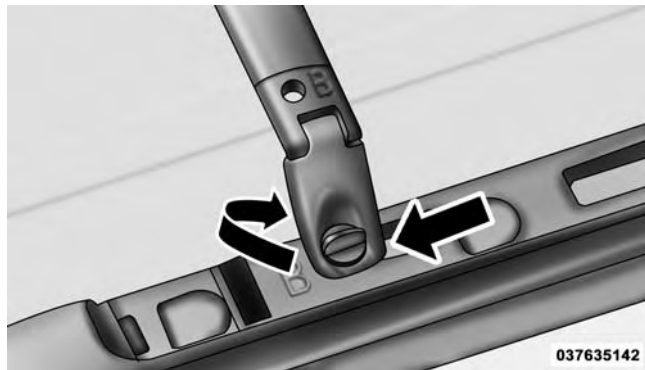

### Installing Crossbars

Deploy and tighten the second crossbar to complete the deployment of the crossbars.

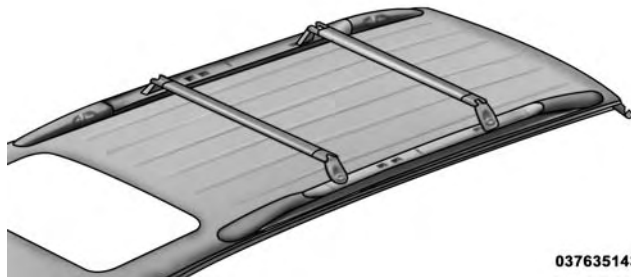

### Deployed Crossbars

### Stowing The Crossbars

Starting with one crossbar, completely loosen the thumb screws at both ends. Slide the crossbar away from the matching letter to remove it from the deployed position. Repeat with the other crossbar.

**CAUTION!**

Be careful when handling the crossbars to prevent damage to the vehicle.

Starting with the one crossbar, bend up the pivot supports at each end.

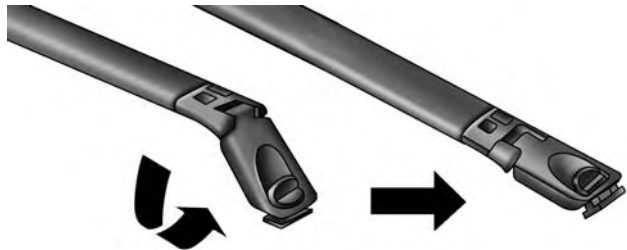

037635145

Crossbar Pivot

Then, position the crossbar along the correct side rail. Make sure the letters on the crossbar align with the matching letters on the side rail.

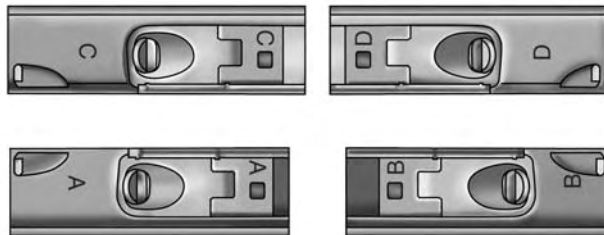

037635147

Stowing Crossbars

Slide the crossbar outward, away from the center of the roof. The crossbar will nest fully within the side rail.

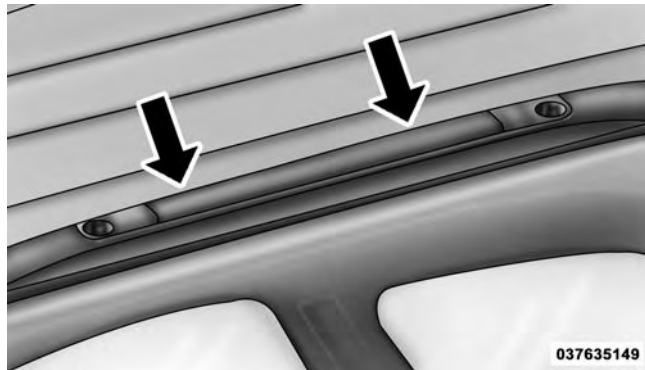

**Crossbar To Side Rail**

Once the driver's side crossbar is in place, tighten the thumb screws completely.



**Tightening Crossbar**

Repeat the procedure to stow the second crossbar on the opposite side.



Stowed Crossbars

**NOTE:**

- To help control wind noise, stow the crossbars in the side rails when they are not in use.

- If any metallic object is placed over the satellite radio antenna (if equipped), you may experience interruption of satellite radio reception.

**WARNING!**

Cargo must be securely tied before driving your vehicle. Improperly secured loads can fly off the vehicle, particularly at high speeds, resulting in personal injury or property damage. Follow the roof rack cautions when carrying cargo on your roof rack.

**CAUTION!**

- To prevent damage to the roof of your vehicle, **DO NOT** carry any loads on the roof rack without the crossbars deployed. The load should be secured and placed on top of the crossbars, not directly on

*(Continued)*

**CAUTION!** *(Continued)*

the roof. If it is necessary to place the load on the roof, place a blanket or other protective layer between the load and the roof surface.

- To avoid damage to the roof rack and vehicle, do not exceed the maximum roof rack load capacity of 150 lb (68 kg). Always distribute heavy loads as evenly as possible and secure the load appropriately.
- Load should always be secured to cross bars first, with tie down loops used as additional securing points if needed. Tie loops are intended as supplementary tie down points only. Do not use ratcheting mechanisms with the tie loops. Check the

*(Continued)*

**CAUTION!** *(Continued)*

straps and thumb wheels frequently to be sure that the load remains securely attached.

- Long loads that extend over the windshield, such as wood panels or surfboards, or loads with large frontal area should be secured to both the front and rear of the vehicle.
- Travel at reduced speeds and turn corners carefully when carrying large or heavy loads on the roof rack. Wind forces, due to natural causes or nearby truck traffic, can add sudden upward lift to a load. This is especially true on large flat loads and may result in damage to the cargo or your vehicle.

# UNDERSTANDING YOUR INSTRUMENT PANEL

## CONTENTS

---

■ INSTRUMENT PANEL FEATURES . . . . .	.288	□ DID Green Telltales . . . . .	.310
■ INSTRUMENT CLUSTER . . . . .	.289	□ DID Selectable Menu Items . . . . .	.310
■ INSTRUMENT CLUSTER DESCRIPTIONS . . . . .	.290	□ Screen Setup Driver Selectable Items . . . . .	.314
■ DRIVER INFORMATION DISPLAY (DID) . . . . .	.299	■ Uconnect® SETTINGS. . . . .	.315
□ DID Displays . . . . .	.301	□ Buttons On The Faceplate. . . . .	.316
□ Engine Oil Life Reset . . . . .	.303	□ Buttons On The Touchscreen. . . . .	.317
□ DID Messages . . . . .	.304	□ Customer Programmable Features — Uconnect® 5.0 Personal Settings . . . . .	.317
□ DID White Telltales . . . . .	.306	□ Customer Programmable Features — Uconnect® 8.4 Personal Settings . . . . .	.333
□ DID Amber Telltales . . . . .	.306		
□ DID Red Telltales. . . . .	.308		

- Uconnect® RADIOS — IF EQUIPPED . . . . . 352
- iPod®/USB/MP3 CONTROL — IF EQUIPPED .353
  - Connecting The iPod® Or External USB Device . . . . . 353
  - Using This Feature. . . . . 354
  - Second Row USB Charging Port . . . . . 354
- Uconnect® REAR SEAT ENTERTAINMENT (RSE) SYSTEM — IF EQUIPPED . . . . . 356
  - Getting Started . . . . . 356
  - Dual Video Screen . . . . . 358
  - Blu-ray™ Disc Player. . . . . 358
  - Play Video Games . . . . . 362
  - Play A DVD/Blu-ray™ Disc Using The Touchscreen Radio. . . . . 363
  - Important Notes For Dual Video Screen System . . . . . 365
  - Blu-ray™ Disc Player Remote Control — If Equipped . . . . . 366
  - Replacing The Remote Control Batteries. . . . . 367
  - Headphones Operation . . . . . 368
  - Controls . . . . . 369
  - Replacing The Headphone Batteries. . . . . 370
  - Unwired® Stereo Headphone Lifetime Limited Warranty . . . . . 370
- STEERING WHEEL AUDIO CONTROLS — IF EQUIPPED . . . . . 377
  - Radio Operation . . . . . 378
  - CD Player. . . . . 378



<ul style="list-style-type: none"> <li>■ CD/DVD/Blu-ray™ Disc MAINTENANCE . . . .378</li> <li>■ RADIO OPERATION AND MOBILE PHONES . .379                     <ul style="list-style-type: none"> <li>□ Regulatory And Safety Information . . . . .379</li> </ul> </li> <li>■ CLIMATE CONTROLS . . . . .381                     <ul style="list-style-type: none"> <li>□ General Overview . . . . .382</li> <li>□ Climate Control Functions . . . . .388</li> <li>□ Automatic Temperature Control (ATC) . . . . .390</li> <li>□ Rear Automatic Temperature Control (ATC) . .391</li> <li>□ Operating Tips . . . . .396</li> </ul> </li> <li>■ Uconnect® VOICE RECOGNITION QUICK TIPS . . . . .399                     <ul style="list-style-type: none"> <li>□ Introducing Uconnect® . . . . .399</li> <li>□ Get Started . . . . .400</li> <li>□ Basic Voice Commands. . . . .402</li> </ul> </li> </ul>	<ul style="list-style-type: none"> <li>□ Radio . . . . .403</li> <li>□ Media. . . . .405</li> <li>□ Phone. . . . .406</li> <li>□ Voice Text Reply . . . . .408</li> <li>□ Climate (8.4A/8.4AN) . . . . .409</li> <li>□ Navigation (8.4A/8.4AN) . . . . .410</li> <li>□ Uconnect® Access (8.4A/8.4AN) . . . . .410</li> <li>□ Register (8.4A/8.4AN) . . . . .411</li> <li>□ Mobile App (8.4A/8.4AN) . . . . .412</li> <li>□ Voice Texting (8.4A/8.4AN) . . . . .413</li> <li>□ Yelp® (8.4A/8.4AN). . . . .414</li> <li>□ SiriusXM Travel Link™ (8.4A/8.4AN) . . . . .415</li> <li>□ Additional Information . . . . .416</li> </ul>
--	---

## INSTRUMENT PANEL FEATURES

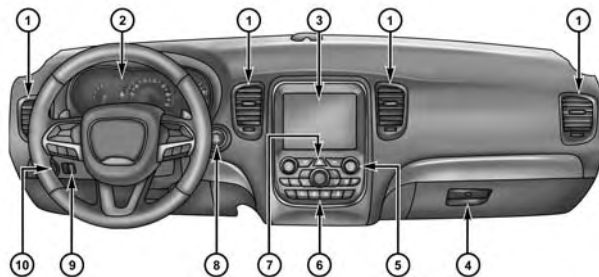

0401054236

- 1 — Air Outlet
- 2 — Instrument Cluster
- 3 — Radio
- 4 — Glove Compartment
- 5 — Climate Controls

- 6 — Lower Switch Bank
- 7 — Hazard Switch
- 8 — Ignition Start/Stop Button
- 9 — Dimmer Switch
- 10 — Headlight Switch

# INSTRUMENT CLUSTER

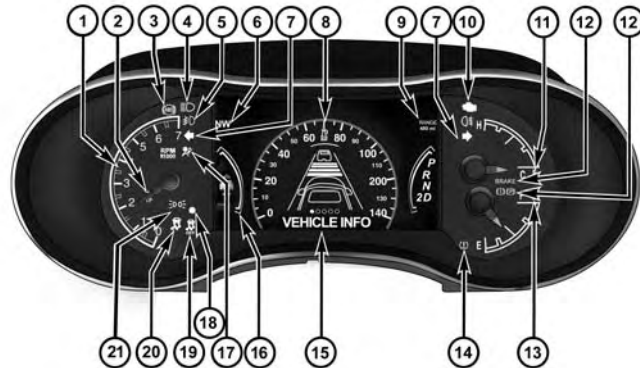

0403054313

## INSTRUMENT CLUSTER DESCRIPTIONS

### 1. Tachometer

Indicates the engine speed in revolutions per minute (RPM x 1000).

### 2. Seat Belt Reminder Light



When the ignition switch is first turned to the ON/RUN position, this light will turn on for four to eight seconds as a bulb check. During the bulb check, if the driver's seat belt is unbuckled, a chime will sound. After the bulb check or when driving, if the driver or front passenger seat belt remains unbuckled, the Seat Belt Indicator Light will flash or remain on continuously. Refer to "Occupant Restraints" in "Things To Know Before Starting Your Vehicle" for further information.

### 3. Anti-Lock Brake (ABS) Light



This light monitors the Anti-Lock Brake System (ABS). The light will turn on when the ignition switch is turned to the ON/RUN position and may stay on for as long as four seconds.

If the ABS light remains on or turns on while driving, it indicates that the Anti-Lock portion of the brake system is not functioning and that service is required. However, the conventional brake system will continue to operate normally if the BRAKE warning light is not on.

If the ABS light is on, the brake system should be serviced as soon as possible to restore the benefits of Anti-Lock brakes. If the ABS light does not turn on when the ignition switch is turned to the ON/RUN position, have the light inspected by an authorized dealer.

#### 4. High Beam Indicator

 Indicates that headlights are on high beam.

#### 5. Front Fog Light Indicator — If Equipped

 This indicator will illuminate when the front fog lights are on.

#### 6. Selectable DID Information

This area of the cluster will display selectable information such as compass, outside temperature, etc. For further information, refer to “Driver Information Display (DID) — If Equipped” of your Owner’s Manual for more information.

#### 7. Turn Signal Indicator

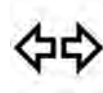
 The arrows will flash with the exterior turn signals when the turn signal lever is operated.

A tone will chime, and an DID message will appear if either turn signal is left on for more than 1 mile (1.6 km).

**NOTE:** If either indicator flashes at a rapid rate, check for a defective outside light bulb.

#### 8. Speedometer

Indicates vehicle speed.

#### 9. Selectable DID Information

This area of the cluster will display selectable information such as compass, outside temperature, etc. For further information, refer to “Driver Information Display (DID) — If Equipped” of your Owner’s Manual for more information.

#### 10. Malfunction Indicator Light (MIL)

 The Malfunction Indicator Light (MIL) is part of an onboard diagnostic system called OBD II that

monitors engine and automatic transmission control systems. The light will illuminate when the key is in the ON/RUN position before engine start. If the bulb does not come on when turning the key from OFF to ON/RUN, have the condition checked promptly.

Certain conditions, poor fuel quality, may illuminate the light after engine start. The vehicle should be serviced if the light stays on through several of your typical driving cycles. In most situations, the vehicle will drive normally and will not require towing.

### CAUTION!

**Prolonged driving with the Malfunction Indicator Light (MIL) on could cause damage to the engine control system. It also could affect fuel economy and driveability. If the MIL is flashing, severe catalytic converter damage and power loss will soon occur. Immediate service is required.**

### WARNING!

**A malfunctioning catalytic converter, as referenced above, can reach higher temperatures than in normal operating conditions. This can cause a fire if you drive slowly or park over flammable substances such as dry plants, wood, cardboard, etc. This could result in death or serious injury to the driver, occupants or others.**

### 11. *Temperature Gauge*

The temperature gauge shows engine coolant temperature. Any reading within the normal range indicates that the engine cooling system is operating satisfactorily.

The gauge pointer will likely indicate a higher temperature when driving in hot weather, up mountain grades, or when towing a trailer. It should not be allowed to exceed the upper limits of the normal operating range.

**CAUTION!**

Driving with a hot engine cooling system could damage your vehicle. If the temperature gauge reads "H" pull over and stop the vehicle. Idle the vehicle with the air conditioner turned off until the pointer drops back into the normal range. If the pointer remains on the "H" and you hear continuous chimes, turn the engine off immediately and call an authorized dealer for service.

**WARNING!**

A hot engine cooling system is dangerous. You or others could be badly burned by steam or boiling coolant. You may want to call an authorized dealer for service if your vehicle overheats. If you decide to look under the hood yourself, see "Maintaining Your

*(Continued)*

**WARNING! (Continued)**

Vehicle". Follow the warnings under the Cooling System Pressure Cap paragraph.

**12. Brake Warning Light****BRAKE**

This light monitors various brake functions, including brake fluid level and parking brake application. If the brake light turns on, it may indicate that the parking brake is applied, that the brake fluid level is low, or that there is a problem with the anti-lock brake system reservoir.

If the light remains on when the parking brake has been disengaged, and the fluid level is at the full mark on the master cylinder reservoir, it indicates a possible brake hydraulic system malfunction or that a problem with the Brake Booster has been detected by the Anti-Lock Brake System (ABS) / Electronic Stability Control (ESC) system.

In this case, the light will remain on until the condition has been corrected. If the problem is related to the brake booster, the ABS pump will run when applying the brake, and a brake pedal pulsation may be felt during each stop.

The dual brake system provides a reserve braking capacity in the event of a failure to a portion of the hydraulic system. A leak in either half of the dual brake system is indicated by the Brake Warning Light, which will turn on when the brake fluid level in the master cylinder has dropped below a specified level.

The light will remain on until the cause is corrected.

**NOTE:** The light may flash momentarily during sharp cornering maneuvers, which change fluid level conditions. The vehicle should have service performed, and the brake fluid level checked.

If brake failure is indicated, immediate repair is necessary.

### WARNING!

**Driving a vehicle with the red brake light on is dangerous. Part of the brake system may have failed. It will take longer to stop the vehicle. You could have a collision. Have the vehicle checked immediately.**

Vehicles equipped with the Anti-Lock Brake System (ABS) are also equipped with Electronic Brake Force Distribution (EBD). In the event of an EBD failure, the Brake Warning Light will turn on along with the ABS Light. Immediate repair to the ABS system is required.

Operation of the Brake Warning Light can be checked by turning the ignition switch from the OFF position to the ON/RUN position. The light should illuminate for approximately two seconds. The light should then turn off unless the parking brake is applied, or a brake fault is detected. If the light does not illuminate, have the light inspected by an authorized dealer.



The light also will turn on when the parking brake is applied with the ignition switch in the ON/RUN position.

**NOTE:** This light shows only that the parking brake is applied. It does not show the degree of brake application.

### 13. *Fuel Gauge/Fuel Door Reminder*

The fuel pump symbol points to the side of the vehicle where the fuel door is located. The pointer shows the level of fuel in the fuel tank when the ignition switch is in the ON/RUN position.

### 14. *Tire Pressure Monitoring Telltale Light*



Each tire, including the spare (if provided), should be checked monthly when cold and inflated to the inflation pressure recommended by the vehicle manufacturer on the vehicle placard or tire inflation pressure label. (If your vehicle has tires of a different size than the size indicated on the

vehicle placard or tire inflation pressure label, you should determine the proper tire inflation pressure for those tires.)

As an added safety feature, your vehicle has been equipped with a Tire Pressure Monitoring System (TPMS) that illuminates a low tire pressure telltale when one or more of your tires is significantly under-inflated. Accordingly, when the low tire pressure telltale illuminates, you should stop and check your tires as soon as possible, and inflate them to the proper pressure. Driving on a significantly under-inflated tire causes the tire to overheat and can lead to tire failure. Under-inflation also reduces fuel efficiency and tire tread life, and may affect the vehicle's handling and stopping ability.

Please note that the TPMS is not a substitute for proper tire maintenance, and it is the driver's responsibility to maintain correct tire pressure, even if under-inflation has not reached the level to trigger illumination of the TPMS low tire pressure telltale.

Your vehicle has also been equipped with a TPMS malfunction indicator to indicate when the system is not operating properly. The TPMS malfunction indicator is combined with the low tire pressure telltale. When the system detects a malfunction, the telltale will flash for approximately one minute and then remain continuously illuminated. This sequence will continue upon subsequent vehicle start-ups as long as the malfunction exists. When the malfunction indicator is illuminated, the system may not be able to detect or signal low tire pressure as intended. TPMS malfunctions may occur for a variety of reasons, including the installation of replacement or alternate tires or wheels on the vehicle that prevent the TPMS from functioning properly. Always check the TPMS malfunction telltale after replacing one or more tires or wheels on your vehicle, to ensure that the replacement or alternate tires and wheels allow the TPMS to continue to function properly.

### **CAUTION!**

**The TPMS has been optimized for the original equipment tires and wheels. TPMS pressures and warning have been established for the tire size equipped on your vehicle. Undesirable system operation or sensor damage may result when using replacement equipment that is not of the same size, type, and/or style. Aftermarket wheels can cause sensor damage. Using aftermarket tire sealants may cause the Tire Pressure Monitoring System (TPMS) sensor to become inoperable. After using an aftermarket tire sealant it is recommended that you take your vehicle to an authorized dealership to have your sensor function checked.**

### 15. *Driver Information Display (DID)/Odometer Display*

The odometer display shows the total distance the vehicle has been driven.

U.S. Federal regulations require that upon transfer of vehicle ownership, the seller certify to the purchaser the correct mileage that the vehicle has been driven. If your odometer needs to be repaired or serviced, the repair technician should leave the odometer reading the same as it was before the repair or service. If s/he cannot do so, then the odometer must be set at zero, and a sticker must be placed in the door jamb stating what the mileage was before the repair or service. It is a good idea for you to make a record of the odometer reading before the repair/service, so that you can be sure that it is properly reset, or that the door jamb sticker is accurate if the odometer must be reset at zero.

When the appropriate conditions exist, this display shows the Driver Information Display (DID) messages. Refer to “Driver Information Display (DID)” of your Owner’s Manual for more information.

### 16. *Selectable DID Menu*

This area of the cluster will display the DID selectable menu. For further information, refer to “Driver Information Display (DID)” section of your Owner’s Manual for more information.

### 17. *Air Bag Warning Light*



This light will turn on for four to eight seconds as a bulb check when the ignition switch is first turned to the ON/RUN position. If the light is either not on during starting, stays on, or turns on while driving, have the system inspected at an authorized dealer as soon as possible. Refer to “Occupant Restraints” in “Things To Know Before Starting Your Vehicle” of your Owner’s Manual for further information.

### 18. *Vehicle Security Light*

 This light will flash rapidly for approximately 15 seconds when the vehicle theft alarm is arming. The light will flash at a slower speed continuously after the alarm is set. The security light will also come on for about three seconds when the ignition is first turned on.

### 19. *Electronic Stability Control (ESC) OFF Indicator Light — If Equipped*



This light indicates the Electronic Stability Control (ESC) is off.

### 20. *Electronic Stability Control (ESC) Activation/Malfunction Indicator Light — If Equipped*



The “ESC Activation/Malfunction Indicator Light” in the instrument cluster will come on when the ignition switch is turned to the

ON/RUN position. It should go out with the engine running. If the “ESC Activation/Malfunction Indicator Light” comes on continuously with the engine running, a malfunction has been detected in the ESC system. If this light remains on after several ignition cycles, and the vehicle has been driven several miles (kilometers) at speeds greater than 30 mph (48 km/h), see your authorized dealer as soon as possible to have the problem diagnosed and corrected.

#### NOTE:

- The “ESC Off Indicator Light” and the “ESC Activation/Malfunction Indicator Light” come on momentarily each time the ignition switch is turned to ON/RUN.
- Each time the ignition is turned to ON/RUN, the ESC system will be ON, even if it was turned off previously.

- The ESC system will make buzzing or clicking sounds when it is active. This is normal; the sounds will stop when ESC becomes inactive following the maneuver that caused the ESC activation.

### 21. Park/Headlight ON Indicator — If Equipped



This indicator will illuminate when the park lights or headlights are turned on.

### DRIVER INFORMATION DISPLAY (DID)

The Driver Information Display (DID) features a driver-interactive display that is located in the instrument cluster.

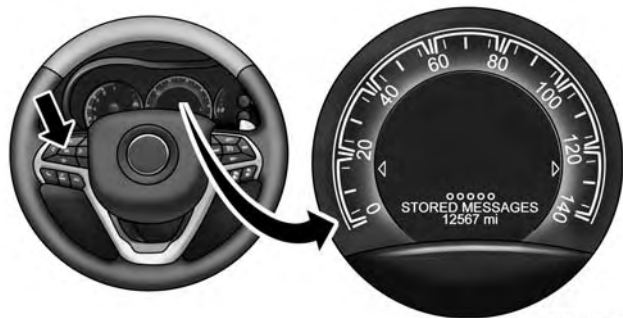

040973365

### 300 UNDERSTANDING YOUR INSTRUMENT PANEL

The DID Menu items consists of the following:

- Speedometer
- MPH or KM/H
- Vehicle Info
- Driver Assist
- Fuel Economy
- Trip
- Audio
- Stored Messages
- Screen Setup

The system allows the driver to select information by pushing the following buttons mounted on the steering wheel:



DID Steering Wheel Buttons

- *UP Arrow Button*



Push and release the UP button to scroll upward through the main menu.

- ***DOWN Arrow Button***



Push and release the DOWN button to scroll downward through the main menu.

- ***RIGHT Arrow Button***



Push and release the RIGHT arrow button to access the information screens or submenu screens of a main menu item.

- ***LEFT Arrow Button***



Push the LEFT arrow button to return to the main menu from an info screen or submenu item.

- ***OK Button***

Push the OK button to access/select the information screens or submenu screens of a main menu item. Push

and hold the OK arrow button for two seconds to reset displayed/selected features that can be reset.

## **DID Displays**

The DID displays are located in the center portion of the cluster and consist of multiple sections:

1. Main Screen — The inner ring of the display will illuminate in grey under normal conditions, yellow for non critical warnings, red for critical warnings, and white for on demand information.
2. Audio Information and Sub-menu Information — Whenever there are submenus available, the position within the submenus is shown here.
3. Reconfigurable Telltales/Information
4. Telltales/Indicators
5. Gear Selector Status (PRNDL)

6. Selectable Information (Compass, Temp, Range to Empty, Trip A, Trip B, Average Fuel Economy, Current Fuel Economy)
7. Air Suspension Status — If Equipped
8. 4WD Status — Status
9. Selectable Gauge 1

The main display area will normally display the main menu or the screens of a selected feature of the main menu. The main display area also displays “pop up” messages that consist of approximately 60 possible warning or information messages. These pop up messages fall into several categories:

- *Five Second Stored Messages*

When the appropriate conditions occur, this type of message takes control of the main display area for five seconds and then returns to the previous screen. Most of the messages of this type are then stored (as long as the

condition that activated it remains active) and can be reviewed from the “Messages” main menu item. Examples of this message type are “Right Front Turn Signal Lamp Out” and “Low Tire Pressure.”

- *Unstored Messages*

This message type is displayed indefinitely or until the condition that activated the message is cleared. Examples of this message type are “Turn Signal On” (if a turn signal is left on) and “Lights On” (if driver leaves the vehicle).

- *Unstored Messages Until RUN*

These messages deal primarily with the Remote Start feature. This message type is displayed until the ignition is in the RUN state. Examples of this message type are “Remote Start Aborted - Door Ajar” and “Press Brake Pedal and Push Button to Start.”



- *Five Second Unstored Messages*

When the appropriate conditions occur, this type of message takes control of the main display area for five seconds and then returns to the previous screen. An example of this message type is “Automatic High Beams On.”

## **Engine Oil Life Reset**

### **Oil Change Required**

Your vehicle is equipped with an engine oil change indicator system. The “Oil Change Required” message will display in the DID for five seconds after a single chime has sounded, to indicate the next scheduled oil change interval. The engine oil change indicator system is duty cycle based, which means the engine oil change interval may fluctuate, dependent upon your personal driving style.

Unless reset, this message will continue to display each time you cycle the ignition to the ON/RUN position. To turn off the message temporarily, push and release the OK button. To reset the oil change indicator system (after performing the scheduled maintenance), refer to the following procedure.

### **Oil Change Reset Procedure**

1. Without pushing the brake pedal, push and release the ENGINE START/STOP button and place the ignition to the ON/RUN position (do not start the engine).
2. Fully push the accelerator pedal, slowly, three times within 10 seconds.
3. Without pushing the brake pedal, push and release the ENGINE START/STOP button once to return the ignition to the OFF/LOCK position.

**NOTE:** If the indicator message illuminates when you start the vehicle, the oil change indicator system did not reset. If necessary, repeat this procedure.

### **DID Messages**

- Front Seatbelts Unbuckled
- Driver Seatbelt Unbuckled
- Passenger Seatbelt Unbuckled
- Service Air Bag System
- Traction Control Off
- Washer Fluid Low
- Oil Pressure Low
- Oil Change Due
- Fuel Low
- Service Antilock Brake System
- Service Electronic Throttle Control
- Service Power Steering
- Cruise Off
- Cruise Ready
- ACC Override
- Cruise Set To XXX MPH
- Tire Pressure Screen With Low Tire(s) “Inflate Tire to XX”
- Service Tire Pressure System
- Speed Warning Set
- Speed Warning Exceeded
- Parking Brake Engaged
- Brake Fluid Low

- Service Electronic Braking System
- Engine Temperature Hot
- Battery Voltage Low
- Service Electronic Throttle Control
- Lights On
- Right Turn Signal Light Out
- Left Turn Signal Light Out
- IGN OR ACC
- Vehicle Not In Park
- IGN OR ACC KEYLESS GO
- Key in Ignition Lights On
- Remote Start Active Key to Run
- Remote Start Active Push Start Button
- Remote Start Aborted Fuel Low
- Remote Start Aborted Too Cold
- Remote Start Aborted Door Open
- Remote Start Aborted Hood Open
- Remote Start Aborted Tailgate Open
- Remote Start Aborted Time Expired
- Remote Start Disabled Start To Reset
- Service Airbag System
- Service Airbag Warning Light
- Door Open
- Doors Open
- Liftgate Open
- Gear Not Available

- Shift Not Allowed
- Vehicle Speed To High To Shift
- Shift to Neutral then Drive or Reverse
- Autostick Unavailable Service Required
- Automatic Unavailable Use Autostick Service Req.
- Transmission Getting Hot Press Brake
- Trans. Hot Stop Safely Shift To Park Wait to Cool
- Transmission Cool Ready to Drive
- Service Transmission
- Service Shifter
- Engage Park Brake To Prevent Rolling
- Transmission Too Cold Idle With Engine On
- Washer Fluid Low

The Reconfigurable Telltales section is divided into the white telltales area on the right, amber telltales in the middle, and red telltales on the left.

### **DID White Telltales**

This area will show reconfigurable white caution telltales. These telltales include:

- *Cruise Ready*



This telltale will turn on to indicate that the Adaptive Cruise Control system is ready to be activated.

### **DID Amber Telltales**

This area will show reconfigurable amber caution telltales. These telltales include:

- *Low Fuel Telltale*



When the fuel level reaches approximately 3.0 gal (11.0 L), this light will turn on and remain on until fuel is added.

- *Windshield Washer Fluid Low Indicator*



This telltale will turn on to indicate the windshield washer fluid is low.

- *Transmission Temperature Warning Telltale*



This telltale indicates that the transmission fluid temperature is running hot. This may occur with severe usage, such as trailer towing. If this telltale turns on, safely pull over and stop the vehicle. Then, shift the transmission into NEUTRAL and run the engine at idle or faster until the light turns off.

- *Service Forward Collision Warning — If Equipped*



This light warns the driver of a potential collision with the vehicle in front and prompts the driver to take action in order to avoid the collision. For further information, refer to “Adaptive Cruise Control (ACC)” in “Understanding The Features Of Your Vehicle.”

- *Service Adaptive Cruise Control — If Equipped*



This light will turn on when a ACC is not operating and needs service. For further information, refer to “Adaptive Cruise Control (ACC)” in “Understanding The Features Of Your Vehicle.”

## DID Red Telltales

This area will show reconfigurable red telltales. These telltales include:

- *Door Ajar*



This light will turn on to indicate that one or more doors may be ajar.

- *Oil Pressure Warning Light*



This telltale indicates low engine oil pressure. If the light turns on while driving, stop the vehicle and shut off the engine as soon as possible. A chime will sound when this light turns on.

Do not operate the vehicle until the cause is corrected. This light does not show how much oil is in the engine. The engine oil level must be checked under the hood.

- *Oil Temperature Warning Light*



This telltale indicates engine oil temperature is high. If the light turns on while driving, stop the vehicle and shut off the engine as soon as possible.

- *Charging System Light*



This light shows the status of the electrical charging system. If the light stays on or comes on while driving, turn off some of the vehicle's non-essential electrical devices or increase engine speed (if at idle). If the charging system light remains on, it means that the vehicle is experiencing a problem with the charging system. Obtain SERVICE IMMEDIATELY. See an authorized dealer.

If jump starting is required, refer to "Jump Starting Procedures" in "What To Do In Emergencies."

- *Electronic Throttle Control (ETC) Light*



This light informs you of a problem with the Electronic Throttle Control (ETC) system. The light will come on when the ignition is first turned ON and remain on briefly as a bulb check. If the light does not come on during starting, have the system checked by an authorized dealer.

If a problem is detected, the light will come on while the engine is running. Cycle the ignition key when the vehicle has completely stopped and the gear selector is placed in the PARK position. The light should turn off.

If the light remains lit with the engine running, your vehicle will usually be drivable. However, see an authorized dealer for service as soon as possible. If the light is flashing when the engine is running, immediate service is required. You may experience reduced performance, an elevated/rough idle or engine stall and your vehicle may require towing.

- *Engine Temperature Warning Light*



This light warns of an overheated engine condition. As temperatures rise and the gauge approaches **H**, this indicator will illuminate, and a single chime will sound after reaching a set threshold. Further overheating will cause the temperature gauge to pass **H**, a continuous chime will occur until the engine is allowed to cool.

If the light turns on while driving, safely pull over and stop the vehicle. If the A/C system is on, turn it off. Also, shift the transmission into NEUTRAL and idle the vehicle. If the temperature reading does not return to normal, turn the engine off immediately and call for service. Refer to “If Your Engine Overheats” in “What To Do In Emergencies” for more information.

- *Electric Power Steering Malfunction – If Equipped*



This telltale is on when the Electric Power Steering is not operating and needs service.

- *Liftgate Ajar*



This light will turn on to indicate that liftgate may be ajar.

### DID Green Telltales

- *Electronic Speed Control SET*



This telltale will illuminate green when the electronic speed control is SET. For further information, refer to “Electronic Speed Control” in “Understanding The Features Of Your Vehicle.”

### DID Selectable Menu Items

Push and release the UP or DOWN arrow buttons until the desired Selectable Menu icon/title is highlighted in the DID.

### Speedometer

Push and release the UP or DOWN arrow button until the Speedometer menu is displayed in the DID. Push and release the OK button to toggle units (km/h or mph) of digital speedometer.

### MPH To km/h



Push and release the UP or DOWN arrow button until the MPH to km/h ICON is highlighted in the DID. Push and release the OK button to change the display between MPH or km/h.



## Vehicle Info



Push and release the **UP** or **DOWN** arrow button until the Vehicle Info icon/title is highlighted in the DID. Push and release the **RIGHT** arrow button and Coolant Temp will be displayed. Push the **LEFT** or **RIGHT** arrow button to scroll through the information submenus and push the **OK** button to select or reset the following resettable submenus:

### Tire Pressure Monitor System

Push and release the **LEFT** or **RIGHT** arrow button until "Tire Pressure" is highlighted in the DID.

- If tire pressure is **OK** for all tires a vehicle **ICON** is displayed with tire pressure values in each corner of the **ICON**.

- If one or more tires have low pressure, "Inflate Tire To XX" is displayed with the vehicle **ICON** and the tire pressure values in each corner of the **ICON** with the pressure value of the low tire are displayed in a different color than the other tire pressure value.
- If the Tire Pressure system requires service, "Service Tire Pressure System" is displayed.

Tire PSI is an information only function and cannot be reset.

Refer to "Tire Pressure Monitoring System (TPMS)" under "Starting and Operating" for further information.

### Transmission Temperature

- Displays the actual transmission temperature.

### Oil Temperature

- Displays the actual oil temperature.

### Oil Pressure

- Displays the actual oil pressure.

### Oil Life

### Battery Voltage

### Driver Assist — If Equipped



Push and release the **UP** or **DOWN** arrow button until the Driver Assist display icon/title is highlighted in the DID. For further information, refer to “Adaptive Cruise Control (ACC)

— If Equipped” in “Understanding The Features Of Your Vehicle.”

### Fuel Economy



Push and release the **UP** or **DOWN** arrow button until the Fuel Economy Menu icon/title is highlighted. Push and hold the OK button to reset feature.

- Range
- Current MPG or L/100 km
- Average MPG or L/100 km

### Trip



Push and release the **UP** or **DOWN** arrow button until the Trip icon/title is highlighted in the DID, then toggle left or right to select Trip A or Trip B.

The Trip A and Trip B information will display the following:

- Distance mi
- Average Fuel Economy
- Elapsed Time

Hold the **OK** button to reset all the information.

### Audio



Push and release the **UP** or **DOWN** arrow button until the Audio Menu icon/title is highlighted in the DID.

### Stored Messages



Push and release the **UP** or **DOWN** arrow button until the Messages Menu icon/title is highlighted in the DID. This feature shows the

number of stored warning messages. Pushing the **RIGHT** arrow button will allow you to see what the stored messages are.

### Screen Setup



Push and release the **UP** or **DOWN** arrow button until the Screen Setup Menu icon/title is highlighted in the DID. Push and release the **OK** button to enter the submenus and follow the prompts on the screen as needed. The Screen Setup feature allows you to change what information is displayed in the instrument cluster as well as the location that information is displayed.

## Screen Setup Driver Selectable Items

### Current Gear

- On
- Off

### Upper Left

- None
- Compass
- Outside Temp (default setting)
- Time
- Range To Empty (RTE)
- Fuel Economy Average
- Fuel Economy Current
- Trip A

- Trip B

### Upper Right

- None
- Compass (default setting)
- Outside Temp
- Time
- Range To Empty (RTE)
- Fuel Economy Average
- Fuel Economy Current
- Trip A
- Trip B

### Restore To Defaults (Restores All Settings To Default Settings)

- Cancel
- Okay

### Uconnect® SETTINGS

The Uconnect® system uses a combination of buttons on the touchscreen and buttons on the faceplate located on the center of the instrument panel that allow you to access and change the customer programmable features. Many features can vary by vehicle.



**Uconnect® 5.0 Buttons On Touchscreen And Buttons On Faceplate**

- 1 — Uconnect® Buttons On The Touchscreen  
 2 — Uconnect® Buttons On The Faceplate



**Uconnect® 8.4A/8.4AN Buttons On Faceplate And Buttons On Touchscreen**

- 1 — Uconnect® Buttons On The Touchscreen  
 2 — Uconnect® Buttons On The Faceplate

## Buttons On The Faceplate

Buttons on the faceplate are located below the Uconnect® system in the center of the instrument panel. In addition, there is a Scroll/Enter control knob located on the right side of the Climate Controls in the center of the instrument panel. Turn the control knob to scroll through menus and change settings (i.e., 30, 60, 90), push the center of the control knob one or more times to select or change a setting (i.e., ON, OFF).

Your Uconnect® system may also have Screen Off and Back buttons located below the Uconnect® system.

Push the Screen Off button to turn off the Uconnect® touchscreen. Push the Screen Off button a second time to turn the touchscreen on.

Push the Back button to exit out of a Menu or certain option on the Uconnect® system.

## Buttons On The Touchscreen

Buttons on the touchscreen are accessible on the Uconnect® display.

### Customer Programmable Features — Uconnect® 5.0 Personal Settings

Push the MORE button on the faceplate to display the menu setting screen. In this mode the Uconnect® system allows you to access programmable features that may be equipped such as Display, Voice, Clock & Date, Safety & Assistance, Lights, Doors & Locks, Auto-On Comfort, Engine Off Options, Compass Settings, Audio, Phone/Bluetooth®, Sirius Setup, Restore Settings, Clear Personal Data, and System Information.

**NOTE:** Only one touchscreen area may be selected at a time.

When making a selection, press the button on the touchscreen to enter the desired mode. Once in the desired mode, press and release the preferred setting and make your selection. Once the setting is complete, either press the Back Arrow/Done button on the touchscreen or the Back button on the faceplate to return to the previous menu or press the “X” button on the touchscreen to close out of the settings screen. Pressing the Up or Down Arrow buttons on the right side of the screen will allow you to toggle up or down through the available settings.

**NOTE:** All settings should be changed with the ignition in the “Run” position.

### Display

After pressing the “Display” button on the touchscreen the following settings will be available.

- *Display Mode*

When in this display you may select the "Auto" or "Manual" display settings. To change Mode status, press and release the "Auto" or "Manual" button on the touchscreen. Then press the arrow back button on the touchscreen.

**NOTE:** When Day or Night is selected for the Display Mode, the usage of the Parade Mode feature will cause the radio to activate the Display Brightness Day control even though the headlights are on.

- *Display Brightness With Headlights ON*

When in this display, you may select the overall screen brightness with the headlights on. Adjust the brightness with the "+" and "-" setting buttons on the touchscreen or by selecting any point on the scale between the "+" and "-" buttons on the touchscreen. Then press the arrow back button on the touchscreen.

**NOTE:** To make changes to the "Display Brightness with Headlights ON" setting, the headlights must be on and the interior dimmer switch must not be in the "party" or "parade" positions.

- *Display Brightness With Headlights OFF*

When in this display, you may select the overall screen brightness with the headlights off. Adjust the brightness with the "+" and "-" setting buttons on the touchscreen or by selecting any point on the scale between the "+" and "-" buttons on the touchscreen. Then press the arrow back button on the touchscreen.

**NOTE:** To make changes to the "Display Brightness with Headlights OFF" setting, the headlights must be off and the interior dimmer switch must not be in the "party" or "parade" positions.



- *Set Language*

When in this display, you may select one of multiple languages (English/Français/Español) for all display nomenclature, including the trip functions and the navigation system (if equipped). Press the “Set Language” button on the touchscreen, then press the desired language button on the touchscreen. Press the back arrow button on the touchscreen to return to the previous menu.

- *Units*

When in this display, you may select to have the DID, odometer, and navigation system (if equipped) changed between US and Metric units of measure. Press “US” or “Metric” to make your selection. Press the back arrow button on the touchscreen to return to the previous menu.

- *Touchscreen Beep*

When in this display, you may turn on or shut off the sound heard when a button on the touchscreen is pressed. Press the “Touchscreen Beep” button on the touchscreen then select from “on” or “off.” Press the back arrow button on the touchscreen to return to the previous menu.

### **Voice**

After pressing the “Voice” button on the touchscreen the following settings will be available:

- *Voice Response Length*

When in this display, you may change the Voice Response Length settings. To change the Voice Response Length, press the “Voice Response Length” button on the touchscreen and select from “Brief” or “Detailed.” Press the back arrow button on the touchscreen to return to the previous menu.

- *Show Command List*

When in this display, you may change the Show Command List settings. To change the Show Command List settings, press the “Show Command List” button on the touchscreen and select from “Always,” “With Help” or “Never.” Press the back arrow button on the touchscreen to return to the previous menu.

### **Clock & Date**

After pressing the “Clock & Date” button on the touchscreen the following settings will be available:

- *Set Time*

When in this display, you may set the time and format manually. Press the “Set Time” button then choose from a “12 hour” or “24 hour format.” Press the corresponding arrow above and below the current time to adjust, then select “AM” or “PM.” Press the back arrow button on the touchscreen to return to the previous menu.

- *Set Date*

When in this display, you may set the date manually. Press the “Set Date” button then press the corresponding arrows above and below the current date to adjust. Press the back arrow button on the touchscreen to return to the previous menu.

### **Safety/Assistance**

After pressing the “Safety/Assistance” button on the touchscreen the following settings will be available:

- *ParkSense®*

The ParkSense® system will scan for objects behind the vehicle when the transmission shift lever/gear selector is in REVERSE and the vehicle speed is less than 11 mph (18 km/h). It will provide an alert (audible and/or visual) to indicate the proximity to other objects. The system can be enabled with Sound Only, or Sound and Display. To change the ParkSense® status, press and release the

“Sound Only” or “Sounds and Display” button. Then press the back arrow button on the touchscreen. Refer to “ParkSense®” in “Understanding The Features Of Your Vehicle” for system function and operating information.

- *Tilt Mirrors In Reverse*

When this feature is selected, the exterior sideview mirrors will tilt downward when the ignition is in the RUN position and the transmission shift lever/gear selector is in the REVERSE position. The mirrors will move back to their previous position when the transmission is shifted out of REVERSE. To make your selection, press the “Tilt Mirrors In Reverse” button on the touchscreen and make your selection. Press the back arrow button on the touchscreen to return to the previous menu.

- *ParkView® Backup Camera Active Guidelines*

Your vehicle may be equipped with the ParkView® Rear Back Up Camera Active Guidelines that allows you to see

active guidelines over the ParkView Back up camera display whenever the shift lever/gear selector is put into REVERSE. The image will be displayed on the radio touchscreen display along with a caution note to “check entire surroundings” across the top of the screen. After five seconds, this note will disappear. To make your selection, press the “ParkView® Backup Camera Active Guidelines” button on the touchscreen and make your selection. Press arrow button on the touchscreen to return to the previous menu.

- *ParkView® Backup Camera Delay*

When the vehicle is shifted out of REVERSE (with camera delay turned OFF), the rear camera mode is exited and the navigation or audio screen appears again. When the vehicle is shifted out of REVERSE (with camera delay turned ON), the rear view image with dynamic grid lines will be displayed for up to 10 seconds after shifting out of “REVERSE” unless the forward vehicle speed exceeds

8 mph (12 km/h), the transmission is shifted into PARK or the ignition is switched to the OFF position. To set the ParkView® Backup Camera Delay push the MORE button on the faceplate, the “settings” button on the touchscreen, then the “Safety & Driving Assistance” button on the touchscreen. Press the “Parkview Backup camera Delay” button on the touchscreen to turn the ParkView® Delay ON or OFF.

- *Rain Sensing Auto Wipers*

When this feature is selected, the system will automatically activate the windshield wipers if it senses moisture on the windshield. To make your selection, press the “Rain Sensing” button on the touchscreen and make your selection. Press the back arrow button on the touchscreen to return to the previous menu.

- *Hill Start Assist — If Equipped*

When this feature is selected, the Hill Start Assist (HSA) system is active. Refer to “Electronic Brake Control

System” in “Starting And Operating” for system function and operating information. To make your selection, press the “Hill Start Assist” button on the touchscreen and make your selection. Press the back arrow button on the touchscreen to return to the previous menu.

## Lights

After pressing the “Lights” button on the touchscreen the following settings will be available.

- *Headlights Off Delay*

When this feature is selected, it allows the adjustment of the amount of time the headlights remain on after the engine is shut off. To change the Headlights Off Delay setting, press the “Headlight Off Delay” button on the touchscreen, and choose either 0 sec, 30 sec, 60 sec or 90 seconds. Press the back arrow button on the touchscreen to return to the previous menu.

- *Headlight Illumination On Approach*

When this feature is selected, it allows the adjustment of the amount of time the headlights remain on after the doors are unlocked with the Remote Keyless Entry (RKE) transmitter. To change the Illuminated Approach status, press the “Illuminated Approach” button and choose either 0 sec, 30 sec, 60 sec or 90 seconds. Press the back arrow button on the touchscreen to return to the previous menu.

- *Headlights With Wipers — If Equipped*

When this feature is selected, and the headlight switch is in the AUTO position, the headlights will turn on approximately 10 seconds after the wipers are turned on. The headlights will also turn off when the wipers are turned off if they were turned on by this feature. To make your selection, press the “Lights w/Wipers” button on

the touchscreen and make your selection. Press the back arrow button on the touchscreen to return to the previous menu.

- *Auto High Beams — If Equipped*

When this feature is selected, the high beam headlights will activate/deactivate automatically under certain conditions. To make your selection, press the “Auto High Beams” button on the touchscreen and make your selection. Press the back arrow button on the touchscreen to return to the previous menu. Refer to “Automatic High Beam Headlamp Control — If Equipped” in “Understanding The Features Of Your Vehicle” for further information.

- *Daytime Running Lights — If Equipped*

When this feature is selected, the headlights will turn on whenever the engine is running. To make your selection, press the “Daytime Running Lights” button on the touchscreen and make your selection. Press the back arrow button on the touchscreen to return to the previous menu.

- *Flash Lights w/Lock*

When this feature is selected, the exterior lights will flash when the doors are locked or unlocked with the Remote Keyless Entry (RKE) transmitter or the Passive Entry Feature. To make your selection, press the “Flash Lights w/Lock” button on the touchscreen and select from “On” or “Off.” Press the back arrow button on the touchscreen to return to the previous menu.

## Doors & Locks

After pressing the “Doors & Locks” button on the touchscreen the following settings will be available.

- *Auto Door Locks*

When this feature is selected, all doors will lock automatically when the vehicle reaches a speed of 15 mph (24 km/h). To make your selection, press the “Auto Door Locks” button on the touchscreen and select from “On” or “Off.” Press the back arrow button on the touchscreen to return to the previous menu.

- *Auto Unlock On Exit*

When this feature is selected, all doors will unlock when the vehicle is stopped and the transmission is in the PARK or NEUTRAL position and the driver’s door is opened. To make your selection, press the “Auto Unlock

On Exit” button on the touchscreen and select from “On” or “Off.” Press the back arrow button on the touchscreen to return to the previous menu.

- *Flash Lights w/Lock*

When this feature is selected, the exterior lights will flash when the doors are locked or unlocked with the Remote Keyless Entry (RKE) transmitter or the Passive Entry Feature. To make your selection, press the “Flash Lights w/Lock” button on the touchscreen and select from “On” or “Off.” Press the back arrow button on the touchscreen to return to the previous menu.

- *Horn w/Lock*

When this feature is selected, the horn will sound when the Key Fob Lock button is pressed. To make your selection, press the “Sound Horn With Lock” button on the touchscreen and select from “Off,” “1st Press,” or “2nd Press.” Press the back arrow button on the touchscreen to return to the previous menu.

- *Horn w/Remote Start — If Equipped*

When this feature is selected, the horn will sound when the remote start is activated. To make your selection, press the “Horn w/Remote Start” button on the touchscreen and select from “On” or “Off.” Press the back arrow button on the touchscreen to return to the previous menu.

- *Remote Door Unlock*

When “Remote Door Unlock” is selected, you may choose from “Driver” or “All.” Select “All” to have all doors unlock with the first push of the Key Fob. Select “Driver” to have the only the driver door open with the first push of the key fob.

**NOTE:** Passive Entry — If Equipped. If “All” is selected, all doors will unlock no matter which Passive Entry door handle is grasped. If “Driver” is selected, only the driver’s door will unlock when the driver’s door is grasped.

- *Passive Entry*

This feature allows you to lock and unlock the vehicle’s door(s) without having to press the Remote Keyless Entry (RKE) transmitter lock or unlock buttons. To make your selection, press the “Passive Entry” button on the touchscreen and select from “On” or “Off.” Press the back arrow button on the touchscreen to return to the previous menu. Refer to “Keyless Enter-N-Go™” in “Things To Know Before Starting Your Vehicle” for further information.

- *Memory Linked to Fob — If Equipped*

This feature provides automatic driver seat positioning to enhance driver mobility when entering and exiting the

vehicle. To make your selection, press the “Memory Linked to Fob” button on the touchscreen and select from “On” or “Off.” Press the back arrow button on the touchscreen to return to the previous menu.

**NOTE:** The seat will return to the memorized seat location if “Memory Linked to Fob” is set to (ON) when the Remote Keyless Entry (RKE) transmitter is used to unlock the door. Refer to “Driver Memory Seat” in “Understanding The Features Of Your Vehicle” for further information.

- *Power Lift Gate Alert — If Equipped*

This feature plays an alert when the power lift gate is raising or lowering. To make your selection, press the “Power Lift Gate Alert” button on the touchscreen and select from “On” or “Off.” Press the back arrow button on the touchscreen to return to the previous menu.



## Auto Comfort Systems — If Equipped

After pressing the “Auto-On Comfort & Remote Start” button on the touchscreen the following settings will be available:

- *Auto-On Driver Heated/Ventilated Seat & Steering Wheel With Vehicle Start — If Equipped*

When this feature is selected the driver’s heated seat and heated steering wheel will automatically turn ON when temperatures are below 40° F (4.4° C). When temperatures are above 80° F (26.7° C) the driver vented seat will turn ON. To make your selection, press the “Auto Heated Seats” button on the touchscreen, then select either “Off,” “Remote Start” or “All Starts.” Press the back arrow button on the touchscreen to return to the previous menu.

## Engine Off Options

After pressing the “Engine Off Options” button on the touchscreen the following settings will be available.

- *Easy Exit Seats — If Equipped*

When this feature is selected, the Driver’s seat will automatically move rearward once the engine is shut off. To make your selection, press the “Easy Exit Seats” button on the touchscreen and make your selection. Press the back arrow button on the touchscreen to return to the previous menu.

- *Headlight Off Delay*

When this feature is selected, the driver can choose to have the headlights remain on for 0, 30, 60, or 90 seconds when exiting the vehicle. Press the “Headlight Off Delay” button on the touchscreen and choose from “0,” “30,”

“60,” or “90” seconds to select your desired time interval. Press the back arrow button on the touchscreen to return to the previous menu.

- *Engine Off Power Delay*

When this feature is selected, the power window switches, radio, Uconnect® phone system (if equipped), DVD video system (if equipped), power sunroof (if equipped), and power outlets will remain active for up to 10 minutes after the ignition is cycled to OFF. Opening either front door will cancel this feature. Press the “Engine Off Power Delay” button on the touchscreen and choose from “0 sec,” “45 sec,” “5 min” or “10 min” to select your desired time interval. Then press the arrow back button on the touchscreen.

### Compass Settings — If Equipped

After pressing the “Compass Settings” button on the touchscreen the following settings will be available:

- *Variance*

Compass Variance is the difference between Magnetic North and Geographic North. To compensate for the differences the variance should be set for the zone where the vehicle is driven, per the zone map. Once properly set, the compass will automatically compensate for the differences, and provide the most accurate compass heading.

**NOTE:** Keep magnetic materials away from the top of the instrument panel, such as Mobile Phones, Laptops and Radar Detectors. This is where the compass module is located, and it can cause interference with the compass sensor, and it may give false readings.

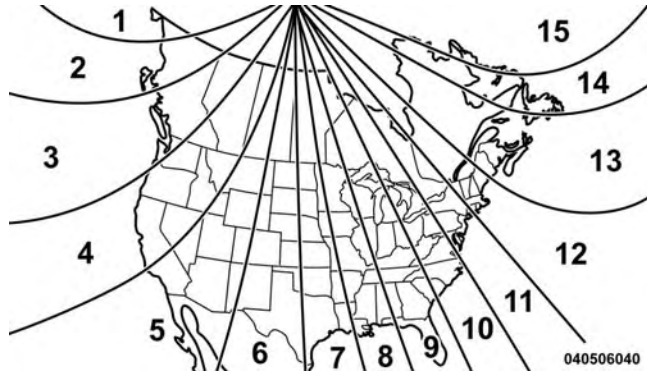

Compass Variance Map

- *Perform Compass Calibration*

Press the “Calibration” button on the touchscreen to change this setting. This compass is self-calibrating, which eliminates the need to manually reset the compass. When the vehicle is new, the compass may appear erratic until it is calibrated. You may also calibrate the compass

by pressing the “ON” button on the touchscreen and completing one or more 360-degree turns (in an area free from large metal or metallic objects). The compass will now function normally.

### Audio

After pressing the “Audio” button on the touchscreen the following settings will be available:

- *Equalizer*

When in this display you may adjust the Bass, Mid and Treble settings. Adjust the settings with the “+” and “-” buttons on the touchscreen or by selecting any point on the scale between the “+” and “-” buttons on the touchscreen. Press the back arrow/Done button on the touchscreen to return to the previous menu.

- *Balance/Fade*

This feature allows you to adjust the Balance and Fade settings. Press and drag the speaker icon or use the arrows to adjust, tap the “C” icon to readjust to the center. Press the back arrow/Done button on the touchscreen to return to the previous menu.

- *Speed Adjusted Volume*

This feature increases or decreases volume relative to vehicle speed. To change the Speed Adjusted Volume press the “Speed Adjusted Volume” button on the touchscreen and select from “Off,” “1,” “2” or “3” buttons on the touchscreen. Press the back arrow/Done button on the touchscreen to return to the previous menu.

- *Surround Sound — If Equipped*

This feature provides simulated surround sound mode. To make your selection, press the “Surround Sound”

button on the touchscreen, select “On” or “Off.” Press the back arrow/Done button on the touchscreen to return to the previous menu.

- *AUX Volume Offset — If Equipped*

This feature provides the ability to tune the audio level for portable devices connected through the AUX input. To make your selection, press the “AUX Volume Offset” button on the touchscreen, select “On” or “Off.” Press the back arrow/Done button on the touchscreen to return to the previous menu.

- *Loudness — If Equipped*

This feature improves sound quality at lower volumes. To make your selection, press the “Loudness” button on the touchscreen, select “On” or “Off.” Press the back arrow/Done button on the touchscreen to return to the previous menu.

## Phone/Bluetooth®

After pressing the “Phone/Bluetooth” button on the touchscreen the following settings will be available:

- *Paired Devices*

This feature shows which phones are paired to the Phone/Bluetooth® system. For further information, refer to your Uconnect® Supplement Manual.

## SiriusXM Setup — If Equipped

After pressing the “SiriusXM Setup” button on the touchscreen, the following settings will be available:

- *Channel Skip*

SiriusXM can be programmed to designate a group of channels that are the most desirable to listen to or to exclude undesirable channels while scanning. To make your selection, press the “Channel Skip” button on the

touchscreen, select the channels you would like to skip followed by pressing the back arrow button on the touchscreen.

- *Subscription Information*

New vehicle purchasers or lessees will receive a free limited time subscription to SiriusXM Satellite Radio with your radio. Following the expiration of the free services, it will be necessary to access the information on the Subscription Information screen to re-subscribe.

Press the “Subscription Info” button on the touchscreen to access the Subscription Information screen.

Write down the SIRIUS ID numbers for your receiver. To reactivate your service, either call the number listed on the screen or visit the provider online.

**NOTE:** SiriusXM Travel Link is a separate subscription and is available for U.S. residents only.

## Restore Settings

After pressing the “Restore Settings” button on the touchscreen the following settings will be available:

- *Restore Settings*

When this feature is selected it will reset the Display, Clock, Audio, and Radio Settings to their default settings. To restore the settings to their default setting, press the Restore Settings button. A pop-up will appear asking “Are you sure you want to reset your settings to default?” select “Yes” to restore, or “Cancel” to exit. Once the settings are restored, a pop up appears stating “settings reset to default.” Press the back arrow button on the touchscreen to exit.

## Clear Personal Data

After pressing the “Clear Personal Data Settings” button on the touchscreen the following settings will be available:

- *Clear Personal Data*

When this feature is selected it will remove personal data including Bluetooth® devices and presets. To remove personal information, press the “Clear Personal Data” button and a pop-up will appear asking “Are you sure you want to clear all personal data?” select “Yes” to Clear, or “Cancel” to exit. Once the data has been cleared, a pop up appears stating “Personal data cleared”. Press the back arrow button on the touchscreen to return to the previous menu.

## System Information

After pressing the “System Information” button on the touchscreen the following information will be available:

- *System Information*

When System Information is selected, a System Information screen will appear displaying the system software version.

## Customer Programmable Features — Uconnect®

### 8.4 Personal Settings

Press the “Apps” or the “Controls” button on the touchscreen, then press the “Settings” button on the touchscreen to display the menu setting screen. In this mode the Uconnect® system allows you to access programmable features that may be equipped such as Display, Voice, Clock, Safety & Driving Assistance, Lights, Doors & Locks, Auto-On Comfort, Engine Off Options, Audio, Phone/Bluetooth®, SiriusXM Setup, Restore Settings, Clear Personal Data, and System Information.

**NOTE:** Only one category may be selected at a time.

To adjust the setting of a programmable feature, press the desired setting option. Once in the desired setting option, press and release the preferred setting until a check-mark appears next to the setting, showing that the setting has been selected.

Once the setting is complete, press the Back Arrow button on the touchscreen to return to the previous menu or press the X button on the touchscreen to close out of the settings screen. Pressing the Up or Down Arrow button on the right side of the screen will allow you to toggle up or down through the list of available settings.

#### Display

After pressing the “Display” button on the touchscreen the following settings will be available.

- *Display Mode*

When in this display you may select one of the auto display settings. To change Mode status, select from “Day,” “Night” or “Auto” until a check-mark appears next to the setting, showing that setting has been selected. Then press the arrow back button on the touchscreen.

**NOTE:** When Day or Night is selected for the Display Mode, the usage of the Parade Mode feature will cause the radio to activate the Display Brightness Day control even though the headlights are on.

- *Display Brightness With Headlights ON*

When in this display, you may select the brightness with the headlights on. Adjust the brightness with the “+” and “-” setting buttons on the touchscreen or by selecting any point on the scale between the “+” and “-” buttons on the touchscreen. Then press the arrow back button on the touchscreen.

**NOTE:** To make changes to the “Display Brightness with Headlights ON” setting, the headlights must be on and the interior dimmer switch must not be in the “party” or “parade” positions.

- *Display Brightness With Headlights OFF*

When in this display, you may select the brightness with the headlights off. Adjust the brightness with the “+” and “-” setting buttons on the touchscreen or by selecting any point on the scale between the “+” and “-” buttons on the touchscreen. Then press the arrow back button on the touchscreen.

**NOTE:** To make changes to the “Display Brightness with Headlights OFF” setting, the headlights must be off and the interior dimmer switch must not be in the “party” or “parade” positions.

- *Set Theme*

This feature will allow you to choose a background theme for the display screen. The theme will change the background color, highlight color, and button color of the display screen.



- *Set Language*

When in this display, you may select one of multiple languages (English / Français / Español) for all display nomenclature, including the trip functions and the navigation system (if equipped). Press the “Set Language” button on the touchscreen, then select the desired language button on the touchscreen. Press the back arrow button on the touchscreen to return to the previous menu.

- *Units*

When in this display, you may select to have the DID, odometer, and navigation system (if equipped) changed between US and Metric units of measure. Press “US” or “Metric” until a check-mark appears next to the setting, showing that setting has been selected. Press the back arrow button on the touchscreen to return to the previous menu.

- *Touchscreen Beep*

When in this display, you may turn on or shut off the sound heard when button on the touchscreen is pressed. Press the “Touchscreen Beep” button on the touchscreen until a check-mark appears next to the setting, showing that setting has been selected. Press the back arrow button on the touchscreen to return to the previous menu.

- *Controls Screen Time-Out*

When in this display, you may turn on or shut off the ability for the controls screen to time out. Press the “Controls Screen Time-Out” button on the touchscreen until a check-mark appears next to the setting, showing that setting has been selected. Press the back arrow button on the touchscreen to return to the previous menu.

- *Navigation Turn-By-Turn Displayed In Cluster — If Equipped*

When this feature is selected, To make your selection, press the “Navigation Turn-By-Turn Displayed In Cluster” button on the touchscreen, until a check-mark appears next to the setting, showing that setting has been selected. Press the back arrow button on the touchscreen to return to the previous menu.

### **Voice**

After pressing the “Voice” button on the touchscreen the following settings will be available:

- *Voice Response Length*

When in this display, you may change the Voice Response Length settings. To change the Voice Response Length, press the “Brief” or “Detailed” button on the touchscreen until a check-mark appears next to the setting, showing that setting has been selected. Press the back arrow button on the touchscreen to return to the previous menu.

- *Show Command List*

When in this display, you may choose to Always, With Help, or Never display the Teleprompter with possible options while in a voice session. To change the Show Command List settings, press the “Always,” “With Help,” or “Never” button on the touchscreen until a check-mark appears next to the setting, showing that setting has been selected. Press the back arrow button on the touchscreen to return to the previous menu.

### **Clock**

After pressing the “Clock” button on the touchscreen the following settings will be available:

- *Sync Time With GPS*

This feature will allow the radio to sync time with a GPS signal. To change the Sync Time setting, press the “Sync

time with GPS” button on the touchscreen until a check-mark appears next to the setting, showing that setting has been selected. Press the back arrow button on the touchscreen to return to the previous menu.

- *Set Time Hours*

This feature will allow you to adjust the hours. The “Sync time with GPS” button on the touchscreen must be unchecked. To make your selection, press the “+” or “-” buttons on the touchscreen to adjust the hours up or down. Press the back arrow button on the touchscreen to return to the previous menu.

- *Set Time Minutes*

This feature will allow you to adjust the minutes. The “Sync time with GPS” button on the touchscreen must be unchecked. To make your selection, press the “+” or “-” buttons on the touchscreen to adjust the minutes up or down. Press the back arrow button on the touchscreen to return to the previous menu.

- *Time Format*

This feature will allow you to select the time format display setting. Press the “Time Format” button on the touchscreen until a check-mark appears next to the “12hrs” or “24hrs” setting, showing that setting has been selected. Press the back arrow button on the touchscreen to return to the previous menu.

- *Show Time In Status Bar — If Equipped*

This feature will allow you to turn on or shut off the digital clock in the status bar. To change the Show Time Status setting press the “Show Time in Status Bar” button on the touchscreen until a check-mark appears next to setting, indicating that the setting has been selected. Press the back arrow button on the touchscreen to return to the previous menu.

## Safety & Driving Assistance

After pressing the “Safety & Driving Assistance” button on the touchscreen the following settings will be available:

- *Forward Collision Warning — If Equipped*

The Front Collision Warning (FCW) feature provides an audible and/or visual warning to potential forward collisions. The feature can be set to Far, or set to Near. The default status of FCW is the Far setting. This means the system will warn you of a possible collision with the vehicle in front of you when you are farther away. This gives you the most reaction time. To change the setting for more dynamic driving, select the Near setting. This warns you of a possible collision when you are much closer to the vehicle in front of you. To change the FCW status, press and release the “Near” or “Far” button. Then press the back arrow button on the touchscreen.

For further information, refer to “Adaptive Cruise Control (ACC)” in “Understanding The Features Of Your Vehicle”.

- *Forward Collision Warning (FCW) Active Braking — If Equipped*

The FCW system includes Advanced Brake Assist (ABA). When this feature is selected, the ABA applies additional brake pressure when the driver requests insufficient brake pressure to avoid a potential frontal collision. The ABA system becomes active at 5 mph (8 km/h). To make your selection, press the “Forward Collision Warning (FCW) with Mitigation - Active Braking” button on the touchscreen, until a check-mark appears next to setting, indicating that the setting had been selected. Press the back arrow button on the touchscreen to return to the previous menu. For further information, refer to “Forward Collision Warning (FCW) With Mitigation” in “Understanding The Features Of Your Vehicle.”

- *ParkSense®*

The ParkSense® system will scan for objects behind the vehicle when the transmission shift lever is in REVERSE and the vehicle speed is less than 11 mph (18 km/h). It will provide an alert (audible and/or visual) to indicate the proximity to other objects. The system can be enabled with Sound Only, or Sound and Display. To change the ParkSense® status, press and release the “Sound” or “Sound and Display” button. Then press the back arrow button on the touchscreen. Refer to “ParkSense®” in “Understanding The Features Of Your Vehicle” for system function and operating information.

- *Front ParkSense® Chime Volume*

The Front ParkSense® Chime Volume settings can be selected from the Driver Information Display (DID) or Uconnect® System — if equipped. The chime volume settings include LOW, MEDIUM, and HIGH. The factory

default volume setting is MEDIUM. To make your selection, press the “ParkSense® Front Chime Volume” button on the touchscreen, until a check-mark appears next to setting, indicating that the setting had been selected. Press the back arrow button on the touchscreen to return to the previous menu. ParkSense® will retain its last known configuration state through ignition cycles.

- *Rear ParkSense® Chime Volume*

The Rear ParkSense® Chime Volume settings can be selected from the DID or Uconnect® System — if equipped. The chime volume settings include LOW, MEDIUM, and HIGH. The factory default volume setting is MEDIUM. To make your selection, press the “ParkSense® Rear Chime Volume” button on the touchscreen, until a check-mark appears next to setting, indicating that the setting had been selected. Press the back

arrow button on the touchscreen to return to the previous menu. ParkSense® will retain its last known configuration state through ignition cycles.

- *Tilt Side Mirrors In Reverse*

When this feature is selected, the exterior side view mirrors will tilt downward when the ignition is in the RUN position and the transmission shift lever is in the REVERSE position. The mirrors will move back to their previous position when the transmission is shifted out of REVERSE. To make your selection, press the “Tilt Side Mirrors In Reverse” button on the touchscreen, until a check-mark appears next to setting, indicating that the setting had been selected. Press the back arrow button on the touchscreen to return to the previous menu.

- *Blind Spot Alert*

When this feature is selected, the Blind Spot Alert feature Provides alerts, visual and/or audible, to indicate objects in your blind spot. The Blind Spot Alert feature can be

activated in “Lights” mode. When this mode is selected, the Blind Spot Monitor (BSM) system is activated and will only show a visual alert in the exterior mirrors. When “Lights & Chime” mode is activated, the Blind Spot Monitor (BSM) will show a visual alert in the exterior mirrors as well as an audible alert when the turn signal is on. When “Off” is selected, the Blind Spot Monitor (BSM) system is deactivated. To change the Blind Spot Alert status, press the “Off,” “Lights” or “Lights & Chime” button on the touchscreen. Then press the back arrow button on the touchscreen.

**NOTE:** If your vehicle has experienced any damage in the area where the sensor is located, even if the fascia is not damaged, the sensor may have become misaligned. Take your vehicle to an authorized dealer to verify sensor alignment. Having a sensor that is misaligned will result in the BSM not operating to specification.

- *ParkView® Backup Camera Active Guidelines*

Your vehicle may be equipped with the ParkView® Rear Back Up Camera Active Guidelines that allows you to see active guidelines over the ParkView Back up camera display whenever the shift lever is put into REVERSE. The image will be displayed on the radio touchscreen display along with a caution note to “check entire surroundings” across the top of the screen. After five seconds, this note will disappear. To change the mode status, press the “ParkView Backup Camera Active Guidelines” button on the touchscreen, until a check-mark appears next to setting, indicating that the setting had been selected. Press the back arrow button on the touchscreen to return to the previous menu.

- *ParkView® Backup Camera Delay*

When the vehicle is shifted out of REVERSE (with camera delay turned OFF), the rear camera mode is exited and the navigation or audio screen appears again. When the

vehicle is shifted out of REVERSE (with camera delay turned ON), the rear view image with dynamic grid lines will be displayed for up to 10 seconds after shifting out of “REVERSE” unless the forward vehicle speed exceeds 8 mph (12 km/h), the transmission is shifted into “PARK” or the ignition is switched to the OFF position. To set the ParkView® Backup Camera Delay press the “Controls” button on the touchscreen, the “settings” button on the touchscreen, then the “Safety & Driving Assistance” button on the touchscreen. Press the “Parkview Backup camera Delay” button on the touchscreen to turn the ParkView® Delay ON or OFF.

- *Rain Sensing Auto Wipers*

When this feature is selected, the system will automatically activate the windshield wipers if it senses moisture

on the windshield. To make your selection, press the “Rain Sensing” button on the touchscreen, until a check-mark appears next to setting, indicating that the setting had been selected. Press the back arrow button on the touchscreen to return to the previous menu.

- *Hill Start Assist — If Equipped*

When this feature is selected, the Hill Start Assist (HSA) system is active. Refer to “Electronic Brake Control System” in “Starting And Operating” for system function and operating information. To make your selection, press the “Hill Start Assist” button on the touchscreen, until a check-mark appears next to setting, indicating that the setting had been selected. Press the back arrow button on the touchscreen to return to the previous menu.

## Lights

After pressing the Lights button on the touchscreen the following settings will be available.

- *Headlight Off Delay*

When this feature is selected, it allows adjustment of the amount of time the headlights remain on after the engine is shut off. To change the Headlights Off Delay setting, press the “+” or “-” button on the touchscreen to select your desired time interval, and choose either 0 sec, 30 sec, 60 sec or 90 seconds. Press the back arrow button on the touchscreen to return to the previous menu, or push the back button on the faceplate.

- *Headlight Illumination On Approach*

When this feature is selected, the headlights will activate and remain on for 0, 30, 60, or 90 seconds when the doors are unlocked with the Remote Keyless Entry (RKE) transmitter. To change the Illuminated Approach status, press the “+” or “-” button on the touchscreen to select your desired time interval. Press the back arrow button on the touchscreen to return to the previous menu, or push the back button on the faceplate.



- *Headlights With Wipers — If Equipped*

When this feature is selected, and the headlight switch is in the AUTO position, the headlights will turn on approximately 10 seconds after the wipers are turned on. The headlights will also turn off when the wipers are turned off if they were turned on by this feature. To make your selection, press the Headlights With Wipers button on the touchscreen, until a check-mark appears next to setting, showing that setting has been selected. Press the back arrow button on the touchscreen to return to the previous menu, or push the back button on the faceplate.

- *Auto Dim High Beams — If Equipped*

When this feature is selected, the high beam headlights will activate/deactivate automatically under certain conditions. To make your selection, press the “Auto High Beams” button on the touchscreen, until a check-mark appears next to setting, showing that setting has been selected. Press the back arrow button on the touchscreen

to return to the previous menu, or push the back button on the faceplate. Refer to “Automatic High Beam Headlamp Control — If Equipped” in “Understanding The Features Of Your Vehicle” for further information.

- *Daytime Running Lights — If Equipped*

When this feature is selected, the headlights will turn on whenever the vehicle is set in motion. To make your selection, press the “Daytime Running Lights” button on the touchscreen, until a check-mark appears next to setting, showing that setting has been selected. Press the back arrow button on the touchscreen to return to the previous menu, or push the back button on the faceplate.

- *Flash Lights With Lock*

When this feature is selected, the exterior lights will flash when the doors are locked or unlocked with the Remote Keyless Entry (RKE) transmitter. This feature may be selected with or without the sound horn on lock feature selected. To make your selection, press the “Flash Lights

with Lock” button on the touchscreen, until a check-mark appears next to setting, showing that setting has been selected. Press the back arrow button on the touchscreen to return to the previous menu, or push the back button on the faceplate.

### **Doors & Locks**

After pressing the Doors & Locks button on the touchscreen the following settings will be available.

- *Auto Door Locks*

When this feature is selected, all doors will lock automatically when the vehicle reaches a speed of 15 mph (24 km/h). To make your selection, press the “Auto Door Locks” button on the touchscreen, until a check-mark appears next to setting, showing that setting has been selected. Press the back arrow button on the touchscreen to return to the previous menu, or push the back button on the faceplate.

- *Auto Unlock On Exit*

When this feature is selected, all doors will unlock when the vehicle is stopped, the transmission is in the PARK or NEUTRAL position and the driver’s door is opened. To make your selection, press the “Auto Unlock on Exit” button on the touchscreen, until a check-mark appears next to setting, showing that setting has been selected. Press the back arrow button on the touchscreen to return to the previous menu, or push the back button on the faceplate.

- *Flash Lights With Lock*

When this feature is selected, the exterior lights will flash when the doors are locked or unlocked with the Remote Keyless Entry (RKE) transmitter, or when using the passive entry feature. This feature may be selected with or without the sound horn on lock feature selected. To make your selection, press the “Flash Lights with Lock” button on the touchscreen, until a check-mark appears

next to setting, indicating that the setting has been selected. Press the back arrow button on the touchscreen to return to the previous menu.

- *Sound Horn With Lock*

When this feature is selected, the horn will sound when the door locks are activated. To make your selection, press either the "Off," "1st Press," or "2nd Press" button on the touchscreen, until a check-mark appears next to setting, showing that setting has been selected. Press the back arrow button on the touchscreen to return to the previous menu.

- *Sound Horn With Remote Start*

When this feature is selected, the horn will sound when the remote start is activated. To make your selection, press the "Sound Horn with Remote Start" button on the touchscreen until a check-mark appears next to setting,

showing that setting has been selected. Press the back arrow button on the touchscreen to return to the previous menu.

- *1st Press Of Key Fob Unlocks*

When "Driver Door" is selected with 1st Press Of Key Fob Unlocks, only the driver's door will unlock with the first press of the Remote Keyless Entry (RKE) transmitter UNLOCK button. You must press the RKE transmitter UNLOCK button twice to unlock the passenger's doors. When "All Doors" is selected for 1st Press Of Key Fob Unlocks, all doors will unlock on the first press of the RKE transmitter UNLOCK button.

**NOTE:** If the vehicle is programmed 1st Press Of Key Fob Unlocks “All Doors,” all doors will unlock no matter which Passive Entry equipped door handle is grasped. If 1st Press Of Key Fob Unlocks “Driver Door” is programmed, only the driver’s door will unlock when the driver’s door is grasped. With Passive Entry, if 1st Press Of Key Fob Unlocks “Driver Door” is programmed, touching the handle more than once will only result in the driver’s door opening. If “Driver Door” is selected, once the driver door is opened, the interior door lock/unlock switch can be used to unlock all doors (or use RKE transmitter).

- *Passive Entry*

This feature allows you to lock and unlock the vehicles door(s) without having to press the Remote Keyless Entry (RKE) transmitter lock or unlock buttons. To make your selection, press the “Passive Entry” button on the touchscreen, until a check-mark appears next to setting,

showing that setting has been selected. Press the back arrow button on the touchscreen to return to the previous menu, or push the back button on the faceplate. Refer to “Keyless Enter-N-Go™” in “Things To Know Before Starting Your Vehicle”.

- *Personal Settings Linked to Key Fob — If Equipped*

This feature provides automatic recall of all settings stored to a memory location (driver’s seat, exterior mirrors, steering column position and radio station presets) to enhance driver mobility when entering and exiting the vehicle. To make your selection, press the “Personal Settings Linked to Key Fob” button on the touchscreen, until a check-mark appears next to setting, showing that setting has been selected. Press the back arrow button on the touchscreen to return to the previous menu, or push the back button on the faceplate.

**NOTE:** The seat will return to the memorized seat location (if Recall Memory with Remote Key Unlock is set to ON) when the Remote Keyless Entry (RKE) transmitter is used to unlock the door. Refer to “Driver Memory Seat” in “Understanding The Features Of Your Vehicle” for further information.

- ***Power Lift Gate Chime — If Equipped***

This feature plays an alert when the power lift gate is raising or lowering. To make your selection, press the “Power Lift Gate Chime” button on the touchscreen, until a check-mark appears next to setting, showing that setting has been selected. Press the back arrow button on the touchscreen to return to the previous menu, or push the back button on the faceplate.

- ***Auto-On Comfort — If Equipped***

After pressing the “Auto-On Comfort” button on the touchscreen the following settings will be available:

- ***Auto-On Driver Heated/Ventilated Seat & Steering Wheel With Vehicle Start — If Equipped***

When this feature is selected the driver’s heated seat will automatically turn on when temperatures are below 40° F (4.4° C). When temperatures are above 80° F (26.7° C) the driver vented seat will turn on. To make your selection, press the “Auto-On Driver Heated/Ventilated Seat & Steering Wheel With Vehicle Start” button on the touchscreen, then select either “Off,” “Remote Start” or “All Starts” until a check-mark appears next to setting, showing that setting has been selected. Press the back arrow/ Done button on the touchscreen to return to the previous menu.

- ***Engine Off Options***

After pressing the Engine Off Options button on the touchscreen the following settings will be available.

- *Easy Exit Seat — If Equipped*

This feature provides automatic driver seat positioning to enhance driver mobility when entering and exiting the vehicle. To make your selection, press the “Easy Exit Seat” button on the touchscreen until a check-mark appears next to setting, showing that setting has been selected. Press the back arrow button on the touchscreen to return to the previous menu.

- *Engine Off Power Delay*

When this feature is selected, the power window switches, radio, Uconnect® phone system (if equipped), DVD video system (if equipped), power sunroof (if equipped), and power outlets will remain active for up to 10 minutes after the ignition is cycled to OFF. Opening either front door will cancel this feature. To change the Engine Off Power Delay status press the “+” or “-” button to choose from “0 seconds,” “45 seconds,” “5

minutes,” or “10 minutes.” Press the back arrow button on the touchscreen to return to the previous menu.

- *Headlight Off Delay*

When this feature is selected, the driver can choose to have the headlights remain on for 0, 30, 60, or 90 seconds when exiting the vehicle. To change the Headlight Off Delay status press the “+” or “-” button on the touchscreen to select your desired time interval. Press the back arrow button on the touchscreen to return to the previous menu.

## **Audio**

After pressing the “Audio” button on the touchscreen the following settings will be available.

- *Balance/Fade*

This feature allows you to adjust the Balance and Fade settings. Press and drag the speaker icon, use the arrows

to adjust, or tap the 'C' icon to readjust to the center. Press the back arrow button on the touchscreen to return to the previous menu.

- *Equalizer*

This feature allows you to adjust the Bass, Mid and Treble settings. Adjust the settings with the "+" and "-" setting buttons on the touchscreen or by selecting any point on the scale between the "+" and "-" buttons on the touchscreen. Press the back arrow button on the touchscreen to return to the previous menu.

**NOTE:** Bass/Mid/Treble allow you to simply slide your finger up or down to change the setting as well as press directly on the desired setting.

- *Speed Adjusted Volume*

This feature increases or decreases volume relative to vehicle speed. To change the Speed Adjusted Volume

press the "Off," "1," "2" or "3" button on the touchscreen. Press the back arrow button on the touchscreen to return to the previous menu.

- *Surround Sound — If Equipped*

This feature provides simulated surround sound mode. To make your selection, press the "Surround Sound" button on the touchscreen, select "On" or "Off." Press the back arrow button on the touchscreen to return to the previous menu.

- *AUX Volume Offset — If Equipped*

This feature provides the ability to tune the audio level for portable devices connected through the AUX input. To make your selection, press the AUX Volume Match button on the touchscreen, choose a level from -3 to +3. Press the back arrow button on the touchscreen to return to the previous menu.

- *Loudness — If Equipped*

Loudness improves sound quality at lower volumes. To make your selection, press the “Loudness” button on the touchscreen, then choose “Yes” or “No.” Press the back arrow button on the touchscreen to return to the previous menu.

### **Phone/Bluetooth®**

After pressing the “Phone/Bluetooth®” button on the touchscreen the following settings will be available:

- *Paired Phones*

This feature shows which phones are paired to the Phone/Bluetooth® system. For further information, refer to the Uconnect® Supplement Manual.

- *Paired Audio Sources*

This feature shows which audio devices are paired to the Phone/Bluetooth® system. For further information, refer to the Uconnect® Supplement Manual.

### **SiriusXM Setup — If Equipped**

After pressing the “SiriusXM Setup” button on the touchscreen, the following settings will be available:

- *Channel Skip*

SiriusXM can be programmed to designate a group of channels that are the most desirable to listen to or to exclude undesirable channels while scanning. To make your selection, press the “Channel Skip” button on the touchscreen, select the channels you would like to skip followed by pressing the back arrow button on the touchscreen.



- *Subscription Information*

New vehicle purchasers or lessees will receive a free limited time subscription to SiriusXM Satellite Radio with your radio. Following the expiration of the free services, it will be necessary to access the information on the Subscription Information screen to re-subscribe.

Press the “Subscription Info” button on the touchscreen to access the Subscription Information screen.

Write down the SIRIUS ID numbers for your receiver. To reactivate your service, either call the number listed on the screen or visit the provider online.

**NOTE:** SiriusXM Travel Link is a separate subscription and is available for U.S. residents only.

## Restore Settings

After pressing the “Restore Settings” button on the touchscreen the following settings will be available:

- *Restore Settings*

When this feature is selected it will reset the Display, Clock, Audio, and Radio Settings to their default settings. To restore the settings to their default setting, press the “Restore Settings” button on the touchscreen and pop-up will appear asking “Are you sure you want to reset your settings to default?” select “OK” to restore, or “Cancel” to exit. Once the settings are restored, a pop-up appears stating “settings reset to default.”

## Clear Personal Data

After pressing the “Clear Personal Data Settings” button on the touchscreen the following settings will be available:

- *Clear Personal Data*

When this feature is selected it will remove personal data including Bluetooth® devices and presets. To remove personal information, press the “Clear Personal Data” button and a pop-up will appear asking “Are you sure you want to clear all personal data?” select “OK” to Clear, or “Cancel” to exit. Once the data has been cleared, a pop up appears stating “Personal data cleared.”

## System Information

After pressing the “System Information” button on the touchscreen the following information will be available:

- *System Information*

When System Information is selected, a System Information screen will appear displaying the system software version.

## Uconnect® RADIOS — IF EQUIPPED

For detailed information about your Uconnect® radio, refer to your Uconnect® Supplement Manual.

## iPod®/USB/MP3 CONTROL — IF EQUIPPED

This feature allows an iPod® or external USB device to be plugged into the USB port, located in the lower section of the front integrated center stack, in front of the rotary shifter.

iPod® control supports Mini, 4G, Photo, Nano, 5G iPod® and iPhone® devices. Some iPod® software versions may not fully support the iPod® control features. Please visit Apple's website for software updates.

For further information, refer to the Uconnect® Supplement Manual.

### Connecting The iPod® Or External USB Device

Use the connection cable to connect an iPod® or external USB device to the vehicle's USB/AUX connector port which is located in the center console.

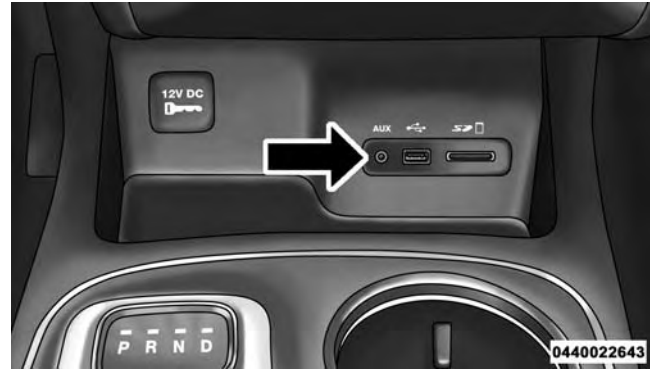

**Integrated Center Console USB/AUX SD Card Media HUB**

Once the audio device is connected and synchronized to the vehicle's iPod®/USB/MP3 control system (iPod® or external USB device may take a few minutes to connect), the audio device starts charging and is ready for use.

**NOTE:** If the audio device battery is completely discharged, it may not communicate with the iPod®/USB/MP3 control system until a minimum charge is attained. Leaving the audio device connected to the iPod®/USB/MP3 control system may charge it to the required level.

### Using This Feature

By using an iPod® cable, or an external USB device to connect to the USB port:

- The audio device can be played on the vehicle's sound system, providing metadata (artist, track title, album, etc.) information on the radio display.
- The audio device can be controlled using the radio buttons to Play, Browse, and List the iPod® contents.

- The audio device battery charges when plugged into the USB/AUX connector (if supported by the specific audio device).

**NOTE:** For further information, refer to the Uconnect® Supplement Manual.

### Second Row USB Charging Port

Second row USB connector ports can be used for charging purposes only. Use the connection cable to connect an iPod® or external USB device to the vehicle's USB charging ports which are located either on the rear of the front center console and/or in the second row center console.

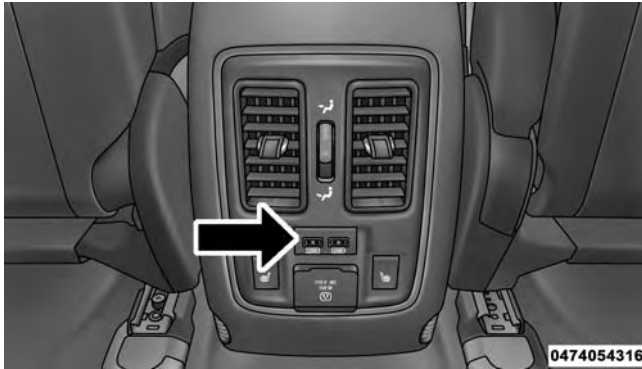

Front Center Console Rear USB Ports



Second Row Center Console USB Port

## Uconnect® REAR SEAT ENTERTAINMENT (RSE) SYSTEM — IF EQUIPPED

Your Rear Seat Entertainment System is designed to give your family years of enjoyment. You can play your favorite CDs, DVDs or Blu-ray™ Discs, listen to audio over the wireless headphones, or plug and play a variety of standard video games or audio devices. Please review this Owner's Manual to become familiar with its features and operation.

### Getting Started

- **Screen(s) located in the rear of front seats:** Open the LCD screen cover by lifting up on cover.



044874385

### Rear Seat Entertainment System Screen

- Place the ignition in the ON or ACC position.
- Your vehicle may be equipped with a Blu-ray™ Disc Player. If equipped with a Blu-ray™ Disc Player, the icon will be present on the Player.

- Turn on the Rear Seat Entertainment system by pushing the Power button on the remote control.
- When the Video Screen(s) are open and a DVD/Blu-ray™ Disc is inserted into the Disc player, the screen(s) turn(s) ON automatically, the headphone transmitters turn ON and playback begins.
- With the Dual Video Screen System, Channel 1 (Rear 1) on the Remote Control and Headphones refers to Screen 1 (driver's side) and Channel 2 (Rear 2) on the Remote Control and Headphones refers to Screen 2 (passenger side).



0449013138

Rear Seat Entertainment System Channel 1 (Rear 1)

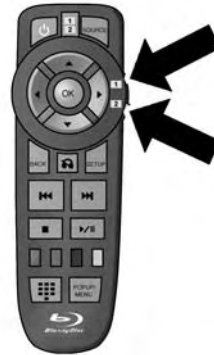

0449013138

Rear Seat Entertainment System Remote Control Channel Selector



0449013137

### Rear Seat Entertainment System Headphone Channel Selector

- The system can be controlled by the front seat occupants utilizing either the touchscreen radio, or by the rear seat occupants using the remote control.

### Dual Video Screen

**NOTE:** Typically there are two different ways to operate the features of the Rear Seat Entertainment System.

- The Remote Control
- The Touchscreen Radio (If Equipped)

### Blu-ray™ Disc Player

#### Play A Blu-ray™ Disc

The Blu-ray™ Disc player is located in the center console.





### Blu-ray™ Disc Player Location

1. Insert a Blu-ray disc into the VES™ disc player with the label facing as indicated on the Blu-ray player. The radio automatically selects the appropriate mode after the disc is recognized and displays the menu screen, the language screen, or starts playing the first track.

2. To watch a Blu-ray disc on Rear 1 for driver's side rear passengers, ensure the Remote Control and Headphone switch is on Rear 1.
3. To watch a Blu-ray disc on Rear 2 for passenger side rear passengers, ensure the Remote Control and Headphone switch is on Rear 2.

### NOTE:

- To view a Blu-ray disc on the radio press the "Media" button on the touchscreen, then press the "Disc" button. Press the "Play" button, then the "full screen" button.
- Viewing a Blu-ray disc on the radio screen is not available in all states/provinces, and the vehicle must be stopped, and the shift lever must be in the PARK position for vehicles with automatic transmission.

## Using The Touchscreen Radio

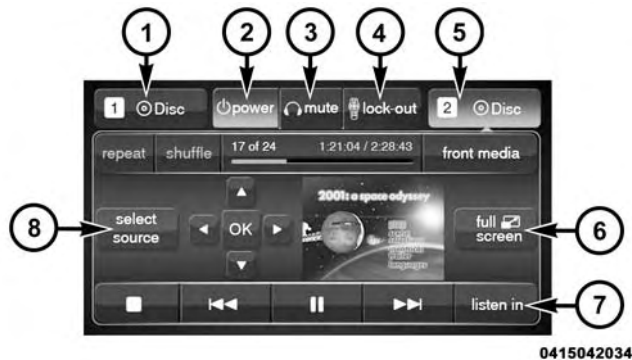

### Rear Media Control Screen

#### 1. RSE Channel 1 Mode

Indicates the current source for Screen 1/Channel 1; This button will be highlighted when it is the active Screen/Channel being controlled by the front user. If this button

is not highlighted select button to access controls for Screen 1/Channel 1 source.

#### 2. RSE Power

Press to turn RSE On/Off.

#### 3. RSE Mute

Mute rear headphones for the current ignition cycle. Pressing mute again will unmute rear headphones.

#### 4. RSE Remote Control Lock Out

Press to enable/disable Remote Control functions.

#### 5. RSE Channel 2 Mode

Indicates the current source for Screen 2/Channel 2; This button will be highlighted when it is the active Screen/Channel being controlled by the front user. If this button is not highlighted select button to access controls for Screen 2/Channel 2 source.

## 6. Radio Full Screen Mode

Select this button to change to Full Screen Mode.

## 7. Cabin Audio Mode

Select this button to change the cabin audio to the rear entertainment source currently shown on the rear media control screen.

## 8. RSE Mode

Select this button to change source for the active (highlighted) rear Screen/Channel on the rear media control screen.

- Press the Media button on the touchscreen, then press the Rear Media button on the touchscreen.

- Press the OK button on the touchscreen to begin playing the Blu-ray™ Disc on the touchscreen radio.

## Using The Remote Control

- Select an audio channel (Rear 1 for driver's side rear screen and Rear 2 for passenger's side rear screen), then press the source key and using the up and down arrows, highlight disc from the menu and press the OK button.
- Press the popup/menu key to navigate the disc menu and options.

## Play Video Games

Connect the video game console to the Audio/Video RCA/HDMI input jacks located on the side of each seat.

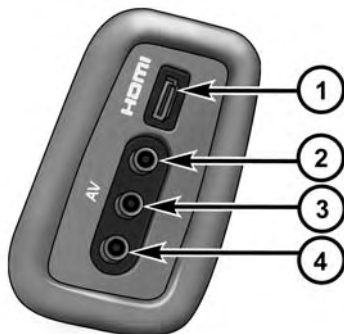

0449012548

### Audio/Video RCA/HDMI Input Jacks

Audio/Video RCA/HDMI Jacks (AUX/HDMI Jacks) on the side of each seat enable the monitor to display video

directly from a video camera, connect video games for display on the screen, or play music directly from an MP3 player.

When connecting an external source to the AUX/HDMI input, ensure to follow the standard color coding for the audio/video jacks:

1. HDMI Input
2. Right audio in (red)
3. Left audio in (white)
4. Video in (yellow)

**NOTE:** Certain high-end video games, such as PlayStation®4 and Xbox One will exceed this power limit of the vehicle's Power Inverter.

## Play A DVD/Blu-ray™ Disc Using The Touchscreen Radio

1. Insert the DVD/Blu-ray™ Disc with the label facing as indicated on the DVD/Blu-ray™ Disc player. The radio automatically selects the appropriate mode after the disc is recognized and displays the menu screen or starts playing the first track.
2. To watch a DVD/Blu-ray™ Disc on Rear 1 (driver's side rear passenger) ensure the Remote Control and Headphone channel selector switch is on Rear 1.
3. To watch a DVD/Blu-ray™ Disc on Rear 2 (passenger's side rear passenger) ensure the Remote Control and Headphone channel selector switch is on Rear 2.

### Using The Remote Control

1. Push the SOURCE button on the Remote Control.

2. While looking at Rear 1 or 2, highlight DISC by either pushing Up/Down/Left/Right buttons, then push ENTER/OK.



Select DISC Mode On The Rear Seat Entertainment Screen

### Using The Touchscreen Radio Controls

1. Press the Media button on the Uconnect® radio touchscreen.
2. Press the Rear Media button to display the Rear Media Control screen.

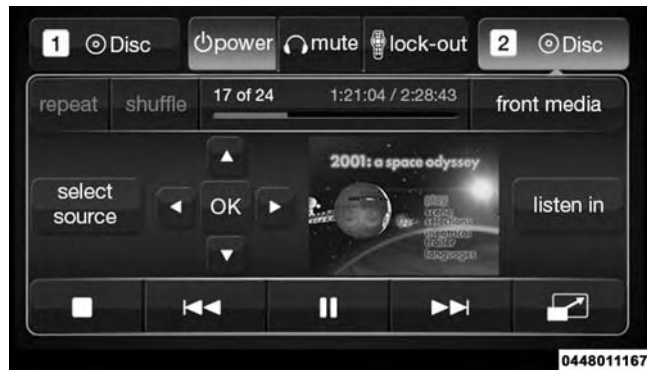

Rear Media Control Screen

3. Press the 1 or 2 buttons on the touchscreen, then select the source button on the touchscreen and then the DISC button on the touchscreen in the MEDIA column. To exit press the X at the top right of the screen.

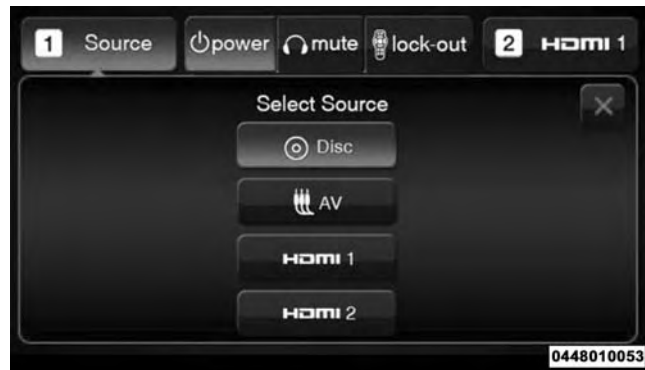

Rear Seat Entertainment Source Screen

**NOTE:** Pressing the screen on the radio while a DVD or Blu-ray™ Disc is playing, brings up the basic remote control functions for DVD play such as scene selection, Play, Pause, FF, RW, and Stop. Pressing the X in the upper corner will turn OFF the remote control screen functions.

### **Important Notes For Dual Video Screen System**

- The Rear Seat Entertainment System is able to transmit two channels of stereo audio and video simultaneously.
- The Blu-ray™ Disc Player can play CDs, DVDs and Blu-ray™ Discs.
- Selecting a video source on Rear 1, the video source will display on Rear 1 and can be heard on Rear 1.
- Selecting a video source on Rear 2, the video source will display on Rear 2 and can be heard on Rear 2.
- Audio can be heard through the headphones even when the screen(s) are closed.

## Blu-ray™ Disc Player Remote Control — If Equipped

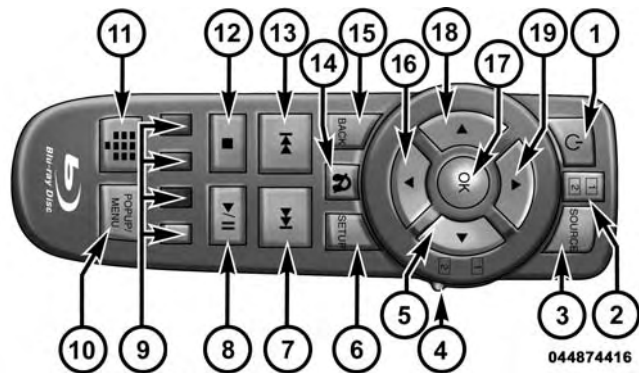









### Blu-ray™ Player Remote Control Controls And Indicators

1. Power — Turns the screen and wireless headphone transmitter for the selected Channel on or off. To hear

audio while the screen is closed, push the Power button to turn the headphone transmitter on.

2. Channel Selector Indicators — When a button is pushed, the currently affected channel or channel button is illuminated momentarily.
3. SOURCE — Push to enter Source Selection screen.
4. Channel/Screen Selector Switch — Indicates which channel is being controlled by the remote control. When the selector switch is in the Rear 1 position, the remote controls the functionality of headphone Channel 1 (left screen). When the selector switch is in the Rear 2 position, the remote controls the functionality of headphone Channel 2 (right screen).
5. ► — Push to navigate menus.
6. SETUP — Push to access the screen settings menu.



7.  — Push and hold to fast forward through the current audio track or video chapter.
8.  (Play/Pause) — Begin/resume or pause disc play.
9. Four Colored Buttons — Push to access Blu-ray™ Disc features.
10. POPUP/MENU — Push to bring up repeat and shuffle options, the Blu-ray™ Disc popup menu, the DVD title menu or to access disc menus.
11. KEYPAD — Push to navigate chapters or titles.
12.  (Stop) — Stops disc play.
13.  — Push and hold to fast rewind through the current audio track or video chapter.
14.  — Mutes headphone audio.
15. BACK — Push to exit out of menus or return to source selection screen.
16.  — Push to navigate menus.
17. OK — Push to select the highlighted option in a menu.
18.  — Push to navigate menus.
19.  — Push to navigate menus.

### Replacing The Remote Control Batteries

The remote control requires two AAA batteries for operation. To replace the batteries:

1. Locate the battery compartment on the back of the remote, then slide the battery cover downward.
2. Replace the batteries, making sure to orient them according to the polarity diagram shown.
3. Replace the battery compartment cover.

## Headphones Operation

The headphones receive two separate channels of audio using an infrared transmitter from the video screen.

If no audio is heard after increasing the volume control, verify that the screen is turned on, the channel is not muted and the headphone channel selector switch is on the desired channel. If audio is still not heard, check that fully charged batteries are installed in the headphones.



0448069382

Rear Seat Entertainment Headphones

- 1 — Power Button
  - 2 — Volume Control
  - 3 — Channel Selection Switch
-

## Controls

The headphone power indicator and controls are located on the right ear cup.

**NOTE:** The rear video system must be turned on before sound can be heard from the headphones. To conserve battery life, the headphones will automatically turn off approximately three minutes after the rear video system is turned off.

### Changing the Audio Mode for Headphones

1. Ensure the Remote Control channel/screen selector switch is in the same position as the headphone selector switch.

### NOTE:

- When both the headphone and the remote control channel selector switches are on Channel 1, the Remote is controlling Channel 1 and the headphones are tuned to the audio on Channel 1.
  - When both the headphone and the remote control channel selector switches are on Channel 2, the Remote is controlling Channel 2 and the headphones are tuned to the audio on Channel 2.
2. Push the SOURCE button on the remote control.
  3. Pushing the SOURCE button will advance to the next mode.
  4. When the Mode Selection menu appears on screen, use the cursor buttons on the remote control to navigate to the available modes and push the OK button to select the new mode.

5. To cancel out of the Mode Selection menu, push the BACK button on the remote control.

### **Replacing The Headphone Batteries**

Each set of headphones requires two AAA batteries for operation. To replace the batteries:

1. Locate the battery compartment on the left ear cup of the headphones, and then slide the battery cover downward.
2. Replace the batteries, making sure to orient them according to the polarity diagram shown.
3. Replace the battery compartment cover.

### **Unwired® Stereo Headphone Lifetime Limited Warranty**

**Who Does This Warranty Cover?** This warranty covers the initial user or purchaser ("you" or "your") of this

particular Unwired Technology LLC ("Unwired") wireless headphone ("Product"). The warranty is not transferable.

**How Long Does the Coverage Last?** This warranty lasts as long as you own the Product.

**What Does This Warranty Cover?** Except as specified below, this warranty covers any Product that in normal use is defective in workmanship or materials.

**What Does This Warranty Not Cover?** This warranty does not cover any damage or defect that results from misuse, abuse or modification of the Product other than by Unwired. Foam earpieces, which will wear over time through normal use, are specifically not covered (replacement foam is available for a nominal charge). UNWIRED TECHNOLOGY IS NOT LIABLE FOR ANY INJURIES OR DAMAGES TO PERSONS OR PROPERTY RESULTING FROM THE USE OF, OR ANY FAILURE OR DEFECT IN, THE PRODUCT, NOR IS UNWIRED LIABLE

FOR ANY GENERAL, SPECIAL, DIRECT, INDIRECT, INCIDENTAL, CONSEQUENTIAL, EXEMPLARY, PUNITIVE OR OTHER DAMAGES OF ANY KIND OR NATURE WHATSOEVER. Some states and jurisdictions may not allow the exclusion or limitation of incidental or consequential damages, so the above limitation may not apply to you. This warranty gives you specific legal rights. You may also have other rights, which vary from jurisdiction to jurisdiction.

**What Will Unwired® Do?** Unwired®, at its option, will repair or replace any defective Product. Unwired® reserves the right to replace any discontinued Product with a comparable model. THIS WARRANTY IS THE SOLE WARRANTY FOR THIS PRODUCT, SETS FORTH YOUR EXCLUSIVE REMEDY REGARDING DEFECTIVE PRODUCTS, AND IS IN LIEU OF ALL OTHER WARRANTIES (EXPRESS OR IMPLIED), INCLUDING ANY WARRANTY OR MERCHANTABILITY OR FITNESS FOR A PARTICULAR PURPOSE.

If you have any questions or comments regarding your Unwired® wireless headphones, please phone 1-888-293-3332 or email [customersupport@unwiredtechnology.com](mailto:customersupport@unwiredtechnology.com).

You may register your Unwired® wireless headphones online at [www.unwiredtechnology.com](http://www.unwiredtechnology.com) or by phone at 1-888-293-3332.

## System Information

### Disc Menu

When listening to a CD Audio or CD Data disc, pushing the remote control's POP UP/MENU button displays a list of all commands which control playback of the disc.

## Display Settings



### Video Screen Display Settings

When watching a video source (Blu-ray™ Disc or DVD Video with the disc in Play mode, Aux Video, etc.), pushing the remote control's SETUP button activates the

Display Settings menu. These settings control the appearance of the video on the screen. The factory default settings are already set for optimum viewing, so there is no need to change these settings under normal circumstances.

To change the settings, push the remote control's navigation buttons (▲, ▼) to select an item, then push the remote control's navigation buttons (▶, ◀) to change the value for the currently selected item. To reset all values back to the original settings, select the Default Settings menu option and push the remote control's ENTER/OK button.

Disc Features control the remote Blu-ray™ Disc player's settings of DVD being watched in the remote player.

## Listening To Audio With The Screen Closed

To listen to only audio portion of the channel with the screen closed:

- Set the audio to the desired source and channel.
- Close the video screen.
- To change the current audio mode, push the remote control's SOURCE button. This will automatically select the next available audio mode without using the Mode/Source Select menu.
- When the screen is reopened, the video screen will automatically turn back on and show the appropriate display menu or media.

If the screen is closed and there is no audio heard, verify that the headphones are turned on (the ON indicator is

illuminated) and the headphone selector switch is on the desired channel. If the headphones are turned on, push the remote control's power button to turn audio on. If audio is still not heard, check that fully charged batteries are installed in the headphones.

## Disc Formats

The Blu-ray™ Disc player is capable of the playing the following types of discs (8 mm or 12 mm diameter):

- BD: BDMV (Profile 1.1), BDAV (Profile 1.1)
- DVD: DVD-Video, DVD-Audio, AVCREC, AVCHD, DVD-VR
- CD: CD-DA, VCD, CD-TEXT
- DVD/CD: MP3, WMA, AAC, DivX (versions 3 – 6) profile 3.0

## DVD Region Codes

The Blu-ray™ Disc player and many DVD discs are coded by geographic region. These region codes must match in order for the disc to play. If the region code for the DVD disc does not match the region code for the player, the disc will not play.

## DVD Audio Support

When a DVD-Audio disc is inserted in the Blu-ray™ Disc player, the DVD-Audio title on the disc is played by default (most DVD-Audio discs also have a Video title, but the Video title is ignored). All multi-channel program material is automatically mixed down to two channels, which may result in a lowered apparent volume level. If you increase the volume level to account for this change in level, remember to lower the volume before changing the disc or to another mode.

## Recorded Discs

The Blu-ray™ Disc player will play CD-R and CD-RW discs recorded in CD-Audio or Video-CD format, or as a CD-ROM containing MP3 or WMA files. The player will also play DVD-Video content recorded to a DVD-R or DVD-RW disc. DVD-ROM discs (either pressed or recorded) are not supported.

If you record a disc using a personal computer, there may be cases where the Blu-ray™ Disc player may not be able to play some or the entire disc, even if it is recorded in a compatible format and is playable on other players. To help avoid playback problems, use the following guidelines when recording discs.

- Open sessions are ignored. Only sessions that are closed are playable.



- For multi-session CDs that contain only multiple CD-Audio sessions, the player will renumber the tracks so each track number is unique.
- For CD Data (or CD-ROM) discs, always use the ISO-9660 (Level 1 or Level 2), Joliet, or Romeo format. Other formats (such as UDF, HFS, or others) are not supported.
- The player recognizes a maximum of 512 files and 99 folders per CD-R and CD-RW disc.
- Mixed media recordable DVD formats will only play the Video\_TS portion of the disc.

If you are still having trouble writing a disc that is playable in the Blu-ray™ Disc player, check with the disc recording software publisher for more information about burning playable discs.

The recommended method for labeling recordable discs (CD-R, CD-RW, and DVD-R) is with a permanent marker.

Do not use adhesive labels as they may separate from the disc, become stuck, and cause permanent damage to the DVD player.

### Compressed Audio Files (MP3 and WMA)

The Blu-ray™ Disc player is capable of playing MP3 (MPEG-1 Audio Layer 3) and WMA (Windows Media Audio) files from a CD Data disc (usually a CD-R or CD-RW).

- The Blu-ray™ Disc player always uses the file extension to determine the audio format, so MP3 files must always end with the extension ".mp3" or ".MP3" and WMA files must always end with the extension ".wma" or ".WMA". To prevent incorrect playback, do not use these extensions for any other types of files.
- For MP3 files, only version 1 ID3 tag data (such as artist name, track title, album, etc.) are supported.

- Any file that is copy protected (such as those downloaded from many online music stores) will not play. The Blu-ray™ player will automatically skip the file and begin playing the next available file.
- Other compression formats such as AAC, MP3 Pro, Ogg Vorbis, and ATRAC3 will not play. The Blu-ray™ player will automatically skip the file and begin playing the next available file.
- If you are creating your own files, the recommended fixed bit rate for MP3 files is between 96 and 192Kbps and the recommended fixed bit rate for WMA files is between 64 and 192Kbps. Variable bit rates are also supported. For both formats, the recommended sample rate is either 44.1kHz or 48kHz.
- To change the current file, use the remote control's or Blu-ray™ Disc player's ▲ button to advance to the next file, or the ▼ button to return to the start of the current or previous file.

### Disc Errors

If the Blu-ray™ Disc player is unable to read the disc, a "Disc Error" message is displayed on the rear screen and Radio displays. A dirty, damaged, or incompatible disc format are all potential causes for a "Disc Error" message.

If a disc has a damaged track which results in audible or visible errors that persists for two seconds, the Blu-ray™ Disc player will attempt to continue playing the disc by skipping forward one to three seconds at a time. If the end of the disc is reached, the Blu-ray™ Disc player will return to the beginning of the disc and attempt to play the start of the first track.

The Blu-ray™ Disc player may shut down during extremely hot conditions, such as when the vehicle's interior temperature is above 120° F (48.9° C). When this occurs, the player will display "High Temp" and will shut

off the Rear Seat displays until a safe temperature is reached. This shutdown is necessary to protect the optics of the Blu-ray™ Disc player.

### Product Agreement

This product incorporates copyright protection technology that is protected by U.S. patents and other intellectual property rights. Use of this copyright protection technology must be authorized by Macrovision, and is intended for home or other limited viewing uses otherwise authorized by Macrovision. Reverse engineering or disassembly is prohibited.

 Dolby® Digital and MLP Lossless Manufactured under license from Dolby Laboratories. "Dolby", "MLP Lossless", and the double-D symbol are trademarks of Dolby Laboratories. Confidential unpublished works. Copyright 1992-1997 Dolby Laboratories. All right reserved.

### STEERING WHEEL AUDIO CONTROLS — IF EQUIPPED

The remote sound system controls are located on the rear surface of the steering wheel. Reach behind the wheel to access the switches.



0450042261

Remote Sound System Controls (Back View Of Steering Wheel)

The right-hand control is a rocker-type switch with a push-button in the center and controls the volume and mode of the sound system. Pushing the top of the rocker switch will increase the volume, and pushing the bottom of the rocker switch will decrease the volume.

Pushing the center button will make the radio switch between the various modes available (AM/FM/SXM/CD/AUX/VES, etc.).

The left-hand control is a rocker-type switch with a push-button in the center. The function of the left-hand control is different depending on which mode you are in.

The following describes the left-hand control operation in each mode.

### **Radio Operation**

Pushing the top of the switch will “Seek” up for the next listenable station and pushing the bottom of the switch will “Seek” down for the next listenable station.

The button located in the center of the left-hand control will tune to the next preset station that you have programmed in the radio preset button.

### **CD Player**

Pushing the top of the switch once will go to the next track on the CD. Pushing the bottom of the switch once will go to the beginning of the current track, or to the beginning of the previous track if it is within one second after the current track begins to play.

If you push the switch up or down twice, it plays the second track; three times, it will play the third, etc.

### **CD/DVD/Blu-ray™ Disc MAINTENANCE**

To keep a CD/DVD/Blu-ray™ Disc in good condition, take the following precautions:

1. Handle the disc by its edge; avoid touching the surface.

2. If the disc is stained, clean the surface with a soft cloth, wiping from center to edge.
3. Do not apply paper or tape to the disc; avoid scratching the disc.
4. Do not use solvents such as benzene, thinner, cleaners, or anti-static sprays.
5. Store the disc in its case after playing.
6. Do not expose the disc to direct sunlight.
7. Do not store the disc where temperatures may become too high.

**NOTE:** If you experience difficulty in playing a particular disc, it may be damaged (i.e., scratched, reflective coating removed, a hair, moisture or dew on the disc) oversized, or have protection encoding. Try a known good disc before considering disc player service.

## **RADIO OPERATION AND MOBILE PHONES**

Under certain conditions, the mobile phone being on in your vehicle can cause erratic or noisy performance from your radio. This condition may be lessened or eliminated by relocating the mobile phone antenna. This condition is not harmful to the radio. If your radio performance does not satisfactorily “clear” by the repositioning of the antenna, it is recommended that the radio volume be turned down or off during mobile phone operation when not using Uconnect® (if equipped).

### **Regulatory And Safety Information**

#### **USA/CANADA**

#### **Exposure to Radio Frequency Radiation**

The radiated output power of the internal wireless radio is far below the FCC radio frequency exposure limits.

Nevertheless, the wireless radio will be used in such a manner that the radio is 20 cm or further from the human body.

The internal wireless radio operates within guidelines found in radio frequency safety standards and recommendations, which reflect the consensus of the scientific community.

The radio manufacturer believes the internal wireless radio is safe for use by consumers. The level of energy emitted is far less than the electromagnetic energy emitted by wireless devices such as mobile phones. However, the use of wireless radios may be restricted in some situations or environments, such as aboard airplanes. If you are unsure of restrictions, you are encouraged to ask for authorization before turning on the wireless radio.

This device complies with Part 15 of the FCC Rules and with Industry Canada license-exempt RSS standard(s). Operation is subject to the following two conditions:

1. This device may not cause harmful interference.
2. This device must accept any interference received, including interference that may cause undesired operation.

Le présent appareil est conforme aux CNR d'Industrie Canada applicables aux appareils radio exempts de licence. L'exploitation est autorisée aux deux conditions suivantes: (1) l'appareil ne doit pas produire de brouillage, et (2) l'utilisateur de l'appareil doit accepter tout brouillage radioélectrique subi, même si le brouillage est susceptible d'en compromettre le fonctionnement.

**NOTE:**

- This equipment has been tested and found to comply with the limits for a Class B digital device, pursuant to Part 15 of the FCC Rules. These limits are designed to provide reasonable protection against harmful interference in a residential installation. This equipment generates, uses and can radiate radio frequency energy and, if not installed and used in accordance with the instructions, may cause harmful interference to radio communications. However, there is no guarantee that interference will not occur in a particular installation.
- If this equipment does cause harmful interference to radio or television reception, which can be determined by turning the equipment off and on, the user is encouraged to try to correct the interference by one or more of the following measures:

- Increase the separation between the equipment and receiver.
- Consult the dealer or an experienced radio technician for help.

**CLIMATE CONTROLS**

The air conditioning and heating system is designed to make you comfortable in all types of weather. This system can be operated through either the controls on the instrument panel or through the Uconnect® system display.

When the Uconnect® system is in different modes (Radio, Player, Settings, More, etc.) the driver and passenger temperature settings will be indicated at the top of the display.

## General Overview

### Buttons On The Faceplate

The buttons on the faceplate are located below the Uconnect® screen.

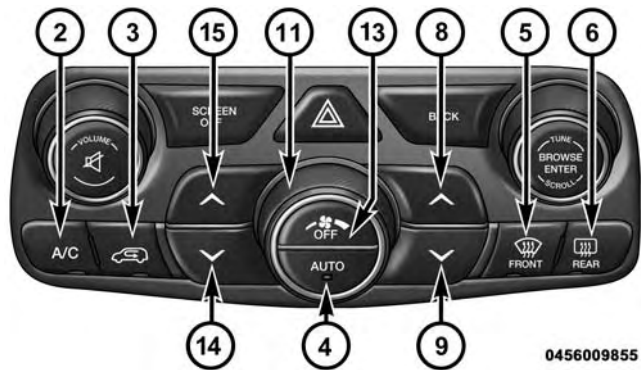

Automatic Climate Controls — Buttons On The Faceplate

### Buttons On The Touchscreen

Buttons on the touchscreen are accessible on the Uconnect® system screen.

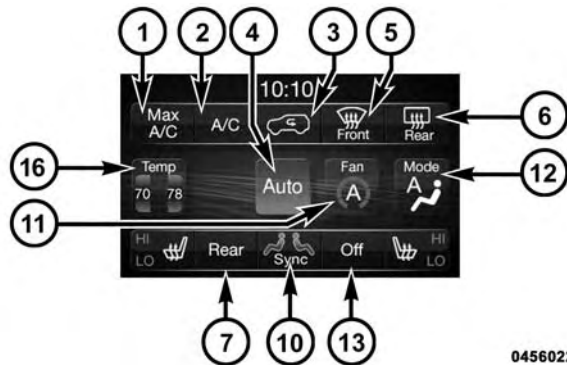

Uconnect® 5.0 Automatic Temperature Controls — Buttons On The Touchscreen



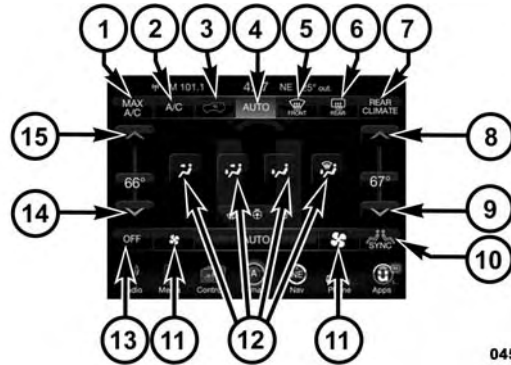

0456006614

### Uconnect® 8.4 Automatic Temperature Controls — Buttons On The Touchscreen

#### Button Descriptions (Applies To Both Buttons On The Faceplate And Buttons On The Touchscreen)

##### 1. MAX A/C Button

Press and release to change the current setting, the indicator illuminates when MAX A/C is ON. Performing

this function again will cause the MAX A/C operation to switch into manual mode and the MAX A/C indicator will turn off.

##### 2. A/C Button

Press and release to change the current setting, the indicator illuminates when A/C is ON. Performing this function again will cause the A/C operation to switch into manual mode and the A/C indicator will turn off.

##### 3. Recirculation Button

Press and release to change the current setting, the indicator illuminates when ON.

##### 4. AUTO Operation Button

Automatically controls the interior cabin temperature by adjusting airflow distribution and amount. Performing this function will cause the ATC to switch between manual mode and automatic modes. Refer to “Automatic Operation” for more information.

### 5. *Front Defrost Button*

Press and release to change the current airflow setting to Defrost mode. The indicator illuminates when this feature is ON. Air comes from the windshield and side window demist outlets. When the defrost button is selected, the blower level will increase. Use Defrost mode with maximum temperature settings for best windshield and side window defrosting and defogging. Performing this function will cause the ATC to switch into manual mode. If the front defrost mode is turned off the climate system will return the previous setting.

### 6. *Rear Defrost Button*

Press and release this button to turn on the rear window defroster and the heated outside mirrors (if equipped). An indicator will illuminate when the rear window defroster is on. The rear window defroster automatically turns off after 10 minutes.

### CAUTION!

**Failure to follow these cautions can cause damage to the heating elements:**

- **Use care when washing the inside of the rear window. Do not use abrasive window cleaners on the interior surface of the window. Use a soft cloth and a mild washing solution, wiping parallel to the heating elements. Labels can be peeled off after soaking with warm water.**
- **Do not use scrapers, sharp instruments, or abrasive window cleaners on the interior surface of the window.**
- **Keep all objects a safe distance from the window.**

### 7. *Rear Climate Button — If Equipped*

Press and release this button to turn on the rear climate controls. The indicator will illuminate when the rear climate controls are ON. Performing this function again will turn OFF the rear climate controls.

### 8. *Passenger Temperature Control Up Button*

Provides the passenger with independent temperature control. Push the button on the faceplate button for warmer temperature settings or on the touchscreen, press and slide the button on the touchscreen temperature bar towards the red arrow button on the touchscreen for warmer temperature settings.

**NOTE:** Pressing this button while in Sync mode will automatically exit Sync.

### 9. *Passenger Temperature Control Down Button*

Provides the passenger with independent temperature control. Push the button on the faceplate button for cooler temperature settings or on the touchscreen, press and slide the button on the touchscreen temperature bar towards the blue arrow button on the touchscreen for cooler temperature settings.

**NOTE:** Pressing this button while in Sync mode will automatically exit Sync.

### 10. *SYNC*

Press the Sync button on the touchscreen to toggle the Sync feature On/Off. The Sync indicator is illuminated when this feature is enabled. Sync is used to synchronize the passenger temperature setting with the driver temperature setting. Changing the passenger temperature setting while in Sync will automatically exit this feature.

### 11. Blower Control

Blower control is used to regulate the amount of air forced through the climate system. There are seven blower speeds available. Adjusting the blower will cause automatic mode to switch to manual operation. The speeds can be selected using either the blower control knob on the faceplate or buttons on the touchscreen as follows:

#### Blower Control Knob On The Faceplate

The blower speed increases as you turn the blower control knob clockwise from the lowest blower setting. The blower speed decreases as you turn the blower control knob counterclockwise.

#### Buttons On The Touchscreen

Use the small blower icon to reduce the blower setting

and the large blower icon to increase the blower setting. Blower can also be selected by pressing the blower bar area between the icons.

### 12. Modes

The airflow distribution mode can be adjusted so air comes from the instrument panel outlets, floor outlets, demist outlets and defrost outlets. The Mode settings are as follows:

- **Panel Mode**



Air comes from the outlets in the instrument panel. Each of these outlets can be individually adjusted to direct the flow of air. The air vanes of the center outlets and outboard outlets can be moved up and down or side to side to regulate airflow direction. There is a shut off wheel located below the air vanes to shut off or adjust the amount of airflow from these outlets.

- **Bi-Level Mode**



Air comes from the instrument panel outlets and floor outlets. A slight amount of air is directed through the defrost and side window demister outlets.

**NOTE:** BI-LEVEL mode is designed under comfort conditions to provide cooler air out of the panel outlets and warmer air from the floor outlets.

- **Floor Mode**



Air comes from the floor outlets. A slight amount of air is directed through the defrost and side window demister outlets.

- **Mix Mode**



Air comes from the floor, defrost and side window demist outlets. This mode works best in cold or snowy conditions.

### 13. *Climate Control OFF Button*

Press and release this button to turn the Climate Control ON/OFF.

### 14. *Driver Temperature Control Down Button*

Provides the driver with independent temperature control. Push the button on the faceplate for cooler temperature settings or on the touchscreen press and slide the button on the touchscreen temperature bar towards the blue arrow button on the touchscreen for cooler temperature settings.

**NOTE:** In Sync mode, this button will also automatically adjust the passenger temperature setting at the same time.

### 15. *Driver Temperature Control Up Button*

Provides the driver with independent temperature control. Push the button for warmer temperature settings or on the touchscreen, press and slide the button on the touchscreen temperature bar towards the red arrow button on the touchscreen for warmer temperature settings.

**NOTE:** In Sync mode, this button will also automatically adjust the passenger temperature setting at the same time.

### 16. *Temperature Control (Uconnect® 5.0 Radio Only)*

Press the temperature button on the touchscreen to regulate the temperature of the air inside the passenger compartment. Moving the temperature bar into the red area, indicates warmer temperatures. Moving the temperature bar into the blue area indicates cooler temperatures.

## Climate Control Functions

### A/C (Air Conditioning)

The Air Conditioning (A/C) button allows the operator to manually activate or deactivate the air conditioning system. When the air conditioning system is turned on, cool dehumidified air will flow through the outlets into the cabin. For improved fuel economy, press the A/C button to turn off the air conditioning and manually adjust the blower and airflow mode settings. Also, make sure to select only Panel, Bi-Level or Floor modes.

### NOTE:

- For Manual Climate Controls, if the system is in Mix, Floor or Defrost Mode, the A/C can be turned off, but the A/C system shall remain active to prevent fogging of the windows.

- If fog or mist appears on the windshield or side glass, select Defrost mode and adjust blower speed if needed.
- If your air conditioning performance seems lower than expected, check the front of the A/C condenser (located in front of the radiator), for an accumulation of dirt or insects. Clean with a gentle water spray from behind the radiator and through the condenser. Fabric front fascia protectors may reduce airflow to the condenser, reducing air conditioning performance.

### MAX A/C

MAX A/C sets the control for maximum cooling performance.

Press and release to toggle between MAX A/C and the prior settings. The button on the touchscreen illuminates when MAX A/C is ON.

In MAX A/C, the blower level and mode position can be adjusted to desired user settings. Pressing other settings will cause the MAX A/C operation to switch to the prior settings and the MAX A/C indicator will turn off.

### Recirculation



When outside air contains smoke, odors, or high humidity, or if rapid cooling is desired, you may wish to recirculate interior air by pressing the Recirculation control button. The recirculation indicator will illuminate when this button is selected. Press the button a second time to turn off the Recirculation mode and allow outside air into the vehicle.

**NOTE:** In cold weather, use of Recirculation mode may lead to excessive window fogging. The recirculation feature may be unavailable (button on the touchscreen greyed out) if conditions exist that could create fogging on the inside of the windshield. On systems with Manual Climate Controls, the Recirculation mode is not allowed in Defrost mode to improve window clearing operation. Recirculation will be disabled automatically if this mode is selected. Attempting to use Recirculation while in this mode will cause the LED in the control button to blink and then turn off.

## **Automatic Temperature Control (ATC)**

### **Automatic Operation**

1. Push the AUTO button on the faceplate or press the "AUTO" button on the touchscreen.

2. Next, adjust the temperature you would like the system to maintain by adjusting the driver and passenger temperature buttons on the faceplate or buttons on the touchscreen. Once the desired temperature is displayed, the system will achieve and automatically maintain that comfort level.
3. When the system is set up for your comfort level, it is not necessary to change the temperature. You will experience the greatest efficiency by simply allowing the system to function automatically.

### **NOTE:**

- It is not necessary to move the temperature settings. The system automatically adjusts the temperature, mode, and blower speed to provide comfort as quickly as possible.



- The temperature can be displayed in U.S. or Metric units by selecting the Uconnect® customer-programmable feature. Refer to the “Uconnect® System Settings” in this section of the manual.

To provide you with maximum comfort in the Automatic mode, during cold start-ups the blower fan will remain on low until the engine warms up. The blower will increase in speed and transition into Auto mode.

### Manual Operation Override

The system allows for manual selection of blower speed, air distribution mode, A/C status and recirculation control.

The blower fan speed can be set to any fixed speed by adjusting the blower control. The fan will now operate at a fixed speed until additional speeds are selected. This allows the front occupants to control the volume of air circulated in the vehicle and cancel the Auto mode.

The operator can also select the direction of the airflow by selecting one of the available mode settings. A/C operation and Recirculation control can also be manually selected in Manual operation.

**NOTE:** Each of these features operates independently from each other. If any feature is controlled manually, temperature control will continue to operate automatically.

### Rear Automatic Temperature Control (ATC)

The rear ATC system has floor air outlets at the rear right side of the 3rd Row seats and overhead outlets at each outboard rear seating position. The system provides heated air through the floor outlets or cool, dehumidified air through the headliner outlets.

The rear system temperature control buttons are located in the Uconnect® system, located on the instrument panel.

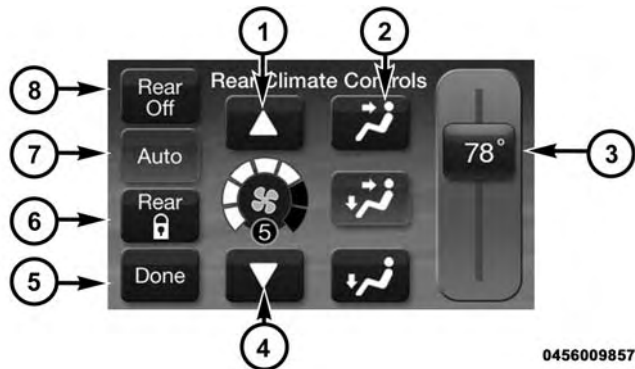

0456009857

**Uconnect® 5.0 Automatic Rear Climate Controls Touchscreen**

- 1 — Press Blower Up Button
- 2 — Press Mode Button
- 3 — Press Temperature Button
- 4 — Press Blower Down Button

- 5 — Press Done Button
- 6 — Press Rear Lock Button
- 7 — Press Rear Auto Button
- 8 — Press Rear Off Button

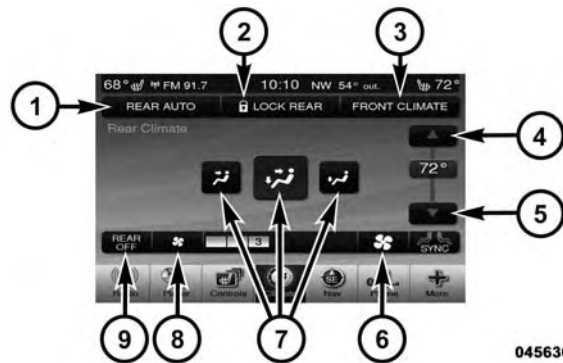

045636686

**Uconnect® 8.4 Automatic Rear Climate Controls Touchscreen**

- 1 — Press Rear Auto Button
- 2 — Press Rear Lock Button
- 3 — Press Front Climate Button
- 4 — Press Temperature Up Button

- 5 — Press Temperature Down Button
- 6 — Press Blower Up Button
- 7 — Press Mode Button
- 8 — Press Blower Down Button
- 9 — Press Rear Off Button

## Controlling The Rear Climate Controls From The Front ATC Panel

The Three-Zone ATC system allows for adjustment of the rear climate controls from the front ATC panel.

### To change the rear system settings:

- Press "REAR" button to change control to rear control mode, Rear display will appear. Control functions now operate rear system.
- To return to Front screen, press "REAR" button again, or it will revert to the Front screen after six seconds.

### Rear Lock

Pressing the Rear Temperature Lock button on the Uconnect® touchscreen, illuminates a lock symbol in the rear display. The rear temperature and air source are controlled from the front Uconnect® system.

Rear second row occupants can only adjust the rear ATC control when the Rear Temperature Lock button is turned off.

The rear ATC is located in the headliner, near the center of the vehicle.

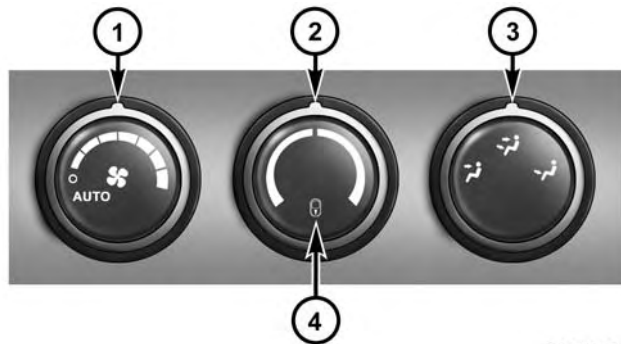

045635064

### Rear ATC Control Features

- |                      |                           |
|----------------------|---------------------------|
| 1 — Blower Speed     | 3 — Rear MODE             |
| 2 — Rear Temperature | 4 — Rear Temperature Lock |

- Press the Rear Temperature Lock button on the Uconnect® touchscreen. This turns off the Rear Temperature Lock icon in the rear temperature knob.

- Rotate the Rear Blower, Rear Temperature and the Rear Mode Control knobs to suit your comfort needs.
- ATC is selected by adjusting the rear blower knob counterclockwise to AUTO.

Once the desired temperature is displayed, the ATC System will automatically achieve and maintain that comfort level. When the system is set up for your comfort level, it is not necessary to change the settings. You will experience the greatest efficiency by simply allowing the system to function automatically.

**NOTE:** It is not necessary to move the temperature. The system automatically adjusts the temperature, mode and fan speed to provide comfort as quickly as possible.

### Rear Blower Control

The rear blower control, located in the rear overhead console, has an off position and a range of blower speeds.

This allows the second row seat occupants to control the volume of air circulated in the rear of the vehicle.

### CAUTION!

Interior air enters the Rear Manual Climate Control system through an intake grille, located in the right side trim panel behind the third row seats. The heater outlets are located in the right side trim panel, just behind the sliding door. Do not block or place objects directly in front of the inlet grille or heater outlets. The electrical system could overload, causing damage to the blower motor.

### Rear Temperature Control

To change the temperature in the rear of the vehicle, rotate the temperature control knob counterclockwise for cold air, and clockwise for heated air.

### Rear Mode Control

- *Auto Mode*

The rear system automatically maintains the correct mode and comfort level desired by the rear seat occupants.

- *Headliner Mode*



Air comes from the outlets in the headliner. Each of these outlets can be individually adjusted to direct the flow of air. Moving the air vanes of the outlets to one side will shut off the airflow.

- *Bi-Level Mode*



Air comes from both the headliner outlets and the floor outlets.

**NOTE:** In many temperature positions, the BI-LEVEL mode is designed to provide cooler air out of the headliner outlets and warmer air from the floor outlets.

- *Floor Mode*



Air comes from the floor outlets.

### **Operating Tips**

**NOTE:** Refer to the chart at the end of this section for suggested control settings for various weather conditions.

### **Summer Operation**

The engine cooling system must be protected with a high-quality antifreeze coolant to provide proper corrosion protection and to protect against engine overheating. A solution of 50% OAT (Organic Additive Technology) coolant that meets the requirements of FCA Material Standard MS.90032 and 50% water is recommended. Refer to “Maintenance Procedures” in “Maintaining Your Vehicle” for proper coolant selection.

### **Winter Operation**

Use of the air Recirculation mode during winter months is not recommended because it may cause window fogging.

### **Vacation Storage**

Any time you store your vehicle or keep it out of service (i.e., vacation) for two weeks or more, run the air conditioning system at idle for about five minutes in the fresh air and high blower setting. This will ensure adequate system lubrication to minimize the possibility of compressor damage when the system is started again.

## Window Fogging

Interior fogging on the windshield can be quickly removed by turning the mode selector to Defrost. The Defrost/Floor mode can be used to maintain a clear windshield and provide sufficient heating. If side window fogging becomes a problem increase blower speed. Vehicle windows tend to fog on the inside in mild but rainy or humid weather.

**NOTE:** Recirculate without A/C should not be used for long periods, as fogging may occur.

## Outside Air Intake









Make sure the air intake, located directly in front of the windshield, is free of obstructions such as leaves. Leaves

collected in the air intake may reduce airflow, and if they enter the plenum, they could plug the water drains. In winter months, make sure the air intake is clear of ice, slush, and snow.

## A/C Air Filter

The climate control system filters outside air containing dust, pollen and some odors. Strong odors cannot be totally filtered out. Refer to “Maintenance Procedures” in “Maintaining Your Vehicle” for filter replacement instructions.

## Control Setting Suggestions For Various Weather Conditions

WEATHER	CONTROL SETTINGS
Hot weather and vehicle interior is very hot 	Set the mode control to  . A/C on, and blower on high. Roll down the windows for a minute to flush out the hot air. Once comfort is achieved adjust controls for comfort.
Warm Weather 	Turn A/C on and set the mode control to the  position.
Cool Sunny	Operate in  position.
Cool & Humid conditions 	Set the mode control to  and turn on A/C to keep windows clear.
Cold Weather	Set the mode control to the  position. If windshield fogging starts to occur, move the control towards the  position.



## Uconnect® VOICE RECOGNITION QUICK TIPS

### Introducing Uconnect®

Start using Uconnect® Voice Recognition with these helpful quick tips. It provides the key Voice Commands and tips you need to know to control your Uconnect® 5.0 or 8.4A/8.4AN system.



Uconnect® 5.0

Key Features:

- 5" touchscreen
- Three buttons on either side of the display



### Uconnect® 8.4AN

If you see the  icon on your touchscreen, you have the Uconnect® 8.4AN system. If not, you have a Uconnect® 8.4A system.

### Get Started

All you need to control your Uconnect® system with your voice are the buttons on your steering wheel.

1. Visit [UconnectPhone.com](http://UconnectPhone.com) to check mobile device and feature compatibility and to find phone pairing instructions.
2. Reduce background noise. Wind and passenger conversations are examples of noise that may impact recognition.
3. Speak clearly at a normal pace and volume while facing straight ahead. The microphone is positioned on the rearview mirror and aimed at the driver.

- Each time you give a Voice Command, you must first push either the VR or Phone button, wait until **after** the beep, then say your Voice Command.
- You can interrupt the help message or system prompts by pushing the VR or Phone button and saying a Voice Command from current category.

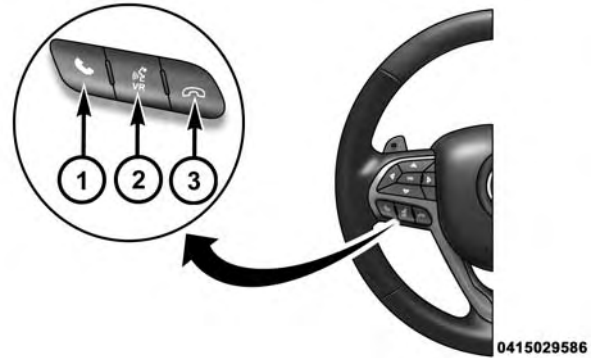

### Uconnect® Voice Command

- 1 — Push To Initiate Or To Answer A Phone Call, Send Or Receive A Text
  - 2 — For all radios: Push To Begin Radio or Media functions. For 8.4A/8.4AN only: Push to begin Navigation, Apps And Climate Functions
  - 3 — Push To End Call
-

## Basic Voice Commands

The basic Voice Commands below can be given at any point while using your Uconnect® system.

Push the VR button . After the beep, say...

- **Cancel** to stop a current voice session
- **Help** to hear a list of suggested Voice Commands
- **Repeat** to listen to the system prompts again

Notice the visual cues that inform you of your voice recognition system's status. Cues appear on the touchscreen.

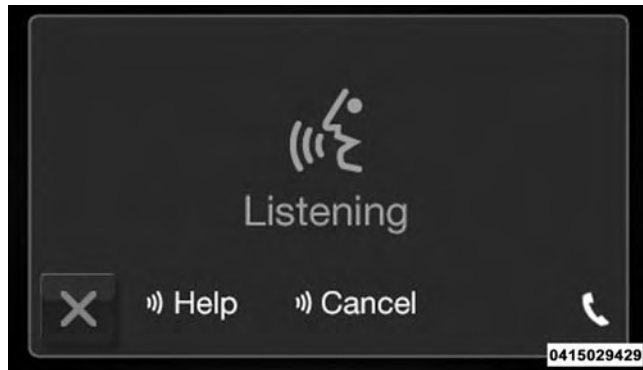

Uconnect® 5.0



Uconnect® 8.4A/8.4AN

## Radio

Use your voice to quickly get to the AM, FM or SiriusXM Satellite Radio® stations you would like to hear. (Subscription or included SiriusXM Satellite Radio® trial required.)

#### 404 UNDERSTANDING YOUR INSTRUMENT PANEL

Push the VR button . After the beep, say...

- **Tune to** ninety-five-point-five FM
- **Tune to** Satellite Channel Hits 1

**TIP:** At any time, if you are not sure of what to say or want to learn a Voice Command, press the VR button  and say **“Help.”** The system will provide you with a list of commands.



Uconnect® 5.0 Radio



Uconnect® 8.4A/8.4AN Radio

## Media

Uconnect® offers connections via USB, SD, Bluetooth® and auxiliary ports (If Equipped). Voice operation is only available for connected USB and iPod® devices. (Remote CD player optional and not available on all vehicles.)

Push the VR button . After the beep, say one of the following commands and follow the prompts to switch your media source or choose an artist.

- **Change source** to Bluetooth®
- **Change source** to iPod®
- **Change source** to USB
- **Play artist** Beethoven; **Play album** Greatest Hits; **Play song** Moonlight Sonata; **Play genre** Classical

**TIP:** Press the Browse button on the touchscreen to see all of the music on your iPod® or USB device. Your Voice Command must match **exactly** how the artist, album, song and genre information is displayed.

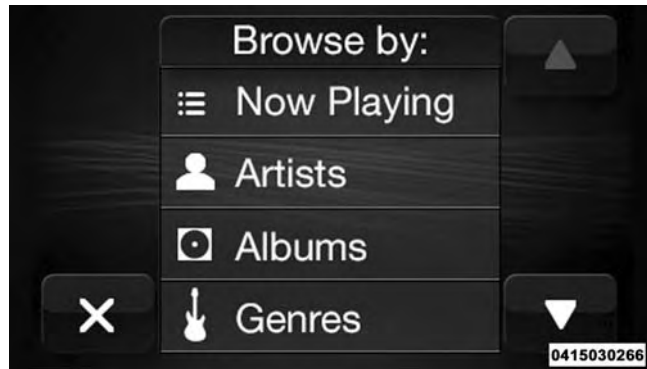

Uconnect® 5.0 Media



Uconnect® 8.4A/8.4AN Media

## Phone

Making and answering hands-free phone calls is easy with Uconnect®. When the Phonebook button is illuminated on your touchscreen, your system is ready. Check [UconnectPhone.com](http://UconnectPhone.com) for mobile phone compatibility and pairing instructions.



Push the Phone button . After the beep, say one of the following commands...

- Call John Smith
- Dial 123-456-7890 and follow the system prompts
- Redial (call previous outgoing phone number)
- Call back (call previous incoming phone number)

**TIP:** When providing a Voice Command, push the Phone button  and say “Call,” then pronounce the name **exactly** as it appears in your phone book. When a contact has multiple phone numbers, you can say “Call John Smith **work.**”





Uconnect® 5.0 Phone



Uconnect® 8.4A/8.4AN Phone

### Voice Text Reply

Uconnect® will announce **incoming** text messages. Push the Phone button  and say **Listen**. (Must have compatible mobile phone paired to Uconnect® system.)

1. Once an incoming text message is read to you, push the Phone button . After the beep, say: **“Reply.”**
2. Listen to the Uconnect® prompts. After the beep, repeat one of the pre-defined messages and follow the system prompts.

#### PRE-DEFINED VOICE TEXT REPLY RESPONSES

Yes.	Stuck in Traffic.	See you later.
No.	Start without me.	I'll be Late.
Okay.	Where are you?	I will be <number> minutes late.
Call me.	Are you there yet?	
I'll call you later.	I need directions.	See you in <number> of minutes.
I'm on my way.	Can't talk right now.	
I'm lost.		Thanks.

**TIP:** Your mobile phone must have the full implementation of the **Message Access Profile (MAP)** to take advantage of this feature. For details about MAP, visit [UconnectPhone.com](http://UconnectPhone.com). Apple iPhone® iOS6 or later supports reading **incoming** text messages only.

### Climate (8.4A/8.4AN)

Too hot? Too cold? Adjust vehicle temperatures hands-free and keep everyone comfortable while you keep moving ahead. (If vehicle is equipped with climate control.)

Push the VR button . After the beep, say one of the following commands:

- Set driver temperature to 70 degrees
- Set passenger temperature to 70 degrees

**TIP:** Voice Command for Climate may only be used to adjust the interior temperature of your vehicle. Voice Command will not work to adjust the heated seats or steering wheel if equipped.



Uconnect 8.4A/8.4AN Climate

## Navigation (8.4A/8.4AN)

The Uconnect® navigation feature helps you save time and become more productive when you know exactly how to get to where you want to go. (Navigation is optional on the Uconnect® 8.4A system. See your dealer to activate navigation at any time.)

- To enter a destination, push the VR button . After the beep, say:
  - For the 8.4A Uconnect® System, say: **“Enter state.”**
  - For the 8.4AN Uconnect® System, say: **“Navigate to 800 Chrysler Drive Auburn Hills, Michigan.”**
- Then follow the system prompts.

**TIP:** To start a POI search, push the VR button . After the beep, say: **“ Find nearest coffee shop.”**



## Uconnect® 8.4A/8.4AN Navigation Uconnect® Access (8.4A/8.4AN)

An included trial and/or subscription is required to take advantage of the Uconnect® Access services in the next section of this guide. To register with Uconnect® Access,

press the Apps button on the 8.4-inch touchscreen to get started. Detailed registration instructions can be found on the next page.

**NOTE:** Uconnect® Access is available only on equipped vehicles purchased within the continental United States and Alaska. Services can only be used where coverage is available; see coverage map for details.

 9-1-1 Call

 Security Alarm Notification

 Remote Door Lock/Unlock

 Stolen Vehicle Assistance

 Remote Vehicle Start\*\*

 Remote Horn and Lights

 Yelp® Search

 Voice Texting

 Roadside Assistance Call

 Wi-Fi Hotspot\*\*\*

\*\*If vehicle is equipped.

\*\*\*Extra charges apply.

### Register (8.4A/8.4AN)

1. Press the **Apps** button on the bottom of the 8.4-inch touchscreen.
2. If a pop-up message appears, press **Register** or go to the **Favorite Apps** menu and press **Uconnect® Registration**.
3. Read through the registration instructions. Enter and confirm your personal email address. Then press **Send**.
4. Check your personal inbox for an email from Uconnect® Access.

## 412 UNDERSTANDING YOUR INSTRUMENT PANEL

5. Click on the link inside the email within **72 hours** and complete the easy online registration process to create a personal Mopar® Owner Connect account linked to your vehicle.



Uconnect® Registration 8.4A/8.4AN

## Mobile App (8.4A/8.4AN)

Securely link your mobile device to your vehicle with the Uconnect® Access App. Once you have downloaded the App, you may start your vehicle or lock it from virtually any distance. (Vehicle must be properly equipped with factory-installed Remote Start.)



Mobile App

0415028348

Download the Uconnect® Access App to a compatible Apple® or Android® mobile devices. All you need to do is:

1. After registering with Uconnect® Access, log on to your Mopar® Owner Connect account at moparownerconnect.com.
2. On the Dashboard page, enter your mobile phone number to receive a link to download the App on your mobile device. Or go to iTunes®, or Google Play, and search for the Uconnect® Access App.
3. To activate the App, enter your Mopar Owner Connect user name and password and log in. Your vehicle is then connected to your mobile device.

### Voice Texting (8.4A/8.4AN)

1. To send a message, push the Phone button . After the beep, say the following command: “**Send message** to John Smith.”

2. Listen to the prompt. After the beep, dictate the message you would like to send. Wait for Uconnect® to process your message.
3. The Uconnect® system will repeat your message and provide a variety of options to add to, delete, send or hear the message again. After the beep, tell Uconnect® what you’d like to do. For instance, if you’re happy with your message, after the beep, say: “**Send.**”

You must be registered with Uconnect® Access and have a compatible MAP – enabled smartphone to use your voice to send a personalized text message.

#### TIP:

- Not compatible with iPhone®.
- Messages are limited to 140 characters.
- The Messaging button on the touchscreen must be illuminated to use the feature.

**Yelp® (8.4A/8.4AN)**

Once registered with Uconnect® Access, you can use your voice to search for the most popular places or things around you.

1. Press the “Apps” button on the touchscreen.
2. Press the “All Apps” button on the touchscreen.
3. Press the “Yelp” button on the touchscreen.
4. Once the YELP® home screen appears on the touchscreen, push the VR button , then say: “YELP search.”
5. Listen to the system prompts and after the beep, tell Uconnect® the place or business that you’d like Uconnect® to find.

**TIP:** Once you perform a search, you can reorganize the results by selecting either the Best Match, Rating or Distance tab on the top of the touchscreen display.

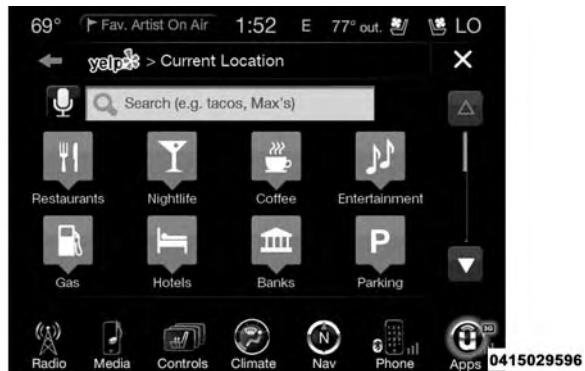

Yelp®



## SiriusXM Travel Link™ (8.4A/8.4AN)

Need to find a gas station, view local movie listings, check a sports score or the 5 - day weather forecast? SiriusXM Travel Link™ is a suite of services that brings a wealth of information right to your Uconnect® 8.4AN system. (Not available for 8.4A system.)

Push the VR button . After the beep, say one of the following commands:

- Show fuel prices
- Show 5 - day weather forecast
- Show extended weather

**TIP:** Traffic alerts are not accessible with Voice Command.



SiriusXM Travel Link™

### Additional Information

© 2015 FCA US LLC. All rights reserved. Mopar and Uconnect are registered trademarks and Mopar Owner Connect is a trademark of FCA US LLC. Android is a trademark of Google Inc. SiriusXM and all related marks and logos are trademarks of SiriusXM Radio Inc. Yelp, Yelp logo, Yelp burst and related marks are registered trademarks of Yelp.

Uconnect® System Support:

- U.S. residents call 1-877-855-8400 or visit [DriveUconnect.com](http://DriveUconnect.com)
- Canadian residents call 1-800-465-2001 (English) or 1-800-387-9983 (French) or visit [DriveUconnect.ca](http://DriveUconnect.ca)

Mon. – Fri., 7:00 am – 12:00 am, ET

Sat., 8:00 am – 10:00 pm, ET

Sun., 9:00 am – 5:00 pm, ET

Uconnect® Access Services Support 1-855-792-4241. Please have your Uconnect® Security PIN ready when you call.

# STARTING AND OPERATING

## CONTENTS

---

- STARTING PROCEDURES . . . . . 422
  - Automatic Transmission . . . . . 422
  - Keyless Enter-N-Go™ . . . . . 423
  - Normal Starting. . . . . 424
  - Extreme Cold Weather (Below -20°F Or -29°C) . . . . . 425
  - If Engine Fails To Start . . . . . 426
  - After Starting . . . . . 427
- ENGINE BLOCK HEATER — IF EQUIPPED . . 427
- AUTOMATIC TRANSMISSION . . . . . 427
  - Key Ignition Park Interlock. . . . . 429
  - Brake/Transmission Shift Interlock System . . 429
  - Fuel Economy (ECO) Mode . . . . . 430
  - Eight-Speed Automatic Transmission . . . . . 431
- ALL-WHEEL DRIVE OPERATION . . . . . 439
  - Single-Speed Operating Instructions/Precautions — If Equipped . . . . . 439
  - Electronically Shifted Transfer Case (Three-Position Switch) — If Equipped . . . . . 440
  - Shifting Procedure . . . . . 444

- ON-ROAD DRIVING TIPS . . . . . 447
- OFF-ROAD DRIVING TIPS . . . . . 447
  - When To Use LOW Range — If Equipped . . . . . 447
  - Driving Through Water . . . . . 448
  - Driving In Snow, Mud And Sand . . . . . 449
  - Hill Climbing . . . . . 450
  - Traction Downhill . . . . . 451
  - After Driving Off-Road . . . . . 451
- POWER STEERING . . . . . 452
  - 3.6L Engine . . . . . 452
  - 5.7L Engine . . . . . 453
  - Power Steering Fluid Check . . . . . 454
- FUEL SAVER TECHNOLOGY 5.7L ENGINE ONLY  
— IF EQUIPPED . . . . . 455
- PARKING BRAKE . . . . . 455
- BRAKE SYSTEM . . . . . 458
- ELECTRONIC BRAKE CONTROL SYSTEM . . . . . 458
  - Anti-Lock Brake System (ABS) . . . . . 459
  - Traction Control System (TCS) . . . . . 459
  - Brake Assist System (BAS) . . . . . 460
  - Electronic Roll Mitigation (ERM) . . . . . 460
  - Electronic Stability Control (ESC) . . . . . 461
  - Trailer Sway Control (TSC) . . . . . 464
  - Hill Start Assist (HSA) . . . . . 465
  - Ready Alert Braking . . . . . 467

- Rain Brake Support . . . . . 467
- ESC Activation/Malfunction Indicator Light And ESC OFF Indicator Light . . . . . 468
- **TIRE SAFETY INFORMATION . . . . . 469**
- Tire Markings . . . . . 469
- Tire Identification Number (TIN). . . . . 473
- Tire Terminology And Definitions . . . . . 475
- Tire Loading And Tire Pressure . . . . . 476
- **TIRES — GENERAL INFORMATION . . . . . 481**
- Tire Pressure . . . . . 481
- Tire Inflation Pressures . . . . . 482
- Tire Pressures For High Speed Operation . . . 484
- Radial Ply Tires . . . . . 484

- Tire Types . . . . . 485
- Run Flat Tires — If Equipped . . . . . 486
- Spare Tires — If Equipped . . . . . 487
- Tire Spinning . . . . . 489
- Tread Wear Indicators . . . . . 490
- Life Of Tire . . . . . 491
- Replacement Tires . . . . . 492
- **TIRE CHAINS (TRACTION DEVICES) . . . . . 493**
- **TIRE ROTATION RECOMMENDATIONS . . . . 495**
- **TIRE PRESSURE MONITOR SYSTEM (TPMS) . 496**
- Premium System . . . . . 499
- Tire Pressure Monitoring Low Pressure Warnings . . . . . 500

□ Service Tpm System Warning . . . . .	.501	■ FLEXIBLE FUEL (3.6L ENGINE ONLY) — IF EQUIPPED . . . . .	.509
□ General Information . . . . .	.504	□ E-85 General Information . . . . .	.509
■ FUEL REQUIREMENTS . . . . .	.504	□ Ethanol Fuel (E-85) . . . . .	.509
□ 3.6L Engine — If Equipped. . . . .	.504	□ Fuel Requirements . . . . .	.510
□ 5.7L Engine — If Equipped. . . . .	.505	□ Selection Of Engine Oil For Flexible Fuel Vehicles (E-85) And Gasoline Vehicles . . . . .	.511
□ Reformulated Gasoline . . . . .	.505	□ Starting . . . . .	.511
□ Gasoline/Oxygenate Blends . . . . .	.506	□ Cruising Range . . . . .	.511
□ E-85 Usage In Non-Flex Fuel Vehicles . . . . .	.506	□ Replacement Parts . . . . .	.511
□ MMT In Gasoline . . . . .	.507	□ Maintenance . . . . .	.512
□ Materials Added To Fuel . . . . .	.507	■ ADDING FUEL . . . . .	.512
□ Fuel System Cautions. . . . .	.507	□ Emergency Fuel Filler Door Release. . . . .	.515
□ Carbon Monoxide Warnings . . . . .	.508	■ VEHICLE LOADING . . . . .	.516

□ Certification Label . . . . .	.516	■ SNOW PLOW . . . . .	.533
■ TRAILER TOWING . . . . .	.518	■ RECREATIONAL TOWING (BEHIND MOTORHOME, ETC.) . . . . .	.534
□ Common Towing Definitions . . . . .	.518	□ Towing This Vehicle Behind Another Vehicle . .	.534
□ Trailer Hitch Classification . . . . .	.521	□ Recreational Towing — Rear-Wheel Drive Models . . . . .	.535
□ Trailer Towing Weights (Maximum Trailer Weight Ratings) . . . . .	.522	□ Recreational Towing — All-Wheel Drive Models (Single-Speed Transfer Case). . . . .	.535
□ Trailer Hitch Receiver Cover Removal — If Equipped . . . . .	.524	□ Recreational Towing — All-Wheel Drive Models (Two-Speed Transfer Case) . . . . .	.536
□ Trailer And Tongue Weight . . . . .	.526		
□ Towing Requirements . . . . .	.527		
□ Towing Tips . . . . .	.532		

## STARTING PROCEDURES

Before starting your vehicle, adjust your seat, adjust the inside and outside mirrors, fasten your seat belt, and if present, instruct all other occupants to buckle their seat belts.

### WARNING!

- When leaving the vehicle, always make sure the ignition is in the OFF position, remove the Key Fob from the vehicle, and lock the vehicle.
- Never leave children alone in a vehicle, or with access to an unlocked vehicle. Leaving children in a vehicle unattended is dangerous for a number of reasons. A child or others could be seriously or fatally injured. Children should be warned not to touch the parking brake, brake pedal or the shift lever/transmission gear selector.

*(Continued)*

### WARNING! *(Continued)*

- Do not leave the Key Fob in or near the vehicle (or in a location accessible to children), and do not leave the ignition (of a vehicle equipped with Keyless Enter-N-Go™) in the ACC or ON/RUN mode. A child could operate power windows, other controls, or move the vehicle.

### Automatic Transmission

The shift lever must be in the NEUTRAL or PARK position before you can start the engine. Apply the brakes before shifting into any driving gear.



**CAUTION!**

Damage to the transmission may occur if the following precautions are not observed:

- Do not shift from REVERSE, PARK, or NEUTRAL into any forward gear when the engine is above idle speed.
- Shift into PARK only after the vehicle has come to a complete stop.
- Shift into or out of REVERSE only after the vehicle has come to a complete stop and the engine is at idle speed.
- Before shifting into any gear, make sure your foot is firmly on the brake pedal.

**Using Fob With Integrated Key (Tip Start)**

**NOTE:** Normal starting of either a cold or a warm engine is obtained without pumping or pressing the accelerator pedal.

**Do not** press the accelerator. Use the Fob with Integrated Key to briefly place the ignition in the START position and release it as soon as the starter engages. The starter motor will continue to run, and it will disengage automatically when the engine is running. If the engine fails to start, the starter will disengage automatically in 10 seconds. If this occurs, place the ignition in the LOCK/OFF position, wait 10 to 15 seconds, then repeat the “Normal Starting” procedure.

**Keyless Enter-N-Go™**

This feature allows the driver to operate the ignition switch with the push of a button, as long as the Remote Start/Keyless Enter-N-Go™ Key Fob is in the passenger compartment.

## Normal Starting

### Using The ENGINE START/STOP Button

1. The transmission must be in PARK or NEUTRAL.
2. Press and hold the brake pedal while pushing the ENGINE START/STOP button once.
3. The system takes over and attempts to start the vehicle. If the vehicle fails to start, the starter will disengage automatically after 10 seconds.
4. If you wish to stop the cranking of the engine prior to the engine starting, push the button again.

**NOTE:** Normal starting of either a cold or a warm engine is obtained without pumping or pressing the accelerator pedal.

### To Turn Off The Engine Using ENGINE START/STOP Button

1. Place the shift lever/gear selector in PARK, then push and release the ENGINE START/STOP button.
2. The ignition switch will return to the OFF position.
3. If the shift lever/gear selector is not in PARK, the ENGINE START/STOP button must be held for two seconds or three short pushes in a row with the vehicle speed above 5 mph (8 km/h) before the engine will shut off. The ignition switch position will remain in the ACC position until the shift lever/gear selector is in PARK and the button is pushed twice to the OFF position. If the shift lever/gear selector is not in PARK and the ENGINE START/STOP button is pushed once, the DID will display a "Vehicle Not In Park" message and the engine will remain running. Never leave a vehicle out of the PARK position, or it could roll.

**NOTE:** If the ignition switch is left in the ACC or RUN (engine not running) position and the transmission is in PARK, the system will automatically time out after 30 minutes of inactivity and the ignition will switch to the OFF position.

### **ENGINE START/STOP Button Functions — With Driver's Foot OFF The Brake Pedal (In PARK Or NEUTRAL Position)**

The ENGINE START/STOP button operates similar to an ignition switch. It has four positions, OFF, ACC, RUN and START. To change the ignition positions without starting the vehicle and use the accessories follow these steps:

- Starting with the ignition in the OFF position.

- Push the ENGINE START/STOP button once to place the ignition to the ACC position (DID will display "ACC").
- Push the ENGINE START/STOP button a second time to place the ignition to the RUN position (DID will display "ON/RUN").
- Push the ENGINE START/STOP button a third time to return the ignition to the OFF position (DID will display "OFF").

### **Extreme Cold Weather (Below $-20^{\circ}\text{F}$ Or $-29^{\circ}\text{C}$ )**

To ensure reliable starting at these temperatures, use of an externally powered electric engine block heater (available from your authorized dealer) is recommended.

## If Engine Fails To Start

### WARNING!

- Never pour fuel or other flammable liquid into the throttle body air inlet opening in an attempt to start the vehicle. This could result in flash fire causing serious personal injury.
- Do not attempt to push or tow your vehicle to get it started. Vehicles equipped with an automatic transmission cannot be started this way. Unburned fuel could enter the catalytic converter and once the engine has started, ignite and damage the converter and vehicle.
- If the vehicle has a discharged battery, booster cables may be used to obtain a start from a booster battery or the battery in another vehicle. This type of start can be dangerous if done improperly. Refer

### WARNING! (Continued)

to “Jump-Starting” in “What To Do In Emergencies” for further information.

### Clearing A Flooded Engine (Using ENGINE START/STOP Button)

If the engine fails to start after you have followed the “Normal Starting” or “Extreme Cold Weather” procedures, it may be flooded. To clear any excess fuel:

1. Press and hold the brake pedal.
2. Press the accelerator pedal all the way to the floor and hold it.
3. Push and release the ENGINE START/STOP button once.

The starter motor will engage automatically, run for 10 seconds, and then disengage. Once this occurs, release the accelerator pedal and the brake pedal, wait 10 to 15 seconds, then repeat the “Normal Starting” procedure.

### After Starting

The idle speed is controlled automatically and it will decrease as the engine warms up.

### ENGINE BLOCK HEATER — IF EQUIPPED

The engine block heater warms the engine, and permits quicker starts in cold weather. Connect the cord to a standard 110-115 Volt AC electrical outlet with a grounded, three-wire extension cord.

The engine block heater must be plugged in at least one hour to have an adequate warming effect on the engine.

### The engine block heater cord is located:

- 3.6L Engine — Coiled and strapped to the engine oil dipstick tube.
- 5.7L Engine — Bundled and fastened to the injector harness.

#### WARNING!

Remember to disconnect the engine block heater cord before driving. Damage to the 110-115 Volt electrical cord could cause electrocution.

### AUTOMATIC TRANSMISSION

#### WARNING!

- It is dangerous to shift out of PARK or NEUTRAL if the engine speed is higher than idle speed. If

*(Continued)*

**WARNING! (Continued)**

your foot is not firmly pressing the brake pedal, the vehicle could accelerate quickly forward or in reverse. You could lose control of the vehicle and hit someone or something. Only shift into gear when the engine is idling normally and your foot is firmly pressing the brake pedal.

- Unintended movement of a vehicle could injure those in or near the vehicle. As with all vehicles, you should never exit a vehicle while the engine is running. Before exiting a vehicle, always apply the parking brake, shift the transmission into PARK, turn the engine OFF, and remove the Key Fob. When the ignition is in the OFF mode, the transmission is locked in PARK, securing the vehicle against unwanted movement.

**WARNING! (Continued)**

- When leaving the vehicle, always make sure the ignition is in the OFF mode, remove the Key Fob from the vehicle, and lock the vehicle.
- Never leave children alone in a vehicle, or with access to an unlocked vehicle. Allowing children to be in a vehicle unattended is dangerous for a number of reasons. A child or others could be seriously or fatally injured. Children should be warned not to touch the parking brake, brake pedal or the transmission gear selector.
- Do not leave the Key Fob in or near the vehicle (or in a location accessible to children), and do not leave the ignition in the ACC or ON/RUN mode. A child could operate power windows, other controls, or move the vehicle.

*(Continued)*

**CAUTION!**

Damage to the transmission may occur if the following precautions are not observed:

- Shift into or out of PARK or REVERSE only after the vehicle has come to a complete stop.
- Do not shift between PARK, REVERSE, NEUTRAL, or DRIVE when the engine is above idle speed.
- Before shifting into any gear, make sure your foot is firmly pressing the brake pedal.

**NOTE:** You must press and hold the brake pedal while shifting out of PARK.

**Key Ignition Park Interlock**

This vehicle is equipped with a Key Ignition Park Interlock which requires the transmission to be in PARK

before the engine can be turned off. This helps the driver avoid inadvertently leaving the vehicle without placing the transmission in PARK.

This system also locks the transmission in PARK whenever the ignition switch is in the OFF position.

**Brake/Transmission Shift Interlock System**

This vehicle is equipped with a Brake Transmission Shift Interlock System (BTSI) that holds the transmission gear selector in PARK unless the brakes are applied. To shift the transmission out of PARK, the engine must be running and the brake pedal must be pressed.

The brake pedal must also be pressed to shift from NEUTRAL into DRIVE or REVERSE when the vehicle is stopped or moving at low speeds.

## Fuel Economy (ECO) Mode

The Fuel Economy (ECO) mode can improve the vehicle's overall fuel economy during normal driving conditions. Each time the vehicle is started ECO mode is engaged and an amber light in the center stack of the instrument panel will be illuminated. To disable ECO mode, press the "ECO" switch in the center stack of the instrument panel and the amber light will go out indicating ECO mode is disabled.



Fuel Economy Mode Switch



When the Fuel Economy (ECO) Mode is engaged, the vehicle control systems will change the following:

- The transmission will upshift sooner and downshift later.
- The overall driving performance will be more conservative.
- Some ECO mode functions may be temporarily inhibited based on temperature and other factors.

### **Eight-Speed Automatic Transmission**

The transmission is controlled using a rotary electronic gear selector located on the center console. The transmission gear range (PRND) is displayed both above the gear selector and in the Driver Information Display (DID). To select a gear range, simply rotate the gear selector. You must also press the brake pedal to shift the transmission out of PARK, or to shift from NEUTRAL into DRIVE or REVERSE when the vehicle is stopped or moving at low

speeds (refer to “Brake/Transmission Shift Interlock System” in this section). To shift past multiple gear ranges at once (such as PARK to DRIVE), simply rotate the gear selector to the appropriate detent. Select the DRIVE range for normal driving.

The electronically-controlled transmission provides a precise shift schedule. The transmission electronics are self-calibrating; therefore, the first few shifts on a new vehicle may be somewhat abrupt. This is a normal condition, and precision shifts will develop within a few hundred miles (kilometers).

Only shift from DRIVE to PARK or REVERSE when the accelerator pedal is released and the vehicle is stopped. Be sure to keep your foot on the brake pedal when shifting between these gears.

The transmission gear selector has only PARK, REVERSE, NEUTRAL, and DRIVE shift positions. Manual shifts can be made using the AutoStick shift control (shift

paddles mounted on the steering wheel). Pressing the shift paddles (-/+ ) while in the DRIVE range will manually select the transmission gear, and will display the current gear in the instrument cluster. Refer to “AutoStick” in this section for further information.



Electronic Gear Selector

## Gear Ranges

DO NOT race the engine when shifting from PARK or NEUTRAL into another gear range.

**NOTE:** After selecting any gear range, wait a moment to allow the selected gear to engage before accelerating. This is especially important when the engine is cold.

### PARK (P)

This range supplements the parking brake by locking the transmission. The engine can be started in this range. Never attempt to use PARK while the vehicle is in motion. Apply the parking brake when leaving the vehicle in this range.

When parking on a level surface, you may shift the transmission into PARK first, and then apply the parking brake.

When parking on a hill, apply the parking brake before shifting the transmission to PARK. As an added precaution, turn the front wheels toward the curb on a downhill grade and away from the curb on an uphill grade.

**NOTE:** On vehicles equipped with the electronically shifted transfer case, ensure that the transfer case is in AWD AUTO or LOW RANGE position on the AWD Control Switch. Ensure that the NEUTRAL position light is NOT illuminated.

### WARNING!

- Never use the PARK position as a substitute for the parking brake. Always apply the parking brake fully when parked to guard against vehicle movement and possible injury or damage.

*(Continued)*

### WARNING! *(Continued)*

- Your vehicle could move and injure you and others if it is not in PARK. Make sure the transmission is in PARK before leaving the vehicle.
- It is dangerous to shift out of PARK or NEUTRAL if the engine speed is higher than idle speed. If your foot is not firmly pressing the brake pedal, the vehicle could accelerate quickly forward or in reverse. You could lose control of the vehicle and hit someone or something. Only shift into gear when the engine is idling normally and your foot is firmly pressing the brake pedal.
- Unintended movement of a vehicle could injure those in or near the vehicle. As with all vehicles, you should never exit a vehicle while the engine is running. Before exiting a vehicle, always apply the parking brake, shift the transmission into PARK,

*(Continued)*

**WARNING! (Continued)**

turn the engine OFF, and remove the key fob. When the ignition is in the OFF position, the transmission is locked in PARK, securing the vehicle against unwanted movement.

- When leaving the vehicle, always make sure the ignition is in the OFF position, remove the key fob from the vehicle, and lock the vehicle.
- Never leave children alone in a vehicle, or with access to an unlocked vehicle. Allowing children to be in a vehicle unattended is dangerous for a number of reasons. A child or others could be seriously or fatally injured. Children should be warned not to touch the parking brake, brake pedal or the transmission gear selector.

*(Continued)*

**WARNING! (Continued)**

- Do not leave the key fob in or near the vehicle (or in a location accessible to children), and do not leave the ignition in the ACC or ON/RUN position. A child could operate power windows, other controls, or move the vehicle.

**NOTE:**

- Before moving the transmission gear selector out of PARK, you must start the engine and also press the brake pedal. Otherwise, damage to the gear selector could result.
- DO NOT race the engine when shifting from PARK or NEUTRAL into another gear range, as this can damage the drivetrain.

The following indicator should be used to ensure that you have engaged the transmission into the PARK position:

- With brake pedal released, look at the transmission gear position display and verify that it indicates the PARK position (P).

### REVERSE (R)

This range is for moving the vehicle backward. Shift into REVERSE only after the vehicle has come to a complete stop.

### NEUTRAL (N)

Use this range when the vehicle is standing for prolonged periods with the engine running. Apply the parking brake and shift the transmission into PARK if you must leave the vehicle.

### WARNING!

**Do not coast in NEUTRAL and never turn off the ignition to coast down a hill. These are unsafe practices that limit your response to changing traffic or road conditions. You might lose control of the vehicle and have a collision.**

### CAUTION!

**Towing the vehicle, coasting, or driving for any other reason with the transmission in NEUTRAL can cause severe transmission damage. Refer to "Recreational Towing" in "Starting And Operating" and "Towing A Disabled Vehicle" in "What To Do In Emergencies" for further information.**

## DRIVE (D)

This range should be used for most city and highway driving. It provides the smoothest upshifts and downshifts, and the best fuel economy. The transmission automatically upshifts through all forward gears. The DRIVE position provides optimum driving characteristics under all normal operating conditions.

When frequent transmission shifting occurs (such as when operating the vehicle under heavy loading conditions, in hilly terrain, traveling into strong head winds, or while towing heavy trailers), use the AutoStick shift control (refer to AutoStick in this section for further information) to select a lower gear. Under these conditions, using a lower gear will improve performance and extend transmission life by reducing excessive shifting and heat buildup.

During cold temperatures, transmission operation may be modified depending on engine and transmission temperature as well as vehicle speed. This feature improves warm up time of the engine and transmission to achieve maximum efficiency. Engagement of the torque converter clutch is inhibited until the transmission fluid is warm. Normal operation will resume once the transmission temperature has risen to a suitable level.

## Transmission Limp Home Mode

Transmission function is monitored electronically for abnormal conditions. If a condition is detected that could result in transmission damage, Transmission Limp Home Mode is activated. In this mode, the transmission may operate only in certain gears, or may not shift at all. Vehicle performance may be severely degraded and the engine may stall. In some situations, the transmission may not re-engage if the engine is turned off and restarted. The Malfunction Indicator Light (MIL) may be

illuminated. A message in the instrument cluster will inform the driver of the more serious conditions, and indicate what actions may be necessary.

In the event of a momentary problem, the transmission can be reset to regain all forward gears by performing the following steps:

**NOTE:** In cases where the instrument cluster message indicates the transmission may not re-engage after engine shutdown, perform this procedure only in a desired location (preferably, at your authorized dealer).

1. Stop the vehicle.
2. Shift the transmission into PARK, if possible. If not, shift the transmission to NEUTRAL.
3. Push and hold the ignition switch until the engine turns OFF.
4. Wait approximately 30 seconds.

5. Restart the engine.
6. Shift into the desired gear range. If the problem is no longer detected, the transmission will return to normal operation.

**NOTE:** Even if the transmission can be reset, we recommend that you visit your authorized dealer at your earliest possible convenience. Your authorized dealer has diagnostic equipment to determine if the problem could recur.

If the transmission cannot be reset, authorized dealer service is required.

### **AutoStick**

AutoStick is a driver-interactive transmission feature providing manual shift control, giving you more control of the vehicle. AutoStick allows you to maximize engine braking, eliminate undesirable upshifts and downshifts, and improve overall vehicle performance. This system

can also provide you with more control during passing, city driving, cold slippery conditions, mountain driving, trailer towing, and many other situations.

### Operation

When the transmission is in DRIVE, it will operate automatically, shifting between the eight available gears. To engage AutoStick, simply tap one of the steering wheel-mounted shift paddles (+/-). Tapping (-) to enter AutoStick mode will downshift the transmission to the next lower gear, while using (+) to enter AutoStick mode will retain the current gear. When AutoStick is active, the current transmission gear is displayed in the instrument cluster.

In AutoStick mode, the transmission will shift up or down when (+/-) is manually selected by the driver, unless an engine lugging or overspeed condition would

result. It will remain in the selected gear until another upshift or downshift is chosen, except as described below.

- The transmission will automatically downshift as the vehicle slows (to prevent engine lugging) and will display the current gear.
- The transmission will automatically downshift to first gear when coming to a stop. After a stop, the driver should manually upshift (+) the transmission as the vehicle is accelerated.
- You can start out, from a stop, in first or second gear. Tapping (+) at a stop will allow starting in second gear. Starting out in second gear can be helpful in snowy or icy conditions.
- If a requested downshift would cause the engine to over-speed, that shift will not occur.



- The system will ignore attempts to upshift at too low of a vehicle speed.
- Holding the (-) paddle depressed will downshift the transmission to the lowest gear possible at the current speed.
- Transmission shifting will be more noticeable when AutoStick is engaged.
- The system may revert to automatic shift mode if a fault or overheat condition is detected.

To disengage AutoStick mode, press and hold the (+) shift paddle until "D" is once again indicated in the instrument cluster. You can shift in or out of AutoStick mode at any time without taking your foot off the accelerator pedal.

## WARNING!

**Do not downshift for additional engine braking on a slippery surface. The drive wheels could lose their grip and the vehicle could skid, causing a collision or personal injury.**

## ALL-WHEEL DRIVE OPERATION

### Single-Speed Operating Instructions/Precautions — If Equipped

This system contains a single-speed (HI range only) transfer case, which provides convenient full-time all-wheel drive. No driver interaction is required. The Brake Traction Control (BTC) System, which combines standard ABS and Traction Control, provides resistance to any wheel that is slipping to allow additional torque transfer to wheels with traction.

**NOTE:** This system is not appropriate for conditions where LOW range is recommended. Refer to “Off-Road Driving Tips” in “Starting and Operating” for further information.

### **Electronically Shifted Transfer Case (Three-Position Switch) — If Equipped**

This is an electronic shift transfer case and it is operated by the AWD Control Switch, which is located on the center console.

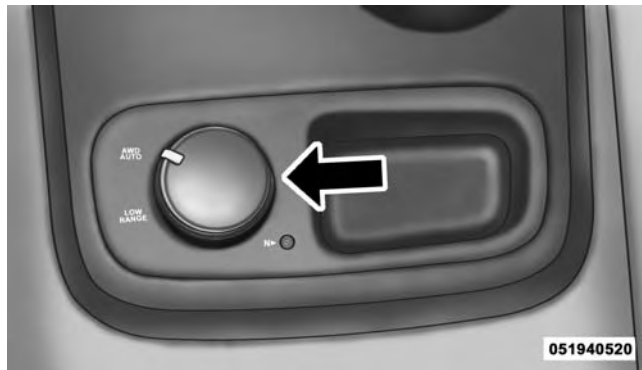

#### **AWD Control Switch (Three-Position)**

This electronically shifted transfer case provides three mode positions:

- All-wheel drive automatic range (AWD AUTO)
- All-wheel drive low range (LOW RANGE)
- Neutral (NEUTRAL)

This electronically shifted transfer case is designed to be driven in the AWD AUTO position for normal street and highway conditions on dry hard surfaced roads.

For variable driving conditions, the AWD AUTO mode can be used. In this mode, the front axle is engaged, but the vehicle's power is sent to the rear wheels. All-wheel drive will be automatically engaged when the vehicle senses a loss of traction.

When additional traction is required, the transfer case LOW RANGE position can be used to lock the front and rear driveshafts together forcing the front and rear wheels to rotate at the same speed. This is accomplished by rotating the AWD Control Switch to the desired position. Refer to "Shifting Procedure" for specific shifting instructions. The LOW RANGE position is designed for loose, slippery road surfaces only. Driving in the LOW RANGE position on dry hard surfaced roads may cause increased tire wear and damage to the driveline components.

### **Transfer Case Position Indicator Messages**

The Transfer Case Position Indicator messages (AWD AUTO and LOW RANGE) are located in the Driver Information Display (DID) and indicate the current and desired transfer case selection. Refer to "Driver Information Display (DID)" in "Understanding Your Instrument Panel" for further information. When you select a different transfer case position, the position indicator lights will do the following:

#### **If All Shift Conditions Are Met:**

1. The current position indicator light will turn OFF.
2. The selected position indicator light will flash until the transfer case completes the shift.
3. When the shift is complete, the indicator light for the selected position will stop flashing and remain ON.

**If One Or More Shift Conditions Are Not Met:**

1. The indicator light for the current position will remain ON.
2. The newly selected position indicator light will continue to flash.
3. The transfer case **will not** shift.

**NOTE:** Before retrying a selection, make certain that all the necessary requirements for selecting a new transfer case position have been met. To retry the selection, turn the control knob back to the current position, wait five seconds, and retry selection. To find the shift requirements, refer to the "Shifting Procedure" for your transfer case, located in this section of the owner's manual.

The "SERV AWD" Warning Light monitors the electronic shift all-wheel drive system. If this light remains on after engine start up or illuminates during driving, it means

that the all-wheel drive system is not functioning properly and that service is required.

**WARNING!**

**Always engage the parking brake when powering down the vehicle if the "SERV AWD Warning Light" is illuminated. Not engaging the parking brake may allow the vehicle to roll which may cause personal injury.**

**NOTE:** Do not attempt to make a shift while only the front or rear wheels are spinning. This could cause damage to driveline components.

When operating your vehicle in LOW RANGE, the engine speed is approximately three times that of the AWD AUTO position at a given road speed. Take care not to overspeed the engine and do not exceed 25 mph (40 km/h).

Proper operation of all-wheel drive vehicles depends on tires of equal size, type and circumference on each wheel. Any difference in tire size can cause damage to the transfer case.

Because all-wheel drive provides improved traction, there is a tendency to exceed safe turning and stopping speeds. Do not go faster than road conditions permit.

### **WARNING!**

**You or others could be injured or killed if you leave the vehicle unattended with the transfer case in the NEUTRAL position without first fully engaging the parking brake. The transfer case NEUTRAL position disengages both the front and rear drive shafts from the powertrain and will allow the vehicle to roll, even if the transmission is in PARK. The parking brake should always be applied when the driver is not in the vehicle.**

For additional information on the appropriate use of each transfer case mode position, see the information below:

#### **AWD Auto**

All-Wheel Drive Auto Range – This range sends power to the rear wheels. The all-wheel drive system will be automatically engaged when the vehicle senses a loss of traction. Additional traction for varying road conditions.

#### **LOW Range**

All-Wheel Drive Low Range – This range provides low speed all-wheel drive. Locks the front and rear drive shafts together forcing the front and rear wheels to rotate at the same speed. Additional traction and maximum pulling power for loose, slippery road surfaces only. Do not exceed 25 mph (40 km/h).

## Neutral (N)

Neutral – This range disengages both the front and rear driveshafts from the powertrain. To be used for flat towing behind another vehicle. Refer to “Recreational Towing” in “Starting And Operating” for further information.

## Shifting Procedure

### NOTE:

- If any of the requirements to select a new transfer case position have not been met, the transfer case will not shift. The position indicator light for the previous position will remain ON and the newly selected position indicator light will continue to flash until all the requirements for the selected position have been met. To retry a shift: return the control knob back to the

original position, make certain all shift requirements have been met, wait five seconds and try the shift again.

- If all the requirements to select a new transfer case position have been met, the current position indicator light will turn OFF, the selected position indicator light will flash until the transfer case completes the shift. When the shift is complete, the position indicator light for the selected position will stop flashing and remain ON.

## AWD Auto To Low Range

**NOTE:** When shifting into or out of LOW RANGE some gear noise may be heard. This noise is normal and is not detrimental to the vehicle or occupants.

Shifting can be performed with the vehicle rolling 2 to 3 mph (3 to 5 km/h) or completely stopped. Use either of the following procedures:

### Preferred Procedure

1. With the engine running, slow the vehicle to 2 to 3 mph (3 to 5 km/h).
2. Shift the transmission into NEUTRAL.
3. While still rolling, rotate the AWD control switch to the desired position.
4. After the desired position indicator light is ON (not flashing), shift the transmission back into gear.

### Alternate Procedure

1. Bring the vehicle to complete stop.
2. With the ignition switch in ON/ RUN position and engine running, shift the transmission to Neutral.

3. Rotate the AWD control switch to the desired position.
4. After the desired position indicator light is ON (not flashing), shift the transmission back into gear.

### NOTE:

- If Steps 1 or 2 of either the Preferred or Alternate Procedure are not satisfied prior to attempting the shift or if they no longer are being met while the shift attempt is in process, the desired position indicator light will flash continuously while the original position indicator light is ON, until all requirements have been met.
- The ignition switch must be in the RUN position for a shift to take place and for the position indicator lights to be operable. If the ignition switch is not in the RUN position, then the shift will not take place and no position indicator lights will be on or flashing.

## NEUTRAL Shift Procedure

1. Bring the vehicle to a complete stop with the engine running.
2. Press and hold the brake pedal.
3. Shift the transmission into NEUTRAL.
4. Using a ballpoint pen or similar object, press and hold the recessed transfer case NEUTRAL (N) button (located by the selector switch) for four seconds. The light next to the N symbol will blink, indicating shift in progress. The light will stop blinking (stay on solid) when the shift to NEUTRAL (N) is complete. A “4WD System in Neutral” message will display on the Driver Information Display (DID). Refer to “Driver Information Display (DID)” in “Understanding Your Instrument Panel” for further information.

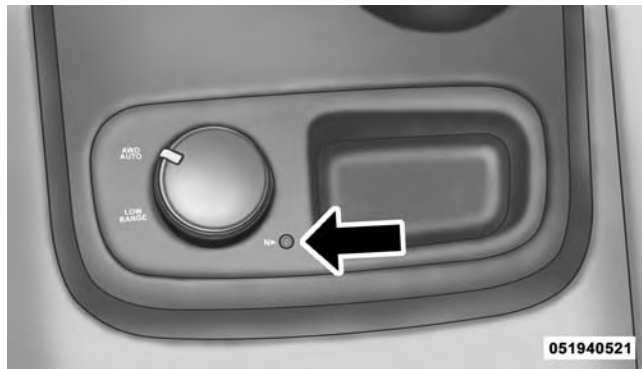

**Neutral Switch**

5. Repeat Steps 1 to 4 to shift out of NEUTRAL.



**NOTE:** If shift conditions/interlocks are not met, a “To Tow Vehicle Safely, Read Neutral Shift Procedure in Owners Manual” message will flash from the Driver Information Display (DID). Refer to “Driver Information Display (DID)” in “Understanding Your Instrument Panel” for further information.

## ON-ROAD DRIVING TIPS

Utility vehicles have higher ground clearance and a narrower track to make them capable of performing in a wide variety of off-road applications. Specific design characteristics give them a higher center of gravity than ordinary cars.

An advantage of the higher ground clearance is a better view of the road, allowing you to anticipate problems. They are not designed for cornering at the same speeds as

conventional two-wheel drive vehicles any more than low-slung sports cars are designed to perform satisfactorily in off-road conditions. If at all possible, avoid sharp turns or abrupt maneuvers. As with other vehicles of this type, failure to operate this vehicle correctly may result in loss of control or vehicle rollover.

## OFF-ROAD DRIVING TIPS

### When To Use LOW Range — If Equipped

When off-road driving, shift to LOW for additional traction. This range should be limited to extreme situations such as deep snow, mud, or sand where additional low speed pulling power is needed. Vehicle speeds in excess of 25 mph (40 km/h) should be avoided when in LOW range.

**CAUTION!**

Do not drive in 4WD-LOW Range on dry pavement; driveline damage may result. 4WD-LOW Range locks front and rear drivelines together and does not allow for differential action between the front to rear driveshafts. Driving in 4WD-LOW on pavement will cause driveline binding; use only on wet or slippery surfaces.

**Driving Through Water**

Although your vehicle is capable of driving through water, there are a number of precautions that must be considered before entering the water.

**CAUTION!**

When driving through water, do not exceed 5 mph (8 km/h). Always check water depth before entering, as a precaution, and check all fluids afterward. Driving through water may cause damage that may not be covered by the New Vehicle Limited Warranty.

Driving through water more than a few inches/centimeters deep will require extra caution to ensure safety and prevent damage to your vehicle. If you must drive through water, try to determine the depth and the bottom condition (and location of any obstacles) prior to entering. Proceed with caution and maintain a steady controlled speed less than 5 mph (8 km/h) in deep water to minimize wave effects.

## Flowing Water

If the water is swift flowing and rising (as in storm run-off), avoid crossing until the water level recedes and/or the flow rate is reduced. If you must cross flowing water avoid depths in excess of 9 in (23 cm). The flowing water can erode the streambed, causing your vehicle to sink into deeper water. Determine exit point(s) that are downstream of your entry point to allow for drifting.

## Standing Water

Avoid driving in standing water deeper than 20 in (51 cm), and reduce speed appropriately to minimize wave effects. Maximum speed in 20 in (51 cm) of water is less than 5 mph (8 km/h).

## Maintenance

After driving through deep water, inspect your vehicle fluids and lubricants (engine oil, transmission oil, axle,

transfer case) to assure the fluids have not been contaminated. Contaminated fluid (milky, foamy in appearance) should be flushed/changed as soon as possible to prevent component damage.

## Driving In Snow, Mud And Sand

In heavy snow, when pulling a load, or for additional control at slower speeds, shift the transmission to a low gear and shift the transfer case to LOW if necessary. Refer to “All-Wheel Drive Operation” in “Starting and Operating” for further information. Do not shift to a lower gear than necessary to maintain forward motion. Over-revving the engine can spin the wheels and traction will be lost.

Avoid abrupt downshifts on icy or slippery roads, because engine braking may cause skidding and loss of control.

## Hill Climbing

**NOTE:** Before attempting to climb a hill, determine the conditions at the crest and/or on the other side.

Before climbing a steep hill, shift the transmission to a lower gear and shift the transfer case to LOW. Use first gear and LOW for very steep hills.

If you stall or begin to lose forward motion while climbing a steep hill, allow your vehicle to come to a stop and immediately apply the brakes. Restart the engine, and shift into REVERSE. Back slowly down the hill, allowing the compression braking of the engine to help regulate your speed. If the brakes are required to control vehicle speed, apply them lightly and avoid locking or skidding the tires.

### WARNING!

**If the engine stalls, you lose forward motion, or cannot make it to the top of a steep hill or grade, never attempt to turn around. To do so may result in tipping and rolling the vehicle. Always back carefully straight down a hill in REVERSE gear. Never back down a hill in NEUTRAL using only the brake.**

**Remember, never drive diagonally across a hill always drive straight up or down.**

If the wheels start to slip as you approach the crest of a hill, ease off the accelerator and maintain forward motion by turning the front wheels slowly. This may provide a fresh “bite” into the surface and will usually provide traction to complete the climb.

## Traction Downhill

Shift the transmission into a low gear, and the transfer case into LOW range. Let the vehicle go slowly down the hill with all four wheels turning against engine compression drag. This will permit you to control the vehicle speed and direction.

When descending mountains or hills, repeated braking can cause brake fade with loss of braking control. Avoid repeated heavy braking by downshifting the transmission whenever possible.

## After Driving Off-Road

Off-road operation puts more stress on your vehicle than does most on-road driving. After going off-road, it is always a good idea to check for damage. That way you can get any problems taken care of right away and have your vehicle ready when you need it.

- Completely inspect the underbody of your vehicle. Check tires, body structure, steering, suspension, and exhaust system for damage.
- Inspect the radiator for mud and debris and clean as required.
- Check threaded fasteners for looseness, particularly on the chassis, drivetrain components, steering, and suspension. Retighten them, if required, and torque to the values specified in the Service Manual.
- Check for accumulations of plants or brush. These things could be a fire hazard. They might hide damage to fuel lines, brake hoses, axle pinion seals, and propeller shafts.
- After extended operation in mud, sand, water, or similar dirty conditions, have the radiator, fan, brake rotors, wheels, brake linings, and axle yokes inspected and cleaned as soon as possible.

**WARNING!**

**Abrasive material in any part of the brakes may cause excessive wear or unpredictable braking. You might not have full braking power when you need it to prevent a collision. If you have been operating your vehicle in dirty conditions, get your brakes checked and cleaned as necessary.**

- If you experience unusual vibration after driving in mud, slush or similar conditions, check the wheels for impacted material. Impacted material can cause a wheel imbalance and freeing the wheels of it will correct the situation.

**POWER STEERING****3.6L Engine**

Your vehicle is equipped with an electro-hydraulic power steering system that will give you good vehicle response

and increased ease of maneuverability in tight spaces. The system will vary its assist to provide light efforts while parking and good feel while driving. If the electro-hydraulic power steering system experiences a fault that prevents it from providing power steering assist, then the system will provide mechanical steering capability.

**CAUTION!**

**Extreme steering maneuvers may cause the electrically driven pump to reduce or stop power steering assistance in order to prevent damage to the system. Normal operation will resume once the system is allowed to cool.**



If the “SERVICE POWER STEERING” message and a flashing icon are displayed on the DID screen, it indicates that the vehicle needs to be taken to the dealer for service. It is likely the vehicle has lost power steering assistance. Refer to “Driver Information Display (DID)” in “Understanding Your Instrument Panel” for further information.

If the “POWER STEERING HOT” message and an icon are displayed on the DID screen, it indicates that extreme steering maneuvers may have occurred, which caused an over temperature condition in the power steering system. You will lose power steering assistance momentarily until the over temperature condition no longer exists. Once driving conditions are safe, then pull over and let vehicle idle for a few moments until the light turns off. Refer to “Driver Information Display (DID)” in “Understanding Your Instrument Panel” for further information.

#### NOTE:

- Even if power steering assistance is no longer operational, it is still possible to steer the vehicle. Under these conditions there will be a substantial increase in steering effort, especially at very low vehicle speeds and during parking maneuvers.
- If the condition persists, see your authorized dealer for service.

#### 5.7L Engine

The standard power steering system will give you good vehicle response and increased ease of maneuverability in tight spaces. The system will provide mechanical steering capability if power assist is lost.

If for some reason the power assist is interrupted, it will still be possible to steer your vehicle. Under these conditions, you will observe a substantial increase in steering effort, especially at very low vehicle speeds and during parking maneuvers.

**NOTE:**

- Increased noise levels at the end of the steering wheel travel are considered normal and do not indicate that there is a problem with the power steering system.
- Upon initial start-up in cold weather, the power steering pump may make noise for a short amount of time. This is due to the cold, thick fluid in the steering system. This noise should be considered normal, and it does not in any way damage the steering system.

**WARNING!**

**Continued operation with reduced power steering assist could pose a safety risk to yourself and others. Service should be obtained as soon as possible.**

**CAUTION!**

**Prolonged operation of the steering system at the end of the steering wheel travel will increase the steering fluid temperature and it should be avoided when possible. Damage to the power steering pump may occur.**

**Power Steering Fluid Check**

Checking the power steering fluid level at a defined service interval is not required. The fluid should only be checked if a leak is suspected, abnormal noises are



apparent, and/or the system is not functioning as anticipated. Coordinate inspection efforts through an authorized dealer.

### CAUTION!

Do not use chemical flushes in your power steering system as the chemicals can damage your power steering components. Such damage is not covered by the New Vehicle Limited Warranty.

### WARNING!

Fluid level should be checked on a level surface and with the engine off to prevent injury from moving parts and to ensure accurate fluid level reading. Do not overfill. Use only manufacturer's recommended power steering fluid.

If necessary, add fluid to restore to the proper indicated level. With a clean cloth, wipe any spilled fluid from all surfaces. Refer to "Fluids, Lubricants, And Genuine Parts" in "Maintaining Your Vehicle" for further information.

### FUEL SAVER TECHNOLOGY 5.7L ENGINE ONLY — IF EQUIPPED

This feature offers improved fuel economy by shutting off four of the engine's eight cylinders during light load and cruise conditions. The system is automatic with no driver inputs or additional driving skills required.

**NOTE:** This system may take some time to return to full functionality after a battery disconnect.

### PARKING BRAKE

Before leaving the vehicle, make sure that the parking brake is fully applied and place the shift lever in the PARK position.

The foot operated parking brake is located below the lower left corner of the instrument panel. To apply the park brake, firmly push the park brake pedal fully. To release the parking brake, press the park brake pedal a second time and let your foot up as you feel the brake disengage.



Parking Brake

When the parking brake is applied with the ignition switch in the ON position, the “Brake” Warning Light in the instrument cluster will illuminate.

**NOTE:**

- When the parking brake is applied and the transmission is placed in gear, the “Brake” Warning Light will flash. If vehicle speed is detected, a chime will sound to alert the driver. Fully release the parking brake before attempting to move the vehicle.
- This light only shows that the parking brake is applied. It does not show the degree of brake application.

When parking on a hill, it is important to turn the front wheels toward the curb on a downhill grade and away from the curb on an uphill grade. Apply the parking brake before placing the shift lever in PARK, otherwise the load on the transmission locking mechanism may

make it difficult to move the shift lever out of PARK. The parking brake should always be applied whenever the driver is not in the vehicle.

### **WARNING!**

- Never use the PARK position as a substitute for the parking brake. Always apply the parking brake fully when parked to guard against vehicle movement and possible injury or damage.
- When leaving the vehicle, always remove the Key Fob from the ignition and lock your vehicle.
- Never leave children alone in a vehicle, or with access to an unlocked vehicle. Allowing children to be in a vehicle unattended is dangerous for a number of reasons. A child or others could be seriously or fatally injured. Children should be warned not to touch the parking brake, brake pedal or the shift lever.

*(Continued)*

### **WARNING! (Continued)**

- When leaving the vehicle, always make sure the keyless ignition node is in the "OFF" mode, remove the Key Fob from the vehicle and lock the vehicle.
- Do not leave the Key Fob in or near the vehicle or in a location accessible to children, and do not leave the ignition of a vehicle equipped with Keyless Enter-N-Go™ in the ACC or ON/RUN mode. A child could operate power windows, other controls, or move the vehicle.
- Be sure the parking brake is fully disengaged before driving; failure to do so can lead to brake failure and a collision.
- Always fully apply the parking brake when leaving your vehicle, or it may roll and cause damage or injury. Also be certain to leave the transmission in PARK. Failure to do so may allow the vehicle to roll and cause damage or injury.

**CAUTION!**

If the “Brake” Warning Light remains on with the parking brake released, a brake system malfunction is indicated. Have the brake system serviced by an authorized dealer immediately.

**BRAKE SYSTEM**

Your vehicle is equipped with dual hydraulic brake systems. If either of the two hydraulic systems loses normal capability, the remaining system will still function. However, there will be some loss of overall braking effectiveness. You may notice increased pedal travel during application, greater pedal force required to slow or stop, and potential activation of the “Brake System Warning Light.”

In the event power assist is lost for any reason (i.e., repeated brake applications with the engine off) the brakes will still function. However, the effort required to brake the vehicle will be much greater than that required with the power system operating.

**ELECTRONIC BRAKE CONTROL SYSTEM**

Your vehicle is equipped with an advanced electronic brake control system that includes the Anti-Lock Brake System (ABS), Traction Control System (TCS), Brake Assist System (BAS), Electronic Roll Mitigation (ERM), and Electronic Stability Control (ESC). All five of these systems work together to enhance vehicle stability and control in various driving conditions.

Also, your vehicle is equipped with Trailer Sway Control (TSC), Hill Start Assist (HSA), Ready Alert Braking, and Rain Brake Support.

## Anti-Lock Brake System (ABS)

This system aids the driver in maintaining vehicle control under adverse braking conditions. The system controls hydraulic brake pressure to prevent wheel lock-up and help avoid skidding on slippery surfaces during braking.

### WARNING!

**The ABS cannot prevent the natural laws of physics from acting on the vehicle, nor can it increase the traction afforded by prevailing road conditions. The ABS cannot prevent collisions, including those resulting from excessive speed in turns, driving on very slippery surfaces, or hydroplaning. The capabilities of an ABS-equipped vehicle must never be exploited in a reckless or dangerous manner which could jeopardize the user's safety or the safety of others.**

## Traction Control System (TCS)

This system monitors the amount of wheel spin of each of the driven wheels. If wheel spin is detected, brake pressure is applied to the slipping wheel(s) and engine power is reduced to provide enhanced acceleration and stability.

A feature of the TCS system, Brake Limited Differential (BLD), functions similar to a limited-slip differential and controls the wheel spin across a driven axle. If one wheel on a driven axle is spinning faster than the other, the system will apply the brake of the spinning wheel. This will allow more engine torque to be applied to the wheel that is not spinning. This feature remains active even if ESC system is in the "Partial Off" mode. Refer to "Electronic Stability Control (ESC)" in this section for further information.

## Brake Assist System (BAS)

The BAS is designed to optimize the vehicle's braking capability during emergency braking maneuvers. The system detects an emergency braking situation by sensing the rate and amount of brake application and then applies optimum pressure to the brakes. This can help reduce braking distances. The BAS complements the anti-lock brake system (ABS). Applying the brakes very quickly results in the best BAS assistance. To receive the benefit of the system, you must apply **continuous** braking pressure during the stopping sequence (do not "pump" the brakes). Do not reduce brake pedal pressure unless braking is no longer desired. Once the brake pedal is released, the BAS is deactivated.

### WARNING!

- The BAS cannot prevent the natural laws of physics from acting on the vehicle, nor can it increase the traction afforded by prevailing road conditions.
- The BAS cannot prevent collisions, including those resulting from excessive speed in turns, driving on very slippery surfaces, or hydroplaning.
- The capabilities of a BAS-equipped vehicle must never be exploited in a reckless or dangerous manner which could jeopardize the user's safety or the safety of others.

## Electronic Roll Mitigation (ERM)

This system anticipates the potential for wheel lift by monitoring the driver's steering wheel input and the speed of the vehicle. When ERM determines that the rate of change of the steering wheel angle and vehicle's speed are sufficient to potentially cause wheel lift, it then

applies the appropriate brake and may also reduce engine power to lessen the chance that wheel lift will occur. ERM will only intervene during very severe or evasive driving maneuvers.

ERM can only reduce the chance of wheel lift occurring during severe or evasive driving maneuvers. It cannot prevent wheel lift due to other factors, such as road conditions, leaving the roadway, or striking objects or other vehicles.

### **WARNING!**

**Many factors, such as vehicle loading, road conditions, and driving conditions, influence the chance that wheel lift or rollover may occur. ERM cannot prevent all wheel lift or rollovers, especially those that involve leaving the roadway or striking objects**

*(Continued)*

### **WARNING! (Continued)**

**or other vehicles. The capabilities of an ERM-equipped vehicle must never be exploited in a reckless or dangerous manner, which could jeopardize the user's safety or the safety of others.**

### **Electronic Stability Control (ESC)**

This system enhances directional control and stability of the vehicle under various driving conditions. ESC corrects for oversteering or understeering of the vehicle by applying the brake of the appropriate wheel to assist in counteracting the oversteer or understeer condition. Engine power may also be reduced to help the vehicle maintain the desired path.

ESC uses sensors in the vehicle to determine the vehicle path intended by the driver and compares it to the actual path of the vehicle. When the actual path does not match

the intended path, ESC applies the brake of the appropriate wheel to assist in counteracting the oversteer or understeer condition.

- Oversteer - when the vehicle is turning more than appropriate for the steering wheel position.
- Understeer - when the vehicle is turning less than appropriate for the steering wheel position.

The “ESC Activation/Malfunction Indicator” located in the instrument cluster will start to flash as soon as the tires lose traction and the ESC system becomes active. The “ESC Activation/Malfunction Indicator” also flashes when the TCS is active. If the “ESC Activation/Malfunction Indicator” begins to flash during acceleration, ease up on the accelerator and apply as little throttle as possible. Be sure to adapt your speed and driving to the prevailing road conditions.

### WARNING!

**Electronic Stability Control (ESC) cannot prevent the natural laws of physics from acting on the vehicle, nor can it increase the traction afforded by prevailing road conditions. ESC cannot prevent accidents, including those resulting from excessive speed in turns, driving on very slippery surfaces, or hydroplaning. ESC also cannot prevent accidents resulting from loss of vehicle control due to inappropriate driver input for the conditions. Only a safe, attentive, and skillful driver can prevent accidents. The capabilities of an ESC equipped vehicle must never be exploited in a reckless or dangerous manner which could jeopardize the user’s safety or the safety of others.**

The ESC system has two available operating modes in AWD AUTO range and two-wheel drive vehicles, and one operating mode in AWD LOW range.



## AUTO Range (All-Wheel Drive Models) Or Two-Wheel Drive Models

### On

This is the normal operating mode for ESC in AWD AUTO range and in two-wheel drive vehicles. Whenever the vehicle is started or the transfer case (if equipped) is shifted from AWD LOW range or NEUTRAL back to AWD AUTO range, the ESC system will be in this “On” mode. This mode should be used for most driving situations. ESC should only be turned to “Partial Off” mode for specific reasons as noted below.

### Partial Off

This mode is entered by momentarily pressing the “ESC OFF” switch. When in “Partial Off” mode, the TCS portion of ESC, except for the BLD feature described in the TCS section, has been disabled and the “ESC Off Indicator Light” will be illuminated. All other stability

features of ESC function normally. This mode is intended to be used if the vehicle is in deep snow, sand, or gravel conditions and more wheel spin than ESC would normally allow is required to gain traction. To turn ESC on again, momentarily press the “ESC OFF” switch. This will restore the normal “ESC On” mode of operation.

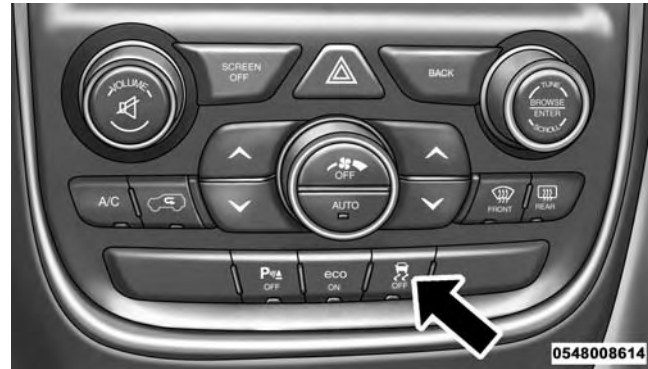

ESC OFF Switch

**NOTE:** To improve the vehicle's traction when driving with snow chains, or starting off in deep snow, sand, or gravel, it may be desirable to switch to the "Partial Off" mode by pressing the "ESC OFF" switch. Once the situation requiring ESC to be switched to the "Partial Off" mode is overcome, turn ESC back on by momentarily pressing the "ESC OFF" switch. This may be done while the vehicle is in motion.

### WARNING!

- When in "Partial Off" mode, the TCS functionality of ESC, (except for the limited slip feature described in the TCS section), has been disabled and the "ESC Off Indicator Light" will be illuminated. When in "Partial Off" mode, the engine power reduction feature of TCS is disabled, and the

*(Continued)*

### WARNING! *(Continued)*

enhanced vehicle stability offered by the ESC system is reduced.

- Trailer Sway control (TSC) is disabled when the ESC system is in the "Partial Off" mode.

### AWD Low Range (LOW)

#### Partial Off

This is the normal operating mode for ESC in AWD LOW range. Whenever the vehicle is started in AWD LOW range, or the transfer case (if equipped) is shifted from AWD AUTO range or NEUTRAL to AWD LOW range, the ESC system will be in the "Partial Off" mode.

#### Trailer Sway Control (TSC)

TSC uses sensors in the vehicle to recognize an excessively swaying trailer and will take the appropriate actions to attempt to stop the sway. The system may

reduce engine power and apply the brake of the appropriate wheel(s) to counteract the sway of the trailer. TSC will become active automatically once an excessively swaying trailer is recognized. Note that TSC cannot stop all trailers from swaying. Always use caution when towing a trailer and follow the trailer tongue weight recommendations. Refer to “Trailer Towing” in this section for further information. When TSC is functioning, the “ESC Activation/Malfunction Indicator Light” will flash, the engine power may be reduced and you may feel the brakes being applied to individual wheels to attempt to stop the trailer from swaying. TSC is disabled when the ESC system is in the “Partial Off” mode.

### **WARNING!**

**If TSC activates while driving, slow the vehicle down, stop at the nearest safe location, and adjust the trailer load to eliminate trailer sway.**

### **Hill Start Assist (HSA)**

The HSA system is designed to assist the driver when starting a vehicle from a stop on a hill. HSA will maintain the level of brake pressure the driver applied for a short period of time after the driver takes their foot off of the brake pedal. If the driver does not apply the throttle during this short period of time, the system will release brake pressure and the vehicle will roll down the hill. The system will release brake pressure in proportion to the amount of throttle applied as the vehicle starts to move in the intended direction of travel.

### **HSA Activation Criteria**

The following criteria must be met in order for HSA to activate:

- Vehicle must be stopped.
- Vehicle must be on a 6% (approximate) grade or greater hill.

- Gear selection matches vehicle uphill direction (i.e., vehicle facing uphill is in forward gear; vehicle backing uphill is in REVERSE gear).

HSA will work in REVERSE and all forward gears when the activation criteria have been met. The system will not activate if the vehicle is placed in NEUTRAL or PARK.

**WARNING!**

There may be situations on minor hills with a loaded vehicle, or while pulling a trailer, when the system will not activate and slight rolling may occur. This could cause a collision with another vehicle or object. Always remember the driver is responsible for braking the vehicle.

**HSA**

HSA will provide assistance when starting on a grade when pulling a trailer.

**WARNING!**

- If you use a trailer brake controller with your trailer, your trailer brakes may be activated and deactivated with the brake switch. If so, when the brake pedal is released, there may not be enough brake pressure to hold the vehicle and trailer on a hill and this could cause a collision with another vehicle or object behind you. In order to avoid rolling down the hill while resuming acceleration, manually activate the trailer brake prior to releasing the brake pedal. Always remember the driver is responsible for braking the vehicle.

*(Continued)*

**WARNING! (Continued)**

- **HSA is not a parking brake. Always apply the parking brake fully when leaving your vehicle. Also, be certain to leave the transmission in PARK. Failure to follow these warnings may cause the vehicle to roll down the incline and could collide with another vehicle, object or person, and cause serious or fatal injury. Always remember to use the parking brake while parking on a hill and that the driver is responsible for braking the vehicle.**

**HSA Off**

If you wish to turn off the HSA system, it can be done using the Uconnect® Settings. Refer to “Uconnect® Settings” in “Understanding Your Instrument Panel” for further information.

**Ready Alert Braking**

Ready Alert Braking may reduce the time required to reach full braking during emergency braking situations. It anticipates when an emergency braking situation may occur by monitoring how fast the throttle is released by the driver. When the throttle is released very quickly, Ready Alert Braking applies a small amount of brake pressure. This brake pressure will not be noticed by the driver. The brake system uses this brake pressure to allow a fast brake response if the driver applies the brakes.

**Rain Brake Support**

Rain Brake Support may improve braking performance in wet conditions. It will periodically apply a small amount of brake pressure to remove any water buildup on the front brake rotors. It only functions when the windshield wipers are in the LO or HI mode, it does not

function in the intermittent mode. When Rain Brake Support is active, there is no notification to the driver and no driver interaction is required.

### **ESC Activation/Malfunction Indicator Light And ESC OFF Indicator Light**



The “ESC Activation/Malfunction Indicator Light” in the instrument cluster will come on when the ignition switch is cycled to the ON/RUN position. It should go out with the engine running. If the “ESC Activation/Malfunction Indicator Light” comes on continuously with the engine running, a malfunction has been detected in the ESC system. If this light remains on after several ignition cycles, and the vehicle has been driven several miles (kilometers) at speeds greater than 30 mph (48 km/h), see your authorized dealer as soon as possible to have the problem diagnosed and corrected.

The “ESC Activation/Malfunction Indicator Light” (located in the instrument cluster) starts to flash as soon as the tires lose traction and the ESC system becomes active. The “ESC Activation/Malfunction Indicator Light” also flashes when TCS is active. If the “ESC Activation/Malfunction Indicator Light” begins to flash during acceleration, ease up on the accelerator and apply as little throttle as possible. Be sure to adapt your speed and driving to the prevailing road conditions.

#### **NOTE:**

- The “ESC Off Indicator Light” and the “ESC Activation/Malfunction Indicator Light” come on momentarily each time the ignition switch is turned to the ON/RUN position.

- Each time the ignition is cycled to the ON/RUN position, the ESC system will be ON even if it was cycled off previously, except for when the vehicle is started while in AWD LOW Range.
- The ESC system will make buzzing or clicking sounds when it is active. This is normal; the sounds will stop when ESC becomes inactive following the maneuver that caused the ESC activation.



The “ESC OFF Indicator Light” indicates the Electronic Stability Control (ESC) is partially off or full off.

## TIRE SAFETY INFORMATION

### Tire Markings

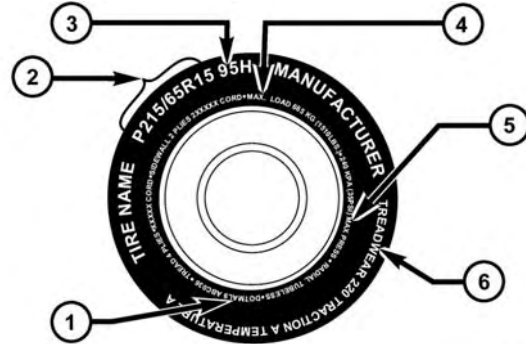

054903773

- |  |  |
|--|--|
| 1 — U.S. DOT Safety Standards Code (TIN) | 4 — Maximum Load                               |
| 2 — Size Designation                     | 5 — Maximum Pressure                           |
| 3 — Service Description                  | 6 — Treadwear, Traction and Temperature Grades |

**NOTE:**

- P (Passenger) — Metric tire sizing is based on U.S. design standards. P-Metric tires have the letter “P” molded into the sidewall preceding the size designation. Example: P215/65R15 95H.
- European — Metric tire sizing is based on European design standards. Tires designed to this standard have the tire size molded into the sidewall beginning with the section width. The letter “P” is absent from this tire size designation. Example: 215/65R15 96H.
- LT (Light Truck) — Metric tire sizing is based on U.S. design standards. The size designation for LT-Metric tires is the same as for P-Metric tires except for the letters “LT” that are molded into the sidewall preceding the size designation. Example: LT235/85R16.
- Temporary spare tires are designed for temporary emergency use only. Temporary high pressure compact spare tires have the letter “T” or “S” molded into the sidewall preceding the size designation. Example: T145/80D18 103M.
- High flotation tire sizing is based on U.S. design standards and it begins with the tire diameter molded into the sidewall. Example: 31x10.5 R15 LT.



## Tire Sizing Chart

### EXAMPLE:

---

Example Size Designation: P215/65R15XL 95H, 215/65R15 96H, LT235/85R16C, T145/80D18 103M, 31x10.5 R15  
LT

---

**P** = Passenger car tire size based on U.S. design standards, or

"...**blank**..." = Passenger car tire based on European design standards, or

**LT** = Light truck tire based on U.S. design standards, or

**T or S** = Temporary spare tire or

**31** = Overall diameter in inches (in)

---

**215, 235, 145** = Section width in millimeters (mm)

---

**65, 85, 80** = Aspect ratio in percent (%)

– Ratio of section height to section width of tire, or

**10.5** = Section width in inches (in)

---

---

**EXAMPLE:**

---

**R** = Construction code

- "R" means radial construction, or
  - "D" means diagonal or bias construction
- 

**15, 16, 18** = Rim diameter in inches (in)

---

**Service Description:**

---

**95** = Load Index

- A numerical code associated with the maximum load a tire can carry
- 

**H** = Speed Symbol

- A symbol indicating the range of speeds at which a tire can carry a load corresponding to its load index under certain operating conditions
  - The maximum speed corresponding to the speed symbol should only be achieved under specified operating conditions (i.e., tire pressure, vehicle loading, road conditions, and posted speed limits)
-

---

**EXAMPLE:**

---

**Load Identification:**

Absence of the following load identification symbols on the sidewall of the tire indicates a Standard Load (SL) tire:

- **XL** = Extra load (or reinforced) tire, or
- **LL** = Light load tire or
- **C, D, E, F, G** = Load range associated with the maximum load a tire can carry at a specified pressure

---

**Maximum Load** – Maximum load indicates the maximum load this tire is designed to carry

---

**Maximum Pressure** – Maximum pressure indicates the maximum permissible cold tire inflation pressure for this tire

---

**Tire Identification Number (TIN)**

The TIN may be found on one or both sides of the tire, however, the date code may only be on one side. Tires with white sidewalls will have the full TIN, including the date code, located on the white sidewall side of the tire.

Look for the TIN on the outboard side of black sidewall tires as mounted on the vehicle. If the TIN is not found on the outboard side, then you will find it on the inboard side of the tire.

**EXAMPLE:****DOT MA L9 ABCD 0301****DOT** = Department of Transportation

- This symbol certifies that the tire is in compliance with the U.S. Department of Transportation tire safety standards and is approved for highway use

**MA** = Code representing the tire manufacturing location (two digits)**L9** = Code representing the tire size (two digits)**ABCD** = Code used by the tire manufacturer (one to four digits)**03** = Number representing the week in which the tire was manufactured (two digits)

- 03 means the 3rd week

**01** = Number representing the year in which the tire was manufactured (two digits)

- 01 means the year 2001
- Prior to July 2000, tire manufacturers were only required to have one number to represent the year in which the tire was manufactured. Example: 031 could represent the 3rd week of 1981 or 1991

## Tire Terminology And Definitions

Term	Definition
<b>B-Pillar</b>	The vehicle B-Pillar is the structural member of the body located behind the front door.
<b>Cold Tire Inflation Pressure</b>	Cold tire inflation pressure is defined as the tire pressure after the vehicle has not been driven for at least three hours, or driven less than 1 mile (1.6 km) after sitting for a minimum of three hours. Inflation pressure is measured in units of PSI (pounds per square inch) or kPa (kilopascals).
<b>Maximum Inflation Pressure</b>	The maximum inflation pressure is the maximum permissible cold tire inflation pressure for this tire. The maximum inflation pressure is molded into the sidewall.
<b>Recommended Cold Tire Inflation Pressure</b>	Vehicle manufacturer's recommended cold tire inflation pressure as shown on the tire placard.
<b>Tire Placard</b>	A label permanently attached to the vehicle describing the vehicle's loading capacity, the original equipment tire sizes and the recommended cold tire inflation pressures.

## Tire Loading And Tire Pressure

### Tire And Loading Information Placard Location

**NOTE:** The proper cold tire inflation pressure is listed on the driver's side B-Pillar or the rear edge of the driver's side door.

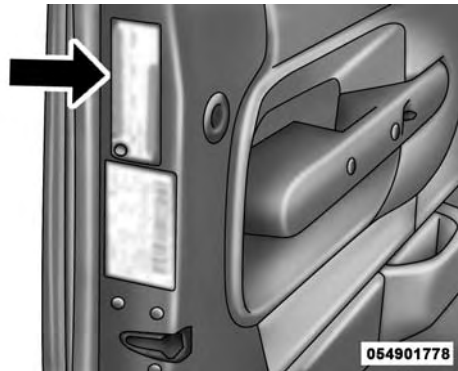

Example Tire Placard Location (Door)

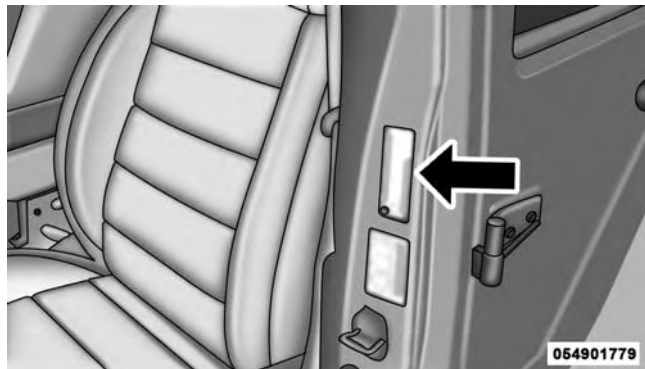

Example Tire Placard Location (B-Pillar)

## Tire And Loading Information Placard

**TIRE AND LOADING INFORMATION**

SEATING CAPACITY - TOTAL 5 FRONT 2 REAR 3

THE COMBINED WEIGHT OF OCCUPANTS AND CARGO SHOULD NEVER EXCEED XXX KG OR XXX LBS.

TIRE	FRONT	REAR	SPARE
ORIGINAL TIRE SIZE	P195/70R14	P195/70R14	T125/70D15
COLD TIRE INFLATION PRESSURE	200kPa, 29PSI	200kPa, 29PSI	420kPa, 60PSI

SEE OWNER'S MANUAL FOR ADDITIONAL INFORMATION

4N109268

811b5a9a

Tire And Loading Information Placard

This placard tells you important information about the:

1. Number of people that can be carried in the vehicle.
2. Total weight your vehicle can carry.
3. Tire size designed for your vehicle.
4. Cold tire inflation pressures for the front, rear, and spare tires.

### **Loading**

The vehicle maximum load on the tire must not exceed the load carrying capacity of the tire on your vehicle. You will not exceed the tire's load carrying capacity if you adhere to the loading conditions, tire size, and cold tire inflation pressures specified on the Tire and Loading Information placard in "Vehicle Loading" in the "Starting And Operating" section of this manual.

**NOTE:** Under a maximum loaded vehicle condition, gross axle weight ratings (GAWRs) for the front and rear axles must not be exceeded. For further information on GAWRs, vehicle loading, and trailer towing, refer to "Vehicle Loading" in the "Starting And Operating" section of this manual.

To determine the maximum loading conditions of your vehicle, locate the statement "The combined weight of occupants and cargo should never exceed XXX lbs or XXX kg" on the Tire and Loading Information placard. The combined weight of occupants, cargo/luggage and trailer tongue weight (if applicable) should never exceed the weight referenced here.

### **Steps For Determining Correct Load Limit**

1. Locate the statement "The combined weight of occupants and cargo should never exceed XXX lbs or XXX kg" on your vehicle's placard.



2. Determine the combined weight of the driver and passengers that will be riding in your vehicle.
3. Subtract the combined weight of the driver and passengers from XXX lbs or XXX kg.
4. The resulting figure equals the available amount of cargo and luggage load capacity. For example, if "XXX" amount equals 1,400 lbs (635 kg) and there will be five 150 lb (68 kg) passengers in your vehicle, the amount of available cargo and luggage load capacity is 650 lbs (295 kg) (since  $5 \times 150 \text{ lbs (68 kg)} = 750 \text{ lbs (340 kg)}$ , and  $1400 \text{ lbs (635 kg)} - 750 \text{ lbs (340 kg)} = 650 \text{ lbs [295 kg]}$ ).
5. Determine the combined weight of luggage and cargo being loaded on the vehicle. That weight may not safely exceed the available cargo and luggage load capacity calculated in step 4.

**NOTE:**

- If your vehicle will be towing a trailer, load from your trailer will be transferred to your vehicle. The following table shows examples on how to calculate total load, cargo/luggage, and towing capacities of your vehicle with varying seating configurations and number and size of occupants. This table is for illustration purposes only and may not be accurate for the seating and load carry capacity of your vehicle.
- For the following example, the combined weight of occupants and cargo should never exceed 865 lbs (392 kg).

Occupants			Combined weight of occupants and cargo from Tire Placard	MINUS	Combined Occupant's weight	=	AVAILABLE Cargo/Luggage and Trailer Tongue Weight
TOTAL	FRONT	REAR					
<b>EXAMPLE 1</b>			865 lbs	minus	670 lbs	=	195 lbs
5	2	3					
<b>EXAMPLE 2</b>			865 lbs	minus	540 lbs	=	325 lbs
3	2	1					
<b>EXAMPLE 3</b>			865 lbs	minus	400 lbs	=	465 lbs
2	2	0					

**WARNING!**

Overloading of your tires is dangerous. Overloading can cause tire failure, affect vehicle handling, and increase your stopping distance. Use tires of the recommended load capacity for your vehicle. Never overload them.

**TIRES — GENERAL INFORMATION****Tire Pressure**

Proper tire inflation pressure is essential to the safe and satisfactory operation of your vehicle. Four primary areas are affected by improper tire pressure:

- Safety and Vehicle Stability
- Economy
- Tread Wear
- Ride Comfort

**Safety****WARNING!**

- Improperly inflated tires are dangerous and can cause collisions.
- Under-inflation increases tire flexing and can result in overheating and tire failure.
- Over-inflation reduces a tire's ability to cushion shock. Objects on the road and chuckholes can cause damage that result in tire failure.
- Overinflated or under-inflated tires can affect vehicle handling and can fail suddenly, resulting in loss of vehicle control.
- Unequal tire pressures can cause steering problems. You could lose control of your vehicle.
- Unequal tire pressures from one side of the vehicle to the other can cause the vehicle to drift to the right or left.

*(Continued)*

**WARNING! (Continued)**

- Always drive with each tire inflated to the recommended cold tire inflation pressure.

Both under-inflation and over-inflation affect the stability of the vehicle and can produce a feeling of sluggish response or over responsiveness in the steering.

**NOTE:**

- Unequal tire pressures from side to side may cause erratic and unpredictable steering response.
- Unequal tire pressure from side to side may cause the vehicle to drift left or right.

**Fuel Economy**

Underinflated tires will increase tire rolling resistance resulting in higher fuel consumption.

**Tread Wear**

Improper cold tire inflation pressures can cause abnormal wear patterns and reduced tread life, resulting in the need for earlier tire replacement.

**Ride Comfort And Vehicle Stability**

Proper tire inflation contributes to a comfortable ride. Over-inflation produces a jarring and uncomfortable ride.

**Tire Inflation Pressures**

The proper cold tire inflation pressure is listed on the driver's side B-Pillar or rear edge of the driver's side door.

At least once a month:

- Check and adjust tire pressure with a good quality pocket-type pressure gauge. Do not make a visual

judgement when determining proper inflation. Tires may look properly inflated even when they are under-inflated.

- Inspect tires for signs of tire wear or visible damage.

### CAUTION!

**After inspecting or adjusting the tire pressure, always reinstall the valve stem cap. This will prevent moisture and dirt from entering the valve stem, which could damage the valve stem.**

Inflation pressures specified on the placard are always “cold tire inflation pressure”. Cold tire inflation pressure is defined as the tire pressure after the vehicle has not been driven for at least three hours, or driven less than 1 mile (1.6 km) after sitting for a minimum of three hours.

The cold tire inflation pressure must not exceed the maximum inflation pressure molded into the tire sidewall.

Check tire pressures more often if subject to a wide range of outdoor temperatures, as tire pressures vary with temperature changes.

Tire pressures change by approximately 1 psi (7 kPa) per 12°F (7°C) of air temperature change. Keep this in mind when checking tire pressure inside a garage, especially in the Winter.

Example: If garage temperature = 68°F (20°C) and the outside temperature = 32°F (0°C) then the cold tire inflation pressure should be increased by 3 psi (21 kPa), which equals 1 psi (7 kPa) for every 12°F (7°C) for this outside temperature condition.

Tire pressure may increase from 2 to 6 psi (13 to 40 kPa) during operation. DO NOT reduce this normal pressure build up or your tire pressure will be too low.

## Tire Pressures For High Speed Operation

The manufacturer advocates driving at safe speeds and within posted speed limits. Where speed limits or conditions are such that the vehicle can be driven at high speeds, maintaining correct tire inflation pressure is very important. Increased tire pressure and reduced vehicle loading may be required for high-speed vehicle operation. Refer to your authorized tire dealer or original equipment vehicle dealer for recommended safe operating speeds, loading and cold tire inflation pressures.

### WARNING!

**High speed driving with your vehicle under maximum load is dangerous. The added strain on your tires could cause them to fail. You could have a serious collision. Do not drive a vehicle loaded to the maximum capacity at continuous speeds above 75 mph (120 km/h).**

## Radial Ply Tires

### WARNING!

**Combining radial ply tires with other types of tires on your vehicle will cause your vehicle to handle poorly. The instability could cause a collision. Always use radial ply tires in sets of four. Never combine them with other types of tires.**

## Tire Repair

If your tire becomes damaged, it may be repaired if it meets the following criteria:

- The tire has not been driven on when flat.
- The damage is only on the tread section of your tire (sidewall damage is not repairable).
- The puncture is no greater than a  $\frac{1}{4}$  of an inch (6 mm).

Consult an authorized tire dealer for tire repairs and additional information.

Damaged Run Flat tires, or Run Flat tires that have experienced a loss of pressure should be replaced immediately with another Run Flat tire of identical size and service description (Load Index and Speed Symbol).

## **Tire Types**

### **All Season Tires — If Equipped**

All Season tires provide traction for all seasons (Spring, Summer, Fall and Winter). Traction levels may vary between different all season tires. All season tires can be identified by the M+S, M&S, M/S or MS designation on the tire sidewall. Use all season tires only in sets of four; failure to do so may adversely affect the safety and handling of your vehicle.

### **Summer Or Three Season Tires — If Equipped**

Summer tires provide traction in both wet and dry conditions, and are not intended to be driven in snow or on ice. If your vehicle is equipped with Summer tires, be aware these tires are not designed for Winter or cold driving conditions. Install Winter tires on your vehicle when ambient temperatures are less than 40°F (5°C) or if roads are covered with ice or snow. For more information, contact an authorized dealer.

Summer tires do not contain the all season designation or mountain/snowflake symbol on the tire sidewall. Use Summer tires only in sets of four; failure to do so may adversely affect the safety and handling of your vehicle.

**WARNING!**

**Do not use Summer tires in snow/ice conditions. You could lose vehicle control, resulting in severe injury or death. Driving too fast for conditions also creates the possibility of loss of vehicle control.**

**Snow Tires**

Some areas of the country require the use of snow tires during the Winter. Snow tires can be identified by a “mountain/snowflake” symbol on the tire sidewall.



If you need snow tires, select tires equivalent in size and type to the original equipment tires. Use snow tires only in sets of four; failure to do so may adversely affect the safety and handling of your vehicle.

Snow tires generally have lower speed ratings than what was originally equipped with your vehicle and should not be operated at sustained speeds over 75 mph (120 km/h). For speeds above 75 mph (120 km/h) refer to original equipment or an authorized tire dealer for recommended safe operating speeds, loading and cold tire inflation pressures.

While studded tires improve performance on ice, skid and traction capability on wet or dry surfaces may be poorer than that of non-studded tires. Some states prohibit studded tires; therefore, local laws should be checked before using these tire types.

**Run Flat Tires — If Equipped**

Run Flat tires allow you the capability to drive 50 miles (80 km) at 50 mph (80 km/h) after a rapid loss of inflation



pressure. This rapid loss of inflation is referred to as the Run Flat mode. A Run Flat mode occurs when the tire inflation pressure is of/or below 14 psi (96 kPa). Once a Run Flat tire reaches the run flat mode it has limited driving capabilities and needs to be replaced immediately. A Run Flat tire is not repairable.

It is not recommended driving a vehicle loaded at full capacity or to tow a trailer while a tire is in the run flat mode.

See the tire pressure monitoring section for more information.

### **Spare Tires — If Equipped**

**NOTE:** For vehicles equipped with Tire Service Kit instead of a spare tire, please refer to “Tire Service Kit” in “What To Do In Emergencies” for further information.

### **CAUTION!**

**Because of the reduced ground clearance, do not take your vehicle through an automatic car wash with a compact or limited-use temporary spare installed. Damage to the vehicle may result.**

### **Spare Tire Matching Original Equipped Tire And Wheel — If Equipped**

Your vehicle may be equipped with a spare tire and wheel equivalent in look and function to the original equipment tire and wheel found on the front or rear axle of your vehicle. This spare tire may be used in the tire rotation for your vehicle. If your vehicle has this option, refer to an authorized tire dealer for the recommended tire rotation pattern.

### Compact Spare Tire — If Equipped

The compact spare is for temporary emergency use only. You can identify if your vehicle is equipped with a compact spare by looking at the spare tire description on the Tire and Loading Information Placard located on the driver's side door opening or on the sidewall of the tire. Compact spare tire descriptions begin with the letter "T" or "S" preceding the size designation. Example: T145/80D18 103M.

T, S = Temporary Spare Tire

Since this tire has limited tread life, the original equipment tire should be repaired (or replaced) and reinstalled on your vehicle at the first opportunity.

Do not install a wheel cover or attempt to mount a conventional tire on the compact spare wheel, since the wheel is designed specifically for the compact spare tire.

Do not install more than one compact spare tire and wheel on the vehicle at any given time.

#### **WARNING!**

**Compact spares are for temporary emergency use only. With these spares, do not drive more than 50 mph (80 km/h). Temporary use spares have limited tread life. When the tread is worn to the tread wear indicators, the temporary use spare tire needs to be replaced. Be sure to follow the warnings, which apply to your spare. Failure to do so could result in spare tire failure and loss of vehicle control.**

### Full Size Spare — If Equipped

The full size spare is for temporary emergency use only. This tire may look like the originally equipped tire on the front or rear axle of your vehicle, but it is not. This spare tire may have limited tread life. When the tread is worn to the tread wear indicators, the temporary use full size

spare tire needs to be replaced. Since it is not the same as your original equipment tire, replace (or repair) the original equipment tire and reinstall on the vehicle at the first opportunity.

### Limited-Use Spare — If Equipped

The limited-use spare tire is for temporary emergency use only. This tire is identified by a label located on the limited-use spare wheel. This label contains the driving limitations for this spare. This tire may look like the original equipped tire on the front or rear axle of your vehicle, but it is not. Installation of this limited-use spare tire affects vehicle handling. Since it is not the same as your original equipment tire, replace (or repair) the original equipment tire and reinstall on the vehicle at the first opportunity.

### WARNING!

**Limited-use spares are for emergency use only. Installation of this limited-use spare tire affects vehicle handling. With this tire, do not drive more than the speed listed on the limit-use spare wheel. Keep inflated to the cold tire inflation pressures listed on your Tire and Loading Information Placard located on the driver's side B-Pillar or the rear edge of the driver's side door. Replace (or repair) the original equipment tire at the first opportunity and reinstall it on your vehicle. Failure to do so could result in loss of vehicle control.**

### Tire Spinning

When stuck in mud, sand, snow, or ice conditions, do not spin your vehicle's wheels above 30 mph (48 km/h) or for longer than 30 seconds continuously without stopping.

Refer to “Freeing A Stuck Vehicle” in “What To Do In Emergencies” for further information.

**WARNING!**

Fast spinning tires can be dangerous. Forces generated by excessive wheel speeds may cause tire damage or failure. A tire could explode and injure someone. Do not spin your vehicle’s wheels faster than 30 mph (48 km/h) for more than 30 seconds continuously when you are stuck, and do not let anyone near a spinning wheel, no matter what the speed.

**Tread Wear Indicators**

Tread wear indicators are in the original equipment tires to help you in determining when your tires should be replaced.



055007576

Tire Tread

- 1 — Worn Tire
  - 2 — New Tire
-

These indicators are molded into the bottom of the tread grooves. They will appear as bands when the tread depth becomes a 1/16 of an inch (1.6 mm). When the tread is worn to the tread wear indicators, the tire should be replaced. Refer to “Replacement Tires” in this section for further information.

### Life Of Tire

The service life of a tire is dependent upon varying factors including, but not limited to:

- Driving style.
- Tire pressure - Improper cold tire inflation pressures can cause uneven wear patterns to develop across the tire tread. These abnormal wear patterns will reduce tread life, resulting in the need for earlier tire replacement.
- Distance driven.

- Performance tires, tires with a speed rating of V or higher, and Summer tires typically have a reduced tread life. Rotation of these tires per the vehicle maintenance schedule is highly recommended.

### WARNING!

**Tires and the spare tire should be replaced after six years, regardless of the remaining tread. Failure to follow this warning can result in sudden tire failure. You could lose control and have a collision resulting in serious injury or death.**

Keep dismounted tires in a cool, dry place with as little exposure to light as possible. Protect tires from contact with oil, grease, and gasoline.

## Replacement Tires

The tires on your new vehicle provide a balance of many characteristics. They should be inspected regularly for wear and correct cold tire inflation pressures. The manufacturer strongly recommends that you use tires equivalent to the originals in size, quality and performance when replacement is needed. Refer to the paragraph on "Tread Wear Indicator". Refer to the Tire and Loading Information placard or the Vehicle Certification Label for the size designation of your tire. The Load Index and Speed Symbol for your tire will be found on the original equipment tire sidewall. See the Tire Sizing Chart example found in the "Tire Safety Information" section of this manual for more information relating to the Load Index and Speed Symbol of a tire.

It is recommended to replace the two front tires or two rear tires as a pair. Replacing just one tire can seriously

affect your vehicle's handling. If you ever replace a wheel, make sure that the wheel's specifications match those of the original wheels.

It is recommended you contact your authorized tire dealer or original equipment dealer with any questions you may have on tire specifications or capability. Failure to use equivalent replacement tires may adversely affect the safety, handling, and ride of your vehicle.

### WARNING!

- **Do not use a tire, wheel size or rating other than that specified for your vehicle. Some combinations of unapproved tires and wheels may change suspension dimensions and performance characteristics, resulting in changes to steering, handling, and**

*(Continued)*

**WARNING! (Continued)**

braking of your vehicle. This can cause unpredictable handling and stress to steering and suspension components. You could lose control and have a collision resulting in serious injury or death. Use only the tire and wheel sizes with load ratings approved for your vehicle.

- Never use a tire with a smaller load index or capacity, other than what was originally equipped on your vehicle. Using a tire with a smaller load index could result in tire overloading and failure. You could lose control and have a collision.
- Failure to equip your vehicle with tires having adequate speed capability can result in sudden tire failure and loss of vehicle control.

**CAUTION!**

Replacing original tires with tires of a different size may result in false speedometer and odometer readings.

**TIRE CHAINS (TRACTION DEVICES)**

Use of traction devices require sufficient tire-to-body clearance. Follow these recommendations to guard against damage.

- Traction device must be of proper size for the tire, as recommended by the traction device manufacturer.
- Install on Rear Tires Only
- Due to limited clearance, the THULE XG-12 PRO traction device or equivalent is recommended on P265/60R18 or 265/50R20 tires.

**WARNING!**

Using tires of different size and type (M+S, Snow) between front and rear axles can cause unpredictable handling. You could lose control and have a collision.

**CAUTION!**

To avoid damage to your vehicle or tires, observe the following precautions:

- Because of restricted traction device clearance between tires and other suspension components, it is important that only traction devices in good condition are used. Broken devices can cause serious damage. Stop the vehicle immediately if noise occurs that could indicate device breakage. Remove the damaged parts of the device before further use.

**CAUTION! (Continued)**

- Install device as tightly as possible and then re-tighten after driving about ½ mile (0.8 km).
- Do not exceed 30 mph (48 km/h).
- Drive cautiously and avoid severe turns and large bumps, especially with a loaded vehicle.
- Do not drive for a prolonged period on dry pavement.
- Observe the traction device manufacturer's instructions on the method of installation, operating speed, and conditions for use. Always use the suggested operating speed of the device manufacturer's if it is less than 30 mph (48 km/h).
- Do not use traction devices on a compact spare tire.

*(Continued)*



## TIRE ROTATION RECOMMENDATIONS

The tires on the front and rear of your vehicle operate at different loads and perform different steering, handling, and braking functions. For these reasons, they wear at unequal rates.

These effects can be reduced by timely rotation of tires. The benefits of rotation are especially worthwhile with aggressive tread designs such as those on On/Off-Road type tires. Rotation will increase tread life, help to maintain mud, snow, and wet traction levels, and contribute to a smooth, quiet ride.

Refer to the “Maintenance Schedule” for the proper maintenance intervals. More frequent rotation is permissible if desired. The reasons for any rapid or unusual wear should be corrected prior to rotation being performed.

**NOTE:** The premium Tire Pressure Monitor System will automatically locate the pressure values displayed in the correct vehicle position following a tire rotation.

The suggested rotation method is the “forward-cross” shown in the following diagram.

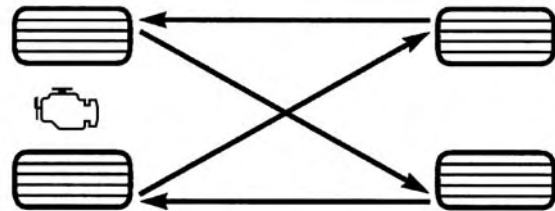

Tire Rotation

055703771

## TIRE PRESSURE MONITOR SYSTEM (TPMS)

The Tire Pressure Monitor System (TPMS) uses wireless technology with wheel rim-mounted electronic sensors to monitor tire pressure levels. Sensors, mounted to each wheel as part of the valve stem, transmit tire pressure readings to the Receiver Module.

**NOTE:** It is particularly important, for you to regularly check the tire pressure in all of your tires and to maintain the proper pressure.

The Tire Pressure Monitor System (TPMS) consists of the following components:

- Receiver Module
- Four Tire Pressure Monitoring Sensors
- Various Tire Pressure Monitoring System Messages, which display in the Driver Information Display (DID), and a graphic displaying tire pressures

- Tire Pressure Monitoring Telltale Light

The Tire Pressure Monitoring System (TPMS) will warn the driver of a low tire pressure based on the vehicle recommended cold tire placard pressure.

The tire pressure will vary with temperature by about 1 psi (7 kPa) for every 12°F (6.5°C). This means that when the outside temperature decreases, the tire pressure will decrease. Tire pressure should always be set based on cold inflation tire pressure. This is defined as the tire pressure after the vehicle has not been driven for at least three hours, or driven less than 1 mile (1.6 km) after a three-hour period. **Refer to “Tires – General Information” in “Starting and Operating” for information on how to properly inflate the vehicle’s tires.** The tire pressure will also increase as the vehicle is driven - this is normal and there should be no adjustment for this increased pressure.

The TPMS will warn the driver of a low tire pressure if the tire pressure falls below the low pressure warning threshold for any reason, including low temperature effects, or natural pressure loss through the tire.

The TPMS will continue to warn the driver of low tire pressure as long as the condition exists, and will not turn off until the tire pressure is at or above recommended cold tire placard pressure. Once the low tire pressure warning has been illuminated, the tire pressure must be increased to the recommended cold tire pressure in order for the Tire Pressure Monitoring Telltale Light to be turned off.

**NOTE:** When filling warm tires, the tire pressure may need to be increased up to an additional 4 psi (30 kPa) above the recommended cold placard pressure in order to turn the Tire Pressure Monitoring Telltale Light off.

The system will automatically update and the Tire Pressure Monitoring Telltale Light will extinguish once the

updated tire pressures have been received. The vehicle may need to be driven for up to 20 minutes above 15 mph (24 km/h) to receive this information.

For example, your vehicle has a recommended cold (parked for more than three hours) tire placard pressure of 33 psi (227 kPa). If the ambient temperature is 68°F (20°C) and the measured tire pressure is 28 psi (193 kPa), a temperature drop to 20°F (-7°C) will decrease the tire pressure to approximately 24 psi (165 kPa). This tire pressure is sufficiently low enough to turn ON the Tire Pressure Monitoring Telltale Light. Driving the vehicle may cause the tire pressure to rise to approximately 28 psi (193 kPa), but the Tire Pressure Monitoring Telltale Light will still be ON. In this situation, the Tire Pressure Monitoring Telltale Light will turn OFF only after the tires have been inflated to the vehicle's recommended cold tire pressure value.

**CAUTION!**

- The TPMS has been optimized for the original equipment tires and wheels. TPMS pressures have been established for the tire size equipped on your vehicle. Undesirable system operation or sensor damage may result when using replacement equipment that is not of the same size, type, and/or style. Aftermarket wheels can cause sensor damage. Using aftermarket tire sealants may cause the Tire Pressure Monitoring System (TPMS) sensor to become inoperable. After using an aftermarket tire sealant it is recommended that you take your vehicle to your authorized dealer to have your sensor function checked.
- After inspecting or adjusting the tire pressure always reinstall the valve stem cap. This will prevent moisture and dirt from entering the valve stem,

**CAUTION! (Continued)**

which could damage the Tire Pressure Monitoring Sensor.

**NOTE:**

- The TPMS is not intended to replace normal tire care and maintenance, or to provide warning of a tire failure or condition.
- The TPMS should not be used as a tire pressure gauge while adjusting your tire pressure.
- Driving on a significantly under-inflated tire causes the tire to overheat and can lead to tire failure. Under-inflation also reduces fuel efficiency and tire tread life, and may affect the vehicle's handling and stopping ability.

*(Continued)*

- The TPMS is not a substitute for proper tire maintenance, and it is the driver's responsibility to maintain correct tire pressure using an accurate tire gauge, even if under-inflation has not reached the level to trigger illumination of the Tire Pressure Monitoring Telltale Light.
- Seasonal temperature changes will affect tire pressure, and the TPMS will monitor the actual tire pressure in the tire.

### Premium System

The Tire Pressure Monitor System (TPMS) uses wireless technology with wheel rim-mounted electronic sensors to monitor tire pressure levels. Sensors, mounted to each wheel as part of the valve stem, transmit tire pressure readings to the Receiver Module.

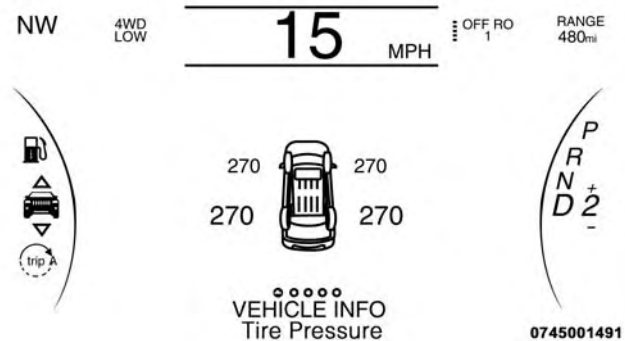

Tire Pressure Monitor Display

**NOTE:** It is particularly important, for you to regularly check the tire pressure in all of your tires and to maintain the proper pressure.

The Tire Pressure Monitor System (TPMS) consists of the following components:

- Receiver Module
- Four Tire Pressure Monitoring Sensors
- Various Tire Pressure Monitoring System Messages, which display in the Driver Information Display (DID), and a graphic displaying tire pressures
- Tire Pressure Monitoring Telltale Light

### Tire Pressure Monitoring Low Pressure Warnings

 The Tire Pressure Monitoring Telltale Light will illuminate in the instrument cluster, and an audible chime will be activated, when one or more of the four active road tire pressures are low. In addition, the DID will display a "Tire Low" message, an "Inflate to XXX" message and a graphic display of the pressure

value(s) with the low tire(s) displayed in a different color. Refer to "Driver Information Display (DID)" in "Understanding Your Instrument Panel" for further information.

**NOTE:** Your system can be set to display pressure units in PSI, BAR or kPa.

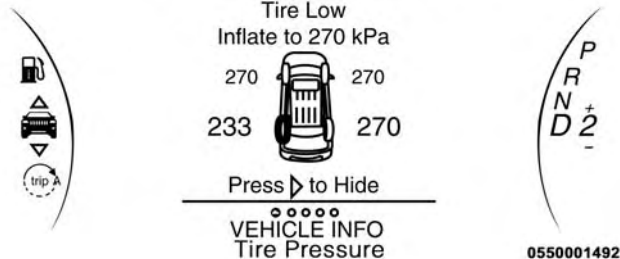

0550001492

Low Tire Pressure Monitor Display

Should a low tire condition occur on any of the four active road tire(s), you should stop as soon as possible, and inflate the low tire(s) that is in a different color on the graphic display to the vehicle's recommended cold tire pressure displayed in the "Inflate to XXX" message.

**NOTE:** When filling warm tires, the tire pressure may need to be increased up to an additional 4 psi (30 kPa) above the recommended cold placard pressure in order to turn the Tire Pressure Monitoring Telltale Light off.

The system will automatically update, the graphic display of the pressure value(s) will return to its original color and the Tire Pressure Monitoring Telltale Light will extinguish once the updated tire pressure(s) have been

received. The vehicle may need to be driven for up to 20 minutes above 15 mph (24 km/h) to receive this information.

### **Service Tpm System Warning**

The Tire Pressure Monitoring Telltale Light will flash on and off for 75 seconds, and remain on solid when a system fault is detected. The system fault will also sound a chime. The DID will display a "SERVICE TPM SYSTEM" message for a minimum of five seconds. This message is then followed by a graphic display, with "- -" in place of the pressure value(s), indicating which Tire Pressure Monitoring Sensor(s) is not being received.

If the ignition switch is cycled, this sequence will repeat, providing the system fault still exists. If the system fault no longer exists, the Tire Pressure Monitoring Telltale Light will no longer flash, the "SERVICE TPM SYSTEM" message will not be present, and a pressure value will be displayed instead of dashes. A system fault can occur by any of the following:

1. Jamming due to electronic devices or driving next to facilities emitting the same Radio Frequencies as the TPM sensors.
2. Installing some form of aftermarket window tinting that affects radio wave signals.
3. Lots of snow or ice around the wheels or wheel housings.

4. Using tire chains on the vehicle.
5. Using wheels/tires not equipped with TPM sensors.

The DID will also display a "SERVICE TPM SYSTEM" message for a minimum of five seconds when a system fault is detected possibly related to an incorrect sensor location fault. In this case, the "SERVICE TPM SYSTEM" message is then followed by a graphic display, with pressure values still shown. This indicates the pressure values are still being received from the TPM Sensors but they may not be located in the correct vehicle position. However, the system still needs to be serviced as long as the "SERVICE TPM SYSTEM" message exists.



**NOTE:** There is no tire pressure monitoring sensor in the spare tire. The TPMS will not be able to monitor the tire pressure. If you install the spare tire in place of a road tire that has a pressure below the low-pressure warning limit, upon the next ignition switch cycle, the Tire Pressure Monitoring Telltale Light will remain ON, a chime will sound, and the DID will still display a pressure value in the different color graphic display and an "Inflate to XXX kPa" message will be displayed. After driving the vehicle for up to 20 minutes above 15 mph (24 km/h), the Tire Pressure Monitoring Telltale Light will flash on and off for 75 seconds and then remain on solid. In addition, the DID will display a "SERVICE TPM SYSTEM" message for five seconds and then display dashes (- -) in place of the pressure value. For each subsequent ignition switch cycle, a chime will sound, the Tire Pressure Monitoring Telltale Light will flash on and off for 75 seconds and then remain on solid, and the DID will display a "SERVICE TPM SYSTEM" message for five seconds and then dis-

play dashes (- -) in place of the pressure value. Once you repair or replace the original road tire, and reinstall it on the vehicle in place of the spare tire, the TPMS will update automatically.

In addition, the Tire Pressure Monitoring Telltale Light will turn OFF and the graphic in the DID will display a new pressure value instead of dashes (- -), as long as no tire pressure is below the low-pressure warning limit in any of the four active road tires. The vehicle may need to be driven for up to 20 minutes above 15 mph (24 km/h) in order for the TPMS to receive this information.

## General Information

This device complies with Part 15 of the FCC rules and RSS-210 of Industry Canada. Operation is subject to the following two conditions:

- (1) This device may not cause harmful interference.
- (2) This device must accept any interference received, including interference that may cause undesired operation.

**NOTE:** Changes or modifications not expressly approved by the party responsible for compliance could void the user's authority to operate the equipment.

## FUEL REQUIREMENTS

### 3.6L Engine — If Equipped



This engine is designed to meet all emissions regulations and provide excellent fuel economy and performance when using high-quality unleaded "Regular" gasoline having an octane rating of 87 as specified by the (R+M)/2 method. The use of higher octane "Premium" gasoline will not provide any benefit over "Regular" gasoline in these engines.

While operating on gasoline with an octane number of 87, hearing a light knocking sound from the engine is not a cause for concern. However, if the engine is heard making a heavy knocking sound, see your dealer immediately. Use of gasoline with an octane number lower than 87 can cause engine failure and may void or not be covered by the New Vehicle Limited Warranty.

Poor quality gasoline can cause problems such as hard starting, stalling, and hesitations. If you experience these symptoms, try another brand of gasoline before considering service for the vehicle.

### 5.7L Engine — If Equipped



This engine is designed to meet all emissions regulations and provide satisfactory fuel economy and performance when using high-quality unleaded gasoline having an octane range of 87 to 89 as specified by the (R+M)/2 method. The use of 89 octane "Plus" gasoline is recommended for optimum performance and fuel economy.

While operating on gasoline with an octane number of 87, hearing a light knocking sound from the engine is not a cause for concern. However, if the engine is heard

making a heavy knocking sound, see your dealer immediately. Use of gasoline with an octane number lower than 87 can cause engine failure and may void or not be covered by the New Vehicle Limited Warranty.

Poor quality gasoline can cause problems such as hard starting, stalling, and hesitations. If you experience these symptoms, try another brand of gasoline before considering service for the vehicle.

### Reformulated Gasoline

Many areas of the country require the use of cleaner burning gasoline referred to as "Reformulated Gasoline". Reformulated gasoline contains oxygenates and are specifically blended to reduce vehicle emissions and improve air quality.

The use of reformulated gasoline is recommended. Properly blended reformulated gasoline will provide improved performance and durability of engine and fuel system components.

## Gasoline/Oxygenate Blends

Some fuel suppliers blend unleaded gasoline with oxygenates such as ethanol.

### CAUTION!

**DO NOT use gasoline containing Methanol or gasoline containing more than 10% Ethanol. Use of these blends may result in starting and drivability problems, damage critical fuel system components, cause emissions to exceed the applicable standard, and/or cause the "Malfunction Indicator Light" to illuminate. Please observe pump labels as they should clearly communicate if a fuel contains greater than 10% ethanol.**

Problems that result from using gasoline containing Methanol or gasoline containing more than 10% ethanol

are not the responsibility of the manufacturer and may void or not be covered under New Vehicle Limited Warranty.

## E-85 Usage In Non-Flex Fuel Vehicles

Non-Flex Fuel Vehicles (FFV) are compatible with gasoline containing up to 10% ethanol (E10). Gasoline with higher ethanol content may void the New Vehicle Limited Warranty.

If a Non-FFV vehicle is inadvertently fueled with E-85 fuel, the engine will have some or all of these symptoms:

- Operate in a lean mode.
- OBD II "Malfunction Indicator Light" on.
- Poor engine performance.
- Poor cold start and cold drivability.
- Increased risk for fuel system component corrosion.

## MMT In Gasoline

Methylcyclopentadienyl Manganese Tricarbonyl (MMT) is a manganese-containing metallic additive that is blended into some gasoline to increase octane. Gasoline blended with MMT provides no performance advantage beyond gasoline of the same octane number without MMT. Gasoline blended with MMT reduces spark plug life and reduces emissions system performance in some vehicles. The manufacturer recommends that gasoline without MMT be used in your vehicle. The MMT content of gasoline may not be indicated on the gasoline pump, therefore, you should ask your gasoline retailer whether the gasoline contains MMT. MMT is prohibited in Federal and California reformulated gasoline.

## Materials Added To Fuel

All gasoline sold in the United States is required to contain effective detergent additives. Use of additional detergents or other additives is not needed under normal

conditions and they would result in additional cost. Therefore, you should not have to add anything to the fuel.

## Fuel System Cautions

### CAUTION!

Follow these guidelines to maintain your vehicle's performance:

- The use of leaded gasoline is prohibited by Federal law. Using leaded gasoline can impair engine performance and damage the emissions control system.
- An out-of-tune engine or certain fuel or ignition malfunctions can cause the catalytic converter to overheat. If you notice a pungent burning odor or some light smoke, your engine may be out of tune

*(Continued)*

**CAUTION!** *(Continued)*

or malfunctioning and may require immediate service. Contact your authorized dealer for service assistance.

- The use of fuel additives, which are now being sold as octane enhancers, is not recommended. Most of these products contain high concentrations of methanol. Fuel system damage or vehicle performance problems resulting from the use of such fuels or additives is not the responsibility of the manufacturer and may void or not be covered under the New Vehicle Limited Warranty.

**NOTE:** Intentional tampering with the emissions control system can result in civil penalties being assessed against you.

**Carbon Monoxide Warnings****WARNING!**

Carbon monoxide (CO) in exhaust gases is deadly. Follow the precautions below to prevent carbon monoxide poisoning:

- Do not inhale exhaust gases. They contain carbon monoxide, a colorless and odorless gas, which can kill. Never run the engine in a closed area, such as a garage, and never sit in a parked vehicle with the engine running for an extended period. If the vehicle is stopped in an open area with the engine running for more than a short period, adjust the ventilation system to force fresh, outside air into the vehicle.
- Guard against carbon monoxide with proper maintenance. Have the exhaust system inspected every

*(Continued)*

**WARNING! (Continued)**

time the vehicle is raised. Have any abnormal conditions repaired promptly. Until repaired, drive with all side windows fully open.

**FLEXIBLE FUEL (3.6L ENGINE ONLY) — IF EQUIPPED****E-85 General Information**

The information in this section is for Flexible Fuel vehicles only. These vehicles can be identified by a unique fuel filler door label that states **Ethanol (E-85) or Unleaded Gasoline Only**. This section only covers those subjects that are unique to these vehicles. Please refer to the other sections of this manual for information on features that are common between Flexible Fuel and gasoline-only powered vehicles.

**CAUTION!**

Only vehicles with the E-85 fuel filler door label or a yellow gas cap can operate on E-85.

**Ethanol Fuel (E-85)**

E-85 is a mixture of approximately 85% ethanol and 15% unleaded gasoline.

**WARNING!**

**Ethanol vapors are extremely flammable and could cause serious personal injury. Never have any smoking materials lit or products that can cause spark in or near the vehicle when removing the fuel filler tube cap (gas cap) or filling the tank. Do not use E-85 as a cleaning agent and never use it near an open flame.**

## Fuel Requirements

If your vehicle is E-85 compatible, it will operate on unleaded gasoline with any octane rating, or solely E-85 fuel, or any mixture of these fuels.

**For best results, avoid fueling patterns alternating between E-85 and unleaded gasoline.**

When switching fuel types:

- Add 5 gallons (19 Liters) or more when refueling.
- Drive the vehicle immediately after refueling for at least 5 miles (8 km).

Observing these precautions will avoid possible hard starting and/or driveability problems during warm up.

## NOTE:

- Use seasonally adjusted E-85 fuel (ASTM D5798). With non-seasonally adjusted E-85 fuel, hard starting and rough idle following start up may be experienced even if the above recommendations are followed, especially when the ambient temperature is below 32°F (0°C).
- Some additives used in regular gasoline are not fully compatible with E-85 and may form deposits in your engine. To eliminate driveability issues that may be caused by these deposits, a supplemental gasoline additive, such as MOPAR® Injector Cleanup or Techron may be used.



## Selection Of Engine Oil For Flexible Fuel Vehicles (E-85) And Gasoline Vehicles

FFV vehicles operated on E-85 require specially formulated engine oils. These special requirements are included in MOPAR® engine oils, and in equivalent oils meeting FCA US Material Standard MS-6395. It is recommended that engine oils that are API Certified and meet the requirements of Material Standard MS-6395 be used. MS-6395 contains additional requirements, developed during extensive fleet testing, to provide additional protection to FCA US LLC engines.

### Starting

The characteristics of E-85 fuel make it unsuitable for use when ambient temperatures fall below 0°F (-18°C). In the range of 0°F (-18°C) to 32°F (0°C), an increase in the time it takes for your engine to start may be experienced, and a deterioration in driveability (sags and/or hesitations)

until the engine is fully warmed up. These issues may be improved with the use of seasonally adjusted E-85 fuel.

**NOTE:** Use of the engine block heater (if equipped) may improve engine start time when using E-85 fuel when the ambient temperature is less than 32°F (0°C).

### Cruising Range

Because E-85 fuel contains less energy per gallon/liter than gasoline, an increase in fuel consumption will be experienced. The miles per gallon (mpg)/kilometers per liter and the driving range will decrease by approximately 30%, compared to gasoline operation.

### Replacement Parts

All fuel and engine components in your Flexible Fuel Vehicle (FFV) are designed to be compatible with ethanol. Ethanol compatible service components are required.

**CAUTION!**

Replacing fuel system components with non-ethanol compatible components can damage your vehicle.

**Maintenance****CAUTION!**

Do not use ethanol mixture greater than 85% in your vehicle. It will cause difficulty in cold starting and may affect drivability.

**ADDING FUEL**

1. Press the fuel filler door release switch (located under the headlamp switch).

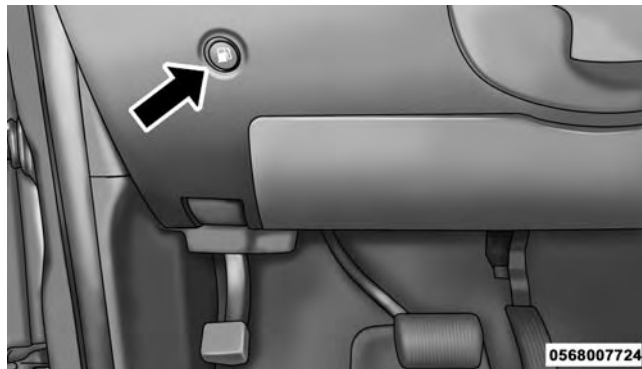

Fuel Filler Door Release Switch

2. Open the fuel filler door.

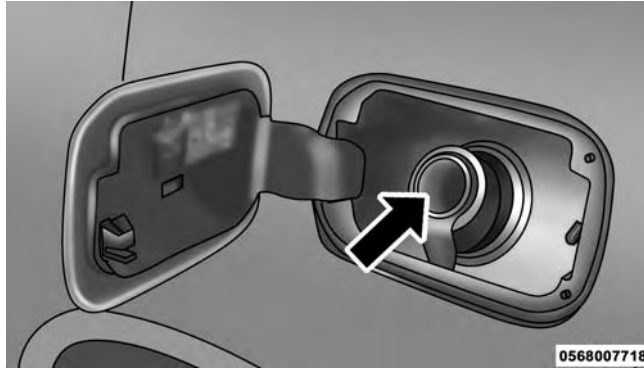

**Fuel Filler Door**

**NOTE:** In certain cold conditions, ice may prevent the fuel door from opening. If this occurs, lightly push on the fuel door to break the ice buildup and re-release the fuel door using the inside release button. Do not pry on the door.

3. There is no fuel filler cap. A flapper door inside the pipe seals the system.
4. Insert the fuel nozzle fully into the filler pipe – the nozzle opens and holds the flapper door while refueling.

**NOTE:** Only the correct size nozzle opens the latches allowing the flapper door to open.

5. Fill the vehicle with fuel – when the fuel nozzle “clicks” or shuts off the fuel tank is full.
6. Wait 5 seconds before removing the fuel nozzle to allow fuel to drain from nozzle.
7. Remove the fuel nozzle and close the fuel door.

### Emergency Gas Can Refueling

- Most gas cans will not open the flapper door.
- A funnel is provided to open the flapper door to allow emergency refueling with a gas can.
- Retrieve funnel from the spare tire storage area.
- Insert funnel into same filler pipe opening as the fuel nozzle.
- Ensure funnel is inserted fully to hold flapper door open.
- Pour fuel into funnel opening.
- Remove funnel from filler pipe, clean off prior to putting back in the spare tire storage area.

#### **CAUTION!**

To avoid fuel spillage and overfilling, do not “top off” the fuel tank after filling.

#### **WARNING!**

- Never have any smoking materials lit in or near the vehicle when the fuel door is open or the tank is being filled.
- Never add fuel when the engine is running. This is in violation of most state and federal fire regulations and may cause the “Malfunction Indicator Light” to turn on.
- A fire may result if fuel is pumped into a portable container that is inside of a vehicle. You could be burned. Always place fuel containers on the ground while filling.

## Emergency Fuel Filler Door Release

If you are unable to open the fuel filler door, use the fuel filler door emergency release.

1. Open the liftgate.
2. Push the inboard edge of the left storage bin to the center, this will pop up the outboard edge.
3. Grab popped up outboard edge with other hand to disengage snaps.
4. Remove the storage bin.
5. Pull the release cable to open the fuel door, push the release cable back to the home position to re-seat the fuel door latch to the closed position.



**Release Cable**

**NOTE:** If the fuel door does not latch after the manual release cable has been activated, the actuator latch should be manually returned to the closed position.

## VEHICLE LOADING

### Certification Label

As required by National Highway Traffic Safety Administration regulations, your vehicle has a certification label affixed to the driver's side door or pillar.

This label contains the month and year of manufacture, Gross Vehicle Weight Rating (GVWR), Gross Axle Weight Rating (GAWR) front and rear, and Vehicle Identification Number (VIN). A Month-Day-Hour (MDH) number is included on this label and indicates the Month, Day and Hour of manufacture. The bar code that appears on the bottom of the label is your VIN.

### Gross Vehicle Weight Rating (GVWR)

The GVWR is the total permissible weight of your vehicle including driver, passengers, vehicle, options and cargo. The label also specifies maximum capacities of front and

rear axle systems (GAWR). Total load must be limited so GVWR and front and rear GAWR are not exceeded.

### Payload

The payload of a vehicle is defined as the allowable load weight a truck can carry, including the weight of the driver, all passengers, options and cargo.

### Gross Axle Weight Rating (GAWR)

The GAWR is the maximum permissible load on the front and rear axles. The load must be distributed in the cargo area so that the GAWR of each axle is not exceeded.

Each axle GAWR is determined by the components in the system with the lowest load carrying capacity (axle, springs, tires or wheels). Heavier axles or suspension components sometimes specified by purchasers for increased durability does not necessarily increase the vehicle's GVWR.

### **Tire Size**

The tire size on the Vehicle Certification Label represents the actual tire size on your vehicle. Replacement tires must be equal to the load capacity of this tire size.

### **Rim Size**

This is the rim size that is appropriate for the tire size listed.

### **Inflation Pressure**

This is the cold tire inflation pressure for your vehicle for all loading conditions up to full GAWR.

### **Curb Weight**

The curb weight of a vehicle is defined as the total weight of the vehicle with all fluids, including vehicle fuel, at full capacity conditions, and with no occupants or cargo loaded into the vehicle. The front and rear curb weight

values are determined by weighing your vehicle on a commercial scale before any occupants or cargo are added.

### **Loading**

The actual total weight and the weight of the front and rear of your vehicle at the ground can best be determined by weighing it when it is loaded and ready for operation.

The entire vehicle should first be weighed on a commercial scale to insure that the GVWR has not been exceeded. The weight on the front and rear of the vehicle should then be determined separately to be sure that the load is properly distributed over the front and rear axle. Weighing the vehicle may show that the GAWR of either the front or rear axles has been exceeded but the total load is within the specified GVWR. If so, weight must be shifted from front to rear or rear to front as appropriate until the specified weight limitations are met. Store the heavier

items down low and be sure that the weight is distributed equally. Stow all loose items securely before driving.

Improper weight distributions can have an adverse effect on the way your vehicle steers and handles and the way the brakes operate.

### **CAUTION!**

**Do not load your vehicle any heavier than the GVWR or the maximum front and rear GAWR. If you do, parts on your vehicle can break, or it can change the way your vehicle handles. This could cause you to lose control. Also overloading can shorten the life of your vehicle.**

## **TRAILER TOWING**

In this section you will find safety tips and information on limits to the type of towing you can reasonably do with your vehicle. Before towing a trailer, carefully review this information to tow your load as efficiently and safely as possible.

To maintain the New Vehicle Limited Warranty coverage, follow the requirements and recommendations in this manual concerning vehicles used for trailer towing.

### **Common Towing Definitions**

The following trailer towing related definitions will assist you in understanding the following information:

#### **Gross Vehicle Weight Rating (GVWR)**

The GVWR is the total allowable weight of your vehicle. This includes driver, passengers, cargo and tongue weight. The total load must be limited so that you do not



exceed the GVWR. Refer to “Vehicle Loading/Vehicle Certification Label” in “Starting And Operating” for further information.

### **Gross Trailer Weight (GTW)**

The GTW is the weight of the trailer plus the weight of all cargo, consumables and equipment (permanent or temporary) loaded in or on the trailer in its “loaded and ready for operation” condition.

The recommended way to measure GTW is to put your fully loaded trailer on a vehicle scale. The entire weight of the trailer must be supported by the scale.

#### **WARNING!**

**If the gross trailer weight is 5,000 lbs (2 267 kg) or more, it is mandatory to use a weight-distributing hitch to ensure stable handling of your vehicle. If**

*(Continued)*

#### **WARNING! (Continued)**

**you use a standard weight-carrying hitch, you could lose control of your vehicle and cause a collision.**

### **Gross Combination Weight Rating (GCWR)**

The GCWR is the total permissible weight of your vehicle and trailer when weighed in combination.

### **Gross Axle Weight Rating (GAWR)**

The GAWR is the maximum capacity of the front and rear axles. Distribute the load over the front and rear axles evenly. Make sure that you do not exceed either front or rear GAWR. Refer to “Vehicle Loading/Vehicle Certification Label” in “Starting And Operating” for further information.

**WARNING!**

**It is important that you do not exceed the maximum front or rear GAWR. A dangerous driving condition can result if either rating is exceeded. You could lose control of the vehicle and have a collision.**

**Tongue Weight (TW)**

The tongue weight is the downward force exerted on the hitch ball by the trailer. The recommended tongue weight is 10% to 15% of the vehicle's GTW for a conventional hitch. You must consider this as part of the load on your vehicle.

**Frontal Area**

The frontal area is the maximum height multiplied by the maximum width of the front of a trailer.

**Trailer Sway Control**

The trailer sway control can be a mechanical telescoping link that can be installed between the hitch receiver and the trailer tongue that typically provides adjustable friction associated with the telescoping motion to dampen any unwanted trailer swaying motions while traveling.

If equipped, the electronic Trailer Sway Control (TSC) recognizes a swaying trailer and automatically applies individual wheel brakes and/or reduces engine power to attempt to eliminate the trailer sway.

**Weight-Carrying Hitch**

A weight-carrying hitch supports the trailer tongue weight, just as if it were luggage located at a hitch ball or some other connecting point of the vehicle. These kinds of hitches are the most popular on the market today and they are commonly used to tow small and medium sized trailers.

## Weight-Distributing Hitch

A weight-distributing system works by applying leverage through spring (load) bars. They are typically used for heavier loads to distribute trailer tongue weight to the tow vehicle's front axle and the trailer axle(s). When used in accordance with the manufacturer's directions, it provides for a more level ride, offering more consistent steering and brake control thereby enhancing towing safety. The addition of a friction/hydraulic sway control also dampens sway caused by traffic and crosswinds and contributes positively to tow vehicle and trailer stability. Trailer sway control and a weight distributing (load equalizing) hitch are recommended for heavier Tongue Weights (TW) and may be required depending on vehicle and trailer configuration/loading to comply with Gross Axle Weight Rating (GAWR) requirements.

### WARNING!

- An improperly adjusted Weight Distributing Hitch system may reduce handling, stability, braking performance, and could result in a collision.
- Weight Distributing Systems may not be compatible with Surge Brake Couplers. Consult with your hitch and trailer manufacturer or a reputable Recreational Vehicle dealer for additional information.

## Trailer Hitch Classification

The following chart provides the industry standard for the maximum trailer weight a given trailer hitch class can tow and should be used to assist you in selecting the correct trailer hitch for your intended towing condition.

### Trailer Hitch Classification Definitions

Class	Max. Trailer Hitch Industry Standards
Class I - Light Duty	2,000 lbs (907 kg)
Class II - Medium Duty	3,500 lbs (1 587 kg)
Class III - Heavy Duty	5,000 lbs (2 268 kg)
Class IV - Extra Heavy Duty	10,000 lbs (4 540 kg)

Refer to the “Trailer Towing Weights (Maximum Trailer Weight Ratings)” chart for the Maximum Gross Trailer Weight (GTW) towable for your given drivetrain.

All trailer hitches should be professionally installed on your vehicle.

### Trailer Towing Weights (Maximum Trailer Weight Ratings)

Engine	Model	GCWR (Gross Combined Wt. Rating)	Frontal Area	Max. GTW (Gross Trailer Wt.)	Max. Trailer Tongue Wt. (See Note)
3.6L	RWD Light Duty Cooling	8,900 lbs (4,037 kg)	40 sq ft (3.72 sq m)	3,500 lbs (1,588 kg)	350 lbs (159 kg)

Engine	Model	GCWR (Gross Combined Wt. Rating)	Frontal Area	Max. GTW (Gross Trailer Wt.)	Max. Trailer Tongue Wt. (See Note)
3.6L	RWD	11,600 lbs (5,262 kg)	40 sq ft (3.72 sq m)	6,200 lbs (2,812 kg)	620 lbs (281 kg)
3.6L	AWD Light Duty Cooling	8,900 lbs (4,037 kg)	40 sq ft (3.72 sq m)	3,500 lbs (1,588 kg)	350 lbs (159 kg)
3.6L	AWD	11,600 lbs (5,262 kg)	40 sq ft (3.72 sq m)	6,200 lbs (2,812 kg)	620 lbs (281 kg)
5.7L	RWD	13,100 lbs (5,942 kg)	60 sq ft (5.57 sq m)	7,400 lbs (3,357 kg)	740 lbs (336 kg)
5.7L	AWD	13,100 lbs (5,942 kg)	60 sq ft (5.57 sq m)	7,200 lbs (3,266 kg)	720 lbs (327 kg)
Refer to local laws for maximum trailer towing speeds.					

**NOTE:**

- The trailer tongue weight must be considered as part of the combined weight of occupants and cargo, and should never exceed the weight referenced on the Tire and Loading Information placard. Refer to “Tire Safety Information” in “Starting and Operating” for further information. The addition of passengers and cargo may require reducing trailer tongue load and Gross Trailer Weight (GTW). Redistributing cargo (to the trailer) may be necessary to avoid exceeding Rear Gross Axle Weight Rating (GAWR) of 3,900 lbs (1 769 kg).
- Vehicles not factory equipped with trailer tow package are limited to 3,500 lbs (350 lbs tongue weight).

**Trailer Hitch Receiver Cover Removal — If Equipped**

Your vehicle may be equipped with a trailer hitch receiver cover, this must be removed to access the trailer hitch receiver (if equipped). This cover is located at the bottom center of the rear fascia.

1. Turn the two locking retainers located at the bottom of the hitch receiver cover a 1/4 turn counterclockwise and pull bottom of the hitch receiver cover outward (towards you).

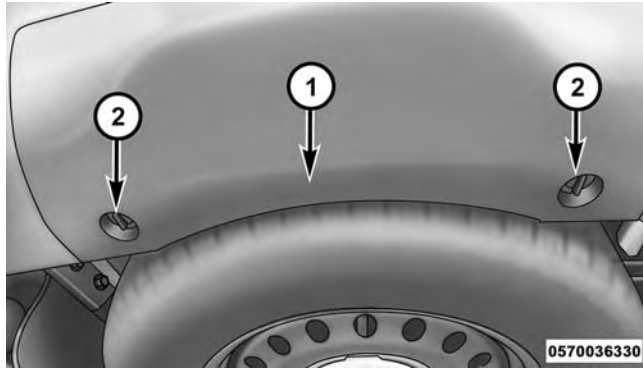

**Hitch Receiver Cover Retainers**

- 1 — Hitch Receiver Cover  
2 — Locking Retainers

2. Pull the bottom of the cover outward (towards you) then downwards to disengage the tabs located at the top of the hitch receiver cover to remove.

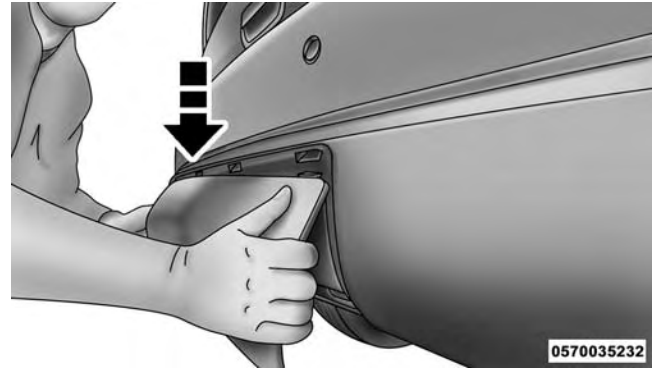

**Hitch Receiver Cover**

To reinstall the cover after towing repeat the procedure in reverse order.

**NOTE:** Be sure to engage all tabs of the hitch receiver cover in the bumper fascia prior to installation.

## Trailer And Tongue Weight

Always load a trailer with 60% of the weight in the front of the trailer. This places 10% of the GTW on the tow hitch of your vehicle. Loads balanced over the wheels or heavier in the rear can cause the trailer to sway **severely** side to side which will cause loss of control of the vehicle and trailer. Failure to load trailers heavier in front is the cause of many trailer collisions. Never exceed the maximum tongue weight stamped on your trailer hitch.

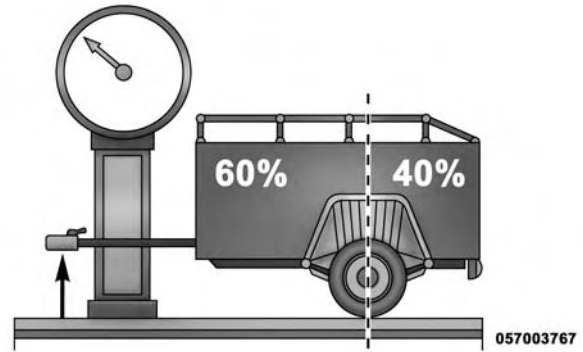

Consider the following items when computing the weight on the rear axle of the vehicle:

- The tongue weight of the trailer
- The weight of any other type of cargo or equipment put in or on your vehicle
- The weight of the driver and all passengers



**NOTE:** Remember that everything put into or on the trailer adds to the load on your vehicle. Also, additional factory-installed options or dealer-installed options must be considered as part of the total load on your vehicle. Refer to “Tire Safety Information/Tire and Loading Information Placard” in “Starting And Operating” for further information.

### **Towing Requirements**

To promote proper break-in of your new vehicle drivetrain components, the following guidelines are recommended.

#### **CAUTION!**

- **Do not tow a trailer at all during the first 500 miles (805 km) the new vehicle is driven. The engine, axle or other parts could be damaged.**
- **Then, during the first 500 miles (805 km) that a trailer is towed, do not drive over 50 mph (80 km/h) and do not make starts at full throttle. This helps the engine and other parts of the vehicle wear in at the heavier loads.**

Perform the maintenance listed in the “Maintenance Schedule”. Refer to “Maintenance Schedule” for the proper maintenance intervals. When towing a trailer, never exceed the GAWR or GCWR ratings.

**WARNING!**

Improper towing can lead to a collision. Follow these guidelines to make your trailer towing as safe as possible:

- Make certain that the load is secured in the trailer and will not shift during travel. When trailering cargo that is not fully secured, dynamic load shifts can occur that may be difficult for the driver to control. You could lose control of your vehicle and have a collision.
- When hauling cargo or towing a trailer, do not overload your vehicle or trailer. Overloading can cause a loss of control, poor performance or damage to brakes, axle, engine, transmission, steering, suspension, chassis structure or tires.
- Safety chains must always be used between your vehicle and trailer. Always connect the chains to the hook retainers of the vehicle hitch. Cross the

*(Continued)*

**WARNING! (Continued)**

chains under the trailer tongue and allow enough slack for turning corners.

- Vehicles with trailers should not be parked on a grade. When parking, apply the parking brake on the tow vehicle. Put the tow vehicle transmission in PARK. For four-wheel drive vehicles, make sure the transfer case is not in NEUTRAL. Always, block or "chock" the trailer wheels.
- GCWR must not be exceeded.
- Total weight must be distributed between the tow vehicle and the trailer such that the following four ratings are not exceeded:
  1. GVWR
  2. GTW
  3. GAWR
  4. Tongue weight rating for the trailer hitch utilized.

## Towing Requirements — Tires

- Do not attempt to tow a trailer while using a compact spare tire.
- Proper tire inflation pressures are essential to the safe and satisfactory operation of your vehicle. Refer to “Tires – General Information” in “Starting And Operating” for proper tire inflation procedures.
- Check the trailer tires for proper tire inflation pressures before trailer usage.
- Check for signs of tire wear or visible tire damage before towing a trailer. Refer to “Tires – General Information” in “Starting And Operating” for the proper inspection procedure.
- When replacing tires, refer to “Tires – General Information” in “Starting And Operating” for the proper

tire replacement procedures. Replacing tires with a higher load carrying capacity will not increase the vehicle’s GVWR and GAWR limits.

## Towing Requirements — Trailer Brakes

- Do **not** interconnect the hydraulic brake system or vacuum system of your vehicle with that of the trailer. This could cause inadequate braking and possible personal injury.
- An electronically actuated trailer brake controller is required when towing a trailer with electronically actuated brakes. When towing a trailer equipped with a hydraulic surge actuated brake system, an electronic brake controller is not required.
- Trailer brakes are recommended for trailers over 1,000 lbs (454 kg) and required for trailers in excess of 2,000 lbs (907 kg).

**WARNING!**

- Do not connect trailer brakes to your vehicle's hydraulic brake lines. It can overload your brake system and cause it to fail. You might not have brakes when you need them and could have a collision.
- Towing any trailer will increase your stopping distance. When towing you should allow for additional space between your vehicle and the vehicle in front of you. Failure to do so could result in a collision.

**CAUTION!**

If the trailer weighs more than 1,000 lbs (454 kg) loaded, it should have its own brakes and they should be of adequate capacity. Failure to do this

**CAUTION! (Continued)**

could lead to accelerated brake lining wear, higher brake pedal effort, and longer stopping distances.

**Towing Requirements — Trailer Lights And Wiring**

Whenever you pull a trailer, regardless of the trailer size, stoplights and turn signals on the trailer are required for motoring safety.

The Trailer Tow Package may include a four- and seven-pin wiring harness. Use a factory approved trailer harness and connector.

**NOTE:** Do not cut or splice wiring into the vehicles wiring harness.

The electrical connections are all complete to the vehicle but you must mate the harness to a trailer connector. Refer to the following illustrations.

*(Continued)*

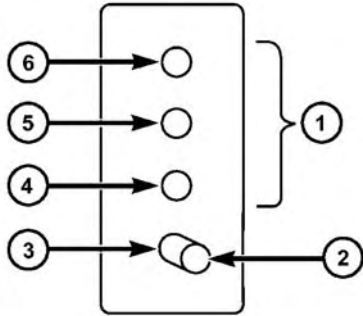

057003766

**Four-Pin Connector**

- |                 |                     |
|-----------------|---------------------|
| 1 — Female Pins | 4 — Park            |
| 2 — Male Pin    | 5 — Left Stop/Turn  |
| 3 — Ground      | 6 — Right Stop/Turn |

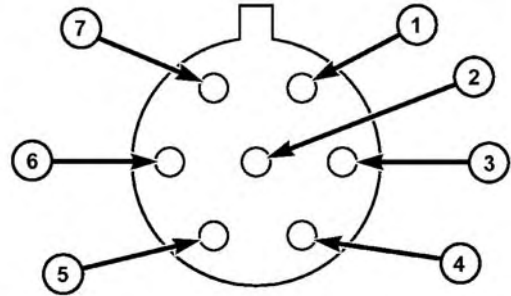

057003765

**Seven-Pin Connector**

- |                     |                    |
|---------------------|--------------------|
| 1 — Battery         | 5 — Ground         |
| 2 — Backup Lamps    | 6 — Left Stop/Turn |
| 3 — Right Stop/Turn | 7 — Running Lamps  |
| 4 — Electric Brakes |                    |

## Towing Tips

Before setting out on a trip, practice turning, stopping and backing the trailer up in an area away from heavy traffic.

## Automatic Transmission

The DRIVE range can be selected when towing. The transmission controls include a drive strategy to avoid frequent shifting when towing. However, if frequent shifting does occur while in DRIVE, you can use the AutoStick shift control to manually select a lower gear.

**NOTE:** Using a lower gear while operating the vehicle under heavy loading conditions, will improve performance and extend transmission life by reducing excessive shifting and heat buildup. This action will also provide better engine braking.

## AutoStick

- When using the AutoStick shift control, select the highest gear that allows for adequate performance and avoids frequent downshifts. For example, choose “5” if the desired speed can be maintained. Choose “4” or “3” if needed to maintain the desired speed.
- To prevent excess heat generation, avoid continuous driving at high RPM. Reduce vehicle speed as necessary to avoid extended driving at high RPM. Return to a higher gear or vehicle speed when grade and road conditions allow.

## Electronic Speed Control — If Equipped

- Do not use in hilly terrain or with heavy loads.
- When using the speed control, if you experience speed drops greater than 10 mph (16 km/h), disengage until you can get back to cruising speed.

- Use speed control in flat terrain and with light loads to maximize fuel efficiency.

### Cooling System

To reduce potential for engine and transmission overheating, take the following actions:

#### City Driving

When stopped for short periods of time, shift the transmission into NEUTRAL and increase engine idle speed.

#### Highway Driving

Reduce speed.

#### Air Conditioning

Turn off temporarily.

### SNOW PLOW

Snow plows, winches, and other aftermarket equipment should **not** be added to the front end of your vehicle. The airbag crash sensors may be affected by the change in the front end structure. The airbags could deploy unexpectedly or could fail to deploy during a collision.

#### WARNING!

**Do not add a snow plow, winches, or any other aftermarket equipment to the front of your vehicle. This could adversely affect the functioning of the airbag system and you could be injured.**

**RECREATIONAL TOWING (BEHIND MOTORHOME, ETC.)****Towing This Vehicle Behind Another Vehicle**

Towing Condition	Wheels OFF the Ground	Rear-Wheel Drive Models	All-Wheel Drive Models With Single-Speed Transfer Case	All-Wheel Drive Models With Two-Speed Transfer Case
Flat Tow	NONE	NOT ALLOWED	NOT ALLOWED	<ul style="list-style-type: none"> <li>• <b>See Instructions</b></li> <li>• Transmission in PARK</li> <li>• Transfer case in NEUTRAL (N)</li> <li>• Tow in forward direction</li> </ul>
Dolly Tow	Front	NOT ALLOWED	NOT ALLOWED	NOT ALLOWED
	Rear	OK	NOT ALLOWED	NOT ALLOWED
On Trailer	ALL	OK	OK	OK

**NOTE:** When recreational towing your vehicle, always follow applicable state and provincial laws. Contact state and provincial Highway Safety offices for additional details.



### Recreational Towing — Rear-Wheel Drive Models

**DO NOT flat tow this vehicle. Damage to the drivetrain will result.**

Recreational towing (for two-wheel drive models) is allowed **ONLY** if the rear wheels are **OFF** the ground. This may be accomplished using a tow dolly or vehicle trailer. If using a tow dolly, follow this procedure:

1. Properly secure the dolly to the tow vehicle, following the dolly manufacturer's instructions.
2. Drive the rear wheels onto the tow dolly.
3. Firmly apply the parking brake. Shift the transmission into PARK.
4. Turn the ignition switch to the OFF position.
5. Properly secure the rear wheels to the dolly, following the dolly manufacturer's instructions.

6. Install a suitable clamping device, designed for towing, to secure the front wheels in the straight position.

#### CAUTION!

**Towing with the rear wheels on the ground will cause severe transmission damage. Damage from improper towing is not covered under the New Vehicle Limited Warranty.**

### Recreational Towing — All-Wheel Drive Models (Single-Speed Transfer Case)

**Recreational towing is not allowed.** These models do not have a NEUTRAL (N) position in the transfer case.

**NOTE:** This vehicle may be towed on a flatbed or vehicle trailer provided all four wheels are **OFF** the ground.

**CAUTION!**

Towing this vehicle in violation of the above requirements can cause severe transmission and/or transfer case damage. Damage from improper towing is not covered under the New Vehicle Limited Warranty.

**Recreational Towing — All-Wheel Drive Models (Two-Speed Transfer Case)**

The transfer case must be shifted into NEUTRAL (N) and the transmission must be in PARK for recreational towing. The NEUTRAL (N) selection button is adjacent to the transfer case selector switch. Shifts into and out of transfer case NEUTRAL (N) can take place with the selector switch in any mode position.

**CAUTION!**

- **DO NOT** dolly tow any AWD vehicle. Towing with only one set of wheels on the ground (front or rear) will cause severe transmission and/or transfer case damage. Tow with all four wheels either ON the ground, or OFF the ground (using a vehicle trailer).
- Tow only in the forward direction. Towing this vehicle backwards can cause severe damage to the transfer case.
- The transmission must be in PARK for recreational towing.
- Before recreational towing, perform the procedure outlined under “Shifting Into NEUTRAL(N)” to be certain that the transfer case is fully in NEUTRAL (N). Otherwise, internal damage will result.
- Towing this vehicle in violation of the above requirements can cause severe transmission and/or

*(Continued)*

**CAUTION!** *(Continued)*

transfer case damage. Damage from improper towing is not covered under the New Vehicle Limited Warranty.

- Do not use a bumper-mounted clamp-on tow bar on your vehicle. The bumper face bar will be damaged.

## Shifting Into NEUTRAL (N)

**WARNING!**

You or others could be injured or killed if you leave the vehicle unattended with the transfer case in the NEUTRAL (N) position without first fully engaging the parking brake. The transfer case NEUTRAL (N) position disengages both the front and rear drive-shafts from the powertrain and will allow the vehicle

*(Continued)*

**WARNING!** *(Continued)*

to roll, even if the transmission is in PARK. The parking brake should always be applied when the driver is not in the vehicle.

Use the following procedure to prepare your vehicle for recreational towing.

**CAUTION!**

It is necessary to follow these steps to be certain that the transfer case is fully in NEUTRAL (N) before recreational towing to prevent damage to internal parts.

1. Bring the vehicle to a complete stop, with the engine running.
2. Press and hold the brake pedal.

3. Shift the transmission into NEUTRAL.
4. Using a ballpoint pen or similar object, press and hold the recessed transfer case NEUTRAL (N) button (located by the selector switch) for four seconds. The light behind the N symbol will blink, indicating shift in progress. The light will stop blinking (stay on solid) when the shift to NEUTRAL (N) is complete. A “FOUR WHEEL DRIVE SYSTEM IN NEUTRAL” message will appear in the Driver Information Display (DID). Refer to “Driver Information Display (DID)” in “Understanding Your Instrument Panel” for further information.

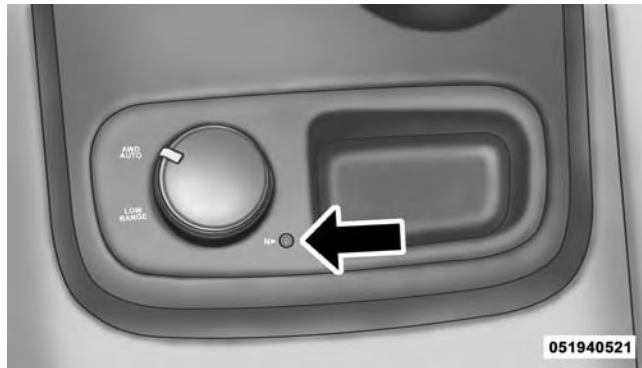

**NEUTRAL (N) Switch**

5. After the shift is completed and the NEUTRAL (N) light stays on, release the NEUTRAL (N) button.
6. Shift the transmission into REVERSE.
7. Release the brake pedal for five seconds and ensure that there is no vehicle movement.

8. Shift the transmission back into NEUTRAL.
9. Firmly apply the parking brake.
10. With the transmission and transfer case in NEUTRAL, press and hold the ENGINE START/STOP button until the engine turns off. Turning the engine off will automatically place the transmission in PARK.
11. Press the ENGINE STOP/START button again (without pressing the brake pedal), if needed, to turn the ignition switch to the OFF position.
12. Attach the vehicle to the tow vehicle using a suitable tow bar.
13. Release the parking brake.

**NOTE:**

- Steps 1 through 3 are requirements that must be met before pressing the NEUTRAL (N) button, and must continue to be met until the shift has been completed. If any of these requirements are not met before pressing the NEUTRAL (N) button or are no longer met during the shift, the NEUTRAL (N) indicator light will flash continuously until all requirements are met or until the NEUTRAL (N) button is released.
- The ignition switch must be in the ON/RUN position for a shift to take place and for the position indicator lights to be operable. If the ignition switch is not in the ON/RUN position, the shift will not take place and no position indicator lights will be on or flashing.

**CAUTION!**

**Damage to the transmission may occur if the transmission is shifted into PARK with the transfer case in NEUTRAL (N) and the engine running. With the transfer case in NEUTRAL (N) ensure that the engine is OFF before shifting the transmission into PARK.**

- A flashing NEUTRAL (N) position indicator light indicates that shift requirements have not been met.

### Shifting Out Of NEUTRAL (N)

Use the following procedure to prepare your vehicle for normal usage.

1. Bring the vehicle to a complete stop, leaving it connected to the tow vehicle.
2. Firmly apply the parking brake.
3. Start the engine.
4. Press and hold the brake pedal.
5. Shift the transmission into NEUTRAL.
6. Using a ballpoint pen or similar object, press and hold the recessed transfer case NEUTRAL (N) button (located by the selector switch) for one second.

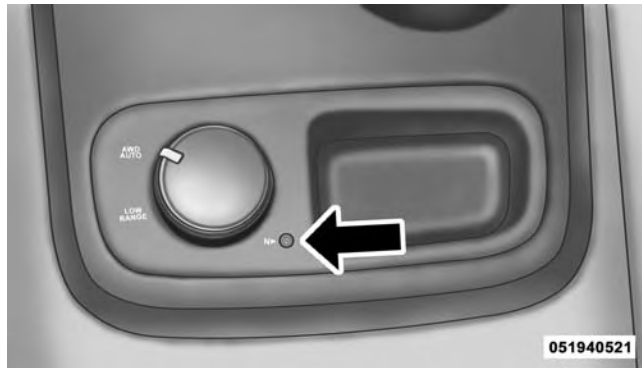

**NEUTRAL (N) Switch**

7. When the NEUTRAL (N) indicator light turns off, release the NEUTRAL (N) button.
8. After the NEUTRAL (N) button has been released, the transfer case will shift to the position indicated by the selector switch.

9. Shift the transmission into PARK and turn the engine OFF.
10. Release the brake pedal.
11. Disconnect vehicle from the tow vehicle.
12. Start the engine.
13. Press and hold the brake pedal.
14. Release the parking brake.
15. Shift the transmission into DRIVE, release the brake pedal, and check that the vehicle operates normally.

**NOTE:**

- Steps 1 through 5 are requirements that must be met before pressing the NEUTRAL (N) button, and must continue to be met until the shift has been completed. If any of these requirements are not met before pressing the NEUTRAL (N) button or are no longer met during the shift, the NEUTRAL (N) indicator light will flash continuously until all requirements are met or until the NEUTRAL (N) button is released.
- The ignition switch must be in the ON/RUN position for a shift to take place and for the position indicator lights to be operable. If the ignition switch is not in the ON/RUN position, the shift will not take place and no position indicator lights will be on or flashing.
- A flashing NEUTRAL (N) position indicator light indicates that shift requirements have not been met.





# WHAT TO DO IN EMERGENCIES

## CONTENTS

■ HAZARD WARNING FLASHERS . . . . .	.544	□ Road Tire Installation . . . . .	.561
■ IF YOUR ENGINE OVERHEATS . . . . .	.544	■ CAP-LESS FUEL FILL FUNNEL . . . . .	.562
■ WHEEL AND TIRE TORQUE SPECIFICATIONS . . . . .	.545	■ JUMP-STARTING . . . . .	.563
□ Torque Specifications . . . . .	.546	□ Preparations For Jump-Start . . . . .	.564
■ JACKING AND TIRE CHANGING . . . . .	.547	□ Jump-Starting Procedure . . . . .	.566
□ Jack Location . . . . .	.548	■ FREEING A STUCK VEHICLE . . . . .	.568
□ Spare Tire Stowage . . . . .	.549	■ EMERGENCY TOW HOOKS — IF EQUIPPED . . . . .	.569
□ Spare Tire Removal . . . . .	.550	■ MANUAL PARK RELEASE . . . . .	.570
□ Preparations For Jacking . . . . .	.553	■ TOWING A DISABLED VEHICLE . . . . .	.574
□ Jacking Instructions . . . . .	.553	□ Rear Wheel Drive Models . . . . .	.576
		□ All-Wheel Drive Models . . . . .	.577

## HAZARD WARNING FLASHERS

The Hazard Warning flasher switch is located on the switch bank just above the climate controls.



Push the switch to turn on the Hazard Warning flasher. When the switch is activated, all directional turn signals will flash on and off to warn oncoming traffic of an emergency. Push the switch a second time to turn off the Hazard Warning flashers.

This is an emergency warning system and it should not be used when the vehicle is in motion. Use it when your vehicle is disabled and it is creating a safety hazard for other motorists.

When you must leave the vehicle to seek assistance, the Hazard Warning flashers will continue to operate even though the ignition is placed in the OFF position.

**NOTE:** With extended use, the Hazard Warning flashers may wear down your battery.

## IF YOUR ENGINE OVERHEATS

In any of the following situations, you can reduce the potential for overheating by taking the appropriate action.

- On the highways — slow down.
- In city traffic — while stopped, place the transmission in NEUTRAL, but do not increase the engine idle speed while maintaining the motion of the vehicle with the brakes.

**NOTE:** There are steps that you can take to slow down an impending overheat condition:

- If your air conditioner (A/C) is on, turn it off. The A/C system adds heat to the engine cooling system and turning the A/C off can help remove this heat.

- You can also turn the temperature control to maximum heat, the mode control to floor and the blower control to high. This allows the heater core to act as a supplement to the radiator and aids in removing heat from the engine cooling system.

### CAUTION!

Driving with a hot cooling system could damage your vehicle. If the temperature gauge reads HOT (H), pull over and stop the vehicle. Idle the vehicle with the air conditioner turned off until the pointer drops back into the normal range. If the pointer remains on HOT (H), and you hear continuous chimes, turn the engine off immediately and call for service.

### WARNING!

You or others can be badly burned by hot engine coolant (antifreeze) or steam from your radiator. If you see or hear steam coming from under the hood, do not open the hood until the radiator has had time to cool. Never try to open a cooling system pressure cap when the radiator or coolant bottle is hot.

## WHEEL AND TIRE TORQUE SPECIFICATIONS

Proper lug nut/bolt torque is very important to ensure that the wheel is properly mounted to the vehicle. Any time a wheel has been removed and reinstalled on the vehicle the lug nuts/bolts should be torqued using a properly calibrated torque wrench.

## Torque Specifications

Lug Nut/Bolt Torque	**Lug Nut/ Bolt Size	Lug Nut/ Bolt Socket Size
130 Ft-Lbs (176 N·m)	M14 x 1.50	22 mm

\*\*Use only your Authorized Dealer recommended lug nuts/bolts and clean or remove any dirt or oil before tightening.

Inspect the wheel mounting surface prior to mounting the tire and remove any corrosion or loose particles.

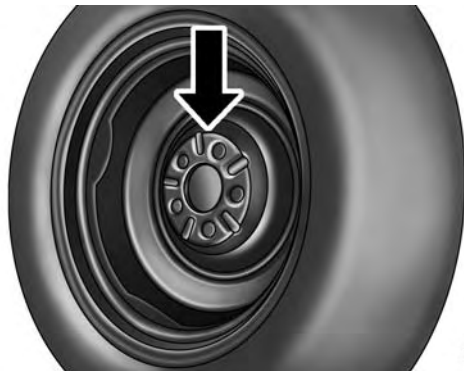

0605005441

### Wheel Mounting Surface

Tighten the lug nuts/bolts in a star pattern until each nut/bolt has been tightened twice.

After 25 miles (40 km) check the lug nut/bolt torque to be sure that all the lug nuts/bolts are properly seated against the wheel.

## JACKING AND TIRE CHANGING



0605006372

Torque Patterns

**WARNING!**

To avoid the risk of forcing the vehicle off the jack, do not tighten the lug nuts fully until the vehicle has been lowered. Failure to follow this warning may result in personal injury.

**WARNING!**

- Do not attempt to change a tire on the side of the vehicle close to moving traffic. Pull far enough off the road to avoid the danger of being hit when operating the jack or changing the wheel.
- Being under a jacked-up vehicle is dangerous. The vehicle could slip off the jack and fall on you. You could be crushed. Never put any part of your body under a vehicle that is on a jack. If you need to get under a raised vehicle, take it to a service center where it can be raised on a lift.
- Never start or run the engine while the vehicle is on a jack.

*(Continued)*

**WARNING!** *(Continued)*

- The jack is designed to be used as a tool for changing tires only. The jack should not be used to lift the vehicle for service purposes. The vehicle should be jacked on a firm level surface only. Avoid ice or slippery areas.

**Jack Location**

The scissor-type jack and tire changing tools are located in rear cargo area, below the load floor.

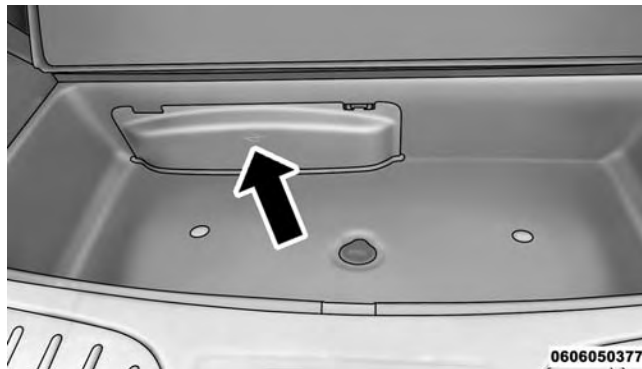

Jack Storage Location

Rotate the plastic thumb screw on the end of the jack to loosen the jack and remove from the bracket.

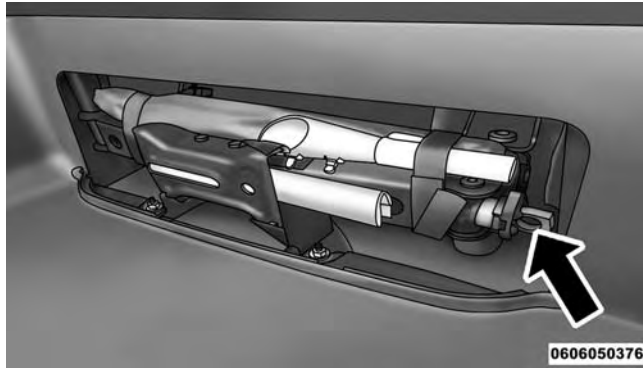

Thumb Screw Location

### Spare Tire Stowage

The spare tire is stowed under the rear of the vehicle by means of a cable winch mechanism. To remove or stow the spare, use the jack handle/lug wrench connected to

the square socket extension to rotate the “spare tire drive” nut. The nut is located under a plastic cover at the center-rear of the cargo floor area, just inside the liftgate opening.

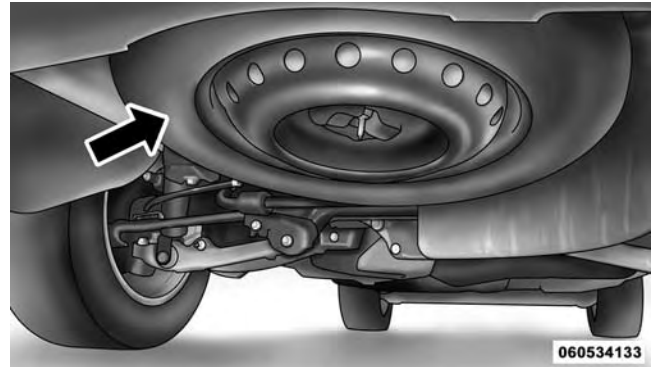

Spare Tire Location

**CAUTION!**

Do not use power tools to winch the tire up or down. Impact type tools can damage the winch mechanism.

**Spare Tire Removal**

1. Remove the jack tools from the bag.
2. Raise the rubber mat and remove the plug from storage compartment floor.
3. Fit the jack handle extension over the drive nut. Use the lug wrench handle and extension to completely lower the spare tire. Keep turning the handle until the winch stops.

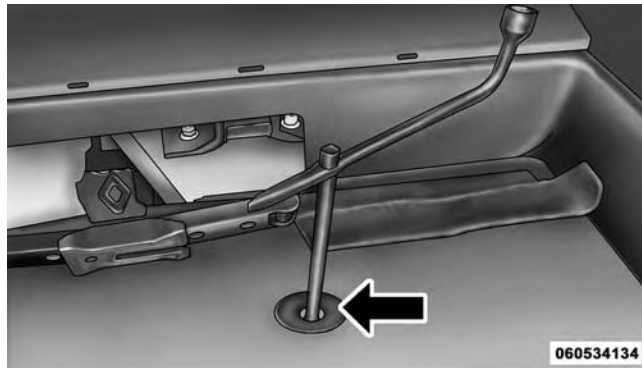

Lowering/Raising Spare Tire



- Slide the tire out from under the vehicle and rotate it vertically behind the rear bumper.



Spare Tire

- Spread the retaining tabs on the plastic plate and pull the metal stamping toward you to release it from the plastic plate.

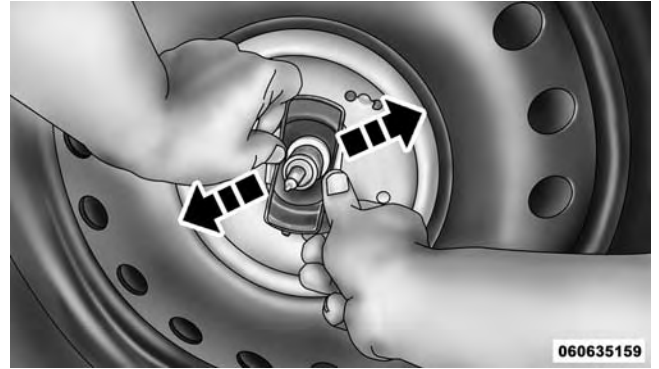

Tab Location

6. Slide the metal stamping up the steel extension tube and winch cable. Rotate the metal stamping and push it through the hole in the plastic plate and wheel.



Sleeve And Cable

7. Pinch the three short and two long tubes to remove the protective plate from the steel spare wheel.



Releasing Protective Plate

## Preparations For Jacking

1. Park the vehicle on a firm, level surface as far from the edge of the roadway as possible. Avoid icy or slippery areas.

### WARNING!

**Do not attempt to change a tire on the side of the vehicle close to moving traffic, pull far enough off the road to avoid being hit when operating the jack or changing the wheel.**

2. Turn on the Hazard Warning flasher.
3. Set the parking brake.
4. Place the gear selector into PARK.
5. Turn OFF the ignition.

6. Block both the front and rear of the wheel diagonally opposite of the jacking position. For example, if changing the right front tire, block the left rear wheel.



**NOTE:** Passengers should not remain in the vehicle when the vehicle is being jacked.

## Jacking Instructions

### WARNING!

Carefully follow these tire changing warnings to help prevent personal injury or damage to your vehicle:

- Always park on a firm, level surface as far from the edge of the roadway as possible before raising the vehicle.

*(Continued)*

**WARNING! (Continued)**

- Turn on the Hazard Warning flasher.
- Block the wheel diagonally opposite the wheel to be raised.
- Set the parking brake firmly and set the automatic transmission in PARK.
- Never start or run the engine with the vehicle on a jack.
- Do not let anyone sit in the vehicle when it is on a jack.
- Do not get under the vehicle when it is on a jack. If you need to get under a raised vehicle, take it to a service center where it can be raised on a lift.
- Only use the jack in the positions indicated and for lifting this vehicle during a tire change.
- If working on or near a roadway, be extremely careful of motor traffic.

*(Continued)***WARNING! (Continued)**

- To assure that spare tires, flat or inflated, are securely stowed, spares must be stowed with the valve stem facing the ground.

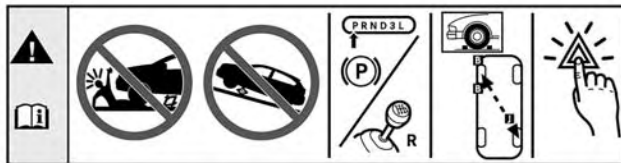

060600714

Jack Warning Label

**CAUTION!**

Do not attempt to raise the vehicle by jacking on locations other than those indicated in the Jacking Instructions for this vehicle.

1. Loosen (but do not remove) the wheel lug nuts by turning them to the left, one turn, while the wheel is still on the ground.
2. Assemble the jack and jacking tools.



060641337

Jack And Tool Assembly

3. For the front axle, place the jack on the body flange just behind the front tire as indicated by the triangular lift point symbol on the sill molding. **Do not raise the vehicle until you are sure the jack is fully engaged.**

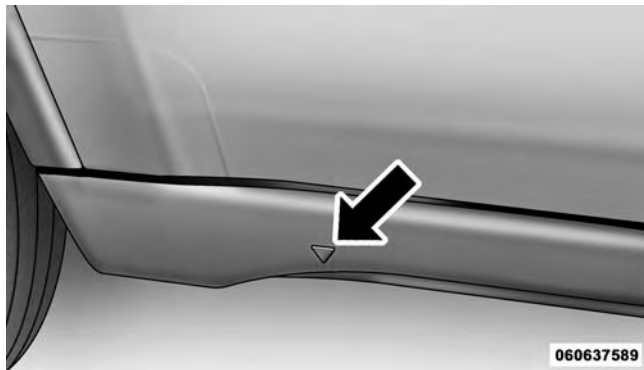

Lift Point Symbol On Sill Molding

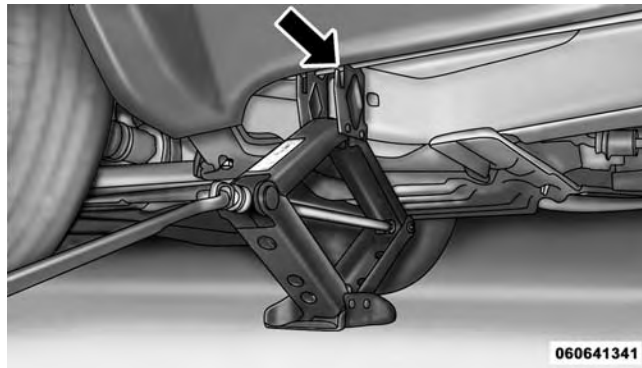

Front Jack Location

4. For a rear tire, place the jack in the slot on the rear tie-down bracket, just forward of the rear tire (as indicated by the triangular lift point symbol on the sill molding). **Do not raise the vehicle until you are sure the jack is fully engaged.**



060637590

Lift Point On Sill Molding

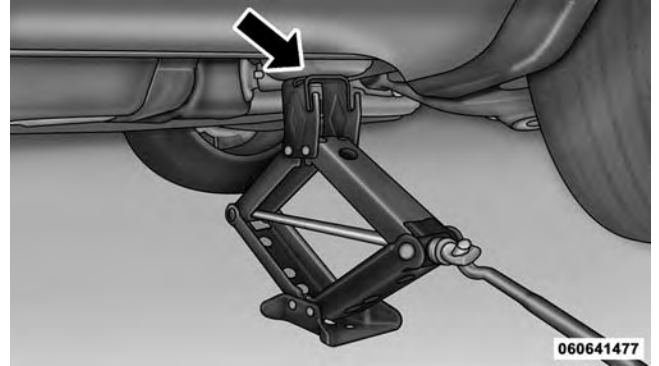

060641477

Rear Jacking Location

5. Raise the vehicle by turning the jack screw clockwise. Raise the vehicle just enough to remove the flat tire.

**WARNING!**

Raising the vehicle higher than necessary can make the vehicle less stable. It could slip off the jack and hurt someone near it. Raise the vehicle only enough to remove the tire.

6. Remove the lug nuts and wheel.
7. Install the spare wheel/tire on the vehicle and install the lug nuts with the cone-shaped end toward the wheel. Lightly tighten the nuts.

**CAUTION!**

Be sure to mount the spare tire with the valve stem facing outward. The vehicle could be damaged if the spare tire is mounted incorrectly.



060633619

Mounting Spare Tire

**WARNING!**

To avoid the risk of forcing the vehicle off the jack, do not fully tighten the lug nuts until the vehicle has been lowered. Failure to follow this warning may result in serious injury.



8. Lower the vehicle by turning the jack screw counter-clockwise, and remove the jack and wheel blocks.
9. Finish tightening the lug nuts. Push down on the wrench while at the end of the handle for increased leverage. Tighten the lug nuts in a star pattern until each nut has been tightened twice. Refer to Torque Specifications in this section for proper lug nut torque. If in doubt about the correct tightness, have them checked with a torque wrench by your authorized dealer or at a service station.
10. Push out the small center cap using the jack tool from inside the aluminum road wheel and position the wheel behind the rear bumper with the "beauty side" facing rearward.

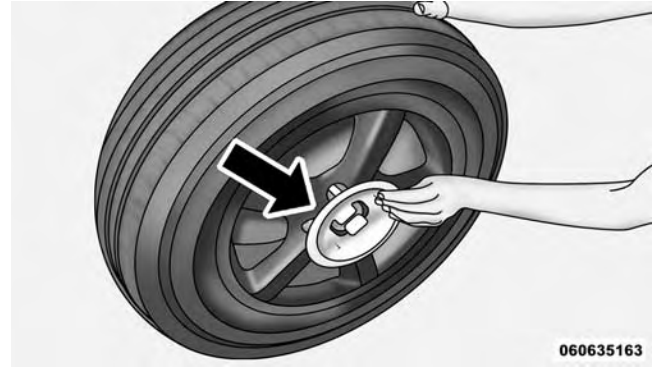

"Beauty Side"

**NOTE:** The plastic plate will prevent the road wheel from being scratched when sliding it under the vehicle.

11. Insert the two long tubes on the plastic protective plate in the lug holes of the road wheel. Push the end of the winch's cable, spring, steel sleeve and stamped cone shape wheel plate through the road wheel and protective plate.

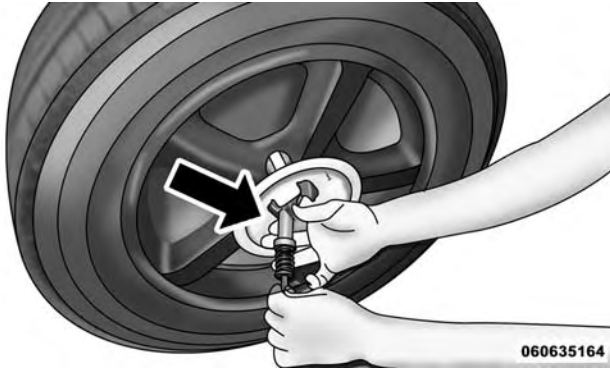

**Installing Winch**

12. Slide the road wheel on the ground using the protective plate until it is directly under the winch and between the rear bumper and exhaust system heat shields. Raise the tire by turn the lug wrench on the winch extension clockwise until it clicks/ratchets three times to make sure the cable is tight.

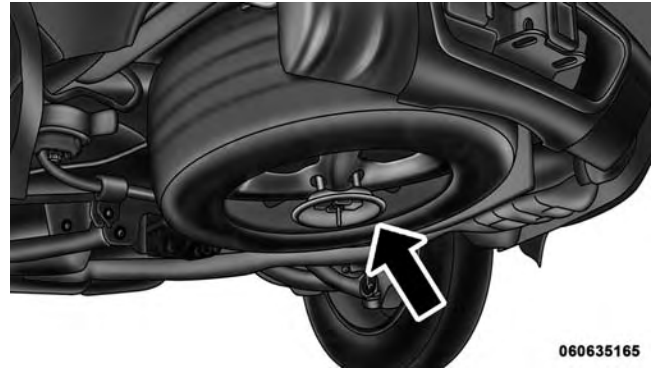

**Road Wheel Installed In Spare Location**

**NOTE:** Double check to ensure the tire is snug against the underbody of the vehicle. Damage to the winch cable may result if the vehicle is driven with the tire loose.

**WARNING!**

**Do not use power tools to winch the tire up or down. Impact-type tools may damage the winch mechanism.**

13. Lower the jack to the fully closed position. Return the tools to the proper positions in the tool bag. Fold the flap on the tool bag under the tools and roll the tools in the bag underneath the others. Use the Velcro straps to secure the tool bag to the jack with the lug wrench on the forward side of the jack. Expand the jack on the bracket by turning the thumb screw clockwise until it is tight to prevent rattles.
14. Reinstall the plastic plug into the floor of the cargo area. Roll up and store the Jack, Tool Kit and Tire Changing Instructions. Reinstall the cover for the jack in the rear storage bin.

15. Have the aluminum road wheel and tire repaired as soon as possible and properly secure the spare tire, jack and tool kit.

**WARNING!**

**A loose tire or jack thrown forward in a collision or hard stop could endanger the occupants of the vehicle. Always stow the jack parts and the spare tire in the places provided.**

**Road Tire Installation**

1. Mount the road tire on the axle.
2. Install the remaining lug nuts with the cone shaped end of the nut toward the wheel. Lightly tighten the lug nuts.

**WARNING!**

**To avoid the risk of forcing the vehicle off the jack, do not tighten the lug nuts fully until the vehicle has been lowered. Failure to follow this warning may result in personal injury.**

3. Lower the vehicle to the ground by turning the jack handle counterclockwise.
4. Refer to Torque Specifications for proper lug nut torque.
5. After 25 miles (40 km) check the lug nut torque with a torque wrench to ensure that all lug nuts are properly seated against the wheel.

**CAP-LESS FUEL FILL FUNNEL**

The funnel for the Cap-Less Fuel System is located with the jack and tire changing tools. If your vehicle is out of fuel and an auxiliary fuel can is needed, insert the funnel into the filler neck and proceed to fill the vehicle.

For more information on the Cap-Less Fuel System refer to “Adding Fuel” in “Starting And Operating ” in this manual.

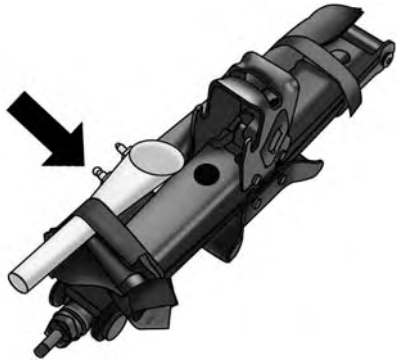

Fuel Funnel

0606009925

## JUMP-STARTING

If your vehicle has a discharged battery it can be jump-started using a set of jumper cables and a battery in another vehicle or by using a portable battery booster

pack. Jump-starting can be dangerous if done improperly so please follow the procedures in this section carefully.

### WARNING!

Do not attempt jump-starting if the battery is frozen. It could rupture or explode and cause personal injury.

### CAUTION!

Do not use a portable battery booster pack or any other booster source with a system voltage greater than 12 Volts or damage to the battery, starter motor, alternator or electrical system may occur.

**NOTE:** When using a portable battery booster pack follow the manufacturer's operating instructions and precautions.

## Preparations For Jump-Start

The battery in your vehicle is located under the passenger's front seat. There are remote locations located under the hood to assist in jump-starting.

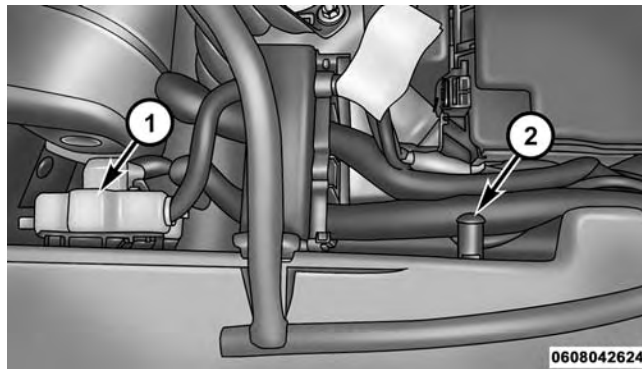

### Remote Battery Posts

- 1 — Remote Positive (+) Post (covered with protective cap)
  - 2 — Remote Negative (-) Post
-

**WARNING!**

- Take care to avoid the radiator cooling fan whenever the hood is raised. It can start anytime the ignition switch is ON. You can be injured by moving fan blades.
- Remove any metal jewelry such as rings, watch bands and bracelets that could make an inadvertent electrical contact. You could be seriously injured.
- Batteries contain sulfuric acid that can burn your skin or eyes and generate hydrogen gas which is flammable and explosive. Keep open flames or sparks away from the battery.

**NOTE:** Be sure that the disconnected ends of the cables do not touch while still connected to the other vehicle.

1. Set the parking brake, shift the automatic transmission into PARK and turn the ignition to LOCK.

2. Turn off the heater, radio, and all unnecessary electrical accessories.
3. Remove the protective cover over the remote positive (+) battery post. Pull upward on the cover to remove it.
4. If using another vehicle to jump-start the battery, park the vehicle within the jumper cables reach, set the parking brake and make sure the ignition is OFF.

**WARNING!**

**Do not allow vehicles to touch each other as this could establish a ground connection and personal injury could result.**

## Jump-Starting Procedure

### **WARNING!**

Failure to follow this jump-starting procedure could result in personal injury or property damage due to battery explosion.

### **CAUTION!**

Failure to follow these procedures could result in damage to the charging system of the booster vehicle or the discharged vehicle.

**NOTE:** Make sure at all times that unused ends of jumper cables are not contacting each other or either vehicle while making connections.

## Connecting The Jumper Cables

1. Connect the positive (+) end of the jumper cable to the remote positive (+) post of the discharged vehicle.
2. Connect the opposite end of the positive (+) jumper cable to the positive (+) post of the booster battery.
3. Connect the negative end (-) of the jumper cable to the negative (-) post of the booster battery.
4. Connect the opposite end of the negative (-) jumper cable to the remote negative (-) post of the vehicle with the discharged battery.

### **WARNING!**

Do not connect the jumper cable to the negative (-) post of the discharged battery. The resulting electrical spark could cause the battery to explode and could result in personal injury. Only use the specific ground point, do not use any other exposed metal parts.



5. Start the engine in the vehicle that has the booster battery, let the engine idle a few minutes, and then start the engine in the vehicle with the discharged battery.
6. Once the engine is started, remove the jumper cables in the reverse sequence:

### Disconnecting The Jumper Cables

1. Disconnect the negative (-) end of the jumper cable from the remote negative (-) post of the discharged vehicle.
2. Disconnect the opposite end of the negative (-) jumper cable from the negative (-) post of the booster battery.
3. Disconnect the positive (+) end of the jumper cable from the positive (+) post of the booster battery.

4. Disconnect the opposite end of the positive (+) jumper cable from the remote positive (+) post of the discharged vehicle.
5. Reinstall the protective cover over the remote positive (+) post of the discharged vehicle.

If frequent jump-starting is required to start your vehicle you should have the battery and charging system tested at your authorized dealer.

### CAUTION!

Accessories plugged into the vehicle power outlets draw power from the vehicle's battery, even when not in use (i.e., cellular phones, etc.). Eventually, if plugged in long enough without engine operation, the vehicle's battery will discharge sufficiently to degrade battery life and/or prevent the engine from starting.

## **FREEING A STUCK VEHICLE**

If your vehicle becomes stuck in mud, sand or snow, it can often be moved using a rocking motion. Turn the steering wheel right and left to clear the area around the front wheels. Then shift back and forth between DRIVE and REVERSE while gently pressing the accelerator.

**NOTE:** Shifts between DRIVE and REVERSE can only be achieved at wheel speeds of 5 mph (8 km/h) or less. Whenever the transmission remains in NEUTRAL for more than two seconds, you must push the brake pedal to engage DRIVE or REVERSE.

Use the least amount of accelerator pedal pressure that will maintain the rocking motion without spinning the wheels or racing the engine.

**NOTE:** Push the "ESC Off" switch, to place the Electronic Stability Control (ESC) system in "Partial Off" mode, before rocking the vehicle. Refer to "Electronic Brake Control" in "Starting And Operating" for further information. Once the vehicle has been freed, push the "ESC Off" switch again to restore "ESC On" mode.

### **CAUTION!**

**Racing the engine or spinning the wheels may lead to transmission overheating and failure. Allow the engine to idle with the transmission in NEUTRAL for at least one minute after every five rocking-motion cycles. This will minimize overheating and reduce the risk of transmission failure during prolonged efforts to free a stuck vehicle.**

**WARNING!**

Fast spinning tires can be dangerous. Forces generated by excessive wheel speeds may cause damage, or even failure, of the axle and tires. A tire could explode and injure someone. Do not spin your vehicle's wheels faster than 30 mph (48 km/h) or for longer than 30 seconds continuously without stopping when you are stuck and do not let anyone near a spinning wheel, no matter what the speed.

**CAUTION!**

- When "rocking" a stuck vehicle by shifting between DRIVE and REVERSE, do not spin the wheels faster than 15 mph (24 km/h), or drivetrain damage may result.

*(Continued)*

**CAUTION! (Continued)**

- Revving the engine or spinning the wheels too fast may lead to transmission overheating and failure. It can also damage the tires. Do not spin the wheels above 30 mph (48 km/h) while in gear (no transmission shifting occurring).

**EMERGENCY TOW HOOKS — IF EQUIPPED**

If your vehicle is equipped with tow hooks, there will be one in the rear and two mounted on the front of the vehicle. The rear hook will be located on the driver's side of the vehicle.

**NOTE:** For off-road recovery, it is recommended to use both of the front tow hooks to minimize the risk of damage to the vehicle.

**WARNING!**

- Do not use a chain for freeing a stuck vehicle. Chains may break, causing serious injury or death.
- Stand clear of vehicles when pulling with tow hooks. Tow straps may become disengaged, causing serious injury.

**CAUTION!**

Tow hooks are for emergency use only, to rescue a vehicle stranded off road. Do not use tow hooks for tow truck hookup or highway towing. You could damage your vehicle.

**MANUAL PARK RELEASE****WARNING!**

Always secure your vehicle by fully applying the parking brake, before activating the Manual Park Release. Activating the Manual Park Release will allow your vehicle to roll away if it is not secured by the parking brake or by proper connection to a tow vehicle. Activating the Manual Park Release on an unsecured vehicle could lead to serious injury or death for those in or around the vehicle.

In order to move the vehicle in cases where the transmission will not shift out of PARK (such as a dead battery), a Manual Park Release is available.

Follow these steps to use the Manual Park Release:

1. Firmly apply the parking brake.
2. Open the center console and locate the Manual Park Release cover, remove it by snapping the cover away from the console hinges.

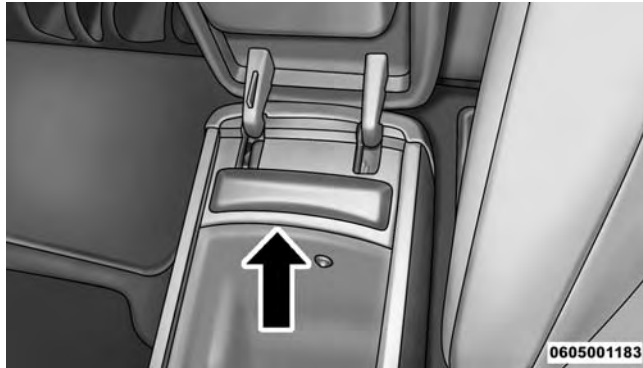

Manual Park Release Cover

3. Using a screwdriver or similar tool, push the metal latch in towards the tether strap.

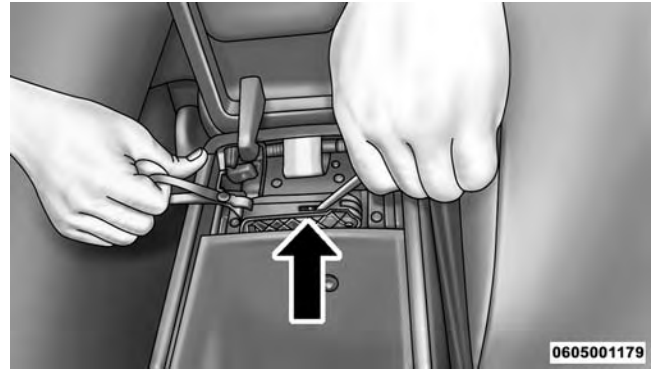

Release Latch

4. While the metal latch is in the open position, simultaneously pull upwards on the tether strap until the lever clicks and latches in the released position. The transmission is now out of PARK and the vehicle can be moved.

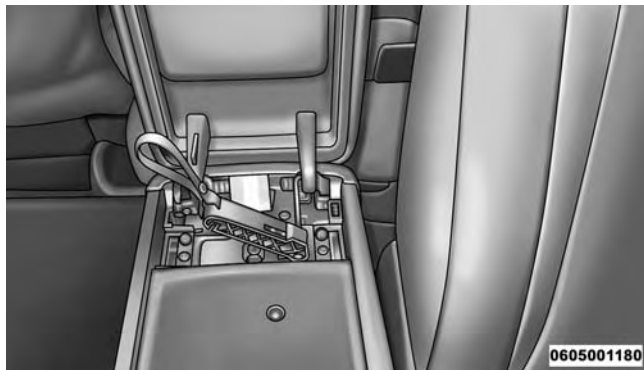

Released Position

**CAUTION!**

**Closing the armrest while the Manual Park Release is activated may damage the Manual Park Release mechanism, the transmission, and/or the armrest.**

**NOTE:** To prevent the vehicle from rolling unintentionally, firmly apply the parking brake.

To Disengage the Manual Park Release Lever:

1. To disengage the Manual Park Release apply tension upward while pushing the release latch towards the tether to unlock the lever.

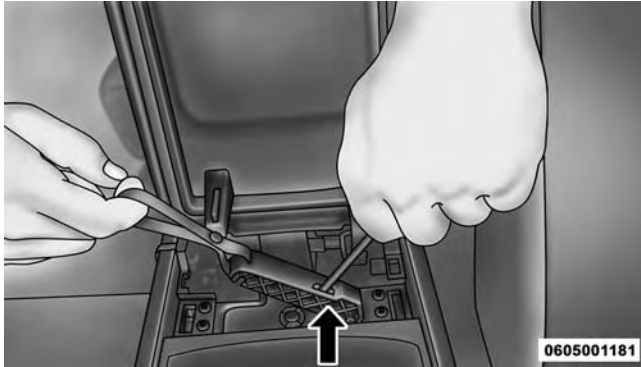

**Release Latch**

2. Once the tension has been released and the lever has been unlocked be sure it is stowed properly and locks into position.

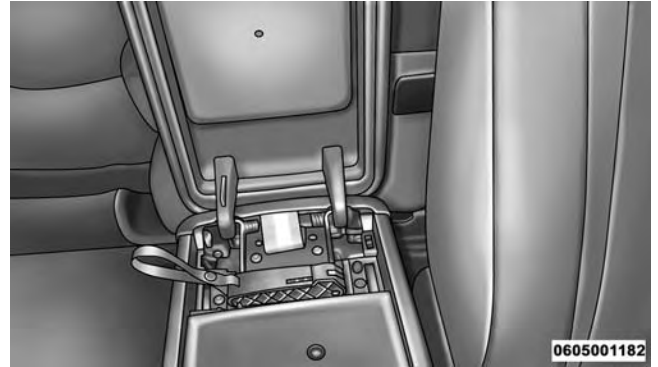

**Stowed Position**

**NOTE:** Be sure to replace the cover by snapping it back in place.

**TOWING A DISABLED VEHICLE**

This section describes procedures for towing a disabled vehicle using a commercial towing service. If the transmission and drivetrain are operable, disabled vehicles

may also be towed as described under “Recreational Towing” in the “Starting and Operating” section.

Towing Condition	Wheels OFF the Ground	Rear-Wheel Drive Models	All-Wheel Drive Models With Single-Speed Transfer Case	All-Wheel Drive Models With Two-Speed Transfer Case
Flat Tow	NONE	<b>If Transmission Is Operable:</b> <ul style="list-style-type: none"> <li>• Transmission in <b>NEUTRAL</b></li> <li>• 30 mph (48 km/h) <b>max speed</b></li> <li>• 30 miles (48 km) <b>max distance</b></li> </ul>	<b>NOT ALLOWED</b>	<b>See Instructions:</b> <ul style="list-style-type: none"> <li>• Transmission in <b>PARK</b></li> <li>• Transfer case in <b>NEUTRAL (N)</b></li> <li>• Tow in forward direction</li> </ul>



Towing Condition	Wheels OFF the Ground	Rear-Wheel Drive Models	All-Wheel Drive Models With Single-Speed Transfer Case	All-Wheel Drive Models With Two-Speed Transfer Case
Wheel Lift or Dolly Tow	Front	<b>If Transmission Is Operable:</b> <ul style="list-style-type: none"> <li>• Transmission in <b>NEUTRAL</b></li> <li>• 30 mph (48 km/h) <b>max speed</b></li> <li>• 30 miles (48 km) <b>max distance</b></li> </ul>	<b>NOT ALLOWED</b>	<b>NOT ALLOWED</b>
	Rear	OK	<b>NOT ALLOWED</b>	<b>NOT ALLOWED</b>
Flatbed	<b>ALL</b>	<b>BEST METHOD</b>	<b>OK</b>	<b>BEST METHOD</b>

Proper towing or lifting equipment is required to prevent damage to your vehicle. Use only tow bars and other equipment designed for this purpose, following equipment manufacturer's instructions. Use of safety chains is mandatory. Attach a tow bar or other towing device to main structural members of the vehicle, not to bumpers or associated brackets. State and local laws regarding vehicles under tow must be observed.

If you must use the accessories (wipers, defrosters, etc.) while being towed, the ignition must be in the ON/RUN position, not the ACC position.

If the key fob is unavailable or the vehicle's battery is discharged, refer to "Manual Park Release" in this section for instructions on shifting the transmission out of PARK for towing.

### CAUTION!

- **Do not use sling type equipment when towing. Vehicle damage may occur.**
- **When securing the vehicle to a flat bed truck, do not attach to front or rear suspension components. Damage to your vehicle may result from improper towing.**

### Rear Wheel Drive Models

The manufacturer recommends towing your vehicle with all four wheels **OFF** the ground using a flatbed.

If flatbed equipment is not available, and the transmission is operable, the vehicle may be towed (with rear wheels on the ground) with the transmission in **NEUTRAL**. Speed must not exceed 30 mph (48 km/h) and the distance must not exceed 30 miles (48 km).

**CAUTION!**

Towing faster than 30 mph (48 km/h) or farther than 30 miles (48 km) with rear wheels on the ground can cause severe transmission damage. Damage from improper towing is not covered under the New Vehicle Limited Warranty.

If the transmission is not operable, or the vehicle must be towed faster than 30 mph (48 km/h) or farther than 30 miles (48 km), tow with the rear wheels **OFF** the ground. Acceptable methods are to tow the vehicle on a flatbed, or with the front wheels raised and the rear wheels on a towing dolly, or (when using a suitable steering wheel stabilizer to hold the front wheels in the straight position) with the rear wheels raised and the front wheels on the ground.

**All-Wheel Drive Models**

The manufacturer recommends towing with all wheels **OFF** the ground. Acceptable methods are to tow the vehicle on a flatbed or with one end of the vehicle raised and the opposite end on a towing dolly.

If flatbed equipment is not available, and the transfer case is operable, the vehicles **with a two-speed transfer case** may be towed (in the forward direction, with **ALL** wheels on the ground), **IF** the transfer case is in **NEUTRAL** and the transmission is in **PARK**. Refer to “Recreational Towing” in “Starting and Operating” for detailed instructions.

Vehicles equipped with a single-speed transfer case have no **NEUTRAL** position, and therefore **must** be towed with all four wheels **OFF** the ground.

**CAUTION!**

- Front or rear wheel lifts must not be used. Internal damage to the transmission or transfer case will occur if a front or rear wheel lift is used when towing.
- Towing this vehicle in violation of the above requirements can cause severe transmission and/or transfer case damage. Damage from improper towing is not covered under the New Vehicle Limited Warranty.

# MAINTAINING YOUR VEHICLE

## CONTENTS

---

■ ENGINE COMPARTMENT — 3.6L . . . . .	.581	□ Engine Air Cleaner Filter . . . . .	.590
■ ENGINE COMPARTMENT — 5.7L . . . . .	.582	□ Maintenance-Free Battery . . . . .	.591
■ ONBOARD DIAGNOSTIC SYSTEM (OBD II) . .	.583	□ Air Conditioner Maintenance . . . . .	.592
■ EMISSIONS INSPECTION AND MAINTENANCE PROGRAMS . . . . .	.583	□ Body Lubrication . . . . .	.597
■ REPLACEMENT PARTS . . . . .	.585	□ Windshield Wiper Blades . . . . .	.597
■ DEALER SERVICE . . . . .	.585	□ Adding Washer Fluid . . . . .	.599
■ MAINTENANCE PROCEDURES . . . . .	.586	□ Exhaust System . . . . .	.600
□ Engine Oil . . . . .	.587	□ Cooling System . . . . .	.602
□ Engine Oil Filter . . . . .	.590	□ Brake System . . . . .	.608
		□ Front/Rear Axle Fluid . . . . .	.610

- Transfer Case . . . . .611
- Automatic Transmission . . . . .612
- Appearance Care And Protection From Corrosion . . . . .614
- FUSES . . . . .621
  - Power Distribution Center . . . . .622
- VEHICLE STORAGE . . . . .630
- REPLACEMENT BULBS . . . . .631
- BULB REPLACEMENT . . . . .633
  - High Intensity Discharge Headlamps (Bi-Xenon) — If Equipped . . . . .633
  - Bi-Halogen Headlamps — If Equipped . . . . .634
  - Front Turn Signal . . . . .635
  - Front Fog Lamps . . . . .635
  - Rear Tail, Stop And Turn Signal Lamps . . . . .636
  - Rear Liftgate Mounted Back-up Lamps . . . . .636
  - Center High-Mounted Stop Lamp (CHMSL) . .636
  - Rear License Lamp . . . . .636
- FLUID CAPACITIES . . . . .637
- FLUIDS, LUBRICANTS, AND GENUINE PARTS . . . . .639
  - Engine . . . . .639
  - Chassis . . . . .641

## ENGINE COMPARTMENT — 3.6L

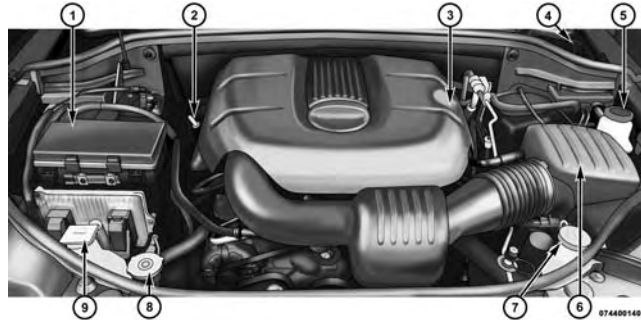

- 1 — Power Distribution Center (Fuses)
- 2 — Engine Oil Dipstick
- 3 — Engine Oil Fill
- 4 — Brake Fluid Reservoir
- 5 — Power Steering Fluid Reservoir

- 6 — Air Cleaner Filter
- 7 — Washer Fluid Reservoir
- 8 — Coolant Pressure Cap (Radiator)
- 9 — Engine Coolant Reservoir

## ENGINE COMPARTMENT — 5.7L

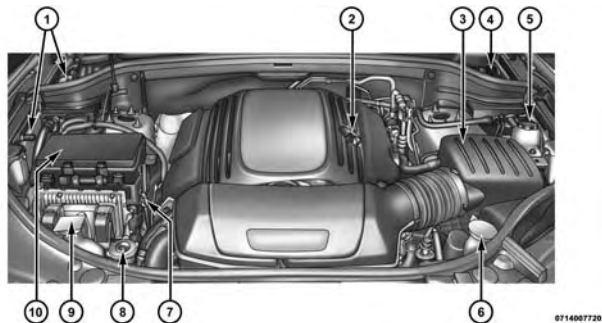

1 — Remote Jump Start Terminals

2 — Engine Oil Fill

3 — Air Cleaner Filter

4 — Brake Fluid Reservoir

5 — Power Steering Fluid Reservoir

6 — Washer Fluid Reservoir

7 — Engine Oil Dipstick

8 — Coolant Pressure Cap

9 — Engine Coolant Reservoir

10 — Power Distribution Center (Fuses)



## ONBOARD DIAGNOSTIC SYSTEM (OBD II)

Your vehicle is equipped with a sophisticated onboard diagnostic system called OBD II. This system monitors the performance of the emissions, engine, and automatic transmission control systems. When these systems are operating properly, your vehicle will provide excellent performance and fuel economy, as well as engine emissions well within current government regulations.

If any of these systems require service, the OBD II system will turn on the “Malfunction Indicator Light (MIL).” It will also store diagnostic codes and other information to assist your service technician in making repairs. Although your vehicle will usually be drivable and not need towing, see your authorized dealer for service as soon as possible.

### CAUTION!

- Prolonged driving with the MIL on could cause further damage to the emission control system. It could also affect fuel economy and driveability. The vehicle must be serviced before any emissions tests can be performed.
- If the MIL is flashing, while the engine is running, severe catalytic converter damage and power loss will soon occur. Immediate service is required.

## EMISSIONS INSPECTION AND MAINTENANCE PROGRAMS

In some localities, it may be a legal requirement to pass an inspection of your vehicle’s emissions control system. Failure to pass could prevent vehicle registration.



For states that require an Inspection and Maintenance (I/M), this check verifies the “Malfunction Indicator Light (MIL)” is functioning and is not on when the engine is running, and that the OBD II system is ready for testing.

Normally, the OBD II system will be ready. The OBD II system may **not** be ready if your vehicle was recently serviced, recently had a dead battery or a battery replacement. If the OBD II system should be determined not ready for the I/M test, your vehicle may fail the test.

Your vehicle has a simple ignition actuated test, which you can use prior to going to the test station. To check if your vehicle’s OBD II system is ready, you must do the following:

1. Cycle the ignition switch to the ON position, but do not crank or start the engine.

**NOTE:** If you crank or start the engine, you will have to start this test over.

2. As soon as you cycle the ignition switch to the ON position, you will see the Malfunction Indicator Light (MIL) symbol come on as part of a normal bulb check.
3. Approximately 15 seconds later, one of two things will happen:
  - The MIL will flash for about 10 seconds and then return to being fully illuminated until you turn OFF the ignition or start the engine. This means that your vehicle’s OBD II system is **not ready** and you should **not** proceed to the I/M station.
  - The MIL will not flash at all and will remain fully illuminated until you place the ignition in the off position or start the engine. This means that your vehicle’s OBD II system is **ready** and you can proceed to the I/M station.

If your OBD II system is **not ready**, you should see your authorized dealer or repair facility. If your vehicle was recently serviced or had a battery failure or replacement, you may need to do nothing more than drive your vehicle as you normally would in order for your OBD II system to update. A recheck with the above test routine may then indicate that the system is **now ready**.

Regardless of whether your vehicle's OBD II system is ready or not, if the MIL is illuminated during normal vehicle operation you should have your vehicle serviced before going to the I/M station. The I/M station can fail your vehicle because the MIL is on with the engine running.

## REPLACEMENT PARTS

Use of genuine MOPAR® parts for normal/scheduled maintenance and repairs is highly recommended to ensure the designed performance. Damage or failures

caused by the use of non-MOPAR® parts for maintenance and repairs will not be covered by the New Vehicle Limited Warranty.

## DEALER SERVICE

Your authorized dealer has the qualified service personnel, special tools, and equipment to perform all service operations in an expert manner. Service Manuals are available which include detailed service information for your vehicle. Refer to these Service Manuals before attempting any procedure yourself.

**NOTE:** Intentional tampering with emissions control systems may void your warranty and could result in civil penalties being assessed against you.

**WARNING!**

You can be badly injured working on or around a motor vehicle. Only do service work for which you have the knowledge and the proper equipment. If you have any doubt about your ability to perform a service job, take your vehicle to a competent mechanic.

**MAINTENANCE PROCEDURES**

The pages that follow contain the **required** maintenance services determined by the engineers who designed your vehicle.

Besides those maintenance items specified in the fixed "Maintenance Schedule", there are other components which may require servicing or replacement in the future.

**CAUTION!**

- Failure to properly maintain your vehicle or perform repairs and service when necessary could result in more costly repairs, damage to other components or negatively impact vehicle performance. Immediately have potential malfunctions examined by an authorized dealer or qualified repair center.
- Your vehicle has been built with improved fluids that protect the performance and durability of your vehicle and also allow extended maintenance intervals. Do not use chemical flushes in these components as the chemicals can damage your engine, transmission, power steering or air conditioning. Such damage is not covered by the New Vehicle Limited Warranty. If a flush is needed because of component malfunction, use only the specified fluid for the flushing procedure.

## Engine Oil

### Checking Oil Level

To assure proper lubrication of your vehicle's engine, the engine oil must be maintained at the correct level. Check the oil level at regular intervals, such as every fuel stop. The best time to check the engine oil level is about five minutes after a fully warmed up engine is shut off.

Checking the oil while the vehicle is on level ground will improve the accuracy of the oil level readings. Always maintain the oil level within the SAFE zone on the dipstick. Adding one quart of oil when the reading is at the bottom of the SAFE zone will result in a reading at the top of the safe zone on these engines.

### CAUTION!

**Overfilling or underfilling the crankcase will cause aeration or loss of oil pressure. This could damage your engine.**

### Change Engine Oil

The oil change indicator system will remind you that it is time to take your vehicle in for scheduled maintenance. Refer to the "Maintenance Schedule" for further information.

**NOTE: Under no circumstances should oil change intervals exceed 10,000 miles (16,000 km) or twelve months, whichever occurs first.**

## Engine Oil Selection

For best performance and maximum protection under all types of operating conditions, the manufacturer only recommends engine oils that are API Certified and meet the requirements of FCA US Material Standard MS-6395.

### American Petroleum Institute (API) Engine Oil Identification Symbol



This symbol means that the oil has been certified by the American Petroleum Institute (API). The manufacturer only recommends API Certified engine oils.

This symbol certifies 0W-20, 5W-20, 0W-30, 5W-30 and 10W-30 engine oils.

## CAUTION!

**Do not use chemical flushes in your engine oil as the chemicals can damage your engine. Such damage is not covered by the New Vehicle Limited Warranty.**

### Engine Oil Viscosity — 3.6L Engine

MOPAR® SAE 5W-20 engine oil approved to FCA US Material Standard MS-6395 such as Pennzoil®, Shell Helix® or equivalent is recommended for all operating temperatures. This engine oil improves low temperature starting and vehicle fuel economy.

The engine oil filler cap also shows the recommended engine oil viscosity for your engine. For information on engine oil filler cap location, refer to the “Engine Compartment” illustration in this section.

**NOTE:** MOPAR® SAE 5W-30 engine oil approved to FCA US Material Standard MS-6395 such as Pennzoil®, Shell Helix® or equivalent may be used when SAE 5W-20 engine oil meeting MS-6395 is not available.

### **Engine Oil Viscosity — 5.7L Engine**

MOPAR® SAE 5W-20 engine oil or equivalent such as Pennzoil® or Shell Helix® is recommended for all operating temperatures. This engine oil improves low temperature starting and vehicle fuel economy.

The engine oil filler cap also shows the recommended engine oil viscosity for your engine. For information on engine oil filler cap location, refer to “Engine Compartment” in “Maintaining Your Vehicle” for further information.

**NOTE:** Vehicles equipped with a 5.7L engine must use SAE 5W-20 oil. Failure to do so may result in improper operation of the Fuel Saver Technology. Refer to “Fuel Saver Technology – If Equipped” in “Starting And Operating” for further information.

Lubricants that do not have both, the engine oil certification mark and the correct SAE viscosity grade number should not be used.

### **Materials Added To Engine Oil**

The manufacturer strongly recommends against the addition of any additives (other than leak detection dyes) to the engine oil. Engine oil is an engineered product and its performance may be impaired by supplemental additives.

## Disposing Of Used Engine Oil And Oil Filters

Care should be taken in disposing of used engine oil and oil filters from your vehicle. Used oil and oil filters, indiscriminately discarded, can present a problem to the environment. Contact your authorized dealer, service station or governmental agency for advice on how and where used oil and oil filters can be safely discarded in your area.

### Engine Oil Filter

The engine oil filter should be replaced with a new filter at every engine oil change.

### Engine Oil Filter Selection

This manufacturer's engines have a full-flow type oil filter. Use a filter of this type for replacement. The quality of replacement filters varies considerably. Only high

quality filters should be used to assure most efficient service. MOPAR® engine oil filters are a high quality oil filter and are recommended.

### Engine Air Cleaner Filter

Refer to the "Maintenance Schedule" in the "Maintenance Schedules" section for the proper maintenance intervals.

#### **WARNING!**

**The air induction system (air cleaner, hoses, etc.) can provide a measure of protection in the case of engine backfire. Do not remove the air induction system (air cleaner, hoses, etc.) unless such removal is necessary for repair or maintenance. Make sure that no one is near the engine compartment before starting the vehicle with the air induction system (air cleaner, hoses, etc.) removed. Failure to do so can result in serious personal injury.**



## Engine Air Cleaner Filter Selection

The quality of replacement engine air cleaner filters varies considerably. Only high quality filters should be used to assure most efficient service. MOPAR® engine air cleaner filters are a high quality filter and are recommended.

## Maintenance-Free Battery

Your vehicle is equipped with a maintenance-free battery. You will never have to add water, nor is periodic maintenance required.

### WARNING!

- Battery fluid is a corrosive acid solution and can burn or even blind you. Do not allow battery fluid

*(Continued)*

### WARNING! *(Continued)*

to contact your eyes, skin, or clothing. Do not lean over a battery when attaching clamps. If acid splashes in eyes or on skin, flush the area immediately with large amounts of water. Refer to "Jump-Starting Procedures" in "What To Do In Emergencies" for further information.

- Battery gas is flammable and explosive. Keep flame or sparks away from the battery. Do not use a booster battery or any other booster source with an output greater than 12 Volts. Do not allow cable clamps to touch each other.
- Battery posts, terminals, and related accessories contain lead and lead compounds. Wash hands after handling.

**CAUTION!**

- It is essential when replacing the cables on the battery that the positive cable is attached to the positive post and the negative cable is attached to the negative post. Battery posts are marked positive (+) and negative (-) and are identified on the battery case. Cable clamps should be tight on the terminal posts and free of corrosion.
- If a “fast charger” is used while the battery is in the vehicle, disconnect both vehicle battery cables before connecting the charger to the battery. Do not use a “fast charger” to provide starting voltage.

**Air Conditioner Maintenance**

For best possible performance, your air conditioner should be checked and serviced by an authorized dealer at the start of each warm season. This service should include cleaning of the condenser fins and a performance

test. Drive belt tension should also be checked at this time.

**WARNING!**

- Use only refrigerants and compressor lubricants approved by the manufacturer for your air conditioning system. Some unapproved refrigerants are flammable and can explode, injuring you. Other unapproved refrigerants or lubricants can cause the system to fail, requiring costly repairs. Refer to Warranty Information Book, located on the DVD, for further warranty information.
- The air conditioning system contains refrigerant under high pressure. To avoid risk of personal injury or damage to the system, adding refrigerant or any repair requiring lines to be disconnected should be done by an experienced technician.

**CAUTION!**

**Do not use chemical flushes in your air conditioning system as the chemicals can damage your air conditioning components. Such damage is not covered by the New Vehicle Limited Warranty.**

**Refrigerant Recovery And Recycling R134a — If Equipped**

R-134a Air Conditioning Refrigerant is a hydrofluorocarbon (HFC) that is endorsed by the Environmental Protection Agency and is an ozone-saving product. However, the manufacturer recommends that air conditioning service be performed by authorized dealer or other service facilities using recovery and recycling equipment.

**NOTE:** Use only manufacturer approved A/C system PAG compressor oil and refrigerants.

**Refrigerant Recovery And Recycling HFO 1234yf — If Equipped**

HFO 1234yf Air Conditioning Refrigerant is a hydrofluoroolefine HFO that is endorsed by the Environmental Protection Agency and is an ozone-saving product with a low GWP (Global Warming Potential). However, the manufacturer recommends that air conditioning service be performed by authorized dealer or other service facilities using recovery and recycling equipment.

**NOTE:** Use only manufacturer approved A/C system PAG compressor oil and refrigerants.

**Air Conditioning Filter Replacement (A/C Air Filter)**

Refer to the “Maintenance Schedule” for the proper maintenance intervals.

**WARNING!**

- Do not remove the A/C air filter while the ignition is in the ON/RUN position or personal injury may result.
- Do not remove the A/C air filter while the blower is operating or personal injury may result.

The A/C air filter is located in the fresh air inlet behind the glove compartment. Perform the following procedure to replace the filter:

1. Open the glove compartment and remove all contents.



**Glove Compartment**

- 1 — Glove Compartment Travel Stops
- 2 — Glove Compartment Tension Tether
- 3 — Glove Compartment Door

2. There are glove compartment travel stops on both sides of the glove compartment door, partially close the glove compartment door and push inward to release the glove compartment travel stop on one side and repeat this procedure for the opposite side.
3. Pull the right hand side of the glove compartment door toward the rear of the vehicle to disengage the glove compartment door from its hinges.

**NOTE:** When disengaging the glove compartment door from its hinges, there will be some resistance.

4. With the glove compartment door loose, remove the glove compartment tension tether and tether clip by sliding the clip toward the face of the glove compartment door and lifting the clip out of glove compartment door.

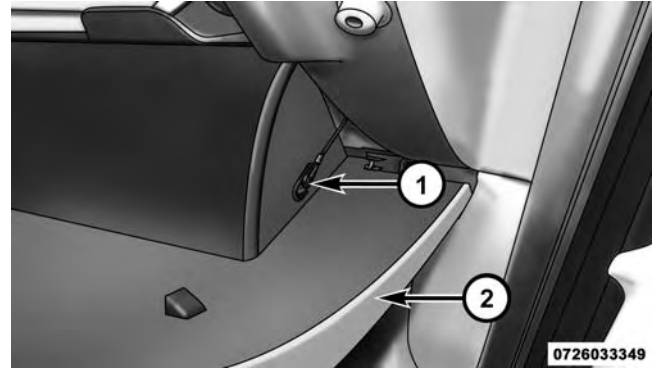

**Right Side Of Glove Compartment**

- 1 — Glove Compartment Tension Tether
- 2 — Glove Compartment Door

5. Remove the filter cover by disengaging the retaining tab and mid way snap that secures the filter cover to the HVAC housing. Disengage the mid way snap by

pulling the door outward. Unhinge the filter cover on the right side to fully remove the cover.

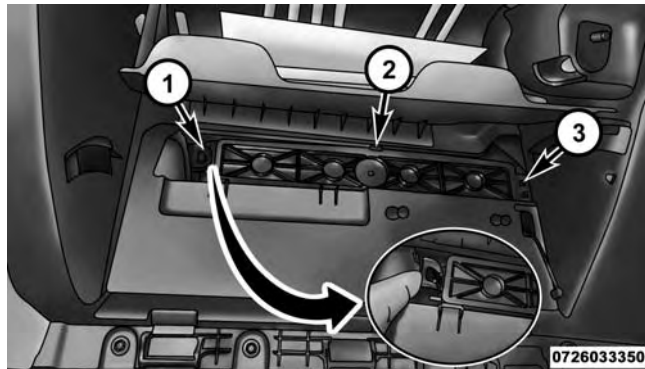

A/C Air Filter Cover

- 1 — Retaining Tab
- 2 — Mid Way Snap
- 3 — Filter Cover Hinge

6. Remove the A/C air filter by pulling it straight out of the housing.
7. Install the A/C air filter with the arrow on the filter pointing toward the floor. When installing the filter cover, make sure the retaining tabs fully engage the cover.

### CAUTION!

The A/C air filter is identified with an arrow to indicate airflow direction through the filter. Failure to properly install the filter will result in the need to replace it more often.

8. Reinstall the glove compartment door on the glove compartment door hinge and reattach the glove compartment tension tether by inserting the tether clip in the glove compartment and sliding the clip away from the face of the glove compartment door.

9. Push the door to the near closed position to reengage the glove compartment travel stops.

**NOTE:** Ensure the glove compartment door hinges and glove compartment travel stops are fully engaged.

### **Body Lubrication**

Locks and all body pivot points, including such items as seat tracks, door hinge pivot points and rollers, liftgate, tailgate, decklid, sliding doors and hood hinges, should be lubricated periodically with a lithium based grease, such as MOPAR® Spray White Lube to assure quiet, easy operation and to protect against rust and wear. Prior to the application of any lubricant, the parts concerned should be wiped clean to remove dust and grit; after lubricating excess oil and grease should be removed. Particular attention should also be given to hood latching components to ensure proper function. When performing other underhood services, the hood latch, release mechanism and safety catch should be cleaned and lubricated.

The external lock cylinders should be lubricated twice a year, preferably in the Fall and Spring. Apply a small amount of a high quality lubricant, such as MOPAR® Lock Cylinder Lubricant directly into the lock cylinder.

### **Windshield Wiper Blades**

Clean the rubber edges of the wiper blades and the windshield periodically with a sponge or soft cloth and a mild nonabrasive cleaner. This will remove accumulations of salt or road film.

Operation of the wipers on dry glass for long periods may cause deterioration of the wiper blades. Always use washer fluid when using the wipers to remove salt or dirt from a dry windshield.

Avoid using the wiper blades to remove frost or ice from the windshield. Keep the blade rubber out of contact with petroleum products such as engine oil, gasoline, etc.

**NOTE:** Life expectancy of wiper blades varies depending on geographical area and frequency of use. Poor performance of blades may be present with chattering, marks, water lines or wet spots. If any of these conditions are present, clean the wiper blades or replace as necessary.

### Rear Wiper Blade Removal/Installation

1. Lift the pivot cap on the rear wiper arm upward, this will allow the rear wiper blade to be raised off of the liftgate glass.

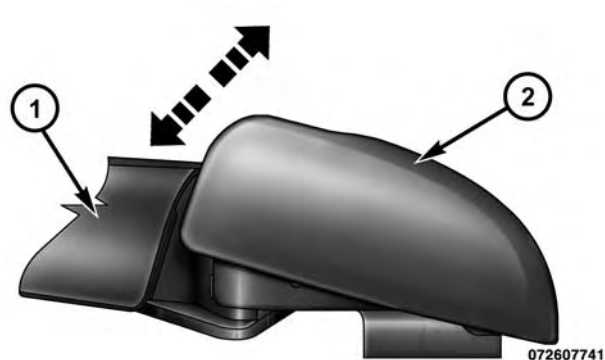

- 1 — Wiper Arm  
2 — Pivot Cap

**NOTE:** The rear wiper arm cannot be raised fully upward unless the pivot cap is raised first.

2. Lift the rear wiper arm upward to raise the wiper blade off of the liftgate glass.



- Grab the bottom of the wiper blade and rotate it forward to unsnap the blade pivot pin from the wiper blade holder.

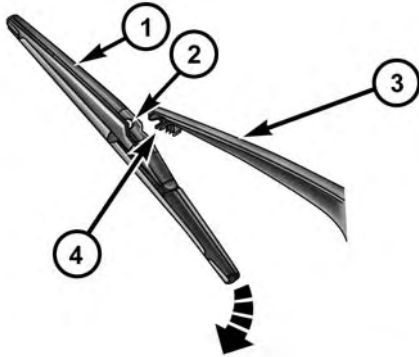

072607742

- 1 — Wiper Blade
- 2 — Blade Pivot Pin
- 3 — Wiper Arm
- 4 — Wiper Blade Holder

- Install the wiper blade pivot pin into the wiper blade holder at the end of the wiper arm, and firmly press the wiper blade until it snaps into place.
- Lower the wiper blade and snap the pivot cap into place.

### Adding Washer Fluid

This vehicle is equipped with a Driver Information Display (DID), the DID will indicate when the washer fluid level is low. When the sensor detects a low fluid level, the windshield will light on the vehicle graphic outline and the “WASHER FLUID LOW” message will be displayed.

The fluid reservoir for the windshield washers and the rear window washer is shared. The fluid reservoir is located in the engine compartment, be sure to check the fluid level at regular intervals. Fill the reservoir with windshield washer solvent only (not radiator antifreeze). When refilling the washer fluid reservoir, take some

washer fluid and apply it to a cloth or towel and wipe clean the wiper blades, this will help blade performance. To prevent freeze-up of your windshield washer system in cold weather, select a solution or mixture that meets or exceeds the temperature range of your climate. This rating information can be found on most washer fluid containers.

**WARNING!**

Commercially available windshield washer solvents are flammable. They could ignite and burn you. Care must be exercised when filling or working around the washer solution.

**Exhaust System**

The best protection against carbon monoxide entry into the vehicle body is a properly maintained engine exhaust system.

If you notice a change in the sound of the exhaust system; or if the exhaust fumes can be detected inside the vehicle; or when the underside or rear of the vehicle is damaged; have an authorized technician inspect the complete exhaust system and adjacent body areas for broken, damaged, deteriorated, or mispositioned parts. Open seams or loose connections could permit exhaust fumes to seep into the passenger compartment. In addition, have the exhaust system inspected each time the vehicle is raised for lubrication or oil change. Replace as required.

**WARNING!**

- Exhaust gases can injure or kill. They contain carbon monoxide (CO), which is colorless and odorless. Breathing it can make you unconscious and can eventually poison you. To avoid breathing CO, refer to "Safety Tips/Exhaust Gas" in "Things

*(Continued)*

**WARNING! (Continued)**

To Know Before Starting Your Vehicle” for further information.

- A hot exhaust system can start a fire if you park over materials that can burn. Such materials might be grass or leaves coming into contact with your exhaust system. Do not park or operate your vehicle in areas where your exhaust system can contact anything that can burn.

**CAUTION!**

- The catalytic converter requires the use of unleaded fuel only. Leaded gasoline will destroy the effectiveness of the catalyst as an emissions control device and may seriously reduce engine performance and cause serious damage to the engine.

*(Continued)*

**CAUTION! (Continued)**

- Damage to the catalytic converter can result if your vehicle is not kept in proper operating condition. In the event of engine malfunction, particularly involving engine misfire or other apparent loss of performance, have your vehicle serviced promptly. Continued operation of your vehicle with a severe malfunction could cause the converter to overheat, resulting in possible damage to the converter and vehicle.

Under normal operating conditions, the catalytic converter will not require maintenance. However, it is important to keep the engine properly tuned to assure proper catalyst operation and prevent possible catalyst damage.

**NOTE:** Intentional tampering with emissions control systems can result in civil penalties being assessed against you.

In unusual situations involving grossly malfunctioning engine operation, a scorching odor may suggest severe and abnormal catalyst overheating. If this occurs, stop the vehicle, turn off the engine and allow it to cool. Service, including a tune-up to manufacturer's specifications, should be obtained immediately.

To minimize the possibility of catalytic converter damage:

- Do not shut off the engine or interrupt the ignition, when the transmission is in gear and the vehicle is in motion.
- Do not try to start the engine by pushing or towing the vehicle.

- Do not idle the engine with any spark plug wires disconnected or removed, such as when diagnostic testing, or for prolonged periods during very rough idle or malfunctioning operating conditions.

### Cooling System

#### **WARNING!**

**You or others can be badly burned by hot engine coolant (antifreeze) or steam from your radiator. If you see or hear steam coming from under the hood, do not open the hood until the radiator has had time to cool. Never try to open a cooling system pressure cap when the radiator or coolant bottle is hot.**

### Engine Coolant Checks

Check the engine coolant (antifreeze) protection every 12 months (before the onset of freezing weather, where applicable). If the engine coolant (antifreeze) is dirty, the

system should be drained, flushed, and refilled with fresh OAT coolant (conforming to MS.90032) by an authorized dealer. Check the front of the A/C condenser for any accumulation of bugs, leaves, etc. If dirty, clean by gently spraying water from a garden hose vertically down the face of the condenser.

Check the engine cooling system hoses for brittle rubber, cracking, tears, cuts, and tightness of the connection at the coolant recovery bottle and radiator. Inspect the entire system for leaks.

With the engine at normal operating temperature (but not running), check the cooling system pressure cap for proper vacuum sealing by draining a small amount of engine coolant (antifreeze) from the radiator drain cock. If the cap is sealing properly, the engine coolant (antifreeze) will begin to drain from the coolant recovery bottle. **DO NOT REMOVE THE COOLANT PRESSURE CAP WHEN THE COOLING SYSTEM IS HOT.**

## Cooling System — Drain, Flush And Refill

**NOTE:** Some vehicles require special tools to add coolant properly. Failure to fill these systems properly could lead to severe internal engine damage. If any coolant is needed to be added to the system please contact your local authorized dealer.

If the engine coolant (antifreeze) is dirty or contains visible sediment, have an authorized dealer clean and flush with OAT coolant (antifreeze) (conforming to MS.90032).

Refer to the “Maintenance Schedule” for the proper maintenance intervals.

## Selection Of Coolant

Refer to “Fluids, Lubricants, And Genuine Parts” in “Maintaining Your Vehicle” for further information.

**CAUTION!**

- Mixing of engine coolant (antifreeze) other than specified Organic Additive Technology (OAT) engine coolant (antifreeze), may result in engine damage and may decrease corrosion protection. Organic Additive Technology (OAT) engine coolant is different and should not be mixed with Hybrid Organic Additive Technology (HOAT) engine coolant (antifreeze) or any “globally compatible” coolant (antifreeze). If a non-OAT engine coolant (antifreeze) is introduced into the cooling system in an emergency, the cooling system will need to be drained, flushed, and refilled with fresh OAT coolant (conforming to MS.90032), by an authorized dealer as soon as possible.
- Do not use water alone or alcohol-based engine coolant (antifreeze) products. Do not use additional

**CAUTION! (Continued)**

- rust inhibitors or antirust products, as they may not be compatible with the radiator engine coolant and may plug the radiator.
- This vehicle has not been designed for use with propylene glycol-based engine coolant (antifreeze). Use of propylene glycol-based engine coolant (antifreeze) is not recommended.

**Adding Coolant**

Your vehicle has been built with an improved engine coolant (OAT coolant conforming to MS.90032) that allows extended maintenance intervals. This engine coolant (antifreeze) can be used up to ten years or 150,000 miles (240,000 km) before replacement. To prevent reducing this extended maintenance period, it is important that you use the same engine coolant (OAT coolant conforming to MS.90032) throughout the life of your vehicle.

*(Continued)*

Please review these recommendations for using Organic Additive Technology (OAT) engine coolant (antifreeze) that meets the requirements of FCA Material Standard MS.90032. When adding engine coolant (antifreeze):

- We recommend using MOPAR® Antifreeze/Coolant 10 Year/150,000 Mile Formula OAT (Organic Additive Technology) that meets the requirements of FCA Material Standard MS.90032.
- Mix a minimum solution of 50% OAT engine coolant that meets the requirements of FCA Material Standard MS.90032 and distilled water. Use higher concentrations (not to exceed 70%) if temperatures below  $-34^{\circ}\text{F}$  ( $-37^{\circ}\text{C}$ ) are anticipated.
- Use only high purity water such as distilled or deionized water when mixing the water/engine coolant (antifreeze) solution. The use of lower quality water will reduce the amount of corrosion protection in the engine cooling system.

Please note that it is the owner's responsibility to maintain the proper level of protection against freezing according to the temperatures occurring in the area where the vehicle is operated.

**NOTE:**

- Some vehicles require special tools to add coolant properly. Failure to fill these systems properly could lead to severe internal engine damage. If any coolant is needed to be added to the system please contact your local authorized dealer.
- Mixing engine coolant (antifreeze) types is not recommended and can result in cooling system damage. If HOAT and OAT coolant are mixed in an emergency, have a authorized dealer drain, flush, and refill with OAT coolant (conforming to MS.90032) as soon as possible.

## Cooling System Pressure Cap

The cap must be fully tightened to prevent loss of engine coolant (antifreeze), and to ensure that engine coolant (antifreeze) will return to the radiator from the coolant recovery tank.

The cap should be inspected and cleaned if there is any accumulation of foreign material on the sealing surfaces.

### **WARNING!**

- **Do not open hot engine cooling system. Never add engine coolant (antifreeze) when the engine is overheated. Do not loosen or remove the cap to cool an overheated engine. Heat causes pressure to build up in the cooling system. To prevent scalding or injury, do not remove the pressure cap while the system is hot or under pressure.**

*(Continued)*

### **WARNING! (Continued)**

- **Do not use a pressure cap other than the one specified for your vehicle. Personal injury or engine damage may result.**

## Disposal Of Used Engine Coolant

Used ethylene glycol-based engine coolant (antifreeze) is a regulated substance requiring proper disposal. Check with your local authorities to determine the disposal rules for your community. To prevent ingestion by animals or children, do not store ethylene glycol-based engine coolant in open containers or allow it to remain in puddles on the ground. If ingested by a child or pet, seek emergency assistance immediately. Clean up any ground spills immediately.



## Coolant Level

The coolant bottle provides a quick visual method for determining that the coolant level is adequate. With the engine OFF and cold, the level of the engine coolant (antifreeze) in the bottle should be between the ranges indicated on the bottle.

The radiator normally remains completely full, so there is no need to remove the radiator/coolant pressure cap unless checking for engine coolant (antifreeze) freeze point or replacing coolant. Advise your service attendant of this. As long as the engine operating temperature is satisfactory, the coolant bottle need only be checked once a month.

When additional engine coolant (antifreeze) is needed to maintain the proper level, only OAT coolant that meets the requirements of FCA Material Standard MS.90032 should be added to the coolant bottle. Do not overfill.

## Points To Remember

**NOTE:** When the vehicle is stopped after a few miles/kilometers of operation, you may observe vapor coming from the front of the engine compartment. This is normally a result of moisture from rain, snow, or high humidity accumulating on the radiator and being vaporized when the thermostat opens, allowing hot engine coolant (antifreeze) to enter the radiator.

If an examination of your engine compartment shows no evidence of radiator or hose leaks, the vehicle may be safely driven. The vapor will soon dissipate.

- Do not overfill the coolant expansion bottle.
- Check the coolant freeze point in the radiator and in the coolant expansion bottle. If engine coolant (antifreeze) needs to be added, the contents of the coolant expansion bottle must also be protected against freezing.

- If frequent engine coolant (antifreeze) additions are required, the cooling system should be pressure tested for leaks.
- Maintain engine coolant (antifreeze) concentration at a minimum of 50% OAT coolant (conforming to MS.90032) and distilled water for proper corrosion protection of your engine which contains aluminum components.
- Make sure that the coolant expansion bottle overflow hoses are not kinked or obstructed.
- Keep the front of the radiator clean. If your vehicle is equipped with air conditioning, keep the front of the condenser clean.
- Do not change the thermostat for Summer or Winter operation. If replacement is ever necessary, install **ONLY** the correct type thermostat. Other designs may

result in unsatisfactory engine coolant (antifreeze) performance, poor gas mileage, and increased emissions.

### **Brake System**

In order to assure brake system performance, all brake system components should be inspected periodically. Refer to the "Maintenance Schedule" for the proper maintenance intervals.

#### **WARNING!**

**Riding the brakes can lead to brake failure and possibly a collision. Driving with your foot resting or riding on the brake pedal can result in abnormally high brake temperatures, excessive lining wear, and possible brake damage. You would not have your full braking capacity in an emergency.**

## Fluid Level Check — Brake Master Cylinder

The fluid level of the master cylinder should be checked when performing under the hood service, or immediately if the brake system warning lamp indicates system failure.

The brake master cylinder has a plastic reservoir. On the outboard side of the reservoir, there is a "MAX" dot and a "MIN" dot. The fluid level must be kept within these two dots. Do not add fluid above the MAX mark, because leakage may occur at the cap.

With disc brakes, the fluid level can be expected to fall as the brake linings wear. However, an unexpected drop in fluid level may be caused by a leak and a system check should be conducted.

Refer to "Fluids, Lubricants, and Genuine Parts" in "Maintaining Your Vehicle" for further information.

### WARNING!

- Use only manufacturer's recommended brake fluid. Refer to "Fluids, Lubricants, And Genuine Parts" in "Maintaining Your Vehicle" for further information. Using the wrong type of brake fluid can severely damage your brake system and/or impair its performance. The proper type of brake fluid for your vehicle is also identified on the original factory installed hydraulic master cylinder reservoir.
- To avoid contamination from foreign matter or moisture, use only new brake fluid or fluid that has been in a tightly closed container. Keep the master cylinder reservoir cap secured at all times. Brake fluid in an open container absorbs moisture from the air resulting in a lower boiling point. This may

*(Continued)*

**WARNING! (Continued)**

cause it to boil unexpectedly during hard or prolonged braking, resulting in sudden brake failure. This could result in a collision.

- Overfilling the brake fluid reservoir can result in spilling brake fluid on hot engine parts, causing the brake fluid to catch fire. Brake fluid can also damage painted and vinyl surfaces, care should be taken to avoid its contact with these surfaces.
- Do not allow petroleum based fluid to contaminate the brake fluid. Brake seal components could be damaged, causing partial or complete brake failure. This could result in a collision.

**Front/Rear Axle Fluid**

For normal service, periodic fluid level checks are not required. When the vehicle is serviced for other reasons the exterior surfaces of the axle assembly should be

inspected. If gear oil leakage is suspected inspect the fluid level. Refer to “Fluids, Lubricants, and Genuine Parts” in “Maintaining Your Vehicle” for further information.

**Front Axle Fluid Level Check**

The front axle oil level needs to be no lower than 1/8 in (3 mm) below the bottom of the fill hole.

The front axle fill and drain plugs should be tightened to 22 to 29 ft lbs (30 to 40 N·m).

**CAUTION!**

**Do not overtighten the plugs as it could damage them and cause them to leak.**

**Rear Axle Fluid Level Check**

The rear axle oil level needs to be no lower than 1/8 in (3 mm) below the bottom of the fill hole.

The rear axle fill and drain plugs should be tightened to 22 to 29 ft lbs (30 to 40 N·m).

### CAUTION!

**Do not overtighten the plugs as it could damage them and cause them to leak.**

### Selection Of Lubricant

Use only the manufacturer's recommended fluid. Refer to "Fluids, Lubricants, and Genuine Parts" in "Maintaining Your Vehicle" for further information.

### Transfer Case

#### Fluid Level Check

For normal service, periodic fluid level checks are not required. When the vehicle is serviced for other reasons the exterior surfaces of the transfer case assembly should be inspected. If oil leakage is suspected inspect the fluid

level. Refer to "Fluids, Lubricants, and Genuine Parts" in "Maintaining Your Vehicle" for further information.

### Adding Fluid

Add fluid at the filler hole, until it runs out of the hole, when the vehicle is in a level position.

### Drain

First remove fill plug, then remove drain plug. Recommended tightening torque for drain and fill plugs is 15 to 25 ft lbs (20 to 34 N·m).

### CAUTION!

**When installing plugs, do not overtighten. You could damage them and cause them to leak.**

### Selection Of Lubricant

Use only the manufacturer's recommended fluid. Refer to "Fluids, Lubricants, and Genuine Parts" in "Maintaining Your Vehicle" for further information.

### Automatic Transmission

#### Selection Of Lubricant

It is important to use the proper transmission fluid to ensure optimum transmission performance and life. Use only the manufacturer's specified transmission fluid. Refer to "Fluids, Lubricants, and Genuine Parts" in this section for fluid specifications. It is important to maintain the transmission fluid at the correct level using the recommended fluid.

**NOTE:** No chemical flushes should be used in any transmission; only the approved lubricant should be used.

### CAUTION!

Using a transmission fluid other than the manufacturer's recommended fluid may cause deterioration in transmission shift quality and/or torque converter shudder. Refer to "Fluids, Lubricants, And Genuine Parts" in this section for fluid specifications.

#### Special Additives

The manufacturer strongly recommends against using any special additives in the transmission.

Automatic Transmission Fluid (ATF) is an engineered product and its performance may be impaired by supplemental additives. Therefore, do not add any fluid additives to the transmission. The only exception to this policy is the use of special dyes for diagnosing fluid leaks. Avoid using transmission sealers as they may adversely affect seals.

**CAUTION!**

Do not use chemical flushes in your transmission as the chemicals can damage your transmission components. Such damage is not covered by the New Vehicle Limited Warranty.

**Fluid Level Check**

The fluid level is preset at the factory and does not require adjustment under normal operating conditions. Routine fluid level checks are not required, therefore the transmission has no dipstick. Your authorized dealer can check your transmission fluid level using special service tools.

If you notice fluid leakage or transmission malfunction, visit your authorized dealer immediately to have the transmission fluid level checked. Operating the vehicle

with an improper fluid level can cause severe transmission damage.

**CAUTION!**

If a transmission fluid leak occurs, visit your authorized dealer immediately. Severe transmission damage may occur. Your authorized dealer has the proper tools to adjust the fluid level accurately.

**Fluid And Filter Changes**

Under normal operating conditions, the fluid installed at the factory will provide satisfactory lubrication for the life of the vehicle.

Routine fluid and filter changes are not required. However, change the fluid and filter if the fluid becomes contaminated (with water, etc.), or if the transmission is disassembled for any reason.

## Appearance Care And Protection From Corrosion

### Protection Of Body And Paint From Corrosion

Vehicle body care requirements vary according to geographic locations and usage. Chemicals that make roads passable in snow and ice and those that are sprayed on trees and road surfaces during other seasons are highly corrosive to the metal in your vehicle. Outside parking, which exposes your vehicle to airborne contaminants, road surfaces on which the vehicle is operated, extreme hot or cold weather and other extreme conditions will have an adverse effect on paint, metal trim, and underbody protection.

The following maintenance recommendations will enable you to obtain maximum benefit from the corrosion resistance built into your vehicle.

### What Causes Corrosion?

Corrosion is the result of deterioration or removal of paint and protective coatings from your vehicle.

The most common causes are:

- Road salt, dirt and moisture accumulation.
- Stone and gravel impact.
- Insects, tree sap and tar.
- Salt in the air near seacoast localities.
- Atmospheric fallout/industrial pollutants.

### Washing

- Wash your vehicle regularly. Always wash your vehicle in the shade using MOPAR® Car Wash, or a mild car wash soap, and rinse the panels completely with clear water.



- If insects, tar, or other similar deposits have accumulated on your vehicle, use MOPAR® Super Kleen Bug and Tar Remover to remove.
- Use a high quality cleaner wax, such as MOPAR® Cleaner Wax to remove road film, stains and to protect your paint finish. Take care never to scratch the paint.
- Avoid using abrasive compounds and power buffing that may diminish the gloss or thin out the paint finish.

### CAUTION!

- **Do not use abrasive or strong cleaning materials such as steel wool or scouring powder that will scratch metal and painted surfaces.**
- **Use of power washers exceeding 1,200 psi (8 274 kPa) can result in damage or removal of paint and decals.**

### Special Care

- If you drive on salted or dusty roads or if you drive near the ocean, hose off the undercarriage at least once a month.
- It is important that the drain holes in the lower edges of the doors, rocker panels, and trunk be kept clear and open.
- If you detect any stone chips or scratches in the paint, touch them up immediately. The cost of such repairs is considered the responsibility of the owner.
- If your vehicle is damaged due to a collision or similar cause that destroys the paint and protective coating, have your vehicle repaired as soon as possible. The cost of such repairs is considered the responsibility of the owner.

- If you carry special cargo such as chemicals, fertilizers, de-icer salt, etc., be sure that such materials are well packaged and sealed.
- If a lot of driving is done on gravel roads, consider mud or stone shields behind each wheel.
- Use MOPAR® Touch Up Paint on scratches as soon as possible. Your authorized dealer has touch up paint to match the color of your vehicle.

### Wheel And Wheel Trim Care

All wheels and wheel trim, especially aluminum and chrome plated wheels, should be cleaned regularly using mild (neutral Ph) soap and water to maintain their luster and to prevent corrosion. Wash wheels with the same soap solution recommended for the body of the vehicle.

Your wheels are susceptible to deterioration caused by salt, sodium chloride, magnesium chloride, calcium chloride, etc., and other road chemicals used to melt ice or

control dust on dirt roads. Use a soft cloth or sponge and mild soap to wipe away promptly. Do not use harsh chemicals or a stiff brush. They can damage the wheel's protective coating that helps keep them from corroding and tarnishing.

**NOTE:** Many aftermarket wheel cleaners contain strong acids or strong alkaline additives that can harm the wheel surface.

### CAUTION!

**Avoid products or automatic car washes that use acidic solutions or strong alkaline additives or harsh brushes. These products and automatic car washes may damage the wheel's protective finish. Such damage is not covered by the New Vehicle Limited Warranty. Only car wash soap, MOPAR Wheel Cleaner or equivalent is recommended.**

When cleaning extremely dirty wheels including excessive brake dust, care must be taken in the selection of tire and wheel cleaning chemicals and equipment to prevent damage to the wheels. Mopar Wheel Treatment or Mopar Chrome Cleaner or their equivalent is recommended or select a non-abrasive, non-acidic cleaner for aluminum or chrome wheels. Do not use any products on Dark Vapor or Black Satin Chrome Wheels. They will permanently damage this finish and such damage is not covered by the New Vehicle Limited Warranty.

### CAUTION!

Do not use scouring pads, steel wool, a bristle brush, metal polishes or oven cleaner. These products may damage the wheel's protective finish. Such damage is not covered by the New Vehicle Limited Warranty. Only car wash soap, MOPAR Wheel Cleaner or equivalent is recommended.

**NOTE:** If you intend parking or storing your vehicle for an extended period after cleaning the wheels with wheel cleaner, drive your vehicle for a few minutes before doing so. Driving the vehicle and applying the brakes when stopping will reduce the risk of brake rotor corrosion.

### Dark Vapor Or Black Satin Chrome Wheels

#### CAUTION!

If your vehicle is equipped with Dark Vapor or Black Satin Chrome wheels **DO NOT USE** wheel cleaners, abrasives or polishing compounds. They will permanently damage this finish and such damage is not covered by the New Vehicle Limited Warranty. **USE ONLY MILD SOAP AND WATER WITH A SOFT CLOTH.** Used on a regular basis; this is all that is required to maintain this finish.

### Stain Repel Fabric Cleaning Procedure — If Equipped

Stain Repel seats may be cleaned in the following manner:

- Remove as much of the stain as possible by blotting with a clean, dry towel.
- Blot any remaining stain with a clean, damp towel.
- For tough stains, apply MOPAR® Total Clean, or a mild soap solution to a clean, damp cloth and remove stain. Use a fresh, damp towel to remove soap residue.
- For grease stains, apply MOPAR® Multi-Purpose Cleaner to a clean, damp cloth and remove stain. Use a fresh, damp towel to remove soap residue.
- Do not use any harsh solvents or any other form of protectants on Stain Repel products.

### Interior Care

Use MOPAR® Total Clean to clean fabric upholstery and carpeting.

Use MOPAR® Total Clean to clean vinyl upholstery.

MOPAR® Total Clean is specifically recommended for leather upholstery.

Your leather upholstery can be best preserved by regular cleaning with a damp soft cloth. Small particles of dirt can act as an abrasive and damage the leather upholstery and should be removed promptly with a damp cloth. Stubborn soils can be removed easily with a soft cloth and MOPAR® Total Clean. Care should be taken to avoid soaking your leather upholstery with any liquid. Please do not use polishes, oils, cleaning fluids, solvents, detergents, or ammonia-based cleaners to clean your leather upholstery. Application of a leather conditioner is not required to maintain the original condition.

**WARNING!**

Do not use volatile solvents for cleaning purposes. Many are potentially flammable, and if used in closed areas they may cause respiratory harm.

**CAUTION!**

Direct contact of air fresheners, insect repellents, suntan lotions, or hand sanitizers to the plastic, painted, or decorated surfaces of the interior may cause permanent damage. Wipe away immediately.

**CAUTION!**

Damage caused by these type of products may not be covered by your New Vehicle Limited Warranty.

**CAUTION!**

Do not use Alcohol and Alcohol-based and/or Keton based cleaning products to clean leather seats, as damage to the seat may result.

**Cleaning Headlights**

Your vehicle is equipped with plastic headlights and fog lights that are lighter and less susceptible to stone breakage than glass headlights.

Plastic is not as scratch resistant as glass and therefore different lens cleaning procedures must be followed.

To minimize the possibility of scratching the lenses and reducing light output, avoid wiping with a dry cloth. To remove road dirt, wash with a mild soap solution followed by rinsing.

Do not use abrasive cleaning components, solvents, steel wool or other aggressive material to clean the lenses.

## Glass Surfaces

All glass surfaces should be cleaned on a regular basis with MOPAR® Glass Cleaner, or any commercial household-type glass cleaner. Never use an abrasive type cleaner. Use caution when cleaning the inside rear window equipped with electric defrosters or windows equipped with radio antennas. Do not use scrapers or other sharp instrument that may scratch the elements.

When cleaning the rear view mirror, spray cleaner on the towel or cloth that you are using. Do not spray cleaner directly on the mirror.

## Cleaning Plastic Instrument Cluster Lenses

The lenses in front of the instruments in this vehicle are molded in clear plastic. When cleaning the lenses, care must be taken to avoid scratching the plastic.

1. Clean with a wet soft cloth. A mild soap solution may be used, but do not use high alcohol content or abrasive cleaners. If soap is used, wipe clean with a clean damp cloth.
2. Dry with a soft cloth.

## Seat Belt Maintenance

Do not bleach, dye, or clean the belts with chemical solvents or abrasive cleaners. This will weaken the fabric. Sun damage can also weaken the fabric.

If the belts need cleaning, use MOPAR® Total Clean, a mild soap solution, or lukewarm water. Do not remove the belts from the vehicle to wash them. Dry with a soft cloth.

Replace the belts if they appear frayed or worn or if the buckles do not work properly.

**WARNING!**

A frayed or torn belt could rip apart in a collision and leave you with no protection. Inspect the belt system periodically, checking for cuts, frays, or loose parts. Damaged parts must be replaced immediately. Do not disassemble or modify the system. Seat belt assemblies must be replaced after a collision if they have been damaged (i.e., bent retractor, torn webbing, etc.).

**FUSES****WARNING!**

- When replacing a blown fuse, always use an appropriate replacement fuse with the same amp rating as the original fuse. Never replace a fuse

**WARNING! (Continued)**

with another fuse of higher amp rating. Never replace a blown fuse with metal wires or any other material. Failure to use proper fuses may result in serious personal injury, fire and/or property damage.

- Before replacing a fuse, make sure that the ignition is off and that all the other services are switched off and/or disengaged.
- If the replaced fuse blows again, contact an authorized dealer.
- If a general protection fuse for safety systems (air bag system, braking system), power unit systems (engine system, gearbox system) or steering system blows, contact an authorized dealer.

*(Continued)*

## Power Distribution Center

The Power Distribution Center is located in the engine compartment near the battery. This center contains cartridge fuses, micro fuses, relays, and circuit breakers. A description of each fuse and component may be stamped on the inside cover, otherwise the cavity number of each fuse is stamped on the inside cover that corresponds to the following chart.

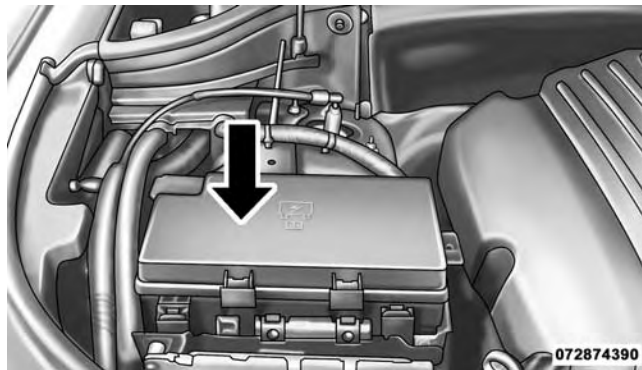

Power Distribution Center

Cavity	Cartridge Fuse	Micro Fuse	Description
F03	60 Amp Yellow	–	Radiator Fan
F05	40 Amp Green	–	Compressor for Air Suspension - If Equipped



Cavity	Cartridge Fuse	Micro Fuse	Description
F06	40 Amp Green	–	Anti-lock Brakes/Electronic Stability Control Pump
F07	40 Amp Green	–	Starter Solenoid
F08	20 Amp Blue	–	Emission Sensors (Diesel engine only)
F09	30 Amp Pink	–	Diesel Fuel Heater (Diesel engine only)
F10	40 Amp Green	–	Body Controller / Exterior Lighting #2
F11	30 Amp Pink	–	Trailer Tow Electric Brake - If Equipped
F12	40 Amp Green	–	Body Controller #3 / Power Locks
F13	40 Amp Green	–	Blower Motor Front
F14	40 Amp Green	–	Body Controller #4 / Interior Lights #2
F17	30 Amp Pink	–	Headlamp Washer- If Equipped
F19	20 Amp Blue	–	Headrest Solenoid- If Equipped
F20	30 Amp Pink	–	Passenger Door Module
F22	20 Amp Blue	–	Engine Control Module
F23	30 Amp Pink	–	Interior Lights #1

Cavity	Cartridge Fuse	Micro Fuse	Description
F24	30 Amp Pink	–	Driver Door Module
F25	30 Amp Pink	–	Front Wipers
F26	30 Amp Pink	–	Anti-lock Brakes/Stability Control Module/Valves
F28	20 Amp Blue	–	Trailer Tow Backup Lights - If Equipped
F29	20 Amp Blue	–	Trailer Tow Parking Lights - If Equipped
F30	30 Amp Pink	–	Trailer Tow Receptacle - If Equipped
F32	30 Amp Pink	–	Drive Train Control Module
F34	30 Amp Pink	–	Slip Differential Control
F35	30 Amp Pink	–	Sunroof - If Equipped
F36	30 Amp Pink	–	Rear Defroster
F37	25 Amp Clear	–	Rear Blower Motor - If Equipped
F38	30 Amp Pink	–	Power Inverter 115V AC - If Equipped
F39	30 Amp Pink	–	Power Liftgate - If Equipped

Cavity	Cartridge Fuse	Micro Fuse	Description
F40	–	10 Amp Red	Daytime Running Lights/Headlamp Leveling
F42	–	20 Amp Yellow	Horn
F44	–	10 Amp Red	Diagnostic Port
F46	–	10 Amp Red	Tire Pressure Monitor - If Equipped
F49	–	10 Amp Red	Integrated Central Stack / Climate Control
F50	–	20 Amp Yellow	Air Suspension Module / Electronic Limited Slip Differentials - If Equipped
F51	–	15 Amp Blue	Ignition Node Module / Keyless Ignition / Steering Column Lock
F52	–	5 Amp Tan	Battery Sensor
F53	–	20 Amp Yellow	Trailer Tow – Left Turn/Stop Lights - If Equipped
F55	–	10 Amp Red	DTV / DSRC
F56	–	15 Amp Blue	Additional Content (Diesel engine only)

Cavity	Cartridge Fuse	Micro Fuse	Description
F57	–	15 Amp Blue	HID Headlamps LH - If Equipped
F59	–	10 Amp Red	Purging Pump (Diesel engine only)
F60	–	15 Amp Blue	Transmission Control Module
F61	–	10 Amp Red	Transmission Control Module/PM Sensor (Diesel engine only)
F62	–	10 Amp Red	Air Conditioning Clutch
F63	–	20 Amp Yellow	Ignition Coils (Gas), Urea Heater (Diesel)
F64	–	25 Amp Clear	Fuel Injectors / Powertrain
F66	–	10 Amp Red	Sunroof / Passenger Window Switches / Rain Sensor
F67	–	15 Amp Blue	CD / DVD / Bluetooth Hands-free Mod- ule - If Equipped
F68	–	20 Amp Yellow	Rear Wiper Motor
F69	–	15 Amp Blue	Spotlight Feed - If Equipped
F70	–	20 Amp Yellow	Fuel Pump Motor

Cavity	Cartridge Fuse	Micro Fuse	Description
F71	–	30 Amp Green	Audio Amplifier
F73	–	15 Amp Blue	HID Headlamp RH - If Equipped
F74	–	20 Amp Yellow	Brake Vacuum Pump - If Equipped
F76	–	10 Amp Red	Anti-lock Brakes/Electronic Stability Control
F77	–	10 Amp Red	Drivetrain Control Module/Front Axle Disconnect Module
F78	–	10 Amp Red	Engine Control Module / Electric Power Steering - If Equipped
F80	–	10 Amp Red	Universal Garage Door Opener / Compass / Anti-Intrusion Module
F81	–	20 Amp Yellow	Trailer Tow Right Turn/Stop Lights
F82	–	10 Amp Red	Steering Column Control Module/ Cruise Control
F83	–	10 Amp Red	Fuel Door

Cavity	Cartridge Fuse	Micro Fuse	Description
F84	–	15 Amp Blue	Switch Bank/Instrument Cluster
F85	–	10 Amp Red	Airbag Module
F86	–	10 Amp Red	Airbag Module
F87	–	10 Amp Red	Air Suspension – If Equipped / Trailer Tow / Steering Column Control Module
F88	–	15 Amp Blue	Instrument Panel Cluster
F90/F91	–	20 Amp Yellow	Power Outlet (Rear seats) Selectable
F92	–	10 Amp Red	Rear Console Lamp - If Equipped
F93	–	20 Amp Yellow	Cigar Lighter
F94	–	10 Amp Red	Shifter / Transfer Case Module
F95	–	10 Amp Red	Rear Camera / ParkSense®
F96	–	10 Amp Red	Rear Seat Heater Switch / Flashlamp Charger - If Equipped
F97	–	20 Amp Yellow	Rear Heated Seats & Heated Steering Wheel - If Equipped

Cavity	Cartridge Fuse	Micro Fuse	Description
F98	–	20 Amp Yellow	Front Heated Seats / Ventilated Seats - If Equipped
F99	–	10 Amp Red	Climate Control / Driver Assistance Systems Module
F100	–	10 Amp Red	Active Damping - If Equipped
F101	–	15 Amp Blue	Electrochromatic Mirror/Smart High Beams - If Equipped
F103	–	10 Amp Red	Cabin Heater (Diesel Engine Only)/Rear HVAC
F104	–	20 Amp Yellow	Power Outlets (Instrument Panel/Center Console)

**CAUTION!**

- When installing the power distribution center cover, it is important to ensure the cover is properly positioned and fully latched. Failure to do so may allow water to get into the power distribution center and possibly result in an electrical system failure.
- When replacing a blown fuse, it is important to use only a fuse having the correct amperage rating. The use of a fuse with a rating other than indicated may result in a dangerous electrical system overload. If a properly rated fuse continues to blow, it indicates a problem in the circuit that must be corrected.

**VEHICLE STORAGE**

If you are leaving your vehicle dormant for more than 21 days you may want to take steps to protect your battery. You may:

- Disconnect the negative cable from the battery.
- Anytime you store your vehicle, or keep it out of service (i.e. vacation) for two weeks or more, run the air conditioning system at idle for about five minutes in the fresh air and high blower setting. This will ensure adequate system lubrication to minimize the possibility of compressor damage when the system is started again.



## REPLACEMENT BULBS

### Interior Bulbs

	<b>Bulb Number</b>
Glove Box Lamp	194
Grab Handle Lamp	L002825W5W
Overhead Console Reading Lamps	VT4976
Visor Vanity Lamp	V26377
Rear Cargo Lamp	214-2
Underpanel Courtesy Lamps	906
Instrument Cluster (General Illumination)	103
Telltale/Hazard Lamp	74

## Exterior Bulbs

	<b>Bulb Number</b>
Low Beam/High Beam (Bi-Xenon) Headlamps	D3S (Service at Authorized Dealer)
Low Beam/High Beam/Daytime Running Lamp (DRL) Bi-Halogen Headlamps (Base)	HIR2LL
Low Beam/High Beam (Bi-Halogen) Headlamps (Uplevel)	HIR2LL
Front Park/Turn Signal Lamps (Base)	3157NAK
Front Turn Signal Lamps (Uplevel & Premium)	3157NAK
Front Park Lamp/Daytime Running Lamp (Uplevel & Premium)	LED (Serviced at Authorized Dealer)
Front Side Marker Lamps	LED (Serviced at Authorized Dealer)
Front Fog Lamps	H11
Rear Tail Lamps/Sidemarkers Lamps	LED (Serviced at Authorized Dealer)
Rear Stop/Turn Signal Lamps	LED (Serviced at Authorized Dealer)
Rear Liftgate Tail Lamps	LED (Serviced at Authorized Dealer)

	Bulb Number
Rear Backup Lamps	921 (W16W)
Rear License Lamps	LED (Serviced at Authorized Dealer)
Center High-Mounted Stop Lamp (CHMSL)	LED (Serviced at Authorized Dealer)

### BULB REPLACEMENT

**NOTE:** Lens fogging can occur under certain atmospheric conditions. This will usually clear as atmospheric conditions change to allow the condensation to change back into a vapor. Turning the lamps on will usually accelerate the clearing process.

#### High Intensity Discharge Headlamps (Bi-Xenon) — If Equipped

The headlamps are a type of high voltage discharge tube. High voltage can remain in the circuit even with the headlamp switch off. **Because of this, you should not attempt to service a headlamp bulb yourself. If a**

**headlamp bulb fails, take your vehicle to an authorized dealer for service.**

<b>WARNING!</b>
<b>A transient high voltage occurs at the bulb sockets of High Intensity Discharge (HID) headlamps when the headlamp switch is turned ON. It may cause serious electrical shock or electrocution if not serviced properly. See your authorized dealer for service.</b>

**NOTE:** On vehicles equipped with High Intensity Discharge (HID) headlamps, when the headlamps are turned on, there is a blue hue to the lamps. This diminishes and becomes more white after approximately 10 seconds, as the system charges.

### **Bi-Halogen Headlamps — If Equipped**

1. Turn the steering wheel to the left to replace the bulb from the right hand lamp, or to the right to replace the bulb from the left hand lamp.
2. Turn the access cap located on the wheel liner counterclockwise to remove from liner.
3. Locate the headlamp bulb access cap through the opening in the wheel liner.
4. Firmly grasp the access cap and rotate counterclockwise to remove lamp housing.
5. Firmly grasp the low/high beam bulb and connector assembly and rotate counterclockwise to remove from housing.
6. Disconnect the electrical connector and then connect the replacement bulb.
7. Install the bulb and connector assembly into the headlamp housing and rotate clockwise to lock in place.
8. Install the bulb access cap in the headlamp housing and rotate clockwise to lock it in place.
9. Install the access cap in the wheel liner and rotate clockwise to lock it in place.

**CAUTION!**

Do not touch the new bulb with your fingers. Oil contamination will severely shorten bulb life. If the bulb comes in contact with any oily surface, clean the bulb with rubbing alcohol.

**Front Turn Signal**

1. Open the hood.
2. Turn the turn signal bulb one-quarter turn counterclockwise to remove from housing.
3. Disconnect the electrical connector and replace the bulb.

**CAUTION!**

Do not touch the new bulb with your fingers. Oil contamination will severely shorten bulb life. If the

*(Continued)*

**CAUTION! (Continued)**

bulb comes in contact with any oily surface, clean the bulb with rubbing alcohol.

**Front Fog Lamps**

1. Reach through the cutout in the splash shield and rotate the bulb's electrical connector one-quarter turn counterclockwise and remove it from the fog lamp housing.
2. Remove the bulb from the connector and install the replacement bulb.
3. Install the bulb and connector assembly into the fog lamp housing and rotate the connector one-quarter turn clockwise to lock it in place.

**CAUTION!**

- Do not touch the new bulb with your fingers. Oil contamination will severely shorten bulb life. If the bulb comes in contact with any oily surface, clean the bulb with rubbing alcohol.
- Always use the correct bulb size and type for replacement. An incorrect bulb size or type may overheat and cause damage to the lamp, the socket or the lamp wiring.

**Rear Tail, Stop And Turn Signal Lamps**

The rear tail, stop, and turn signal lamps are LED. See your authorized dealer for replacement.

**Rear Liftgate Mounted Back-up Lamps**

1. Raise the liftgate.

2. Use a fiber stick or flat blade screw driver to pry the lower trim from the liftgate.
3. Back-up lamps are now visible. Rotate socket(s) counter clockwise.
4. Remove/replace bulb(s).
5. Reinstall the socket(s)
6. Reverse process to reinstall the liftgate trim.

**Center High-Mounted Stop Lamp (CHMSL)**

The center high-mounted stop lamp is an LED assembly. See your authorized dealer for replacement.

**Rear License Lamp**

The rear license lamps are LED. See your authorized dealer for replacement.

## FLUID CAPACITIES

	U.S	Metric
<b>Fuel (Approximate)</b>		
3.6L and 5.7L Engines	25 Gallons	94 Liters
<b>Engine Oil With Filter</b>		
3.6L Engine (SAE 5W-20, API Certified)	6 Quarts	5.6 Liters
5.7L Engine (SAE 5W-20, API Certified)	7 Quarts	6.6 Liters
<b>Cooling System *</b>		
3.6L Engine (MOPAR® Antifreeze/Engine Coolant 10 Year/150,000 Mile Formula or equivalent) – Without Trailer Tow Package	10.4 Quarts	9.9 Liters
3.6L Engine (MOPAR® Antifreeze/Engine Coolant 10 Year/150,000	11 Quarts	10.4 Liters

	U.S	Metric
Mile Formula or equivalent) – With Trailer Tow Package		
5.7 Liter Engine (MOPAR® Antifreeze/Engine Coolant 10 Year/150,000 Mile Formula or equivalent) – Without Trailer Tow Package	15.4 Quarts	14.6 Liters
5.7 Liter Engine (MOPAR® Antifreeze/Engine Coolant 10 Year/150,000 Mile Formula or equivalent) – With Trailer Tow Package	16 Quarts	15.2 Liters
* Includes heater and coolant recovery bottle filled to MAX level.		



## FLUIDS, LUBRICANTS, AND GENUINE PARTS

### Engine

Component	Fluid, Lubricant, or Genuine Part
Engine Coolant	We recommend you use MOPAR® Antifreeze/Coolant 10 Year/150,000 Mile Formula OAT (Organic Additive Technology) meeting the requirements of FCA Material Standard MS.90032.
Engine Oil – 3.6L Engine	We recommend you use API Certified SAE 5W-20 Engine Oil, meeting the requirements of FCA US Material Standard MS-6395 such as MOPAR®, Pennzoil®, Shell Helix® or equivalent. Refer to your engine oil filler cap for correct SAE grade.
Engine Oil – 5.7L Engine	We recommend you use API Certified SAE 5W-20 Engine Oil, meeting the requirements of FCA US Material Standard MS-6395 such as MOPAR®, Pennzoil®, Shell Helix® or equivalent. Refer to your engine oil filler cap for correct SAE grade.

Component	Fluid, Lubricant, or Genuine Part
Engine Oil Filter	We recommend you use a MOPAR® Engine Oil Filter.
Spark Plugs	We recommend you use MOPAR® Spark Plugs.
Fuel Selection – 3.6L Engine	87 Octane.
Fuel Selection – 5.7L Engine	89 Octane Recommended – 87 Octane Acceptable.

**CAUTION!**

- Mixing of engine coolant (antifreeze) other than specified Organic Additive Technology (OAT) engine coolant (antifreeze), may result in engine damage and may decrease corrosion protection. Organic Additive Technology (OAT) engine coolant is different and should not be mixed with Hybrid Organic Additive Technology (HOAT) engine coolant (antifreeze) or any “globally compatible” coolant (antifreeze). If a non-OAT engine

*(Continued)***CAUTION! (Continued)**

- coolant (antifreeze) is introduced into the cooling system in an emergency, the cooling system will need to be drained, flushed, and refilled with fresh OAT coolant (conforming to MS.90032), by an authorized dealer as soon as possible.
- Do not use water alone or alcohol-based engine coolant (antifreeze) products. Do not use additional rust inhibitors or antirust products, as they may not be compatible with the radiator engine coolant and may plug the radiator.

*(Continued)*

**CAUTION! (Continued)**

- This vehicle has not been designed for use with propylene glycol-based engine coolant (antifreeze).

**CAUTION! (Continued)**

Use of propylene glycol-based engine coolant (antifreeze) is not recommended.

**Chassis**
*(Continued)*

Component	Fluid, Lubricant, or Genuine Part
Automatic Transmission	Use only Mopar® ZF 8&9 Speed ATF™ Automatic Transmission Fluid or equivalent. Failure to use the correct fluid may affect the function or performance of your transmission.
Transfer Case – 3.6L Engine	We recommend you use Shell Automatic Transmission Fluid.
Transfer Case – 5.7L Engine	We recommend you use MOPAR® ATF+4® Automatic Transmission Fluid.
Axle Differential (Front-Rear)	We recommend you use MOPAR® GL-5 Synthetic Axle Lubricant SAE 75W-85.

Component	Fluid, Lubricant, or Genuine Part
Brake Master Cylinder	We recommend you use MOPAR® DOT 3 Brake Fluid, SAE J1703. If DOT 3, SAE J1703 brake fluid is not available, then DOT 4 is acceptable.
Power Steering Reservoir – 3.6L Engine	We recommend you use MOPAR® Hydraulic Fluid.
Power Steering Reservoir – 5.7L Engine	We recommend you use MOPAR® Power Steering Fluid +4, or MOPAR® ATF+4® Automatic Transmission Fluid.

---

# MAINTENANCE SCHEDULES

## CONTENTS

---

■ MAINTENANCE SCHEDULE . . . . .	.644	□ Maintenance Chart. . . . .	.645
----------------------------------	------	------------------------------	------

## MAINTENANCE SCHEDULE

Your vehicle is equipped with an automatic oil change indicator system. The oil change indicator system will remind you that it is time to take your vehicle in for scheduled maintenance.

Based on engine operation conditions, the oil change indicator message will illuminate. This means that service is required for your vehicle. Operating conditions such as frequent short-trips, trailer tow, extremely hot or cold ambient temperatures, and E85 fuel usage will influence when the “Oil Change Required” message is displayed. Severe Operating Conditions can cause the change oil message to illuminate as early as 3,500 miles (5,600 km) since last reset. Have your vehicle serviced as soon as possible, within the next 500 miles (805 km).

Your authorized dealer will reset the oil change indicator message after completing the scheduled oil change.

**NOTE:** Under no circumstances should oil change intervals exceed 10,000 miles (16,000 km) or twelve months, whichever comes first.

### Severe Duty All Models

Change Engine Oil at 4,000 miles (6,500 km) if the vehicle is operated in a dusty and off road environment. This type of vehicle use is considered Severe Duty.

### Once A Month Or Before A Long Trip:

- Check engine oil level
- Check windshield washer fluid level
- Check the tire inflation pressures and look for unusual wear or damage
- Check the fluid levels of the coolant reservoir, brake master cylinder and power steering, and fill as needed.
- Check function of all interior and exterior lights

## Maintenance Chart

### Required Maintenance

Refer to the Maintenance Schedules on the following pages for required maintenance.

<b>At Every Oil Change Interval As Indicated By Oil Change Indicator System:</b>
<ul style="list-style-type: none"> <li>• Change oil and filter.</li> </ul>
<ul style="list-style-type: none"> <li>• Rotate the tires. <b>Rotate at the first sign of irregular wear, even if it occurs before the oil indicator system turns on.</b></li> </ul>
<ul style="list-style-type: none"> <li>• Inspect battery and clean and tighten terminals as required.</li> </ul>
<ul style="list-style-type: none"> <li>• Inspect brake pads, shoes, rotors, drums, hoses and park brake.</li> </ul>
<ul style="list-style-type: none"> <li>• Inspect engine cooling system protection and hoses.</li> </ul>
<ul style="list-style-type: none"> <li>• Inspect exhaust system.</li> </ul>
<ul style="list-style-type: none"> <li>• Inspect engine air cleaner if using in dusty or off-road conditions.</li> </ul>

Mileage or time passed (whichever comes first)	20,000	30,000	40,000	50,000	60,000	70,000	80,000	90,000	100,000	110,000	120,000	130,000	140,000	150,000
Or Years:	2	3	4	5	6	7	8	9	10	11	12	13	14	15
Or Kilometers:	32,000	48,000	64,000	80,000	96,000	112,000	128,000	144,000	160,000	176,000	192,000	208,000	224,000	240,000
<b>Additional Inspections</b>														
Inspect the CV joints.		X			X			X			X			X
Inspect front suspension, tie rod ends, and replace if necessary.	X		X		X		X		X		X		X	
Inspect the front and rear axle fluid, change if using your vehicle for police, taxi, fleet, off-road or frequent trailer towing.	X		X		X		X		X		X		X	
Inspect the brake linings, parking brake function.	X		X		X		X		X		X		X	
Inspect transfer case fluid.		X			X			X						X



Mileage or time passed (whichever comes first)	20,000	30,000	40,000	50,000	60,000	70,000	80,000	90,000	100,000	110,000	120,000	130,000	140,000	150,000
Or Years:	2	3	4	5	6	7	8	9	10	11	12	13	14	15
Or Kilometers:	32,000	48,000	64,000	80,000	96,000	112,000	128,000	144,000	160,000	176,000	192,000	208,000	224,000	240,000
<b>Additional Maintenance</b>														
Replace engine air filter.		X			X			X			X			X
Replace the air conditioning filter.	X		X		X		X		X		X		X	
Replace spark plugs.**									X					
Flush and replace the engine coolant at 10 years or 150,000 miles (240,000 km) whichever comes first.									X					X
Change transfer case fluid.											X			
Inspect and replace PCV valve if necessary.									X					

\*\* The spark plug change interval is mileage based only, yearly intervals do not apply.

**WARNING!**

- You can be badly injured working on or around a motor vehicle. Do only service work for which you have the knowledge and the right equipment. If you have any doubt about your ability to perform a service job, take your vehicle to a competent mechanic.
- Failure to properly inspect and maintain your vehicle could result in a component malfunction and effect vehicle handling and performance. This could cause an accident.

# IF YOU NEED CONSUMER ASSISTANCE

## CONTENTS

---

■ SUGGESTIONS FOR OBTAINING SERVICE FOR YOUR VEHICLE . . . . .	.651	□ Customer Assistance For The Hearing Or Speech Impaired (TDD/TTY). . . . .	.653
□ Prepare For The Appointment. . . . .	.651	□ Service Contract . . . . .	.653
□ Prepare A List . . . . .	.651	■ WARRANTY INFORMATION . . . . .	.654
□ Be Reasonable With Requests . . . . .	.651	■ MOPAR® PARTS . . . . .	.655
■ IF YOU NEED ASSISTANCE . . . . .	.651	■ REPORTING SAFETY DEFECTS . . . . .	.655
□ FCA US LLC Customer Center . . . . .	.652	□ In The 50 United States And Washington, D.C. .655	
□ FCA Canada Inc. Customer Center . . . . .	.652	□ In Canada. . . . .	.655
□ In Mexico Contact . . . . .	.653	■ PUBLICATION ORDER FORMS . . . . .	.656

**650 IF YOU NEED CONSUMER ASSISTANCE**

■ DEPARTMENT OF TRANSPORTATION UNIFORM  
TIRE QUALITY GRADES . . . . .657

□ Treadwear. . . . .657

□ Traction Grades . . . . .658

□ Temperature Grades. . . . .658

## **SUGGESTIONS FOR OBTAINING SERVICE FOR YOUR VEHICLE**

### **Prepare For The Appointment**

If you are having warranty work done, be sure to have the right papers with you. Take your warranty folder. All work to be performed may not be covered by the warranty. Discuss additional charges with the service manager. Keep a maintenance log of your vehicle's service history. This can often provide a clue to the current problem.

### **Prepare A List**

Make a written list of your vehicle's problems or the specific work you want done. If you've had an accident or work done that is not on your maintenance log, let the service advisor know.

### **Be Reasonable With Requests**

If you list a number of items and you must have your vehicle by the end of the day, discuss the situation with the service advisor and list the items in order of priority. At many authorized dealers, you may obtain a rental vehicle at a minimal daily charge. If you need a rental, it is advisable to make these arrangements when you call for an appointment.

### **IF YOU NEED ASSISTANCE**

The manufacturer and its authorized dealer are vitally interested in your satisfaction. We want you to be happy with our products and services.

Warranty service must be done by an authorized dealer. We strongly recommend that you take the vehicle to an authorized dealer. They know your vehicle the best, and are most concerned that you get prompt and high quality service. The manufacturer's authorized dealer have the facilities, factory-trained technicians, special tools, and the latest information to ensure the vehicle is fixed correctly and in a timely manner.

This is why you should always talk to an authorized dealer service manager first. Most matters can be resolved with this process.

- If for some reason you are still not satisfied, talk to the general manager or owner of the authorized dealer. They want to know if you need assistance.
- If an authorized dealer is unable to resolve the concern, you may contact the manufacturer's customer center.

Any communication to the manufacturer's customer center should include the following information:

- Owner's name and address
- Owner's telephone number (home and office)
- Authorized dealer name
- Vehicle Identification Number (VIN)
- Vehicle delivery date and mileage

**FCA US LLC Customer Center**

P.O. Box 21-8004

Auburn Hills, MI 48321-8004

Phone: (800) 423-6343

**FCA Canada Inc. Customer Center**

P.O. Box 1621

Windsor, Ontario N9A 4H6

Phone: (800) 465-2001 English / (800) 387-9983 French

**In Mexico Contact**

Av. Prolongacion Paseo de la Reforma, 1240

Sante Fe C.P. 05109

Mexico, D. F.

In Mexico City: 5081-7568

Outside Mexico City: 1-800-505-1300

**Customer Assistance For The Hearing Or Speech Impaired (TDD/TTY)**

To assist customers who have hearing difficulties, the manufacturer has installed special TDD (Telecommunication Devices for the Deaf) equipment at its customer center. Any hearing or speech impaired customer, who has access to a TDD or a conventional teletypewriter (TTY) in the United States, can communicate with the manufacturer by dialing 1-800-380-CHRY.

Canadian residents with hearing difficulties that require assistance can use the special needs relay service offered by Bell Canada. For TTY teletypewriter users, dial 711 and for Voice callers, dial 1-800-855-0511 to connect with a Bell Relay Service operator.

**Service Contract**

You may have purchased a service contract for a vehicle to help protect you from the high cost of unexpected repairs after the manufacturer's New Vehicle Limited Warranty expires. The manufacturer stands behind only the manufacturer's service contracts. If you purchased a manufacturer's service contract, you will receive Plan Provisions and an Owner Identification Card in the mail within three weeks of the vehicle delivery date. If you have any questions about the service contract, call the manufacturer's Service Contract National Customer Hotline at 1-800-521-9922 (Canadian residents, call (800) 465-2001 English / (800) 387-9983 French).

The manufacturer will not stand behind any service contract that is not the manufacturer's service contract. It is not responsible for any service contract other than the manufacturer's service contract. If you purchased a service contract that is not a manufacturer's service contract, and you require service after the manufacturer's New Vehicle Limited Warranty expires, please refer to the contract documents, and contact the person listed in those documents.

We appreciate that you have made a major investment when you purchased the vehicle. An authorized dealer has also made a major investment in facilities, tools, and training to assure that you are absolutely delighted with the ownership experience. You will be pleased with their sincere efforts to resolve any warranty issues or related concerns.

**WARNING!**

**Engine exhaust (internal combustion engines only), some of its constituents, and certain vehicle components contain, or emit, chemicals known to the State of California to cause cancer and birth defects, or other reproductive harm. In addition, certain fluids contained in vehicles and certain products of component wear contain, or emit, chemicals known to the State of California to cause cancer and birth defects, or other reproductive harm.**

**WARRANTY INFORMATION**

See the Warranty Information Booklet, located on the DVD, for the terms and provisions of FCA US LLC warranties applicable to this vehicle and market.



## **MOPAR® PARTS**

MOPAR® fluids, lubricants, parts, and accessories are available from an authorized dealer. They are recommended for your vehicle in order to help keep the vehicle operating at its best.

## **REPORTING SAFETY DEFECTS**

### **In The 50 United States And Washington, D.C.**

If you believe that your vehicle has a defect that could cause a crash or cause injury or death, you should immediately inform the National Highway Traffic Safety Administration (NHTSA) in addition to notifying the manufacturer.

If NHTSA receives similar complaints, it may open an investigation, and if it finds that a safety defect exists in a group of vehicles, it may order a recall and remedy

campaign. However, NHTSA cannot become involved in individual problems between you, your authorized dealer, and the manufacturer.

To contact NHTSA, you may either call the Auto Safety Hotline toll free at 1-888-327-4236 (TTY: 1-800-424-9153), or go to <http://www.safercar.gov>; or write to: Administrator, NHTSA, 1200 New Jersey Avenue, SE., West Building, Washington, D.C. 20590.

You can also obtain other information about motor vehicle safety from <http://www.safercar.gov>.

### **In Canada**

If you believe that your vehicle has a safety defect, you should contact the Customer Service Department immediately. Canadian customers who wish to report a safety defect to the Canadian government should contact Transport Canada, Motor Vehicle Defect Investigations and Recalls at 1-800-333-0510 or go to <http://www.tc.gc.ca/roadsafety/>

## PUBLICATION ORDER FORMS

To order the following manuals, you may use either the website or the phone numbers listed below. Visa, Mastercard, American Express, and Discover orders are accepted. If you prefer mailing your payment, please call for an order form.

**NOTE:** A street address is required when ordering manuals (no P.O. Boxes).

### Service Manuals

These comprehensive Service Manuals provide the information that students and professional technicians need in diagnosing/troubleshooting, problem solving, maintaining, servicing, and repairing FCA US LLC vehicles. A complete working knowledge of the vehicle, system, and/or components is written in straightforward language with illustrations, diagrams, and charts.

### Diagnostic Procedure Manuals

Diagnostic Procedure Manuals are filled with diagrams, charts and detailed illustrations. These practical manuals make it easy for students and technicians to find and fix problems on computer-controlled vehicle systems and features. They show exactly how to find and correct problems the first time, using step-by-step troubleshooting and drivability procedures, proven diagnostic tests and a complete list of all tools and equipment.

### Owner's Manuals

These Owner's Manuals have been prepared with the assistance of service and engineering specialists to acquaint you with specific FCA US LLC vehicles. Included are starting, operating, emergency and maintenance procedures as well as specifications, capabilities and safety tips.

Call toll free at:

- 1-800-890-4038 (U.S.)
- 1-800-387-1143 (Canada)

Or

Visit us on the Worldwide Web at:

- [www.techauthority.com](http://www.techauthority.com)

## **DEPARTMENT OF TRANSPORTATION UNIFORM TIRE QUALITY GRADES**

The following tire grading categories were established by the National Highway Traffic Safety Administration. The specific grade rating assigned by the tire's manufacturer in each category is shown on the sidewall of the tires on your vehicle.

All passenger car tires must conform to Federal safety requirements in addition to these grades.

### **Treadwear**

The Treadwear grade is a comparative rating, based on the wear rate of the tire when tested under controlled conditions on a specified government test course. For example, a tire graded 150 would wear one and one-half times as well on the government course as a tire graded 100. The relative performance of tires depends upon the actual conditions of their use, however, and may depart significantly from the norm due to variations in driving habits, service practices, and differences in road characteristics and climate.

## Traction Grades

The Traction grades, from highest to lowest, are AA, A, B, and C. These grades represent the tire's ability to stop on wet pavement, as measured under controlled conditions on specified government test surfaces of asphalt and concrete. A tire marked C may have poor traction performance.

### WARNING!

The traction grade assigned to this tire is based on straight-ahead braking traction tests, and does not include acceleration, cornering, hydroplaning, or peak traction characteristics.

## Temperature Grades

The temperature grades are A (the highest), B, and C, representing the tire's resistance to the generation of heat and its ability to dissipate heat, when tested under

controlled conditions on a specified indoor laboratory test wheel. Sustained high temperature can cause the material of the tire to degenerate and reduce tire life, and excessive temperature can lead to sudden tire failure. The grade C corresponds to a level of performance, which all passenger vehicle tires must meet under the Federal Motor Vehicle Safety Standard No. 109. Grades B and A represent higher levels of performance on the laboratory test wheel, than the minimum required by law.

### WARNING!

The temperature grade for this tire is established for a tire that is properly inflated and not overloaded. Excessive speed, under-inflation, or excessive loading, either separately or in combination, can cause heat buildup and possible tire failure.

---

# INDEX

- About Your Brakes . . . . .458
- Adaptive Cruise Control (ACC) (Cruise Control) . . .196
- Adding Engine Coolant (Antifreeze) . . . . .604
- Adding Fuel . . . . .512
- Additives, Fuel . . . . .507
- Air Bag . . . . .67
- Advance Front Air Bag . . . . .67, 69
- Air Bag Components . . . . .67
- Air Bag Operation . . . . .70
- Air Bag Warning Light . . . . .78
- Driver Knee Air Bag . . . . .71
- Enhanced Accident Response . . . . .78
- Event Data Recorder (EDR) . . . . .81
- Front Air Bag . . . . .67
- If A Deployment Occurs . . . . .76
- Knee Impact Bolsters . . . . .71
- Maintaining Your Air Bag System . . . . .80
- Side Air Bags . . . . .72
- Transporting Pets . . . . .109
- Air Bag Deployment . . . . .67
- Air Bag Light . . . . .78, 112, 290
- Air Bag Maintenance . . . . .80
- Air Cleaner, Engine (Engine Air Cleaner Filter) . . . .590
- Air Conditioner Maintenance . . . . .592
- Air Conditioning Filter . . . . .397, 593
- Air Conditioning, Operating Tips . . . . .396, 398
- Air Conditioning, Rear Zone . . . . .391
- Air Conditioning Refrigerant . . . . .592, 593
- Air Conditioning System . . . . .390, 592
- Air Pressure, Tires . . . . .482
- Alarm
- Arm The System . . . . .20
- Disarm The System . . . . .21
- Tamper Alert . . . . .22
- Alarm, Panic . . . . .25
- Alarm (Security Alarm) . . . . .19, 290
- All Wheel Drive (AWD) . . . . .439
- Alterations/Modifications, Vehicle . . . . .9

- Antifreeze (Engine Coolant) . . . . .603, 637
  - Disposal . . . . .606
- Anti-Lock Brake System (ABS) . . . . .459
- Anti-Lock Warning Light . . . . .290
- Appearance Care . . . . .614
- Assist, Hill Start . . . . .465
- Auto Down Power Windows . . . . .42
- Automatic Headlights . . . . .174
- Automatic High Beams . . . . .174
- Automatic Temperature Control (ATC) . . . . .381, 390
- Automatic Transmission . . . . .431, 613
  - Adding Fluid . . . . .613
  - Fluid And Filter Changes . . . . .613
  - Fluid Change . . . . .613
  - Fluid Level Check . . . . .612, 613
  - Fluid Type . . . . .612, 641
  - Gear Ranges . . . . .432
  - Special Additives . . . . .612
- Auxiliary Electrical Outlet (Power Outlet) . . . . .255
- Auxiliary Power Outlet . . . . .255
- Axle Fluid . . . . .641
- Battery . . . . .591
  - Keyless Transmitter Replacement (RKE) . . . . .26
- Belts, Seat . . . . .112
- Blind Spot Monitoring . . . . .132
- Body Mechanism Lubrication . . . . .597
- B-Pillar Location . . . . .476
- Brake Assist System . . . . .460
- Brake Control System, Electronic . . . . .458
- Brake Fluid . . . . .609, 641
- Brake System . . . . .458, 608
  - Anti-Lock (ABS) . . . . .458, 459
  - Fluid Check . . . . .609
  - Master Cylinder . . . . .609
  - Parking . . . . .455
  - Warning Light . . . . .290
- Brake/Transmission Interlock . . . . .429

- Bulb Replacement . . . . .631, 633
- Bulbs, Light . . . . .114
- Camera, Rear . . . . .237
- Capacities, Fluid . . . . .637
- Caps, Filler
- Fuel . . . . .562
  - Oil (Engine) . . . . .589
  - Power Steering . . . . .454
  - Radiator (Coolant Pressure) . . . . .606
- Carbon Monoxide Warning . . . . .111, 508
- Cargo Area Cover . . . . .272
- Cargo Area Features . . . . .270
- Cargo Compartment . . . . .270
- Light . . . . .271
  - Luggage Carrier . . . . .277
- Cargo Light . . . . .271
- Cargo Tie-Downs . . . . .273
- Car Washes . . . . .614
- Cellular Phone . . . . .379
- Center High Mounted Stop Light . . . . .636
- Certification Label . . . . .516
- Chains, Tire . . . . .493
- Changing A Flat Tire . . . . .547
- Chart, Tire Sizing . . . . .471
- Check Engine Light (Malfunction Indicator Light) . . . . .583
- Checking Your Vehicle For Safety . . . . .110
- Checks, Safety . . . . .110
- Child Restraint . . . . .82
- Child Restraints
- Booster Seats . . . . .87
  - Child Restraints . . . . .82
  - Child Seat Installation . . . . .104
  - How To Stow An Unused ALR Seat Belt . . . . .100
  - Infants And Child Restraints . . . . .85
  - Install A LATCH-Compatible Child Restraint . . . . .99
  - Installing Child Restraints Using The Vehicle Seat Belt . . . . .101



Locating The LATCH Anchorages . . . . .	.94	Coolant Level . . . . .	.607
Lower Anchors And Tethers For Children . . . . .	.90	Disposal Of Used Coolant . . . . .	.606
Older Children And Child Restraints . . . . .	.86	Drain, Flush, And Refill . . . . .	.603
Seating Positions . . . . .	.89	Inspection . . . . .	.602, 607
Child Safety Locks . . . . .	.34	Points To Remember . . . . .	.607
Clean Air Gasoline . . . . .	.505	Pressure Cap . . . . .	.606
Cleaning		Radiator Cap . . . . .	.606
Wheels . . . . .	.616	Selection Of Coolant (Antifreeze) . . . . .	.603, 637, 639
Climate Control . . . . .	.381	Corrosion Protection . . . . .	.614
Automatic . . . . .	.381	Cruise Control (Speed Control) . . . . .	.196
Cold Weather Operation . . . . .	.425	Cupholders . . . . .	.261
Compact Disc (CD) Maintenance . . . . .	.378	Customer Assistance . . . . .	.651
Compact Spare Tire . . . . .	.488		
Console, Overhead . . . . .	.240	Data Recorder, Event . . . . .	.81
Contract, Service . . . . .	.653	Daytime Running Lights . . . . .	.175
Coolant Pressure Cap (Radiator Cap) . . . . .	.606	Dealer Service . . . . .	.585
Cooling System . . . . .	.602	Defroster, Rear Window . . . . .	.276
Adding Coolant (Antifreeze) . . . . .	.604	Defroster, Windshield . . . . .	.112
Coolant Capacity . . . . .	.637		

- Dipsticks
  - Oil (Engine) . . . . .587
  - Power Steering . . . . .454
- Disabled Vehicle Towing . . . . .574
- Disposal
  - Antifreeze (Engine Coolant) . . . . .606
- Door Locks . . . . .31
  - Child-Protection Door Lock — Rear Doors . . . . .34
  - Door Locks . . . . .31, 34
  - Key Fob . . . . .31
  - Remote . . . . .31
  - Remote Keyless Entry (RKE) . . . . .31
- Door Opener, Garage. . . . .242
- Driver Information Display
  - DID . . . . .303
  - Instrument Cluster Display . . . . .303
- Driving . . . . .447
- DVD Player (Video Entertainment System™). . . . .356
- E-85 Fuel . . . . .509
- Economy (Fuel) Mode . . . . .430
- Electrical Outlet, Auxiliary (Power Outlet). . . . .255
- Electric Rear Window Defrost. . . . .276
- Electric Remote Mirrors. . . . .129
- Electronically Shifted Transfer Case. . . . .440
- Electronic Brake Control System. . . . .458
  - Brake Assist System . . . . .460
- Electronic Roll Mitigation (ERM) . . . . .460
- Electronic Speed Control (Cruise Control) .192, 193, 196
- Electronic Stability Control (ESC) . . . . .461
- Emergency, In Case Of
  - Freeing Vehicle When Stuck . . . . .568
  - Hazard Warning Flasher . . . . .544
  - Jacking . . . . .547
  - Jump Starting . . . . .563
  - Tow Hooks . . . . .569
- Emission Control System Maintenance . . . . .583

- Engine
- Air Cleaner . . . . .590
  - Block Heater . . . . .427
  - Break-In Recommendations . . . . .109
  - Compartment . . . . .581, 582
  - Compartment Identification . . . . .581, 582
  - Cooling . . . . .602
  - Exhaust Gas Caution . . . . .111, 508
  - Fails To Start . . . . .426
  - Flooded, Starting . . . . .426
  - Fuel Requirements . . . . .504, 637
  - Jump Starting . . . . .563
  - Oil . . . . .587, 637
  - Oil Filler Cap . . . . .589
  - Oil Filter . . . . .590
  - Oil Selection . . . . .588, 637, 639
  - Overheating . . . . .544
  - Starting . . . . .422
  - Temperature Gauge . . . . .290
  - Engine Oil Viscosity . . . . .588, 589
  - Engine Oil Viscosity Chart . . . . .588
  - Enhanced Accident Response Feature . . . . .78
  - Entry System, Illuminated . . . . .22
  - Ethanol . . . . .506
  - Event Data Recorder . . . . .81
  - Exhaust Gas Caution . . . . .111, 508
  - Exhaust System . . . . .111, 600
  - Exterior Lights . . . . .114, 631
- Filters
- Air Cleaner . . . . .590
  - Air Conditioning . . . . .397, 593
  - Engine Oil . . . . .590
  - Engine Oil Disposal . . . . .590
- Flashers . . . . .544
- Hazard Warning . . . . .544
  - Turn Signal . . . . .114, 290, 635, 636

Flexible Fuel Vehicles		Folding Rear Seat . . . . .	.158
Cruising Range . . . . .	.511	Forward Collision Warning . . . . .	.223
Engine Oil . . . . .	.511	Four-Way Hazard Flasher . . . . .	.544
Fuel Requirements . . . . .	.509, 510	Freeing A Stuck Vehicle . . . . .	.568
Maintenance . . . . .	.512	Front Axle (Differential). . . . .	.610
Replacement Parts . . . . .	.511	Fuel. . . . .	.504
Starting . . . . .	.511	Adding . . . . .	.512
Flooded Engine Starting . . . . .	.426	Additives . . . . .	.507
Fluid Capacities . . . . .	.637	Clean Air . . . . .	.505
Fluid Leaks . . . . .	.114	Economy Mode . . . . .	.430
Fluid Level Checks		Ethanol . . . . .	.506
Automatic Transmission . . . . .	.613	Gasoline . . . . .	.504
Brake . . . . .	.609	Gauge . . . . .	.290
Engine Oil . . . . .	.587	Materials Added . . . . .	.507
Power Steering . . . . .	.454	Methanol . . . . .	.506
Fluids . . . . .	.641	Octane Rating . . . . .	.504
Fluids, Lubricants And Genuine Parts . . . . .	.639	Requirements . . . . .	.504, 637
Fog Lights . . . . .	.290, 635	Specifications . . . . .	.639
Fog Light Service . . . . .	.635	Tank Capacity . . . . .	.637

Fuel, Flexible . . . . .	.509	GVWR . . . . .	.516
Fueling . . . . .	.512	Hazard Warning Flasher . . . . .	.544
Fuses . . . . .	.621	Headlights . . . . .	.633
Garage Door Opener (HomeLink®) . . . . .	.242	Automatic . . . . .	.174
Gasoline, Clean Air . . . . .	.505	Bulb Replacement . . . . .	.634
Gasoline (Fuel) . . . . .	.504	Cleaning . . . . .	.619
Gasoline, Reformulated . . . . .	.505	On With Wipers . . . . .	.174
Gauges		Passing . . . . .	.182
Coolant Temperature . . . . .	.290	Replacing . . . . .	.634
Fuel . . . . .	.290	Heated Mirrors . . . . .	.130, 276
Speedometer . . . . .	.290	Heater, Engine Block . . . . .	.427
Tachometer . . . . .	.290	High Beam Indicator . . . . .	.290
Gear Ranges . . . . .	.432	Hill Start Assist . . . . .	.465
General Information . . . . .	.504	Hitches	
Glass Cleaning . . . . .	.620	Trailer Towing . . . . .	.521
Gross Axle Weight Rating . . . . .	.519	Holder, Cup . . . . .	.261
Gross Vehicle Weight Rating . . . . .	.518	HomeLink® (Garage Door Opener) . . . . .	.242

- Hood Release . . . . .171
- Ignition
- Key . . . . .13
  - Illuminated Entry . . . . .22
  - Immobilizer (Sentry Key) . . . . .17
  - Inside Rearview Mirror . . . . .122, 123
  - Instrument Cluster . . . . .290
  - Instrument Panel And Controls . . . . .288
  - Instrument Panel Lens Cleaning . . . . .620
  - Interior Appearance Care . . . . .618
  - Intermittent Wipers (Delay Wipers) . . . . .184
  - Introduction . . . . .4
  - Inverter, Power . . . . .259
  - iPod®/USB/MP3 Control . . . . .353
- Jacking And Tire Changing Instructions . . . . .553
- Jacking Instructions . . . . .553
- Jack Location . . . . .548
- Jack Operation . . . . .547, 553
- Jump Starting . . . . .563
- Key Fob . . . . .14
- Arm The Alarm . . . . .20
  - Disarm The Alarm . . . . .21
  - Panic Alarm . . . . .25
  - Programming Additional Key Fobs . . . . .19, 26
  - Programming Additional Transmitters . . . . .19, 26
  - Unlock Liftgate . . . . .45
- Key-In Reminder . . . . .16
- Keyless Enter-N-Go . . . . .423
- Keyless Enter-N-Go™
- Lock The Vehicle's Doors . . . . .324
  - Passive Entry . . . . .35
  - Passive Entry Programming . . . . .35, 324
  - Unlock Liftgate . . . . .45, 324
- Keyless Entry System . . . . .23
- Keyless Go . . . . .13

Key, Replacement . . . . .	.18	Bulb Replacement . . . . .	.633
Keys . . . . .	.13	Cargo . . . . .	.271
Key, Sentry (Immobilizer) . . . . .	.17	Center Mounted Stop . . . . .	.636
		Daytime Running . . . . .	.175
Lane Change Assist . . . . .	.182	Dimmer Switch, Headlight . . . . .	.172
Lap/Shoulder Belts . . . . .	.52	Exterior . . . . .	.114
Latches . . . . .	.114	Fog . . . . .	.290, 635
Lead Free Gasoline . . . . .	.504	Hazard Warning Flasher . . . . .	.544
Leaks, Fluid . . . . .	.114	Headlights . . . . .	.633, 634
Life Of Tires . . . . .	.491	Headlights On With Wipers . . . . .	.174
Liftgate . . . . .	.45	High Beam Indicator . . . . .	.290
Liftgate Window Wiper/Washer . . . . .	.274	Illuminated Entry . . . . .	.22
Light Bulbs . . . . .	.114	Malfunction Indicator (Check Engine) . . . . .	.290
Lights . . . . .	.114, 172	Map Reading . . . . .	.179
Air Bag . . . . .	.78, 112, 290	Passing . . . . .	.182
Anti-Lock . . . . .	.290	Reading . . . . .	.179, 240
Automatic Headlights . . . . .	.174	Rear Servicing . . . . .	.636
Brake Assist Warning . . . . .	.468	Rear Tail Lamps . . . . .	.636
Brake Warning . . . . .	.290	Seat Belt Reminder . . . . .	.290

Security Alarm . . . . .	.290	Maintenance Procedures . . . . .	.586
Service . . . . .	.633	Maintenance Schedule . . . . .	.644
Service Engine Soon (Malfunction Indicator) . . .	.290	Malfunction Indicator Light (Check Engine) . .	.290, 584
Side Marker . . . . .	.636	Manual, Service . . . . .	.656
Tire Pressure Monitoring (TPMS) . . . . .	.290	Memory Feature (Memory Seat) . . . . .	.165
Traction Control . . . . .	.468	Memory Seat . . . . .	.165
Turn Signal . . . . .	.114, 172, 635, 636	Memory Seats And Radio . . . . .	.165
Vanity Mirror . . . . .	.131	Methanol . . . . .	.506
Loading Vehicle . . . . .	.516	Mirrors . . . . .	.122
Tires . . . . .	.476	Electric Powered . . . . .	.129
Locks . . . . .	.31	Electric Remote . . . . .	.129
Child Protection . . . . .	.34	Exterior Folding . . . . .	.129
Door . . . . .	.31	Heated . . . . .	.130
Power Door . . . . .	.33	Outside . . . . .	.122
Lubrication, Body . . . . .	.597	Rearview . . . . .	.122, 123
Luggage Rack (Roof Rack) . . . . .	.277	Vanity . . . . .	.131
Lug Nuts . . . . .	.545	Modifications/Alterations, Vehicle . . . . .	.9
Maintenance Free Battery . . . . .	.591	Monitor, Tire Pressure System . . . . .	.496
		MOPAR® Parts . . . . .	.585, 655



MTBE/ETBE . . . . .	.506	Viscosity . . . . .	.588, 589, 637
Multi-Function Control Lever . . . . .	.172	Oil Filter, Change . . . . .	.590
New Vehicle Break-In Period . . . . .	.109	Oil Filter, Selection . . . . .	.590
Occupant Restraints . . . . .	.49	Onboard Diagnostic System . . . . .	.583
Octane Rating, Gasoline (Fuel) . . . . .	.504	Opener, Garage Door (HomeLink®) . . . . .	.242
Odometer . . . . .	.290	Operating Precautions . . . . .	.583
Trip . . . . .	.290	Operator Manual (Owner's Manual) . . . . .	.6
Oil, Engine . . . . .	.303, 587	Outside Rearview Mirrors . . . . .	.122
Capacity . . . . .	.637	Overhead Console . . . . .	.240
Change Interval . . . . .	.587	Overheating, Engine . . . . .	.544
Dipstick . . . . .	.587	Owner's Manual (Operator Manual) . . . . .	.6, 656
Disposal . . . . .	.590	Paint Care . . . . .	.614
Filter . . . . .	.590	Panic Alarm . . . . .	.25
Filter Disposal . . . . .	.590	Parking Brake . . . . .	.455
Identification Logo . . . . .	.588	ParkSense® System, Rear . . . . .	.228
Materials Added To . . . . .	.589	Passing Light . . . . .	.182
Recommendation . . . . .	.588, 637	Passive Entry . . . . .	.35
		Pets . . . . .	.109

Placard, Tire And Loading Information . . . . .	.477	Programming Transmitters (Remote Keyless Entry) . . . . .	.23
Power		Quadra-Trac . . . . .	.439
Brakes . . . . .	.458	Radial Ply Tires . . . . .	.484
Distribution Center (Fuses) . . . . .	.622	Radiator Cap (Coolant Pressure Cap) . . . . .	.606
Door Locks . . . . .	.33	Radio Operation . . . . .	.379
Inverter . . . . .	.259	Radio Remote Controls . . . . .	.377
Lift Gate . . . . .	.46	Radio (Sound Systems) . . . . .	.352
Mirrors . . . . .	.129	Rain Sensitive Wiper System . . . . .	.187
Outlet (Auxiliary Electrical Outlet) . . . . .	.255	Rear Air Conditioning . . . . .	.391
Seats . . . . .	.142, 144	Rear Axle (Differential) . . . . .	.610
Steering . . . . .	.452, 454, 641	Rear Camera . . . . .	.237
Sunroof . . . . .	.252	Rear Cross Path . . . . .	.139
Tilt/Telescoping Steering Column . . . . .	.189	Rear Cupholder . . . . .	.261
Windows . . . . .	.41	Rear ParkSense System . . . . .	.228
Pregnant Women And Seat Belts . . . . .	.59	Rear Seat, Folding . . . . .	.158
Preparation For Jacking . . . . .	.553	Rear Window Features . . . . .	.274
Pretensioners		Rear Wiper/Washer . . . . .	.274
Seat Belts . . . . .	.59		

Reclining Front Seats . . . . .	.147	Remote Starting	
Recorder, Event Data . . . . .	.81	Exit Remote Start Mode . . . . .	.30
Recreational Towing . . . . .	.534	Uconnect® Customer Programmable Features .31, 327	
Shifting Into Transfer Case Neutral (N) . . . . .	.537	Uconnect® Settings . . . . .	.31, 327
Shifting Out Of Transfer Case Neutral (N) . . . . .	.540	Remote Starting System. . . . .	.28
Reformulated Gasoline . . . . .	.505	Replacement Bulbs . . . . .	.631
Refrigerant . . . . .	.593	Replacement Keys . . . . .	.18
Reminder, Seat Belt. . . . .	.51	Replacement Parts. . . . .	.585
Remote Control		Replacement Tires. . . . .	.492
Starting System . . . . .	.28	Reporting Safety Defects . . . . .	.655
Remote Keyless Entry (RKE) . . . . .	.23	Restraints, Child. . . . .	.82
Arm The Alarm . . . . .	.20	Retractable Cargo Area Cover . . . . .	.272
Disarm The Alarm . . . . .	.21	Roll Over Warning. . . . .	.5
FCC General Information . . . . .	.27	Roof Type Carrier . . . . .	.277
Panic Alarm . . . . .	.25	Rotation, Tires . . . . .	.495
Programming Additional Key Fobs . . . . .	.19, 26		
Programming Additional Transmitters . . . . .	.19, 26	Safety Checks Inside Vehicle. . . . .	.112
Remote Sound System (Radio) Controls . . . . .	.377	Safety Checks Outside Vehicle . . . . .	.114
		Safety Defects, Reporting. . . . .	.655

Safety, Exhaust Gas . . . . .	.111	Seat Belts. . . . .	.51, 112
Safety Information, Tire . . . . .	.469	Adjustable Shoulder Belt . . . . .	.57
Safety Tips . . . . .	.110	Adjustable Upper Shoulder Anchorage . . . . .	.57
Schedule, Maintenance . . . . .	.644	Child Restraint . . . . .	.82
Seat Belt		Extender . . . . .	.58
Adjustable Upper Shoulder Belt Anchorage . . . . .	.57	Front Seat . . . . .	.51, 52, 55
Automatic Locking Retractor (ALR) . . . . .	.60	Inspection . . . . .	.112
Disengage The Automatic Locking Mode . . . . .	.62	Operating Instructions . . . . .	.55
Energy Management Feature . . . . .	.60	Pregnant Women . . . . .	.59
Engage The Automatic Locking Mode . . . . .	.62	Pretensioners . . . . .	.59
Lap/Shoulder Belt Operation . . . . .	.55	Rear Seat . . . . .	.52
Lap/Shoulder Belts . . . . .	.52	Reminder . . . . .	.290
Lap/Shoulder Belt Untwisting . . . . .	.57	Untwisting Procedure . . . . .	.57
Pregnant Women . . . . .	.59	Seats . . . . .	.142
Seat Belt Extender . . . . .	.58	Adjustment . . . . .	.146
Seat Belt Pretensioner . . . . .	.59	Easy Entry . . . . .	.170
Seat Belt Reminder . . . . .	.51	Memory . . . . .	.165
Seat Belt Maintenance . . . . .	.620	Power . . . . .	.144
Seat Belt Reminder . . . . .	.51	Rear Folding . . . . .	.158

- Reclining . . . . .147
- Security Alarm. . . . .19, 290
  - Arm The System . . . . .20
  - Disarm The System . . . . .21
  - Tamper Alert . . . . .22
- Security System . . . . .19
- SENTRY KEY®
  - FCC General Information . . . . .19
  - Key Programming . . . . .19
- Sentry Key (Immobilizer) . . . . .17
- Sentry Key Replacement . . . . .18
- Service Assistance . . . . .651
- Service Contract . . . . .653
- Service Manuals . . . . .656
- Shifting . . . . .427
  - Automatic Transmission . . . . .427, 431
- Shoulder Belts . . . . .52
- Signals, Turn. . . . .114, 290, 635, 636
- Snow Chains (Tire Chains). . . . .493
- Snow Plow. . . . .533
- Snow Tires . . . . .486
- Spare Tire. . . . .487, 488, 489, 549
- Spark Plugs . . . . .639, 641
- Speed Control
  - Accel/Decel . . . . .195
  - Accel/Decel (ACC Only) . . . . .203
  - Cancel . . . . .194
  - Resume . . . . .194
  - Set . . . . .193
- Speed Control (Cruise Control) . . . . .192, 193, 196
- Speedometer. . . . .290
- Starting. . . . .28, 422
  - Automatic Transmission . . . . .422
  - Cold Weather . . . . .425, 427
  - Engine Block Heater . . . . .427
  - Engine Fails To Start . . . . .426
  - Remote . . . . .28
- Starting And Operating . . . . .422

Starting Procedures . . . . .	.422	Telescoping Steering Column. . . . .	.188, 189
Steering		Temperature Control, Automatic (ATC) . . . . .	.390
Power . . . . .	.452, 454	Temperature Gauge, Engine Coolant . . . . .	.290
Tilt Column . . . . .	.188, 189	Tie Down Hooks, Cargo . . . . .	.273
Wheel, Heated . . . . .	.191	Tilt Steering Column. . . . .	.188, 189
Wheel, Tilt . . . . .	.188, 189	Tire And Loading Information Placard . . . . .	.476, 477
Steering Wheel Audio Controls . . . . .	.377	Tire Markings . . . . .	.469
Steering Wheel Mounted Sound System Controls . . . . .	.377	Tires. . . . .	.114, 481, 487, 657
Storage . . . . .	.630	Aging (Life Of Tires) . . . . .	.491
Storage, Vehicle . . . . .	.396, 630	Air Pressure . . . . .	.481
Storing Your Vehicle . . . . .	.630	Chains . . . . .	.493
Sunglasses Storage . . . . .	.242	Changing . . . . .	.547
Sun Roof . . . . .	.252	Compact Spare . . . . .	.488
Sun Visor Extension . . . . .	.132	General Information . . . . .	.481, 487
Supplemental Restraint System - Air Bag . . . . .	.67	High Speed . . . . .	.484
Sway Control, Trailer. . . . .	.464	Inflation Pressures . . . . .	.482
System, Remote Starting . . . . .	.28	Jacking . . . . .	.547
		Life Of Tires . . . . .	.491
Tachometer. . . . .	.290	Load Capacity . . . . .	.476, 478

Pressure Monitor System (TPMS) . . . . .	.496	Recreational . . . . .	.534
Pressure Warning Light . . . . .	.290	Weight . . . . .	.522
Quality Grading . . . . .	.657	Towing Vehicle Behind A Motorhome . . . . .	.534
Radial . . . . .	.484	Traction Control . . . . .	.459
Replacement . . . . .	.492	Trailer Sway Control (TSC) . . . . .	.464
Rotation . . . . .	.495	Trailer Towing . . . . .	.518
Safety . . . . .	.469, 481	Cooling System Tips . . . . .	.533
Sizes . . . . .	.471	Hitches . . . . .	.521
Snow Tires . . . . .	.486	Minimum Requirements . . . . .	.527
Spare Tire . . . . .	.487, 488, 489, 549	Trailer And Tongue Weight . . . . .	.526
Spinning . . . . .	.489	Wiring . . . . .	.530
Trailer Towing . . . . .	.529	Trailer Towing Guide. . . . .	.522
Tread Wear Indicators . . . . .	.490	Trailer Weight. . . . .	.522
Tire Safety Information . . . . .	.469	Transfer Case . . . . .	.611
Tongue Weight/Trailer Weight . . . . .	.526	Electronically Shifted . . . . .	.440
Tow Hooks, Emergency . . . . .	.569	Fluid . . . . .	.641
Towing . . . . .	.518, 574	Maintenance . . . . .	.611
Disabled Vehicle . . . . .	.574	Transmission . . . . .	.431
Guide . . . . .	.522	Automatic . . . . .	.431, 612

- Fluid . . . . .641
- Maintenance . . . . .612
- Shifting . . . . .427
- Transmitter Battery Service (Remote Keyless Entry) . .26
- Transmitter, Garage Door Opener (HomeLink®). . . .242
- Transmitter Programming (Remote Keyless Entry).23, 26
- Transmitter, Remote Keyless Entry (RKE) . . . . .23
- Transporting Pets . . . . .109
- Tread Wear Indicators . . . . .490
- Turn Signals . . . . .290, 635, 636
  
- Uconnect®
  - Customer Programmable Features . . . . .31, 327
  - Operation . . . . .352
  - Screen Activated Features . . . . .24
  - Uconnect® Settings . . . . .25, 31, 327
- Uconnect® Settings. . . . .24
  - Customer Programmable Features . . . .34, 35, 45, 324
  - Passive Entry Programming . . . . .34, 35, 45, 324
  - Uconnect® Settings . . . . .45, 324
  - Uconnect® Voice Command. . . . .399
- Uniform Tire Quality Grades . . . . .657
- Universal Transmitter . . . . .242
- Unleaded Gasoline . . . . .504
- Untwisting Procedure, Seat Belt . . . . .57
  
- Vanity Mirrors . . . . .131
- Vehicle Identification Number (VIN) . . . . .8
- Vehicle Loading . . . . .478, 516
- Vehicle Modifications/Alterations . . . . .9
- Vehicle Storage. . . . .396, 630
- Viscosity, Engine Oil. . . . .588, 589
- Voice Recognition System (VR). . . . .399
  
- Warning Flasher, Hazard . . . . .544
- Warning, Roll Over . . . . .5
- Warnings And Cautions . . . . .8
- Warranty Information . . . . .654



Washers, Windshield . . . . .	.183, 599
Washing Vehicle . . . . .	.614
Wheel And Wheel Trim . . . . .	.616
Wheel And Wheel Trim Care . . . . .	.616
Wind Buffeting . . . . .	.45, 254
Window Fogging . . . . .	.397
Windows . . . . .	.41
Power . . . . .	.41
Wind Buffeting . . . . .	.45
Windshield Defroster . . . . .	.112
Windshield Washers . . . . .	.183
Fluid . . . . .	.599
Windshield Wiper Blades . . . . .	.597
Windshield Wipers . . . . .	.183
Wiper Blade Replacement . . . . .	.597
Wipers, Intermittent . . . . .	.184
Wipers, Rain Sensitive . . . . .	.187

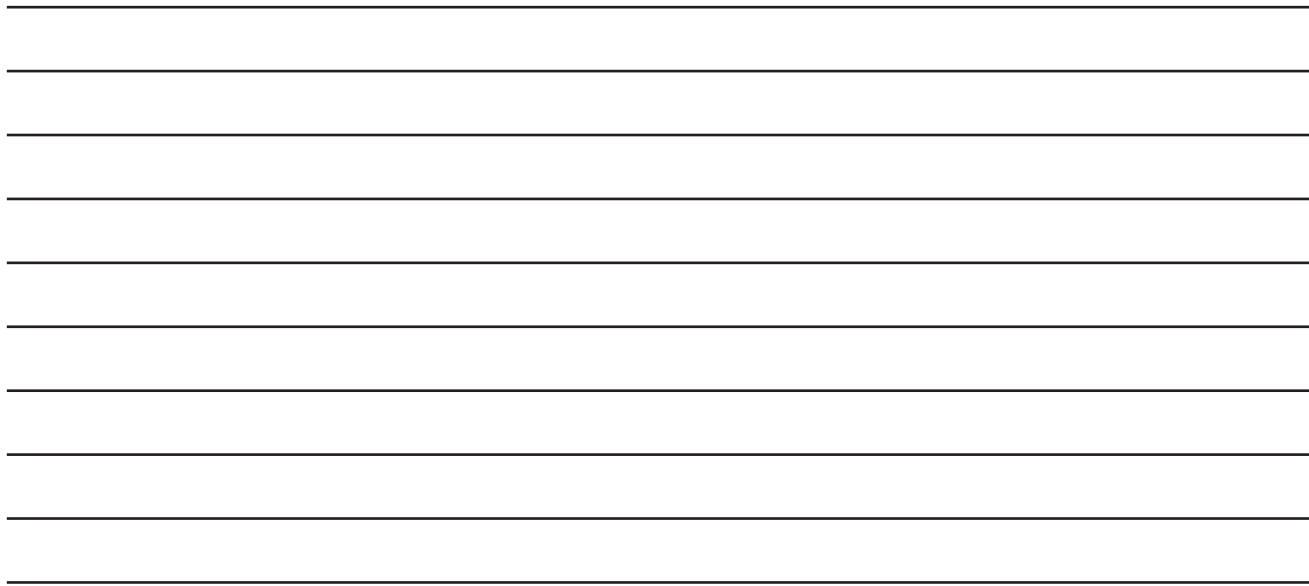

## **INSTALLATION OF RADIO TRANSMITTING EQUIPMENT**

Special design considerations are incorporated into this vehicle's electronic system to provide immunity to radio frequency signals. Mobile two-way radios and telephone equipment must be installed properly by trained personnel. The following must be observed during installation.

The positive power connection should be made directly to the battery and fused as close to the battery as possible. The negative power connection should be made to body sheet metal adjacent to the negative battery connection. This connection should not be fused.

Antennas for two-way radios should be mounted on the roof or the rear area of the vehicle. Care should be used in mounting antennas with magnet bases. Magnets may affect the accuracy or operation of the compass on vehicles so equipped.

The antenna cable should be as short as practical and routed away from the vehicle wiring when possible. Use only fully shielded coaxial cable.

Carefully match the antenna and cable to the radio to ensure a low Standing Wave Ratio (SWR).

Mobile radio equipment with output power greater than normal may require special precautions.

All installations should be checked for possible interference between the communications equipment and the vehicle's electronic systems.



STICK WITH THE SPECIALISTS®

FCA US LLC

15WD01-126-AF



Sixth Edition Rev 1

Printed in U.S.A.