



RAM

2012

OWNER'S MANUAL

Ram Truck
Diesel Supplement

INSTALLATION OF RADIO TRANSMITTING EQUIPMENT

Special design considerations are incorporated into this vehicle's electronic system to provide immunity to radio frequency signals. Mobile two-way radios and telephone equipment must be installed properly by trained personnel. The following must be observed during installation.

The positive power connection should be made directly to the battery and fused as close to the battery as possible. The negative power connection should be made to body sheet metal adjacent to the negative battery connection. This connection should not be fused.

Antennas for two-way radios should be mounted on the roof or the rear area of the vehicle. Care should be used in mounting antennas with magnet bases. Magnets may affect the accuracy or operation of the compass on vehicles so equipped.

The antenna cable should be as short as practical and routed away from the vehicle wiring when possible. Use only fully shielded coaxial cable.

Carefully match the antenna and cable to the radio to ensure a low Standing Wave Ratio (SWR).

Mobile radio equipment with output power greater than normal may require special precautions.

All installations should be checked for possible interference between the communications equipment and the vehicle's electronic systems.

TABLE OF CONTENTS

SECTION		PAGE
1	INTRODUCTION	3
2	THINGS TO KNOW BEFORE STARTING YOUR VEHICLE	7
3	UNDERSTANDING YOUR INSTRUMENT PANEL	13
4	STARTING AND OPERATING	31
5	WHAT TO DO IN EMERGENCIES	91
6	MAINTAINING YOUR VEHICLE	97
7	MAINTENANCE SCHEDULES	137
8	INDEX	163

INTRODUCTION

CONTENTS

■ A Message From Chrysler Group LLC	4
---	---

A MESSAGE FROM CHRYSLER GROUP LLC

Chrysler Group LLC and Cummins® welcome you as a Cummins® turbocharged diesel-powered truck owner. Your diesel truck will sound, feel, drive, and operate differently from a gasoline-powered truck. It is important that you read and understand this manual.

Almost 100% of the heavy duty trucks in the United States and Canada are diesel-powered because of the fuel economy, rugged durability, and high torque which permits pulling heavy loads. Cummins® engines power well over half of these trucks. Now this same technology and proven performance is yours in your truck equipped with the Cummins® turbocharged diesel engine.

You may find that some of the starting, operating, and maintenance procedures are different. However, they are simple to follow and careful adherence to them will ensure that you take full advantage of the features of this engine.

NOTE: Some aftermarket products may cause severe engine/transmission and/or exhaust system damage. Your vehicle's Powertrain Control Systems can detect and store information about vehicle modifications that increase horsepower and torque output such as whether or not performance-enhancing powertrain components, commonly referred to as downloaders, power boxes, or performance chips have been used.

This information cannot be erased and will stay in the system's memory even if the modification is removed. This information can be retrieved by Chrysler Group LLC, and service and repair facilities, when servicing your vehicle. This information may be used to determine if repair will be covered by New Vehicle Limited Warranty.

There is a probability that the use of a “performance chip” will prohibit the engine from starting. In this instance, the vehicle will need to be serviced by a authorized dealer in order to return the vehicle to it’s factory settings.

THINGS TO KNOW BEFORE STARTING YOUR VEHICLE

CONTENTS

■ Steering Wheel Lock — If Equipped	8	■ Remote Starting System — If Equipped	8
□ To Manually Lock The Steering Wheel	8	□ How To Use Remote Start	9
□ To Release The Steering Wheel Lock	8	■ Engine Break-In Recommendations	12

STEERING WHEEL LOCK — IF EQUIPPED

Your vehicle may be equipped with a passive steering wheel lock. This lock prevents steering the vehicle without the key fob. If the steering wheel is moved approximately a half turn in either direction and the key fob is not in the ignition switch, the steering wheel will lock.

To Manually Lock The Steering Wheel

With the engine running, turn the steering wheel upside down, turn off the engine and remove the key fob. Turn the steering wheel slightly in either direction until the lock engages.

To Release The Steering Wheel Lock

Insert the key fob into the ignition switch and start the engine. If the key fob is difficult to turn, move the wheel slightly to the right or left to disengage the lock.

NOTE: If you turned the wheel to the right to engage the lock, you must turn the wheel slightly to the right to

disengage it. If you turned the wheel to the left to engage the lock, turn the wheel slightly to the left to disengage it.

REMOTE STARTING SYSTEM — IF EQUIPPED



This system uses the Remote Keyless Entry (RKE) transmitter to start the engine conveniently from outside the vehicle while still maintaining security. The system has a range of approximately 328 ft (100 m).

NOTE:

- The vehicle must be equipped with an automatic transmission to be equipped with Remote Start.
- The remote start system will wait for the “Wait To Start Light” to extinguish before cranking the engine. This allows time for the intake heater to pre-heat the incoming air, and is normal operation in cold weather. Refer to “Electronic Vehicle Information Center/EVIC

Warning Lights” in “Understanding Your Instrument Panel” for further information on and “Wait To Start Light” and pre-heat cycle.

How To Use Remote Start

All of the following conditions must be met before the engine will remote start:

- Shift lever in PARK
- Doors closed
- Hood closed
- HAZARD switch off
- BRAKE switch inactive (brake pedal not pressed)
- Ignition key removed from ignition switch
- Battery at an acceptable charge level
- RKE PANIC button not pressed

- Fuel meets minimum requirement
- Water In Fuel Indicator Light is not illuminated
- Wait To Start Light is not illuminated

WARNING!

- Do not start or run an engine in a closed garage or confined area. Exhaust gas contains Carbon Monoxide (CO) which is odorless and colorless. Carbon Monoxide is poisonous and can cause serious injury or death when inhaled.
- Keep Remote Keyless Entry (RKE) transmitters away from children. Operation of the Remote Start System, windows, door locks or other controls could cause serious injury or death.

Remote Start Abort Message On Electronic Vehicle Information Center (EVIC) – If Equipped

The following messages will display in the EVIC if the vehicle fails to remote start or exits remote start prematurely:

- Remote Start Aborted - Door Ajar
- Remote Start Aborted - Hood Ajar
- Remote Start Aborted - Fuel Low
- Remote Start Aborted - System Fault

The EVIC message stays active until the ignition is turned to the ON/RUN position.

To Enter Remote Start Mode



Press and release the REMOTE START button on the RKE transmitter twice, within five seconds. The parking lights will flash and the horn

will chirp twice (if programmed). In cold ambient temperature conditions, the diesel vehicle may delay crank up to 30 seconds for the glow plugs or grid heater. Once the vehicle has started, the engine will run for 15 minutes.

NOTE:

- The park lamps will turn on and remain on during Remote Start mode.
- For security, power window and power sunroof operation (if equipped) are disabled when the vehicle is in the Remote Start mode.
- The engine can be started two consecutive times (two 15-minute cycles) with the RKE transmitter. However, the ignition switch must be cycled to the ON position before you can repeat the start sequence for a third cycle.

To Exit Remote Start Mode Without Driving The Vehicle

Press and release the REMOTE START button one time or allow the engine to run for the entire 15-minute cycle.

NOTE: To avoid unintentional shut downs, the system will disable the one time press of the REMOTE START button for two seconds after receiving a valid Remote Start request.

To Exit Remote Start Mode And Drive The Vehicle

Before the end of the 15-minute cycle, press and release the UNLOCK button on the RKE transmitter to unlock the doors and disarm the Vehicle Security Alarm System (if equipped). Insert the Key Fob into the ignition switch and turn the switch to the ON/RUN position.

NOTE:

- The ignition switch must be in the ON/RUN position in order to drive the vehicle.

- For vehicles equipped with the Electronic Vehicle Information Center (EVIC), the message “Insert Key/ Turn To On” will flash in the EVIC until you insert the Key Fob into the ignition switch. Once inserted, the message “Turn To On” will flash in the EVIC until you turn the ignition switch to the ON/RUN position.

Remote Start Comfort Systems – If Equipped

When remote start is activated, the heated steering wheel, and driver heated seat features will automatically turn on in cold weather. In warm weather, the driver vented seat feature will automatically turn on when the remote start is activated. These features will stay on through the duration of remote start or until the ignition switch is turned to the ON position.

The Remote Start Comfort System can be activated and deactivated through the Electronic Vehicle Information Center (EVIC). For more information on Remote Start Comfort System operation refer to “Electronic Vehicle

12 THINGS TO KNOW BEFORE STARTING YOUR VEHICLE

Information Center (EVIC)/Customer-Programmable Features (System Setup)" in "Understanding Your Instrument Panel".

ENGINE BREAK-IN RECOMMENDATIONS

The Cummins® turbocharged diesel engine does not require a break-in period due to its construction. Normal operation is allowed, providing the following recommendations are followed:

- Warm up the engine before placing it under load.
- Do not operate the engine at idle for prolonged periods.
- Use the appropriate transmission gear to prevent engine lugging.
- Observe vehicle oil pressure and temperature indicators.
- Check the coolant and oil levels frequently.

- Vary throttle position at highway speeds when carrying or towing significant weight.

NOTE: Light duty operation such as light trailer towing or no load operation will extend the time before the engine is at full efficiency. Reduced fuel economy and power may be seen at this time.

For additional vehicle break-in requirements, refer to "Trailer Towing" in "Starting and Operating" of the Owners Manual.

Because of the construction of the Cummins® turbocharged diesel engine, engine run-in is enhanced by loaded operating conditions which allow the engine parts to achieve final finish and fit during the first 6,000 miles (10 000 km).

UNDERSTANDING YOUR INSTRUMENT PANEL

CONTENTS

■ Instrument Cluster	14	□ EVIC Displays	26
■ Instrument Cluster Description	15	□ Vehicle Information (Customer Information Features)	30
■ Electronic Vehicle Information Center (EVIC)	25		

INSTRUMENT CLUSTER

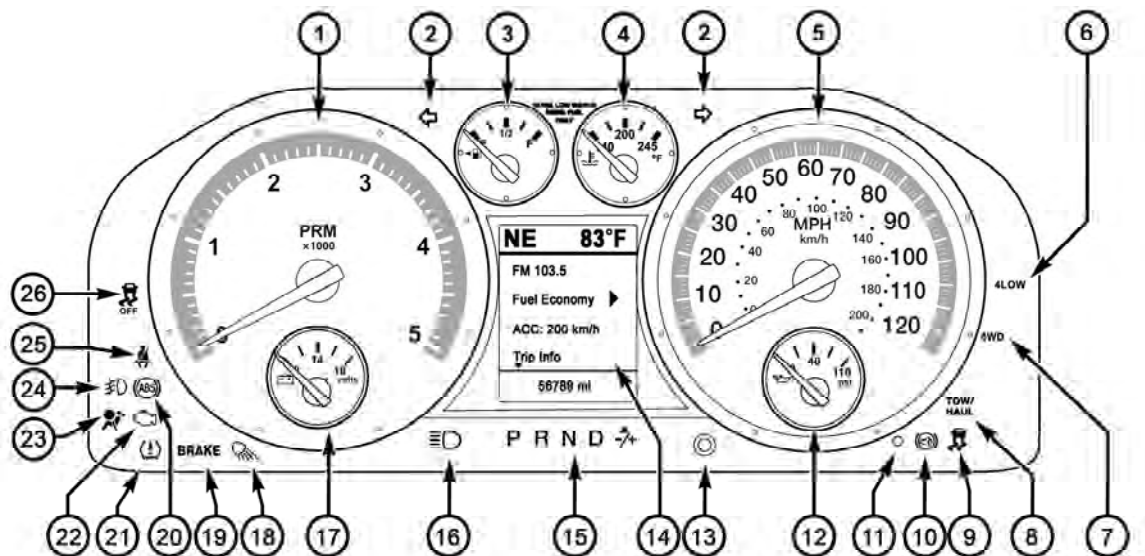

INSTRUMENT CLUSTER DESCRIPTION

1. *Tachometer*

The tachometer indicates engine speed in revolutions per minute.

CAUTION!

Do not operate the engine with the tachometer pointer at high RPM for extended periods. Engine damage may occur.

2. *Turn Signal Indicator Light*

 The arrow will flash with the exterior turn signal when the turn signal lever is operated.

NOTE:

- A continuous chime will sound if the vehicle is driven more than 1 mile (1.6 km) with either turn signal on.

- Check for an inoperative outside light bulb if either indicator flashes at a rapid rate.

3. *Fuel Gauge*

Shows level of fuel in tank when ignition switch is in the ON position.

4. *Temperature Gauge*

The temperature gauge shows engine coolant temperature. Any reading within the normal range indicates that the engine cooling system is operating satisfactorily.

The gauge pointer will likely indicate a higher temperature when driving in hot weather, up mountain grades, or when towing a trailer. It should not be allowed to exceed the upper limits of the normal operating range.

WARNING!

A hot engine cooling system is dangerous. You or others could be badly burned by steam or boiling coolant. You may want to call an authorized dealership for service if your vehicle overheats.

5. *Speedometer*

The speedometer shows the vehicle speed in miles per hour and/or kilometers per hour (MPH/km/h).

6. *4LOW Indicator Light – If Equipped*



This light alerts the driver that the vehicle is in the four-wheel drive LOW mode. The front and rear driveshafts are mechanically locked together forcing the front and rear wheels to rotate at the same speed. Low range provides a greater gear reduction ratio to provide increased torque at the wheels.

For vehicles equipped with a premium cluster this indicator will display in the Electronic Vehicle Information Center (EVIC). Refer to “Electronic Vehicle Information Center (EVIC)” in “Understanding Your Instrument Panel” for further information.

7. *4WD Indicator Light – If Equipped*

4WD

This light indicates the vehicle is in four-wheel drive and 4LOCK. 4WD allows all four wheels to receive torque from the engine simultaneously.

8. *TOW/HAUL Indicator Light – If Equipped*

TOW/ HAUL

The TOW HAUL button is located on the center stack switch bank. This light will illuminate when TOW HAUL mode is selected

9. *Electronic Stability Control (ESC) Indicator Light/Traction Control System (TCS) Indicator Light – If Equipped*



If the Electronic Stability Control (ESC)/Traction Control System (TCS) Indicator Light begins to flash during acceleration, ease up on the accelerator and apply as little throttle as possible. This indicator light starts to flash as soon as the tires lose traction and the Electronic Stability Control (ESC) becomes active. The “ESC/TCS Indicator Light” also flashes when TCS is active. Be sure to adapt your speed and driving to the prevailing road conditions. If the “ESC/TCS Indicator Light” is on solid, the ESC system has been turned off by the driver or a temporary condition exists that will not allow full ESC function.

10. *Exhaust Brake Indicator Light*

This light will illuminate when the exhaust brake has been turned on.

11. *Vehicle Security Light — If Equipped*



This light will flash at a fast rate for approximately 15 seconds, when the vehicle security alarm is arming, and then will flash slowly until the vehicle is disarmed.

12. *Oil Pressure Gauge*

The pointer should always indicate some oil pressure when the engine is running. A continuous high or low reading under normal driving conditions may indicate a lubrication system malfunction. Immediate service should be obtained from an authorized dealer.

13. *Odometer/Trip Odometer Button*

Press this button to toggle between the odometer and the trip odometer display. Holding the button in resets the trip odometer reading when in trip mode.

14. *Odometer/Electronic Vehicle Information Center (EVIC) Display*

Odometer

The odometer shows the total distance the vehicle has been driven. U.S. federal regulations require that upon transfer of vehicle ownership, the seller certify to the purchaser the correct mileage that the vehicle has been driven. Therefore, if the odometer reading is changed during repair or replacement, be sure to keep a record of the reading before and after the service so that the correct mileage can be determined.

The two trip odometers show individual trip mileage. To switch from odometer to trip odometers, press and release the TRIP ODOMETER button.

To reset a trip odometer, display the desired trip odometer to be reset then push and hold the button for approximately two seconds until the display resets.

15. *Shift Lever Indicator*

This display indicator shows the transmission shift lever selection.

16. *High Beam Indicator Light*



This indicator shows that headlights are on high beam. Push the multifunction lever forward to switch the headlights to high beam, and pull toward yourself (normal position) to return to low beam.

17. *Voltmeter*

When the engine is running, the gauge indicates the electrical system voltage. The pointer should stay within the normal range if the battery is charged. If the pointer moves to either extreme left or right and remains there during normal driving, the electrical system should be serviced.

NOTE: The voltmeter may show a gauge fluctuation at various engine temperatures. This cycling operation is caused by the post-heat cycle of the intake manifold heater system. The number of cycles and the length of the cycling operation is controlled by the engine control module. Post-heat operation can run for several minutes, and then the electrical system and voltmeter needle will stabilize.

18. *Cargo Light*



The cargo light will illuminate when the cargo light is activated by pressing the cargo light button on the headlight switch.

19. *Brake Warning Light*

BRAKE

This light monitors various brake functions, including brake fluid level and parking brake application. If the brake light turns on, it may

indicate that the parking brake is applied, that the brake fluid level is low, or that there is a problem with the Anti-Lock Brake System reservoir.

If the light remains on when the parking brake has been disengaged, and the fluid level is at the full mark on the master cylinder reservoir, it indicates a possible brake hydraulic system malfunction or that a problem with the Brake Booster has been detected by the Anti-Lock Brake System (ABS). In this case, the light will remain on until the condition has been corrected. If the problem is related to the brake booster, the ABS pump will run when applying the brake and a brake pedal pulsation may be felt during each stop.

The dual brake system provides a reserve braking capacity in the event of a failure to a portion of the hydraulic system. A leak in either half of the dual brake system is

indicated by the “Brake Warning Light,” which will turn on when the brake fluid level in the master cylinder has dropped below a specified level.

The light will remain on until the cause is corrected.

NOTE: The light may flash momentarily during sharp cornering maneuvers, which change fluid level conditions. The vehicle should have service performed, and the brake fluid level checked.

If brake failure is indicated, immediate repair is necessary.

WARNING!

Driving a vehicle with the “Brake Warning Light” on is dangerous. Part of the brake system may have failed. It will take longer to stop the vehicle. You could have an accident. Have the vehicle checked immediately.

Vehicles equipped with the ABS, are also equipped with Electronic Brake Force Distribution (EBD). In the event of an EBD failure, the “Brake Warning Light” will turn on along with the “ABS Warning Light.” Immediate repair to the ABS system is required.

Operation of the “Brake Warning Light” can be checked by turning the ignition switch from the OFF position to the ON position. The light should illuminate for approximately two seconds. The light should then turn off unless the parking brake is applied or a brake fault is detected. If the light does not illuminate, have the light inspected by an authorized dealer.

The light also will turn on when the parking brake is applied with the ignition switch in the ON position.

NOTE: This light shows only that the parking brake is applied. It does not show the degree of brake application.

20. Anti-Lock Brake (ABS) Warning Light



This light monitors the Anti-Lock Brake System (ABS). The light will turn on when the ignition switch is turned to the ON position and may stay on for as long as four seconds.

If the “ABS Warning Light” remains on or turns on while driving, it indicates that the anti-lock portion of the brake system is not functioning and that service is required. However, the conventional brake system will continue to operate normally if the “Brake Warning Light” is not on.

If the “ABS Warning Light” is on, the brake system should be serviced as soon as possible to restore the benefits of anti-lock brakes. If the “ABS Warning Light” does not turn on when the ignition switch is turned to the ON position, have the light inspected by an authorized dealer.

21. Tire Pressure Monitoring Telltale Light – If Equipped



Each tire, including the spare (if provided), should be checked monthly, when cold and inflated to the inflation pressure recommended by the vehicle manufacturer on the vehicle placard or tire inflation pressure label. (If your vehicle has tires of a different size than the size indicated on the vehicle placard or tire inflation pressure label, you should determine the proper tire inflation pressure for those tires.)

As an added safety feature, your vehicle has been equipped with a Tire Pressure Monitoring System (TPMS) that illuminates a low tire pressure telltale when one or more of your tires is significantly under-inflated. Accordingly, when the low tire pressure telltale illuminates, you should stop and check your tires as soon as possible, and inflate them to the proper pressure. Driving on a significantly under-inflated tire causes the tire to overheat and can lead to tire failure. Under-inflation also reduces fuel efficiency and tire tread life, and may affect the vehicle's handling and stopping ability.

Please note that the TPMS is not a substitute for proper tire maintenance, and it is the driver's responsibility to maintain correct tire pressure, even if under-inflation has not reached the level to trigger illumination of the TPMS low tire pressure telltale.

Your vehicle has also been equipped with a TPMS malfunction indicator to indicate when the system is not operating properly. The TPMS malfunction indicator is combined with the low tire pressure telltale. When the system detects a malfunction, the telltale will flash for approximately one minute and then remain continuously illuminated. This sequence will continue upon subsequent vehicle start-ups as long as the malfunction exists. When the malfunction indicator is illuminated, the system may not be able to detect or signal low tire pressure as intended. TPMS malfunctions may occur for a variety of reasons, including the installation of replacement or alternate tires or wheels on the vehicle that prevent the TPMS from functioning properly. Always check the TPMS malfunction telltale after replacing one or more tires or wheels on your vehicle, to ensure that the replacement or alternate tires and wheels allow the TPMS to continue to function properly.

CAUTION!

The TPMS has been optimized for the original equipment tires and wheels. TPMS pressures and warning have been established for the tire size equipped on your vehicle. Undesirable system operation or sensor damage may result when using replacement equipment that is not of the same size, type, and/or style. Aftermarket wheels can cause sensor damage. Do not use tire sealant from a can, or balance beads if your vehicle is equipped with a TPMS, as damage to the sensors may result.

NOTE: The TPMS telltale is also accompanied by a “Low Tire” message in the Electronic Vehicle Information Center (EVIC) screen. Refer to “Starting and Operating/Tire Pressure Monitor System (TPMS)” in the Owner’s Manual for further information.

22. Malfunction Indicator Light (MIL)

The Malfunction Indicator Light (MIL) is part of an onboard diagnostic (OBDII) system which monitors the emissions and engine control system. If the vehicle is ready for emissions testing, the light will come on when the ignition is first turned on and remain on, as a bulb check, until the engine is started. If the vehicle is not ready for emissions testing the light will come on when the ignition is first turned on and remain on for 15 seconds, then blink for 5 seconds, and remain on until the vehicle is started. If the bulb does not come on during starting, have the condition investigated promptly.

If this light comes on and remains on while driving, it suggests a potential engine control problem and the need for system service.

Although your vehicle will usually be drivable and not need towing, see your authorized dealer for service as soon as possible.

CAUTION!

Prolonged driving with the MIL on could cause damage to the engine control system. It also could affect fuel economy and drivability.

23. Airbag Warning Light



This light turns on and remains on for six to eight seconds as a bulb check when the ignition switch is first turned ON. If the light is not on during starting, stays on, or turns on while driving, have the system inspected by an authorized dealer as soon as possible.

24. Front Fog Light Indicator Light – If Equipped



This indicator will illuminate when the front fog lights are on.

25. Seat Belt Reminder Light



When the ignition switch is first turned ON, this light will turn on for five to eight seconds as a bulb check. During the bulb check, if the driver's seat belt is unbuckled, a chime will sound. After the bulb check or when driving, if the driver's seat belt remains unbuckled, the seat belt reminder light will flash or remain on continuously. Refer to "Occupant Restraints/Enhanced Seat Belt Use Reminder System (BeltAlert®)" in "Things To Know Before Starting Your Vehicle" in the Owners Manual for further information.

26. Electronic Stability Control (ESC) OFF Indicator Light — If Equipped



This light indicates the Electronic Stability Control (ESC) is off.

ELECTRONIC VEHICLE INFORMATION CENTER (EVIC)

The Electronic Vehicle Information Center (EVIC) features a driver-interactive display that is located in the instrument cluster.



Electronic Vehicle Information Center (EVIC)

NOTE: The compass on your vehicle is self-calibrating, eliminating the need to manually calibrate the compass.

This system conveniently allows the driver to select a variety of useful information by pressing the switches mounted on the steering wheel.

Refer to “Electronic Vehicle Information Center – If Equipped” in the Owner’s Manual for further information.

EVIC Displays

When the appropriate conditions exist, the EVIC displays the following messages:

- System Setup Unavailable – Vehicle Not in Park
- System Setup Unavailable – Vehicle in Motion
- Service Air Filter
- Perform Service
- Exhaust Filter XX% Full
- Exhaust Filter Full – Power Reduced See Dealer
- Exhaust Service Required – See Dealer Now
- Exhaust System – Regeneration Required Now
- Exhaust System – Regeneration In Process
- Exhaust System – Regeneration Completed
- Low DEF Refill Soon
- Refill DEF Engine Will Not Start In XXX Miles
- Refill DEF Engine Will Not Start
- Service DEF System See Dealer
- Service DEF Syst Engine Will Not Start in XXX Mi See Dealer
- Service DEF System Engine Will Not Start See Dealer
- Engine Power Reduced During Warmup
- Engine Power Reduced up to 30-sec During Warmup
- Engine Power Reduced up to 2-min During Warmup

EVIC Warning Lights

- *Water In Fuel Indicator Light*



The “Water In Fuel Indicator Light” will illuminate when there is water detected in the fuel filter. If this light remains on, DO NOT start the vehicle before you drain the water from the fuel filter to prevent engine damage. Refer to “Maintenance Procedures/ Draining Fuel/Water Separator Filter” in “Maintaining Your Vehicle” for further information.

- *Wait To Start Light*

 The “Wait To Start Light” will illuminate when the ignition is turned to the RUN position and the intake manifold temperature is below 66°F (19°C). Wait until the “Wait To Start Light” turns OFF, then start the vehicle. Refer to “Starting Procedures” in “Starting and Operating” for further information.

NOTE: The “Wait To Start Light” may not illuminate if the intake manifold temperature is warm enough.

Turbocharger Derate Mode Messages

The vehicle will display messages when a derate is activated to protect the turbocharger during engine start up in cold ambient temperatures.

- **Engine Power Reduced During Warmup** - This message will display during start up when the ambient temperature is between 10° F (-12° C) and -10° F (-23° C).
- **Engine Power Reduced Up To 30 Sec (Seconds) During Warmup** - This message will display during start up when the ambient temperature is between -10° F (-23° C) and -25 F (-32° C).

- **Engine Power Reduced Up To 2 Min (Minutes) During Warmup** - This message will display during start up when the ambient temperature is -25° F (-32° C) and below.

Diesel Exhaust Fluid (DEF) Warning Messages – Chassis Cab Only

Your vehicle will begin displaying warning messages when the DEF level reaches a driving range of approximately 1,000 miles (1 609 km). If the following warning message sequence is ignored, your vehicle will not start unless DEF is added.

- **Low DEF Refill Soon** – This message will display when the low level is reached, during vehicle start up, and with increased frequency during vehicle operation. It will be accompanied by a single chime. Approximately 6 gallons (23 Liters) of DEF is required to refill the tank when this message is initially displayed.

- **Refill DEF Engine Will Not Restart In XXX Miles** – This message will continuously display if the “Low DEF Refill Soon” message is ignored, and the frequency of occurrence of the chime will increase unless up to 2 gallons (7.5 Liters) of DEF is added to the tank. The engine will not restart if the mileage counter reaches zero.

- **Refill DEF Engine Will Not Start** – This message will continuously display when the counter reaches zero, and will be accompanied by a periodic chime. The engine will not start after it has been turned off unless up to 2.5 gallons (9.5 Liters) of DEF is added to the tank.

NOTE: A minimum of up to 2.5 gallons (9.5 Liters) may be required to restart the engine. Although the vehicle will continue to operate while this warning message is initially displayed, the engine will not restart the next time the vehicle is shut off.

Diesel Exhaust Fluid (DEF) Fault Warning Messages – Chassis Cab Only

There are three different messages which are displayed if the vehicle detects that the DEF system has been filled with a fluid other than DEF, has experienced component failures, or when tampering has been detected. The vehicle will not start if the DEF system is not serviced within less than 250 miles (402 km) of the fault being detected.

When the DEF system needs to be serviced the following warnings will display:

- **Service DEF System – See Dealer** — This message will display when the fault is initially detected, each time the vehicle is started, and periodically during driving. The message will be accompanied by a single chime. We recommend you drive to your nearest authorized dealer and have your vehicle serviced as soon as possible.

- **Service DEF System Engine Will Not Start In 200 Miles – See Dealer** — This message will display if the DEF system has not been serviced after the “Service DEF System – See Dealer” message is displayed. This message will continuously display until the mileage counter reaches zero, and will be accompanied by a periodic chime. The message will continue to count-down until it reaches zero unless the vehicle is serviced. We recommend you drive to your nearest authorized dealer and have your vehicle serviced immediately.

NOTE: Under some circumstances this mileage counter may start with a value of less than 200 miles (322 km). For example, if recurring faults are detected in a time interval of less than 40 hours, the counter may restart at the value where it stopped when a previous fault was temporarily remedied, or at a minimum of 50 miles (80 km).

- **Service DEF System Engine Will Not Start – See Dealer** — This message will continuously display when the mileage counter reaches zero, and will be accompanied by a periodic chime. The engine will not restart after it has been turned off, your vehicle will require towing, see your authorized dealer for service.

NOTE: When this message is displayed, the engine will no longer start after it has been turned off.

Vehicle Information (Customer Information Features)

Press and release the UP or DOWN button until “Vehicle Info” displays in the EVIC and press the SELECT button. Press the UP and DOWN button to scroll through the available information displays, then press SELECT to display anyone of the following choices.

- **DEF Fluid Level – Chassis Cab Only**
Displays the Diesel Exhaust Fluid (DEF) fluid level.
- **Coolant Temp**
Displays the actual coolant temperature.
- **Oil Pressure**
Displays the actual oil pressure.
- **Trans Temperature**
Displays the actual transmission sump temperature.
- **Engine Hours**
Displays the hours of engine operation.

STARTING AND OPERATING

CONTENTS

■ Starting Procedures	34	□ Starting Fluids	40
□ Manual Transmission – If Equipped	34	■ Normal Operation – Diesel Engine	41
□ Automatic Transmission – If Equipped	34	□ Cold Weather Precautions	41
□ Extreme Cold Weather	35	□ Engine Idling	44
□ Normal Starting Procedure – Engine Manifold Air Temperature Above 66°F (19°C)	35	□ Stopping The Engine	45
□ Starting Procedure – Engine Manifold Air Temperature 0°F To 66°F (-18°C To 19°C)	37	□ Idle Shutdown (Chassis Cab Only)	46
□ Starting Procedure – Engine Manifold Air Temperature Below 0°F (-18°C)	38	□ Programmable Maximum Vehicle Speed (Chassis Cab Only)	46
		□ Snow Plow Mode	47

32 STARTING AND OPERATING

- Operating Precautions 47
- Cooling System Tips – Automatic Transmission 48
- Engine Block Heater — If Equipped 49
 - Block Heater Usage 50
- Diesel Exhaust Brake (Engine Braking) — If Equipped 50
- Automatic Transmission — If Equipped 52
 - Key Ignition Park Interlock 53
 - Brake/Transmission Shift Interlock System . . . 53
 - Six-Speed Automatic Transmission – If Equipped (Ram Truck Only) 54
 - Six-Speed Automatic Transmission – If Equipped (Chassis Cab Only) 64
- Manual Transmission — If Equipped 75
 - Shifting 75
 - Downshifting 76
 - Reverse Shifting 78
- Power Take Off Operation — If Equipped (Chassis Cab Only) 78
 - Stationary Mode 79
 - Mobile Mode 80
 - Power Take Off – Aftermarket Installation 81
- Engine Runaway 81
- Fuel Requirements 82
 - Fuel Specifications 83
- Adding Fuel 83

□ Fuel Filler Cap	84	□ Adding Diesel Exhaust Fluid – Chassis Cab Only	86
□ Avoid Using Contaminated Fuel	84	■ Diesel Exhaust Fluid — Chassis Cab Only	88
□ Bulk Fuel Storage – Diesel Fuel	84	□ System Overview	88
□ Diesel Exhaust Fluid Storage	85		

STARTING PROCEDURES

Before starting your vehicle, adjust your seat, adjust both inside and outside mirrors, and fasten your seat belts.

The starter should not be operated for more than 15-second intervals. Waiting a few minutes between such intervals will protect the starter from overheating.

WARNING!

- **Do not leave children or animals inside parked vehicles in hot weather. Interior heat build up may cause serious injury or death.**
- **Leaving children in a vehicle unattended is dangerous for a number of reasons. A child or others could be seriously or fatally injured. Children should be warned not to touch the parking brake, brake pedal or the shift lever. Do not leave the key in the ignition. A child could operate power windows, other controls, or move the vehicle.**

Manual Transmission – If Equipped

Apply the parking brake, place the shift lever in NEUTRAL and press the clutch pedal to the floor before starting the vehicle. This vehicle is equipped with a clutch interlocking ignition system. It will not start unless the clutch is fully pressed.

Automatic Transmission – If Equipped

Start the engine with the shift lever in NEUTRAL or PARK position. Apply the brake before shifting to any driving range.

Tip Start Feature

Do not press the accelerator. Turn the ignition switch briefly to the START position and release it. The starter motor will continue to run but will automatically disengage when the engine is running.

Extreme Cold Weather

The Cummins® diesel engine is equipped with several features designed to assist cold weather starting and operation:

- The engine block heater is a resistance heater installed in the water jacket of the engine just above and behind the oil filter. It requires a 110–115 Volt AC electrical outlet with a grounded, three-wire extension cord.

NOTE: The engine block heater cord is a factory installed option. If your vehicle is not equipped, heater cords are available from your authorized MOPAR® dealer.

- A 12 Volt heater built into the fuel filter housing aids in preventing fuel gelling. It is controlled by a built-in thermostat.

- A heated intake air system both improves engine starting and reduces the amount of white smoke generated by a warming engine.

Normal Starting Procedure – Engine Manifold Air Temperature Above 66°F (19°C)

Observe the instrument panel cluster lights when starting the engine.

1. Always apply the parking brake.
2. Shift into PARK for an automatic transmission. For vehicles equipped with a manual transmission, fully press and hold the clutch pedal and shift into NEUTRAL.
3. Turn the ignition switch to the ON position and watch the instrument panel cluster lights.

CAUTION!

If the "Water in Fuel Indicator Light" remains on, DO NOT START the engine before you drain the water from the fuel filter to avoid engine damage. Refer to "Maintenance Procedures/Draining Fuel/Water Separator Filter" in "Maintaining Your Vehicle" for further information.

4. Turn the ignition switch to the START position and crank the engine. Do not press the accelerator during starting.

CAUTION!

Do not crank engine for more than 15 seconds at a time or starter motor damage may result. Turn the ignition switch to the OFF position and wait at least two minutes for the starter to cool before repeating start procedure.

5. When the engine starts, release the key fob.
6. Check to see that there is oil pressure.
7. Release the parking brake.

Starting Procedure – Engine Manifold Air Temperature 0°F To 66°F (–18°C to 19°C)

NOTE: The temperature displayed in the Electronic Vehicle Information Center (EVIC) does not necessarily reflect the engine manifold air temperature. Refer to “Electronic Vehicle Information Center (EVIC)” in “Understanding Your Instrument Panel” for further information. When engine temperatures fall below 66°F (19°C) the “Wait To Start Light” will remain on indicating the intake manifold heater system is active.

Follow the steps in the “Normal Starting” procedure except:

1. The “Wait To Start Light” will remain on for a period of time (length of time depends on engine temperature).

CAUTION!

If the “Water in Fuel Indicator Light” remains on, **DO NOT START** engine before you drain the water from the fuel filter to avoid engine damage. Refer to “Maintenance Procedures/Draining Fuel/Water Separator Filter” in “Maintaining Your Vehicle” for further information.

2. After the “Wait To Start Light” goes off, turn the ignition switch to the START position. Do not press the accelerator during starting.

CAUTION!

Do not crank engine for more than 15 seconds at a time or starter motor damage may result. Turn the ignition switch to the OFF position and wait at least two minutes for the starter to cool before repeating start procedure.

3. After engine start-up, check to see that there is oil pressure.
4. Allow the engine to idle about three minutes until the manifold heaters have completed the post-heat cycle.
5. Release the parking brake and drive.

NOTE:

- Engine idle speed will automatically increase to 1,000 RPM and engage the Variable Geometry Turbocharger at low coolant temperatures to improve engine warm-up.

- If the engine stalls, or if the ignition switch is left ON for more than two minutes after the “Wait To Start Light” goes out, reset the grid heaters by turning the ignition switch to the OFF position for at least five seconds and then back ON. Repeat steps 1 through 5 of “Starting Procedure – Engine Manifold Air Temperature Below 66°F (19°C).”

Starting Procedure – Engine Manifold Air Temperature Below 0°F (-18°C)

In extremely cold weather below 0°F (-18°C) it may be beneficial to cycle the manifold heaters twice before attempting to start the engine. This can be accomplished by turning the ignition OFF for at least five seconds and then back ON after the “Wait To Start Light” has turned off, but before the engine is started. However, excessive cycling of the manifold heaters will result in damage to the heater elements or reduced battery voltage.

NOTE: If multiple pre-heat cycles are used before starting, additional engine run time may be required to maintain battery state of charge at a satisfactory level.

1. If the engine stalls after the initial start, the ignition must be turned to the OFF position for at least five seconds and then to the ON position to recycle the manifold heaters.

NOTE: Excessive white smoke and poor engine performance will result if manifold heaters are not recycled.

2. Heat generated by the manifold heaters dissipates rapidly in a cold engine. If more than two minutes pass between the time the “Wait To Start Light” turns off and the engine is started, recycle the manifold heaters by turning the ignition switch to the OFF position for at least five seconds and then back ON.

3. If the vehicle is driven and vehicle speed exceeds 19 mph (31 km/h) before the manifold heater post-heat (after start) cycle is complete, the manifold heaters will shut off.

4. If the engine is started before the “Wait To Start Light” turns off, the preheat cycle will turn off.

5. If the engine is cranked for more than 10 seconds, the post-heat cycle will turn off.

NOTE:

- Engine idle speed will automatically increase to 1,000 RPM and engage the Variable Geometry Turbocharger at low coolant temperatures to improve engine warm-up.

- When a diesel engine is allowed to run out of fuel or the fuel gels at low temperatures, air is pulled into the fuel system. If your engine has run out of fuel, refer to “Maintenance Procedures/Priming If The Engine Has Run Out Of Fuel” in “Maintaining Your Vehicle” for further information.

Starting Fluids

WARNING!

Starting fluids or flammable liquids are never to be used in the Cummins® diesel engine (see Warning label). Never pour diesel fuel, flammable liquid, starting fluids (ether) into the air cleaner canister, air intake piping, or turbocharger inlet in an attempt to start the vehicle. This could result in a flash fire and explosion causing serious personal injury and engine damage.

The engine is equipped with an automatic electric air preheating system. If the instructions in this manual are followed, the engine should start in all conditions.

WARNING!

- Do not leave children or animals inside parked vehicles in hot weather. Interior heat build up may cause serious injury or death.
- Leaving children in a vehicle unattended is dangerous for a number of reasons. A child or others could be seriously or fatally injured. Children should be warned not to touch the parking brake, brake pedal or the shift lever. Do not leave the key in the ignition. A child could operate power windows, other controls, or move the vehicle.

NORMAL OPERATION – DIESEL ENGINE

Observe the following when the engine is operating.

- All message center lights are off.
- Malfunction Indicator Light (MIL) is off.
- Engine oil pressure is above 10 psi (69 kPa) at idle.
- Voltmeter operation:
 - The voltmeter may show a gauge fluctuation at various engine temperatures. This cycling operation is caused by the post-heat cycle of the intake manifold heater system. The number of cycles and the length of the cycling operation is controlled by the engine control module. Post-heat operation can run for several minutes, and then the electrical system and voltmeter needle will stabilize.

- The cycling action will cause temporary dimming of the headlamps, interior lamps, and also a noticeable reduction in blower motor speed.

Cold Weather Precautions

Operation in ambient temperature below 32°F (0°C) may require special considerations. The following charts suggest these options:

Fuel Operating Range

NOTE: Use “Ultra Low Sulfur Diesel Fuels” **ONLY**.

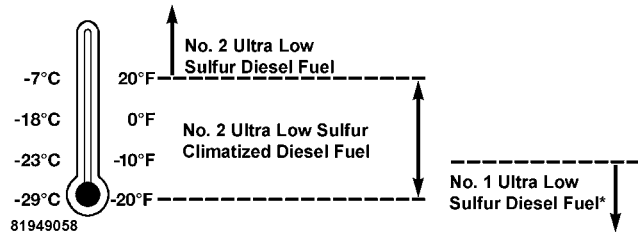

*No. 1 Ultra Low Sulfur Diesel Fuel should only be used where extended arctic conditions (-10°F/-23°C) exist.

NOTE:

- Use of Climatized Ultra Low Sulfur Diesel Fuel or Number 1 Ultra Low Sulfur Diesel Fuel results in a noticeable decrease in fuel economy.
- Climatized Ultra Low Sulfur Diesel Fuel is a blend of Number 2 Ultra Low Sulfur and Number 1 Ultra Low Sulfur Diesel Fuels which reduces the temperature at which wax crystals form in fuel.
- The engine requires the use of **“Ultra Low Sulfur Diesel Fuel”**. Use of incorrect fuel could result in engine and exhaust system damage. Refer to “Fuel Requirements” in “Starting and Operating” for further information.

Engine Oil Usage

Refer to “Maintenance Procedures” in “Maintaining Your Vehicle” for the correct engine oil viscosity.

Winter Front Usage

If a winter front or cold weather cover is to be used, a percentage of the total grille opening area must be left uncovered to provide sufficient air flow to the charge air cooler and automatic transmission oil cooler. The percentage of opening must be increased with the increasing ambient air temperature and/or engine load. If the cooling fan can be heard cycling frequently, increase the size of the opening in the winter front. A suitable cold weather cover is available from your MOPAR® dealer.

Battery Blanket Usage

A battery loses 60% of its cranking power as the battery temperature decreases to 0°F (-18°C). For the same decrease in temperature, the engine requires twice as much power to crank at the same RPM. The use of 120 VAC powered battery blankets will greatly increase starting capability at low temperatures. Suitable battery blankets are available from your authorized MOPAR® dealer.

Engine Warm-Up

Avoid full throttle operation when the engine is cold. When starting a cold engine, bring the engine up to operating speed slowly to allow the oil pressure to stabilize as the engine warms up.

NOTE: High-speed, no-load running of a cold engine can result in excessive white smoke and poor engine performance. No-load engine speeds should be kept under 1,200 RPM during the warm-up period, especially in cold ambient temperature conditions.

Your vehicle is equipped with a turbo speed limiter, this feature limits the engine speed to 1,200 RPM when engine coolant temperatures are below 70°F (21°C). This feature is designed to protect the turbocharger from damage and will only operate in PARK or NEUTRAL.

If temperatures are below 32°F (0°C), operate the engine at moderate speeds for five minutes before full loads are applied.

NOTE:

- If ambient temperatures are low and the coolant temperature is below 180°F (82°C), the engine idle speed will slowly increase to 1,000 RPM after two minutes of idle, if the following conditions are met:
 - foot is off brake pedal and throttle pedal
 - automatic transmission is in PARK
 - vehicle speed is zero
 - Applying the throttle will cancel fast idle

- If the engine is equipped with an exhaust brake, operating the exhaust brake at idle will greatly improve warm up rate and will help keep the engine close to operating temperature during extended idle.

Engine Idling

Avoid prolonged idling, long periods of idling may be harmful to your engine because combustion chamber temperatures can drop so low that the fuel may not burn completely. Incomplete combustion allows carbon and varnish to form on piston rings, engine valves, and injector nozzles. Also, the unburned fuel can enter the crankcase, diluting the oil and causing rapid wear to the engine.

If the engine is allowed to idle, under some conditions the idle speed may increase to 900 RPM then return to normal idle speed. This is normal operation.

NOTE: For EVIC messages related to the vehicle's exhaust system, refer to "Maintenance Procedures/ Intervention Regeneration Strategy – EVIC Message Process Flow" in "Maintaining Your Vehicle" for further information.

Idle-Up Feature – Automatic Transmission Only

The driver-controlled high idle speed feature will help increase cylinder temperatures and provide additional cab heat, however, excessive idling may still cause the exhaust aftertreatment system to not properly regenerate. Extended periods of idle time should be avoided.

The Idle-Up feature uses the speed control switches to increase engine idle speed and quickly warm the vehicle's interior.

1. With the transmission in PARK, the parking brake applied, and the engine running, press the speed control switch to the ON position, then press the SET switch.

2. The engine RPM will go up to 1100 RPM. To increase the RPM, press and hold the ACCEL/RESUME switch and the idle speed will increase to approximately 1500 RPM. To decrease the RPM, press and hold the DECEL switch and the idle speed will decrease to approximately 1100 RPM.

3. To cancel the Idle-Up feature, either press the CANCEL switch, press the ON/OFF switch, or press the brake pedal.

Stopping The Engine

Idle the engine a few minutes before routine shutdown. After full load operation, idle the engine three to five minutes before shutting it down. This idle period will allow the lubricating oil and coolant to carry excess heat away from the combustion chamber, bearings, internal components, and turbocharger. This is especially important for turbocharged, charge air-cooled engines.

NOTE:

- During engine shut down on vehicles equipped with manual transmissions, it is normal for the diesel engine to resonate heavily for a moment during engine shut off. When the engine is connected to a manual transmission, this resonance causes load gear rattle from the transmission. This is commonly referred to as “shut down rattle.” The manufacturer recommends performing engine shut down with the clutch pedal pushed to the floor (clutch disengaged). When engine shut down is performed in this manner the rattle is reduced (not eliminated).

- Refer to the following chart for proper engine shutdown.

Driving Condition	Load	Turbo-charger Temperature	Idle Time (min.) Before Engine Shutdown
Stop and Go	Empty	Cool	Less than One
Stop and Go	Medium		One
Highway Speeds	Medium	Warm	Two
City Traffic	Maximum GCWR		Three
Highway Speeds	Maximum GCWR		Four
Uphill Grade	Maximum GCWR	Hot	Five

Idle Shutdown (Chassis Cab Only)

This feature can be enabled so that the truck will automatically shutdown when the truck has been idling for a set period of time when the engine is at operating temperature. Idle time can be set in 5 minute increments between 5 and 30 minutes. See your local authorized dealer to enable this feature.

Programmable Maximum Vehicle Speed (Chassis Cab Only)

This feature allows the owner to set a maximum vehicle speed for the vehicle. The 3500 Series maximum vehicle speed can be set between 40 mph (64 km/h) and 87 mph (164 km/h). The 4500/5500 Series maximum vehicle speed can be set between 40 mph (64 km/h) and 85 mph (136 km/h). See your local authorized dealer to enable this feature.

NOTE: DO NOT set the maximum vehicle speed to a value greater than what the vehicle tires are rated for.

Snow Plow Mode

Snow Plow Mode can be activated when the vehicle has a snow plow installed. This mode fully engages the fan clutch to increase the airflow when the plow is attached to the vehicle.

NOTE: There may be an increase in fan noise and a decrease in fuel economy may result when using this feature. The fan clutch operation can be initiated by performing the following button sequence.

1. Turn the ignition key to the on position or start the vehicle.
2. Pull in the Cruise Control “Cancel” button/lever and hold. While holding the Cruise Control “Cancel”, push the “Exhaust Brake” button twice within five seconds. Repeat this sequence four times. The chime will sound twice as an audible indicator that the function is engaged.

3. To disable the function, repeat Step 2. The chime will sound four times as an audible indicator that the function is disengaged.

Operating Precautions

Avoid Overheating The Engine

The temperature of the engine coolant (antifreeze) (a mixture of 50% ethylene-glycol and 50% water) must not exceed the normal range of the temperature gauge 240°F (116°C) with a 16 psi (110 kPa) radiator cap.

Usually the engine coolant (antifreeze) temperature indicated during operation will be to the left of center in the normal range of the gauge.

Avoid Low Coolant Temperature Operation

Continual operation at low engine coolant (antifreeze) temperature below the normal range on the gauge 140°F (60°C) can be harmful to the engine. Low engine coolant

(antifreeze) temperature can cause incomplete combustion which allows carbon and varnish to form on piston rings and injector nozzles. Also, the unburned fuel can enter the crankcase, diluting the lubricating oil and causing rapid wear to the engine.

Cooling System Tips – Automatic Transmission

To reduce potential for engine and transmission overheating in high ambient temperature conditions, take the following actions:

- *City Driving* —

When stopped, shift the transmission into NEUTRAL and increase engine idle speed.

- *Highway Driving* —

Reduce your speed.

- *Up Steep Hills* —

Select a lower transmission gear, but try and keep the torque converter clutch engaged.

- *Air Conditioning* —

Turn it off temporarily.

Do Not Operate The Engine With Low Oil Pressure

When the engine is at normal operating temperature, the minimum oil pressures required are:

Idle 700 to 800 RPM	10 psi (69 kPa)
Full speed and load	30 psi (207 kPa)

CAUTION!

If oil pressure falls to less than normal readings, shut the engine off immediately. Failure to do so could result in immediate and severe engine damage.

Do Not Operate The Engine With Failed Parts

Practically all failures give some warning before the parts fail. Be on the alert for changes in performance, sounds, and visual evidence that the engine requires service. Some important clues are:

- engine misfiring or vibrating severely
- sudden loss of power
- unusual engine noises
- fuel, oil or coolant leaks
- sudden change, outside the normal operating range, in the engine operating temperature
- excessive smoke
- oil pressure drop

ENGINE BLOCK HEATER — IF EQUIPPED

The engine block heater warms engine coolant and permits quicker starts in cold weather. Connect the heater cord to a ground-fault interrupter protected 110–115 Volt AC electrical outlet with a grounded, three-wire extension cord.

The engine block heater cord is routed under the hood to the right side and can be located just behind the grille near the headlamp.

NOTE: The engine block heater cord is a factory installed option. If your vehicle is not equipped, heater cords are available from your authorized MOPAR® dealer.

The block heater must be plugged in at least one hour to have an adequate warming effect on the coolant.

WARNING!

Remember to disconnect the cord before driving. Damage to the 110–115 Volt electrical cord could cause electrocution.

NOTE: The block heater will require 110 Volts AC and 6.5 Amps to activate the heater element.

Block Heater Usage

For ambient temperatures below 0°F (-18°C), engine block heater usage is recommended.

For ambient temperatures below -20°F (-29°C), engine block heater usage is required.

DIESEL EXHAUST BRAKE (ENGINE BRAKING) — IF EQUIPPED

The exhaust brake feature will only function when the driver turns the exhaust brake switch to the ON position.

**Exhaust Brake Switch**

Once the switch is in the ON position and the vehicle is moving faster than 5 mph (8 km/h); the exhaust brake will automatically operate when the driver removes pressure from the accelerator pedal. Exhaust braking is most effective when the engine RPM is higher. The automatic transmission has been programmed in TOW/

HAUL mode only to downshift more aggressively when the exhaust brake is enabled to increase brake performance.

CAUTION!

Use of aftermarket exhaust brakes is not recommended and could lead to engine damage

WARNING!

Do not use the exhaust brake feature when driving in icy or slippery conditions as the increased engine braking can cause the rear wheels to slide and the vehicle to swing around with the possible loss of vehicle control, which may cause an accident possibly resulting in personal injury or death.

NOTE: For optimum braking power it is recommended to use the exhaust brake while in TOW/HAUL mode.

The purpose of the exhaust brake (engine braking) feature is to supply negative (braking) torque to the engine. Typically, the engine braking is used for, but not limited to, vehicle towing applications where vehicle braking can be achieved by the internal engine power, thereby sparing the mechanical brakes of the vehicle.

Benefits of the exhaust brake are:

- vehicle driving control
- reduced brake fade
- longer brake life
- faster cab warm-up.

The exhaust brake feature can also be used to reduce the engine warm up time. To use the exhaust brake as a warm-up device, the vehicle must be stopped or moving less than 5 mph (8 km/h), the exhaust brake switch must

be in the ON position, and the coolant temperature must be below 180°F (82°C) and ambient temperature below 60°F (16°C).

AUTOMATIC TRANSMISSION — IF EQUIPPED

CAUTION!

Damage to the transmission may occur if the following precautions are not observed:

- Shift into PARK only after the vehicle has come to a complete stop.
- Shift into or out of REVERSE only after the vehicle has come to a complete stop and the engine is at idle speed.
- Do not shift between PARK, REVERSE, NEUTRAL, or DRIVE into any forward gear when the engine is above idle speed.

(Continued)

CAUTION! (Continued)

- Before shifting into any gear, make sure your foot is firmly pressing on the brake pedal.

WARNING!

- Unintended movement of a vehicle could injure those in and near the vehicle. As with all vehicles, you should never exit a vehicle while the engine is running. Before exiting a vehicle, apply the parking brake, shift the transmission into PARK, and remove the key fob. Once the key fob is removed, the shift lever is locked in the PARK position, securing the vehicle against unwanted movement. Furthermore, you should never leave unattended children inside a vehicle.

(Continued)

WARNING! (Continued)

- Leaving children in a vehicle unattended is dangerous for a number of reasons. A child or others could be seriously or fatally injured. Children should be warned not to touch the parking brake, brake pedal or the shift lever. Do not leave the key fob in the vehicle. A child could operate power windows, other controls, or move the vehicle.
- It is dangerous to move the shift lever out of PARK or NEUTRAL if the engine speed is higher than idle speed. If your foot is not firmly pressing on the brake pedal, the vehicle could accelerate quickly forward or in reverse. You could lose control of the vehicle and hit someone or something. Only shift into gear when the engine is idling normally and when your right foot is firmly pressing on the brake pedal.

Key Ignition Park Interlock

This vehicle is equipped with a Key Ignition Park Interlock which requires the shift lever to be placed in PARK before the ignition switch can be turned to the LOCK/OFF position. The key fob can only be removed from the ignition when the ignition is in the LOCK/OFF position and once removed the shift lever is locked in PARK.

Brake/Transmission Shift Interlock System

This vehicle is equipped with a Brake Transmission Shift Interlock System (BTSI) that holds the shift lever in the PARK position when the ignition switch is in the LOCK/OFF position. To move the shift lever out of the PARK position, the ignition switch must be turned to the ON/RUN position (engine running or not) and the brake pedal must be pressed.

Six-Speed Automatic Transmission – If Equipped (Ram Truck Only)

The shift lever position display (located in the instrument panel cluster) indicates the transmission gear range. The shift lever is mounted on the right side of the steering column. You must press the brake pedal to move the shift lever out of the PARK position (refer to “Brake/Transmission Shift Interlock System” in this section). To drive, move the shift lever from PARK or NEUTRAL to the DRIVE position. Pull the shift lever toward you when shifting into REVERSE or PARK, or when shifting out of PARK.

The electronically-controlled transmission provides a precise shift schedule. The transmission electronics are self-calibrating; therefore, the first few shifts on a new vehicle may be somewhat abrupt. This is a normal condition, and precision shifts will develop within a few hundred miles (kilometers).

Shifting from DRIVE to PARK or REVERSE should be done only after the accelerator pedal is released and the vehicle is stopped. Be sure to keep your foot on the brake pedal when moving the shift lever between these gears.

The transmission shift lever has only Park, Reverse, Neutral, and Drive shift positions. Manual downshifts can be made using the Electronic Range Select (ERS) shift control (described later). Pressing the ERS (-/+) buttons while in the DRIVE position will select the highest available transmission gear, and will display that gear in the instrument cluster as 6, 5, 4, 3, 2, 1.

Gear Ranges

DO NOT race the engine when shifting from PARK or NEUTRAL into another gear range.

PARK

This range supplements the parking brake by locking the transmission. The engine can be started in this range.

Never attempt to use PARK while the vehicle is in motion. Apply the parking brake when leaving the vehicle in this range.

When parking on a level surface, you may place the shift lever in the PARK position first, and then apply the parking brake.

When parking on a hill, apply the parking brake before placing the shift lever in PARK, otherwise the load on the transmission locking mechanism may make it difficult to move the shift lever out of PARK. As an added precaution, turn the front wheels toward the curb on a downhill grade and away from the curb on an uphill grade.

WARNING!

- **Never use the PARK position as a substitute for the parking brake. Always apply the parking brake fully when parked to guard against vehicle movement and possible injury or damage.**
- **Your vehicle could move and injure you and others if it is not completely in PARK. Check by trying to move the shift lever clockwise without first pulling it toward you after you have placed it in PARK. Make sure the transmission is in PARK before leaving the vehicle.**

(Continued)

WARNING! (Continued)

- It is dangerous to move the shift lever out of PARK or NEUTRAL if the engine speed is higher than idle speed. If your foot is not firmly pressing on the brake pedal, the vehicle could accelerate quickly forward or in reverse. You could lose control of the vehicle and hit someone or something. Only shift into gear when the engine is idling normally and when your foot is firmly pressing on the brake pedal.

(Continued)

WARNING! (Continued)

- Unintended movement of a vehicle could injure those in and near the vehicle. As with all vehicles, you should never exit a vehicle while the engine is running. Before exiting a vehicle, always apply the parking brake, shift the transmission into PARK, and remove the key fob. Once the key fob is removed, the shift lever is locked in the PARK position, securing the vehicle against unwanted movement. Furthermore, you should never leave unattended children inside a vehicle.
- Never leave children alone in a vehicle. Leaving unattended children in a vehicle is dangerous for a number of reasons. A child or others could be seriously or fatally injured. Do not leave the key fob in the vehicle. A child could operate power windows, other controls, or move the vehicle.

CAUTION!

- Before moving the shift lever out of PARK, you must turn the ignition switch from the LOCK/OFF position to the ON/RUN position, and also press the brake pedal. Otherwise, damage to the shift lever could result.
- DO NOT race the engine when shifting from PARK or NEUTRAL into another gear range, as this can damage the drivetrain.

The following indicators should be used to ensure that you have engaged the shift lever into the PARK position:

- When shifting into PARK, pull the shift lever toward you and move it all the way counterclockwise until it stops.
- Release the shift lever and make sure it is fully seated in the PARK gate.

- Look at the shift lever position display and verify that it indicates the PARK position.
- With brake pedal released, verify that the shift lever will not move out of PARK.

REVERSE

This range is for moving the vehicle backward. Shift into REVERSE only after the vehicle has come to a complete stop.

NEUTRAL

Use this range when the vehicle is standing for prolonged periods with the engine running. The engine may be started in this range. Set the parking brake and shift the transmission into PARK if you must leave the vehicle.

WARNING!

Do not coast in NEUTRAL and never turn off the ignition to coast down a hill. These are unsafe practices that limit your response to changing traffic or road conditions. You might lose control of the vehicle and have an accident.

CAUTION!

Towing the vehicle, coasting, or driving for any other reason with the transmission in NEUTRAL can result in severe transmission damage. Refer to "Recreational Towing" in "Starting And Operating" and "Towing A Disabled Vehicle" in "What To Do In Emergencies" for further information.

DRIVE

This range should be used for most city and highway driving. It provides the smoothest upshifts and downshifts, and the best fuel economy. The transmission automatically upshifts through underdrive first, second, and third gears, direct fourth gear and overdrive fifth and sixth gears. The DRIVE position provides optimum driving characteristics under all normal operating conditions.

When frequent transmission shifting occurs (such as when operating the vehicle under heavy loading conditions, in hilly terrain, traveling into strong head winds, or while towing heavy trailers), use the Electronic Range Select (ERS) feature (refer to "Electronic Range Select (ERS)" in this section) to select a lower gear range. Under these conditions, using a lower gear range will improve performance and extend transmission life by reducing excessive shifting and heat buildup.

If the transmission operating temperature exceeds normal operating limits, the powertrain controller will modify the transmission shift schedule and expand the range of torque converter clutch engagement. This is done to prevent transmission damage due to overheating.

If the transmission becomes extremely hot, the “Transmission Temperature Warning Light” may illuminate and the transmission may downshift out of Overdrive until the transmission cools down.

NOTE: Use caution when operating a heavily loaded vehicle at low speeds (such as towing a trailer up a steep grade, or in stop-and-go traffic) during hot weather. In these conditions, torque converter slip can impose a significant additional heat load on the cooling system. Downshifting the transmission to the lowest possible

gear (when climbing a grade), or shifting to NEUTRAL (when stopped in heavy traffic) can help to reduce this excess heat generation.

During cold temperatures, transmission operation may be modified depending on engine and transmission temperature as well as vehicle speed. This feature improves warm up time of the engine and transmission to achieve maximum efficiency. Engagement of both the torque converter clutch and the top overdrive gear are inhibited until the transmission fluid is warm (refer to the “Note” under “Torque Converter Clutch” in this section). During extremely cold temperatures (-16°F [-27°C] or below), operation may briefly be limited to first and direct gears only. Normal operation will resume once the transmission temperature has risen to a suitable level.

Transmission Limp Home Mode

Transmission function is monitored electronically for abnormal conditions. If a condition is detected that could result in transmission damage, Transmission Limp Home Mode is activated. In this mode, the transmission remains in fourth gear regardless of which forward gear is selected. PARK, REVERSE, and NEUTRAL will continue to operate. Limp Home Mode allows the vehicle to be driven to an authorized dealer for service without damaging the transmission.

In the event of a momentary problem, the transmission can be reset to regain all forward gears by performing the following steps:

1. Stop the vehicle.
2. Shift the transmission into PARK.
3. Turn the ignition switch to the LOCK/OFF position.
4. Wait approximately 10 seconds.

5. Restart the engine.

6. Shift into the desired gear range. If the problem is no longer detected, the transmission will return to normal operation.

NOTE: Even if the transmission can be reset, we recommend that you visit your authorized dealer at your earliest possible convenience. Your authorized dealer has diagnostic equipment to determine if the problem could recur.

If the transmission cannot be reset, authorized dealer service is required.

Electronic Range Select (ERS) Operation

The Electronic Range Select (ERS) shift control allows the driver to limit the highest available gear when the shift lever is in the DRIVE position. For example, if you shift the transmission into 3 (third gear), the transmission will never shift above third gear, but will shift down into second and first gear normally.

You can switch between DRIVE and ERS mode at any vehicle speed. When the shift lever is in the DRIVE position, the transmission will operate automatically, shifting between all available gears. Tapping the ERS (-) switch will activate ERS mode, display the current gear in the instrument cluster, and maintain that gear as the top available gear. Once in ERS mode, tapping the ERS (-) or (+) switch will change the top available gear.

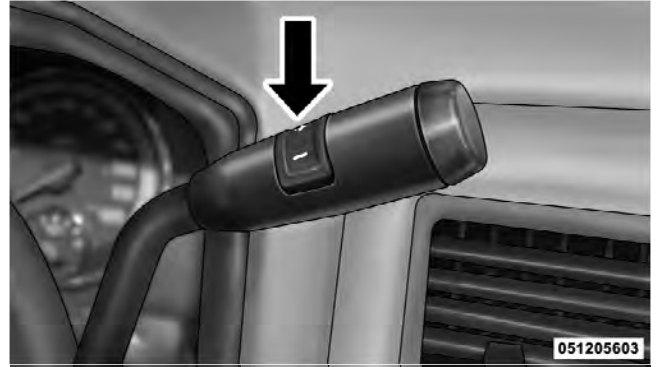

Column Shift Lever

To exit ERS mode, simply press and hold the ERS (+) switch until "D" is once again displayed in the shift lever position indicator in the instrument cluster.

WARNING!

Do not downshift for additional engine braking on a slippery surface. The drive wheels could lose their grip and the vehicle could skid, causing an accident or personal injury.

Screen Display	1	2	3	4	5	6	D
Actual Gear(s) Allowed	1	1-2	1-3	1-4	1-5	1-6	1-6

NOTE: To select the proper gear position for maximum deceleration (engine braking), simply press and hold the ERS (-) switch down. The transmission will shift to the range from which the vehicle can best be slowed down.

Overdrive Operation

The automatic transmission includes an electronically controlled Overdrive (fifth and sixth gears). The transmission will automatically shift into the Overdrive gear if the following conditions are present:

- the shift lever is in the DRIVE position,
- the transmission fluid has reached an adequate temperature,
- the engine coolant has reached an adequate temperature,
- vehicle speed is sufficiently high, and
- the TOW/HAUL switch has not been activated.

When To Use TOW/HAUL Mode

When driving in hilly areas, towing a trailer, carrying a heavy load, etc., and frequent transmission shifting occurs, press the TOW/HAUL switch to select TOW/HAUL mode. This will improve performance and reduce the potential for transmission overheating or failure due to excessive shifting. When operating in TOW/HAUL mode, transmission upshifts are delayed, and the transmission will automatically downshift (for engine braking) during steady braking maneuvers.

WARNING!

Do not use the “TOW/HAUL” feature when driving in icy or slippery conditions. The increased engine braking could cause the rear wheels to slide, and the vehicle to swing around with the possible loss of vehicle control, which could cause an accident possibly resulting in personal injury or death.

4

**TOW/HAUL Switch**

The “TOW/HAUL Indicator Light” will illuminate in the instrument cluster to indicate that TOW/HAUL mode has been activated. Pressing the switch a second time restores normal operation. If the TOW/HAUL mode is desired, the switch must be pressed each time the engine is started.

Torque Converter Clutch

A feature designed to improve fuel economy has been included in the automatic transmission on your vehicle. A clutch within the torque converter engages automatically at calibrated speeds. This may result in a slightly different feeling or response during normal operation in the upper gears. When the vehicle speed drops or during some accelerations, the clutch automatically disengages.

NOTE:

- The torque converter clutch will not engage, and the transmission will not shift to sixth gear, until the transmission fluid and engine coolant are warm [usually after 1 to 3 miles (1.6 to 4.8 km) of driving]. Because sixth gear is disabled, and engine speed is higher when the torque converter clutch is not engaged, it may seem as if the transmission is not shifting properly when cold. This is normal. Using the Electronic Range Select (ERS) feature, when the transmission is sufficiently warm, will demonstrate that the transmission is able to shift into and out of Overdrive.
- If the vehicle has not been driven for several days, the first few seconds of operation after shifting the transmission into gear may seem sluggish. This is due to the fluid partially draining from the torque converter into the transmission. This condition is normal and will not cause damage to the transmission. The torque converter will refill within five seconds after starting the engine.

Six-Speed Automatic Transmission – If Equipped (Chassis Cab Only)

The shift lever position display (located in the instrument panel cluster) indicates the transmission gear range. The shift lever is mounted on the right side of the steering column. You must press the brake pedal to move the shift lever out of the PARK position (refer to “Brake/Transmission Shift Interlock System” in this section). To drive, move the shift lever from PARK or NEUTRAL to the DRIVE position. Pull the shift lever toward you when shifting into REVERSE or PARK, or when shifting out of PARK.

The electronically-controlled transmission provides a precise shift schedule. The transmission electronics are self-calibrating; therefore, the first few shifts on a new vehicle may be somewhat abrupt. This is a normal condition, and precision shifts will develop within a few hundred miles (kilometers).

Shifting from DRIVE to PARK or REVERSE should be done only after the accelerator pedal is released and the vehicle is stopped. Be sure to keep your foot on the brake pedal when moving the shift lever between these gears.

The transmission shift lever has only PARK, REVERSE, NEUTRAL, and DRIVE shift positions. Manual downshifts can be made using the Electronic Range Select (ERS) shift control (described later). Pressing the ERS (-/+) switches (on the shift lever) while in the DRIVE position will select the highest available transmission gear, and will display that gear in the instrument cluster as 6, 5, 4, 3, 2, 1.

Gear Ranges

DO NOT race the engine when shifting from PARK or NEUTRAL into another gear range.

PARK

This range supplements the parking brake by locking the transmission. The engine can be started in this range. Never attempt to use PARK while vehicle is in motion. Apply the parking brake when leaving the vehicle in this range.

When parking on a level surface, you may place the shift lever in the PARK position first, and then apply the parking brake.

When parking on a hill, apply the parking brake before placing the shift lever in PARK, otherwise the load on the transmission locking mechanism may make it difficult to move the shift lever out of PARK. As an added precaution, turn the front wheels toward the curb on a downhill grade and away from the curb on an uphill grade.

WARNING!

- Never use the PARK position as a substitute for the parking brake. Always apply the parking brake fully when parked to guard against vehicle movement and possible injury or damage.
- Your vehicle could move and injure you and others if it is not completely in PARK. Check by trying to move the shift lever clockwise without first pulling it toward you after you have placed it in PARK. Make sure the transmission is in PARK before leaving the vehicle.

(Continued)

WARNING! (Continued)

- It is dangerous to move the shift lever out of PARK or NEUTRAL if the engine speed is higher than idle speed. If your foot is not firmly pressing on the brake pedal, the vehicle could accelerate quickly forward or in reverse. You could lose control of the vehicle and hit someone or something. Only shift into gear when the engine is idling normally and your foot is firmly pressed on the brake pedal.

(Continued)

WARNING! (Continued)

- Unintended movement of a vehicle could injure those in and near the vehicle. As with all vehicles, you should never exit a vehicle while the engine is running. Before exiting a vehicle, always apply the parking brake, shift the transmission into PARK, and remove the key fob. Once the key fob is removed, the shift lever is locked in the PARK position, securing the vehicle against unwanted movement. Furthermore, you should never leave unattended children inside a vehicle.
- Never leave children alone in a vehicle. Leaving unattended children in a vehicle is dangerous for a number of reasons. A child or others could be seriously or fatally injured. Do not leave the key fob in the vehicle. A child could operate power windows, other controls, or move the vehicle.

CAUTION!

- Before moving the shift lever out of PARK, you must turn the ignition switch from the LOCK/OFF position to the ON/RUN position, and also press the brake pedal. Otherwise, damage to the shift lever could result.
- DO NOT race the engine when shifting from PARK or NEUTRAL into another gear range, as this can damage the drivetrain.

The following indicators should be used to ensure that you have engaged the shift lever into the PARK position:

- When shifting into PARK, pull the shift lever toward you and move it all the way counterclockwise until it stops.
- Release the shift lever and make sure it is fully seated in the PARK gate.

- Look at the shift lever position display and verify that it indicates the PARK position.
- With brake pedal released, verify that the shift lever will not move out of PARK.

REVERSE

This range is for moving the vehicle backward. Shift into REVERSE only after the vehicle has come to a complete stop.

NEUTRAL

Use this range when the vehicle is standing for prolonged periods with the engine running. The engine may be started in this range. Set the parking brake and shift the transmission into PARK if you must leave the vehicle.

WARNING!

Do not coast in NEUTRAL and never turn off the ignition to coast down a hill. These are unsafe practices that limit your response to changing traffic or road conditions. You might lose control of the vehicle and have an accident.

CAUTION!

Towing the vehicle, coasting, or driving for any other reason with the transmission in NEUTRAL can result in severe transmission damage. Refer to "Recreational Towing" in "Starting And Operating" and "Towing A Disabled Vehicle" in "What To Do In Emergencies" for further information.

DRIVE

This range should be used for most city and highway driving. It provides the smoothest upshifts and downshifts, and the best fuel economy. The transmission automatically upshifts through underdrive first, second, and third gears, direct fourth gear and overdrive fifth and sixth gears. The DRIVE position provides optimum driving characteristics under all normal operating conditions.

When frequent transmission shifting occurs (such as when operating the vehicle under heavy loading conditions, in hilly terrain, traveling into strong head winds, or while towing heavy trailers), use the Electronic Range Select (ERS) feature (refer to “Electronic Range Select (ERS)” in this section) to select a lower gear range. Under these conditions, using a lower gear range will improve performance and extend transmission life by reducing excessive shifting and heat buildup.

If the transmission operating temperature exceeds normal operating limits, the powertrain controller will modify the transmission shift schedule and expand the range of torque converter clutch engagement. This is done to prevent transmission damage due to overheating.

If the transmission becomes extremely hot, the “Transmission Temperature Warning Light” may illuminate and the transmission may downshift out of Overdrive until the transmission cools down.

NOTE: Use caution when operating a heavily loaded vehicle at low speeds (such as towing a trailer up a steep grade, or in stop-and-go traffic) during hot weather. In these conditions, torque converter slip can impose a significant additional heat load on the cooling system. Downshifting the transmission to the lowest possible

gear (when climbing a grade), or shifting to NEUTRAL (when stopped in heavy traffic) can help to reduce this excess heat generation.

During cold temperatures, transmission operation may be modified depending on engine and transmission temperature as well as vehicle speed. This feature improves warm up time of the engine and transmission to achieve maximum efficiency. Engagement of the torque converter clutch is inhibited until the transmission fluid is warm (refer to the “Note” under “Torque Converter Clutch” in this section). On cold starts below 41°F (5°C), fifth and sixth gears may be inhibited briefly. During very cold temperatures (-4°F [-20°C] or below), operation may briefly be limited to third gear only. During this condition, the ability of the vehicle to accelerate under heavily loaded conditions may be reduced. Normal operation will resume once the transmission temperature has risen to a suitable level.

Transmission Limp Home Mode

Transmission function is monitored electronically for abnormal conditions. If a condition is detected that could result in transmission damage, Transmission Limp Home Mode is activated. In this mode, the transmission remains in third gear regardless of which forward gear is selected. If the vehicle enters Limp Home Mode at highway speeds, it will initially engage fifth gear, until the vehicle slows to a speed where third gear can be engaged. PARK, REVERSE, and NEUTRAL will continue to operate. Limp Home Mode allows the vehicle to be driven to an authorized dealer for service without damaging the transmission.

In the event of a momentary problem, the transmission can be reset to regain all forward gears by performing the following steps:

1. Stop the vehicle.

2. Shift the transmission into PARK.
3. Turn the ignition switch to the LOCK/OFF position.
4. Wait approximately 10 seconds.
5. Restart the engine.
6. Shift into the desired gear range. If the problem is no longer detected, the transmission will return to normal operation.

NOTE: Even if the transmission can be reset, we recommend that you visit your authorized dealer at your earliest possible convenience. Your authorized dealer has diagnostic equipment to determine if the problem could recur.

If the transmission cannot be reset, authorized dealer service is required.

Electronic Range Select (ERS) Operation

The Electronic Range Select (ERS) shift control allows the driver to limit the highest available gear when the shift lever is in the DRIVE position. For example, if you shift the transmission into 3 (third gear), the transmission will never shift above third gear, but will shift down into second and first gear normally.

You can switch between DRIVE and ERS mode at any vehicle speed. When the shift lever is in the DRIVE position, the transmission will operate automatically, shifting between all available gears. Tapping the ERS (-) switch will activate ERS mode, display the current gear in the instrument cluster, and maintain that gear as the top available gear. Once in ERS mode, tapping the ERS (-) or (+) switch will change the top available gear.

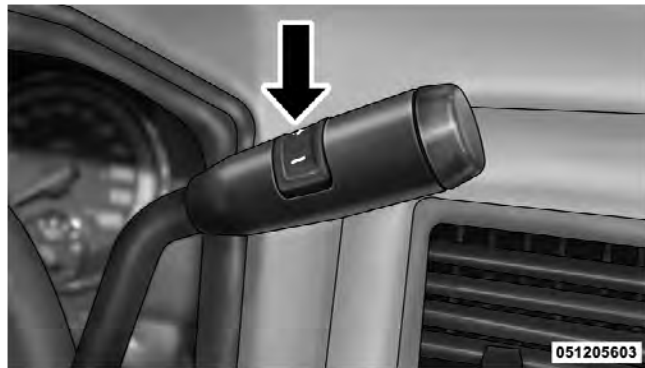

Column Shift Lever

To exit ERS mode, simply press and hold the ERS (+) switch until “D” is once again displayed in the shift lever position indicator in the instrument cluster.

WARNING!

Do not downshift for additional engine braking on a slippery surface. The drive wheels could lose their grip and the vehicle could skid, causing an accident or personal injury.

Screen Display	1	2	3	4	5	6	D
Actual Gear(s) Allowed	1	1-2	1-3	1-4	1-5	1-6	1-6

NOTE: To select the proper gear position for maximum deceleration (engine braking), simply press and hold the ERS (-) switch down. The transmission will shift to the range from which the vehicle can best be slowed down.

Overdrive Operation

The automatic transmission includes an electronically controlled Overdrive (fifth and sixth gears). The transmission will automatically shift into the Overdrive gear if the following conditions are present:

- the shift lever is in the DRIVE position,
- the transmission fluid has reached an adequate temperature,
- the engine coolant has reached an adequate temperature,
- vehicle speed is sufficiently high, and
- the “TOW/HAUL” switch has not been activated.

When To Use TOW/HAUL Mode

When driving in hilly areas, towing a trailer, carrying a heavy load, etc., and frequent transmission shifting occurs, press the TOW/HAUL switch to select TOW/HAUL mode. This will improve performance and reduce the potential for transmission overheating or failure due to excessive shifting.



TOW/HAUL Switch

The “TOW/HAUL Indicator Light” will illuminate in the instrument cluster to indicate that TOW/HAUL mode has been activated. Pressing the switch a second time restores normal operation. If the TOW/HAUL mode is desired, the switch must be pressed each time the engine is started.

WARNING!

Do not use the “TOW/HAUL” feature when driving in icy or slippery conditions. The increased engine braking can cause the rear wheels to slide, and the vehicle to swing around with the possible loss of vehicle control, which could cause an accident possibly resulting in personal injury or death.

Torque Converter Clutch

A feature designed to improve fuel economy has been included in the automatic transmission on your vehicle. A clutch within the torque converter engages automatically at calibrated speeds. This may result in a slightly different feeling or response during normal operation in the upper gears. When the vehicle speed drops or during some accelerations, the clutch automatically disengages.

NOTE:

- The torque converter clutch will not engage until the transmission fluid and engine coolant are warm [usually after 1 to 3 miles (1.6 to 4.8 km) of driving]. Because the engine speed is higher when the torque converter clutch is not engaged, it may seem as if the transmission is not shifting into Overdrive when cold. This is normal. Using the Electronic Range Select (ERS) feature, when the transmission is sufficiently warm, will demonstrate that the transmission is able to shift into and out of Overdrive.
- If the vehicle has not been driven for several days, the first few seconds of operation after shifting the transmission into gear may seem sluggish. This is due to the fluid partially draining from the torque converter into the transmission. This condition is normal and will not cause damage to the transmission. The torque converter will refill within five seconds after starting the engine.

MANUAL TRANSMISSION — IF EQUIPPED

WARNING!

You or others could be injured if you leave the vehicle unattended without having the parking brake fully applied. The parking brake should always be applied when the driver is not in the vehicle, especially on an incline.

CAUTION!

Never drive with your foot resting on the clutch pedal, or attempt to hold the vehicle on a hill with the clutch pedal partially engaged, as this will cause abnormal wear on the clutch.

NOTE: During cold weather, you may experience increased effort in shifting until the transmission fluid warms up. This is normal.

Shifting

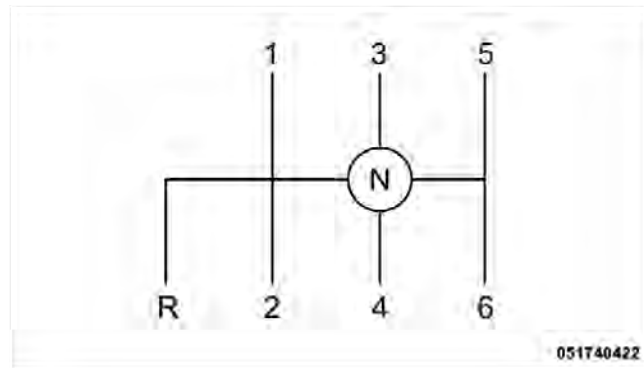

Shift Pattern

Truck models with manual transmission are equipped with a clutch interlocking ignition system. The clutch pedal must be fully pressed to start the vehicle.

Fully press the clutch pedal before shifting gears. As you release the clutch pedal, lightly press the accelerator pedal.

This transmission has a “creeper” first gear which should be used to start from a standing position when carrying a payload or towing a trailer. Damage to the clutch can result from starting in second or third gear with a loaded vehicle. An unloaded vehicle may be launched in second gear. Use each gear in numerical order – do not skip a gear.

NOTE: When loaded, pulling a trailer or on a grade, the truck should always start in first gear and not skip gears.

Recommended Vehicle Shift Speeds

To utilize your manual transmission efficiently for both fuel economy and performance, it should be upshifted as listed in recommended shift speed chart. Shift at the

vehicle speeds listed for acceleration. When heavily loaded or pulling a trailer these recommended up-shift speeds may not apply.

Maximum Recommended Up-Shift Speeds

Gear Selection	1 to 2	2 to 3	3 to 4	4 to 5	5 to 6
Maximum Speed	7 mph (11 km/h)	15 mph (24 km/h)	25 mph (40 km/h)	40 mph (64 km/h)	45 mph (72 km/h)

Downshifting

Moving from a high gear down to a lower gear is recommended to preserve brakes when driving down steep hills. In addition, downshifting at the right time provides better acceleration when you desire to resume speed. Downshift progressively. Do not skip gears to avoid overspeeding the engine and clutch.

WARNING!

Do not downshift for additional engine braking on a slippery surface. The drive wheels could lose their grip and the vehicle could skid.

CAUTION!

When descending a hill, be very careful to downshift one gear at a time to prevent overspeeding the engine which can cause valve damage, and/or clutch disc damage even if the clutch pedal is pressed.

Maximum Recommended Downshift Speeds**CAUTION!**

Failure to follow the recommended downshifting speeds may cause the engine to overspeed and/or damage the clutch disc even if the clutch pedal is pressed.

Maximum Recommended Downshifting Speeds

Gear Selection	6 to 5	5 to 4	4 to 3	3 to 2	2 to 1
Maximum Speed	68 mph (109 km/h)	50 mph (80 km/h)	32 mph (51 km/h)	19 mph (31 km/h)	10 mph (16 km/h)

Reverse Shifting

To shift into REVERSE (R), bring the vehicle to a complete stop. Press the clutch and pause briefly to allow the gear train to stop rotating. Beginning from the NEUTRAL (N) position, move the shift lever in one quick smooth motion straight across and into the REVERSE (R) area (the driver will feel a firm “click” as the shifter passes the “knock-over”). Complete the shift by pulling the shift lever into REVERSE (R).

The “knock-over” prevents the driver from accidentally entering the REVERSE (R) shift area and warns the driver that they are about to shift the transmission into REVERSE (R). Due to this feature, a slow shift to REVERSE (R) can be perceived as a high shift effort.

To shift out of REVERSE bring the vehicle to a complete stop and press the clutch. Shifting out of REVERSE prior to a complete stop may cause high shift effort.

POWER TAKE OFF OPERATION — IF EQUIPPED (CHASSIS CAB ONLY)

This vehicle when equipped with either the AS68RC automatic six-speed or G-56 manual six-speed transmissions, will allow for an aftermarket upfit with a transmission driven PTO (power take off). The customer will have the ability to operate the PTO in either a “stationary” or “mobile” mode. The vehicles will be factory set to the “stationary” mode. In order to select the “mobile” mode an authorized dealership is required to modify the vehicle’s settings using their proprietary authorized dealer service tool.

AS68RC Six-Speed Automatic Transmission Only

The PTO drive gear (part of the AS68RC) operates at torque converter turbine speed. The turbine speed will be less than engine speed when the torque converter clutch is not engaged and will be same as engine speed when the torque converter clutch is engaged.

Stationary Mode

To operate the PTO in this mode the vehicle must meet the following conditions:

- Be in PARK position (vehicles equipped with automatic transmission)
- Upfitter provider (on/off) switch has been activated
- Parking brake applied (vehicles equipped with manual transmission)
- Brake pedal must not be applied
- Vehicle engine must be running
- No vehicle, brake or clutch switch faults present
- PTO must be correctly installed using the vehicle provided circuits

The customer has the choice to operate the PTO by utilizing the cruise control switches or by utilizing a

remote control (provided by the PTO supplier). To operate the feature using the cruise control switches, the customer must first activate the upfitter-provided on/off switch which will turn on the PTO. In order to increase or decrease the engine idle speed, to optimize the PTO function, the “RESUME/ACCEL” and “DECEL” cruise switches can be used respectively. To disengage PTO operation and return to “standard vehicle operation” simply turn the upfitter-provided on/off switch to the OFF position.

The torque converter lockup clutch will automatically engage at engine speeds above 1,200 RPM (engine speed) in PTO stationary mode. Once engaged, the lockup clutch will remain on and not disengage until the engine speed is below 1,000 RPM. Lockup clutch engagement is desirable for certain types of PTO applications (AS68RC Six-Speed Automatic Transmission Only).

To operate the PTO via a remote switch, the customer must make sure the above conditions are met. It is vital for proper operation that the PTO and remote have been installed correctly, paying special attention to ensure the vehicle provided wiring has been connected properly. This is the responsibility of the installer of the PTO and switches/remote system. It is the responsibility of the PTO manufacturer to ensure that their electrical (switches and remote) system is compatible with the vehicle's electrical architecture and software functionality.

NOTE: If you desire a single PTO speed, your vehicle must be wired to use a remote PTO switch. For instructions on programming the SET speed, refer to the LEARNING SET SPEED section of the Body Builder's Guide which can be found at www.ramtrucks.com.

Mobile Mode

To operate the PTO in this mode the vehicle must meet the following conditions:

- Authorized dealer-selected "mobile" mode activated via authorized dealer proprietary service tool
- Upfitter-provided (on/off) switch has been activated
- Vehicle must be in PARK or DRIVE position (vehicles equipped with automatic transmission)
- Parking brake must not be applied
- Brake pedal must not be applied
- No vehicle, brake or clutch switch faults present
- Vehicle engine must be running
- PTO must be correctly installed using the vehicle provided circuits

The customer may choose to use the PTO while the vehicle is moving. To do so, the PTO function must be activated prior to taking the vehicle out of PARK. This is accomplished by activating the upfitter-provided PTO

on/off switch. At this point, the customer may place the vehicle in a forward or reverse gear and have PTO operation once the vehicle begins to move. To disengage PTO operation and return to “standard vehicle operation” simply turn the upfitter-provided on/off switch to the OFF position.

NOTE: For application specific information with respect to PTO and pump requirements and additional vehicle information (wiring schematics, preset idle values, engine speed limits, and vehicle hardware and software requirements) please refer to the Body Builders Guide by accessing www.ramtrucks.com and choosing the appropriate links.

Power Take Off – Aftermarket Installation

If you did not order the PTO (Power Take Off) Prep Package from the factory and want to convert your

vehicle, refer to the Body Builder’s Guide at www.ramtrucks.com or contact the manufacturer directly at (866) 205-4102 (toll free).

ENGINE RUNAWAY

WARNING!

In case of engine runaway due to flammable fumes from gasoline spills or turbocharger oil leaks being sucked into the engine, do the following to help avoid personal injury and/or vehicle damage:

- 1. Turn the ignition switch to the OFF position.**
- 2. Using a CO₂ or dry chemical type fire extinguisher, direct the spray from the fire extinguisher into the grille on the passenger side so that the spray enters the engine air intake.**

(Continued)

WARNING! (Continued)

The inlet for the engine air intake is located behind the passenger side headlamp and receives air through the grille.

FUEL REQUIREMENTS

Use good quality diesel fuel from a reputable supplier in your vehicle. Federal law requires that you must fuel this vehicle with Ultra Low Sulfur Highway Diesel fuel (15 ppm Sulfur maximum) and prohibits the use of Low Sulfur Highway Diesel fuel (500 ppm Sulfur maximum) to avoid damage to the emissions control system. For most year-round service, No. 2 diesel fuel meeting ASTM specification D-975 Grade S15 will provide good performance. If the vehicle is exposed to extreme cold (below 20°F or -7°C), or is required to operate at colder-than-normal conditions for prolonged periods, use climatized No. 2 diesel fuel or dilute the No. 2 diesel fuel with 50%

No. 1 diesel fuel. This will provide better protection from fuel gelling or wax-plugging of the fuel filters.

WARNING!

Do not use alcohol or gasoline as a fuel blending agent. They can be unstable under certain conditions and hazardous or explosive when mixed with diesel fuel.

Diesel fuel is seldom completely free of water. To prevent fuel system trouble, drain the accumulated water from the **fuel/water separator using the fuel/water separator drain** provided. If you buy good quality fuel and follow the cold weather advice above, fuel conditioners should not be required in your vehicle. If available in your area, a high cetane “premium” diesel fuel may offer improved cold-starting and warm-up performance.

Fuel Specifications

The Cummins® diesel engine has been developed to take advantage of the high energy content and generally lower cost No. 2 Ultra Low Sulfur diesel fuel or No. 2 Ultra Low Sulfur climatized diesel fuels. Experience has shown that it also operates on No. 1 Ultra Low Sulfur diesel fuels or other fuels within specification.

NOTE:

- A maximum blend of 5% biodiesel meeting ASTM specification D-6751 may be used with your Cummins® diesel engine.
- In addition, commercially available fuel additives are not necessary for the proper operation of your Cummins® diesel engine.
- No. 1 Ultra Low Sulfur diesel fuel should only be used where extended arctic conditions (-10°F or -23°C) exist.

ADDING FUEL

CAUTION!

To avoid fuel spillage and overfilling, do not “top off” the fuel tank after filling.

NOTE:

- When the fuel nozzle “clicks” or shuts off, the fuel tank is full.
- Tighten the fuel filler cap until you hear a “clicking” sound. This is an indication that the fuel filler cap is properly tightened.
- Make sure that the fuel filler cap is tightened each time the vehicle is refueled.

WARNING!

A fire may result if fuel is pumped into a portable container that is on a truck bed. You could be burned. Always place fuel containers on the ground while filling.

Fuel Filler Cap

If the fuel filler cap is lost or damaged, be sure the replacement cap is for use with this vehicle.

CAUTION!

Damage to the fuel system or emission control system could result from using an improper fuel tank filler tube cap. A poorly fitting cap could let impurities into the fuel system.

WARNING!

- Never have any smoking materials lit in or near the vehicle when the fuel filler cap is removed or the tank filled.
- Never add fuel to the vehicle when the engine is running.

Avoid Using Contaminated Fuel

Fuel that is contaminated by water or dirt can cause severe damage to the engine fuel system. Proper maintenance of the engine fuel filter and fuel tank is essential. Refer to "Maintenance Procedures" in "Maintaining Your Vehicle" for further information.

Bulk Fuel Storage – Diesel Fuel

If you store quantities of fuel, good maintenance of the stored fuel is also essential. Fuel contaminated with water will promote the growth of "microbes." These

microbes form “slime” that will clog fuel filters and lines. Drain condensation from the supply tank and change the line filter on a regular basis.

NOTE: When a diesel engine is allowed to run out of fuel, air is pulled into the fuel system.

If the vehicle will not start, refer to “Maintenance Procedures/Priming If The Engine Has Run Out Of Fuel” in “Maintaining Your Vehicle” for further information.

WARNING!

Do not open the high pressure fuel system with the engine running. Engine operation causes high fuel pressure. High pressure fuel spray can cause serious injury or death.

Diesel Exhaust Fluid Storage

Diesel Exhaust Fluid (DEF) is considered a very stable product with a long shelf life. If DEF is kept in temperatures between 10° to 90°F (-12° to 32°C), it will last a minimum of one year.

DEF is subject to freezing at the lowest temperatures. For example, DEF may freeze at temperatures at or below 12° F (-11° C). The system has been designed to operate in this environment.

NOTE: When working with DEF, it is important to know that:

- Any containers or parts that come into contact with DEF must be DEF compatible (plastic or stainless steel). Copper, brass, aluminum, iron or non-stainless steel should be avoided as they are subject to corrosion by DEF.
- If DEF is spilled, it should be wiped up completely

Adding Diesel Exhaust Fluid – Chassis Cab Only

The DEF gauge (located on the EVIC display) will display the level of DEF remaining in the tank. Refer to “Electronic Vehicle Information Center (EVIC)” in “Understanding Your Instrument Panel” for further information.

- When the DEF gauge reads 75%, add approximately 2 gallons (7.5 Liters) to fill the DEF tank.
- When the DEF gauge reads 50%, add approximately 4 gallons (15 Liters) to fill the DEF tank.
- When the DEF gauge reads 25%, add approximately 6 gallons (23 Liters) to fill the DEF tank.

NOTE: Driving conditions (altitude, vehicle speed, load, etc.) will effect the amount of DEF that is used in your vehicle.

DEF Fill Procedure

NOTE: Refer to “Fluids, Lubricants, and Genuine Parts” in “Maintaining Your Vehicle” for the correct fluid type.

1. Remove cap from DEF tank (located on drivers side of the vehicle).

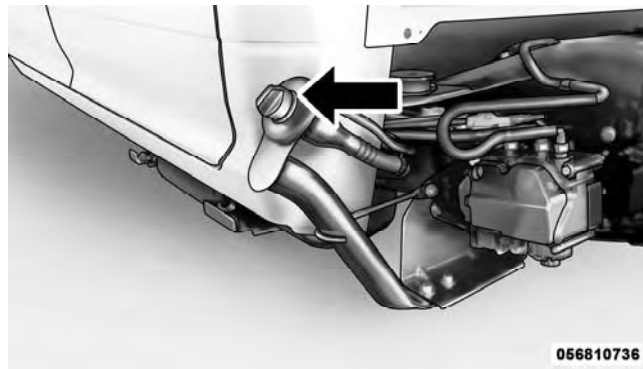

DEF Filler Cap

2. Insert DEF fill adapter/nozzle into DEF tank filler neck.

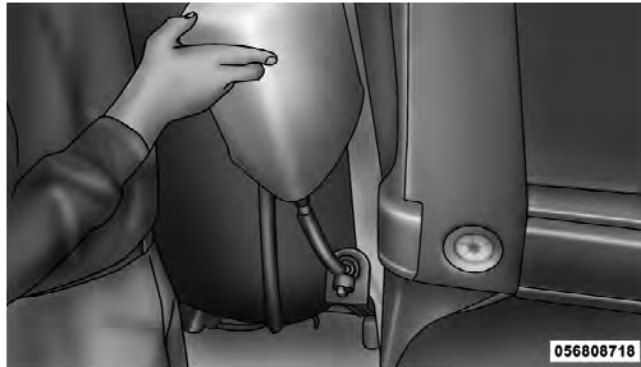

Filling the DEF Tank

CAUTION!

- To avoid DEF spillage, and possible damage to the DEF tank from overfilling, do not “top off” the DEF tank after filling.
- When DEF is spilled, clean the area immediately with water or use an absorbent material to soak up and spills on the ground.

3. Stop filling the DEF tank immediately when any of the following happen: DEF stops flowing from the fill bottle into the DEF tank, DEF splashes out the filler neck, or a DEF pump nozzle automatically shuts off.

4. Reinstall cap onto DEF tank.

DIESEL EXHAUST FLUID — CHASSIS CAB ONLY

Your vehicle is equipped with a Selective Catalytic Reduction system in order to meet the very stringent diesel emissions standards required by the Environmental Protection Agency. Selective Catalytic Reduction (SCR) is the first and only technology in decades to be as good for the environment as it is good for business and vehicle performance.

The purpose of the SCR system is to reduce levels of NO_x (oxides of nitrogen emitted from engines) that are harmful to our health and the environment to an almost near-zero level. Small quantities of Diesel Exhaust Fluid (DEF) are injected into the exhaust upstream of a catalyst where, when vaporized, convert smog-forming nitrogen oxides (NO_x) into harmless nitrogen (N₂) and water vapor (H₂O), two natural components of the air we breathe. You can operate with the comfort that your vehicle is contributing to a cleaner, healthier world environment for this and generations to come.

System Overview

This vehicle is equipped with a Diesel Exhaust Fluid (DEF) injection system and a Selective Catalytic Reduction (SCR) catalyst to meet the emission requirements.

The DEF injection system consists of the following components:

- DEF tank
- DEF pump
- DEF injector
- Electronically-heated DEF lines
- DEF control module
- NO_x sensors
- Temperature sensors
- SCR catalyst

The DEF injection system and SCR catalyst enable the achievement of diesel emissions requirements; while maintaining outstanding fuel economy, drivability, torque and power ratings.

Refer to “Electronic Vehicle Information Center (EVIC)” in “Understanding Your Instrument Panel” for system messages and warnings.

NOTE: The DEF pump will run for a period of time after engine shutdown to purge the DEF system. This is normal operation.

WHAT TO DO IN EMERGENCIES

CONTENTS

■ Jump Starting	92	□ With Portable Starting Unit	95
-----------------------	----	-------------------------------------	----

JUMP STARTING

WARNING!

- To prevent personal injury or damage to clothing, do not allow battery fluid to contact eyes, skin or fabrics. Do not lean over a battery when connecting jumper cables or allow cable clamps to touch each other. Keep open flames or sparks away from battery vent holes. Always wear eye protection when working with batteries.
- Do not use a booster battery or any other booster source that has a greater than 12 Volt system, i.e., do not use a 24 Volt power source.

NOTE: Replacement batteries should both be of equal size to prevent damage to the vehicle's charging system.

Your vehicle is equipped with two 12 Volt batteries. If it becomes necessary to use a booster battery with jumper

cables to start a vehicle's engine because its batteries are discharged, the following procedure should be used:

Set the parking brake and place an automatic transmission in PARK (or NEUTRAL for a manual transmission). Turn off lights, heater and other electrical loads. Observe charge indicator (if equipped) in both batteries. If the indicator (if equipped) is light or yellow on either battery, replace that battery.

CAUTION!

Use the jump start procedure only when the charge indicator (if equipped) in both batteries is dark in the center. Do not attempt jump starting when either battery charge indicator (if equipped) is bright or yellow. If the charge indicator (if equipped) has a green dot in the center, failure to start is not due to a discharged battery and cranking system should be checked.

1. Attach one jumper cable to the positive terminal of booster battery and the other end of the same cable to the positive terminal of the discharged battery.

WARNING!

Do not permit vehicles to touch each other as this could establish a ground connection and personal injury could result.

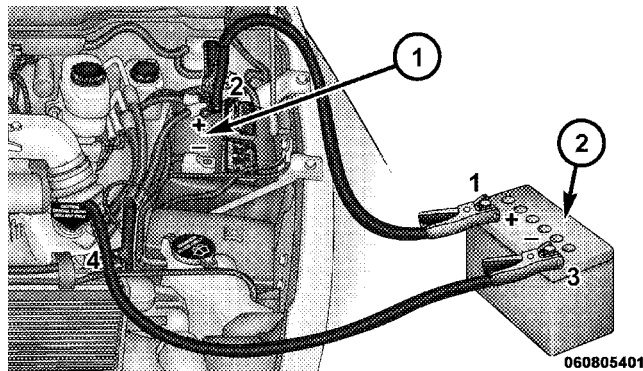

Attaching Booster Cables

- 1 — Discharged Battery
- 2 — Booster Battery

2. Connect one end of the other jumper cable to negative (-) post of booster battery. Connect the other end of the jumper cable to a good ground on the engine block of the

vehicle with the discharged battery. Make sure a good connection is made, free of dirt and grease.

WARNING!

- **Do not connect the cable to the negative post of the discharge battery. The resulting electrical spark could cause the battery to explode.**
- **During cold weather when temperatures are below freezing point, electrolyte in a discharged battery may freeze. Do not attempt jump starting because the battery could rupture or explode. The battery temperature must be brought up above freezing point before attempting to jump start.**

3. Take care that the clamps from one cable do not inadvertently touch clamps from the other cable. Do not lean over the battery when making connection. The negative connection must provide good electrical conductivity and current carrying capacity.

4. After the engine is started or if the engine fails to start, cables must be disconnected in the following order:

- a. Disconnect the negative cable at the engine ground.
- b. Disconnect the negative cable at the negative post on booster battery.
- c. Disconnect the cable from the positive post of both batteries.

WARNING!

Any procedure other than above could result in:

- **Personal injury caused by electrolyte squirting out the battery vent;**
- **Personal injury or property damage due to battery explosion;**
- **Damage to charging system of booster vehicle or of immobilized vehicle.**

With Portable Starting Unit

There are many types of these units available. Follow the manufacturer's instructions for necessary precautions and operation.

CAUTION!

It is very important that the starting unit operating voltage does not exceed 12 Volts DC or damage to battery, starter motor, alternator, or electrical system may occur.

MAINTAINING YOUR VEHICLE

CONTENTS

■ Engine Compartment — 6.7L Diesel	99	□ Diesel Exhaust Fluid – Chassis Cab Only	114
■ Maintenance Procedures	100	□ Maintenance-Free Batteries	114
□ Engine Oil	100	□ Cooling System	115
□ Engine Air Cleaner Filter	104	□ Charge Air Cooler – Inter-Cooler	121
□ Draining Fuel/Water Separator Filter	106	□ Brake System	121
□ Fuel Filter Replacement	108	□ Clutch Hydraulic System	123
□ Priming If The Engine Has Run Out Of Fuel	110	□ Transfer Case – If Equipped	123
□ Intervention Regeneration Strategy – EVIC Message Process Flow	111	□ Manual Transmission – If Equipped	124
		□ Automatic Transmission – If Equipped	124

98 MAINTAINING YOUR VEHICLE

□ Noise Control System Required Maintenance & Warranty	128	□ Engine	134
■ Fluid Capacities	133	□ Chassis	136
■ Fluids, Lubricants And Genuine Parts	134		

ENGINE COMPARTMENT — 6.7L DIESEL

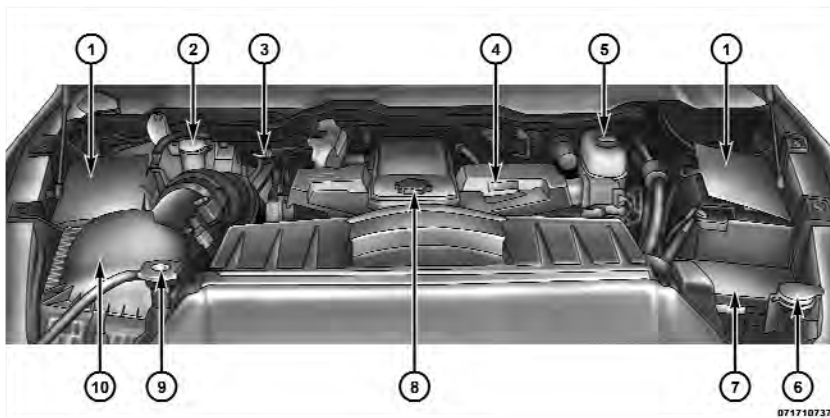

- 1 — Battery
- 2 — Engine Coolant Reservoir
- 3 — Automatic Transmission Dipstick (If Equipped)
- 4 — Engine Oil Dipstick
- 5 — Brake Fluid Reservoir

- 6 — Washer Fluid Reservoir
- 7 — Integrated Power Module
- 8 — Engine Oil Fill
- 9 — Coolant Pressure Cap
- 10 — Air Cleaner Filter

MAINTENANCE PROCEDURES

The pages that follow contain the **required** maintenance services determined by the engineers who designed your vehicle.

Besides those maintenance items specified in the fixed maintenance schedule, there are other components which may require servicing or replacement in the future.

CAUTION!

- Failure to properly maintain your vehicle or perform repairs and service when necessary could result in more costly repairs, damage to other components or negatively impact vehicle performance. Immediately have potential malfunctions examined by an authorized Chrysler Group LLC dealership or qualified repair center.

(Continued)

CAUTION! (Continued)

- Your vehicle has been built with improved fluids that protect the performance and durability of your vehicle and also allow extended maintenance intervals. Do not use chemical flushes in these components as the chemicals can damage your engine, transmission, power steering or air conditioning. Such damage is not covered by the New Vehicle Limited Warranty. If a flush is needed because of component malfunction, use only the specified fluid for the flushing procedure.

Engine Oil

Checking Oil Level

To assure proper lubrication of your vehicle's engine, the engine oil must be maintained at the correct level. Check the oil level at regular intervals. The best time to check the oil level is before starting the engine after it has been

parked overnight. When checking oil after operating the engine, first ensure the engine is at full operating temperature, then wait for 30 minutes after engine shutdown to check the oil.

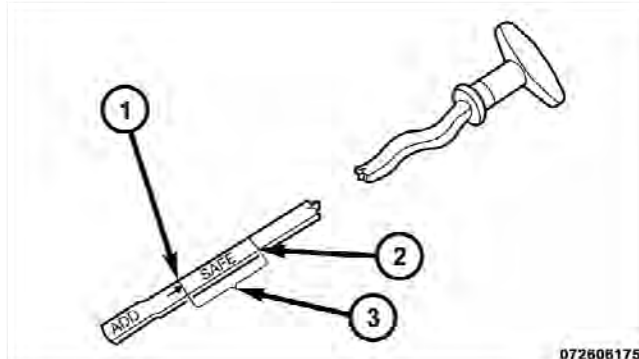

- 1 — ADD Range
- 2 — Full Mark
- 3 — SAFE Range

Checking the oil while the vehicle is on level ground will improve the accuracy of the oil level readings. Add oil only when the level on the dipstick is below the “ADD” mark. The total capacity from the low mark to the high mark is 2 qts (1.9L).

CAUTION!

Overfilling or underfilling the crankcase will cause oil aeration or loss of oil pressure. This could damage your engine.

Never operate the engine with oil level below the “ADD” mark or above the upper “SAFE” mark.

Change Engine Oil

Refer to the “Maintenance Schedule” for the proper maintenance intervals.

Engine Oil Selection

For best performance and maximum protection under all types of operating conditions, the manufacturer only recommends engine oils that are API CJ-4 certified and meet the requirements of Chrysler Group LLC. Use MOPAR® or an equivalent oil meeting Chrysler Material Standard MS-10902. Products meeting Cummins® CES 20081 may also be used. The identification of these engine oils are typically located on the back of the oil container.

American Petroleum Institute (API) Engine Oil Identification Symbol



072610767

This symbol means that the oil has been certified by the American Petroleum Institute (API). The manufacturer only recommends API Certified engine oils.

Oils with a high ash content may produce damaging deposits on engine valves and/or aftertreatment system damage. A maximum sulfated ash content of 1.00 mass % is recommended for all oil used in the engine.

The same oil change interval is to be followed for synthetic oil as for petroleum based oil. Also, synthetic oil must meet the same performance specifications as petroleum oil.

CAUTION!

Do not use chemical flushes in your engine oil as the chemicals can damage your engine. Such damage is not covered by the New Vehicle Limited Warranty.

Engine Oil Viscosity (SAE Grade)

Use SAE 15W-40 MOPAR® or an equivalent engine oil meeting Chrysler Material Standard MS-10902. Products meeting Cummins CES 20081 may also be used. The identification of these engine oils is typically located on the back of the oil container.

In ambient temperatures below 0°F (-18°C), SAE 5W-40 **synthetic** engine oil that meets Chrysler Materials Standard MS-10902 and the API CJ-4 engine oil category is required.

CAUTION!

Failure to use SAE 5W-40 synthetic engine oil in ambient temperatures below 0°F (-18°C) could result in severe engine damage.

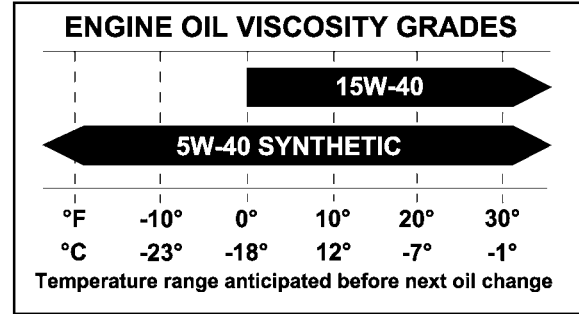

80f2247d

6

Engine oil not designated by the Chrysler or Cummins® Material Standards and API CJ-4 should not be used, as engine and exhaust system durability may be compromised. The engine oil filler cap also shows the recommended engine oil viscosity for your engine. For information on engine oil filler cap location, refer to “Engine Compartment” in “Maintaining Your Vehicle” for further information.

Synthetic Engine Oils

You may use synthetic engine oils provided the recommended oil quality requirements are met, and the recommended maintenance intervals for oil and filter changes are followed.

Materials Added To Engine Oil

The manufacturer strongly recommends against the addition of any additives (other than leak detection dyes or lube odorants) to the engine oil. Engine oil is an engineered product and its performance may be impaired by supplemental additives.

Engine Oil Filter

Refer to “Fluids, Lubricants, and Genuine Parts” in “Maintaining Your Vehicle” for further information. The engine oil filter should be changed at every engine oil change.

Disposing Of Used Engine Oil And Filter

Care should be taken in disposing of the used engine fluids from your vehicle. Used fluids, indiscriminately discarded, can present a problem to the environment. Contact an authorized dealer, service station, or governmental agency for advice on recycling programs and where used fluids and filters can be safely discarded in your area.

Engine Air Cleaner Filter

CAUTION!

All air entering the engine intake must be filtered. The abrasive particles in unfiltered air will cause rapid wear to engine components.

The condition of the air cleaner filter is monitored by the Engine Control Module. The “SERVICE AIR FILTER” message will display in the Electronic Vehicle Information Center (EVIC) when service is required. Refer to “Electronic Vehicle Information Center (EVIC)” in “Understanding Your Instrument Panel” for further information.

Do not remove the top of the air filter housing to inspect the filter element on your diesel engine under normal operating conditions.

The “SERVICE AIR FILTER” message could be displayed periodically. This is because engine air flow requirements change based on driving conditions. As the filter becomes more restrictive and air flow requirements increase the “SERVICE AIR FILTER” message will be displayed. The message may not be displayed in subsequent drive cycles if the same conditions are not met. The air filter element should be replaced within 250 miles (402 km) from the

first time this message is displayed to ensure proper engine operation during all driving conditions.

CAUTION!

Driving with a restricted air filter can cause engine damage. Driving in dusty environments for extended periods will lead to rapid air filter plugging. Action should be taken as soon as the “SERVICE AIR FILTER” message is displayed.

If the vehicle experiences a sudden loss of engine power while being driven in heavy snow or rain, or when plowing snow, and/or the “SERVICE AIR FILTER” message is displayed on the EVIC along with a chime that repeats every 60 seconds, visually inspect the air filter for snow/ice build up or extreme water saturation. If the air filter is not damaged, remove all snow/ice and reinstall air filter. If the air filter is damaged, replace filter element.

NOTE: The air filter housing contains a Mass Air Flow sensor. This sensor is critical to proper engine operation and component longevity. Any damage or modification to this sensor could result in major engine and/or exhaust aftertreatment damage. This includes the use of non-approved air filters. Use only MOPAR® approved air filters or equivalent.

A visual inspection of the air cleaner filter element is never recommended under normal circumstances. A badly restricted element may appear clean while a soiled element may be quite effective in filtering particles without restricting air flow. Rely on the Engine Control Module to determine when a filter change is necessary.

CAUTION!

Many aftermarket performance air filter elements do not adequately filter the air entering the engine. Use of such filters can severely damage your engine.

Draining Fuel/Water Separator Filter

The fuel filter and water separator assembly is located on the driver's side of the engine. The best access to the water drain valve is from under the hood.

CAUTION!

- **Do not drain the fuel/water separator filter when the engine is running.**
- **Diesel fuel will damage blacktop paving surfaces. Drain the filter into an appropriate container.**

If water is detected in the water separator while the engine is running, or while the ignition switch is in the ON position, the "Water In Fuel Indicator Light" will illuminate and an audible chime will be heard five times. At this point you should stop the engine and drain the water from the separator.

CAUTION!

If the “Water In Fuel Indicator Light” remains on, DO NOT START the engine before you drain water from the fuel filter to avoid engine damage.

If the “Water In Fuel Indicator Light” comes on and a single chime is heard while you are driving, or with the ignition switch in the ON position, there may be a problem with your water separator wiring or sensor. See your authorized dealer for service.

Upon proper draining of the water from the fuel filter, the “Water In Fuel Indicator Light” will remain illuminated for approximately 10 seconds. If the water was drained while the engine was running, the “Water In Fuel Indicator Light” may remain on for approximately three minutes.

NOTE: Care should be taken in disposing of used fluids from your vehicle. Used fluids, indiscriminately discarded, can present a problem to the environment. Contact an authorized dealer, service station, or government agency for advice on recycling programs and for where used fluids and filters can be properly disposed of in your area.

Drain the fuel/water separator filter when the “Water In Fuel Indicator Light” is ON. Within 10 minutes of vehicle shutdown, turn the drain valve (located on the side of the filter) counterclockwise 1/4 turn, turn the ignition switch to the ON position, and allow any accumulated water to drain. Leave the drain valve open until all water and contaminants have been removed. When clean fuel is visible, close the drain valve by turning it clockwise, and turn the ignition switch to OFF.

NOTE: The fuel/water separator drain valve is located on the bottom of the fuel filter housing.

If more than a couple ounces/milliliters of fuel have been drained, follow the directions for “Priming If The Engine Has Run Out Of Fuel.”

Fuel Filter Replacement

NOTE: Using a fuel filter that does not meet the manufacturer’s filtration and water separating requirements can severely impact fuel system life and reliability.



1 — Drain Valve

CAUTION!

- Diesel fuel will damage blacktop paving surfaces. Drain the filter into an appropriate container.

(Continued)

CAUTION! (Continued)

- **Do not prefill the fuel filter when installing a new fuel filter. There is a possibility debris could be introduced into the fuel filter during this action. It is best to install the filter dry and allow the in-tank lift pump to prime the fuel system.**

1. Ensure engine is turned off.
2. Place drain pan under the fuel filter drain hose.
3. Open the water drain valve 1/4 turn counterclockwise and completely drain fuel and water into the approved container.
4. Close the water drain valve.
5. Remove lid using a socket or strap wrench. Rotate counterclockwise for removal. Remove used o-ring and discard it.

6. Remove the used filter cartridge from the housing and dispose of according to your local regulations.
7. Wipe clean the sealing surfaces of the lid and housing.
8. Install new o-ring back into ring groove on the filter housing and lubricate with clean engine oil.
9. Remove new filter cartridge from plastic bag and install into housing.

NOTE: Do not remove cartridge from bag until you reach this step in order to keep cartridge clean.

10. Push down on the cartridge to ensure it is properly seated. **Do not pre-fill the filter housing with fuel.**
11. Install lid onto housing and tighten to 22.5 ft lbs (30.5 N.m). Do not overtighten the lid.
12. Prime the engine using the procedure in "Priming If The Engine Has Run Out Of Fuel." Then start the engine and confirm there are no leaks.

Priming If The Engine Has Run Out Of Fuel

WARNING!

Do not open the high pressure fuel system with the engine running. Engine operation causes high fuel pressure. High pressure fuel spray can cause serious injury or death.

1. Add a substantial amount of fuel to the tank, approximately 5 to 10 gal (19L to 38L).
2. Turn the ignition switch to the RUN position, wait for four seconds, then turn the ignition switch back to the OFF position. Repeat this step four times.
3. Start the engine using the "Normal Starting" procedure. Refer to "Starting Procedures" in "Starting and Operating" for further information.

CAUTION!

Do not engage the starter motor for more than 15 seconds at a time. Allow two minutes between the cranking intervals.

NOTE: The engine may run rough until the air is forced from all the fuel lines.

WARNING!

Do not use alcohol or gasoline as a fuel blending agent. They can be unstable under certain conditions and be hazardous or explosive when mixed with diesel fuel.

CAUTION!

Due to lack of lubricants in alcohol or gasoline, the use of these fuels can cause damage to the fuel system.

NOTE:

- A maximum blend of 5% biodiesel, meeting ASTM specification D-6751 may be used with your Cummins® diesel engine. Use of biodiesel mixture in excess of 5% can negatively impact the fuel filter's ability to separate water from the fuel, resulting in high pressure fuel system corrosion or damage.
- Ethanol blends are not recommended or approved for use with your Cummins® diesel engine.
- In addition, commercially available fuel additives are not necessary for the proper operation of your Cummins® diesel engine.

**Intervention Regeneration Strategy – EVIC
Message Process Flow**

The Cummins® diesel engine meets all EPA Heavy Duty Diesel Engine Emissions Standards, resulting in the lowest emitting diesel engine ever produced.

To achieve these emissions standards, your vehicle is equipped with a state-of-the-art engine and exhaust system. The engine and exhaust after-treatment system work together to achieve the EPA Heavy Duty Diesel Engine Emissions Standards. These systems are seamlessly integrated into your vehicle and managed by the Cummins® Powertrain Control Module (PCM). The PCM manages engine combustion to allow the exhaust system's catalyst to trap and burn Particulate Matter (PM) pollutants, with no input or interaction on your part.

Additionally, your vehicle has the ability to alert you to additional maintenance required on your truck or engine.

Refer to the following messages that may be displayed on your Electronic Vehicle Information Center (EVIC):

WARNING!

A hot exhaust system can start a fire if you park over materials that can burn. Such materials might be grass or leaves coming into contact with your exhaust system. Do not park or operate your vehicle in areas where your exhaust system can contact anything that can burn.

Perform Service

Your vehicle will require emissions maintenance at a set interval. To help remind you when this maintenance is due, the Electronic Vehicle Information Center (EVIC) will display "Perform Service". When the "Perform Service" message is displayed on the EVIC it is necessary to have the emissions maintenance performed. Emissions

maintenance may include replacing the Closed Crankcase Ventilation (CCV) filter element, and cleaning of the EGR Cooler. The procedure for clearing and resetting the "Perform Service" indicator message is located in the appropriate Service Information.

Exhaust System – Regeneration Required Now

"Exhaust System — Regeneration Required Now" will be displayed on the Electronic Vehicle Information Center (EVIC) if the exhaust particulate filter reaches 80% of its maximum storage capacity. Under conditions of exclusive short duration and low speed driving cycles, your Cummins® diesel engine and exhaust after-treatment system may never reach the conditions required to remove the trapped PM. If this occurs, the "Exhaust System — Regeneration Required Now" message will be displayed in the EVIC. If this message is displayed, you will hear one chime to assist in alerting you of this condition.

By simply driving your vehicle at highway speeds for as little as 45 minutes, you can remedy the condition in the particulate filter system and allow your Cummins® diesel engine and exhaust after-treatment system to remove the trapped PM and restore the system to normal operating condition.

Exhaust Filter XX% Full

Indicates that the Diesel Particulate Filter (DPF) is approaching full.

Exhaust System – Regeneration In Process

Indicates that the Diesel Particulate Filter (DPF) is self-cleaning. Maintain your current driving condition until regeneration is completed.

Exhaust System – Regeneration Completed

Indicates that the Diesel Particulate Filter (DPF) self-cleaning is completed. If this message is displayed, you will hear one chime to assist in alerting you of this condition.

Exhaust Service Required - See Dealer Now

Regeneration has been disabled due to a system malfunction. At this point the engine PCM will register a fault code, the instrument panel will display a MIL light.

CAUTION!

See your authorized dealer, as damage to the exhaust system could occur soon with continued operation.

Exhaust Filter Full – Power Reduced See Dealer

The PCM derates the engine in order to limit the likelihood of permanent damage to the after-treatment system. If this condition is not corrected and a dealer service is not performed, extensive exhaust after-treatment damage can occur. In order to correct this condition it will be necessary to have your vehicle serviced by your local authorized dealer.

CAUTION!

See your authorized dealer, as damage to the exhaust system could occur soon with continued operation.

Diesel Exhaust Fluid – Chassis Cab Only

Diesel Exhaust Fluid (DEF) sometimes known simply by the name of its active component, UREA—is a key component of selective catalytic reduction (SCR) systems, which help diesel vehicles meet stringent emission regulations. DEF is a liquid reducing agent that reacts with engine exhaust in the presence of a catalyst to convert smog-forming nitrogen oxides (NO_x) into harmless nitrogen and water vapor.

Refer to “Fluids, Lubricants, and Genuine Parts” in “Maintaining Your Vehicle” for further information.

You can receive assistance in locating DEF by calling 866-RAM-INFO (866-726-4636).

Maintenance-Free Batteries

The top of the maintenance-free batteries are permanently sealed. You will never have to add water, nor is periodic maintenance required.

NOTE: Replacement batteries should both be of equal capacity to prevent damage to the vehicle’s charging system.

CAUTION!

It is essential when replacing the cables on the battery that the positive cable is attached to the positive post and the negative cable is attached to the negative post. Battery posts are marked (+) positive and negative (-) and are identified on the battery case. Also, if a “fast charger” is used while the battery is in vehicle, disconnect both vehicle battery cables before connecting the charger to the battery. Do not use a “fast charger” to provide starting voltage.

WARNING!

Battery posts, terminals, and related accessories contain lead and lead compounds. Always wash hands after handling the battery.

Battery Blanket Usage

A battery loses 60% of its cranking power as the battery temperature decreases to 0°F (-18°). For the same decrease in temperature, the engine requires twice as much power to crank at the same RPM. The use of 120 Volt AC powered battery blankets will greatly increase starting capability at low temperatures. Suitable battery blankets are available from your authorized MOPAR® dealer.

Cooling System**WARNING!**

You or others can be badly burned by hot engine coolant (antifreeze) or steam from your radiator. If you see or hear steam coming from under the hood, do not open the hood until the radiator has had time to cool. Never try to open a cooling system pressure cap when the radiator is hot.

Engine Coolant Checks

Check the engine coolant (antifreeze) protection every 12 months (before the onset of freezing weather, where applicable). If the engine coolant (antifreeze) is dirty or rusty in appearance, the system should be drained, flushed and refilled with fresh engine coolant (antifreeze). Check the front of the A/C condenser for any

accumulation of bugs, leaves, etc. If dirty, clean by gently spraying water from a garden hose vertically down the face of the condenser.

Check the coolant recovery bottle tubing for brittle rubber, cracking, tears, cuts and tightness of the connection at the bottle and radiator. Inspect the entire system for leaks.

With the engine at normal operating temperature (but not running), check the cooling system pressure cap for proper vacuum sealing by draining a small amount of engine coolant (antifreeze) from the radiator drain cock. If the cap is sealing properly, the engine coolant (antifreeze) will begin to drain from the coolant recovery bottle. **DO NOT REMOVE THE COOLANT PRESSURE CAP WHEN THE COOLING SYSTEM IS HOT.**

Cooling System – Drain, Flush, And Refill

Refer to the “Maintenance Schedule” for the proper maintenance intervals.

If the engine coolant (antifreeze) is dirty or contains a considerable amount of sediment, clean and flush with a reliable cooling system cleaner. Follow with a thorough rinsing to remove all deposits and chemicals. Properly dispose of the old engine coolant (antifreeze) solution.

Selection Of Coolant

Use only the manufacturers recommended engine coolant (antifreeze). Refer to “Fluids, Lubricants, and Genuine Parts” in “Maintaining Your Vehicle” for further information.

CAUTION!

- Mixing of engine coolant (antifreeze) other than specified HOAT engine coolant (antifreeze), may result in engine damage and may decrease corrosion protection. If a non-HOAT engine coolant (antifreeze) is introduced into the cooling system in an emergency, it should be replaced with the specified engine coolant (antifreeze) as soon as possible.
- Do not use water alone or alcohol-based engine coolant (antifreeze) products. Do not use additional rust inhibitors or antirust products, as they may not be compatible with the radiator engine coolant (antifreeze) and may plug the radiator.

CAUTION! (Continued)

- This vehicle has not been designed for use with Propylene Glycol based engine coolant (antifreeze). Use of Propylene Glycol based engine coolant (antifreeze) is not recommended.

Adding Coolant

Your vehicle has been built with an improved engine coolant (antifreeze) that allows extended maintenance intervals. This engine coolant (antifreeze) can be used up to 5 Years or 105,000 miles (168 000 km) before replacement. To prevent reducing this extended maintenance period, it is important that you use the same engine coolant (antifreeze) throughout the life of your vehicle. Please review these recommendations for using Hybrid Organic Additive Technology (HOAT) engine coolant (antifreeze).

When adding engine coolant (antifreeze):

- The manufacturer recommends using MOPAR® Antifreeze/Coolant 5 Year/100,000 Mile Formula HOAT (Hybrid Organic Additive Technology) or equivalent.
- Mix a minimum solution of 50% HOAT engine coolant (antifreeze) and distilled water. Use higher concentrations (not to exceed 70%) if temperatures below -34°F (-37°C) are anticipated.
- Use only high purity water such as distilled or deionized water when mixing the water/engine coolant (antifreeze) solution. The use of lower quality water will reduce the amount of corrosion protection in the engine cooling system.

Please note that it is the owner's responsibility to maintain the proper level of protection against freezing according to the temperatures occurring in the area where the vehicle is operated.

NOTE: Mixing engine coolant (antifreeze) types will decrease the life of the engine coolant (antifreeze) and will require more frequent engine coolant (antifreeze) changes.

Cooling System Pressure Cap

The cap must be fully tightened to prevent loss of engine coolant (antifreeze), and to ensure that engine coolant (antifreeze) will return to the radiator from the coolant recovery bottle.

The cap should be inspected and cleaned if there is any accumulation of foreign material on the sealing surfaces.

WARNING!

- The warning words “DO NOT OPEN HOT” on the cooling system pressure cap are a safety precaution. Never add engine coolant (antifreeze) when the engine is overheated. Do not loosen or remove the cap to cool an overheated engine. Heat causes pressure to build up in the cooling system. To prevent scalding or injury, do not remove the pressure cap while the system is hot or under pressure.
- Do not use a pressure cap other than the one specified for your vehicle. Personal injury or engine damage may result.

Disposal Of Used Engine Coolant

Used ethylene glycol based engine coolant (antifreeze) is a regulated substance requiring proper disposal. Check with your local authorities to determine the disposal

rules for your community. To prevent ingestion by animals or children, do not store ethylene glycol based engine coolant (antifreeze) in open containers or allow it to remain in puddles on the ground. If ingested by a child or pet, seek emergency assistance immediately. Clean up any ground spills immediately.

Coolant Level

The coolant bottle provides a quick visual method for determining that the coolant level is adequate. With the engine cold, the level of the engine coolant (antifreeze) in the coolant recovery bottle should be between the ranges indicated on the bottle.

The radiator normally remains completely full, so there is no need to remove the radiator cap unless checking for engine coolant (antifreeze) freeze point or replacing engine coolant (antifreeze). Advise your service attendant

of this. As long as the engine operating temperature is satisfactory, the coolant bottle need only be checked once a month.

When additional engine coolant (antifreeze) is needed to maintain the proper level, it should be added to the coolant bottle. Do not overfill.

Points To Remember

NOTE: When the vehicle is stopped after a few miles (a few kilometers) of operation, you may observe vapor coming from the front of the engine compartment. This is normally a result of moisture from rain, snow, or high humidity accumulating on the radiator and being vaporized when the thermostat opens, allowing hot engine coolant (antifreeze) to enter the radiator.

If an examination of your engine compartment shows no evidence of radiator or hose leaks, the vehicle may be safely driven. The vapor will soon dissipate.

- Do not overfill the coolant recovery bottle.
- Check the engine coolant (antifreeze) freeze point in the radiator and in the coolant recovery bottle. If engine coolant (antifreeze) needs to be added, the contents of the coolant recovery bottle must also be protected against freezing.
- If frequent engine coolant (antifreeze) additions are required, or if the level in the coolant recovery bottle does not drop when the engine cools, the cooling system should be pressure tested for leaks.
- Maintain engine coolant (antifreeze) concentration at 50% HOAT engine coolant (antifreeze) (minimum) and distilled water for proper corrosion protection of your engine, which contains aluminum components.
- Make sure that the radiator and coolant recovery bottle overflow hoses are not kinked or obstructed.

- Keep the front of the radiator clean. If your vehicle is equipped with air conditioning, keep the front of the condenser clean.
- Do not change the thermostat for Summer or Winter operation. If replacement is ever necessary, install **ONLY** the correct type thermostat. Other designs may result in unsatisfactory cooling performance, poor gas mileage, and increased emissions.

Charge Air Cooler – Inter-Cooler

The charge air cooler is positioned between the radiator and the air conditioner condenser. Air enters the engine through the air cleaner and passes through the turbo-charger, where it is pressurized. This pressurized air rapidly reaches high temperature. The air is then directed through a hose to the charge air cooler and through another hose to the intake manifold of the engine. The air entering the engine has been cooled by about 50° to 100°F

(10° to 38°C). This cooling process enables more efficient burning of fuel resulting in fewer emissions.

To guarantee optimum performance of the system, keep the surfaces of the charge air cooler, condenser and radiator clean and free of debris. Periodically check the hoses leading to and from the charge air cooler for cracks or loose clamps resulting in loss of pressure and reduced engine performance.

Brake System

Brake Master Cylinder – Brake Fluid Level Check

The fluid level of the master cylinder should be checked when performing under the hood service, or immediately if the “Brake System Warning Light” indicates system failure.

The brake master cylinder has a translucent plastic reservoir. On the outboard side of the reservoir, there is a "MAX" mark and an "MIN" mark. The fluid level must be kept within these two marks. Do not add fluid above the full mark because leakage may occur at the cap.

With disc brakes, the fluid level can be expected to fall as the brake linings wear. However, an unexpected drop in fluid level may be caused by a leak and a system check should be conducted.

Refer to "Fluids, Lubricants, and Genuine Parts" in "Maintaining Your Vehicle" for further information.

WARNING!

- Use only manufacturer's recommended brake fluid. Refer to "Fluids, Lubricants, and Genuine Parts" in "Maintaining Your Vehicle" for further information. Using the wrong type of brake fluid can severely damage your brake system and/or impair its performance. The proper type of brake fluid for your vehicle is also identified on the original factory installed hydraulic master cylinder reservoir.

(Continued)

WARNING! (Continued)

- To avoid contamination from foreign matter or moisture, use only new brake fluid or fluid that has been in a tightly closed container. Keep the master cylinder reservoir cap secured at all times. Brake fluid in an open container absorbs moisture from the air resulting in a lower boiling point. This may cause it to boil unexpectedly during hard or prolonged braking, resulting in sudden brake failure. This could result in an accident.
- Overfilling the brake fluid reservoir can result in spilling brake fluid on hot engine parts, causing the brake fluid to catch fire. Brake fluid can also damage painted and vinyl surfaces, care should be taken to avoid its contact with these surfaces.

(Continued)

WARNING! (Continued)

- Do not allow petroleum based fluid to contaminate the brake fluid. Brake seal components could be damaged, causing partial or complete brake failure. This could result in an accident.

Clutch Hydraulic System

The clutch hydraulic system is a sealed maintenance-free system. In the event of leakage or other malfunction, the system must be replaced.

Transfer Case – If Equipped**Drain And Refill**

Refer to the “Maintenance Schedule” for the proper maintenance intervals.

Lubricant Selection

Refer to “Fluids, Lubricants, and Genuine Parts” in “Maintaining Your Vehicle” for further information.

Fluid Level Check

This fluid level can be checked by removing the filler plug. The fluid level should be to the bottom edge of the filler plug hole with the vehicle in a level position.

Manual Transmission – If Equipped

Lubricant Selection

Refer to “Fluids, Lubricants, and Genuine Parts” in “Maintaining Your Vehicle” for further information.

Fluid Level Check

The fluid level can be checked by removing the filler plug. If the level of the lubricant is more than 1/2 in (12 mm) below the bottom of the filler hole while the vehicle is on level ground, enough lubricant should be added to bring the level to 1/4 in (6 mm) below the bottom of the filler hole.

Automatic Transmission – If Equipped

Lubricant Selection

Refer to “Fluids, Lubricants, and Genuine Parts” in “Maintaining Your Vehicle” for further information.

Fluid Level Check – Ram Truck Only

The fluid level should be checked when the engine is fully warmed up and the fluid in the transmission is at normal operating temperature. At normal operating temperature, the fluid cannot be held comfortably between the fingertips. Operation of the transmission with an improper fluid level will greatly reduce the life of the transmission and of the fluid. Check the fluid level whenever the vehicle is serviced.

To properly check the automatic transmission fluid level, the following procedure must be used:

1. Operate the engine at idle speed and normal operating temperature.

2. The vehicle must be on level ground.
3. Fully apply the parking brake and press the brake pedal.
4. Place the shift lever momentarily into each gear position ending with the shift lever in PARK.
5. Remove the dipstick, wipe it clean and reinsert it until seated.
6. Remove the dipstick again and note the fluid level on both sides. The fluid level should be between the "HOT" (upper) reference holes on the dipstick at normal operating temperature. Verify that solid coating of oil is seen on both sides of the dipstick. If the fluid is low, add as required into the dipstick tube. **Do not overfill.** After adding any quantity of oil through the oil fill tube, wait a minimum of two minutes for the oil to fully drain into the transmission before rechecking the fluid level.

NOTE: If it is necessary to check the transmission **below** the operating temperature, the fluid level should be between the two "COLD" (lower) holes on the dipstick with the fluid at approximately 70°F (21°C) (room temperature). If the fluid level is correctly established at room temperature, it should be between the "HOT" (upper) reference holes when the transmission reaches 180°F (82°C). Remember it is best to check the level at the normal operating temperature.

CAUTION!

Be aware that if the fluid temperature is below 50°F (10°C) it may not register on the dipstick. Do not add fluid until the temperature is elevated enough to produce an accurate reading.

7. Check for leaks. Release parking brake.

To prevent dirt and water from entering the transmission after checking or replenishing fluid, make certain that the dipstick cap is properly reseated. It is normal for the dipstick cap to spring back slightly from its fully seated position, as long as its seal remains engaged in the dipstick tube.

Fluid Level Check – Chassis Cab Only

Check the fluid level while the transmission is at normal operating temperature. This occurs after at least 15 miles (25 km) of driving. At normal operating temperature, the fluid cannot be held comfortably between the fingertips.

To properly check the transmission fluid, the following procedure must be used.

1. The vehicle must be on level ground.
2. Operate the engine at idle speed for a minimum of 60 seconds and normal operating temperature.

3. Fully apply the parking brake and press the brake pedal.

4. Place the shift lever momentarily into each gear position ending with the shift lever in PARK. Make sure the engine is running at idle speed.

5. Remove the dipstick and determine if the fluid is hot or cold. Hot fluid is approximately 160°F to 175°F (70°C to 82°C). This is the normal operating temperature after the vehicle has been driven at least 15 miles (25 km). The fluid cannot be comfortably held between the fingertips. Only use the cold region of the dipstick as a rough reference when doing initial oil level set after transmission rebuild or transmission refill.

6. Wipe the dipstick clean and reinsert it until seated.

7. Remove the dipstick again and note the fluid level on both sides. The fluid level should be between the HOT (upper) reference holes on the dipstick at normal operating temperature. Verify that a solid coating of oil is seen on both sides of the dipstick. If the fluid is low, add MOPAR® AS68RC Automatic Transmission Fluid or equivalent as required into the dipstick tube. **Do not overfill. Never use any ATF other than MOPAR® AS68RC Automatic Transmission Fluid or equivalent.** After adding any quantity of oil through the dipstick tube, wait a minimum of two minutes for the oil to fully drain into the transmission before rechecking the fluid level.

NOTE: If it is necessary to check the transmission below the operating temperature, the fluid level should be between the two COLD (lower) holes on the dipstick with the fluid at approximately 70°F to 85°F (20°C to 30°C). If the fluid level is correctly established at room

temperature, it should be between the HOT (upper) reference holes when the transmission reaches 160°F to 175°F (70°C to 82°C).

CAUTION!

Be aware that if the fluid level is below 50°F (10°C), it may not register on the dipstick. Do not add fluid until the temperature is elevated enough to produce a accurate reading.

8. Check for leaks. Release the parking brake.

NOTE: To prevent dirt and water from entering the transmission after checking or adding fluid, make sure that the dipstick cap is properly reseated. It is normal for the dipstick cap to spring back slightly from its fully seated position, as long as the seal remains engaged in the dipstick tube.

Fluid And Filter Change

Refer to the "Maintenance Schedule" for the proper maintenance intervals.

Noise Control System Required Maintenance & Warranty

All vehicles built over 10,000 lbs. (4 535 kg) Gross Vehicle Weight Rating and manufactured for sale and use in the United States are required to comply with the Federal Government's Exterior Noise Regulations. These vehicles can be identified by the Noise Emission Control Label located in the operator's compartment.

Vehicle Noise Emission Control Information

Date of Vehicle Manufacture

This vehicle conforms to U.S. EPA regulations for noise emission applicable to medium and heavy duty trucks.

The following acts or the causing thereof by any person are prohibited by the Noise Control Act of 1972: (A) the removal or rendering inoperative, other than for purposes of maintenance, repair, or replacement, of any noise control device or element of design (listed in the Owner's Manual) incorporated into this vehicle in compliance with the Noise Control Act (B) the use of this vehicle after such device or element of design has been removed or rendered inoperative.

802d4b72

55216044

Required Maintenance For Noise Control Systems

The following maintenance services must be performed every six months or 7,500 miles (12 000 km) whichever comes first, to assure proper operation of the noise control systems. In addition, inspection and service should be performed anytime a malfunction is observed

or suspected. Proper maintenance of the entire vehicle will help the effectiveness of the noise control systems.

Exhaust System

Inspect the entire exhaust system for leaks and damaged parts. Devices such as hangers, clamps, and U-bolts should be tight and in good condition. Damaged components, burned or blown out mufflers, burned or rusted out exhaust pipes should be replaced according to the procedures and specifications outlined in the appropriate service manual.

Air Cleaner Assembly

Inspect air cleaner housing for proper assembly and fit. Make certain that the air cleaner is properly positioned and that the cover is tight. Check all hoses leading to the air cleaner for tightness. The air filter element must also be clean and serviced according to the instructions outlined in the Maintenance Schedule section of this manual.

Tampering With Noise Control System Prohibited

Federal law prohibits the following acts or the causing thereof: (1) the removal or rendering inoperative by any person, other than for purposes of maintenance, repair, or replacement, of any device or element of design incorporated into any new vehicle for the purpose of noise control prior to its sale or delivery to the ultimate purchaser or while it is in use, or (2) the use of the vehicle after such device or element of design has been removed or rendered inoperative by any person.

Among those acts presumed to constitute tampering are the acts listed below.

- **AIR CLEANER**
 - Removal of the air cleaner.
 - Removal of the air cleaner filter element from the air cleaner housing.
 - Removal of the air ducting.

- **EXHAUST SYSTEM**

- Removal or rendering inoperative exhaust system components including the muffler or tailpipe.

- **ENGINE COOLING SYSTEM**

- Removal or rendering inoperative the fan clutch.
- Removal of the fan shroud.

Noise Emission Warranty

The manufacturer warrants that this vehicle as manufactured by the manufacturer, was designed, built and equipped to conform at the time it left the manufacturer's

control with all applicable U.S. EPA Noise Control Regulations.

This warranty covers this vehicle as designed, built and equipped by the manufacturer, and is not limited to any particular part, component or system of the vehicle manufactured by the manufacturer. Defects in design, assembly or in any part, component or system of the vehicle as manufactured by the manufacturer, which, at the time it left the manufacturer's control, caused noise emissions to exceed Federal standards, are covered by this warranty for the life of the vehicle.

Maintenance Log and Service Chart (Diesel Engines)

Noise Systems Maintenance Chart and Service Log — Insert Month, Day, Year under column mileage closest to the mileage at which service was performed.

MILES	7,500	15,000	22,500	30,000	37,500	45,000	52,500	60,000
KILOMETERS	12 000	24 000	36 000	48 000	60 000	72 000	84 000	96 000
Exhaust system- inspect								
Air cleaner assembly-inspect								
ODOMETER READING								
PERFORMED BY								
PERFORMED AT								

FLUID CAPACITIES

	U.S.	Metric
Fuel (Approximate)		
2500/3500 Shortbed Models	34 Gallons	129 Liters
2500/3500 Longbed Models	35 Gallons	132 Liters
Standard Rear Tank – Chassis Cab Only	52 Gallons	197 Liters
Optional Midship Tank – Chassis Cab Only	22 Gallons	83 Liters
Diesel Exhaust Fluid Tank (Approximate) – Chassis Cab Only	8 Gallons	30 Liters
Engine Oil with Filter		
6.7L Turbo Diesel Engine	12 Quarts	11.4 Liters
Cooling System		
6.7L Turbo Diesel Engine (MOPAR® Engine Coolant/ Antifreeze 5 Year/100,000 Mile Formula or equivalent)	5.7 Gallons	21.4 Liters

FLUIDS, LUBRICANTS AND GENUINE PARTS

Engine

Component	Fluid, Lubricant, or Genuine Part
Engine Coolant	MOPAR® Antifreeze/Coolant 5 Year/100,000 Mile Formula HOAT (Hybrid Organic Additive Technology) or equivalent.
Engine Oil	In ambient temperatures below 0°F (-18°C), 5W-40 synthetic engine oil that meets Chrysler Materials Standard MS-10902 and the API CJ-4 engine oil category is required. In ambient temperatures above 0°F (-18°C), 15W-40 engine oil that meets Chrysler Materials Standard MS-10902 and the API CJ-4 engine oil category is required.
Engine Oil Filter	MOPAR® Engine Oil Filter or equivalent.
Engine Fuel Filter	MOPAR® Fuel Filter or equivalent. Must meet 5 micron rating. Using a fuel filter that does not meet the manufacturers filtration and water separating requirements can severely impact fuel system life and reliability.
Crankcase Ventilation Filter	MOPAR® CCV Filter or equivalent.

Component	Fluid, Lubricant, or Genuine Part
Fuel Selection	<p>Use good quality diesel fuel from a reputable supplier in your vehicle. Federal law requires that you must fuel this vehicle with Ultra Low Sulfur Highway Diesel fuel (15 ppm Sulfur maximum) and prohibits the use of Low Sulfur Highway Diesel fuel (500 ppm Sulfur maximum) to avoid damage to the emissions control system. For most year-round service, No. 2 diesel fuel meeting ASTM specification D-975 Grade S15 will provide good performance. If the vehicle is exposed to extreme cold (below 20°F or -7°C), or is required to operate at colder-than-normal conditions for prolonged periods, use climatized No. 2 diesel fuel or dilute the No. 2 diesel fuel with 50% No. 1 diesel fuel. This will provide better protection from fuel gelling or wax-plugging of the fuel filters. This vehicle is fully compatible with biodiesel blends up to 5% biodiesel meeting ASTM specification D-975.</p>
Diesel Exhaust Fluid – Chassis Cab Only	<p>MOPAR® Diesel Exhaust Fluid (API Certified) (DEF) or equivalent that has been API Certified to the ISO 22241 standard. Use of fluids not API Certified to ISO 22241 may result in system damage. You can receive assistance in locating DEF by calling 866-RAM-INFO (866-726-4636).</p>

Chassis

Component	Fluid, Lubricant, or Genuine Part
Automatic Transmission – If Equipped (Six-Speed 68RFE) – Ram Truck Only	MOPAR® ATF+4® Automatic Transmission Fluid or equivalent licensed ATF+4® product.
Automatic Transmission – If Equipped (Six-Speed AS68RC) – Chassis Cab Only	MOPAR® AS68RC Automatic Transmission Fluid or equivalent.
Clutch Linkage	MOPAR® Multi-Purpose Grease, NLGI Grade 2 E.P. or equivalent.
Manual Transmission (G-56) – If Equipped	MOPAR® ATF+4® Automatic Transmission Fluid or equivalent licensed ATF+4® product.

MAINTENANCE SCHEDULES

CONTENTS

■ Maintenance Schedule	138	□ Perform Service Indicator	140
□ Oil Change Indicator System	139	□ Required Maintenance Intervals	140

MAINTENANCE SCHEDULE**CAUTION!**

Failure to perform the required maintenance items may result in damage to the vehicle.

At Each Stop For Fuel

- Check the engine oil level at least 30 minutes after a fully warmed engine is shut off. Checking the oil level while the vehicle is on level ground will improve the accuracy of the oil level reading. Add oil only when the level is at or below the ADD or MIN mark.

Once A Month

- Inspect the batteries, and clean and tighten the terminals as required.

- Check the fluid levels of the coolant reservoir, brake master cylinder, and transmission and transfer case (if equipped), add as needed.

At Each Oil Change

- Change the engine oil filter.
- Inspect the exhaust system.
- Check the automatic transmission fluid level (if equipped).
- Check the manual transmission fluid level (if equipped).
- Check the coolant level, hoses, and clamps.
- Lubricate outer tie rod ends.

Inspection and service should also be performed anytime a malfunction is observed or suspected. Retain all receipts.

Oil Change Indicator System

Ram Truck Pick-Up (2500 And 3500 Models)

Your vehicle is equipped with an engine oil change indicator system. This system will alert you when it is time to change your engine oil by displaying the words “Oil Change Due” on your Electronic Vehicle Information Center (EVIC). The engine oil change indicator system is duty cycle based, which means the engine oil change interval may fluctuate depending on your personal driving style. Driving styles such as frequent stop and go type driving or extended idle time can increase the frequency of the engine oil change. This is the result of more frequent regeneration of the exhaust after treatment system, which can decrease the life of the engine oil. Failure to change the engine oil per the maintenance schedule can result in internal engine damage.

For information on resetting the Oil Change Indicator message, refer to “Oil Change Due” under “Electronic Vehicle Information Center (EVIC)/EVIC Warning Lights” in “Understanding Your Instrument Panel” for further information.

When prompted by the Engine Oil Indicator System, the engine oil and filter must be changed. If not prompted by the Engine Oil Indicator System within 7,500 miles (12 000 km) or six months since the last oil and filter change, replace the engine oil and engine oil filter. Under no circumstances should oil change intervals exceed 7,500 miles (12 000 km) or six months, whichever comes first.

Ram Truck Chassis Cab (3500, 4500, And 5500 Models)

Replace the engine oil and oil filter every 7,500 miles (12 000 km) or six months, or sooner if prompted by the oil change indicator system (if equipped). Under no circumstances should oil change intervals exceed 7,500 miles (12 000 km) or six months, whichever comes first.

Perform Service Indicator

Your vehicle will require emissions maintenance at a set interval. To help remind you when this maintenance is due, the Electronic Vehicle Information Center (EVIC) will display “Perform Service”. When the “Perform Service” message is displayed on the EVIC it is necessary to have the emissions maintenance performed. Emissions maintenance may include replacing the Closed Crankcase Ventilation (CCV) filter element, and cleaning of the

EGR Cooler. The procedure for clearing and resetting the “Perform Service” indicator message is located in the appropriate Service Information.

Required Maintenance Intervals

Refer to the Maintenance Schedules on the following pages for the required maintenance intervals.

7,500 Miles (12,000 km) or 6 Months Maintenance Service Schedule

- When prompted by the Engine Oil Indicator System, the engine oil and filter must be changed. If not prompted by the Engine Oil Indicator System within 7,500 miles (12 000 km) or six months since the last oil and filter change, change the engine oil and engine oil filter.
- Check the Diesel Exhaust Fluid (DEF) tank, refill if necessary (Chassis Cab Only).
- Rotate tires.
- Lubricate front drive shaft fitting (4x4).
- Lubricate outer tie rod ends.

Odometer Reading Date

Repair Order # Dealer Code

Signature, Authorized Service Center

15,000 Miles (24,000 km) or 12 Months Maintenance Service Schedule

- When prompted by the Engine Oil Indicator System, the engine oil and filter must be changed. If not prompted by the Engine Oil Indicator System within 7,500 miles (12 000 km) or six months since the last oil and filter change, change the engine oil and engine oil filter.
- Check the Diesel Exhaust Fluid (DEF) tank, refill if necessary (Chassis Cab Only).
- Rotate tires.
- Replace fuel filter element.
- Lubricate front drive shaft fitting (4x4).
- Lubricate outer tie rod ends.
- Inspect the front suspension, tie rod ends and boot seals for cracks or leaks and all parts for damage, wear, improper looseness or end play; replace if necessary.
- Inspect the front (4x4) and rear axle fluid, change if using your vehicle for police, taxi, fleet, off-road or frequent trailer towing.

Odometer Reading Date

Repair Order # Dealer Code

Signature, Authorized Service Center

22,500 Miles (36,000 km) or 18 Months Maintenance Service Schedule

- When prompted by the Engine Oil Indicator System, the engine oil and filter must be changed. If not prompted by the Engine Oil Indicator System within 7,500 miles (12 000 km) or six months since the last oil and filter change, change the engine oil and engine oil filter.
- Check the Diesel Exhaust Fluid (DEF) tank, refill if necessary (Chassis Cab Only).
- Rotate tires.
- Inspect drive belt, replace if necessary.
- Lubricate front drive shaft fitting (4x4).
- Lubricate outer tie rod ends.
- Inspect brake linings.
- Inspect and adjust parking brake if necessary.

Odometer Reading Date

Repair Order # Dealer Code

Signature, Authorized Service Center

30,000 Miles (48,000 km) or 24 Months Maintenance Service Schedule

- When prompted by the Engine Oil Indicator System, the engine oil and filter must be changed. If not prompted by the Engine Oil Indicator System within 7,500 miles (12 000 km) or six months since the last oil and filter change, change the engine oil and engine oil filter.
- Check the Diesel Exhaust Fluid (DEF) tank, refill if necessary (Chassis Cab Only).
- Rotate tires.
- Replace fuel filter element.
- Lubricate front drive shaft fitting (4x4).
- Lubricate outer tie rod ends.
- Inspect the wheel bearings.
- Inspect the front suspension, tie rod ends and boot seals for cracks or leaks and all parts for damage, wear, improper looseness or end play; replace if necessary.
- Inspect the front (4x4) and rear axle fluid, change if using your vehicle for police, taxi, fleet, off-road or frequent trailer towing.
- Check the transfer case fluid (4x4).
- Change automatic transmission fluid (Chassis Cab Only).

Odometer Reading Date

Repair Order # Dealer Code

Signature, Authorized Service Center

37,500 Miles (60,000 km) or 30 Months Maintenance Service Schedule

- When prompted by the Engine Oil Indicator System, the engine oil and filter must be changed. If not prompted by the Engine Oil Indicator System within 7,500 miles (12 000 km) or six months since the last oil and filter change, change the engine oil and engine oil filter.
- Check the Diesel Exhaust Fluid (DEF) tank, refill if necessary (Chassis Cab Only).
- Rotate tires.
- Lubricate front drive shaft fitting (4x4).
- Lubricate outer tie rod ends.

Odometer Reading Date

Repair Order # Dealer Code

Signature, Authorized Service Center

45,000 Miles (72,000 km) or 36 Months Maintenance Service Schedule

- When prompted by the Engine Oil Indicator System, the engine oil and filter must be changed. If not prompted by the Engine Oil Indicator System within 7,500 miles (12 000 km) or six months since the last oil and filter change, change the engine oil and engine oil filter.
- Check the Diesel Exhaust Fluid (DEF) tank, refill if necessary (Chassis Cab Only).
- Rotate tires.
- Inspect drive belt, replace as necessary.
- Replace fuel filter element.
- Lubricate front drive shaft fitting (4x4).
- Lubricate outer tie rod ends.
- Inspect the front suspension, tie rod ends and boot seals for cracks or leaks and all parts for damage, wear, improper looseness or end play; replace if necessary.
- Inspect brake linings.
- Inspect and adjust parking brake if necessary.
- Inspect the front (4x4) and rear axle fluid, change if using your vehicle for police, taxi, fleet, off-road or frequent trailer towing.

Odometer Reading Date

Repair Order # Dealer Code

Signature, Authorized Service Center

52,500 Miles (84,000 km) or 42 Months Maintenance Service Schedule

- When prompted by the Engine Oil Indicator System, the engine oil and filter must be changed. If not prompted by the Engine Oil Indicator System within 7,500 miles (12 000 km) or six months since the last oil and filter change, change the engine oil and engine oil filter.
- Check the Diesel Exhaust Fluid (DEF) tank, refill if necessary (Chassis Cab Only).
- Rotate tires.
- Lubricate front drive shaft fitting (4x4).
- Lubricate outer tie rod ends.

Odometer Reading Date

Repair Order # Dealer Code

Signature, Authorized Service Center

60,000 Miles (96,000 km) or 48 Months Maintenance Service Schedule

- When prompted by the Engine Oil Indicator System, the engine oil and filter must be changed. If not prompted by the Engine Oil Indicator System within 7,500 miles (12 000 km) or six months since the last oil and filter change, change the engine oil and engine oil filter.
- Check the Diesel Exhaust Fluid (DEF) tank, refill if necessary (Chassis Cab Only).
- Rotate tires.
- Replace fuel filter element.
- Lubricate front drive shaft fitting (4x4).
- Lubricate outer tie rod ends.
- Inspect the wheel bearings.
- Inspect the front suspension, tie rod ends and boot seals for cracks or leaks and all parts for damage, wear, improper looseness or end play; replace if necessary.
- Inspect the front (4x4) and rear axle fluid, change if using your vehicle for police, taxi, fleet, off-road or frequent trailer towing.
- Change automatic transmission fluid and sump filter (Chassis Cab Only).
- Change automatic transmission fluid and filter(s) if using your vehicle for any of the following: police, fleet, or frequent trailer towing (Ram Truck Only).
- Inspect the manual transmission fluid, add if necessary.
- Change the transfer case fluid (4x4).

Odometer Reading Date

Repair Order # Dealer Code

Signature, Authorized Service Center

67,500 Miles (108,000 km) or 54 Months Maintenance Service Schedule

- When prompted by the Engine Oil Indicator System, the engine oil and filter must be changed. If not prompted by the Engine Oil Indicator System within 7,500 miles (12 000 km) or six months since the last oil and filter change, change the engine oil and engine oil filter.
- Check the Diesel Exhaust Fluid (DEF) tank, refill if necessary (Chassis Cab Only).
- Rotate tires.
- Inspect drive belt, replace as necessary.
- Lubricate front drive shaft fitting (4x4).
- Lubricate outer tie rod ends.
- Inspect brake linings.
- Inspect and adjust parking brake if necessary.
- Replace Crankcase Ventilation Filter (CCV).**
- Clean EGR Valve (Ram Truck Only)**.**
- Clean EGR Cooler (Ram Truck Only)**.**

_____ Date

Odometer Reading

_____ Dealer Code

Repair Order #

Signature, Authorized Service Center

75,000 Miles (120,000 km) or 60 Months Maintenance Service Schedule

- When prompted by the Engine Oil Indicator System, the engine oil and filter must be changed. If not prompted by the Engine Oil Indicator System within 7,500 miles (12 000 km) or six months since the last oil and filter change, change the engine oil and engine oil filter.
- Check the Diesel Exhaust Fluid (DEF) tank, refill if necessary (Chassis Cab Only).
- Rotate tires.
- Flush and replace engine coolant at 60 months, if not replaced at 97,500 miles (157 000 km).
- Replace fuel filter element.
- Lubricate front drive shaft fitting (4x4).
- Lubricate outer tie rod ends.
- Inspect the front suspension, tie rod ends and boot seals for cracks or leaks and all parts for damage, wear, improper looseness or end play; replace if necessary.
- Inspect the front (4x4) and rear axle fluid, change if using your vehicle for police, taxi, fleet, off-road or frequent trailer towing.

Odometer Reading Date

Repair Order # Dealer Code

Signature, Authorized Service Center

82,500 Miles (132,000 km) or 66 Months Maintenance Service Schedule

- When prompted by the Engine Oil Indicator System, the engine oil and filter must be changed. If not prompted by the Engine Oil Indicator System within 7,500 miles (12 000 km) or six months since the last oil and filter change, change the engine oil and engine oil filter.
- Check the Diesel Exhaust Fluid (DEF) tank, refill if necessary (Chassis Cab Only).
- Rotate tires.
- Lubricate front drive shaft fitting (4x4).
- Lubricate outer tie rod ends.

Odometer Reading Date

Repair Order # Dealer Code

Signature, Authorized Service Center

90,000 Miles (144,000 km) or 72 Months Maintenance Service Schedule

- When prompted by the Engine Oil Indicator System, the engine oil and filter must be changed. If not prompted by the Engine Oil Indicator System within 7,500 miles (12 000 km) or six months since the last oil and filter change, change the engine oil and engine oil filter.
- Check the Diesel Exhaust Fluid (DEF) tank, refill if necessary (Chassis Cab Only).
- Rotate tires.
- Inspect drive belt, replace as required.
- Replace fuel filter element.
- Lubricate front drive shaft fitting (4x4).
- Lubricate outer tie rod ends.
- Inspect the wheel bearings.
- Inspect the front suspension, tie rod ends and boot seals for cracks or leaks and all parts for damage, wear, improper looseness or end play; replace if necessary.
- Inspect brake linings.
- Inspect and adjust parking brake if necessary.
- Inspect the front (4x4) and rear axle fluid, change if using your vehicle for police, taxi, fleet, off-road or frequent trailer towing.
- Check the transfer case fluid (4x4).
- Change automatic transmission fluid (Chassis Cab Only).

Odometer Reading Date

Repair Order # Dealer Code

Signature, Authorized Service Center

97,500 Miles (157,000 km) or 78 Months Maintenance Service Schedule

- When prompted by the Engine Oil Indicator System, the engine oil and filter must be changed. If not prompted by the Engine Oil Indicator System within 7,500 miles (12 000 km) or six months since the last oil and filter change, change the engine oil and engine oil filter.
- Check the Diesel Exhaust Fluid (DEF) tank, refill if necessary (Chassis Cab Only).
- Flush and replace engine coolant.
- Rotate tires.
- Lubricate front drive shaft fitting (4x4).
- Lubricate outer tie rod ends.
- Flush and replace power steering fluid (3500 Ram Truck Only).

Odometer Reading Date

Repair Order # Dealer Code

Signature, Authorized Service Center

105,000 Miles (168,000 km) or 84 Months Maintenance Service Schedule

- When prompted by the Engine Oil Indicator System, the engine oil and filter must be changed. If not prompted by the Engine Oil Indicator System within 7,500 miles (12 000 km) or six months since the last oil and filter change, change the engine oil and engine oil filter.
- Check the Diesel Exhaust Fluid (DEF) tank, refill if necessary (Chassis Cab Only).
- Flush and replace engine coolant, if not replaced at 60 months.
- Rotate tires.
- Inspect drive belt, replace as required.
- Replace fuel filter element.
- Lubricate front drive shaft fitting (4x4).
- Lubricate outer tie rod ends.
- Inspect the front suspension, tie rod ends and boot seals for cracks or leaks and all parts for damage, wear, improper looseness or end play; replace if necessary.
- Flush and replace power steering fluid.
- Inspect the front (4x4) and rear axle fluid, change if using your vehicle for police, taxi, fleet, off-road or frequent trailer towing.

Odometer Reading Date

Repair Order # Dealer Code

Signature, Authorized Service Center

112,500 Miles (180,000 km) or 90 Months Maintenance Service Schedule

- When prompted by the Engine Oil Indicator System, the engine oil and filter must be changed. If not prompted by the Engine Oil Indicator System within 7,500 miles (12 000 km) or six months since the last oil and filter change, change the engine oil and engine oil filter.
- Check the Diesel Exhaust Fluid (DEF) tank, refill if necessary (Chassis Cab Only).
- Rotate tires.
- Inspect drive belt, replace as required.
- Lubricate front drive shaft fitting (4x4).
- Lubricate outer tie rod ends.
- Inspect brake linings.
- Inspect and adjust parking brake if necessary.

Odometer Reading Date

Repair Order # Dealer Code

Signature, Authorized Service Center

120,000 Miles (192,000 km) or 96 Months Maintenance Service Schedule

- When prompted by the Engine Oil Indicator System, the engine oil and filter must be changed. If not prompted by the Engine Oil Indicator System within 7,500 miles (12 000 km) or six months since the last oil and filter change, change the engine oil and engine oil filter.
- Check the Diesel Exhaust Fluid (DEF) tank, refill if necessary (Chassis Cab Only).
- Rotate tires.
- Replace fuel filter element.
- Lubricate front drive shaft fitting (4x4).
- Lubricate outer tie rod ends.
- Inspect the wheel bearings.
- Inspect the front suspension, tie rod ends and boot seals for cracks or leaks and all parts for damage, wear, improper looseness or end play; replace if necessary.
- Inspect the front (4x4) and rear axle fluid, change if using your vehicle for police, taxi, fleet, off-road or frequent trailer towing.
- Change automatic transmission fluid and sump filter (Chassis Cab Only).
- Change automatic transmission fluid and filter(s) (Ram Truck Only).
- Change the manual transmission fluid if using your vehicle for any of the following: police, fleet, or frequent trailer towing.
- Change the transfer case fluid (4x4).

Odometer Reading Date

Repair Order # Dealer Code

Signature, Authorized Service Center

127,500 Miles (204,000 km) or 102 Months Maintenance Service Schedule

- When prompted by the Engine Oil Indicator System, the engine oil and filter must be changed. If not prompted by the Engine Oil Indicator System within 7,500 miles (12 000 km) or six months since the last oil and filter change, change the engine oil and engine oil filter.
- Check the Diesel Exhaust Fluid (DEF) tank, refill if necessary (Chassis Cab Only).
- Rotate tires.
- Lubricate front drive shaft fitting (4x4).
- Lubricate outer tie rod ends.

_____ Date

_____ Dealer Code

_____ Signature, Authorized Service Center

135,000 Miles (216,000 km) or 108 Months Maintenance Service Schedule

- When prompted by the Engine Oil Indicator System, the engine oil and filter must be changed. If not prompted by the Engine Oil Indicator System within 7,500 miles (12 000 km) or six months since the last oil and filter change, change the engine oil and engine oil filter.
- Check the Diesel Exhaust Fluid (DEF) tank, refill if necessary (Chassis Cab Only).
- Rotate tires.
- Inspect drive belt, replace as required.
- Replace fuel filter element.
- Lubricate front drive shaft fitting (4x4).
- Lubricate outer tie rod ends.
- Inspect the front suspension, tie rod ends and boot seals for cracks or leaks and all parts for damage, wear, improper looseness or end play; replace if necessary.
- Inspect brake linings.
- Inspect and adjust parking brake if necessary.
- Inspect the front (4x4) and rear axle fluid, change if using your vehicle for police, taxi, fleet, off-road or frequent trailer towing.
- Replace Crankcase Ventilation Filter (CCV).**
- Clean EGR Valve (Ram Truck Only).**
- Clean EGR Cooler (Ram Truck Only).**

Odometer Reading Date

Repair Order # Dealer Code

Signature, Authorized Service Center

142,500 Miles (228,000 km) or 114 Months Maintenance Service Schedule

- When prompted by the Engine Oil Indicator System, the engine oil and filter must be changed. If not prompted by the Engine Oil Indicator System within 7,500 miles (12 000 km) or six months since the last oil and filter change, change the engine oil and engine oil filter.
- Check the Diesel Exhaust Fluid (DEF) tank, refill if necessary (Chassis Cab Only).
- Rotate tires.
- Lubricate front drive shaft fitting (4x4).
- Lubricate outer tie rod ends.

Odometer Reading Date

Repair Order # Dealer Code

Signature, Authorized Service Center

150,000 Miles (240,000 km) or 120 Months Maintenance Service Schedule

- When prompted by the Engine Oil Indicator System, the engine oil and filter must be changed. If not prompted by the Engine Oil Indicator System within 7,500 miles (12 000 km) or six months since the last oil and filter change, change the engine oil and engine oil filter.
- Check the Diesel Exhaust Fluid (DEF) tank, refill if necessary (Chassis Cab Only).
- Rotate tires.
- Replace fuel filter element.
- Adjust valve lash clearance.
- Lubricate front drive shaft fitting (4x4).
- Lubricate outer tie rod ends.
- Inspect the wheel bearings.
- Inspect the front suspension, tie rod ends and boot seals for cracks or leaks and all parts for damage, wear, improper looseness or end play; replace if necessary.
- Flush and replace engine coolant at 120 months, if not replaced at 97,500 miles (157 000 km).
- Inspect the front (4x4) and rear axle fluid, change if using your vehicle for police, taxi, fleet, off-road or frequent trailer towing.
- Check the transfer case fluid (4x4).
- Change automatic transmission fluid (Chassis Cab Only).
- Change DEF Filter Cartridge (Chassis Cab Only).

Odometer Reading Date

Repair Order # Dealer Code

Signature, Authorized Service Center

Inspection and service should also be performed anytime a malfunction is observed or suspected. Retain all receipts.

* This maintenance is not required if belt was previously replaced.

** The EGR Cooler and the EGR Valve cleaning will be covered by the manufacturer only at this maintenance interval, for vehicles in California, Maine, Maryland, Massachusetts, New Mexico, New York, Vermont, Connecticut, Oregon, and Rhode Island.

CAUTION!

***The manufacturer highly recommends that all cooling system service, maintenance, and repairs be performed by your local authorized dealer.

WARNING!

- You can be badly injured working on or around a motor vehicle. Do only service work for which you have the knowledge and the right equipment. If you have any doubt about your ability to perform a service job, take your vehicle to a competent mechanic.
- Failure to properly inspect and maintain your vehicle could result in a component malfunction and effect vehicle handling and performance. This could cause an accident

INDEX

Adding Fuel	83	Emergency Starting	92
Air Cleaner, Engine (Engine Air Cleaner Filter)	104,129	Brake Fluid	136
Air Filter	104	Brake System	121
Airbag Light	24	Fluid Check	121
Alarm Light	17	Master Cylinder	121
Anti-Lock Warning Light	21	Warning Light	19
Antifreeze (Engine Coolant)	116,117	Brake/Transmission Interlock	53
Capacities	133	Capacities, Antifreeze (Engine Coolant)	133
Disposal	119	Capacities, Fluid	133
Automatic Transmission	64	Caps, Filler	
Adding Fluid	125	Oil (Engine)	103
Fluid Level Check	124	Radiator (Coolant Pressure)	118
Fluid Type	124,136	Charge Air Cooler	121
Shifting	54	Check Engine Light (Malfunction Indicator Light)	23
Axle Fluid	136	Coolant Pressure Cap (Radiator Cap)	118
Battery	114	Cooling System	115
Blanket	43,115	Adding Coolant (Antifreeze)	117

- Coolant Capacity 133
- Coolant Level 115,119
- Disposal of Used Coolant 119
- Drain, Flush, and Refill 116
- Inspection 119
- Points to Remember 120
- Pressure Cap 118
- Radiator Cap 118
- Selection of Coolant (Antifreeze) 116,134

- Diesel Exhaust Brake 50
- Diesel Fuel 82
- Diesel Fuel Requirements 82
 - Bulk Storage of 84
- Diesel Fuel System, Re-Priming 110
- Dipsticks 100
- Disposal 104
 - Antifreeze (Engine Coolant) 119
 - Engine Oil 104

- Draining Fuel/Water Separator Filter 106
- Electronic Range Select (ERS) 60,71
- Electronic Vehicle Information Center (EVIC) 25
- Emergency, In Case of
 - Jump Starting 92
- Engine 99
 - Air Cleaner 104
 - Block Heater 35,49
 - Break-In Recommendations 12
 - Compartment 99
 - Coolant (Antifreeze) 134
 - Identification 99
 - Idling 44
 - Jump Starting 92
 - Oil 100,134
 - Oil Filler Cap 103
 - Oil Synthetic 104
 - Runaway 81

Temperature Gauge	15	Diesel	82,83,134
Exhaust Brake	50	Filter	106
Exhaust System	129	Gauge	15
Filters		Requirements	82
Engine Fuel	106	Specifications	83
Engine Oil	100,104,134	Tank Capacity	133
Flashers		Gauges	
Turn Signal	15	Coolant Temperature	15
Fluid Capacities	133	Fuel	15
Fluid Level Checks		Oil Pressure	17
Brake	121	Speedometer	16
Manual Transmission	124	Tachometer	15
Transfer Case	123	Voltmeter	18,41
Fluid, Brake	136	Gear Ranges	54,65,76
Fluids, Lubricants and Genuine Parts	134	Idle Up Feature	44
Fog Lights	24	Information Center, Vehicle	25
Fuel	82,83	Instrument Cluster	14,15
Adding	83		

Intervention Regeneration Strategy	111	Traction Control	17
Jump Starting	92	Warning (Instrument Cluster Description)	15
Lights		Locks	
Airbag	24	Steering Wheel	8
Alarm	17	Maintenance Procedures	100
Anti-Lock	21	Maintenance Schedule	138
Brake Warning	19	Manual Transmission	75
Check Engine (Malfunction Indicator)	23	Fluid Level Check	124
Electronic Stability Program (ESP) Indicator	17	Lubricant Selection	136
Fog	24	Shift Speeds	76
High Beam	18	New Vehicle Break-In Period	12
High Beam Indicator	18	Noise Control	
Instrument Cluster	15	Maintenance	128
Seat Belt Reminder	24	Tampering Prohibited	129
Security Alarm (Theft Alarm)	17	Noise Emission Warranty	128,130
Theft Alarm (Security Alarm)	17	Odometer	17,18
Tire Pressure Monitoring (TPMS)	21		

Trip	17,18	Power	
Oil Change Indicator	139	Take-Off Adapter	78
Oil, Engine	134	Take-Off Operation	78
Capacity	133	Power Steering Fluid	136
Change Interval	101	PTO (Power Take-Off)	78
Dipstick	100	Radiator Cap (Coolant Pressure Cap)	116,118
Disposal	104	Remote Control	
Filter	100,104,134	Starting System	8
Identification Logo	102	Remote Starting System	8
Materials Added to	104	Resetting Perform Service Indicator	140
Pressure Gauge	17	Seat Belts	
Recommendation	102	Reminder	24
Synthetic	104	Selection of Coolant (Antifreeze)	116,134
Viscosity	103	Shifting	52
Overdrive	62,72	Automatic Transmission	54
Overdrive OFF Switch	62,72	Manual Transmission	75
Perform Service Indicator, Reset	140		

Signals, Turn	15	Torque Converter Clutch	63,74
Speedometer	16	Tow/Haul	62
Starting	8,34	Traction Control	123
Automatic Transmission	34	Traction Control Light	17
Engine Block Heater	35,49	Transfer Case	
Manual Transmission	34	Fluid	136
Remote	8	Transmission	
Starting Procedures	34	Automatic	54,64
Starting Procedures (Diesel Engines)	34	Fluid	136
Steering		Manual	34,75
Wheel Lock	8	Shifting	52
Synthetic Engine Oil	104	Trip Odometer	17,18
System, Remote Starting	8	Turn Signals	15
Tachometer	15	Viscosity, Engine Oil	103
Temperature Gauge, Engine Coolant	15	Voltmeter	18,41
Tip Start	34	Warning Lights (Instrument Cluster Description)	15
Tires		Water Separator, Diesel Fuel	106
Pressure Warning Light	21		

INSTALLATION OF RADIO TRANSMITTING EQUIPMENT

Special design considerations are incorporated into this vehicle's electronic system to provide immunity to radio frequency signals. Mobile two-way radios and telephone equipment must be installed properly by trained personnel. The following must be observed during installation.

The positive power connection should be made directly to the battery and fused as close to the battery as possible. The negative power connection should be made to body sheet metal adjacent to the negative battery connection. This connection should not be fused.

Antennas for two-way radios should be mounted on the roof or the rear area of the vehicle. Care should be used in mounting antennas with magnet bases. Magnets may affect the accuracy or operation of the compass on vehicles so equipped.

The antenna cable should be as short as practical and routed away from the vehicle wiring when possible. Use only fully shielded coaxial cable.

Carefully match the antenna and cable to the radio to ensure a low Standing Wave Ratio (SWR).

Mobile radio equipment with output power greater than normal may require special precautions.

All installations should be checked for possible interference between the communications equipment and the vehicle's electronic systems.



STICK WITH THE SPECIALISTS®

Chrysler Group LLC

12D241-226-AD



4th Edition

Printed in U.S.A.