

2012

RAM CV CARGO VAN ★ USER GUIDE

GUTS·GLORY



RAM



If you are the first registered retail owner of your vehicle, you may obtain a complimentary printed copy of the Owner's Manual, Navigation/Media Center Manuals or Warranty Booklet by calling 1-866-726-4636 (U.S.) or 1-800-387-1143 (Canada) or by contacting your dealer.

The driver's primary responsibility is the safe operation of the vehicle. Driving while distracted can result in loss of vehicle control, resulting in a collision and personal injury. Chrysler Group LLC strongly recommends that the driver use extreme caution when using any device or feature that may take their attention off the road. Use of any electrical devices such as cell phones, computers, portable radios, vehicle navigation or other devices by the driver while the vehicle is moving is dangerous and could lead to a serious collision. Texting while driving is also dangerous and should never be done while the vehicle is moving. If you find yourself unable to devote your full attention to vehicle operation, pull off the road to a safe location and stop your vehicle. Some States or Provinces prohibit the use of cellular telephones or texting while driving. It is always the driver's responsibility to comply with all local laws.

IMPORTANT: This User Guide is intended to familiarize you with the important features of your vehicle. The DVD enclosed contains your Owner's Manual, Navigation/Media Center Manuals, Warranty Booklets, Tire Warranty and 24-Hour Towing Assistance (new vehicles purchased in the U.S.) or Roadside Assistance (new vehicles purchased in Canada) in electronic format. We hope you find it useful.

Copyright 2012 Chrysler Group LLC.

TABLE OF CONTENTS

INTRODUCTION/WELCOME

Welcome From Chrysler Group LLC 2

CONTROLS AT A GLANCE

Driver Cockpit 4

Instrument Cluster 6

GETTING STARTED

Key Fob 8

Remote Start 9

Theft Alarm 9

Seat Belt 10

Supplemental Restraint System (SRS)

— Air Bags 10

Child Restraints 11

Front Seats 13

Rear Seats 15

Heated Seats 20

Heated Steering Wheel 21

Tilt/Telescoping Steering Column 21

Adjustable Pedals 22

OPERATING YOUR VEHICLE

Engine Break-In Recommendations 23

Turn Signal/Wiper/Washer/High Beam

Lever 23

Headlight Switch And Halo Light

Switch 25

Speed Control 26

Electronic Range Selection (ERS) 27

Fuel Economy (Econ) Mode 27

Manual Climate Controls 28

Three Zone Manual Climate Controls 29

Three Zone Automatic Temperature

Controls (ATC) 30

ParkSense® Rear Park Assist 32

ParkView® Rear Back-Up Camera 32

Rear Cross Path With Blind Spot

Monitoring 32

Power Sliding Side Doors 33

Power Liftgate 33

Power Sunroof 34

Wind Buffeting 35

ELECTRONICS

Your Vehicle's Sound System 36

Media Center 130 (Sales Code RES) 38

Media Center 130 With Satellite Radio

(Sales Code RES + RSC) 40

Media Center 430/430N (Sales Code

RBZ/RHB) 42

Media Center 730N (Sales Code RHR) 51

Sirius XM™ Satellite Radio/Travel Link 61

Steering Wheel Audio Controls 64

iPod®/USB/MP3 Control 64

Uconnect™ Phone 65

Uconnect™ Voice Command 68

Bluetooth® Streaming Audio 70

Video Entertainment System (VES)™ 70

Electronic Vehicle Information Center

(EVIC) 72

Programmable Features 73

Universal Garage Door Opener

(HomeLink®) 74

Power Inverter 76

Power Outlets 77

UTILITY

In-Floor Storage – Stow 'N Go® 79

Roof Luggage Rack 79

Trailer Towing Weights (Maximum Trailer

Weight Ratings) 80

Recreational Towing (Behind Motorhome,

Etc.) 81

WHAT TO DO IN EMERGENCIES

24-Hour Towing Assistance 82

Instrument Cluster Warning Lights 82

If Your Engine Overheats 86

Jacking And Tire Changing 87

Jump-Starting 96

Shift Lever Override 98

Towing A Disabled Vehicle 99

Freeing A Stuck Vehicle 100

Event Data Recorder (EDR) 101

MAINTAINING YOUR VEHICLE

Opening The Hood 102

Adding Fuel 102

Engine Compartment 104

Fluids And Capacities 105

Maintenance Chart 106

Fuses 109

Tire Pressures 113

Wheel And Wheel Trim Care 113

Exterior Bulbs 114

CONSUMER ASSISTANCE

Chrysler Group LLC Customer Center 115

Chrysler Canada Inc. Customer

Center 115

Assistance For The Hearing Impaired 115

Publications Ordering 115

Reporting Safety Defects In The

50 United States And

Washington, D.C. 116

MOPAR ACCESSORIES

Authentic Accessories By MOPAR® 117

INDEX

. 118

FAQ (How To?)

Frequently Asked Questions 121

INTRODUCTION/WELCOME

WELCOME FROM CHRYSLER GROUP LLC

Congratulations on selecting your new Chrysler Group LLC vehicle. Be assured that it represents precision workmanship, distinctive styling, and high quality - all essentials that are traditional to our vehicles.

Your new Chrysler Group LLC vehicle has characteristics to enhance the driver's control under some driving conditions. These are to assist the driver and are never a substitute for attentive driving. They can never take the driver's place. Always drive carefully.

Your new vehicle has many features for the comfort and convenience of you and your passengers. Some of these should not be used when driving because they take your eyes from the road or your attention from driving. Never text while driving or take your eyes more than momentarily off the road.

This guide illustrates and describes the operation of features and equipment that are either standard or optional on this vehicle. This guide may also include a description of features and equipment that are no longer available or were not ordered on this vehicle. Please disregard any features and equipment described in this guide that are not available on this vehicle. Chrysler Group LLC reserves the right to make changes in design and specifications and/or make additions to or improvements to its products without imposing any obligation upon itself to install them on products previously manufactured.

This User Guide has been prepared to help you quickly become acquainted with the important features of your vehicle. It contains most things you will need to operate and maintain the vehicle, including emergency information.

The DVD includes a computer application containing detailed owner's information which can be viewed on a personal computer or MAC computer. The multimedia DVD also includes videos which can be played on any standard DVD player (including the Media Center Touch-Screen Radios). Additional DVD operational information is located on the back of the DVD sleeve.

For complete owner information, refer to your Owner's Manual on the DVD in the owner's kit provided at the time of new vehicle purchase. For your convenience, the information contained on the DVD may also be printed and saved for future reference.

Chrysler Group LLC is committed to protecting our environment and natural resources. By converting from paper to electronic delivery for the majority of the user information for your vehicle, together we greatly reduce the demand for tree-based products and lessen the stress on our environment.

INTRODUCTION/WELCOME

Vehicles Sold In Canada

With respect to any vehicles sold in Canada, the name Chrysler Group LLC shall be deemed to be deleted and the name Chrysler Canada Inc. used in substitution therefore.

WARNING!

- Pedals that cannot move freely can cause loss of vehicle control and increase the risk of serious personal injury.
- Always make sure that objects cannot fall into the driver foot well while the vehicle is moving. Objects can become trapped under the brake pedal and accelerator pedal causing a loss of vehicle control.
- Failure to properly follow floor mat installation or mounting can cause interference with the brake pedal and accelerator pedal operation causing loss of control of the vehicle.
- Never use the 'PARK' position as a substitute for the parking brake. Always apply the parking brake fully when parked to guard against vehicle movement and possible injury or damage.
- Refer to your Owner's Manual on the DVD for further details.

USE OF AFTERMARKET PRODUCTS (ELECTRONICS)

The use of aftermarket devices including cell phones, MP3 players, GPS systems, or chargers may affect the performance of on-board wireless features including Keyless Enter-N-Go and Remote Start range. If you are experiencing difficulties with any of your wireless features, try disconnecting your aftermarket devices to see if the situation improves. If your symptoms persist, please see an authorized dealer.

CHRYSLER, DODGE, JEEP, RAM TRUCK, ATF+4, MOPAR and Uconnect are registered trademarks of Chrysler Group LLC.

COPYRIGHT ©2012 CHRYSLER GROUP LLC



CONTROLS AT A GLANCE

4 DRIVER COCKPIT



CONTROLS AT A GLANCE

- A. Headlight Switch pg. 25
- B. Turn Signal/Wiper/Washer/High Beams Lever (behind steering wheel) pg. 23
- C. Electronic Vehicle Information Center (EVIC) Controls pg. 72
- D. Electronic Vehicle Information Center (EVIC) Display pg. 72
- E. Instrument Cluster pg. 6
- F. Transmission Gear Selector
- G. Audio System (touch-screen-radio shown) pg. 36
- H. Climate Controls pg. 28
- I. SWITCH PANEL
 - Economy Mode
 - Hazard Switch
 - Power Inverter pg. 76
 - Electronic Stability Control pg. 82
- J. Power Outlets (inside console storage) pg. 77
- K. Speed Control pg. 26
- L. Hood Release pg. 102
- M. Parking Brake Release
- N. Power Mirrors
- O. Power Windows
- P. Power Door Locks
- Q. Power Vent Windows

CONTROLS AT A GLANCE



INSTRUMENT CLUSTER

Warning Lights





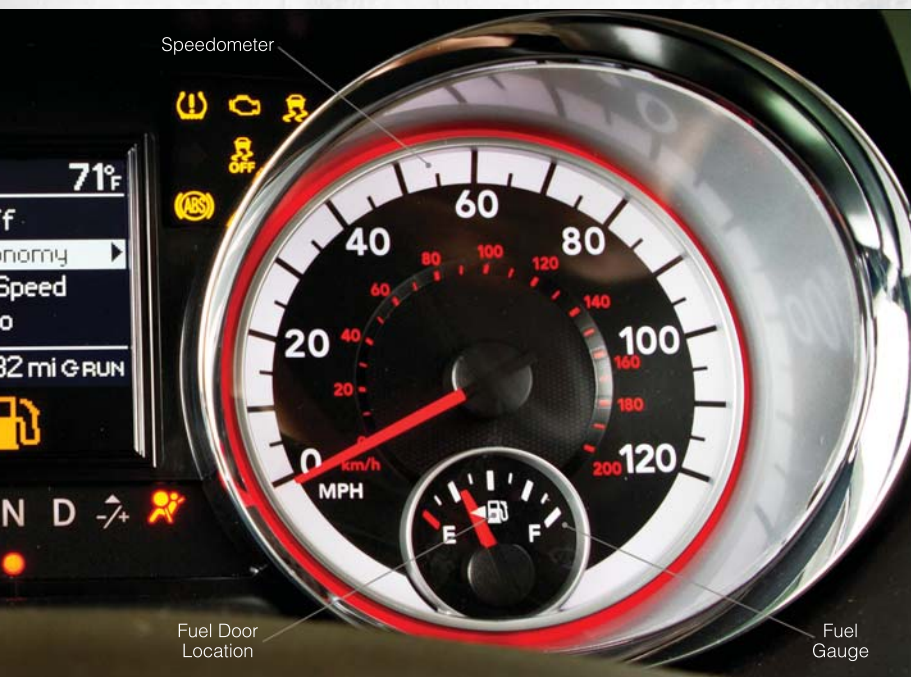

-  - Low Fuel Warning Light
-  - Charging System Light
-  - Oil Pressure Warning Light**
-  - Anti-Lock Brake (ABS) Light**
-  - Air Bag Warning Light**
-  - Electronic Throttle Control (ETC) Light
-  - Tire Pressure Monitoring System (TPMS) Light
-  - Engine Temperature Warning Light
-  - Seat Belt Reminder Light
- BRAKE** - Brake Warning Light**
-  - Malfunction Indicator Light (MIL)**
-  - Electronic Stability Control (ESC) Activation/Malfunction Indicator Light*

(See page 82 for more information.)

CONTROLS AT A GLANCE



Indicators

-  - Turn Signal Indicators
-  - High Beam Indicator
-  - Front Fog Light Indicator
-  - Vehicle Security Indicator*
-  - Electronic Stability Control (ESC) Off Indicator*
-  - Electronic Speed Control ON Indicator
-  - Electronic Speed Control Set Indicator

Odometer Messages

door - Door Ajar

gATE* - Liftgate Ajar

gASCAP - Fuel Cap Fault

LoW tirE* - Low Tire Pressure

noFUSE* - Fuse Fault

CHAngE OIL* - Change Engine Oil

LoCOOL - Low Coolant

* If equipped

** Bulb Check with Key On

GETTING STARTED

KEY FOB

Locking And Unlocking The Doors/Liftgate

- Press the LOCK button once to lock all the doors and the liftgate. Press the UNLOCK button once to unlock the driver's door only and twice within five seconds to unlock all the doors and liftgate.
- All doors can be programmed to unlock on the first press of the UNLOCK button. Refer to Programmable Features in this guide.



Panic Alarm

- Press the PANIC button once to turn the panic alarm on.
- Wait approximately three seconds and press the button a second time to turn the panic alarm off.

Power Liftgate

- Press the LIFTGATE button twice within five seconds to power open/close the Power Liftgate. If the button is pressed twice again while the liftgate is being power closed, the liftgate will reverse to the full open position.

Power Sliding Doors

- Press the LEFT or RIGHT Power Sliding Door button twice within five seconds to power open/close the Power Sliding Door. If the button is pressed twice again while the door is being power closed, the door will reverse to the full open position.

Emergency Key

- Should the battery in the vehicle or the Key Fob transmitter go dead, there is an emergency key located in the Key Fob that can be used for locking and unlocking the doors. To remove the emergency key, slide the button at the top of the Key Fob sideways with your thumb and then pull the key out with your other hand.

CAUTION!

- If your vehicle battery becomes low or dead, your Key Fob will become locked in the ignition.
- Do not attempt to remove the Key Fob while in this condition, damage could occur to the Key Fob or ignition module. Only remove the emergency key for locking and unlocking the doors.
- Leave the Key Fob in the ignition and either:
 - Jump Start the vehicle.
 - Charge the battery.
 - Contact your dealer for assistance on how to remove the Key Fob using the manual over ride method.

GETTING STARTED

WARNING!

- Leaving unattended children in a vehicle is dangerous for a number of reasons. A child or others could be severely injured or killed. Children should be warned not to touch the parking brake, brake pedal, or the shift lever. Do not leave the Key Fob inside the vehicle or in the ignition. A child could start the vehicle, operate power windows, other controls, or move the vehicle.
- Do not leave children or animals inside parked vehicles in hot weather. Interior heat build-up may cause them to be severely injured or killed.
- Keep Key Fob transmitters away from children. Operation of the Remote Start System, windows, door locks or other controls could cause serious injury or death.

REMOTE START

- Press the REMOTE START button  on the Key Fob twice within five seconds. Pressing the REMOTE START button a third time shuts the engine off.
- To drive the vehicle, press the UNLOCK button, insert the Key Fob in the ignition and turn to the ON/RUN position.
- With remote start, the engine will only run for 15 minutes (timeout) unless the ignition Key Fob is placed in the ON/RUN position.
- The vehicle must be started with the Key Fob after two consecutive timeouts.

WARNING!

- Do not start or run an engine in a closed garage or confined area. Exhaust gas contains Carbon Monoxide (CO) which is odorless and colorless. Carbon Monoxide is poisonous and can cause you or others to be severely injured or killed when inhaled.
- Keep Key Fob transmitters away from children. Operation of the Remote Start System, windows, door locks or other controls could cause you and others to be severely injured or killed.

THEFT ALARM

To Arm

- Press the Key Fob LOCK button or the power door lock switch while the door is open.

To Disarm

- Press the Key Fob UNLOCK button or turn the ignition to the ON/RUN position.

GETTING STARTED

SEAT BELT

- Be sure everyone in your vehicle is in a seat and using a seat belt properly.
- Position the lap belt across your thighs, below your abdomen. To remove slack in the lap portion, pull up a bit on the shoulder belt. To loosen the lap belt if it is too tight, tilt the latch plate and pull on the lap belt. A snug belt reduces the risk of sliding under the belt in a collision.
- Position the shoulder belt on your chest so that it is comfortable and not resting on your neck. The retractor will withdraw any slack in the belt.
- A shoulder belt placed behind you will not protect you from injury during a collision. You are more likely to hit your head in a collision if you do not wear your shoulder belt. The lap and shoulder belt are meant to be used together.
- A belt that is too loose will not protect you properly. In a sudden stop you could move too far forward, increasing the possibility of injury. Wear your seat belt snugly.
- A frayed or torn belt could rip apart in a collision and leave you with no protection. Inspect the belt system periodically, checking for cuts, frays, or loose parts. Damaged parts must be replaced immediately. Do not disassemble or modify the system. Seat belt assemblies must be replaced after a collision if they have been damaged (bent retractor, torn webbing, etc.).
- The seat belts for both front seating positions are equipped with pretensioning devices that are designed to remove slack from the seat belt in the event of a collision.
- A deployed pretensioner or a deployed air bag must be replaced immediately.

WARNING!

In a collision, you and your passengers can suffer much greater injuries if you are not buckled up properly. You can strike the interior of your vehicle or other passengers, or you can be thrown out of the vehicle. Always be sure you and others in your vehicle are buckled up properly.

SUPPLEMENTAL RESTRAINT SYSTEM (SRS) — AIR BAGS

- This vehicle has Advanced Front Air Bags for both the driver and right front passenger as a supplement to the seat belt restraint system. The Advanced Front Air Bags will not deploy in every type of collision.
- Advanced Front Air Bags are designed to provide additional protection by supplementing the seat belts in certain frontal collisions depending on the severity and type of collision. Advanced Front Air Bags are not expected to reduce the risk of injury in rear, side, or rollover collisions.
- This vehicle is equipped with Supplemental Side Air Bag Inflatable Curtains to protect the driver, front and rear passengers sitting next to a window.
- This vehicle is equipped with Supplemental Seat-Mounted Side Air Bags to provide enhanced protection to help protect an occupant during a side impact.

GETTING STARTED

- This vehicle is equipped with a Supplemental Driver Side Knee Air Bag to provide enhanced protection and work together with the Driver Advanced Front Air Bag during a frontal impact.
- If the Air Bag Warning Light  is not on during starting, stays on, or turns on while driving, have the vehicle serviced by an authorized service center immediately.
- Refer to the Owner's Manual on the DVD for further details regarding the Supplemental Restraint System (SRS).

WARNING!

- Relying on the air bags alone could lead to more severe injuries in a collision. The air bags work with your seat belt to restrain you properly. In some collisions, the air bags won't deploy at all. Always wear your seat belts even though you have air bags.
- Being too close to the steering wheel or instrument panel during Advanced Front Air Bag deployment could cause serious injury, including death. Air bags need room to inflate. Sit back, comfortably extending your arms to reach the steering wheel or instrument panel.
- Supplemental Side Air Bag Inflatable Curtains and Supplemental Seat-Mounted Side Air Bags need room to inflate. Do not lean against the door or window. Sit upright in the center of the seat.
- Being too close to the Supplemental Side Air Bag Inflatable Curtain and/or Seat-Mounted Side Air Bag during deployment could cause you to be severely injured or killed.
- Do not drive your vehicle after the air bags have deployed. If you are involved in another collision, the air bags will not be in place to protect you.
- After any collision, the vehicle should be taken to an authorized dealer immediately.

CHILD RESTRAINTS

- Children 12 years and under should ride properly buckled up in a rear seat, if available. According to crash statistics, children are safer when properly restrained in the rear seats rather than in the front.
- Every state in the United States and all Canadian provinces require that small children ride in proper restraint systems. This is the law, and you can be prosecuted for ignoring it.

Installing The LATCH - Compatible Child Restraint System

- Each vehicle, except commercial cargo vehicles, is equipped with the child restraint anchorage system called LATCH, which stands for Lower Anchors and Tether for CHildren.
- Two LATCH child restraint anchorage systems are installed on all second-row seats and in the center position on all third row fold-in-floor seats.

GETTING STARTED

- Second-row seats also feature tether strap anchorages, located in the rear surface of the seatback.
- In addition, all third row fold-in-floor seats are equipped with a child restraint tether anchor at the center seating position.

Installing The Lower Attachments:

- The vehicle lower anchorages are round bars located at the rear of the seat cushion where it meets the seatback.
- Loosen the child seat adjusters on the lower child restraint attachment straps to ease the installation.

NOTE: It is recommended to loosen the top tether strap and route it loosely prior to securing the lower anchors so the top tether strap is not trapped between the vehicle seat and child restraint.



- Attach the lower child restraint attachment straps to the vehicle's lower anchor bars. Ensure that the lower attachment strap is firmly engaged and that the hook is secure.
- Tighten the lower attachment strap while firmly pushing the child restraint rearward and downward into the vehicle seat. Remove all slack in the lower attachment straps.

Installing The Top Tether Strap (With Either Lower Anchors Or Vehicle Seat Belt):

- Route the top tether strap under the adjustable head restraint between the steel posts.
- Provide enough slack for the tether strap to reach the tether anchor located near the bottom of the seat back.
- Clip tether hook to tether anchor. Ensure that the hook is firmly engaged and secure.
- Remove all slack and tighten tether strap according to child restraint manufacturer's instructions.



NOTE: The top tether strap is always to be secured, regardless of if the child restraint is installed with the lower anchors or the vehicle seat belt.

GETTING STARTED

Installing The Child Restraint Using The Vehicle Seat Belts

- To install a child restraint, first, pull enough of the seat belt webbing from the retractor to route it through the belt path of the child restraint and slide the latch plate into the buckle.
- Next, extract all the seat belt webbing out of the retractor and then allow the belt to retract into the retractor. Finally, pull on any excess webbing to tighten the lap portion around the child restraint. Any seat belt system will loosen with time, so check the belt occasionally, and pull it tight if necessary.
- Once you have completed securing the child restraint with the seat belt, secure the top tether strap.

WARNING!

- In a collision, an unrestrained child, even a tiny baby, can become a projectile inside the vehicle. The force required to hold even an infant on your lap could become so great that you could not hold the child, no matter how strong you are. The child and others could be severely injured or killed. Any child riding in your vehicle should be in a proper restraint for the child's size.
- Failure to comply with the following conditions could result in you and others being severely injured or killed:
- An incorrectly anchored tether strap could lead to increased head motion and possible injury to the child. Use only the anchor positions directly behind the child seat to secure a child restraint top tether strap.
- Rearward-facing child seats must never be used in the front seat of a vehicle with a front passenger air bag. An air bag deployment could cause infants in this position to be severely injured or killed.

FRONT SEATS

Power Seat

- The power seat switch controls forward/back, up/down, and tilt adjustment.
- The recline switch, located on the outboard side of the seat, controls seatback adjustment.

Power Lumbar

- Push the switch forward to increase the lumbar support. Push the switch rearward to decrease the lumbar support.



GETTING STARTED

Manual Seat Adjustment

Forward/Rearward

- Lift up on the adjusting bar located at the front of the seat near the floor and release at the desired position.

Recliner

- Lift the recliner lever located on the outboard side of the seat, lean back and release at the desired position.



Memory Seat

- The memory seat feature allows you to save two different driver seating positions, driver's outside mirror, adjustable brake and accelerator pedals, and radio station preset settings. The memory seat buttons are located on the driver's door panel.
- Adjust all memory profile settings, press the SET button then press 1 or 2 within five seconds.



- To program a Key Fob to the memory position, press and release the LOCK button within 10 seconds on the Key Fob to be programmed.
- Place the ignition switch in the ON position, select Remote Linked to Memory in the Electronic Vehicle Information Center (EVIC) and enter Yes.
- Press 1 or 2 to recall the saved positions, or press UNLOCK on the programmed Key Fob.

CAUTION!

DO NOT place any article under a power seat or impede its ability to move as it may cause damage to the seat controls. Seat travel may become limited if movement is stopped by an obstruction in the seat's path.

GETTING STARTED

WARNING!

- Adjusting a seat while the vehicle is moving is dangerous. The sudden movement of the seat could cause you to lose control. The seat belt might not be properly adjusted, and you could be severely injured or killed. Only adjust a seat while the vehicle is parked.
- Do not ride with the seatback reclined so that the seat belt is no longer resting against your chest. In a collision, you could slide under the seat belt and be severely injured or killed. Use the recliner only when the vehicle is parked.

REAR SEATS

Second Row Seats – Stow 'n Go®

- On vehicles equipped with Stow 'n Go® seats, the seats will fold and tumble in one motion.
- Move the front seat fully forward.
- Recline the front seatback fully forward.
- Raise the armrests on the second row seat.

NOTE: Seat will not stow in the storage bin unless the armrests are raised.

- Slide the storage bin locking mechanism to the “LOCK” position and then pull up on the storage bin latch to open the cover.

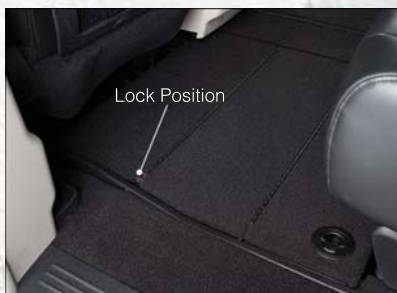
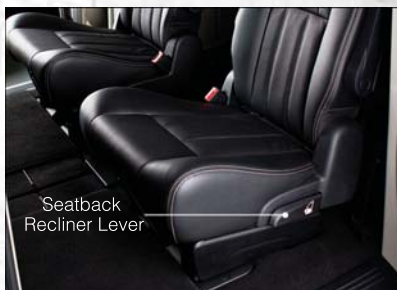

GETTING STARTED

- Pull upward on the seatback recliner lever located on the outboard side of the seat.
- The non-adjustable head restraint and seatback will fold automatically during the seat tumble.



- The seat will automatically tumble into position for easy storage.



- Push the seat into the storage bin and close the storage bin cover.



To Unstow Second Row Seats

- Pull up on the storage bin latch to open the cover.
- Pull up on the strap to lift the seat out of the storage bin and push the seat rearward to latch the seat anchors.
- Lift the seatback to the full upright position.
- Return the head restraint to its upright position, close the storage bin cover and slide the storage bin locking mechanism to the “Unlocked” position.

GETTING STARTED

Third Row Seats

Third Row Power Recliner

- The power recline feature, located on the side of the seat cushion, adjusts the seatback angle forward/rearward for occupant comfort.

Third Row Power Seat Switch

NOTE:

- Disconnect the center shoulder belt from the small buckle and lower the head restraints before attempting to fold/stow the power third row seats.
- A one-touch power folding seat switch is located in the left rear trim panel as part of a switch bank.
- Left and right third row seats can be folded individually or together. The third row power folding seats adjust to multiple positions.



- The switch is only functional when the liftgate is open and the vehicle is in PARK.

NOTE:

- To abort seat operation while the seat is in motion, press a different seat position selector switch to stop the seat. Once the seat stops moving, then the desired position can be selected.
- The third row power seat system includes obstacle detection for safe operation. When the system detects an obstacle, the motors will stop and reverse the motion a short distance to move the seat away from the obstacle. Should this occur, remove the obstacle and press the button again for the desired position.
- Refer to your Owner's Manual on the DVD for manual third row seat folding instructions.

GETTING STARTED

Manually Folding Third Row Seats



- Lower the center head restraint down to the seatback by pushing the button on the guide and pushing the head restraint down.
- Lower the outboard head restraints by pulling on the release strap marked "1" located on the outboard side of the head restraint.



- Pull release strap marked "2" located on the rear of the seat to lower the seatback.
- Pull release strap marked "3" to release the anchors.



GETTING STARTED

- Pull release strap marked “4” and tumble the seat rearward into the storage bin.



To Unfold Third Row Seats

- Pull up on the assist strap to lift the seat out of the storage bin and push the seat forward until the anchors latch.
- Pull release strap marked “2” to unlock the recliner.
- Pulling strap “4” releases the seatback to return to its full upright position.
- Raise the head restraint to its upright position.

CAUTION!

The storage bin cover must be locked and flat to avoid damage from contact with the front seat tracks, which have minimal clearance to the cover.

WARNING!

- In a collision, serious injury could result if the seat storage bin covers are not properly latched.
 - Do not drive the vehicle with the storage bin covers open.
 - Keep the storage bin covers closed and latched while the vehicle is in motion.
 - Do not use a storage bin latch as a tie down.
- In a collision, you or others in your vehicle could be injured if seats are not properly latched to their floor attachments. Always be sure the seats are fully latched.

GETTING STARTED

HEATED SEATS

Front Heated Seats

- The controls for front heated seats are located on the center instrument panel area.
- Press the switch once to select High-level heating. Press the switch a second time to select Low-level heating. Press the switch a third time to shut the heating elements Off.



- If the High-level setting is selected, the system will automatically switch to Low-level after approximately 30 minutes. The Low-level setting will turn Off automatically after approximately 45 minutes.

Second Row Heated Seats

- Second row heated seat switches are located in the sliding door handle trim panels.
- Press the switch once to select High-level heating. Press the switch a second time to select Low-level heating. Press the switch a third time to shut the heating elements Off.



- If the High-level setting is selected, the system will automatically switch to Low-level after approximately 30 minutes. The Low-level setting will turn Off automatically after approximately 45 minutes.

WARNING!

- Persons who are unable to feel pain to the skin because of advanced age, chronic illness, diabetes, spinal cord injury, medication, alcohol use, exhaustion or other physical conditions must exercise care when using the seat heater. It may cause burns even at low temperatures, especially if used for long periods of time.

GETTING STARTED

WARNING! *(Continued)*

- Do not place anything on the seat that insulates against heat, such as a blanket or cushion. This may cause the seat heater to overheat. Sitting in a seat that has been overheated could cause serious burns due to the increased surface temperature of the seat.

HEATED STEERING WHEEL

- The steering wheel contains a heating element that heats the steering wheel to one temperature setting.
- The heated steering wheel switch is located on the center instrument panel.
- Press the switch once to turn the heating element On. Press the switch a second time to turn the heating element Off.



- Once the heated steering wheel has been turned on, it will operate for approximately 58 to 70 minutes before automatically shutting off. The heated steering wheel can shut off early or may not turn on when the steering wheel is already warm.

TILT/TELESCOPING STEERING COLUMN

- The tilt steering column tilt lever is located below the steering wheel.
- Push down on the tilt lever to unlock the steering column.
- With one hand firmly on the steering wheel, move the steering column upward or downward as desired. To lengthen or shorten the steering column, pull the steering wheel outward or push it inward as desired.
- Pull upward on the tilt lever to lock the column firmly in place.

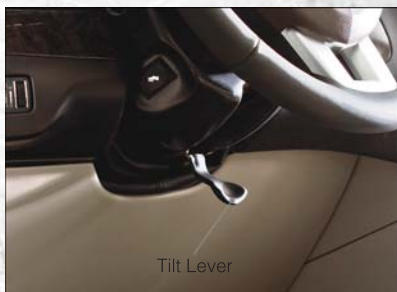

GETTING STARTED

WARNING!

Do not adjust the steering wheel while driving. The tilt adjustment must be locked while driving. Adjusting the steering wheel while driving or driving without the tilt adjustment locked could cause the driver to lose control of the vehicle. Failure to follow this warning may result in you and others being severely injured or killed.

ADJUSTABLE PEDALS

- Press the switch located on the left side of the steering column forward to move the brake and accelerator pedals away from the driver and press the switch rearward to move the pedals closer to the driver.

NOTE: The pedals cannot be adjusted when the vehicle is in REVERSE or when the Electronic Speed Control is set.



CAUTION!

Do not place any article under the adjustable pedals or impede its ability to move, as it may cause damage to the pedal controls. Pedal travel may become limited if movement is stopped by an obstruction in the adjustable pedal's path.

WARNING!

Do not adjust the pedals while the vehicle is moving. You could lose control and have a collision. Always adjust the pedals while the vehicle is parked.

OPERATING YOUR VEHICLE

ENGINE BREAK-IN RECOMMENDATIONS

- A long break-in period is not required for the engine and drivetrain (transmission and axle) in your vehicle.
- Drive moderately during the first 300 miles (500 km). After the initial 60 miles (100 km), speeds up to 50 or 55 mph (80 or 90 km/h) are desirable.
- While cruising, brief full-throttle acceleration within the limits of local traffic laws contributes to a good break-in. Wide-open throttle acceleration in low gear can be detrimental and should be avoided.
- The engine oil installed in the engine at the factory is a high-quality energy conserving type lubricant. Oil changes should be consistent with anticipated climate conditions under which vehicle operations will occur. For the recommended viscosity and quality grades, refer to “Maintaining Your Vehicle”.

NOTE: A new engine may consume some oil during its first few thousand miles (kilometers) of operation. This should be considered a normal part of the break-in and not interpreted as an indication of difficulty.

CAUTION!

Never use Non-Detergent Oil or Straight Mineral Oil in the engine or damage may result.

TURN SIGNAL/WIPER/WASHER/HIGH BEAM LEVER



Turn Signal/Lane Change Assist

- Tap the lever up or down once and the turn signal (right or left) will flash three times and automatically turn off.
- Vehicles equipped with Blind Spot Monitoring will produce a visual alert and may be programmed to produce an audible alert when signaling a lane change; refer to your Owner's Manual on the DVD for operation.

OPERATING YOUR VEHICLE

Front Wipers

Intermittent, Low And High Operation

- Rotate the end of the lever to the first detent position for one of five intermittent settings, the second detent for low wiper operation and the third detent for high wiper operation.

Rain Sensing Wipers

- This feature senses moisture on the vehicle's windshield and automatically activates the wipers for the driver when the switch is in the intermittent positions. Refer to Programmable Features in Electronics for further details.

Mist

- Push the end of the lever inward to the first detent when a single wipe is desired.

NOTE: The mist feature does not activate the washer pump; therefore, no washer fluid will be sprayed on the windshield. The wash function must be activated in order to spray the windshield with washer fluid.

Washer Operation

- Push the end of the lever inward to the second detent and hold for as long as spray is desired.

Rear Wiper

- Rotate the center portion of the lever forward to the first detent for rear wiper operation.

Rear Washer

- Rotate the center portion of the lever past the first detent to activate the rear washer.

High Beams

- Push the lever away from you to activate the high beams.
- A high beam symbol will illuminate in the cluster to indicate the high beams are on.

NOTE: For safe driving, turn off the high beams when oncoming traffic is present to prevent headlight glare and as a courtesy to other motorists.



Flash To Pass

- Pull the lever toward you to activate the high beams. The high beams will remain on until the lever is released.

OPERATING YOUR VEHICLE

HEADLIGHT SWITCH AND HALO LIGHT SWITCH

Automatic Headlights/Parking Lights/Headlights

- Rotate the headlight switch, located on the instrument panel to the left of the steering wheel, to the first detent for parking lights  and to the second detent for headlights .
- With the parking lights or low beam headlights on, push the headlight switch once for fog lights.
- Rotate the headlight switch to “AUTO” for AUTO headlights.



- When set to AUTO, the system automatically turns the headlights on or off based on ambient light levels.

SmartBeams™

- This system automatically controls the use of the headlight high beams. Refer to Programmable Features in Electronics for further details.

Instrument Panel Dimmer

- Rotate the dimmer control to the extreme bottom position to fully dim the instrument panel lights and prevent the interior lights from illuminating when a door is opened.
- Rotate the dimmer control up to increase the brightness of the instrument panel when the parking lights or headlights are on.
- Rotate the dimmer control up to the next detent position to fully brighten the odometer and radio when the parking lights or headlights are on. Refer to your Media Center/Radio User Manual on the DVD for display dimming.
- Rotate the dimmer control up to the last detent position to turn on the interior lighting.

Overhead (Halo) Light

- To activate the Halo lights, rotate the Halo switch control upward or downward to increase or decrease the lighting.

OPERATING YOUR VEHICLE

SPEED CONTROL

- The speed control switches are located on the steering wheel.

Cruise ON/OFF

- Push the ON/OFF button to activate the Speed Control.
- CRUISE  will appear on the instrument cluster to indicate the Speed Control is on.
- Push the ON/OFF button a second time to turn the system off.

Set

- With the Speed Control on, push and release the SET - button to set a desired speed.

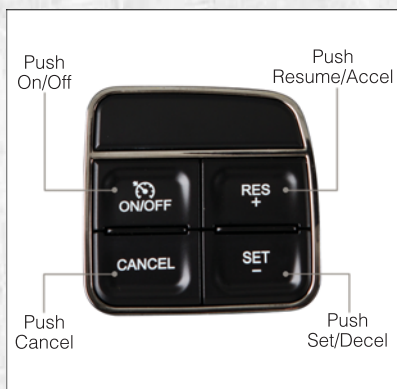

Accel/Decel

- Once a speed is set, pushing the RES + button once or the SET - button once will increase or decrease the set speed approximately 1 mph (2 km/h).
- Push and hold the RES + button to accelerate in 5mph (8 km/h) increments or push and hold the SET - button to decelerate in 5mph (8 km/h) increments; release the button to save the new set speed.

Resume

- To resume a previously selected set speed in memory, push the RES + button and release.

Cancel

- Push the CANCEL button, or apply the brakes to cancel the set speed and maintain the set speed memory.
- Push the ON/OFF button to turn the system off and erase the set speed memory.

WARNING!

- Leaving the Electronic Speed Control system on when not in use is dangerous. You could accidentally set the system or cause it to go faster than you want. You could lose control and have a collision. Always leave the Electronic Speed Control system off when you are not using it.
- Electronic Speed Control can be dangerous where the system cannot maintain a constant speed. Your vehicle could go too fast for the conditions, and you could lose control. A collision could be the result. Do not use Electronic Speed Control in heavy traffic or on roads that are winding, icy, snow-covered or slippery.

OPERATING YOUR VEHICLE

ELECTRONIC RANGE SELECTION (ERS)

- Electronic Range Select (ERS) allows you to limit the highest available transmission gear, and can be activated during any driving condition. When towing a trailer or operating the vehicle in off-road conditions, using ERS shift control will help you maximize both performance and engine braking.
- To shift from DRIVE mode to ERS mode, move the shift lever to the left (-) once. The current gear will be maintained as the top gear. To disable ERS, simply press and hold the shift lever to the right (+) until “D” is displayed in the instrument cluster odometer.
- Switching between ERS and DRIVE mode can be done at any vehicle speed.
- Refer to your Owner's Manual on the DVD for further details.



FUEL ECONOMY (ECON) MODE



- The Fuel Economy (ECON) mode can improve the vehicle's overall fuel economy during normal driving conditions.
- Press the “econ” switch in the center stack of the instrument panel and a green light will indicate the ECON mode is engaged.
- When the Fuel Economy (ECON) Mode is engaged, the vehicle control systems will be able to change the following:

OPERATING YOUR VEHICLE

- The transmission will upshift sooner and downshift later.
- The transmission will skip select gears during shifts to allow the engine to operate at lower speeds.
- The torque converter clutch will engage sooner (lower engine rpm's) and remain on longer.
- The engine idle speed will be lower.
- The overall driving performance will be more conservative.

MANUAL CLIMATE CONTROLS

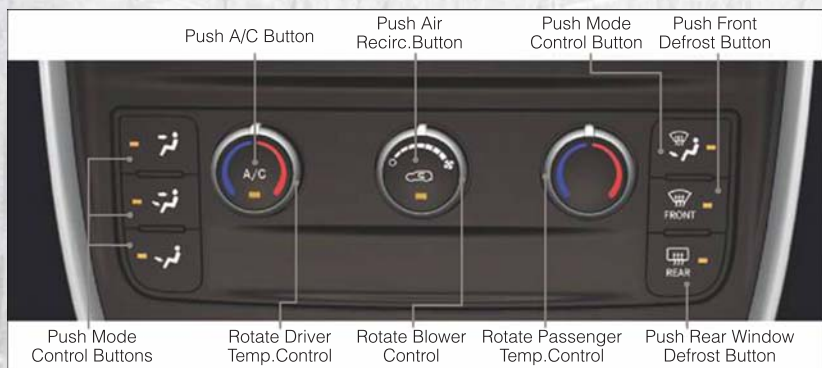

Air Recirculation

- Use recirculation for maximum A/C operation.
- For window defogging, turn the recirculation button off.
- Recirculation is not allowed in defrost mode.

Heated Mirrors

- The mirrors are heated to melt frost or ice. This feature is activated whenever you turn on the rear window defroster.

OPERATING YOUR VEHICLE

THREE ZONE MANUAL CLIMATE CONTROLS

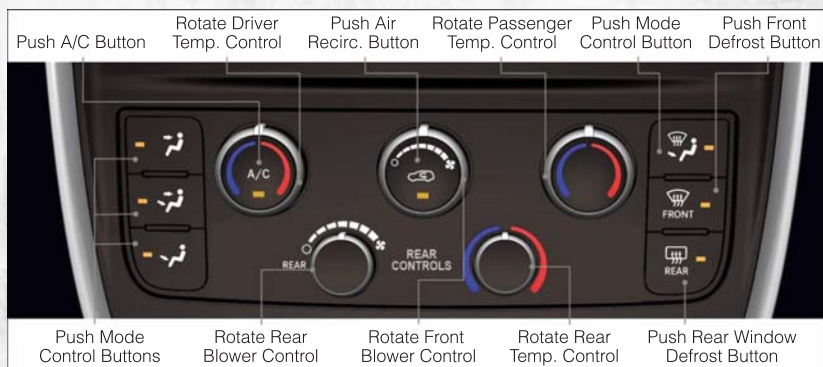

Air Recirculation

- Use recirculation for maximum A/C operation.
- For window defogging, turn the recirculation button off.
- Recirculation is not allowed in defrost mode.

Heated Mirrors

- The mirrors are heated to melt frost or ice. This feature is activated whenever you turn on the rear window defroster.

Rear Window Defroster

- Pressing the rear window defroster button will turn on the defroster for approximately 10 minutes. An indicator in the button will illuminate when the rear window defroster is on. For an additional five minutes of operation, press the button a second time.



OPERATING YOUR VEHICLE

Activating Rear Passenger Climate Controls

- Rotate the rear blower control, located on the main climate control in the instrument panel, to the “REAR” position. This enables the rear passenger climate controls located in the headliner above the second row seats.



THREE ZONE AUTOMATIC TEMPERATURE CONTROLS (ATC)

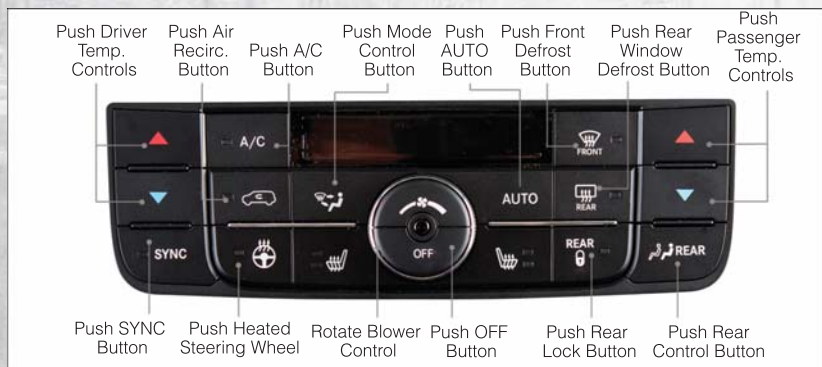

Automatic Operation

- Push the AUTO mode button to activate the ATC system.
- Select the desired temperature by pressing the temperature control buttons for the driver or passenger.
- The system will maintain the set temperature automatically.

Air Conditioning (A/C)

- If the A/C button is pushed while in AUTO mode, the indicator light may flash three times to indicate the air conditioning is being controlled automatically.

OPERATING YOUR VEHICLE

SYNC Temperature Button

- Push the SYNC button once to control driver and passenger temperatures simultaneously. Push the SYNC button a second time to control the temperatures individually.

Air Recirculation

- Use recirculation for maximum A/C operation.
- For window defogging, turn the recirculation button off.
- If the Recirculation button is pressed when the system is in Defrost mode the Recirculation LED indicator will flash 3 times to indicate Recirculation mode is not allowed.

Heated Mirrors

- The mirrors are heated to melt frost or ice. This feature is activated whenever you turn on the rear window defroster.

Rear Window Defroster

- Pressing the rear window defroster button will turn on the defroster for approximately 10 minutes. An indicator in the button will illuminate when the rear window defroster is on. For an additional five minutes of operation, press the button a second time.

Activating Rear Automatic Temperature Control



- Pressing the REAR LOCK button for the Rear ATC System from the front lower ATC panel, illuminates a LOCK symbol in the rear display. The rear temperature and air source are controlled from the front lower ATC panel.
- Rear second row occupants can only adjust the rear ATC control when the REAR LOCK button is turned off.
- The Rear ATC System is located in the headliner, near the center of the vehicle.

OPERATING YOUR VEHICLE

PARKSENSE® REAR PARK ASSIST

- If an object is detected behind the rear bumper while the vehicle is in REVERSE, a warning will display in the instrument cluster and a tone, that changes speed depending on the distance of the object from the bumper, will sound.
- When the Instrument Cluster reads either “Clean Sensor” or “Blinded”, clean off the bumper sensors to see if the condition is corrected.

PARKVIEW® REAR BACK-UP CAMERA

- You can see an on-screen image of the rear of your vehicle whenever the shift lever is put into REVERSE. The ParkView® Rear Back-Up Camera image will be displayed on the radio display screen, located on the center stack of the instrument panel.
- If the radio display screen appears foggy, clean the camera lens located on the liftgate.

WARNING!

Drivers must be careful when backing up even when using the ParkView® Rear Back-Up Camera. Always check carefully behind your vehicle, and be sure to check for pedestrians, animals, other vehicles, obstructions, or blind spots before backing up. You must continue to pay attention while backing up. Failure to do so can result in serious injury or death.

REAR CROSS PATH WITH BLIND SPOT MONITORING

- The Blind Spot Monitoring (BSM) system uses two radar-based sensors, located inside the rear bumper fascia, to detect Highway licensable vehicles (automobiles, trucks, motorcycles etc.) that enter the blind spot zones from the rear/front/side of the vehicle.
- The Blind Spot Monitoring (BSM) system warning light, located in the outside mirrors, will illuminate if a vehicle moves into a blind spot zone.
- The BSM system can also be configured to sound an audible (chime) alert and mute the radio to notify you of objects that have entered the detection zones.
- Refer to your owner's manual on the DVD for further details.

OPERATING YOUR VEHICLE

POWER SLIDING SIDE DOORS

Automatic/Manual Operation

- The power sliding door may be opened or closed manually or by using the buttons on the Key Fob, overhead console switch, or rear door switch.
- Pulling the inside or outside power sliding door handle will also power open the power sliding doors.

NOTE: When the power sliding door master lock switch is in the OFF position, the power sliding side door may not be opened or closed by pressing the switch located on the b-pillar trim panel, just in front of the sliding door or activating the inside power sliding door handle.

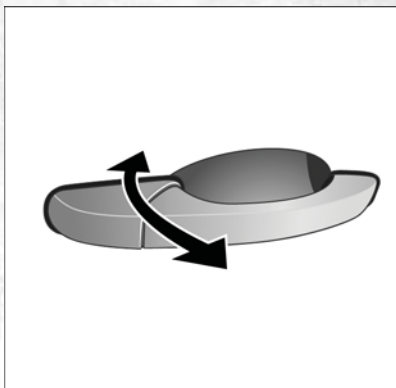

Sliding Side Door Child Protection Lock

- When this system is engaged, the inside manual door handle will not open the sliding door even though the inside door lock is in the unlocked position.
- To engage the Child Protection Door Lock, open the sliding side door. Slide the child protection door lock control, located on the rear of the sliding door, inward (toward the vehicle) to engage.
- Repeat these steps on the opposite sliding door.

POWER LIFTGATE

- The power liftgate may be opened and closed by pressing the button located on the overhead console. Press the button once to open, and a second time to close the power liftgate.
- The power liftgate may also be opened and closed by pressing the button on the Key Fob. Press the button twice to open, and twice to close the power liftgate.
- The power liftgate may be closed by the button, located in the upper left trim in the liftgate opening. Pressing once will only close the liftgate. This button cannot be used to open the liftgate.

OPERATING YOUR VEHICLE

POWER SUNROOF

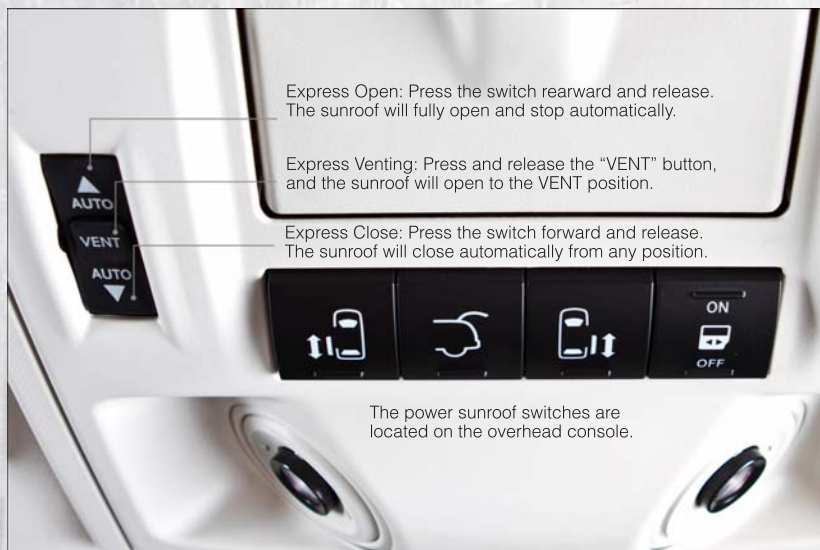

Manual Open/Close

- Press and hold the switch rearward to open or forward to close the sunroof. Any release of the switch will stop the movement, and the sunroof will remain in a partially open or closed position until the switch is pressed again.

Pinch Protection Feature

- This feature will detect an obstruction in the opening of the sunroof or the shade during Express Close operation. If an obstruction in the path of the sunroof or shade is detected, the sunroof or shade will automatically return to the open position.

NOTE: Pinch protection is disabled while the switch is pressed and held during manual opening and closing of the sunroof or shade.

OPERATING YOUR VEHICLE

WARNING!

- Never leave children in a vehicle with the key in the ignition switch. Occupants, particularly unattended children, can become entrapped by the power sunroof while operating the power sunroof switch. Such entrapment may result in serious injury or death.
- In a collision, there is a greater risk of being thrown from a vehicle with an open sunroof. You could also be severely injured or killed. Always fasten your seat belt properly and make sure all passengers are properly secured.
- Do not allow small children to operate the sunroof. Never allow your fingers, other body parts, or any object to project through the sunroof opening. Injury may result.

WIND BUFFETING

- Wind buffeting can be described as a helicopter-type percussion sound. If buffeting occurs with the rear windows open, adjust the front and rear windows together.
- If buffeting occurs with the sunroof open, adjust the sunroof opening, or adjust any window. This will minimize buffeting.

ELECTRONICS

YOUR VEHICLE'S SOUND SYSTEM



Uconnect™ Voice
Command Button

Uconnect™
Phone Button

Next Station
or CD Track

Next Radio
Preset

Previous Station
or CD Track

Steering Wheel
Audio Controls
(left rear surface
of steering wheel)

PUSH TO
RELEASE

Bluetooth Streaming Audio – allows you to control your Bluetooth device through the radio, steering wheel audio controls or voice commands. See Uconnect™ Phone in this section for more details. Also, Bluetooth device must be compatible. Refer to your Bluetooth device's manual to see if it supports A2DP+AVCRP 1.3 protocol.

ELECTRONICS

USB Port on Radio – for copying files from a memory stick to your radio's hard drive.

Audio Jack – works with iPod® devices or other players with a headphones jack and a 3.5mm cable.

Your Radio Sales Code

Steering Wheel Audio Controls (right rear surface of steering wheel)

Volume Up

Change Audio Source

Volume Down

USB Port (inside upper glove box) - when connected, allows you to control your iPod® -or memory stick using the radio or steering wheel audio controls.

ELECTRONICS

MEDIA CENTER 130 (SALES CODE RES)

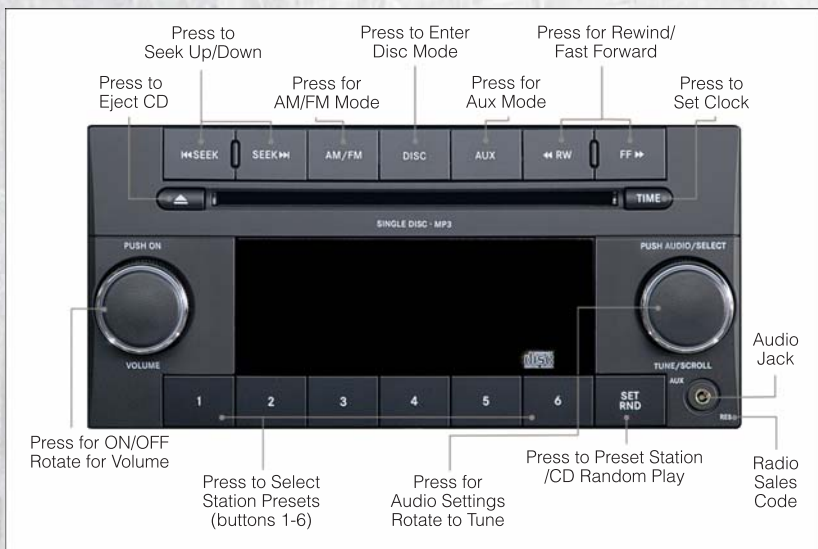

NOTE:

- Your radio has many features that add to the comfort and convenience of you and your passengers. Some of these radio features should not be used when driving because they take your eyes from the road or your attention from driving.

Clock Setting

- Press and hold the "TIME" button until the hours blink; turn the "TUNE/SCROLL" control knob to set the hours.
- Press the "TUNE/SCROLL" control knob until the minutes begin to blink; turn the "TUNE/SCROLL" control knob to set the minutes.
- Press the "TUNE/SCROLL" control knob to save the time change.
- To exit, press any button/knob or wait five seconds.

Equalizer, Balance And Fade

- Press the "TUNE/SCROLL" control knob and BASS, MID, TREBLE, BALANCE and FADE will display. Rotate the "TUNE/SCROLL" control knob to select the desired setting.

Radio Operation

Seek Up/Down Buttons

- Press to seek through radio stations in AM, FM, or SAT bands.
- Hold either button to bypass stations without stopping.

Store Radio Presets

- Press the “SET/RND” button once and SET 1 will show in the display. Then select button (1–6).
- A second station may be added to each push button. Press the “SET/RND” button twice and SET 2 will show in the display. Then select button (1–6).

CD/DISC Operation

Seek Up/Down Buttons

- Press to seek through CD tracks.
- Hold either button to bypass tracks without stopping.

SET/RND Button (Random Play)

- Press this button while the CD is playing to activate Random Play.
- This feature plays the selections on the CD in random order to provide an interesting change of pace.

Audio Jack Operation

- The Audio Jack allows a portable device, such as an MP3 player or a cassette player, to be plugged into the radio and utilize the vehicle’s audio system, using a 3.5 mm audio cable, to amplify the source and play through the vehicle speakers.
- Pressing the “AUX” button will change the mode to auxiliary device if the Audio Jack is connected, allowing the music from your portable device to play through the vehicle’s speakers.
- The functions of the portable device are controlled using the device buttons. The volume may be controlled using the radio or portable device.

ELECTRONICS

MEDIA CENTER 130 WITH SATELLITE RADIO (SALES CODE RES + RSC)

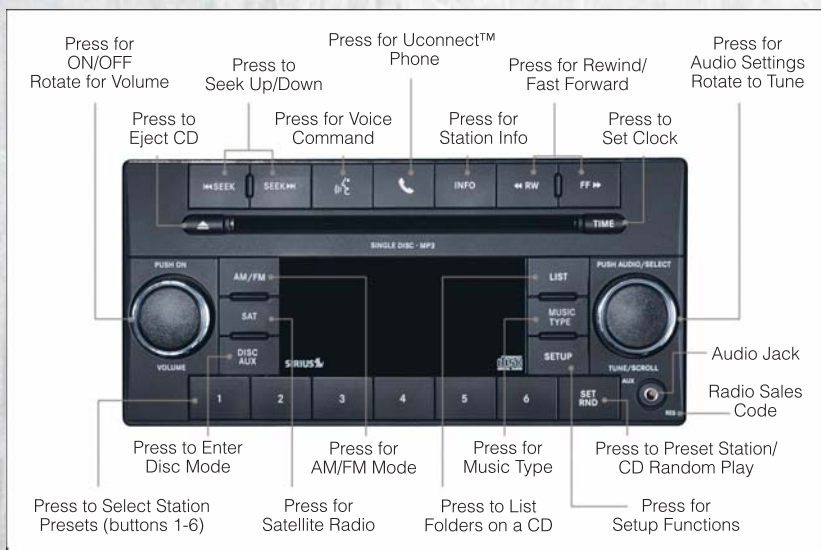

NOTE:

- Your radio may not be equipped with the Uconnect™ Voice Command and Uconnect™ Phone features. To determine if your radio has these features, press the Voice Command button on the radio. You will hear a voice prompt if you have the feature, or see a message on the radio stating “Uconnect Phone not available” if you do not.
- Your radio has many features that add to the comfort and convenience of you and your passengers. Some of these radio features should not be used when driving because they take your eyes from the road or your attention from driving.

Clock Setting

- Press and hold the “TIME” button until the hours blink; turn the “TUNE/SCROLL” control knob to set the hours.
- Press the “TUNE/SCROLL” control knob until the minutes begin to blink; turn the “TUNE/SCROLL” control knob to set the minutes.
- Press the “TUNE/SCROLL” control knob to save the time change.
- To exit, press any button/knob or wait five seconds.

Equalizer, Balance And Fade

- Press the “TUNE/SCROLL” control knob and BASS, MID, TREBLE, BALANCE and FADE will display. Rotate the “TUNE/SCROLL” control knob to select the desired setting.

Radio Operation

Seek Up/Down Buttons

- Press to seek through radio stations in AM, FM, or SAT bands.
- Hold either button to bypass stations without stopping.

Store Radio Presets

- Press the “SET/RND” button once and SET 1 will show in the display. Then select button (1–6).
- A second station may be added to each push button. Press the “SET/RND” button twice and SET 2 will show in the display. Then select button (1–6).

Music Type

- Press the “MUSIC TYPE” button to activate this mode. Press the “MUSIC TYPE” button again or turn the “TUNE/SCROLL” control knob to select the desired music type (Adult Hits, Country, Jazz, Oldies, Rock, etc.).
- Once a music type is chosen and the icon is displayed, press either “SEEK” button and the radio will only search for stations with the selected music type.

NOTE: The Music Type function only operates when in FM mode.

SETUP Button

- Pressing the “SETUP” button allows you to select between items that are available in that particular mode.
- Turn the “TUNE/SCROLL” control knob to scroll through the entries. Push the “AUDIO/SELECT” button to select an entry and make changes.

Sirius XM™ Satellite Radio

- Sirius XM™ Satellite Radio gives you over 130 channels, including 100% commercial-free music from nearly every genre, plus all your favorite sports, news, talk and entertainment channels—all with crystal clear, coast-to-coast coverage, all in one place and all at your fingertips.
- To access Sirius XM™ Satellite Radio, press the “SAT” hard-key.

CD/DISC Operation

Seek Up/Down Buttons

- Press to seek through CD tracks.
- Hold either button to bypass tracks without stopping.

SET/RND Button (Random Play)

- Press this button while the CD is playing to activate Random Play.
- This feature plays the selections on the CD in random order to provide an interesting change of pace.

LIST Button

- Press the “LIST” button to bring up a list of all folders on the CD. Scroll up or down the list by turning the “TUNE/SCROLL” control knob.

ELECTRONICS

- To select a folder from the list, press the “TUNE/SCROLL” control knob and the radio will begin playing the files contained in that folder.

Audio Jack Operation

- The Audio Jack allows a portable device, such as an MP3 player or a cassette player, to be plugged into the radio and utilize the vehicle’s audio system, using a 3.5 mm audio cable, to amplify the source and play through the vehicle speakers.
- Pressing the “AUX” button will change the mode to auxiliary device if the Audio Jack is connected, allowing the music from your portable device to play through the vehicle’s speakers.
- The functions of the portable device are controlled using the device buttons. The volume may be controlled using the radio or portable device.

MEDIA CENTER 430/430N (SALES CODE RBZ/RHB)

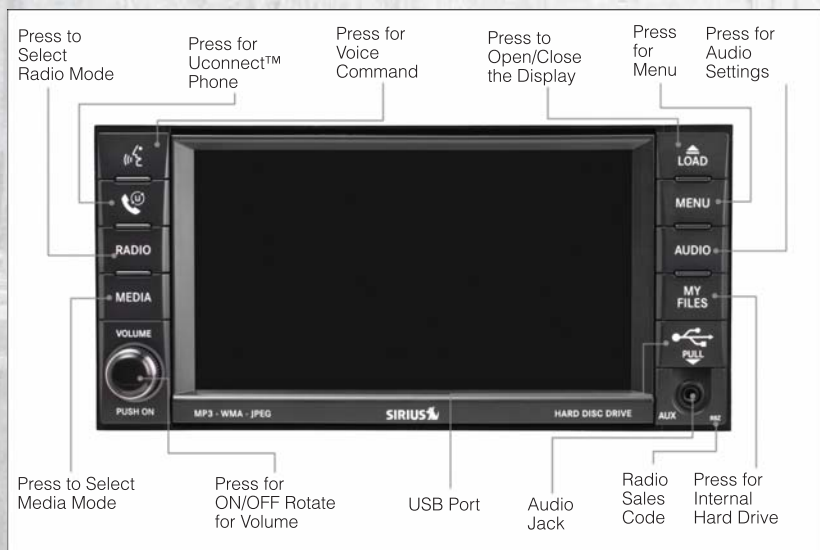

NOTE:

- Your radio may not be equipped with the Uconnect™ Voice Command and Uconnect™ Phone features. To determine if your radio has these features, press the Voice Command button on the radio. You will hear a voice prompt if you have the feature, or see a message on the radio stating “Uconnect Phone not available” if you do not.
- Your radio has many features that add to the comfort and convenience of you and your passengers. Some of these radio features should not be used when driving because they take your eyes from the road or your attention from driving.

Clock Setting

- Turn the radio on, then touch the screen where the time is displayed.
- Touch the “USER CLOCK” soft-key (Navigation radio only).
- To adjust the hours, touch either the “HOUR FORWARD” or “HOUR BACKWARD” soft-key.
- To adjust the minutes, touch either the “MINUTE FORWARD” or “MINUTE BACKWARD” soft-key.
- To save the new time setting, touch the screen where the word “Save” is displayed.

Menu

- Press the “MENU” hard-key to access the System Setup menu and the My Files menu.
- Press the “MENU” hard-key in an active mode (SAT, CD, AUX, etc.) in order to change mode specific settings.

Equalizer, Balance And Fade

Audio Control Menu

- Press the “AUDIO” hard-key on the right side of the radio.
- Use either the arrow soft-keys or the cross-hair on the screen to change Balance and Fade. The “CENTER” soft-key resets the settings.



- Touch the “Equalizer” soft-key and use either the arrow soft-keys or the sliders on the screen to adjust BASS, MID, and/or TREBLE.

Display Settings

- Press the “MENU” hard-key and touch the “Display Settings” soft-key to access the Display Settings menu.
- Select the “Daytime Colors” soft-key to switch to manual daytime mode and to adjust the brightness of the display using daytime colors.

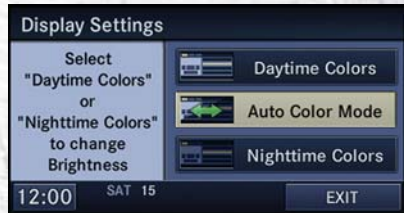

- Select the “Nighttime Colors” soft-key to switch to manual nighttime mode and to adjust the brightness of the display using nighttime colors.
- Select the “Auto Color Mode” soft-key to switch to automatic daytime/nighttime mode and to control the brightness of the display using the dimmer switch of the vehicle.
- Touch the “EXIT” soft-key to save your settings.

ELECTRONICS

Radio Operation

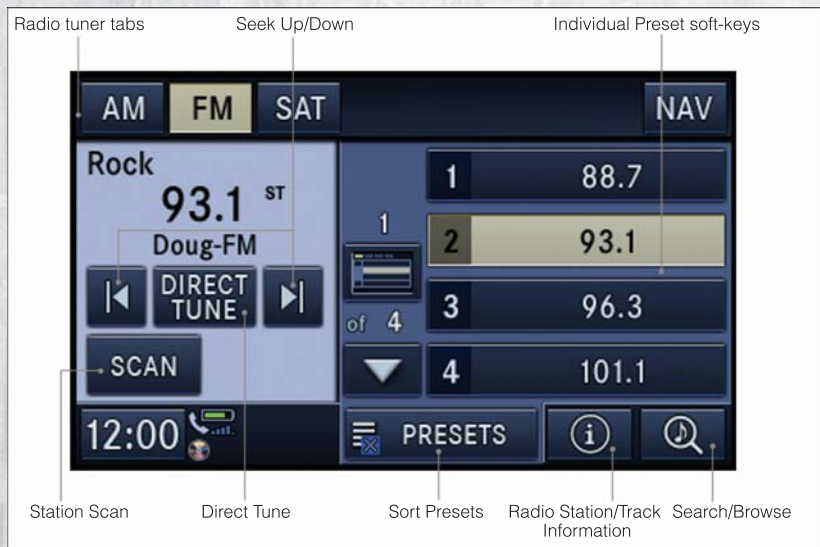

- To access Radio Mode, touch the “RADIO” hard-key on the left side of the faceplate, then touch the “AM,” “FM” or “SAT” soft-key at the top of the screen to select the band.

Seek Up/Seek Down

- Press the “Seek Up” or “Seek Down” soft-keys to seek through radio stations in AM, FM, or SAT bands. Hold either Seek to bypass stations without stopping.

Store Radio Presets

- Select the radio band by touching either the “AM,” “FM,” or “SAT” soft-key.
- Find the station to store by either pressing the “Seek Up” or “Seek Down” soft-keys, touching the “SCAN” soft-key, or by using the “DIRECT TUNE” soft-key.
- Once the station is found, touch and hold one of the “PRESET” soft-keys in the list to the right, until you hear a confirmation beep.

NOTE: If the Presets are not visible on the right side of the screen, press the “Presets” soft-key.

CD/DVD Disc Operation



- Press the “MEDIA” hard key to display the media source tabs at the top of the screen. Select the source by touching the “HDD,” “DISC,” or “AUX” media source soft-key tab.

NOTE: Your Touch-Screen Radio will usually automatically switch to the appropriate mode when something is first connected or inserted into the system.

Insert a CD/DVD Disc

- To insert a disc, press the “LOAD” hard-key.
- With the printed side upwards, insert the disc into the disc slot of the radio. The radio pulls the disc in automatically and closes the flip screen. The radio selects the appropriate mode after the disc is recognized, and starts playing the first track. The display shows “Reading...” during this process.

Seek Up/Seek Down

- Press the “Seek Up” or “Seek Down” soft-keys to seek through tracks in Disc Mode. Hold either Seek to bypass tracks without stopping.

Audio Jack Operation

- The Audio Jack allows a portable device, such as an MP3 player or a cassette player, to be plugged into the radio and utilize the vehicle’s audio system, using a 3.5 mm audio cable, to amplify the source and play through the vehicle speakers.
- Pressing the “MEDIA” hard-key and then the “AUX” soft-key to change the mode to auxiliary device if the Audio Jack is connected, allowing the music from your portable device to play through the vehicle’s speakers.

ELECTRONICS

- The functions of the portable device are controlled using the device buttons. The volume may be controlled using the radio or portable device.

Hard Disk Drive (HDD) Operation

- The Hard Disk Drive (HDD) mode gives you access to the audio files on the internal hard disk drive. It functions similar to a CD player, with the exception that the internal HDD can hold more tracks.
- It is also possible to import display pictures to the internal hard disk drive. The pictures can be displayed on the right half of the radio screen.
- Before using the HDD mode, you will need to copy songs and pictures to the internal hard drive. Songs and pictures can be added to the hard drive by using a CD or USB device (e.g. thumb drive or memory stick).

NOTE: WMA/MP3 Files and Selective Songs from a CD can also be added to the HDD. See the Media Center 430/430N User's Manual for more information.

Copying Music From CD

- Press the "LOAD" hard-key.
- Insert a disc, then press the "MENU" hard-key.
- Touch the "MY FILES" soft-key, then select "MY MUSIC."
- Touch the "Add Music Files to HDD" soft-key, then touch the "From Disc" soft-key in the next screen to start the process.



NOTE:

- You might need to select the folder or title depending on the CD, then press "DONE" to start the copy process.
- The copy progress is shown in the lower left corner of the screen.



Copying Music From USB

- The USB port on the radio face plate allows you to copy files to your hard drive. To access, lift up on the cover.
- Insert a USB device (e.g. thumb drive or memory stick), then select "MY MUSIC."
- Touch the "Add Music Files to HDD" soft-key, then touch the "From USB" soft-key in the next screen.

- Select the folders or titles you would like to copy, then touch the “DONE” soft-key to start the copy process.

NOTE: The copy progress is shown in the lower left corner of the screen.



Copying Pictures To The HDD

- Insert either a CD or a USB device containing your pictures in JPEG format.
- Press the “MY FILES” hard-key.
- Touch the “My Pictures” soft-key to get an overview of the currently stored images, then touch the “Add” soft-key.
- Touch the “From Disc” or “From USB” soft-key, then select the folders or pictures you wish to copy to the HDD. Use the “PAGE” soft-keys to page through the list of pictures.
- Touch the desired pictures or press the “All” soft-key for all pictures. Confirm your selections by touching the “SAVE” soft key.



NOTE: The copy progress is shown in the lower left corner of the screen.

Display a Picture on the Radio Screen

- Once the import is complete, the pictures will then be available in the “MY PICTURES” screen.
- Press the “MY FILES” hard-key, then touch the “My Pictures” soft-key. Touch the desired picture, then touch the “Set as Picture View” soft-key and then touch the “Exit” soft-key. Lastly press the “MENU” hard-key and then touch the “Picture View” soft-key to display the chosen picture on the radio screen.

NOTE:

- A check mark in the My Pictures screen indicates the currently used picture.
- You can also delete pictures by touching the “Delete” soft-key.

Playing Music From The HDD

- Press the “MEDIA” hard key to display the media source tabs at the top of the screen. Touch the “HDD” soft-key tab. Touch the desired track soft-key to play or touch the “SEARCH/BROWSE” soft-key to search by artist, by album, by song, by genre, from a folder, or from Favorites.



ELECTRONICS

Cleaning Your Touch-Screen Radio

- Do not spray any liquid or caustic chemicals directly on the screen. Use a clean and dry micro fiber lens cleaning cloth in order to clean the touch-screen.

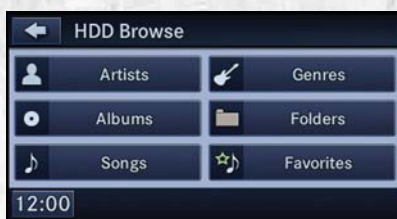

- If necessary, use a lint-free cloth dampened with a cleaning solution such as isopropyl alcohol or an isopropyl alcohol and water solution ratio of 50:50. Be sure to follow the solvent manufacturer's precautions and directions.

Garmin® Navigation

- Media Center 430N integrates Garmin's consumer-friendly navigation into your vehicle. Garmin Navigation includes a database with over 6 million points of interest.
- Touch the "NAV" soft-key in the upper right corner of the screen to access the Navigation system.

NOTE: For your own safety and the safety of others, it is not possible to use certain features while the vehicle is in motion.



Main Navigation Menu

Finding Points Of Interest

- From the main Navigation menu, touch "Where To?," then touch "Points of Interest."
- Select a Category and then a subcategory, if necessary.
- Select your destination and touch "Go."

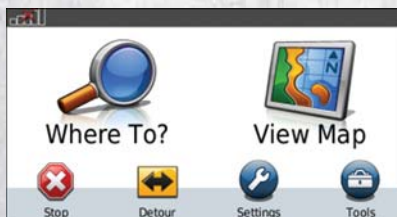

Finding A Place By Spelling The Name

- From the Main Navigation Menu, touch “Where to?,” then touch “Points of Interest” and then touch “Spell Name.”
- Enter the name of your destination.
- Touch “Done.”
- Select your destination and touch “Go.”

Entering A Destination Address

- From the main Navigation menu, touch “Where To?,” then touch “Address.”
- Follow the on-screen prompts to enter the address and touch “Go.”

Searching Near Another Location

- From the main Navigation menu, touch “Where To?,” then touch a destination and then touch “Near.”
- Select an option from the available choices.

Setting Your Home Location

- From the main Navigation menu, touch “Where To?,” then touch “Go Home.”
- You may enter your address directly, use your current location as your home address, or choose from recently found locations.

Edit Home Location

- From the main Navigation menu, touch “Where To?,” then touch “Favorites.”
- Next, touch the location you would like to edit, then touch “Press for More,” and then “Edit.”

Go Home

- A Home location must be saved in the system. From the Main Navigation menu, touch “Where To?,” then touch “Go Home.”

ELECTRONICS

Following Your Route



- Your route is marked with a magenta line on the map. If you depart from the original route, your route is recalculated. A speed limit icon could appear as you travel on major roadways.

Adding A Via Point

- To add a stop (Via Point) you must be navigating a route.
- Touch the “back arrow icon” to return to the Main Navigation menu.
- Touch “Where To?,” then search for the extra stop. Then select the stop to add from the search results.
- Touch “Go,” then touch “Add to Current Route.”

Taking A Detour

- To take a detour you must be navigating a route.
- Touch the “back arrow” icon to return to the Main Navigation menu.
- Touch “Detour.”

NOTE: If the route you are currently taking is the only reasonable option, the device might not calculate a detour.

Acquiring Satellites

- The GPS Satellite strength bars indicate the strength of your satellite reception.
- Acquiring satellite signals can take a few minutes. When at least one of the bars is green, your device has acquired satellite signals.
- You may experience delays in acquisition of satellite signals when in areas with an obstructed view to the sky, such as garages, tunnels, or large cities with tall buildings.

MEDIA CENTER 730N (SALES CODE RHR)

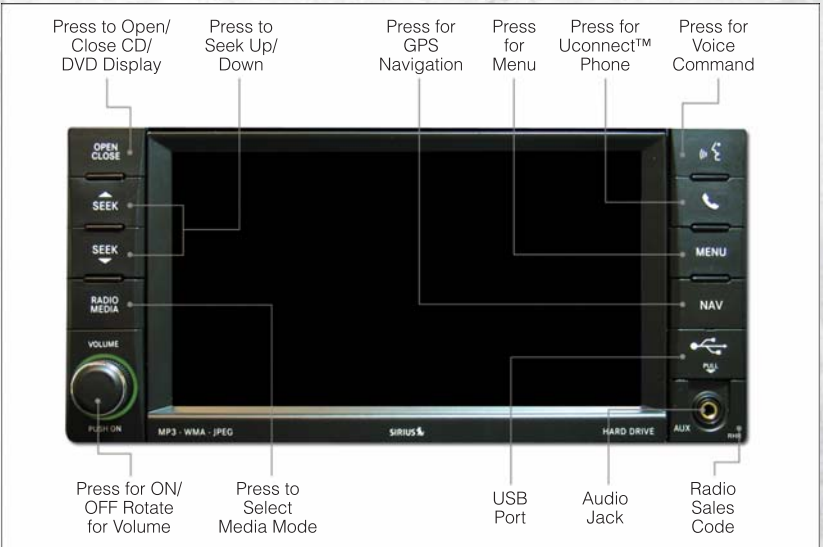

NOTE: Your radio may not be equipped with the Uconnect™ Voice Command and Uconnect™ Phone features. To determine if your radio has these features, press the Voice Command button on the radio. You will hear a voice prompt if you have the feature, or see a message on the radio stating “Uconnect Phone not available” if you do not.

- Your radio has many features that add to the comfort and convenience of you and your passengers. Some of these radio features should not be used when driving because they take your eyes from the road or your attention from driving.

ELECTRONICS

Clock Setting

- Turn the radio on, then touch the screen where the time is displayed.
- Touch the “USER CLOCK” soft-key.
- To adjust the hours, touch either the “HOUR FORWARD” or “HOUR BACKWARD” soft-key.
- To adjust the minutes, touch either the “MINUTE FORWARD” or “MINUTE BACKWARD” soft-key.
- To save the new time setting, touch the screen where the word “Save” is displayed.

Menu

- Press the “MENU” hard-key to access the System Setup menu and the My Files menu.
- Press the “MENU” hard-key in an active mode (SAT, CD, AUX, etc.) in order to change mode specific settings.

Equalizer, Balance And Fade

Audio Control Menu

- Press the “MENU” hard-key on the right side of the radio. Then press the “Audio Control” soft-key to get to the audio control menu.
- Use either the arrow soft-keys or the cross-hair on the screen to change Balance and Fade. The “CENTER” soft-key resets the settings.



- Touch the “Equalizer” soft-key and use either the arrow soft-keys or the sliders on the screen to adjust BASS, MID, and/or TREBLE.

Display Settings

- Press the “MENU” hard-key and touch the Display Settings soft-key to access the Display Settings menu.
- Select the “Daytime Colors” soft-key to switch to manual daytime mode and to adjust the brightness of the display using daytime colors.

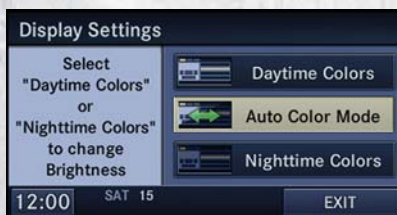

- Select the “Nighttime Colors” soft-key to switch to manual nighttime mode and to adjust the brightness of the display using nighttime colors.
- Select the “Auto Color Mode” soft-key to switch to automatic daytime/nighttime mode and to control the brightness of the display using the dimmer switch of the vehicle.
- Touch the “EXIT” soft-key to save your settings.

Radio Operation



- To access Radio Mode, touch the “RADIO/MEDIA” hard-key on the left side of the faceplate repeatedly until AM/FM/SAT appears at the top of the screen, then touch the “AM,” “FM” or “SAT” soft-key to select the band.

Seek Up/Seek Down

- Press the “Seek Up” or “Seek Down” hard-keys to seek through radio stations in AM, FM, or SAT bands. Hold either Seek to bypass stations without stopping.

Store Radio Presets

- Select the radio band by touching either the “AM,” “FM,” or “SAT” soft-key.
- Find the station to store by either pressing the “Seek Up” or “Seek Down” hard-keys, touching the “SCAN” soft-key, or by using the “DIRECT TUNE” soft-key.
- Once the station is found, touch and hold one of the PRESET soft-keys in the list to the right, until you hear a confirmation beep.

NOTE: If the Presets are not visible on the right side of the screen, press the “Presets” soft-key.

ELECTRONICS

CD/DVD Disc Operation



- Press the “RADIO/MEDIA” hard key until the media source tabs are displayed at the top of the screen. Select the source by touching the “HDD,” “DISC,” or “AUX” media source soft-key tab.

NOTE: Your Touch-Screen Radio will usually automatically switch to the appropriate mode when something is first connected or inserted into the system.

Insert a CD/DVD Disc

- To insert a disc, press the “OPEN/CLOSE” hard-key.
- With the printed side upwards, insert the disc into the disc slot of the radio. The radio pulls the disc in automatically and closes the flip screen. The radio selects the appropriate mode after the disc is recognized, and starts playing the first track. The display shows “Reading...” during this process.

Seek Up/Seek Down

- Press the “Seek Up” or “Seek Down” hard-keys to seek through tracks in Disc Mode. Hold either Seek to bypass tracks without stopping.

Audio Jack Operation

- The Audio Jack allows a portable device, such as an MP3 player or a cassette player, to be plugged into the radio and utilize the vehicle’s audio system, using a 3.5 mm audio cable, to amplify the source and play through the vehicle speakers.
- Pressing the “RADIO/MEDIA” hard-key and then the “AUX” soft-key to change the mode to auxiliary device if the Audio Jack is connected, allowing the music from your portable device to play through the vehicle’s speakers.

- The functions of the portable device are controlled using the device buttons. The volume may be controlled using the radio or portable device.

Hard Disk Drive (HDD) Operation

- The Hard Disk Drive (HDD) mode gives you access to the audio files on the internal hard disk drive. It functions similar to a CD player, with the exception that the internal HDD can hold more tracks.
- It is also possible to import display pictures to the internal hard disk drive. The pictures can be displayed on the right half of the radio screen.
- Before using the HDD mode, you will need to copy songs and pictures to the internal hard drive. Songs and pictures can be added to the hard drive by using a CD or USB device (e.g. thumb drive or memory stick).

NOTE: WMA/MP3 Files and Selective Songs from a CD can also be added to the HDD. See the Media Center 730N User's Manual for more information.

Copying Music From CD

- Press the "OPEN/CLOSE" hard-key.
- Insert a disc, then press the "MENU" hard-key.
- Touch the "MY FILES" soft-key, then select "MY MUSIC."
- Touch the "Add Music Files to HDD" soft-key, then touch the "From Disc" soft-key in the next screen to start the process.

NOTE:

- You might need to select the folder or title depending on the CD, then press "Done" to start the copy process.
- The copy progress is shown in the lower left corner of the screen.



ELECTRONICS

Copying Music From USB

- The USB port on the radio face plate allows you to copy files to your hard drive. To access, lift up on the cover.
- Insert a USB device (e.g. thumb drive or memory stick), then select “MY FILES”.
- Touch the “MY MUSIC” soft-key, then touch the “Add Music Files” to HDD soft-key.



- Touch “From USB” soft-key, then select the folders or titles you would like to copy, and then touch the “SAVE” soft-key to start the copy process.

NOTE: The copy progress is shown in the lower left corner of the screen.

Copying Pictures To The HDD

- Insert either a CD or a USB device containing your pictures in JPEG format.
- Press the “MENU” hard-key to access the Settings Menu, then touch the “My Files” soft-key.
- Touch the “My Pictures” soft-key to get an overview of the currently stored images, then touch the “Add” soft-key.
- Touch the “From Disc” or “From USB” soft-key, then select the folders or pictures you wish to copy to the HDD. Use the “PAGE” soft-keys to page through the list of pictures.
- Touch the desired pictures or press the “All” soft-key for all pictures. Confirm your selections by touching the “SAVE” soft key.



NOTE: The copy progress is shown in the lower left corner of the screen.

Display a Picture on the Radio Screen

- Once the import is complete, the pictures will then be available in the “MY PICTURES” screen.

ELECTRONICS

- Press the “MENU” hard-key to access the Settings Menu, then touch the “My Files” soft-key and then touch the “My Pictures” soft-key. Touch the desired picture, then touch the “Set as Picture View” soft-key and then touch the “Exit” soft-key. Lastly press the “MENU” hard-key and then touch the “Picture View” soft-key to display the chosen picture on the radio screen.

NOTE:

- A check mark in the My Pictures screen indicates the currently used picture.
- You can also delete pictures by touching the “Delete” soft-key.

Playing Music From The HDD

- Press the “RADIO/MEDIA” hard key until the media source tabs are displayed at the top of the screen. Touch the “HDD” soft-key tab. Touch the desired track soft-key to play or touch the “SEARCH/BROWSE” soft-key to search by artist, by album, by song, by genre, from a folder, or from Favorites.

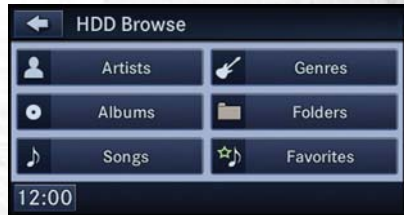

Cleaning Your Touch-Screen Radio

- Do not spray any liquid or caustic chemicals directly on the screen. Use a clean and dry micro fiber lens cleaning cloth in order to clean the touch-screen.
- If necessary, use a lint-free cloth dampened with a cleaning solution such as isopropyl alcohol or an isopropyl alcohol and water solution ratio of 50:50. Be sure to follow the solvent manufacturer's precautions and directions.

NAVIGATION

- Your navigation system receives GPS signals from up to 16 satellites to display the position of your vehicle. Map and database information is supplied through a hard disk drive.
- Touch the “NAV” hard-key on the radio face plate to access the Navigation system and the NAV – Main Menu.

ELECTRONICS

NOTE: For your own safety and the safety of others, it is not possible to use certain features while the vehicle is in motion.



Main Navigation Menu

Program a new destination	Route to a destination you programmed before	Search destination by Point of Interest	Enter or select a favorite Point of Interest
Program or save trips with multiple destinations	Route to your Home destination	Search Points of Interest near the current vehicle position	View the map
			Route to a nearby emergency facility

Finding Points Of Interest

- From the NAV main menu, touch the “Points of Interest” soft-key.
- Select a Category and then a subcategory, if necessary.
- Select your destination and touch “GO.”

Finding A Place By Entering The Street Address

- From the NAV main menu, touch “New Destination,” then touch “Street Address.”

NOTE: If the wrong State and/or Country displayed are incorrect, touch the corresponding soft-key to make the correction.

- Once the Country and State are set and the Street Address screen is displayed, begin spelling the street name in the speller. In the upper right corner the number of possible roads decreases.

- Touch the “LIST” soft-key to display a list of possible street names. Select the correct street name.
- Next input the number.
- In the Confirm Route screen the navigation radio displays the complete address, a map of the destination area, and the current routing method for you to verify.
- Touch the “GO” soft-key to activate the route guidance.

Entering Your Home Location

- Press the “NAV” hard-key on the right side of the radio.
- From the Nav – Main Menu, touch “Guide Me Home” to enter your home address. If no home address has been set, touch “YES” to access the Enter Home Address menu.
- Touch “Street Address” to enter your address. Touch the soft-key with your state’s name and enter your street name into the speller.
- Once the street name has been input, touch “CONTINUE” to confirm. Enter the house number into the next screen. If more than one city has this address, you will then need to select your city from a list.
- Once the address is entered completely, the system shows a map of your home address area. Touch “SAVE” to confirm the address. The system will then ask if you want to go there, yes or no.

Change Home Address

- This procedure will allow you to change your Home Address if one has already been entered.
- Press the “MENU” hard-key, touch “My Files” and then touch “My Address Book.”
- Touch “Home,” then touch “Edit Contacts” and then “Change Address.”
- Touch the soft-key with your state’s name and enter your street name into the speller.
- Once the street name has been input, touch “CONTINUE” to confirm.
- Enter the house number into the next screen. If more than one city has this address, you will then need to select your city from a list.
- Touch the “SAVE” soft-key to confirm the address.

Go Home

- From the NAV main menu, touch “Guide Me Home” when you want to route to your home destination.

Where Am I Now?

- From the NAV main menu, touch “Where Am I Now?.” The Where Am I Now? menu displays location information for the current vehicle position.
- Touch the “NEARBY POI” soft-key to search for a local Point of Interest.
- Touch the “SAVE LOCATION” soft-key to save the current location in the Saved Locations memory.

ELECTRONICS

Route Guidance

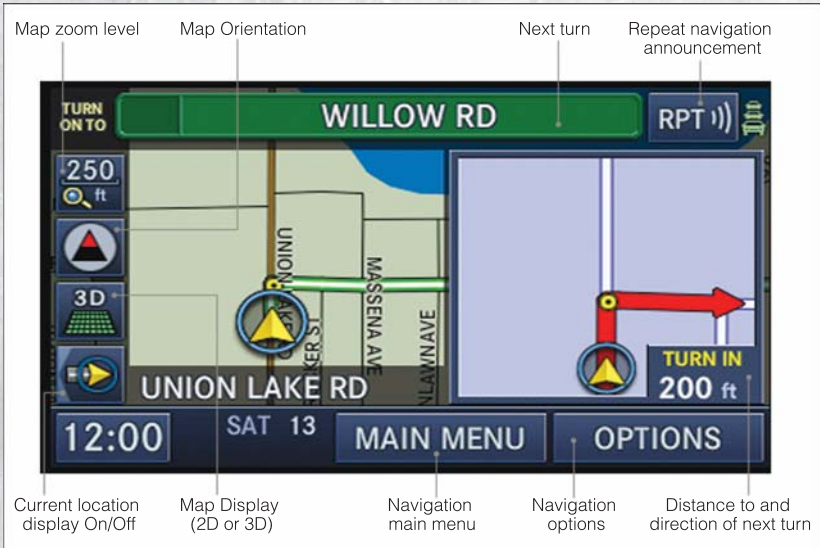

- After starting route guidance, the system calculates the route and announces: “Follow the arrows on the display.” You will receive navigation recommendations by voice messages and screen displays.

Route Options

- After pressing the “OPTIONS” soft-key in the Route Guidance Menu, the following information is displayed:
 - In the left half of the screen, the current position and the current routing method are displayed.
 - “Take Detour” will allow you to calculate a different route.
 - “Find Nearby POI” to search for a local POI.
 - “Destination Info” displays destination information.
 - “View Turn List” lists streets utilized for the current route.
 - “Save Destination” to save the destination address.
 - “Change Method” will allow you to change the routing method.

SIRIUS XM™ SATELLITE RADIO/TRAVEL LINK

- The following describes features that are available when in Sirius XM™ Satellite Radio mode.
- To access Sirius XM™ Satellite Radio, press the “RADIO/MEDIA” or “RADIO” and then touch the “SAT” soft-key tab.

Info

- Touch the “i” soft-key to view detailed information about the current Sirius XM™ Satellite channel.

Sirius XM™ Parental Controls

- Sirius XM™ offers the option to permanently block selected channels. Call 1-888-539-7474 and request the Family Package.
- Media Center 430/430N and 730N: Press the “MENU” hard-key while in Sirius XM™ Satellite Radio Mode, then touch the “Channel Lock” to enable and/or disable desired channels. The SEEK and SCAN function will then only display channels without Channel lock.

Search/Browse

- Touch the “magnifying glass” soft-key to search/browse the Sirius XM™ channel listing by Favorites and Categories such as Song, Artist and Channel Name. The Search/Browse also allows you manage your Favorites.

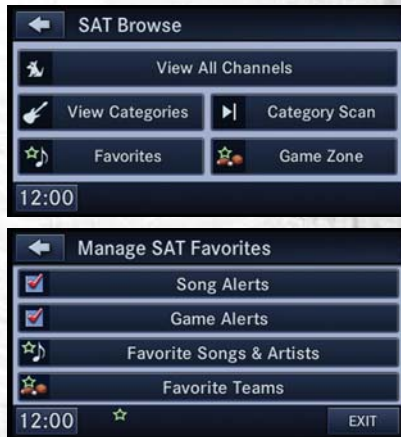

Sirius XM™ Satellite Radio Favorites (SAT Favorites)

- You can save 50 favorite songs and 50 favorite artists.
- Touch the “add favorite” soft-key to add either the song or the artist of the currently playing program to the SAT Favorites list.

ELECTRONICS

- You will see a favorite star indicator in the lower left side of the screen and a pop up will alert you that a favorite song or artist is currently playing on one of the Sirius XM™ satellite radio channels.

NOTE: Refer to your Media Center 730N or Media Center 430/430N User's Manual for more information.



Display SAT Favorites List

- Touch the "Search/Browse" soft-key and select "Favorites" from the SAT Browse screen.
- Touch the desired favorites soft-key to switch the SAT tuner to the corresponding channel.

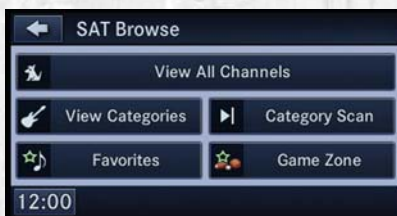

- You may use the "LIST" soft-key to toggle between:
 - Favorite Songs.
 - Favorite Artists.
 - Currently playing favorites.



Replay

- While you are in SAT mode, you can replay 44 minutes of the current Sirius XM™ channel (when the channel is changed, this audio buffer is erased). Press the REPLAY button to listen to the stored audio.



- You can touch the on-screen controls to pause and rewind audio playback, touch the SCAN button to preview each of the tracks stored in the buffer, or select a track from the list.
- The time displayed below the bar indicates how much time is present between the current buffer play position and the live broadcast.

ELECTRONICS

Replay Option	Option Description
Play/Pause	Touch to Pause content playback. Touch Pause/Play again to resume playback.
Rewind/RW	Rewinds the channel content in steps of 5 seconds. Touch and hold to rewind continuously, then release to begin playing content at that point.
Fast Forward/FW	Forwards the content, and works similarly to Rewind/RW. However, Fast Forward/FW can only be used when content has been previously rewound.
Replay Time	Displays the amount of time in the upper center of the screen by which your content lags the Live channel.
Live	Resumes playback of Live content at any time while replaying rewound content.

Sirius Travel Link (Media Center 730N (RHR) & Media Center 430N (RHB) Only)

- Sirius Travel Link brings a wealth of useful information into your vehicle and right to your fingertips.
- To access Travel Link, press the MENU hard-key, then the Travel Link soft-key.

NOTE:

- Sirius Travel Link requires a subscription, sold separately after the 1 year trial subscription included with your vehicle purchase.
- Sirius Travel Link is only available in the United States.



1 – Favorites	View and store your favorite location, theater and sport teams for quick access.
2 – Forecast	View detailed weather conditions, forecasts and ski/snowboarding conditions at local resorts.
3 – Ski Info	View ski and snowboarding conditions at local ski resorts.
4 – Fuel Prices	View detailed price information for fuel stations near your current location.
5 – Movies	View information on movies that are playing at theaters near your current location.
6 – Sports	View sports scores and upcoming events for all major sports.

ELECTRONICS

STEERING WHEEL AUDIO CONTROLS

- The steering wheel audio controls are located on the rear surface of the steering wheel.

Right Switch

- Press the switch up or down to increase or decrease the volume.
- Press the button in the center to change modes AM/FM/CD/SAT.



Left Switch

- Press the switch up or down to search for the next listenable station or select the next or previous CD track.
- Press the button in the center to select the next preset station (radio) or to change CDs if equipped with a CD Changer.

iPOD®/USB/MP3 CONTROL

- There are many ways to play music from iPod®/MP3 players or USB devices through your vehicle's sound system.
- The remote USB port, located within the upper glove box, allows you to plug an iPod® into the vehicle's sound system.



NOTE: If equipped with the Media Center 730N (RHR), the USB port on the faceplate allows the same functions as the remote USB port.

- Non-Touch-Screen Radios: To hear audio from devices connected to the USB port, press the "AUX" button on the radio faceplate
- Touch-Screen Radios: To hear audio from devices connected to the USB port, press the "MEDIA" hard-key, then touch the "AUX" or "iPod®" soft-key.

- When connected to this feature:
- The iPod® can be controlled using the radio buttons to Play, Browse, and List the iPod® or external devices contents.
- The iPod® battery charges when plugged into the USB port (if supported by the specific audio device).
- Compatible iPod® devices may also be controllable using voice commands. Refer to the Owner's Manual on the DVD for details.



NOTE:

- The USB port supports certain Mini, Classic, Nano, Touch, and iPhone® devices. The USB port also supports playing music from compatible external USB Mass Storage Class memory devices. For supported audio file formats, refer to the USB Port section in the Owner's Manual on the DVD. Refer to www.dodge.com/uconnect website for a list of tested iPod®s. Some iPod® software versions may not fully support the USB port features. Please visit Apple's website for iPod® software updates.

WARNING!

Do not plug in or remove the iPod® or external device while driving. Failure to follow this warning could result in a collision.

UCONNECT™ PHONE

- To determine if your vehicle is equipped with Uconnect™ Phone, press the "Uconnect™ Phone" button . If your vehicle has this feature, after a couple seconds you will hear a voice prompt. If not, you will see a message on the radio "Uconnect phone not available".
- The Uconnect™ Phone is a voice-activated, hands-free, in-vehicle communications system with Voice Command Capability (see Voice Command section).

NOTE: To access the tutorial, press the "Uconnect™ Phone" button . After the BEEP, say "tutorial". Press any hard-key/button or touch the display (Touch-Screen radio) to cancel the tutorial.

- The Uconnect™ Phone allows you to dial a phone number with your mobile phone using simple voice commands.
- Refer to your vehicle Owner's Manual on the DVD for further details.

NOTE: The Uconnect™ Phone requires a mobile phone equipped with the Bluetooth® Hands-Free Profile, Version 1.0 or higher. For Uconnect™ customer support, call 1-877-855-8400 or visit www.UconnectPhone.com.

ELECTRONICS

Phone Pairing

NOTE: Pairing is a one-time initial setup before using the phone.

- Press the “Phone” button  to begin.
- Wait for the “ready” prompt and BEEP.
- (After the BEEP), say “setup” or “Uconnect device setup”.
- (After the BEEP), say “device pairing”.
- (After the BEEP), say “pair a device”.
- Follow the audible prompts.
- You will be asked to say a four-digit Personal Identification Number (PIN), which you will later need to enter into your mobile phone. You can say any four-digit PIN. You will not need to remember this PIN after the initial pairing process.
- You will then be prompted to give the phone pairing a name (each phone paired should have a unique name).
- Next you will be asked to give this new pairing a priority of 1 thru 7 (up to seven phones may be paired); 1 is the highest and 7 is the lowest priority. The system will only connect to the highest priority phone that exists within the proximity of the vehicle.
- You will then need to start the pairing procedure on your cell phone. Follow the Bluetooth® instructions in your cell phone Owner's Manual to complete the phone pairing setup.



Phonebook

Phonebook Download – Automatic Phonebook Transfer From Mobile Phone

If equipped and specifically supported by your phone, Uconnect™ Phone automatically downloads names (text names) and number entries from your mobile phone's phonebook. Specific Bluetooth® Phones with Phone Book Access Profile may support this feature. Automatic Transfer is indicated by a green arrow at the bottom of the screen. See Uconnect™ website for supported phones.



- Automatic download and update, if supported, begins as soon as the Bluetooth® wireless phone connection is made to the Uconnect™ Phone, for example, after you start the vehicle.
- A maximum of 1000 entries per phone will be downloaded and updated every time a phone is connected to the Uconnect™ Phone.

- Depending on the maximum number of entries downloaded, there may be a short delay before the latest downloaded names can be used. Until then, if available, the previously downloaded phonebook is available for use.
- Only the phonebook of the currently connected mobile phone is accessible.
- Only the mobile phone's phonebook is downloaded. SIM card phonebook is not part of the Mobile phonebook.
- This downloaded phonebook cannot be edited or deleted on the Uconnect™ Phone. These can only be edited on the mobile phone. The changes are transferred and updated to Uconnect™ Phone on the next phone connection.



Phonebook Edit

- Press the "Phone" button .
- (After the BEEP), say "phonebook".
- (After the BEEP), say "new entry" or "list names" or "delete".
- Follow the prompts.

Making A Phone Call

- Press the "Phone" button .
- (After the BEEP), say "dial" (or "call" a name).
- (After the BEEP), say number (or name).

Receiving A Call – Accept (And End)

- When an incoming call rings/is announced on Uconnect™, press the Phone button .
- To end a call, press the Phone button .

Mute (Or Unmute) Microphone During Call

- During a call, press the "Voice Command" button  VR .
- (After the BEEP), say "mute" (or "mute off").

Transfer Ongoing Call Between Handset And Vehicle

- During a call, press the "Voice Command" button  VR .
- (After the BEEP), say "transfer call".

Changing The Volume



- Start a dialogue by pressing the "Phone" button , then adjust the volume during a normal call.
- Use the radio ON/OFF VOLUME rotary knob to adjust the volume to a comfortable level while the Uconnect™ system is speaking. Please note the volume setting for Uconnect™ is different than the audio system.

ELECTRONICS

WARNING!

- Any voice commanded system should be used only in safe driving conditions following local laws and phone use. All attention should be kept on the roadway ahead. Failure to do so may result in a collision causing you and others to be severely injured or killed.
- In an emergency, to use Uconnect™ Phone, your mobile phone must be:
 - turned on,
 - paired to Uconnect™ Phone,
 - and have network coverage.

UCONNECT™ VOICE COMMAND

- The Uconnect™ Voice Command system allows you to control your AM, FM radio, satellite radio, disc player, HDD, Uconnect™ Phone, a memo recorder, and supported portable media devices.
- When you press the “Voice Command” button  VR located on the radio faceplate or steering wheel, you will hear a beep. The beep is your signal to give a command. If you do not say a command within a few seconds, the system will present you with a list of options. If you ever wish to interrupt the system while it lists options, press the “Voice Command” button  VR, listen for the BEEP, and say your command.



Voice Command Operation

- Start a dialogue by pressing the “Voice Command” button  VR, you will hear a beep. The beep is your signal to give a command. Below are a list of voice commands for each of the different modes.





Common Voice Commands (Examples)

Main Menu	“Radio” (to switch to the radio mode) “Disc” (to switch to the disc mode) “Memo” (to switch to the memo recorder) “System Setup” (to switch to system setup)
Radio Mode	“Frequency” (to change the frequency) “Next Station” (to select the next station) “Previous Station” (to select the previous station) “Radio Menu” (to switch to the radio menu) “Main Menu” (to switch to the main menu)

Sirius XM™ Satellite Radio Mode	<p>“Channel Number” (to change the channel by its spoken number)</p> <p>“Next Channel” (to select the next channel)</p> <p>“Previous Channel” (to select the previous channel)</p> <p>“List Channel” (to hear a list of available channels)</p> <p>“Select Name” (to say the name of a channel)</p> <p>“Radio Menu” (to switch to the radio menu)</p> <p>“Main Menu” (to switch to the main menu)</p>
Disc Mode	<p>“Track” (#) (to change the track)</p> <p>“Next Track” (to play the next track)</p> <p>“Previous Track” (to play the previous track)</p> <p>“Main Menu” (to switch to the main menu)</p>
Memo Mode	<p>To switch to the voice recorder mode, say “Memo”. The following are common voice commands for this mode:</p> <p>“New Memo” (to record a new memo) — During the recording, you may press the Voice Command button  VR to stop recording. You proceed by saying one of the following commands:</p> <ul style="list-style-type: none"> — “Save” (to save the memo) — “Continue” (to continue recording) — “Delete” (to delete the recording) — “Play Memos” (to play previously recorded memos) — During the playback you may press the Voice Command button  VR to stop playing memos. You proceed by saying one of the following commands: <ul style="list-style-type: none"> — “Repeat” (to repeat a memo) — “Next” (to play the next memo) — “Previous” (to play the previous memo) — “Delete” (to delete a memo) — “Delete All” (to delete all memos)

SMS (Text Messaging)

- If equipped with Uconnect™ Voice Command, your Media Center 430N & 730N radios may be able to play incoming Short Message Service (SMS) messages (text messages) through the vehicle's sound system.
- It also allows you to respond by selecting from various pre-defined phrases.
- Not all phones are compatible with this feature. Refer to the phone compatibility list at www.UconnectPhone.com. Connected mobile phones must be bluetooth-compatible, and paired with your radio.
- Press the “Voice Command” button  VR and after the BEEP, say “SMS” to get started.

NOTE: To access the tutorial, press the “Voice Command” button  VR. After the BEEP, say “tutorial”. Press any hard-key/button or touch the display (Touch-Screen radio) to cancel the tutorial.

ELECTRONICS

WARNING!

Any voice commanded system should be used only in safe driving conditions following local laws and phone use. All attention should be kept on the roadway ahead. Failure to do so may result in a collision causing you and others to be severely injured or killed.

BLUETOOTH® STREAMING AUDIO



- If equipped with Uconnect™ Voice Command, your Bluetooth-equipped iPod® devices, cell phones or other media players, may also be able to stream music to your vehicle's speakers. Your connected device must be Bluetooth-compatible, and paired with your Media Center radio (see Uconnect™ Phone for pairing instructions). Non-Touch-Screen Radios: Press the "AUX" button on the radio faceplate until "BT" or "Audio Streaming" is displayed on the radio screen. Touch-Screen-Radios: Press the "RADIO/MEDIA" or "MEDIA" hard-key and then touch the "AUX" soft-key tab.

VIDEO ENTERTAINMENT SYSTEM (VES)™

System Operation

- The screen is located in the overhead compartment console. To lower the screen, press the release button located in the center of the console rear of the screen.
- The system may be controlled by the front seat occupants using either the radio or DVD player controls, or by the rear seat occupants using the remote control.
- The video screen displays information in a split screen format. The left side of the screen is referred to as Channel 1 and the right side of the screen is referred to as Channel 2. All modes except video modes are displayed in a split screen format.
- To use the headphones, press the power button located on the right ear cup. Select the channel on the headphones (1 or 2) which corresponds to the channel selected on the desired video screen.

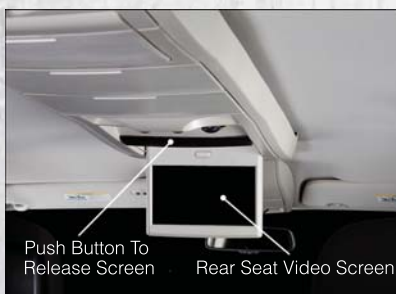

- To receive VES™ audio through the vehicle's sound system, press the VES™ soft-key on the radio's touch-screen.

Operation Of The Touch-Screen Radio/DVD Player

- To view a DVD press the OPEN/CLOSE or LOAD hard-key on the touch-screen radio and insert the disc or insert the disc into the optional DVD player. Playback will begin automatically after the DVD is recognized by the disc drive. If playback does not begin automatically when the disc is inserted into the DVD player press the PLAY button. If playback does not begin automatically after the disc is inserted into the touch-screen radio follow these steps:
 - Press the MENU hard-key, then touch the Rear VES™ soft-key. If a chapter list appears on the right side of the screen, touch the HIDE LIST soft-key to display the Rear VES™ control screen.
 - Touch the 1 soft key to select an audio channel, then touch the DISC soft-key in the MEDIA column.

Operation Of The Remote Control

- The remote control operates similarly to any DVD remote you may have used before and allows the rear seat passengers to change stations, tracks, discs and audio/video modes.
- The remote control is designed to control either channel by using the selector switch located on the right side of the remote.
- Connect the video game or other external media devices to the AUX jacks following the color coding for the VES™ jacks.
- Pressing the power button will turn the VES™ system ON/OFF.
- Pressing the mode button causes the MODE SELECTION menu to appear on the VES™ screen. Use the remote control arrow buttons to scroll through the available modes, and then press ENTER to select the desired mode.

Auxiliary Audio/Video Input Jacks

- The AUX jacks are located on the drivers side rear trim panel behind the sliding door.
- Connect the video game or other external media devices to the AUX jacks following the color coding for the VES™ jacks.
- Using either the touch-screen radio or remote control, select AUX from the REAR VES™ CONTROL or the MODE SELECTION screen.
- Refer to the Uconnect™ Multimedia – Video Entertainment System (VES)™ section in the vehicle Owner's Manual on the DVD for further details.

ELECTRONICS

ELECTRONIC VEHICLE INFORMATION CENTER (EVIC)

- The EVIC features a driver interactive display that is located in the instrument cluster. Pressing the controls on the left side of the steering wheel allows the driver to select vehicle information and Personal Settings. For additional information, refer to Programmable Features in this guide.



- Press and release the UP Δ button to scroll upward through the main menus (Fuel Economy, Vehicle Info, Tire PSI, Cruise, Messages, Units, System Setup) and sub menus.
- Press and release the DOWN ∇ button to scroll downward through the main menus and sub menus.
- Press and release the SELECT \triangleright button for access to main menus, sub menus or to select a personal setting in the setup menu.
- Press the BACK button to scroll back to a previous menu or sub menu.

Compass Calibration

- This compass is self-calibrating, which eliminates the need to set the compass manually. When the vehicle is new, the compass may appear erratic and the EVIC will display "CAL" until the compass is calibrated.
- You may also calibrate the compass by completing one or more 360 degree turns (in an area free from large metal or metallic objects) until the "CAL" message displayed in the EVIC turns off. The compass will now function normally.

PROGRAMMABLE FEATURES

Electronic Vehicle Information Center (EVIC)

- The EVIC can be used to program the following Personal Settings. Press and release the MENU button until Personal Settings displays, then press the DOWN button ▾ to scroll through the settings. Press the SELECT button ▷ to change the setting.
 - Language
 - Nav-Turn By Turn
 - Enable/Disable the Rear Park Assist System
 - Auto Unlock Doors
 - Remote Unlock Sequence
 - RKE Linked To Memory
 - Remote Start Comfort Sys.
 - Horn With Remote Lock
 - Flash Lamps With Lock
 - Headlamp Off Delay
 - Headlamps with Wipers (Available with Auto Headlights Only)
 - Intermittent Wiper Option
 - Rain Sensing Wipers
 - Key-Off Power Delay
 - Illuminated Approach
 - Flashers with Sliding Door
 - Hill Start Assist (HSA)
 - Easy Exit Seat
 - Tilt Mirror In Reverse
 - Blind Spot Alert
 - Calibrate Compass
 - Compass Variance
 - Turn Menu Off

Key Fob Programmable Features

- The following features may also be programmed by using the Key Fob transmitter or the ignition switch and driver's door lock switch.

NOTE: Pressing the LOCK button while you are inside the vehicle will activate the Vehicle Security Alarm. Opening a door with the Vehicle Security Alarm activated will cause the alarm to sound. Press the UNLOCK button to deactivate the Vehicle Security Alarm.

Unlock On First Press

- To unlock either the driver's side, or all doors, on the first press of the UNLOCK button:
 - Press and hold the LOCK button for at least 4 seconds, but no longer than 10 seconds. Then, press and hold the UNLOCK button while still holding the LOCK button.
 - Release both buttons at the same time.

Auto Unlock Doors On Exit

- To have all of the vehicle doors unlock when any door is opened:
 - Enter your vehicle and close all the doors.
 - Cycle the ignition switch between LOCK and ON and then back to LOCK four times, ending up in the LOCK position (do not start the engine).
 - Press the power door UNLOCK switch to unlock the doors. A single chime will indicate that programming is complete.

ELECTRONICS

Sound Horn With Lock

- To turn the horn chirp on or off when the doors are locked:
- Press the LOCK button for at least 4 seconds, but no longer than 10 seconds. Then, press the PANIC button while still holding the LOCK button.
- Release both buttons at the same time.

Flashing Lights With Lock

- The turn signal lights flashing, when the doors are locked or unlocked, feature can be turned on or off. To turn this feature on or off:
- Press and hold the UNLOCK button for at least 4 seconds, but no longer than 10 seconds. Then, press and hold the LOCK button while still holding the UNLOCK button.
- Release both buttons at the same time.

UNIVERSAL GARAGE DOOR OPENER

(HOMELINK®)

- HomeLink® replaces up to three hand-held transmitters that operate devices such as garage door openers, motorized gates, lighting or home security systems. The HomeLink® unit is powered by your vehicles 12 Volt battery.
- The HomeLink® buttons that are located in the overhead console or sunvisor designate the three different HomeLink® channels.
- The HomeLink® indicator is located above the center button.

Before You Begin Programming HomeLink®

- Be sure that your vehicle is parked outside of the garage before you begin programming.
- For more efficient programming and accurate transmission of the radio-frequency signal it is recommended that a new battery be placed in the hand-held transmitter of the device that is being programmed to the HomeLink® system.
- Erase all channels before you begin programming. To erase the channels, place the ignition switch into the ON/RUN position, then press and hold the two outside HomeLink® buttons (I and III) for up 20 seconds or until the red indicator flashes.



NOTE:

- Erasing all channels should only be performed when programming HomeLink® for the first time. Do not erase channels when programming additional buttons.
- If you have any problems, or require assistance, please call toll-free 1-800-355-3515 or, on the Internet at www.HomeLink.com for information or assistance.

Programming A Rolling Code

- For programming Garage Door Openers that were manufactured after 1995. These Garage Door Openers can be identified by the “LEARN” or “TRAIN” button located where the hanging antenna is attached to the Garage Door Opener. It is NOT the button that is normally used to open and close the door. The name and color of the button may vary by manufacturer.
- Place the ignition switch into the ON/RUN position.
- Place the hand-held transmitter 1 to 3 inches (3 to 8 cm) away from the HomeLink® button you wish to program while keeping the HomeLink® indicator light in view.
- Simultaneously press and hold both the HomeLink® button you want to program and the hand-held transmitter button.
- Continue to hold both buttons and observe the indicator light. The Homelink® indicator will flash slowly and then rapidly after Homelink® has received the frequency signal from the hand-held transmitter. Release both buttons after the indicator light changes from slow to rapid.
- At the garage door opener motor (in the garage), locate the “LEARN” or “TRAINING” button. This can usually be found where the hanging antenna wire is attached to the garage door opener motor. Firmly press and release the “LEARN” or “TRAINING” button.

NOTE: You have 30 seconds in which to initiate the next step after the LEARN button has been pressed.

- Return to the vehicle and press the programmed HomeLink® button twice (holding the button for two seconds each time). If the device is plugged in and activates, programming is complete.

NOTE: If the device does not activate, press the button a third time (for two seconds) to complete the training.

- To program the remaining two HomeLink® buttons, repeat each step for each remaining button. DO NOT erase the channels.

Programming A Non-Rolling Code

- For programming Garage Door Openers manufactured before 1995.
- Turn the ignition switch to the ON/RUN position.
- Place the hand-held transmitter 1 to 3 inches (3 to 8 cm) away from the HomeLink® button you wish to program while keeping the HomeLink® indicator light in view.
- Simultaneously press and hold both the HomeLink® button you want to program and the hand-held transmitter button.
- Continue to hold both buttons and observe the indicator light. The Homelink® indicator will flash slowly and then rapidly after Homelink® has received the frequency signal from the hand-held transmitter. Release both buttons after the indicator light changes from slow to rapid.
- Press and hold the programmed HomeLink® button and observe the indicator light.

ELECTRONICS

NOTE:

- If the indicator light stays on constantly, programming is complete and the garage door (or device) should activate when the HomeLink® button is pressed.
- To program the two remaining HomeLink® buttons, repeat each step for each remaining button. DO NOT erase the channels.

Using HomeLink®

- To operate, press and release the programmed HomeLink® button. Activation will now occur for the programmed device (i.e., garage door opener, gate operator, security system, entry door lock, home/office lighting, etc.,). The hand-held transmitter of the device may also be used at any time.

WARNING!

- Your motorized door or gate will open and close while you are programming the universal transceiver. Do not program the transceiver if people or pets are in the path of the door or gate.
- Do not run your vehicle in a closed garage or confined area while programming the transceiver. Exhaust gas from your vehicle contains Carbon Monoxide (CO) which is odorless and colorless. Carbon Monoxide is poisonous when inhaled and can cause you and others to be severely injured or killed.

POWER INVERTER

- There is a 115 Volt, 150 Watt power inverter outlet located on the left rear trim panel immediately behind the second row left passenger seat. This outlet can power cellular phones, electronics and other low power devices requiring power up to 150 Watts.
- Press the switch located in the center of the instrument panel to turn the power to the outlet on.
- Press the switch again to turn the power off.
- The status indicator of the AC power inverter indicates whether the inverter is producing AC power.



ELECTRONICS

NOTE: The power inverter is designed with built-in overload protection. If the power rating of 150 Watts is exceeded, the power inverter will automatically shut down. Once the electrical device has been removed from the outlet, the inverter should automatically reset. If the power rating exceeds approximately 170 Watts, the power inverter may have to be reset manually. To reset the inverter manually, unplug the device and plug it in again. To avoid overloading the circuit, check the power ratings on electrical devices prior to using the inverter.

WARNING!

To Avoid Serious Injury or Death: Do not use a three-prong adaptor. Do not insert any objects into the receptacles. Do not touch with wet hands. Close the lid when not in use. If this outlet is mishandled, it may cause an electric shock and failure.

POWER OUTLETS

- Two 12 Volt (13 Amp) power outlets are located on the lower instrument panel, below the open storage bin. The driver-side power outlet is controlled by the ignition switch and the passenger-side power outlet is connected directly to the battery. The driver-side power outlet will also operate a conventional cigar lighter unit (if equipped with an optional Smoker's Package).



- One outlet in the removable floor console (if equipped) shares a fuse with the lower outlet in the instrument panel and is also connected to the battery. Do not exceed a maximum power of 160 Watts (13 Amps) shared between the lower panel outlet and the removable floor console outlet.
- On vehicles equipped with the Super Console the power outlets are located under the retractable cover. To access the power outlets push down on the cover and slide it toward the instrument panel.
- The outlet in the rear quarter panel near the liftgate and the upper outlet in the instrument panel are both controlled by the ignition switch. Each of these outlets can support 160 Watts (13 Amps). Do not exceed 160 Watts (13 Amps) for each of these outlets.

ELECTRONICS

NOTE:

- Do not exceed the maximum power of 160 Watts (13 Amps) at 12 Volts. If the 160 Watt (13 Amp) power rating is exceeded, the fuse protecting the system will need to be replaced.
- Power outlets are designed for accessory plugs only. Do not insert any other object in the power outlet as this will damage the outlet and blow the fuse. Improper use of the power outlet can cause damage not covered by your new vehicle warranty.



M7 Fuse 20 Amp
Yellow – Power Outlet
Left of Second Row
Passenger Seat

M6 Fuse 20 Amp
Yellow – Cigar
Lighter/Power Outlet
Instrument Panel

M36 Fuse 20 Amp
Yellow – Power Outlet
Instrument Panel & in
Console – If Equipped

IN-FLOOR STORAGE – STOW 'N GO®

Second Row Seat Storage Bins

- Storage bins are located in the floor in front of the second row seats that can be used when the second row seat is in the upright position. Pull up on the storage bin latch to open the cover. Slide the storage bin locking mechanism to the "Lock" position to allow greater access to the storage bin.

Cargo Area Storage

- The liftgate sill plate has a raised line with the statement "Load To This Line". This line indicates how far rearward cargo can be placed without interfering with liftgate closing.

WARNING!

In a collision, serious injury could result if the seat storage bin covers are not properly latched. Do not drive the vehicle with the storage bin covers open. Keep the storage bin covers closed and latched while the vehicle is in motion. Do not use a storage bin latch as a tie down.

ROOF LUGGAGE RACK

- The crossbars on your vehicle are delivered stowed within the roof rack side rails. When installed, the roof rack can hold a maximum of 150 lbs (68 kg) of evenly distributed weight.

Installing The Crossbars

- To install the crossbars, completely loosen the thumb screws at both ends and lift the crossbar from its stowed position.
- Bend the pivot points at each end of the crossbar and slide the thumb screw down.
- Set the crossbars into position and tighten the thumb screws.

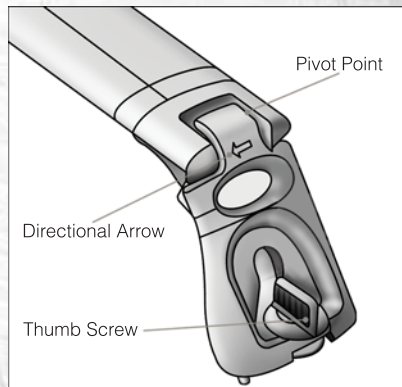

NOTE: Make sure the directional arrow on the crossbar aligns with the directional arrow on the side rail.

- Refer to the Owner's Manual on the DVD for further details.

TRAILER TOWING WEIGHTS (MAXIMUM TRAILER WEIGHT RATINGS)

Engine/Transmission	GCWR (Gross Combined Wt. Rating)	Frontal Area	Max. GTW (Gross Trailer Wt.)	Max. Tongue Wt.
3.6L/Automatic	8,750 lbs (3 969 kg)	40 sq ft (3.72 sq m)	Up to 2 persons & Luggage 3,600 lbs (1 633 kg)*	360 lbs (163 kg)
	8,750 lbs (3 969 kg)	40 sq ft (3.72 sq m)	3 to 5 persons & Luggage 3,350 lbs (1 519 kg)*	335 lbs (152 kg)
	8,750 lbs (3 969 kg)	40 sq ft (3.72 sq m)	6 to 7 persons & Luggage 3,000 lbs (1 360 kg)*	300 lbs (136 kg)

* For vehicles equipped with Fold-in-Floor seating, the Gross Trailer Weight must be reduced by 100 lbs (45 kg). Refer to local laws for maximum trailer towing speeds.

NOTE: The trailer tongue weight must be considered as part of the combined weight of occupants and cargo, and should never exceed the weight referenced on the Tire and Loading Information placard.

RECREATIONAL TOWING (BEHIND MOTORHOME, ETC.)

NOTE: If the vehicle requires towing, make sure all four wheels are off the ground.

CAUTION!

Towing this vehicle behind another vehicle (flat-towing with all four wheels on the ground) is not recommended.

WHAT TO DO IN EMERGENCIES

24-HOUR TOWING ASSISTANCE

- Dial toll-free 1-800-521-2779 or 1-800-363-4869 for Canadian residents.
- Provide your name, vehicle identification number and license plate number.
- Provide your location, including telephone number, from which you are calling.
- Briefly describe the nature of the problem and answer a few simple questions.
- You will be given the name of the service provider and an estimated time of arrival. If you feel you are in an "unsafe situation", please let us know. With your consent, we will contact local police or safety authorities.

INSTRUMENT CLUSTER WARNING LIGHTS

- Electronic Stability Control (ESC) Indicator Light

- If this indicator light flashes during acceleration, apply as little throttle as possible. While driving, ease up on the accelerator. Adapt your speed and driving to the prevailing road conditions. To improve the vehicle's traction when starting off in deep snow, sand or gravel, it may be desirable to switch the ESC system off.

- Tire Pressure Monitoring System (TPMS) Light

- Each tire, including the spare (if provided), should be checked monthly, when cold and inflated to the inflation pressure recommended by the vehicle manufacturer on the vehicle placard or tire inflation pressure label. (If your vehicle has tires of a different size than the size indicated on the vehicle placard or tire inflation pressure label, you should determine the proper tire inflation pressure for those tires.)
- As an added safety feature, your vehicle has been equipped with a Tire Pressure Monitoring System (TPMS) that illuminates a low tire pressure telltale when one or more of your tires is significantly under-inflated. Accordingly, when the low tire pressure telltale illuminates, you should stop and check your tires as soon as possible, and inflate them to the proper pressure. Driving on a significantly under-inflated tire causes the tire to overheat and can lead to tire failure. Under-inflation also reduces fuel efficiency and tire tread life, and may affect the vehicle's handling and stopping ability.
- **IF THE LIGHT STARTS FLASHING INDICATING A LOW TIRE PRESSURE, ADJUST THE AIR PRESSURE IN THE LOW TIRE TO THE AIR PRESSURE SHOWN ON THE VEHICLE PLACARD OR TIRE INFLATION PRESSURE LABEL LOCATED ON THE DRIVER'S DOOR. NOTE: AFTER INFLATION, THE VEHICLE MAY NEED TO BE DRIVEN FOR 20 MINUTES BEFORE THE FLASHING LIGHT WILL TURN OFF.**
- Please note that the TPMS is not a substitute for proper tire maintenance, and it is the driver's responsibility to maintain correct tire pressure, even if under-inflation has not reached the level to trigger illumination of the TPMS low tire pressure telltale.

WHAT TO DO IN EMERGENCIES

- Your vehicle has also been equipped with a TPMS malfunction indicator to indicate when the system is not operating properly. The TPMS malfunction indicator is combined with the low tire pressure telltale. When the system detects a malfunction, the telltale will flash for approximately one minute and then remain continuously illuminated. This sequence will continue each time the vehicle is restarted as long as the malfunction exists.
- When the malfunction indicator is illuminated, the system may not be able to detect or signal low tire pressure as intended. TPMS malfunctions may occur for a variety of reasons, including the installation of replacement or alternate tires or wheels on the vehicle that prevent the TPMS from functioning properly. Always check the TPMS malfunction telltale after replacing one or more tires or wheels on your vehicle, to ensure that the replacement or alternate tires and wheels allow the TPMS to continue to function properly.

NOTE: Tire pressures change by approximately 1 psi (7 kPa) per 12° F (7° C) of air temperature change. Keep this in mind when checking tire pressure inside a garage, especially in the Winter. Example: If garage temperature is 68°F (20°C) and the outside temperature is 32°F (0°C), then the cold tire inflation pressure should be increased by 3 psi (21 kPa), which equals 1 psi (7 kPa) for every 12°F (7°C) for this outside temperature condition.

CAUTION!

The TPMS has been optimized for the original equipment tires and wheels. TPMS pressures and warning have been established for the tire size equipped on your vehicle. Undesirable system operation or sensor damage may result when using replacement equipment that is not of the same size, type, and/or style. Aftermarket wheels can cause sensor damage. Do not use tire sealant from a can, or balance beads if your vehicle is equipped with a TPMS, as damage to the sensors may result.

- Engine Temperature Warning Light

- This light warns of an overheated engine condition.
- If the light turns on or flashes continuously while driving, safely pull over and stop the vehicle. If the A/C system is on, turn it off. Also, shift the transmission into NEUTRAL and idle the vehicle. If the temperature reading does not return to normal, turn the engine off immediately and call for service.
- We recommend that you do not operate the vehicle or engine damage will occur. Have the vehicle serviced immediately.

WARNING!

A hot engine cooling system is dangerous. You or others could be badly burned by steam or boiling coolant. You may want to call an authorized service center for service if your vehicle overheats.

WHAT TO DO IN EMERGENCIES

BRAKE - Brake Warning Light

- The Brake Warning light illuminates when there is either a system malfunction or the parking brake is applied. If the light is on and the parking brake is not applied, it indicates a possible brake hydraulic malfunction, brake booster problem or an Anti-Lock Brake System problem.
- Please have your vehicle serviced immediately.

WARNING!

Driving a vehicle with the red brake light on is dangerous. Part of the brake system may have failed. It will take longer to stop the vehicle. You could have a collision. Have the vehicle checked immediately.

- Malfunction Indicator Light (MIL)

- Certain conditions, such as a loose or missing gas cap, poor fuel quality, etc., may illuminate the MIL after engine start. The vehicle should be serviced if the light stays on through several typical driving cycles. In most situations, the vehicle will drive normally and not require towing.
- If the MIL flashes when the engine is running, serious conditions may exist that could lead to immediate loss of power or severe catalytic converter damage. We recommend you do not operate the vehicle. Have the vehicle serviced immediately.

- Electronic Stability Control (ESC) Indicator Light/Brake Assist System (BAS) Warning Light

- If the ESC/BAS warning light comes on continuously with the engine running, a malfunction has been detected.
- If this light remains on after several ignition cycles, and the vehicle has been driven several miles (kilometers) at speeds greater than 30 mph (48 km/h), we recommend you drive to the nearest service center and have the vehicle serviced immediately.

- Charging System Light

- This light shows the status of the electrical charging system. If the charging system light remains on, it means that the vehicle is experiencing a problem with the charging system.
- We recommend you do not continue driving if the charging system light is on. Have the vehicle serviced immediately.

- Oil Pressure Warning Light

- This light indicates low engine oil pressure. If the light turns on while driving, stop the vehicle and shut off the engine as soon as possible. A chime will sound for four minutes when this light turns on.
- We recommend you do not operate the vehicle or engine damage will occur. Have the vehicle serviced immediately.

WHAT TO DO IN EMERGENCIES

- Anti-Lock Brake (ABS) Light

- This light monitors the Anti-Lock Brake System (ABS).
- If the light is not on during starting, stays on, or turns on while driving, we recommend you drive to the nearest service center and have the vehicle serviced immediately.

- Electronic Throttle Control (ETC) Light

- This light informs you of a problem with the Electronic Throttle Control (ETC) system.
- If a problem is detected, the light will come on while the engine is running. Cycle the ignition when the vehicle has completely stopped and the shift lever is placed in the PARK position; the light should turn off.
- If the light remains lit with the engine running, your vehicle will usually be drivable; however, see an authorized service center immediately. If the light is flashing when the engine is running, immediate service is required and you may experience reduced performance, an elevated/rough idle or engine stall and your vehicle may require towing.

- Air Bag Warning Light

- If the light is not on during starting, stays on, or turns on while driving, have the vehicle serviced by an authorized service center immediately.

Fuel Cap/Loose Gas Cap Message

- If a “gas cap” message (shown as gASCAP) appears, tighten the gas cap until a “clicking” sound is heard.
- Press the odometer reset button to turn the message off.
- If the message continues to appear for more than three days after tightening the gas cap, see your authorized service center.

Oil Change Indicator Message

- If an “oil change” message (shown as CHAnGE OIL) appears and a single chime sounds, it is time for your next required oil change.

Resetting The Light After Servicing Vehicles Equipped With Keyless Enter-N-Go

- Without pressing the brake pedal, push the ENGINE START/STOP button and cycle the ignition to the ON/RUN position (Do not start the engine.)
- Fully depress the accelerator pedal, slowly, three times within 10 seconds.
- Without pressing the brake pedal, push the ENGINE START/STOP button once to return the ignition to the OFF/LOCK position.

Vehicles Not Equipped With Keyless Enter-N-Go

- Turn the ignition switch to the ON/RUN position (Do not start the engine.)
- Fully depress the accelerator pedal, slowly, three times within 10 seconds.
- Turn the ignition switch to the OFF/LOCK position.

WHAT TO DO IN EMERGENCIES

IF YOUR ENGINE OVERHEATS

- In any of the following situations, you can reduce the potential for overheating by taking the appropriate action.
- On the highways — slow down.
- In city traffic — while stopped, place the transmission in NEUTRAL, but do not increase engine idle speed.

NOTE: There are steps that you can take to slow down an impending overheat condition:

- If your air conditioner (A/C) is on, turn it off. The A/C system adds heat to the engine cooling system and turning the A/C off can help remove this heat.
- You can also turn the temperature control to maximum heat, the mode control to floor and the blower control to high. This allows the heater core to act as a supplement to the radiator and aids in removing heat from the engine cooling system.

CAUTION!

Driving with a hot cooling system could damage your vehicle. If the temperature gauge reads 240°F (116 °C) or greater pull over and stop the vehicle. Idle the vehicle with the air conditioner turned off until the pointer drops back into the normal range 200–230°F (93–110°C). If the pointer remains at 240°F (116°C) or greater and you hear a chime, turn the engine off immediately and call for service.

WARNING!

You or others can be badly burned by hot engine coolant (antifreeze) or steam from your radiator. If you see or hear steam coming from under the hood, do not open the hood until the radiator has had time to cool. Never try to open a cooling system pressure cap when the radiator or coolant bottle is hot.

WHAT TO DO IN EMERGENCIES

JACKING AND TIRE CHANGING

Jack Location

- The jack, jack handle and winch handle tools are stowed behind the rear left side trim panel in the rear cargo area. Turn the two cover latches to release the cover.
- Remove the pouch containing the scissors jack, jack handle, and tools.

Spare Tire Removal

- The spare tire is stowed inside a protective cover located under the center of the vehicle between the front doors by means of a cable winch mechanism. The “spare tire drive” nut is located on the floor, under a plastic cap at the front of the floor console or under front super console forward bin liner.



To Access Spare Tire Winch Drive Nut

- To access the spare tire winch drive nut and lower the spare tire, you will need to refer to one of the following center console configurations.

Super Console

- For vehicles equipped with the Super Console, the spare tire winch assembly drive nut is located beneath the console.



WHAT TO DO IN EMERGENCIES

1. Pull the lower drawer out from the rear of the floor console.
2. Open the front drawer to expose the storage compartment.



3. Remove the liner from the console's storage compartment to access the spare tire winch drive nut.



Premium/Base/Cargo Center Console

- Pull the Winch Cover assembly plug (if equipped) to access the winch drive nut.

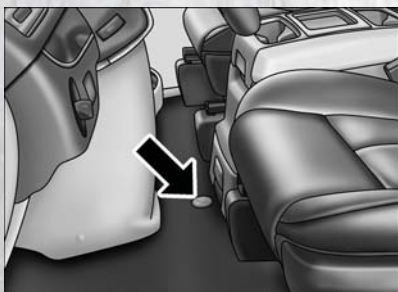

WHAT TO DO IN EMERGENCIES

Spare Tire Tools

- The tool pouch contains three pieces and can be assembled into a spare tire hook; to remove the compact spare tire/cover assembly from under the vehicle, or a Winch T-handle; to raise/lower the compact spare tire/cover assembly.

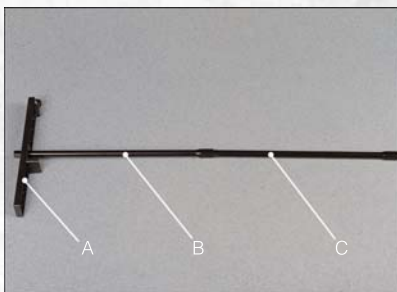

- A — Spare Tire Hook/T-handle
B — Extension 1
C — Extension 2

Assembled T-handle

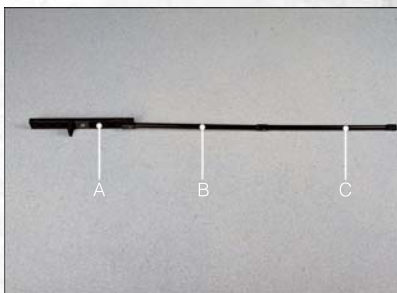

- A — Spare Tire Hook/T-handle
B — Extension 1
C — Extension 2

Assembling The Spare Tire Hook

WHAT TO DO IN EMERGENCIES

Spare Tire Removal Instructions

- The spare tire is located under the vehicle beneath the center console area.

1. Assemble the spare tire tools into a T-handle and place the square end over the spare tire winch drive nut.
2. Rotate the nut to the left until the winch mechanism stops turning freely. This will allow enough slack in the cable to allow you to pull the spare tire out from underneath the vehicle.
3. Assemble the winch handle extensions to form the spare tire hook, and pull the spare tire from under the vehicle.



NOTE: If either front tire is flat it may be necessary to jack up the vehicle to remove the compact spare tire/cover assembly from under the vehicle.



4. Stand the tire/cover assembly upright and remove the wheel spacer by squeezing the winch retaining tabs together. Push the retainer through the spare tire to release it from the wheel.

Preparations For Jacking

1. Park the vehicle on a firm, level surface. Avoid ice or slippery areas.
2. Turn on the Hazard Warning flasher.
3. Set the parking brake.
4. Place the shift lever into PARK.
5. Turn OFF the ignition.



WHAT TO DO IN EMERGENCIES

NOTE: Passengers should not remain in the vehicle when the vehicle is being jacked.

- Block both the front and rear of the wheel diagonally opposite the jacking position. For example, if changing the right front tire, block the left rear wheel.

Jacking Instructions

1. Loosen (but do not remove) the wheel lug nuts by turning them to the left one turn while the wheel is still on the ground.
2. There are two jack engagement locations on each side of the vehicle body. These locations are on the sill flange of the vehicle body.

Rear jack locations are between a pair of down-facing tabs on the sill flange of the vehicle side body.

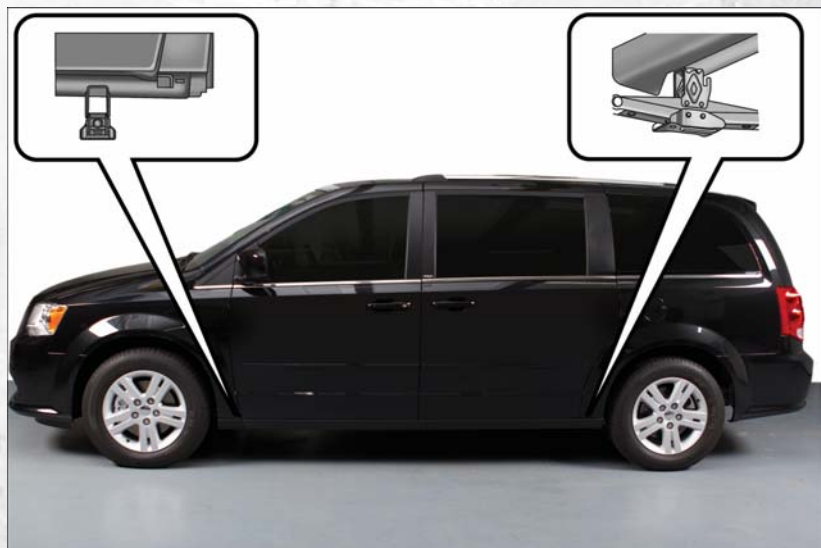
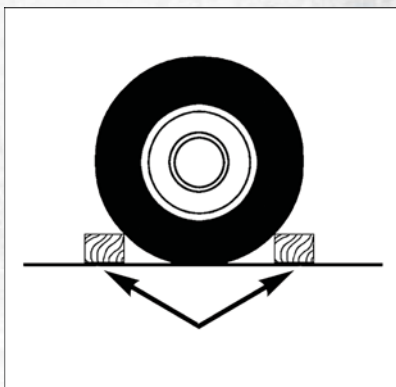

WHAT TO DO IN EMERGENCIES

Front jack location is on the sill flange of the vehicle body and is located 6 in (150 mm) from door edge.

NOTE: In some situations the jack may need to be placed on its side in order to be pushed under the vehicle. Return the jack to its correct orientation once it is under the vehicle.

3. Place the wrench on the jack screw and turn to the right until the jack head is properly engaged in the described location. **Do not raise the vehicle until you are sure the jack is securely engaged.**
4. Raise the vehicle by turning the jack screw to the right, using the swivel wrench. Raise the vehicle only until the tire just clears the surface and enough clearance is obtained to install the spare tire. Minimum tire lift provides maximum stability.

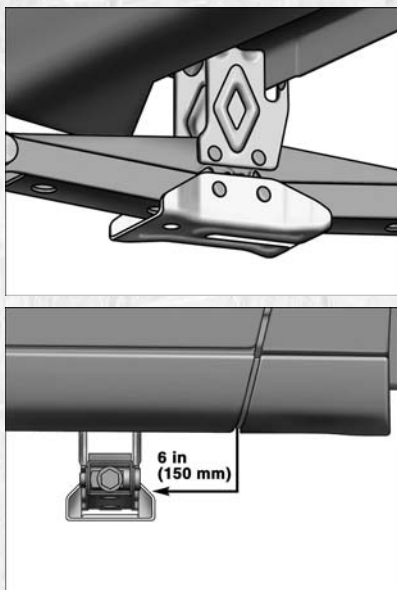

5. Remove the wheel lug nuts, for vehicles with wheel covers, remove the cover from the wheel by hand. Do not pry the wheel cover off. Then pull the wheel off the hub.
6. Install the compact spare tire. Lightly tighten the lug nuts.

NOTE:

- Do not install the wheel cover on the compact spare.
 - Do not use a hammer or force to install the wheel covers.
7. Lower the vehicle by turning the jack screw to the left.



8. Finish tightening the lug nuts. Push down on the wrench while at the end of the handle for increased leverage. Tighten the lug nuts in a star pattern until each nut has been tightened twice. The correct wheel nut tightness is 102 ft lbs (138 N-m). If in doubt about the correct tightness, have them checked with a torque wrench by your authorized dealer or at a service station.
9. Lower the jack to its fully-closed position.

WHAT TO DO IN EMERGENCIES

10. Place the deflated (flat) tire and compact spare tire cover assembly in the rear cargo area. **Do not stow the deflated tire in the spare tire location.** Have the full-sized tire repaired or replaced, as soon as possible.
11. Stow the cable and wheel spacer before driving the vehicle. Reassemble the winch handle extensions to form a “T” and fit the winch T-handle over the drive nut. Rotate the nut to the right until the winch mechanism clicks at least three times.

NOTE: Refer to the “Spare Tire Tools” section for instructions on assembling the T-handle.

12. Stow the jack, jack handle and winch handle tools back in the stowage compartment.
13. Check the compact spare tire pressure as soon as possible. Correct the tire pressure, as required.

Securing The Spare Tire

1. Assemble the winch handle extensions to form a T-handle and fit the winch T-handle over the drive nut. Rotate the nut to the left until the winch mechanism stops turning freely. This will allow enough slack in the cable to allow you to pull the wheel spacer out from under the vehicle.
2. Assemble the winch handle extensions to form the spare tire hook, and pull the wheel spacer from under the vehicle.
3. Turn the compact spare tire so that the valve stem is down, and place the tire into the spare tire/cover assembly. Slide the wheel spacer through the center of the wheel and spare tire/cover assembly, so that the two retainer tabs snap out and engage the spare tire cover on the opposite side.
4. Using the winch T-handle, rotate the drive nut to the right until the compact spare tire/cover assembly is drawn into place against the underside of the vehicle.
5. Continue to rotate the nut to the right until you hear the winch mechanism click three times. It cannot be overtightened. Check under the vehicle to ensure the compact spare tire/cover assembly is positioned correctly against the underside of the vehicle.

WHAT TO DO IN EMERGENCIES

Road Tire Installation

Vehicles Equipped With Wheel Covers

1. Mount the road tire on the axle.
2. To ease the installation process for steel wheels with wheel covers, install two lug nuts on the mounting studs which are on each side of the valve stem. Install the lug nuts with the cone shaped end of the nut toward the wheel. Lightly tighten the lug nuts.
3. Align the valve notch in the wheel cover with the valve stem on the wheel. Install the cover by hand, snapping the cover over the two lug nuts. Do not use a hammer or excessive force to install the cover.
4. Install the remaining lug nuts with the cone shaped end of the nut toward the wheel. Lightly tighten the lug nuts.
5. Lower the vehicle to the ground by turning the jack handle counterclockwise.

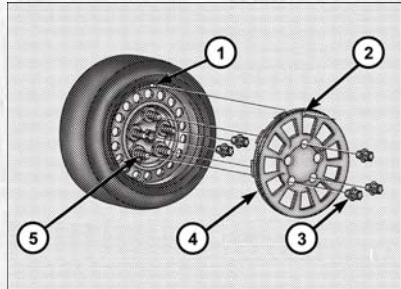

1 — Valve Stem 4 — Wheel Cover
2 — Valve Notch 5 — Mounting
 Stud
3 — Wheel Lug
Nut

6. Finish tightening the lug nuts. Push down on the wrench while at the end of the handle for increased leverage. Tighten the lug nuts in a star pattern until each nut has been tightened twice. The correct tightness of each lug nut is 102 ft/lbs (138 N·m). If in doubt about the correct tightness, have them checked with a torque wrench by your authorized dealer or service station.
7. After 25 miles (40 km) check the lug nut torque with a torque wrench to ensure that all lug nuts are properly seated against the wheel.

Vehicles Without Wheel Covers

1. Mount the road tire on the axle.
2. Install the remaining lug nuts with the cone shaped end of the nut toward the wheel. Lightly tighten the lug nuts.
3. Lower the vehicle to the ground by turning the jack handle counterclockwise.
4. Finish tightening the lug nuts. Push down on the wrench while at the end of the handle for increased leverage. Tighten the lug nuts in a star pattern until each nut has been tightened twice. The correct tightness of each lug nut is 102 ft/lbs (138 N·m). If in doubt about the correct tightness, have them checked with a torque wrench by your authorized dealer or service station.
5. After 25 miles (40 km) check the lug nut torque with a torque wrench to ensure that all lug nuts are properly seated against the wheel.

WHAT TO DO IN EMERGENCIES

CAUTION!

- The winch mechanism is designed for use with the winch T-handle only. Use of an air wrench or other power tools is not recommended and can damage the winch.
- Do not attempt to raise the vehicle by jacking on locations other than those indicated in the Jacking Instructions for this vehicle.
- Be sure to mount the spare tire with the valve stem facing outward. The vehicle could be damaged if the spare tire is mounted incorrectly.
- The compact spare tire/cover assembly must be used when the compact spare tire is stored. Failure to use this cover could drastically reduce the life of the compact spare tire.
- The winch mechanism is designed specifically to stow a compact spare tire only. Do not attempt to use the winch to stow the full size flat tire, or any other full-size tire. Vehicle damage may result.

WARNING!

- Do not attempt to change a tire on the side of the vehicle close to moving traffic. Pull far enough off the road to avoid the danger of being hit when operating the jack or changing the wheel.
- Being under a jacked-up vehicle is dangerous. The vehicle could slip off the jack and fall on you. You could be crushed. Never put any part of your body under a vehicle that is on a jack. If you need to get under a raised vehicle, take it to a service center where it can be raised on a lift.
- Never start or run the engine while the vehicle is on a jack.
- The jack is designed to be used as a tool for changing tires only. The jack should not be used to lift the vehicle for service purposes. The vehicle should be jacked on a firm level surface only. Avoid ice or slippery areas.
- Carefully follow these tire changing warnings to help prevent personal injury or damage to your vehicle:
- Always park on a firm, level surface as far from the edge of the roadway as possible before raising the vehicle.
- Turn on the Hazard Warning flasher.
- Block the wheel diagonally opposite the wheel to be raised.
- Set the parking brake firmly and set an automatic transmission in PARK; a manual transmission in REVERSE.
- Never start or run the engine with the vehicle on a jack.
- Do not let anyone sit in the vehicle when it is on a jack.
- Do not get under the vehicle when it is on a jack.
- Only use the jack in the positions indicated and for lifting this vehicle during a tire change.

(Continued)

WHAT TO DO IN EMERGENCIES

WARNING! *(Continued)*

- If working on or near a roadway, be extremely careful of motor traffic.
- To assure that spare tires, flat or inflated, are securely stowed, spares must be stowed with the valve stem facing the ground.
- Raising the vehicle higher than necessary can make the vehicle less stable. It could slip off the jack and hurt someone near it. Raise the vehicle only enough to remove the tire.
- To avoid the risk of forcing the vehicle off the jack, do not tighten the wheel nuts fully until the vehicle has been lowered. Failure to follow this warning may result in personal injury.
- A loose tire or jack thrown forward in a collision or hard stop could endanger the occupants of the vehicle. Always stow the jack parts and the spare tire in the places provided. Have the deflated (flat) tire repaired or replaced immediately.
- Verify that both retainer tabs of the wheel spacer have been properly extended through the center of the wheel and spare tire/cover assembly. Failure to properly engage both retainer tabs could result in loss of the spare tire and cover assembly, which will cause vehicle damage and may cause loss of vehicle control.

JUMP-STARTING

- If your vehicle has a discharged battery it can be jump-started using a set of jumper cables and a battery in another vehicle or by using a portable battery booster pack.
- Jump-starting can be dangerous if done improperly so please follow the procedures in this section carefully.

NOTE: When using a portable battery booster pack follow the manufacturer's operating instructions and precautions.



Preparations for Jump-Start

- The battery in your vehicle is located on the left side of the engine compartment.
- Set the parking brake, shift the automatic transmission into PARK and turn the ignition to LOCK.
- Turn off the heater, radio, and all unnecessary electrical accessories.
- If using another vehicle to jump-start the battery, park the vehicle within the jumper cables reach, set the parking brake and make sure the ignition is OFF.

WHAT TO DO IN EMERGENCIES

Jump-Starting Procedure

- Connect the positive (+) end of the jumper cable to the positive (+) post of the discharged vehicle.
- Connect the opposite end of the positive (+) jumper cable to the positive (+) post of the booster battery.
- Connect the negative end (-) of the jumper cable to the negative (-) post of the booster battery.
- Connect the opposite end of the negative (-) jumper cable to a good engine ground (exposed metal part of the discharged vehicle's engine) away from the battery and fuel injection system.
- Start the engine in the vehicle that has the booster battery, let the engine idle a few minutes, and then start the engine in the vehicle with the discharged battery. Once the engine is started, remove the jumper cables in the reverse sequence:
- Disconnect the negative (-) jumper cable from the negative (-) post of the vehicle with the discharged battery.
- Disconnect the negative end (-) of the jumper cable from the negative (-) post of the booster battery.
- Disconnect the opposite end of the positive (+) jumper cable from the positive (+) post of the booster battery.
- Disconnect the positive (+) end of the jumper cable from the positive (+) post of the discharged vehicle.
- If frequent jump-starting is required to start your vehicle you should have the battery and charging system inspected at your authorized dealer.

CAUTION!

- Do not use a portable battery booster pack or any other booster source with a system voltage greater than 12 Volts or damage to the battery, starter motor, alternator or electrical system may occur.
- Failure to follow these procedures could result in damage to the charging system of the booster vehicle or the discharged vehicle.
- Accessories that can be plugged into the vehicle power outlets draw power from the vehicle's battery, even when not in use (i.e., cellular phones, etc.). Eventually, if plugged in long enough, the vehicle's battery will discharge sufficiently to degrade battery life and/or prevent the engine from starting.

WARNING!

- When temperatures are below the freezing point, electrolyte in a discharged battery may freeze. Do not attempt jump-starting because the battery could rupture or explode and cause personal injury. Battery temperature must be brought above freezing point before attempting a jump-start.

(Continued)

WHAT TO DO IN EMERGENCIES

WARNING! *(Continued)*

- Take care to avoid the radiator cooling fan whenever the hood is raised. It can start anytime the ignition switch is on. You can be injured by moving fan blades.
- Remove any metal jewelry, such as watch bands or bracelets, that might make an inadvertent electrical contact. You could be severely injured.
- Batteries contain sulfuric acid that can burn your skin or eyes and generate hydrogen gas which is flammable and explosive. Keep open flames or sparks away from the battery.
- Do not allow vehicles to touch each other as this could establish a ground connection and personal injury could result.
- Failure to follow this procedure could result in personal injury or property damage due to battery explosion.
- Do not connect the cable to the negative post (-) of the discharged battery. The resulting electrical spark could cause the battery to explode and could result in personal injury.

SHIFT LEVER OVERRIDE

- If a malfunction occurs and the shift lever cannot be moved out of the PARK position, you can use the following procedure to temporarily move the shift lever:
 - To access the shift lever override, remove the cover located to the top right of the shift lever in the instrument panel.
 - Firmly set the parking brake.
 - Turn the ignition switch to the ACC or ON position without starting the engine.
 - Press and maintain firm pressure on the brake pedal.
 - The override can be activated by pressing the white-colored tab, which can be accessed through the hole in the instrument panel.
 - Move the shift lever into the NEUTRAL position.
 - The vehicle may then be started in NEUTRAL.
 - Reinstall the override cover.



WHAT TO DO IN EMERGENCIES

TOWING A DISABLED VEHICLE

Towing Condition	Wheels OFF the Ground	ALL MODELS
Flat Tow	NONE	If transmission is operable: • Transmission in NEUTRAL • 25 mph (40 km/h) max speed • 15 miles (24 km) max distance
Wheel lift	Rear	OK
Flatbed	Front ALL	BEST METHOD

WHAT TO DO IN EMERGENCIES

FREEING A STUCK VEHICLE

- If your vehicle becomes stuck in mud, sand or snow, it can often be moved by a rocking motion. Turn your steering wheel right and left to clear the area around the front wheels. Then, move the shift lever back and forth between REVERSE and DRIVE. Using minimal accelerator pedal pressure to maintain the rocking motion, without spinning the wheels, is most effective.

NOTE: If your vehicle is equipped with Electronic Stability Control (ESC) or Traction Control , turn the system off before attempting to “rock” the vehicle.

CAUTION!

- When “rocking” a stuck vehicle by moving between REVERSE and DRIVE, do not spin the wheels faster than 15 mph (24 km/h), or drivetrain damage may result.
- Revving the engine or spinning the wheels too fast may lead to transmission overheating and failure. It can also damage the tires. Do not spin the wheels above 30 mph (48 km/h) while in gear (no transmission shifting occurring).

WARNING!

Fast spinning tires can be dangerous. Forces generated by excessive wheel speeds may cause tire damage or failure. A tire could explode and injure someone. Do not spin your vehicle's wheels faster than 30 mph (48 km/h) when you are stuck. Do not let anyone near a spinning wheel, no matter what the speed.

WHAT TO DO IN EMERGENCIES

EVENT DATA RECORDER (EDR)

- This vehicle is equipped with an event data recorder (EDR). The main purpose of an EDR is to record, in certain crash or near crash-like situations, such as an air bag deployment or hitting a road obstacle, data that will assist in understanding how a vehicle's systems performed. The EDR is designed to record data related to vehicle dynamics and safety systems for a short period of time, typically 30 seconds or less. The EDR in this vehicle is designed to record such data as:
 - How various systems in your vehicle were operating;
 - Whether or not the driver and passenger safety belts were buckled/fastened;
 - How far (if at all) the driver was depressing the accelerator and/or brake pedal; and,
 - How fast the vehicle was traveling.
- These data can help provide a better understanding of the circumstances in which crashes and injuries occur.

NOTE: EDR data are recorded by your vehicle only if a non-trivial crash situation occurs; no data are recorded by the EDR under normal driving conditions and no personal data (e.g. name, gender, age, and crash location) are recorded. However, other parties, such as law enforcement, could combine the EDR data with the type of personally identifying data routinely acquired during a crash investigation.

- To read data recorded by an EDR, special equipment is required, and access to the vehicle or the EDR is needed. In addition to the vehicle manufacturer, other parties such as law enforcement, that have the special equipment, can read the information if they have access to the vehicle or the EDR.

MAINTAINING YOUR VEHICLE

OPENING THE HOOD

- Pull the hood release lever located on the instrument panel, below the steering column.
- Raise the hood and locate the safety catch lever, in the middle of the hood opening.
- Move the safety latch while lifting the hood at the same time.
- Insert the support rod into the slot on the hood.
- To close the hood, remove the support rod and place it in the retaining clip, then lower the hood slowly.

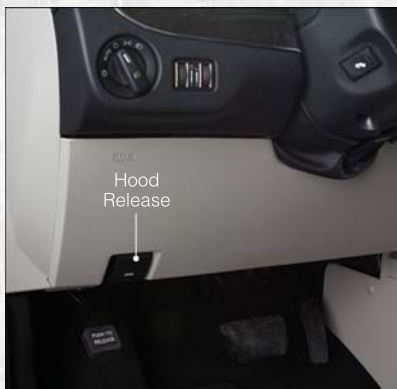

WARNING!

Be sure the hood is fully latched before driving your vehicle. If the hood is not fully latched, it could open when the vehicle is in motion and block your vision. Failure to follow this warning could result in serious injury or death.

ADDING FUEL

Fuel Filler Cap (Gas Cap)

- The gas cap is located behind the fuel filler door on the left side of the vehicle. If the gas cap is lost or damaged, be sure the replacement cap is for use with this vehicle.
- When the fuel nozzle “clicks” or shuts off, the fuel tank is full.
- Tighten the gas cap until you hear a “clicking” sound. This is an indication that the gas cap is properly tightened. If not properly tightened, the MIL (Malfunction Indicator Light) may come on.

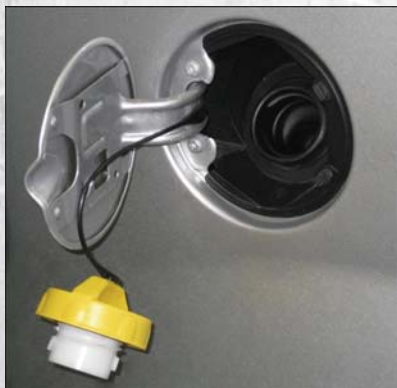

NOTE: The driver's side sliding door cannot be opened while the fuel door is open.

MAINTAINING YOUR VEHICLE

CAUTION!

- Damage to the fuel system or emissions control system could result from using an improper gas cap. A poorly fitting cap could let impurities into the fuel system and may cause the MIL to turn on, due to fuel vapors escaping from the system.
- To avoid fuel spillage and overfilling, do not “top off” the fuel tank after filling.

WARNING!

- Never have any smoking materials lit in or near the vehicle when the gas cap is removed or the tank filled.
- Never add fuel when the engine is running. This is in violation of most state and federal fire regulations and will cause the MIL to turn on.
- A fire may result if gasoline is pumped into a portable container that is inside of a vehicle. You could be burned. Always place gas containers on the ground while filling.

MAINTAINING YOUR VEHICLE

ENGINE COMPARTMENT

3.6L



MAINTAINING YOUR VEHICLE

FLUIDS AND CAPACITIES

Component	Fluid, Lubricant, or Genuine Part	Capacities
Engine Coolant 3.6L	MOPAR® Antifreeze/Coolant Five Year/100,000 Mile Formula HOAT (Hybrid Organic Additive Technology) or equivalent.	13.4 Quarts (12.6 Liters) Includes heater and coolant recovery bottle filled to MAX level. Add 2.9 Quarts (2.8 Liters) if equipped with rear heater.
Engine Oil with Filter 3.6L	API certified 5W-30 engine oil, meeting the requirements of Chrysler Material Standard MS-6395. Refer to your oil filler cap for correct SAE grade.	6 Quarts (5.6 Liters)
Engine Oil Filter 3.6L	MOPAR® Engine Oil Filter or equivalent.	—
Spark Plug 3.6L	RER8ZWYCB4 (Gap 0.043 in [1.1 mm])	—
Automatic Transmission	MOPAR® ATF+4® Automatic Transmission Fluid or equivalent licensed ATF+4® product.	—
Brake Master Cylinder	MOPAR® DOT 3 and SAE J1703 should be used or equivalent. If DOT 3 is not available, then DOT 4 is acceptable. Use only recommended brake fluids.	—
Power Steering Reservoir	MOPAR® Power Steering Fluid +4 or MOPAR® ATF+4® Automatic Transmission Fluid or equivalent licensed ATF+4® product.	—
Fuel Selection 3.6L	87 Octane	20 Gallons (76 Liters) (Approximate)

E-85 Flexible Fuel – 3.6L Engine Only

CAUTION!

Only vehicles with the E-85 fuel filler door label or a yellow gas cap can operate on E-85.

- Refer to your Owner's Manual on the DVD for further details.

MAINTAINING YOUR VEHICLE

MAINTENANCE CHART

	8,000	16,000	24,000	32,000	40,000	48,000	56,000	64,000	72,000	80,000	88,000	96,000	104,000
Miles:	6	12	18	24	30	36	42	48	54	60	66	72	78
Or Months:		26,000	39,000	52,000	65,000	78,000	91,000	104,000	117,000	130,000	143,000	156,000	169,000
Or Kilometers:													
Change the engine oil and filter.	X	X	X	X	X	X	X	X	X	X	X	X	X
Rotate the tires, rotate at the first sign of irregular wear, even if it occurs before scheduled maintenance.	X	X	X	X	X	X	X	X	X	X	X	X	X
Open the left and right sliding doors (slowly) and inspect for excessive dirt. If noise exists, wipe clean and apply krytox lube to the door rollers.	X	X	X	X	X	X	X	X	X	X	X	X	X
If using your vehicle for any of the following: dusty or off-road conditions. Inspect the engine air cleaner filter; replace if necessary.		X				X				X			
Replace the air conditioning filter.		X		X		X		X		X		X	
Inspect the brake linings; replace if necessary.		X		X		X		X		X		X	
Inspect the CV joints.			X			X			X			X	
Inspect the front suspension, tie rod ends and boot seals for cracks or leaks and all parts for damage, wear, improper looseness or end play; replace if necessary.		X		X		X		X		X		X	
Inspect the exhaust system.		X		X		X			X			X	
Replace the engine air cleaner filter.				X				X				X	
Change the automatic transmission fluid and filter if using your vehicle for any of the following: police, taxi, fleet or frequent trailer towing.								X					
Flush and replace the engine coolant at 60 months or 104,000 miles (169,000 km) whichever comes first.										X			

MAINTAINING YOUR VEHICLE

	Miles:		8,000	16,000	24,000	32,000	40,000	48,000	56,000	64,000	72,000	80,000	88,000	96,000	104,000
	Or Months:		6	12	18	24	30	36	42	48	54	60	66	72	78
	Or Kilometers:		13,000	26,000	39,000	52,000	65,000	78,000	91,000	104,000	117,000	130,000	143,000	156,000	169,000
Flush and replace the engine coolant at 104,000 miles (169,000 km) or 60 months whichever comes first.															
Replace the spark plugs (3.6L engine).															
Inspect and replace the PCV valve if necessary.															
<ul style="list-style-type: none"> Refer to the Owner's Manual on the DVD for the complete maintenance schedule. 															

MAINTAINING YOUR VEHICLE

Maintenance Record

	Odometer	Date	Signature, Authorized Service Center
8,000 Miles (13,000 km) or 6 Months			
16,000 Miles (26,000 km) or 12 Months			
24,000 Miles (39,000 km) or 18 Months			
32,000 Miles (52,000 km) or 24 Months			
40,000 Miles (65,000 km) or 30 Months			
48,000 Miles (78,000 km) or 36 Months			
56,000 Miles (91,000 km) or 42 Months			
64,000 Miles (104,000 km) or 48 Months			
72,000 Miles (117,000 km) or 54 Months			
80,000 Miles (130,000 km) or 60 Months			
88,000 Miles (143,000 km) or 66 Months			
96,000 Miles (156,000 km) or 72 Months			
104,000 Miles (169,000 km) or 78 Months			

MAINTAINING YOUR VEHICLE

FUSES

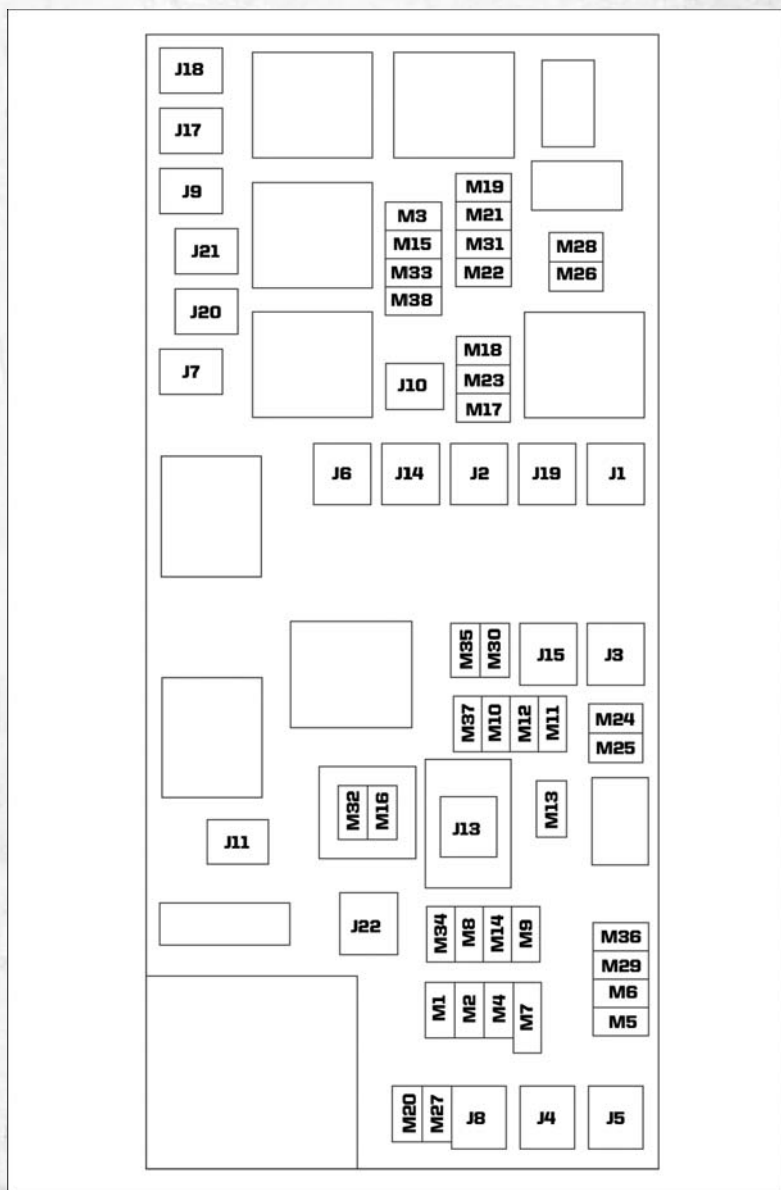

MAINTAINING YOUR VEHICLE

Integrated Power Module (fuses)

- The Integrated Power Module (fuses) is located in the engine compartment near the battery. This center contains cartridge fuses, mini-fuses and relays.

Cavity	Cartridge Fuse	Mini-Fuse	Description
J1	40 Amp Green		Power Folding Seat
J2	30 Amp Pink		Power Liftgate Module
J3	30 Amp Pink		Rear Door Module (RR Door Node)
J4	25 Amp Natural		Driver Door Node
J5	25 Amp Natural		Passenger Door Node
J6	40 Amp Green		Anti-Lock Brake System (ABS) Pump/ESP
J7	30 Amp Pink		Anti-Lock Brake System (ABS) Valve/ESP
J8	40 Amp Green		Power Memory Seat (If Equipped)
J9	40 Amp Green		PZEV Motor/Flex Fuel
J10	30 Amp Pink		Headlamp Wash Relay/Manifold Tuning Valve
J11	30 Amp Pink		Power Sliding Door Module/ Thatchum Relay Lock Feed
J12	30 Amp Pink		HVAC Rear Blower, Radiator Fan Motor
J13	60 Amp Yellow		Ignition Off Draw (IOD) — Main
J14	40 Amp Green		Rear Window Defogger
J15	40 Amp Green		Front Blower
J17	40 Amp Green		Starter Solenoid
J18	20 Amp Blue		Powertrain Control Module (PCM) Trans Range
J19	60 Amp Yellow		Radiator Fan
J20	30 Amp Pink		Front Wiper LO/HI
J21	20 Amp Blue		Front/Rear Washer
J22	25 Amp Natural		Sunroof Module
M1		15 Amp Blue	Center High Mounted Stop Light (CHMSL)/Brake Switch
M2		20 Amp Yellow	Trailer Lighting, Front Fog Lamps, Intelligent Battery Sensor (IBS)
M3		20 Amp Yellow	Front/Rear Axle Locker, Vacuum Pump Motor
M4		10 Amp Red	Trailer Tow
M5		25 Amp Natural	Inverter
M6		20 Amp Yellow	Power Outlet #1 (ACC), Rain Sensor
M7		20 Amp Yellow	Power Outlet #2 (BATT/ACC SELECT)
M8		20 Amp Yellow	Front Heated Seat (If Equipped)
M9		20 Amp Yellow	Rear Heated Seat (If Equipped)

MAINTAINING YOUR VEHICLE

Cavity	Cartridge Fuse	Mini-Fuse	Description
M10		15 Amp Blue	Ignition Off Draw — Vehicle Entertainment System (IOD-VES), Satellite Digital Audio Receiver (SDARS), DVD, Hands-Free Module (HFM), Universal Garage Door Opener (UGDO), Vanity Lamp (VANITY LP), Streaming Video Module
M11		10 Amp Red	(Ignition Off Draw) IOD-HVAC/ATC
M12		30 Amp Green	Amplifier (AMP)/Radio
M13		20 Amp Yellow	Ignition Off Draw— Cabin Compartment Node (IOD-CCN), SIREN, Clock Module (CLK MOD), Multi-Function Control Switch (MULTIFCTN SW)/ITM
M14		20 Amp Yellow	Trailer Tow – If Equipped
M15		20 Amp Yellow	Rear View Mirror (RR VW MIR), Cabin Compartment Node (CCN), Multi-Function Control Switch (MULTIFCTN SW), Tire Pressure Monitor (TPM), Glow Plug Module (GLW PLG MOD) — Export Diesel Only, Assy-Shifter (Hall Effect), Acoustic Noise Cancellation (ANC)
M16		10 Amp Red	Occupant Restraint Controller/ Occupant Classification Module (ORC/OCM)
M17		15 Amp Blue	Left Tail/License/Park Lamp (LT-TAIL/LIC/PRK LMP), Running Lamps
M18		15 Amp Blue	Right Tail/Park/Run Lamp (RT-TAIL/PRK/RUN LMP)
M19		25 Amp Natural	Auto Shut Down (ASD #1 and #2)
M20		15 Amp Blue	Cabin Compartment Node Interior Light (CCN INT LIGHT), Switch Bank (SW BANK), Steering Control Module (SCM), Switch Steering Wheel
M21		20 Amp Yellow	Auto Shut Down (ASD #3)
M22		10 Amp Red	Right Horn (RT HORN (HI/LOW)
M23		10 Amp Red	Left Horn (LT HORN (HI/LOW)
M24		25 Amp Natural	Rear Wiper (REAR WIPER)
M25		20 Amp Yellow	Fuel Pump (FUEL PUMP), Diesel Lift Pump (DSL LIFT PUMP) — Export Only
M26		10 Amp Red	Power Mirror Switch (PWR MIRR SW), Driver Window Switch (DRVR WIND SW)

MAINTAINING YOUR VEHICLE

Cavity	Cartridge Fuse	Mini-Fuse	Description
M27		10 Amp Red	Wireless Ignition Module, Keyless Entry Module
M28		10 Amp Red	Next Generation Controller (NGC), PCM, Transmission Feed (TRANS FEED), TCM
M29		10 Amp Red	Occupant Classification Module (OCM)
M30		15 Amp Blue	Rear Wiper Module (RR WIPER MOD), Power Folding Mirror (PWR FOLD MIR), J1962 Diagnostic Feed
M31		20 Amp Yellow	Back-Up Lamps (B/U LAMPS)
M32		10 Amp Red	Occupant Restraint Controller (ORC), TT EUROPE
M33		10 Amp Red	Next Generation Controller (NGC), Global Powertrain Engine Controller (GPEC), TCM
M34		10 Amp Red	Park Assist (PRK ASST), Heater Ventilation, Air Conditioning Module (HVAC MOD), Headlamp Wash (HDLP WASH), Compass (COMPAS), IR Sensor, Rear Camera, Lamp Door FT Drv/Pass, Lamp Flashlight, AHLM, Relay Diesel Cabin Heater, Rad Fan Diesel
M35		10 Amp Red	Heated Mirrors
M36		20 Amp Yellow	Power Outlet #3 (BATT)
M37		10 Amp Red	Anti-Lock Brake System (ABS), Electronic Stability Program (ESP), Stop Lamp Switch (STP LP SW), Fuel Pump Rly Hi Control
M38		25 Amp Natural	Door Lock/Unlock Motors (LOCK/UNLOCK MTRS), Liftgate Lock/Unlock Motors

MAINTAINING YOUR VEHICLE

TIRE PRESSURES

- Check the inflation pressure of each tire, including the spare tire, at least monthly and inflate to the recommended pressure for your vehicle.
- The tire pressures recommended for your vehicle are found on the “Tire and Loading Information” label located on the driver’s side door opening.

NOTE: Refer to the Owner’s Manual on the DVD for more information regarding tire warnings and instructions.

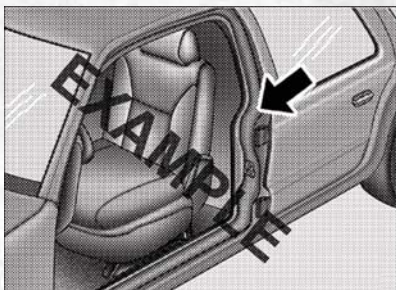

WARNING!

- Overloading of your tires is dangerous. Overloading can cause tire failure, affect vehicle handling, and increase your stopping distance. Use tires of the recommended load capacity for your vehicle. Never overload them.
- Improperly inflated tires are dangerous and can cause collisions. Under-inflation is the leading cause of tire failure and may result in severe cracking, component separation, or “blow out”. Over-inflation reduces a tire’s ability to cushion shock. Objects on the road and chuck holes can cause damage that results in tire failure. Unequal tire pressures can cause steering problems. You could lose control of your vehicle. Over-inflated or under-inflated tires can affect vehicle handling and can fail suddenly, resulting in loss of vehicle control.

WHEEL AND WHEEL TRIM CARE

- All wheels and wheel trim, especially aluminum and chrome plated wheels, should be cleaned regularly with a mild soap and water to prevent corrosion.
- To remove heavy soil and/or excessive brake dust the following MOPAR® wheel cleaners are recommended or select a non-abrasive, non acidic cleaner.
- For chrome wheels, use MOPAR® Chrome Cleaner (Part# 04318013) or equivalent.
- For aluminum wheels, use MOPAR® Wheel Cleaner (Part# 04796239AB) or equivalent.

MAINTAINING YOUR VEHICLE

CAUTION!

Do not use scouring pads, steel wool, a bristle brush, or metal polishes. Do not use oven cleaner. These products may damage the wheel's protective finish. Avoid automatic car washes that use acidic solutions or harsh brushes that may damage the wheel's protective finish. Use only the approved MOPAR® Wheel Cleaners or equivalent.

EXTERIOR BULBS

LIGHT BULBS – Exterior	Bulb Number
Backup Lamp	3157
Rear Tail, Stop, Turn Signal Lamp	LED (Serviced at Authorized Dealer)
Center High-Mounted Stop Lamp	LED (*)
Fog Lamp – If Equipped	PSX24W
Front Side Marker/Front Park/Turn Signal	PY27/7W or 3757A
Headlamp – (Low and High Beam Halogen)	H11
License Lamp	168

*CHMSL is not serviceable. It is a LED lamp. To replace the LED, the entire CHMSL assembly must be replaced.

CONSUMER ASSISTANCE

CHRYSLER GROUP LLC CUSTOMER CENTER

P.O. Box 21-8004

Auburn Hills, MI 48321-8004

Phone: 1-800-423-6343

CHRYSLER CANADA INC. CUSTOMER CENTER

P.O. Box 1621

Windsor, Ontario N9A 4H6

Phone: 1-800-465-2001 (English)

Phone: 1-800-387-9983 (French)

ASSISTANCE FOR THE HEARING IMPAIRED

- To assist customers who have hearing difficulties, the manufacturer has installed special TDD (Telecommunication Devices for the Deaf) equipment at its customer center. Any hearing or speech impaired customer, who has access to a TDD or a conventional teletypewriter (TTY) in the United States, can communicate with the manufacturer by dialing 1-800-380-CHRY. Canadian residents with hearing difficulties that require assistance can use the special needs relay service offered by Bell Canada. For TTY teletypewriter users, dial 711 and for Voice callers, dial 1-800-855-0511 to connect with a Bell Relay Service operator.

WARNING!

Engine exhaust, some of its constituents, and certain vehicle components contain, or emit, chemicals known to the State of California to cause cancer and birth defects, or other reproductive harm. In addition, certain fluids contained in vehicles and certain products of component wear contain, or emit, chemicals known to the State of California to cause cancer and birth defects, or other reproductive harm.

PUBLICATIONS ORDERING

- **If you are the first registered retail owner of your vehicle**, you may obtain one free printed copy of the Owner's Manual, Warranty Booklet or Radio Manuals on your DVD by calling 1-800-423-6343 (U.S.) or 1-800-387-1143 (Canada) or by contacting your dealer.
- Replacement User Guide kits or DVDs or, if you prefer, additional printed copies of the Owner's Manual, Warranty Booklet or Radio Manuals may be purchased by visiting www.techauthority.com or by calling 1-800-890-4038 (U.S.) or 1-800-387-1143 (Canada). Visa, Master Card, American Express and Discover orders are accepted. If you prefer mailing your order, please call the above numbers for an order form.

NOTE: A street address is required when ordering manuals (no P.O. Boxes).

CONSUMER ASSISTANCE

NOTE:

- The Owner's Manual and User Guide electronic files are also available on the Chrysler, Jeep, Ram Truck and Dodge websites.
- Click on the "For Owners" tab, select "Owner/Service Manuals", then select your desired model year and vehicle from the drop down lists.

REPORTING SAFETY DEFECTS IN THE 50 UNITED STATES AND WASHINGTON, D.C.

- If you believe that your vehicle has a defect that could cause a collision or cause injury or death, you should immediately inform the National Highway Traffic Safety Administration (NHTSA) in addition to notifying the manufacturer.
- If NHTSA receives similar complaints, it may open an investigation, and if it finds that a safety defect exists in a group of vehicles, it may order a recall and remedy campaign. However, NHTSA cannot become involved in individual problems between you, your authorized dealer, and the manufacturer.
- To contact NHTSA, you may either call the Auto Safety Hotline toll free at 1-888-327-4236 (TTY: 1-800-424-9153), or go to <http://www.safercar.gov>; or write to: Administrator, NHTSA, 1200 New Jersey Avenue, SE., West Building, Washington, D.C. 20590. You can also obtain other information about motor vehicle safety from <http://www.safercar.gov>.

In Canada

- If you believe that your vehicle has a safety defect, you should contact the Customer Service Department immediately. Canadian customers who wish to report a safety defect to the Canadian government should contact Transport Canada, Motor Vehicle Defect Investigations and Recalls at 1-800-333-0510 or go to <http://www.tc.gc.ca/roadsafety/>
- French Canadian customers who wish to report a safety defect to the Canadian government should contact Transport Canada, Motor Vehicle Defect Investigations and Recalls at 1-800-333-0510 or go to <http://www.tc.gc.ca/securiteroutiere/>

MOPAR ACCESSORIES

AUTHENTIC ACCESSORIES BY MOPAR®

- The following highlights just some of the many Authentic Dodge Accessories by Mopar featuring a fit, finish, and functionality specifically for your Dodge Grand Caravan.
- In choosing Authentic Accessories you gain far more than expressive style, premium protection, or extreme entertainment, you also benefit from enhancing your vehicle with accessories that have been thoroughly tested and factory-approved.
- For the full line of Authentic Dodge Accessories by Mopar, visit your local Dodge dealership or online at mopar.com.

EXTERIOR:

- Front Air Deflector
- Front End Cover
- Molded Splash Guards
- Hitch Receiver
- Fog Lights
- Full Vehicle Cover
- Molded Running Boards

INTERIOR:

- Premium Carpet Floor Mats
- Door Sill Guards
- Rear Seat Floor Liner
- Slush Mats
- Ambient Light Kit
- Katzkin Leather Seats
- Cargo Management

ELECTRONICS:

- Portable Navigation Systems
- Uconnect™ Web (WiFi)
- Rearview Camera
- iPod® Adapter
- Ecometer
- DVD Rear Seat Video™
- Electronic Vehicle Tracking System
- Radio Upgrades
- Remote Start

CARRIERS:

- Hitch-mount Bike Carrier
- Roof Mount Bike Carrier
- Roof Box Cargo Carrier
- Roof Mount Ski and Snowboard Carrier
- Tent Kit
- Roof Mount Canoe Carrier

iPod® is a registered trademark of Apple, Inc.

INDEX

- Adjustable Pedals 22
- Airbag 10
- Alarm, Panic 8
- Arming Theft System (Security Alarm) 9
- Audio Settings . . . 38,39,40,42,45,54
- Automatic Headlights 25
- Automatic Temperature Control (ATC) 30
- Automatic Transmission
 - Fluid Type 105
- Auxiliary Audio/Video Input Jacks . . . 71
- Axle Fluid 105

- Belts, Seat 10
- Blind Spot Monitoring 32
- Brake Fluid 105
- Break-In Recommendations, New Vehicle 23
- Bulb Replacement 114

- Calibration, Compass 72
- Cargo Compartment
 - Luggage Carrier 79
- Change Oil Indicator 85
- Changing A Flat Tire 87
- Child Restraint 11
- Child Restraint Tether Anchors 11
- Clock Setting 38,40,43,52
- Compass Calibration 72
- Cooling System
 - Coolant Capacity 105
- Cruise Control (Speed Control) 26
- Cruise Light 26
- Customer Assistance 115

- Defects, Reporting 116
- Dimmer Control 25
- Dimmer Switch, Headlight 25
- Disarming, Theft System 9

- E-85 Fuel 105
- Economy (Fuel) Mode 27
- Electronic Speed Control (Cruise Control) 26
- Electronic Vehicle Information Center (EVIC) 72,73

- Electronics
 - Your Vehicle's Sound System 36
- Emergency Key 8
- Emergency, In Case of
 - Freeing Vehicle When Stuck 100
 - Jacking 87,91
 - Overheating 86
- Engine
 - Break-In Recommendations 23
 - Compartment 104
 - Oil Selection 105
 - Overheating 86
- Event Data Recorder 101
- Exterior Lights 114

- Flash-To-Pass 24
- Flexible Fuel Vehicles 105
- Fluid Capacities 105
- Fluids 105
- Fog Lights 25
- Fold in Floor (Stow 'n Go) Seating . . 15
- Freeing A Stuck Vehicle 100
- Front Heated Seats 20
- Fuel
 - Economy Mode 27
 - Specifications 105
- Garage Door Opener (HomeLink®) . . . 74

- Headlights
 - Automatic 25
 - Dimmer Switch 25
 - High Beam 24
- Heated Mirrors 28,29,31
- Heated Seats 20
- Heated Steering Wheel 21
- High Beam/Low Beam Select (Dimmer) Switch 24
- HomeLink® (Garage Door Opener) Transmitter 74
- Hood Release 102

- Instrument Cluster 6
 - Indicators 7
- Instrument Cluster Warning Lights . . 6,82
- Intermittent Wipers (Delay Wipers) . . 24
- Introduction 2

INDEX

- Inverter Outlet (115V) 76
- Inverter, Power 76
- iPod®/USB/MP3 Control 64
 - Bluetooth Streaming Audio 70
- Jack Location 87
- Jack Operation 87
- Jump Starting 96
- Key Fob 8
- Key Fob Programmable Features 73
- Lane Change Assist 23
- LATCH (Lower Anchors and Tether for Children) 11
- Liftgate, Power 8
- Lights
 - Turn Signal 23
 - Warning (Instrument Cluster Description) 6
- Luggage Rack (Roof Rack) 79
- Maintenance Record 108
- Maintenance Schedule 106
- Media Center Radio 38,40
- Memory Seat 14
- Mirrors
 - Heated 28,29,31
- MOPAR® Accessories 117
- Navigation 48,57
- New Vehicle Break-In Period 23
- Oil Change Indicator 85
- Oil, Engine
 - Capacity 105
- Outlet
 - Power 77
- Overheating, Engine 86
- Panic Alarm 8
- Pedals, Adjustable 22
- Phone (Pairing) 66
- Phone (Uconnect) 65
- Placard, Tire and Loading Information 113
- Power
 - Glass Sunroof 34
 - Inverter 76
 - Lift Gate 8
 - Outlet (Auxiliary Electrical Outlet) 77
 - Seats 13
 - Sliding Door 8
 - Steering 105
- Preparation for Jacking 90
- Programmable Electronic Features 73
- Radio Operation 42,51
- Rain Sensitive Wiper System 24
- Rear Cross Path 32
- Rear Heated Seats 20
- Recreational Towing 81
- Remote Starting System 9
- Replacement Bulbs 114
- Reporting Safety Defects 116
- Restraints, Child 11
- Rocking Vehicle When Stuck 100
- Roof Rack (Luggage Rack) 79
- Seat Belts 10
- Seats 13
 - Adjustment 14
 - Fold in Floor (Stow 'n Go) 15
 - Heated 20
 - Lumbar Support 13
 - Memory 14
 - Power 13
 - Stow 'n Go (Fold in Floor) 15
- Seek Button 39,41
- Setting the Clock 38,40,43,52
- Shift Lever Override 98
- Short Message Service (SMS) 69
- Signals, Turn 23
- SIRIUS Travel Link 63
- SmartBeams 25
- Spare Tire 87
- Spark Plugs 105
- Speed Control
 - Accel/Decel 26
 - Cancel 26

INDEX

Resume	26	Towing	80
Speed Control (Cruise Control)	26	24-Hour Towing Assistance	82
Starting		Disabled Vehicle	99
Remote	9	Recreational	81
Steering		Trailer Towing	
Tilt Column	21	Trailer and Tongue Weight	80
Wheel, Heated	21	Trailer Weight	80
Steering Wheel Audio Controls	64	Transmission	
Store Radio Presets	39,41	Fluid	105
Stow `n Go (Fold in Floor) Seats	15	Turn Signals	23
Stuck, Freeing	100	Uconnect™ Phone	65
Sun Roof	34	Uconnect™ Voice Command	68
Supplemental Restraint System -		Video Entertainment System™	
Airbag	10	(Rear Seat Video System)	70
Temperature Gauge, Engine Coolant	86	Voice Commands	68
Text Messaging	69	Washer	
Theft Alarm (Security Alarm)	9	Rear	24
Theft System Arming	9	Washers, Windshield	24
Theft System Disarming	9	Wheel and Wheel Trim Care	113
Tilt Steering Column	21	Wind Buffeting	35
Tires		Windshield Washers	24
Air Pressure	113	Windshield Wipers	24
Changing	87	Wiper, Rear	24
Jacking	87,91		
Pressure Warning Light	82		
Spare Tire	87		

FAQ (How To?)

FREQUENTLY ASKED QUESTIONS

GETTING STARTED

- How do I install my LATCH Equipped Child Seat? pg. 11
- How do I program my Front Seat Memory? pg. 14

OPERATING YOUR VEHICLE

- How does the Electronic Range Select (ERS) operate? pg. 27

ELECTRONICS

- Which radio is in my vehicle? pg. 38, 40, 42, 51
- How do I activate the Audio Jack? pg. 39, 42, 45, 54
- How do I set the clock on my radio? pg. 38, 40, 43, 52
- How do I use the Navigation feature? pg. 48, 57
- How do I pair my cell phone via Bluetooth® with the UConnect™ Hands-Free Voice Activation System? pg. 65
- How do I use my iPod®? pg. 64
- How do I use my USB port to listen to audio through my touch-screen radio? pg. 64
- How do I configure my Universal Garage Door Opener (HomeLink)? pg. 74

UTILITY

- How do I know how much I can tow with my Dodge Grand Caravan? pg. 80

WHAT TO DO IN EMERGENCIES

- What do I do if my TPMS warning light is blinking? pg. 82
- How do I change a flat tire? pg. 87
- How do I Jump-Start my vehicle? pg. 96

MAINTAINING YOUR VEHICLE

- Where is my Fuse Block located? pg. 109
- What type of oil do I use? pg. 105
- How often should I change my engine's oil? pg. 106
- What should my tire pressure be set at? pg. 113

NOTES

NOTES

NOTES

RAMTRUCKS.COM

This guide has been prepared to help you get quickly acquainted with your new RAM and to provide a convenient reference source for common questions. However, it is not a substitute for your Owner's Manual.

For complete operational instructions, maintenance procedures and important safety messages, please consult your Owner's Manual, Navigation/Media Center Manuals, Multimedia User Manual and other Warning Labels in your vehicle.

Not all features shown in this guide may apply to your vehicle. For additional information on accessories to help personalize your vehicle, visit www.mopar.com or your local RAM dealer.

Driving and Alcohol: Drunken driving is one of the most frequent causes of collisions. Your driving ability can be seriously impaired with blood alcohol levels far below the legal minimum. If you are drinking, don't drive. Ride with a designated non-drinking driver, call a cab, a friend, or use public transportation.

WARNING!

Driving after drinking can lead to a collision. Your perceptions are less sharp, your reflexes are slower, and your judgment is impaired when you have been drinking. Never drink and then drive.

Download a *FREE* electronic copy
of the Owner's Manual or Warranty Booklet
by visiting the **Ownership tab** at
www.ramtrucks.com (U.S.) or
www.ramtruck.ca (Canada).



12MZZ-926-AA
RAM CV Cargo Van
First Edition
User Guide