

**DODGE** 

# CHARGER

INCLUDES SRT8

2012



USER  
**GUIDE**



IF YOU ARE THE FIRST REGISTERED RETAIL OWNER OF YOUR VEHICLE, YOU MAY OBTAIN A COMPLIMENTARY PRINTED COPY OF THE OWNER'S MANUAL, NAVIGATION/MEDIA CENTER MANUALS OR WARRANTY BOOKLET BY CALLING 1-800-423-6343 (U.S.) OR 1-800-387-1143 (CANADA) OR BY CONTACTING YOUR DEALER.

The driver's primary responsibility is the safe operation of the vehicle. Driving while distracted can result in loss of vehicle control, resulting in a collision and personal injury. Chrysler Group LLC strongly recommends that the driver use extreme caution when using any device or feature that may take their attention off the road. Use of any electrical devices such as cell phones, computers, portable radios, vehicle navigation or other devices by the driver while the vehicle is moving is dangerous and could lead to a serious collision. Texting while driving is also dangerous and should never be done while the vehicle is moving. If you find yourself unable to devote your full attention to vehicle operation, pull off the road to a safe location and stop your vehicle. Some States or Provinces prohibit the use of cellular telephones or texting while driving. It is always the driver's responsibility to comply with all local laws.

### IMPORTANT

This User Guide is intended to familiarize you with the important features of your vehicle. The DVD enclosed contains your Owner's Manual, Navigation/Media Center Manuals, Warranty Booklets, Tire Warranty and 24-Hour Towing Assistance (new vehicles purchased in the U.S.) or Roadside Assistance (new vehicles purchased in Canada) in electronic format. We hope you find it useful. Replacement DVD kits may be purchased by visiting [www.techauthority.com](http://www.techauthority.com). Copyright 2011 Chrysler Group LLC.

# TABLE OF CONTENTS

## INTRODUCTION/WELCOME

Welcome From Chrysler Group LLC . . . . .	2
---	---

## CONTROLS AT A GLANCE

Driver Cockpit . . . . .	4
Instrument Cluster . . . . .	6

## GETTING STARTED

Key Fob . . . . .	8
Remote Start . . . . .	8
Keyless Enter-N-Go . . . . .	9
Theft Alarm . . . . .	11
Seat Belt . . . . .	12
Supplemental Restraint System (SRS) —	
Air Bags . . . . .	13
Child Restraints . . . . .	14
Front Seats . . . . .	16
Rear Seat . . . . .	18
Heated Seats . . . . .	18
Heated And Cooled Cupholders . . . . .	19
Adjustable Pedals . . . . .	20
Tilt/Telescoping Steering Column . . . . .	20

## OPERATING YOUR VEHICLE

Engine Break-In Recommendations . . . . .	22
Turn Signal/Wiper/Washer/High Beam Lever . . . . .	23
Headlight Switch . . . . .	24
Speed Control . . . . .	25
Electronic Shifter — 3.6L Engine . . . . .	28
Transmission Modes/AutoStick® . . . . .	30
Climate Controls . . . . .	31
Power Sunroof . . . . .	34
Wind Buffeting . . . . .	35

## ELECTRONICS

Your Vehicle's Sound System . . . . .	36
Identifying Your Radio . . . . .	38
Uconnect Touch™ 4.3 & 4.3S At A Glance . . . . .	39
Uconnect Touch™ 8.4 & 8.4N At A Glance . . . . .	40
Radio . . . . .	42
Sirius XM™ Satellite Radio . . . . .	43
iPod®/CD/AUX Controls . . . . .	46
Garmin® Navigation (8.4N Only) . . . . .	47
Sirius Travel Link (8.4N Only) . . . . .	51
Playing iPod/USB/MP3 Devices . . . . .	52
Uconnect™ Phone (Bluetooth® Hands Free Calling) . . . . .	53
Uconnect™ Voice Command (8.4 & 8.4N Only) . . . . .	58
Electronic Vehicle Information Center (EVIC) . . . . .	61
Programmable Features . . . . .	62

Universal Garage Door Opener (HomeLink®) . . . . .	63
Power Outlet . . . . .	65

## UTILITY

Trailer Towing Weights (Maximum Trailer Weight Ratings) . . . . .	67
Recreational Towing (Behind Motorhome, Etc.) . . . . .	68

## SRT8

AutoStick® . . . . .	69
Electronic Control Damping System . . . . .	70
Performance Features . . . . .	71
Summer/Three-Season Tires . . . . .	73

## WHAT TO DO IN EMERGENCIES

24-Hour Towing Assistance . . . . .	74
Instrument Cluster Warning Lights . . . . .	74
If Your Engine Overheats . . . . .	78
Jacking And Tire Changing . . . . .	78
TIREFIT Kit . . . . .	84
Battery Location . . . . .	89
Jump-Starting . . . . .	89
Shift Lever Override . . . . .	91
Towing A Disabled Vehicle . . . . .	94
Freeing A Stuck Vehicle . . . . .	95
Event Data Recorder (EDR) . . . . .	96

## MAINTAINING YOUR VEHICLE

Opening The Hood . . . . .	97
Fuel Door Release . . . . .	97
Engine Compartment . . . . .	100
Fluids And Capacities . . . . .	103
Maintenance Chart . . . . .	106
Fuses . . . . .	111
Tire Pressures . . . . .	115
Wheel And Wheel Trim Care . . . . .	116
Exterior Bulbs . . . . .	116

## CONSUMER ASSISTANCE

Chrysler Group LLC Customer Center . . . . .	117
Chrysler Canada Inc. Customer Center . . . . .	117
Assistance For The Hearing Impaired . . . . .	117
Publications Ordering . . . . .	117
Reporting Safety Defects In The 50 United States And Washington, D.C. . . . .	118

## MOPAR ACCESSORIES

Authentic Accessories By MOPAR® . . . . .	119
---	-----

INDEX . . . . .	120
-----------------	-----

## FAQ (How To?)

Frequently Asked Questions . . . . .	123
--------------------------------------	-----

# INTRODUCTION/WELCOME

## WELCOME FROM CHRYSLER GROUP LLC

Congratulations on selecting your new Chrysler Group LLC vehicle. Be assured that it represents precision workmanship, distinctive styling, and high quality - all essentials that are traditional to our vehicles.

Your new Chrysler Group LLC vehicle has characteristics to enhance the driver's control under some driving conditions. These are to assist the driver and are never a substitute for attentive driving. They can never take the driver's place. Always drive carefully.

Your new vehicle has many features for the comfort and convenience of you and your passengers. Some of these should not be used when driving because they take your eyes from the road or your attention from driving. Never text while driving or take your eyes more than momentarily off the road.

This guide illustrates and describes the operation of features and equipment that are either standard or optional on this vehicle. This guide may also include a description of features and equipment that are no longer available or were not ordered on this vehicle. Please disregard any features and equipment described in this guide that are not available on this vehicle. Chrysler Group LLC reserves the right to make changes in design and specifications and/or make additions to or improvements to its products without imposing any obligation upon itself to install them on products previously manufactured.

This User Guide has been prepared to help you quickly become acquainted with the important features of your vehicle. It contains most things you will need to operate and maintain the vehicle, including emergency information.

The DVD includes a computer application containing detailed owner's information which can be viewed on a personal computer or MAC computer. The multimedia DVD also includes videos which can be played on any standard DVD player (including the Media Center Touch-Screen Radios). Additional DVD operational information is located on the back of the DVD sleeve.

For complete owner information, refer to your Owner's Manual on the DVD in the owner's kit provided at the time of new vehicle purchase. For your convenience, the information contained on the DVD may also be printed and saved for future reference.

Chrysler Group LLC is committed to protecting our environment and natural resources. By converting from paper to electronic delivery for the majority of the user information for your vehicle, together we greatly reduce the demand for tree-based products and lessen the stress on our environment.

# INTRODUCTION/WELCOME

## Vehicles Sold In Canada

With respect to any vehicles sold in Canada, the name Chrysler Group LLC shall be deemed to be deleted and the name Chrysler Canada Inc. used in substitution therefore.

### **WARNING!**

- Pedals that cannot move freely can cause loss of vehicle control and increase the risk of serious personal injury.
- Always make sure that objects cannot fall into the driver foot well while the vehicle is moving. Objects can become trapped under the brake pedal and accelerator pedal causing a loss of vehicle control.
- Failure to properly follow floor mat installation or mounting can cause interference with the brake pedal and accelerator pedal operation causing loss of control of the vehicle.
- Never use the 'PARK' position as a substitute for the parking brake. Always apply the parking brake fully when parked to guard against vehicle movement and possible injury or damage.
- Refer to your Owner's Manual on the DVD for further details.

## **USE OF AFTERMARKET PRODUCTS (ELECTRONICS)**

The use of aftermarket devices including cell phones, MP3 players, GPS systems, or chargers may affect the performance of on-board wireless features including Keyless Enter-N-Go and Remote Start range. If you are experiencing difficulties with any of your wireless features, try disconnecting your aftermarket devices to see if the situation improves. If your symptoms persist, please see an authorized dealer.

CHRYSLER, DODGE, JEEP, RAM TRUCK, ATF+4, MOPAR and Uconnect are registered trademarks of Chrysler Group LLC.

**COPYRIGHT ©2011 CHRYSLER GROUP LLC**



# CONTROLS AT A GLANCE

## DRIVER COCKPIT





# CONTROLS AT A GLANCE













- A. Driver's Memory Buttons pg. 16
- B. Headlight Switch pg. 24
- C. Turn Signal/Wiper/Washer/High Beams Lever (behind steering wheel) pg. 23
- D. Instrument Cluster pg. 6
- E. Electronic Vehicle Information Center (EVIC) Display pg. 61
- F. Ignition Start/Stop Button (behind steering wheel) pg. 10
- G. Uconnect Touch™ System pg. 36
- H. SWITCH PANEL
  - Hazard Switch
  - A/C pg. 31
  - Recirculation pg. 31
  - Front Defrost pg. 31
  - Rear Defrost pg. 31
  - Electronic Stability Control (ESC) Off pg. 74
- I. Climate Control Hard-Keys pg. 31
- J. Transmission Shift Lever
- K. Speed Control pg. 25
- L. EVIC Controls pg. 61
- M. Trunk Release Button
- N. Parking Brake Pedal
- O. Hood Release (behind steering wheel) pg. 97
- P. Power Mirrors
- Q. Power Windows
- R. Power Door Locks
- S. Fuel Door Release (driver's door panel) pg. 97

# CONTROLS AT A GLANCE



## INSTRUMENT CLUSTER

### Warning Lights

-  - Low Fuel Warning Light
-  - Charging System Light\*\*
-  - Oil Pressure Warning Light
-  - Anti-Lock Brake (ABS) Light\*\*
-  - Air Bag Warning Light\*\*
-  - Electronic Throttle Control (ETC) Light
-  - Tire Pressure Monitoring System (TPMS) Light
-  - Engine Temperature Warning Light
-  - Seat Belt Reminder Light
- BRAKE**  - Brake Warning Light\*\*
-  - Malfunction Indicator Light (MIL)\*\*
-  - Electronic Stability Control (ESC) Activation/Malfunction Indicator Light\*







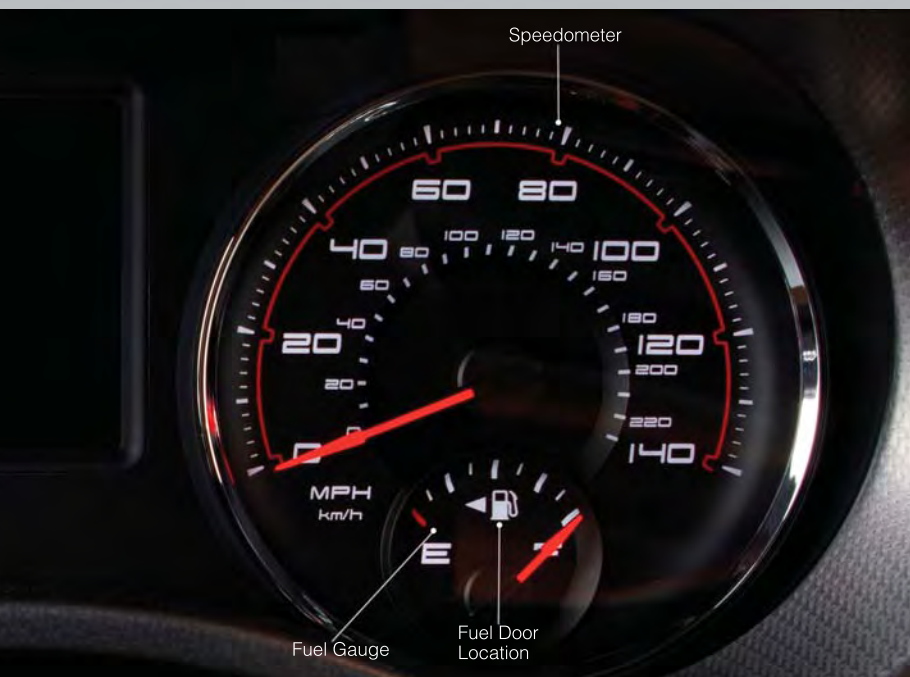



(See page 74 for more information.)



# CONTROLS AT A GLANCE



## Indicators

-  - Turn Signal Indicators
-  - High Beam Indicator
-  - Front Fog Light Indicator
-  - Vehicle Security Indicator\*
-  - Electronic Speed Control Set Indicator
-  - Adaptive Cruise Control (ACC) ON Indicator\*
-  - Electronic Stability Control (ESC) Off Indicator\*
-  - Door Ajar Indicator\*\*\*
-  - Decklid Ajar Indicator\*\*\*
-  - Windshield Washer Fluid Low Indicator\*\*\*
-  - Sport Mode Indicator

## EVIC Messages

ECO/Fuel Economy  
 Low Tire Pressure  
 Turn Signal On

Oil Change Required  
 Press Brake Pedal and Push Button to Start

\* If equipped

\*\* Bulb Check with Ignition On

\*\*\*On vehicles equipped with a Premium Instrument Cluster, this display shows the Electronic Vehicle Information Center (EVIC) messages when the appropriate conditions exist.

# GETTING STARTED

## KEY FOB



### Locking And Unlocking The Doors

- Press the LOCK button once to lock all the doors. Press the UNLOCK button once to unlock the driver's door only and twice within five seconds to unlock all the doors.
- All doors can be programmed to unlock on the first press of the UNLOCK button. Refer to Programmable Features in this guide.

### Opening The Trunk

- Press the TRUNK button two times within five seconds to open the trunk.

### Panic Alarm

- Press the PANIC button once to turn the panic alarm on.
- Wait approximately three seconds and press the button a second time to turn the panic alarm off.

### Emergency Key

- Should the battery in the vehicle or the Key Fob transmitter go dead, there is an emergency key located in the Key Fob. To remove the emergency key, slide the button at the back of the Key Fob sideways with your thumb and then pull the key out with your other hand.
- The emergency key is also for locking the glove compartment.

## WARNING!

- Leaving unattended children in a vehicle is dangerous for a number of reasons. A child or others could be severely injured or killed. Children should be warned not to touch the parking brake, brake pedal, or the shift lever. Do not leave the Key Fob in the vehicle. A child could operate power windows, other controls, or move the vehicle.

## REMOTE START

- Press the REMOTE START button  on the Key Fob twice within five seconds. Pressing the REMOTE START button a third time shuts the engine off.
- To drive the vehicle, press the UNLOCK button and cycle the ignition to the ON/RUN position.
- With remote start, the engine will only run for 15 minutes (timeout) unless the ignition is cycled to the ON/RUN position.

# GETTING STARTED

- The vehicle must be cycled to the ON/RUN position after two consecutive timeouts.

## WARNING!

- Do not start or run an engine in a closed garage or confined area. Exhaust gas contains Carbon Monoxide (CO) which is odorless and colorless. Carbon Monoxide is poisonous and can cause you or others to be severely injured or killed when inhaled.
- Keep Key Fob transmitters away from children. Operation of the Remote Start System, windows, door locks or other controls could cause you and others to be severely injured or killed.

## KEYLESS ENTER-N-GO

- The Keyless Enter-N-Go system is an enhancement to the vehicle's Key Fob. This feature allows you to lock and unlock the vehicle's door(s) and trunk without having to press the Key Fob lock or unlock buttons, as well as starting and stopping the vehicle with the press of a button.

### To Unlock From The Driver or Passenger Side:



- With a valid Keyless Enter-N-Go Key Fob located outside the vehicle and within 5 ft (1.5m) of the driver or passenger side door handle, grab either front door handle to unlock the door automatically.

### To Lock the Vehicle:



- Both front door handles have LOCK buttons located on the outside of the handle. With one of the vehicle's Keyless Enter-N-Go Key Fobs located outside the vehicle and within 5 ft (1.5m) of the driver's or passenger front door handle, press the door handle LOCK button to lock all four doors and trunk.

# GETTING STARTED

## NOTE:

- If “Unlock All Doors 1st Press” is programmed all doors will unlock when you grab hold of the front driver's door handle. To select between “Unlock Driver Door 1st Press” and “Unlock All Doors 1st Press”, refer to the Uconnect Touch™ Settings in your vehicle's Owner's Manual on the DVD or Programmable Features in this guide for further information.
- To select between “Unlock Driver Door 1st Press” and “Unlock All Doors 1st Press”, refer to the Uconnect Touch™ Settings in your vehicle's Owner's Manual on the DVD or Programmable Features in this guide for further information.
- If a Key Fob is detected in the vehicle when locking the vehicle using the power door lock switch, the doors will unlock and the horn will chirp three times. On the third attempt, your Key Fob can be locked inside the vehicle.
- After pressing the Keyless Enter-N-Go LOCK button, you must wait two seconds before you can lock or unlock the vehicle using the door handle. This is done to allow you to check if the vehicle is locked by pulling the door handle, without the vehicle reacting and unlocking.
- If a Keyless Enter-N-Go door handle has not been used for 72 hours, the Keyless Enter-N-Go feature for that handle may time out. Pulling the deactivated front door handle will reactivate the door handle's Keyless Enter-N-Go feature.

## To Enter the Trunk:



- With a valid Keyless Enter-N-Go Key Fob located outside the vehicle and within 5ft (1.5 m) of the deck lid, press the button on the right side of CHMSL, (Center High Mounted Stop Light) which is located on the deck lid.

## NOTE:

- Refer to your Owner's Manual on the DVD for further information.

## Engine Starting/Stopping



## Starting

- With a valid Keyless Enter-N-Go Key Fob inside the vehicle.
- Place the shift lever in PARK or NEUTRAL.
- While pressing the brake pedal, press the ENGINE START/STOP button once. If the engine fails to start, the starter will disengage automatically after 10 seconds.

# GETTING STARTED

- To stop the cranking of the engine prior to the engine starting, press the button again.

## NOTE:

- In case the ignition switch does not change with the push of a button, the RKE transmitter (Key Fob) may have a low or dead battery. In this situation a back up method can be used to operate the ignition switch. Put the nose side of the Key Fob against the ENGINE START/STOP button and push to operate the ignition switch.

## Stopping

- Place the shift lever in PARK.
- Press the ENGINE START/STOP button once. The ignition switch will return to the OFF position.
- **If the shift lever is not in PARK, the ENGINE START/STOP button must be held for two seconds and vehicle speed must be above 5 mph (8 km/h) before the engine will shut off.**

## Accessory Positions with Engine Off

### NOTE:

- The following functions are with the driver's foot OFF the Brake Pedal (Transmission in PARK or NEUTRAL Position).

### Starting With The Ignition Switch In The OFF Position:

- Press the ENGINE START/STOP button once to change the ignition switch to the ACC position.
- Press the ENGINE START/STOP button a second time to change the ignition switch to the ON/RUN position.
- Press the ENGINE START/STOP button a third time to return the ignition switch to the OFF position.

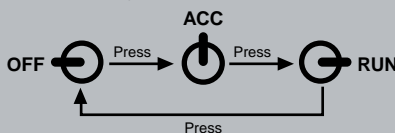

### NOTE:

- If the ignition switch is left in the ACC or ON/RUN (engine not running) position and the transmission is in PARK, the system will automatically time out after 30 minutes of inactivity and the ignition will switch to the OFF position.

## THEFT ALARM

### To Arm

- Press the Keyless Enter-N-Go Start/Stop button until the Electronic Vehicle Information Center (EVIC) indicates that the vehicle ignition is "OFF". Press the power door lock switch while the door is open, press the Key Fob LOCK button, or with one of the Key Fobs located outside the vehicle and within 5 ft (1.5m) of the driver's and passenger front door handles, press the Keyless Enter-N-Go LOCK button located on the door handle.

# GETTING STARTED

**NOTE:** After pressing the Keyless Enter-N-Go LOCK button, you must wait two seconds before you can lock or unlock the vehicle via the door handle.

## To Disarm

- Press the Key Fob UNLOCK button or with one of the Key Fobs located outside the vehicle and within 5 ft (1.5m) of the driver's and passenger front door handles, grab the Keyless Enter-N-Go door handle and enter the vehicle, then press the Keyless Enter-N-Go Start/Stop button (requires at least one valid Key Fob in the vehicle).

## SEAT BELT

- Be sure everyone in your vehicle is in a seat and using a seat belt properly.
- Position the lap belt across your thighs, below your abdomen. To remove slack in the lap portion, pull up a bit on the shoulder belt. To loosen the lap belt if it is too tight, tilt the latch plate and pull on the lap belt. A snug belt reduces the risk of sliding under the belt in a collision.
- Position the shoulder belt on your chest so that it is comfortable and not resting on your neck. The retractor will withdraw any slack in the belt.
- A shoulder belt placed behind you will not protect you from injury during a collision. You are more likely to hit your head in a collision if you do not wear your shoulder belt. The lap and shoulder belt are meant to be used together.
- A belt that is too loose will not protect you properly. In a sudden stop you could move too far forward, increasing the possibility of injury. Wear your seat belt snugly.
- A frayed or torn belt could rip apart in a collision and leave you with no protection. Inspect the belt system periodically, checking for cuts, frays, or loose parts. Damaged parts must be replaced immediately. Do not disassemble or modify the system. Seat belt assemblies must be replaced after a collision if they have been damaged (bent retractor, torn webbing, etc.).
- The seat belts for both front seating positions are equipped with pretensioning devices that are designed to remove slack from the seat belt in the event of a collision.
- A deployed pretensioner or a deployed air bag must be replaced immediately.

### WARNING!

In a collision, you and your passengers can suffer much greater injuries if you are not buckled up properly. You can strike the interior of your vehicle or other passengers, or you can be thrown out of the vehicle. Always be sure you and others in your vehicle are buckled up properly.



# GETTING STARTED

## SUPPLEMENTAL RESTRAINT SYSTEM (SRS) — AIR BAGS

- This vehicle has Advanced Front Air Bags for both the driver and right front passenger as a supplement to the seat belt restraint system. The Advanced Front Air Bags will not deploy in every type of collision.
- Advanced Front Air Bags are designed to provide additional protection by supplementing the seat belts in certain frontal collisions depending on the severity and type of collision. Advanced Front Air Bags are not expected to reduce the risk of injury in rear, side, or rollover collisions.
- This vehicle is equipped with Supplemental Side Air Bag Inflatable Curtains to protect the driver, front and rear passengers sitting next to a window.
- This vehicle is equipped with Supplemental Seat-Mounted Side Air Bags to provide enhanced protection to help protect an occupant during a side impact.
- This vehicle is equipped with a Supplemental Driver Side Knee Air Bag to provide enhanced protection and work together with the Driver Advanced Front Air Bag during a frontal impact.
- If the Air Bag Warning Light  is not on during starting, stays on, or turns on while driving, have the vehicle serviced by an authorized service center immediately.
- Refer to the Owner's Manual on the DVD for further details regarding the Supplemental Restraint System (SRS).

### WARNING!

- Relying on the air bags alone could lead to more severe injuries in a collision. The air bags work with your seat belt to restrain you properly. In some collisions, the air bags won't deploy at all. Always wear your seat belts even though you have air bags.
- Being too close to the steering wheel or instrument panel during Advanced Front Air Bag deployment could cause serious injury, including death. Air bags need room to inflate. Sit back, comfortably extending your arms to reach the steering wheel or instrument panel.
- Supplemental Side Air Bag Inflatable Curtains and Supplemental Seat-Mounted Side Air Bags need room to inflate. Do not lean against the door or window. Sit upright in the center of the seat.
- Being too close to the Supplemental Side Air Bag Inflatable Curtain and/or Seat-Mounted Side Air Bag during deployment could cause you to be severely injured or killed.
- Do not drive your vehicle after the air bags have deployed. If you are involved in another collision, the air bags will not be in place to protect you.
- After any collision, the vehicle should be taken to an authorized dealer immediately.

# GETTING STARTED

## CHILD RESTRAINTS

- Children 12 years and under should ride properly buckled up in a rear seat, if available. According to crash statistics, children are safer when properly restrained in the rear seats rather than in the front.
- Every state in the United States and all Canadian provinces require that small children ride in proper restraint systems. This is the law, and you can be prosecuted for ignoring it.

### Installing The LATCH-Compatible Child Restraint System

- Your vehicle's second row passenger seats are equipped with the child restraint anchorage system called LATCH, which stands for Lower Anchors and Tether for Children. LATCH child restraint anchorage systems are installed at all three rear seating positions.
- Both rear outboard seating positions and the rear center seating position have lower anchors and top tether anchors.
- Child seats with flexible or fixed rigid attachments can be installed in all rear seating positions. Child seats can be installed using the LATCH system in either or both outboard seating positions or the center position, but not all three at the same time. If a child seat is installed in an outboard seating position using the lower anchors, then the vehicle seatbelt must be used for the center position.
- **Never** install LATCH-compatible child seats such that two seats share a common lower anchorage.
- The rear seat lower anchorages are round bars, located at the rear of the seat cushion where it meets the seatback. The rear seat lower anchors can be readily identified by the symbol  located on the seatback directly above the anchorages and are just visible when you lean into the rear seat to install the child restraint.
- In addition, there are tether strap anchorages behind each rear seating position located in the panel between the rear seatback and the rear window. These tether strap anchorages are under a plastic cover.



- Loosen the child seat adjusters on the lower straps and tether straps so that you can attach the hook or connector to the lower and tether anchorages more easily.
- Attach the lower hooks or connectors over the top of the seat cover material.

- Then rotate the tether anchorage cover directly behind the seat where you are placing the child restraint and attach the tether strap to the anchorage, being careful to route the tether strap to provide the most direct path between the anchor and the child restraint.

# GETTING STARTED

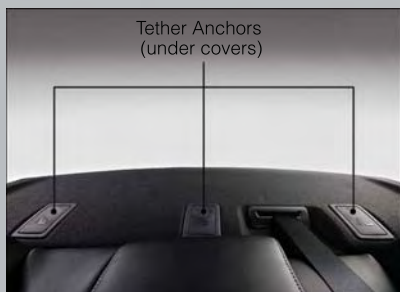

- Tighten all three straps as you push the child restraint rearward and downward into the seat.
- For center seating position route the tether strap over the seatback and adjustable headrest (with the headrest in the full down position) then attach the hook to the tether anchor located in the panel between the rear seatback and the rear window.

## Installing The Child Restraint Using The Vehicle Seat Belts

- To install a child restraint, first, pull enough of the seat belt webbing from the retractor to route it through the belt path of the child restraint and slide the latch plate into the buckle.
- Next, extract all the seat belt webbing out of the retractor and then allow the belt to retract into the retractor. Finally, pull on any excess webbing to tighten the lap portion around the child restraint. Any seat belt system will loosen with time, so check the belt occasionally, and pull it tight if necessary.
- Rotate the cover over the anchor directly behind the seat where you are placing the child restraint. These tether strap anchorages are under a plastic cover.
- Route the tether strap to provide the most direct path for the strap between the anchor and the child seat.
- Attach the tether strap hook of the child restraint to the anchor and remove slack in the tether strap according to the child restraint manufacturer's instructions.

## WARNING!

- In a collision, an unrestrained child, even a tiny baby, can become a projectile inside the vehicle. The force required to hold even an infant on your lap could become so great that you could not hold the child, no matter how strong you are. The child and others could be severely injured or killed. Any child riding in your vehicle should be in a proper restraint for the child's size.
- Rearward-facing child seats must never be used in the front seat of a vehicle with a front passenger air bag. An air bag deployment could cause infants in this position to be severely injured or killed.
- Improper installation of a child restraint to the LATCH anchorages can lead to failure of an infant or child restraint. The child could be severely injured or killed. Follow the manufacturer's directions exactly when installing an infant or child restraint.
- An incorrectly anchored tether strap could lead to increased head motion and possible injury to the child. Use only the anchor positions directly behind the child seat to secure a child restraint top tether strap.

# GETTING STARTED

## FRONT SEATS

### Power Seats

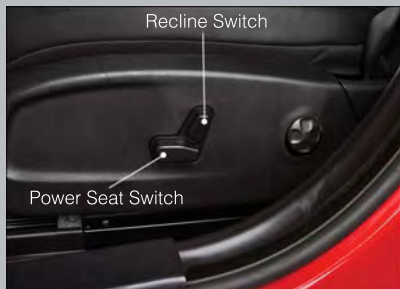

- The power seat switches are located on the outboard side of the front seat cushions.
- The power seat switch controls forward/back, up/down and tilt adjustment.
- The recline switch controls the angle of the seatback. Press the switch forward or rearward and the seatback will move in either direction.

### Power Lumbar



- Push the switch forward to increase the lumbar support. Push the switch rearward to decrease the lumbar support.
- Pushing upward or downward on the switch will raise and lower the position of the support.

### Memory Seat



- The memory seat feature allows you to save two different driver seating positions, driver's outside mirror, adjustable brake and accelerator pedals, power tilt and telescopic steering column and radio station preset settings. The memory seat buttons are located on the driver's door panel.
  - Adjust all memory profile settings, press the SET (S) button then press 1 or 2 within five seconds.
- Your Key Fob can be programmed to recall one of two pre-programmed memory profiles by pressing the UNLOCK button on the Key Fob.

# GETTING STARTED

- To program your Key Fobs, perform the following:
  - Change the ignition to OFF.
  - Select desired memory profile 1 or 2.
  - Once the profile has been recalled, press and release the SET (S) button on the memory switch, then press and release the side of the rocker switch labeled 1 or 2 accordingly.
  - (1 or 2) will display in the instrument cluster if the vehicle is equipped with the EVIC.
  - Press and release the LOCK button on the Key Fob within 10 seconds.

**NOTE:** Your Key Fob can be unlinked to your memory settings by pressing the SET (S) button followed by the UNLOCK button on the Key Fob in the fourth step.

- Press 1 or 2 to recall the saved positions, or press UNLOCK on the programmed Key Fob.
- Refer to the Owner's Manual on the DVD for further details.

## Manual Seat Adjustment



### Forward/Rearward

- Lift up on the adjusting bar located at the front of the seat near the floor and release at the desired position.

### Recliner

- Lean forward in the seat and lift the recliner lever, then lean back to the desired position and release the lever.
- Lift the lever to return the seatback to an upright position.

## CAUTION!

DO NOT place any article under a power seat or impede its ability to move as it may cause damage to the seat controls. Seat travel may become limited if movement is stopped by an obstruction in the seat's path.

## WARNING!

- Adjusting a seat while the vehicle is moving is dangerous. The sudden movement of the seat could cause you to lose control. The seat belt might not be properly adjusted, and you could be severely injured or killed. Only adjust a seat while the vehicle is parked.
- Do not ride with the seatback reclined so that the seat belt is no longer resting against your chest. In a collision, you could slide under the seat belt and be severely injured or killed. Use the recliner only when the vehicle is parked.

# GETTING STARTED

## REAR SEAT

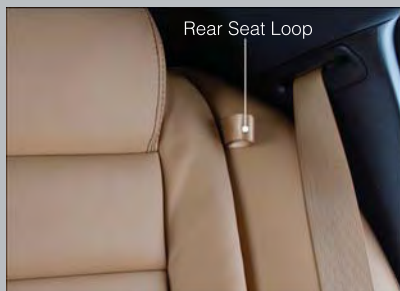

### Folding Rear Seatback

- Pull on the loops, located near the outer top of the seatbacks, to fold down either or both seatbacks. These loops can be tucked away when not in use.
- When the seatback is raised to the upright position, make sure it is latched by strongly pulling on the top of the seatback above the seat loop.

## WARNING!

- Be certain that the seatback is securely locked into position. If the seatback is not securely locked into position, the seat will not provide the proper stability for child seats and/or passengers. An improperly latched seat could cause you and others to severely injured or killed.
- The cargo area in the rear of the vehicle (with the rear seatbacks in the locked-up or folded-down position) should not be used as a play area by children when the vehicle is in motion. They could be severely injured or killed in a collision. Children should be seated and using the proper restraint system.

## HEATED SEATS

### Front Heated Seats

- The heated seats are operated using the Uconnect Touch™ System.

### Uconnect Touch™ 8.4



- Press the Controls soft-key located on the Uconnect Touch™ display.
- Press the Driver or Passenger seat soft-key once to select HI-level heating. Press the soft-key a second time to select LO-level heating. Press the soft-key a third time to shut the heating elements OFF.

- If the High-level setting is selected, the system will automatically switch to Low-level after approximately 60 minutes. The Low-level setting will turn Off automatically after approximately 45 minutes.



# GETTING STARTED

## Rear Heated Seats

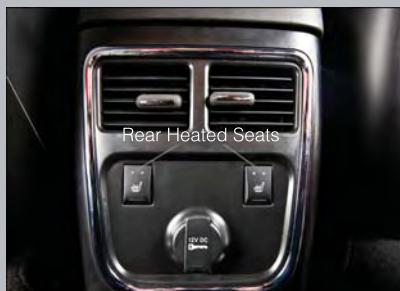

- Second row heated seat switches are located on the rear of the center console.
- Press the switch once to select High-level heating. Press the switch a second time to select Low-level heating. Press the switch a third time to shut the heating elements Off.

- If the High-level setting is selected, the system will automatically switch to Low-level after approximately 60 minutes. The Low-level setting will turn Off automatically after approximately 45 minutes.

## WARNING!

- Persons who are unable to feel pain to the skin because of advanced age, chronic illness, diabetes, spinal cord injury, medication, alcohol use, exhaustion or other physical conditions must exercise care when using the seat heater. It may cause burns even at low temperatures, especially if used for long periods of time.
- Do not place anything on the seat that insulates against heat, such as a blanket or cushion. This may cause the seat heater to overheat. Sitting in a seat that has been overheated could cause serious burns due to the increased surface temperature of the seat.

## HEATED AND COOLED CUPHOLDERS



- Your vehicle may be equipped with heated and cooled cupholders. The cupholders are designed to help keep warm beverages warm and cold beverages cool.
- Press the "Cold" symbol once to turn on the cupholder; press the symbol a second time to turn the cupholder off. Press the "Hot" symbol once to activate the cupholder; press the symbol a second time to turn off the cupholder.

# GETTING STARTED

## ADJUSTABLE PEDALS



- The adjustable pedal switch is located on the front side of the driver's seat cushion side shield.
- Press the switch forward to move the pedals forward (toward the front of the vehicle).
- Press the switch rearward to move the pedals rearward (toward the driver).

**NOTE:** The pedals cannot be adjusted when the vehicle is in REVERSE or when the Electronic Speed Control is set.

### CAUTION!

Do not place any article under the adjustable pedals or impede its ability to move, as it may cause damage to the pedal controls. Pedal travel may become limited if movement is stopped by an obstruction in the adjustable pedal's path.

### WARNING!

Do not adjust the pedals while the vehicle is moving. You could lose control and have a collision. Always adjust the pedals while the vehicle is parked.

## TILT/TELESCOPING STEERING COLUMN

### Manual - Tilt/Telescoping Steering Column



- The tilt/telescoping control handle is located below the steering wheel at the end of the steering column.
- To unlock the steering column, push the lever downward (toward the floor).
- To tilt the steering column, move the steering wheel upward or downward as desired. To lengthen or shorten the steering column, pull the steering wheel outward or push it inward as desired.
- To lock the steering column in position, push the lever upward until fully engaged.

# GETTING STARTED

## Power - Tilt/Telescoping Steering Column



- The power tilt/telescoping steering control is located below the turn signal/wiper/washer/high beam lever on the steering column.
- To tilt the steering column, move the power tilt/telescoping control up or down as desired. To lengthen or shorten the steering column, pull the control toward you or push the control away from you as desired.

### **WARNING!**

- Do not adjust the steering wheel while driving. The tilt/telescoping adjustment must be locked while driving. Adjusting the steering wheel while driving or driving without the tilt/telescoping adjustment locked could cause the driver to lose control of the vehicle. Failure to follow this warning may result in you and others being severely injured or killed.
- Moving the steering column while the vehicle is moving is dangerous. Without a stable steering column, you could lose control of the vehicle and have a collision. Adjust the column only while the vehicle is stopped.

# OPERATING YOUR VEHICLE

## ENGINE BREAK-IN RECOMMENDATIONS

- A long break-in period is not required for the engine and drivetrain (transmission and axle) in your vehicle.
- Drive moderately during the first 300 miles (500 km). After the initial 60 miles (100 km), speeds up to 50 or 55 mph (80 or 90 km/h) are desirable.
- While cruising, brief full-throttle acceleration within the limits of local traffic laws contributes to a good break-in. Wide-open throttle acceleration in low gear can be detrimental and should be avoided.
- The engine oil installed in the engine at the factory is a high-quality energy conserving type lubricant. Oil changes should be consistent with anticipated climate conditions under which vehicle operations will occur. For the recommended viscosity and quality grades, refer to “Maintaining Your Vehicle”.

**NOTE:** A new engine may consume some oil during its first few thousand miles (kilometers) of operation. This should be considered a normal part of the break-in and not interpreted as an indication of difficulty.

### CAUTION!

Never use Non-Detergent Oil or Straight Mineral Oil in the engine or damage may result.

## ENGINE BREAK-IN RECOMMENDATIONS — SRT8 VERSIONS

- A long break-in period is not required for the drivetrain (engine, transmission, and rear axle) in your new vehicle.
- Drive moderately during the first 500 mi (800 km). After the initial 60 mi (100 km), speeds up to 50 or 55 mph (80 or 90 km/h) are desirable.
- While cruising, brief full-throttle acceleration within the limits of local traffic laws contributes to a good break-in. However, wide-open throttle acceleration in low gear can be detrimental and should be avoided.
- The engine oil, transmission fluid, and axle lubricant installed at the factory is high-quality and energy-conserving. Oil, fluid, and lubricant changes should be consistent with anticipated climate and conditions under which vehicle operations will occur. For the recommended viscosity and quality grades, refer to “Maintaining Your Vehicle”.

**NOTE:** A new engine may consume some oil during its first few thousand miles (kilometers) of operation. This should be considered a normal part of the break-in and not interpreted as an indication of difficulty.

### CAUTION!

Never use Non-Detergent Oil or Straight Mineral Oil in the engine or damage may result.

# OPERATING YOUR VEHICLE

## TURN SIGNAL/WIPER/WASHER/HIGH BEAM LEVER

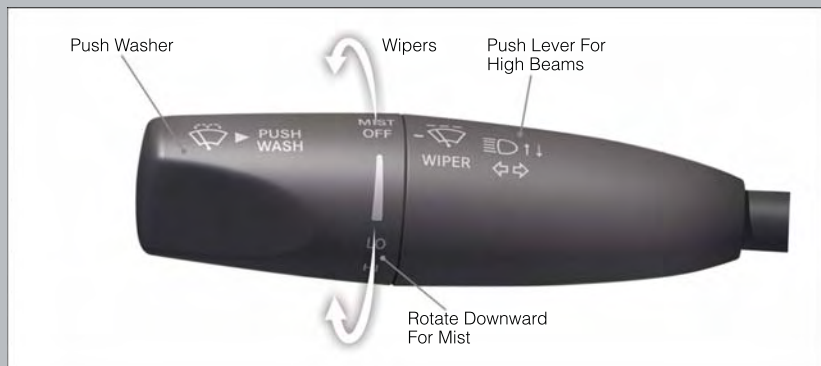

### Turn Signal/Lane Change Assist

- Tap the lever up or down once and the turn signal (right or left) will flash three times and automatically turn off.

### Front Wipers

#### Intermittent, Low And High Operation

- Rotate the end of the lever to the first detent position for one of four intermittent settings, the second detent for low wiper operation and the third detent for high wiper operation.

#### Mist

- Rotate the end of the lever downward when a single wipe is desired.

**NOTE:** The mist feature does not activate the washer pump; therefore, no washer fluid will be sprayed on the windshield. The wash function must be activated in order to spray the windshield with washer fluid.

#### Washer Operation

- Push the end of the lever inward and hold for as long as spray is desired.

#### Rain Sensing Wipers

- This feature senses moisture on the vehicle's windshield and automatically activates the wipers for the driver when the switch is in the intermittent position. Rotate the end of the lever to one of four settings to activate this feature and adjust sensitivity.
- Rain Sensing can be turned on and off using the Uconnect Touch™ System, refer to the Owner's Manual on the DVD for further details.

### High Beam Operation

- Push the lever forward to activate the high beams. Pull the lever toward you for flash to pass.



# OPERATING YOUR VEHICLE

**NOTE:** For safe driving, turn off the high beams when oncoming traffic is present to prevent headlight glare and as a courtesy to other motorists.

## HEADLIGHT SWITCH



### Automatic Headlights/Parking Lights/Headlights

- Rotate the headlight switch, located on the instrument panel to the left of the steering wheel, to the first detent from the off position for parking light  and to the second detent for headlight .

- With the parking lights or low beam headlights on, push the headlight switch for fog lights. Press the switch a second time for front and rear fog lights. Pressing the switch a third time will deactivate the rear fog lights, and a fourth time will deactivate the front fog lights. Turning the headlight switch off will also deactivate the fog lights.
- Rotate the headlight switch to “AUTO” for AUTO headlights.
- When set to AUTO, the system automatically turns the headlights on or off based on ambient light levels.

### SmartBeams™

- This system automatically controls the use of the headlight high beams. Refer to Programmable Features in Electronics for further details.

### Instrument Panel Dimmer

- Rotate the dimmer control to the extreme bottom position to fully dim the instrument panel lights and prevent the interior lights from illuminating when a door is opened.
- Rotate the dimmer control up to increase the brightness of the instrument panel and cupholders when the parking lights or headlights are on.
- Rotate the dimmer control up to the next detent position to fully brighten the odometer and radio when the parking lights or headlights are on. Refer to your Media Center/Radio User Manual on the DVD for display dimming.
- Rotate the dimmer control up to the last detent position to turn on the interior lighting.



# OPERATING YOUR VEHICLE

## Ambient Light Dimmer

- Rotate the ambient light control up or down to increase or decrease the brightness of the release handle, map pocket (if equipped), overhead and floor lighting when the parking lights or headlights are on.

## SPEED CONTROL

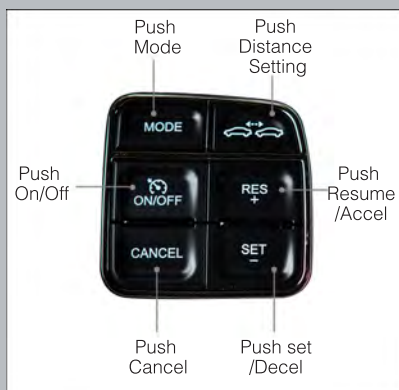

- The speed control switches are located on the steering wheel.

### Cruise ON/OFF

- Push the ON/OFF button to activate the Speed Control.
- CRUISE READY  will appear on the instrument cluster to indicate the Speed Control is on.
- Push the ON/OFF button a second time to turn the system off.

### Set

- With the Speed Control on, push and release the SET – button to set a desired speed.

### Accel/Decel

- Once a speed is set, pushing the RES + button once or the SET – button once will increase or decrease the set speed approximately 1 mph (2 km/h).
- Push and hold the RES + button to accelerate in 5mph (8 km/h) increments or push and hold the SET – button to decelerate in 5mph (8 km/h) increments; release the button to save the new set speed.

### Resume

- To resume a previously selected set speed in memory, push the RES + button and release.

### Cancel

- Push the CANCEL button, or apply the brakes to cancel the set speed and maintain the set speed memory.
- Push the ON/OFF button to turn the system off and erase the set speed memory.

### Adaptive Cruise Control (ACC)

- If your vehicle is equipped with adaptive cruise control the controls operate exactly the same as the standard cruise control with one difference. You can set a specified distance you would like to maintain between you and the vehicle in front of you.

# OPERATING YOUR VEHICLE

- If the ACC sensor detects a vehicle ahead, ACC will apply limited braking or acceleration automatically to maintain a preset following distance, while matching the speed of the vehicle ahead.
- If the sensor does not detect a vehicle directly ahead of you, it functions like a standard cruise control system, maintaining the speed you set.

## Distance Setting (ACC Only)

- To set or change the distance setting, press the Distance button and release. Each time the button is pressed, the distance setting adjusts between long (3), medium (2), and short (1). The distance setting will default to the last set mode the next time the vehicle is restarted and the ACC system is turned on.
- The specified following distance for ACC can be set by varying the distance setting between 3 (long), 2 (medium), and 1 (short). Using this distance setting and the vehicle speed, ACC calculates and sets the distance to the vehicle ahead. This distance setting displays in the EVIC.

## Mode (ACC Only)

- If desired, the Adaptive Cruise Control mode can be turned off and the system can be operated as a standard (fixed speed) Cruise Control. When in the standard (fixed speed) Cruise Control mode the distance setting feature will be disabled and the system will maintain the speed you set.
- To change modes, press the MODE button when the system is in either the OFF, READY, or SET position. Cruise Ready will be displayed if the system was in ACC READY or ACC SET position. Cruise Off will be displayed if the system was in the ACC OFF position. To switch back to Adaptive Cruise Control mode, press the MODE button a second time.
- Refer to your Owner's Manual on the DVD for further information.

## Forward Collision Warning

- The Forward Collision Warning (FCW) system provides the driver with audible and visual warnings within the Electronic Vehicle Information Center (EVIC) when it detects a potential frontal collision. The warnings are intended to provide the driver with enough time to react and avoid the potential collision.

### Changing FCW Status

- The FCW feature has three settings and can be changed within the Uconnect Touch™ system.
  - Far
  - Near
  - Off

**NOTE:** The FCW settings can only be changed when the vehicle is in PARK.

### Far

- The default status of FCW is the “Far” setting.
- The far setting provides warnings for potential collisions more distant in front of the vehicle, allowing the driver to have the most reaction time to avoid a collision.

# OPERATING YOUR VEHICLE

- This setting is designed to provide early warnings per NHTSA (National Highway Traffic Safety Administration) recommendations.
- More cautious drivers that do not mind frequent warnings may prefer this setting.

**NOTE:** This setting gives you the most reaction time.

## **Near**

- Changing the FCW status to the “Near” setting, allows the system to warn you of a potential frontal collision when you are much closer.
- This setting provides less reaction time than the “Far” setting, which allows for a more dynamic driving experience.
- More dynamic or aggressive drivers that want to avoid frequent warnings may prefer this setting.

## **Off**

- Changing the FCW status to “Off” prevents the system from warning you of a potential frontal collision.

## **NOTE:**

- If FCW is set to “Off”, “FCW OFF” will be displayed in the EVIC.

Refer to the Owner's Manual on the DVD for further details.

## **WARNING!**

- Leaving the Electronic or Adaptive Speed Control system on when not in use is dangerous. You could accidentally set the system or cause it to go faster than you want. You could lose control and have a collision. Always leave the Electronic or Adaptive Speed Control system off when you are not using it.
- Electronic Speed Control can be dangerous where the system cannot maintain a constant speed. Your vehicle could go too fast for the conditions, and you could lose control. A collision could be the result. Do not use Electronic Speed Control in heavy traffic or on roads that are winding, icy, snow-covered or slippery.
- Adaptive Cruise Control (ACC) is a convenience system. It is not a substitute for active driving involvement. Pay attention to road, traffic, and weather conditions, vehicle speed, distance to the vehicle ahead; and, brake operation to ensure safe operation of the vehicle under all road conditions. Your attention is always required while driving to maintain safe control of your vehicle. Failure to follow these warnings can result in a collision or serious personal injury.

The ACC system:

- Does not react to pedestrians, oncoming vehicles, and stationary objects (i.e., a stopped vehicle in a traffic jam or a disabled vehicle).
- Cannot take street, traffic, and weather conditions into account, and may be limited upon adverse sight distance conditions.

*(Continued)*

# OPERATING YOUR VEHICLE

## WARNING! *(Continued)*

- Does not predict the lane curvature or the movement of preceding vehicles and will not compensate for such changes.
- Does not always fully recognize complex driving conditions, which can result in wrong or missing distance warnings.
- May not detect a vehicle ahead when strong light (for example, sunrise or sunset) is directly shining on the front of the vehicle.
- Can only apply a maximum of 25% of the vehicle's braking capability, and will not bring the vehicle to a complete stop.

You should switch off the ACC system:

- When driving in fog, heavy rain, heavy snow, sleet, heavy traffic, and complex driving situations (i.e., in highway construction zones).
- When entering a turn lane or highway off ramp; when driving on roads that are winding, icy, snow-covered, slippery, or have steep uphill or downhill slopes; and when towing a trailer.
- When circumstances do not allow safe driving at a constant speed.
- Failure to follow these warnings can result in a collision.
- Forward Collision Warning (FCW) is not intended to avoid a collision on its own. The driver has the responsibility to avoid a collision by controlling the vehicle via braking and steering. Failure to follow this warning could lead to serious injury or death.

## ELECTRONIC SHIFTER – 3.6L ENGINE

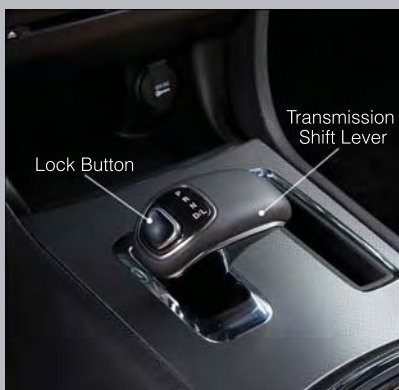

- Your new vehicle is equipped with a state of the art, fuel efficient 8 speed transmission. The electronic shift lever in this vehicle does not slide like a conventional shifter. Instead, the shift lever is spring loaded and moves forward and rearward, always returning to the center position after each gear is selected.
- The transmission gear (PRND) is displayed both on the shift lever and in the Electronic Vehicle Information Center (EVIC).

# OPERATING YOUR VEHICLE



## Shifting From PARK to DRIVE

- Firmly depress the brake pedal, press the lock button on the shift lever, then pull and hold the shift lever fully rearward until “D” is displayed in the EVIC.
- To shift back into PARK from DRIVE, bring the vehicle to a complete stop, fully depress the brake pedal, press the lock button on the shift lever, then push and hold the shift lever fully forward until “P” is displayed in the EVIC.

## Shifting From REVERSE to NEUTRAL

- Pull the shift lever rearward to the first detent and release. “N” will display in the EVIC.
- To shift back into REVERSE from NEUTRAL, firmly depress the brake pedal, press the lock button on the shift lever, then push the shift lever forward to the first detent and release. “R” will display in the EVIC.

## Shifting From NEUTRAL to DRIVE

- Firmly depress the brake pedal, press the lock button on the shift lever, then pull the shift lever rearward and release. “D” will display in the EVIC.
- To shift back into NEUTRAL from DRIVE, firmly depress the brake pedal, press the lock button on the shift lever, then push the shift lever forward and release. “N” will display in the EVIC.

## Shifting From REVERSE to DRIVE

- Bring the vehicle to a complete stop, firmly depress the brake pedal, press the lock button on the shift lever, then pull the shift lever rearward and release when “D” is displayed in the EVIC.
- To shift back into REVERSE from DRIVE, bring the vehicle to a complete stop, firmly depress the brake pedal, press the lock button on the shift lever, then push the shift lever forward and release when “R” is displayed in the EVIC.

## Shifting From DRIVE to SPORT/LOW

### Vehicles Equipped with SPORT Mode

- To shift from DRIVE to SPORT, pull the shift lever rearward until “S” is displayed in the EVIC.
- To shift back into DRIVE from SPORT, pull the shift lever rearward until “D” is displayed in the EVIC.

# OPERATING YOUR VEHICLE

## Vehicles Equipped with LOW Mode

- To shift from DRIVE to LOW, pull the shift lever rearward until “L” is displayed in the EVIC.
- To shift back into DRIVE from LOW, pull the shift lever rearward until “D” is displayed in the EVIC.

## TRANSMISSION MODES/AUTOSTICK®

- AUTOSTICK® is only available on sport equipped vehicles.

### For Vehicles Equipped With Sport Mode

- This mode is driver selectable and will provide more aggressive shifting and is intended for spirited driving.
- Shifting into SPORT mode can be done anytime the vehicle is in the “D” Drive position. Simply pull the shift lever and release when “S” is displayed in the EVIC. Pulling the shift lever rearward a second time will return the vehicle to the “D” Drive position.

**NOTE:** When the vehicle is in SPORT mode, there is a green “sport flag” illuminated in the instrument cluster.

### For Vehicles Equipped With Low Mode

- This range should be used for engine braking when descending very steep grades. In this range, the transmission will downshift for increased engine braking. To switch between DRIVE and LOW mode, pull the shift lever rearward and release when “L” is displayed in the EVIC.
- Shifting into LOW can be done anytime the vehicle is in “D” DRIVE position.

## AUTOSTICK®

- When the transmission is in DRIVE, it will operate automatically, shifting between the eight available gears. While in SPORT mode, the transmission will only shift between seven of the eight available gears.
- To engage AutoStick®, simply tap one of the steering wheel-mounted shift paddles (+/-).
- In AutoStick® mode, the transmission will only shift up or down when (+/-) is manually selected by the driver, except as described below. It will remain in the selected gear until another upshift or downshift is chosen.
- When AutoStick® is active, the current transmission gear is displayed in the EVIC.
- If AutoStick® is engaged while in DRIVE mode, lack of accelerator pedal activity will cause the transmission to revert to automatic operation. The transmission will also upshift automatically once redline, (where the tachometer needle points to the red portion of the gauge) is reached. If the accelerator is pressed to the floor, the transmission will downshift when possible (based on current vehicle speed and gear).
- When AutoStick® is used in SPORT mode, the transmission will only shift up or down when commanded by the driver, except as noted below.



# OPERATING YOUR VEHICLE

- In either DRIVE or SPORT mode, the transmission will automatically downshift as the vehicle slows to a stop (to prevent engine lugging) and will display the current gear. Tapping the (+) paddle (at a stop) will allow starting in second gear. After a stop, the driver should manually upshift (+) the transmission as the vehicle accelerates.

**NOTE:** To disengage AutoStick® mode, press and hold the (+) shift paddle until “D” or “S” is once again displayed in the EVIC. You can shift in or out of the AutoStick® mode at any time without taking your foot off the accelerator pedal.

## CLIMATE CONTROLS

### Uconnect Touch™ 4.3 Manual Climate Controls



# OPERATING YOUR VEHICLE

## Uconnect Touch™ 8.4 Automatic Climate Controls



### Climate Control Knobs

- For your convenience the climate controls can also be operated by using the soft-keys located on the touch screen or the climate control knobs below the Uconnect Touch display.

# OPERATING YOUR VEHICLE



## Automatic Operation

- Press the AUTO button.
- Select the desired temperature by pressing the Temperature Control buttons.
- The system will maintain the set temperature automatically.

## Air Conditioning (A/C)

- If the air conditioning button is pressed while in the AUTO mode, the system will enter manual mode with the air conditioning on.

## Air Recirculation

- Use recirculation for maximum A/C operation.
- For window defogging, turn the recirculation button off.
- If the recirculation button is pressed while in the AUTO mode, the indicator light may flash three times to indicate the cabin air is being controlled automatically.

## Heated Mirrors

- The mirrors are heated to melt frost or ice. This feature is activated whenever you turn on the rear window defroster.

# OPERATING YOUR VEHICLE

## POWER SUNROOF

**Express Open:** Press the switch rearward and release. The sunroof will fully open and stop automatically.

**Express Close:** Press the switch forward and release. The sunroof will close automatically from any position.

**Express Venting:** Press and release the "VENT" button, and the sunroof will open to the vent position.



The power sunroof switches are located on the overhead console.

### Manual Open/Close

- Press and hold the switch rearward to open or forward to close the sunroof. Any release of the switch will stop the movement, and the sunroof will remain in a partially open or closed position until the switch is pressed again.

### Pinch Protection Feature

- This feature will detect an obstruction in the opening of the sunroof or the shade during Express Close operation. If an obstruction in the path of the sunroof or shade is detected, the sunroof or shade will automatically return to the open position.

**NOTE:** Pinch protection is disabled while the switch is pressed and held during manual opening and closing of the sunroof or shade.

## WARNING!

- Never leave children in a vehicle with the key in the ignition switch. Occupants, particularly unattended children, can become entrapped by the power sunroof while operating the power sunroof switch. Such entrapment may result in serious injury or death.
- In a collision, there is a greater risk of being thrown from a vehicle with an open sunroof. You could also be severely injured or killed. Always fasten your seat belt properly and make sure all passengers are properly secured.
- Do not allow small children to operate the sunroof. Never allow your fingers, other body parts, or any object to project through the sunroof opening. Injury may result.

## WIND BUFFETING

- Wind buffeting can be described as a helicopter-type percussion sound. If buffeting occurs with the rear windows open, adjust the front and rear windows together.
- If buffeting occurs with the sunroof open, adjust the sunroof opening, or adjust any window. This will minimize buffeting.

# ELECTRONICS

## YOUR VEHICLE'S SOUND SYSTEM



Uconnect™ Voice  
Command Button

Uconnect™  
Phone Button

Next Station  
or CD Track

Next Radio  
Preset

Previous Station  
or CD Track

Steering Wheel  
Audio Controls  
(left rear surface  
of steering wheel)



# ELECTRONICS



# ELECTRONICS

## IDENTIFYING YOUR RADIO

### Uconnect Touch™ 4.3 & 4.3S



- Models 4.3 and 4.3S have a 4.3 inch touch screen with hard-keys to each side of it.
- Model 4.3S has all Model 4.3 features, plus Sirius XM™ Satellite Radio (1 year trial subscription included).
- Model 4.3S is identified by the presence of SAT on the band button, indicating the presence of satellite radio.

### Uconnect Touch™ 8.4 & 8.4N



- Models 8.4 and 8.4N have an 8.4 inch touch screen.
- Model 8.4N has all Model 8.4 features, plus Garmin® Navigation and Sirius Travel Link (1-year trial subscription included).
- Model 8.4N is identified by the unique Nav button on the main screen menu bar, located at the bottom of the screen, and the presence of Travel Link within the More menu.

## Uconnect TOUCH™ 4.3 & 4.3S AT A GLANCE



### Displaying the Time

- If the time is not currently displayed at the top of the screen when in Radio mode, press the Settings button, then touch clock. Select Show Time, then touch On.

### Setting the Time

- Press the Settings hard-key, then touch the Clock soft-key.
- Touch the Set the Time soft-key.
- Touch the up or down soft-keys to adjust the hours, minutes or AM/PM.

**NOTE:** 12hr format and 24hr format can also be set.

- Once the time is set press the "Done" soft-key to exit the time screen.

### Audio Settings

- Press the SETTINGS hard-key on the right side of the unit.
- Then scroll down and press the Audio soft-key to get to the Audio menu.
- The Audio Menu shows the following options for you to customize your audio settings.
  - Equalizer
  - Balance/Fade
  - Speed Adjust Volume
- Touch the Exit soft-key to exit from the Audio Menu.

# ELECTRONICS

## Equalizer

- Touch the Equalizer soft-key to adjust the Bass, Mid and Treble. Use the + or - soft-key to adjust the equalizer to your desired settings. Press the back arrow soft-key when done.

## Balance/Fade

- Touch the Balance/Fade soft-key to adjust the sound from the speakers. Use the arrow soft-key to adjust the sound level from the front and rear or right and left side speakers. Touch the Center "C" soft-key to reset the balance and fade to the factory setting. Press the back arrow soft-key when done.

## Speed Adjust Volume

- Touch the Speed Adjust Volume soft-key to select between OFF, 1, 2 or 3. This will decrease the radio volume relative to a decrease in vehicle speed. Press the back arrow soft-key when done.

## UCONNECT TOUCH™ 8.4 & 8.4N AT A GLANCE



## Displaying the Time

- If the time is not currently displayed on the radio or player main page, touch the More soft-key and then touch the Settings soft-key. In the Settings list, touch the Clock soft-key then touch the check box next to Show Time in Status Bar.

## Setting the Time

- Model 8.4N synchronizes time automatically via GPS, so should not require any time adjustment. If you do need to set the time manually, follow the instructions below for Model 8.4.
- For Model 8.4, turn the unit on, then touch the time display at the top of the screen. Touch Yes.
- If the time is not displayed at the top of the screen, touch More soft-key and then Settings soft-key. In the Settings screen, touch the Clock soft-key, then check or uncheck this option.
- Touch + or – next to Set Time Hours and Set Time Minutes to adjust the time.
- If these features are not available, uncheck the Sync with GPS box.
- Touch X to save your settings and exit out of the Clock Setting screen.

## Audio Settings

- Touch the Audio soft-key to activate the Audio settings screen to adjust Balance\Fade, Equalizer, and Speed Adjusted Volume.
- You can return to the Radio screen by touching the X located at the top right.

### Balance/Fade

- Touch the Balance/Fade soft-key to Balance audio between the front speakers or fade the audio between the rear and front speakers.
- Touching the Front, Rear, Left, or Right soft-keys or touch and drag the red Speaker Icon to adjust the Balance/Fade.

### Equalizer

- Touch the Equalizer soft-key to activate the Equalizer screen.
- Touch the + or - soft-keys, or by touching and dragging over the level bar for each of the equalizer bands. The level value, which spans between  $\pm 9$ , is displayed at the bottom of each of the Bands.

### Speed Adjusted Volume

- Touch the Speed Adjusted Volume soft-key to activate the Speed Adjusted Volume screen. The Speed Adjusted Volume is adjusted by touching the + and - buttons or by touching and dragging over the level bar. This alters the automatic adjustment of the audio volume with variation to vehicle speed.

# ELECTRONICS

## RADIO



### Models 4.3 & 4.3S

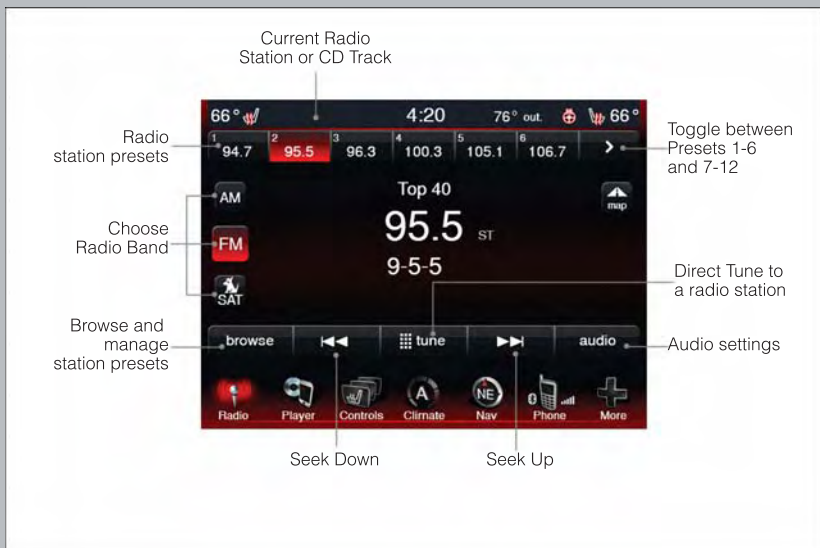

### Models 8.4 & 8.4N



- To access the Radio mode, touch the Radio hard-key on the upper left side of the faceplate (4.3 & 4.3S) or the Radio soft-key at the lower left of the screen (8.4 & 8.4N).
- Unless otherwise noted, the information provided on the operation and functionality of the radios in this section is common to all Uconnect Touch™ radios.

## Selecting Radio Stations

- Touch the Radio band soft-key to cycle through AM, FM or SAT (4.3 & 4.3S) or the desired radio band (AM, FM or SAT) soft-key (8.4 & 8.4N). Satellite Radio is not available on the 4.3.

## Seek Up/Seek Down

- Touch the Seek arrow soft-keys for less than two seconds to seek through radio stations.
- Touch and hold either arrow soft-key for more than two seconds to bypass stations without stopping. The radio will stop at the next listenable station once the arrow soft-key is released.

## Direct Tune

- Tune directly to a radio station by pressing the “Tune” button on the screen, and entering the desired station number.

## Store Radio Presets

- Your radio can store 12 total preset stations. They are shown at the top of your screen. To see all 12 stations, Press the all soft-key (4.3 & 4.3S) or press the arrow soft-key at the top right of the screen to toggle between the six presets (8.4 & 8.4N).
- To set a station into memory press and hold the desired numbered soft-key for more than two seconds or until you hear a confirmation beep.

## SIRIUS XM™ SATELLITE RADIO

- Sirius XM™ Satellite Radio gives you over 130 channels, including 100% commercial-free music from nearly every genre, plus all your favorite sports, news, talk and entertainment channels –all with crystal clear, coast-to-coast coverage, all in one place and all at your fingertips.
- To access Sirius XM™ Satellite Radio, touch the Radio band soft-key and select the SAT soft-key (4.3S) or touch the SAT soft-key on the main Radio screen (8.4 & 8.4N).
- The following describes features that are available when in Sirius XM™ Satellite Radio mode.
- Unless otherwise noted, the information provided on the operation and functionality of the radios in this section is common to all Uconnect Touch™ radios.

## Selecting Sirius XM™ Satellite Channels

### Seek Up/Seek Down

- Touch the Seek arrow soft-keys for less than 2 seconds to seek through channels in SAT mode.
- Touch and hold either arrow soft-key for more than 2 seconds to bypass channels without stopping. The radio will stop at the next listenable channel once the arrow soft-key is released.

### Direct Tune

- Tune directly to a SAT channel by pressing the “Tune” button on the screen, and entering the desired station number.

### Info (4.3S Only)

- Provides detailed information about the current Sirius XM™ Satellite channel.

### More... (4.3S Only)

- Access more menus: Audio, Favorites, Game Zone, and Replay.

### Jump (8.4 & 8.4N Only)

- Automatically tells you when Traffic & Weather for a favorite city is available, and gives you the option to switch to that channel. Touch Jump to activate the feature. After listening to Traffic and Weather, touch Jump again to return to the previous channel.

### Fav (8.4 & 8.4N Only)

- Activates the favorites menu. You can add up to 50 favorite artists or songs. Just touch Add Fav Artist or Add Fav Song while the song is playing. You will then be alerted any time one of these songs, or works by these artists, is playing on other Sirius XM™ channels.

### Sirius XM™ Parental Controls

- You can skip or hide certain channels from view if you do not want access to them. Press the Settings hard-key (4.3S) or touch the More soft-key, then the Settings soft-key (8.4 & 8.4N), next touch the Sirius Setup soft-key, then select Channel Skip. Touch the channel(s) to be skipped (4.3S) or touch the box, check-mark, next to the channel you want skipped (8.4 & 8.4N). They will not show up in normal usage.
- Sirius XM™ also offers the option to permanently block selected channels. Call 1-888-539-7474 and request the Family Package.

## Browse

- Lets you browse the Sirius XM™ channel listing, Favorites, Genres, Game Zone, and Weather channels. Jump setting, and also provides the Sirius XM™ channel list. Browse contains many sub-menus.

Browse Sub-Menu	Sub-Menu Description
All	Shows the channel listing.
Genre	Provides a list of all genres, and lets you jump to a channel within the selected genre.
Presets (8.4 & 8.4N Only)	Lets you scroll the list of Preset satellite channels. Touch the channel, or press Enter on the Tune knob, to go to that channel. Touch the trash can icon to delete a preset. Your presets are also shown at the top of the main Satellite Radio screen.
Favorites	Lets you manage artists and songs in the Favorites list and configure Alert Settings to let you know when favorite songs or artists are playing on other channels). Also, view a list of channels airing any of your Favorites.
Game Zone	Provides alerts when your favorite sports teams are starting a game which is being aired on other Sirius XM™ channels, or when their game score is announced. You can select and manage your Teams list here, and configure alerts.
Traffic/Weather (4.3S only)	Lets you browse Traffic & Weather information by city.
Jump (8.4 & 8.4N only)	Lets you select your favorite cities for Traffic & Weather information, which is used by the Jump feature on the main satellite radio screen.

## Replay

- Lets you replay up to 44 minutes of the content of the current Sirius XM™ channel.

Replay Option	Option Description
Play/Pause	Touch to Pause content playback. Touch Pause/Play again to resume playback.
Rewind/RW	Rewinds the channel content in steps of 5 seconds. Touch and hold to rewind continuously, then release to begin playing content at that point.
Fast Forward/FW	Forwards the content, and works similarly to Rewind/RW. However, Fast Forward/FW can only be used when content has been previously rewound
Replay Time	Displays the amount of time in the upper center of the screen by which your content lags the Live channel.
Live	Resumes playback of Live content at any time while replaying rewound content.

# ELECTRONICS

## iPod®/CD/AUX CONTROLS

Models 4.3 & 4.3S

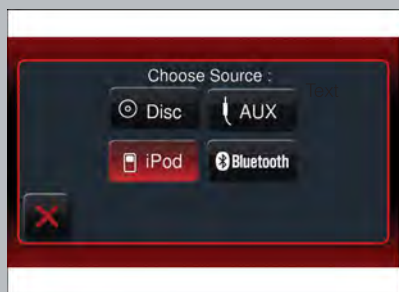
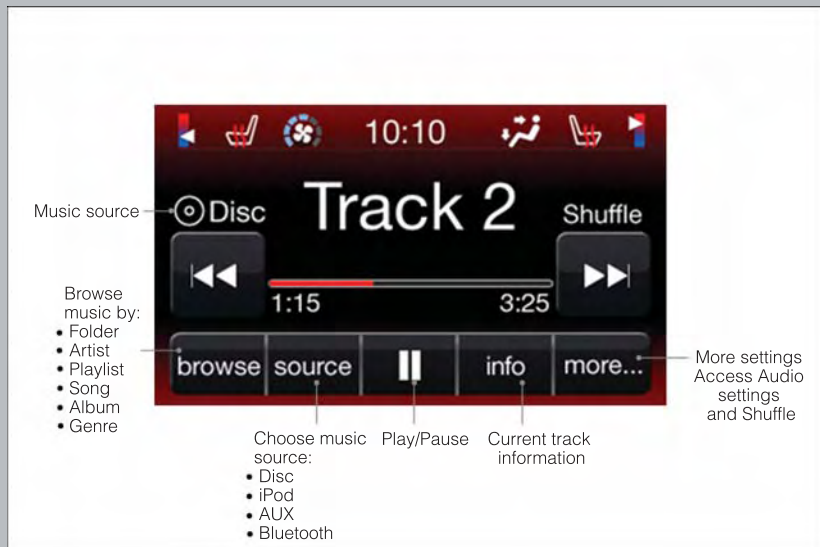

- The iPod®/CD/AUX controls are accessed by pressing the Player hard-key to enter the Player main screen, then touch the source soft-key and choose between Disc, AUX, iPod® or Bluetooth.

**NOTE:** Uconnect Touch™ will usually automatically switch to the appropriate mode when something is first connected or inserted into the system.

## Models 8.4 & 8.4N

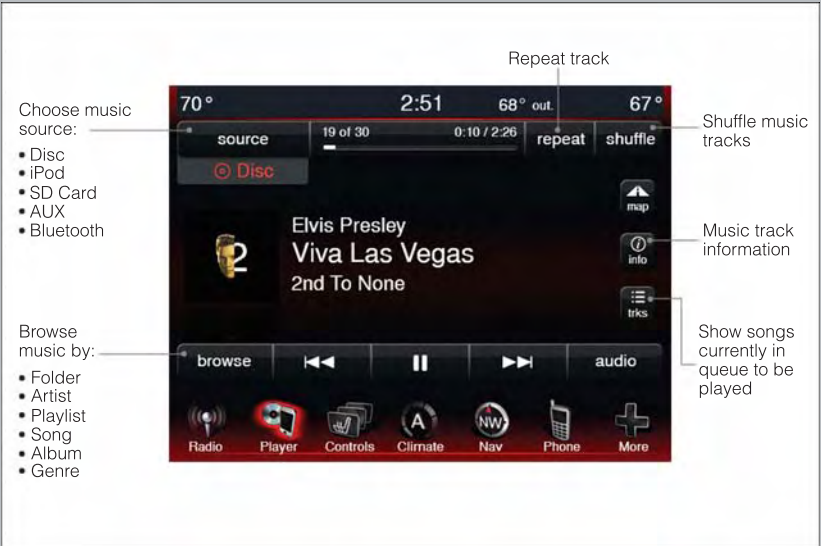

- The iPod®/USB, CD, Audio Jack, SD Card or Bluetooth® source is accessed by touching the Player soft-key to enter the Player main screen, then touch the source soft-key and choose between Disc, Aux, iPod®, Bluetooth or SD Card.

**NOTE:** Uconnect Touch™ will usually automatically switch to the appropriate mode when something is first connected or inserted into the system.

## GARMIN® NAVIGATION (8.4N ONLY)

- Uconnect Touch 8.4N integrates Garmin's consumer-friendly navigation into your vehicle. Garmin Navigation includes Lane Assist and Junction View, Speed Limit information, and a database with over 6 million points of interest.
- Touch the NAV soft-key in the menu bar to access the Navigation system

## Main Navigation Menu



## Acquiring Satellites

- The GPS Satellite strength bars indicate the strength of your satellite reception.
- Acquiring satellite signals can take a few minutes. When at least one of the bars is green, your device has acquired satellite signals. If no signal is found the Navigation system still can operate with internal gyro direction & location based on data provided by the vehicle.
- Dead Reckoning technology uses the speed sensors attached to your vehicle's drivetrain and a gyroscope to supplement the existing GPS data. The combined data provides accurate positioning for your vehicle in tunnels, indoor parking garages, urban canyons, and any other area where GPS signals can become obstructed.

## Finding Points of Interest

- From the main Navigation menu, touch Where To?, then touch Points of Interest.
- Select a Category and then a subcategory, if necessary.
- Select your destination and touch Go.

## Finding a Place by Spelling the Name

- From the Main Navigation Menu, touch Where to?, then touch Points of Interest and then touch Spell Name.
- Enter the name of your destination.
- Touch Done.
- Select your destination and touch Go.



## **Entering a Destination Address**

- From the main Navigation menu, touch Where To?, then touch Address.
- Follow the on-screen prompts to enter the address and touch Go.

## **Searching Near Another Location**

- From the main Navigation menu, touch Where To?, then touch a destination and then touch Near.
- Select an option from the available choices.

## **Setting or Editing Your Home Location**

- Touch the NAV soft-key in the menu bar to access the Navigation system and the Main Navigation menu.
- Touch Where To?, then touch Go Home.
- You may enter your address directly, use your current location as your home address, or choose from recently found locations.
- To edit your Home location (or other saved locations), touch Where To? from the Main Navigation menu, then touch Favorites, and touch the location you want to edit. After selecting a location to edit, touch Press for More, then Edit.

## **Go Home**

- A Home location must be saved in the system. From the Main Navigation menu, touch Where To?, then touch Go Home.

## Following Your Route

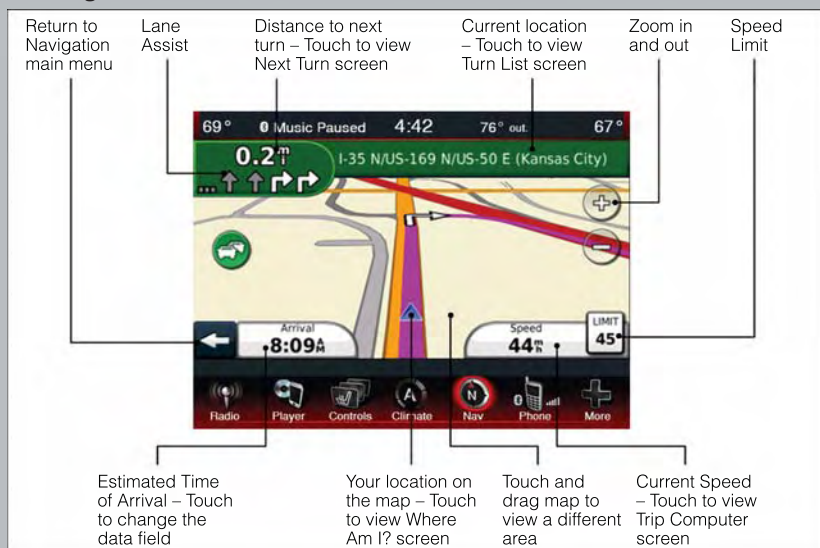

- Your route is marked with a magenta line on the map. If you depart from the original route, your route is recalculated. A speed limit icon could appear as you travel on major roadways.
- Lane Assist helps you decide which lane to be in at upcoming junctions.
- Junction View gives you an expanded view as junctions approach.

## Adding a Via Point

- To add a via point you must be navigating a route
- Touch the back arrow to return to the Main Navigation menu.
- Touch Where To?, then search for the via point. Then select the via point to add from the search results.
- Touch Go, then touch Add as a Via Point.

## Taking a Detour

- To take a detour you must be navigating a route
- Touch Detour

**NOTE:** If the route you are currently taking is the only reasonable option, the device might not calculate a detour.

**SIRIUS TRAVEL LINK (8.4N ONLY)**

- Sirius Travel Link brings a wealth of useful information into your vehicle and right to your fingertips.
- To access Travel Link, touch More soft-key, then the Travel Link soft-key

**NOTE:**

- Sirius Travel Link requires a subscription, sold separately after the 1 year trial subscription included with your vehicle purchase.
- Sirius Travel Link is only available in the United States.



<b>1 – Fuel Prices</b>	View detailed price information for fuel stations near your current location.
<b>2 – Movie Listings</b>	View information on movies that are playing at theaters near your current location.
<b>3 – Sports Scores</b>	View scores and upcoming events for all major sports.
<b>4 – SIRIUS</b>	View subscription information.
<b>5 – My Favorites</b>	View and store your favorite location, theater and sport teams for quick access.
<b>6 – Weather</b>	View detailed weather conditions, forecasts and ski/snowboarding conditions at local resorts.

# ELECTRONICS

## PLAYING iPod/USB/MP3 DEVICES

- There are many ways to play music from iPod®/MP3 players or USB devices through your vehicle's sound system.



### 1. Audio Jack

- The Audio Jack allows a portable device, such as an MP3 player or a cassette player, to be plugged into the radio and utilize the vehicle's sound system, using a 3.5 mm audio cable, to amplify the source and play through the vehicle speakers.
- Touching the Player soft-key then choose AUX source will change the mode to auxiliary device if the Audio Jack is connected, allowing the music from your portable device to be heard through the vehicle's speakers.
- The functions of the portable device are controlled using the device buttons. The volume may be controlled using the radio or portable device.
- To route the audio cable out of the center console, use the access cut out in the front of the console.

### 2. USB Port

- Connect your iPod® or compatible device using a USB cable into the USB Port. USB Memory sticks with audio files can also be used. Then, audio from the device can be played on the vehicles sound system while providing metadata (artist, track title, album, etc.) information on the radio display.
- When connected, the iPod®/compatible USB device can be controlled using the radio or Steering Wheel Audio Controls to play, skip to the next or previous track, browse, and list the contents.

- The iPod® battery charges when plugged into the USB port (if supported by the specific device).
- To route the USB/iPod® cable out of the center console, use the access cut out in the front of the console.

**NOTE:**

- When connecting your iPod® device for the first time, the system may take several minutes to read your music, depending on the number of files. For example, the system will take approximately 5 minutes for every 1000 songs loaded on the device. Also during the reading process, the Shuffle and Browse functions will be disabled. This process is needed to ensure the full use of your iPod® features and only happens the first time it is connected. After the first time, the reading process of your iPod® will take considerably less time unless changes are made or new songs are added to the playlist.
- The USB port supports certain Mini, Classic, Nano, Touch, and iPhone® devices. The USB port also supports playing music from compatible external USB Mass Storage Class memory devices. Some iPod® software versions may not fully support the USB port features. Please visit Apple's website for iPod® software updates.

### 3. SD Card (8.4 & 8.4N Only)

- Play songs stored on an SD card inserted into the SD card slot.
- Song playback can be controlled using the radio or Steering Wheel Audio Controls to play, skip to the next or previous track, browse, and list the contents.

### 4. Bluetooth® Streaming Audio

- If equipped with Uconnect™ Voice Command, your Bluetooth-equipped iPod® devices, cell phones or other media players, may also be able to stream music to your vehicle's sound system. Your connected device must be Bluetooth-compatible, and paired with your Uconnect Touch® system (see Uconnect™ Phone for pairing instructions). You can access the music from your connected Bluetooth® device by touching the Source soft-key while in Player mode.

## UCONNECT™ PHONE (BLUETOOTH® HANDS FREE CALLING)

- If the Uconnect™ Phone  Button exists on your steering wheel, then you have the Uconnect™ Phone features.
- The Uconnect™ Phone is a voice-activated, hands-free, in-vehicle communications system with Voice Command Capability (see Voice Command section).
- The Uconnect™ Phone allows you to dial a phone number with your mobile phone using simple voice commands or using screen soft-keys.
- Refer to the Understand The Features Of Your Vehicle section of your vehicle's Owner's Manual on the DVD for further details.

**NOTE:** The Uconnect™ Phone requires a mobile phone equipped with the Bluetooth® Hands-Free Profile, Version 1.0 or higher. For Uconnect™ customer support, call 1-877-855-8400 or visit [www.UconnectPhone.com](http://www.UconnectPhone.com).

## Pairing a Phone

- To use the Uconnect™ Phone feature, you must first pair your bluetooth phone with the Uconnect™ system.

### Start pairing procedure on the radio

- Models 8.4, 8.4N: Touch the Phone soft-key and then the Settings soft-key. Next, touch Add Device.
- Models 4.3, 4.3S: Press the More hard-key, then touch the Phone soft-key. Next, touch the settings soft-key and then Add Device.
- Uconnect™ Phone will display an “In progress” screen while the system is connecting.

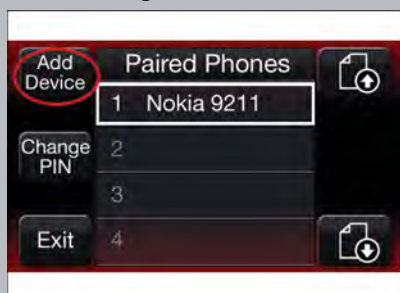

### Models 4.3 & 4.3S



### Models 8.4 & 8.4N

### Start pairing procedure on mobile phone

- Search for available devices on your Bluetooth® enabled mobile phone. This is usually within Settings or Options under “Bluetooth”. See your mobile phone’s manual for details.
- When your phone finds the system, select “Uconnect” as the paired device.



## Complete the pairing procedure

- When prompted on the phone, enter the 4-digit PIN number shown on the Uconnect Touch™ Screen.
- If your phone asks you to accept a connection request from Uconnect, select "Yes". If available, check the box telling it not to ask again – that way your phone will automatically connect each time you start the vehicle.

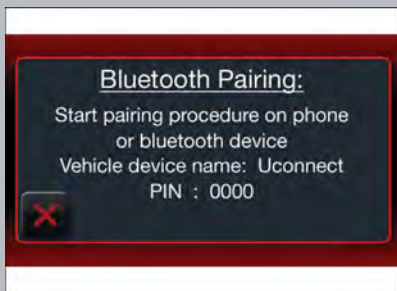

## Models 4.3 & 4.3S

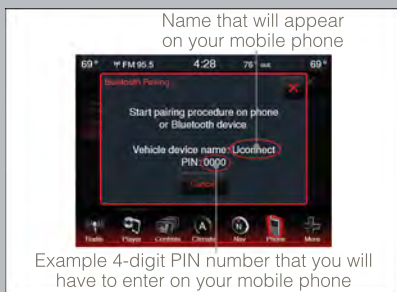

Example 4-digit PIN number that you will have to enter on your mobile phone

## Models 8.4 & 8.4N

## Select the mobile phone's priority level

- When the pairing process has successfully completed, the system will prompt you to choose whether or not this is your favorite phone. Selecting Yes will make this phone the highest priority. This phone will take precedence over other paired phones within range. Only one phone can be paired at a time.
- You are now ready to make hands-free calls. Press the Uconnect™ Phone button on your steering wheel to begin.

## Phone Menu Screen – Models 4.3 & 4.3S



## Phone Menu Screen – Models 8.4 & 8.4N





### Making A Phone Call

- Press the Uconnect™ Phone button .
- (After the BEEP), say “dial” then the number (or “call” then the name as listed in your phone; see Phonebook below).

**NOTE:** You can also initiate a call by using the touch-screen on the Phone main screen.

### Receiving A Call – Accept (And End)

- When an incoming call rings/is announced on Uconnect™, press the Phone button .
- To end a call, press the Phone button .

### Mute (Or Unmute) Microphone During Call

- During a call, touch the mute soft-key on the Phone main screen to mute and unmute the call.

### Transfer Ongoing Call Between Handset And Vehicle

- During a call, touch the Transfer soft-key on the Phone main screen to transfer an on going call between handset and vehicle.

### Common Phone Commands

“Call John Smith”  
 “Call John Smith mobile”  
 “Dial 1 248 555 12XX”  
 “Call Emergency”  
 “Call Towing Assistance”  
 “Redial”

### Phonebook

- Uconnect Touch™ radios will automatically download your phonebook from your paired phone, if this feature is supported by your phone. Entries are updated each time that the phone is paired. If your phone book entries do not appear, check the settings on your phone. Some phones require you to enable this feature manually.
- Your phonebook can be browsed on your radio screen, but editing can only be done on your phone. To browse, touch the Phone soft-key, then the Phonebook soft-key.
- Favorite phonebook entries can be saved as Favorites for quicker access. Favorites are shown at the top of your main phone screen (8.4 & 8.4N Only).



### Voice Command Tips

- Use longer names that are less easily mistaken for others. For examples, say “Call John Doe” instead of “Call John”.
- You can “chain” commands together for faster results. Say “Call John Doe, mobile”, for example.
- You can interrupt while the system is talking to you, enabling you to say your response without waiting. Just press the  VR button on the steering wheel to say your command.

# ELECTRONICS

## Changing The Volume

- Start a dialogue by pressing the Phone button , then say a command for example - "Help".
- Use the radio ON/OFF VOLUME rotary knob to adjust the volume to a comfortable level while the Uconnect™ system is speaking. Please note the volume setting for Uconnect™ is different than the audio system.

**NOTE:** To access help, press the Uconnect™ Phone  button on the steering wheel and say "help." Touch the display or push either  or  VR button and say "cancel" to cancel the help session.

## SMS (Text Messaging)

- Uconnect™ Phone can read or send new text messages on your mobile phone.
- Your mobile phone must support SMS over Bluetooth® in order to use this feature. If the Uconnect™ Phone determines your phone is not compatible with SMS messaging over Bluetooth® the "Messaging" button will be greyed out and the feature will not be available for use.



### NOTE:

- For mobile phone compatibility and pairing instructions, please visit [www.UconnectPhone.com](http://www.UconnectPhone.com)
- Uconnect™ Phone SMS is only available when the vehicle is not in moving.

## WARNING!

- Any voice commanded system should be used only in safe driving conditions following local laws and phone use. All attention should be kept on the roadway ahead. Failure to do so may result in a collision causing you and others to be severely injured or killed.
- In an emergency, to use Uconnect™ Phone, your mobile phone must be:
  - turned on,
  - paired to Uconnect™ Phone,
  - and have network coverage.

## UCONNECT™ VOICE COMMAND (8.4 & 8.4N ONLY)

- If the Uconnect™ Voice Command  VR button exists on your steering wheel, then you have the Voice Command feature.
- The Voice Command feature lets you keep your hands on the steering wheel, and your eyes on the road.
- When you press the Voice Command button  VR located on the radio faceplate or steering wheel, you will hear a beep. The beep is your signal to give a command. If you do not know what commands to say, you can say "help" and the system will provide options to you. If you ever wish to interrupt the system while it lists options, press the Voice Command button  VR, listen for the BEEP, and say your command.

- You can “chain” commands together for faster results. Say “Call John Doe, mobile”, for example.

## Changing The Volume

- Start a dialogue by pressing the Voice Command button (Ⓜ VR), then say a command (for example, “help”).
- Use the radio ON/OFF VOLUME rotary knob to adjust the volume to a comfortable level while the Voice Command system is speaking. The volume setting for Voice Command is different than the audio system.
- Refer to the Understand The Features Of Your Vehicle section of your vehicle's Owner's Manual on the DVD for further details.

## Common Voice Commands (Examples)

<b>Switch Modes</b>	“FM” “Satellite” “AM” “Change Source to my iPod” “Change Source to SD Card”
<b>Radio (FM, AM)</b>	“95.5” “95.5 FM” “Go to preset 5”
<b>Player</b>	“Play Album 'Greatest Hits” “Play Artist 'Scott Joplin” “Play Genre 'Rock” “Play Song 'Maple Leaf Rag”
<b>Sirius XM™ Satellite Radio</b>	“39” “Foxhole”
<b>Sirius Travel Link</b>	“Show fuel prices” “Show movie listings” “Show current weather” “Show extended weather” “Show Travel Link favorites” “Show NFL headlines” “Show NBA rankings” “Show NFL schedules” “Show NBA scores”

### NOTE:

- You must have that particular mode selected for the command to be recognized. For example, if you are in Sirius XM™ Satellite Radio mode you can say “39”, but if you are not in Sirius XM mode, you would need to say “Tune to Satellite Channel 39.”

## Common Navigation Voice Commands

- To access the navigation voice commands, press the Uconnect™ Voice Command (Ⓜ VR) button while in any mode and say “Navigation.”
- Once in the Navigation feature, you can simply **Say What You See** on the touch-screen to give a navigation voice command.

# ELECTRONICS

- Locating an address can be given as a **one shot entry**. For example, after saying “Find Address” and the system is ready, you can say the entire address in one command, “1234 1st Street, Any Town, Michigan.” If you are searching for a particular address or Point Of Interest, the available voice commands depend on what is displayed on the touch-screen.
- When the Voice Command system is ready to be given a command, the green indicator is visible in the right corner of the touch-screen.

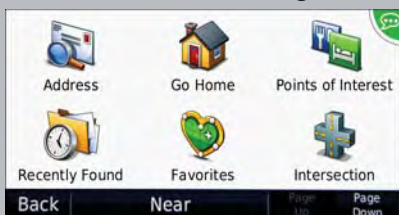

- The following chart lists the navigation voice commands that may be available.

<p><b>Navigation Voice Commands:</b></p>	<p>“Where To?” (Main Menu command)          “View Map” (Main Menu command)          “Repeat guidance”          “Cancel Route”          “Detour” (During a Route Guidance)          “Where Am I?”          “Find Address”          “Go Home”          “Find Place by Category”          “Find Place by Name”          “Find Recently Found”          “Find Favorite”          “Find City”          “Find Nearest Restaurant”          “Find Nearest Fuel”</p>	<p>“Find Nearest Transit”          “Find Nearest Lodging”          “Find Nearest Shopping”          “Find Nearest Bank”          “Find Nearest Parking”          “Find Nearest Entertainment”          “Find Nearest Recreation”          “Find Nearest Attractions”          “Find Nearest Hospitals”          “Find Nearest Community”          “Find Nearest Auto Services”          “Find Nearest Airport”          “Find Nearest Police Stations”          “Find Nearest Fire Stations”          “Find Nearest Auto Dealers”</p>
--	--	---

## WARNING!

Any voice commanded system should be used only in safe driving conditions following local laws and phone use. All attention should be kept on the roadway ahead. Failure to do so may result in a collision causing you and others to be severely injured or killed.

## ELECTRONIC VEHICLE INFORMATION CENTER (EVIC)

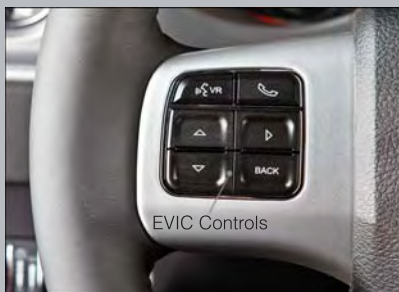

- The EVIC features a driver interactive display that is located in the instrument cluster. Pressing the controls on the left side of the steering wheel allows the driver to select vehicle information and Personal Settings. For additional information, refer to Programmable Features in this guide.

- Press and release the UP  $\Delta$  button to scroll upward through the main menus (Fuel Economy, Vehicle Info, Tire PSI, Cruise, Messages, Trip Info, Vehicle Speed and Turn Menu Off) and sub menus.
- Press and release the DOWN  $\nabla$  button to scroll downward through the main menus and sub menus.
- Press and release the SELECT  $\triangleright$  button for access to main menus, sub menus or to select a personal setting in the setup menu. Press and hold the SELECT button for two seconds to reset features
- Press the BACK button to scroll back to a previous menu or sub menu.

### Compass Calibration

- This compass is self-calibrating, which eliminates the need to set the compass manually. When the vehicle is new, the compass may appear erratic and the EVIC will display "CAL" until the compass is calibrated.
- You may also calibrate the compass by completing one or more 360 degree turns (in an area free from large metal or metallic objects) until the "CAL" message displayed in the EVIC turns off. The compass will now function normally.

### ECO

- The ECO message will appear in your EVIC display when the Fuel Saver Technology is active and you are driving in a fuel efficient manner.
- This feature allows you to monitor when you are driving in a fuel efficient manner, and it can be used to modify driving habits in order to increase fuel economy.



## PROGRAMMABLE FEATURES

### Electronic Vehicle Information Center (EVIC)

- The EVIC can be used to view or change the following settings. Press the UP  $\Delta$  or DOWN  $\nabla$  button until System Setup displays, then press the SELECT  $\triangleright$  button. Scroll through the settings using the UP or DOWN buttons. Press the SELECT  $\triangleright$  button to change the setting. Press the BACK button to scroll back to a previous menu or sub menu.
- Fuel Economy
- Vehicle Speed
- Trip Info
- Units
- Vehicle Info (Customer Information Features)
- Messages
- Turn Menu Off

### Uconnect Touch™ 4.3 Customer Programmable Features

- The Uconnect Touch™ 4.3 system allows you to access Customer Programmable feature settings such as Display, Clock, Safety/Assistance, Lights, Doors & Locks, Heated Seats, Engine Off Operation, Compass Settings, Audio, Phone/ Bluetooth and Sirius XM™ Setup through hard-keys and soft-keys.
- Press the Settings hard-key to on the right side of the unit to access the Settings screen, use the Page Up/Down soft-keys to scroll through the following settings. The following feature settings are available:
  - Display
  - Safety / Assistance
  - Heated Seats
  - Compass Settings
  - Phone / Bluetooth
  - Auto-On Comfort & Remote Start
  - Clock
  - Doors & Locks
  - Engine Off Options
  - Audio
  - Sirius XM™ Setup

### Uconnect Touch™ 8.4 Customer Programmable Features

- The Uconnect Touch™ 8.4 system allows you to access Customer Programmable feature settings such as Display, Clock, Safety/Assistance, Lights, Doors & Locks, Heated Seats, Engine Off Operation, Compass Settings, Audio, Phone/ Bluetooth and Sirius XM™ Setup through soft-keys.
- Touch the Settings soft-key to on the bottom of the screen, then touch the Settings soft-key to access the Settings screen. When making a selection, scroll up or down until the preferred setting is highlighted, then press and release the preferred setting until a check-mark appears next to the setting, showing that setting has been selected. The following feature settings are available:
  - Display
  - Safety / Assistance
  - Auto-On Comfort & Remote Start
  - Compass Settings
  - Phone / Bluetooth
  - Clock
  - Doors & Locks
  - Engine Off Options
  - Audio
  - Sirius XM™ Setup

## UNIVERSAL GARAGE DOOR OPENER (HOMELINK®)

- HomeLink® replaces up to three hand-held transmitters that operate devices such as garage door openers, motorized gates, lighting or home security systems. The HomeLink® unit is powered by your vehicle's 12 Volt battery.
- The HomeLink® buttons that are located in the overhead console or sunvisor designate the three different HomeLink® channels.
- The HomeLink® indicator is located above the center button.

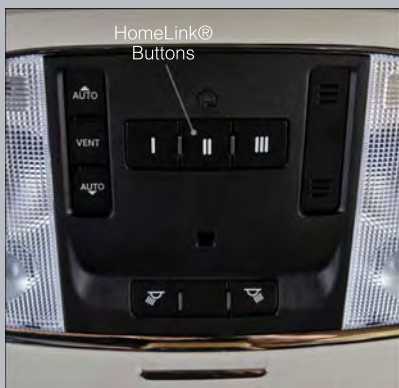

### Before You Begin Programming HomeLink®

- Be sure that your vehicle is parked outside of the garage before you begin programming.
- For more efficient programming and accurate transmission of the radio-frequency signal it is recommended that a new battery be placed in the hand-held transmitter of the device that is being programmed to the HomeLink® system.

- Erase all channels before you begin programming. To erase the channels, place the ignition switch into the ON/RUN position, then press and hold the two outside HomeLink® buttons (I and III) for up to 20 seconds or until the red indicator flashes.

### NOTE:

- Erasing all channels should only be performed when programming HomeLink® for the first time. Do not erase channels when programming additional buttons.
- If you have any problems, or require assistance, please call toll-free 1-800-355-3515 or, on the Internet at [www.HomeLink.com](http://www.HomeLink.com) for information or assistance.

### Programming A Rolling Code

- For programming Garage Door Openers that were manufactured after 1995. These Garage Door Openers can be identified by the "LEARN" or "TRAIN" button located where the hanging antenna is attached to the Garage Door Opener. It is NOT the button that is normally used to open and close the door. The name and color of the button may vary by manufacturer.
- Place the ignition switch into the ON/RUN position.
- Place the hand-held transmitter 1 to 3 in (3 to 8 cm) away from the HomeLink® button you wish to program while keeping the HomeLink® indicator light in view.
- Simultaneously press and hold both the HomeLink® button you want to program and the hand-held transmitter button.

- Continue to hold both buttons and observe the indicator light. The Homelink® indicator will flash slowly and then rapidly after Homelink® has received the frequency signal from the hand-held transmitter. Release both buttons after the indicator light changes from slow to rapid.
- At the garage door opener motor (in the garage), locate the “LEARN” or “TRAINING” button. This can usually be found where the hanging antenna wire is attached to the garage door opener motor. Firmly press and release the “LEARN” or “TRAINING” button.

**NOTE:** You have 30 seconds in which to initiate the next step after the LEARN button has been pressed.

- Return to the vehicle and press the programmed HomeLink® button twice (holding the button for two seconds each time). If the device is plugged in and activates, programming is complete.

**NOTE:** If the device does not activate, press the button a third time (for two seconds) to complete the training.

- To program the remaining two HomeLink® buttons, repeat each step for each remaining button. DO NOT erase the channels.

## Programming A Non-Rolling Code

- For programming Garage Door Openers manufactured before 1995.
- Turn the ignition switch to the ON/RUN position.
- Place the hand-held transmitter 1 to 3 in (3 to 8 cm) away from the HomeLink® button you wish to program while keeping the HomeLink® indicator light in view.
- Simultaneously press and hold both the HomeLink® button you want to program and the hand-held transmitter button.
- Continue to hold both buttons and observe the indicator light. The Homelink® indicator will flash slowly and then rapidly after Homelink® has received the frequency signal from the hand-held transmitter. Release both buttons after the indicator light changes from slow to rapid.
- Press and hold the programmed HomeLink® button and observe the indicator light.

### **NOTE:**

- If the indicator light stays on constantly, programming is complete and the garage door (or device) should activate when the HomeLink® button is pressed.
- To program the two remaining HomeLink® buttons, repeat each step for each remaining button. DO NOT erase the channels.

## Using HomeLink®

- To operate, press and release the programmed HomeLink® button. Activation will now occur for the programmed device (i.e., garage door opener, gate operator, security system, entry door lock, home/office lighting, etc.). The hand-held transmitter of the device may also be used at any time.

### WARNING!

- Your motorized door or gate will open and close while you are programming the universal transceiver. Do not program the transceiver if people or pets are in the path of the door or gate.
- Do not run your vehicle in a closed garage or confined area while programming the transceiver. Exhaust gas from your vehicle contains Carbon Monoxide (CO) which is odorless and colorless. Carbon Monoxide is poisonous when inhaled and can cause you and others to be severely injured or killed.

## POWER OUTLET



- There are three 12 Volt electrical outlets on this vehicle.
  - The front 12 Volt power outlet has power available only when the ignition is placed in the ACC or RUN position.
  - The center console outlet is powered directly from the battery (power available at all times). Items plugged into this outlet may discharge the battery and/or prevent the engine from starting.
- There is also a 12 volt power outlet located on the back of the center console for rear passengers. This power outlet has power available only when the ignition is placed in the ACC or RUN position.

# ELECTRONICS

## NOTE:

- Do not exceed the maximum power of 160 Watts (13 Amps) at 12 Volts. If the 160 Watt (13 Amp) power rating is exceeded, the fuse protecting the system will need to be replaced.
- Power outlets are designed for accessory plugs only. Do not insert any other object in the power outlet as this will damage the outlet and blow the fuse. Improper use of the power outlet can cause damage not covered by your new vehicle warranty.

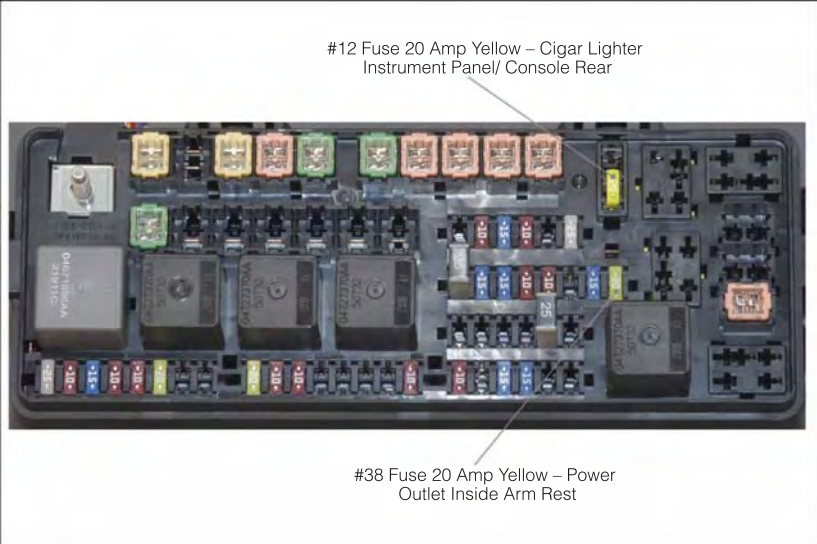

**TRAILER TOWING WEIGHTS (MAXIMUM TRAILER WEIGHT RATINGS)**

Engine/Transmission	Frontal Area	Max. GTW (Gross Trailer Wt.)	Max. Tongue Wt. (See Note)
<b>3.6L Automatic</b>	22 sq ft (2.04 sq m)	1,000 lbs (454 kg)	100 lbs (45 kg)
<b>5.7L Automatic</b>	32 sq ft (2.97 sq m)	1,000 lbs (454 kg)	100 lbs (45 kg)

Refer to local laws for maximum trailer towing speeds

## RECREATIONAL TOWING (BEHIND MOTORHOME, ETC.)

### Two-Wheel Drive and All-Wheel Drive

- Recreational towing (with all four wheels on the ground, or using a tow dolly) is **NOT ALLOWED**. The only acceptable method for towing this vehicle (behind another vehicle) is on a vehicle trailer with all four wheels **OFF** the ground.

### CAUTION!

Towing this vehicle in violation of the above requirements can cause severe transmission and/or transfer case damage. Such damage is not covered by the New Vehicle Limited Warranty.



## AUTOSTICK®

### Steering Wheel Mounted Paddle Shifters Or Console Mounted Shifter



- AutoStick® is a driver-interactive transmission feature that offers manual gear shifting to provide you with more control of the vehicle. AutoStick® allows you to maximize engine braking, and improve overall vehicle performance.
- This system can also provide you with more control during passing, city driving, cold slippery conditions, mountain driving, trailer towing, and many other situations.

#### Operation

- When the shift lever is in the DRIVE position, the transmission will operate automatically, shifting between the five available gears. To engage AutoStick®, simply move the shift lever to the right or left (+/-) while in the DRIVE position, or press one of the steering wheel mounted shift paddles (+/-). When AutoStick® is active, the current transmission gear is displayed in the Electronic Vehicle Information Center (EVIC) portion of the instrument cluster. In AutoStick® mode, the transmission will shift when manually selected by the driver (using the shift lever, or the shift paddles), unless an engine lugging or overspeed condition would result. It will remain in the selected gear until another upshift or downshift is chosen, except as described below:
  - The transmission will automatically downshift as the vehicle slows (to prevent engine lugging) and will display the current gear.
  - The transmission will automatically downshift to first gear when coming to a stop.
  - You can start out in first or second gear. Tapping (+) (at a stop) will allow starting in second gear. Starting out in second gear is helpful in snowy or icy conditions.
  - The system will ignore attempts to upshift at too low of a vehicle speed.
  - Transmission shifting will be more noticeable when AutoStick® is engaged. To disengage AutoStick® mode, hold the shift lever to the right or press and hold the (+) shift paddle until “D” is once again displayed in the instrument cluster. You can shift in or out of the AutoStick® mode at any time without taking your foot off the accelerator pedal.
  - An “UPSHIFT” message will appear in the Electronic Vehicle Information Center (EVIC) portion of the instrument cluster when using AutoStick®, to alert the driver to upshift to the next gear. The “UPSHIFT” message will appear when approaching the maximum engine speed.

**WARNING!**

Do not downshift for additional engine braking on a slippery surface. The drive wheels could lose their grip and the vehicle could skid, causing a collision or personal injury.

**ELECTRONIC CONTROL DAMPING SYSTEM**

- This vehicle may be equipped with an electronic controlled damping system. This system reduces body roll and pitch in many driving situations including cornering, acceleration and braking. There are three modes of operation:

**Automatic (Auto) Mode**

- This is the default position when vehicle ignition is first turned on. This mode will give a sporty, but comfortable ride. Within this mode, the suspension will adapt to the vehicle inputs, including vehicle speed, steering inputs, braking, and acceleration.
- If AutoStick® is engaged while in “Auto” mode, the transmission will automatically shift up if maximum engine speed is reached.

- Heavily pressing the accelerator pedal may generate an automatic downshift for improved acceleration.
- This mode should be used for most driving situations.

**SPORT Sport Mode**

- This mode is driver selectable when the vehicle is placed in SPORT mode (press the CONTROLS button and then the SPORT button on the display screen). This mode will set suspension for maximum performance handling and is intended for spirited driving.
- When SPORT mode is enabled, a flag will light up in the instrument cluster.

- If AutoStick is engaged while in “Sport” mode, the transmission will remain in the selected gear even when maximum engine speed is reached.
- Engine overspeed protection is achieved through fuel cut off at or near redline.
- This mode will provide aggressive shifting and is intended for spirited driving.

**NOTE:** The SPORT setting will provide a firmer ride.

### Track Mode



- In track mode, the transmission has a sportier, more aggressive shift pattern.
- This mode includes SPORT Suspension and affects transmission shifting in either Auto or Manual mode.

**NOTE:** In Manual mode, the transmission will hold gear at redline during manual shifting console shifter or paddle shifters.

## PERFORMANCE FEATURES

### Electronic Vehicle Information Center (EVIC)



- The EVIC can be used to view or change the following Performance Features. Press the UP  $\Delta$  or DOWN  $\nabla$  button until System Setup displays, then press the SELECT  $\triangleright$  button. Scroll through the settings using the UP or DOWN buttons. Press the SELECT  $\triangleright$  button to change the setting. Press the BACK button to scroll back to a previous menu or sub menu.
- Instantaneous G-Force
- Peak G-Force
- Digital Speedometer

- 0-60 mph (0-100 km/h)
- Braking Distance
- 1/8 Mile
- 1/4 Mile

#### 0-60 mph (0-100 km/h)

- When selected, this screen displays the time it takes for the vehicle to go from 0 to 60 mph (0 to 100 km/h) within 10 seconds.

#### Braking Distance

- When selected, this screen displays the vehicle's braking distance and the speed at which the brake pedal was depressed.

#### 1/8 Mile, 1/4 Mile

- When selected, this screen displays the time it takes the vehicle to travel 1/8 mile (1/4 mile) within 30 seconds and the vehicle's speed when it reaches 1/8 mile (1/4 mile).

## Instantaneous G-Force

- When selected, this screen displays the current G-Force (lateral and longitudinal) along with a friction circle that displays the directions of the forces.

## Peak G-Force

- When selected, this screen displays all four G-Force values (two lateral and two longitudinal).

## Uconnect Touch SRT8 Performance Features

- To access the SRT8 Performance Features, touch the “More” soft-key then touch the “SRT” soft-key. Press the UP or DOWN soft-key to cycle through the features. Press the feature soft-key to select that feature.
- The Performance Page include the following:
  - Timers
  - Engine Values
  - Digital Gauge Displays
  - 0-60 mph (0-100 km/h)
  - Braking Distance
  - 1/8 Mile
  - 1/4 Mile
  - Instantaneous G-Force
  - Peak G-Force
  - Digital Speedometer

### Timers

0-60 mph (0-100 km/h), 1/8 Mile, 1/4 Mile

- When selected, this screen displays the time it takes for the vehicle to go from 0 to 60 mph (0 to 100 km/h), 1/8 mile or 1/4 mile.

Braking Distance

- When selected, this screen displays the vehicle's braking distance and the speed at which the brake pedal was depressed.

### G-Force

- When selected, this screen displays all four G-Force values (two lateral and two longitudinal) as well as steering angle.

### Gauges 1

- Oil Temperature
- Oil Pressure
- Battery Voltage

### Gauges 2

- Coolant Temperature
- Oil Temperature
- Transmission Temperature
- Intake Air Temperature
- Oil Pressure
- Battery Voltage

**Engine**

- When selected, this screen displays miles per hour (mph), horsepower (hp), torque (ft/lb), oil pressure (psi) and gear selector values.

**Handling**

- When selected, this screen displays peak g-force, instantaneous g-force, steering and yaw angles.

**Options**

- When selected, this screen allows you to choose a standard or customize display for your SRT home page.

**WARNING!**

Measurement of vehicle statistics with the Performance Features is intended for off-highway or off-road use only and should not be done on any public roadways. It is recommended that these features be used in a controlled environment and within the limits of the law. The capabilities of the vehicle as measured by the performance pages must never be exploited in a reckless or dangerous manner, which can jeopardize the user's safety or the safety of others. Only a safe, attentive, and skillful driver can prevent accidents.

**SUMMER/THREE-SEASON TIRES**

- This vehicle may be equipped with wheels and tires to enhance traction in both wet and dry conditions.
- Summer tires are not intended to be driven in snow or on ice.
- Use summer tires only in sets of four.

**NOTE:** Summer tires will not contain the all season designation or mountain/snowflake symbol on the sidewall of the tire.

**WARNING!**

Do not use summer tires in snow/ice conditions. You could lose control, resulting in severe injury or death.

# WHAT TO DO IN EMERGENCIES

## 24-HOUR TOWING ASSISTANCE

- Dial toll-free 1-800-521-2779 or 1-800-363-4869 for Canadian residents.
- Provide your name, vehicle identification number and license plate number.
- Provide your location, including telephone number, from which you are calling.
- Briefly describe the nature of the problem and answer a few simple questions.
- You will be given the name of the service provider and an estimated time of arrival. If you feel you are in an “unsafe situation”, please let us know. With your consent, we will contact local police or safety authorities.

## INSTRUMENT CLUSTER WARNING LIGHTS

### - Electronic Stability Control (ESC) Activation/Malfunction Indicator Light

- The “ESC Activation/Malfunction Indicator Light” in the instrument cluster will come on when the ignition switch is turned to the ON/RUN position. It should go out with the engine running. If the “ESC Activation/Malfunction Indicator Light” comes on continuously with the engine running, a malfunction has been detected in the ESC system.
- If this light remains on after several ignition cycles, and the vehicle has been driven several miles (kilometers) at speeds greater than 30 mph (48 km/h), we recommend you drive to the nearest service center and have the vehicle serviced immediately.

### - Tire Pressure Monitoring System (TPMS) Light

- Each tire, including the spare (if provided), should be checked monthly, when cold and inflated to the inflation pressure recommended by the vehicle manufacturer on the vehicle placard or tire inflation pressure label. (If your vehicle has tires of a different size than the size indicated on the vehicle placard or tire inflation pressure label, you should determine the proper tire inflation pressure for those tires.)
- As an added safety feature, your vehicle has been equipped with a Tire Pressure Monitoring System (TPMS) that illuminates a low tire pressure telltale when one or more of your tires is significantly under-inflated. Accordingly, when the low tire pressure telltale illuminates, you should stop and check your tires as soon as possible, and inflate them to the proper pressure. Driving on a significantly under-inflated tire causes the tire to overheat and can lead to tire failure. Under-inflation also reduces fuel efficiency and tire tread life, and may affect the vehicle’s handling and stopping ability.
- **IF THE LIGHT STARTS FLASHING INDICATING A LOW TIRE PRESSURE, ADJUST THE AIR PRESSURE IN THE LOW TIRE TO THE AIR PRESSURE SHOWN ON THE VEHICLE PLACARD OR TIRE INFLATION PRESSURE LABEL LOCATED ON THE DRIVER’S DOOR. NOTE: AFTER INFLATION, THE VEHICLE MAY NEED TO BE DRIVEN FOR 20 MINUTES BEFORE THE FLASHING LIGHT WILL TURN OFF.**
- Please note that the TPMS is not a substitute for proper tire maintenance, and it is the driver’s responsibility to maintain correct tire pressure, even if under-inflation has not reached the level to trigger illumination of the TPMS low tire pressure telltale.

# WHAT TO DO IN EMERGENCIES

- Your vehicle has also been equipped with a TPMS malfunction indicator to indicate when the system is not operating properly. The TPMS malfunction indicator is combined with the low tire pressure telltale. When the system detects a malfunction, the telltale will flash for approximately one minute and then remain continuously illuminated. This sequence will continue each time the vehicle is restarted as long as the malfunction exists.
- When the malfunction indicator is illuminated, the system may not be able to detect or signal low tire pressure as intended. TPMS malfunctions may occur for a variety of reasons, including the installation of replacement or alternate tires or wheels on the vehicle that prevent the TPMS from functioning properly. Always check the TPMS malfunction telltale after replacing one or more tires or wheels on your vehicle, to ensure that the replacement or alternate tires and wheels allow the TPMS to continue to function properly.

**NOTE:** Tire pressures change by approximately 1 psi (7 kPa) per 12° F (7° C) of air temperature change. Keep this in mind when checking tire pressure inside a garage, especially in the Winter. Example: If garage temperature is 68°F (20°C) and the outside temperature is 32°F (0°C), then the cold tire inflation pressure should be increased by 3 psi (21 kPa), which equals 1 psi (7 kPa) for every 12°F (7°C) for this outside temperature condition.

## CAUTION!

The TPMS has been optimized for the original equipment tires and wheels. TPMS pressures and warning have been established for the tire size equipped on your vehicle. Undesirable system operation or sensor damage may result when using replacement equipment that is not of the same size, type, and/or style. Aftermarket wheels can cause sensor damage. Do not use tire sealant from a can, or balance beads if your vehicle is equipped with a TPMS, as damage to the sensors may result.

## - Engine Temperature Warning Light

- This light warns of an overheated engine condition.
- If the light turns on or flashes continuously while driving, safely pull over and stop the vehicle. If the A/C system is on, turn it off. Also, shift the transmission into NEUTRAL and idle the vehicle. If the temperature reading does not return to normal, turn the engine off immediately.
- We recommend that you do not operate the vehicle or engine damage will occur. Have the vehicle serviced immediately.

## WARNING!

A hot engine cooling system is dangerous. You or others could be badly burned by steam or boiling coolant. You may want to call an authorized service center for service if your vehicle overheats.



# WHAT TO DO IN EMERGENCIES

## **BRAKE - Brake Warning Light**

- The Brake Warning light illuminates when there is either a system malfunction or the parking brake is applied. If the light is on and the parking brake is not applied, it indicates a possible brake hydraulic malfunction, brake booster problem or an Anti-Lock Brake System problem.
- Please have your vehicle serviced immediately.

### **WARNING!**

Driving a vehicle with the red brake light on is dangerous. Part of the brake system may have failed. It will take longer to stop the vehicle. You could have a collision. Have the vehicle checked immediately.

## - **Malfunction Indicator Light (MIL)**

- Certain conditions, such as a poor fuel quality, etc., may illuminate the MIL after engine start. The vehicle should be serviced if the light stays on through several typical driving cycles. In most situations, the vehicle will drive normally and not require towing.
- If the MIL flashes when the engine is running, serious conditions may exist that could lead to immediate loss of power or severe catalytic converter damage. We recommend you do not operate the vehicle. Have the vehicle serviced immediately.

## - **Electronic Stability Control (ESC) OFF Indicator Light**

- This light indicates the Electronic Stability Control (ESC) is off.

## - **Charging System Light**

- This light shows the status of the electrical charging system. If the charging system light remains on, it means that the vehicle is experiencing a problem with the charging system.
- We recommend you do not continue driving if the charging system light is on. Have the vehicle serviced immediately.

## - **Oil Pressure Warning Light**

- This light indicates low engine oil pressure. If the light turns on while driving, stop the vehicle and shut off the engine as soon as possible. A chime will sound for four minutes when this light turns on.
- We recommend you do not operate the vehicle or engine damage will occur. Have the vehicle serviced immediately.

## - **Anti-Lock Brake (ABS) Light**

- This light monitors the Anti-Lock Brake System (ABS).
- If the light is not on during starting, stays on, or turns on while driving, we recommend you drive to the nearest service center and have the vehicle serviced immediately.

# WHAT TO DO IN EMERGENCIES

## - Electronic Throttle Control (ETC) Light

- This light informs you of a problem with the Electronic Throttle Control (ETC) system.
- If a problem is detected, the light will come on while the engine is running. Cycle the ignition when the vehicle has completely stopped and the shift lever is placed in the PARK position; the light should turn off.
- If the light remains lit with the engine running, your vehicle will usually be drivable; however, see an authorized service center immediately. If the light is flashing when the engine is running, immediate service is required and you may experience reduced performance, an elevated/rough idle or engine stall and your vehicle may require towing.

## - Air Bag Warning Light

- If the light is not on during starting, stays on, or turns on while driving, have the vehicle serviced by an authorized service center immediately.

## **SERVICE AWD SYSTEM Message**

- If the SERVICE AWD SYSTEM warning message appears after engine start up, or during driving, it means the AWD system is not functioning properly. We recommend you do not operate the vehicle. Have the vehicle serviced immediately.

## **SPORT Sport Mode**

- This light will illuminate when the sport mode is selected. This mode provides performance based tuning.

## **Oil Change Indicator Message**

- If an “oil change” message (shown as Oil Change Due) appears and a single chime sounds, it is time for your next required oil change.

### **Resetting The Light After Servicing**

#### **Vehicles Equipped With Keyless Enter-N-Go**

- Without pressing the brake pedal, push the ENGINE START/STOP button and cycle the ignition to the ON/RUN position (Do not start the engine.)
- Fully depress the accelerator pedal, slowly, three times within 10 seconds.
- Without pressing the brake pedal, push the ENGINE START/STOP button once to return the ignition to the OFF/LOCK position.

#### **Vehicles Not Equipped With Keyless Enter-N-Go**

- Turn the ignition switch to the ON/RUN position (Do not start the engine.)
- Fully depress the accelerator pedal, slowly, three times within 10 seconds.
- Turn the ignition switch to the OFF/LOCK position.

# WHAT TO DO IN EMERGENCIES

## IF YOUR ENGINE OVERHEATS

- In any of the following situations, you can reduce the potential for overheating by taking the appropriate action.
- On the highways — slow down.
- In city traffic — while stopped, place the transmission in NEUTRAL, but do not increase engine idle speed.

**NOTE:** There are steps that you can take to slow down an impending overheat condition:

- If your air conditioner (A/C) is on, turn it off. The A/C system adds heat to the engine cooling system and turning the A/C off can help remove this heat.
- You can also turn the temperature control to maximum heat, the mode control to floor and the blower control to high. This allows the heater core to act as a supplement to the radiator and aids in removing heat from the engine cooling system.

### CAUTION!

Driving with a hot cooling system could damage your vehicle. If the temperature gauge reads 240°F (116 °C) or greater pull over and stop the vehicle. Idle the vehicle with the air conditioner turned off until the pointer drops back into the normal range 200–230°F (93–110°C). If the pointer remains at 240°F (116°C) or greater and you hear a chime, turn the engine off immediately and call for service.

### WARNING!

You or others can be badly burned by hot engine coolant (antifreeze) or steam from your radiator. If you see or hear steam coming from under the hood, do not open the hood until the radiator has had time to cool. Never try to open a cooling system pressure cap when the radiator or coolant bottle is hot.

## JACKING AND TIRE CHANGING

### Jack Location/Spare Tire Stowage

- The jack and spare tire are both stowed under an access cover in the trunk. Follow these steps to access the jack and spare tire.

**NOTE:** The spare tire must be removed in order to access the jack.

1. Open the trunk.

# WHAT TO DO IN EMERGENCIES

2. Lift the access cover using the pull strap. To hold the cover up and into place, hang the hook that is located on the end of the strap over the trunk upper weather strip located in the channel below the rear window.

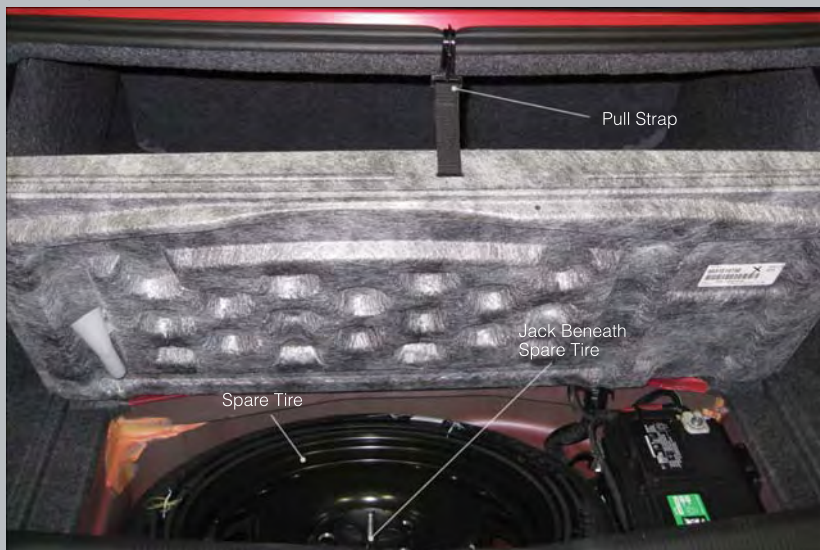

3. Remove the fastener securing the spare tire.



4. Remove the spare tire.
5. Remove the fastener securing the jack.

# WHAT TO DO IN EMERGENCIES



6. Remove the scissors jack and lug wrench from the spare wheel as an assembly. Turn the jack screw to the left to loosen the lug wrench, and remove the wrench from the jack assembly.

## Preparations For Jacking

1. Park the vehicle on a firm, level surface as far from the edge of the roadway as possible. Avoid icy or slippery areas.
2. Turn on the Hazard Warning flasher.
3. Set the parking brake.
4. Place the shift lever into PARK.
5. Turn OFF the ignition.

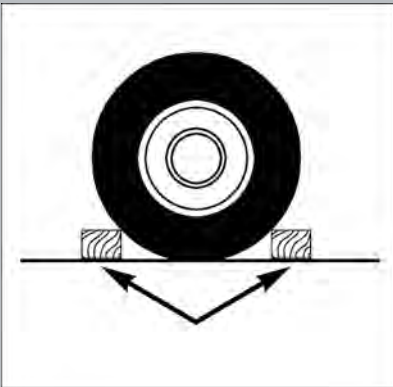

Block the front and rear of the wheel diagonally opposite of the jacking position. For example, if changing the right front tire, block the left rear wheel.

**NOTE:** Passengers should not remain in the vehicle when the vehicle is being jacked.

# WHAT TO DO IN EMERGENCIES

## Jacking And Changing A Tire



1. Remove the spare tire, jack, and lug wrench.
2. If equipped with aluminum wheels where the center cap covers the lug nuts, use the lug wrench to pry the center cap off carefully before raising the vehicle.
3. Before raising the vehicle, use the lug wrench to loosen, but not remove, the lug nuts on the wheel with the flat tire. Turn the lug nuts counterclockwise one turn while the wheel is still on the ground.
4. Place the jack underneath the lift area that is closest to the flat tire. Turn the jack screw clockwise to firmly engage the jack saddle with the lift area of the sill flange.



Front Jacking Location



Rear Jacking Location

5. Raise the vehicle just enough to remove the flat tire and install the spare tire.
6. Remove the lug nuts and tire.
7. Mount the spare tire.



# WHAT TO DO IN EMERGENCIES



## NOTE:

- For vehicles so equipped, do not attempt to install a center cap or wheel cover on the compact spare.
- Refer to “Compact Spare Tire” and to “Limited-Use Spare” under “Tires—General Information” in “Starting and Operating” in the Owner’s Manual on the DVD for additional warnings, cautions, and information about the spare tire, its use, and operation.

8. Install the lug nuts with the cone shaped end of the lug nut toward the wheel. Lightly tighten the lug nuts.
9. Lower the vehicle to the ground by turning the jack handle counterclockwise.
10. Finish tightening the lug nuts. Push down on the wrench while at the end of the handle for increased leverage. Tighten the lug nuts in a star pattern until each nut has been tightened twice. The correct tightness of each lug nut is 110 ft/lb. (150 N·m). If in doubt about the correct tightness, have them checked with a torque wrench by your authorized dealer or at a service station.
11. Stow the jack, tools and flat tire. Make sure the base of the jack faces the front of the vehicle before tightening down the fastener.

## Road Tire Installation

1. Mount the road tire on the axle.
2. Install the remaining lug nuts with the cone shaped end of the nut toward the wheel. Lightly tighten the lug nuts.
3. Lower the vehicle to the ground by turning the jack handle counterclockwise.
4. Finish tightening the lug nuts. Push down on the wrench while at the end of the handle for increased leverage. Tighten the lug nuts in a star pattern until each nut has been tightened twice. The correct tightness of each lug nut is 110 ft/lbs (150 N·m). If in doubt about the correct tightness, have them checked with a torque wrench by your authorized dealer or service station.
5. After 25 miles (40 km) check the lug nut torque with a torque wrench to ensure that all lug nuts are properly seated against the wheel.

## CAUTION!

Do not attempt to raise the vehicle by jacking on locations other than those indicated in the Jacking Instructions for this vehicle.

# WHAT TO DO IN EMERGENCIES

## WARNING!

- Do not attempt to change a tire on the side of the vehicle close to moving traffic. Pull far enough off the road to avoid the danger of being hit when operating the jack or changing the wheel.
- Being under a jacked-up vehicle is dangerous. The vehicle could slip off the jack and fall on you. You could be crushed. Never put any part of your body under a vehicle that is on a jack.
- Never start or run the engine while the vehicle is on a jack. If you need to get under a raised vehicle, take it to a service center where it can be raised on a lift.
- The jack is designed to be used as a tool for changing tires only. The jack should not be used to lift the vehicle for service purposes. The vehicle should be jacked on a firm level surface only. Avoid ice or slippery areas.
- A loose tire or jack thrown forward in a collision or hard stop could endanger the occupants of the vehicle. Always stow the jack parts and the spare tire in the places provided.
- Carefully follow these tire changing warnings to help prevent personal injury or damage to your vehicle:
- Always park on a firm, level surface as far from the edge of the roadway as possible before raising the vehicle.
- Turn on the Hazard Warning flasher.
- Block the wheel diagonally opposite the wheel to be raised.
- Set the parking brake firmly and set an automatic transmission in PARK; a manual transmission in REVERSE.
- Do not let anyone sit in the vehicle when it is on a jack.
- Do not get under the vehicle when it is on a jack.
- Only use the jack in the positions indicated and for lifting this vehicle during a tire change.
- If working on or near a roadway, be extremely careful of motor traffic.
- Raising the vehicle higher than necessary can make the vehicle less stable. It could slip off the jack and hurt someone near it. Raise the vehicle only enough to remove the tire.
- To avoid the risk of forcing the vehicle off the jack, do not fully tighten the wheel nuts until the vehicle has been lowered. Failure to follow this warning may result in personal injury.
- The limited-use spare tires are for emergency use only. Installation of this limited-use spare tire affects vehicle handling. With this tire, do not drive more than 60 mph (100 km/h). Keep inflated to the cold tire inflation pressure listed on either your tire placard or limited-use spare tire and wheel assembly. Replace (or repair) the original tire at the first opportunity and reinstall it on your vehicle. Failure to do so could result in loss of vehicle control.

# WHAT TO DO IN EMERGENCIES

## TIREFIT KIT

- Small punctures up to ¼ in (6 mm) in the tire tread can be sealed with TIREFIT. Foreign objects (e.g., screws or nails) should not be removed from the tire. TIREFIT can be used in outside temperatures down to approximately -4°F (-20°C).
- This kit will provide a temporary tire seal, allowing you to drive your vehicle up to 100 miles (160 km) with a maximum speed of 55 mph (88 km/h).

### TIREFIT Storage

- The TIREFIT kit is located in the trunk.

### TIREFIT Kit Components And Operation

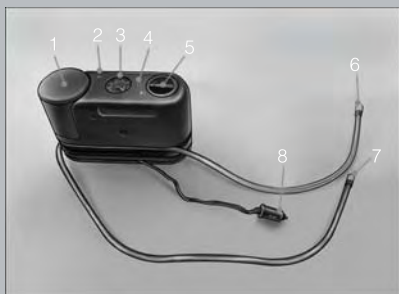

- |                     |                          |
|---------------------|--------------------------|
| 1. Sealant Bottle   | 5. Mode Select Knob      |
| 2. Deflation Button | 6. Sealant Hose (Clear)  |
| 3. Pressure Gauge   | 7. Air Pump Hose (Black) |
| 4. Power Button     | 8. Power Plug            |

#### Using The Mode Select Knob And Hoses

- Your TIREFIT kit is equipped with the following symbols to indicate the air or sealant mode.

##### Selecting Air Mode

- Turn the Mode Select Knob (5) to this position for air pump operation only. Use the Black Air Pump Hose (7) when selecting this mode.

##### Selecting Sealant Mode

- Turn the Mode Select Knob (5) to this position to inject the TIREFIT Sealant and to inflate the tire. Use the Sealant Hose (clear hose) (6) when selecting this mode.

##### Using The Power Button

- Push and release the Power Button (4) once to turn On the TIREFIT kit. Push and release the Power Button (4) again to turn Off the TIREFIT kit.

##### Using The Deflation Button

- Press the Deflation Button (2) to reduce the air pressure in the tire if it becomes over-inflated.

# WHAT TO DO IN EMERGENCIES

## TIREFIT Usage Precautions

- Replace the TIREFIT Sealant Bottle (1) and Sealant Hose (6) prior to the expiration date (printed on the bottle label) to assure optimum operation of the system. Refer to “Sealing a Tire with TIREFIT” section (F) “Sealant Bottle and Hose Replacement”.
- The Sealant Bottle (1) and Sealant Hose (6) are a one tire application use. After each use, always replace these components immediately at an authorized dealer.
- When the TIREFIT sealant is in a liquid form, clean water, and a damp cloth will remove the material from the vehicle or tire and wheel components. Once the sealant dries, it can easily be peeled off and properly discarded.
- For optimum performance, make sure the valve stem on the wheel is free of debris before connecting the TIREFIT kit.
- You can use the TIREFIT air pump to inflate bicycle tires. The kit also comes with two needles, located in the Accessory Storage Compartment (on the bottom of the air pump) for inflating sport balls, rafts, or similar inflatable items. However, use only the Air Pump Hose (7) and make sure the Mode Select Knob (5) is in the Air Mode when inflating such items to avoid injecting sealant into them. The TIREFIT Sealant is only intended to seal punctures less than ¼ in (6 mm) diameter in the tread of your vehicle.
- Do not lift or carry the TIREFIT kit by the hoses.

## Sealing A Tire With TIREFIT

### (A) Whenever You Stop To Use TIREFIT:

- Pull over to a safe location and turn on the vehicle’s Hazard Warning flashers.
- Verify that the valve stem (on the wheel with the deflated tire) is in a position that is near to the ground. This will allow the TIREFIT Hoses (6) and (7) to reach the valve stem and keep the TIREFIT kit flat on the ground. This will provide the best positioning of the kit when injecting the sealant into the deflated tire and running the air pump. Move the vehicle as necessary to place the valve stem in this position before proceeding.
- Place the transmission in PARK (auto transmission) or in Gear (manual transmission) and turn Off the ignition.
- Set the parking brake.

### (B) Setting Up To Use TIREFIT:

- Turn the Mode Select Knob (5) to the Sealant Mode position.
- Uncoil the Sealant Hose (6) and then remove the cap from the fitting at the end of the hose.
- Place the TIREFIT kit flat on the ground next to the deflated tire.
- Remove the cap from the valve stem and then screw the fitting at the end of the Sealant Hose (6) onto the valve stem.
- Uncoil the Power Plug (8) and insert the plug into the vehicle’s 12 Volt power outlet.

**NOTE:** Do not remove foreign objects (e.g., screws or nails) from the tire.

# WHAT TO DO IN EMERGENCIES

## **(C) Injecting TIREFIT Sealant Into The Deflated Tire:**

- Always start the engine before turning ON the TIREFIT kit.

**NOTE:** Manual transmission vehicles must have the parking brake engaged and the shift lever in NEUTRAL.

- After pressing the Power Button (4), the sealant (white fluid) will flow from the Sealant Bottle (1) through the Sealant Hose (6) and into the tire.

**NOTE:** Sealant may leak out through the puncture in the tire.

**If the sealant (white fluid) does not flow** within 0 – 10 seconds through the Sealant Hose (6):

- Press the Power Button (4) to turn Off the TIREFIT kit. Disconnect the Sealant Hose (6) from the valve stem. Make sure the valve stem is free of debris. Reconnect the Sealant Hose (6) to the valve stem. Check that the Mode Select Knob (5) is in the Sealant Mode position and not Air Mode. Press the Power Button (4) to turn On the TIREFIT kit.
- Connect the Power Plug (8) to a different 12 Volt power outlet in your vehicle or another vehicle, if available. Make sure the engine is running before turning ON the TIREFIT kit.
- The Sealant Bottle (1) may be empty due to previous use. Call for assistance.

**NOTE:** If the Mode Select Knob (5) is on Air Mode and the pump is operating, air will dispense from the Air Pump Hose (7) only, not the Sealant Hose (6).

- **If the sealant (white fluid) does flow** through the Sealant Hose (6):
- Continue to operate the pump until sealant is no longer flowing through hose (typically takes 30 - 70 seconds). As the sealant flows through the Sealant Hose (6), the Pressure Gauge (3) can read as high as 70 psi (5 Bar). The Pressure Gauge (3) will decrease quickly from approximately 70 psi (5 Bar) to the actual tire pressure when the Sealant Bottle (1) is empty.
- The pump will start to inject air into the tire immediately after the Sealant Bottle (1) is empty. Continue to operate the pump and inflate the tire to the pressure indicated on the tire pressure label on the driver-side latch pillar (recommended pressure). Check the tire pressure by looking at the Pressure Gauge (3).
- **If the tire does not inflate to at least 26 psi (1.8 Bar) pressure within 15 minutes:**
- The tire is too badly damaged. Do not attempt to drive the vehicle further. Call for assistance.

**NOTE:** If the tire becomes over-inflated, press the Deflation Button to reduce the tire pressure to the recommended inflation pressure before continuing.

- **If the tire inflates to the recommended pressure or is at least 26 psi (1.8 Bar) pressure within 15 minutes:**
- Press the Power Button (4) to turn off the TIREFIT kit.
- Remove the Speed Limit sticker from the top of the Sealant Bottle (1) and place the sticker on the instrument panel.

# WHAT TO DO IN EMERGENCIES

- Immediately disconnect the Sealant Hose (6) from the valve stem, reinstall the cap on the fitting at the end of the hose, and place the TIREFIT kit in the vehicle storage location. Quickly proceed to (D) “Drive Vehicle”.

## **(D) Drive Vehicle:**

- Immediately after injecting sealant and inflating the tire, drive the vehicle 5 miles (8 km) or 10 minutes to ensure distribution of the TIREFIT Sealant within the tire. Do not exceed 55 mph (88 km/h).

## **(E) After Driving:**

- Pull over to a safe location. Refer to “Whenever You Stop to Use TIREFIT” before continuing.
- Turn the Mode Select Knob (5) to the Air Mode position.
- Uncoil the power plug and insert the plug into the vehicle's 12 Volt power outlet.
- Uncoil the Air Pump Hose (7) (black in color) and screw the fitting at the end of hose (7) onto the valve stem.
- Check the pressure in the tire by reading the Pressure Gauge (3).
- **If tire pressure is less than 19 psi (1.3 Bar)**, the tire is too badly damaged. Do not attempt to drive the vehicle further. Call for assistance.
- **If the tire pressure is 19 psi (1.3 bar) or higher:**
  - Press the Power Button (4) to turn on TIREFIT and inflate the tire to the pressure indicated on the tire and loading information label on the driver-side door opening.

**NOTE:** If the tire becomes over-inflated, press the Deflation Button to reduce the tire pressure to the recommended inflation pressure before continuing.

- Disconnect the TIREFIT kit from the valve stem, reinstall the cap on the valve stem and unplug from 12 Volt outlet.
- Place the TIREFIT kit in its proper storage area in the vehicle.
- Have the tire inspected and repaired or replaced at the earliest opportunity at an authorized dealer or tire service center.
- Replace the Sealant Bottle (1) and Sealant Hose (6) assembly at your authorized dealer as soon as possible. Refer to “(F) Sealant Bottle and Hose Replacement.”

**NOTE:** When having the tire serviced, advise the authorized dealer or service center that the tire has been sealed using the TIREFIT service kit.

## **(F) Sealant Bottle And Hose Replacement:**

- Uncoil the Sealant Hose (6) (clear in color).
- Locate the round Sealant Bottle release button in the recessed area under the sealant bottle.
- Press the Sealant Bottle release button. The Sealant Bottle (1) will pop up. Remove the bottle and dispose of it accordingly.
- Clean any remaining sealant from the TIREFIT housing.

# WHAT TO DO IN EMERGENCIES

- Position the new Sealant Bottle (1) in the housing so that the Sealant Hose (6) aligns with the hose slot in the front of the housing. Press the bottle into the housing. An audible click will be heard indicating the bottle is locked into place.
- Verify that the cap is installed on the fitting at the end of the Sealant Hose (6) and return the hose to its storage area (located on the bottom of the air pump).
- Return the TIREFIT kit to its storage location in the vehicle.

## CAUTION!

- The metal end fitting from Power Plug (8) may get hot after use, so it should be handled carefully.
- Failure to reinstall the cap on the fitting at the end of the Sealant Hose (6) can result in sealant contacting your skin, clothing, and the vehicle's interior. It can also result in sealant contacting internal TIREFIT kit components which may cause permanent damage to the kit.

## WARNING!

- Do not attempt to seal a tire on the side of the vehicle closest to traffic. Pull far enough off the road to avoid the danger of being hit when using the TIREFIT kit.
- Do not use TIREFIT or drive the vehicle under the following circumstances:
  - If the puncture in the tire tread is approximately 1/4 in. (6 mm) or larger.
  - If the tire has any sidewall damage.
  - If the tire has any damage from driving with extremely low tire pressure.
  - If the tire has any damage from driving on a flat tire.
  - If the wheel has any damage.
  - If you are unsure of the condition of the tire or the wheel.
- Keep TIREFIT away from open flames or heat source.
- A loose TIREFIT kit thrown forward in a collision or hard stop could endanger the occupants of the vehicle. Always stow the TIREFIT kit in the place provided. Failure to follow these warnings can result in injuries that are serious or fatal to you, your passengers, and others around you.
- Take care not to allow the contents of TIREFIT to come in contact with hair, eyes, or clothing. TIREFIT is harmful if inhaled, swallowed, or absorbed through the skin. It causes skin, eye, and respiratory irritation. Flush immediately with plenty of water if there is any contact with eyes or skin. Change clothing as soon as possible, if there is any contact with clothing.
- TIREFIT Sealant solution contains latex. In case of an allergic reaction or rash, consult a physician immediately. Keep TIREFIT out of reach of children. If swallowed, rinse mouth immediately with plenty of water and drink plenty of water. Do not induce vomiting! Consult a physician immediately.

*(Continued)*



# WHAT TO DO IN EMERGENCIES

## WARNING! (Continued)

- TIREFIT is not a permanent flat tire repair. Have the tire inspected and repaired or replaced after using TIREFIT. Do not exceed 55 mph (88 km/h) until the tire is repaired or replaced. Failure to follow this warning can result in injuries that are serious or fatal to you, your passengers, and others around you.

## BATTERY LOCATION

- The battery is stored under an access cover in the trunk. Remote battery posts are located on the right side of the engine compartment for jump-starting.

## JUMP-STARTING

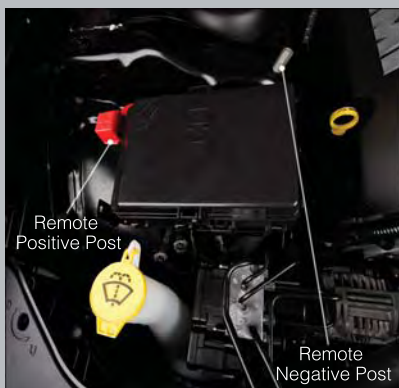

- If your vehicle has a discharged battery it can be jump-started using a set of jumper cables and a battery in another vehicle or by using a portable battery booster pack.
- Jump-starting can be dangerous if done improperly so please follow the procedures in this section carefully.

**NOTE:** When using a portable battery booster pack follow the manufacturer's operating instructions and precautions.

### Preparations for Jump-Start

- The battery is stored under an access cover in the trunk. Remote battery posts are located on the right side of the engine compartment for jump-starting.

**NOTE:** The remote battery posts are viewed by standing on the right side of the vehicle looking over the fender.

- Set the parking brake, shift the automatic transmission into PARK and turn the ignition to OFF.
- Turn off the heater, radio, and all unnecessary electrical accessories.
- If using another vehicle to jump-start the battery, park the vehicle within the jumper cables reach, set the parking brake and make sure the ignition is OFF.

### Jump-Starting Procedure

- Connect the positive (+) end of the jumper cable to the remote positive (+) post of the discharged vehicle.

# WHAT TO DO IN EMERGENCIES

- Connect the opposite end of the positive (+) jumper cable to the positive (+) post of the booster battery.
- Connect the negative end (-) of the jumper cable to the negative (-) post of the booster battery.
- Connect the opposite end of the negative (-) jumper cable to the remote negative (-) post of the vehicle with the discharged battery.
- Start the engine in the vehicle that has the booster battery, let the engine idle a few minutes, and then start the engine in the vehicle with the discharged battery. Once the engine is started, remove the jumper cables in the reverse sequence:
- Disconnect the negative (-) jumper cable from the remote negative (-) post of the vehicle with the discharged battery.
- Disconnect the negative end (-) of the jumper cable from the negative (-) post of the booster battery.
- Disconnect the opposite end of the positive (+) jumper cable from the positive (+) post of the booster battery.
- Disconnect the positive (+) end of the jumper cable from the remote positive (+) post of the discharged vehicle.
- If frequent jump-starting is required to start your vehicle you should have the battery and charging system inspected at your authorized dealer.

## CAUTION!

- Do not use a portable battery booster pack or any other booster source with a system voltage greater than 12 Volts or damage to the battery, starter motor, alternator or electrical system may occur.
- Failure to follow these procedures could result in damage to the charging system of the booster vehicle or the discharged vehicle.
- Accessories that can be plugged into the vehicle power outlets draw power from the vehicle's battery, even when not in use (i.e., cellular phones, etc.). Eventually, if plugged in long enough, the vehicle's battery will discharge sufficiently to degrade battery life and/or prevent the engine from starting.

## WARNING!

- When temperatures are below the freezing point, electrolyte in a discharged battery may freeze. Do not attempt jump-starting because the battery could rupture or explode and cause personal injury. Battery temperature must be brought above freezing point before attempting a jump-start.
- Take care to avoid the radiator cooling fan whenever the hood is raised. It can start anytime the ignition switch is on. You can be injured by moving fan blades.
- Remove any metal jewelry, such as watch bands or bracelets, that might make an inadvertent electrical contact. You could be severely injured.

*(Continued)*

# WHAT TO DO IN EMERGENCIES

## **WARNING!** *(Continued)*

- Batteries contain sulfuric acid that can burn your skin or eyes and generate hydrogen gas which is flammable and explosive. Keep open flames or sparks away from the battery.
- Do not allow vehicles to touch each other as this could establish a ground connection and personal injury could result.
- Failure to follow this procedure could result in personal injury or property damage due to battery explosion.
- Do not connect the cable to the negative post (-) of the discharged battery. The resulting electrical spark could cause the battery to explode and could result in personal injury.

## **SHIFT LEVER OVERRIDE**

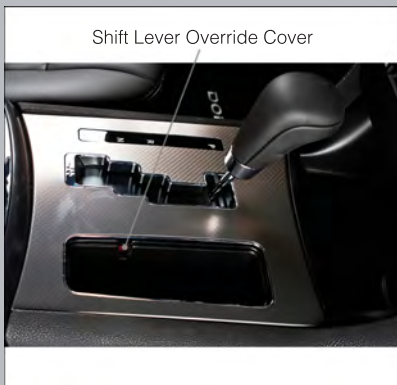

- If a malfunction occurs and the shift lever cannot be moved out of the PARK position, you can use the following procedure to temporarily move the shift lever:
  - Remove the storage bin liner to access the shift lever override port located to the right of the shift lever.
  - Firmly set the parking brake.
  - Turn the ignition switch to the ACC or ON position without starting the engine.
- Press and maintain firm pressure on the brake pedal.
- Using a screwdriver or similar tool, press and hold the override tab through the access port on the center console.
- Move the shift lever into the NEUTRAL position.
- The vehicle may then be started in NEUTRAL.
- Reinstall the override cover.

# WHAT TO DO IN EMERGENCIES

## MANUAL PARK RELEASE — 8 SPEED TRANSMISSION (3.6L Engine)

- If a malfunction occurs and the shift lever cannot be moved out of the PARK position, you can use the following procedure to temporarily move the shift lever:
- Remove the console storage bin to access the Manual Park Release lever.

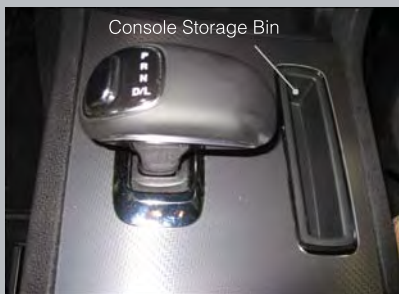

- Using a small screwdriver or similar tool, fish the tether strap up through the opening in the console base.
- Insert the screwdriver into the slot in the center of the lever, and disengage the spring steel lever locking tab by pushing it to the right.



- While holding the locking tab in the disengaged position, pull the tether strap to rotate the lever up and rearward, until it locks in place in the vertical position. The vehicle is now out of PARK and can be towed. Release the parking brake only when the vehicle is securely connected to a tow vehicle.



# WHAT TO DO IN EMERGENCIES

## To Reset The Manual Park Release:

- Push the latch (at the base of the lever, on the rear side) rearward (away from the lever) to unlatch the lever.
- Rotate the Manual Park Release lever forward and down, to its original position, until the locking tab snaps into place to secure the lever.
- Pull up gently on the tether strap to confirm that the lever is locked in its stowed position.
- Tuck the tether strap into the base of the console. Reinstall the console storage bin.

## **WARNING!**

Always secure your vehicle by fully applying the parking brake, before activating the Manual Park Release. Activating the Manual Park Release will allow your vehicle to roll away if it is not secured by the parking brake or by proper connection to a tow vehicle. Activating the Manual Park Release on an unsecured vehicle could lead to serious injury or death for those in or around the vehicle.

# WHAT TO DO IN EMERGENCIES

## TOWING A DISABLED VEHICLE

Model	Flat Towing (all four wheels on the ground)	Flatbed Towing (all four wheels suspended OFF the ground)	Front Wheels Raised, Rear Wheels on the Ground	Rear Wheels Raised, Front Wheels on the Ground
<b>RWD Without a Key</b>	NOT Permitted	Recommended Method	NOT Permitted	NOT Permitted
<b>RWD With a Key</b>	Shift lever must be in NEUTRAL. The distance to be traveled must not exceed 15 mi (24 km), and the towing speed must not exceed 30 mph (48 km/h).	Recommended Method	May Be Used	NOT Permitted
<b>AWD Without a Key</b>	NOT Permitted	Recommended Method	NOT Permitted	NOT Permitted
<b>AWD With a Key</b>	Shift lever must be in NEUTRAL and the driveshaft must be removed.	Recommended Method	NOT Permitted	NOT Permitted

# WHAT TO DO IN EMERGENCIES

## FREEDING A STUCK VEHICLE

- If your vehicle becomes stuck in mud, sand or snow, it can often be moved by a rocking motion. Turn your steering wheel right and left to clear the area around the front wheels. Then, move the shift lever back and forth between REVERSE and DRIVE. Using minimal accelerator pedal pressure to maintain the rocking motion, without spinning the wheels, is most effective.

**NOTE:** If your vehicle is equipped with Electronic Stability Control (ESC) or Traction Control , turn the system off before attempting to “rock” the vehicle.

### CAUTION!

- When “rocking” a stuck vehicle by moving between REVERSE and DRIVE, do not spin the wheels faster than 15 mph (24 km/h), or drivetrain damage may result.
- Revving the engine or spinning the wheels too fast may lead to transmission overheating and failure. It can also damage the tires. Do not spin the wheels above 30 mph (48 km/h) while in gear (no transmission shifting occurring).

### WARNING!

Fast spinning tires can be dangerous. Forces generated by excessive wheel speeds may cause tire damage or failure. A tire could explode and injure someone. Do not spin your vehicle's wheels faster than 30 mph (48 km/h) when you are stuck. Do not let anyone near a spinning wheel, no matter what the speed.



# WHAT TO DO IN EMERGENCIES

## EVENT DATA RECORDER (EDR)

- This vehicle is equipped with an event data recorder (EDR). The main purpose of an EDR is to record, in certain crash or near crash-like situations, such as an air bag deployment or hitting a road obstacle, data that will assist in understanding how a vehicle's systems performed. The EDR is designed to record data related to vehicle dynamics and safety systems for a short period of time, typically 30 seconds or less. The EDR in this vehicle is designed to record such data as:
  - How various systems in your vehicle were operating;
  - Whether or not the driver and passenger safety belts were buckled/fastened;
  - How far (if at all) the driver was depressing the accelerator and/or brake pedal; and,
  - How fast the vehicle was traveling.
- These data can help provide a better understanding of the circumstances in which crashes and injuries occur.

**NOTE:** EDR data are recorded by your vehicle only if a non-trivial crash situation occurs; no data are recorded by the EDR under normal driving conditions and no personal data (e.g. name, gender, age, and crash location) are recorded. However, other parties, such as law enforcement, could combine the EDR data with the type of personally identifying data routinely acquired during a crash investigation.

- To read data recorded by an EDR, special equipment is required, and access to the vehicle or the EDR is needed. In addition to the vehicle manufacturer, other parties such as law enforcement, that have the special equipment, can read the information if they have access to the vehicle or the EDR.

# MAINTAINING YOUR VEHICLE

## OPENING THE HOOD

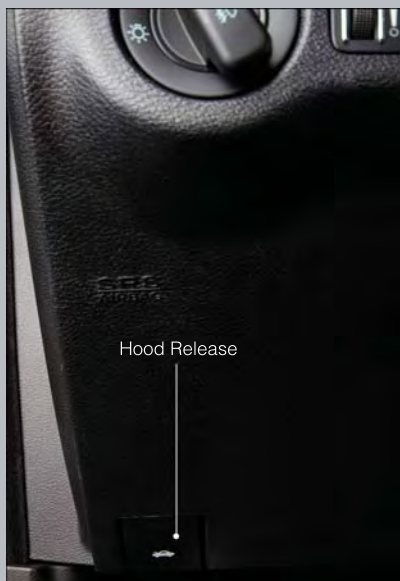

- Pull the hood release lever located on the instrument panel, below the headlight switch.
- Raise the hood and locate the safety catch lever, in the middle of the hood opening.
- Move the safety latch while lifting the hood at the same time.

### WARNING!

Be sure the hood is fully latched before driving your vehicle. If the hood is not fully latched, it could open when the vehicle is in motion and block your vision. Failure to follow this warning could result in serious injury or death.

## FUEL DOOR RELEASE

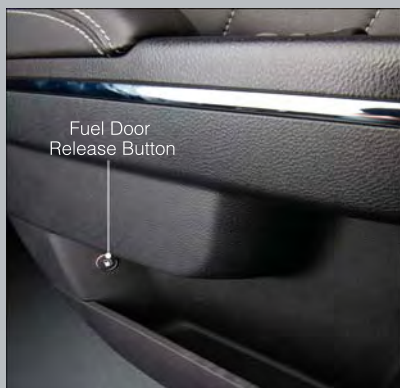

- The fuel door release button is located in the driver's door map pocket.
- Push the button once and release to open the fuel door.

# MAINTAINING YOUR VEHICLE

## Fuel Door Emergency Release

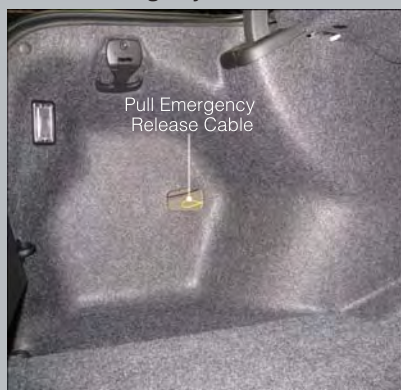

- To manually open the fuel door, remove the cover and pull the release cable located in the trunk.

## Emergency Refueling



- A funnel is provided (located in the trunk in the spare tire area) to open the flapper door to allow for emergency refueling with a gas can.

### CAUTION!

To avoid fuel spillage and overfilling, do not “top off” the fuel tank after filling.

# MAINTAINING YOUR VEHICLE

## **WARNING!**

- Never have any smoking materials lit in or near the vehicle when the fuel door is open or the tank is being filled.
- Never add fuel when the engine is running. This is in violation of most state and federal fire regulations and may cause the "Malfunction Indicator Light" to turn on.
- A fire may result if gasoline is pumped into a portable container that is inside of a vehicle. You could be burned. Always place gas containers on the ground while filling.

# MAINTAINING YOUR VEHICLE

## ENGINE COMPARTMENT

### 3.6L Engine

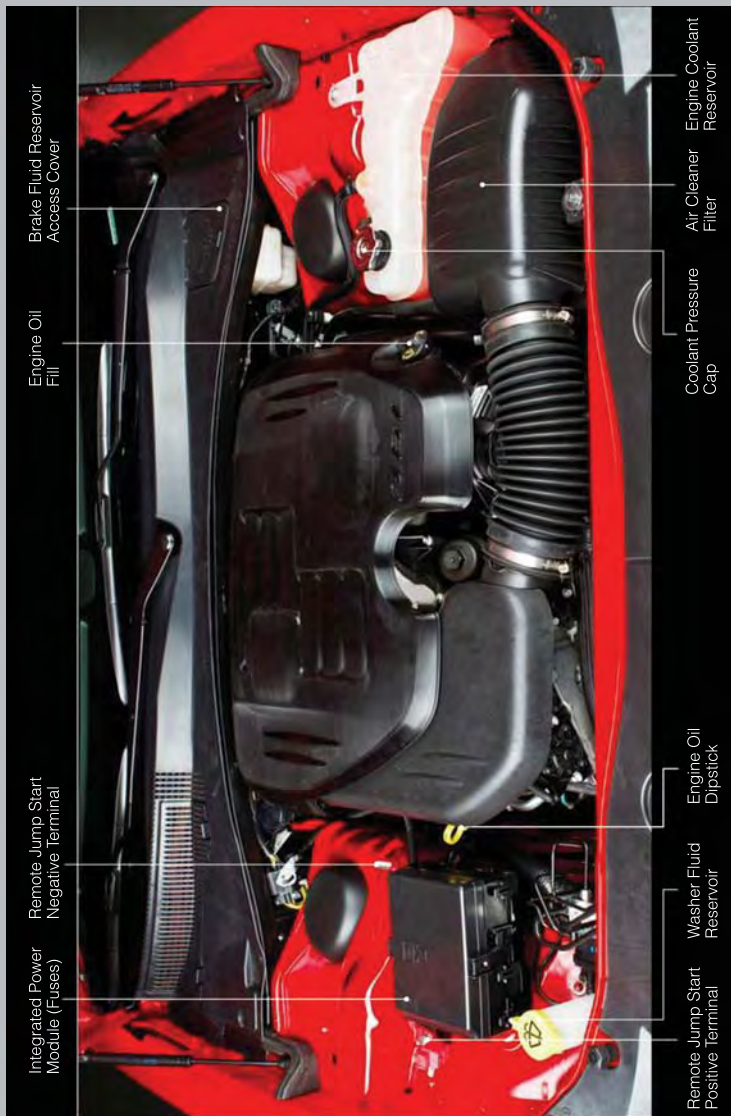

# MAINTAINING YOUR VEHICLE

## 5.7L Engine

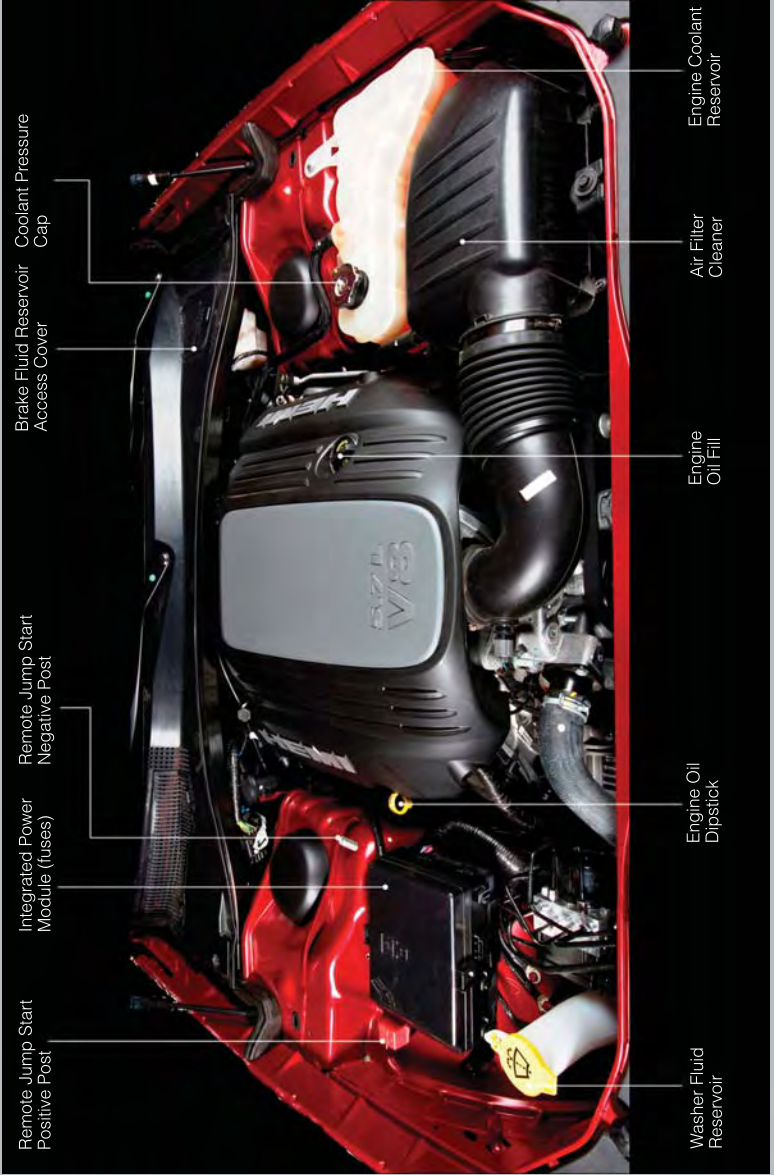



# MAINTAINING YOUR VEHICLE

## 6.4L Engine (392 HEMI)

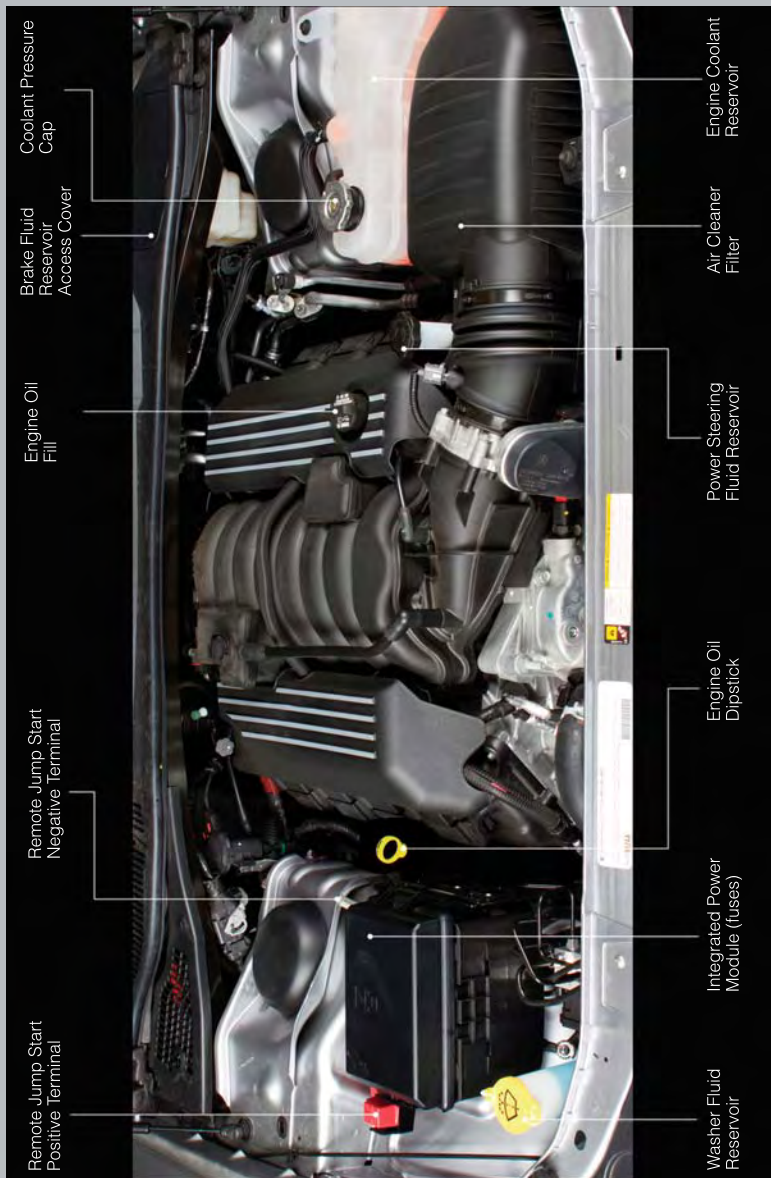



# MAINTAINING YOUR VEHICLE

## FLUIDS AND CAPACITIES

### Non SRT8

Component	Fluid, Lubricant, or Genuine Part	Capacities
Engine Coolant 3.6 Liter Engine	MOPAR® Antifreeze/Coolant 5 Year/100,000 Mile Formula HOAT (Hybrid Organic Additive Technology) or equivalent.	10 Quarts (9.5 Liters) Includes heater and coolant recovery bottle filled to MAX level.
5.7 Liter Engine without Severe Duty II Cooling System	MOPAR® Antifreeze/Coolant Five Year/100,000 Mile FormulaHOAT (Hybrid Organic Additive Technology) or equivalent.	14.7 Quarts (13.9 Liters) Includes heater and coolant recovery bottle filled to MAX level.
5.7 Liter Engine with Severe Duty II Cooling System	MOPAR® Antifreeze/Coolant Five Year/100,000 Mile FormulaHOAT (Hybrid Organic Additive Technology) or equivalent.	15.1 Quarts (14.3 Liters) Includes heater and coolant recovery bottle filled to MAX level.
Engine Oil with Filter 3.6L	API Certified SAE 5W-30 engine oil, meeting Chrysler Material Standard MS-6395. Refer to your engine oil filler cap for correct SAE grade.	6 Quarts (5.6 Liters)
Engine Oil with Filter 5.7L	API Certified SAE 5W-20 engine oil, meeting the requirements of Chrysler Material Standard MS-6395. Refer to the engine oil filler cap for correct SAE grade.	7 Quarts (6.6 Liters)
Engine Oil Filter 3.6L, 5.7L	MOPAR® Engine Oil Filter or equivalent.	—
Spark Plug 3.6L	RER8ZWYCB4 (Gap 0.043 in [1.1 mm])	—
Spark Plug 5.7L	LZFR5C-11 (Gap 0.043 in [1.1 mm])	—
Automatic Transmission – 3.6L Engine	Shell L12108 Transmission Fluid or equivalent.	—
Automatic Transmission – 5.7L Engine	MOPAR® ATF+4® Automatic Transmission Fluid or equivalent licensed ATF+4® product.	—

# MAINTAINING YOUR VEHICLE

Component	Fluid, Lubricant, or Genuine Part	Capacities
Transfer Case	MOPAR® BorgWarner 44–40 Transfer Case Lubricant or equivalent.	—
Axle Front	API GL-5 SAE 75W90 Synthetic Gear Lubricant or equivalent.	—
Axle Rear	API GL-5 SAE 75W140 Synthetic Gear Lubricant or equivalent.	—
Brake Master Cylinder	MOPAR® DOT 3 and SAE J1703 should be used or equivalent. If DOT 3 is not available, then DOT 4 is acceptable. Use only recommended brake fluids.	—
Power Steering Reservoir	MOPAR® Hydraulic Fluid or equivalent meeting MS-11655, such as Fuchs EG ZH 3044 or Pentosin CHF 11s.	—
Fuel Selection 3.6L	87 Octane	19.1 Gallons (72 Liters) (Approximate)
Fuel Selection 5.7L	87 Octane Acceptable. 89 Octane Recommended.	19.1 Gallons (72 Liters) (Approximate)

## E-85 Flexible Fuel – 3.6L Engine Only

### CAUTION!

Only vehicles with the E-85 fuel filler door label or a yellow gas cap can operate on E-85.

- Refer to your Owner's Manual on the DVD for further details.

# MAINTAINING YOUR VEHICLE

## SRT8

Component	Fluid, Lubricant, or Genuine Part	Capacities
Engine Coolant 6.4L	MOPAR® Antifreeze/Coolant Five Year/100,000 Mile FormulaHOAT (Hybrid Organic Additive Technology) or equivalent.	15.2 Quarts (14.4 Liters) Includes heater and coolant recovery bottle filled to MAX level.
Engine Oil With Filter 6.4L	For best performance and maximum protection under all types of operating conditions, the manufacturer only recommends full synthetic engine oils that meet the American Petroleum Institute (API) categories of SM or SM/CF. The manufacturer recommends the use of a full synthetic SAE OW-40 engine oil or equivalent.	7 Quarts (6.6 Liters)
Engine Oil Filter 6.4L	MOPAR® Engine Oil Filter or equivalent.	—
Spark Plugs 6.4L	LZTR6AP11EG (Gap 0.043 in [1.1 mm])	—
Automatic Transmission – 6.4L Engine	MOPAR® ATF+4® Automatic Transmission Fluid or equivalent licensed ATF+4® product.	—
Axle Rear (SRT8)	MOPAR® Synthetic Gear Lubricant SAE 75W-90 (API GL-5) or equivalent (with MOPAR® Friction Modifier – Hypoid Gear Additive).	—
Power Steering Reservoir (SRT8)	MOPAR® Power Steering Fluid + 4, MOPAR® ATF+4® Automatic Transmission Fluid or equivalent licensed ATF+4® product.	—
Fuel Selection 6.4L	Premium Unleaded 91 Octane Only or higher.	19.1 Gallons (72 Liters) (Approximate)

# MAINTAINING YOUR VEHICLE

## MAINTENANCE CHART

	8,000	16,000	24,000	32,000	40,000	48,000	56,000	64,000	72,000	80,000	88,000	96,000	104,000
	Or Months: 6	12	18	24	30	36	42	48	54	60	66	72	78
	13,000	26,000	39,000	52,000	65,000	78,000	91,000	104,000	117,000	130,000	143,000	156,000	169,000
Change the engine oil and engine oil filter.	X	X	X	X	X	X	X	X	X	X	X	X	X
Rotate the tires, rotate at the first sign of irregular wear, even if it occurs before scheduled maintenance.	X	X	X	X	X	X	X	X	X	X	X	X	X
If using your vehicle for any of the following: dusty or off-road conditions. Inspect the engine air cleaner filter; replace if necessary.						X				X			
Inspect the brake linings; replace if necessary.				X				X		X		X	
Inspect the CV joints.			X						X			X	
Inspect the exhaust system.		X	X			X			X			X	
Adjust the parking brake on vehicles equipped with four wheel disc brakes.		X											X
Change the automatic transmission fluid and filter if using your vehicle for any of the following: police, taxi, fleet or frequent trailer towing.													
Inspect the rear axle fluid. Inspect the front axle fluid – All Wheel Drive (AWD).			X						X				
Change the rear axle fluid and on models equipped with All Wheel Drive (AWD) change the front axle fluid if using your vehicle for any of the following: police, taxi, fleet, or frequent trailer towing.						X						X	
Inspect the transfer case fluid – All Wheel Drive (AWD).				X									X
Change the transfer case fluid if using your vehicle for any of the following: police, taxi, fleet, or frequent trailer towing – All Wheel Drive (AWD).								X					

# MAINTAINING YOUR VEHICLE

	8,000		16,000		24,000		32,000		40,000		48,000		56,000		64,000		72,000		80,000		88,000		96,000		104,000								
	Miles: Or Months: Or Kilometers:	6	12	18	24	30	36	42	48	54	60	66	72	78	84	90	96	102	108	114	120	126	132	138	144	150	156	162	168	174			
Inspect front suspension, tie rod ends, and boot seals, for cracks and all parts for damage, wear, improper looseness or end play; replace if necessary.		X		X			X		X			X		X		X		X		X		X		X		X		X		X			
Replace the engine air cleaner.					X																												
Replace the air conditioning filter.		X		X		X		X		X		X		X		X		X		X		X		X		X		X		X			
<b>Replace the spark plugs (5.7L engine)</b>					X																												
<b>Replace the spark plugs (3.6L engine)</b>					X																												
<b>Inspect and replace PCV valve.*</b>																																	
Flush and replace the engine coolant at 60 months or 104,000 miles (169,000 km) whichever comes first.																																	
Flush and replace the engine coolant at 104,000 miles (169,000 km) or 60 months whichever comes first.																																	

- \* This maintenance is recommended by the manufacturer to the owner, but is not required to maintain emissions warranty.
- Refer to the Owner's Manual on the DVD for complete maintenance schedule.

# MAINTAINING YOUR VEHICLE

## Maintenance Record

	Odometer	Date	Signature, Authorized Service Center
8,000 Miles (13,000 km) or 6 Months			
16,000 Miles (26,000 km) or 12 Months			
24,000 Miles (39,000 km) or 18 Months			
32,000 Miles (52,000 km) or 24 Months			
40,000 Miles (65,000 km) or 30 Months			
48,000 Miles (78,000 km) or 36 Months			
56,000 Miles (91,000 km) or 42 Months			
64,000 Miles (104,000 km) or 48 Months			
72,000 Miles (117,000 km) or 54 Months			
80,000 Miles (130,000 km) or 60 Months			
88,000 Miles (143,000 km) or 66 Months			
96,000 Miles (156,000 km) or 72 Months			
104,000 Miles (169,000 km) or 78 Months			

# MAINTAINING YOUR VEHICLE

## SRT8 — MAINTENANCE CHART

	Miles:		6,000	12,000	18,000	24,000	30,000	36,000	42,000	48,000	54,000	60,000	66,000	72,000	78,000
	Or Months:		6	12	18	24	30	36	42	48	54	60	66	72	78
	Or Kilometers:		10,000	20,000	30,000	40,000	50,000	60,000	70,000	80,000	90,000	100,000	110,000	120,000	130,000
Change the engine oil and engine oil filter.	X	X	X	X	X	X	X	X	X	X	X	X	X	X	X
Rotate the tires, rotate at the first sign of irregular wear, even if it occurs before scheduled maintenance.	X	X	X	X	X	X	X	X	X	X	X	X	X	X	X
If using your vehicle for any of the following: dusty or off-road conditions. Inspect the engine air cleaner filter; replace if necessary.	X	X	X	X	X	X	X	X	X	X	X	X	X	X	X
Inspect the brake linings; replace if necessary.	X	X	X	X	X	X	X	X	X	X	X	X	X	X	X
Inspect the CV joints.	X	X	X	X	X	X	X	X	X	X	X	X	X	X	X
Inspect the exhaust system.	X	X	X	X	X	X	X	X	X	X	X	X	X	X	X
Adjust the parking brake on vehicles equipped with four wheel disc brakes.				X								X			
Change the automatic transmission fluid and filter if using your vehicle for any of the following: police, taxi, fleet or frequent trailer towing.												X			
Change the rear axle fluid if using your vehicle for any of the following: police, taxi, fleet or frequent trailer towing.										X					
Inspect the rear axle fluid.					X			X			X			X	
Inspect front suspension, tie rod ends, and boot seals, for cracks or leaks and all parts for damage, wear, improper looseness or end play; replace if necessary.		X				X		X		X		X		X	
Replace the engine air cleaner.							X						X		
Replace the air conditioning filter.		X			X		X			X		X		X	
Flush and replace the engine coolant at 60 months if not done at 102,000 miles (170,000 km).												X			

- \* This maintenance is recommended by the manufacturer to the owner, but is not required to maintain emissions warranty.
- Refer to the Owner's Manual on the DVD for complete maintenance schedule.



# MAINTAINING YOUR VEHICLE

## SRT8 – Maintenance Record

	Odometer	Date	Signature, Authorized Service Center
6,000 Miles (10,000 km) or 6 Months			
12,000 Miles (20,000 km) or 12 Months			
18,000 Miles (30,000 km) or 18 Months			
24,000 Miles (40,000 km) or 24 Months			
30,000 Miles (50,000 km) or 30 Months			
36,000 Miles (60,000 km) or 36 Months			
42,000 Miles (70,000 km) or 42 Months			
48,000 Miles (80,000 km) or 48 Months			
54,000 Miles (90,000 km) or 54 Months			
60,000 Miles (100,000 km) or 60 Months			
66,000 Miles (110,000 km) or 66 Months			
72,000 Miles (120,000 km) or 72 Months			
78,000 Miles (130,000 km) or 78 Months			

# MAINTAINING YOUR VEHICLE

## FUSES

### Integrated Power Module

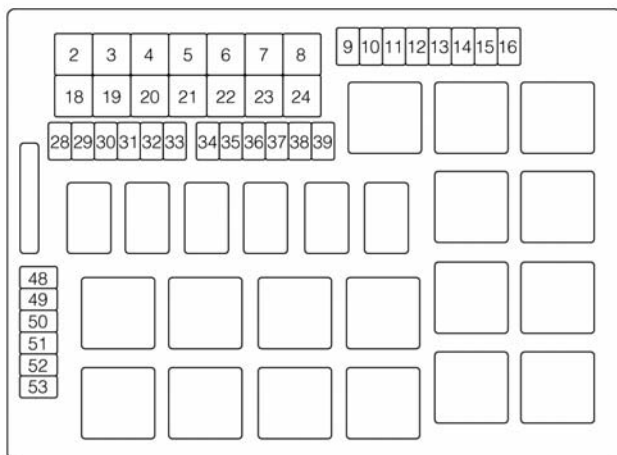

- The Integrated Power Module (fuses) is located in the engine compartment on the right hand side near the Washer Fluid Reservoir. This module contains fuses and relays.

Cavity	Cartridge Fuse	Mini-Fuse	Description
2	40 Amp Green	—	Radiator Fan #1
3	50 Amp Red	—	Power Steering #1
4	30 Amp Pink	—	Starter
5	40 Amp Green	—	Anti-Lock Brakes
9	—	20 Amp Yellow	All-Wheel Drive Module – If Equipped
10	—	10 Amp Red	Security
11	—	20 Amp Yellow	Horns
12	—	10 Amp Red	Air Conditioning Clutch
14	—	25 Amp Neutral	Anti-Lock Brakes
15	—	25 Amp Neutral	Transmission
18	50 Amp Red	—	Radiator Fan #2
19	50 Amp Red	—	Power Steering #2

# MAINTAINING YOUR VEHICLE

<b>Cavity</b>	<b>Cartridge Fuse</b>	<b>Mini-Fuse</b>	<b>Description</b>
20	30 Amp Pink	—	Wiper Motor
21	30 Amp Pink	—	Headlamp Washers
28	—	25 Amp Neutral	Fuel Pump
29	—	15 Amp Blue	Transmission Shifter
31	—	25 Amp Neutral	Engine Module
34	—	25 Amp Neutral	Powertrain #1
35	—	20 Amp Yellow	Powertrain #2
36	—	10 Amp Red	Anti-Lock Brake Module
37	—	10 Amp Red	Engine Controller/Rad Fan Relays
38	—	10 Amp Red	Airbag Module
39	—	10 Amp Red	Power Steering Module/AC Clutch Relay
48	—	10 Amp Red	AWD Module/Front Axle Disconnect
51	—	20 Amp Yellow	Vacuum Pump

# MAINTAINING YOUR VEHICLE

## Fuses – Rear Power Distribution Center

- There is also a power distribution center located in the trunk under the spare tire access panel. This center contains fuses and relays.

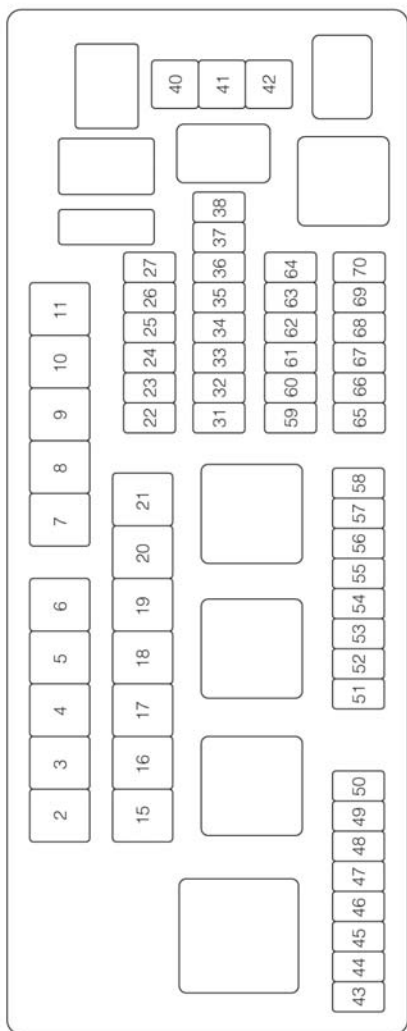

# MAINTAINING YOUR VEHICLE

Cavity	Cartridge Fuse	Mini-Fuse	Description
2	60 Amp Yellow	—	Front PDC Feed #1
4	60 Amp Yellow	—	Front PDC Feed #2
5	30 Amp Pink	—	Sunroof
6	40 Amp Green	—	Exterior Lighting #1
7	40 Amp Green	—	Exterior Lighting #2
8	30 Amp Pink	—	Interior Lighting/Washer Pump
9	30 Amp Pink	—	Power Locks
10	30 Amp Pink	—	Driver Door
11	30 Amp Pink	—	Passenger Door
12	—	20 Amp Yellow	Cigar Lighters (Selectable)
15	40 Amp Green	—	HVAC Blower
23	—	10 Amp Red	Fuel Door/Diagnostic Port
24	—	15 Amp Blue	Radio Screen
25	—	10 Amp Red	Tire Pressure Monitor
27	—	25 Amp Neutral	Amplifier
31	—	25 Amp Neutral	Power Seats
32	—	15 Amp Blue	HVAC Module/Cluster
33	—	15 Amp Blue	Ignition Switch/Wireless Module
34	—	10 Amp Red	Steering Column Module/Clock
35	—	10 Amp Red	Battery Sensor
37	—	15 Amp Blue	Radio
38	—	20 Amp Yellow	Power Outlet
42	30 Amp Pink	—	Rear Defrost
43	—	25 Amp Neutral	Rear Heated Seats/Steering Wheel
44	—	10 Amp Red	Park Assist/Blind Spot/Camera
45	—	15 Amp Blue	Cluster/Rearview Mirror/Compass
46	—	10 Amp Red	Adaptive Cruise Control
47	—	10 Amp Red	Adaptive Front Lighting
48	—	20 Amp Yellow	Active Suspension
51	—	20 Amp Yellow	Front Heated Seats
52	—	10 Amp Red	Heated Cupholders/Rear Heated Seat Switches

# MAINTAINING YOUR VEHICLE

Cavity	Cartridge Fuse	Mini-Fuse	Description
53	—	10 Amp Red	HVAC Module/In Car Temperature Sensor
58	—	10 Amp Red	Airbag Module
64	—	25 Amp Neutral	Rear Windows
65	—	10 Amp Red	Airbag Module
67	—	15 Amp Blue	Run Sense
68	—	15 Amp Blue	Power Outlet Illumination/Rear Sunshade

## TIRE PRESSURES

- Check the inflation pressure of each tire, including the spare tire, at least monthly and inflate to the recommended pressure for your vehicle.
- The tire pressures recommended for your vehicle are found on the “Tire and Loading Information” label located on the driver’s side door opening.

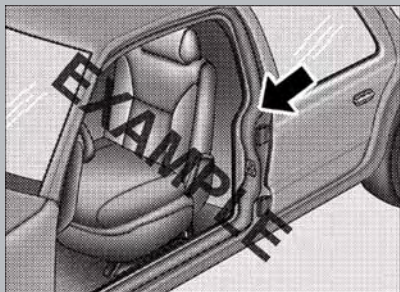

**NOTE:** Refer to the Owner's Manual on the DVD for more information regarding tire warnings and instructions.

### WARNING!

- Overloading of your tires is dangerous. Overloading can cause tire failure, affect vehicle handling, and increase your stopping distance. Use tires of the recommended load capacity for your vehicle. Never overload them.
- Improperly inflated tires are dangerous and can cause collisions. Under-inflation is the leading cause of tire failure and may result in severe cracking, component separation, or “blow out”. Over-inflation reduces a tire’s ability to cushion shock. Objects on the road and chuck holes can cause damage that results in tire failure. Unequal tire pressures can cause steering problems. You could lose control of your vehicle. Over-inflated or under-inflated tires can affect vehicle handling and can fail suddenly, resulting in loss of vehicle control.

# MAINTAINING YOUR VEHICLE

## WHEEL AND WHEEL TRIM CARE

- All wheels and wheel trim, especially aluminum and chrome plated wheels, should be cleaned regularly with a mild soap and water to prevent corrosion.
- To remove heavy soil and/or excessive brake dust, use MOPAR® Wheel Cleaner or equivalent or select a non-abrasive, non-acidic cleaner.

### CAUTION!

Do not use scouring pads, steel wool, a bristle brush, or metal polishes. Do not use oven cleaner. These products may damage the wheel's protective finish. Avoid automatic car washes that use acidic solutions or harsh brushes that may damage the wheel's protective finish. Only MOPAR® Wheel Cleaner or equivalent is recommended.

## EXTERIOR BULBS

LIGHT BULBS – Exterior	Bulb Number
Backup Lamp	3157
Tail, Stop, Turn Lamp	LED – Service at Authorized Dealer
Center High-Mounted Stop Lamp (CHMSL)	LED (*)
Fog Lamp – If Equipped	PSX24W
Front Park/Turn Signal	3157A
Front/Rear Side Marker	168
Headlamp – High Intensity Discharge (HID)	Service at Authorized Dealer (**)
Headlamp – Low Beam	H11
Headlamp – High Beam	9005
License Lamp	168

\* CHMSL is not serviceable. It is a LED lamp. To replace the LED, the entire CHMSL assembly must be replaced.

\*\* The headlamps are a type of high-voltage discharge tube. High voltage can remain in the circuit even with the headlamp switch off and the key removed. Because of this, you should not attempt to service a headlamp bulb yourself. If a headlamp bulb fails, take your vehicle to an authorized dealer for service.



# CONSUMER ASSISTANCE

## CHRYSLER GROUP LLC CUSTOMER CENTER

P.O. Box 21-8004

Auburn Hills, MI 48321-8004

Phone: 1-800-423-6343

## CHRYSLER CANADA INC. CUSTOMER CENTER

P.O. Box 1621

Windsor, Ontario N9A 4H6

Phone: 1-800-465-2001 (English)

Phone: 1-800-387-9983 (French)

## ASSISTANCE FOR THE HEARING IMPAIRED

- To assist customers who have hearing difficulties, the manufacturer has installed special TDD (Telecommunication Devices for the Deaf) equipment at its customer center. Any hearing or speech impaired customer, who has access to a TDD or a conventional teletypewriter (TTY) in the United States, can communicate with the manufacturer by dialing 1-800-380-CHRY. Canadian residents with hearing difficulties that require assistance can use the special needs relay service offered by Bell Canada. For TTY teletypewriter users, dial 711 and for Voice callers, dial 1-800-855-0511 to connect with a Bell Relay Service operator.

### WARNING!

Engine exhaust, some of its constituents, and certain vehicle components contain, or emit, chemicals known to the State of California to cause cancer and birth defects, or other reproductive harm. In addition, certain fluids contained in vehicles and certain products of component wear contain, or emit, chemicals known to the State of California to cause cancer and birth defects, or other reproductive harm.

## PUBLICATIONS ORDERING

- **If you are the first registered retail owner of your vehicle**, you may obtain one free printed copy of the Owner's Manual, Warranty Booklet or Radio Manuals on your DVD by calling 1-800-423-6343 (U.S.) or 1-800-387-1143 (Canada) or by contacting your dealer.
- Replacement User Guide kits or DVDs or, if you prefer, additional printed copies of the Owner's Manual, Warranty Booklet or Radio Manuals may be purchased by visiting [www.techauthority.com](http://www.techauthority.com) or by calling 1-800-890-4038 (U.S.) or 1-800-387-1143 (Canada). Visa, Master Card, American Express and Discover orders are accepted. If you prefer mailing your order, please call the above numbers for an order form.

**NOTE:** A street address is required when ordering manuals (no P.O. Boxes).

# CONSUMER ASSISTANCE

## NOTE:

- The Owner's Manual and User Guide electronic files are also available on the Chrysler, Jeep, Ram Truck and Dodge websites.
- Click on the "For Owners" tab, select "Owner/Service Manuals", then select your desired model year and vehicle from the drop down lists.

## REPORTING SAFETY DEFECTS IN THE 50 UNITED STATES AND WASHINGTON, D.C.

- If you believe that your vehicle has a defect that could cause a collision or cause injury or death, you should immediately inform the National Highway Traffic Safety Administration (NHTSA) in addition to notifying the manufacturer.
- If NHTSA receives similar complaints, it may open an investigation, and if it finds that a safety defect exists in a group of vehicles, it may order a recall and remedy campaign. However, NHTSA cannot become involved in individual problems between you, your authorized dealer, and the manufacturer.
- To contact NHTSA, you may either call the Auto Safety Hotline toll free at 1-888-327-4236 (TTY: 1-800-424-9153), or go to <http://www.safercar.gov>; or write to: Administrator, NHTSA, 1200 New Jersey Avenue, SE., West Building, Washington, D.C. 20590. You can also obtain other information about motor vehicle safety from <http://www.safercar.gov>.

## In Canada

- If you believe that your vehicle has a safety defect, you should contact the Customer Service Department immediately. Canadian customers who wish to report a safety defect to the Canadian government should contact Transport Canada, Motor Vehicle Defect Investigations and Recalls at 1-800-333-0510 or go to <http://www.tc.gc.ca/roadsafety/>
- French Canadian customers who wish to report a safety defect to the Canadian government should contact Transport Canada, Motor Vehicle Defect Investigations and Recalls at 1-800-333-0510 or go to <http://www.tc.gc.ca/securiteroutiere/>

# MOPAR ACCESSORIES

## AUTHENTIC ACCESSORIES BY MOPAR®

- The following highlights just some of the many Authentic Dodge Accessories by Mopar featuring a fit, finish, and functionality specifically for your Dodge Charger.
- In choosing Authentic Accessories you gain far more than expressive style, premium protection, or extreme entertainment, you also benefit from enhancing your vehicle with accessories that have been thoroughly tested and factory-approved.
- For the full line of Authentic Dodge Accessories by Mopar, visit your local Dodge dealership or online at [mopar.com](http://mopar.com).

### EXTERIOR:

- Rear Spoiler
- Molded Splash Guards
- Custom Wheels
- Chrome Grill Insert
- Lower Front Fascia Air Dam
- Graphics Packages
- Fog Lights
- Front End Cover

### INTERIOR:

- Premium Carpet Floor Mats
- Door Sill Guards
- Instrument Panel Bezel Kits
- Katzkin Leather Seats
- Premium Carpet Cargo Mat
- Bright Pedal Kit
- T-Handle Shifter

### CARRIERS:

- Cargo Carriers
- Water Sports Carriers
- Sport Utility Bars
- Bike Carriers

### ELECTRONICS:

- Portable Navigation Systems
- iPod® Adapter
- Kicker® Sound System
- Ecometer
- Uconnect™ Web (WiFi)
- Radio Upgrades
- Uconnect™ Phone
- Remote Start
- DVD Rear Seat Video™
- Electronic Vehicle Tracking System

- iPod® is a registered trademark of Apple, Inc.
- Kicker® is a registered trademark of Stillwater Designs and Audio, Inc.

# INDEX

- Adaptive Cruise Control (ACC) (Cruise Control) . . . . . 25
- Adjustable Pedals . . . . . 20
- Airbag . . . . . 13
- Alarm, Panic . . . . . 8
- Arming Theft System (Security Alarm) . . . . . 11
- Audio Settings . . . . . 39,41
- Automatic Headlights . . . . . 24
- Automatic Temperature Control (ATC) . . . . . 31
- Automatic Transmission
  - Autostick . . . . . 69
  - Fluid Type . . . . . 103
- Autostick . . . . . 69
- Axle Fluid . . . . . 103
  
- Belts, Seat . . . . . 12
- Brake Fluid . . . . . 103
- Break-In Recommendations, New Vehicle . . . . . 22
- Bulb Replacement . . . . . 116
  
- Calibration, Compass . . . . . 61
- Change Oil Indicator . . . . . 77
- Changing A Flat Tire . . . . . 78
- Child Restraint . . . . . 14
- Child Restraint Tether Anchors . . . . 14
- Clock Setting . . . . . 39,41
- Compass Calibration . . . . . 61
- Cooling System
  - Coolant Capacity . . . . . 103
- Cruise Control (Speed Control) . . . . 25
- Cruise Light . . . . . 25
- Cupholders
  - Heated/Cooled (Beverage Holder) . . . . . 19
- Customer Assistance . . . . . 117
- Customer Programmable Features . . . . . 62,72
  
- Defects, Reporting . . . . . 118
- Dimmer Control . . . . . 24
- Dimmer Switch, Headlight . . . . . 24
- Disarming, Theft System . . . . . 12
  
- E-85 Fuel . . . . . 104
- ECO . . . . . 61
- Electronic Speed Control (Cruise Control) . . . . . 25
- Electronic Vehicle Information Center (EVIC) . . . . . 61,62,71
- Electronics
  - Your Vehicle's Sound System . . . . 36
- Emergency Key . . . . . 8
- Emergency, In Case of
  - Jacking . . . . . 78
  - Overheating . . . . . 78
- Engine
  - Break-In Recommendations . . . . 22
  - Compartment . . . . . 100
  - Oil Selection . . . . . 103
  - Overheating . . . . . 78
  - Starting . . . . . 10
  - Stopping . . . . . 10
- Event Data Recorder . . . . . 96
- Exterior Lights . . . . . 116
  
- Flat Tire Changing . . . . . 78
- Flexible Fuel Vehicles . . . . . 104
- Fluid Capacities . . . . . 103
- Fluids . . . . . 103
- Fog Lights . . . . . 24
- Folding Rear Seat . . . . . 18
- Forward Collision Warning . . . . . 26
- Freeing A Stuck Vehicle . . . . . 95
- Front Heated Seats . . . . . 18
- Fuel
  - Filler Door (Gas Cap) . . . . . 97
  - Filler Door Emergency Release . . . 98
  - Specifications . . . . . 103
- Garage Door Opener (HomeLink®) . . . . 63
  
- Headlights
  - Automatic . . . . . 24
  - Dimmer Switch . . . . . 24
  - High Beam . . . . . 23
- Heated Mirrors . . . . . 33
- Heated Seats . . . . . 18
- High Beam/Low Beam Select (Dimmer) Switch . . . . . 23

HomeLink® (Garage Door Opener) Transmitter . . . . .	63	Outlet Power . . . . .	65
Hood Release . . . . .	97	Overheating, Engine . . . . .	78
Instrument Cluster . . . . .	6	Panic Alarm . . . . .	8
Indicators . . . . .	7	Pedals, Adjustable . . . . .	20
Instrument Cluster Warning Lights . . . . .	6,74	Phone (Uconnect) . . . . .	53
Intermittent Wipers (Delay Wipers) . . . . .	23	Placard, Tire and Loading Information . . . . .	115
Introduction . . . . .	2	Power	
iPod®/USB/MP3 Control . . . . .	52	Glass Sunroof . . . . .	34
Bluetooth Streaming Audio . . . . .	53	Outlet (Auxiliary Electrical Outlet) . . . . .	65
Jack Location . . . . .	78	Seats . . . . .	16
Jack Operation . . . . .	81	Steering . . . . .	103
Jacking Instructions . . . . .	81	Tilt/Telescoping Steering Column . . . . .	21
Jump Starting . . . . .	89	Preparation for Jacking . . . . .	80
Key Fob . . . . .	8	Programmable Electronic Features . . . . .	62,71
Keyless Enter-N-Go . . . . .	9	Radio Operation . . . . .	42
Lock/Unlock . . . . .	9	Rain Sensitive Wiper System . . . . .	23
Starting/Stopping . . . . .	10	Rear Heated Seats . . . . .	19
Lane Change Assist . . . . .	23	Rear Seat, Folding . . . . .	18
LATCH (Lower Anchors and Tether for Children) . . . . .	14	Recreational Towing . . . . .	68
Lights		Remote Starting System . . . . .	8
Turn Signal . . . . .	23	Replacement Bulbs . . . . .	116
Warning (Instrument Cluster Description) . . . . .	6	Reporting Safety Defects . . . . .	118
Maintenance Record . . . . .	108,110	Restraints, Child . . . . .	14
Maintenance Schedule . . . . .	106,109	Seat Belts . . . . .	12
Memory Seat . . . . .	16	Seats . . . . .	16
Mirrors		Adjustment . . . . .	17
Heated . . . . .	33	Heated . . . . .	18
MOPAR® Accessories . . . . .	119	Lumbar Support . . . . .	16
Navigation . . . . .	47	Memory . . . . .	16
Navigation Voice Commands . . . . .	59	Power . . . . .	16
New Vehicle Break-In Period . . . . .	22	Rear Folding . . . . .	18
Oil Change Indicator . . . . .	77	Setting the Clock . . . . .	39,41
Oil, Engine		Shift Lever Override . . . . .	91
Capacity . . . . .	103	Short Message Service (SMS) . . . . .	58
		Signals, Turn . . . . .	23
		SIRIUS Travel Link . . . . .	51
		SmartBeams . . . . .	24
		Spare Tire . . . . .	78
		Spark Plugs . . . . .	103

# INDEX

Speed Control (Cruise Control) . . . . .	25	24-Hour Towing Assistance . . . . .	74
Starting		Disabled Vehicle . . . . .	94
Remote . . . . .	8	Recreational . . . . .	68
Steering		Towing Vehicle Behind a	
Tilt Column . . . . .	20	Motorhome . . . . .	68
Store Radio Presets . . . . .	43	Trailer Towing	
Sun Roof . . . . .	34	Trailer and Tongue Weight . . . . .	67
Supplemental Restraint System -		Trailer Weight . . . . .	67
Airbag . . . . .	13	Transmission	
Temperature Gauge, Engine		Fluid . . . . .	103
Coolant . . . . .	78	Turn Signals . . . . .	23
Text Messaging . . . . .	58	Uconnect™ Phone . . . . .	53
Theft Alarm (Security Alarm) . . . . .	11	Uconnect™ Voice Command . . . . .	58
Theft System Arming . . . . .	11	USB Port . . . . .	52
Theft System Disarming . . . . .	12	Voice Commands . . . . .	58
Tilt Steering Column . . . . .	20	Navigation . . . . .	59
TIREFIT . . . . .	84	Washers, Windshield . . . . .	23
Tires		Wheel and Wheel Trim Care . . . . .	116
Air Pressure . . . . .	115	Wind Buffeting . . . . .	35
Changing . . . . .	78,81	Windshield Washers . . . . .	23
Flat Changing . . . . .	78	Windshield Wipers . . . . .	23
Jacking . . . . .	80,81		
Pressure Warning Light . . . . .	74		
Spare Tire . . . . .	78		
Towing . . . . .	67		

## FREQUENTLY ASKED QUESTIONS

### GETTING STARTED

- How do I install my LATCH Equipped Child Seat? pg. 14
- How do I program my Front Seat Memory? pg. 16

### ELECTRONICS

- How do I know which radio I have? pg. 38
- How do I select the AUX music source? pg. 52
- How do I set the clock on my radio? pg. 41
- How do I use the Navigation feature? pg. 47
- How do I pair my cell phone via Bluetooth® with the UConnect™ Hands-Free Voice Activation System? pg. 53
- How do I hear the audio from my iPod® through the USB port using the radio? pg. 52
- How do I configure my Universal Garage Door Opener (HomeLink)? pg. 63

### UTILITY

- How do I know how much I can tow with my Dodge Charger? pg. 67

### WHAT TO DO IN EMERGENCIES

- What do I do if my TPMS warning light is blinking? pg. 74
- How do I change a flat tire? pg. 78
- How do I Jump-Start my vehicle? pg. 89

### MAINTAINING YOUR VEHICLE

- Where is my Fuse Block located? pg. 111
- What type of oil do I use? pg. 103
- How often should I change my engine's oil? pg. 106
- What should my tire pressure be set at? pg. 115









# NOTES

---

---

---

---

---

---

---

---

---

---

---

---

---

---

---

---

---

---

---

---

---

---

---

---



## **DODGE.COM**

This guide has been prepared to help you get quickly acquainted with your new Dodge and to provide a convenient reference source for common questions. However, it is not a substitute for your Owner's Manual.

For complete operational instructions, maintenance procedures and important safety messages, please consult your Owner's Manual, Navigation/Media Center Manuals, Multimedia User Manual and other Warning Labels in your vehicle.

Not all features shown in this guide may apply to your vehicle. For additional information on accessories to help personalize your vehicle, visit [www.mopar.com](http://www.mopar.com) or your local Dodge dealer.

## **DRIVING AND ALCOHOL**

Drunken driving is one of the most frequent causes of accidents. Your driving ability can be seriously impaired with blood alcohol levels far below the legal minimum. If you are drinking, don't drive. Ride with a designated non-drinking driver, call a cab, a friend, or use public transportation.

## **WARNING!**

Driving after drinking can lead to an accident. Your perceptions are less sharp, your reflexes are slower, and your judgment is impaired when you have been drinking. Never drink and then drive.



12D481-926-AA  
Charger

Third Edition  
User Guide

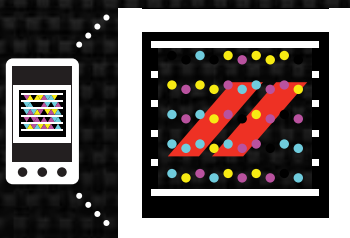

U.S. Only

**Download a free *Vehicle Information App*** by visiting your application store, Keyword (Dodge), or scanning the Microsoft Tag. To put Microsoft Tags to work for you, use your mobile phone's browser or App store to download a Microsoft Tag reader, like the free one at [www.gettag.mobi](http://www.gettag.mobi). Then follow the directions to scan the code.

**Download a *FREE electronic copy***  
of the Owner's Manual or Warranty Booklet  
by visiting the ***For Owner's tab*** at:

**[www.dodge.com](http://www.dodge.com)** (U.S.)  
**[www.dodge.ca](http://www.dodge.ca)** (Canada)

